

Lattice Path Enumeration

Christian Krattenthaler

FAKULTÄT FÜR MATHEMATIK, UNIVERSITÄT WIEN, OSKAR-MORGEN-
STERN-PLATZ 1, A-1090 VIENNA, AUSTRIA.

WWW: <http://www.mat.univie.ac.at/~kratt>.

CHAPTER 10

Lattice Path Enumeration

10.1. Introduction

A *lattice path* (*path* for short) is what the name says: a path (walk) in a lattice in some d -dimensional Euclidean space. Formally, a lattice path P is a sequence $P = (P_0, P_1, \dots, P_l)$ of points P_i in \mathbb{Z}^d . Figure 1 shows the lattice path $((0, 0), (1, 1), (2, 1), (3, 1), (3, 2), (4, 3))$. The point P_0 is called the *starting point* and P_l is called the *end point* of P . The vectors $\overrightarrow{P_0P_1}, \overrightarrow{P_1P_2}, \dots, \overrightarrow{P_{l-1}P_l}$ are called the *steps* of P .

Lattice paths have been studied for a very long time, explicitly at least since the second half of the 19th century. At the beginning stand the investigations concerning the two-candidate ballot problem [8, 123] (see the paragraph below Corollary 10.3.2 in Section 10.3) and the gambler's ruin problem [65] (see [38, Ch. XIV, Sec. 2] and Example 10.11.3 in Section 10.11). Since then, lattice paths have penetrated many fields of mathematics, computer science, and physics. The reason for their ubiquity is, on the one hand, that they are well-suited to encode various (combinatorial) objects and their properties, and, thus, problems in various fields can be solved by solving lattice path problems. On the other hand, since lattice paths are — at the outset — reasonably simple combinatorial objects, the study of physical, probabilistic, or statistical models is attractive in its own right. In particular, the importance of lattice path enumeration in non-parametric statistics seems to explain that the only books which are entirely devoted to lattice path combinatorics that I am aware of, namely [95] and [97], are written by statisticians.

The aim of this chapter is to provide an overview of results and methods in lattice path enumeration. Since, in view of the vast literature on the subject, comprehensiveness is hopeless, I have made a personal selection of topics that I consider of importance in the theory, the same applying to the methods which I present here.

Clearly, when one talks of “enumeration,” this comes in two different “flavours”: exact and asymptotic. In this chapter, I only rarely touch asymptotics, but rather

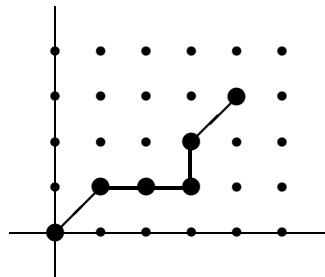

FIGURE 1.

concentrate on exact enumeration results. In most cases, corresponding asymptotic results are easily derivable from the exact formulas by using standard methods from asymptotic analysis. See [43] for *the* standard text on asymptotic methods in combinatorial enumeration.

In many cases, I omit proofs. The proofs which are given are either reasonably short, or they serve to illustrate a key method or idea in lattice path enumeration. If one attempts to make a list of the important methods in lattice path enumeration, then this will include:

- (1) *generating functions* (of course), in combination with the *Lagrange inversion formula* and/or *residue calculus* (see the second proof of Theorem 10.4.5, the proof of Theorem 10.3.4, and the proof of Theorem 10.12.1 for examples);
- (2) *bijections* (they appear explicitly or implicitly at many places);
- (3) *reflection principle* (see the proof of Theorem 10.3.1 and Section 10.18);
- (4) *cycle lemma* (see Section 10.4);
- (5) *transfer matrix method* (see the proof of Theorem 10.11.1);
- (6) *kernel method* (see the proof of Theorem 10.12.2 and the paragraphs thereafter);
- (7) the *path switching involution for non-intersecting lattice paths* (see Section 10.13);
- (8) manipulation of *two-rowed arrays* for turn enumeration (see Section 10.14);
- (9) *orthogonal polynomials, continued fractions* (see Sections 10.9–10.11).

We start with some simple results on the enumeration of paths in the d -dimensional integer lattice in Section 10.2. The sections which follow, Sections 10.3–10.7, discuss so-called *simple lattice paths* in the plane integer lattice \mathbb{Z}^2 ; these are paths in \mathbb{Z}^2 consisting of horizontal and vertical unit steps in the positive direction. While still staying in the plane integer lattice, beginning from Section 10.8, we allow three kinds of steps: changing the geometry slightly by a rotation about 45° , these are up-, down-, and level-steps. The case of Motzkin paths is intimately related to the theory of orthogonal polynomials and continued fractions. This link is explained in Sections 10.9–10.11. Section 10.12 provides a loose collection of further results for lattice paths in the plane integer lattice, with many pointers to the literature. The subsequent section, Section 10.13, is devoted to the theory of non-intersecting lattice paths, which is an extremely useful enumeration theory with many applications — particularly in the enumeration of tilings, plane partitions, and tableaux —, but is also of great interest in its own right. Turn statistics are investigated in Section 10.14. Again, the original motivation comes from statistics, but more recent work, most importantly work on counting non-intersecting lattice paths by their number of turns, arose from problems in commutative algebra. Then we move into higher-dimensional space. Sections 10.15–10.17 present standard results for lattice paths in higher-dimensional lattices. How far one can go with the reflection principle is explained in Section 10.18. The brief Section 10.19 gives some glimpses of q -analogues, including pointers to the connections of lattice path enumeration with the Rogers–Ramanujan identities.

We conclude this introduction by fixing some notation which will be used consistently in this chapter. (It is in part inspired by standard probability notation.) Given lattice points A and E , a set \mathbb{S} of steps (vectors), a set of restrictions R , and a non-negative integer m , we write

$$L_m(A \rightarrow E; \mathbb{S} \mid R) \quad (10.1)$$

for the set of all lattice paths from A to E with m steps, all of which from \mathbb{S} , which obey the restrictions in R . The lattice itself in which these paths are considered will be always clear from the context and is therefore not included in the notation. For example, the path in Figure 1 is in

$$L_5((0,0) \rightarrow (4,3); \{(1,0), (0,1), (1,1)\} \mid x \geq y),$$

where $x \geq y$ indicates the restriction that the x -coordinate of any lattice point of the path is at least as large as its y -coordinate, or, equivalently, obeys the restriction to stay weakly below the diagonal $x = y$.

Parts in (10.1) may be left out if we do not intend to require the corresponding restriction, or if that restriction is clear from the context. For example, the set of lattice paths in \mathbb{Z}^2 from A to E with horizontal and vertical unit steps in the positive direction without further restriction will be denoted by $L(A \rightarrow E; \{(1,0), (0,1)\})$, or sometimes even shorter, if the step set is clear from the context, $L(A \rightarrow E)$.

When we consider *weighted counting*, then we shall also use a uniform notation. Given a set \mathcal{M} and a weight function w on \mathcal{M} , we denote by $GF(\mathcal{M}; w)$ the *generating function* for \mathcal{M} with respect to w , i.e.,

$$GF(\mathcal{M}; w) := \sum_{x \in \mathcal{M}} w(x). \quad (10.2)$$

Finally, by convention, whenever we write a binomial coefficient $\binom{n}{k}$, it is assumed to be zero if k is not an integer satisfying $0 \leq k \leq n$.

10.2. Lattice paths without restrictions

In this short section, we briefly cover the simplest enumeration problems for lattice paths. If we are given a set of steps S , then the number of paths starting from the origin and using n steps from S is $|S|^n$. If we are also fixing the end point, then we cannot expect a reasonable formula in this generality.

However, in the case of (positive) unit steps such formulae are available. Namely, the number of paths in the plane integer lattice \mathbb{Z}^2 from (a, b) to (c, d) consisting of horizontal and vertical unit steps in the positive direction is

$$|L((a, b) \rightarrow (c, d))| = \binom{c+d-a-b}{c-a}, \quad (10.3)$$

since each path from (a, b) to (c, d) can be identified with a sequence of $(c - a)$ horizontal steps and $(d - b)$ vertical steps, the number of those sequences being given by the binomial coefficient in (10.3).

More generally, for the same reason, the number of paths in the d -dimensional integer lattice \mathbb{Z}^d from $\mathbf{a} = (a_1, a_2, \dots, a_d)$ to $\mathbf{e} = (e_1, e_2, \dots, e_d)$ consisting of positive unit steps in the direction of some coordinate axis is given by a multinomial

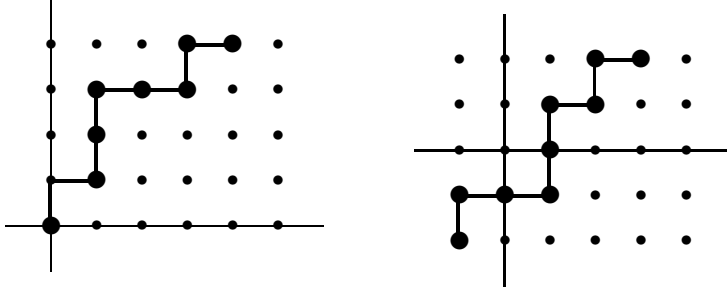

FIGURE 2.

coefficient, namely

$$|L(\mathbf{a} \rightarrow \mathbf{e})| = \binom{\sum_{i=1}^d (e_i - a_i)}{e_1 - a_1, e_2 - a_2, \dots, e_d - a_d} := \frac{(\sum_{i=1}^d (e_i - a_i))!}{(e_1 - a_1)! (e_2 - a_2)! \cdots (e_d - a_d)!}. \quad (10.4)$$

There is another special case, in which one can write down a closed form expression for the number of paths between two given points with a fixed number of steps. Namely, the number of paths with n horizontal and vertical unit steps (in the positive *or* negative direction) from (a, b) to (c, d) is given by

$$|L_n((a, b) \rightarrow (c, d); \{(\pm 1, 0), (0, \pm 1)\})| = \binom{n}{\frac{n+c+d-a-b}{2}} \binom{n}{\frac{n+c-d-a+b}{2}}. \quad (10.5)$$

See [60] and the references given there.

If one considers other step sets then it may often be possible to obtain (non-closed) formulae by “mixing” steps. A typical example is the case where we consider lattice paths in the plane allowing three types of steps, namely horizontal unit steps $(1, 0)$, vertical unit steps $(0, 1)$, and diagonal steps $(1, 1)$. Let $S = \{(1, 0), (0, 1), (1, 1)\}$ be this step set. If we want to know how many lattice paths there exist from (a, b) to (c, d) consisting of steps from S , then we find

$$|L((a, b) \rightarrow (c, d); S)| = \sum_{k=0}^{c-a} \binom{c+d-a-b-k}{k, c-a-k, d-b-k}, \quad (10.6)$$

since, if we fix the number of diagonal steps to k , then the number of ways to mix k diagonal steps, $c - a - k$ horizontal steps, and $d - b - k$ vertical steps is given by the multinomial coefficient which represents the summand in (10.6). In the special case where $(a, b) = (0, 0)$, the corresponding numbers are called *Delannoy numbers*, and, if $(c, d) = (n, n)$, *central Delannoy numbers*.

As a first excursion to weighted counting, we consider the generating function for lattice paths in \mathbb{Z}^2 from $A = (a, b)$ to $E = (c, d)$ consisting of horizontal and vertical unit steps in the positive direction, in which each path is weighted by $q^{a(P)}$, where $a(P)$ denotes the area between the path and the x -axis (with portions of the path which lie below the x -axis contributing a negative area). More precisely, the area $a(P)$ is the sum of the heights (abscissa) of the horizontal steps of P . For example, for the left-hand path in Figure 2 we have $a(\cdot) = 1 + 3 + 3 + 4 = 11$, while for the right-hand path we have $a(\cdot) = (-1) + (-1) + 1 + 2 = 1$. It is then

straightforward to check (by induction on the length of paths) that

$$GF(L((a, b) \rightarrow (c, d)); q^{a(\cdot)}) = q^{b(c-a)} \begin{bmatrix} c+d-a-b \\ c-a \end{bmatrix}_q, \quad (10.7)$$

where $\begin{bmatrix} c+d-a-b \\ c-a \end{bmatrix}_q$ denotes the q -binomial coefficient defined by

$$\begin{bmatrix} n \\ k \end{bmatrix}_q := \frac{(1-q^n)(1-q^{n-1})\cdots(1-q)}{(1-q^k)(1-q^{k-1})\cdots(1-q)(1-q^{n-k})(1-q^{n-k-1})\cdots(1-q)},$$

and $\begin{bmatrix} n \\ k \end{bmatrix}_q = 0$ if $k < 0$. This result connects lattice path enumeration with the theory of integer partitions. What we have computed in (10.7) is equivalent to the classical result that the generating function for integer partitions with at most k parts, each of which is bounded above by n is given by $\begin{bmatrix} n+k \\ k \end{bmatrix}_q$. We shall say a little bit more about q -counting in Section 10.19. The reader is referred to [2] for an excellent survey of the theory of partitions.

10.3. Linear boundaries of slope 1

Next we want to count paths from (a, b) to (c, d) , where $a \geq b$ and $c \geq d$, which stay weakly below the main diagonal $y = x$. So, what we want to know is the number $|L((a, b) \rightarrow (c, d) \mid x \geq y)|$. This problem is most conveniently solved by the so-called *reflection principle* most often attributed to André [1]. However, while André did solve the ballot problem, he did not use the reflection principle. Its origin lies most likely in the method of images of electrostatics, see Sections 2.3–2.6 in [64].

THEOREM 10.3.1. *Let $a \geq b$ and $c \geq d$. The number of all paths from (a, b) to (c, d) staying weakly below the line $y = x$ is given by*

$$|L((a, b) \rightarrow (c, d) \mid x \geq y)| = \binom{c+d-a-b}{c-a} - \binom{c+d-a-b}{c-b+1}. \quad (10.8)$$

PROOF. First we observe that the number in question is the number of all paths from (a, b) to (c, d) minus the number of those paths which cross the line $y = x$,

$$|L((a, b) \rightarrow (c, d) \mid x \geq y)| = |L((a, b) \rightarrow (c, d))| - |L((a, b) \rightarrow (c, d) \mid x \not\geq y \text{ at least once})|. \quad (10.9)$$

By (10.3) we already know $|L((a, b) \rightarrow (c, d))|$. The reflection principle shows that paths from (a, b) to (c, d) which cross $y = x$ are in bijection with paths from $(b-1, a+1)$ to (c, d) . This implies

$$|L((a, b) \rightarrow (c, d) \mid x \not\geq y \text{ at least once})| = |L((b-1, a+1) \rightarrow (c, d))|.$$

Hence, using (10.3) again, we establish (10.8).

The claimed bijection is obtained as follows. Consider a path P from (a, b) to (c, d) crossing the line $y = x$. See Figure 3 for an example. Then P must meet the line $y = x + 1$. Among all the meeting points of P and $y = x + 1$ choose the right-most. Denote this point by S . Now reflect the portion of P from (a, b) to S in the line $y = x + 1$, leaving the portion from S to (c, d) invariant. Thus we obtain a new path P' from $(b-1, a+1)$ to (c, d) . To construct the reverse mapping we only have to observe that any path from $(b-1, a+1)$ to (c, d) must meet $y = x + 1$ since

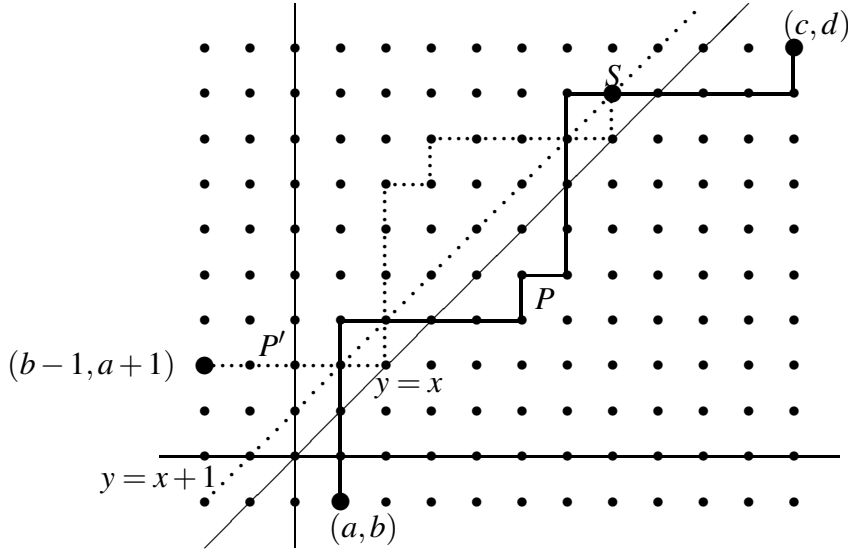

FIGURE 3.

$(b-1, a+1)$ and (c, d) lie on different sides of $y = x + 1$. Again we choose the right-most meeting point, denote it by S , and reflect the portion from $(b-1, a+1)$ to S in the line $y = x + 1$, thus obtaining a path from (a, b) to (c, d) that meets the line $y = x + 1$, or, equivalently, crosses the line $y = x$. \square

In particular, for $a = b = 0$ we obtain the following compact formula.

COROLLARY 10.3.2. *If $c \geq d$ we have*

$$|L((0,0) \rightarrow (c,d) \mid x \geq y)| = \frac{c+1-d}{c+d+1} \binom{c+d+1}{d} \quad (10.10)$$

and

$$|L((0,0) \rightarrow (n,n) \mid x \geq y)| = \frac{1}{n+1} \binom{2n}{n}. \quad (10.11)$$

The numbers $\frac{c+1-d}{c+d+1} \binom{c+d+1}{d}$ are called *ballot numbers* since they give the answer to the classical ballot problem, which is usually attributed to Bertrand [8], but was actually first stated and solved by Whitworth [123]. The problem is stated as follows: in an election candidate A received c votes and candidate B received d votes; how many ways of counting the votes are there such that at each stage during the counting candidate A has at least as many votes as candidate B ? By representing a vote for A by a horizontal step and a vote for B by a vertical step, it is seen that the number in question is the same as the number of lattice paths from $(0,0)$ to (c,d) staying weakly below $y = x$. This number is given in (10.10). More about ballot problems appears in Sections 10.12 and 10.18.

The numbers $\frac{1}{n+1} \binom{2n}{n}$ are called *Catalan numbers* [27, 28]. However, they have been considered earlier by Segner [106] and Euler [37], and independently even earlier in China; see the historical remarks in [101] and [113, p. 212]. They appear in numerous places; see [113, Ex. 6.19], with many more occurrences in the addendum [111].

An iterated reflection argument will give the number of paths between two diagonal lines.

THEOREM 10.3.3. *Let $a + t \geq b \geq a + s$ and $c + t \geq d \geq c + s$. The number of all paths from (a, b) to (c, d) staying weakly below the line $y = x + t$ and above the line $y = x + s$ is given by*

$$\begin{aligned} & |L((a, b) \rightarrow (c, d) \mid x + t \geq y \geq x + s)| \\ &= \sum_{k \in \mathbb{Z}} \left(\binom{c + d - a - b}{c - a - k(t - s + 2)} - \binom{c + d - a - b}{c - b - k(t - s + 2) + t + 1} \right). \end{aligned} \quad (10.12)$$

Since this is (as well as Theorem 10.3.1) an instance of the general formula (10.145) for the number of paths staying in regions defined by hyperplanes, we omit the proof.

The formula in Theorem 10.3.3 is very convenient for computing the number of paths as long as the parameters are not too large. On the other hand, it is of no use if one is interested in asymptotic information, because the summands on the right-hand side of (10.12) alternate in sign so that there is considerable cancellation. However, with the help of little residue calculus, the formula can be transformed into a surprising formula featuring cosines and sines, from which asymptotic information can be easily read off.

THEOREM 10.3.4. *Let $a + t \geq b \geq a + s$ and $c + t \geq d \geq c + s$. The number of all paths from (a, b) to (c, d) staying weakly below the line $y = x + t$ and above the line $y = x + s$ is given by*

$$\begin{aligned} & |L((a, b) \rightarrow (c, d) \mid x + t \geq y \geq x + s)| \\ &= \sum_{k=1}^{\lfloor (t-s+1)/2 \rfloor} \frac{4}{t-s+2} \left(2 \cos \frac{\pi k}{t-s+2} \right)^{c+d-a-b} \\ & \quad \cdot \sin \left(\frac{\pi k(a-b+t+1)}{t-s+2} \right) \cdot \sin \left(\frac{\pi k(c-d+t+1)}{t-s+2} \right). \end{aligned} \quad (10.13)$$

PROOF. Trivially, the binomial coefficient $\binom{n}{k}$ is the coefficient of z^{-1} in the Laurent series

$$\frac{(1+z)^n}{z^{k+1}}.$$

Thus, the sum (10.12) equals the coefficient of z^{-1} in

$$\begin{aligned}
& \sum_{k=0}^{\infty} \left(\frac{(1+z)^{c+d-a-b} z^{k(t-s+2)}}{z^{c-a+(c+d-a-b)(t-s+2)+1}} - \frac{(1+z)^{c+d-a-b} z^{k(t-s+2)}}{z^{c-b+t+(c+d-a-b)(t-s+2)+2}} \right) \\
&= \frac{(1+z)^{c+d-a-b}}{z^{c-a+(c+d-a-b)(t-s+2)+1} (1-z^{t-s+2})} \\
&\quad - \frac{(1+z)^{c+d-a-b}}{z^{c-b+t+(c+d-a-b)(t-s+2)+2} (1-z^{t-s+2})} \\
&= \frac{(1+z)^{c+d-a-b} \left(z^{(-c+d+a-b)/2} - z^{(-c+d-a+b)/2-t-1} \right)}{z^{(c+d-a-b)/2+(c+d-a-b)(t-s+2)+1} (1-z^{t-s+2})}. \tag{10.14}
\end{aligned}$$

(In the second line we used the formula for the geometric series. It can be either regarded as a summation in the formal sense, or else one must assume that $|z| < 1$.) Equivalently, the sum (10.12) equals the residuum of the Laurent series (10.14) at $z = 0$. Now consider the contour integral of (10.14) (with respect to z , of course) along a circle of radius r around the origin. It is a standard fact that in the limit $r \rightarrow \infty$ this integral vanishes, because the integrand (10.14) is of the order $O(1/z^2)$. Therefore, by the theorem of residues, the sum of the residues of (10.14) must be 0, or, equivalently, the residuum at $z = 0$, which we are interested in, equals the negative of the sum of the other residues. As the other poles of (10.14) are the $(t-s+2)$ -th roots of unity different from 1, we obtain

$$\begin{aligned}
& - \sum_{k=1}^{t-s+1} \frac{\left(1 + e^{\frac{2\pi ik}{t-s+2}}\right)^{c+d-a-b} \left(e^{\frac{\pi ik}{t-s+2}(-c+d+a-b)} - e^{\frac{\pi ik}{t-s+2}(-c+d-a+b-2t-2)} \right)}{e^{\frac{2\pi ik}{t-s+2}(\frac{c+d-a-b}{2}+1)} \left(-(t-s+2) e^{\frac{2\pi ik}{t-s+2}(t-s+1)} \right)} \\
&= \sum_{k=1}^{t-s+1} \frac{1}{t-s+2} \left(2 \cos \frac{\pi k}{t-s+2} \right)^{c+d-a-b} e^{\frac{\pi ik}{t-s+2}(-c+d-t-1)} \\
&\quad \cdot \left(e^{\frac{\pi ik}{t-s+2}(a-b+t+1)} - e^{-\frac{\pi ik}{t-s+2}(a-b+t+1)} \right)
\end{aligned}$$

for the sum (10.12). Now, in the last line, we pair the k -th and the $(t-s+2-k)$ -th summand. Thus, upon little manipulation, the above sum turns into

$$\begin{aligned}
& \sum_{k=1}^{\lfloor (t-s+1)/2 \rfloor} \frac{1}{t-s+2} \left(2 \cos \frac{\pi k}{t-s+2} \right)^{c+d-a-b} \\
& \cdot \left(e^{-\frac{\pi ik}{t-s+2}(c-d+t+1)} - e^{\frac{\pi ik}{t-s+2}(c-d+t+1)} \right) \left(e^{\frac{\pi ik}{t-s+2}(a-b+t+1)} - e^{-\frac{\pi ik}{t-s+2}(a-b+t+1)} \right).
\end{aligned}$$

Clearly, this formula is equivalent to (10.13). \square

From the generating function formula given in Section 10.11 (see Example 10.11.2), one can see that this asymptotic formula comes from *Chebyshev polynomials*.

10.4. Simple paths with linear boundaries of rational slope, I

When we want to count simple lattice paths (recall the meaning of “simple” from the introduction) in the plane bounded by an arbitrary line $y = kx + d$, $k, d \in \mathbb{R}$, the reflection principle obviously does not help, since the reflection of a lattice path in a generic line does not necessarily give a lattice path. In fact, a solution in form of a determinant can be given when the boundary is viewed as a special case of a set of general boundaries (see Section 10.7, Theorem 10.7.1; another solution was proposed by Takács [118], which is of similar complexity as it involves the solution of a large system of linear equations). However, there are cases where simpler expressions can be obtained, and these are discussed in this section. All of them can be derived from a very basic combinatorial lemma, the so-called “*cycle lemma*”, which exists in several variations.

The first case which we discuss is the enumeration of simple lattice paths from the origin to a lattice point (r, s) , with r and s relatively prime, which stay weakly below the line connecting the origin and (r, s) .

THEOREM 10.4.1. *Let r and s be relatively prime positive integers. The number of all paths from $(0, 0)$ to (r, s) staying weakly below the line $ry = sx$ is given by*

$$|L((0, 0) \rightarrow (r, s) \mid sx \geq ry)| = \frac{1}{r+s} \binom{r+s}{r}. \quad (10.15)$$

REMARK 10.4.2. The numbers in (10.15) are nowadays called *rational Catalan numbers* (cf. [4]), the Catalan numbers being the special case where $r = n$ and $s = n + 1$.

The above result follows easily from a form of the cycle lemma which is known in the statistics literature as Spitzer’s lemma [110].

LEMMA 10.4.3 (SPITZER’S LEMMA). *Let a_1, a_2, \dots, a_N be real numbers with the property that $a_1 + a_2 + \dots + a_N = 0$ and no other partial sum of consecutive a_i ’s, read cyclically (by which we mean sums of the form $a_j + a_{j+1} + \dots + a_k$ with $j \leq k$ and $k - j < N$, where indices are interpreted modulo N), vanishes. Then there exists a unique cyclic permutation $a_i, a_{i+1}, \dots, a_N, a_1, \dots, a_{i-1}$ with the property that for all $j = 1, 2, \dots, N$ the sum of the first j letters of this permuted array is non-negative.*

REMARK 10.4.4. This lemma could be further generalized by weakening the above assumption to demanding that K partial sums of consecutive a_i ’s, read cyclically, of *minimal length* vanish, with the conclusion that there be K cyclic permutations with the above non-negativity property.

PROOF. We interpret the real numbers a_i as steps of a path (although not necessarily of a *lattice* path), by concatenating the steps $(1, a_1), (1, a_2), \dots, (1, a_N)$ to a path starting at the origin. See the left half of Figure 4 for a typical example.

Since the sum of all a_i ’s vanishes, the end point of the path lies on the x -axis. We identify this end point with the starting point (located at the origin), so that we consider this path as a cyclic object.

By the non-vanishing of cyclic subsums, there is a unique point of minimal height, A say. (This may also be the starting/end point, which we identified.) In the figure this point is marked by a thick dot. Now “permute” the path cyclically,

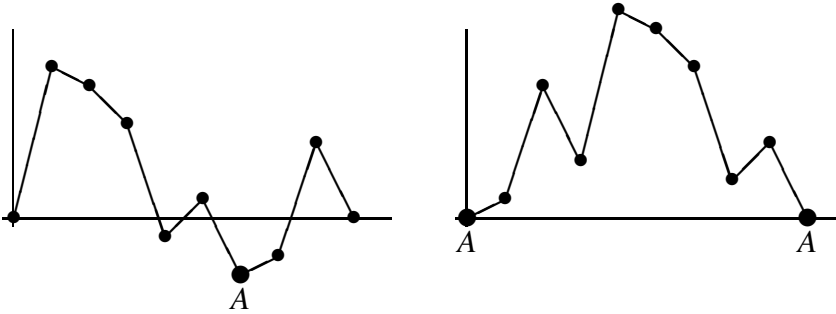

FIGURE 4.

that is, take the portion of the path from A to the end, and concatenate it with the initial portion of the path until A . See the right half of Figure 4 for the result in our example. Obviously, the new path always lies strictly above the x -axis, except at the beginning and at the end. This identifies the cyclic permutation of the a_i 's with the required property. \square

Proof of Theorem 10.4.1 We consider *all* paths from $(0,0)$ to (r,s) . There are $\binom{r+s}{s}$ such paths. Given a path P from $(0,0)$ to (r,s) , we consider the sequence a_1, a_2, \dots, a_{r+s} , where $a_i = s$ if the i -th step of the path is a horizontal step, and $a_i = -r$ if the i -th step of the path is a vertical step. Since r and s are relatively prime, no cyclic subsum of the a_i 's, except the complete sum, can vanish. The cycle lemma in Lemma 10.4.3 then implies that, out of the $r+s$ cyclic “permutations” of the path P , there is exactly one which stays (weakly) below the line $sx = ry$. Thus, there are in total $\frac{1}{r+s} \binom{r+s}{r}$ paths with that property.

The next case where a closed form formula can be obtained (partially overlapping with the result in Theorem 10.4.1) is when counting lattice paths from $(0,0)$ to (c,d) which stay weakly below the line $x = \mu y$, where μ is a positive integer. Of course we have to assume $c \geq \mu d$. There are two conceptually different standard approaches to obtain the corresponding result: application of another version of the cycle lemma (see Lemma 10.4.6), respectively generating functions combined with the use of the Lagrange inversion formula.

THEOREM 10.4.5. *Let μ be a non-negative integer and $c \geq \mu d$. The number of all lattice paths from the origin to (c,d) which lie weakly below $x = \mu y$ is given by*

$$|L((0,0) \rightarrow (c,d) \mid x \geq \mu y)| = \frac{c - \mu d + 1}{c + d + 1} \binom{c + d + 1}{d}. \quad (10.16)$$

This result is essentially equivalent to the cycle lemma due to Dvoretzky and Motzkin [36]. It has been rediscovered many times; see [35] for a partial survey and many related references, as well as [113, Lemma 5.3.6 and Example 5,3,7].

LEMMA 10.4.6 (CYCLE LEMMA). *Let μ be a non-negative integer. For any sequence $p_1 p_2 \dots p_{m+n}$ of m 1's and n 2's, with $m \geq \mu n$, there exist exactly $m - \mu n$ cyclic permutations $p_i p_{i+1} \dots p_{m+n} p_1 \dots p_{i-1}$, $1 \leq i \leq m+n$, that have the property that for all $j = 1, 2, \dots, m+n$ the first j letters of this permutation contain more 1's than μ times the number of 2's.*

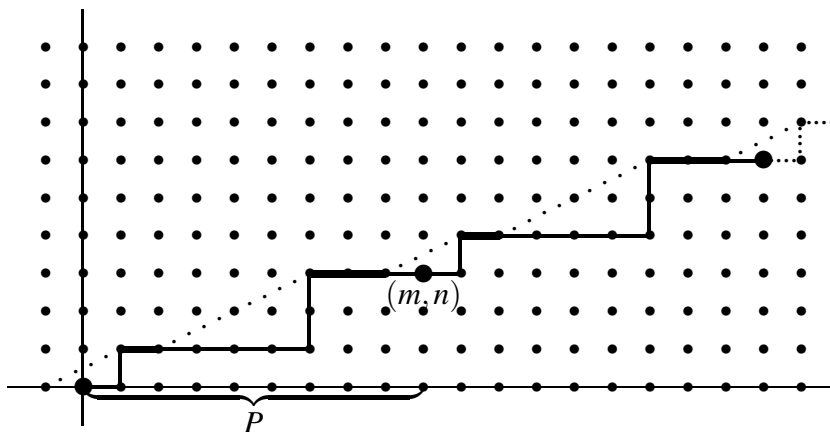

FIGURE 5.

PROOF. A sequence $p_1 p_2 \dots p_{m+n}$ of m 1's and n 2's can be seen as a lattice path from $(0,0)$ to (m,n) by interpreting the 1's as horizontal steps and the 2's as vertical steps. Cyclically permuting $p_1 p_2 \dots p_{m+n}$ means to cut the corresponding lattice path into two pieces and put them together in exchanged order, thus obtaining a new lattice path from $(0,0)$ to (m,n) . Finally, the property that in each initial string of a sequence the number of 1's dominates (i.e., is larger than) μ times the number of 2's means that the corresponding lattice path stays strictly below the line $x = \mu y$, with the exception of the starting point $(0,0)$.

For the proof of the lemma interpret $p_1 p_2 \dots p_{m+n}$ as a path, as described before, and join a shifted copy of this path at the end point (m,n) , another shifted copy at $(2m,2n)$, etc. Figure 5 shows an example with $\mu = 2$, $m = 9$, $n = 3$. The path P corresponds to the sequence 12111122111. Cyclic permutations of $p_1 p_2 \dots p_{m+n}$ correspond to cutting a piece of $m+n$ successive steps out of this lattice path structure. Then imagine a sun to be located in direction $(\mu, 1)$ illuminating the lattice path structure. A cyclic permutation will satisfy the dominance property for each initial string if and only if the first step of the corresponding lattice path is illuminated. In Figure 5 the illuminated steps are indicated by thick lines. It is an easy matter of fact that of any $m+n$ successive steps there are exactly $m - \mu n$ illuminated steps. Therefore out of the $m+n$ cyclic permutations of $p_1 p_2 \dots p_{m+n}$ there are exactly $m - \mu n$ cyclic permutations having the dominance property for each initial string. \square

First proof of Theorem 10.4.5 We want to count paths from $(0,0)$ to (c,d) staying weakly below $x = \mu y$. To fit with the cycle lemma we adjoin a horizontal step at the beginning and shift everything by one unit to the right. Thus we are now asking for the number of paths from $(0,0)$ to $(c+1,d)$ staying *strictly* below $x = \mu y$, except for the starting point $(0,0)$. Now one applies Lemma 10.4.6 with $m = c+1$ and $n = d$: given a path P from $(0,0)$ to $(c+1,d)$, exactly $m - \mu n = c+1 - \mu d$ of its cyclic "permutations" satisfy the property of staying *strictly* below $x = \mu y$, except for the starting point $(0,0)$. Thus, the total number of paths from $(0,0)$ to (c,d) with that property is given by (10.16).

For instructional purposes, we also present the generating function proof.

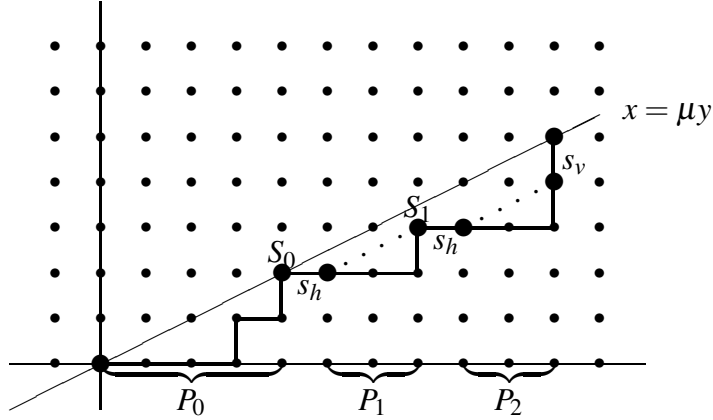

FIGURE 6.

Second proof of Theorem 10.4.5 The generating function proof works in two steps. First, an equation is found for the generating function of those paths which return in the end to the boundary $x = \mu y$. Then, in a second step, paths ending arbitrarily are decomposed into paths of the former type, leading to a generating function expression in terms of the earlier generating function to which the Lagrange inversion formula is applicable.

Let P be a path in $L((0,0) \rightarrow (\mu d, d) \mid x \geq \mu y)$ (see Figure 6). For $l = 0, 1, \dots, \mu - 1$, the path P will meet the line $x = \mu y + l$ (which is parallel to our boundary $x = \mu y$) somewhere for the last time. Denote this point by S_l . Clearly, the path P must leave S_l by a horizontal step, which we denote by s_h for short. This gives us a unique decomposition of P of the form

$$P = P_0 s_h P_1 s_h \dots s_h P_{\mu} s_v,$$

where P_0 is P 's portion from the origin up to S_0 , P_1 is P 's portion from the point immediately following S_0 up to S_1 , etc. By s_v we denote the final vertical step. All the portions P_i (when shifted appropriately) belong to $L((0,0) \rightarrow (\mu n, n) \mid x \geq \mu y)$ for some n . Let

$$\mathcal{L}_0 = \bigcup_{n \geq 0} L((0,0) \rightarrow (\mu n, n) \mid x \geq \mu y). \quad (10.17)$$

Then we have the following decomposition:

$$\mathcal{L}_0 = \{\varepsilon\} \cup ((\mathcal{L}_0 s_h)^\mu \mathcal{L}_0 s_v).$$

Here, as always in the sequel, ε denotes the empty path.

By elementary combinatorial principles, this immediately translates into a functional equation for the generating function

$$F_0(z) := \sum_{n \geq 0} |L((0,0) \rightarrow (\mu n, n) \mid x \geq \mu y)| z^n$$

for \mathcal{L}_0 (note that the summation index n records the vertical height of the end point of paths), namely

$$F_0(z) = 1 + z F_0(z)^{\mu+1}. \quad (10.18)$$

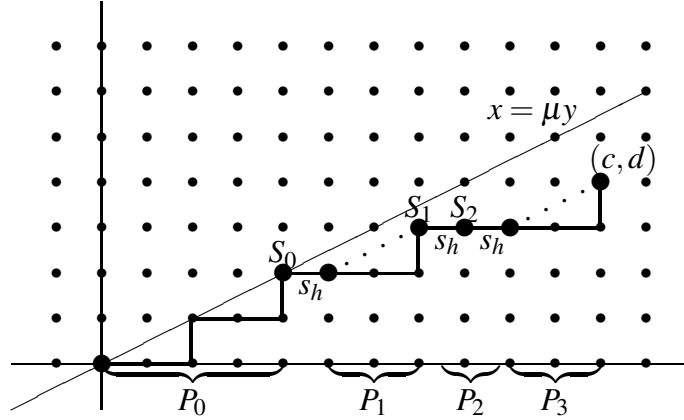

FIGURE 7.

If we write $F_0(z) = 1 + G_0(z)$, then Equation (10.18) in terms of the series $G_0(z)$ reads

$$\frac{G_0(z)}{(1 + G_0(z))^{\mu+1}} = z, \quad (10.19)$$

which simply says that $G_0(z)$ is the compositional inverse of $z/(1+z)^{\mu+1}$.

Turning to the more general problem, consider a lattice path P in $|L((0,0) \rightarrow (\mu d + k, d) \mid x \geq \mu y)|$ (see Figure 7). For $l = 0, 1, \dots, k-1$ the path will meet the line $x = \mu y + l$ somewhere for the last time. Denote this point by S_l . Clearly, the path P must leave S_l by a horizontal step, for which we again write s_h . This gives us a decomposition of P of the form

$$P = P_0 s_h P_1 s_h \dots s_h P_k,$$

where P_0 is the portion of P from the origin up to S_0 , P_1 is the portion of P from the point immediately following S_0 up to S_1 , and so on. Observe that again the portions P_l belong to \mathcal{L}_0 (being defined in (10.17)). Let

$$\mathcal{L}_k = \bigcup_{n \geq 0} L((0,0) \rightarrow (\mu n + k, n) \mid x \geq \mu y).$$

Then we have the following decomposition:

$$\mathcal{L}_k = (\mathcal{L}_0 s_h)^k \mathcal{L}_0.$$

This translates again into an equation for the corresponding generating function

$$F_k(z) := \sum_{n \geq 0} |L((0,0) \rightarrow (\mu n + k, n) \mid x \geq \mu y)| z^n$$

for \mathcal{L}_k , namely into

$$F_k(z) = F_0(z)^{k+1} = (1 + G_0(z))^{k+1},$$

We noted above that $G_0(z)$ is the compositional inverse of $z/(1+z)^{\mu+1}$. Therefore, we may apply the Lagrange formula (see [113, Corollary 5.4.3]; for the current

purpose, we have to choose $H(z) = (1+z)^{k+1}$, $f(z) = z/(1+z)^{\mu+1}$ there). This yields

$$\begin{aligned} L((0,0) \rightarrow (\mu n+k, n) \mid x \geq \mu y) &= \frac{1}{n} \langle z^{-1} \rangle (k+1) (1+z)^k \frac{(1+z)^{n(\mu+1)}}{z^n} \\ &= \frac{k+1}{n} \binom{\mu n+k+n}{n-1} \\ &= \frac{k+1}{\mu n+k+n+1} \binom{\mu n+k+n+1}{n}, \end{aligned}$$

which turns into (10.16) once we replace $\mu n+k$ by c and n by d .

In particular, for $\mu = 1$ the generating function $F_0(z)$ can be explicitly evaluated from solving the quadratic equation (10.18). In the case, where the paths return to the boundary $x = y$, i.e., where $(c, d) = (n, n)$, this gives the familiar generating function for the Catalan numbers (compare with the second paragraph after Corollary 10.3.2)

$$\sum_{n \geq 0} C_n z^n = \frac{1 - \sqrt{1-4z}}{2z}. \quad (10.20)$$

More generally, if μ is kept generic and $(c, d) = (\mu n, n)$ (that is, we consider again paths which return to the boundary), then the formula on the right-hand side of (10.16) becomes $\frac{1}{\mu n+1} \binom{(\mu+1)n}{n}$. These numbers are now commonly called *Fuß-Catalan numbers*, cf. [3, pp. 59–60] for more information on their significance and historical remarks.

So far we only counted paths bounded by $x = \mu y$ where the starting point lies on the boundary. If we drop this latter assumption and now want to enumerate all paths from (a, b) to (c, d) staying weakly below $x = \mu y$, there is still an answer, although only in terms of a sum. In fact, we can offer two different expressions. Which of these two is preferable depends on the particular situation, to be more precise, on which of the numbers $(a/\mu - b)$ or $(d - a/\mu)$ being larger (see Figure 8 for the pictorial significance of these numbers). While the proof for the first expression is rather straightforward, the proof for the second expression is more difficult. The result below was first found by Korolyuk [73]. It is a special case of an even more general result of Niederhausen [98, Sec. 2.2] on the enumeration of simple paths with piecewise linear boundaries, which we will discuss in Section 10.6.

THEOREM 10.4.7. *Let μ be a non-negative integer, $a \geq \mu b$ and $c \geq \mu d$. The number of all lattice paths from (a, b) to (c, d) staying weakly below $x = \mu y$ is given*

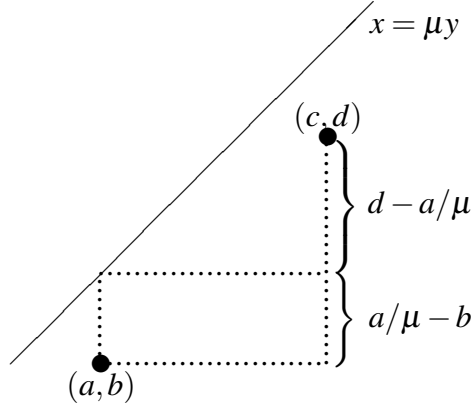

FIGURE 8.

by

$$\begin{aligned}
 |L((a, b) \rightarrow (c, d) \mid x \geq \mu y)| &= \binom{c+d-a-b}{c-a} \\
 - \sum_{i=\lfloor a/\mu \rfloor + 1}^d &\binom{i(\mu+1)-a-b-1}{i-b} \frac{c-\mu d+1}{c+d-i(\mu+1)+1} \binom{c+d-i(\mu+1)+1}{d-i},
 \end{aligned} \tag{10.21}$$

and also

$$\begin{aligned}
 |L((a, b) \rightarrow (c, d) \mid x \geq \mu y)| &= \sum_{i=0}^{\lfloor a/\mu \rfloor - b} (-1)^i \binom{a-\mu(b+i)}{i} \\
 &\times \frac{c-\mu d+1}{c+d-(\mu+1)(b+i)+1} \binom{c+d-(\mu+1)(b+i)+1}{d-b-i}. \tag{10.22}
 \end{aligned}$$

Proof of (10.21) The number of paths in question equals the number of all paths from (a, b) to (c, d) minus those paths which cross $x = \mu y$. To count the latter observe that any path crossing $x = \mu y$ must meet the line $x = \mu y - 1$, and for the last time in some point $(\mu i - 1, i)$ where $\lfloor a/\mu \rfloor + 1 \leq i \leq c$. Fix such an i , then the number of all these paths is

$$|L((a, b) \rightarrow (\mu i - 1, i))| \cdot |L((\mu i, i) \rightarrow (c, d) \mid x \geq \mu y)|.$$

We already know the first number due to (10.3), and we also know the second number due to (10.16), since a shift in direction $(-\mu i, -i)$ shows that the second number equals $|L((0, 0) \rightarrow (c - \mu i, d - i) \mid x \geq \mu y)|$.

Proof of (10.22) This is the special case of Theorem 10.6.1 where $m = 2$, $\mu_1 = v_1 = 0$, $y_1 = \lfloor a/\mu \rfloor - b$, $\mu_2 = \mu$, $v_2 = \mu b - a$.

For a different, direct proof, in the sum in (10.21) replace the index i by $i + b$; the new index then ranges from $\lfloor a/\mu \rfloor - b + 1$ to $d - b$; extend the sum to all i between 0 and $d - b$, thereby adding a partial sum where i ranges from 0 to $\lfloor a/\mu \rfloor - b$; the

former sum can be evaluated by means of a convolution formula of the Hagen–Rothe type (cf. [54, Eq. (11)]), and the result is the binomial coefficient $\binom{c+d-a-b}{c-a}$.

Enumeration of lattice paths in the presence of several linear boundaries can in the best cases be solved by an iterated application of the reflection principle; see Section 10.18 for the most general situation where the reflection principle applies. But, if it does not apply (which, in a random case, will certainly be so), then the enumeration problem will be very challenging. Usually, one cannot expect to find a useful exact formula (but see Section 10.7), and will instead investigate asymptotic behaviours. This is still quite challenging. The reader is referred to [22, 68, 69] for work in this direction.

10.5. Simple paths with linear boundaries with rational slope, II

In Section 10.4 we considered lattice paths bounded by a line $x = \mu y$, with μ a non-negative integer. Now we want to consider a more general linear boundary of the form $\nu x = \mu y$, where ν, μ are non-negative integers. We describe a generating function approach, due to Sato [104], which works for a large class of cases. Alternative solutions, which work in all cases, in the form of a determinant, can be given as a special case of a set of general boundaries. These are discussed in Section 10.7, see in particular Theorem 10.7.1.

The problem that we want to attack here is to enumerate all lattice paths from an arbitrary starting point to an arbitrary end point staying weakly below the line $\nu x = \mu y$, where ν and μ are positive integers. A simple shift of the plane shows that this is equivalent to enumerating paths from the origin to an arbitrary end point staying weakly below $\nu x = \mu y - \rho$, for an appropriate ρ . Without loss of generality we may assume in the sequel that $\nu < \mu$. For the approach of Sato, this is the more convenient formulation of the problem. The idea is to introduce $\nu \times \nu$ matrices which contain the path numbers that we are looking for. More precisely, define the $\nu \times \nu$ matrix $W(z; c, \rho)$ by

$$W(z; c, \rho) := (w(z; c + g, \rho + h))_{0 \leq g, h \leq \nu-1}, \quad (10.23)$$

where

$$w(z; c, \rho) = \sum_{\mu n + c \equiv \rho \pmod{\nu}} w(n; c, \rho) z^n, \quad (10.24)$$

with

$$w(n; c, \rho) = \begin{cases} \left| L((0, 0) \rightarrow (\frac{\mu n + c - \rho}{\nu}, n) \mid \nu x \geq \mu y - \rho) \right|, & \begin{array}{l} \mu n + c \equiv \rho \pmod{\nu} \\ \text{and } \mu n + c \geq \rho, \\ \mu n + c \equiv \rho \pmod{\nu} \\ \text{and } \mu n + c < \rho. \end{array} \\ \binom{n + \frac{\mu n + c - \rho}{\nu}}{n}, & \end{cases} \quad (10.25)$$

So, what the matrix $W(z; c, \rho)$ contains is generating functions of the path numbers $w(n; c, \rho)$ that we want to know. The definition of $w(n; c, \rho)$ for $\mu n + c < \rho$ (in which case there cannot be any paths from $(0, 0)$ to $(\frac{\mu n + c - \rho}{\nu}, n)$) is just for technical convenience. Basically, the matrix $W(z; c, \rho)$ is

$$W(z; c, \rho) = \left(\sum_{\mu n + c + g - h \equiv \rho \pmod{\nu}} \left| L((0, 0) \rightarrow \left(\frac{\mu n + c + g - \rho - h}{\nu}, n \right) \mid \nu x \geq \mu y - \rho - h) \right| z^n \right)_{0 \leq g, h \leq \nu - 1}. \quad (10.26)$$

The following theorem of Sato [104, Theorem 1] tells us how to compute $W(z; c, \rho)$.

THEOREM 10.5.1. *Let*

$$M = \left((-1)^{\nu - h - 1} s_{(c+g+1, 1^{\nu-h-1})}(u_0(z), \dots, u_{\nu-1}(z)) \right)_{0 \leq g, h \leq \nu - 1}, \quad (10.27)$$

where

$$s_{(\alpha, 1^\beta)}(u_0, \dots, u_{\nu-1}) = \sum_{\nu-1 \geq i_\alpha \geq i_{\alpha-1} \geq \dots \geq i_1 < j_1 < \dots < j_\beta \leq \nu-1} u_{i_\alpha}(z) u_{i_{\alpha-1}}(z) \cdots u_{i_1}(z) u_{j_1}(z) \cdots u_{j_\beta}(z), \quad (10.28)$$

$u_i(z)$ being defined by

$$u_l(z) = e^{(2\pi i l / \nu)} \sum_{n \geq 0} \frac{1}{1 + (\nu + \mu)n} \binom{\frac{1}{\nu} + (1 + \frac{\mu}{\nu})n}{n} \left(z e^{2\pi i l \mu / \nu} \right)^n, \quad l = 0, 1, \dots, \nu - 1. \quad (10.29)$$

Furthermore, let

$$\Phi(z; \rho) = \left(\sum_{\substack{\mu l \equiv \rho - g + h \pmod{\nu} \\ \mu l \leq \rho - g + h}} (-1)^l \binom{(\rho - g + h - \mu l) / \nu}{l} z^l \right)_{0 \leq g, h \leq \nu - 1}. \quad (10.30)$$

Then, for any non-negative integers c, ρ, ν, μ , with $\nu < \mu$, we have

$$W(z; c, \rho) = M(z; c, \rho) \Phi(z; \rho). \quad (10.31)$$

NOTE 10.5.2. Note that $s_{(\alpha, 1^\beta)}(u_0, \dots, u_{\nu-1})$ is a Schur function of hook shape (cf. [89, Ch. I, Sec. 3, Ex. 9]).

It might be useful to discuss an example, in order to illustrate what this is all about.

EXAMPLE 10.5.3. We take $\nu = 2, \mu = 3$. So, by (10.25), the quantity $w(n; c, \rho)$ represents the number of all lattice paths from $(0, 0)$ to $((3n + c - \rho)/2, n)$ which stay weakly below the line $2x = 3y - \rho$, where $c \equiv 3n - \rho \pmod{2}$, i.e., $c \equiv n + \rho \pmod{2}$.

By definition (10.23), we have

$$\begin{aligned} W(z; c, \rho) &= (w(z; c+g, \rho+h))_{0 \leq g, h \leq 1} \\ &= \begin{pmatrix} w(z; c, \rho) & w(z; c, \rho+1) \\ w(z; c+1, \rho) & w(z; c+1, \rho+1) \end{pmatrix}. \end{aligned}$$

Using (10.31), this can be written as

$$W(z; c, \rho) = M(z; c, 2) \Phi(z; \rho),$$

where

$$\begin{aligned} &\Phi(z; \rho) \\ &= \begin{pmatrix} \sum_{\substack{\mu l \equiv \rho \pmod{v} \\ \mu l \leq \rho}} (-1)^l \binom{\rho - \mu l}{l} z^l & \sum_{\substack{\mu l \equiv \rho+1 \pmod{v} \\ \mu l \leq \rho+1}} (-1)^l \binom{\rho+1 - \mu l}{l} z^l \\ \sum_{\substack{\mu l \equiv \rho-1 \pmod{v} \\ \mu l \leq \rho-1}} (-1)^l \binom{\rho-1 - \mu l}{l} z^l & \sum_{\mu l \equiv \rho \pmod{v}} (-1)^l \binom{\rho - \mu l}{l} z^l \end{pmatrix} \end{aligned}$$

by (10.30), and

$$M(z; c, 2) = \begin{pmatrix} -s_{(c+1,1)}(u_0(z), u_1(z)) & s_{(c+1)}(u_0(z), u_1(z)) \\ -s_{(c+2,1)}(u_0(z), u_1(z)) & s_{(c+2)}(u_0(z), u_1(z)) \end{pmatrix}$$

by (10.27), with $s_{(\alpha,1\beta)}(u_0(z), u_1(z))$ being defined in (10.28), and

$$u_l(z) = (-1)^l \sum_{n \geq 0} \frac{(-1)^{ln}}{1+5n} \binom{\frac{1}{2} + \frac{5}{2}n}{n} z^n,$$

as given in (10.29).

So, in particular, in case that $c = \rho = 0$ the matrix $\Phi(z; 0)$ is the 2×2 identity matrix, and so we have

$$\begin{aligned} W(z; 0, 0) &= \begin{pmatrix} w(z; 0, 0) & w(z; 0, 1) \\ w(z; 1, 0) & w(z; 1, 1) \end{pmatrix} \\ &= M(z; 0, 2) = \begin{pmatrix} -u_0(z)u_1(z) & u_0(z) + u_1(z) \\ -u_0(z)u_1(z)(u_0(z) + u_1(z)) & u_0^2(z) + u_0(z)u_1(z) + u_1^2(z) \end{pmatrix}. \end{aligned}$$

Whence, for even n the number of all lattice paths from $(0, 0)$ to $(3n/2, n)$ which stay weakly below the line $2x \geq 3y$ equals

$$\begin{aligned} |L((0, 0) \rightarrow (\frac{3n}{2}, n) \mid 2x \geq 3y)| &= \langle z^n \rangle w(z; 0, 0) \\ &= \sum_{l=0}^n (-1)^l \frac{1}{1+5l} \binom{\frac{1}{2} + \frac{5}{2}l}{l} \cdot \frac{1}{1+5(n-l)} \binom{\frac{1}{2} + \frac{5}{2}(n-l)}{n-l}, \end{aligned}$$

and for odd n the number of all lattice paths from $(0, 0)$ to $((3n-1)/2, n)$ which stay weakly below the line $2x \geq 3y-1$ equals

$$|L((0, 0) \rightarrow (\frac{3n-1}{2}, n) \mid 2x \geq 3y-1)| = \langle z^n \rangle w(z; 0, 1) = \frac{2}{1+5n} \binom{\frac{1}{2} + \frac{5}{2}n}{n}.$$

Sato [104] also derived a result of similar type for two parallel linear boundaries with rational slope. To be precise, we want to enumerate all lattice paths from an arbitrary starting point to an arbitrary end point staying weakly below a given line $vx = \mu y - \rho$ and above another given line $vx = \mu y + \sigma$, where μ, v, ρ, σ are non-negative integers. Again, without loss of generality we may assume that $v < \mu$ and that the starting point is the origin.

Following the approach we have taken earlier, we define the $v \times v$ matrix $T(z; c, \rho, \sigma)$ by

$$T(z; c, \rho, \sigma) := (t(z; c + g, \rho + h, \sigma - h))_{0 \leq g, h \leq v-1}, \quad (10.32)$$

where

$$t(z; c, \rho, \sigma) = \sum_{\mu n + c \equiv \rho \pmod{v}} t(n; c, \rho, \sigma) z^n, \quad (10.33)$$

with

$$t(n; c, \rho, \sigma) = \begin{cases} \left| L((0, 0) \rightarrow (\frac{\mu n + c - \rho}{v}, n) \mid \mu y + \sigma \geq vx \geq \mu y - \rho) \right|, & \mu n + c \equiv \rho \pmod{v} \\ & \text{and } \mu n + c \geq \rho, \\ \binom{n + \frac{\mu n + c - \rho}{v}}{n}, & \mu n + c \equiv \rho \pmod{v} \\ & \text{and } \mu n + c < \rho. \end{cases} \quad (10.34)$$

Similarly to the one boundary case, what the matrix $T(z; c, \rho, \sigma)$ contains is generating functions of the path numbers $t(n; c, \rho, \sigma)$ that we want to compute. The definition of $t(n; c, \rho, \sigma)$ for $\mu n + c < \rho$ (in which case there cannot be any paths from $(0, 0)$ to $(\frac{\mu n + c - \rho}{v}, n)$) is just for technical convenience. Basically, the matrix $T(z; c, \rho, \sigma)$ is

$$T(z; c, \rho, \sigma) = \left(\sum_{\mu n + c + g - h \equiv \rho \pmod{v}} \left| L((0, 0) \rightarrow \left(\frac{\mu n + c + g - \rho - h}{v}, n \right) \mid \mu y + \sigma - h \geq vx \geq \mu y - \rho - g) \right| z^n \right)_{0 \leq g, h \leq v-1}. \quad (10.35)$$

The following theorem of Sato [104, Theorem 4] tells us how to compute $T(z; c, \rho, \sigma)$.

THEOREM 10.5.4. *For any non-negative integers c, ρ, σ, v, μ , with $v < \mu$, we have*

$$T(z; c, \rho, \sigma) = \Phi(z; \rho + \sigma + 1 - c - \mu) \Phi^{-1}(z; \rho + \sigma + 1) \Phi(z; \rho), \quad (10.36)$$

where $\Phi(z; \vartheta)$ is given by (10.30).

EXAMPLE 10.5.5. As an illustration, let us again consider the case $v = 2$, $\mu = 3$. By (10.34), the quantity $t(n; c, \rho, \sigma)$ represents the number of all lattice paths from $(0, 0)$ to $((3n + c - \rho)/2, n)$ which stay weakly below the line $2x = 3y - \rho$ and above the line $2x = 3y + \sigma$, where $c \equiv 3n - \rho \pmod{2}$, i.e., $c \equiv n + \rho \pmod{2}$.

By definition (10.32), we have

$$\begin{aligned} T(z; c, \rho, \sigma) &= (t(z; c + g, \rho + h, \sigma - h))_{0 \leq g, h \leq 1} \\ &= \begin{pmatrix} t(z; c, \rho, \sigma) & t(z; c, \rho + 1, \sigma - 1) \\ t(z; c + 1, \rho, \sigma) & t(z; c + 1, \rho + 1, \sigma - 1) \end{pmatrix}. \end{aligned}$$

By Theorem 10.5.4, this can be written as

$$\begin{aligned} T(z; c, \rho, \sigma) &= \begin{pmatrix} \phi(z; \rho + \sigma - c - 1) & \phi(z; \rho + \sigma - c) \\ \phi(z; \rho + \sigma - c - 2) & \phi(z; \rho + \sigma - c - 1) \end{pmatrix} \\ &\quad \times \begin{pmatrix} \phi(z; \rho + \sigma + 1) & \phi(z; \rho + \sigma + 2) \\ \phi(z; \rho + \sigma) & \phi(z; \rho + \sigma + 1) \end{pmatrix}^{-1} \\ &\quad \times \begin{pmatrix} \phi(z; \rho) & \phi(z; \rho + 1) \\ \phi(z; \rho - 1) & \phi(z; \rho) \end{pmatrix}, \end{aligned} \quad (10.37)$$

where

$$\phi(z; a) = \sum_{\substack{\mu l \equiv a \pmod{v} \\ \mu l \leq a}} (-1)^l \binom{(a - \mu l)/v}{l} z^l.$$

In particular, if $c = \sigma$ and $\rho = 0$, so that we are e.g. interested in the number of all lattice paths from $(0, 0)$ to $((3n + c)/2, n)$ which stay weakly below the line $2x = 3y$ and above the line $2x = 3y + c$ (the reader should observe that this means that the starting point is on the first line whereas the end point is on the second line), then our formula (10.37) reduces to

$$\begin{aligned} T(z; c, \rho) &= \begin{pmatrix} t(z; c, 0, c) & t(z; c, 1, c - 1) \\ t(z; c + 1, 0, c) & t(z; c + 1, 1, c - 1) \end{pmatrix} \\ &= \frac{1}{\phi^2(z; c + 1) - \phi(z; c)\phi(z; c + 2)} \begin{pmatrix} \phi(z; c) & \phi(z; c + 1) \\ 0 & 0 \end{pmatrix}. \end{aligned}$$

Thus we obtain

$$\begin{aligned} t(z; c, 0, c) &= \sum_{n \equiv c \pmod{2}} |L((0, 0) \rightarrow (\frac{3n+c}{2}, n) \mid 3y + c \geq 2x \geq 3y)| z^n \\ &= \frac{\phi(z; c)}{\phi^2(z; c + 1) - \phi(z; c)\phi(z; c + 2)}, \end{aligned} \quad (10.38)$$

with

$$\phi(z; a) = \sum_{\substack{3l \equiv a \pmod{2} \\ 3l \leq a}} (-1)^l \binom{(a - 3l)/2}{l} z^l.$$

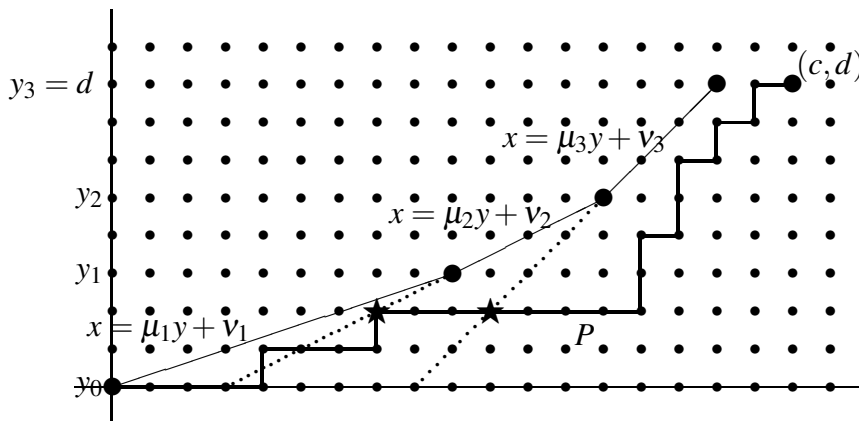

FIGURE 9. A piecewise linear boundary

10.6. Simple paths with a piecewise linear boundary

In this section we generalize the one-sided linear boundary results in Corollary 10.3.2 and Theorems 10.4.5, 10.4.7 to piecewise linear boundaries. To be more precise, we want to count lattice paths from the origin $(0,0)$ to (c,d) staying weakly below the line segments

$$\{(x,y) : x = \mu_1 y + v_1, 0 = y_0 \leq y \leq y_1\}, \{(x,y) : x = \mu_2 y + v_2, y_1 < y \leq y_2\}, \\ \dots, \{(x,y) : x = \mu_m y + v_m, y_{m-1} < y \leq y_m = d\}, \quad (10.39)$$

for some sequence $0 = y_0 < y_1 < \dots < y_m = d$ of non-negative integers, non-negative integers $\mu_1, \mu_2, \dots, \mu_m$, and integers v_1, v_2, \dots, v_m . Let us denote this piecewise linear restriction by R_m . See Figure 9 for an example. By an iteration argument it will be seen that the solution to this problem can be given in form of an m -fold sum.

The result below is due to Niederhausen [98, Sec. 2.2 in connection with (2.4) and (2.7)], but see also [96]. In order to understand the statement below, it is important to observe that the number of paths which we want to determine is a polynomial in c , while keeping all other variables fixed. We shall not provide a detailed argument here but, instead, refer to [98, Sec. 2.2]. For convenience, let us denote this polynomial by $L_{R_m, d}(c)$.

THEOREM 10.6.1. *The number of lattice paths from $(0,0)$ to (c,d) staying weakly below the piecewise linear boundary R_m given in (10.39) is equal to*

$$|L((0,0) \rightarrow (c,d) | R_m)| = \sum_{i=0}^{y_{m-1}} L_{R_{m-1}, i}(\mu_m i + v_m - 1) \\ \cdot \frac{c - \mu_m d - v_m + 1}{c + d - i(\mu_m + 1) - v_m + 1} \binom{c + d - i(\mu_m + 1) - v_m + 1}{d - i}. \quad (10.40)$$

REMARK 10.6.2. Clearly, we may now apply Theorem 10.6.1 to $L_{R_{m-1}, i}(\mu_m i + v_m - 1)$ so that, iteratively, we obtain an m -fold sum. (In the last step, one applies (10.22).)

Idea of proof of Theorem 10.6.1 To begin with, let us assume that the piecewise linear boundary be convex. See Figure 9 for an example. Evidently, any path from $(0,0)$ to (c,d) has to touch $x = \mu_m y + v_m$ for the last time, say in $(\mu_m i + v_m, i)$. In Figure 9 we have $m = 3$, the last touching point of the path P with $x = \mu_m y + v_m$ is $(10,2)$, it is marked by a star. Then we utilize the same idea which led to the formula (10.21) to obtain the number in question being equal to

$$\begin{aligned} & |L((0,0) \rightarrow (c,d) \mid R_m)| \\ &= \sum_{i=0}^{y_{m-1}} |L((0,0) \rightarrow (\mu_m i + v_m - 1, i) \mid R_m)| \\ &\quad \cdot |L((\mu_m i + v_m, i) \rightarrow (c,d) \mid x \geq \mu_m y + v_m)| \\ &= \sum_{i=0}^{y_{m-1}} |L((0,0) \rightarrow (\mu_m i + v_m - 1, i) \mid R_{m-1})| \\ &\quad \cdot \frac{c - \mu_m d - v_m + 1}{c + d - i(\mu_m + 1) - v_m + 1} \binom{c + d - i(\mu_m + 1) - v_m + 1}{d - i}, \end{aligned}$$

by virtue of Theorem 10.4.5. In the summand, we were allowed to replace R_m by R_{m-1} since the summation ends at $i = y_{m-1}$, and thus the m -th segment does not come into play.

Evidently, if the piecewise linear boundary should not be convex, then this argument breaks down. However, Niederhausen shows in [98, Sec. 2.2], using the polynomiality of the path numbers (and some results from umbral calculus), that the above formula continues to hold in that case also, even if the substitution of $\mu_m i + v_m - 1$ in the argument of the polynomial $L_{R_{m-1},i}(\cdot)$ has no combinatorial meaning anymore.

10.7. Simple paths with general boundaries

The most general problem to encounter is to count paths in a region that is bounded by nonlinear upper and lower boundaries as exemplified in Figure 10.

To have a convenient notation, let $a_1 \leq a_2 \leq \dots \leq a_n$ and $b_1 \leq b_2 \leq \dots \leq b_n$ be integers with $a_i \geq b_i$. We abbreviate $\mathbf{a} = (a_1, a_2, \dots, a_n)$ and $\mathbf{b} = (b_1, b_2, \dots, b_n)$. By $L((0, b_1) \rightarrow (n, a_n) \mid \mathbf{a} \geq \mathbf{y} \geq \mathbf{b})$ we denote the set of all lattice paths from $(0, b_1)$ to (n, a_n) that satisfy the property that for all $i = 1, 2, \dots, n$ the height y_i of the i -th horizontal step is in the interval $[b_i, a_i]$. If we also write $\mathbf{y}(P) = (y_1, y_2, \dots, y_n)$ for the sequence of heights of horizontal steps of a path P , then the notation just introduced explains itself. Pictorially (see Figure 10), the described restriction means that we consider paths in a ladder-shaped region, the upper ladder being determined by \mathbf{a} , the lower ladder being determined by \mathbf{b} . See Figure 11, which displays an example with $n = 6$, $\mathbf{a} = (3, 5, 7, 8, 8, 8)$, $\mathbf{b} = (0, 1, 1, 2, 5, 5)$, $\mathbf{y}(P_0) = (2, 2, 2, 4, 6, 8)$.

Originally, the result below was derived by Kreweras [85] using recurrence relations, but the most conceptual and most elegant way to attack this problem is by the method of non-intersecting lattice paths; see Section 10.13 and [115].

THEOREM 10.7.1. *Let $\mathbf{a} = (a_1, a_2, \dots, a_n)$ and $\mathbf{b} = (b_1, b_2, \dots, b_n)$ be integer sequences with $a_1 \leq a_2 \leq \dots \leq a_n$, $b_1 \leq b_2 \leq \dots \leq b_n$, and $a_i \geq b_i$, $i = 1, 2, \dots, n$.*

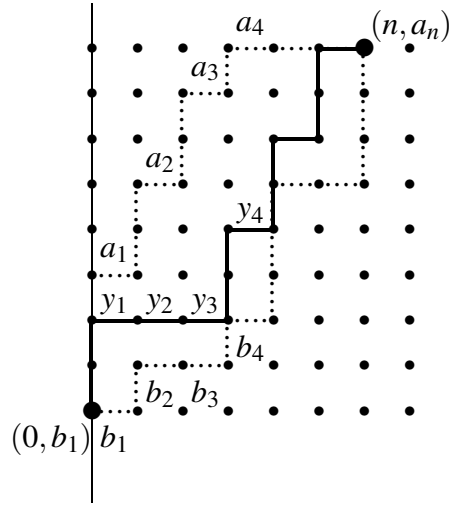

FIGURE 10.

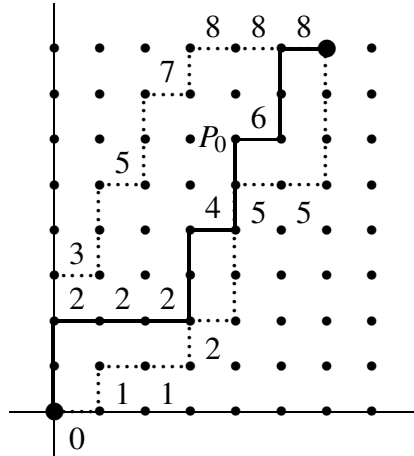

FIGURE 11. Lattice path with a general boundary

The number of all paths from $(0, b_1)$ to (n, a_n) satisfying the property that for all $i = 1, 2, \dots, n$ the height of the i -th horizontal step is between b_i and a_i is given by

$$|L((0, b_1) \rightarrow (n, a_n) \mid \mathbf{a} \geq \mathbf{y} \geq \mathbf{b})| = \det_{1 \leq i, j \leq n} \left(\binom{a_i - b_j + 1}{j - i + 1} \right). \quad (10.41)$$

PROOF. We apply Theorem 10.13.3 with $\lambda = (1, 1, \dots, 1)$ and $\mu = (0, 0, \dots, 0)$, both vectors containing n entries. This counts vectors $(\pi_1, \pi_2, \dots, \pi_n)$ with $\pi_1 < \pi_2 < \dots < \pi_n$ with a lower and an upper bound on each π_i . By replacing π_i by $\pi_i - i$, this counting problem is translated into the counting problem we consider here, $\pi_i - i$ corresponding to the height of the i -th horizontal step of a path. \square

Of course, with increasing n this formula will become less tractable. An alternative formula can be obtained by rotating the whole picture by 90° and applying formula (10.41) to the new situation. Now the size of the determinant is a_n , which is

smaller than before if $a_n < n$, i.e., if the difference between the y -coordinates of end and starting point is less than the difference between the respective x -coordinates.

In some cases, a different type of formula might be preferable, which one may obtain by the so-called *dummy path technique*, as proposed in Krattenthaler and Mohanty [83]. Again, it comes from non-intersecting lattice paths. It is based on the following observation (see Stanley [112, Ex. 2.7.2]).

LEMMA 10.7.2. *Let C_1, C_2, \dots, C_n be pairwise distinct points in \mathbb{Z}^2 . Then the number of lattice paths from (a, b) to (c, d) which avoid C_1, C_2, \dots, C_n is given by*

$$\det_{1 \leq i, j \leq n+1} (|L(A_j \rightarrow E_i)|), \quad (10.42)$$

where $A_1 = (a, b)$, $A_2 = C_1, \dots, A_{n+1} = C_n$, $E_1 = (c, d)$, $E_2 = C_1, \dots, E_{n+1} = C_n$.

PROOF. We reformulate our counting problem in that we want to determine the number of families $(P_1, P_2, \dots, P_{n+1})$ of non-intersecting lattice paths, where P_1 runs from $A_1 = (a, b)$ to $E_1 = (c, d)$, and for $i = 1, 2, \dots, n$ the “dummy path” P_{i+1} runs from $A_{i+1} = C_i$ to $E_{i+1} = C_i$. By Theorem 10.13.1, with G the directed graph with vertices \mathbb{Z}^2 and edges given by horizontal and vertical unit steps in the positive direction, all weights being 1, A_i and E_i as above, this number equals the determinant in (10.42). \square

The idea now is that, given some (possibly two-sided) boundary, one “describes” this boundary by such “dummy points” (paths) and uses the above lemma to compute the number of paths which avoid these, thus avoiding the boundary. In cases the boundary can be “described” by only very few “dummy points”, this may lead to a useful formula. Several formulae which appear in the literature are instances of this idea (sometimes of minor variations), although it may not be stated there that way; see [95, Theorem 2 on p. 36] and [83] and the references given there.

10.8. Elementary results on Motzkin and Schröder paths

The subject of this section and the following three sections is lattice paths in \mathbb{Z}^2 which consist of *up-steps* $(1, 1)$, *down-steps* $(1, -1)$, and *level-steps* $(1, 0)$ or $(2, 0)$, and which do not pass below the x -axis. If the only allowed level-steps are unit steps $(1, 0)$, then the corresponding paths are called *Motzkin paths*. If the only allowed level-steps are double steps $(2, 0)$, then the corresponding paths are called *Schröder paths*. We call the special paths which consist of just up- and down-steps (but contain no level-steps) *Catalan paths*. In the special case, where these paths start and end on the x -axis, they are commonly called *Dyck paths*.

Let $M = \{(1, 1), (1, -1), (1, 0)\}$ and $S = \{(1, 1), (1, -1), (2, 0)\}$, so that M is the set of steps allowed in Motzkin paths (see Figure 12 for an example) and S is the set of steps allowed in Schröder paths (see Figure 13 for an example).

A frequently used alternative way to view Schröder paths is by reflecting the picture with respect to the x -axis, rotating the result by 45° , and finally scaling everything by a factor of $1/\sqrt{2}$, so that the steps $(1, 1), (1, -1), (2, 0)$ are replaced by the steps $(1, 0), (0, 1), (1, 1)$, in that order. Figure 15 shows the result of this translation when applied to the Schröder path in Figure 13. It translates Schröder paths

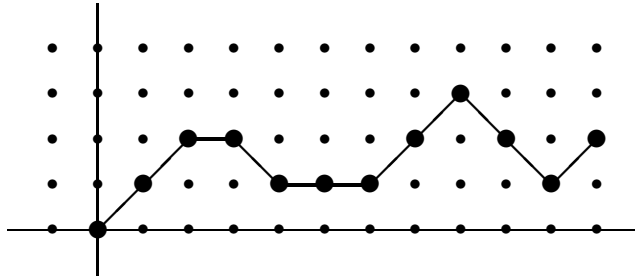

FIGURE 12. A Motzkin path

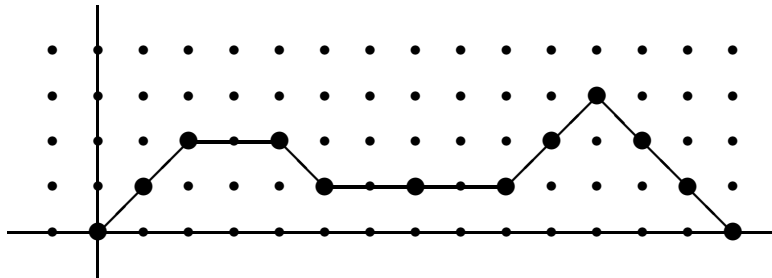

FIGURE 13. A Schröder path

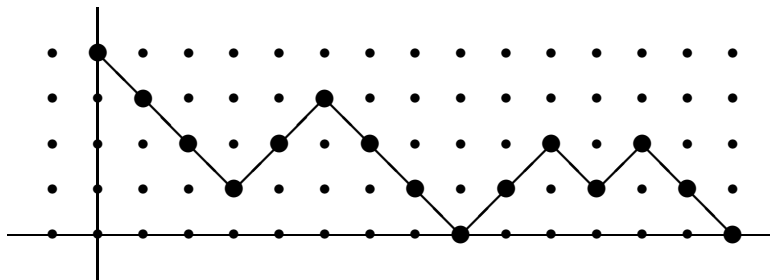

FIGURE 14. A Catalan path

into paths which consist of unit horizontal and vertical steps in the positive direction and of upwards diagonal steps, and which stay weakly below the main diagonal $y = x$. Without the diagonal restriction, the counting problem would be solved by the Delannoy numbers in (10.6).

Nevertheless, this translation, combined with Theorem 10.3.1, already tells us how to enumerate Motzkin and Schröder paths with given starting and end point.

THEOREM 10.8.1. *Let $b \geq 0$ and $d \geq 0$. The number of all paths from (a, b) to (c, d) which consist of steps out of $M = \{(1, 1), (1, -1), (1, 0)\}$ and do not pass*

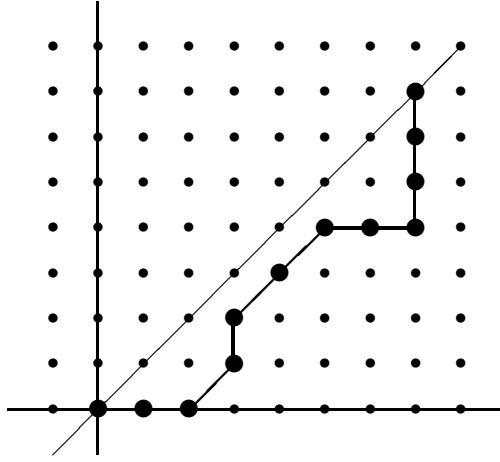

FIGURE 15. A Schröder path rotated-reflected

below the x -axis (Motzkin paths) is given by

$$|L((a,b) \rightarrow (c,d); M \mid y \geq 0)| = \sum_{k=0}^{c-a} \binom{c-a}{k} \left(\binom{c-a-k}{(c+d-k-a-b)/2} - \binom{c-a-k}{(c+d-k-a+b+2)/2} \right), \quad (10.43)$$

where, by convention, a binomial coefficient is 0 if its bottom parameter is not an integer.

Furthermore, the number of all paths from (a,b) to (c,d) which consist of steps out of $S = \{(1,1), (1,-1), (2,0)\}$ and do not pass below the x -axis (Schröder paths) is given by

$$|L((a,b) \rightarrow (c,d); S \mid y \geq 0)| = \sum_{k=0}^{(c-a)/2} \binom{c-a-k}{k} \cdot \left(\binom{c-a-2k}{(c+d-2k-a-b)/2} - \binom{c-a-2k}{(c+d-2k-a+b+2)/2} \right), \quad (10.44)$$

with the same convention for binomial coefficients.

PROOF. By the above described translation (reflection + rotation), a Motzkin path from (a,b) to (c,d) with exactly k level-steps is translated into a path from $(\frac{a+b}{2}, \frac{a-b}{2})$ to $(\frac{c+d}{2}, \frac{c-d}{2})$, which consists of steps from $\{(1,0), (0,1), (\frac{1}{2}, \frac{1}{2})\}$, among them exactly k diagonal steps $(\frac{1}{2}, \frac{1}{2})$, and which stays weakly below the main diagonal $y = x$. Clearly, if we remove the k diagonal steps and concatenate the resulting path pieces, we obtain a simple path from $(\frac{a+b}{2}, \frac{a-b}{2})$ to $(\frac{c+d}{2} - \frac{k}{2}, \frac{c-d}{2} - \frac{k}{2})$ which stays weakly below $y = x$. The number of the latter paths was determined in Theorem 10.3.1. On the other hand, there are $\binom{c-a}{k}$ ways to reinsert the k diagonal steps. Thus, Eq. (10.43) is established.

The proof of (10.44) is analogous. \square

We will derive expressions for corresponding generating functions in Section 10.9, see Theorem 10.9.2.

It is worth stating the special case of Theorem 10.8.1 where the paths start and terminate on the x -axis separately.

COROLLARY 10.8.2. *The number of Motzkin paths from $(0,0)$ to $(n,0)$ is given by*

$$|L((0,0) \rightarrow (n,0); M \mid y \geq 0)| = \sum_{k=0}^{\lfloor n/2 \rfloor} \binom{n}{2k} \frac{1}{k+1} \binom{2k}{k}. \quad (10.45)$$

If n is even, the number of Schröder paths from $(0,0)$ to $(n,0)$ is given by

$$|L((0,0) \rightarrow (n,0); S \mid y \geq 0)| = \sum_{k=0}^{n/2} \binom{n/2+k}{2k} \frac{1}{k+1} \binom{2k}{k}. \quad (10.46)$$

The numbers in (10.45) are called *Motzkin numbers*. The numbers in (10.46) are called *large Schröder numbers*. If $n \geq 1$, the latter are all divisible by 2 (which is easily seen by switching the first occurrence of a level-step with a pair consisting of an up-step and a down-step, and vice versa). Dividing these numbers by 2, we obtain the *little Schröder numbers*. Similarly to Catalan numbers, also Motzkin and Schröder numbers appear in numerous contexts; see [113, Ex. 6.38 and 6.39].

The summations in (10.43) and (10.44) do not simplify, not even in the special cases given in (10.45) and (10.46).

In concluding this section, we point out that Motzkin paths, or, more precisely, *decorated* Motzkin paths, are of utmost importance for the enumeration of many other combinatorial objects, most importantly for the enumeration of permutations and (set) partitions. A decorated Motzkin path (in the french literature: “*histoire*”) is a Motzkin path in which each step carries a certain label. In terms of enumeration, one may consider this as allowing several different steps of the same kind: for example, several different horizontal steps, etc. In terms of generating functions, this labelling is reflected by appropriate weights of the steps. The importance of decorated Motzkin paths comes from the fact that several bijections have been constructed between them and permutations or partitions, which have the property that they “transfer” detailed information about permutations or partitions to the world of (decorated) Motzkin paths, allowing for very refined enumeration results for permutations and partitions. Such bijections have been constructed by Biane [9], Foata and Zeilberger [44], Françon and Viennot [46], Médicis and Viennot [94], and by Simion and Stanton [107]. See [33] for a unifying view.

10.9. A continued fraction for the weighted counting of Motzkin paths

We now assign a weight to each Motzkin path which starts and ends on the x -axis, and express the corresponding generating function in terms of a *continued fraction*. The corresponding result is due to Flajolet [42]. The weight is so general that the result also covers Schröder paths and Catalan paths.

Given a Motzkin path P , we define the weight $w(P)$ to be the product of the weights of all its steps, where the weight of an up-step is 1 (hence, does not contribute anything to the weight), the weight of a level-step at height h is b_h , and the

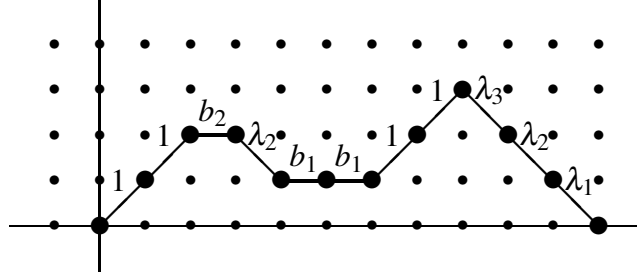

FIGURE 16.

weight of a down-step from height h to $h - 1$ is λ_h . Figure 16 shows a Motzkin path the steps of which are labelled by their corresponding weights, so that the weight of the path is $b_2\lambda_2b_1b_1\lambda_3\lambda_2\lambda_1 = b_1^2b_2\lambda_1\lambda_2^2\lambda_3$.

Then the following theorem is true.

THEOREM 10.9.1. *With the weight w defined as above, the generating function for Motzkin paths running from the origin back to the x -axis, which stay weakly below the line $y = k$, is given by*

$$\begin{aligned} GF(L((0,0) \rightarrow (*,0); M \mid 0 \leq y \leq k); w) \\ = \frac{1}{1 - b_0 - \frac{\lambda_1}{1 - b_1 - \frac{\lambda_2}{1 - b_2 - \dots - \frac{\lambda_k}{1 - b_k}}}}. \end{aligned} \quad (10.47)$$

In particular, the generating function for all Motzkin paths running from the origin back to the x -axis is given by the infinite continued fraction

$$GF(L((0,0) \rightarrow (*,0); M \mid 0 \leq y); w) = \frac{1}{1 - b_0 - \frac{\lambda_1}{1 - b_1 - \frac{\lambda_2}{1 - b_2 - \dots}}}. \quad (10.48)$$

PROOF. Clearly, it suffices to prove (10.47). Equation (10.48) then follows upon letting $k \rightarrow \infty$.

We prove (10.47) by induction on k . For $k = 0$, Equation (10.47) is trivially true. Hence, let us assume the truth of (10.47) for k replaced by $k - 1$. For accomplishing the induction step, we consider a Motzkin path starting at the origin, staying weakly below $y = k$, and finally returning to the x -axis, see Figure 17 for an example with $k = 3$.

Such a path can be uniquely decomposed into

$$l^{e_0}uP_1dl^{e_1}uP_2dl^{e_2}\dots,$$

where l denotes a level-step at height 0, u an up-step, and d a down-step, where e_i are non-negative integers, and where, for any i , P_i is some path between the lines

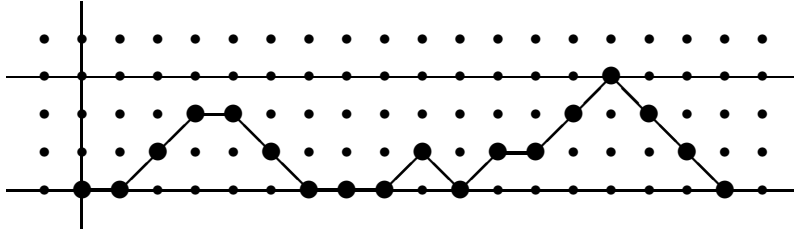

FIGURE 17.

$y = 1$ and $y = k$ which starts at and returns to the line $y = 1$. For example, this decomposition applied to the path in Figure 17 yields

$$l^1 u P_1 d l^2 u P_2 d l^0 u P_3 d,$$

where $P_1 = uld$, P_2 is the empty path, and $P_3 = luudd$. This implies immediately the generating function equation

$$\begin{aligned} GF(L((0,0) \rightarrow (*,0); M \mid 0 \leq y \leq k); w) \\ = \frac{1}{1 - b_0 - \lambda_1 \cdot GF(L((0,1) \rightarrow (*,1); M \mid 1 \leq y \leq k); w)}. \end{aligned}$$

By induction, the generating function on the right-hand side is known: it is given by (10.47) with k replaced by $k - 1$, b_i replaced by b_{i+1} , and λ_i replaced by λ_{i+1} , for all i . This completes the induction step. \square

This result has numerous consequences. First of all, it allows us to derive algebraic expressions for the generating functions $\sum_{n \geq 0} M_n z^n$ and $\sum_{n \geq 0} S_n z^n$, where M_n denotes the number of all Motzkin paths from $(0,0)$ to $(n,0)$, and where S_n denotes the number of all Schröder paths from $(0,0)$ to $(2n,0)$. By definition, $M_0 = S_0 = 1$. The numbers M_n are called *Motzkin numbers*, while the numbers S_n are called *large Schröder numbers*.

THEOREM 10.9.2. *We have*

$$\sum_{n \geq 0} M_n z^n = \frac{1 - z - \sqrt{1 - 2z - 3z^2}}{2z^2} \quad (10.49)$$

and

$$\sum_{n \geq 0} S_n z^n = \frac{1 - z - \sqrt{1 - 6z + z^2}}{2z}. \quad (10.50)$$

PROOF. By (10.48) with $b_i = z$ and $\lambda_i = z^2$ for all i (the reader should note that for any down-step there is a corresponding up-step before), we have

$$\sum_{n \geq 0} M_n z^n = \frac{1}{1 - z - \frac{z^2}{1 - z - \frac{z^2}{1 - z - \dots}}}$$

Thus, in particular, we have $M(z) = 1/(1 - z - z^2 M(z))$. The appropriate solution of this quadratic equation is exactly the right-hand side of (10.49).

Similarly, by setting $b_i = \lambda_i = z^2$ in (10.48) for all i , we obtain

$$\sum_{n \geq 0} S_n z^{2n} = \frac{1}{1 - z^2 - \frac{z^2}{1 - z^2 - \frac{z^2}{1 - z^2 - \dots}}},$$

and eventually (10.50) after solving the analogous quadratic equation. \square

In Section 10.11, we will express the continued fraction (10.47) in numerator/denominator form, the numerator and denominator being orthogonal polynomials.

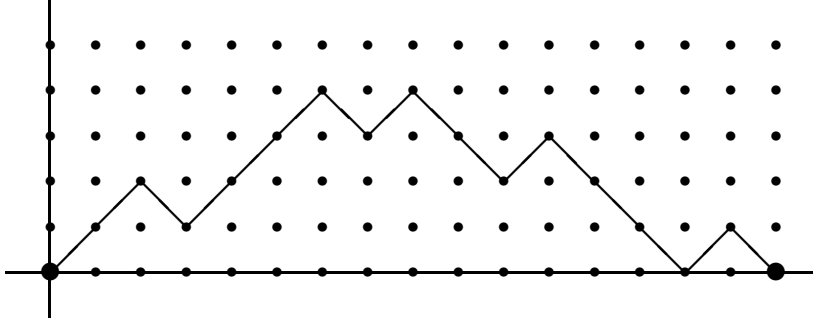

FIGURE 18.

We conclude this section with another continued fraction result, due to Roblet and Viennot [102]. We restrict our attention to Dyck paths, that is, to paths consisting of up- and down-steps, starting at the origin and returning to the x -axis, and never running below the x -axis. We refine the earlier defined weight w in the following way, so that in addition it also takes into account peaks: given a Dyck path P , we define the weight $\hat{w}(P)$ of P to be the product of the weights of all its steps, where the weight of an up-step is 1, the weight of a down-step from height h to $h-1$ which follows immediately after an up-step (thus, together, forming a peak of the path) is v_h , and where the weight of a down-step from height h to $h-1$ which follows after another down-step is λ_h . Thus, the weight of the Dyck path in Figure 18 is $v_2 v_4 v_4 \lambda_3 v_3 \lambda_2 \lambda_1 v_1 = v_1 v_2 v_3 v_4^2 \lambda_1 \lambda_2 \lambda_3$. With these definitions, the theorem of Roblet and Viennot [102, Prop. 1] reads as follows.

THEOREM 10.9.3. *With the weight \hat{w} defined as above, the generating function $\sum_P \hat{w}(P)$, where the sum is over all Dyck paths starting at the origin and returning to the x -axis, is given by*

$$\begin{aligned} & GF(L((0,0) \rightarrow (*,0); \{(1,1), (1,-1)\} \mid y \geq 0); \hat{w}) \\ &= \frac{1}{1 - (v_1 - \lambda_1) - \frac{\lambda_1}{1 - (v_2 - \lambda_2) - \frac{\lambda_2}{1 - (v_3 - \lambda_3) - \dots}}}. \end{aligned} \quad (10.51)$$

10.10. Lattice paths and orthogonal polynomials

Orthogonal polynomials play an important role in many different subject areas, may they be pure or applied. The reader is referred to [117] for an in-depth introduction. It is well-known that the theory of orthogonal polynomials is intimately connected with Hankel determinants and continued fractions, which we just discussed in Section 10.9 from a combinatorial point of view. It is Viennot [119] who made the connection, and who showed that a large part of the theory of orthogonal polynomials is in fact combinatorics. The key objects in this *combinatorial theory of orthogonal polynomials* are *Motzkin paths*. If one is forced to, one may compress the interplay between the theory of orthogonal polynomials and path enumeration to two key facts: first, (generalized) moments of orthogonal polynomials are generating functions for Motzkin paths, see Theorem 10.10.3; second, generating functions for bounded Motzkin paths can be expressed in terms of orthogonal polynomials; see Theorem 10.11.1. But, of course, this combinatorial theory of orthogonal polynomials has much more to offer, of which we present an extract in this section, with a focus on path enumeration.

We call a sequence $(p_n(x))_{n \geq 0}$ of polynomials over \mathbb{C} , where $p_n(x)$ is of degree n , *orthogonal* if there exists a linear functional L on polynomials over \mathbb{C} (i.e., a linear map, which maps a polynomial to a complex number) such that

$$L(p_n(x)p_m(x)) = \begin{cases} 0, & \text{if } n \neq m, \\ \text{nonzero}, & \text{if } n = m. \end{cases} \quad (10.52)$$

We alert the reader that our definition deviates from the classical *analytic* definition in that we *do not* require $L(p_n(x)^2)$ to be *positive*. The above somewhat weaker notion of orthogonality is sometimes referred to as *formal orthogonality*. The term ‘formal’ expresses the fact that the corresponding theory does not require any analytic tools, just formal, algebraic arguments. In fact, the formal theory could be equally well developed over any field K of characteristic 0 (instead of over \mathbb{C}).

It is easy to see that it is not true that for every linear functional L there is a corresponding sequence of orthogonal polynomials. Let us consider the example of the linear functional defined by $L(x^n) := 1$, $n = 0, 1, 2, \dots$. Equivalently, this means that $L(p(x)) = p(1)$. In order to construct a corresponding sequence of orthogonal polynomials, we start with $p_0(x)$. This must be a polynomial of degree 0, but otherwise we are completely free. Without loss of generality we may choose $p_0(x) \equiv 1$. To determine $p_1(x)$, we use (10.52) with $m = 0$ and $n = 1$. Thus we obtain $p_1(x) = x - 1$. But then we have $L(p_1(x)^2) = L((x - 1)^2) = 0$, which violates the requirement (10.52), with $m = n = 1$, that $L(p_1(x)^2)$ should be nonzero.

On the other hand, if we have a linear functional L such that there exists a sequence of orthogonal polynomials, then it is easy to see that all other sequences are just linear multiples of the former sequence.

LEMMA 10.10.1. *Let L be a linear functional on polynomials and $(p_n(x))_{n \geq 0}$ be a sequence of polynomials orthogonal with respect to L . If $(q_n(x))_{n \geq 0}$ is another sequence of polynomials orthogonal with respect to L , then there are nonzero numbers $a_n \in \mathbb{C}$ such that $q_n(x) = a_n p_n(x)$.*

Lemma 10.10.1 justifies that from now on we will restrict our attention to sequences of *monic* polynomials.

One of the key results in the theory of orthogonal polynomials is *Favard's Theorem*, which we state next.

THEOREM 10.10.2. *A sequence $(p_n(x))_{n \geq 0}$ of monic polynomials, $p_n(x)$ being of degree n , is orthogonal if and only if there exist sequences $(b_n)_{n \geq 0}$ and $(\lambda_n)_{n \geq 1}$, with $\lambda_n \neq 0$ for all $n \geq 1$, such that the three-term recurrence*

$$xp_n(x) = p_{n+1}(x) + b_n p_n(x) + \lambda_n p_{n-1}(x), \quad \text{for } n \geq 1, \quad (10.53)$$

holds, with initial conditions $p_0(x) = 1$ and $p_1(x) = x - b_0$.

In our context, more important than the statement of the theorem itself is its proof, which introduces Motzkin paths in a surprising way in (10.57), and in particular Theorem 10.10.3 below, which is the key ingredient in the proof, given after the proof of Theorem 10.10.3.

THEOREM 10.10.3. *Let the polynomials $p_n(x)$ be given by the three-term recurrence (10.53), and let L be the linear functional defined by $L(1) = 1$ and $L(p_n(x)) = 0$ for $n \geq 1$. Then*

$$L(x^n p_k(x) p_l(x)) = \lambda_1 \cdots \lambda_l \cdot GF(L((0, k) \rightarrow (n, l); M \mid 0 \leq y); w), \quad (10.54)$$

where w is the weight on Motzkin paths defined in Section 10.9.

PROOF. We prove the assertion by induction on n .

If $n = 0$, then we have to show

$$L(p_k(x) p_l(x)) = \lambda_1 \cdots \lambda_l \cdot \delta_{k,l}, \quad (10.55)$$

where $\delta_{k,l}$ denotes the Kronecker delta. We establish this claim by induction on $k + l$. It is obviously true for $k = l = 0$. Without loss of generality, we assume $k \geq l$. Then, using the three-term recurrence (10.53) twice, together with the induction hypothesis, we have

$$\begin{aligned} L(p_k(x) p_l(x)) &= L(p_k(x) x p_{l-1}(x)) - b_{l-1} L(p_k(x) p_{l-1}(x)) - \lambda_{l-1} L(p_k(x) p_{l-2}(x)) \\ &= L(x p_k(x) p_{l-1}(x)) \\ &= L(p_{k+1}(x) p_{l-1}(x)) + b_k L(p_k(x) p_{l-1}(x)) + \lambda_k L(p_{k-1}(x) p_{l-1}(x)) \\ &= \lambda_k L(p_{k-1}(x) p_{l-1}(x)). \end{aligned}$$

Clearly, this achieves the induction step, and thus establishes (10.55).

We may now continue with the induction on n . For the induction step, we apply (10.53) with $n = k$ on the left-hand side of (10.54). This leads to

$$\begin{aligned} L(x^n p_k(x) p_l(x)) &= L(x^{n-1} p_{k+1}(x) p_l(x)) + b_k L(x^{n-1} p_k(x) p_l(x)) + \lambda_k L(x^{n-1} p_{k-1}(x) p_l(x)). \end{aligned}$$

By the induction hypothesis, we may interpret the right-hand side of this equality as generating function for Motzkin paths, as described by (10.54) with n replaced by $n - 1$. It is then straightforward to see that this implies (10.54) itself. \square

Now we have all the prerequisites available in order to prove Theorem 10.10.2.

Proof of Theorem 10.10.2 For showing the forward implication, let $(p_n(x))_{n \geq 0}$ be a sequence of monic polynomials, $p_n(x)$ of degree n , which is orthogonal with respect to the linear functional L . Then we can express $xp_n(x)$ in terms of a linear combination of the polynomials $p_{n+1}(x), p_n(x), \dots, p_0(x)$,

$$xp_n(x) = p_{n+1}(x) + b_n p_n(x) + \lambda_n p_{n-1}(x) + \omega_{n,n-2} p_{n-2}(x) + \dots + \omega_{n,0} p_0(x). \quad (10.56)$$

We have to show that in fact the first three terms on the right-hand side suffice, i.e., that all other terms are zero.

In order to do that, we multiply both sides of (10.56) by $p_i(x)$, for some $i < n-1$, and apply L on both sides. Because of (10.52), on the right-hand side it is only the term $\omega_{n,i} L(p_i(x)^2)$ which survives. On the left-hand side we obtain $L(xp_i(x)p_n(x))$. The polynomial $xp_i(x)$ of degree $i+1$ can be expressed as a linear combination of the polynomials $p_{i+1}(x), p_i(x), \dots, p_0(x)$. Because of (10.52) and $i < n-1$, we therefore conclude that $L(xp_i(x)p_n(x)) = 0$. Hence, $\omega_{n,i}$ is indeed 0 for $i < n-1$. Similarly, we have

$$\lambda_n L(p_{n-1}(x)^2) = L(xp_{n-1}(x)p_n(x)) = L(p_n(x)^2),$$

which is nonzero because of (10.52). Hence, we have $\lambda_n \neq 0$, as desired.

For the proof of the backward implication, we must construct a linear functional L such that (10.52) holds, given a sequence $(p_n(x))$ of polynomials, $p_n(x)$ of degree n , satisfying the three-term recurrence (10.53). We construct L by defining $L(1) = 1$ and $L(p_n(x)) = 0$ for $n \geq 1$. Theorem 10.10.3 with $n = 0$ immediately implies that $L(p_k(x)p_l(x)) = 0$ if $k \neq l$, as there is no Motzkin path from $(0, k)$ to $(0, l)$, and that $L(p_k(x)^2) = \lambda_1 \cdots \lambda_k \neq 0$. This completes the proof of the theorem.

In the above proof, we have found a linear functional L by defining (cf. Theorem 10.10.3) its moments $\mu_n := L(x^n)$ to be generating functions for Motzkin paths, namely

$$\mu_n = GF(L((0,0) \rightarrow (n,0); M \mid 0 \leq y); w) = \sum_{\substack{P \text{ a Motzkin path} \\ \text{from } (0,0) \text{ to } (n,0)}} w(P), \quad (10.57)$$

the weights of the paths carrying the coefficients in the three-term recurrence (10.53). This definition generates a linear functional with $\mu_0 = L(1) = 1$. It is easy to see that all other such linear functionals are constant nonzero multiples of the linear functional defined by (10.57). This justifies to restrict ourselves to linear functionals with first moment equal to 1.

In view of Theorem 10.9.1, the backward implication of Theorem 10.10.2 can also be phrased in the following way.

COROLLARY 10.10.4. *Let $(p_n(x))_{n \geq 0}$ be a sequence of polynomials satisfying the three-term recurrence (10.53) with initial conditions $p_0(x) = 1$ and $p_1(x) = x - b_0$. Then $(p_n(x))_{n \geq 0}$ is orthogonal with respect to the linear functional L , where the*

generating function of its moments $\mu_n = L(x^n)$ is given by

$$\sum_{n \geq 0} \mu_n z^n = \frac{1}{1 - b_0 z - \frac{\lambda_1 z^2}{1 - b_1 z - \frac{\lambda_2 z^2}{1 - b_2 z - \dots}}}. \quad (10.58)$$

All other linear functionals with respect to which the sequence $(p_n(x))_{n \geq 0}$ is orthogonal are constant nonzero multiples of L .

REMARK 10.10.5. A continued fraction of the type (10.58) is called a *Jacobi continued fraction* or *J-fraction*.

Proof of Corollary 10.10.4 Combine (10.57) and (10.48) with b_i replaced by $b_i z$ and λ_i replaced by $\lambda_i z$.

Below, we illustrate what we have found so far by an example. The polynomials which appear in this example, the *Chebyshev polynomials*, are of particular importance for path counting.

EXAMPLE 10.10.6. We choose $b_i = 0$ and $\lambda_i = 1$ for all i . Then the three-term recurrence (10.53) becomes

$$x u_n(x) = u_{n+1}(x) + u_{n-1}(x), \quad \text{for } n \geq 1, \quad (10.59)$$

with initial values $u_0(x) = 1$ and $u_1(x) = x$. These polynomials are, up to reparametrization, *Chebyshev polynomials of the second kind*. To see that, recall that the latter are defined by

$$U_n(\cos \vartheta) = \frac{\sin((n+1)\vartheta)}{\sin \vartheta},$$

or, equivalently,

$$U_n(x) = \frac{\sin((n+1) \arccos x)}{\sqrt{1-x^2}}.$$

Because of the easily verified fact that

$$\sin((n+1)\vartheta) + \sin((n-1)\vartheta) = 2 \cos \vartheta \sin n\vartheta,$$

the Chebyshev polynomials of the second kind satisfy the three-term recurrence

$$2x U_n(x) = U_{n+1}(x) + U_{n-1}(x), \quad \text{for } n \geq 1, \quad (10.60)$$

with initial values $U_0(x) = 1$ and $U_1(x) = 2x$. Therefore we have

$$U_n(x) = u_n(2x) \quad (10.61)$$

for all n .

It is straightforward to verify

$$U_n(x) = \sum_{k \geq 0} (-1)^k \binom{n-k}{k} (2x)^{n-2k}, \quad (10.62)$$

whence, by (10.61), we have

$$u_n(x) = \sum_{k \geq 0} (-1)^k \binom{n-k}{k} x^{n-2k}.$$

Another well-known fact is

$$\frac{2}{\pi} \int_0^\pi \sin((n+1)\vartheta) \sin((m+1)\vartheta) d\vartheta = \begin{cases} 1, & n = m, \\ 0, & n \neq m. \end{cases}$$

Substitution of $x = \cos \vartheta$ then yields

$$\frac{2}{\pi} \int_{-1}^1 U_n(x) U_m(x) \sqrt{1-x^2} dx = \delta_{nm}. \quad (10.63)$$

Thus the linear functional L for Chebyshev polynomials of the second kind is given by

$$L(p(x)) = \frac{2}{\pi} \int_0^\pi p(x) \sqrt{1-x^2} dx.$$

Using (10.57) we can now easily compute the corresponding moments. On the right-hand side of (10.57) all the terms corresponding to paths which contain a level-step vanish, because $b_i = 0$ for all i . Therefore, what the right-hand side counts are paths which contain only up-steps and down-steps (and never pass below the x -axis). Clearly, there cannot be such a path if n is odd. If n is even, then by (10.11) the number of these paths is the Catalan number $\frac{1}{n/2+1} \binom{n}{n/2}$. Hence, by also taking into account (10.61), we have shown that

$$\frac{2}{\pi} \int_{-1}^1 x^m \sqrt{1-x^2} dx = \begin{cases} \frac{1}{4^n} \frac{1}{n+1} \binom{2n}{n}, & m = 2n, \\ 0, & m = 2n+1. \end{cases}$$

Chebyshev polynomials are not only tied to Catalan paths (Dyck paths), i.e., paths that consist of just up- and down-steps, but also to Motzkin paths. To see this, let us now choose $b_i = \lambda_i = 1$ for all i . Then the three-term recurrence (10.53) becomes

$$xm_n(x) = m_{n+1}(x) + m_n(x) + m_{n-1}(x), \quad \text{for } n \geq 1, \quad (10.64)$$

with initial values $m_0(x) = 1$ and $m_1(x) = x - 1$. Comparison with (10.60) reveals that these polynomials are expressible by means of Chebyshev polynomials of the second kind as

$$m_n(x) = U_n \left(\frac{x-1}{2} \right). \quad (10.65)$$

We will take advantage of this relation in Section 10.11 to obtain further enumerative results on Motzkin paths.

We now come back to the earlier observed fact that not all linear functionals allow for a corresponding sequence of orthogonal polynomials. Which linear functionals do is told by the following theorem. The criterion is given in terms of *Hankel determinants* of the moments of L . A Hankel determinant (or *persymmetric* or *Turánian determinant*) is a determinant of a matrix which has constant entries along antidiagonals, i.e., it is a determinant of the form $\det_{1 \leq i, j, \leq n} (a_{i+j})$. We omit the proof here, but Viennot [119, Ch. IV, Cor. 6 and 7] has shown that it can be given by an elegant application of the main theorem on non-intersecting lattice paths, Theorem 10.13.1, by using the interpretation of moments in terms of generating functions for Motzkin paths as given in Theorem 10.10.3.

THEOREM 10.10.7. *Let L be a linear functional on polynomials with n -th moment $\mu_n = L(x^n)$. For any non-negative integer n let*

$$\Delta_n = \det \begin{pmatrix} \mu_0 & \mu_1 & \mu_2 & \dots & \mu_n \\ \mu_1 & \mu_2 & \dots & \dots & \mu_{n+1} \\ \mu_2 & \dots & \dots & \dots & \mu_{n+2} \\ \vdots & & & & \vdots \\ \mu_n & \dots & \dots & \dots & \mu_{2n} \end{pmatrix}$$

and

$$\chi_n = \det \begin{pmatrix} \mu_0 & \mu_1 & \dots & \mu_{n-1} & \mu_n \\ \mu_1 & \mu_2 & \dots & \mu_n & \mu_{n+1} \\ \vdots & \vdots & & \vdots & \vdots \\ \mu_{n-1} & \mu_n & \dots & \mu_{2n-2} & \mu_{2n-1} \\ \mu_{n+1} & \mu_{n+2} & \dots & \mu_{2n} & \mu_{2n+1} \end{pmatrix}$$

Let $(p_n(x))_{n \geq 0}$ be the sequence of monic polynomials which is orthogonal with respect to L . Then the polynomials satisfy the three-term recurrence (10.53) with

$$\lambda_n = \frac{\Delta_n \Delta_{n-2}}{\Delta_{n-1}^2} \quad (10.66)$$

and

$$b_n = \frac{\chi_n}{\Delta_n} - \frac{\chi_{n-1}}{\Delta_{n-1}}. \quad (10.67)$$

In particular, given a linear functional L on the set of polynomials, then there exists a sequence of orthogonal polynomials which are orthogonal with respect to L if and only if all Hankel determinants $\Delta_n = \det_{0 \leq i, j \leq n} (\mu_{i+j})$ of moments are nonzero.

Implicit in (10.66) is the Hankel determinant evaluation

$$\Delta_n = \lambda_1^n \lambda_2^{n-1} \dots \lambda_n^1, \quad (10.68)$$

which expresses the close interplay between Hankel determinants, moments of orthogonal polynomials, and Motzkin path enumeration (via Theorem 10.10.3).

We conclude this section with an explicit, determinantal formula for orthogonal polynomials, given the moments of the orthogonality functional. Again, Viennot [119, Ch. IV, §4] has given a beautiful combinatorial proof for this formula. using non-intersecting lattice paths.

THEOREM 10.10.8. *Let L be a linear functional defined on polynomials with moments $\mu_n = L(x^n)$. Then the corresponding sequence $(p_n(x))_{n \geq 0}$ of monic orthogonal polynomials is given by*

$$p_n(x) = \frac{1}{\Delta_{n-1}} \det \begin{pmatrix} \mu_0 & \mu_1 & \mu_2 & \dots & \mu_n \\ \mu_1 & \mu_2 & \dots & \mu_n & \mu_{n+1} \\ \mu_2 & \dots & \mu_n & \mu_{n+1} & \mu_{n+2} \\ \dots & \dots & \dots & \dots & \dots \\ \mu_{n-1} & \mu_n & \mu_{n+1} & \dots & \mu_{2n-1} \\ 1 & x & \dots & x^{n-1} & x^n \end{pmatrix}, \quad (10.69)$$

where, again, $\Delta_{n-1} = \det_{0 \leq i, j \leq n-1} (\mu_{i+j})$.

PROOF. It suffices to check that $L(x^m p_n(x)) = 0$ for $0 \leq m < n$. Indeed, by (10.69) we have

$$L(x^m p_n(x)) = \frac{1}{\Delta_{n-1}} \det \begin{pmatrix} \mu_0 & \mu_1 & \mu_2 & \dots & \mu_n \\ \mu_1 & \mu_2 & \dots & \mu_n & \mu_{n+1} \\ \mu_2 & \dots & \mu_n & \mu_{n+1} & \mu_{n+2} \\ \dots & \dots & \dots & \dots & \dots \\ \mu_{n-1} & \mu_n & \mu_{n+1} & \dots & \mu_{2n-1} \\ \mu_m & \mu_{m+1} & \dots & \mu_{m+n-1} & \mu_{m+n} \end{pmatrix}.$$

Thus the result is zero, because for $0 \leq m < n$ the m -th and the last row in the above determinant are identical. \square

In Section 10.11 we derive several further enumeration results on Motzkin paths which feature orthogonal polynomials.

We close this section by pointing out that Motzkin paths can be seen as so-called *heaps of pieces*. The corresponding theory has been developed by Viennot [120]. As a matter of fact, it is the combinatorial realization of the *Cartier–Foata monoid* [26].

For further intriguing work on the connections between lattice path counting, Hankel determinants, and continued fractions, the reader is referred to Gessel and Xin [52], and also Sulanke and Xin [116].

10.11. Motzkin paths in a strip

In Sections 10.8 and 10.9 we have derived enumeration results for Motzkin paths which start and terminate on the x -axis. In particular, Theorem 10.9.1 provided a continued fraction for the generating function with respect to a very general weight. This continued fraction can be compactly brought in numerator/denominator form, using orthogonal polynomials. In fact, more generally, a compact expression for the generating function of Motzkin paths which start and terminate at *arbitrary* points can be given, again using orthogonal polynomials.

In order to be able to state the corresponding result, we need two definitions. Recall that, given sequences $(b_n)_{n \geq 0}$ and $(\lambda_n)_{n \geq 1}$, with $\lambda_n \neq 0$ for all $n \geq 1$, the three-term recurrence (10.53),

$$xp_n(x) = p_{n+1}(x) + b_n p_n(x) + \lambda_n p_{n-1}(x), \quad \text{for } n \geq 1, \quad (10.70)$$

with initial conditions $p_0(x) = 1$ and $p_1(x) = x - b_0$, produces a sequence $(p_n(x))_{n \geq 0}$ of orthogonal polynomials. We also need associated “shifted” polynomials (often simply called *associated orthogonal polynomials*), denoted by $(Sp_n(x))_{n \geq 0}$, which arise from the sequence $(p_n(x))$ by replacing λ_i by λ_{i+1} and b_i by b_{i+1} , $i = 0, 1, 2, \dots$, everywhere in the three-term recurrence (10.70) and in the initial conditions. Furthermore, given a polynomial $p(x)$ of degree n , we denote the corresponding *reciprocal polynomial* $x^n p(1/x)$ by $p^*(x)$.

THEOREM 10.11.1. *With the weight w defined as before Theorem 10.9.1, the generating function for Motzkin paths running from height r to height s which stay*

weakly below the line $y = k$ is given by

$$\sum_{n \geq 0} GF(L((0, r) \rightarrow (n, s); M \mid 0 \leq y \leq k); w) x^n = \begin{cases} \frac{x^{s-r} p_r^*(x) S^{s+1} p_{k-s}^*(x)}{p_{k+1}^*(x)}, & \text{if } r \leq s, \\ \lambda_r \cdots \lambda_{s+1} \frac{x^{r-s} p_s^*(x) S^{r+1} p_{k-r}^*(x)}{p_{k+1}^*(x)}, & \text{if } r \geq s. \end{cases} \quad (10.71)$$

In particular, the generating function for Motzkin paths running from the origin back to the x -axis which stay weakly below the line $y = k$, is given by

$$\sum_{n \geq 0} GF(L((0, 0) \rightarrow (n, 0); M \mid 0 \leq y \leq k); w) x^n = \frac{S p_k^*(x)}{p_{k+1}^*(x)}. \quad (10.72)$$

PROOF. Consider the directed graph, P_{k+1} say, with vertices v_0, v_1, \dots, v_k , where for $h = 0, 1, \dots, k-1$ there is an arc from v_h to v_{h+1} as well as an arc from v_{h+1} to v_h , and where there is a loop for each vertex v_h . Motzkin paths which never exceed height k correspond in a one-to-one fashion to walks on P_{k+1} . In this correspondence, an up-step from height h to $h+1$ in the Motzkin path corresponds to a step from vertex v_h to vertex v_{h+1} in the walk, and similarly for level- and down-steps. To make the correspondence also weight-preserving, we attach a weight of 1 to an arc from v_h to v_{h+1} , $h = 0, 1, \dots, k-1$, a weight of λ_h to an arc from v_h to v_{h-1} , and a weight of b_h to a loop at v_h .

By the *transfer matrix method* (see e.g. [112, Theorem 4.7.2]), the generating function for walks from v_r to v_s is given by

$$\frac{(-1)^{r+s} \det(I - xA; s, r)}{\det(I - xA)},$$

where A is the (weighted) *adjacency matrix* of P_{k+1} , where I is the $(k+1) \times (k+1)$ identity matrix, and where $\det(I - xA; s, r)$ is the minor of $(I - xA)$ with the s -th row and r -th column deleted.

Now, the (weighted) adjacency matrix of P_{k+1} with the property that the weight of a particular walk would correspond to the weight w of the corresponding Motzkin path is the tridiagonal matrix

$$A = \begin{pmatrix} b_0 & 1 & 0 & \dots & & & \\ \lambda_1 & b_1 & 1 & 0 & \dots & & \\ 0 & \lambda_2 & b_2 & 1 & 0 & \dots & \\ \vdots & \ddots & \ddots & \ddots & \ddots & \ddots & \vdots \\ & \dots & 0 & \lambda_{k-2} & b_{k-2} & 1 & 0 \\ & & \dots & 0 & \lambda_{k-1} & b_{k-1} & 1 \\ & & & \dots & 0 & \lambda_k & b_k \end{pmatrix}.$$

It is easily verified that, with this choice of A , we have $\det(I - xA) = p_{k+1}^*(x)$ (by expanding the determinant with respect to the last row and comparing with the three-term recurrence (10.53)), and, similarly, that the numerator in (10.71) agrees with $(-1)^{r+s} \det(I - xA; r, s)$. \square

EXAMPLE 10.11.2. We illustrate Theorem 10.11.1 for the special cases which were considered in Example 10.10.6.

Let first $b_i = 0$ and $\lambda_i = 1$ for all i . Combinatorially, we are talking about paths consisting of up- and down-steps, that is, Catalan paths (Dyck paths). Since for this choice of b_i 's and λ_i 's there is no difference between the orthogonal polynomials and the corresponding associated orthogonal polynomials arising from (10.53), Example 10.10.6 tells us that

$$p_n(x) = Sp_n(x) = U_n(x/2).$$

From (10.71), it then follows that

$$\begin{aligned} \sum_{n \geq 0} |L((0, r) \rightarrow (n, s); \{(1, 1), (1, -1)\} | 0 \leq y \leq k)| \cdot x^n \\ = \begin{cases} \frac{U_r(1/2x) U_{k-s}(1/2x)}{x U_{k+1}(1/2x)}, & \text{if } r \leq s, \\ \frac{U_s(1/2x) U_{k-r}(1/2x)}{x U_{k+1}(1/2x)}, & \text{if } r \geq s. \end{cases} \end{aligned} \quad (10.73)$$

Next let $b_i = \lambda_i = 1$ for all i . Combinatorially, we are talking about paths consisting of up-, down-, and level-steps, that is, Motzkin paths. Again, since for this choice of b_i 's and λ_i 's there is no difference between the orthogonal polynomials and the corresponding associated orthogonal polynomials arising from (10.53), Example 10.10.6 tells us that

$$p_n(x) = Sp_n(x) = U_n\left(\frac{x-1}{2}\right).$$

From (10.71), it then follows that

$$\begin{aligned} \sum_{n \geq 0} |L((0, r) \rightarrow (n, s); M | 0 \leq y \leq k)| \cdot x^n \\ = \begin{cases} \frac{U_r\left(\frac{1-x}{2x}\right) U_{k-s}\left(\frac{1-x}{2x}\right)}{x U_{k+1}\left(\frac{1-x}{2x}\right)}, & \text{if } r \leq s, \\ \frac{U_s\left(\frac{1-x}{2x}\right) U_{k-r}\left(\frac{1-x}{2x}\right)}{x U_{k+1}\left(\frac{1-x}{2x}\right)}, & \text{if } r \geq s. \end{cases} \end{aligned} \quad (10.74)$$

EXAMPLE 10.11.3. The standard application of (10.74) concerns the *gambler's ruin problem* (see also [38, Ch. XIV]): two players A and B have initially a and $R - a$ dollars, respectively. They play several rounds, in each of which the probability that player A wins is p_A , the probability that player B wins is p_B , and the probability that there is a tie is $p_T = 1 - p_A - p_B$. If one player wins, (s)he takes a dollar from the other. If there is a tie, nothing happens. The play stops when one of the players is bankrupt. What is the probability that player A , say, goes bankrupt after N rounds?

By disregarding the last round (which is necessarily a round in which B wins), this problem can be represented by a lattice path starting at $(0, a - 1)$, ending at $(N - 1, 0)$, with steps $(1, 1)$ (corresponding to player A to win a round), $(1, -1)$ (corresponding to player B to win a round), and $(1, 0)$ (corresponding to a tie), which does not pass below the x -axis, and which does not pass above the horizontal line

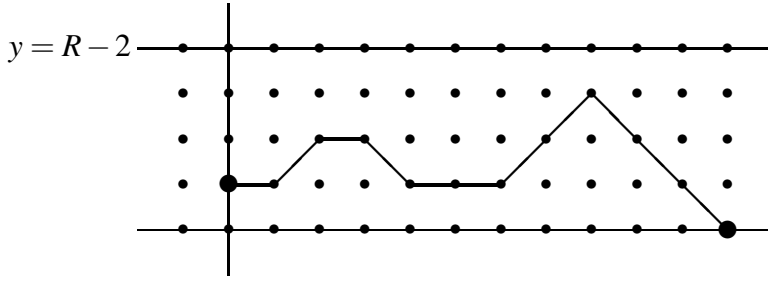

FIGURE 19.

$y = R - 2$. For example, the lattice path in Figure 19 corresponds to the play, where player A starts with 2 dollar, player B starts with 4 dollar, the outcome of the rounds is in turn TATBTAAABBBB (the letter A symbolizing a round where A won, with an analogous meaning of the letter B, and the letter T symbolizing a tie), so that A goes bankrupt after $N = 12$ rounds (while B did not).

If we assign the *weight* p_A to an up-step $(1, 1)$, p_B to a down-step $(1, -1)$, and p_T to a level-step $(1, 0)$, then the probability of this play is the product of the weights of all the steps of the path P times p_B (corresponding to the last round where B wins and A goes bankrupt; in our example, it is $p_T p_A p_T p_B p_T p_T p_A p_A p_B p_B p_B p_B$). If we write $p(P)$ for the product of the weights of the steps of P , then, in order to solve the problem, we need to compute the sum $\sum_P p_B p(P)$, where the sum is over all the above described paths from $(0, a - 1)$ to $(N - 1, 0)$.

Clearly, (10.74) with $r = a - 1$ and $s = 0$ provides the solution for the above problem, in terms of a generating function. Since the zeroes of the Chebyshev polynomials are explicitly known, one can apply partial fraction decomposition to obtain an explicit formula for the coefficients in the generating function. If this is carried out, then we get

$$|L((0, r) \rightarrow (n, s); M \mid 0 \leq y \leq k)| \\ = \frac{2}{k+2} \sum_{j=1}^{k+1} \left(2 \cos \frac{\pi j}{k+2} + 1 \right)^n \cdot \sin \frac{\pi j(r+1)}{k+2} \cdot \sin \frac{\pi j(s+1)}{k+2}. \quad (10.75)$$

10.12. Further results for lattice paths in the plane

In this section we collect various further results on the enumeration of two-dimensional lattice paths, respectively pointers to further such results.

The first set of results that we describe concerns lattice paths in the plane integer lattice \mathbb{Z}^2 which consist of steps from a finite set \mathbb{S} that contains steps of the form $(1, b)$. Here, b is some integer. Say,

$$\mathbb{S} = \{(1, b_1), (1, b_2), \dots, (1, b_m)\}. \quad (10.76)$$

We also assume that to each step $(1, b_j)$ there is associated a weight $w_j \in \mathbb{C}$.

Banderier and Flajolet [5] completely solved the exact and asymptotic enumeration of lattice paths consisting of steps from \mathbb{S} obeying certain restrictions. We concentrate here on the exact enumeration results.

The key object in their theory is the *characteristic polynomial* of the step set \mathbb{S} ,

$$P_{\mathbb{S}}(u) = \sum_{j=1}^m w_j u^{b_j}. \quad (10.77)$$

If we write $c = -\min_j b_j$ and $d = \max_j b_j$, then $P_{\mathbb{S}}(u)$ can be rewritten in the form

$$P_{\mathbb{S}}(u) = \sum_{j=-c}^d p_j u^j,$$

for appropriate coefficients p_j . Associated with the characteristic polynomial is the *characteristic equation*

$$1 - zP_{\mathbb{S}}(u) = 0, \quad (10.78)$$

or, equivalently,

$$u^c - zu^c P_{\mathbb{S}}(u) = u^c - z \sum_{j=0}^{c+d} p_{j-c} u^j = 0. \quad (10.79)$$

The form (10.79) has only non-negative powers in u , and it shows that, counting multiplicity, there are $c + d$ solutions to the characteristic equation when u is expressed as a function in z . These $c + d$ solutions fall into two categories; there are c “small branches” $u_1(z), u_2(z), \dots, u_c(z)$ satisfying

$$u_j(z) \sim e^{2\pi i(j-1)/c} p_{-c}^{1/c} z^{1/c} \quad \text{as } z \rightarrow 0,$$

and d “large branches” $u_{c+1}(z), u_{c+2}(z), \dots, u_{c+d}(z)$ satisfying

$$u_j(z) \sim e^{2\pi i(c+1-j)/d} p_d^{-1/d} z^{-1/d} \quad \text{as } z \rightarrow 0.$$

One can show that there are functions $A(z)$ and $B(z)$ which are analytic and non-zero at 0 such that, in a neighbourhood of 0,

$$u_j(z) = \omega^{j-1} z^{1/c} A(\omega^{j-1} z^{1/c}), \quad \text{with } \omega = e^{2\pi i/c}, \quad j = 1, 2, \dots, c, \quad (10.80)$$

$$u_j(z) = \bar{\omega}^{c+1-j} z^{-1/d} B(\bar{\omega}^{j-c-1} z^{1/d}), \quad \text{with } \bar{\omega} = e^{2\pi i/d}, \quad j = c+1, c+2, \dots, c+d. \quad (10.81)$$

We are now in the position to state the enumeration results for lattice paths with steps from \mathbb{S} without further restriction. In the formulation, we use $\ell(P)$ to denote the length of a path P , and $h(P)$ to denote the abscissa (height) of the end point of P .

THEOREM 10.12.1. *The generating function $\sum_P z^{\ell(P)} u^{h(P)}$ for lattice paths P which start at the origin and consist of steps from \mathbb{S} as given in (10.76) equals*

$$GF(L((0,0) \rightarrow (*,*) ; \mathbb{S}) ; z^{\ell(\cdot)} u^{h(\cdot)}) = \frac{1}{1 - zP_{\mathbb{S}}(u)}, \quad (10.82)$$

with $P_{\mathbb{S}}(u)$ the characteristic polynomial of \mathbb{S} given in (10.77). Moreover, the generating function $\sum_P z^{\ell(P)}$ for those paths P which end at height 0 equals

$$GF(L((0,0) \rightarrow (*,0) ; \mathbb{S}) ; z^{\ell(\cdot)}) = z \sum_{j=1}^c \frac{u'_j(z)}{u_j(z)} = z \frac{d}{dz} (u_1(z) u_2(z) \cdots u_c(z)), \quad (10.83)$$

where $u_1(z), u_2(z), \dots, u_c(z)$ are the small branches given in (10.80). Finally, for $k < c$ the generating function $\sum_P z^{\ell(P)}$ for those paths P which end at height k equals

$$GF(L((0,0) \rightarrow (*,k); \mathbb{S}); z^{\ell(\cdot)}) = z \sum_{j=1}^c \frac{u'_j(z)}{u_j^{k+1}(z)} = -\frac{z}{k} \frac{d}{dz} \left(\sum_{j=1}^c u_j^{-k}(z) \right), \quad (10.84)$$

where again $u_1(z), u_2(z), \dots, u_c(z)$ are the small branches given in (10.80), while for $k > -d$ it equals

$$GF(L((0,0) \rightarrow (*,k); \mathbb{S}); z^{\ell(\cdot)}) = -z \sum_{j=c+1}^{c+d} \frac{u'_j(z)}{u_j^{k+1}(z)} = \frac{z}{k} \frac{d}{dz} \left(\sum_{j=c+1}^{c+d} u_j^{-k}(z) \right), \quad (10.85)$$

PROOF. By elementary combinatorial principles, the generating function $\sum_P z^{\ell(P)} u^{h(P)}$ for lattice paths P which start at the origin and consist of steps from \mathbb{S} is given by $\sum_{n \geq 0} z^n P_{\mathbb{S}}^n(u)$, which equals (10.82).

In order to determine the generating function $\sum_P z^{\ell(P)}$ for those lattice paths P which end at height 0, we have to extract the coefficient of u^0 in (10.82). This can be achieved by computing the contour integral

$$\frac{1}{2\pi i} \int_C \frac{1}{1 - zP_{\mathbb{S}}(u)} \frac{du}{u}, \quad (10.86)$$

where C is a contour encircling the origin in the positive direction. One has to choose C so that, for sufficiently small z , the small branches lie within the contour, while the large branches lie outside. Then, by the residue theorem, only the small branches contribute to the integral (10.86). The residue at $u = u_j(z)$ equals (assuming that, in addition, we have chosen z so that all small branches are different)

$$\operatorname{Res}_{u=u_j(z)} \left(\frac{1}{u(1 - zP_{\mathbb{S}}(u))} \right) = -\frac{1}{zu_j(z)P'_{\mathbb{S}}(u_j(z))}.$$

The integral in (10.86) equals the sum of these residues. This sum simplifies to (10.83) since differentiation of both sides of the characteristic equation (10.78) shows that $P'_{\mathbb{S}}(u_j(z))^{-1} = -z^2 u'_j(z)$ for all small branches $u_j(z)$.

The arguments for establishing (10.84) and (10.85) are similar. \square

The second set of results concerns lattice paths starting at the origin with steps from \mathbb{S} which do not run below the x -axis.

THEOREM 10.12.2. *The generating function $\sum_P z^{\ell(P)} u^{h(P)}$ for lattice paths P which start at the origin, consist of steps from \mathbb{S} as given in (10.76), and do not run below the x -axis, equals*

$$\begin{aligned} GF(L((0,0) \rightarrow (*,*) ; \mathbb{S} | y \geq 0); z^{\ell(\cdot)} u^{h(\cdot)}) &= \frac{\prod_{j=1}^c (u - u_j(z))}{u^c (1 - zP_{\mathbb{S}}(u))} \\ &= -\frac{1}{pdz} \prod_{j=c+1}^{c+d} \frac{1}{(u - u_j(z))}, \end{aligned} \quad (10.87)$$

with $P_{\mathbb{S}}(u)$ the characteristic polynomial of \mathbb{S} given in (10.77), and $u_1(z), u_2(z), \dots, u_c(z)$ and $u_{c+1}(z), u_{c+2}(z), \dots, u_{c+d}(z)$ the small and large branches given in (10.80)

and (10.81). In particular, the generating function $\sum_P z^{\ell(P)}$ for those paths P which end at height 0 equals

$$\begin{aligned} GF(L((0,0) \rightarrow (*,0); \mathbb{S} \mid y \geq 0); z^{\ell(\cdot)}) &= \frac{(-1)^{c-1}}{p-cz} \prod_{j=1}^c u_j(z) \\ &= \frac{(-1)^{d-1}}{pdz} \prod_{j=c+1}^{c+d} \frac{1}{u_j(z)}. \end{aligned} \quad (10.88)$$

PROOF. Here, we use the so-called *kernel method* (cf. e.g. [18]). Let $F(z, u)$ denote the generating function on the left-hand side of (10.87). Then we have

$$F(z, u) = 1 + zP_{\mathbb{S}}(u)F(z, u) - z[u^{<0}] (P_{\mathbb{S}}(u)F(z, u)), \quad (10.89)$$

where $[u^{<0}]G(z, u)$ means that in the series $G(z, u)$ all monomials $z^n u^m$ with $m \geq 0$ are dropped. For, any lattice path that is counted by $F(z, u)$ is either empty, or it consists of a step ($zP_{\mathbb{S}}(u)$ describes the possibilities) added to a path, except that the steps that would take the walk below level 0 are to be taken out (the operator $[u^{<0}]$ extracts the terms to be taken out). Since $P_{\mathbb{S}}(u)$ involves only a finite number of negative powers, we may rewrite (10.89) in the form

$$F(z, u)(1 - zP_{\mathbb{S}}(u)) = 1 - z \sum_{k=0}^{c-1} r_k(u)F_k(z), \quad (10.90)$$

for some Laurent polynomials $r_k(u)$ that can be computed from $P_{\mathbb{S}}(u)$ via (10.89),

$$r_k(u) = [u^{<0}] (P_{\mathbb{S}}(u)u^k) = \sum_{j=-c}^{-k-1} p_j u^{j+k}.$$

Here, $F_k(z)$ is the generating function $\sum_P z^{\ell(P)}$ for those paths P which end at height k .

In the current context, the factor $1 - zP_{\mathbb{S}}(u)$ on the left-hand side of (10.90) (which is identical with the left-hand side of the characteristic equation (10.78)) is called the *kernel*. The idea of the kernel method is to substitute $u = u_j(z)$, $j = 1, 2, \dots, c$ (that is, the small branches) on both sides of (10.90) so that the kernel — and thus the left-hand side — vanishes. In this way, we arrive at the system of equations

$$u_j^c(z) - z \sum_{k=0}^{c-1} u_j^c(z) r_k(u_j(z)) F_k(z) = 0, \quad j = 1, 2, \dots, c.$$

This system of linear equations in the unknowns $F_0(z), F_1(z), \dots, F_{c-1}(z)$ could now be solved. Alternatively, we could observe that the expression

$$u^c - z \sum_{k=0}^{c-1} u^c r_k(u) F_k(z)$$

is a polynomial in u of degree c with leading monomial u^c . Its roots are exactly the small branches $u_j(z)$, $j = 1, 2, \dots, c$. Hence, it factorizes as

$$u^c - z \sum_{k=0}^{c-1} u^c r_k(u) F_k(z) = \prod_{j=1}^c (u - u_j(z)). \quad (10.91)$$

Extraction of the coefficient of u^0 on both sides gives immediately $F_0(z)$, the generating function for the paths which end at height 0. This leads directly to (10.88). The formula (10.87) follows from (10.90) and (10.91). \square

Sometimes, the kernel method is also applicable if the the set of steps \mathbb{S} is infinite. This is, for instance, the case for *Łukasiewicz paths*, which are paths consisting of steps from $\mathbb{S}_L = \{(1, b) : b \in \{-1, 0, 1, 2, \dots\}\}$, which start at the origin, return to the x -axis, never running below it. In that case, the equation (10.90) for the generating function $\sum_P z^{\ell(P)} u^{h(P)}$ becomes

$$F(z, u) \left(1 - \frac{z}{u(1-u)} \right) = 1 - zu^{-1}F_0(z), \quad (10.92)$$

where, as before, $F_0(z)$ is the generating function for those paths which end at height 0 (that is, return to the x -axis). Here, the kernel is

$$1 - \frac{z}{u(1-u)},$$

and it vanishes for $u(z) = \frac{1-\sqrt{1-4z}}{2}$. If this is substituted in (10.92), then we obtain

$$GF(L((0,0) \rightarrow (*,0); \mathbb{S}_L \mid y \geq 0); z^{\ell(\cdot)}) = F_0(z) = \frac{1 - \sqrt{1-4z}}{2z},$$

the Catalan number generating function (10.20). Hence, also Łukasiewicz paths of length n are enumerated by the Catalan number $C_n = \frac{1}{n+1} \binom{2n}{n}$.

To conclude this topic, it must be mentioned that Banderier and Gittenberger [6] have extended the analyses of [5] to also include the area statistics.

A very cute problem, which arose in a probabilistic context around 2000, is the problem of counting paths (walks) in the *slit plane*. The slit plane is the integer lattice \mathbb{Z}^2 where one has taken out the half-axis $\{(k, 0) : k \leq 0\}$. Investigation of this problem started with the conjecture that the number of paths in the slit plane which start at $(1, 0)$ and do $2n + 1$ horizontal or vertical unit steps (in the positive or in the negative direction) is given by the Catalan number C_{2n+1} . This conjecture was proved by Bousquet-Mélou and Schaeffer in [20], but they provide much stronger and more general results on the enumeration of lattice paths in the slit plane in that paper. When it is not possible to find exact formulas, then the focus is on the nature of the generating function, whether it be algebraic or not, D-finite or not, etc. Methods used are the cycle lemma and the kernel method.

An innocent looking three-candidate ballot problem stands at the beginning of another long line of investigation: Let E_1, E_2, E_3 be candidates in an election, E_1 receiving e_1 votes, E_2 receiving e_2 votes, and E_3 receiving e_3 votes, $e_1 \geq \max\{e_2, e_3\}$. How many ways of counting the votes are there such that at any stage during the counting candidate E_1 has at least as many votes as E_2 and at least as many votes as E_3 ? In lattice path formulation this means to count all simple lattice paths in \mathbb{Z}^3 from the origin to (e_1, e_2, e_3) staying in the region $\{(x_1, x_2, x_3) : x_1 \geq x_2 \text{ and } x_1 \geq x_3\}$.¹ We state the result below. Solutions were given by Kreweras [85] and Niederhausen

¹It seems that this is a non-planar lattice path problem, contradicting the title of the section. However, the problem can be translated into a two-dimensional problem, see [16].

[99], see also Gessel [48]. This line of research was picked up later by Bousquet-Mélou [16] who showed, again with the help of the kernel method, that the generating function of these “Kreweras walks” is algebraic. It must be pointed out that this counting problem is a “non-example” for the reflection principle (see Section 10.18), that is, the reflection principle does not apply. The reason is that, if one tries to set it up for application of the reflection principle, then one realizes that the nice property that for permutations other than the identity permutation some hyperplane has to be touched would fail.

THEOREM 10.12.3. *Let $e_1 \geq \max\{e_2, e_3\}$. The number of all lattice paths in \mathbb{Z}^3 from $(0, 0, 0)$ to (e_1, e_2, e_3) subject to $x_1 \geq x_2$ and $x_1 \geq x_3$ is given by*

$$\begin{aligned} & |L((0, 0, 0) \rightarrow (e_1, e_2, e_3) \mid x_1 \geq \max\{x_2, x_3\})| \\ &= \binom{e_1 + e_2 + e_3}{e_1, e_2, e_3} - \frac{e_2 + e_3}{1 + e_1} \binom{e_1 + e_2 + e_3}{e_1, e_2, e_3} \\ &+ \sum_{i, j \geq 1} (-1)^{i+j} \frac{(e_1 + e_2 + e_3)! (2i + 2j - 2)! (i + j - 2)!}{i! (e_3 - i)! j! (e_2 - j)! (2i - 1)! (2j - 1)! (i + j + e_1)!}. \end{aligned} \quad (10.93)$$

In particular, if $e_1 = e_2$ this number simplifies to

$$\begin{aligned} & |L((0, 0, 0) \rightarrow (e_1, e_1, e_3) \mid x_1 \geq \max\{x_2, x_3\})| \\ &= 2^{2e_3+1} \frac{(2e_1 + e_3)! (2e_1 - 2e_3 + 1)!}{(2e_1 + 2)! e_3! (e_1 - e_3)!^2}. \end{aligned} \quad (10.94)$$

We come to a relatively recent research field: the enumeration of walks in the quarter plane. The question that was posed is: given a particular step set, can one find an explicit formula for the corresponding generating function, and, if not, is the generating function rational, algebraic, D-finite, or neither? For “small” step sets, the analysis is now complete, due to work by Bousquet-Mélou and Mishna [19], by Bostan and Kauers [12], and by Bostan, Kurkova, Raschel and Salvy [13, 14]. However, there is not yet a good understanding how, or whether at all, one can decide from the step set that the generating function has one of the above mentioned properties.

The last topic that I mention here is the connection between Dyck and Schröder path enumeration on the one hand, and Hilbert series for diagonal harmonics and Macdonald polynomials on the other hand. This topic would by itself require a whole chapter. We refer the reader to the survey [61] and the references therein. One of the most intriguing combinatorial problems originating from the investigations in this area is new statistics for Dyck paths, most prominently “bounce” and “dinv.” It has been shown (algebraically) that the pair (bounce, area) is equally distributed as (area, bounce), and the same for area and dinv. However, although much effort has been put into it, so far nobody could come up with a direct combinatorial reason (in the best case: a bijection) why this symmetry holds.

10.13. Non-intersecting lattice paths

The technique of non-intersecting lattice paths is a powerful counting method. We have already seen its effectiveness in Section 10.7. Originally, non-intersecting

paths arose in matroid theory, in the work of Lindström [88]. Lindström’s result was rediscovered (not always in its most general form) in the 1980s at about the same time in three different communities, not knowing of each other at that time: in statistical physics by Fisher [41, Sec. 5.3] in order to apply it to the analysis of vicious walkers as a model of wetting and melting, in combinatorial chemistry by John and Sachs [70] and Gronau, Just, Schade, Scheffler and Wojciechowski [58] in order to compute Pauling’s bond order in benzenoid hydrocarbon molecules, and in enumerative combinatorics by Gessel and Viennot [50, 51] in order to count tableaux and plane partitions. It must however be mentioned that in fact the same idea appeared even earlier in work by Karlin and McGregor [72, 71] in a probabilistic framework, as well as that the so-called “Slater determinant” in quantum mechanics (cf. [108] and [109, Ch. 11]) may qualify as an “ancestor” of the determinantal formula of Lindström. Since then, many more applications have been found, particularly in plane partition and rhombus tiling enumeration, see e.g. [23, 30, 40, 114] and Chapter [Tiling Enumeration by Jim Propp] for more information on this topic.

We devote this section to developing the theory of non-intersecting lattice paths and give some sample applications. This will be continued in Section 10.14, where we give results on the enumeration of non-intersecting lattice paths in the plane with respect to turns.

The most general version of the non-intersecting path theorem ([88, Lemma 1], [51, Theorem 1]) is formulated for paths in a *directed graph*. Let G be a directed graph with vertices V and (directed) edges E . A *path* (actually, the usual notion in graph theory is *walk*) in G is a sequence v_0, v_1, \dots, v_m of vertices, for some m , such that there is an edge from v_i to v_{i+1} , $i = 0, 1, \dots, m-1$. We denote the set of all paths in G from A to E by $L_G(A \rightarrow E)$. The directed graph G is called *acyclic* if there is no non-trivial closed path in G , i.e., if there is no path that starts and ends in the same vertex other than a zero-length path.

The central definition is that a family $\mathbf{P} = (P_1, P_2, \dots, P_n)$ of paths P_i in G is called *non-intersecting* if no two paths of \mathbf{P} have a vertex in common. Otherwise \mathbf{P} is called *intersecting*. In the context of lattice path enumeration, the graph G comes from a lattice. In many examples, the vertices of G are the lattice points \mathbb{Z}^2 in the plane, and the edges of G connect a point (i, j) to $(i+1, j)$, respectively a point (i, j) to $(i, j+1)$. Figure 20 displays a family of non-intersecting lattice paths in this sense, Figure 21 a family of intersecting lattice paths. (It is very important to note that, in the geometric realization of paths as piecewise linear trails, the corresponding trails may very well have common points, but never in starting and end points of steps, see Figure 22 for such an example. In particular, non-intersecting lattice paths may even cross each other in the geometric visualization.)

Returning to the general setup, we furthermore assume that to any edge e in the graph G there is assigned a weight $w(e)$ (an element in some commutative ring \mathcal{R}). The *weight* of a path P is the product $w(P) = \prod_e w(e)$, where the product is over all edges e of the path P . The weight $w(\mathbf{P})$ of a family $\mathbf{P} = (P_1, P_2, \dots, P_n)$ of paths is defined as the product of all the weights of paths in the family, $w(\mathbf{P}) = w((P_1, P_2, \dots, P_n)) = \prod_{i=1}^n w(P_i)$.

Given two sequences $\mathbf{A} = (A_1, A_2, \dots, A_n)$ and $\mathbf{E} = (E_1, E_2, \dots, E_n)$ of vertices of G , we write $L_G(\mathbf{A} \rightarrow \mathbf{E})$ for the set of all families (P_1, P_2, \dots, P_n) of paths, where

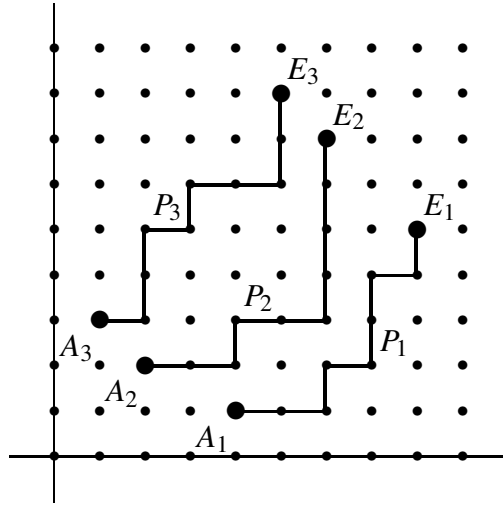

FIGURE 20. Family of non-intersecting paths

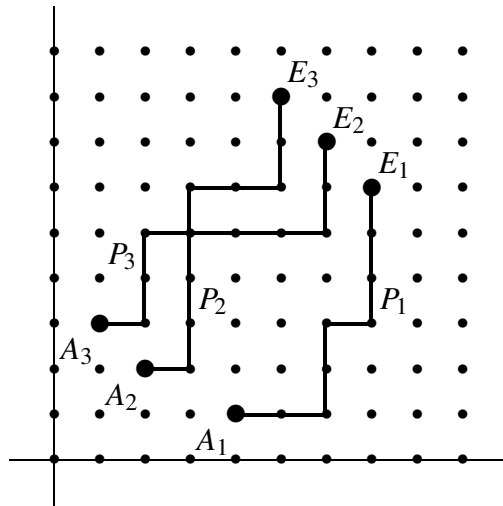

FIGURE 21. Family of intersecting paths

P_i runs from A_i to E_i , $i = 1, 2, \dots, n$, whereas $L_G(\mathbf{A} \rightarrow \mathbf{E} \mid \text{non-intersecting})$ denotes the subset of families of non-intersecting paths.

We need one more piece of notation. Given a permutation $\sigma \in \mathfrak{S}_n$ and a vector $\mathbf{v} = (v_1, v_2, \dots, v_n)$, by \mathbf{v}_σ we mean $(v_{\sigma(1)}, v_{\sigma(2)}, \dots, v_{\sigma(n)})$. We are now in the position to state and prove the main theorem on non-intersecting paths, due to Lindström [88, Lemma 1].

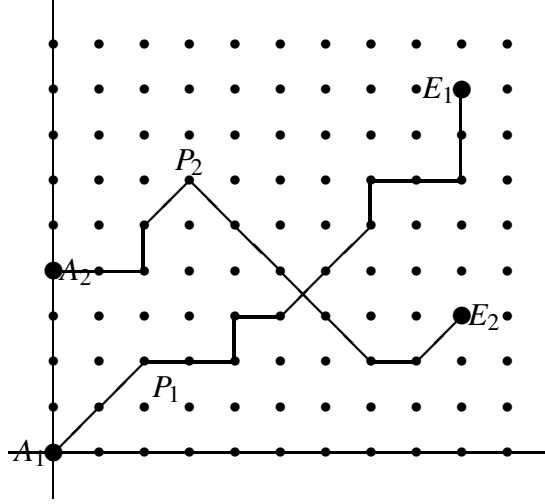

FIGURE 22. Non-intersecting lattice paths may even cross

THEOREM 10.13.1. Let G be a directed, acyclic graph, and let $\mathbf{A} = (A_1, A_2, \dots, A_n)$ and $\mathbf{E} = (E_1, E_2, \dots, E_n)$ be sequences of vertices in G . Then

$$\sum_{\sigma \in \mathfrak{S}_n} (\text{sgn } \sigma) \cdot GF(L_G(\mathbf{A}_\sigma \rightarrow \mathbf{E} \mid \text{non-intersecting}); w) = \det_{1 \leq i, j \leq n} (GF(L_G(A_j \rightarrow E_i); w)). \quad (10.95)$$

PROOF. By expanding the determinant on the right-hand side of (10.95), we obtain

$$\begin{aligned} \det_{1 \leq i, j \leq n} (GF(L_G(A_j \rightarrow E_i); w)) &= \sum_{\sigma \in \mathfrak{S}_n} \text{sgn } \sigma \prod_{i=1}^n GF(L_G(A_{\sigma(i)} \rightarrow E_i); w) \\ &= \sum_{\substack{(\sigma, \mathbf{P}) \\ \sigma \in \mathfrak{S}_n, \mathbf{P} \in L_G(\mathbf{A}_\sigma \rightarrow \mathbf{E})}} \text{sgn } \sigma w(\mathbf{P}). \end{aligned} \quad (10.96)$$

The sum in (10.96) expresses the determinant in (10.95) as a generating function for pairs (σ, \mathbf{P}) in the set

$$\bigcup_{\sigma \in \mathfrak{S}_n} L_G(\mathbf{A}_\sigma \rightarrow \mathbf{E}). \quad (10.97)$$

We now define a sign-reversing, weight-preserving involution φ on the set of all pairs (σ, \mathbf{P}) in (10.97) with the property that \mathbf{P} is intersecting. Sign-reversing means that if $\varphi((\sigma, \mathbf{P})) = (\sigma_\varphi, \mathbf{P}_\varphi)$ then $\text{sgn } \sigma = -\text{sgn } \sigma_\varphi$, while weight-preserving means that $w(\mathbf{P}) = w(\mathbf{P}_\varphi)$. Suppose that we had already constructed such a φ . Then, in the sum (10.96), all contributions of pairs (σ, \mathbf{P}) in (10.97) where \mathbf{P} is intersecting would cancel. Only contributions of pairs (σ, \mathbf{P}) in (10.97) where \mathbf{P} is non-intersecting would survive, establishing (10.95).

Next we construct the sign-reversing, weight-preserving involution φ . Let (σ, \mathbf{P}) be in $L_G(\mathbf{A}_\sigma \rightarrow \mathbf{E})$ where \mathbf{P} is intersecting. In the left-hand picture of Figure 23 an example is shown with G the directed graph corresponding to the integer lattice \mathbb{Z}^2 ,

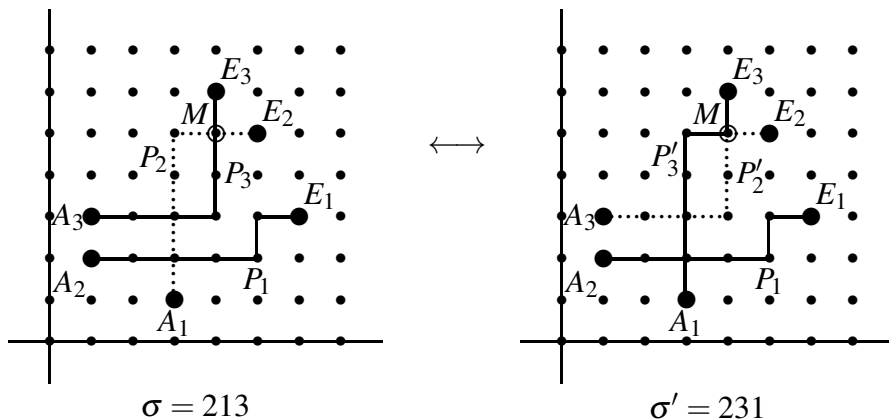

FIGURE 23.

$n = 3$, and $\sigma = 213$. Among all pairs of paths with a common point, choose the lexicographically largest, say (P_i, P_j) , $i < j$, and among all common points of that pair choose the last along the paths. (It does not matter on which of the two paths of the pair we choose the last common point since the graph G is acyclic.) Denote this common point by M . In our example, the common points between paths are $(3, 2)$, $(3, 3)$, $(4, 5)$. The lexicographically largest pair of paths with common points is (P_2, P_3) . The last common point of this pair is $M = (4, 5)$.

Returning to the general construction of the involution φ , we now interchange the initial portions of P_i and P_j up to M . To be more precise, we form the new paths

$$P'_i = [\text{subpath of } P_j \text{ from } A_{\sigma(j)} \text{ to } M \text{ joined with subpath of } P_i \text{ from } M \text{ to } E_i]$$

and

$$P'_j = [\text{subpath of } P_i \text{ from } A_{\sigma(i)} \text{ to } M \text{ joined with subpath of } P_j \text{ from } M \text{ to } E_j].$$

Then we define

$$\begin{aligned} \varphi((\sigma, \mathbf{P})) &= \varphi((\sigma, (P_1, \dots, P_i, \dots, P_j, \dots, P_n))) \\ &= (\sigma \circ (ij), (P_1, \dots, P'_i, \dots, P'_j, \dots, P_n)), \end{aligned}$$

where (i, j) denotes the transposition interchanging i and j . The right-hand picture in Figure 23 shows what is obtained by this operation in our example. The image $\varphi((\sigma, \mathbf{P}))$ is again an element of the set in (10.97) since the new permutation of the starting points of \mathbf{P} is exactly $\sigma \circ (ij)$. Moreover, $(P_1, \dots, P'_i, \dots, P'_j, \dots, P_n)$ is intersecting since P'_i and P'_j are. From all this it is obvious that when φ is applied to $\varphi((\sigma, \mathbf{P}))$ we arrive back at (σ, \mathbf{P}) . Hence, φ is an involution. Since σ and $\sigma \circ (ij)$ differ in sign, φ is sign-reversing. Finally, since the total (multi)set of edges in the path families does not change under application of φ , the map φ is also weight-preserving. This finishes the proof. \square

The most frequent situation in which the general result in Theorem 10.13.1 is applied is the one where non-intersecting paths can only occur if the starting and end points are connected via the identity permutation, that is, if (P_1, P_2, \dots, P_n) can only be non-intersecting if P_i connects A_i with E_i , $i = 1, 2, \dots, n$. In that situation, Theorem 10.13.1 simplifies to the following result.

COROLLARY 10.13.2. *Let G be a directed, acyclic graph, and let $\mathbf{A} = (A_1, A_2, \dots, A_n)$ and $\mathbf{E} = (E_1, E_2, \dots, E_n)$ be sequences of vertices in G such that the only permutation σ that allows for a family (P_1, P_2, \dots, P_n) of non-intersecting paths such that P_i connects $A_{\sigma(i)}$ with E_i , $i = 1, 2, \dots, n$, is the identity permutation. Then the generating function $\sum_{\mathbf{P}} w(\mathbf{P})$ for families $\mathbf{P} = (P_1, P_2, \dots, P_n)$ of non-intersecting paths, where P_i is a path running from A_i to E_i , $i = 1, 2, \dots, n$, is given by*

$$GF(L_G(\mathbf{A} \rightarrow \mathbf{E} \mid \text{non-intersecting}); w) = \det_{1 \leq i, j \leq n} (GF(L_G(A_j \rightarrow E_i); w)). \quad (10.98)$$

The standard application of Corollary 10.13.2 concerns *semistandard tableaux*. These are important objects particularly in the representation theory of the general and the special linear groups, cf. [103].

Let $\lambda = (\lambda_1, \lambda_2, \dots, \lambda_n)$ and $\mu = (\mu_1, \mu_2, \dots, \mu_n)$ be n -tuples of integers such that

$$\lambda_1 \geq \lambda_2 \geq \lambda_3 \geq \dots \geq \lambda_n, \quad (10.99a)$$

$$\mu_1 \geq \mu_2 \geq \mu_3 \geq \dots \geq \mu_n, \quad (10.99b)$$

$$\text{and } \lambda_i \geq \mu_i \text{ for all } i. \quad (10.99c)$$

A semistandard tableau T of shape λ/μ is an array of integers

$$\begin{array}{ccccccc} & & & \pi_{1, \mu_1+1} & \dots & \dots & \pi_{1, \lambda_1} \\ & & \pi_{2, \mu_2+1} & \dots & \pi_{2, \mu_1+1} & \dots & \pi_{2, \lambda_2} \\ \dots & & \dots & \vdots & \dots & \dots & \dots \\ \pi_{n, \mu_n+1} & \dots & \dots & \dots & \dots & \dots & \pi_{n, \lambda_n} \end{array} \quad (10.100)$$

such that entries along rows are weakly increasing and entries along columns are strictly increasing. A semistandard tableau of shape $(7, 6, 6, 4)/(3, 3, 1, 0)$ is shown in Figure 24.a. (The lower and upper bounds on the entries displayed to the left and right of the tableau should be ignored at this point.)

Let $\mathbf{a} = (a_1, a_2, \dots, a_n)$ and $\mathbf{b} = (b_1, b_2, \dots, b_n)$ be sequences of integers such that

$$a_1 \leq a_2 \leq \dots \leq a_n \quad (10.101a)$$

$$b_1 \leq b_2 \leq \dots \leq b_n, \quad (10.101b)$$

$$\text{and } a_i \geq b_i \text{ for all } i. \quad (10.101c)$$

We claim that *semistandard tableaux of shape λ/μ where the entries in row i are at most a_i and at least b_i bijectively correspond to families (P_1, P_2, \dots, P_n) of non-intersecting lattice paths P_i , where P_i runs from $(\mu_i - i, b_i)$ to $(\lambda_i - i, a_i)$.*

This is seen as follows. Let π be a semistandard tableau of shape λ/μ where the entries in row i are at most a_i and at least b_i . The semistandard tableau π is mapped to a family of lattice paths by associating the i -th row of π with a path P_i from $(\mu_i - i, b_i)$ to $(\lambda_i - i, a_i)$ where the entries in the i -th row are interpreted as heights of the horizontal steps in the path P_i . Thus, from π we obtain the family $\mathbf{P} = (P_1, \dots, P_n)$ of lattice paths. The lower picture of Figure 24 displays the family of lattice paths that in this way results from the array displayed in the upper picture of Figure 24.

$$\begin{array}{cccccc}
 -2 \leq & & 1 & 1 & 4 & 5 & \leq 7 \\
 -1 \leq & & 5 & 5 & 7 & & \leq 8 \\
 0 \leq & 2 & 5 & 6 & 9 & 9 & \leq 9 \\
 1 \leq & 1 & 5 & 6 & 8 & & \leq 10
 \end{array}$$

a. Semistandard tableau

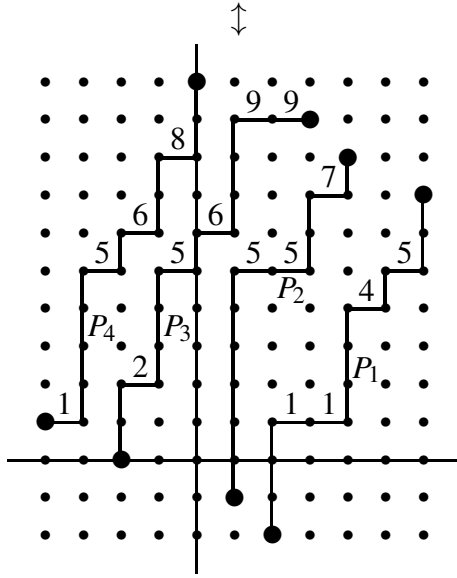

b. Family of non-intersecting lattice paths

FIGURE 24.

Clearly, the property that the columns of π are strictly increasing translates into the condition that (P_1, P_2, \dots, P_n) is non-intersecting.

By applying Corollary 10.13.2 to this situation, we obtain the following enumeration result.

THEOREM 10.13.3. *Let $\lambda = (\lambda_1, \lambda_2, \dots, \lambda_n)$ and $\mu = (\mu_1, \mu_2, \dots, \mu_n)$ be sequences of integers satisfying (10.99). Let $\mathbf{a} = (a_1, a_2, \dots, a_n)$ and $\mathbf{b} = (b_1, b_2, \dots, b_n)$ be sequences of integers satisfying (10.101). Then the number of all semistandard tableaux π of shape λ/μ where the entries in row i are at most a_i and at least b_i equals*

$$\det_{1 \leq i, j \leq n} \left(\binom{a_i - b_j + \lambda_i - \mu_j - i + j}{\lambda_i - \mu_j - i + j} \right). \tag{10.102}$$

More generally, the generating function $\sum_{\pi} q^{n(\pi)}$ for the same set of semistandard tableaux π , where $n(\pi)$ denotes the sum of all entries of π , equals

$$\det_{1 \leq i, j \leq n} \left(q^{b_j(\lambda_i - \mu_j - i + j)} \begin{bmatrix} a_i - b_j + \lambda_i - \mu_j - i + j \\ \lambda_i - \mu_j - i + j \end{bmatrix}_q \right). \tag{10.103}$$

If the shape λ/μ is a straight shape and the bounds \mathbf{a} and \mathbf{b} are constant, that is, if, say, $\mu = (0, 0, \dots, 0)$, $\mathbf{b} = (1, 1, \dots, 1)$, and $\mathbf{a} = (a, a, \dots, a)$, then the above determinants can be evaluated in closed form. Rewritten appropriately, the result is the

hook-content formula. (We refer the reader to [103, Sec. 3.10] or [113, Cor. 7.21.6] for unexplained terminology).

THEOREM 10.13.4. *Let $\lambda = (\lambda_1, \lambda_2, \dots, \lambda_n)$ be a sequence of non-negative integers satisfying (10.99). Then the number of all semistandard tableaux π of shape λ with entries in row i being positive integers at most a equals*

$$\prod_{\rho} \frac{a + c(\rho)}{h(\rho)}, \quad (10.104)$$

where the product is over all cells ρ in the Ferrers diagram of the partition λ , $c(\rho)$ is the content of the cell ρ , and $h(\rho)$ is the hook-length of the cell ρ . More generally, the generating function $\sum_{\pi} q^{n(\pi)}$ for the same set of semistandard tableaux π equals

$$q^{\sum_{i=1}^n i\lambda_i} \prod_{\rho} \frac{1 - q^{a+c(\rho)}}{1 - q^{h(\rho)}}. \quad (10.105)$$

By introducing more general weights, in the same way one can provide combinatorial proofs for the Jacobi–Trudi-type identities for Schur functions (cf. [103, Sec. 4.5]), respectively formulas for so-called flagged Schur functions, originally introduced by Lascoux and Schützenberger [87], see also [121].

If in an array (10.100) one also introduces a relationship between the first row and the last row, then one is led to define so-called *cylindric partitions*, as was done by Gessel and Krattenthaler [49]. Also in that theory, non-intersecting paths play an essential role.

It may seem that the general result in Theorem 10.13.1 is a very artificial statement, perhaps being of no use. However, even this result does have several applications. For example, the most elegant proof of the determinant formula for higher-dimensional path counting under a general two-sided restriction ([115]; see Section 10.17, Theorem 10.17.1) fundamentally makes use of the full generality of Theorem 10.13.1. Further applications of the general formula (10.95) can be found in rhombus tiling enumeration (see [30, 40]), in combinatorial commutative algebra (see [79]), and in the combinatorial theory of orthogonal polynomials developed in Section 10.10 (see the proof of Theorem 10.10.8 as given in [119]).

In several applications, one has to deal with the problem of enumerating non-intersecting lattice paths where the starting and end points are not fixed. Either it is only the starting points which are fixed and the end points are any points from a given set (or the other way round), or it is even that the starting points may come from one set and the end points from another. The solution to these counting problems comes from *Pfaffians*.

A Pfaffian is very similar to a determinant. Whereas in the definition of a determinant there appear *permutations*, in the definition of a Pfaffian there appear *perfect matchings*. A *perfect matching* of a set of objects, \mathcal{A} say, is a pairing of the objects. For example, if $\mathcal{A} = \{1, 2, 3, 4, 5, 6\}$, then $\{\{1, 3\}, \{2, 5\}, \{4, 6\}\}$ is a matching of \mathcal{A} . A matching of $\{1, 2, \dots, N\}$ can be realized geometrically by drawing points labelled $1, 2, \dots, N$ along a line, and then connecting any two points whose labels are paired in the matching by a curve, so that there are no touching points

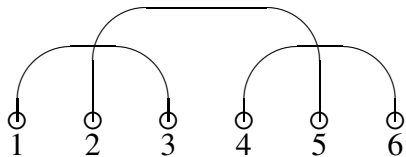

FIGURE 25. A perfect matching

between curves and no triple intersections. Figure 25 shows the geometric realization of $\{\{1,3\}, \{2,5\}, \{4,6\}\}$. Any two pairs $\{i,k\}$ and $\{j,l\}$ in a matching for which $i < j < k < l$ are called a *crossing* of the matching. The *sign* $\text{sgn } \pi$ of a matching π is $(-1)^c$, where c is the number of crossings of π . Thus, the sign of $\{\{1,3\}, \{2,5\}, \{4,6\}\}$ is $(-1)^2 = +1$. In the geometric realization of a matching, its sign can be read off as $(-1)^{c'}$, where c' is the number of crossing points between two curves. (It is easily checked that it does not matter how we draw the curves.)

With these definitions, the *Pfaffian* $\text{Pf}(A)$ of an upper triangular array $A = (a_{ij})_{1 \leq i < j \leq 2n}$ is defined by

$$\text{Pf}(A) := \sum_{\pi \text{ a perfect matching of } \{1,2,\dots,2n\}} \text{sgn } \pi \prod_{\{i,j\} \in \pi} a_{ij}. \quad (10.106)$$

For example, for $n = 2$ we have

$$\text{Pf}((a_{ij})_{1 \leq i < j \leq 4}) = a_{12}a_{34} - a_{13}a_{24} + a_{14}a_{23}.$$

Alternatively, the Pfaffian could be defined as the (appropriate) square root of a skew symmetric matrix. To be precise, if A is a skew symmetric matrix, then

$$\text{Pf}(A)^2 = \det(A), \quad (10.107)$$

where $\text{Pf}(A)$ has to be interpreted as the Pfaffian of the upper triangular part of A . For a (combinatorial) proof of this fact see e.g. [114, Prop. 2.2].

Now let again G be a directed, acyclic graph. Let A_1, A_2, \dots, A_n be vertices in G , and $\mathbf{E} = (\dots, E_1, E_2, \dots)$ be an ordered set of vertices. What we want to count is the number of *all families* $\mathbf{P} = (P_1, P_2, \dots, P_n)$ of *non-intersecting paths*, where P_i runs from A_i to some vertex in \mathbf{E} , $i = 1, 2, \dots, n$. The difference to the situation in Theorem 10.13.1 is that the end vertices of the paths are not fixed. Nevertheless, we adopt the earlier notation for this more general situation. To be precise, by $L_G(\mathbf{A} \rightarrow \mathbf{E} \mid \text{non-intersecting})$ we mean the set of all families $\mathbf{P} = (P_1, P_2, \dots, P_n)$ of non-intersecting paths in G , where P_i runs from A_i to some vertex E_{k_i} in \mathbf{E} , $i = 1, 2, \dots, n$ and $k_1 < k_2 < \dots < k_n$. The corresponding enumeration result is due to Okada [100, Theorem 3] and Stembridge [114, Theorem 3.1].

THEOREM 10.13.5. *Let G be a directed, acyclic graph with a weight function w on its edges. Let $\mathbf{A} = (A_1, A_2, \dots, A_{2n})$ and $\mathbf{E} = (\dots, E_1, E_2, \dots)$ be sequences of vertices in G . Then*

$$\sum_{\sigma \in \mathfrak{S}_{2n}} (\text{sgn } \sigma) \cdot GF(L_G(\mathbf{A}_\sigma \rightarrow \mathbf{E} \mid \text{non-intersecting}); w) = \text{Pf}_{1 \leq i < j \leq 2n}(Q_G(i, j; w)), \quad (10.108)$$

where $L_G(\mathbf{A}_\sigma \rightarrow \mathbf{E} \mid \text{non-intersecting})$ is the set of all families $(P_1, P_2, \dots, P_{2n})$ of non-intersecting paths, P_i connecting $A_{\sigma(i)}$ with E_{k_i} , $i = 1, 2, \dots, 2n$ and $k_1 < k_2 < \dots < k_{2n}$, and $Q_G(i, j; w)$ is the generating function $\sum_{(P', P'')} w(P')w(P'')$ for all pairs (P', P'') of non-intersecting lattice paths, where P' connects A_i with some E_k and P'' connects A_j with some E_l , with $k < l$.

The proof uses the same involution idea as the proof of Theorem 10.13.1 does. See [114, Proof of Theorem 3.1].

Similarly to Theorem 10.13.1, the most frequent situation in which the general result in Theorem 10.13.5 is applied is the one where non-intersecting paths can only occur if the starting and end points are connected via the identity permutation, that is, if $(P_1, P_2, \dots, P_{2n})$ can only be non-intersecting if P_i connects A_i with E_{k_i} , $i = 1, 2, \dots, 2n$ and $k_1 < k_2 < \dots < k_{2n}$. In that situation, Theorem 10.13.5 simplifies to the following result.

COROLLARY 10.13.6. *Let G be a directed, acyclic graph with a weight function w on its edges. Let $\mathbf{A} = (A_1, A_2, \dots, A_{2n})$ and $\mathbf{E} = (\dots, E_1, E_2, \dots)$ be sequences of vertices in G such that the only permutation σ that allows for a family $(P_1, P_2, \dots, P_{2n})$ of non-intersecting paths such that P_i connects $A_{\sigma(i)}$ with E_{k_i} , $i = 1, 2, \dots, 2n$ and $k_1 < k_2 < \dots < k_{2n}$, is the identity permutation. Then the generating function $\sum_{\mathbf{P}} w(\mathbf{P})$ for families $\mathbf{P} = (P_1, P_2, \dots, P_{2n})$ of non-intersecting paths, where P_i is a path running from A_i to E_{k_i} , $i = 1, 2, \dots, 2n$ and $k_1 < k_2 < \dots < k_{2n}$, is given by*

$$GF(L_G(\mathbf{A} \rightarrow \mathbf{E} \mid \text{non-intersecting}); w) = \text{Pf}_{1 \leq i < j \leq 2n}(Q_G(i, j; w)), \quad (10.109)$$

where $Q_G(i, j; w)$ has the same meaning as in Theorem 10.13.5.

Theorem 10.13.5 and Corollary 10.13.6 are only formulated for an even number of paths. However, a simple trick allows us to also use it for an odd number of paths: one introduces a ‘‘phantom’’ vertex X that cannot be reached by any other vertex (one can think of a vertex at infinity), and adjoins this point as a new starting point *and* as a new end point. A family of non-intersecting paths would necessarily contain the zero-length path from X to X as one of the paths, which therefore can be ignored. Theorem 10.13.5 applies, and yields the following corollary.

COROLLARY 10.13.7. *Let G be a directed, acyclic graph with a weight function w on its edges. Let $\mathbf{A} = (A_1, A_2, \dots, A_{2n-1})$ and $\mathbf{E} = (\dots, E_1, E_2, \dots)$ be sequences of vertices in G . Then*

$$\sum_{\sigma \in \mathfrak{S}_{2n}} (\text{sgn } \sigma) \cdot GF(L_G(\mathbf{A}_\sigma \rightarrow \mathbf{E} \mid \text{non-intersecting}); w) = \text{Pf}(Q_G(i, j; w))_{1 \leq i < j \leq 2n}, \quad (10.110)$$

where $L_G(\mathbf{A}_\sigma \rightarrow \mathbf{E} \mid \text{non-intersecting})$ has the same meaning as in Theorem 10.13.5, where for $j \leq 2n - 1$ the quantity $Q_G(i, j; w)$ has the same meaning as in Theorem 10.13.5, and where $Q_G(i, 2n; w)$ is the generating function $\sum_P w(P)$ for all paths running from A_i to some point of \mathbf{E} .

In particular, if the vertices \mathbf{A} and \mathbf{E} are such that the only permutation σ that allows for a family $(P_1, P_2, \dots, P_{2n-1})$ of non-intersecting paths such that P_i connects

$A_{\sigma(i)}$ with E_{k_i} , $i = 1, 2, \dots, 2n - 1$ and $k_1 < k_2 < \dots < k_{2n-1}$, is the identity permutation, then the generating function $\sum_{\mathbf{P}} w(\mathbf{P})$ for families $\mathbf{P} = (P_1, P_2, \dots, P_{2n-1})$ of non-intersecting paths, where P_i is a path running from A_i to E_{k_i} , $i = 1, 2, \dots, 2n - 1$ and $k_1 < k_2 < \dots < k_{2n-1}$, is given by

$$GF(L_G(\mathbf{A} \rightarrow \mathbf{E} \mid \text{non-intersecting}); w) = \text{Pf}(Q_G(i, j; w))_{1 \leq i < j \leq 2n}. \quad (10.111)$$

For various applications of this theorem, see e.g. [77, 100, 114].

Next we consider a mixed case, in which the starting points of the paths are fixed, some end points are fixed, but some end points can be chosen from a given set. To be precise, let m and n be a positive integer with $m \leq n$, let $\mathbf{A} = (A_1, A_2, \dots, A_n)$ and $\mathbf{E} = (E_1, E_2, \dots, E_m)$ be vertices in a given directed, acyclic graph G , let $\hat{\mathbf{E}} = (\dots, \hat{E}_1, \hat{E}_2, \dots)$ be an ordered set of (finitely many or infinitely many) vertices. What we want to determine is the generating function for all families $\mathbf{P} = (P_1, P_2, \dots, P_n)$ of non-intersecting paths, where for $i = 1, 2, \dots, m$ the path P_i runs from A_i to E_i , and where for $i = m + 1, m + 2, \dots, n$ the path P_i runs from A_i to some point \hat{E}_{k_i} in $\hat{\mathbf{E}}$, with $k_{m+1} < k_{m+2} < \dots < k_n$. We write $L_G(\mathbf{A} \rightarrow \mathbf{E} \cup \hat{\mathbf{E}} \mid \text{non-intersecting})$ for the set of these families of paths. The corresponding enumeration result is due to Stembridge [114, Theorem 3.2].

THEOREM 10.13.8. *Let G be a directed, acyclic graph with a weight function w on its edges, and let m and n be a positive integer such that $m \leq n$ and $m + n$ is even. Let $\mathbf{A} = (A_1, A_2, \dots, A_n)$, $\mathbf{E} = (E_1, E_2, \dots, E_m)$ and $\hat{\mathbf{E}} = (\dots, \hat{E}_1, \hat{E}_2, \dots)$ be sequences of vertices in G . Then*

$$\sum_{\sigma \in \mathfrak{S}_n} (\text{sgn } \sigma) \cdot GF(L_G(\mathbf{A}_\sigma \rightarrow \mathbf{E} \cup \hat{\mathbf{E}} \mid \text{non-intersecting}); w) = \text{Pf} \begin{pmatrix} Q & H \\ -H^t & 0 \end{pmatrix}, \quad (10.112)$$

where $L_G(\mathbf{A}_\sigma \rightarrow \mathbf{E} \cup \hat{\mathbf{E}} \mid \text{non-intersecting})$ is the set of all families (P_1, P_2, \dots, P_n) of non-intersecting paths, P_i connecting $A_{\sigma(i)}$ with E_i , $i = 1, 2, \dots, m$, P_i connecting $A_{\sigma(i)}$ with \hat{E}_{k_i} , $i = m + 1, m + 2, \dots, n$ and $k_{m+1} < k_{m+2} < \dots < k_n$, where $Q = (Q_G(i, j; w))_{1 \leq i, j \leq n}$ is a skew-symmetric matrix with $Q_G(i, j; w)$ denoting the generating function $\sum_{(P', P'')} w(P')w(P'')$ for all pairs (P', P'') of non-intersecting lattice paths, where P' connects A_i with some \hat{E}_k and P'' connects A_j with some \hat{E}_l , with $k < l$, and where $H = (H_G(i, j; w))_{1 \leq i \leq n, 1 \leq j \leq m}$ is the rectangular matrix with $H_G(i, j; w)$ denoting the generating function $\sum_{\mathbf{P}} w(\mathbf{P})$ for all paths P from A_i to E_j . The Pfaffian of a skew-symmetric matrix has to be interpreted according to the remark containing (10.107).

In particular, if the vertices \mathbf{A} and $\mathbf{E} \cup \hat{\mathbf{E}}$ are such that the only permutation σ that allows for a family (P_1, P_2, \dots, P_n) of non-intersecting paths such that P_i connects $A_{\sigma(i)}$ with E_i , $i = 1, 2, \dots, m$, and P_i connects $A_{\sigma(i)}$ with \hat{E}_{k_i} , $i = m + 1, m + 2, \dots, n$ and $k_{m+1} < k_{m+2} < \dots < k_n$, is the identity permutation, then the generating function $\sum_{\mathbf{P}} w(\mathbf{P})$ for all families (P_1, P_2, \dots, P_n) of non-intersecting lattice paths, where for $i = 1, 2, \dots, m$ the path P_i runs from A_i to E_i , and where for $i = m + 1, m + 2, \dots, n$ the path P_i runs from A_i to some point \hat{E}_{k_i} in $\hat{\mathbf{E}}$, $k_{m+1} <$

$k_{m+2} < \dots < k_n$, is given by

$$GF(L_G(\mathbf{A} \rightarrow \mathbf{E} \cup \hat{\mathbf{E}} \mid \text{non-intersecting}); w) = (-1)^{\binom{m}{2}} \text{Pf} \begin{pmatrix} Q & H \\ -H^t & 0 \end{pmatrix}. \quad (10.113)$$

Again, the proof uses the same involution idea as the proof of Theorem 10.13.1 does. See [114, Proof of Theorem 3.2]. Applications can for example be found in [32, 31, 114].

As a matter of fact, Theorem 10.13.8 is a special case of the so-called minor summation formula due to Ishikawa and Wakayama [66, Theorem 2].

THEOREM 10.13.9. *Let m, n, p be integers such that $n + m$ is even and $0 \leq n - m \leq p$. Let M be any $n \times p$ matrix, H be any $n \times m$ matrix, and $A = (a_{ij})_{1 \leq i, j \leq p}$ be any skew-symmetric matrix. Then we have*

$$\sum_K \text{Pf}(A_K^K) \det(M_K : H) = (-1)^{\binom{m}{2}} \text{Pf} \begin{pmatrix} MAM^t & H \\ -H^t & 0 \end{pmatrix}.$$

where K runs over all $(n - m)$ -element subsets of $[1, p]$, A_K^K is the skew-symmetric matrix obtained by picking the rows and columns indexed by K , and M_K is the submatrix of M consisting of the columns corresponding to K .

Theorem 10.13.8 results from the special case of Theorem 10.13.9 where A is the $p \times p$ skew-symmetric matrix with all 1s above the diagonal, and M and H are matrices the entries of which are appropriately chosen path generating functions. This is based on the well-known fact (see e.g. [114, Prop. 2.3(c)]) that $\text{Pf}(1)_{1 \leq i < j \leq 2N} = 1$ for all N .

The last theorem in this section addresses the case where starting *and* end points are chosen from given sets. To be precise, let $\mathbf{A} = (A_1, A_2, \dots, A_n)$ and $\mathbf{E} = (\dots, E_1, E_2, \dots)$ be ordered sets of vertices (finitely many or infinitely many in the case of \mathbf{E}). What we want to determine is the generating function for *all families* $\mathbf{P} = (P_1, P_2, \dots, P_s)$ of non-intersecting paths, where for $i = 1, 2, \dots, s$ the path P_i runs from some A_{k_i} to some E_{l_i} . The corresponding enumeration result is due to Okada [100, Theorem 4] and Stembridge [114, Theorem 4.1]. In the formulation below, by abuse of notation, $\mathbf{A}' \subseteq \mathbf{A}$ means that \mathbf{A}' is a subsequence of \mathbf{A} , with an analogous meaning for $\mathbf{E}' \subseteq \mathbf{E}$.

THEOREM 10.13.10. *Let G be a directed, acyclic graph with a weight function w on its edges, and let $\mathbf{A} = (A_1, A_2, \dots, A_n)$ and $\mathbf{E} = (\dots, E_1, E_2, \dots)$ be sequences of vertices in G .*

(a) *If n is even, then*

$$\begin{aligned} \sum_{s=0}^{n/2} t^s \sum_{\substack{\mathbf{A}' \subseteq \mathbf{A}, \mathbf{E}' \subseteq \mathbf{E} \\ |\mathbf{A}'| = |\mathbf{E}'| = 2s}} GF(L_G(\mathbf{A}' \rightarrow \mathbf{E}' \mid \text{non-intersecting}); w) \\ = \text{Pf}_{1 \leq i < j \leq n} \left((-1)^{i+j-1} + t Q_G(i, j; w) \right), \end{aligned} \quad (10.114)$$

where $Q_G(i, j; w)$ has the same meaning as in Theorem 10.13.5.

(b) If n is odd, then

$$\sum_{s=0}^n t^s \sum_{\substack{\mathbf{A}' \subseteq \mathbf{A}, \mathbf{E}' \subseteq \mathbf{E} \\ |\mathbf{A}'|=|\mathbf{E}'|=s}} GF(L_G(\mathbf{A}' \rightarrow \mathbf{E}' \mid \text{non-intersecting}); w) \\ = \text{Pf}_{1 \leq i < j \leq n+1} \left((-1)^{i+j-1} + t^2 Q_G(i, j; w) \right), \quad (10.115)$$

where for $j \leq n$ the quantity $Q_G(i, j; w)$ has the same meaning as in Theorem 10.13.5, while $Q_G(i, n+1; w)$ equals the generating function $t^{-1} \sum_P w(P)$ for all paths P from A_i to some vertex in \mathbf{E} .

(c) If n is even, then

$$\sum_{s=0}^n t^s \sum_{\substack{\mathbf{A}' \subseteq \mathbf{A}, \mathbf{E}' \subseteq \mathbf{E} \\ |\mathbf{A}'|=|\mathbf{E}'|=s}} GF(L_G(\mathbf{A}' \rightarrow \mathbf{E}' \mid \text{non-intersecting}); w) \\ = \text{Pf}_{1 \leq i < j \leq n+2} \left((-1)^{i+j-1} + t^2 Q_G(i, j; w) \right), \quad (10.116)$$

where for $j \leq n+1$ the quantity $Q_G(i, j; w)$ has the same meaning as in (b), and $Q_G(i, n+2; w) = 0$.

For applications of this theorem in plane partition enumeration see [100] and [114].

If one weakens the condition of non-intersection of lattice paths in the plane to the requirement that paths are allowed to touch each other in isolated points but not to change sides, then one arrives at the model of *osculating paths*. The motivation to consider this model comes from an observation of Bousquet-Mélou and Habsieger [17] that *alternating sign matrices* are in bijection with families of osculating paths with appropriate starting and end points. Alternating sign matrices are fascinating, but notoriously difficult to count, therefore it may be useful to investigate objects which are equivalent to them. So far, this point of view has not led to much, but recently Brak and Galleas [21] proved a constant term formula for families of osculating paths.

10.14. Lattice paths and their turns

In this section we consider *turns* of lattice paths. Literally, a *turn* of a lattice path is any vertex of a path where the direction of the path changes. The enumeration of lattice paths with a given number of turns is motivated by problems of correlated random walks, distribution of runs (cf. [95]), coefficients of Hilbert polynomials of determinantal and Pfaffian rings (cf. [84, 86]), and summations for Schur functions (cf. [76]).

The approach for the enumeration of simple plane lattice paths with respect to their number of turns which we present here is by encoding lattice paths in terms of two-rowed arrays, a point of view put forward in [78].

For simple lattice paths in the plane there are two types of turns. We call a vertex T of a path a *North-East turn* (*NE-turn* for short) if T is reached by a step towards

Again, as earlier, we write

$$\begin{array}{rcccccl} a+1 & \leq & p_1 & p_2 & \cdots & p_\ell & \leq & c \\ b & \leq & q_1 & q_2 & \cdots & q_\ell & \leq & d-1. \end{array} \quad (10.119)$$

For a given starting point and a given final point, by definition the empty array is the representation for the only path that has no EN-turn. For the path in our running example we obtain the EN-turn representation

$$\begin{array}{ccc} 2 & 5 & 6 \\ 1 & 3 & 4 \end{array},$$

or, with bounds included,

$$\begin{array}{ccccccc} 2 & \leq & 2 & 5 & 6 & \leq & 6 \\ -1 & \leq & 1 & 3 & 4 & \leq & 5 \end{array}.$$

Also two-rowed arrays with its rows being of unequal length will be considered. These arrays will also have the property that the rows are strictly increasing. So, by convention, whenever we speak of two-rowed arrays, we mean two-rowed arrays with strictly increasing rows. For these arrays we will use a notation of the kind (10.118) or (10.119) as well. We shall frequently use the short notation $(\mathbf{a} \mid \mathbf{b})$ for two-rowed arrays, where \mathbf{a} denotes the sequence (a_i) of elements of the first row, and \mathbf{b} denotes the sequence (b_i) of elements of the second row.

From (10.118) we see at once that the number of all paths from (a, b) to (c, d) with exactly ℓ NE-turns equals the number of ℓ -element subsets of $\{a, a+1, \dots, c-1\}$ times the number of ℓ -element subsets of $\{b+1, b+2, \dots, d\}$. A similar argument holds for EN-turns. Thus we have proved

$$\begin{aligned} |L((a, b) \rightarrow (c, d) \mid NE(\cdot) = \ell)| &= |L((a, b) \rightarrow (c, d) \mid EN(\cdot) = \ell)| \\ &= \binom{c-a}{\ell} \binom{d-b}{\ell}. \end{aligned} \quad (10.120)$$

A lattice path statistic that is frequently used is the number of *runs* of a lattice path. A *run* in a path P is a maximal subpath of P consisting of steps of equal type. We write $\text{run}(P)$ for the number of runs of P . The runs of the path P_0 in Figure 26 are the subpaths from $(1, -1)$ to $(1, 1)$, from $(1, 1)$ to $(2, 1)$, from $(2, 1)$ to $(2, 3)$, from $(2, 3)$ to $(5, 3)$, from $(5, 3)$ to $(5, 4)$, from $(5, 4)$ to $(6, 4)$, and from $(6, 4)$ to $(6, 6)$. Thus we have $\text{run}(P_0) = 7$. Obviously, the number of runs of a path is exactly one more than the total number of turns (both, NE-turns and EN-turns). Besides, there is also a close relation between NE-turns and runs, which allows us to translate any enumeration result for NE-turns into one for runs.

To avoid case by case formulations, depending on whether the number of runs is even or odd, we prefer to consider generating functions. Suppose we know the number of all paths from A to E satisfying some property R and containing a given number of NE-turns. Then we know the generating function $GF(L(A \rightarrow E \mid R); x^{NE(\cdot)})$. For brevity, let us denote it by $F(A \rightarrow E \mid R; x)$. We define four refinements of $F(A \rightarrow E \mid R; x)$. Let $F_{hv}(A \rightarrow E \mid R; x)$ be the generating function $\sum_P x^{NE(P)}$ where the sum is over all paths in $L(A \rightarrow E \mid R)$ that start with a horizontal step and end with a vertical step. The notations $F_{hh}(A \rightarrow E \mid R; x)$, $F_{vh}(A \rightarrow E \mid R; x)$, and

$F_{vv}(A \rightarrow E \mid R; x)$ are defined analogously. The relation between enumeration by runs and enumeration by NE-turns is given by

$$GF(L(A \rightarrow E \mid R); x^{\text{run}(\cdot)}) = xF_{hh}(A \rightarrow E \mid R; x^2) + x^2F_{hv}(A \rightarrow E \mid R; x^2) \\ + F_{vh}(A \rightarrow E \mid R; x^2) + xF_{vv}(A \rightarrow E \mid R; x^2). \quad (10.121)$$

All the four refinements of the NE-turn generating function can be expressed in terms of NE-turn generating functions. This is seen by setting up a few linear equation and solving them. Evidently, the following is true:

$$F(A \rightarrow E \mid R; x) = F_{hh}(A \rightarrow E \mid R; x) + F_{hv}(A \rightarrow E \mid R; x) \\ + F_{vh}(A \rightarrow E \mid R; x) + F_{vv}(A \rightarrow E \mid R; x).$$

Besides, if $E_1 = (1, 0)$ and $E_2 = (0, 1)$ denote the standard unit vectors, we have

$$F_{hh}(A \rightarrow E \mid R; x) + F_{hv}(A \rightarrow E \mid R; x) = F(A + E_1 \rightarrow E \mid R; x) \\ F_{hv}(A \rightarrow E \mid R; x) + F_{vv}(A \rightarrow E \mid R; x) = F(A \rightarrow E - E_2 \mid R; x) \\ F_{hv}(A \rightarrow E \mid R; x) = F(A + E_1 \rightarrow E - E_2 \mid R; x).$$

Solving for F_{hh} , F_{hv} , F_{vh} , F_{vv} we get

$$F_{hh}(A \rightarrow E \mid R; x) = F(A + E_1 \rightarrow E \mid R; x) - F(A + E_1 \rightarrow E - E_2 \mid R; x) \quad (10.122a)$$

$$F_{hv}(A \rightarrow E \mid R; x) = F(A + E_1 \rightarrow E - E_2 \mid R; x) \quad (10.122b)$$

$$F_{vh}(A \rightarrow E \mid R; x) = F(A \rightarrow E \mid R; x) + (A + E_1 \rightarrow E - E_2 \mid R; x) \\ - F(A + E_1 \rightarrow E \mid R; x) - F(A \rightarrow E - E_2 \mid R; x) \quad (10.122c)$$

$$F_{vv}(A \rightarrow E \mid R; x) = F(A \rightarrow E - E_2 \mid R; x) - F(A + E_1 \rightarrow E - E_2 \mid R; x). \quad (10.122d)$$

As we know from Section 10.3, counting paths restricted by $x = y$, or even by two lines $x = y + t$ and $x = y + s$, is effectively solved by the reflection principle. Of course, reflection by itself is useless for counting paths by turns, since the reflection of portions of paths does not take care of turns. It might introduce new turns or make turns disappear. However, there are ‘‘analogues’’ of reflection for two-rowed arrays, which are due to Krattenthaler and Mohanty [81].

THEOREM 10.14.1. *Let $a \geq b$ and $c \geq d$. The number of all paths from (a, b) to (c, d) staying weakly below $x = y$ with exactly ℓ NE-turns is given by*

$$|L((a, b) \rightarrow (c, d) \mid x \geq y, NE(\cdot) = \ell)| \\ = \binom{c-a}{\ell} \binom{d-b}{\ell} - \binom{c-b-1}{\ell-1} \binom{d-a+1}{\ell+1}, \quad (10.123)$$

and with exactly ℓ EN-turns is given by

$$|L((a, b) \rightarrow (c, d) \mid x \geq y, EN(\cdot) = \ell)| \\ = \binom{c-a}{\ell} \binom{d-b}{\ell} - \binom{c-b+1}{\ell} \binom{d-a-1}{\ell}. \quad (10.124)$$

PROOF. We start with proving (10.123). By the NE-turn representation (10.118), the paths from (a, b) to (c, d) staying weakly below $x = y$ with exactly ℓ NE-turns can be represented by

$$\begin{array}{rcccccc} a \leq & p_1 & p_2 & \dots & p_\ell & \leq c-1 \\ b+1 \leq & q_1 & q_2 & \dots & q_\ell & \leq d, \end{array} \quad (10.125a)$$

where

$$p_i \geq q_i, \quad i = 1, 2, \dots, \ell. \quad (10.125b)$$

Following the argument in the proof of Theorem 10.3.1, the number of these two-rowed arrays is the number of *all* two-rowed arrays of the type (10.125a) minus those two-rowed arrays of the type (10.125a) which *violate* (10.125b), i.e., where $p_i < q_i$ for some i between 1 and ℓ . We know the first number from (10.120).

Concerning the second number, we claim that two-rowed arrays of the type (10.125a) which violate (10.125b) are in one-to-one correspondence with two-rowed arrays of the type

$$\begin{array}{rcccccc} b+1 \leq & & \bar{p}_2 & \dots & \bar{p}_\ell & \leq c-1 \\ a \leq & \bar{q}_0 & \bar{q}_1 & \bar{q}_2 & \dots & \bar{q}_\ell & \leq d. \end{array} \quad (10.126)$$

The number of all these two-rowed arrays is $\binom{c-b-1}{\ell-1} \binom{d-a+1}{\ell+1}$, as desired. So it only remains to construct the one-to-one correspondence.

Take a two-rowed array $(\mathbf{p} \mid \mathbf{q})$ of the type (10.125a) such that $p_i < q_i$ for some i . Let I be the largest integer such that $p_I < q_I$. Then map $(\mathbf{p} \mid \mathbf{q})$ to

$$\begin{array}{cccccccc} & q_1 & \dots & q_{I-1} & p_{I+1} & \dots & p_\ell & \\ p_1 & p_2 & \dots & p_I & q_I & q_{I+1} & \dots & q_\ell \end{array}. \quad (10.127)$$

Note that both rows are strictly increasing because of $q_{I-1} < q_I < q_{I+1} \leq p_{I+1}$ and $p_I < q_I$. By some case by case analysis it can be seen that (10.127) is of type (10.126). For example, if $I = \ell$ then we must check $q_{I-1} \leq c-1$, among others. Clearly, this follows from the inequalities $q_{I-1} < q_I \leq d \leq c$.

The inverse of this map is defined in the same way. Let $(\bar{\mathbf{p}} \mid \bar{\mathbf{q}})$ be a two-rowed array of the type (10.126). Let \bar{I} be the largest integer such that $\bar{p}_{\bar{I}} < \bar{q}_{\bar{I}}$. If there are none, take $\bar{I} = 2$. Then map $(\bar{\mathbf{p}} \mid \bar{\mathbf{q}})$ to

$$\begin{array}{cccccccc} \bar{q}_0 & \dots & \bar{q}_{\bar{I}-1} & \bar{p}_{\bar{I}+1} & \dots & \bar{p}_\ell & \\ \bar{p}_2 & \dots & \bar{p}_{\bar{I}} & \bar{q}_{\bar{I}} & \dots & \bar{q}_\ell & \end{array}. \quad (10.128)$$

It is not difficult to check that the mappings (10.127) and (10.128) are inverses of each other. This completes the proof of (10.123).

The second identity, (10.124), can be established similarly. \square

REMARK 10.14.2. The above proof leads in fact to q -analogues; see [81].

A refinement of Theorem 10.3.3 taking into account turns may as well be derived in this way.

THEOREM 10.14.3. *Let $a+t \geq b \geq a+s$ and $c+t \geq d \geq c+s$. The number of all paths from (a, b) to (c, d) staying weakly below the line $y = x+t$ and above the*

line $y = x + s$ with exactly ℓ NE-turns is given by

$$\begin{aligned} & |L((a, b) \rightarrow (c, d) \mid x+t \geq y \geq x+s, NE(\cdot) = \ell)| \\ &= \sum_{k \in \mathbb{Z}} \left(\binom{c-a-k(t-s)}{\ell+k} \binom{d-b+k(t-s)}{\ell-k} \right. \\ & \quad \left. - \binom{c-b-k(t-s)+s-1}{\ell+k} \binom{d-a+k(t-s)-s+1}{\ell-k} \right). \end{aligned} \quad (10.129)$$

Some of the results in Section 10.4 allow also for refinements taking into account turns.

THEOREM 10.14.4. *Let μ be a positive integer and $c \geq \mu d$. The number of all lattice paths from the origin to (c, d) which stay weakly below $x = \mu y$ with exactly ℓ NE-turns is given by*

$$|L((0, 0) \rightarrow (c, d) \mid x \geq \mu y, NE(\cdot) = \ell)| = \binom{c}{\ell} \binom{d}{\ell} - \mu \binom{c-1}{\ell-1} \binom{d+1}{\ell+1}, \quad (10.130)$$

and with exactly ℓ EN-turns is given by

$$\begin{aligned} & |L((0, 0) \rightarrow (c, d) \mid x \geq \mu y, EN(\cdot) = \ell)| \\ &= \frac{c - \mu d + 1}{c + 1} \binom{c+1}{\ell} \binom{d-1}{\ell-1} = \binom{c+1}{\ell} \binom{d-1}{\ell-1} - \mu \binom{c}{\ell-1} \binom{d}{\ell}. \end{aligned} \quad (10.131)$$

Two-rowed arrays may also be used to prove this result, see [78]. A very elegant alternative proof using a rotation operation on paths is given by Goulden and Serrano [55].

We conclude this section by stating results on the enumeration of families of *non-intersecting* lattice paths with respect to turns. This type of problem originally arose from the study of the Hilbert polynomial of certain determinantal and Pfaffian rings (cf. [84, 86]). The results are due to Krattenthaler [75]. We do not provide proofs. Suffice it to mention that they work by using two-rowed arrays.

Let $\mathbf{A} = (A_1, A_2, \dots, A_n)$ and $\mathbf{E} = (E_1, E_2, \dots, E_n)$ be points in \mathbb{Z}^2 . How many families $\mathbf{P} = (P_1, P_2, \dots, P_n)$ of non-intersecting lattice paths, where P_i runs from A_i to E_i , $i = 1, 2, \dots, n$, are there such that the total number of NE-turns in \mathbf{P} is some fixed number, ℓ say?

We give the following three theorems about the counting of non-intersecting lattice paths with a given number of turns. The first theorem concerns counting families of non-intersecting lattice paths with given starting and end points with a given number of NE-turns.

THEOREM 10.14.5. *Let $A_i = (a_1^{(i)}, a_2^{(i)})$ and $E_i = (e_1^{(i)}, e_2^{(i)})$ be lattice points satisfying*

$$a_1^{(1)} \leq a_1^{(2)} \leq \dots \leq a_1^{(n)}, \quad a_2^{(1)} > a_2^{(2)} > \dots > a_2^{(n)},$$

and

$$e_1^{(1)} < e_1^{(2)} < \dots < e_1^{(n)}, \quad e_2^{(1)} \geq e_2^{(2)} \geq \dots \geq e_2^{(n)}.$$

The number of all families $\mathbf{P} = (P_1, P_2, \dots, P_n)$ of non-intersecting lattice paths $P_i : A_i \rightarrow E_i$, such that the paths of \mathbf{P} altogether contain exactly ℓ NE-turns, is

$$\sum_{\ell_1 + \dots + \ell_n = \ell} \det_{1 \leq i, j \leq n} \left(\binom{e_1^{(j)} - a_1^{(i)} + i - j}{\ell_i + i - j} \binom{e_2^{(j)} - a_2^{(i)} - i + j}{\ell_i} \right). \quad (10.132)$$

The second theorem concerns counting families of non-intersecting lattice paths staying weakly below $x = y$, with given starting and end points, by their number of NE-turns.

THEOREM 10.14.6. *Let $A_i = (a_1^{(i)}, a_2^{(i)})$ and $E_i = (e_1^{(i)}, e_2^{(i)})$ be lattice points satisfying*

$$\begin{aligned} a_1^{(1)} &\leq a_1^{(2)} \leq \dots \leq a_1^{(n)}, & a_2^{(1)} &> a_2^{(2)} > \dots > a_2^{(n)}, \\ e_1^{(1)} &< e_1^{(2)} < \dots < e_1^{(n)}, & e_2^{(1)} &\geq e_2^{(2)} \geq \dots \geq e_2^{(n)}, \end{aligned}$$

and $a_1^{(i)} \geq a_2^{(i)}$, $e_1^{(i)} \geq e_2^{(i)}$, $i = 1, 2, \dots, n$. The number of all families $\mathbf{P} = (P_1, P_2, \dots, P_n)$ of non-intersecting lattice paths $P_i : A_i \rightarrow E_i$, which stay weakly below the line $x = y$, and where the paths of \mathbf{P} altogether contain exactly ℓ NE-turns, is

$$\begin{aligned} \sum_{\ell_1 + \dots + \ell_n = \ell} \det_{1 \leq i, j \leq n} &\left(\binom{e_1^{(j)} - a_1^{(i)} + i - j}{\ell_i + i - j} \binom{e_2^{(j)} - a_2^{(i)} - i + j}{\ell_i} \right. \\ &\left. - \binom{e_1^{(j)} - a_2^{(i)} - i - j + 1}{\ell_i - j} \binom{e_2^{(j)} - a_1^{(i)} + i + j - 1}{\ell_i + i} \right). \quad (10.133) \end{aligned}$$

In the third theorem (basically) the same families of non-intersecting lattice paths as before are counted, but with respect to their number of EN-turns. By a rotation by 180° this could be translated into a result about counting families of non-intersecting lattice paths staying above $x = y$, with given starting and end points, with respect to NE-turns.

THEOREM 10.14.7. *Let $A_i = (a_1^{(i)}, a_2^{(i)})$ and $E_i = (e_1^{(i)}, e_2^{(i)})$ be lattice points satisfying*

$$\begin{aligned} a_1^{(1)} &< a_1^{(2)} < \dots < a_1^{(n)}, & a_2^{(1)} &\geq a_2^{(2)} \geq \dots \geq a_2^{(n)}, \\ e_1^{(1)} &\leq e_1^{(2)} \leq \dots \leq e_1^{(n)}, & e_2^{(1)} &> e_2^{(2)} > \dots > e_2^{(n)}, \end{aligned}$$

and $a_1^{(i)} \geq a_2^{(i)}$, $e_1^{(i)} \geq e_2^{(i)}$, $i = 1, 2, \dots, n$. The number of all families $\mathbf{P} = (P_1, P_2, \dots, P_n)$ of non-intersecting lattice paths $P_i : A_i \rightarrow E_i$, which stay weakly below the line $x = y$, and where the paths of \mathbf{P} altogether contain exactly ℓ EN-turns, is

$$\begin{aligned} \sum_{\ell_1 + \dots + \ell_n = \ell} \det_{1 \leq i, j \leq n} &\left(\binom{e_1^{(j)} - a_1^{(i)} + i - j}{\ell_i + i - j} \binom{e_2^{(j)} - a_2^{(i)} - i + j}{\ell_i} \right. \\ &\left. - \binom{e_1^{(j)} - a_2^{(i)} - i - j + 3}{\ell_i - j + 1} \binom{e_2^{(j)} - a_1^{(i)} + i + j - 3}{\ell_i + i - 1} \right). \quad (10.134) \end{aligned}$$

10.15. Multidimensional lattice paths

This section and the following three contain enumeration results for lattice paths in spaces of higher dimension. Most of the time, we shall be concerned with the d -dimensional lattice \mathbb{Z}^d . The coordinates in d -dimensional space will be denoted by x_1, x_2, \dots, x_d .

Obviously, as a basis to start with, we need the number of all simple paths in \mathbb{Z}^d (that is, paths consisting of positive unit steps in the direction of some coordinate axis) from (a_1, a_2, \dots, a_d) to (e_1, e_2, \dots, e_d) . Since these lattice paths can be seen as permutations of $e_1 - a_1$ steps in x_1 -direction, $e_2 - a_2$ steps in x_2 -direction, \dots , $e_d - a_d$ steps in x_d -direction, the answer is a multinomial coefficient,

$$|L((a_1, \dots, a_d) \rightarrow (e_1, \dots, e_d))| = \binom{\sum_{i=1}^d (e_i - a_i)}{e_1 - a_1, e_2 - a_2, \dots, e_d - a_d}. \quad (10.135)$$

10.16. Multidimensional lattice paths bounded by a hyperplane

Here, we consider simple lattice paths in \mathbb{Z}^{d+1} restricted by a hyperplane of the form $x_0 = \sum_{i=1}^d \mu_i x_i$ where the μ_i 's, $i = 0, 1, \dots, d$, are non-negative integers. It should be noted that the reflection principle does not apply because, in general, the set of steps is not invariant under reflection with respect to such a hyperplane (except of course when $\mu_i = 1$ for all i , in which case the reflection principle does apply).

THEOREM 10.16.1. *Let $\mu_0, \mu_1, \dots, \mu_d$ be non-negative integers and c_0, c_1, \dots, c_d integers such that $c_0 \geq \sum_{i=1}^d \mu_i c_i$. The number of all lattice paths from the origin to (c_0, c_1, \dots, c_d) not crossing the hyperplane $x_0 = \sum_{i=1}^d \mu_i x_i$ is given by*

$$\left| L(0 \rightarrow (c_0, c_1, \dots, c_d) \mid x_0 \geq \sum_{i=1}^d \mu_i x_i) \right| = \frac{c_0 - \sum_{i=1}^d \mu_i c_i + 1}{1 + \sum_{i=0}^d c_i} \binom{1 + \sum_{i=0}^d c_i}{c_0 + 1, c_1, c_2, \dots, c_d}. \quad (10.136)$$

We omit the proof. Both proofs of Theorem 10.4.5, the generating function proof and the proof by use of the cycle lemma, can be extended to proofs of the above theorem.

To conclude this section, we point out that Sato [105] has extended his generating function results for the number of paths in the plane integer lattice between two parallel lines that we presented in Section 10.5 to the multidimensional case. Similarly, the result of Niederhausen on the enumeration of paths in the plane integer lattice subject to a piece-wise linear boundary, which was presented in Section 10.6, has a multidimensional extension, see [98, Sec. 2.2].

10.17. Multidimensional paths with a general boundary

In this section we generalize the enumeration problem of Section 10.7 to arbitrary dimensions. Let n_1, n_2, \dots, n_d be non-negative integers and \mathbf{a} and \mathbf{b} be increasing integer functions defined on the box

$$[0, \mathbf{n}] := \prod_{i=1}^d \{0, 1, \dots, n_i\}$$

such that $\mathbf{a} \geq \mathbf{b}$. \mathbf{a} is increasing means that $\mathbf{a}(\mathbf{i}) \leq \mathbf{a}(\mathbf{j})$ whenever $\mathbf{i} \leq \mathbf{j}$ in the usual product order. We ask for the number of all paths in \mathbb{Z}^{d+1} from $(0, \mathbf{b}(0))$ to $(\mathbf{n}, \mathbf{a}(\mathbf{n}))$ that always stay in the region “that is bounded by \mathbf{a} and \mathbf{b} ”, by which we mean the region

$$\{(\mathbf{i}, y) : \mathbf{b}(\mathbf{i}) \leq y \leq \mathbf{a}(\mathbf{i})\}. \quad (10.137)$$

The generalization of Theorem 10.7.1, due to Handa and Mohanty [62], reads as follows.

THEOREM 10.17.1. *Let n_1, n_2, \dots, n_d be non-negative integers and $p = \prod_{i=1}^d n_i$. Assume that the points in the box $[0, \mathbf{n}]$ are $0 = \mathbf{u}_0, \mathbf{u}_1, \mathbf{u}_2, \dots, \mathbf{u}_p = \mathbf{n}$, ordered lexicographically. Then the number of all lattice paths in \mathbb{Z}^{d+1} from $(0, \mathbf{b}(0))$ to $(\mathbf{n}, \mathbf{a}(\mathbf{n}))$ that always stay in the region (10.137) equals*

$$\begin{aligned} & |L((0, \mathbf{b}(0)) \rightarrow (\mathbf{n}, \mathbf{a}(\mathbf{n})) \mid \mathbf{a} \geq \mathbf{y} \geq \mathbf{b})| \\ &= (-1)^{\sum_{i=1}^d n_i + \prod_{i=1}^d n_i} \det_{0 \leq i, j \leq \sum_{i=1}^d n_i - 1} \left(\begin{pmatrix} \mathbf{a}(\mathbf{u}_i) - \mathbf{b}(\mathbf{u}_{j+1}) + 1 \\ \mathbf{u}_{j+1} - \mathbf{u}_i \end{pmatrix} \right). \end{aligned} \quad (10.138)$$

The most elegant and illuminating proof is by the use of non-intersecting lattice paths, see [115]. Sulanke proves in fact a q -analogue in [115].

10.18. The reflection principle in full generality

We have explained the reflection principle in the proof of Theorem 10.3.1 in Section 10.3, where it solved the problem of counting simple lattice paths in the plane bounded by the diagonal. Nothing prevents us from applying the same idea in a higher-dimensional setting. It is then natural to ask: how far can we go with the reflection principle? What is the most general situation where it applies? This question was raised and answered by Gessel and Zeilberger [53], and, independently, by Biane [10] in a more restricted setting, see also Grabiner and Magyar [57].

The standard example, which will serve as our running example, is the problem of counting all paths from (a_1, a_2, \dots, a_d) to (e_1, e_2, \dots, e_d) which always stay in the region $x_1 \geq x_2 \geq \dots \geq x_d$. This problem is equivalent to several other enumeration problems, the most prominent being the d -candidate ballot problem (for the 2-candidate ballot problem see Section 10.3) and the problem of counting *standard Young tableaux* of a given shape.

In the d -candidate ballot problem there are d candidates in an election, say E_1, E_2, \dots, E_d , E_1 receiving e_1 votes, E_2 receiving e_2 votes, \dots , E_d receiving e_d votes. How many ways of counting the votes are there, such that at any stage during the counting E_1 has at least as many votes as E_2 , E_2 has at least as many votes as E_3 , etc.? It is evident that by encoding each vote for candidate E_i by a step in x_i -direction this ballot problem is transferred into counting paths from the origin to (e_1, e_2, \dots, e_d) which are staying in the region $x_1 \geq x_2 \geq \dots \geq x_d$.

A *standard Young tableaux* of skew shape λ/μ , where $\lambda = (\lambda_1, \lambda_2, \dots, \lambda_d)$ and $\mu = (\mu_1, \mu_2, \dots, \mu_d)$ are d -tuples of non-negative integers which are in non-increasing order and satisfy $\lambda_i \geq \mu_i$ for all i , is an arrangement of the numbers

$1, 2, \dots, \sum_{i=1}^d (\lambda_i - \mu_i)$ of the form

$$\begin{array}{ccccccc}
 & & & & \pi_{1,\mu_1+1} & \dots\dots\dots & \pi_{1,\lambda_1} \\
 & & & & \pi_{2,\mu_1+1} & \dots\dots\dots & \pi_{2,\lambda_2} \\
 & & \dots & & \vdots & & \dots \\
 & \pi_{d,\mu_d+1} & \dots\dots\dots & & \pi_{d,\lambda_d} & &
 \end{array}$$

such that numbers along rows and columns are increasing. See Chapter [Standard Young Tableaux by Adin and Roichman] for more information on these important combinatorial objects. By encoding an entry i located in row j of the tableau by a step in x_j -direction, $i = 1, 2, \dots, \sum_{i=1}^d (\lambda_i - \mu_i)$, it is easy to see that standard tableaux of shape λ/μ are in bijection with lattice paths from $\mu = (\mu_1, \mu_2, \dots, \mu_d)$ to $\lambda = (\lambda_1, \lambda_2, \dots, \lambda_d)$ consisting of positive unit steps in the direction of some coordinate axis, and which stay in the region $x_1 \geq x_2 \geq \dots \geq x_d$.

It is a classical result due to MacMahon [90, p. 175] (see also [91, §103]) that the solution to the counting problem is given by a determinant, see e.g. [113, Prop. 7.10.3 combined with Cor. 7.16.3].

THEOREM 10.18.1. *Let $A = (a_1, a_2, \dots, a_d)$ and $E = (e_1, e_2, \dots, e_d)$ be points in \mathbb{Z}^d with $a_1 \geq a_2 \geq \dots \geq a_d$ and $e_1 \geq e_2 \geq \dots \geq e_d$. The number of all lattice paths from A to E consisting of positive unit steps in the direction of some coordinate axis and staying in the region $x_1 \geq x_2 \geq \dots \geq x_d$ equals*

$$|L(A \rightarrow E \mid x_1 \geq x_2 \geq \dots \geq x_d)| = \left(\sum_{i=1}^d (e_i - a_i) \right)! \det_{1 \leq i, j \leq d} \left(\frac{1}{(e_i - a_j - i + j)!} \right). \tag{10.139}$$

If the starting point A equals the origin, then the above determinant can be reduced to a Vandermonde determinant by elementary column operations, and thus it can be evaluated in closed form. If one rewrites the result appropriately, then one arrives at the celebrated *hook formula* due to Frame, Robinson and Thrall [45]. (We refer the reader to [103, Sec. 3.10] or [113, Cor. 7.21.6] for unexplained terminology).

THEOREM 10.18.2. *Let $E = (e_1, e_2, \dots, e_d)$ be a point in \mathbb{Z}^d with $e_1 \geq e_2 \geq \dots \geq e_d \geq 0$. The number of all lattice paths from the origin to E consisting of positive unit steps in the direction of some coordinate axis and staying in the region $x_1 \geq x_2 \geq \dots \geq x_d$ equals*

$$|L(A \rightarrow E \mid x_1 \geq x_2 \geq \dots \geq x_d)| = \frac{\left(\sum_{i=1}^d e_i \right)!}{\prod_{\rho} h(\rho)}, \tag{10.140}$$

where the product is over all cells ρ in the Ferrers diagram of the partition (e_1, e_2, \dots, e_d) , and $h(\rho)$ is the hook-length of the cell ρ .

It was pointed out by Zeilberger [124] that the formula in (10.139) can be proved by means of the reflection principle. The natural environment for a “general reflection principle” is within the setting of *reflection groups*. A *reflection group* is a group which is generated by all reflections with respect to the hyperplanes H in a given set \mathcal{H} of hyperplanes (in some \mathbb{R}^d). We review the facts about reflection groups that are

relevant for us below. For an excellent exposition of the subject see Humphreys [63]. As we already said, the situation of Theorem 10.18.1 will be our running example.

As above, let \mathcal{H} be a (finite) set of hyperplanes in some \mathbb{R}^d . Let W denote the group that is generated by the corresponding reflections. By definition, W is a subgroup of $O(d)$. Some of the elements of W happen to be reflections with respect to a hyperplane (not necessarily belonging to \mathcal{H}), and let \mathcal{R} denote the collection of all these hyperplanes. Of course, \mathcal{R} contains \mathcal{H} . In the example when \mathcal{H} is the set of hyperplanes H_i given by

$$H_i: \quad x_i - x_{i+1} = 0, \quad i = 1, 2, \dots, d-1, \quad (10.141)$$

(these are the hyperplanes restricting the paths in Theorem 10.18.1), the group W is the permutation group \mathfrak{S}_d , acting on \mathbb{R}^d by permuting coordinates. All the reflections in this group are the interchanges of two coordinates x_i and x_j , $1 \leq i < j \leq d$, corresponding to the transpositions (i, j) in \mathfrak{S}_d . Hence, the corresponding set \mathcal{R} of hyperplanes in this case is

$$\mathcal{R} = \{x_i - x_j = 0 : 1 \leq i < j \leq d\}. \quad (10.142)$$

The hyperplanes in \mathcal{R} cut the space into different regions. The connected components of the complement of $\bigcup_{H \in \mathcal{R}} H$ in \mathbb{R}^d are called *chambers*. Each chamber is enclosed by a set \mathcal{R}_0 of bordering hyperplanes. Clearly, \mathcal{R}_0 is a subset of \mathcal{R} . In our running example a typical chamber is the region

$$\{(x_1, x_2, \dots, x_d) : x_1 > x_2 > \dots > x_d\}, \quad (10.143)$$

which is bounded by the hyperplanes in (10.141). As a matter of fact, in this special case any chamber has the form

$$\{(x_1, x_2, \dots, x_d) : x_{\sigma(1)} > x_{\sigma(2)} > \dots > x_{\sigma(d)}\}, \quad (10.144)$$

where σ is some permutation in \mathfrak{S}_d .

It can be shown that the reflections with respect to the hyperplanes in \mathcal{R}_0 generate the complete reflection group W . Another important fact is that, given one chamber C , all chambers are $w(C)$, where w runs through the elements of the reflection group W , all $w(C)$'s being distinct.

Now we are in the position to formulate and prove Gessel and Zeilberger's result [53, Theorem 1]. The motivation for the technical conditions in the statement of the theorem involving k_H and r_H is that they make sure that it is not possible to "jump" over a hyperplane without touching it in a lattice point.

THEOREM 10.18.3. *Let C be a chamber of some reflection group W , determined by the hyperplanes in the set \mathcal{R}_0 . Let \mathbb{S} be a set of steps which is invariant under W , i.e., $w(\mathbb{S}) = \mathbb{S}$, and with the property that for all hyperplanes $H \in \mathcal{R}_0$ and all steps $s \in \mathbb{S}$ the Euclidean inner product (s, r_H) is either 0 or $\pm k_H$, where k_H is a fixed constant, r_H is a fixed non-zero vector perpendicular to H , both depending only on the hyperplane H . Furthermore, let A and E be lattice points inside the chamber C such that also $w(A)$ and $w(E)$ are lattice points for all $w \in W$, and such that for all hyperplanes $H \in \mathcal{R}_0$ the Euclidean inner product (A, r_H) is an integral multiple of k_H .*

Then the number of all lattice paths from A to E , with exactly m steps from \mathbb{S} , and staying strictly inside the chamber C , equals

$$|L_m(A \rightarrow E; \mathbb{S} \mid \text{inside } C)| = \sum_{w \in W} (\text{sgn } w) |L_m(w(A) \rightarrow E; \mathbb{S})|, \quad (10.145)$$

where $\text{sgn } w = \det w$, considering w as an orthogonal transformation of \mathbb{R}^d .

REMARK 10.18.4. A weighted version of the above theorem in which steps carry weights such that images of steps under W carry the same weight holds as well.

PROOF. We may rewrite (10.145) in the form

$$|L_m(A \rightarrow E; \mathbb{S} \mid \text{inside } C)| = \sum_{(w, P)} \text{sgn } w, \quad (10.146)$$

where the sum is over all pairs (w, P) with $w \in W$ and $P \in L_m(w(A) \rightarrow E; \mathbb{S})$. The proof of (10.146) is by a sign-reversing involution on the set of all such pairs (w, P) , where P touches at least one of the hyperplanes in \mathcal{H}_0 . Sign-reversing has to be understood with respect to $\text{sgn } w$. Provided the existence of such an involution, the only contributions to the sum in (10.146) would be by pairs (w, P) where P does not touch any of the hyperplanes in \mathcal{H}_0 . We claim that this can only be the case for $w = \text{id}$. In fact, as we already mentioned, it is one of the properties of a reflection group W that, given one chamber C , all chambers are $w(C)$, $w \in W$, and all $w(C)$'s are distinct. Therefore, if A is in C and $w \neq \text{id}$, then $w(A)$ must be in a different chamber and so cannot be in C . Thus, evidently, any path from $w(A)$ to E , the point E being inside C , must touch at least one of the bordering hyperplanes. This would prove (10.146) and hence the theorem.

Now we construct the promised involution. Fix some order of the hyperplanes in \mathcal{H}_0 . Let (w, P) be a pair with $w \in W$, $P \in L_m(w(A) \rightarrow E; \mathbb{S})$, and P touching at least one of the hyperplanes in \mathcal{H}_0 . Consider all meeting points of P with hyperplanes in \mathcal{H}_0 . Choose the last meeting point along the path P and denote it by M . M must be a lattice point because of the assumptions that involve the constants k_H . Let H be the first hyperplane (in the chosen order) that meets P . Then we form the new path P' by reflecting the portion of P from the starting point $w(A)$ up to M with respect to H and leaving the portion from M to P invariant. By assumption, reflection of a step from \mathbb{S} is again a step in \mathbb{S} . So, also P' consists of steps from \mathbb{S} only. Evidently, the starting point of P' is $w_H w(A)$, where w_H denotes the reflection with respect to H . Hence, $(w_H w, P')$ is a pair under consideration for the sum in (10.146), and P' touches one of the hyperplanes in \mathcal{H}_0 (namely H). This mapping is an involution since nothing was changed after M . Moreover, we have $\text{sgn } w_H w = -\text{sgn } w$. Therefore it is also sign-reversing. This completes the proof of the theorem. \square

In the case of our running example, W is the group of permutations of coordinates, C is given by (10.143), the set of hyperplanes is (10.141), the set of steps is $\{\varepsilon_1, \varepsilon_2, \dots, \varepsilon_d\}$, with ε_i denoting the positive unit vector in x_i -direction. If H_i is the hyperplane $x_i - x_{i+1} = 0$, we may choose $r_{H_i} = \varepsilon_i - \varepsilon_{i+1}$, so that all constants k_{H_i} are 1, $i = 1, 2, \dots, d-1$. Since the number of lattice paths between two given lattice points is given by a multinomial coefficient (see (10.135)), it is then not difficult to see that (10.145) yields (10.139) in this special case.

Which other examples are covered by the general setup in Theorem 10.18.3? The answer is that all reflection groups that are “relevant” in our context are completely classified. The meaning of “relevant” is as follows. In order our formula (10.145) to make sense, the sum on the right-hand side of (10.145) should be finite. So, only reflection groups that are “discrete” and act “locally finite” will be of interest to us. It is exactly these reflection groups that are precisely known (see Humphreys [63, Sec. 4.10], Bourbaki [15, Ch. V, VI]).

The classification of all *finite* reflection groups says that any such finite reflection group decomposes into the direct product of irreducible reflection groups, all of which act on pairwise orthogonal subspaces. These irreducible reflection groups do not decompose further. There exist four infinite families of types $I_2(m)$ ($m = 1, 2, \dots$), A_d , $B_d = C_d$, D_d ($d = 1, 2, \dots$) of such groups, and the seven exceptional groups of types G_2 , F_4 , E_6 , E_7 , E_8 , and H_3 , H_4 . (The indices mark the dimension of the vector space on which they act faithfully.) In addition, for most of these irreducible finite reflection groups there exists an *affine* reflection group, which is infinite. The finite reflection group is generated by all reflections with respect to the hyperplanes which run through a given point (we assume that this is the origin). The affine reflection group is generated by a larger set of hyperplanes, which includes the aforementioned hyperplanes plus certain translates of them. The reflection groups corresponding to G_2 are the same as those for $I_2(6)$, therefore we need not consider G_2 .

Grabiner and Magyar [57, p. 247] have determined all possible step sets (up to dilation) for each of the irreducible reflection groups such that the technical conditions of Theorem 10.18.3 are satisfied. Not for all types do there exist such step sets. It should be noted however that the “empty” step $(0, 0, \dots, 0)$ can always be added to any possible step set. The following list describes all possible instances of Theorem 10.18.3 when applied to an irreducible finite or affine reflection group. The results for lattice paths in chambers of affine reflection groups have been made explicit by Grabiner [56].

Types H_3 , H_4 , F_4 , E_8 , $I_2(m)$: There are no possible step sets.

Type A_{d-1} : The set of reflecting hyperplanes is $\mathcal{R} = \{x_i - x_j = 0 : 1 \leq i < j \leq d\}$. Obviously, the reflection with respect to $x_i - x_j = 0$ acts by interchanging the i -th and j -th coordinate. So, the associated finite reflection group is the group of permutations of the coordinates x_1, x_2, \dots, x_d , which is isomorphic to the permutation group \mathfrak{S}_d . A typical chamber is $C = \{(x_1, x_2, \dots, x_d) : x_1 > x_2 > \dots > x_d\}$.

Possible step sets are the sets

$$\mathbb{S}_k := \{w \cdot (1, \dots, 1, 0, \dots, 0) : w \in \mathfrak{S}_d\}, \quad k = 1, 2, \dots, d,$$

(with k occurrences of 1), all compatible with each other, as well as

$$\mathbb{S}_k^\pm := \{w \cdot (\pm 1, \dots, \pm 1, 0, \dots, 0) : w \in \mathfrak{S}_d\}, \quad k = 1 \text{ and } k = d,$$

(with k occurrences of ± 1), which can not be mixed together.

Theorem 10.18.1 is a direct consequence of Theorem 10.18.3 with $W = \mathfrak{S}_d$ and $\mathbb{S} = \mathbb{S}_1$.

The second standard application is the one for $\mathbb{S} = \mathbb{S}_d^\pm$.

THEOREM 10.18.5. *Let $A = (a_1, a_2, \dots, a_d)$ and $E = (e_1, e_2, \dots, e_d)$ be points in \mathbb{Z}^d , with all a_i 's of the same parity, all e_i 's of the same parity, $a_1 > a_2 > \dots > a_d$ and $e_1 > e_2 > \dots > e_d$. The number of all lattice paths from A to E consisting of m steps from \mathbb{S}_d^\pm and staying in the region $x_1 > x_2 > \dots > x_d$ equals*

$$|L(A \rightarrow E; \mathbb{S}_d^\pm \mid x_1 > x_2 > \dots > x_d)| = \det_{1 \leq i, j \leq d} \left(\binom{m}{\frac{m+e_i-a_j}{2}} \right). \quad (10.147)$$

We should point out that the lattice paths in Theorem 10.18.5 are in bijection with configurations in the *lock step model*, a frequently studied *vicious walker model*. On the other hand, the lattice paths in Theorem 10.18.1 are in bijection with configurations in another popular vicious walker model, the so-called *random turns model*. We refer the reader to [80, Sec. 2] for more detailed comments on these connections.

The associated affine reflection group, the affine reflection group of type \tilde{A}_{d-1} , is generated by the reflections with respect to the hyperplanes $\mathcal{R} = \{x_i - x_j = k : 1 \leq i < j \leq d, k \in \mathbb{Z}\}$. The elements of this group are called *affine permutations*. They act by permuting the coordinates x_1, x_2, \dots, x_d and adding a vector (k_1, k_2, \dots, k_d) with $k_1 + k_2 + \dots + k_d = 0$. A typical chamber² is $C = \{(x_1, x_2, \dots, x_d) : x_1 > x_2 > \dots > x_d > x_1 - 1\}$. For enumeration purposes, we inflate this chamber, see (10.148) below.

The probably first explicitly stated enumeration result for lattice paths in an affine chamber is the result below due to Filaseta [39], although it was not formulated in that way.

THEOREM 10.18.6. *Let $A = (a_1, a_2, \dots, a_d)$ and $E = (e_1, e_2, \dots, e_d)$ be points in \mathbb{Z}^d with $a_1 > a_2 > \dots > a_d$ and $e_1 > e_2 > \dots > e_d$. The number of all paths from A to E consisting of steps from \mathbb{S}_1 and staying in the chamber*

$$\{(x_1, x_2, \dots, x_d) : x_1 > x_2 > \dots > x_d > x_1 - N\} \quad (10.148)$$

of type \tilde{A}_{d-1} , equals

$$|L(A \rightarrow E; \mathbb{S}_1 \mid x_1 > x_2 > \dots > x_d > x_1 - N)| \\ = \left(\sum_{i=1}^d (e_i - a_i) \right)! \sum_{k_1 + \dots + k_d = 0} \det_{1 \leq i, j \leq d} \left(\frac{1}{(e_i - a_j + k_i N)!} \right). \quad (10.149)$$

See [82] for a q -analogue. It should be noted that Theorem 10.3.3 follows from the special case of the above theorem where $d = 2$.

For the step set \mathbb{S}_1^\pm consisting of positive *and* negative unit steps in the direction of some coordinate axis, we obtain the following result.

THEOREM 10.18.7. *Let m and N be positive integers. Furthermore, let $A = (a_1, a_2, \dots, a_d)$ and $E = (e_1, e_2, \dots, e_d)$ be vectors of integers in the chamber (10.148) of type \tilde{A}_{d-1} . Then the number of lattice paths from A to E with exactly m steps from \mathbb{S}_1^\pm , which stay in the alcove (10.148), is given by the coefficient of $x^m/m!$ in*

$$\sum_{k_1 + \dots + k_d = 0} \det_{1 \leq i, j \leq d} (I_{e_j - a_i + Nk_i}(2x)), \quad (10.150)$$

²Actually, the chambers of affine reflection groups are usually called *alcoves*.

where $I_\alpha(x)$ is the modified Bessel function of the first kind

$$I_\alpha(x) = \sum_{j=0}^{\infty} \frac{(x/2)^{2j+\alpha}}{j!(j+\alpha)!}.$$

The last result for type A_{d-1} which we state is the one for paths in an affine chamber of type \tilde{A}_{d-1} with steps from \mathbb{S}_d^\pm .

THEOREM 10.18.8 ([56, Eq. (35)]). *Let m and N be positive integers. Furthermore, let $A = (a_1, a_2, \dots, a_d)$ and $E = (e_1, e_2, \dots, e_d)$ be vectors of integers in the chamber (10.148) of type \tilde{A}_{d-1} such that all a_i 's have the same parity, and all e_i 's have the same parity. Then the number of lattice paths from A to E with exactly m steps from \mathbb{S}_d^\pm , which stay in the chamber (10.148), is given by*

$$\begin{aligned} & |L_m(A \rightarrow E; \mathbb{S}_d^\pm \mid x_1 > x_2 > \dots > x_d > x_1 - N)| \\ &= \sum_{k_1 + \dots + k_d = 0} \det_{1 \leq i, j \leq d} \left(\binom{m}{\frac{m+e_i-a_j}{2} + Nk_j} \right). \end{aligned} \quad (10.151)$$

Types B_d, C_d : The finite reflection groups of types B_d and C_d are identical. The set of reflecting hyperplanes is $\mathcal{R} = \{\pm x_i \pm x_j = 0 : 1 \leq i < j \leq d\} \cup \{x_i = 0 : 1 \leq i \leq d\}$. Obviously, the reflection with respect to $x_i - x_j = 0$ acts by interchanging the i -th and j -th coordinate, the reflection with respect to $x_i + x_j = 0$ acts by interchanging the i -th and j -th coordinate and changing the sign of both, while the reflection with respect to $x_i = 0$ acts by changing sign of the i -th coordinate.

Here, the possible step sets are only \mathbb{S}_1^\pm and \mathbb{S}_d^\pm .

The associated finite reflection group is the group of *signed permutations* of the coordinates x_1, x_2, \dots, x_d , which acts by permuting and changing signs of (some of) the coordinates x_1, x_2, \dots, x_d . It is frequently called the *hyperoctahedral group*, since it is the symmetry group of a d -dimensional octahedron. It is furthermore isomorphic to the semidirect product $(\mathbb{Z}/2\mathbb{Z})^d \rtimes \mathfrak{S}_d$. A typical chamber is $C = \{(x_1, x_2, \dots, x_d) : x_1 > x_2 > \dots > x_d > 0\}$. We have the following enumeration result for lattice paths staying in this chamber.

THEOREM 10.18.9. *Let $A = (a_1, a_2, \dots, a_d)$ and $E = (e_1, e_2, \dots, e_d)$ be points in \mathbb{Z}^d , with all a_i 's of the same parity, all e_i 's of the same parity, $a_1 > a_2 > \dots > a_d > 0$ and $e_1 > e_2 > \dots > e_d > 0$. The number of all lattice paths from A to E consisting of m steps from \mathbb{S}_d^\pm and staying in the region $x_1 > x_2 > \dots > x_d > 0$ equals*

$$|L_m(A \rightarrow E; \mathbb{S}_d^\pm \mid x_1 > x_2 > \dots > x_d)| = \det_{1 \leq i, j \leq d} \left(\binom{m}{\frac{m+e_i-a_j}{2}} - \binom{m}{\frac{m+e_i+a_j}{2}} \right). \quad (10.152)$$

The associated affine reflection group now comes in two flavours, types \tilde{B}_d and \tilde{C}_d . A typical chamber of type \tilde{C}_d is $C = \{(x_1, x_2, \dots, x_d) : 1 > x_1 > x_2 > \dots > x_d > 0\}$, while a typical chamber of type \tilde{B}_d is $C = \{(x_1, x_2, \dots, x_d) : x_1 > x_2 > \dots > x_d > 0 \text{ and } x_1 + x_2 < 1\}$,

Next we quote the two results from [56] on the enumeration of lattice paths in chambers of type \tilde{C}_d .

THEOREM 10.18.10 ([56, Eq. (23)]). *Let m and N be positive integers. Furthermore, let $A = (a_1, a_2, \dots, a_d)$ and $E = (e_1, e_2, \dots, e_d)$ be vectors of integers in the chamber*

$$\{(x_1, x_2, \dots, x_n) : N > x_1 > x_2 > \dots > x_d > 0\} \quad (10.153)$$

of type \tilde{C}_d . Then the number of lattice paths from A to E with exactly m steps from \mathbb{S}_1^\pm , which stay in the chamber (10.153), is given by the coefficient of $x^m/m!$ in

$$\det_{1 \leq i, j \leq d} \left(\frac{1}{N} \sum_{r=0}^{2N-1} \sin \frac{\pi r e_i}{N} \cdot \sin \frac{\pi r a_j}{N} \cdot \exp \left(2x \cos \frac{\pi r}{N} \right) \right). \quad (10.154)$$

The result for lattice paths with steps from \mathbb{S}_d^\pm is the following.

THEOREM 10.18.11 ([56, Eq. (18)]). *Let m and N be positive integers. Furthermore, let $A = (a_1, a_2, \dots, a_d)$ and $E = (e_1, e_2, \dots, e_d)$ be vectors of integers in the chamber (10.153) of type \tilde{C}_d such that all a_i 's are of the same parity, and all e_i 's are of the same parity. Then the number of lattice paths from A to E with exactly m steps from \mathbb{S}_d^\pm , which stay in the chamber (10.153), is given by*

$$\det_{1 \leq i, j \leq d} \left(\frac{2^{m-1}}{N} \sum_{r=0}^{4N-1} \sin \frac{\pi r \lambda_t}{N} \cdot \sin \frac{\pi r \eta_h}{N} \cdot \cos^m \frac{\pi r}{2N} \right). \quad (10.155)$$

Enumeration results for lattice paths in a chamber of type \tilde{B}_d can be also derived from Theorem 10.18.3. We omit to state them here, but instead refer to [56] and [80, Theorems 8 and 9].

Type D_d : The set of reflecting hyperplanes is $\mathcal{R} = \{\pm x_i \pm x_j = 0 : 1 \leq i < j \leq d\}$. Obviously, D_d is a subset of B_d or C_d . The action of the reflection with respect to a hyperplane $\pm x_i \pm x_j = 0$ was already explained there.

The associated finite reflection group is the group of signed permutations of the coordinates x_1, x_2, \dots, x_d with an even number of sign changes. It acts by permuting the coordinates x_1, x_2, \dots, x_d and changing an even number of signs thereof. A typical chamber is $C = \{(x_1, x_2, \dots, x_d) : x_1 > x_2 > \dots > x_{d-1} > |x_d|\}$.

The associated affine reflection group is generated by the reflections with respect to the hyperplanes $\mathcal{R} = \{\pm x_i \pm x_j = k : 1 \leq i < j \leq d, k \in \mathbb{Z}\}$. The elements of this group act by permuting the coordinates x_1, x_2, \dots, x_d , changing an even number of signs thereof, and adding a vector (k_1, k_2, \dots, k_d) with $k_1 + k_2 + \dots + k_d \equiv 0 \pmod{2}$. A typical chamber is $C = \{(x_1, x_2, \dots, x_d) : x_1 > x_2 > \dots > x_{d-1} > |x_d|, \text{ and } x_1 + x_2 < 1\}$.

We omit the explicit statement of enumeration results for types D_d and \tilde{D}_d which one may derive from Theorem 10.18.3, and instead refer to [56] and [80, Theorems 10 and 11].

Types E_6 and E_7 : There are possible step sets (see [57, p. 247]), but since this does not yield interesting enumeration results, we refrain from discussing these two cases further.

A non-example for the application of the reflection principle has been discussed in Section 10.12, see Theorem 10.12.3.

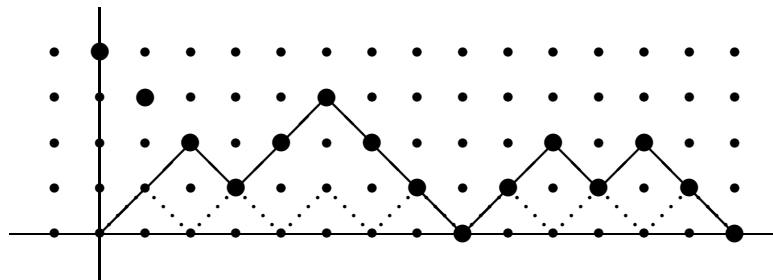

FIGURE 27. A Dyck path

10.19. q -Counting of lattice paths and Rogers–Ramanujan identities

In this section, we discuss some q -analogues of earlier (plain) enumeration results, and we briefly present work showing the close link between lattice path enumeration and the celebrated Rogers–Ramanujan identities.

As we have already seen in the introduction, one source of q -analogues is area counting of lattice paths. This idea has also been used to construct a q -analogue of Catalan numbers. Given a Dyck path P (see Section 10.8) from $(0,0)$ to $(2n,0)$, let $\tilde{a}(P) := \frac{1}{2}(a(P) - n)$. In other words, $\tilde{a}(P)$ is half of the area between P and the “lowest” Dyck path from $(0,0)$ and $(2n,0)$, that is, the zig-zag path in which up-steps and down-steps alternate. Alternatively, $\tilde{a}(P)$ counts the squares with side length $\sqrt{2}$ (rotated by 45°) which fit between P and the zig-zag path. In Figure 27 this zig-zag path is indicated as the dotted path. For the Dyck path shown with full lines in the figure, we have $\tilde{a}(\cdot) = 6$. This (modified) area statistics is now used to define the q -Catalan number $C_n(q)$ as the generating function for Dyck paths of length $2n$ with respect to the statistics $\tilde{a}(\cdot)$,

$$C_n(q) = GF(L((0,0) \rightarrow (2n,0); \{(1,1), (1,-1)\}); q^{\tilde{a}(P)}). \quad (10.156)$$

By decomposing a given Dyck path P uniquely into

$$P = s_u P_1 s_d P_2,$$

where s_u denotes an up-step, s_d denotes a down-step, and P_1 and P_2 are Dyck paths, one obtains the recurrence

$$C_n(q) = \sum_{k=0}^{n-1} q^k C_k(q) C_{n-k-1}(q), \quad n \geq 1, \quad (10.157)$$

with initial condition $C_0(q) = 1$. These q -Catalan numbers have been originally introduced by Carlitz and Riordan [25]. We shall say more about these further below.

A different statistics can be derived from turn enumeration (cf. Section 10.14). In the geometry which we are considering here, turns are peaks and valleys of a Dyck path. For a peak at lattice point S , denote by $x(S)$ the number of steps along the path from the origin to S . (Equivalently, $x(S)$ is the ordinate of S .) In the Dyck path in Figure 27, the peaks are at $(2,2)$, $(5,3)$, $(10,2)$, and $(12,2)$. The ordinates are $x((2,2)) = 2$, $x((5,3)) = 5$, $x((10,2)) = 10$, $x((12,2)) = 12$. The *major index* of a Dyck path P , denoted by $\text{maj}(P)$, is the sum of all values $x(S)$ over all peaks S of

P . For the Dyck path in Figure 27, we have $\text{maj}(\cdot) = 2 + 5 + 10 + 12 = 29$. Fürlinger and Hofbauer [47] used this statistic to define alternative q -Catalan numbers, namely

$$c_n(q) = GF(L((0,0) \rightarrow (2n,0); \{(1,1), (1,-1)\}); q^{\text{maj}(P)}). \quad (10.158)$$

They showed that

$$c_n(q) = \frac{1-q}{1-q^{n+1}} \begin{bmatrix} 2n \\ n \end{bmatrix}_q, \quad (10.159)$$

the “natural” q -analogue of the Catalan number in view of its explicit formula $\frac{1}{n+1} \binom{2n}{n}$. More on these q -Catalan numbers and further work in this direction can be found in [47, 74, 81]. These ideas have been extended to Schröder paths and numbers by Bonin, Shapiro and Simion in [11],

Returning to the q -Catalan numbers of Carlitz and Riordan, we see that by the choice of $b_i = 0, i = 0, 1, \dots, \lambda_i = q^{i-1}z, i = 1, 2, \dots$, in Theorem 10.9.1, we obtain a continued fraction for the generating function of q -Catalan numbers $C_n(q)$, namely

$$\sum_{n=0}^{\infty} C_n(q)z^n = \frac{1}{1 - \frac{z}{1 - \frac{qz}{1 - \frac{q^2z}{1 - \frac{q^3z}{1 - \ddots}}}}} . \quad (10.160)$$

If one substitutes $z = -q$ in this continued fraction, then it becomes the reciprocal of the celebrated Ramanujan continued fraction (cf. [2, Ch. 7])

$$1 + \frac{q}{1 + \frac{q^2}{1 + \frac{q^3}{1 + \frac{q^4}{\ddots}}}} = \frac{\sum_{n=0}^{\infty} \frac{q^{n^2}}{(q; q)_n}}{\sum_{n=0}^{\infty} \frac{q^{n(n+1)}}{(q; q)_n}}, \quad (10.161)$$

where $(\alpha; q)_n := (1 - \alpha)(1 - \alpha q) \cdots (1 - \alpha q^{n-1}), n \geq 1$, and $(\alpha; q)_0 := 1$.

Numerator and denominator on the right-hand side of this identity feature in the equally celebrated Rogers–Ramanujan identities (cf. also [2, Ch. 7])

$$\sum_{n=0}^{\infty} \frac{q^{n^2}}{(q; q)_n} = \frac{1}{(q; q^5)_{\infty} (q^4; q^5)_{\infty}} \quad (10.162)$$

and

$$\sum_{n=0}^{\infty} \frac{q^{n(n+1)}}{(q; q)_n} = \frac{1}{(q^2; q^5)_{\infty} (q^3; q^5)_{\infty}}. \quad (10.163)$$

The fact that we came across the left-hand sides of these identities by starting with lattice path counting problems may indicate that the Rogers–Ramanujan identities themselves may be linked with lattice path enumeration. Bressoud [24] was the first to actually set up such a link. Since then, this connection has been explored much

further and extended in various directions, particularly so in the physics literature, see [7, 29, 34, 93, 122] and the references therein.

10.20. Self-avoiding walks

A path (walk) in a lattice in d -dimensional Euclidean space is called *self-avoiding* if it visits each point of the lattice at most once. One cannot expect useful formulas for the exact enumeration of self-avoiding paths (except in extremely simple lattices). This is the reason why, with a few exceptions, research in this area concentrates on *asymptotic* counting: how many self-avoiding walks are there in a particular lattice, consisting of n steps from a given step set, asymptotically as n tends to infinity? This is a notoriously difficult question, which has been investigated mainly in the physics and probability literature. In fact, the self-avoiding walk constitutes a fascinating, vast subject area, which would need a chapter by itself. We refer the reader to the standard book [92], and to the more recent volumes [59, 67] which contain more recent material on or relating to self-avoiding walks.

Bibliography

- [1] D. André. Solution directe du problème résolu par M. Bertrand. *Comptes Rendus Acad. Sci. Paris Sér. I*, 105:436–437, 1887.
- [2] G. E. Andrews. *The Theory of Partitions*. Addison–Wesley, Reading, Encyclopedia of Math. and its Applications, vol. 2, 1976. Reprinted by Cambridge University Press, Cambridge, 1998.
- [3] D. Armstrong. *Generalized Noncrossing Partitions and Combinatorics of Coxeter Groups*. Mem. Amer. Math. Soc., vol. 202, no. 949, Amer. Math. Soc., Providence, R.I., 2009.
- [4] D. Armstrong, B. Rhoades, and N. Williams. Rational associahedra and noncrossing partitions. *Electron. J. Combin.*, 20:Paper 54, 27 pp, 2013.
- [5] C. Banderier and P. Flajolet. Basic analytic combinatorics of directed lattice paths. *Theoret. Computer Science*, 281:37–80, 2002.
- [6] C. Banderier and B. Gittenberger. Analytic combinatorics of lattice paths: enumeration and asymptotics for the area. In *Fourth Colloquium on Mathematics and Computer Science Algorithms, Trees, Combinatorics and Probabilities*, pages 345–355, Assoc. Discrete Math. Theor. Comput. Sci., Nancy, 2006. Discrete Math. Theor. Comput. Sci. Proc., AG.
- [7] A. Berkovich and P. Paule. Lattice paths, q -multinomials and two variants of the Andrews–Gordon identities. *Ramanujan J.*, 5:409–425, 2001.
- [8] J. F. L. Bertrand. Solution d’un problème. *Comptes Rendus Acad. Sci. Paris Sér. I*, 105:369, 1887.
- [9] P. Biane. Permutations suivant le type d’excédance et le nombre d’inversions et interprétation combinatoire d’une fraction continue de Heine. *European J. Combin.*, 14:277–284, 1993.
- [10] P. Biane. Representations of symmetric groups and free probability. *Adv. Math.*, 138:126–181, 1998.
- [11] J. Bonin, L. Shapiro, and R. Simion. Some q -analogues of the Schröder numbers arising from combinatorial statistics on lattice paths. *J. Statist. Plann. Inference*, 34:35–56, 1993.
- [12] A. Bostan and M. Kauers. The complete generating function for Gessel walks is algebraic. *Proc. Amer. Math. Soc.*, 138:3063–3078, 2010.
- [13] A. Bostan, I. Kurkova, and K. Raschel. A human proof of Gessel’s lattice path conjecture. Preprint; [arXiv:1309.1023](https://arxiv.org/abs/1309.1023).
- [14] A. Bostan, K. Raschel, and B. Salvy. Non-D-finite excursions in the quarter plane. *J. Combin. Theory Ser. A*, 121:45–63, 2014.
- [15] N. Bourbaki. *Groupes et algèbres de Lie*. Chapitres IV, V, VI, Éléments de Mathématiques, Fasc. 34, Hermann, Paris, 1968.
- [16] M. Bousquet-Mélou. Walks in the quarter plane — Kreweras’ algebraic model. *Ann. Appl. Probab.*, 15:1451–1491, 2005.
- [17] M. Bousquet-Mélou and L. Habsieger. Sur les matrices à signes alternants. *Discrete Math.*, 139:57–72, 1995.
- [18] M. Bousquet-Mélou and A. Jehanne. Polynomial equations with one catalytic variable, algebraic series and map enumeration. *J. Combin. Theory Ser. B*, 96:623–672, 2006.
- [19] M. Bousquet-Mélou and M. Mishna. Walks with small steps in the quarter plane. In *Algorithmic probability and combinatorics*, pages 1–39. Contemp. Math., vol. 520, Amer. Math. Soc., Providence, R.I., 2010.
- [20] M. Bousquet-Mélou and G. Schaeffer. Walks on the slit plane. *Probab. Theory Related Fields*, 124:305–344, 2002.

- [21] R. Brak and W. Galleas. Constant term solution for an arbitrary number of osculating lattice paths. *Lett. Math. Phys.*, 103:1261–1272, 2013.
- [22] R. Brak, A. L. Owczarek, A. Rechnitzer, and S. G. Whittington. A directed walk model of a long chain polymer in a slit with attractive walls. *J. Phys. A*, 38:4309–4325, 2005.
- [23] F. Brenti. Combinatorics and total positivity. *J. Combin. Theory Ser. A*, 71:175–218, 1995.
- [24] D. M. Bressoud. Lattice paths and the Rogers–Ramanujan identities. In *Number theory, Madras 1987*, pages 140–172, Berlin, 1989. Lecture Notes in Math., 1395, Springer.
- [25] L. Carlitz and J. Riordan. Two element lattice path permutation numbers and their q -generalization. *Duke Math. J.*, 31:371–388, 1964.
- [26] P. Cartier and D. Foata. *Problèmes combinatoires de commutation et réarrangements*. Lecture Notes in Mathematics, no. 85, Springer–Verlag, Berlin, New York, 1969. Republished in the “books” section of the Séminaire Lotharingien de Combinatoire.
- [27] E. C. Catalan. Note sur une équation aux différences finies. *J. Math. Pures Appl.*, 3:508–515, 1838.
- [28] E. C. Catalan. Solution nouvelle de cette question : Un polygone étant donné, de combien de manières peut-on le partager en triangles au moyen de diagonales ? *J. Math. Pures Appl.*, 4:91–94, 1839.
- [29] J. Cigler. Fibonacci–Zahlen, Gitterpunktwege und die Identitäten von Rogers–Ramanujan. *Math. Semesterber.*, 52:97–125, 2005.
- [30] M. Ciucu, T. Eisenkölbl, C. Krattenthaler, and D. Zare. Enumeration of lozenge tilings of hexagons with a central triangular hole. *J. Combin. Theory Ser. A*, 95:251–334, 2001.
- [31] M. Ciucu and C. Krattenthaler. A factorization theorem for rhombus tilings of a hexagon with triangular holes. Preprint; [arXiv:1403.3323](https://arxiv.org/abs/1403.3323).
- [32] M. Ciucu and C. Krattenthaler. The interaction of a gap with a free boundary in a two dimensional dimer system. *Commun. Math. Phys.*, 302:253–289, 2011.
- [33] R. J. Clarke, E. Steingrímsson, and J. Zeng. New Euler–Mahonian statistics on permutations and words. *Adv. in Appl. Math.*, 18:237–270, 1997.
- [34] S. Corteel and O. Mallet. Overpartitions, lattice paths, and Rogers–Ramanujan identities. *J. Combin. Theory Ser. A*, 114:1407–1437, 2007.
- [35] N. Dershovitz and S. Zaks. The cycle lemma and some applications. *Europ. J. Combin.*, 11:35–40, 1990.
- [36] A. Dvoretzky and T. Motzkin. A problem of arrangements. *Duke Math. J.*, 14:305–313, 1947.
- [37] L. Euler. Summarium. *Novi Commentarii Academiae Scientiarum Petropolitanae*, 7:13–15, 1758/59. Reprinted in *Opera Omnia (1)* **26** (1953), xvi–xviii.
- [38] W. Feller. *An Introduction to Probability Theory and Its Applications*. vol. 1, 2nd ed., Wiley, New York, 1957.
- [39] M. Filaseta. A new method for solving a class of ballot problem. *J. Combin. Theory Ser. A*, 39:102–111, 1985.
- [40] I. Fischer. Enumeration of rhombus tilings of a hexagon which contain a fixed rhombus in the centre. *J. Combin. Theory Ser. A*, 96:31–88, 2001.
- [41] M. E. Fisher. Walks, walls, wetting, and melting. *J. Statist. Phys.*, 34:667–729, 1984.
- [42] P. Flajolet. Combinatorial aspects of continued fractions. *Discrete Math.*, 32:125–161, 1980.
- [43] P. Flajolet and R. Sedgewick. *Analytic Combinatorics*. Cambridge University Press, Cambridge, 2009.
- [44] D. Foata and D. Zeilberger. Denert’s permutation statistic is indeed Euler–Mahonian. *Stud. Appl. Math.*, 83:31–59, 1990.
- [45] J. S. Frame, G. B. Robinson, and R. M. Thrall. The hook graphs of the symmetric group. *Canad. J. Math.*, 6:316–325, 1954.
- [46] J. Françon and X. G. Viennot. Permutations selon leurs pics, creux, doubles montés et double descentes, nombres d’Euler et nombres de Genocchi. *Discrete Math.*, 28:21–35, 1979.
- [47] J. Fürlinger and J. Hofbauer. q -Catalan numbers. *J. Combin. Theory A*, 40:248–264, 1985.
- [48] I. M. Gessel. A probabilistic method for lattice path enumeration. *J. Statist. Plann. Inference*, 14:49–58, 1986.

- [49] I. M. Gessel and C. Krattenthaler. Cylindric partitions. *Trans. Amer. Math. Soc.*, 349:429–479, 1997.
- [50] I. M. Gessel and X. Viennot. Binomial determinants, paths, and hook length formulae. *Adv. Math.*, 58:300–321, 1985.
- [51] I. M. Gessel and X. Viennot. Determinants, paths, and plane partitions. Preprint; available at <http://www.cs.brandeis.edu/~ira>, 1989.
- [52] I. M. Gessel and G. Xin. The generating function of ternary trees and continued fractions. *Electron. J. Combin.*, 13:Research Paper 53, 48 pp., 2006.
- [53] I. M. Gessel and D. Zeilberger. Random walk in a Weyl chamber. *Proc. Amer. Math. Soc.*, 115:27–31, 1992.
- [54] H. W. Gould. Some generalizations of Vandermonde’s convolution. *Amer. Math. Monthly*, 63:84–91, 1956.
- [55] I. P. Goulden and L. G. Serrano. Maintaining the spirit of the reflection principle when the boundary has arbitrary integer slope. *J. Combin. Theory Ser. A*, 104:317–326, 2003.
- [56] D. J. Grabiner. Random walk in an alcove of an affine Weyl group, and non-colliding random walks on an interval. *J. Combin. Theory Ser. A*, 97:285–306, 2002.
- [57] D. J. Grabiner and P. Magyar. Random walks in Weyl chambers and the decomposition of tensor powers. *J. Alg. Combin.*, 2:239–260, 1993.
- [58] H.-D. O. F. Gronau, W. Just, W. Schade, P. Scheffler, and J. Wojciechowski. Path systems in acyclic directed graphs. *Zastos. Mat.*, 19:399–411, 1988.
- [59] A. J. Guttmann, editor. *Polygons, Polyominoes and Polycubes*. Lecture Notes in Physics, vol. 775, Springer–Verlag, Dordrecht, 2009.
- [60] R. Guy, C. Krattenthaler, and B. E. Sagan. Lattice paths, reflections, & dimension-changing bijections. *Ars Combin.*, 34:3–15, 1992.
- [61] J. Haglund. *The q, t -Catalan Numbers and the Space of Diagonal Harmonics*. University Lecture Series, vol. 41, Amer. Math. Soc., Providence, R.I., 2008.
- [62] B. R. Handa and S. G. Mohanty. Enumeration of higher-dimensional paths under restrictions. *Discrete Math.*, 26:119–128, 1979.
- [63] J. E. Humphreys. *Reflection Groups and Coxeter Groups*. Cambridge University Press, Cambridge, 1990.
- [64] K. Humphreys. A history and a survey of lattice path enumeration. *J. Statist. Plann. Inference*, 140:2237–2254, 2010.
- [65] C. Huygens. De ratiociniis in ludo aleae. In van Schooten, editor, *Exercitationum Mathematicarum Libri quinque*. Amsterdam, 1657. Reprinted in *Œuvres complètes de Christiaan Huygens*, vol. 14, La Haye: Nijhoff.
- [66] M. Ishikawa and M. Wakayama. Minor summation formula for pfaffians. *Linear and Multilinear Algebra*, 39:285–305, 1995.
- [67] E. J. Janse van Rensburg. *The Statistical Mechanics of Interacting Walks, Polygons, Animals and Vesicles*. Oxford Lecture Series in Mathematics and its Applications, vol. 18, Oxford University Press, Oxford, 2000.
- [68] E. J. Janse van Rensburg, T. Prellberg, and A. Rechnitzer. Directed paths in a wedge. *J. Phys. A*, 40:14069–14084, 2007.
- [69] E. J. Janse van Rensburg, T. Prellberg, and A. Rechnitzer. Partially directed paths in a wedge. *J. Combin. Theory Ser. A*, 115:623–650, 2008.
- [70] P. John and H. Sachs. Wegesysteme und Linearfaktoren in hexagonalen und quadratischen Systemen. In *Graphs in research and teaching*, (Kiel, 1985), pages 85–101, Bad Salzdetfurth, 1985. Franzbecker.
- [71] S. Karlin and J. L. McGregor. Coincidence probabilities. *Pacific J. Math.*, 9:1141–1164, 1959.
- [72] S. Karlin and J. L. McGregor. Coincidence properties of birth-and-death processes. *Pacific J. Math.*, 9:1109–1140, 1959.
- [73] V. S. Korolyuk. On the discrepancy of empiric distributions for the case of two independent samples. *Izv. Akad. Nauk SSSR Ser. Math.*, 19:81–96, 1955. IMS & AMS Selected Translations Math. Statist. Prob. 4 (1963), 105–122.

- [74] C. Krattenthaler. Counting lattice paths with a linear boundary, part 2: q -ballot and q -Catalan numbers. *Sitz.ber. Österr. Akad. Wiss., math.-naturwiss. Klasse*, 198:171–199, 1989.
- [75] C. Krattenthaler. Counting nonintersecting lattice paths with turns. *Séminaire Lotharingien Combin.*, 34:paper B34i, 17 pp, 1995.
- [76] C. Krattenthaler. *The Major Counting of Nonintersecting Lattice Paths and Generating Functions for Tableaux*. Mem. Amer. Math. Soc., vol. 115, no. 552, Providence, R.I., 1995.
- [77] C. Krattenthaler. Determinant identities and a generalization of the number of totally symmetric self-complementary plane partitions. *Electron. J. Combin.*, 4(1):Article #R27, 62 pp, 1997.
- [78] C. Krattenthaler. The enumeration of lattice paths with respect to their number of turns. In N. Balakrishnan, editor, *Advances in Combinatorial Methods and Applications to Probability and Statistics*, pages 29–58. Birkhäuser, Boston, 1997.
- [79] C. Krattenthaler. On multiplicities of points on Schubert varieties in Grassmannians. *Séminaire Lotharingien Combin.*, 45:Article B45c, 11 pp, 2001.
- [80] C. Krattenthaler. Asymptotics for random walks in alcoves of affine Weyl groups. *Séminaire Lotharingien Combin.*, 52:Article B52i, 72 pp, 2007.
- [81] C. Krattenthaler and S. G. Mohanty. On lattice path counting by major and descents. *Europ. J. Combin.*, 14:43–51, 1993.
- [82] C. Krattenthaler and S. G. Mohanty. q -Generalization of a ballot problem. *Discrete Math.*, 126:195–208, 1994.
- [83] C. Krattenthaler and S. G. Mohanty. Counting tableaux with row and column bounds. *Discrete Math.*, 136:273–286, 1995.
- [84] C. Krattenthaler and M. Prohaska. A remarkable formula for counting nonintersecting lattice paths in a ladder with respect to turns. *Trans. Amer. Math. Soc.*, 351:1015–1042, 1999.
- [85] G. Kreweras. Sur une classe de problèmes de dénombrement liés au treillis des partitions des entiers. *Cahiers du B.U.R.O. Univ. de Rech. Opér.*, 6:5–105, 1965.
- [86] D. M. Kulkarni. Counting of paths and coefficients of Hilbert polynomial of a determinantal ideal. *Discrete Math.*, 154:141–151, 1996.
- [87] A. Lascoux and M.-P. Schützenberger. Polynômes de Schubert. *C. R. Acad. Sci. Paris*, 294:447–450, 1982.
- [88] B. Lindström. On the vector representations of induced matroids. *Bull. London Math. Soc.*, 5:85–90, 1973.
- [89] I. G. Macdonald. *Symmetric Functions and Hall Polynomials*. second edition, Oxford University Press, New York/London, 1995.
- [90] P. A. MacMahon. Memoir on the theory of the partitions of numbers — Part IV. *Phil. Trans. Royal Soc. London (A)*, 209:153–175, 1909.
- [91] P. A. MacMahon. *Combinatory Analysis*. vols. 1 and 2, Cambridge University Press, Cambridge, 1915, 1916. Reprinted by Chelsea, New York, 1955.
- [92] N. Madras and G. Slade. *The Self-Avoiding Walk*. Probability and its Applications, Birkhäuser Boston, Inc., Boston, MA, 1993.
- [93] P. Mathieu. Paths and partitions: combinatorial descriptions of the parafermionic states. *J. Math. Phys.*, 50:095210, 43 pp., 2009.
- [94] A. de Médicis and X. G. Viennot. Moments des q -polynômes de Laguerre et la bijection de Foata–Zeilberger. *Adv. Appl. Math.*, 15:262–304, 1994.
- [95] S. G. Mohanty. *Lattice Path Counting and Applications*. Academic Press, New York, 1979.
- [96] S. G. Mohanty and T. V. Narayana. Some properties of compositions and their application to probability and statistics, I. *Biometrische Z.*, 3:252–258, 1963.
- [97] T. V. Narayana. *Lattice Path Combinatorics With Statistical Applications*. Math. Expositions, no. 23, Univ. of Toronto Press, Toronto, 1979.
- [98] H. Niederhausen. Linear recurrences under side conditions. *Europ. J. Combin.*, 1:353–368, 1980.
- [99] H. Niederhausen. The ballot problem with three candidates. *Europ. J. Combin.*, 4:161–167, 1983.

- [100] S. Okada. On the generating functions for certain classes of plane partitions. *J. Combin. Theory Ser. A*, 51:1–23, 1989.
- [101] I. Pak. History of Catalan numbers. Preprint; arXiv:1408.5711. To appear as an appendix to Richard Stanley’s book “Catalan Numbers”, 2014.
- [102] E. Roblet and X. Viennot. Théorie combinatoire des T -fractions et approximants de Padé en deux points. *Discrete Math.*, 153:271–288, 1996.
- [103] B. E. Sagan. *The Symmetric Group*. 2nd edition, Springer–Verlag, New York, 2001.
- [104] M. Sato. Generating functions for the number of lattice paths between two parallel lines with a rational incline. *Math. Japonica*, 34:123–137, 1989.
- [105] M. Sato. Generating functions for the number of lattice paths restricted by two parallel hyperplanes. *J. Statist. Plann. Inference*, 34:251–258, 1993.
- [106] J. A. Segner. Enumeratio modorum, quibus figurae planaerectilineae per diagonales dividuntur in triangula. *Novi Commentarii Academiae Scientiarum Petropolitanae*, 7:203–209, 1758/59.
- [107] R. Simion and D. Stanton. Octabasic Laguerre polynomials and permutation statistics. *J. Comput. Appl. Math.*, 68:297–329, 1996.
- [108] J. C. Slater. The theory of complex spectra. *Phys. Rev.*, 34:1293–1322, 1929.
- [109] J. C. Slater. *Quantum Theory of Matter*. 2nd ed., McGraw–Hill, New York, 1968.
- [110] F. Spitzer. A combinatorial lemma and its application to probability theory. *Trans. Amer. Math. Soc.*, 82:323–339, 1956.
- [111] R. P. Stanley. Catalan addendum. Continuation of Exercise 6.19 from [113]; available at <http://math.mit.edu/~rstan/ec/catadd.pdf>.
- [112] R. P. Stanley. *Enumerative Combinatorics*. vol. 1, Wadsworth & Brooks/Cole, Pacific Grove, California, 1986. Reprinted by Cambridge University Press, Cambridge, 1998.
- [113] R. P. Stanley. *Enumerative Combinatorics*. vol. 2, Cambridge University Press, Cambridge, 1999.
- [114] J. R. Stembridge. Nonintersecting paths, pfaffians and plane partitions. *Adv. Math.*, 83:96–131, 1990.
- [115] R. A. Sulanke. A determinant for q -counting lattice paths. *Discrete Math.*, 81:91–96, 1990.
- [116] R. A. Sulanke and G. Xin. Hankel determinants for some common lattice paths. *Adv. in Appl. Math.*, 40:149–167, 2008.
- [117] G. Szegő. *Orthogonal Polynomials*. American Mathematical Society Colloquium Publications, vol. XXIII, New York, 1959.
- [118] L. Takács. A generalization of the ballot problem and its application in the theory of queues. *J. Amer. Statist. Assoc.*, 57:327–337, 1962.
- [119] X. Viennot. *Une théorie combinatoire des polynômes orthogonaux généraux*. UQAM, Montréal, Québec, 1983. Available at http://www.xavierviennot.org/xavier/polynomes_orthogonaux.html.
- [120] X. G. Viennot. Heaps of pieces. I. Basic definitions and combinatorial lemmas. In *Combinatoire énumérative*, pages 321–350. Lecture Notes in Math., 1234, Springer, Berlin, 1986.
- [121] M. L. Wachs. Flagged Schur functions, Schubert polynomials, and symmetrizing operators. *J. Combin. Theory Ser. A*, 40:276–289, 1985.
- [122] T. A. Welsh. *Fermionic Expressions for Minimal Model Virasoro Characters*. Mem. Amer. Math. Soc., vol. 175, no. 827, 2005.
- [123] W. A. Whitworth. Arrangements of m things of one sort and n things of another sort, under certain conditions of priority. *Messenger Math.*, 8:105–114, 1878.
- [124] D. Zeilberger. André’s reflection proof generalized to the many candidate ballot problem. *Discrete Math.*, 44:325–326, 1983.