

Games Without Frontiers: Investigating Video Games as a Covert Channel

Bridger Hahn
Stony Brook University
bridger.hahn@stonybrook.edu

Rishab Nithyanand
Stony Brook University
rnithyanand@cs.stonybrook.edu

Phillipa Gill
Stony Brook University
phillipa@cs.stonybrook.edu

Rob Johnson
Stony Brook University
rob@cs.stonybrook.edu

Abstract

The Internet has become a critical communication infrastructure for citizens to organize protests and express dissatisfaction with their governments. This fact has not gone unnoticed, with governments clamping down on this medium via censorship, and circumvention researchers working tirelessly to stay one step ahead. In this paper, we explore a promising new avenue for covert channels: using video games as a cover protocol. The popularity of platforms like Steam have given rise to a rich population of video games for use as cover. The common properties of games in the same genre simplify the process of adapting channels to evade detection. We demonstrate the feasibility of this approach using two real time strategy games (including a popular closed-source game). We show how common properties of these games can be used to design a coding scheme to translate data into game commands in a way that is general across games and requires little per-game customizations. We evaluate the security of Castle by quantifying its resilience to a censor-adversary, its similarity to real game traffic, and its ability to avoid common pitfalls in covert channel design. We use our prototype to demonstrate that Castle can provide throughput which is amenable to transfer of textual data (*e.g.*, e-mail, short articles, etc.).

1 Introduction

Recent years have seen the Internet become a critical communication infrastructure for citizens to organize protests [16] and express dissatisfaction with their governments [13]. This fact has not gone unnoticed, with governments clamping down on this medium via censorship [20–22], surveillance [12] and even large-scale Internet take downs [9, 24, 26]. The situation is only getting worse, with Freedom house reporting 36 of the 65 countries they survey experiencing decreasing levels of Internet freedom between 2013 and 2014 [10].

Researchers working towards circumventing online information controls are currently engaged in an arms race with censors. A key research direction in recent years has been the idea of *look-like-something* circumvention approaches, which aim to disguise covert traffic as another protocol to evade detection by censors. This can take two forms: either mimicking the cover protocol using

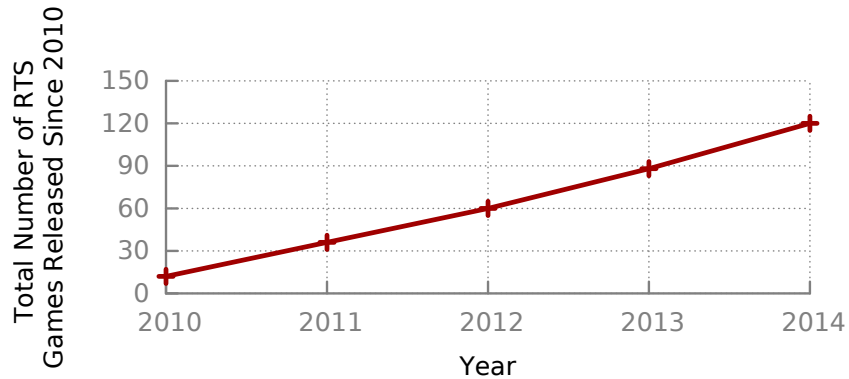

Figure 1: Growth of the real-time strategy game video-game genre from 2010 to 2014.

an independent implementation, as in SkypeMorph [18] and StegoTorus [25], or encoding data for transmission via an off-the-shelf implementation of the cover protocol, as in FreeWave [15].

However, subsequent work has shown that it is difficult to build a covert channel that perfectly mimics another application. For example, Houmansadr *et al.* showed that, when a covert channel re-implements its cover protocol, the re-implementation is unlikely to be a perfect mimic of the original protocol, and a censor can use the differences to recognize when a client is using the covert channel [14]. Geddes *et al.* [11] further highlight discrepancies between loss tolerance, architecture, and content features, even when circumvention systems use the application directly.

With these prior results in mind, we consider a new avenue for covert channels: using video games as a cover protocol. Similar to Skype, video games provide another opportunity to encode data using off-the-shelf game implementations. However, the current video game landscape also presents three advantages that distinguish games from other covert channels and make them amenable to winning the arms race between censors and circumvention tool developers.

Democratization of game publishing. Recent years have seen the rise of Steam, a platform for distributing online games. Steam provides an app store-like distribution model for video games which enables many smaller-scale developers to create and distribute games to users [3]. In Figure 1 we show the number of games published in the real-time strategy category on Steam in the past 5 years. Each of these games presents a possible source of cover traffic for a covert channel. Further, games within a given genre have common properties which means an encoding scheme designed for one game is easily adaptable to another game within the same genre. For example, our prototype, Castle, leverages the common command structure, map design capabilities, and tools for decoding saved games and replays generated by real-time strategy games. A survey of real-time strategy games on Steam reveals that 7 of the top 10 best-selling games also include these features.

Security is a first order priority in games. To mitigate the risk of cheating, games include many security mechanisms including encrypted and authenticated data transport (all of the top 10 best-selling real-time strategy games on Steam have secure data channels) and checks of game state consistency between endpoints to detect falsified game data. Many games also include the notion of private games between a limited number of players which may only be accessed using a password. This means that, even a highly motivated adversary (*e.g.*, one who is willing to run a game client themselves) still cannot observe the game state.

Architectural agility. Finally, games may operate in two architectural modes: (1) server-based where users connect to a server hosting the games or (2) peer-to-peer where players connect directly to each other. The first mode is advantageous, as clients using the covert channel look just like any other game client connecting to the server, from the point of view of the censor. However, the game server presents an easy target for blocking if the censor is willing to incur the collateral damage. The second mode mitigates this issue but has weaker deniability if the censor is able to learn the IPs of players acting as proxies for the covert traffic. Having both of these options allows the covert channel to operate in whatever mode is most common in the game and then switch to the alternate mode if the primary one is blocked.

In this paper, we argue that censorship circumvention using video games as a cover protocol is a promising direction with potential to shift the censorship arms race in favor of circumvention tool developers. We demonstrate the feasibility of this approach by developing covert channels for two real-time strategy games: the open source “0-A.D.” [1] and an extremely popular (over three million copies sold) closed source game we will refer to as RTS-Game. Once we had developed the 0-A.D.-based prototype, it took a bright undergrad less than 6 hours to develop the channel based on RTS-Game. Indeed, the data encoding scheme and input mechanism are virtually identical between the games with the majority of effort spent determining how to decode moves on the receiving client.

An evaluation of the security of our prototype shows that it is able to avoid detection by network level censors and is resilient to simple attacks such as IP/port filtering and deep packet inspection, and more expensive attacks such as flow-level traffic analysis and the use of custom game clients. Further, we find that our prototype is able to avoid the most common pitfalls in covert channel design, as described by Geddes, *et al.* [11].

A performance evaluation reveals that our prototype achieves throughput that is amenable to transferring e-mails and other text-based articles. We note that there are several avenues for increasing throughput (at the cost of developer overhead, or detectability). For example, with an additional 3 hours, the undergraduate researcher was also able to make RTS-Game specific modifications to our prototype to improve its throughput by a full order of magnitude.

This paper is structured as follows: In Section 2 we present an overview of the current state-of-the-art in look-like-something circumvention tools and the censorship arms race. In Section 3, we present our prototype – Castle, an easily adaptable circumvention tool that uses real-time strategy games as a covert communication channel. In Section 4, we briefly describe the implementation of Castle. This implementation is then evaluated for extensibility, security, and throughput. The methodology and empirical results of this evaluation are presented in Section 5. Finally, in Section 6, we discuss the implications of Castle provided deniability, throughput, and extensibility on the censorship arms race.

2 Censorship Arms Race

Censorship circumvention tools face an arms race as they work to evade increasingly motivated censors. Tools which have distinctive features can be detected and blocked by censors (*e.g.*, Tor is actively targeted by censors around the world [5]). As a result, there is increasing interest in disguising censorship circumvention traffic as benign protocols. SkypeMorph [18] and StegoTorus [25] are two pluggable transports [6] for Tor which aim to mask Tor traffic as Skype traffic, and a combination of Skype, HTTP and Ventrilo, respectively.

While these pluggable transports are able to capture features of the traffic they aim to imitate (*e.g.*, inter-packet timings, packet size distributions), Houmansadr *et al.* [14] point out that imitating a protocol is not enough to evade detection. Namely, if circumvention endpoints do not run the application they aim to hide within, they are vulnerable to censors who may probe to observe that the endpoint does not actually implement the full functionality of the mimicked application. As such, Houmansadr *et al.* advocate that circumvention schemes should actually run the application they are using as cover, rather than mimicking properties of the cover traffic.

Towards this goal, FreeWave uses the Skype application as a modem to transmit IP data between two endpoints [15]. However, Geddes *et al.* demonstrate that even running the cover application is not enough to avoid detection by censors [11]. Namely, approaches like FreeWave may be detected via discrepancies between application behavior when it is acting as a covert channel, vs. regular application operation. They classify these discrepancies into three categories: (1) architectural mismatches between communication patterns of the application when it is acting as a covert channel vs. regular operation, (2) channel mismatches between reliability requirements of the application and the covert traffic and (3) content mismatches where the packet contents of the application differ because of the covert traffic being sent in place of regular application traffic.

Thus, circumventors are in a race to design new cover channels that are difficult to detect, while censors search for low-cost mechanisms to distinguish legitimate traffic from covert channels. In this paper, we argue that online games as a covert channel presents a solution that can tip the scales heavily in the favor of circumvention tool developers. The large number of games and common features of games within a given genre facilitate adaptation of existing game-based covert channels to new games. Further, security features of games and their ability to leverage either a central server or peer-to-peer architecture significantly raise the bar for censors that aim to detect and block covert channels. Finally, as we will demonstrate with our prototype, game-based covert channels can be designed such that they match the three properties highlighted by Geddes *et al.*

3 The Castle Circumvention Scheme

Castle aims to demonstrate that secure and low bandwidth *look-like-something* defenses are possible via interactive channels such as real-time strategy video-games. In this section, we provide a background on real-time strategy games and highlight key properties of these games that enable Castle to create covert channels that are applicable across this entire genre. We then describe how Castle encodes, sends, and receives data.

3.1 Real-time strategy games

We now present background on real-time strategy games, the genre we focus on in this paper. Real-time strategy games are a genre of video games that center around the idea of empire-building. Typically, the goal is for a player to assert control over enemy territory through a combination of military conquest and economic maneuvering. There are four key elements that are common to every real-time strategy game.

- **Maps:** Real-time strategy games are set in a landscape covered by plains, forests, mountains, and/or oceans. Players are provided with two views of the game world: a zoomed-out top-down perspective (mini-map) and a zoomed-in isometric perspective (the main game screen). Most real-time strategy games allow users to create their own, and modify existing maps for use within the game.

- **Units:** Real-time strategy games allow players to *train* and *create* a large number of units (*e.g.*, human characters, livestock, machinery). Players can command their units by clicking the unit and performing one of many actions – *e.g.*, in most games, a unit can be instructed to move to a location on the map by left-clicking it and then right clicking the destination location on the map.
- **Buildings:** Players may construct a number of buildings over the course of a game. Buildings are required to train certain units and research new technologies. For instance, barracks may be required to train infantry and a university may be required to obtain the benefits of metallurgy. In most real-time strategy games, unit producing buildings can be assigned a rally point – *i.e.*, a location on the map at which all units created by the building will assemble.
- **Resources:** In order to train units and construct buildings, players are required to gather resources – *e.g.*, gold, food, stone, etc. These resources are typically spread out over the game world.

Network communications. For scalability reasons, real-time strategy games do not broadcast state information (*e.g.*, location, health, current action status) of each unit to all players in the game. Instead, they pass commands issued by the players in fixed intervals (*e.g.*, 100 ms). These commands are then simultaneously simulated in each game client. This allows clients to execute the game identically, while requiring little bandwidth. [8]

In terms of network architecture, modern real-time strategy games may take two forms, with players joining a common game hosted on a game server (*e.g.*, servers hosted by game publishers such as Microsoft, Blizzard, Electronic Arts, etc.), or connecting directly to each other in a peer-to-peer mode. Our covert channel system can employ whichever is the dominant mode of operation and shift from one to the other if required, to evade censorship.

Security considerations. To ensure that all clients are synchronized with regard to the game state, a hashed value of the current state is also frequently communicated. This allows the game to drop a client that is out of sync with other clients (*e.g.*, because of cheating). Further, to prevent snooping of game traffic, the majority of games encrypt the game’s communication channel. Finally, many games offer users the option to play private multi-player games where players must supply a password before they are allowed to join.

3.2 Building game-based covert channels

In order to create a covert channel mechanism that is general to the majority of games in the real-time strategy genre, Castle exploits two key properties.

- Most real-time strategy games share a common set of actions. Specifically, the ability to select buildings and assign a location where units created/trained in a building should go. This location is called a “rally point,” and we denote the command of setting the rally point for units created in a given building by `SET-RALLY-POINT`. Games also provide the ability to move a selected unit to a given location (denoted by the `MOVE` command). Thus, any encoding that translates data into a combination of unit/building selections and these primitives will be general across most games in this class.
- Most real-time strategy games provide a replay option which saves every players’ moves to disk (for later playback). Therefore, all in-game commands are written to disk where they can be read and decoded in real-time, with little effort.

Castle consists of two main components to send and receive data. These are illustrated in Figure 2. Sending is done by encoding data into game commands and then executing them within

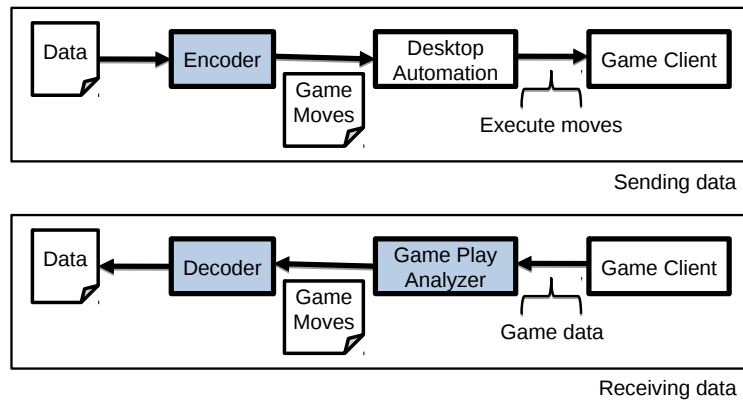

Figure 2: Overview of data flow for sending and receiving in Castle. Shaded components are implemented as part of Castle while the others use existing off-the-shelf software.

the game using desktop automation. The receiving process monitors the log of game commands and decodes this list to retrieve data sent via the system.

Figure 3 overviews how the Castle system could be used to relay data from outside of a censored region to a client within the region. The client first installs Castle (*e.g.*, as a browser extension). The Castle client then initiates a game through a game lobby (or directly with the client outside of the censoring region). The client in the censoring region can then encode and send data (*e.g.*, Web requests) as game moves that can be decoded by the client outside of the censoring region. The game client outside of the censoring region can then act as a proxy to retrieve censored content and send it via Castle to the client in the censoring region.

3.3 Encoding data into game commands

Castle relies on the ability of the player to select units and buildings and set rally points to encode data. A naive encoding may consider selecting each unit and directing it to a different point on the game map to encode a few bytes of information per unit. However, in preliminary experiments, we observed that this approach resulted in a covert channel that could not match the properties of the original game traffic (moving $O(100s)$ of units to distinct locations is not a usual action for players). Thus, we needed to find another way to encode data in Castle.

Encoding in Castle is accomplished, without inflating the amount of game data transferred, using the following scheme. First, the participants in Castle download a custom map (distributed via game forums or stores such as Steam) which contains either n immobilized units (*e.g.*, units placed in unit sized islands, within walls, etc.) or n unit producing buildings (*e.g.*, barracks, stable, etc.). The Castle sending process then encodes data by selecting a subset of these n units and executing either a `MOVE` command in the case of units or `SET-RALLY-POINT` in the case of buildings. (We will discuss the encoding in the context of units and the `MOVE` command but it may be implemented using either primitive.)

Instead of using selection of each unit to represent a single bit sequence, which would result in $\log_2(n)$ bits of data transferred per command, we use a combinatorial scheme where we select k of the

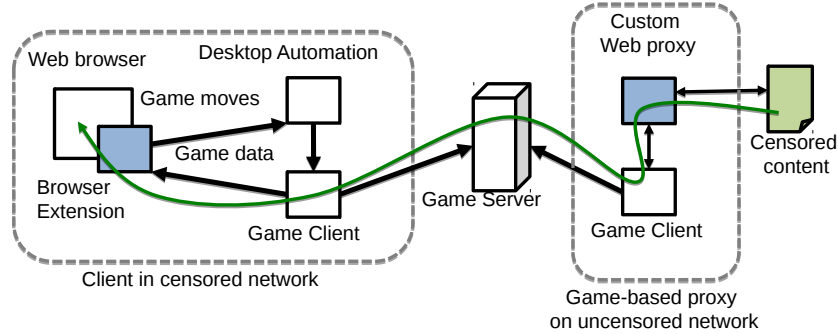

Figure 3: Overview of how Castle can be used as a proxy for clients within censoring countries. A game client outside of the censoring region acts as a proxy between the game and the censored content (*e.g.*, Web pages).

n units, to increase efficiency. Intuitively, the selection of k of n units results in $\binom{n}{k}$ different values or $\log_2 \binom{n}{k}$ bits that may be transferred per command. We use combinatorial number systems [17] to convert $\log_2 \binom{n}{k}$ bits of data into a selection of k of the n units on the game screen. In preliminary experiments, we found that the selection of a constant number of units per command resulted in traffic which was more uniform than regular game traffic. As a result, we adjusted our scheme to select between 0 and k units for encoding to increase variability of packet sizes. Section 5 provides a more in-depth view of how we evaluate our similarity to actual game traffic.

In addition to selecting the set of units, we can also select a location for all k selected units to move to. Note that since we select a single location for k units (instead of k distinct locations) this does not impact the data transfer size). Given a game map with $m = x_{max} \times y_{max}$ potential locations we can also encode $\log_2 m$ additional bits of data in a given turn. The entire encoding process is illustrated in Appendix A (Algorithm 1).

The combination of selecting between 0 and k units and setting the location to move to, results in an average of $\left(\frac{\sum_{i=1}^k \log_2 \binom{n}{i}}{k} + \log_2 m \right)$ bits transferred per command. As mentioned earlier, one may achieve higher data-rates by always selecting k units, however, this causes identically sized commands and therefore affects the packet size distribution negatively.

3.4 Sending covert data

Once the covert data is encoded into in-game commands, the sending process must actually execute the commands in order to communicate them to the receiver. One way to do this is to modify the game AI to issue commands as dictated by our encoder. However, this is non-trivial since most games are closed-source and viewing/modifying game code is not always an option. Even when source code is available, the overhead of understanding the game code and modifying the AI presents a non-trivial hurdle. Given our vision of adaptability to the large number of available real-time strategy games, we leverage off-the-shelf desktop automation to achieve our goal of executing our encoded game commands in the game client. This opens the door to extending our approach to a much larger set of games than would otherwise be possible.

Since the map used in Castle is custom made, the starting location of all units is known in

advance. Further, since units/buildings are immobile, Castle is aware of their location at all times. The location of units on the game map, along with the list of commands to be executed is sufficient for Castle to automatically generate a sequence of key-presses, left-clicks, and right-clicks to be made by the desktop automation tool. This sequence is then passed to the automation tool for execution.

We note that, certain automation tools allow keystrokes and clicks to be sent to windows that are not currently in focus. This ensures that Castle does not detract from the user experience by requiring the game window to be in focus during data transfer periods. Finally, since automation tools allow control over the speed of clicks and key-presses, Castle can be configured to either mimic human input speeds (lower clicks/second) or maximize throughput (higher clicks/second). We investigate the tradeoff between these two variables in Section 5.

3.5 Receiving covert data

Since the receiving game client does not have the same in-game screen as the sending client (due to each client having their camera focused on different map locations), directly observing the commands made by the sending client via the screen output is prohibitively complex. Fortunately, most real-time strategy games maintain a real-time log of all commands issued in the game to enable replaying moves or saving game state. In Castle, the receiving process constantly monitors this log file for commands issued by other participants. These commands can then be decoded back into their original covert data via the decoding algorithm specified in Appendix A (Algorithm 2).

This approach suffers from one minor drawback: replay logs are often stored in proprietary and undocumented formats that vary from game to game. However, reverse engineering the format of the replay logs is made significantly easier since Castle only issues `MOVE` or `SET-RALLY-POINT` commands. Therefore, we only need to understand how these commands are stored in replay logs. This can be done by simple techniques – e.g., sending a unit to the exact same location multiple times allows us to obtain the byte code used to signify the `MOVE` command, sending a unit to two locations in sequence (with each separated by a single pixel) allows us to obtain the bytes used to denote the (x, y) destination co-ordinates, etc. Further, for many popular real-time strategy games, these formats have already been reverse-engineered by the gaming/hacking community.

4 Castle Prototype Implementation

In this section, we describe our prototype implementation of Castle. We prototype on two games to illustrate the extensibility of our approach.

- **0 A.D.:** An award-winning, free, open-source, and cross-platform real-time strategy game made available under the GPLv2 license, by Wildfire Games.
- **RTS-Game:** A best-selling (currently in the top 5 grossing real-time strategy games of all-time), closed-source, Windows-based real-time strategy game.

Our prototype is comprised of ~ 500 LOC and is coded in a combination of C++ and AutoHotkey (desktop automation) [7] scripts. It includes the following components:

Custom map: To test Castle, we create a custom game map for each game. The map is comprised of n buildings packed as tightly as possible to facilitate our selection-based encoding.

For 0 A.D., we create a map with $n = 1600$ buildings on a single game screen, while for RTS-Game, we are only able to have $n = 435$ (owing to larger unit sizes). For both games, a region

large enough to contain 16 bits of location data is left unoccupied. This is used to assign rally-point coordinates to the selected buildings.

Since 0 A.D. stores maps in a simple and readable XML format, the process of map creation is easily automated (via a Python script). This is not the case for RTS-Game which required manual generation of the map using the official GUI map editor. We are currently exploring automation options for map creation in RTS-Game.

Data encoding and decoding: Code for translating between covert data and in-game commands (and vice-versa) is written in 198 lines of C++ using the encoding and decoding described in Section 3.3. The output of the encoding is a vector of buildings to be selected and a single (x, y) coordinate.

Desktop automation: We use the open-source desktop automation tool, AutoHotkey, to execute the series of commands determined by the encoding scheme. Since the locations of all buildings are known, selecting those indicated by the encoding is straightforward. We write an AutoHotkey script to execute these commands, and leverage its ability to operate on windows that are not currently focused (*i.e.*, in the background).

Reading recorded game data: We implement code that monitors the log file of commands issued (maintained by the game), for both games. For 0 A.D., this information is already made available in a simple to parse text file. In order to obtain this information for RTS-Game, the game replay file is parsed using tools made available by the gaming/hacking community. The file is then scanned to obtain each command as a vector of selected buildings and an (x, y) coordinate. The commands are then decoded to retrieve the originally encoded covert data.

Coordinate calibration: The isometric perspective of the game screen poses a challenge during the decoding process. Specifically, the presence of a *viewing angle* means that a sender may have intended to move a unit to the screen coordinate (x_s, y_s) , but the game actually logs the command as an order to move the unit to the game coordinate (x_g, y_g) . This is also the command obtained by the receiver on decoding the move log. In order to avoid this problem, Castle goes through a one-time (per game title per resolution) calibration process of mapping on-screen coordinates to coordinates as interpreted in the game. Note that the results of this calibration process can be shared across game clients that utilize the same in-game resolution.

5 Security and Performance Evaluation

We evaluate Castle along two axes. First, we consider security of the system by quantifying its resilience to a censor-adversary, its similarity to regular game traffic, and its ability to avoid the mismatches highlighted by Geddes *et al.* [11]. We then study throughput of Castle using the encoding scheme as laid out in Section 3. We also consider the effect of minor game-specific improvements to Castle’s throughput in Section 5.6.

5.1 Experiment setup

For the results reported in this section, we use our implementation of Castle with a building based map. The evaluation was performed on Windows 8.1 running AutoHotkey [7] for automation. The game was set up in direct connect mode – *i.e.*, the two players were connected directly to each other via their IP address (rather than through the game lobby). Since both players were on the same (fast) university network, negligible effects of lag were experienced.

Castle was used to transfer a randomly generated (via `/dev/urandom`) 100KB binary file from one player to another. Network traffic generated by the game was captured using *Rawcap* (a command line raw socket packet sniffer for Windows) with additional processing done using `tcpdump` on Linux.

AutoHotkey requires an average of $\approx 300ms$ to perform the clicks required to issue a command. We consider the impact of command rate (*i.e.*, how long AutoHotkey waits between each command) and the impact of the maximum number of buildings selected (k in the encoding described in Section 3) on the performance and security of Castle. We vary the command delays from 100 ms/command to 1000 ms/command. The number of selected buildings is varied from 25 to 200 buildings.

In order to compare the traffic characteristics of Castle with characteristics of the standard game, we gather network traces of regular 0 A.D. two player games. These were also collected in a similar setting – *i.e.*, with both players on the same university network and via direct connect. Three traces collected (one per game played). Each of the recorded games was between 48 to 60 minutes long and included a different pair of players.

To observe the impact of game specific modifications, we evaluated the throughput of Castle over the closed-source RTS-Game, with and without any game-specific modifications, in the same settings described above.

5.2 Threat model

We use the following threat model when evaluating the security of Castle. Our threat model concerns a network censor (*e.g.*, an ISP) who is able to monitor traffic between clients in their network and destinations either within, or external to, their network.

Detecting the covert channel. We assume a network censor willing to expend significant computational resources to analyze and detect covert channels at line rate. Our censor can not only implement a range of detection approaches used in practice today (*e.g.*, inexpensive IP/port number based detection or relatively costlier deep packet inspection (DPI)), but also implement custom detection tools specific to our covert channels. These custom tools may include a custom game client that is able to participate in a specified video game and monitor player behaviors for signs of covert activity. The censor may also implement custom network traffic analysis based on known properties of game traffic (*e.g.*, flow-level properties, inter-packet timings).

Blocking the covert channel. Once the censor has detected that a given flow or game is being used for covert communications they may take steps to block the specific flow (*e.g.*, if they use DPI or network traffic analysis to trigger blocking) or block the entire game (if they cannot distinguish covert communications from regular game-play). Blocking actions may include sending reset packets to stop active connections, dropping network traffic, or DNS tampering. We assume that once a censor can identify the flow or game they would like to block they have the requisite tools to implement the desired blocking behavior.

It is also worth noting that blocking game flows is not without costs to the censor, specifically with respect to political good will and PR internationally. For example, blocking all traffic for a given game, especially a popular game, may upset citizens within their country and reflect poorly on Internet freedom within the censoring country.

Adversary limitations. While the censor has high computational abilities to process network traffic to detect and block the covert channel, we assume that they are not able to decrypt encrypted game channels or enter password protected games.

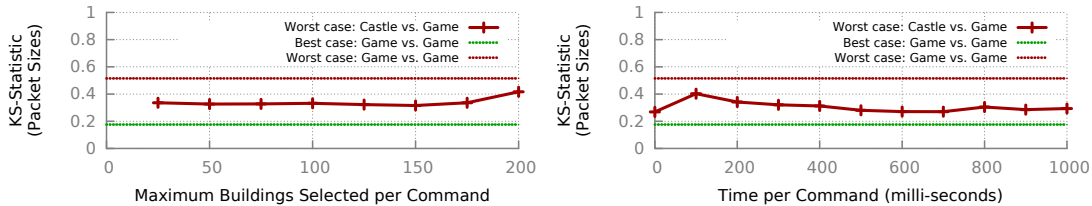

(a) Effect of maximum number of buildings selected per command (b) Effect of time delays per command (at ≤ 200 units buildings/command)

Figure 4: Kolmogorov-Smirnov (KS) statistic on the distributions of packet sizes. The difference between Castle and the legitimate game flows is within the variance observed when comparing traffic between legitimate game flows.

5.3 Resilience to a network censor

We now perform an evaluation of Castle against the network adversary described in Section 5.2. In particular, we focus on Castle’s ability to avoid detection by IP/port filtering, deep packet inspection, custom game clients, and traffic analysis.

IP/Port Filtering and DPI: Since Castle executes the game application itself, the IP and port of Castle and the game cover protocol will be indistinguishable. This means that an adversary that triggers blocking based on destination IP (*e.g.*, the game server) or port number, will be forced to block all traffic to the game that is being used as cover in order to stop Castle. Further, since game traffic is encrypted and authenticated (to prevent cheating), simple DPI will not be able to distinguish Castle from run of the mill game traffic.

If the adversary is willing to block *all connections* to dedicated game servers (often hosted by the game publishers – *e.g.*, Electronic Arts, Microsoft, Blizzard, etc.), users may still utilize Castle in the game-provided direct connect mode, forcing the adversary into a game of whack-a-mole with Castle proxies outside their jurisdiction. Further, users of Castle may also choose to migrate to another game (whose publisher hosted servers utilize different IP/ports) as their covert channel.

Custom Game Clients: A motivated adversary may also attempt to detect users of Castle by running their own game client. They may then join games in popular game lobbies and analyze maps and commands issued by players. inspecting

However, many publishers permit users to password protect their multi-player games. This allows Castle proxies to be available only to people with knowledge of the password – thereby preventing the censor from joining/observing games being used for covert communication. We envision that passwords to Castle proxies will be distributed in a way similar to Tor bridge distribution [2] – *i.e.*, open games and passwords are distributed by a central authority in a location dependent and slow release fashion.

Traffic Analysis: Castle is also resistant to attacks that depend on analysis of flow level features such as packet sizes and inter-packet times. Since the traffic generated by a standard multi-player game is strongly dependent on many parameters (*e.g.*, player personality, strategies employed, scenario type, map, number of players, etc.), flow level features may vary widely between game instances. Castle (under all configurations) generated traffic was will within the variance seen in real human vs. human game traffic.

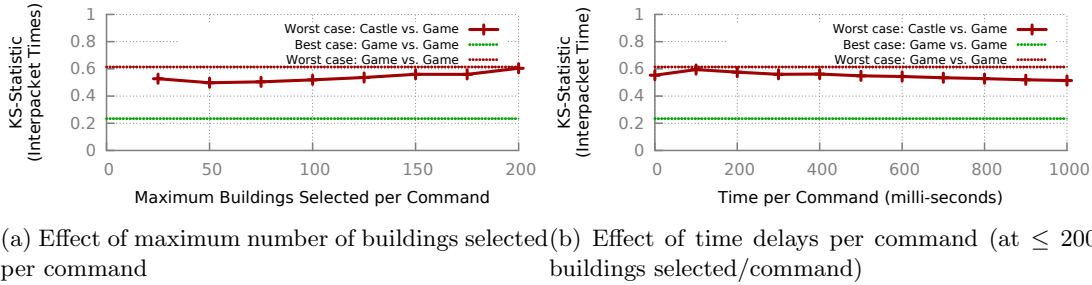

Figure 5: KS statistic on the distributions of inter-packet times. The difference between Castle and the legitimate game flows is within the variance observed when comparing traffic between legitimate game flows.

To quantify the resilience of Castle to traffic analysis attacks we use the Kolmogorov-Smirnov (KS) statistic to make three comparisons. First, we compare the three control games to each other to derive the minimum and maximum difference between legitimate game flows. We then compare traffic from Castle to each of the control games in turn. We use the maximum difference between Castle and any of the control flows in our evaluation.

Figure 4 and 5 show the results of this process to compare packet sizes and inter-packet times between Castle and the control flows for 0 A.D. In our comparison, we also vary the command input rate by the desktop automation software and the maximum number of buildings selected by the encoding. In all cases, the difference between Castle and control traffic is within the variance of traffic between different game instances.

Interestingly, in real-time strategy games, it is often the case that non-command-related traffic dominates ($\approx 70\%$ of all 0 A.D. and RTS-Game traffic is to maintain synchronization between clients, and is unrelated to game commands). Since Castle actually plays the game and only issues commands (of reasonable size and at realistic rates), the majority of the traffic it generates always remains indistinguishable from the standard use of the real-time strategy game, under any Castle configuration. Also note that command related and non-command related traffic are indistinguishable without the game-instance specific decryption key.

5.4 Avoiding covert channel pitfalls

Geddes *et al.*, highlight three key mismatches between covert channels and cover traffic which make these look-like-something circumvention tools detectable to external observers [11]. Here we discuss how Castle avoids each of these three mismatches.

The Architecture Mismatch: Games provide agility in terms of architecture that few other channels provide. They often operate in client-server mode on publisher hosted game servers and in peer-to-peer mode in direct connect multi-player games. Our proxying approach can operate in whichever mode is the dominant architectural mode of the given game, and in the presence of blocking can even shift (*e.g.*, from client-server to peer-to-peer).

The Channel Mismatch: While real-time strategy game generated data is typically communicated over a UDP channel, it is unlike most other UDP channels. Unlike channels such as VoIP,

game traffic is not resilient to packet loss, thus clients come with the ability to handle packet losses and retransmissions. Further, they also guarantee in-order delivery and processing of sent data. This makes it especially useful as a covert channel for proxied TCP connections which require reliable transmission. Therefore, attacks that allow the censor to drop traffic to levels which are tolerable to legitimate players (but intolerable to Castle users) are not possible. Further, active modification of communicated content, by an adversary, is easily detected and ignored by the game state machine and cheat detection modules.

The Content Mismatch: Content mismatches arise when the content being embedded in the covert channel changes the flow-level features of the channel. Since the flow-level features of real-time strategy games are strongly dependent on many parameters (identified above), they are highly variable. We have shown that Castle, under every configuration, generates traffic that is well within this variance.

5.5 Castle throughput

Without any game specific modifications, Castle offers performance amenable to transfer of textual data (*e.g.*, tweets, e-mail, news articles).¹

Since each real-time strategy game has a limit on the number of objects that can be selected for a single command, the data rate obtained by Castle is game dependent. For example, 0 A.D. allows the selection of up to 200 units for a single command, giving us an average of $\frac{\sum_{i=1}^{200} \log_2 \binom{1600}{i}}{200 \times 8} \approx 65$ bytes per command. On the other hand, RTS-Game has no limits on the number of units that may be selected for a single command, however allows only ≤ 435 objects to be placed within a single screen – giving us an average of ≈ 39 bytes per command.

Throughput is also dependent on the time required by the desktop automation tool to perform the actions required to issue a command (*i.e.*, click each unit to be selected and click the target coordinate). We found that on average, issuing a single command required between 300-350 ms. With no delays between the issue of each command, this allows ≈ 3 commands/second.

In Figure 6, we see the effect of Castle’s parameters on it’s performance when implemented over 0 A.D. Specifically, Figure 6a shows the effect of increasing the maximum number of buildings selected in a single command and Figure 6b demonstrates the effect of decreasing the command rate. At a configuration where Castle may select up to 200 buildings in a single command and issues commands with no delays in between, Castle implemented over 0 A.D. is able to provide a data rate of ≈ 190 Bytes per second – requiring about 52 seconds for the transfer of a short 10KB text news article.

5.6 Game specific enhancements for Castle

In this section, we show that the performance of Castle can be improved significantly through simple game-specific tweaks. To be able to observe the impact of these game specific modifications, RTS-Game was used as the channel for *vanilla* Castle and Castle with RTS-Game specific modifications. The game specific modifications were introduced and implemented for Castle in just under three hours by an undergraduate researcher.

The low throughput of Castle over RTS-Game was because RTS-Game had larger units than 0 A.D., thereby allowing players to place only 435 units within a single screen (as opposed to 1,600

¹The success of the voices feeds [4] during the Arab Spring shows that in some situations textual data is enough to get information out.

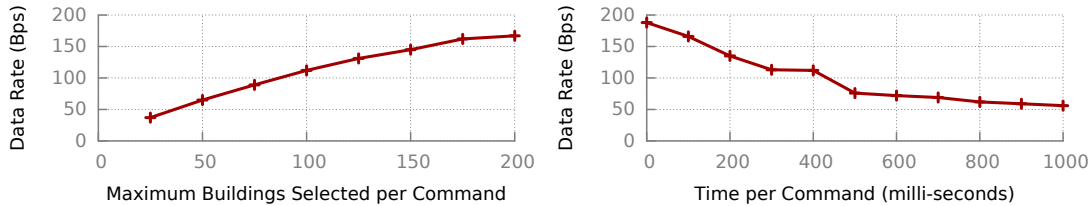

(a) Effect of maximum number of buildings selected per command (b) Effect of time delays per command (at ≤ 200 buildings selected/command)

Figure 6: Throughput of Castle implemented over 0 A.D. under various configurations

for 0 A.D.). As a result, the throughput of vanilla Castle was only ≈ 38 bytes/command (i.e., ≤ 130 bytes/second) at best – i.e., with the maximum command rate of AutoHotkey and selection of up to 435 units/command.

A quick investigation into the RTS-Game replay mode and save-game files revealed that even the selection of a single unit was communicated over the network and logged by other players. We exploit this fact by creating a set of 2^m units (256 in our case) and mapping each unit to an $m - \text{bit}$ value (i.e., a byte). We then sequentially transfer the data byte-by-byte via selecting the unit corresponding to the byte to be encoded.

This encoding allowed AutoHotkey to issue commands at a significantly faster rate than before (a command was now just a single mouse click, as opposed to up to 435 key presses and clicks). At AutoHotkey’s fastest mouse click rate and $m = 8$, this encoding achieved a throughput of up to 3KByte/second. However, in order to more closely mimic the command rate and traffic generated by a human player, we add a delay of between 2 and 3 ms per command. In Figure 7, we show the effect of this game specific modification on the throughput of Castle. From the same figure, we can also observe the effect of varying the total number of units with vanilla Castle and the RTS-Game specific version of Castle. We see that increasing n results in a linearly increasing throughput for vanilla Castle, and a logarithmically increasing throughput for RTS-Game specific Castle. However, because the cross-over point of these functions is higher than the game allows, RTS-Game specific Castle always achieves better throughput for RTS-Game.

6 Discussion

In the previous sections, we have discussed our prototype of Castle on two real-time strategy games. We now discuss the implications of Castle in terms of providing deniability to users of the system, increasing throughput, and how its extensibility can tip the scales in favor of circumvention developers.

Deniability and ease of distribution: One of the advantages of Castle is that the covert channel is largely implemented with off-the-shelf software components with only 500 lines of code dedicated to encoding data and desktop automation scripting. Desktop automation tools, are already commonly used by gamers and the game, game specific mods, etc., are generally widespread enough to warrant little suspicion from censors (e.g., RTS-Game is installed by millions of users).

Castle also benefits from an extremely small code base of under 500 lines, of which ≈ 200 lines

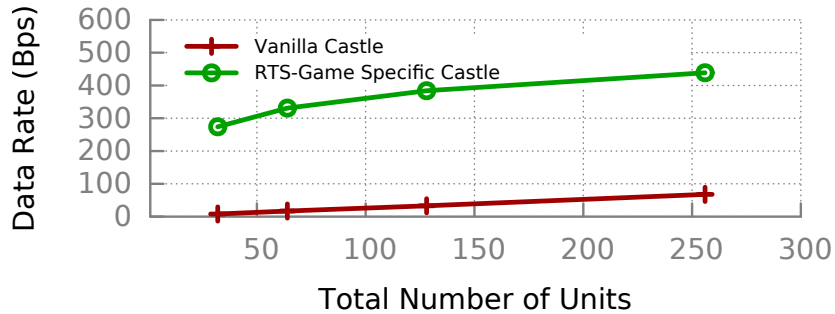

Figure 7: Throughput of Castle (with and without enhancements) implemented over closed-source RTS-Game

is specific to the encoding and decoding of covert data. The remainder is from generic desktop automation scripts which are commonly used by gamers. Other software, such as the game, game specific mods, etc., are generally widespread enough to warrant little suspicion from censors. Castle’s core size also makes it easy to distribute through hard to block methods – e.g., via the text body in emails and even through instant messaging services.

Improving Castle throughput: In addition to making game specific modifications, Castle presents many opportunities to increase throughput of the system.

- *Parallel requests:* Since most modern real-time strategy games allow up to eight players to participate in a single multi-player game, it is possible for one censored user to decode content responses from up to seven proxies in parallel – achieving up to $7x$ downstream throughput. This is particularly useful in the context of web data, where requests are easy to parallelize.
- *Content compression:* Castle proxies may improve performance by compressing requested content before encoding. In the context of web data, the proxies may also pre-render and compress content before sending them to the receiver (e.g., as was done by the Opera mobile browser [23]).
- *Trade-off throughput and detectability.* Depending on the level of surveillance in a given region Castle may expose an option to allow users to trade off throughput vs. detectability of the system (e.g., by increasing the rate of clicks in the automation tool).

Extensibility of Castle: Castle’s strength comes from the ease with which it can be ported to new games. As an example, it took a bright undergrad less than 6 hours to complete a basic port of Castle over a very popular closed-source real-time strategy game. Due to the availability of game specific hacks and reverse engineering guides in popular gaming forums [19], completing game specific enhancements in order to improve the data rate of Castle, as described in Section 5.6, required only an additional 3 hours. We have also successfully ported the encoding and decoding logic of Castle to a third real-time strategy game where the main hurdle to deployment is the manual creation of the game map, which a determined individual could easily create with a few hours of manual effort.

Although individual game titles do not present a high collateral damage (in the event that they are blocked), Castle presents a simple way to convert each of them into an ephemeral and effective covert channel, with little development overhead. This ability, along with the fact that

every newly released title is a potential covert channel, makes Castle particularly useful in the arms-race that censors and developers are currently engaged in. In particular, it is the first censorship circumvention tool to provide an asymmetry in favor of the developer (i.e., creating a new channel is significantly less expensive than detecting the channel).

7 Conclusions

In this paper we have presented Castle, a general approach for creating covert channels using real-time strategy games as a cover for covert communications. We demonstrate our approach by prototyping on two different games with minimal additional development overhead and show its resilience to a network adversary. We argue that the popularity, availability, and generic functionalities of modern games make them an effective circumvention tool in the arms-race against censors. Specifically, our results show that Castle is:

- *Secure*: Castle is resistant to attacks such as IP/port filtering and deep-packet inspection since it actually executes the game application. More complicated and expensive attacks such as traffic analysis attacks are avoided due to the high variability of standard game flows.
- *Usable*: Even without any game specific modifications, Castle is able to provide throughput sufficient for transfer of textual data. Additional enhancements make it suitable for use as a web proxy.
- *Extensible*: Incorporating new closed-source games as covert channels for Castle requires only a few hours of developer time – including the addition of title specific enhancements for increased throughput.

The results presented in this work motivates two independent future research directions. First, extending our work to different classes of games which may enable higher throughput rates (*e.g.*, racing games, first person shooters). Second, integrating the Castle approach into platforms to make it usable to users *e.g.*, via a Web browser plugin or integration with the suite of Tor Pluggable Transports [6].

References

- [1] 0 A.D.: A Free, Open-Source Game of Ancient Warfare. <http://play0ad.com>. Accessed: 2015-02-22.
- [2] BridgeDB: The Bridge Distribution Database. <https://gitweb.torproject.org/bridgedb.git/tree>. Accessed: 2015-02-22.
- [3] Steam, The Ultimate Online Game Platform. <http://store.steampowered.com/about/>. Accessed: 2015-02-22.
- [4] The Voices Feeds. <http://johnscottrailton.com/the-voices-feeds/>. Accessed: 2015-02-22.
- [5] Tor Blocked: The Tor Blog. <https://blog.torproject.org/category/tags/tor-blocked>. Accessed: 2015-02-22.
- [6] Tor Project: Pluggable Transport. <https://www.torproject.org/docs/pluggable-ports.html.en>. Accessed: 2015-02-22.

- [7] AutoHotkey. Macro and Automation Windows Scripting Language. <http://www.autohotkey.com/>.
- [8] Paul Bettner and Mark Terrano. 1500 Archers on a 28.8: Network Programming in Age of Empires and Beyond. *Presented at GDC2001*, 2:30p, 2001.
- [9] A. Dainotti, C. Squarcella, E. Aben, K.C. Claffy, M. Chiesa, M. Russo, and A. Pescapé. Analysis of Country-wide Internet Outages Caused by Censorship. In *Proceedings of the 2011 ACM SIGCOMM conference on Internet measurement conference*, pages 1–18. ACM, 2011.
- [10] Freedom House. Freedom on the Net 2014. https://freedomhouse.org/sites/default/files/FOTN_2014_Full_Report_compressedv2_0.pdf.
- [11] John Geddes, Max Schuchard, and Nicholas Hopper. Cover Your ACKs: Pitfalls of Covert Channel Censorship Circumvention. In *Proceedings of the 2013 ACM SIGSAC Conference on Computer & Communications Security, CCS '13*, pages 361–372, New York, NY, USA, 2013. ACM.
- [12] Glenn Greenwald and Ewen MacAskill. NSA Prism Taps into User Data of Apple, Google, and Others. <http://www.theguardian.com/world/2013/jun/06/us-tech-giants-nsa-data>.
- [13] Lev Grossman. Iran protests: Twitter, the Medium of the Movement. *Time Magazine*, 17, 2009.
- [14] A. Houmansadr, C. Brubaker, and V. Shmatikov. The Parrot Is Dead: Observing Unobservable Network Communications. In *Security and Privacy (SP), 2013 IEEE Symposium on*, pages 65–79, May 2013.
- [15] Amir Houmansadr, Thomas Riedl, Nikita Borisov, and Andrew Singer. I Want my Voice to be Heard: IP over Voice-over-IP for Unobservable Censorship Circumvention. In *Proceedings of the Network and Distributed System Security Symposium - NDSS'13*. Internet Society, February 2013.
- [16] Philip N Howard, Aiden Duffy, Deen Freelon, Muzammil Hussain, Will Mari, and Marwa Mazaid. Opening Closed Regimes: What Was the Role of Social Media During the Arab Spring? 2011.
- [17] Donald E Knuth. *The Art of Computer Programming, Volume 4: Generating all Combinations and Partitions, Fascicle 3*, 2005.
- [18] Hooman Mohajeri Moghaddam, Baiyu Li, Mohammad Derakhshani, and Ian Goldberg. SkypeMorph: Protocol Obfuscation for Tor Bridges. In *Proceedings of the 2012 ACM Conference on Computer and Communications Security, CCS '12*, pages 97–108, New York, NY, USA, 2012. ACM.
- [19] MPGH. MultiPlayer Game Hacking and Cheats. <http://www.mpg.net>.
- [20] H. Noman. Dubai Free Zone No Longer Has Filter-Free Internet Access. <http://opennet.net/blog/2008/04/dubai-free-zone-no-longer-has-filter-free-internet-access>.
- [21] ONI Research Profile: Burma. <http://opennet.net/research/profiles/burma>, 2012.

- [22] ONI Research Profile: Indonesia. <http://opennet.net/research/profiles/indonesia>, 2012.
- [23] Opera Turbo. Opera Help: Opera Turbo. <http://help.opera.com/Mac/11.60/en/turbo.html>.
- [24] Rensys Blog. Pakistan Hijacks YouTube. http://www.rensys.com/blog/2008/02/pakistan_hijacks_youtube_1.shtml.
- [25] Zachary Weinberg, Jeffrey Wang, Vinod Yegneswaran, Linda Briesemeister, Steven Cheung, Frank Wang, and Dan Boneh. StegoTorus: A Camouflage Proxy for the Tor Anonymity System. In *Proceedings of the 19th ACM conference on Computer and Communications Security (CCS 2012)*, October 2012.
- [26] E. Zmijewski. Accidentally Importing Censorship. Rensys blog. <http://www.rensys.com/blog/2010/03/fouling-the-global-nest.shtml>, 2010.

A Algorithms for encoding data and decoding commands

In this section, we present pseudo-code for the encoding and decoding process used by vanilla Castle, as described in Section 3.

Assuming a map with n units/buildings, a maximum of $m = x_{max} \times y_{max}$ map locations, and a game which allows for a maximum of k units/buildings to be selected simultaneously, the game-independent encoding of covert data into a MOVE or SET-RALLY-POINT command is done as shown in Algorithm 1. Decoding is done as shown in Algorithm 2.

Algorithm 1 Algorithm for encoding covert data into game commands

```

function ENCODE( $data, k, n, m, x_{max}$ )
   $r \stackrel{\$}{\leftarrow} \{1, \dots, k\}$ 
   $z_1 \leftarrow \text{READ}(data, \log_2 \binom{n}{r})$ 
  for  $i = n \rightarrow 0$  do
    if  $\binom{i}{r} \leq z_1$  then
       $z_1 \leftarrow z_1 - \binom{i}{r}$ 
       $selected \leftarrow selected || i$ 
    end if
  end for
   $z_2 \leftarrow \text{READ}(data, \log_2 m)$ 
   $(x, y) \leftarrow (z_2 \bmod x_{max}, \lfloor z_2/x_{max} \rfloor)$ 
  return  $\{selected, (x, y)\}$ 
end function

function READ( $file, x$ )
  return next  $x$  bits from  $file$  in base 10.
end function

```

Algorithm 2 Algorithm for obtaining covert data from game commands

```
function DECODE(selected, (x, y))  
  size  $\leftarrow$  |selected|,  $z_1 = 0$   
  selected  $\leftarrow$  SORT-DESCENDING(selected)  
  for  $i \in$  selected do  
     $z_1 \leftarrow z_1 + \binom{i}{size-i}$   
  end for  
   $z_2 \leftarrow (\mathbf{y} \times x_{max}) + \mathbf{x}$   
  return (base2( $z_1$ )||base2( $z_2$ ))  
end function
```
