

# The CR-UAV Problem is PSPACE-Complete

Hsi-Ming Ho and Joël Ouaknine

Department of Computer Science, University of Oxford  
Wolfson Building, Parks Road, Oxford, OX1 3QD, UK

**Abstract.** Consider a finite set of targets, with each target assigned a *relative deadline*, and each pair of targets assigned a fixed transit *flight time*. Given a flock of identical UAVs, can one ensure that every target is repeatedly visited by some UAV at intervals of duration at most the target’s relative deadline? The *Cyclic-Routing UAV Problem (CR-UAV)* is the question of whether this task has a solution.

This problem can straightforwardly be solved in PSPACE by modelling it as a network of timed automata. The special case of there being a single UAV is claimed to be NP-complete in the literature. In this paper, we show that the CR-UAV Problem is in fact PSPACE-complete even in the single-UAV case.

## 1 Introduction

Unmanned aerial vehicles (UAVs) have many uses, ranging from civilian to military operations. Like other autonomous systems, they are particularly well-suited to ‘dull, dirty, and/or dangerous’ missions [1]. A common scenario in such missions is that a set of targets have to be visited by a limited number of UAVs. This has given rise to a large body of research on *path planning* for UAVs.<sup>1</sup> Depending on the specific application at hand, paths of UAVs may be subject to various complex constraints, e.g., related to kinematics or fuel (see, e.g., [2, 17, 19, 22]).

In this work, we consider the *Cyclic-Routing UAV Problem (CR-UAV)* [8]: the decision version of a simple *recurrent* UAV path-planning problem in which each target must be visited not only once but repeatedly, i.e., at intervals of prescribed maximal duration. Problems of this type have long been considered in many other fields such as transportation [16, 21] and robotics [7, 12]. More recently, a number of game-theoretic frameworks have been developed to study similar problems in the context of security [5, 11, 20].

A special case of the problem (with a single UAV) is considered in [4, 5, 13], and is claimed to be NP-complete in [5]. However, the proof of NP-membership in [5] is not detailed.<sup>2</sup> The main result of the present paper is that the CR-UAV Problem is in fact PSPACE-complete, even in the single-UAV case. We note that this problem can be seen as a recurrent variant of the decision version of the *Travelling Salesman Problem with Time Windows (TSPTW)* with upper

<sup>1</sup> <http://scholar.google.com/> lists thousands of papers on the subject.

<sup>2</sup> A counterexample to a crucial claim in [5] is given in Appendix A.

bounds only. Its PSPACE-hardness hence stems from recurrence: the decision version of the (non-recurrent) TSPTW Problem is NP-complete [18].

PSPACE-membership of the (general) CR-UAV Problem follows straightforwardly by encoding the problem as the existence of infinite paths in a network of timed automata; we briefly sketch the argument in the next section. The bulk of the paper is then devoted to establishing PSPACE-hardness of the single-UAV case. This is accomplished by reduction from the PERIODIC SAT Problem, known to be PSPACE-complete [15].

## 2 Preliminaries

### 2.1 Scenario

Let there be a set of targets and a number of identical UAVs. Each target has a *relative deadline*: an upper bound requirement on the time between successive visits by UAVs. The UAVs are allowed to fly freely between targets, with a *flight time* given for each pair of targets: the amount of time required for a UAV to fly from one of the targets to the other. We assume that flight times are symmetric, that they obey the triangle inequality, and that the flight time from target  $v$  to target  $v'$  is zero iff  $v$  and  $v'$  denote the same target. In other words, flight times are a metric on the set of targets. The goal is to decide whether there is a way to coordinate UAVs such that no relative deadline is ever violated. We make a few further assumptions:

- Initially, each UAV starts at some target; there may be more than one UAV at the same target.
- The first visit to each target must take place at the latest by the expiration time of its relative deadline.
- The UAVs are allowed to ‘wait’ as long as they wish at any given target.
- Time units are chosen so that all relative deadlines and flight times are integers, and moreover all relative deadlines are interpreted as closed constraints (i.e., using non-strict inequalities).

### 2.2 Modelling via Networks of Timed Automata

We briefly sketch how to model the CR-UAV Problem as the existence of infinite non-Zeno paths in a network of Büchi timed automata, following the notation and results of [3], from which PSPACE-membership immediately follows.

Intuitively, one ascribes a particular timed automaton to each UAV and to each target. Each UAV-automaton keeps track of the location of its associated UAV, and enforces flight times by means of a single clock, which is reset the instant the UAV leaves a given target. Each target-automaton is likewise equipped with a single clock, keeping track of time elapsed since the last visit by some UAV. The action of a UAV visiting a target is modelled by synchronising on a particular event; when this takes place, provided the target’s relative deadline has not been violated, the target resets its internal clock and instantaneously

visits a Büchi location. Similarly, the action of a UAV leaving a target is modelled by event synchronisation. Finally, since multiple UAVs may visit a given target simultaneously, each target is in addition equipped with a counter to keep track at any time of whether or not it is currently being visited by some UAV.

The given instance of the CR-UAV Problem therefore has a solution iff there exists a non-Zeno run of the resulting network of timed automata in which each Büchi accepting location is visited infinitely often. By Thm. 7 of [3], this can be decided in PSPACE.

It is worth noting that, since all timing constraints are closed by assumption, standard digitisation results apply (cf. [10]) and it is sufficient to consider integer (i.e., discrete) time. In the next section, we therefore present a discrete graph-based (and timed-automaton independent) formulation of the problem specialised to a single UAV, in order to establish PSPACE-hardness.

### 2.3 Weighted Graph Formulation

The solution to a single-UAV instance of the CR-UAV Problem consists of an infinite path from target to target in which each target is visited infinitely often, at time intervals never greater than the target’s relative deadline. One may clearly assume that the UAV never ‘lingers’ at any given target, i.e., targets are visited instantaneously. Formally, a single-UAV instance of the CR-UAV Problem can be described as follows. Let  $V$  be a set of  $n \geq 2$  vertices, with each vertex  $v \in V$  assigned a strictly positive integer weight  $RD(v)$  (intuitively, the relative deadline of target  $v$ ). Consider a weighted undirected clique over  $V$ , i.e., to each pair of vertices  $(v, v')$  with  $v \neq v'$ , one assigns a strictly positive integer weight  $FT(v, v')$  (intuitively, the flight time from  $v$  to  $v'$ ). In addition we require that  $FT$  be symmetric and satisfy the triangle inequality.

Let  $G = \langle V, RD, FT \rangle$  be an instance of the above data. Given a finite path  $u$  in (the clique associated with)  $G$ , the **duration**  $dur(u)$  of  $u$  is defined to be the sum of the weights of the edges in  $u$ . A **solution** to  $G$  is an infinite path  $s$  through  $G$  with the following properties:

- $s$  visits every vertex in  $V$  infinitely often;
- Any finite subpath of  $s$  that starts and ends at consecutive occurrences of a given vertex  $v$  must have duration at most  $RD(v)$ .

**Definition 1 (The CR-UAV Problem with a Single UAV).** *Given  $G$  as described above, does  $G$  have a solution?*

As pointed out in [13], if a solution exists at all then a *periodic* solution can be found, i.e., an infinite path in which the targets are visited repeatedly in the same order.

### 2.4 The PERIODIC SAT Problem

PERIODIC SAT is one of the many PSPACE-complete problems introduced in [15]. In the following definition (and in the rest of this paper), let  $\bar{x}$  be a finite set

of variables and let  $\bar{x}^j$  be the set of variables obtained from  $\bar{x}$  by adding a superscript  $j$  to each variable.

**Definition 2 (The PERIODIC SAT Problem [15]).** *Consider a CNF formula  $\varphi(0)$  over  $\bar{x}^0 \cup \bar{x}^1$ . Let  $\varphi(j)$  be the formula obtained from  $\varphi(0)$  by replacing all variables  $x_i^0 \in \bar{x}^0$  by  $x_i^j$  and all variables  $x_i^1 \in \bar{x}^1$  by  $x_i^{j+1}$ . Is there an assignment of  $\bigcup_{j \geq 0} \bar{x}^j$  such that  $\bigwedge_{j \geq 0} \varphi(j)$  is satisfied?*

### 3 PSPACE-Hardness

In this section, we give a reduction from the PERIODIC SAT Problem to the CR-UAV Problem with a single UAV. Consider a CNF formula  $\varphi(0) = c_1 \wedge \dots \wedge c_h$  over  $\bar{x}^0 = \{x_1^0, \dots, x_m^0\}$  and  $\bar{x}^1 = \{x_1^1, \dots, x_m^1\}$ . Without loss of generality, we assume that each clause  $c_j$  of  $\varphi(0)$  is non-trivial (i.e.,  $c_j$  does not contain both positive and negative occurrences of a variable) and  $m > 2$ ,  $h > 0$ . We can construct an instance  $G$  of the CR-UAV Problem (with the largest constant having magnitude  $O(m^2h)$  and  $|V| = O(mh)$ ) such that  $\bigwedge_{j \geq 0} \varphi(j)$  is satisfiable if and only if  $G$  has a solution.

The general idea of the reduction can be described as follows. We construct *variable gadgets* that can be traversed in two ‘directions’ (corresponding to assignments **true** and **false** to variables). A *clause vertex* is visited if the corresponding clause is satisfied by the assignment. Crucially, we use *consistency gadgets*, in which we set the relative deadlines of the vertices carefully to ensure that the directions of traversals of the variable gadgets for  $\bar{x}^1$  (corresponding to a particular assignment of variables) in a given iteration is consistent with the directions of traversals of the variable gadgets for  $\bar{x}^0$  in the next iteration.

#### 3.1 The Construction

We describe and explain each part of  $G$  in detail (a concise yet complete specification of  $G$  is given in Appendix B). The reader is advised to glance ahead to Figure 5 to form an impression of  $G$ . Note that for ease of presentation, we temporarily relax the requirement that  $FT$  be a metric and describe  $G$  as an incomplete graph.<sup>3</sup> In what follows, let  $l = 24h + 34$  and

$$T = 2\left(m(2(3m+1)l+l) + m(2(3m+2)l+l) + l + 2h\right).$$

**Variable Gadgets** For each variable  $x_i^0$ , we construct (as a subgraph of  $G$ ) a *variable gadget*. It consists of the following vertices (see Figure 1):

- Three vertices on the left side ( $LS_i = \{v_i^{t,L}, v_i^{m,L}, v_i^{b,L}\}$ )
- Three vertices on the right side ( $RS_i = \{v_i^{t,R}, v_i^{m,R}, v_i^{b,R}\}$ )

<sup>3</sup> In the single-UAV case, if the  $FT$  of some edge is greater than any value in  $RD$ , that edge can simply be seen as non-existent.

- A ‘clause box’ ( $CB_i^j = \{v_i^{a,j}, v_i^{b,j}, v_i^{c,j}, v_i^{d,j}, v_i^{e,j}, v_i^{f,j}\}$ ) for each  $j \in \{1, \dots, h\}$
- A ‘separator box’ ( $SB_i^j = \{v_i^{\bar{a},j}, v_i^{\bar{b},j}, v_i^{\bar{c},j}, v_i^{\bar{d},j}, v_i^{\bar{e},j}, v_i^{\bar{f},j}\}$ ) for each  $j \in \{0, \dots, h\}$
- A vertex at the top ( $v_{top}$  if  $i = 0$ ,  $v_{i-1}$  otherwise)
- A vertex at the bottom ( $v_i$ ).

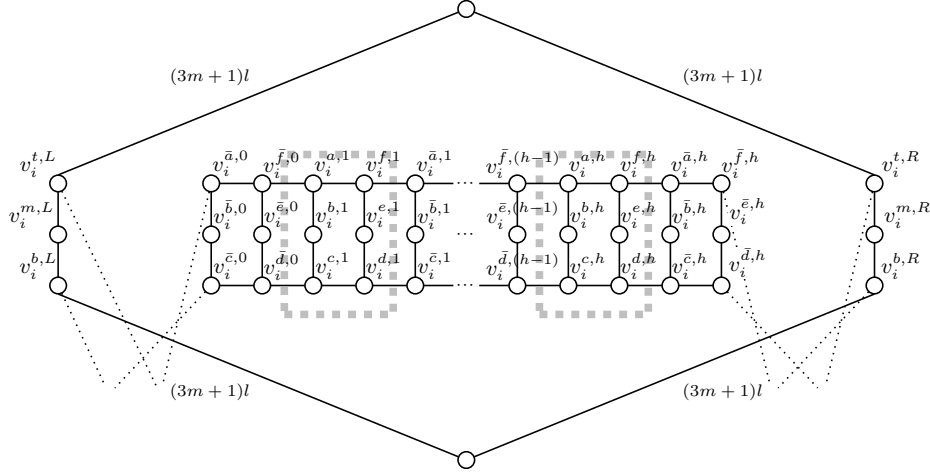

**Fig. 1.** The variable gadget for  $x_i^0$

The clause boxes for  $j \in \{1, \dots, h\}$  are aligned horizontally in the figure. A separator box is laid between each adjacent pair of clause boxes and at both ends. This row of boxes ( $Row_i = \bigcup_{j \in \{1, \dots, h\}} CB_i^j \cup \bigcup_{j \in \{0, \dots, h\}} SB_i^j$ ) is then put between  $LS_i$  and  $RS_i$ . The  $RD$  of all vertices  $v \in LS_i \cup RS_i \cup Row_i$  are set to  $T + l + 2h$ .

The vertices are connected as indicated by solid lines in the figure. The four ‘long’ edges in the figure have their  $FT$  set to  $(3m + 1)l$  while all other edges have  $FT$  equal to 2, e.g.,  $FT(v_{top}, v_1^{t,L}) = (3m + 1)l$  and  $FT(v_1^{b,L}, v_1^{c,L}) = 2$ . There is an exception though:  $FT(v_m^{b,L}, v_m)$  and  $FT(v_m^{b,R}, v_m)$  (in the variable gadget for  $x_m^0$ ) are equal to  $(3m + 2)l$ .

The variable gadgets for variables  $x_i^1$  are constructed almost identically. The three vertices on the left and right side are now  $LS_{i+m}$  and  $RS_{i+m}$ . The set of vertices in the row is now  $Row_{i+m} = \bigcup_{j \in \{1, \dots, h\}} CB_{i+m}^j \cup \bigcup_{j \in \{0, \dots, h\}} SB_{i+m}^j$ . The vertex at the top is  $v_{i+m-1}$  and the vertex at the bottom is  $v_{i+m}$  ( $i \neq m$ ) or  $v_{bot}$  ( $i = m$ ). The  $RD$  of vertices in  $LS_{i+m} \cup RS_{i+m} \cup Row_{i+m}$  are set to  $T + l + 2h$ , and the  $FT$  of the edges are set as before, except that all the ‘long’ edges now have  $FT$  equal to  $(3m + 2)l$ .

Now consider the following ordering of variables:

$$x_1^0, x_2^0, \dots, x_m^0, x_1^1, x_2^1, \dots, x_m^1.$$

Observe that the variable gadgets for two ‘neighbouring’ variables (with respect to this ordering) have a vertex in common. To be precise, the set of shared vertices is  $S = \{v_1, \dots, v_{2m-1}\}$ . We set the  $RD$  of all vertices in  $S$  to  $T + 2h$  and the  $RD$  of  $v_{top}$  and  $v_{bot}$  to  $T$ .

**Clause Vertices** For each clause  $c_j$  in  $\varphi(0)$ , there is a *clause vertex*  $v^{c_j}$  with  $RD$  set to  $\frac{3}{2}T$ . If  $x_i^0$  occurs in  $c_j$  as a literal, we connect the  $j$ -th clause box in the variable gadget for  $x_i^0$  to  $v^{c_j}$  as shown in Figure 2 and set the  $FT$  of these new edges to 2 (e.g.,  $FT(v^{c_j}, v_i^{c,j}) = FT(v^{c_j}, v_i^{d,j}) = 2$ ). If instead  $\neg x_i^0$  occurs in  $c_j$ , then  $v^{c_j}$  is connected to  $v_i^{a,j}$  and  $v_i^{f,j}$  (with  $FT$  equal to 2). Likewise, the variable gadget for  $x_i^1$  may be connected to  $v^{c_j}$  via  $\{v_{i+m}^{c,j}, v_{i+m}^{d,j}\}$  (if  $x_i^1$  occurs in  $c_j$ ) or  $\{v_{i+m}^{a,j}, v_{i+m}^{f,j}\}$  (if  $\neg x_i^1$  occurs in  $c_j$ ).

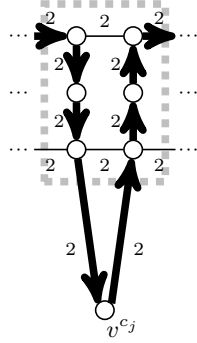

Fig. 2. The variable occurs positively in  $c_j$

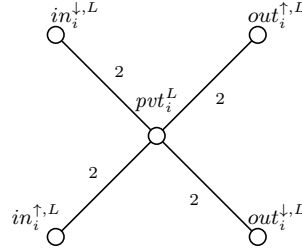
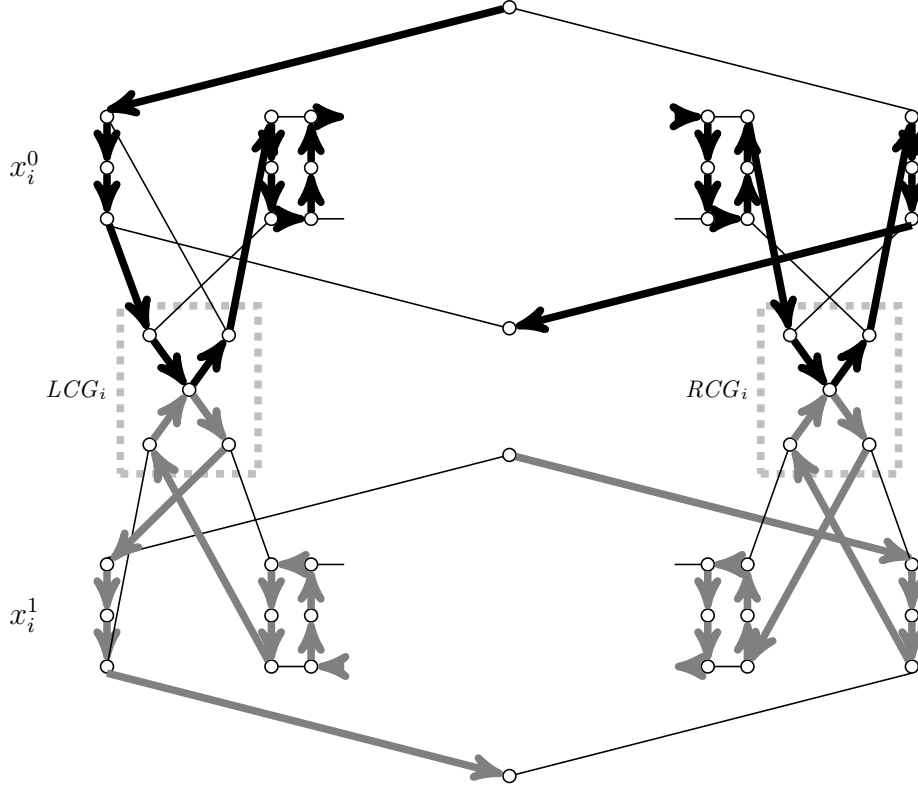

Fig. 3. A consistency gadget  $LCG_i$

**Consistency Gadgets** For each  $i \in \{1, \dots, m\}$ , we construct two *consistency gadgets*  $LCG_i$  (see Figure 3) and  $RCG_i$ . In  $LCG_i$ , the vertex at the centre ( $pvt_i^{t,L}$ ) has  $RD$  equal to  $\frac{1}{2}T + m(2(3m+2)l+l) - (2i-1)l + 4h$ . The other four vertices ( $in_i^{\downarrow,L}$ ,  $out_i^{\uparrow,L}$ ,  $in_i^{\uparrow,L}$  and  $out_i^{\downarrow,L}$ ) have  $RD$  equal to  $\frac{3}{2}T$ . The  $FT$  from  $pvt_i^{t,L}$  to any of the other four vertices is 2.  $RCG_i$  is identical except that the subscripts on the vertices change from  $L$  to  $R$ .

$LCG_i$  and  $RCG_i$  are connected to the variable gadgets for  $x_i^0$  and  $x_i^1$  as in Figure 4. The vertices  $in_i^{\downarrow,L}$ ,  $out_i^{\uparrow,L}$ ,  $in_i^{\downarrow,R}$ ,  $out_i^{\uparrow,R}$  are connected to certain vertices in the variable gadget for  $x_i^0$ —this allows  $pvt_i^L$  and  $pvt_i^R$  to be traversed ‘from above’. Similarly, the edges connected to  $in_i^{\uparrow,L}$ ,  $out_i^{\downarrow,L}$ ,  $in_i^{\uparrow,R}$ ,  $out_i^{\downarrow,R}$  allow  $pvt_i^L$  and  $pvt_i^R$  to be traversed ‘from below’. Formally,  $FT(v, v') = 2$  if

- $v = in_i^{\downarrow,L}$ ,  $v' \in \{v_i^{b,L}, v_i^{\bar{c},0}\}$  or  $v = in_i^{\downarrow,R}$ ,  $v' \in \{v_i^{\bar{f},h}, v_i^{b,R}\}$
- $v = out_i^{\uparrow,L}$ ,  $v' \in \{v_i^{t,L}, v_i^{\bar{a},0}\}$  or  $v = out_i^{\uparrow,R}$ ,  $v' \in \{v_i^{\bar{d},h}, v_i^{t,R}\}$



**Fig. 4.** Connecting the variable gadgets for  $x_i^0$  and  $x_i^1$  to  $LCG_i$  and  $RCG_i$

- $v = in_i^{\uparrow,L}, v' \in \{v_{(i+m)}^{b,L}, v_{(i+m)}^{\bar{c},0}\}$  or  $v = in_i^{\uparrow,R}, v' \in \{v_{(i+m)}^{\bar{f},h}, v_{(i+m)}^{b,R}\}$
- $v = out_i^{\downarrow,L}, v' \in \{v_{(i+m)}^{t,L}, v_{(i+m)}^{\bar{a},0}\}$  or  $v = out_i^{\downarrow,R}, v' \in \{v_{(i+m)}^{\bar{d},h}, v_{(i+m)}^{t,R}\}$ .

Two parts of an intended path, which we will explain in more detail later, is also illustrated in Figure 4.

Finally, there is a vertex  $v_{mid}$  with  $RD(v_{mid}) = T$  connected to  $v_{bot}$  and  $v_{top}$  with two edges, both with  $FT$  equal to  $\frac{1}{4}T$ . The  $FT$  of all the missing edges are  $2T$  (note that the largest value in  $RD$  is less than  $2T$ , so these edges can never be taken). This completes the construction of  $G$ . An example with  $m = 3$  is given in Figure 5, where vertices in  $S$  (shared by two variable gadgets) are depicted as solid circles.

The rest of this section is devoted to the proof of the following proposition.

**Proposition 3.**  $\bigwedge_{j \geq 0} \varphi(j)$  is satisfiable iff  $G$  has a solution.

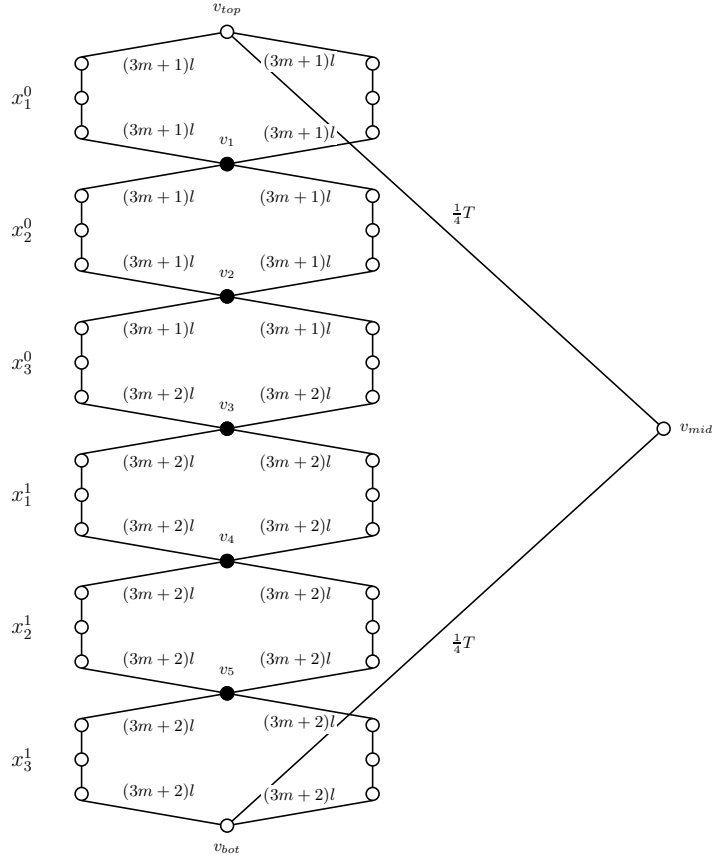
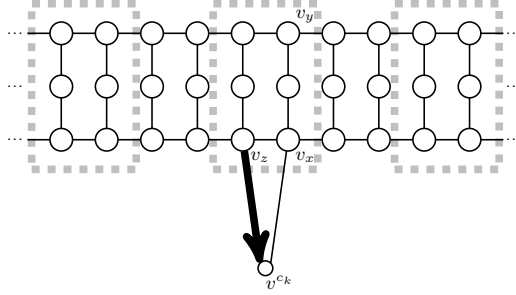

**Fig. 5.** An example with  $m = 3$ . Solid circles denote shared vertices  $S = \{v_1, \dots, v_5\}$ .

### 3.2 The Proof of Proposition 3

We first prove the forward direction. Given a satisfying assignment of  $\bigwedge_{j \geq 0} \varphi(j)$ , we construct a solution  $s$  as follows:  $s$  starts from  $v_{top}$  and goes through the variable gadgets for  $x_1^0, x_2^0, \dots, x_m^0, x_1^1, x_2^1, \dots, x_m^1$  in order, eventually reaching  $v_{bot}$ . Each variable gadget is traversed according to the truth value assigned to its corresponding variable. In such a traversal, both  $pvt_i^L$  and  $pvt_i^R$  are visited once (see the thick arrows in Figure 4 for the situation when  $x_i^0$  is assigned **true** and  $x_i^1$  is assigned **false**). Along the way from  $v_{top}$  to  $v_{bot}$ ,  $s$  detours at certain times and ‘hits’ each clause vertex exactly once as illustrated by the thick arrows in Figure 2 (this can be done as  $\varphi(0)$  is satisfied by the assignment). Then  $s$  goes back to  $v_{top}$  through  $v_{mid}$  and starts over again, this time following the truth values assigned to variables in  $\bar{x}^1 \cup \bar{x}^2$ , and so on. One can verify that this describes a solution to  $G$ .





**Fig. 8.**  $x_i^0$  occurs positively in  $c_k$

will be visited twice). Assume that  $s_j$  does not visit  $v_x$  immediately after  $v^{c_k}$ . As  $v_x$  cannot be entered or left via  $v_z$  and  $v^{c_k}$ , the  $3 \times 3$  box with  $v_x$  at its lower-left must also be traversed in Pattern ‘ $\sqcap$ ’. However, there is then no way to enter or leave  $v_y$ . This is a contradiction.  $\square$

Note that in Figure 8, the three clause boxes (framed by dotted lines) are all traversed in Pattern ‘ $\sqcap$ ’ or they are all traversed in Pattern ‘ $\sqcup$ ’. More generally, we have the following proposition.

**Proposition 7.** *In each segment  $s_j$ , clause boxes in a given variable gadget are all traversed in Pattern ‘ $\sqcap$ ’ or they are all traversed in Pattern ‘ $\sqcup$ ’ (with possible detours via clause vertices).*

Write  $v \rightarrow v'$  for the edge from  $v$  to  $v'$  and  $v \rightsquigarrow v'$  for a finite path that starts with  $v$  and ends with  $v'$ . By Lemma 5, each segment  $s_j$  can be written as  $v_{top} \rightsquigarrow v_{b_1} \rightsquigarrow \dots \rightsquigarrow v_{b_{2m-1}} \rightsquigarrow v_{bot}$  where  $b_1, \dots, b_{2m-1}$  is a permutation of  $1, \dots, 2m-1$ . We show that each subpath  $v \rightsquigarrow v'$  of  $s_j$  with distinct  $v, v' \in S \cup \{v_{top}, v_{bot}\}$  and no  $v'' \in S \cup \{v_{top}, v_{bot}\}$  in between must be of a very restricted form. For convenience, we call such a subpath  $v \rightsquigarrow v'$  a *fragment*.

**Proposition 8.** *In each segment  $s_j = v_{top} \rightsquigarrow v_{b_1} \rightsquigarrow \dots \rightsquigarrow v_{b_{2m-1}} \rightsquigarrow v_{bot}$ , a fragment  $v \rightsquigarrow v'$  visits  $pvt_i^L$  and  $pvt_i^R$  (once for each) for some  $i \in \{1, \dots, m\}$ . Moreover, each fragment  $v \rightsquigarrow v'$  in  $v_{top} \rightsquigarrow v_{b_1} \rightsquigarrow \dots \rightsquigarrow v_{b_m}$  visits a different set  $\{pvt_i^L, pvt_i^R\}$ . The same holds for  $v_{b_m} \rightsquigarrow v_{b_{m+1}} \rightsquigarrow \dots \rightsquigarrow v_{bot}$ .*

*Proof.* It is clear that  $dur(v \rightsquigarrow v') \geq 2(3m+1)l$ , and hence  $dur(v_{top} \rightsquigarrow v_{b_1} \rightsquigarrow \dots \rightsquigarrow v_{b_m}) \geq m(2(3m+1)l)$ . Let there be a vertex  $v \in \bigcup_{i \in \{1, \dots, m\}} \{pvt_i^L, pvt_i^R\}$  missing in  $v_{top} \rightsquigarrow v_{b_1} \rightsquigarrow \dots \rightsquigarrow v_{b_m}$ . Since the time needed from  $v_{b_m}$  to  $v$  is greater than  $(3m+1)l$ , even if  $s_j$  visits  $v$  as soon as possible after  $v_{b_m}$ , the duration from  $v_{bot}$  in  $s_{j-1}$  to  $v$  in  $s_j$  will still be greater than  $\frac{1}{2}T + m(2(3m+1)l) + (3m+1)l > RD(v)$ , which is a contradiction. Therefore, all vertices in  $\bigcup_{i \in \{1, \dots, m\}} \{pvt_i^L, pvt_i^R\}$  must appear in the subpath from  $v_{top}$  to  $v_{b_m}$ . The same holds for the subpath from  $v_{b_m}$  to  $v_{bot}$  by similar arguments. Now note that by Proposition 6, a fragment  $v \rightsquigarrow v'$  may visit at most two vertices— $\{pvt_i^L, pvt_i^R\}$  for some  $i \in \{1, \dots, m\}$ . The proposition then follows from Lemma 5.  $\square$

**Proposition 9.** *In each segment  $s_j$ , a fragment  $v \rightsquigarrow v'$  visits all vertices in either  $Row_i$  or  $Row_{i+m}$  for some  $i \in \{1, \dots, m\}$  but not a single vertex in  $\bigcup_{j \in \{1, \dots, m\}, j \neq i} (Row_j \cup Row_{j+m})$ .*

Now consider a fragment  $v \rightsquigarrow v'$  that visits  $pvt_i^L$  and  $pvt_i^R$  (by Proposition 8). By Lemma 5,  $v \rightsquigarrow v'$  must also visit exactly two vertices other than  $pvt_i^L$  in  $LCG_i$  and exactly two vertices other than  $pvt_i^R$  in  $RCG_i$  (once for each). It is not hard to see that  $v \rightsquigarrow v'$  must contain, in order, the following subpaths (together with some obvious choices of edges connecting these subpaths):

- (i). A long edge, e.g.,  $v_i \rightarrow v_i^{b,R}$ .
- (ii). A ‘side’, e.g.,  $v_i^{b,R} \rightarrow v_i^{m,R} \rightarrow v_i^{t,R}$ .
- (iii). A subpath consisting of a  $pvt$  vertex and two other vertices in the relevant consistency gadget, e.g.,  $out_i^{\uparrow,R} \rightarrow pvt_i^R \rightarrow in_i^{\downarrow,R}$ .
- (iv). A traversal of a row with detours.
- (v). A subpath consisting of a  $pvt$  vertex and two other vertices in the relevant consistency gadget.
- (vi). A side.
- (vii). A long edge.

The following proposition is then immediate. In particular, the exact value of  $dur(v \rightsquigarrow v')$  is decided by:

- $FT$  of the long edges taken in (i) and (vii)
- detours to clause vertices in (iv).

**Proposition 10.** *In each segment  $s_j$ , the following holds for all fragments  $v \rightsquigarrow v'$ :*

$$2(3m+1)l + l \leq dur(v \rightsquigarrow v') \leq 2(3m+2)l + l + 2h.$$

**Proposition 11.** *The order the sets  $\{pvt_i^L, pvt_i^R\}$  are visited (regardless of which vertex in the set is first visited) in the first  $m$  fragments of each segment  $s_j$  is identical to the order they are visited in the last  $m$  fragments of  $s_{j-1}$ .*

*Proof.* By Proposition 10, if this does not hold then there must be a  $pvt$  vertex having two occurrences in  $s$  separated by more than  $\frac{1}{2}T + m(2(3m+1)l + l) + 2(3m+1)l$ . This is a contradiction.  $\square$

For each segment  $s_j$ , we denote by  $first(s_j)$  the ‘first half’ of  $s_j$ , i.e., the subpath of  $s_j$  that consists of the first  $m$  fragments of  $s_j$  and by  $second(s_j)$  the ‘second half’ of  $s_j$ . Write  $\exists(v \rightsquigarrow v') \subseteq u$  if  $u$  has a subpath of the form  $v \rightsquigarrow v'$ .

**Proposition 12.** *In each segment  $s_j = v_{top} \rightsquigarrow v_{b_1} \rightsquigarrow \dots \rightsquigarrow v_{b_{2m-1}} \rightsquigarrow v_{bot}$ , we have  $b_i = i$  for all  $i \in \{1, \dots, 2m-1\}$ .*

*Proof.* First note that by construction and Proposition 8,  $\{pvt_m^L, pvt_m^R\}$  must be the last set of  $pvt$  vertices visited in  $second(s_{j-1})$ . By Proposition 11, it must also be the last set of  $pvt$  vertices visited in  $first(s_j)$ . Now assume that a long edge of flight time  $(3m+2)l$  is taken before  $pvt_m^L$  and  $pvt_m^R$  are visited in  $first(s_j)$ . Consider the following cases:

- $\exists(pvt_m^L \rightsquigarrow pvt_m^R) \subseteq \text{second}(s_{j-1})$  and  $\exists(pvt_m^R \rightsquigarrow pvt_m^L) \subseteq \text{first}(s_j)$ : Note that the last edge taken in  $s_{j-1}$  is a long edge of flight time  $(3m+2)l$ , and hence there are two occurrences of  $pvt_m^L$  in  $s$  separated by at least  $\frac{1}{2}T + m(2(3m+1)l+l) + 2l > \frac{1}{2}T + m(2(3m+1)l+l) + l + 4h = RD(pvt_m^L)$ .
- $\exists(pvt_m^R \rightsquigarrow pvt_m^L) \subseteq \text{second}(s_{j-1})$  and  $\exists(pvt_m^L \rightsquigarrow pvt_m^R) \subseteq \text{first}(s_j)$ : The same argument shows that  $pvt_m^R$  must miss its relative deadline.
- $\exists(pvt_m^L \rightsquigarrow pvt_m^R) \subseteq \text{second}(s_{j-1})$  and  $\exists(pvt_m^L \rightsquigarrow pvt_m^R) \subseteq \text{first}(s_j)$ : The same argument shows that both  $pvt_m^L$  and  $pvt_m^R$  must miss their relative deadlines.
- $\exists(pvt_m^R \rightsquigarrow pvt_m^L) \subseteq \text{second}(s_{j-1})$  and  $\exists(pvt_m^R \rightsquigarrow pvt_m^L) \subseteq \text{first}(s_j)$ : The same argument shows that both  $pvt_m^L$  and  $pvt_m^R$  must miss their relative deadlines.

We therefore conclude that in  $\text{first}(s_j)$ , all long edges taken before  $pvt_m^L$  and  $pvt_m^R$  are visited must have  $FT$  equal to  $(3m+1)l$ . Furthermore, all such long edges must be traversed ‘downwards’ (by Lemma 5). It follows that  $b_i = i$  for  $i \in \{1, \dots, m-1\}$ . By Proposition 11, Lemma 5 and  $m > 2$ , we easily derive that  $b_m = m$  and then  $b_i = i$  for  $i \in \{m+1, \dots, 2m-1\}$ .  $\square$

By Proposition 12, the long edges in each variable gadget must be traversed in the ways shown in Figures 9 and 10.

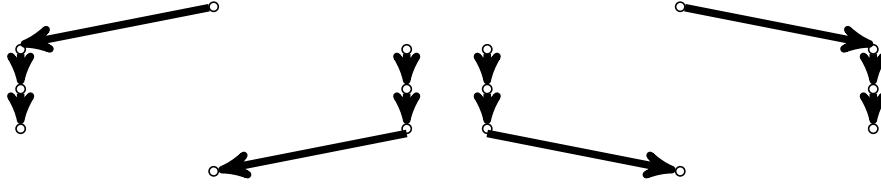

**Fig. 9.** The variable is assigned to **true**    **Fig. 10.** The variable is assigned to **false**

**Proposition 13.** *For each segment  $s_j$ , the ways in which the long edges are traversed in the last  $m$  fragments of  $s_j$  are consistent with the ways in which the long edges are traversed in the first  $m$  fragments of  $s_{j+1}$ .*

*Proof.* Without loss of generality, consider the case that  $\exists(pvt_i^L \rightsquigarrow pvt_i^R) \subseteq \text{second}(s_j)$  and  $\exists(pvt_i^R \rightsquigarrow pvt_i^L) \subseteq \text{first}(s_{j+1})$ . By Proposition 12, these two occurrences of  $pvt_i^L$  in  $s$  are separated by, at least, the sum of  $\frac{1}{2}T + m(2(3m+2)l+l) - (2i-1)l$  and the duration of the actual subpath  $pvt_i^R \rightsquigarrow pvt_i^L$  in  $\text{first}(s_{j+1})$ . It is clear that  $pvt_i^L$  must miss its relative deadline.  $\square$

**Proposition 14.** *In each segment  $s_j$ , if a variable gadget is traversed as in Figure 9 (Figure 10), then all of its clause boxes are traversed in Pattern ‘ $\sqcup$ ’ (Pattern ‘ $\sqcap$ ’).*

Consider a segment  $s_j$ . As each clause vertex is visited once in  $s_j$  (by Lemma 5), the ways in which the long edges are traversed in all fragments  $v \rightsquigarrow v'$  of  $s_j$  (i.e.,

as in Figure 9 or Figure 10) can be seen as a satisfying assignment of  $\varphi(0)$  (by construction and Proposition 14). By the same argument, the ways in which the long edges are traversed in all fragments of  $s_{j+1}$  can be seen as a satisfying assignment of  $\varphi(1)$ . Now by Proposition 13, the assignment of variables  $\bar{x}^1$  is consistent in both segments. By IH,  $s$  witnesses a (periodic) satisfying assignment of  $\bigwedge_{j \geq 0} \varphi(j)$ . Proposition 3 is hence proved.

Finally, note that  $FT$  can easily be modified into a metric over  $V$  by replacing each entry of value  $2T$  with the ‘shortest distance’ between the two relevant vertices. It is easy to see that Proposition 3 still holds. Our main result, which holds for the metric case, follows immediately from Section 2.2.

**Theorem 15.** *The CR-UAV Problem is PSPACE-complete.*<sup>4</sup>

## 4 Conclusion

We have proved that the CR-UAV Problem is PSPACE-complete even in the single-UAV case. The proof reveals a connection between a periodically specified problem and a recurrent path-planning problem (which is not *succinctly specified* in the sense of [14]). We list below some possible directions for future work:

1. A number of crucial problems in other domains, e.g., the generalised pin-wheel scheduling problem [9] and the message ferrying problem [23], share similarities with the CR-UAV Problem—namely, they have relative deadlines and therefore ‘contexts’. Most of these problems are only known to be NP-hard. It would be interesting to investigate whether our construction can be adapted to establish PSPACE-hardness of these problems.
2. It is claimed in [13] that the restricted case in which vertices can be realised as points in a two-dimensional plane (with discretised distances between points) is NP-complete (with a single UAV). A natural question is the relationship with the problem studied in the present paper.
3. Current approaches to solving the CR-UAV Problem often formulate it as a Mixed-Integer Linear Program (MILP) and then invoke an off-the-shelf solver (see, e.g., [5]). Yet as implied by Proposition 3, the length of a solution can however be exponential in the size of the problem instance. We are currently investigating alternative implementations which would overcome such difficulties.

## References

1. Unmanned air vehicle systems association. <http://www.uavs.org/>
2. Alighanbari, M., Kuwata, Y., How, J.: Coordination and control of multiple uavs with timing constraints and loitering. In: Proceedings of ACC 2003. vol. 6, pp. 5311–5316. IEEE Press (2003)

---

<sup>4</sup> Our result holds irrespective of whether the numbers are encoded in unary or binary.

3. Alur, R.: Timed automata. In: NATO-ASI Summer School on Verification of Digital and Hybrid Systems. Springer (1998), <http://www.cis.upenn.edu/~alur/Nato97.ps>
4. Basilico, N., Gatti, N., Amigoni, F.: Developing a deterministic patrolling strategy for security agents. In: Proceedings of WI-IAT 2009. pp. 565–572. IEEE Computer Society Press (2009)
5. Basilico, N., Gatti, N., Amigoni, F.: Patrolling security games: Definition and algorithms for solving large instances with single patroller and single intruder. *Artificial Intelligence* 184–185, 78–123 (2012)
6. Cimatti, A., Clarke, E., Giunchiglia, E., Giunchiglia, F., Pistore, M., Roveri, M., Sebastiani, R., Tacchella, A.: NuSMV2: An opensource tool for symbolic model checking. In: Proceedings of CAV 2002. Lecture Notes in Computer Science, vol. 2404, pp. 359–364. Springer (2002)
7. Crama, Y., Van De Klundert, J.: Cyclic scheduling of identical parts in a robotic cell. *Operations Research* 45(6), 952–965 (1997)
8. Drucker, N., Penn, M., Strichman, O.: Cyclic routing of unmanned air vehicles. Tech. Rep. IE/IS-2014-02, Faculty of Industrial Engineering and Management, Technion (2010), [http://ie.technion.ac.il/tech\\_reports/1393234936\\_AUVSI-Abstract-31Aug2010-submitted.pdf](http://ie.technion.ac.il/tech_reports/1393234936_AUVSI-Abstract-31Aug2010-submitted.pdf)
9. Feinberg, E.A., Curry, M.T.: Generalized pinwheel problem. *Mathematical Methods of Operations Research* 62(1), 99–122 (2005)
10. Henzinger, T.A., Manna, Z., Pnueli, A.: What good are digital clocks? In: Proceedings of ICALP 1992. LNCS, vol. 623, pp. 545–558. Springer (1992)
11. Jain, M., Kardes, E., Kiekintveld, C., Ordóñez, F., Tambe, M.: Security games with arbitrary schedules: A branch and price approach. In: Proceedings of AAAI 2010. pp. 792–797. AAAI Press (2010)
12. Kats, V., Levner, E.: Minimizing the number of robots to meet a given cyclic schedule. *Annals of Operations Research* 69, 209–226 (1997)
13. Las Fargeas, J., Hyun, B., Kabamba, P., Girard, A.: Persistent visitation under revisit constraints. In: Proceedings of ICUAS 2013. pp. 952–957. IEEE Press (2013)
14. Marathe, M.V., Hunt, III, H.B., Stearns, R.E., Radhakrishnan, V.: Complexity of hierarchically and 1-dimensional periodically specified problems. In: Satisfiability Problem: Theory and Applications. DIMACS Series in Discrete Mathematics and Theoretical Computer Science, vol. 35, pp. 225–260. DIMACS (1997)
15. Orlin, J.B.: The complexity of dynamic languages and dynamic optimization problems. In: Proceedings of STOC 1981. pp. 218–227. ACM Press (1981)
16. Orlin, J.B.: Minimizing the number of vehicles to meet a fixed periodic schedule: An application of periodic posets. *Operations Research* 30(4), 760–776 (1982)
17. Richards, A., How, J.P.: Aircraft trajectory planning with collision avoidance using mixed integer linear programming. In: Proceedings of ACC 2002. vol. 3, pp. 1936–1941. IEEE Press (2002)
18. Savelsbergh, M.W.: Local search in routing problems with time windows. *Annals of Operations Research* 4(1), 285–305 (1985)
19. Sundar, K., Rathinam, S.: Route planning algorithms for unmanned aerial vehicles with refueling constraints. In: Proceedings of ACC 2012. pp. 3266–3271. IEEE Press (2012)
20. Tsai, J., Kiekintveld, C., Ordóñez, F., Tambe, M., Rathi, S.: IRIS—a tool for strategic security allocation in transportation networks. In: Tambe, M. (ed.) Security and game theory: algorithms, deployed systems, lessons learned. Cambridge University Press (2009)

21. Wollmer, R.D.: An airline tail routing algorithm for periodic schedules. *Networks* 20(1), 49–54 (1990)
22. Yang, G., Kapila, V.: Optimal path planning for unmanned air vehicles with kinematic and tactical constraints. In: *Proceedings of CDC 2002*. vol. 2, pp. 1301–1306. IEEE Press (2002)
23. Zhao, W., Ammar, M.H., Zegura, E.W.: A message ferrying approach for data delivery in sparse mobile ad hoc networks. In: *Proceedings of MobiHoc 2004*. pp. 187–198. ACM Press (2004)

## A A Counterexample

In [5] it is claimed that the special case of the CR-UAV Problem with a single UAV is in NP. This claim is based on the following bound on the ‘period’ of a solution to the problem:

*Claim ([5], Theorem 4.5).* Consider an instance  $G$  of the CR-UAV Problem with a single UAV. If there is a solution, then there is one in the form  $u^\omega$  where  $u$  is a finite path through  $G$  whose length is bounded by  $\frac{\max_{v \in V} RD(v)}{\min_{\substack{v, v' \in V \\ v \neq v'}} FT(v, v')}$ .

Note that if numbers are encoded in unary then the above bound would imply the existence of a periodic solution whose period is bounded by a polynomial in the size of the instance. Since such a solution can easily be checked in polynomial time, membership in NP would follow.

However we provide below a counterexample to the above claim. Consider the problem instance  $G$  where  $G$  is depicted in Figure 11. A periodic solution with the shortest period has period  $11^5$  whereas the theorem implies a bound of at most 10.

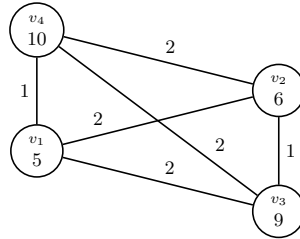

**Fig. 11.** A periodic solution with the shortest period:  $(v_3 v_2 v_1 v_4 v_1 v_2 v_3 v_1 v_2 v_4 v_1)^\omega$

The above counterexample suggests that one can devise instances of the CR-UAV problem, even in the case of a single UAV, for which any solution requires that the UAV maintain a polynomial amount of memory to record previously visited targets. This intuition forms the basis of our PSPACE-hardness proof.

<sup>5</sup> This is verified with NuSMV [6].

## B The Constructed Graph $G$

For convenience we write, e.g.,  $\neg x_1^0 \in c_1$  if  $\neg x_1^0$  is a conjunct of  $c_1$ . For each  $i \in \{1, \dots, 2m\}$ , let

$$\begin{aligned} LS_i &= \{v_i^{t,L}, v_i^{m,L}, v_i^{b,L}\} \\ RS_i &= \{v_i^{t,R}, v_i^{m,R}, v_i^{b,R}\} \\ CB_i^j &= \{v_i^{a,j}, v_i^{b,j}, v_i^{c,j}, v_i^{d,j}, v_i^{e,j}, v_i^{f,j}\} \\ SB_i^j &= \{v_i^{\bar{a},j}, v_i^{\bar{b},j}, v_i^{\bar{c},j}, v_i^{\bar{d},j}, v_i^{\bar{e},j}, v_i^{\bar{f},j}\} \\ Row_i &= \bigcup_{j \in \{1, \dots, h\}} CB_i^j \cup \bigcup_{j \in \{0, \dots, h\}} SB_i^j. \end{aligned}$$

For each  $i \in \{1, \dots, m\}$ , let

$$\begin{aligned} LCG_i &= \{in_i^{\downarrow,L}, out_i^{\uparrow,L}, pvt_i^L, in_i^{\uparrow,L}, out_i^{\downarrow,L}\} \\ RCG_i &= \{in_i^{\downarrow,R}, out_i^{\uparrow,R}, pvt_i^R, in_i^{\uparrow,R}, out_i^{\downarrow,R}\}. \end{aligned}$$

Let  $C = \{v^{c_1}, \dots, v^{c_h}\}$  where for each  $j \in \{1, \dots, h\}$ ,  $c_j$  is a clause of  $\varphi(0)$ . Additionally, let  $S = \{v_1, \dots, v_{2m-1}\}$ . The set of vertices  $V$  is defined as the following union:

$$\{v_{top}, v_{mid}, v_{bot}\} \cup S \cup C \cup \bigcup_{i \in \{1, \dots, m\}} (LCG_i \cup RCG_i) \cup \bigcup_{i \in \{1, \dots, 2m\}} (LS_i \cup RS_i \cup Row_i).$$

The array  $RD$  is defined as follows:

$$RD(v) = \begin{cases} T + l + 2h & \text{if } v \in \bigcup_{i \in \{1, \dots, 2m\}} (LS_i \cup RS_i \cup Row_i) \\ \frac{1}{2}T + m(2(3m+2)l+l) - (2i-1)l + 4h & \text{if } v \in \{pvt_i^L, pvt_i^R\} \\ \frac{3}{2}T & \text{if } v \in \bigcup_{i \in \{1, \dots, m\}} ((LCG_i \setminus \{pvt_i^L\}) \cup (RCG_i \setminus \{pvt_i^R\})) \\ \frac{3}{2}T & \text{if } v \in C \\ T + 2h & \text{if } v \in S \\ T & \text{if } v \in \{v_{top}, v_{mid}, v_{bot}\}. \end{cases}$$

The matrix  $FT$  is defined as follows (undefined entries are set to  $2T$ ):

$$FT(v, v') = \begin{cases} 0 & \text{if } v = v' \\ (3m+1)l & \text{if } v = v_{top}, v' \in \{v_1^{t,L}, v_1^{t,R}\} \\ (3m+1)l & \text{if } v = v_i, v' \in \{v_i^{b,L}, v_i^{b,R}, v_{i+1}^{t,L}, v_{i+1}^{t,R}\} \\ & \text{for some } i \in \{1, \dots, m-1\} \\ (3m+2)l & \text{if } v = v_m, v' \in \{v_m^{b,L}, v_m^{b,R}, v_{m+1}^{t,L}, v_{m+1}^{t,R}\} \\ (3m+2)l & \text{if } v = v_i, v' \in \{v_i^{b,L}, v_i^{b,R}, v_{i+1}^{t,L}, v_{i+1}^{t,R}\} \\ & \text{for some } i \in \{m+1, \dots, 2m-1\} \\ (3m+2)l & \text{if } v = v_{bot}, v' \in \{v_{2m}^{b,L}, v_{2m}^{b,R}\} \\ 2 & \text{if } v = v_i^{m,L}, v' \in \{v_i^{t,L}, v_i^{b,L}\} \text{ or } v = v_i^{m,R}, v' \in \{v_i^{t,R}, v_i^{b,R}\} \\ 2 & \text{if } v = v_i^{b,j}, v' \in \{v_i^{a,j}, v_i^{c,j}\} \text{ or } v = v_i^{e,j}, v' \in \{v_i^{d,j}, v_i^{f,j}\} \\ 2 & \text{if } v = v_i^{b,j}, v' \in \{v_i^{a,j}, v_i^{c,j}\} \text{ or } v = v_i^{e,j}, v' \in \{v_i^{d,j}, v_i^{f,j}\} \\ 2 & \text{if } v = v_i^{d,j}, v' \in \{v_i^{c,j}, v_i^{e,(j+1)}\} \text{ or } v = v_i^{f,j}, v' \in \{v_i^{a,j}, v_i^{a,(j+1)}\} \\ 2 & \text{if } v = v_i^{a,j}, v' \in \{v_i^{c,j}, v_i^{e,j}\} \text{ or } v = v_i^{f,j}, v' \in \{v_i^{a,j}, v_i^{a,j}\} \\ 2 & \text{if } v = v_{c_j}, v' \in \{v_i^{c,j}, v_i^{d,j}\} \text{ and } x_i^0 \in c_j \text{ for some } i \in \{1, \dots, m\} \\ 2 & \text{if } v = v_{c_j}, v' \in \{v_i^{a,j}, v_i^{f,j}\} \text{ and } \neg x_i^0 \in c_j \text{ for some } i \in \{1, \dots, m\} \\ 2 & \text{if } v = v_{c_j}, v' \in \{v_i^{c,j}, v_i^{d,j}\} \text{ and } x_{(i-m)}^1 \in c_j \text{ for some } i \in \{m+1, \dots, 2m\} \\ 2 & \text{if } v = v_{c_j}, v' \in \{v_i^{a,j}, v_i^{f,j}\} \text{ and } \neg x_{(i-m)}^1 \in c_j \text{ for some } i \in \{m+1, \dots, 2m\} \\ 2 & \text{if } v = prv_i^L, v' \in LCG_i \setminus \{prv_i^L\} \text{ or } v = prv_i^R, v' \in RCG_i \setminus \{prv_i^R\} \\ 2 & \text{if } v = in_i^{\downarrow,L}, v' \in \{v_i^{b,L}, v_i^{\bar{c},0}\} \text{ or } v = in_i^{\downarrow,R}, v' \in \{v_i^{\bar{f},h}, v_i^{b,R}\} \\ 2 & \text{if } v = out_i^{\uparrow,L}, v' \in \{v_i^{t,L}, v_i^{\bar{a},0}\} \text{ or } v = out_i^{\uparrow,R}, v' \in \{v_i^{\bar{d},h}, v_i^{t,R}\} \\ 2 & \text{if } v = in_i^{\uparrow,L}, v' \in \{v_{(i+m)}^{b,L}, v_{(i+m)}^{\bar{c},0}\} \text{ or } v = in_i^{\uparrow,R}, v' \in \{v_{(i+m)}^{\bar{f},h}, v_{(i+m)}^{b,R}\} \\ 2 & \text{if } v = out_i^{\downarrow,L}, v' \in \{v_{(i+m)}^{t,L}, v_{(i+m)}^{\bar{a},0}\} \text{ or } v = out_i^{\downarrow,R}, v' \in \{v_{(i+m)}^{\bar{d},h}, v_{(i+m)}^{t,R}\} \\ \frac{1}{4}T & \text{if } v = v_{mid}, v' \in \{v_{top}, v_{bot}\}. \end{cases}$$

## C Proof of Proposition 4

**Lemma 16.** *Each segment  $s_j$  must start with and end with  $v_{top}$  or  $v_{bot}$ .*

**Lemma 17.** *The time needed from  $v_{top}$  or  $v_{bot}$  to any other vertex is at least  $(3m+1)l$ .*

**Lemma 18.** *The time needed from  $v_{mid}$  to any other vertex is at least  $\frac{1}{4}T$ .*

**Lemma 19.** *Each segment  $s_j$  must contain more than one vertex.*

*Proof.* By Lemma 16, without loss of generality let  $s_j = v_{bot}$ , a single vertex. It is easy to see that  $s_{j-1}$  must end with  $v_{top}$  and  $s_{j+1}$  must start with  $v_{top}$ , otherwise the relative deadline of  $v_{top}$  will be violated. Now consider  $v_1$  (with  $RD(v_1) = T + 2h$ ). By Lemma 17 and the fact that  $dur(v_{top}v_{mid}v_{bot}v_{mid}v_{top}) = T$ , the relative deadline of  $v_1$  is violated for sure even if  $s$  visits  $v_1$  immediately after  $v_{top}$ . This is a contradiction.  $\square$

**Proposition 20.** For each segment  $s_j$ ,  $0 < dur(s_j) \leq \frac{1}{2}T$ .

*Proof.* By Lemma 19 we have  $dur(s_j) > 0$ . For the upper bound, note that  $dur(v_{mid}s_jv_{mid}) = \frac{1}{2}T + dur(s_j)$  and  $RD(v_{mid}) = T$ .  $\square$

**Proposition 21.** Each segment  $s_j$  contains all vertices in  $V \setminus \{v_{mid}\}$  with relative deadlines less or equal than  $T + l + 2h$ .

*Proof.* Let  $v \in V \setminus \{v_{mid}\}$  be a vertex missing in  $s_j$  with  $RD(v) \leq T + l + 2h$ . By Lemmas 16, 17 and 19,  $dur(s_j) \geq 2(3m + 1)l > l + l > l + 2h$ . We have  $dur(v_{mid}s_jv_{mid}) = \frac{1}{2}T + dur(s_j) > \frac{1}{2}T + l + 2h$ . By Lemma 18,  $dur(vv_{mid}s_jv_{mid}v)$  must be greater than  $T + l + 2h$  for any  $v \in V \setminus \{v_{mid}\}$ , which is a contradiction.  $\square$

By Proposition 21, we first derive a (crude) lower bound on  $dur(s_j)$ . The sum of the minimum times needed to enter and leave every  $v \in S$  and the minimum times needed to enter and leave both ends of  $s_j$  gives

$$dur(s_j) \geq (m - 1)(2(3m + 1)l) + m(2(3m + 2)l) + 2(3m + 1)l. \quad (1)$$

**Proposition 22.**  $v_{top}$ ,  $v_{bot}$  and each  $v \in S$  appears once in each segment  $s_j$ .

*Proof.* Without loss of generality, assume one of these vertices appears more than once in  $s_j$ . By a similar argument as above, we derive that  $dur(s_j)$  is at least  $(m - 1)(2(3m + 1)l) + m(2(3m + 2)l) + 2(3m + 1)l + 2(3m + 1)l > \frac{1}{2}T$ . This contradicts Proposition 20.  $\square$

By the proposition above, we can revise our lower bound in Eq.(1) by noting that  $s_j$  must start and end with different vertices. This gives

$$dur(s_j) \geq (m - 1)(2(3m + 1)l) + m(2(3m + 2)l) + (3m + 1)l + (3m + 2)l. \quad (2)$$

Now without loss of generality let  $s_j$  ends with  $v_{top}$  and  $s_{j+1}$  starts with  $v_{top}$ . By Eq.(2),  $dur(s_j) + dur(s_{j+1}) \geq 2\left((m - 1)(2(3m + 1)l) + m(2(3m + 2)l) + (3m + 1)l + (3m + 2)l\right) > \frac{1}{2}T$ , and hence  $dur(s_jv_{mid}s_{j+1}) > T$ . By Proposition 22,  $v_{bot}$  can only appear at both ends of  $s_jv_{mid}s_{j+1}$ , hence its relative deadline must be violated. This is a contradiction. Proposition 4 is hence proved.

## D Proof of Lemma 5

Now we refine our lower bound in Eq.(2) by taking into account other vertices in variable gadgets and consistency gadgets with  $RD$  less or equal to  $T + l + 2h$  (by Proposition 21). As many of these vertices are adjacent, we only accumulate the minimum times needed to enter them. This gives an extra time of  $m(24h + 22) + 4m + m(24h + 22)$  (note that by Proposition 22, only one of the four vertices connected to a shared vertex has been entered and cannot be included in the calculation). In total, we have

$$dur(s_j) \geq \frac{1}{2}T - 20m - 2h. \quad (3)$$

**Proposition 23.** *Each segment  $s_j$  contains all vertices with relative deadlines equal to  $\frac{3}{2}T$ , i.e., clause vertices and vertices in  $\bigcup_{i \in \{1, \dots, m\}} ((LCG_i \setminus \{pvt_i^L\}) \cup (RCG_i \setminus \{pvt_i^R\}))$ .*

*Proof.* Assume that there is such a vertex  $v$  not appearing in  $s_j$ . By Eq.(3), we have  $dur(v_{bot}v_{mid}s_jv_{mid}v_{top}) \geq \frac{3}{2}T - 20m - 2h$ . By Lemma 17, the relative deadline of  $v$  must be violated as  $dur(vv_{bot}v_{mid}s_jv_{mid}v_{top}v) \geq \frac{3}{2}T - 20m - 2h + 2(3m + 1)l > \frac{3}{2}T$ . This is a contradiction.  $\square$

Based on the previous proposition, we can further refine our lower bound on the duration of a segment. The minimum times needed to enter

- clause vertices  $v^{c_j}, j \in \{1, \dots, h\}$
- vertices in  $\bigcup_{i \in \{1, \dots, m\}} ((LCG_i \setminus \{pvt_i^L\}) \cup (RCG_i \setminus \{pvt_i^R\}))$

can now be included in the calculation. We have

$$dur(s_j) \geq \frac{1}{2}T - 4h. \quad (4)$$

**Proposition 24.** *In each segment  $s_j$ , each vertex in  $\bigcup_{i \in \{1, \dots, m\}} \{pvt_i^L, pvt_i^R\}$  appears more than once.*

*Proof.* Let there be such a vertex  $v$  appearing only once in a segment. By Lemma 17, there are two occurrences of  $v$  in  $s$  separated by at least  $\frac{1}{2} \cdot (\frac{1}{2}T + (\frac{1}{2}T - 4h) + \frac{1}{2}T) + (3m + 1)l$ . This exceeds all possible values of  $RD(v)$ .  $\square$

By the proposition above, we assume that each vertex in  $\bigcup_{i \in \{1, \dots, m\}} \{pvt_i^L, pvt_i^R\}$  appears twice in a segment. Counting each such vertex once again gives an extra time of  $4h$ . The sum of this with Eq.(4) matches the upper bound in Proposition 20. Any more visit to a vertex in  $V \setminus \{v_{mid}, v_{top}, v_{bot}, v_1, \dots, v_{2m-1}\}$  will immediately contradict Proposition 20. Lemma 5 is hence proved.