

# Performance analysis of a 240 thread tournament level MCTS Go program on the Intel Xeon Phi

Ali Mirsoleimani<sup>\*1,2</sup>, Aske Plaat<sup>1</sup>, Jos Vermaseren<sup>2</sup>, and Jaap van den Herik<sup>1</sup>

<sup>1</sup>Leiden Centre of Data Science, Leiden University, The Netherlands

<sup>2</sup>Nikhef Theory Group, Nikhef Amsterdam, The Netherlands

## KEYWORDS

Distributed and Parallel Systems Simulation, Simulation Fidelity and Performance Evaluation, Monte Carlo Methods, Special Architectures, Experimental and Comparative Studies, Memory access patterns, Game playing.

## ABSTRACT

In 2013 Intel introduced the Xeon Phi, a new parallel co-processor board. The Xeon Phi is a cache-coherent many-core shared memory architecture claiming CPU-like versatility, programmability, high performance, and power efficiency. The first published micro-benchmark studies indicate that many of Intel's claims appear to be true. The current paper is the first study on the Phi of a complex artificial intelligence application. It contains an open source MCTS application for playing tournament quality Go (an oriental board game). We report the first speedup figures for up to 240 parallel threads on a real machine, allowing a direct comparison to previous simulation studies. After a substantial amount of work, we observed that performance scales well up to 32 threads, largely confirming previous simulation results of this Go program, although the performance surprisingly deteriorates between 32 and 240 threads. Furthermore, we report (1) unexpected performance anomalies between the Xeon Phi and Xeon CPU for small problem sizes and small numbers of threads, and (2) that performance is sensitive to scheduling choices. Achieving good performance on the Xeon Phi for complex programs is not straightforward; it requires a deep understanding of (1) search patterns, (2) of scheduling, and (3) of the architecture and its many cores and caches. In practice, the Xeon Phi is less straightforward to program for than originally envisioned by Intel.

## Introduction

In 2013 Intel introduced a new many-core architecture, a cache-coherent shared memory co-processor architecture claiming CPU-like versatility, programmability, high performance, and power efficiency (in contrast to hard-to-program energy-hungry GPU co-processor architectures from companies such as NVIDIA). When a new architecture emerges there is a great interest in the community for analyzing and understanding its performance. When GPGPU programming

became prevalent, a rich literature on GPU performance modeling and simulations emerged. See, e.g., [11, 15], and [14]. This trend is now starting for the Xeon Phi. The first published micro-benchmark studies indicate that many of Intel's claims are true [7]. Of course, micro-benchmarks only tell a part of the story and performance of actual applications may differ in practice. In this paper we have chosen to study an important application from the domain of artificial intelligence.

Ever since the victory of IBM's DEEP BLUE over World Chess Champion Garry Kasparov on 11 May 1997 [22], computer Go has been the *Drosophila Melanogaster* of Artificial Intelligence. The complexity and depth of the game has frustrated AI researchers trying to replicate the computer chess successes for many years [25]. The brute-force minimax approach, so successful in chess, turned out to be a dead end in Go, when in 2006 a new probabilistic simulation algorithm was introduced. This new algorithm, Monte Carlo Tree Search [3, 4, 12, 8] was successful, beating the first human Go-grandmaster in 2008. Not only was MCTS successful in Go, it also proved successful in many other combinatorial optimization and simulation problems [13, 20, 2].

Because of the successes with MCTS, much research effort has been put into improving the performance of parallel MCTS algorithms. MCTS performance studies have become important in their own right in recent years [3, 27, 1, 23, 21]. However, scaling studies of MCTS on shared memory many-core machines have been limited to smaller studies, typically 8-24 core machines [3], or have been performed in simulation [23]. The advent of the Intel Xeon Phi allows for the first time to replicate such simulation studies on actual hardware, up to 240 simultaneous threads. We have performed this study using FUEGO [5], the same open source program that was used in the simulation study [23], allowing a direct comparison.

This paper has two main contributions.

- We have performed, to the best of our knowledge, the first performance study of a non-trivial MCTS program on the Intel Xeon Phi. We find unexpected sensitivity to problem size and scheduling, which we attribute to a low integer performance and complex interconnect architecture.
- We have performed the first large scale (up to 240 threads) study of MCTS tree parallelism on a real shared

<sup>\*</sup>email: s.a.mirsoleimani@liacs.leidenuniv.nl

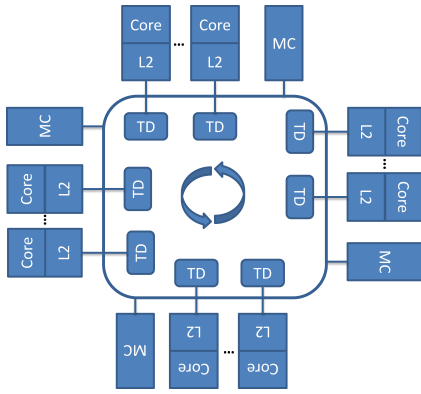

Figure 1: Intel Xeon Phi microarchitecture

memory many core machine. We find good performance up to 32 threads, confirming a previous simulation study, and deteriorating performance from 32 to 240 threads.

Moreover, we have two more findings. First, Intel’s wish of high performance at no cost to the programmer is only partly achieved, due to the complex hardware characteristics of the Xeon Phi architecture. Second, the scaling of the algorithm is dependent on many details including cache hierarchy, access latency, scheduling policy, and core architecture.

The remainder of this paper is structured as follows: in section 2 the architecture of the Xeon Phi is briefly discussed. Section 3 discusses related work. Section 4 gives the experimental setup, and section 5 gives the experimental results. Finally, scalability and thread affinity are discussed, and a conclusion is given.

### Architecture of Intel Xeon Phi Co-processor

We start providing an overview of the Intel Xeon Phi co-processor architecture (see Figure 1). A Xeon Phi co-processor board consists of up to 61 cores based on the Intel 64-bit ISA. Each of these cores contains *vector processing units* (VPU) to execute 512 bits of 8 double-precision floating point elements or 16 single-precision floats or 32-bit integers at the same time, 4-way SMT, and dedicated L1 and fully coherent L2 caches [16]. The *tag directories* (TD) are used to look up cache data distributed among the cores. The connection between cores and other functional units such as *memory controllers* (MC) is through a bidirectional *ring interconnect*. There are 8 distributed memory controllers as interface between the ring burst and main memory which is up to 16 GB.

The scheduling policy on the Xeon Phi can be influenced manually at run time. By setting an environment variable one can control how the threads are bound to cores. This can be advantageous for exploiting data locality of the algorithm. Using the *KMP\_AFFINITY* environmental variable threads can be distributed among cores. Possible settings are: *compact*, *balanced*, or *scatter*. The *compact* type allocates threads to cores in a way that maximizes cache utilization

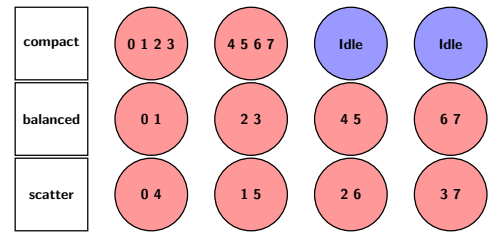

Figure 2: Allocation of 8 threads on a 4 core system with 4 threads per core with different affinity types.

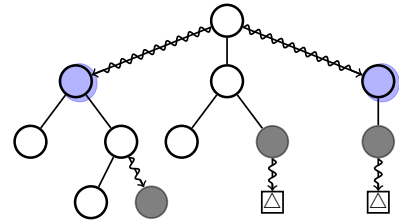

Figure 3: Tree parallelization with local lock. The curly arrows represent threads. The shadowy nodes are locked ones. The black nodes are newly added to the tree.

while *scatter* type do thread allocation to maximize core utilization. Figure 2 shows the allocations of threads for different types. If threads access data that is stored in a cache nearby, the *balanced* type is the best choice because it maximizes cache and core utilization simultaneously.

### Related Work

Below we review related work on MCTS parallelizations. The four major parallelization methods for MCTS are leaf parallelization, root parallelization, tree parallelization [3], and transposition table driven work scheduling (TDS) based approaches [27]. Of these, tree parallelization is the method most often used on shared memory machines. It is the method used in FUEGO. In tree parallelization one MCTS tree is shared among several threads that are performing simultaneous searches [3]. The main challenge in this method is using data locks to prevent data corruption. Figure 3 shows the tree parallelization algorithm with local locks. A lock-free implementation of this algorithm addressed the aforementioned problem with better scaling than a locked approach [5]. There is also a case study that shows a good performance of a (non-MCTS) Monte Carlo simulation on the Xeon Phi co-processor [24].

Schaefer et al. [21] propose a parallel MCTS method for distributed memory systems called *UCT-Treesplit*. Yoshizoe et al. [27] describe a parallelization approach based on TDS [19, 18] for MCTS called *depth-first UCT*. There are some attempts to parallelize MCTS on accelerator processors including GPU [17].

Segal reports the scaling of tree parallelization with virtual loss in FUEGO for different number of threads and time controls on a simulated idealized shared-memory system [23].

He finds that strength of play increases asymptotically with as resources increase (more time or more threads). A near-perfect speedup is reported for 64 threads and 60-minute per game. Segal suggests that speedup starts decreasing beyond 64 threads, although, with large time settings, further scaling to 512 threads still shows performance increases.

Enzenberger et al.[6] evaluate tree parallelization with virtual loss and local locks on a 16-core shared-memory system. The algorithm shows an eight-fold speedup with 16 threads.

### Experimental Setup: Xeon CPU against Xeon Phi

To determine the effective performance on the Xeon Phi we have performed self-play experiments. A major problem with parallel game playing programs is the phenomenon of *search overhead*, which occurs since, in parallel, parts of the search tree will be searched that a sequential search would already have found to be unimportant. Therefore a simple *efficiency* measure such as games per second will not tell the whole story. In order to determine the *effective speedup* a different method is needed. We have performed self-play experiments in which a version of the program with double the resources (2x # of threads) against a version with single resources (1x # of threads) are compared [3].

In order to generate statistically significant results in a reasonable amount of time most works use the setting of 1 second per move, and so did we, initially. FUEGO is an open source, tournament level Go playing program, developed by a team headed by Martin Mueller at the University of Alberta [5]. The experiments were conducted with FUEGO SVN revision 1900, on a 9x9 board, with komi 6, Chinese rules, alternating player color was enabled, opening book was disabled. The win-rate of two opponents is measured by running at least a 100-game match. A single game of Go typically lasts 200 moves. The games were played using the Gomill python library for tournament play [26].

A statistical method based on [9] is used to calculate 95%-level confidence lower and upper bounds on the real winning rate of a player. Assume  $p$  is the true winning probability of a player. The value of  $p$  is estimated by  $0 \leq w = x/n \leq 1$  which results from  $x \leq n$  wins in a match of  $n$  games. Therefore, we may simply assume  $w$  the sample mean of a binary-valued random variable that counts two draws as a loss plus a win. The expected value of  $w$  is  $E(w) = p$  and the variance of  $w$  is  $Var(w) = p(1-p)/n$ . According to the central limit theorem approximately,  $w \approx Normal(p, p(1-p)/n)$ , so  $(w-p)/\sqrt{p(1-p)/n} \approx Normal(0, 1)$ . Let  $z_{\%}$  denote the upper critical value of the standard  $N(0, 1)$  normal distribution for any desired %-level of statistical confidence ( $z_{90\%} = 1.645$ ,  $z_{95\%} = 1.96$ ). Then, the probability of  $w - 1.96\sqrt{p(1-p)/n} \leq p \leq w + 1.96\sqrt{p(1-p)/n}$  is about 95%. Therefore, the 95% confidence interval on the true winning probability  $p$  is  $[w - 1.96\sqrt{p(1-p)/n}, w + 1.96\sqrt{p(1-p)/n}]$ . The value of unknown  $p$  is substituted for  $w$ :  $[w - 1.96\sqrt{w(1-w)/n}, w + 1.96\sqrt{w(1-w)/n}]$ .

Our Xeon Phi co-processor board is hosted on a machine in which a standard 12-core Xeon CPU is present. This allows experiments in which a conventional parallel Xeon CPU architecture is pitted against the new parallel Xeon Phi architecture.

The results were measured on a machine with (1) an Intel *Xeon CPU* E5-2695 2.40GHz with 12 cores and 48 hyperthreads. Each physical core has 256KB L2 cache and the chip has a total of 30MB L3 cache. The machine has 160GB physical memory. (2) An Intel *Xeon Phi* 7120P 1.238GHz is installed which has 61 cores and 244 hardware threads. Each core has 512KB L2 cache. The co-processor has 16GB GDDR5 memory on board with an aggregate theoretical bandwidth of 352 GB/s. The peak turbo frequency is 1.33GHz. The theoretical performance of the 7120P is 2.416 TFLOPS or TIPS and 1.208 TFLOPS for single-precision or integer and double-precision floating-point arithmetic operations, respectively [10].

Intel's *icc 14.0.1* compiler is used to compile FUEGO in *native mode*. A *native application* runs directly on the Xeon Phi and its embedded Linux operating system.

### Experimental Results

*Xeon CPU*: Figure 4 shows the results of the self-play experiments for FUEGO on the conventional *Xeon CPU*. For the 9x9 board the win-rate of the program with double the number of threads is better than the base program, starting at 70%, decreasing to 58% at 32 threads and then becomes flat. (The 19x19 board has a similar performance, not shown). These results are entirely in line with results reported in [6] for 16 vs 8 threads. The slightly decreasing lines are explained by the phenomenon of search overhead: the parallel program with double the amount of threads (e.g., 16 threads) searches more parts of the tree than the version of the program with half the number of threads (e.g., 8 threads).

*Xeon Phi*: Figure 5 shows our initial results for the win-rate on the *Xeon Phi*. For these experimental settings (1 second per move) the Phi-graph differs markedly from the CPU-graph in Figure 4. The Xeon CPU shows a smooth, slightly decreasing line. The Xeon Phi shows a more ragged line that first slopes up, and then slopes down. Also, the overall win-rate is lower than on the CPU, and even dips below 50%, implying that more threads actually loses from less threads! (all within margins of error as indicated by the error bars). The best win-rate on the Xeon Phi is for 8 threads while on the Xeon CPU it is on 2 threads. The playing strength remains above the break-even point of 50% for the first player until 48 threads and then sharply decreases, until 128 threads and becomes 50 percent for 240 threads. Up to 64 threads, these results basically confirm the simulation study by Segal [23]. However, beyond 64 threads the performance drop is unexpectedly large.

The most striking feature of the experiment with these settings is the difference in performance of an identical program in an identical setup on the Xeon CPU versus the Xeon Phi: Figures 4 and 5 do not look alike at all. The Xeon CPU

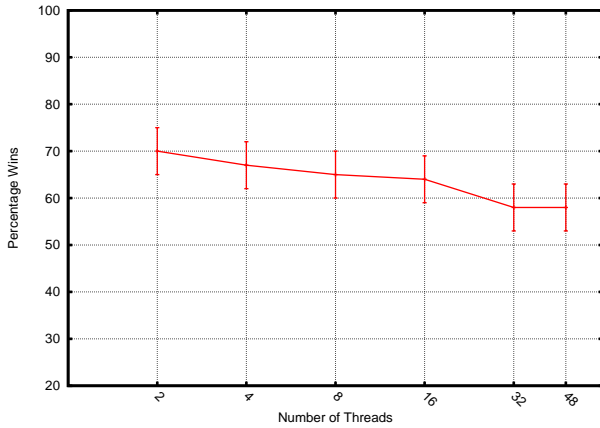

Figure 4: Performance of self-play FUEGO with  $n$  threads against FUEGO with  $n/2$  threads on the Xeon CPU processor. 200 games for each data point.

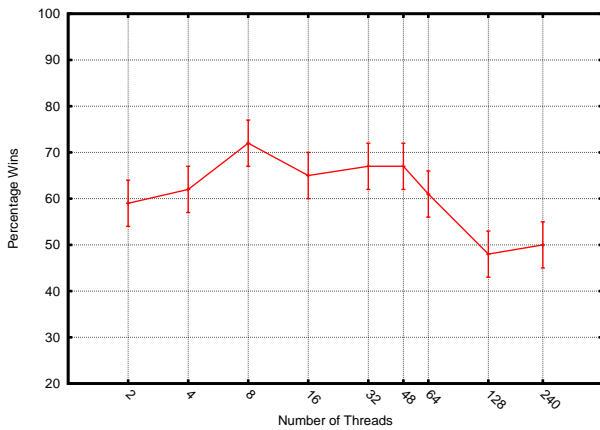

Figure 5: Performance of self-play FUEGO on the Xeon Phi with  $n$  threads against FUEGO with  $n/2$  threads. The board size is  $9 \times 9$ . 300 games for each data point.

shows a steadily decreasing performance, as expected, where the Xeon Phi shows a ragged hump-like shape.

To study the possible causes of these results, we performed experiments to delve deeper into the Xeon Phi architecture.

### Efficiency, Thread Affinity, and Problem Size

As mentioned before, the thread scheduling policy on the Xeon Phi can be influenced manually at run time. In order to illustrate graphically the effect of different scheduling policies we have performed a small experiment. Figure 6 and 7 show the effect of different thread affinities on the performance of the Xeon Phi for double-precision and integer arithmetic operations. The benchmark is executing a loop which contains  $c[j] = a[j] * b[j] + c[j]$  operation for many times. The effect of thread affinities on the bandwidth of the Xeon Phi for executing the same program in double-precision is also shown in Figure 8. The results were measured with turbo mode set to on.

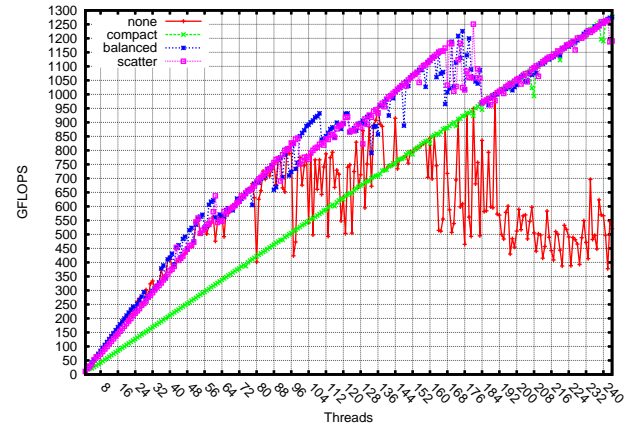

Figure 6: Performance of double-precision operations of the Xeon Phi for different numbers of threads.

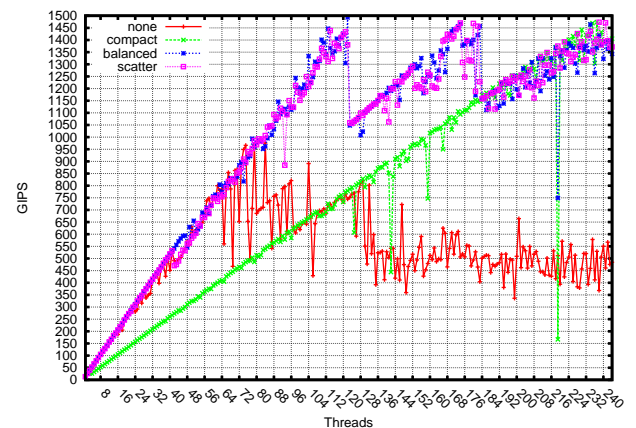

Figure 7: Performance of integer operations of the Xeon Phi for different numbers of threads.

In the *compact* mode the performance was steadily increased and the bandwidth reached a plateau. In the *balanced* and *scatter* modes depending on how many threads are assigned to each core 4 different regions for double and 3 different region for integer performance existed. For example, as shown in Figure 7 between 122 threads and 183 threads some cores have 2 threads and some others have three threads in *balanced* mode. This asymmetry degraded the performance dramatically at the beginning of the region and then started to increase performance. The memory bandwidth has also 4 regions in *balanced* mode. By using more thread the bandwidth never reached the same level as the previous region. These type of performance behavior makes it really tricky to select best thread configuration for executing a program like FUEGO.

For the FUEGO self-play experiments the *compact* affinity type has been used. To show the effect of different scheduling policies on FUEGO the three different methods have been run. Figure 9 shows the effect of different thread affinity types on the performance of FUEGO. The percentage of wins for *balanced* mode shows more stability compared to the two

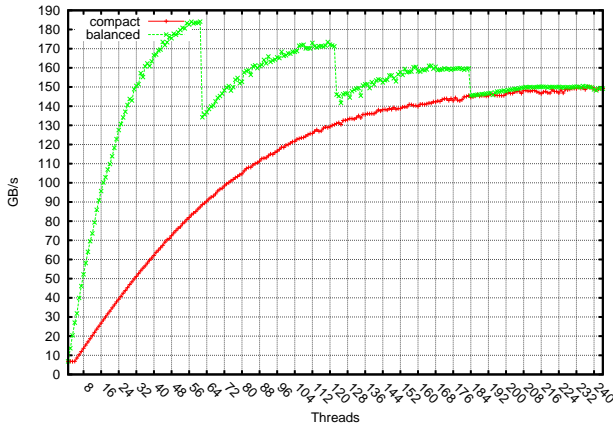

Figure 8: Memory bandwidth of the Xeon Phi for different numbers of threads.

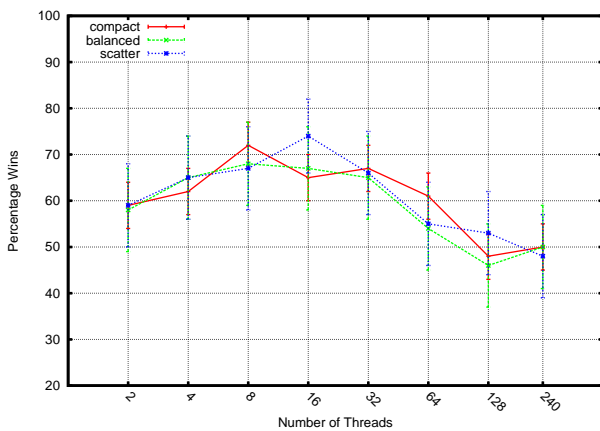

Figure 9: Self-play performance of FUEGO for different thread affinity types on the Xeon Phi. The board size is 9x9. 100 games for each data point.

other scheduling methods. The best win-rate is for 4 threads (1 core) in *compact* mode and for 16 threads (16 cores) for *scatter* mode.

As noted before, the most striking feature of these experiments is the difference in performance of an identical program in an identical setup on the Xeon CPU versus the Xeon Phi using the standard experimental settings of the 9x9 board and 1 second per move. The Xeon CPU shows a steadily decreasing performance, as expected, where the Xeon Phi shows a ragged hump-like shape.

The win-rate graph shows an *effective speedup*, a speedup measure that includes search overhead. We have also computed basic *efficiency-speedup* figures to compare the parallel speed of the Xeon CPU and the Xeon Phi. The FUEGO program can output the number of games per second that are performed. Figure 10 shows the number of games per second that is performed by FUEGO on a 9x9 board. This is a convenient measure of how efficient the architecture is running the program. Games per second is the number of games that are played by FUEGO before making a move. The num-

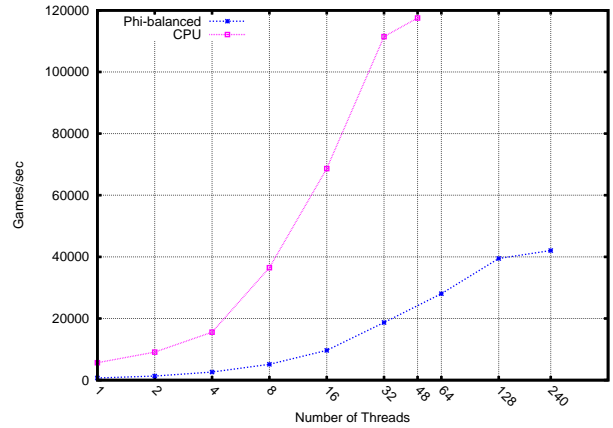

Figure 10: Number of games per second for a 9x9 board when FUEGO makes the second move.

ber increases for both architectures. Due to the higher clock speed, the amount of work by the each core of the Xeon CPU is much more than the Xeon Phi core. However, the difference in clock speed is only a factor of two, whereas in the figure the difference is more than a factor of 5. Figure 10 shows that even using all cores of the Xeon Phi cannot reach the performance of 16 threads on The Xeon CPU. The low games-per-second numbers of the Xeon Phi suggests inefficiencies due to a small problem size. Closer inspection of the results on which Figure 10 is based suggests that FUEGO is not able to do enough simulation on the Xeon Phi for small number of threads in just 1 second. Therefore, we increase the time limit per move to 10 seconds. Figure 11 shows the results of the self-play experiment when the FUEGO can make a move with 10 seconds for doing simulation on The Xeon Phi. We see that now the graph is approaching that of the Xeon CPU. The win-rate behavior for low number of threads is now much closer to that of the CPU (Figure 5), and the counter-intuitive hump-shape has changed to the familiar down-sloping trend. However, we still see fluctuation in the *balanced* mode. Up to 32 threads performance is still reasonable (close to 70% win-rate for the 2x thread program) but up to 240 threads performance deteriorates. The maximum win-rate is for 8 threads and there is still a marginal benefit for using 128 threads.

The reason behind the difference between the results in Figures 5 and 11 is shown in Figure 12 which shows how large the search tree is when making a move. The size of the tree when FUEGO has 10 seconds per move on the Xeon Phi is similar to Xeon CPU with 1 second per move.

## Conclusion

Intel's Xeon Phi has been designed to offer high performance without the associated hassle of difficult programming. To this end, the Xeon Phi architecture has many cores, many levels of caches, an intricate cache-coherency protocol, vector units, and a fast and complex interconnect. A complex machinery to offer a simple programming model. Previously,

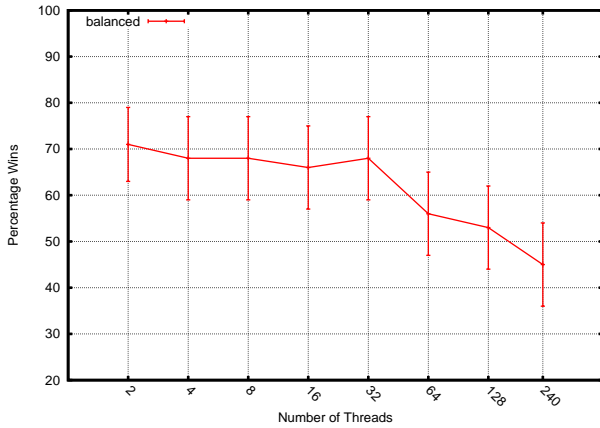

Figure 11: Self-play performance of FUEGO for 10 second per move on the Xeon Phi. The board size is 9x9. 100 games for each data point.

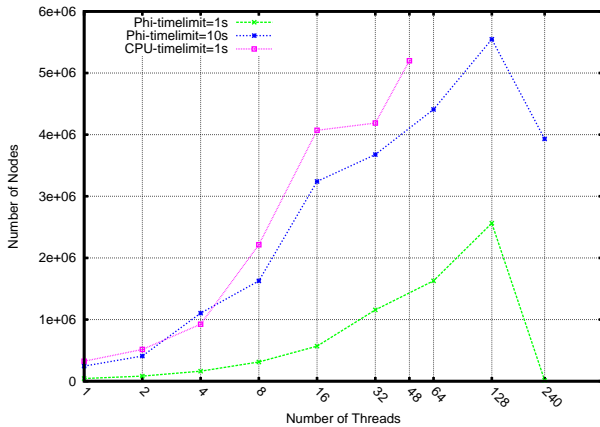

Figure 12: The number of nodes in the search tree when FUEGO makes the second move. *balanced* thread affinity type on the Xeon Phi is used. The board size is 9x9.

micro-benchmarks have been reported that indicate that Intel’s published figures are essentially achieved in practice [7]. Using a tournament quality game playing program that employs a popular Monte Carlo method [2], our results show that porting a complex program and getting it to run correctly on the Xeon Phi is indeed relatively straightforward. Our results are, to our knowledge, the first performance results of a non-trivial AI program on a shared memory architecture with up to 240 threads, allowing comparison of a simulation study up to 64 threads [23] and an extension beyond.

However, the results also show that achieving good performance is not straightforward: on the conventional Xeon CPU architecture our results are as predicted, a smooth, slightly down-sloping line, while, using the standard experimental settings of 1 second per move, on the Xeon Phi we initially see a ragged hump-like shape that differs markedly from the Xeon CPU. Our further experiments with scheduling policies and problem sizes were prompted by the assumption that cache locality issues and memory access patterns caused the

unexpected performance results. We find that performance is quite sensitive to different settings, especially problem size. By judicious choice of scheduling strategy and problem size, we were able to achieve reasonable results after considerable analysis and tuning. Results appear first to be largely in line with a previous simulation study, showing reasonable scaling up to 32 threads, but deteriorating performance up to 240 threads.

From our experimental results we may conclude that achieving good performance on the Xeon Phi for complex programs is not straightforward; achieving good performance requires a deep understanding of the search algorithm on the one hand and the architecture and its many cores and caches on the other hand. We suggest that in this case a complex architecture does not automatically equal a simple performance model. Given the industry trend towards heterogeneous many-core architectures, increasing our understanding of the interplay between algorithm and architecture is vital for achieving good performance. More research is under way to create more accurate performance models of the Intel Xeon Phi for different types of algorithms and MCTS-like access patterns.

### Acknowledgment

This work is supported in part by the ERC Advanced Grant no. 320651, “HEPGAME.”

### REFERENCES

- [1] A. Bourki, G. Chaslot, M. Coulm, V. Danjean, H. Doghmen, J.-B. Hoock, H. Thomas, A. Rimmel, F. Teytaud, O. Teytaud, P. Vayssi, T. Héroult, P. Vayssière, and Z. Yu. Scalability and Parallelization of Monte-Carlo Tree Search. In *Proceedings of the 7th International Conference on Computers and Games*, CG’10, pages 48–58, Berlin, Heidelberg, 2011. Springer-Verlag.
- [2] C. B. Browne, E. Powley, D. Whitehouse, S. M. Lucas, P. I. Cowling, P. Rohlfshagen, S. Tavener, D. Perez, S. Samothrakis, and S. Colton. A Survey of Monte Carlo Tree Search Methods. *Computational Intelligence and AI in Games, IEEE Transactions on*, 4(1):1–43, 2012.
- [3] G. M. J. B. Chaslot, M. H. M. Winands, and H. J. van den Herik. Parallel monte-carlo tree search. *Computers and Games*, 5131:60–71, 2008.
- [4] R. Coulom. Efficient Selectivity and Backup Operators in Monte-Carlo Tree Search. In *Proceedings of the 5th International Conference on Computers and Games*, CG’06, pages 72–83, Berlin, Heidelberg, May 2006. Springer-Verlag.
- [5] M. Enzenberger and M. Müller. A lock-free multi-threaded Monte-Carlo tree search algorithm. *Advances in Computer Games*, 6048:14–20, 2010.



- [6] M. Enzenberger, M. Muller, B. Arneson, and R. Segal. Fuego-An Open-Source Framework for Board Games and Go Engine Based on Monte Carlo Tree Search. *IEEE Transactions on Computational Intelligence and AI in Games*, 2(4):259–270, Dec. 2010.
- [7] J. Fang, A. A. L. Varbanescu, H. Sips, L. Zhang, C. Xu, and Y. Che. Test-driving Intel Xeon Phi. In *Proceedings of the 5th ACM/SPEC international conference on Performance engineering - ICPE '14*, number Section III, pages 137–148, New York, New York, USA, Mar. 2014. ACM Press.
- [8] S. Gelly and D. Silver. Monte-Carlo tree search and rapid action value estimation in computer Go. *Artificial Intelligence*, 175(11):1856–1875, 2011.
- [9] E. Heinz. New self-play results in computer chess. In *Computers and Games*, pages 262–276, 2001.
- [10] Intel. Intel Xeon Phi Product Family Highly parallel processing to power your breakthrough innovations. <http://www.intel.com/content/www/us/en/benchmarks/server/xeon-phi/xeon-phi-theoretical-maximums.html>, 2013.
- [11] A. Karami, S. A. Mirsoleimani, and F. Khunjush. A Statistical Performance Prediction Model for OpenCL Kernels on NVIDIA GPUs. In *The 17th CSI International Symposium on Computer Architecture & Digital Systems (CADS'13)*, Tehran, Iran, 2013. IEEE.
- [12] L. Kocsis and C. Szepesvári. Bandit based monte-carlo planning. *Machine Learning: ECML 2006*, 2006.
- [13] J. Kuipers, A. Plaat, J. Vermaseren, and H. van den Herik. Improving multivariate Horner schemes with Monte Carlo tree search. *Computer Physics Communications*, 184(11):2391–2395, Nov. 2013.
- [14] U. Lopez-Novoa, A. Mendiburu, and J. Miguel-Alonso. A Survey of Performance Modeling and Simulation Techniques for Accelerator-based Computing. *IEEE Transactions on Parallel and Distributed Systems*, 9219(c):1–1, 2014.
- [15] S. A. Mirsoleimani, A. Karami, and F. Khunjush. A Two-Tier Design Space Exploration Algorithm to Construct a GPU Performance Predictor. In *Architecture of Computing Systems—ARCS 2014*, pages 135–146. Springer, 2014.
- [16] R. Rahman. *Intel Xeon Phi Coprocessor Architecture and Tools: The Guide for Application Developers*. Apress, Sept. 2013.
- [17] K. Rocki and R. Suda. Large-Scale Parallel Monte Carlo Tree Search on GPU. In *Parallel and Distributed Processing Workshops and Phd Forum (IPDPSW), 2011 IEEE International Symposium on*, pages 2034–2037, May 2011.
- [18] J. Romein, H. Bal, J. Schaeffer, and A. Plaat. A performance analysis of transposition-table-driven work scheduling in distributed search. *IEEE Transactions on Parallel and Distributed Systems*, 13(5):447–459, May 2002.
- [19] J. Romein, A. Plaat, H. E. Bal, and J. Schaeffer. Transposition Table Driven Work Scheduling in Distributed Search. In *In 16th National Conference on Artificial Intelligence (AAAI'99)*, pages 725–731, 1999.
- [20] B. Ruijl, J. Vermaseren, A. Plaat, J. Herik, and H. J. van den Herik. Combining Simulated Annealing and Monte Carlo Tree Search for Expression Simplification. *Proceedings of ICAART Conference 2014*, 1(1):724–731, 2014.
- [21] L. Schaeffers, M. Platzner, and S. Member. Distributed Monte-Carlo Tree Search : A Novel Technique and its Application to Computer Go. *IEEE Transactions on Computational Intelligence and AI in Games*, 6(3):1–15, 2014.
- [22] J. Schaeffer and A. Plaat. Kasparov versus deep blue: The re-match. *ICCA Journal*, 20(2):95–102, 1997.
- [23] R. B. Segal. On the Scalability of Parallel UCT. In *Proceedings of the 7th International Conference on Computers and Games, CG'10*, pages 36–47, Berlin, Heidelberg, 2011. Springer-Verlag.
- [24] Shuo-li. Case Study: Achieving High Performance on Monte Carlo European Option Using Stepwise Optimization Framework. <https://software.intel.com/en-us/articles/case-study-achieving-high-performance-on-monte-carlo-european-option-using-stepwise>, 2013.
- [25] H. J. van den Herik, A. Plaat, J. Kuipers, and J. A. M. Vermaseren. Connecting Sciences. In *5th International Conference on Agents and Artificial Intelligence (ICAART 2013)*, 1:IS-7 – IS-16, 2013.
- [26] M. Woodcraft. Gomill library. <http://mjw.woodcraft.me.uk/gomill/>, 2014.
- [27] K. Yoshizoe, A. Kishimoto, T. Kaneko, H. Yoshimoto, and Y. Ishikawa. Scalable Distributed Monte-Carlo Tree Search. *Fourth Annual Symposium on Combinatorial Search*, pages 180–187, May 2011.