

# Generation bidding game with flexible demand

Y. Shan\*, J. Raghuram\*, G. Kesidis\*, C. Griffin\*, K. Levitt†, D.J. Miller\*, J. Rowe†, A. Scaglione†

\* CS&E, EE, & Math Depts and ARL, The Pennsylvania State University, University Park, PA, 16802

† CS and EE Depts, The University of California at Davis, Davis, CA, 95616

## I. INTRODUCTION

Game theoretic approaches to the study of electricity markets have been explored for decades [2], [7], [10]. Recently problems associated with variations of the optimal power flow problem with static (inelastic) demand for an electrical power grid [5], [21], [22], have been considered by several authors, *e.g.*, [15], [17]. Indeed, demand elasticity for electricity is motivated by the onset of potentially enormous load from plug-in electric and hybrid-electric vehicles, see *e.g.*, [1], [14] and the references therein.

We consider a noncooperative, iterated Bertrand-type game played by the generators based on information from the grid (independent system operator (ISO)). That is, the grid is assumed to provide sufficient information so that the generators can modify their prices to improve upon their net utility. The game is a “discriminatory” sealed-bid auction in that the generators earn at the price they bid but in a quantity determined by the ISO [7], [10]. To simplify matters herein, we do not consider strategic bidding by the generators wherein they may infer demand and/or the bidding strategies of their competitors via a probabilistic model, nor multipart bidding to account for start-up/ramp-up costs, secure contracts involving minimum and maximum supply per generator, and the like<sup>1</sup>, nor peak-power consumption penalties [8], [11]. Also, we assume a continuously differentiable and convex cost of supply [2], quadratic in particular. Also, rather than demand-side bidding, we assume a simple “passive” linear demand response based on *average* cost of supply, *i.e.*, the ISO ensures that its customers pay the same rates irrespective of their location or demand volume.

Here we attempt to understand demand-response on the wholesale (generation-level) market<sup>2</sup>. As such, we are focusing here on how a demand-response consumers (load) can influence the wholesale generation market [4], [20].

In summary, in this paper, we are interested in studying the optimum power-flow (economic dispatch) in the presence of flexible elastic demand for a mean clearing-price based

This work supported by NSF grant SaTC 1228717. An earlier conference version of this paper, focusing on commodity flow experimentation, appeared in *Proc. USENIX Feedback Computing*, Philadelphia, June 2014.

<sup>1</sup>For example, in [21], an affine single-part bid and associated “uplift” payments that are part of a joint integer-programming unit commitment and continuous-linear optimal power flow (OPF, or “economic dispatch”) problem was considered.

<sup>2</sup>Again, simplified here by not considering generation constraints and costs of ramp-up in day-ahead provisioning, and associated reliability issues.

marketplace, assuming the generators are free to set their prices; however in so doing energy demand will change. We formulate a noncooperative game involving

- generators (suppliers, wholesalers) of a single commodity (electricity) as players,
- a retailer-distributor (grid, ISO) that merely delivers sufficient information to the supplier-players to act to reach a Nash equilibrium, and
- consumers (individual loads) who are also informed by the ISO of the current spot clearing prices for power, of course.

Consistent with an ISO, we assume that the retailer/distributor controls the conduits of supply.

In this setting, by numerically studying the relatively simple benchmark IEEE 9-bus system, we found that even for a generation duopoly with neither transmission-capacity bounds nor thermal losses, and quadratic (continuous) cost of supply under DC approximation, there is a surprising plurality of Nash equilibria and surprisingly complex dynamics. Similar non-convergent/unstable phenomena were also mentioned in [5], [13], [18]. Although our model resembles a Bertrand game by letting customers respond to the prices offered by suppliers, the result of our experiment is not a typical Bertrand outcome, *i.e.*, the outcome of a competition wherein no competitor earns a profit. This is largely due to the strictly convex, instead of linear, form of generation cost and the guarantee of a minimum allocated amount of power generation for each generator.

In all of our numerical experiments, we found a desirable interior Nash equilibria with equal prices and equal power-generation allocations for generators.

## II. PROBLEM SET-UP

Consider a retailer with suppliers and consumers of a single commodity. As in [17], supposing that each supplier  $g \in G$  sets its own price  $p_g$  per unit commodity. We model aggregate consumer demand to be linear in response to clearing price,  $P$ <sup>3</sup>

$$D(P) = (D_{\max} - D_{\min})\left(1 - \frac{P}{P_{\max}}\right) + D_{\min}, \quad (1)$$

where  $D_{\min}$  represents inflexible demand.

Suppose that suppliers have strictly convex cost of supply,

<sup>3</sup>Herein, just the mean price of supply.

*e.g.*, quadratic cost<sup>4</sup>, so that the net utility/revenue<sup>5</sup> so that the  $g^{\text{th}}$  supplier's net utility is

$$u_g(\underline{p}) = p_g S_g(\underline{p}) - c_g(S_g(\underline{p})) = p_g S_g(\underline{p}) - a_g S_g^2(\underline{p}), \quad (2)$$

with different suppliers/generators  $g$  having different  $a_g$  cost parameters.

We assume that supply allocations are the result of the optimization of a supply network by a mathematical program. In electricity markets, the retailer is sometimes also the distribution system. Consider power flow in a power system with the bus set  $B$  and branch set  $R$ .

- Let  $G \subset B$  be the set of generator buses  $g$ , having generated power  $S_g$ , price per unit supply  $p_g$ , and minimum and maximum supply  $S_g^{(\min)}$  and  $S_g^{(\max)}$  respectively.
- Let  $L \subset B$  be the set of load buses  $l$ , having a demand  $D_l$  that depends on the clearing price  $P$ .
- For each bus  $b \in B$ ,  $\theta_b$  is its voltage angle.
- Finally, let  $r_{i,j}$  be the branch connecting buses  $b_i$  and  $b_j$ , with reactance of the branch  $x_{i,j}$ ,  $P_{i,j}$  power "flowing" from  $b_j$  to  $b_i$  (neglecting power loss on the transmission line, we get  $P_{i,j} = -P_{j,i}$ ), and the maximum tolerable power on the branch  $c_{i,j}$ .

#### A. Optimal power flow problem formulation

Assuming fixed generation prices  $\underline{p}$ , and associated clearing price  $P$ , the total consumer demand is given by (1). The individual consumer demands (loads) are assumed to be some fixed proportion of the total demand, *i.e.*,  $D_l(P) = \alpha_l D(P)$ ,  $\forall l \in L$ , where  $\alpha_l > 0$  and  $\sum_{l \in L} \alpha_l = 1$ . The ISO/retailer solves a constrained optimization problem in order to find  $\underline{S} = [S_1, \dots, S_{|G|}]$ , the optimum power generating assignment for the generators, and  $\underline{\theta} = [\theta_1, \dots, \theta_{|B|}]$ , the voltage angles on the buses, which minimize the charges by the generators. The constrained optimization problem is thus given by:

$$\begin{aligned} & \min_{\underline{S}, \underline{\theta}} \sum_{g \in G} p_g S_g \\ & \text{such that:} \\ & P_{i,j} = \frac{1}{x_{i,j}} (\theta_j - \theta_i) \quad (\text{DC approximation [22]}) \\ & S_g = \sum_{k \in B} P_{k,g}, \quad \forall g \in G \quad (\text{power generation}) \\ & D_l = \sum_{k \in B} P_{l,k}, \quad \forall l \in L \quad (\text{consumer demand}) \\ & S_g^{(\min)} \leq S_g \leq S_g^{(\max)}, \quad \forall g \in G \quad (\text{supplier limits}) \\ & -c_{i,j} \leq P_{i,j} \leq c_{i,j}, \quad \forall i, j \in B \quad (\text{branch limits}) \end{aligned} \quad (3)$$

<sup>4</sup>We assumed quadratic cost of supply for tractability of the duopoly studied in [13]. An alternative cost structure could be asymptotic to a maximum, *e.g.*,  $c(0)/(s - s_{\max})$  where  $c(0)$  is the cost of keeping the generator/supplier online even if zero supply is being delivered. In this paper, we do not consider ramp up/ramp-down constraints for generators/suppliers.

<sup>5</sup>If the *net* consumer utility is collectively  $V(D) - PD$ , then for this linear demand-response to price (1), the utility is quadratic, concave and increasing,  $V(D) = (P_{\max}/2)(D_{\max}^2 - (D_{\max} - D)^2)/(D_{\max} - D_{\min})$  for  $D_{\min} \leq D \leq D_{\max}$ .

Neglecting the power loss in generation and transmission, we have  $\sum_{g \in G} S_g = \sum_{l \in L} D_l$ .

In the above formulation, we used fixed upper and lower bounds on the supply allocations  $S_g$ . Alternatively, a quadratic penalty term in the utility function (2) can serve as a "soft" penalty (cost) on the supply allocation. For a positive  $a_g$  and fixed supplier prices  $\underline{p}$ , suppose supplier  $g$  wants to ensure that its utility function is never smaller than some positive value  $u_g^{(\min)}$ , then this imposes lower and upper bounds on its supply allocation, given by

$$\frac{1}{2a_g} (p_g - \sqrt{p_g^2 - 4a_g u_g^{(\min)}}) \leq S_g \leq \frac{1}{2a_g} (p_g + \sqrt{p_g^2 - 4a_g u_g^{(\min)}}),$$

provided the supplier price satisfies the condition  $p_g \geq 2\sqrt{a_g u_g^{(\min)}}$ . If  $u_g^{\min} = 0$ , then we observe that as  $a_g$  is made larger, *i.e.*, as the cost of supply allocation increases, the maximum supply allocation (or capacity) decreases, and vice-versa.

In practice for power-transmission circuits, thermal losses may determine edge (transmission line) capacities and costs, the latter typically in a power-flow dependent fashion, *e.g.*, " $I^2R$ " losses (Sec. 3.1 of [22]). In order to focus on the bidding behavior among the generators, we neglect the power loss on the transmission lines; hence the cost in power transmission is also neglected.

#### B. Set-up of suppliers' iterative game on a platform of demand response

We neither assume that each supplier's cost of production is known to the retailer (*i.e.*, the  $a_g$  terms), nor, equivalently, that the retailer chooses its allocations to the suppliers based on this (as in [17]). In the following, denote as  $\underline{S}(\underline{D}(P), \underline{p})$  the solution of the above optimal power flow allocation problem to determine supply allocations for *fixed* demands (which are based on the clearing price  $P$ )  $\underline{D}(P) = \{D_j(P) \mid j \in J\}$  and fixed supplier prices  $\underline{p} = \{p_g \mid g \in G\}$ . We propose the following iterative supplier game wherein, for fixed supplier prices, the clearing price and the consumer demands are adjusted iteratively until they converge to a fixed point. Then each supplier  $g \in G$  adjusts its price  $p_g$ , given the current price for all other suppliers  $\underline{p}_{-g}$ , such that its utility function  $u_g(p_g, \underline{p}_{-g})$  is increased. Given initial prices set by the suppliers  $\underline{p}$ , the iterative supplier game proceeds as follows:

- 1) The retailer/ISO sets an *initial* mean price of supply (clearing price charged to all consumers),  $P$ , say just as the mean of the initial supplier prices,  $p_g$ ,  $\forall g \in G$ .
- 2) Determine the price-dependent consumer demands  $\underline{D}(P)$ , where  $D_j(P) = \alpha_j D(P)$ ,  $\forall j \in J$ .
- 3) Retailer solves the economic dispatch optimal power flow allocation problem  $\underline{S}(\underline{D}(P), \underline{p})$  given fixed demands  $\underline{D}$  and generation/supply costs  $\underline{p}$ .
- 4) Retailer computes a new mean (clearing) price of supply,  $P = \sum_{g \in G} S_g p_g / \sum_{g \in G} S_g$ .

- 5) If the change in clearing price  $P$  is significant (larger than some threshold), then go back to Step 2; else continue to Step 6.
- 6) For the current set of supplier prices, consistent supply allocations, consumer demands, and clearing price have been found. Now each supplier sets a new price of supply such that there is an increase in its utility function using one of the following two approaches:

(i) *Best-response play action*: Each supplier  $g$  sets a new price of supply based on (an estimate of)<sup>6</sup>

$$\arg \max_{p_g} p_g S_g(p_g; \underline{p}_{-g}) - c_g(S_g(p_g; \underline{p}_{-g})), \quad (4)$$

where  $c_g(x)$  is the cost of supply (assumed  $= a_g x^2$  above).

(ii) *Better-response play action*: Each supplier  $g$  calculates approximate left and right partial derivatives of its utility function with respect to its price  $p_g$ , *i.e.*,

$$\Delta u_g^+ = \frac{u_g(p_g + \varepsilon, \underline{p}_{-g}) - u_g(p_g, \underline{p}_{-g})}{\varepsilon}$$

$$\Delta u_g^- = \frac{u_g(p_g, \underline{p}_{-g}) - u_g(p_g - \varepsilon, \underline{p}_{-g})}{\varepsilon},$$

where  $\varepsilon \searrow 0^7$ . If the left and right derivatives have different signs (a non-differentiable point), then there are two possibilities. If  $\Delta u_g^- > 0$  and  $\Delta u_g^+ < 0$ , the current price  $p_g$  is a local maximum and there is no need to change  $p_g$ . If  $\Delta u_g^- < 0$  and  $\Delta u_g^+ > 0$ , the current price is a local minimum. In this case, we increase  $p_g$  by a small value  $\zeta$  if  $|\Delta u_g^+| > |\Delta u_g^-|$ ; otherwise we decrease  $p_g$  by  $\zeta$ . In case the derivatives have the same sign (may still be a non-differentiable point), we increase  $p_g$  by  $\zeta$  if both derivatives are positive and decrease  $p_g$  by  $\zeta$  if both derivatives are negative. The step  $\zeta$  should increase the price by a small value such that there is an increase in the value of the utility function. It should not make large changes to the price like the best-response play action<sup>8</sup>.

- 7) Exit if there is no change in the supplier prices (*i.e.*, if an equilibrium set of prices is obtained); Else go back to Step 1.

Even for simple power circuits, the best-response iterated play may lead to convergence problems including limit-cycle behavior (*cf.*, Section III). Alternatively, the suppliers could play the iterated better-response non-cooperative game, possibly with more reliable convergence properties [12], [19].

<sup>6</sup>Since a closed-form solution to the objective is not found, we use a small positive step-size to directly search for optimal prices within their defined range.

<sup>7</sup>We chose a value of  $\varepsilon = 10^{-6}$ .

<sup>8</sup>We chose  $\zeta$  as follows. Starting with a small trial value of  $\zeta = 0.005 p_g$ , if  $u_g(p_g + \zeta, \underline{p}_{-g}) > u_g(p_g, \underline{p}_{-g})$  we accept the value of  $\zeta$ , else  $\zeta$  is decreased by a factor of 2 iteratively until  $u_g(p_g + \zeta, \underline{p}_{-g}) > u_g(p_g, \underline{p}_{-g})$ .

Given global knowledge of the retailer's supply conduits<sup>9</sup>, each supplier can compute its "best-response" prices in Step 6 leading to a Nash equilibrium. Alternatively, the retailer may not explicitly divulge its system state (just as the cost of supply is not known to the retailer in our set-up) and compute the revenue function  $f_g(p_g) = p_g S_g(p_g; \underline{p}_{-g})$  for each supplier  $g \in G$ , again assuming  $\underline{p}_{-g}$  fixed from the previous iteration.

Note how this algorithm depends on forecasts of demand for the upcoming epoch (which needs to be long enough to accommodate the ramp-up/down delays of the generators). Day-ahead forecasts [16] could be used to inform the initial prices set by the generators.

### III. NUMERICAL STUDY

We study the iterative generation game described in section II-B with a 9-bus power system that has three generators and three loads as shown in Fig. 1. We consider the scenario where cost of delivering power is zero, and the branch capacities are set to fixed values.

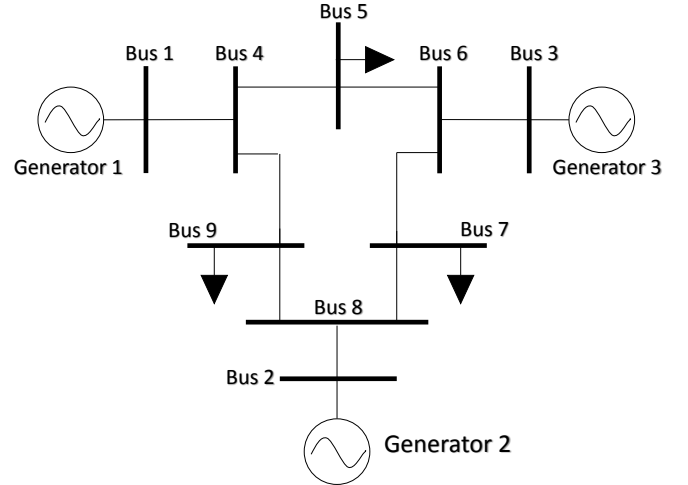

Fig. 1. IEEE 9-bus system used in our study with three generators and three loads

For the benchmark IEEE 9-bus system [23], the maximum and minimum power generated by the three generators are set to  $[250, 300, 270]$  MW and  $[10, 10, 10]$  MW, respectively. The constants in  $D(P)$ , our model for the total consumer demand, were chosen as the possible maximum/minimum power provided by the generators, that is,  $D_{\max} = 770$  MW,  $D_{\min} = 30$  MW (note that, although generator 2 can generate 300 MW, the capacity of the branch connecting bus 2 and bus 8 is only 250 MW, therefore generator 2 can only provide 250 MW at most). The total consumer demand  $D(P)$  is assumed to be proportionally divided among the individual loads, *i.e.*,  $\alpha_l = \frac{1}{|L|}$ ,  $\forall l \in L$ . The maximum clearing price,  $P_{\max}$ , is set to 5; for clearing prices  $P > P_{\max}$ , the flexible demand is 0. The reactance of the transmission line is based on the

<sup>9</sup>Again, the motivating example here is a power system retailer/ISO which owns and operates the grid connecting generators/suppliers to loads/consumers.

data from [6]. The constants ( $a_g$ ) in the utility function (2) of generators are set to 0.009, 0.01, and 0.018 respectively.

1) *Best response game with three players:* Assume all three generators participate. By choosing different starting points, we have both convergent and non-convergent trajectories, as shown below.

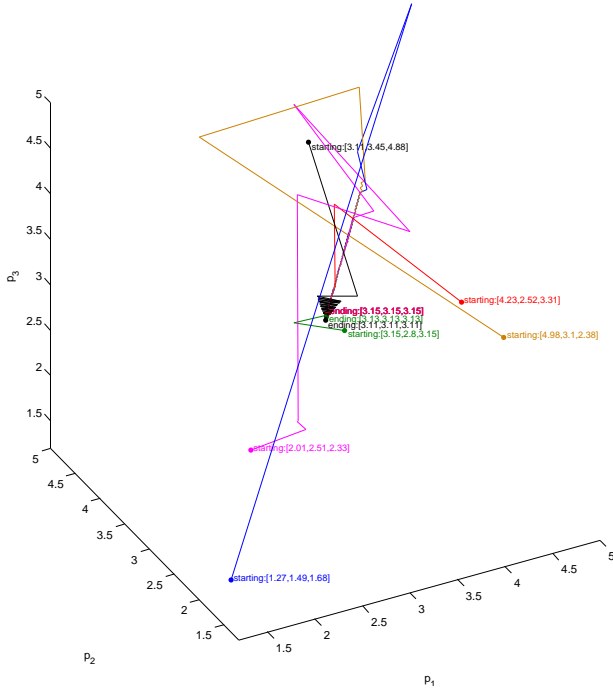

Fig. 2. The three-player best-response trajectories which start from different initial prices and end up with equilibrium points.

In Fig. 2, these trajectories will finally converge to definite points. For most initial generator prices, the limit pricing point is  $[3.15, 3.15, 3.15]$ , however there are several exceptions. For example, trajectories starting from  $[3.11, 3.45, 4.88]$  and  $[3.15, 2.8, 3.15]$  converge to  $[3.11, 3.11, 3.11]$  and  $[3.13, 3.13, 3.13]$ , respectively. We found that when the prices fall at the points along the line from  $[2.61, 2.61, 2.61]$  to  $[3.15, 3.15, 3.15]$ , all the generator will keep their prices unchanged, which means, once a trajectory intersects with this line, it terminates at the intersection point (convergence occurs). At these equal-prices equilibrium points, there are equal power allocations  $S$  to the generators.

On the other hand, we also found some best-response trajectories which do not converge, as shown in Fig. 3, because of the finite step-size when searching for optimal prices, given the current prices of other generators (Step 6 in *cf.*, Section II-B). In our numerical experiments, we set the step-size to 0.01.

2) *Best response game with two players:* By fixing the price of generator 3 to 5, we can focus on the best-response game between generators 1 and 2, and plot the trajectory in a two-dimensional plane. Similar to three-player best-response, we also found both convergent and non-convergent trajectories.

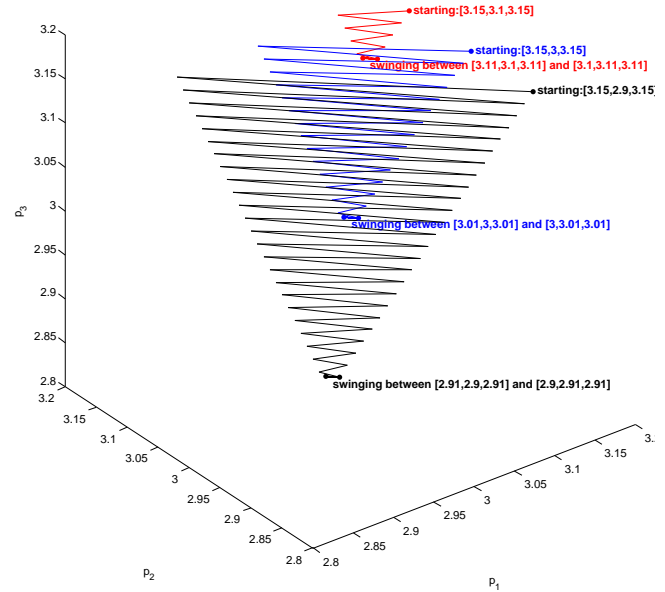

Fig. 3. The three-player best-response trajectories which end up oscillating between two points.

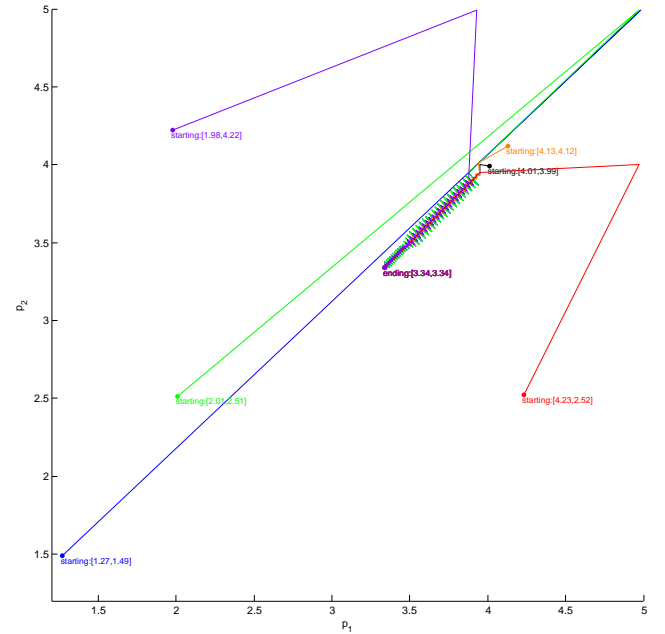

Fig. 4. The two-player best-response trajectories which start from different points and converge to the same point.

However, our numerical results presented in Fig. 4 show that, unlike the games with three players, the best-response games with two competitors, if convergent, will converge to the point  $(3.34, 3.34, 3.34)$ .

Moreover, non-convergent phenomena in the two-player best-response game are more manifest than in the three-player game. As demonstrated in Fig. 5, the amplitude of oscillation, compared with 2 players, is much larger. Also, unlike the non-

convergent cases in the three-player game, decreasing the step length will not shorten the oscillation amplitude.

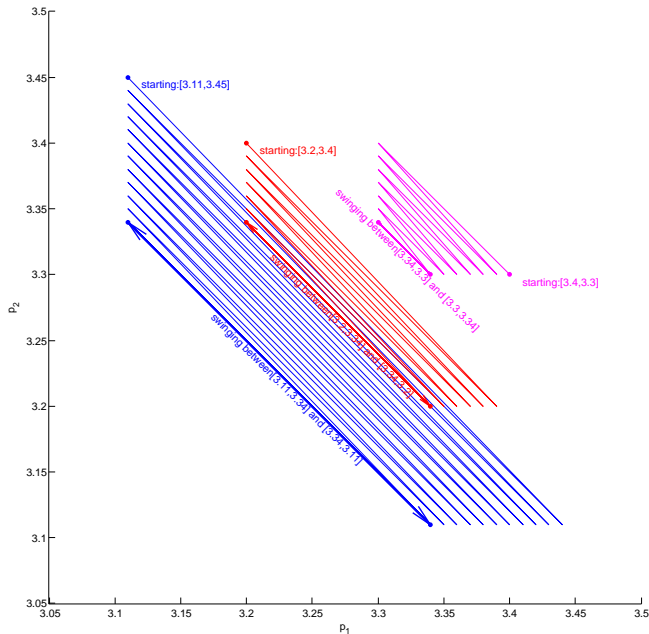

Fig. 5. The two-player best-response trajectories which start from different points and end up oscillating between two points.

3) *Better response game with two players:* We simulate two-player better-response game, an alternative approach, which avoids the oscillatory behavior of the best-response game. The quiver plot shown in Fig. 6 can visualize the dynamics of better-response iterated play microscopically. Note that we have set an upper bound price to 5, otherwise prices will diverge from an infinitely large set of initial prices. This is because we set a minimum power allocation for each generator in our optimal power flow calculation, *i.e.*, the generators always have some power to generate, no matter how high the prices are. However, such minimum allocated amounts of generation power typically are not guaranteed irrespective of price in practice.

Based on the quiver plot shown in Fig. 6, we conjecture that trajectories starting from some area (most likely the lower left area) will converge to an interior NEP, while those starting from the other area will converge to the boundary (points where either  $p_1$  or  $p_2$  is 5), as demonstrated in Fig. 7. Note that, in our experiment, the better-response trajectories with an interior NEP actually do not converge, but arrive at small limit cycles because of finite step-size for search, recall footnote 8.

## REFERENCES

- [1] M. Alizadeh, A. Scaglione, and G. Kesidis. Scalable Model Predictive Control of Demand For Ancillary Services. *Proc. IEEE SmartGridComm*, Vancouver, Oct. 2013.
- [2] E.J. Anderson and H. Xu. Supply function equilibrium in electricity spot markets with contracts and price caps. *Journal of Optimization Theory and Applications* **124**(2):257-283, Feb. 2005.
- [3] T. Basar and G. J. Olsder. *Dynamic noncooperative game theory*. 2nd Ed. Academic Press, 1996.

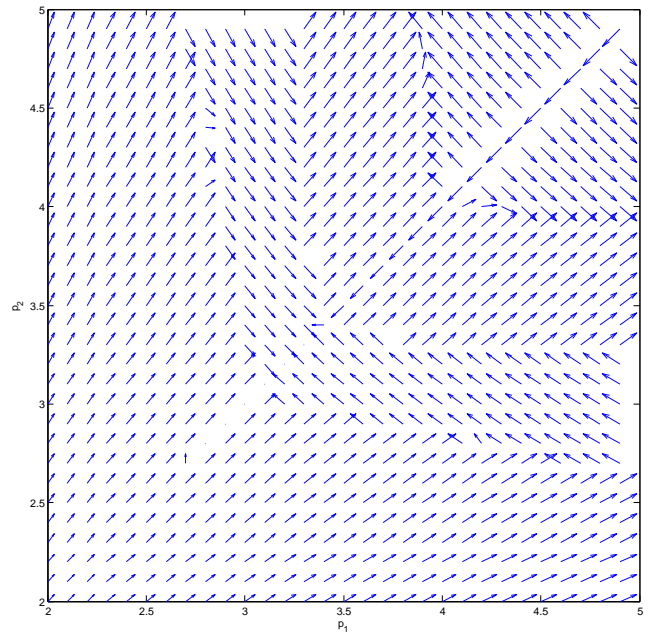

Fig. 6. Quiver plot of the better response dynamics with price of generator 3 set to 5.

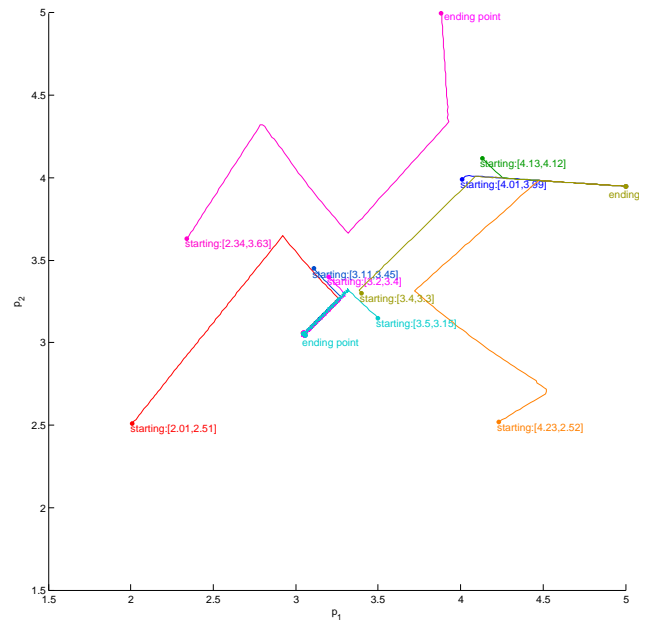

Fig. 7. The two-player better-response trajectories starting from different points, the mass around point (3.05, 3.05) can be approximated to a point if the step length is small enough.

- [4] C. Chen, S. Kishore, Z. Wang M. Alizadeh, and A. Scaglione. A Cournot game analysis on market effects of queuing energy request as demand response. In *Proc. IEEE Power and Energy Society (PES) General Meeting*, July 2012.
- [5] L. Chen, N. Li, S. Low and J. Doyle. Two market models for demand response in power networks. *IEEE SmartGridComm*, 2010.
- [6] J.H. Chow. *Time-scale modeling of dynamic network with applications to power systems*. Springer, 1982.
- [7] A.K. David and F. Wen. Strategic bidding in competitive electricity markets: a literature survey. *Proc. Power Engineering Society Summer Meeting*, 2000.

- [8] Duke utility bill tariff, 2012. <http://www.considerthecarolinas.com/pdfs/scscheduleopt.pdf>
- [9] J. Edmonds and R.M. Karp. Theoretical improvements in algorithmic efficiency for network flow problems. *Journal of ACM* **19**(2):248-264, Apr. 1972.
- [10] N. Fabra, N.-H. von der Fehr, and D. Harbord. Designing Electricity Auctions. Center for the Study of Energy Markets (CSEM) Working Paper 122, Feb. 2004.
- [11] Fort Collins Coincident Peak, 2013. <http://www.fcgov.com/utilities/business/rates/electric/coincident-peak>.
- [12] Y. Jin and G. Kesidis. Dynamics of usage-priced communication networks: the case of a single bottleneck resource. *IEEE/ACM Trans. Networking*, Oct. 2005.
- [13] G. Kesidis, C. Griffin and D.J. Miller. A marketplace game with neither distribution costs nor distribution-capacity constraints. PSU CSE Dept Technical Report CSE-13-013, Nov. 22, 2013.
- [14] H. Lu, G. Pang and G. Kesidis. Automated scheduling of deferrable PEV/PHEV load by power-profile unevenness. *Proc. IEEE SmartGridComm*, Vancouver, Oct. 2013.
- [15] A.-H. Mohsenian-Rad and A. Leon-Garcia. Distributed Internet-Based Load Altering Attacks Against Smart Power Grids. *IEEE Trans. on Smart Grid* **2**(4), Dec. 2011.
- [16] F. Rahimi and A. Ipakchi. Overview of Demand Response under the smart grid and market paradigms. In *Proc. IEEE PES Conf. on Innovative Smart Grid Technologies*, Gaithersburg, MD, Jan. 2010.
- [17] M. Roozbehani, M. Dahleh, and S. Mitter. Dynamic Pricing and Stabilization of Supply and Demand in Modern Electric Power Grids. In *Proc. IEEE SmartGridComm*, 2010.
- [18] M. Roozbehani, M. Dahleh, and S. Mitter. Volatility of power grids under real-time pricing. *Power Systems, IEEE Trans.* **27**(4):1926-1940, 2012.
- [19] J.S. Shamma and G. Arslan. Dynamic fictitious play, dynamic gradient play, and distributed convergence to Nash equilibria. *IEEE Trans. Auto. Contr.* **50**(3):312-327, 2005.
- [20] M.G. Vaya and G. Andersson. Optimal bidding strategy of a plug-in electric vehicle aggregator in day-ahead electricity markets. In *Proc. Int'l Conf. on European Energy Market (EEM)*, May 2013.
- [21] G. Wang and S.V. Shanbhag and S. Meyn. On Nash equilibria of duopolistic power markets subject to make whole uplift. *Proc. IEEE CDC*, Maui, Dec. 2012.
- [22] A.J. Wood and B.F. Wollenberg. *Power Generation Operation and Control*. 2nd Ed. Wiley, 1996.
- [23] R.D. Zimmerman, C.E. Murillo-Sánchez, and R.J. Thomas. MATPOWER: Steady-state operations, planning and analysis tools for power systems research and education. *Power Systems, IEEE Trans.*, Feb. 2011. See also <http://www.pserc.cornell.edu/matpower>