

**WIND FINSLERIAN STRUCTURES:
FROM ZERMELO'S NAVIGATION TO
THE CAUSALITY OF SPACETIMES**

ERASMO CAPONIO, MIGUEL ANGEL JAVALOYES, AND MIGUEL SÁNCHEZ

ABSTRACT. The notion of *wind Finslerian structure* Σ is developed; this is a generalization of Finsler metrics (and Kropina ones) where the indicatrices at the tangent spaces may not contain the zero vector. In the particular case that these indicatrices are ellipsoids, called here *wind Riemannian structures*, they admit a double interpretation which provides: (a) a model for classical *Zermelo's navigation problem* even when the trajectories of the moving objects (planes, ships) are influenced by *strong* winds or streams, and (b) a natural description of the *causal structure* of relativistic spacetimes endowed with a non-vanishing Killing vector field K (*SSTK splittings*), in terms of Finslerian elements. These elements can be regarded as conformally invariant Killing initial data on a partial Cauchy hypersurface. The links between both interpretations as well as the possibility to improve the results on one of them using the other viewpoint are stressed.

The wind Finslerian structure Σ is described in terms of two (conic, pseudo) Finsler metrics, F and F_l , the former with a convex indicatrix and the latter with a concave one. Notions such as balls and geodesics are extended to Σ . Among the applications, we obtain the solution of Zermelo's navigation with arbitrary stationary wind, metric-type properties for Σ (distance-type arrival function, completeness, existence of minimizing, maximizing or closed geodesics), as well as description of spacetime elements (Cauchy developments, black hole horizons) in terms of Finslerian elements in Killing initial data. A general Fermat's principle of independent interest for arbitrary spacetimes, as well as its applications to SSTK spacetimes and Zermelo's navigation, are also provided.

2010 *Mathematics Subject Classification.* 53B40, 53C50, 53C60, 53C22.

Key words and phrases. Finsler spaces and generalizations, Killing vector field, Zermelo navigation problem, Kropina metric, spacetime.

EC is a member of and has been partially supported during this research by the "Gruppo Nazionale per l'Analisi Matematica, la Probabilità e le loro Applicazioni" (GNAMPA) of the "Istituto Nazionale di Alta Matematica (INdAM)".

MAJ is partially supported by MINECO (Ministerio de Economía y Competitividad) and FEDER (Fondo Europeo de Desarrollo Regional) project MTM2012-34037 and Fundación Séneca project 04540/GERM/06, Spain. This research is a result of the activity developed within the framework of the Programme in Support of Excellence Groups of the Región de Murcia, Spain, by Fundación Séneca, Regional Agency for Science and Technology (Regional Plan for Science and Technology 2007-2010).

MS and EC have been partially supported by the Spanish Ministry of Economy and Competitiveness and European Regional Development Fund (ERDF), project MTM2013-47828-C2-1-P.

CONTENTS

1. Introduction	3
2. Wind Finslerian structures	9
2.1. Wind Minkowskian structures on vector spaces	9
2.2. Notions on manifolds and characterizations	12
2.3. Wind lengths and balls	16
2.4. Geodesics	23
2.5. Link with geodesics of conic pseudo-Finsler metrics	28
2.6. Wind Riemannian structures	30
3. Fermat structures for SSTK splittings	34
3.1. Spacetimes with a space-transverse Killing field	34
3.2. Associated wind Riemannian structure	36
3.3. Lightlike vectors and link with Zermelo metrics	38
3.4. Projection on ∂_t^\perp and interpretation of A_l, \tilde{A}_l	43
3.5. Fundamental tensors for F, F_l	44
4. The case of causal K : Randers-Kropina metrics	45
4.1. Characterization of the chronological relation	46
4.2. Continuity of the Finslerian separation for Randers-Kropina spaces	47
4.3. Ladder of causality and properties for Randers-Kropina separation	49
5. The case of arbitrary K : general wind Riemannian structures	50
5.1. Causal futures and lightlike geodesics	50
5.2. Characterization of the causal ladder	54
6. Applications to wind Riemannian structures and navigation	58
6.1. Characterization of geodesics and Hopf-Rinow properties	58
6.2. Consequences of the different splittings of an SSTK spacetime.	61
6.3. Precedence relation and solutions of Zermelo's navigation	64
7. Fermat's principle and generalized Zermelo navigation problem.	72
7.1. A new problem: Fermat's principle for arbitrary arrival curves	72
7.2. A general Fermat's Principle	74
7.3. Fermat's principle for SSTK spacetimes	79
8. Further applications	85
8.1. Cauchy developments	85
8.2. Differentiability of the Randers-Kropina separation	87
8.3. K -horizons	89
Appendix: List of some symbols and conventions	92
References	95

1. INTRODUCTION

Among the classic and recent applications of Finsler metrics, Randers ones can be linked to two quite different problems. The first one is Zermelo navigation problem that was considered for the first time in [71]. It consists in determining the trajectories which minimize the flight time of an airship (or of any other object capable of a certain maximum speed and moving in a wind or a current). Zermelo determined the differential equations of the optimal trajectories in dimension 2 and 3 (the so-called *navigation equations*). The problem was then considered by Levi-Civita, Von Mises, Caratheodory, Manià [44, 67, 22, 48] becoming a classical problem in optimal control theory. Randers metrics turned then out to appear naturally in the problem of navigation under a mild stationary wind [63, 4].

The second one is the description of the geometry of spacetimes $(\mathbb{R} \times M, g)$ endowed with a timelike Killing vector field K (the so-called *standard stationary spacetimes*). This is an important class of spacetimes: for example, the region outside the ergosphere in the Kerr's solution to the Einstein's equation is of this type and, more generally, the region outside the horizon of any black hole should be so, at sufficiently late times (see [45, §14.4]). Also in this case, Randers metrics arise naturally on M , encoding the conformal geometry and causality of the spacetime [20].

In both cases, the interpretation of a Randers metric as a Riemannian one (M, g_R) “with a displaced unit ball” becomes apparent: the displacement is caused by the vector field W which represents the wind in the case of Zermelo's problem, and which is constructed in a conformally invariant way from the *lapse* $\Lambda = -g(K, K)$ and the *shift* $\omega = g(K, \cdot)|_M$ in the case of spacetimes. It is remarkable that Randers metrics provide a natural way to go from the navigation problem to spacetimes, and vice versa. In both problems, however, there is a neat restriction: the wind must be mild ($g_R(W, W) < 1$) and, accordingly, the lapse of the spacetime must be positive ($\Lambda > 0$); otherwise, the displaced unit ball would not contain the zero vector, making to collapse the classical Finslerian description. Nevertheless, both problems are natural without such restrictions and, in fact, they become even more geometrically interesting then. Under a strong wind or current, the moving object (a Zeppelin or a plane in the air, a ship in the ocean, or even sound rays in the presence of a wind [35, 36]) may faces both, regions which cannot be reached and others that can be reached but must be abandoned by, say, the compelling wind. Analogously, the change in the sign of the lapse Λ means that the causal character of the Killing vector field K changes from timelike to spacelike and, so, one might find a *Killing horizon*, which is an especially interesting type of relativistic hypersurface [25, 49]. The correspondence between navigation and spacetimes becomes now even more appealing: although the description of the movement of the object is non-relativistic, the set of points that can be reached at each instant of time becomes naturally described by the causal future of an event in the spacetime, and the latter may exhibit some of the known subtle possibilities in relativistic fauna: horizons, no-escape regions (black holes) and so on.

Our aim here is to show that both Zermelo navigation with arbitrary stationary wind and the geometry of a spacetime $\mathbb{R} \times M$ with a non-vanishing Killing vector field can still be described by a generalized Finsler structure, that we call *wind Riemannian* structure.

By using this structure, we are able to interpret Zermelo navigation as a problem about geodesics whatever the stationary wind is and we give sufficient conditions for the existence of a travel time minimizing or maximizing solution (Theorem 6.13). These are based on an assumption, called *w-convexity* which is satisfied if the wind Riemannian structure is geodesically complete. Clearly, this might hold also when M is not compact, a case in that the so-called *common compact support* hypothesis in Filippov's theorem, applied to the time-optimal control problem describing Zermelo navigation, does not hold (see [2, Th. 10.1] and [61, p. 52]). For example, our techniques can also be used to prove existence of a solution in a (possibly unbounded) open subset of a manifold M , provided that the wind is mild in its boundary and the boundary is convex (Theorem 6.16 and Remark 6.17).

As mentioned above, wind Riemannian structures allow us to describe also the causal structure of a spacetime $(\mathbb{R} \times M, g)$ endowed with a non-vanishing Killing vector field which is everywhere transverse to the spacelike hypersurfaces $S_t = \{t\} \times M$. We name this type of spacetimes *standard with a space-transverse Killing vector field*, abbreviated in SSTK *splitting*. They are endowed with a t -independent metric

$$g = -\Lambda dt^2 + 2\omega dt + g_0 \quad (1)$$

(see Definition 3.2 and Proposition 3.3 for accurate details), so the Killing vector field is $K = \partial_t$. Even though SSTK splittings are commonly used in General Relativity (see for example [49] and references therein), our work is the first one where a systematic study of their causal structure appears. Of course, SSTK splittings include standard stationary spacetimes (i.e. the case in that K is timelike or, equivalently, $\Lambda = -g(\partial_t, \partial_t)$ is positive) and also asymptotically flat spacetimes admitting a Killing vector field which is only asymptotically timelike (which, sometimes in the literature on Mathematical Relativity, are also called stationary spacetimes, see for example [45, Definition 12.2]).

The point at which Zermelo navigation and the causal geometry of an SSTK splitting are more closely related is, without any doubt, Fermat's principle. We prove here a Fermat principle in a very general setting which is then refined when the ambient spacetime is an SSTK splitting. Classical Fermat's principle, as established by Kovner [43] and Perlick [56], characterizes lightlike pregeodesics as the critical points of the arrival functional for smooth lightlike curves joining a prescribed point z_0 and a *timelike* curve α . However, the case when α is not timelike becomes also very interesting for different purposes. First, of course, this completes the mathematical development of the problem. In particular, the proof of the result here, Theorem 7.3 (plus Remark 7.4), refines all previous approaches. However, this result and its strengthening to SSTK spacetimes (Theorem 7.8, including the timelike case Corollary 7.11), admit interpretations for Zermelo's navigation, as well as for spacetimes (arrival at a Killing horizon) and even for the classical Riemannian viewpoint (Remark 7.6). Concretely, about Zermelo's navigation, the case when the arrival curve α is not timelike corresponds to a target point which lies in a zone of critical or strong wind ($g_R(W, W) \geq 1$). Thus, Fermat's principle can be interpreted as a variational principle for a generalized Zermelo's navigation problem, in the sense that navigation paths are the stationary (rather than only local minimum) points of the time of navigation.

Under the point of view of variational calculus, we would like to point out that the travel time minimizing paths between two given points $x_0, y_0 \in M$ are the

curves σ connecting x_0 to y_0 which minimize the functional

$$\sigma \mapsto \int_{\sigma} \frac{g_R(\dot{\sigma}, \dot{\sigma})}{g_R(\dot{\sigma}, W) + \sqrt{h(\dot{\sigma}, \dot{\sigma})}},$$

where

$$h(v, v) := (1 - g_R(W, W))g_R(v, v) + g_R(v, W)^2 \quad (2)$$

is a signature changing tensor on M which is Riemannian on the region of mild wind, Lorentzian on the region of strong wind, while in the region of critical wind (i.e., at the points $p \in M$ where $g_R(W_p, W_p) = 1$), it is degenerate on the g_R -orthogonal space to W_p . On the region of critical or strong wind, this functional is defined (and positive) only for curves whose velocities belong to a conic sub-bundle of TM (see Proposition 2.46 and Remark 2.47). This constraint on the admissible velocities plus the signature changing characteristic of h make it difficult the use of direct methods. Actually, we are able to prove the existence of a minimum by using results about the existence of *limit curves* (see Definition 4.4, Lemma 5.9) in the SSTK splitting that can be associated to a data set (M, g_R, W) for Zermelo navigation (Theorem 3.10). On the other hand, focusing only on the minimizing problem (or the optimal time control problem) is, in our opinion, somehow reductive of the rich geometrical features that Zermelo navigation presents: as just a single example, we mention that abnormal extremals (compare, e.g., with [22, §282], see also Remark 6.21-(b)) can be interpreted either as lightlike pregeodesics of h (up to a finite number of instants where the velocity vanishes) or as exceptional geodesics of the wind Riemannian structure (Definition 2.36).

A natural extension of the notion of wind Riemannian structure is obtained by replacing its field of ellipsoids by a field of *any* type of strongly convex, compact hypersurfaces. We call the structure Σ so obtained a *wind Finslerian structure* and we provide a thorough study of it which is then strengthened for a wind Riemannian structure thanks to the correspondence with conformal classes of SSTK splittings. Of course, wind Finslerian structures generalize the class of all Finsler manifolds because the zero vector is allowed to belong to or to be outside each hypersurface Σ_p . As another matter of fact, the correspondence between SSTK splittings and wind Riemannian structures allows us to study some “singular” Finslerian geometries (as Kropina metrics, where the 0 vector belongs to the indicatrix Σ_p) in terms of the corresponding (non-singular) SSTK splitting.

The paper is organized as follows. In Section 2, we start by introducing and making a general description of wind Finslerian structures on a manifold. These will be defined in terms of a hypersurface Σ of TM , satisfying a transversality condition which provides a strongly convex compact hypersurface $\Sigma_p = T_pM \cap \Sigma$ at each point $p \in M$, called *wind Minkowskian structure*. This structure plays the role of indicatrix, although it might not surround the origin $0_p \in T_pM$ and appears naturally when the indicatrix bundle of a Finsler manifold F_0 is displaced along a vector field W (Proposition 2.13); clearly, F_0 and W are not univocally determined, even though a canonical choice (namely, each 0_p is the centroid of $F_0^{-1}(1) \cap T_pM$) could be made. The moral is then:

Any wind Finslerian structure Σ can be described in terms of two conic pseudo-Finsler metrics F and F_l , the former F (resp. the latter F_l) defined on all M (resp. in the region M_l of strong wind, i.e., whenever the zero vector is not enclosed by Σ) with:

(i) domain $A_p \subset T_p M$ at each $p \in M$ (resp. each $p \in M_l$) equal to the interior of the conic region of $T_p M$ determined by the half lines from the origin to Σ_p , and

(ii) indicatrix the part of Σ_p that is convex (resp. concave) with respect to the position vector —so that F becomes a conic Finsler metric and F_l a Lorentzian Finsler metric (Proposition 2.3).

Moreover, Σ admits general notions of lengths and balls (Definitions 2.18, 2.21), which allows us to define geodesics (Definitions 2.30, 2.36), recovering the usual geodesics for F and F_l (Theorem 2.42).

Remarkably, we introduce the notion of c -ball in order to define geodesics. These balls are intermediate between open and closed balls. They make sense even in the Riemannian case (Remark 2.22), allowing a well motivated notion of convexity, namely, w -convexity (Proposition 2.29, Definition 2.37).

Especially, we focus on the case when Σ is a *wind Riemannian structure* (Section 2.6), i.e., the case when Σ is obtained by displacing a Riemannian metric g_R along a vector field W —now, necessarily both, g_R and W , univocally determined (Proposition 2.44). The link with Zermelo’s problem becomes apparent: F describes the maximum velocity that the ship can reach in each direction and F_l the minimum one. In this case, the conic pseudo-Finsler metrics F, F_l can be described naturally in terms of g_0 and W (Proposition 2.46), and a generalization of the Zermelo/Randers correspondence is carried out: now Randers metrics appear for mild wind ($g_0(W, W) < 1$), the pair (F, F_l) for strong wind ($g_0(W, W) > 1$), and Kropina metrics for the case of critical wind ($g_0(W, W) = 1$). In particular, F becomes a Randers-Kropina metric in the region of non-strong wind (Definition 2.48, Remark 2.47).

In Section 3, our aim is to describe the correspondence between the wind Riemannian structures and the (conformal classes) of SSTK splittings. The existence of a unique *Fermat structure*, i.e., a wind Riemannian structure Σ naturally associated with the conformal class $[(\Lambda, \omega, g_0)]$ of an SSTK decomposition, is characterized in Theorem 3.10. Moreover, the equivalence between these conformal SSTK-classes, and the description of a wind Riemannian structure either with Zermelo-type elements (i.e., in terms of a Randers-Kropina metric or a pair of metrics (F, F_l)) or with its explicit Riemannian metric and wind (i.e., the pair (g_0, W)) is analysed in detail, see the summary in Fig. 6.

In Subsection 3.4 we identify and interpret the (signature-changing) metric h in (2), which becomes Riemannian when $\Lambda > 0$, Lorentzian of coindex 1 when $\Lambda < 0$ and degenerate otherwise. In particular, on its causal (timelike or lightlike) vectors in TM_l , it holds

$$h(v, v) = \frac{1}{4}(1 - g_0(W, W))^2(F - F_l)^2(v), \quad (3)$$

(see (34), Corollary 3.19). As mentioned above, the metric h will turn out essential for describing certain solutions of the Zermelo navigation problem. Remarkably, it has a natural interpretation from the spacetime viewpoint (Proposition 3.18) but its importance would be difficult to discover from the purely Finslerian viewpoint (that is, from an expression such as (3)). Summing up:

Any wind Riemannian structure (g_R, W) becomes equivalent to an SSTK conformal class $[(g_0, \omega, \Lambda)]$. The spacetime interpretation

allows us to construct elements (as the metric h in (2), (34)) which become important for Finslerian properties.

We end with a subsection where the fundamental tensors of F and F_l are computed explicitly and discussed—in particular, this makes possible to check the Finslerian character of the former and the Lorentzian Finsler one of the latter.

The main theorems of this paper deal with an exhaustive correspondence between the causal properties of an SSTK splitting and the metric-type properties of wind Riemannian structures. These theorems will become fundamental from both, the spacetime viewpoint (as important relativistic properties are characterized) and the viewpoint of navigation and wind Riemannian structures (as sharp characterizations on the existence of critical points/ geodesics are derived by applying the spacetime machinery). For the convenience of the reader, they are obtained gradually in Sections 4 and 5. In Section 4, we consider the case when the Killing field K is causal or, consistently, when the Fermat structure has (pointwise) either mild or critical wind. In this case, the Lorentzian Finsler metric F_l is not defined, and the conic Finsler metric F becomes a Randers-Kropina one. We introduce the F -separation d_F in a way formally analogous to the (non-necessarily symmetric) distance of a Finsler manifold. But, as the curves connecting each pair of points must be admissible now (i.e., in the Kropina region, the velocity of the curves must be included in the open half tangent spaces where F can be applied), one may have, for example, $d_F(x, x) = +\infty$ for some $x \in M$. In any case, the chronological relation \ll of the SSTK splitting can be characterized in terms of d_F (Proposition 4.1), and this allows us to prove that d_F is still continuous outside the diagonal (Theorem 4.5). The main result, Theorem 4.7, yields a full characterization of the possible positions of the SSTK splitting in the so-called *causal ladder of spacetimes* in terms of the properties of d_F . This extends the results for stationary spacetimes in [20], and they are applicable to relativistic spacetimes as the pp-waves (Example 4.9). A nice straightforward consequence is a version of Hopf-Rinow theorem for the F -separation of any Randers-Kropina metric (Corollary 4.8).

In Section 5 the general case when there is no restriction on K (i.e., a strong wind is permitted) is considered. In this case, there is definitively no any element similar to a distance. However, our definitions of balls and geodesics are enough for a full description of the causal ladder. In fact, the chronological and causal futures, $I^+(z_0), J^+(z_0)$, of any SSTK-point $z_0 \in \mathbb{R} \times M$ can be described in terms of the Σ -balls and c -balls (Proposition 5.1). Moreover, the horismotically related points (those in $J^+(z_0) \setminus I^+(z_0)$) are characterized by the existence of extremizing geodesics (Corollary 5.4) and this leads to a complete description of the geodesics of an SSTK splitting in terms of the geodesics of its Fermat structure (Theorem 5.7, Corollary 5.8, see also Fig. 10). In order to characterize the closedness of $J^+(z_0)$ (Proposition 5.10), as well as to carry out some other technical steps, we require a result of independent interest about limit curves (Lemma 5.9). This machinery allows us to prove our structural Theorem 5.11 which, roughly, means:

Any SSTK splitting $(\mathbb{R} \times M, g)$ is stably causal and it will have further causality properties when some appropriate properties of the balls or geodesics of the corresponding Fermat structure (M, Σ) hold. In particular, $(\mathbb{R} \times M, g)$ is causally continuous iff a natural property of symmetry holds for the closed balls of (M, Σ) , it is causally simple iff (M, Σ) is w -convex and it is globally hyperbolic iff

the intersections between the forward and backward closed Σ -balls are compact. Moreover, the fact that the slices $S_t = \{t\} \times M$ are Cauchy hypersurfaces is equivalent to the (forward and backward) geodesic completeness of (M, Σ) .

Section 6 is devoted to the applications of the SSTK viewpoint to the geometry of wind Riemannian structures. The first applications (Subsection 6.1) are direct consequences, for any wind Riemannian structure (M, Σ) , of the previous results: (1) a full characterization of the Σ -geodesics as geodesics for either F or F_l or lightlike geodesics of the metric $-h$ (Theorem 6.1; the last possibility refines the result for any wind Finslerian structure in Theorem 2.42) and (2) a characterization of completeness and w -convexity in the spirit of Hopf-Rinow theorem (Proposition 6.4). However, in Subsection 6.2 a subtler application on (M, Σ) is developed. Indeed, the same spacetime may split as an SSTK in two different ways (Lemma 6.5), yielding two different Fermat structures (Proposition 6.8). These structures share some properties, which are discussed there.

In Subsection 6.3 we introduce a relation of *weak precedence* \preceq (resp. *precedence* \prec) between pairs of points in (M, Σ) defined by the existence of a connecting *wind curve* (resp. an *F-wind curve*), namely, a curve with velocity included in the region (resp. the interior of the region) allowed by Σ . Such a relation can be characterized as the projection of the causal (resp. chronological) relation on the corresponding SSTK (Proposition 6.11). This allows us to prove results on existence of minimizing and maximizing connecting geodesics (Theorems 6.13 and 6.16, Corollary 6.26) and of closed geodesics for (M, Σ) (Theorem 6.27). In particular, Theorem 6.13, Corollary 6.14 and Corollary 6.26 (see also Remarks 6.18) and 6.21) provide the full solution to Zermelo navigation problem:

For any wind Riemannian structure, the metric h in (34) –or (2)– defines a natural relation of weak precedence (resp. precedence) which is essentially determined by the causal (resp. chronological) relation for the metric $-h$ where it is Lorentzian (i.e., in the region of strong wind). Such a relation is equal to the relation \preceq (resp. \prec) which determines if a point x_0 can be connected with a second one y_0 by means of a wind (resp. F-wind) curve. Moreover:

- (a) if $x_0 \preceq y_0$, $x_0 \neq y_0$, and the c -balls are closed (i.e. (M, Σ) is w -convex) then there exists a geodesic of (M, Σ) of minimum F -length from x_0 to y_0 (which is also a lightlike pregeodesic of $-h$ when $x_0 \neq y_0$, if it is contained in the region of strong wind);*
- (b) if $x_0 \preceq y_0$, $x_0 \neq y_0$, and $-h$ is globally hyperbolic on all M (in particular, the wind is strong and then $M = M_l$) then there exists a geodesic of (M, Σ) of maximum F_l -length from x_0 to y_0 (which is also a lightlike pregeodesic of $-h$ if $x_0 \neq y_0$).*

The possibility of the existence of maximal solutions as well as of solutions which are limits of minimal and maximal ones was pointed out by Caratheodory in [22] (see part (b) of Remark 6.21). We stress that our result interprets geometrically all of them as geodesics. In particular, the limits of minimal and maximal ones correspond (up to isolated points) to the lightlike pregeodesics of $-h$ (so, they can be parametrized as regular curves).

We would like to emphasize that the accuracy of most of our results for wind Riemannian structures relies on their correspondence to SSTK splittings. Nevertheless, some of these results might be extendible to general wind Finslerian ones (see Remark 5.5). Indeed, in the case of the correspondence of Randers metrics with stationary spacetimes, some of the properties obtained by using the spacetime viewpoint could be extended to any Finslerian manifold (see for example [51] or compare [20, Th. 4,10] with [64, Theorem A]). Thus, the results for the wind Riemannian case might serve as a guide for a further development of wind Finslerian structures.

In Section 7, we discuss Fermat's principle, which constitutes a topic of interest in its own right, (recall the introductory Subsection 7.1). Indeed, we consider a first Fermat's principle in Subsection 7.2, under a very general viewpoint independent of our previous study. Then, we focus again on SSTK splittings in Subsection 7.3.

In Section 8, we go further in the description of causal elements of SSTK splittings. Indeed, Cauchy developments and horizons of subsets included in a slice S_t are described accurately in terms of the Fermat structure (Proposition 8.1). As a nice consequence, the results on differentiability of horizons for spacetimes can be now applied to obtain results on smoothability of the Randers-Kropina separation d_F to a subset (Proposition 8.6), so extending results in [26] for the Riemannian case and in [20, §5.4] for the Randers one.

In the last part (Subsection 8.3), we also introduce and develop the notion of K -horizon for any wind Finslerian structure. In particular, such horizons allow us to describe the regions where the ship in Zermelo's navigation cannot enter (or from where it cannot escape). Accordingly, from the spacetime viewpoint, it provides a description of black hole regions from the *Killing initial data* (KID) on a Riemannian manifold (M, g_0) for any SSTK splitting (see [23, 9, 47, 49]). Notice that these data appear naturally in the initial value problem for the Einstein equation, and include our Λ and ω (usually denoted N and Y in Physics literature, the latter regarded eventually as a vector field). Given the initial data, the SSTK splitting is called its *(infinite) Killing development* [49, Definition 2]. When the initial data are well posed (namely, they satisfy conditions of compatibility with matter in the sense of [23, Definition 2]), the Cauchy development of S will include the unique maximal globally hyperbolic spacetime obtained as a solution of the Einstein equation. Our results on Cauchy developments make it possible to determine these regions in terms of the Fermat structure, as well as possible black hole horizons.

Due to the big number of notions here introduced, an appendix containing a list of symbols and definitions used throughout the paper is given for the reader's convenience.

Acknowledgements

The authors would like to thank Lorenzo D'Ambrosio for questions and conversations about the existence of a solution to the Zermelo navigation problem in the compact case.

2. WIND FINSLERIAN STRUCTURES

2.1. Wind Minkowskian structures on vector spaces. Let us begin by recalling the classical notion of Minkowski norm.

Definition 2.1. Let V be a real vector space of finite dimension $m \geq 1$. We say that a continuous non-negative function $F : V \rightarrow [0, +\infty)$ is a Minkowski norm if

- (i) it is positive and smooth away from the zero vector,
- (ii) it is positively homogeneous, namely, $F(\lambda v) = \lambda F(v)$ for every $\lambda > 0$ and $v \in V$,
- (iii) for any $v \in V \setminus \{0\}$, its *fundamental tensor* g_v , defined as

$$g_v(u, w) = \frac{1}{2} \frac{\partial^2}{\partial s \partial t} F(v + tu + sw)^2 \Big|_{t=s=0} \quad (4)$$

for any $u, w \in V$, is positive definite.

The *indicatrix* of F is defined as the subset $\Sigma_F = \{v \in V : F(v) = 1\}$. Observe that Σ_F is a *strongly convex* smooth hypersurface embedded in V , in the sense that its second fundamental form II with respect to one (and then all) transversal vector field is definite —in the remainder, we choose the orientation of the transverse so that II will be positive definite, as usual. Notice that, in general, any (connected) compact, strongly convex hypersurface Σ embedded in V must be a topological sphere (the Gauss map with respect to any auxiliary scalar product would yield a diffeomorphism) and both, Σ and the bounded region B determined by Σ , are *strictly convex* in the usual sense (i.e. Σ touches every hyperplane tangent to it only at the tangency point and lies in one of the two half-spaces determined by the hyperplane, and B satisfies that the segment between any two points in $\bar{B} = B \cup \Sigma$ is contained in B , except at most its endpoints). When $0 \in B$, a Minkowski norm is uniquely determined having Σ as indicatrix just by putting $F(v) = 1/\lambda(v)$ for all $v \in V \setminus \{0\}$, where $\lambda(v) \in \mathbb{R}$ is the unique positive number such that $\lambda(v)v \in \Sigma$ (see for example [40, Prop. 2.3]).

If the indicatrix Σ_0 of a given Minkowski norm is translated, one obtains another strongly convex smooth hypersurface Σ that determines a new Minkowski norm whenever 0 still belongs to the new bounded region B . As explained in the Introduction, this process of generating Minkowski norms is used pointwise in Zermelo’s navigation problem. The translated indicatrix Σ defines a Minkowski norm if and only if the opposite of the translation vector $W \in V$ is contained in the indicatrix of F_0 , i.e., whenever $F_0(-W) < 1$. This is a restriction of “mild wind” in Zermelo’s problem; so, let us consider now the case in that $F_0(-W) \geq 1$. In this case, the zero vector is not contained in the open bounded region B delimited by the translated indicatrix Σ and, as a consequence, Σ does not define a classical Finsler metric. Indeed, not all the rays departing from the zero vector must intersect Σ and, among the intersecting ones, those intersecting transversely will cross Σ twice, and those intersecting non-transversely will intersect only once, see Fig. 1. The above discussion motivates the following definition.

Definition 2.2. A *wind Minkowskian structure* on a real vector space V of dimension $m \geq 2$ (resp. $m = 1$) is a compact, connected, strongly convex, smooth hypersurface Σ embedded in V (resp. a set of two points $\Sigma = \{\lambda_- v_0, \lambda_+ v_0\}$, $\lambda_- < \lambda_+$, for some $v_0 \in V \setminus \{0\}$). The bounded open domain B (resp. the open segment $\{t\lambda_- v_0 + (1-t)\lambda_+ v_0 : t \in (0, 1)\}$) enclosed by Σ will be called the *unit ball* of the wind Minkowskian structure.

As an abuse of language, Σ may also be said the *unit sphere* or the *indicatrix* of the wind Minkowskian structure. In order to study wind Minkowskian structures,

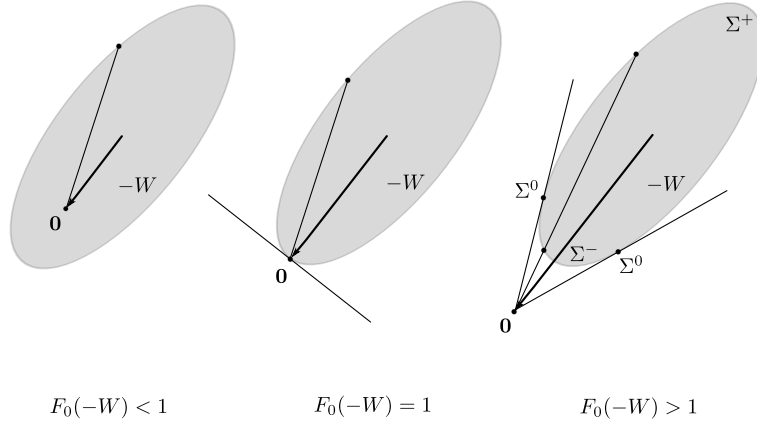

FIGURE 1. Wind Minkowskian structures

it is convenient to consider the following generalization of Minkowski norms (see [40] for a detailed study). Let $A \subset V \setminus \{0\}$ be an open *conic subset*, in the sense that if $v \in A$, then $\lambda v \in A$ for every $\lambda > 0$,¹ and let A_E be the closure of A in $V \setminus \{0\}$. We say that a function $F : A \rightarrow [0, +\infty)$ is a *conic pseudo-Minkowski norm* if it satisfies (i) and (ii) in Definition 2.1 (see [40, Definition 2.4]). Of course, any conic pseudo-Minkowski norm can be extended continuously to 0 whenever 0 does not lie in the closure in V of the indicatrix and this is natural in the case $A = V \setminus \{0\}$; in particular, Minkowski norms are also included as conic pseudo-Minkowski norms. We will focus on the following two non-degenerate cases for the fundamental tensor g_v of F in (4):

- (i) g_v is positive definite for every $v \in A$, that is, F is a *conic Minkowski norm*.
- (ii) g_v has coindex 1 for every $v \in A$, i.e., F is a *Lorentzian norm*.

Observe that when $A = V \setminus \{0\}$ and the fundamental tensor is positive definite, F can be extended continuously to zero and it is a Minkowski norm. According to these definitions, there are three different possibilities for a wind Minkowskian structure.

Proposition 2.3. *Let Σ be a wind Minkowskian structure in V and B its unit ball.*

- (i) *If $0 \in B$, then Σ is the indicatrix of a Minkowski norm.*
- (ii) *If $0 \in \Sigma$, then Σ is the indicatrix of a conic Minkowski norm with domain A equal to an (open) half vector space.*
- (iii) *If $0 \notin \bar{B}$, then define $A \subset V \setminus \{0\}$ as the interior of the set which includes all the rays starting at 0 and crossing Σ ; then A is a (convex) conic open set and, when $m \geq 2$, two conic pseudo-Minkowski norms F, F_1 with domain A can be characterized as follows:*
 - (a) *each one of their indicatrices is a connected part of $A \cap \Sigma$, and*
 - (b) *F is a conic Minkowski norm and F_1 , a Lorentzian norm.*

¹Notice that, if an open conic subset A contains the zero vector then $A = V$. As we will be especially interested in the case $A \neq V$, in the remainder the 0 vector will be always removed from A for convenience. For comparison with the results in [40], notice that $A \cup \{0\}$ will be always convex in the following sections, even though one does not need to assume this a priori.

Moreover, $F < F_l$ on all A , both pseudo-Minkowski norms can be extended continuously to the closure A_E of A in $V \setminus \{0\}$ and both extensions coincide on the boundary of A_E .

We will say that Σ in each one of the previous cases is, respectively, a Minkowski norm, a Kropina type norm or a strong (or proper) wind Minkowskian structure.

Proof. Parts (i) and (ii) are an easy consequence of [40, Theorem 2.14]. For part (iii), if a ray from zero meets Σ transversely, it will cut Σ in two points whereas if it is tangent to Σ there will be a unique cut point. Then we can divide Σ in three disjoint regions $\Sigma = \Sigma^- \cup \Sigma^0 \cup \Sigma^+$, where Σ^- and Σ^+ are the sets of the points where the rays departing from 0 cut Σ transversely, first in Σ^- and then in Σ^+ , and Σ^0 is the set of points where the rays from zero are tangent to Σ (see Fig. 1). The rays cutting $\Sigma^- \cup \Sigma^+$ generate the open subset $A \subset V$; recall that the compactness and strong convexity of Σ imply both, the arc-connectedness of Σ^- and Σ^+ , and the convexity of A , ensuring (a). Moreover, Σ^- defines a Lorentzian norm F_l , since the restriction of its fundamental tensor g_v to the tangent hypersurface to Σ^- is negative definite and g_v -orthogonal to v [40, Prop. 2.2] (recall that this restriction coincides, up to a negative constant, with the second fundamental form of Σ^- with respect to the opposite to the position vector, [40, Eq. (2.5)]). Analogously, Σ^+ defines a conic norm F (thus completing (b)) and, by the choice of Σ^+ , one has $F < F_l$. Finally, observe that the points of Σ^0 lie necessarily in the boundary of A_E since the rays from zero are tangent to Σ (which is strictly convex, in particular); moreover, Σ^0 lies in the boundary of both Σ^+ and Σ^- , which ensures the properties of the extension. \square

Remark 2.4. Observe that, in general, a converse of Proposition 2.3 (namely, whether a wind Minkowski norm is determined by a conic Minkowski norm F and a Lorentzian norm F_l defined both in an open conic subset $A \subset V$, such that F and F_l can be continuously extended to A_E and the extensions coincide) would require further hypotheses in order to ensure that the closures in A_E of the indicatrices of F and F_l glue smoothly at their intersection with the boundary of A_E .

Convention 2.5. As a limit case $m = 1$ of Proposition 2.3 and, thus, $\Sigma = \{\lambda_- v_0, \lambda_+ v_0\}$, one has naturally a Minkowski norm or a Kropina norm (the latter identifiable to a norm with domain only a half line) when $0 \in B$ or $0 \in \Sigma$, resp. When $0 \notin \bar{B}$, choose $v_0 \in B$ and assume $(0 <) \lambda_- (< 1) < \lambda_+$. Then, define $\Sigma^+ = \{\lambda_+ v_0\}$ (resp. $\Sigma^- = \{\lambda_- v_0\}$), as the indicatrix of a conic Minkowski norm, which will also be regarded as Lorentzian norm in the case of Σ^- (Σ^+, Σ^- are clearly independent of the chosen vector v_0).

2.2. Notions on manifolds and characterizations. Let M be a smooth m -dimensional manifold², TM its tangent bundle and $\pi : TM \rightarrow M$ the natural projection. Let us recall that a *Finsler metric* in M is a continuous function $F : TM \rightarrow [0, +\infty)$ smooth away from the zero section and such that $F_p = F|_{T_p M}$ is a Minkowski norm for every $p \in M$. Analogously, a *conic Finsler metric*, *conic pseudo-Finsler metric* or a *Lorentzian Finsler metric* is a smooth function $F : A \rightarrow$

² Manifolds are always assumed to be Hausdorff and paracompact. However, the latter can be deduced from the existence of a Finsler metric (as then the manifold M will admit a reversible one, and M will be metrizable) as well as from the existence of a wind Finsler structure (as in this case the centroid vector field is univocally defined, and M will admit a Finsler metric, see Proposition 2.13 below).

$[0, +\infty)$, where A is a *conic* open subset of $TM \setminus \mathbf{0}$ (i.e., each $A \cap T_p M$ is a conic subset) such that $F_p = F|_{A \cap T_p M}$ is, respectively, a conic Minkowski norm, a conic pseudo-Minkowski norm or a Lorentzian norm.

Definition 2.6. A smooth (embedded) hypersurface $\Sigma \subset TM$ is a *wind Finslerian structure* on the manifold M if, for every $p \in M$: (a) $\Sigma_p := \Sigma \cap T_p M$ defines a wind Minkowskian structure in $T_p M$, and (b) for each $v \in \Sigma_p$, Σ is transversal to the vertical space $\mathcal{V}(v) \equiv T_v(T_p M)$ in TM . In this case, the pair (M, Σ) is a *wind Finslerian manifold*.

Remark 2.7. For a standard Finsler structure $F: TM \rightarrow [0, +\infty)$, the indicatrix $\Sigma_F = \{v \in TM : F(v) = 1\}$ is a wind Finslerian structure. In fact, (a) follows trivially, and (b) holds because, otherwise, being F smooth on $TM \setminus \mathbf{0}$, $\mathcal{V}(v)$ would lie in the kernel of dF_v , in contradiction with the homogeneity of F in the direction v . Notice that this property of transversality (b) also holds for the indicatrix of any conic Finsler or Lorentzian Finsler metric defined on $A \subset TM$ (while (a) does not).

R.L. Bryant [14] defined a generalization of Finsler metrics also as a hypersurface. The proof of Proposition 2.10 below shows that this notion is clearly related to the notion of *conic Finsler metric* used here (even though, among other differences, in his definition Σ must be radially transverse and it may be non-embedded and non-compact).

Let us denote by B_p the unit ball of each Σ_p ; the (*open*) *domain* A of the wind Finslerian structure is the union of the sets $A_p \subset T_p M, p \in M$, where A_p is defined as $A_p = T_p M \setminus \{0\}$ if $0 \in B_p$ and by parts (ii) and (iii) of Proposition 2.3 otherwise.

Proposition 2.8. *The wind Finslerian structure Σ is closed as a subset of TM and the union of all the unit balls $B_p, p \in M$, as well as A , are open in TM . If M is connected and $m \geq 2$ (resp. $m = 1$), then Σ is connected (resp. Σ has two connected parts, each one naturally diffeomorphic to M).*

Proof. For the first sentence, recall that the property (a) of Definition 2.6 implies that Σ is foliated by topological spheres S^{m-1} and each $p \in M$ admits a neighborhood U such that $\Sigma \cap \pi^{-1}(U)$ is compact and homeomorphic to $U \times S^{m-1}$. For the last assertion, notice that, otherwise, any two non-empty disjoint open subsets that covered Σ would project onto open subsets of M with a non-empty intersection W , in contradiction with the connectedness of Σ_p at each $p \in W$ (for $m = 1$, M admits a non-vanishing vector field V , so that each two points in Σ_p can be written now as $\lambda_-(p)V_p, \lambda_+(p)V_p$, with $\lambda_- < \lambda_+$ on all M , thus $p \rightarrow \lambda_-(p)V_p, \lambda_+(p)V_p$ yield the required diffeomorphisms with M). \square

Definition 2.9. Let (M, Σ) be a wind Finslerian manifold. The *region of critical wind* (resp. *mild wind*) is

$$M_{crit} = \{p \in M : 0_p \in \Sigma_p\} \quad (\text{resp. } M_{mild} = \{p \in M : 0_p \in B_p\}),$$

and the *properly wind Finslerian region* or *region of strong wind* is

$$M_l := \{p \in M : 0_p \notin \bar{B}_p\}.$$

The (*open*) *conic domain* of the associated Lorentzian Finsler metric F_l is

$$A_l := \pi^{-1}(M_l) \cap A.$$

Let $\mathbf{0}$ be the 0-section of TM . The *extended domain* of F_l is

$$A_E := (\text{Closure of } A_l \text{ in } TM_l \setminus \mathbf{0}) \cup \{0_p \in T_p M : p \in M_{crit}\}.$$

The zero vectors 0_p (with $p \in M_{crit}$) are included in A_E for convenience (see Convention 2.17). Notice also that $A_l \subset TM \setminus \mathbf{0}$, $A_l \subseteq A$ and, whenever $p \in M_l$, $A \cap T_p M = A_l \cap T_p M$.

Proposition 2.10. *Any wind Finslerian structure Σ in M determines the conic pseudo-Finsler metrics $F : A \rightarrow [0, +\infty)$ and $F_l : A_l \rightarrow [0, +\infty)$ in M and M_l respectively (the latter when $M_l \neq \emptyset$) characterized by the properties:*

- (i) F is a conic Finsler metric with indicatrix included in $\Sigma \cap A$,
- (ii) F_l is a Lorentzian Finsler metric with indicatrix included in $\Sigma \cap A_l$

Moreover, $F < F_l$ on A_l , both F_l and F can be extended continuously to the boundary of A_l in $TM_l \setminus \mathbf{0}$ (i.e., $A_E \setminus \mathbf{0}$), and both extensions coincide in this boundary.

Proof. From Proposition 2.3, we have to prove just the smoothability of F, F_l in A , by using both, the smoothness of Σ and its transversality. Let $v \in A_p \cap \Sigma$, and consider the ray $\{\lambda v : \lambda > 0\}$ (recall that $v \neq 0$). This ray is transversal to Σ_p and, because of the property of transversality of Σ , it is transversal to Σ in TM too. This property holds also for some open connected neighborhood U^Σ of v in $A \cap \Sigma$, where $U_{\pi(v')}^\Sigma (:= U^\Sigma \cap T_{\pi(v')} M)$ will be either strongly convex (thus defining F) or strongly concave (defining F_l) towards $0_{\pi(v')}$, for all $v' \in U^\Sigma$. Moreover, the map:

$$\psi : (0, +\infty) \times U^\Sigma \rightarrow TM \quad (t, w) \mapsto tw$$

is injective and smooth. Even more, $d\psi$ is bijective at each point $(1, w), w \in U^\Sigma$, because of transversality, and it is also bijective at any $(\lambda, w), \lambda > 0$, because the homothety $H_\lambda : TM \rightarrow TM$ maps U^Σ in the hypersurface λU^Σ which is also transversal to the radial direction. Summing up, ψ is a diffeomorphism onto its image $U^{TM} \subset TM$, and the inverse

$$\psi^{-1} : U^{TM} \rightarrow (0, +\infty) \times U^\Sigma$$

maps each v in either $(F(v), v/F(v))$ or in $(F_l(v), v/F_l(v))$, depending on the convexity or concaveness of $U_{\pi(v)}^\Sigma$, $v \in U^\Sigma$, proving consistently the smoothness of F or F_l . \square

Remark 2.11. Because of their extensibility to the boundary, the metrics F and F_l are Riemannianly lower bounded on M_l (according to [40, Definition 3.10]). This means the existence of a Riemannian metric g_0 on M such that $F(v) \geq \sqrt{g_0(v, v)}$, for all $v \in A$, and also $F_l(v) \geq \sqrt{g_0(v, v)}$, for all $v \in A_l$ (which are consequences of part (1) of Remark 3.11 in [40]). The fact that F (resp. F_l) is Riemannianly lower bounded on M (resp. M_l) has important consequences, as the fact that forward and backward open balls $B_F^\pm(x, r)$ (resp. $B_{F_l}^\pm(x, r)$), defined by using its *Finslerian separation* (a sort of distance, see [40, Definition 3.8] or Section 4.1) constitute a basis for the topology of M (resp. M_l) (see [40, Proposition 3.13]). Some cautions, however, must be taken. For example, the Finslerian separation of the conic Finsler metric F may be discontinuous, (see Section 4); in fact, the conic Finsler metric in [40, Example 3.18] exhibits this property and, easily, it can be regarded as the one determined by a wind Finslerian structure. We refer to [40, Section 3.5] for a summary of these properties.

Proposition 2.12. *Let Σ and W be, resp., a wind Finslerian structure and a (smooth) vector field on M . Then, $\Sigma + W := \{v + W_{\pi(v)} : v \in \Sigma\}$ is a wind Finslerian structure on M .*

Proof. The translation $T_W : TM \rightarrow TM, v \mapsto v + W_{\pi(v)}$, is a bundle isomorphism of TM ; so, it preserves the properties of smoothness and transversality of Σ . \square

In particular, the translation of the indicatrix Σ_{F_0} of any standard Finsler metric F_0 along W is a wind Finslerian structure Σ , which will be the indicatrix of a Finsler metric Z iff $F_0(-W) < 1$ on M . In this case, Z is determined by the relation:

$$F_0\left(\frac{v}{Z(v)} - W\right) = 1, \quad (5)$$

consistently with the definition of the Zermelo metric Z in [63]. In fact, the assumption on W plus the convexity of the indicatrix of F_0 imply that this equation will have a unique solution $\lambda_v > 0$ for any $v \in TM \setminus \mathbf{0}$. When the assumption $F_0(-W) < 1$ is dropped, the expression (5) allows us to determine also the wind Finslerian structure, even though now λ_v may not exist or take two different positive values for some v (which would correspond to $Z(v)$ and $Z_l(v)$). Conversely:

Proposition 2.13. *Any wind Finslerian structure Σ can be obtained as the displacement $\Sigma_{F_0} + W$ of the indicatrix Σ_{F_0} of a Finsler metric F_0 along some vector field W . Moreover, W can be chosen such that each W_p is the centroid of Σ_p .*

Proof. Even if this proof can be carried out by choosing a family of vector fields W_i defined in some open subset with this property, whose existence is trivial, and then doing a convex sum in all the manifold with the help of a partition of unity, we will prove in fact that the vector field provided by the centroid is smooth because this will be needed in the future. For this aim, we can actually assume that Σ is the indicatrix of a standard Finsler metric F defined on some open subset U of \mathbb{R}^m (notice that (i) the smoothability of W is a local property, (ii) if a vector w_p belongs to the open ball B_p enclosed by Σ , this property will hold for any vector field W extending w_p in some neighborhood of p , so that Propositions 2.12 and 2.10 can be claimed, and (iii) the translation T_W also translates the centroids). Let S^{m-1} be the canonical unit sphere in \mathbb{R}^m with volume element $d\Omega$. So, the natural x^i -coordinate of the centroid W_p is computed as:

$$\begin{aligned} x^i(W_p) &= \int_{S^{m-1}} \int_0^{1/F_p(u)} r x^i(u) r^{m-1} dr d\Omega / \int_{S^{m-1}} \int_0^{1/F_p(u)} r^{m-1} dr d\Omega \\ &= \frac{m}{m+1} \int_{S^{m-1}} \frac{x^i(u)}{F_p(u)^{m+1}} d\Omega / \int_{S^{m-1}} \frac{d\Omega}{F_p(u)^m} \end{aligned} \quad (6)$$

and its smoothness follows from the smooth variation of the integrands with p . \square

Remark 2.14. Notice that the smoothness of W relies on the smoothness of F in (6) and, thus, the transversality of Σ imposed in the assumption (b) of Definition 2.6 becomes essential. Figure 2 shows a 1-dimensional counterexample if this condition is not imposed.

Notice also that, as the absence of transversality would lead to non-smooth metrics, then this would lead to non-smooth SSTK splittings in the next Section 3. The well-known exotic properties of the chronological and causal futures and pasts

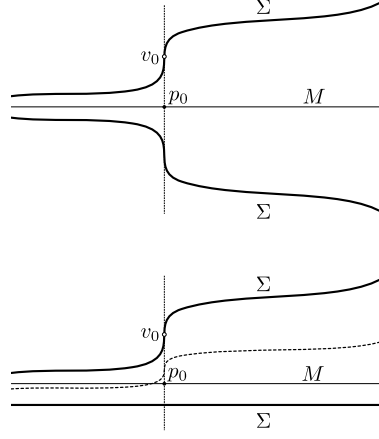

FIGURE 2. In the top figure, Σ is a smooth hypersurface of $TM \equiv \mathbb{R}^2$ consisting of two curves which intersect the vertical space at (p_0, v_0) (depicted as a vertical line) non-transversely. So Σ satisfies the property (a) in Definition 2.6 and (as the curves are symmetric with respect to the zero section of TM) it determines continuously a scalar product in the tangent space at each $p \in M \equiv \mathbb{R}$. Nevertheless, the failure of (b) implies that this product does not vary smoothly with respect to p and, so, Σ does not determine a (smooth) Riemannian metric on M . In the second figure, changing the lower curve by a horizontal line, one obtains at each tangent space a wind Minkowskian structure varying continuously (but not smoothly) with the point. Moreover, the vector field determined by the centroids (the dashed curve) is not differentiable at p_0 .

of spacetimes with non-smooth metrics (see for example [23]) would be related to exotic properties of the Σ - and c -balls of (M, Σ) , to be defined below.

Definition 2.15. Let Σ be a wind Finslerian structure on M . Then,

$$\tilde{\Sigma} := -\Sigma := \{v \in TM : -v \in \Sigma\}$$

is the *reverse wind Finslerian structure* of Σ .

Obviously, $\tilde{\Sigma}$ is a wind Finslerian structure too and, from the definition, one gets easily the following.

Proposition 2.16. *Given a wind Finslerian structure Σ , the conic Finsler metric \tilde{F} and the Lorentzian Finsler one \tilde{F}_l associated with the reverse wind Finslerian structure $-\Sigma$ are the (natural) reverse conic pseudo-Finsler metrics of F and F_l , that is, the domains of \tilde{F} and \tilde{F}_l are, respectively, $\tilde{A} = -A = \{v \in TM : -v \in A\}$ and $\tilde{A}_l = -A_l = \{v \in TM : -v \in A_l\}$ and they are defined as $\tilde{F}(v) = F(-v)$ for every $v \in \tilde{A}$ and $\tilde{F}_l(v) = F_l(-v)$ for every $v \in \tilde{A}_l$.*

2.3. Wind lengths and balls. In order to deal with curves, the following conventions will be useful.

Convention 2.17. For any wind Finslerian structure Σ we extend F and F_l to $A \cup A_E$ as follows. First, consistently with Proposition 2.10, F and F_l are regarded as continuously extended to the boundary of A_l in $TM_l \setminus \mathbf{0}$. F_l is extended as equal to $+\infty$ on A in the regions of mild and critical wind i.e. on the set $\{v \in A_p : 0_p \in \bar{B}_p\}$ (that is, F_l is equal to $+\infty$ on the vectors where F has been defined and F_l has not). Finally, we define F_l and F as equal to 1 on the set of critical wind zeroes (i.e., the set $\{0_p : 0_p \in \Sigma_p\}$, which was included in the definition of A_E , Definition 2.9). Notice that neither this choice of F_l and F on the critical wind region nor any other can ensure their continuity; however, F_l and F are continuous on $A \cup (A_E \setminus \mathbf{0})$. We also use natural notation such as $(A_l)_p = A_l \cap T_p M$, $(A_E)_p = A_E \cap T_p M$.

To understand this choice, recall first that the necessity to extend A to A_E in the critical and strong wind regions comes from the fact that all the indicatrices Σ_p should be contained in A_E . In the critical region, $\Sigma_p \setminus \{0_p\}$ lies in A and, so, in the domain of F . Therefore, it is not strange to include 0_p in A_E so that F_l is defined on this vector and, obviously, the choice $F_l(0_p) = F(0_p) = 1$ comes from the fact that 0_p lies in the indicatrix and in the boundary of A_E . A further support for these choices will come from the viewpoint of spacetimes, as the vectors in $A \cup A_E$ are those which can be obtained as the projection of a lightlike vector in the spacetime.

As usual, a *piecewise smooth curve* γ will be defined in a compact interval $I = [a, b]$, and it will be smooth except in a finite number of breaks $t_i \in I, i = \{1, \dots, k\}$, where it is continuous and its one-sided derivatives are well defined³; its reparametrizations will be assumed also piecewise smooth and with positive one-sided derivatives (so that, for example a piecewise smooth geodesic with proportional one-sided derivatives at each break pointing in the same direction can be reparametrized as smooth geodesics), unless otherwise specified.

Definition 2.18. Let Σ be a wind Finslerian structure with associated pseudo-Finsler metrics F and F_l and consider a piecewise smooth curve $\gamma : [a, b] \subset \mathbb{R} \rightarrow M$, $a < b$.

(i) γ is Σ -*admissible* if its left and right derivatives $\dot{\gamma}(s^-), \dot{\gamma}(s^+)$ belong to $A \cup A_E$ at every $s \in [a, b]$. Analogously, γ is F -*admissible* if $\dot{\gamma}(s^\pm) \in A$, for each $s \in [a, b]$. Accordingly, a vector field V on M is Σ -admissible (resp. F -admissible) if $V_p \in A \cup A_E$ for each $p \in M$, (resp. $V_p \in A$ for each $p \in M$).

(ii) A Σ -admissible curve γ is a *wind curve* if

$$F(\dot{\gamma}(s)) \leq 1 \leq F_l(\dot{\gamma}(s)) \quad \forall s \in [a, b], \quad (7)$$

and an F -admissible wind curve will be called just F -*wind curve*.

(iii) A Σ -admissible curve γ is a *regular curve* if its one-sided derivatives can vanish only at isolated points (which can be regarded as break points, even though the curve may be smooth there), and it is a *strictly regular curve* if its one-sided derivatives (and, thus, its velocity outside the breaks) cannot vanish at any point.

(iv) The *wind lengths* of a Σ -admissible curve γ (not necessarily a wind curve) are defined as

$$\ell_F(\gamma) = \int_a^b F(\dot{\gamma}) ds \quad (\in (0, +\infty]), \quad \ell_{F_l}(\gamma) = \int_a^b F_l(\dot{\gamma}) ds \quad (\in (0, +\infty]).$$

³Even though typically, all the curves will be defined on a compact interval I , when necessary all the following notions can be used for non-compact I . In this case, one assumes that the restriction of γ to compact subintervals of I satisfies the stated property, and it is natural to impose additionally that the images of the breaks $\{\gamma(t_i)\}$ do not accumulate.

Remark 2.19. (1) Wind curves collect the intuitive idea of Zermelo's navigation problem, namely: the possible velocities attained by the moving object are those satisfying the inequalities in (7). Notice that these velocities never include 0_p if $p \in M_l$ and must include 0_p if $0_p \in \overline{B}_p$ (even though, by convenience, we have excluded 0_p of A_p when $0_p \in \overline{B}_p$). In the region $M \setminus M_l$, the inequalities in (7) reduce to $F(\dot{\gamma}(s)) \leq 1$.

(2) The reason to exclude 0_p from A when $p \in M_{mild}$ is just to emphasize the different role of the zero vector in this region and in M_{crit} (as well as avoiding problems of differentiability with F). In fact, in order to connect points by means of curves included in M_{mild} , one can avoid to use velocities that vanish (and this may be convenient for purposes such as reparametrizing the curve at constant speed; such an assumption is frequent in Riemannian Geometry too). However, the vanishing of the velocity may be essential for connecting curves in the closure of M_l . Observe also that the continuity of $F \circ \dot{\gamma}$ and $F_l \circ \dot{\gamma}$ has to be checked only when $\dot{\gamma}(s)$ is equal to a zero of the critical region (see Proposition 2.24-(ii)) and, in this case, F and F_l are defined as equal to 1 there. A further explanation of this choice is provided in Example 2.20 below, where two paradigmatic examples of curves with Kropina's zeroes in the derivatives are given.

If the reader felt more comfortable, he/she could redefine A by adding $\{0_p : p \in M_{mild}\}$ with no harm. In the part of spacetimes, the so redefined subset A could be interpreted as the set which contains the projections of all the (future-directed) timelike vectors, and $A \cup A_E$ as the set which contains the projections of the causal vectors. However, the reader should take into account that the fundamental tensor of a pseudo-Finsler metric is not well-defined in the zero section.

(3) Recall that (7) also yields

$$\ell_F(\gamma|_{[a',b']}) \leq b' - a' \leq \ell_{F_l}(\gamma|_{[a',b']}) \quad (8)$$

for all $a \leq a' < b' \leq b$. We will use other natural properties (as the fact that the concatenation of two wind curves γ_1, γ_2 such that $\gamma_1(b_1) = \gamma_2(a_2)$ is another wind curve) with no further mention.

Example 2.20. Let \mathbb{R}^2 be endowed with the Kropina norm $F(x, y) = (x^2 + y^2)/x$ defined in $A = \{(x, y) \in \mathbb{R}^2 : x > 0\}$. Then the curve $\alpha : [0, 1] \rightarrow \mathbb{R}^2$, $\alpha(t) = (t^2, t^3)$, satisfies that $\dot{\alpha}(0) = (0, 0)$ and $\lim_{t \rightarrow 0} F(\dot{\alpha}(t)) = 0$. Clearly, the reparametrization of this curve as an F -unit curve is not differentiable at $t = 0$. In fact, this kind of curves was excluded in the mild region. However, consider the indicatrix of F as a curve, take the part which is Σ -admissible and reparametrize it as an F -unit curve. In such a way, you get a curve $\gamma : [a, b] \rightarrow \mathbb{R}^2$ whose derivative is zero in the two end-points, but with $F \circ \dot{\gamma}$ constantly equal to 1. This second kind of curves is the main reason for including the zero in the Kropina region in the domains of F and F_l . Observe that if you want to exclude the first kind of curves, it is enough to require the continuity of $F \circ \dot{\gamma}$ in the definition of wind curves in every smooth piece.

Let $x_0, x_1 \in M$ and let us denote by C_{x_0, x_1}^Σ (resp.⁴ C_{x_0, x_1}^A) the set of the wind curves (resp. F -wind curves) from x_0 to x_1 (each curve γ defined in a possibly different interval $[a_\gamma, b_\gamma]$).

Definition 2.21. Let $x_0 \in M$ and $r \geq 0$. The *forward* (resp. *backward*) *wind balls* associated with the wind Finslerian structure Σ are:

$$B_\Sigma^+(x_0, r) = \{x \in M : \exists \gamma \in C_{x_0, x}^\Sigma, \text{ s.t. } r = b_\gamma - a_\gamma \text{ and } \ell_F(\gamma) < r < \ell_{F_l}(\gamma)\},$$

$$B_\Sigma^-(x_0, r) = \{x \in M : \exists \gamma \in C_{x, x_0}^\Sigma, \text{ s.t. } r = b_\gamma - a_\gamma \text{ and } \ell_F(\gamma) < r < \ell_{F_l}(\gamma)\}.$$

Moreover, the (forward, backward) *c-balls* are defined as:

$$\hat{B}_\Sigma^+(x_0, r) = \{x \in M : \exists \gamma \in C_{x_0, x}^\Sigma, \text{ s.t. } r = b_\gamma - a_\gamma \text{ (so, } \ell_F(\gamma) \leq r \leq \ell_{F_l}(\gamma)\}\},$$

$$\hat{B}_\Sigma^-(x_0, r) = \{x \in M : \exists \gamma \in C_{x, x_0}^\Sigma, \text{ s.t. } r = b_\gamma - a_\gamma \text{ (so, } \ell_F(\gamma) \leq r \leq \ell_{F_l}(\gamma)\}\}$$

for $r > 0$ and, by convention for $r = 0$, $\hat{B}_\Sigma^\pm(x_0, 0) = x_0$.

Remark 2.22. Recall that, consistently with our conventions, if $0_{x_0} \in \Sigma_{x_0}$ then $x_0 \in \hat{B}_\Sigma^\pm(x, r)$ for all $r \geq 0$ (this will be interpreted naturally in the description of the causal future of a point in an SSTK see, e.g. Proposition 5.1).

Moreover, when the wind Finslerian structure comes from a Finsler one (i.e. $0 \in B_p$, for all $p \in M$ and $F_l(v) = +\infty$, for all $v \in A = TM \setminus \mathbf{0}$) the sets $B_\Sigma^+(x_0, r)$ and $B_\Sigma^-(x_0, r)$ simply coincide with the standard forward and backward open balls centred at x_0 (notice that, in this case, our conventions lead to prove the inclusion $x_0 \in \hat{B}_\Sigma^\pm(x_0, r)$ for $r > 0$ by using arbitrarily short loops with non-vanishing velocity; such loops can be chosen smooth, rather than piecewise smooth, in dimension $m > 1$).

Nevertheless, $\hat{B}_\Sigma^+(x_0, r)$ and $\hat{B}_\Sigma^-(x_0, r)$ do not coincide in general with the closures $\bar{B}_\Sigma^+(x_0, r)$ and $\bar{B}_\Sigma^-(x_0, r)$. This may occur even when Σ comes from a Riemannian metric (in $\mathbb{R}^2 \setminus \{(1, 0)\}$, $\hat{B}_\Sigma^+(0, 2)$ is not closed); another simple example (using a strong wind Minkowskian structure) can be seen in Fig. 3. In fact, as we will see, the closedness of the c-balls will be related with the convexity of the manifold.

The next three propositions provide a better understanding of $\hat{B}_\Sigma^\pm(x_0, r)$. Before them, we will prove a technical lemma, which stresses the importance of transversality (recall Remark 2.14).

Lemma 2.23. *Let Σ be a wind Finslerian structure on M and $p \in M$ such that $0_p \in \Sigma_p$, and let $\gamma : (-\varepsilon, \varepsilon) \rightarrow M$ be a smooth F -admissible curve such that $\gamma(0) = p$. Then, reducing ε if necessary, the surface*

$$T_\gamma = \{\lambda \dot{\gamma}(s) : \lambda \in \mathbb{R}, s \in (-\varepsilon, \varepsilon)\}$$

is embedded in TM and it is transverse to Σ . Moreover, if ε is small enough, a smooth function $(-\varepsilon, \varepsilon) \ni s \mapsto \lambda(s) \in \mathbb{R}$ is obtained by requiring that each $\lambda(s) \dot{\gamma}(s)$ be the point in $\Sigma_{\gamma(s)} \cap T_\gamma = \{\lambda_1 \dot{\gamma}(s), \lambda_2 \dot{\gamma}(s)\}$ with smaller $|\lambda_i|$, $i = 1, 2$.

⁴In the case of a conic pseudo-Finsler metric F , these curves must satisfy both, their velocities $\dot{\gamma}$ lie in A and $F(\dot{\gamma}) \leq 1$. This last restriction is not relevant for such metrics and, so, it was not imposed for C_{x_0, x_1}^A in [40]. Here, we avoid to use a different notation, and the reader can assume that this restriction holds (or not) for conic pseudo-Finsler metrics, with no harm.

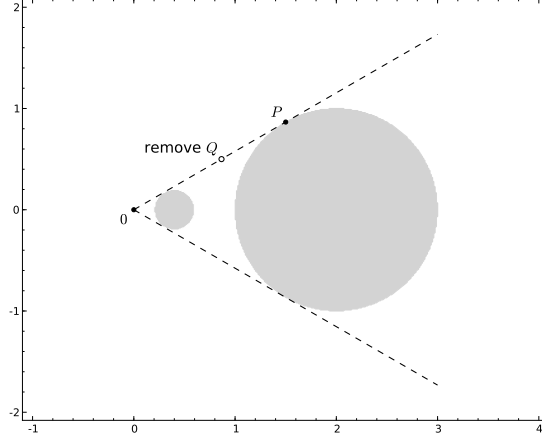

FIGURE 3. A wind Minkowskian structure Σ in $\mathbb{R}^2 \setminus \{Q\}$. The shaded regions represent the wind balls $B_{\Sigma}^{+}(0, 1/5)$ and $B_{\Sigma}^{+}(0, 1)$ which satisfy $\hat{B}_{\Sigma}^{+}(0, 1/5) = \bar{B}_{\Sigma}^{+}(0, 1/5)$ but $P \in \bar{B}_{\Sigma}^{+}(0, 1) \setminus \hat{B}_{\Sigma}^{+}(0, 1)$.

Proof. Clearly, T_{γ} is embedded and it cuts Σ transversely in two points because $\dot{\gamma}(s) \in A$ for every $s \in (-\varepsilon, \varepsilon)$ (with $\varepsilon > 0$ small enough). So, T_{γ} fulfils the required property of transversality and, moreover, $\Sigma \cap T_{\gamma}$ is composed by two connected one-dimensional smooth submanifolds ρ_1 , which contains 0_p , and ρ_2 . The parameter s of γ can be chosen as a natural coordinate for ρ_1 . In this coordinate, the inclusion of ρ_1 in TM is the smooth map $s \mapsto \lambda(s)\dot{\gamma}(s)$, so that the map λ is smooth. \square

Proposition 2.24. *With the above notation:*

- (i) *Let (M, Σ) , $p \in M$, $0_p \in \Sigma_p$ and $\gamma : (-\varepsilon, \varepsilon) \rightarrow M$, $\gamma(0) = p$, smooth and F -admissible, as in the previous lemma. Then, $\ell_{F_l}(\gamma|_{[0, \varepsilon']}) = +\infty$ for all $0 < \varepsilon' \leq \varepsilon$. As a consequence, for each $r_0 > 0$ there exists $\varepsilon_0 \leq \varepsilon$ such that $\gamma((0, \varepsilon_0]) \subset B_{\Sigma}^{+}(p, r)$ for all $r \geq r_0$.*
- (ii) *If a smooth curve $\gamma : [a, b] \rightarrow M$ is Σ -admissible and strictly regular, then $F \circ \dot{\gamma}$ and $F_l \circ \dot{\gamma}$ are continuous (the latter as a map from $[a, b]$ to $(0, +\infty]$).*
- (iii) *A Σ -admissible curve $\gamma : [a, b] \rightarrow M$ satisfies $\ell_{F_l}(\gamma) = +\infty$ if $F_l(\dot{\gamma}(s_0)) = +\infty$ at some $s_0 \in [a, b]$. The converse holds when γ is strictly regular.*

Proof. (i) Choose any sequence $\varepsilon_k \searrow 0$ in $(0, \varepsilon)$. Clearly, we have $\gamma(\varepsilon_k) \rightarrow p$ and $\ell_F(\gamma|_{[0, \varepsilon_k]}) \searrow 0$; so, it is enough to prove $\ell_{F_l}(\gamma|_{[0, \varepsilon_k]}) = +\infty$ for all k . From the definition of $\lambda(s)$ in Lemma 2.23 and F_l , we have

$$F_l(\dot{\gamma}(s)) = \begin{cases} 1/\lambda(s) & \text{if } \lambda(s) > 0 \\ +\infty & \text{if } \lambda(s) \leq 0 \end{cases} \quad (9)$$

As $\lambda(0) = 0$ and λ is smooth around 0

$$\int_0^{\varepsilon_k} \frac{ds}{\lambda(s)} = +\infty,$$

and all the assertions follow directly.

(ii) Observe that $F \circ \dot{\gamma}$ is always continuous in this case and $F_l \circ \dot{\gamma}$ can be discontinuous in $s_0 \in [a, b]$, only when $\gamma(s_0)$ belongs to M_{crit} . Moreover, in this case,

γ has to be F -admissible in a neighborhood of s_0 because it is smooth and strictly regular. Then applying Lemma 2.23 in order to get (9) to the reparametrization $\tilde{\gamma}(s) = \gamma(s - s_0)$, we conclude.

(iii) Necessarily, $\gamma(s_0)$ must belong either to M_{crit} , and the part (i) applies (recall that, being $F_l(\dot{\gamma}(s_0)) = +\infty$, $\dot{\gamma}(s_0) \in A_{\gamma(s_0)}$ and γ must be F -admissible and smooth in a right or a left neighborhood of s_0), or to M_{mild} and $F_l(\dot{\gamma}) = +\infty$ in some neighbourhood of s_0 . For the converse, notice that at least one of the smooth pieces of γ has to be of infinite F_l -length then, necessarily, $F_l(\dot{\gamma}(s_0)) = +\infty$ for at least one point $s_0 \in [a, b]$ otherwise the F_l -length of a such a piece would be finite by part (ii). \square

Remark 2.25. (1) F -admissible curves are always strictly regular Σ -admissible ones. For these curves, $\ell_{F_l}(\gamma)$ may be infinite even in the case of an F -admissible curve contained in M_l except at one endpoint, see Proposition 2.24. The role of strict regularity becomes apparent from the discussion in Convention 2.17 (see also Prop. 2.26 below).

(2) For any Σ -admissible curve, Proposition 2.10 and Convention 2.17 imply,

$$\ell_F(\gamma) \leq \ell_{F_l}(\gamma) \quad (10)$$

with equality iff $\dot{\gamma}(s) \in A_E \setminus A$. Moreover, for a wind curve satisfying the equality in (10), $F_l(\dot{\gamma}) = F(\dot{\gamma}) \equiv 1$ everywhere.

Wind curves will become the natural ones for our approach, while regularity may be an interesting additional property. Notice that these curves are a subclass of Σ -admissible curves but, as a relevant difference, wind curves depend on reparametrizations. However, the following result suggests that this is not a relevant restriction, at least when the velocities do not vanish; it also provides a control on the possible reparametrizations.

Proposition 2.26. *Let γ be a smooth Σ -admissible curve with $F \circ \dot{\gamma}$ continuous and $F_l \circ \dot{\gamma}$ which is infinite at some point or continuous. Then, γ admits a reparametrization $\tilde{\gamma} : [0, r_0] \rightarrow M$ as a wind curve and, necessarily then, $\ell_F(\gamma) \leq r_0 \leq \ell_{F_l}(\gamma)$. Moreover, r_0 can be chosen equal to any value of $[\ell_F(\gamma), \ell_{F_l}(\gamma)]$ if $\ell_{F_l}(\gamma) < +\infty$, and, any value of $[\ell_F(\gamma), +\infty)$ otherwise. In particular, this applies for any strictly regular Σ -admissible curve and, therefore, for any F -admissible curve.*

Proof. Put $\tilde{\gamma}(r) = \gamma(s(r))$. The reparametrization $s(r)$ as a wind curve is characterized by

$$F(\dot{\tilde{\gamma}}(s(r)))\dot{s}(r) \leq 1 \leq F_l(\dot{\tilde{\gamma}}(s(r)))\dot{s}(r).$$

As $F \circ \dot{\gamma}$ is continuous, we can first reparametrize γ with $F(\dot{\gamma}) \equiv 1$. Clearly, this gives also a parametrization of γ as a wind curve. In order to prove the last part of the proposition let us distinguish three cases:

(a) If $F_l(\dot{\gamma}) < +\infty$ at all the points then, by assumptions, $F_l \circ \dot{\gamma}$ is continuous and the family of reparametrizations, defined by $\dot{r}_\lambda(s) = \lambda F_l(\dot{\gamma}(s)) + (1 - \lambda)F(\dot{\gamma}(s))$, $\lambda \in [0, 1]$, is enough to obtain all the required values of r_0 .

(b) If $F_l(\dot{\gamma}(\bar{s})) = +\infty$, for some $\bar{s} \in [a, b]$, and $F_l \circ \dot{\gamma}$ is continuous (as a map assuming values in $(0, +\infty]$) everywhere, then, by Proposition 2.24-(iii), $\ell_{F_l}(\gamma) = +\infty$ and the conclusion follows modifying the expression of \dot{r}_λ in case (a) by substituting

$F_l(\dot{\gamma}(s))$ with $\varphi_\lambda(F_l(\dot{\gamma}(s)))$, $\lambda \in [0, 1]$, where:

$$\varphi_\lambda(t) = \begin{cases} t & \text{if } t \leq 1/(1-\lambda) \\ \phi_0(t - 1/(1-\lambda)) + 1/(1-\lambda) & \text{if } t \in (1/(1-\lambda), 2 + 1/(1-\lambda)) \\ 1 + 1/(1-\lambda) & \text{if } t \geq 2 + 1/(1-\lambda) \end{cases}$$

being $\phi_0 : [0, 2] \rightarrow [0, 1]$ any curve with $\phi_0(t) \leq t$, $t \in [0, 2]$ that connects smoothly the graphs of $t \mapsto t$ for $t \leq 0$ and of $t \mapsto 1$ for $t \geq 2$, and recalling that we have assumed $F(\dot{\gamma}) = 1$.

(c) Finally, if $F_l(\dot{\gamma}(\bar{s})) = +\infty$, for some $\bar{s} \in [a, b]$, then γ must be strictly regular in a neighbourhood $[a', b']$ of \bar{s} and then, by Proposition 2.24-(ii), $F_l \circ \dot{\gamma}$ must be continuous in $[a', b']$. Therefore, as in case (b), we can change the parametrization of γ only on the interval $[a', b']$ to get all the values $r_0 \in [\ell_F(\gamma), +\infty)$ also in this case. \square

Remark 2.27. Clearly, Proposition 2.26 holds also for a piecewise smooth curve γ if the hypotheses are satisfied in each interval where γ is smooth. In this case, the reparametrization as a wind curve is only piecewise smooth.

Proposition 2.28. *For any wind Finslerian structure Σ and $r > 0$:*

$$\begin{aligned} B_\Sigma^+(x_0, r) &\subset \hat{B}_\Sigma^+(x_0, r) \subset \bar{B}_\Sigma^+(x_0, r), \\ B_\Sigma^-(x_0, r) &\subset \hat{B}_\Sigma^-(x_0, r) \subset \bar{B}_\Sigma^-(x_0, r). \end{aligned}$$

Thus, the closures of $B_\Sigma^\pm(x, r)$ and $\hat{B}_\Sigma^\pm(x, r)$ are equal.

Proof. The first inclusions follow trivially from the definitions. Let $x \in \hat{B}_\Sigma^+(x_0, r)$ and consider a wind curve $\gamma : [a, b] \rightarrow M$ from x_0 to x such that $\ell_F(\gamma) \leq r = b - a \leq \ell_{F_l}(\gamma)$. If the two inequalities held strictly, there would be nothing to prove. Otherwise, consider the following cases:

(a) $\ell_F(\gamma) = r = \ell_{F_l}(\gamma)$ (in particular, $\dot{\gamma}(s) \in A_E \setminus A$ for all s and $F(\dot{\gamma}) \equiv 1$, recall Remark 2.25(2)). Choose any F -admissible vector field V such that $F(V) \equiv 1$ defined in some neighborhood U of x ; notice that the integral curves of V are wind curves. Take a smaller neighborhood U' and some $\varepsilon > 0$ so that the flow of V is defined in $[0, \varepsilon] \times U'$ and $\gamma([b - \varepsilon, b]) \subset U'$. Choose $\{s_n\} \nearrow b$ and consider the curve γ_n obtained by concatenating $\gamma|_{[a, s_n]}$ and the integral curve $\rho_n : [0, \varepsilon_n] \rightarrow M$ of V starting at $\gamma(s_n)$, where $\varepsilon_n := b - s_n > 0$. By construction, $\ell_F(\rho_n) = \varepsilon_n = \ell_F(\gamma|_{[b - s_n, b]})$ and $\ell_F(\gamma_n) = r < \ell_{F_l}(\gamma_n)$. So, choosing some close $\varepsilon'_n < \varepsilon_n$, the lengths of the corresponding restriction of γ_n allow us to write $\rho_n(\varepsilon'_n) \in B_\Sigma^+(x_0, r)$ and $\rho_n(\varepsilon'_n) \rightarrow x$, as required.

(b) $\ell_F(\gamma) = r < \ell_{F_l}(\gamma)$. Just notice that the points $\gamma(b - \varepsilon)$ will belong to $B_\Sigma^+(x_0, r)$ for small ε .

(c) $\ell_F(\gamma) < r \leq \ell_{F_l}(\gamma)$. Extending γ beyond b by concatenating an F -admissible piece, the points in the extension close to x will belong to $B_\Sigma^+(x_0, r)$. \square

Finally, an interpretation of the c-balls is provided for the classical Finsler case. Notice that, in this case, the restriction for a piecewise smooth curve to be ‘‘wind’’ is just to assume that its speed is not bigger than 1 (in order to travel not faster than the maximum allowed speed) and the velocity not to be 0 (by convenience, see Remark 2.19 (3)); so, there are no relevant restrictions from a practical viewpoint.

Proposition 2.29. *Let (M, F) be a connected Finsler manifold and Σ its indicatrix, regarded as a wind Finslerian structure with forward and backward balls $B_F^+(x_0, r)$ ($= B_\Sigma^+(x_0, r)$) and $B_F^-(x_0, r)$ ($= B_\Sigma^-(x_0, r)$). The following assertions are equivalent:*

- (i) $\hat{B}_\Sigma^+(x_0, r) = \bar{B}_F^+(x_0, r)$ for all $x_0 \in M, r > 0$.
- (ii) $\hat{B}_\Sigma^-(x_0, r) = \bar{B}_F^-(x_0, r)$ for all $x_0 \in M, r > 0$.
- (iii) (M, F) is (geodesically) convex, i.e., any pair of points (p, q) can be connected by a geodesic of length equal to the Finsler distance $d_F(p, q)$.

Proof. We will consider only the equivalence between (i) and (iii), as the convexity of F is equivalent to the convexity of its reverse metric \tilde{F} .

(iii) \Rightarrow (i). Otherwise, there exists some $x_1 \in \bar{B}_F^+(x_0, r) \setminus \hat{B}_\Sigma^+(x_0, r)$ and, by the continuity of the distance, $d_F(x_0, x_1) = r$. But no curve of length equal to r can join these points, which contradicts geodesic convexity.

(i) \Rightarrow (iii). Straightforward from the definitions (recall that when the wind Finslerian structure is Finsler, $F_l = +\infty$ and a minimizing curve must be a geodesic). \square

2.4. Geodesics. We aim now to introduce a notion of geodesic for a wind Finslerian structure which recovers the standard one for F and F_l . As the radius corresponding to each $v \in \Sigma \cap (A_E \setminus A)$ is not transversal to Σ , Σ does not carry a globally defined smooth contact form such that the flow of its associated Reeb vector field is compatible with the geodesic flow of both F and F_l (compare with [14, Section 2]). Thus, we start by defining extremizing geodesics of Σ by unifying local extremizing properties of both type of geodesics as follows.

Definition 2.30. Let (M, Σ) be a wind Finslerian manifold. A wind curve $\gamma : [a, b] \rightarrow M$, $a < b$, is called a *unit extremizing geodesic* if

$$\gamma(b) \in \hat{B}_\Sigma^+(\gamma(a), b-a) \setminus B_\Sigma^+(\gamma(a), b-a). \quad (11)$$

We will say that γ is an *extremizing geodesic* (resp. *pregeodesic*) if it is an affine (resp. arbitrary, according to the end of Convention 2.17) reparametrization of a unit extremizing geodesic.

Some elementary properties of these geodesics are the following.

Proposition 2.31. *Let (M, Σ) be a wind Finsler structure.*

- (i) *If γ is a unit extremizing geodesic of (M, Σ) , then:*
 - (a) *its restriction $\gamma|_{[a', b']}$ to any subinterval $[a', b]$, $a \leq a' < b' \leq b$ is also a unit extremizing geodesic. In particular,*

$$\gamma(t) \in \hat{B}_\Sigma^+(\gamma(a), t-a) \setminus B_\Sigma^+(\gamma(a), t-a)$$

for every $t \in [a, b]$;

- (b) *at least one of the following two properties holds:*

$$\gamma(b) \notin B_\Sigma^+(\gamma(a), \ell_F(\gamma)), \quad (12)$$

$$\gamma(b) \notin B_\Sigma^+(\gamma(a), \ell_{F_l}(\gamma)) \quad (\text{with } \ell_{F_l}(\gamma) < +\infty). \quad (13)$$

Moreover, in the first case, $F(\dot{\gamma}) \equiv 1$ everywhere and in the second $F_l(\dot{\gamma}) \equiv 1$ everywhere.

- (ii) If a wind curve γ satisfies (12) (resp. (13)), then this same property holds for the restriction $\gamma|_{[a',b']}$. Moreover, if γ is also strictly regular or, more generally, it satisfies the hypotheses in Proposition 2.26, then it is an extremizing pregeodesic.
- (iii) If a constant curve $\gamma_{x_0}(t) = x_0$ for all $t \in [a, b]$ is a (unit) extremizing geodesic then $x_0 \in M_{crit}$. In this case, γ_{x_0} will be called an extremizing exceptional geodesic.

Proof. (i) For (a), assume by contradiction that (11) is violated in a subinterval so that $\gamma(b') \in B_{\Sigma}^+(\gamma(a'), b' - a')$ (recall that (8) holds). So, there will exist a wind curve $\tilde{\gamma} : [a', b'] \rightarrow M$ satisfying both strict inequalities in (8), and so will do the concatenation $\gamma_1 : [a, b] \rightarrow M$ of $\gamma|_{[a,a']}$, $\tilde{\gamma}$ and $\gamma|_{[b,b']}$ defined as

$$\gamma_1(t) = \begin{cases} \gamma(t) & \text{if } t \in [a, b] \setminus [a', b'], \\ \tilde{\gamma}(t) & \text{if } t \in [a', b'], \end{cases}$$

in contradiction with (11) (for all the interval $[a, b]$).

For (b), notice that by the assumptions,

$$\gamma(b) \notin B_{\Sigma}^+(\gamma(a), b - a) \quad (14)$$

and $\ell_F(\gamma) \leq b - a \leq \ell_{F_i}(\gamma)$. Moreover (14) implies that at least one of the inequalities must be an equality; so, replace $b - a$ with $\ell_F(\gamma)$ or $\ell_{F_i}(\gamma)$ in (14). For the last assertion, observe that, among the points where $F \circ \dot{\gamma}$ and $F_i \circ \dot{\gamma}$ can be different from 1, they are continuous except in the (finite set of) breaks.

(ii) The curve $\tilde{\gamma}$ which shows that (12) (resp. (13)) does not hold for $\gamma|_{[a',b']}$, can be concatenated (as in (a) above) to obtain the contradiction that neither this property could hold for γ .

For the last assertion, reparametrize γ as a wind curve with domain $[0, \ell_F(\gamma)]$ or $[0, \ell_{F_i}(\gamma)]$, (see Prop. 2.26), and (11) must hold.

(iii) By our conventions, γ_{x_0} is Σ -admissible only when $x_0 \in M_{crit}$. \square

Proposition 2.31 (i)-(b) suggests that extremizing pregeodesics satisfy minimization or maximization properties. Let us introduce a natural variational setting. Let $\gamma : [a, b] \rightarrow M$ be a wind curve between x_0 and x_1 , and assume that $\{a = t_0 \leq \dots \leq t_n = b\}$ is a subset of the interval $[a, b]$ such that $\gamma|_{[t_{i-1}, t_i]}$ is smooth, for each $i \in \{1, \dots, n\}$. A (proper) wind variation of γ is a continuous map $\psi : (-\varepsilon, \varepsilon) \times [a, b] \rightarrow M$, such that $\psi = \psi(s, t)$ is a C^2 map on $(-\varepsilon, \varepsilon) \times [t_{i-1}, t_i]$, $\psi(0, \cdot) = \gamma$ and for each $s \in (-\varepsilon, \varepsilon)$, $\psi_s := \psi(s, \cdot) \in C_{x_0, x_1}^{\Sigma}$. A wind variation will be said an F -wind variation if $\psi_s \in C_{x_0, x_1}^A$, for each $s \in (-\varepsilon, \varepsilon) \setminus \{0\}$. Observe that any wind variation of an F -wind curve must be F -wind (reducing ε if necessary). Notice that all the curves ψ_s must be defined in the same interval $[a, b]$; this will be emphasized by writing $C_{x_0, x_1}^{\Sigma}[a, b] := \{\gamma \in C_{x_0, x_1}^{\Sigma} : \gamma \text{ is defined on } [a, b]\}$, and analogously $C_{x_0, x_1}^A[a, b]$.

The wind restriction for a variation may be somewhat subtle. Consider, for example, the case in that the wind Finsler manifold is just a Riemannian one, and one is looking for wind variations ψ of a unit extremizing geodesic $\gamma : [a, b] \rightarrow M$. Of course, such geodesics are just the minimizing geodesics for the Riemannian manifold parametrized by arc length. For the variation ψ we must impose $F(\psi_s) \leq 1$, and $\ell_F(\psi_s) \leq \ell_F(\gamma)$. So, a non-trivial wind variation can exist only when $\gamma(b)$ is the first conjugate point of γ . The non-existence of such a variation before the first

conjugate point means implicitly that γ minimizes strictly among nearby curves. Of course, one can consider also geodesics parametrized at a different speed c : in the case $c < 1$ wind variations are equal to classical variations but, in the case $c > 1$, the geodesic is not a wind curve and, so, no wind variation is defined.

In general, Proposition 2.26 ensures that, when the curve is strictly regular (resp. F -admissible), the only relevant condition for the variations will be that each ψ_s is Σ - (resp. F -)admissible and we can speak accordingly on Σ or F -admissible variations.

The following result suggests that the question of maximization / minimization becomes somewhat subtle.

Lemma 2.32. *Let $\gamma \in C_{x_0, x_1}^\Sigma[a, b]$ be a unit extremizing geodesic satisfying (12), hence $\ell_F(\gamma) = b - a \leq \ell_{F_l}(\gamma)$. If there exists a wind curve $\alpha \in C_{x_0, x_1}^\Sigma[a, b]$ s.t. $\ell_F(\alpha) < \ell_F(\gamma)$ then α is a unit extremizing geodesic satisfying (13) but not (12), i.e.:*

$$\ell_F(\alpha) < \ell_F(\gamma) = b - a = \ell_{F_l}(\alpha) \leq \ell_{F_l}(\gamma).$$

Proof. Being α a wind curve, (8) holds and, so, $b - a = \ell_{F_l}(\alpha)$ because, otherwise, $x_1 \in B_\Sigma^+(x_0, b - a)$. \square

Of course, a dual version of the result holds for the case that γ satisfies (13).

Example 2.33. We emphasize that such an α can exist in some particular cases. In fact, notice first that, for any wind Minkowskian norm Σ on \mathbb{R}^n , the unit extremizing geodesics are the straight lines with velocity constantly equal to any vector of Σ . Now, consider a strong wind Minkowskian example (\mathbb{R}^2, Σ) obtained by the displacement of the usual unit sphere by the (constant) vector $(2, 0)$, and construct a wind Finslerian cylinder $(S^1 \times \mathbb{R}, \Sigma)$ by identifying each (x, y) with $(x + 1, y)$, see Fig. 4. Choose the Minkowskian wind c -ball $\hat{B}_\Sigma^+((0, 0), r_0) \subset \mathbb{R}^2$ with radius $r_0 = 1/2$. As the natural Euclidean diameter (as a subset of the Euclidean space \mathbb{R}^2) of $\hat{B}_\Sigma^+((0, 0), r_0)$ is 1, its projection in $S^1 \times \mathbb{R}$ identifies the points $p_1 = (1/2, 0), p_2 = (3/2, 0)$ in a single one p_C . Then, the univocally determined unit extremizing geodesics $\beta_1, \beta_2 : [0, r_0] \rightarrow \mathbb{R}^2$ from $(0, 0)$ to p_1, p_2 (resp.), project onto geodesics of $S^1 \times \mathbb{R}$ which play the role of α and γ in Lemma 2.32.

That is, extremizing geodesics are either global minimizers of ℓ_F or global maximizers of ℓ_{F_l} on $C_{x_0, x_1}^\Sigma[a, b]$ except when a curve α as above appears. However, one can check that such a curve cannot appear among nearby geodesics in the following sense.

Proposition 2.34. *Let γ be a unit extremizing geodesic between x_0 and x_1 . Then, one of the following exclusive alternatives holds:*

- (i) $\ell_F(\gamma) < \ell_{F_l}(\gamma)$ and $x_1 \notin B_\Sigma^+(x_0, \ell_F(\gamma))$ or, equally, $\ell_F(\gamma) = b - a < \ell_{F_l}(\gamma)$. Then γ minimizes the length functional of F between the curves ψ_s defined by any wind variation $\psi : (-\epsilon, \epsilon) \times [a, b] \rightarrow M$ of γ for $|s|$ sufficiently small ($0 \leq |s| < \epsilon'$ for some $\epsilon' \leq \epsilon$). In this case γ will be called a minimizing unit geodesic.
- (ii) $\ell_F(\gamma) < \ell_{F_l}(\gamma) < +\infty$ and $x_1 \notin B_\Sigma^+(x_0, \ell_{F_l}(\gamma))$ or, equally, $\ell_F(\gamma) < b - a = \ell_{F_l}(\gamma)$. Then, γ maximizes the length functional of F_l in a sense analogous to (i) above. In this case, γ will be called a maximizing unit geodesic.

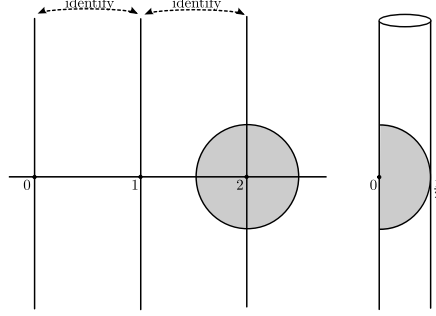

FIGURE 4. A wind Finslerian cylinder $(S^1 \times \mathbb{R}, \Sigma)$. The shaded region represents the c-ball $\hat{B}_\Sigma^+((0, 0), 1/2)$

(iii) $\ell_F(\gamma) = \ell_{F_l}(\gamma)$ (necessarily equal to $b - a$). Then, both (12) and (13) hold, and the velocity of γ lies in $A_E \setminus A_l$. In this case, γ will be called a boundary unit geodesic.

Moreover, the restriction of γ to any closed subinterval $[a', b']$ of $[a, b]$ also satisfies the same type of extremizing property (i), (ii), (iii) as above (minimization, maximization or velocity in $A \setminus A_l$ as the original γ).

Proof. The distinction of cases comes from Proposition 2.31.

(i) Assume, by contradiction, that there exists a wind variation of γ such that for some sequence $s_n \rightarrow 0$, $\ell_F(\psi_{s_n}) < \ell_F(\gamma)$, for each $n \in \mathbb{N}$. By Lemma 2.32, $\ell_{F_l}(\psi_{s_n}) = b - a$ and, thus, $F_l(\dot{\psi}_{s_n}) \equiv 1$ (recall Proposition 2.31 (i) – (b)). As $\{\psi_{s_n}(t)\}_n \rightarrow \dot{\gamma}(t)$ for all t , and F_l is continuous away from $\mathbf{0}$ (but, there, its value is equal to 1 too) then $F_l(\dot{\gamma}) \equiv 1$. As a consequence, a contradiction with the inequality in the lengths of γ appears.

(ii) Analogous to part (i).

For (iii) use part (2) of Remark 2.25. For the last assertion, recall the parts (i) and (ii) of Proposition 2.31. □

Remark 2.35. (1) Notice that if γ is an F -admissible geodesic then it minimizes ℓ_F or maximizes ℓ_{F_l} among the curves of any variation ψ (which, in this case, is necessarily made by F -admissible curves). In fact, any proper variation of γ by F -admissible curves can be reparametrized as a variation by wind curves all of them defined on the same interval (recall Proposition 2.26).

(2) Implicitly, these minimization and maximization properties of the geodesics come, essentially, resp., from a triangle inequality for F (which relies on the convexity of its indicatrix, see [40, Remark 2.9]) and from a reverse triangle inequality for F_l (which can be proved in a similar way than the reverse triangle inequality for a Lorentzian metric by using the concaveness of the indicatrix). However, it is not explicitly necessary at this point.

(3) Accordingly to previous definitions, we say now that an extremizing geodesic (resp. pregeodesic) is *minimizing*, *maximizing* or *boundary* if it can be

reparametrized as a unit extremizing geodesic satisfying (resp.) (i), (ii) or (iii) in Proposition 2.34. However, notice that the same geodesic can admit two different reparametrizations, one as a minimizing unit geodesic and the other as a maximizing one, so that the possibilities (i) and (ii) are not exclusive.

For example, this will happen for all the Σ -admissible straight lines of a strong wind Minkowskian structure regarded as a wind Finslerian structure. In fact, the straight lines starting at the origin and tangent to the indicatrix determine the boundary geodesics, where both equalities (12) and (13) hold, as the F - and F_l -lengths coincide for each one of them. The straight lines inside this cone also satisfy (12) and (13), even though these lengths are now different, and they consequently admit two different parametrizations as unit geodesics, one with $F(\dot{\gamma}) \equiv 1$ (minimizing) and the other one with $F_l(\dot{\gamma}) \equiv 1$ (maximizing). Notice also that a more classical approach also shows that such lines minimize locally for *any* conic Finsler norm F (see [40, Section 3.4]), and an analogous reasoning shows that they maximize locally for *any* Lorentzian norm.

Finally, we arrive at the following definition of geodesic.

Definition 2.36. Let $I \subset \mathbb{R}$ be an interval. We say that a curve $\gamma : I \rightarrow M$ is a *unit geodesic of the wind Finslerian structure* (M, Σ) if, locally, it is a unit extremizing geodesic, namely, for every $t \in I$ there exists $\varepsilon > 0$ such that $\gamma|_{[t-\varepsilon, t+\varepsilon] \cap I}$ is a unit extremizing geodesic. We will say that γ is a *geodesic (resp. pregeodesic)* of the wind Finslerian manifold (M, Σ) if it is an affine (resp. arbitrary) reparametrization of a unit geodesic. An *exceptional geodesic* is a constant curve γ_{x_0} which is locally an extremizing exceptional geodesic (according to Prop. 2.31(iii)).

Notice that when the interval I is open, $\varepsilon > 0$ can be chosen such that $[t - \varepsilon, t + \varepsilon] \subset I$ (in agreement with Definition 2.30), while if I is compact, the intersection with I must be taken properly in the endpoints.

Remark 2.35-(3) stresses that a (non-boundary extremizing) geodesic can satisfy simultaneously both (12) and (13) for different “radii”

$$r_1(t, \varepsilon) = \ell_F(\gamma|_{[t-\varepsilon, t+\varepsilon] \cap I}) \text{ and } r_2(t, \varepsilon) = \ell_{F_l}(\gamma|_{[t-\varepsilon, t+\varepsilon] \cap I}).$$

Thus, the names *boundary*, and *locally minimizing* or *maximizing* can be used only as non-exclusive possibilities.

Proposition 2.29 suggests the following general definition of convexity.

Definition 2.37. A wind Finslerian structure (M, Σ) is *w-convex* if for any $x_0 \in M$ and $r > 0$, both $\hat{B}_\Sigma^+(x_0, r)$ and $\hat{B}_\Sigma^-(x_0, r)$ are closed.

Definition 2.38. We say that a wind Finslerian structure is *forward (resp. backward) complete* if the domain of every inextendible geodesic is an interval of the type $(a, +\infty)$ with $a \geq -\infty$ (resp. $(-\infty, b)$ with $b \leq +\infty$).

Remark 2.39. Clearly, the reverse Finsler structure $\tilde{\Sigma} = -\Sigma$ satisfies:

$$B_\Sigma^+(x_0, r) = B_{-\Sigma}^-(x_0, r), \quad \hat{B}_\Sigma^+(x_0, r) = \hat{B}_{-\Sigma}^-(x_0, r).$$

So, it is w-convex iff so is Σ . Moreover, changing the orientation of a Σ -geodesic, a $\tilde{\Sigma}$ -geodesic is obtained. So, Σ is forward complete iff $\tilde{\Sigma}$ is backward complete.

As we use only “forward” balls for the definition of geodesics, these geodesics could also be named *forward geodesics* —and an analogous definition with backwards balls would give backward geodesics. Nevertheless, we will not need both

concepts (and speak only on geodesics) as the reverse parametrization of a forward geodesic is a backward one. In any case, the (geodesic) completeness of a wind Finslerian structure will be remarked as forward and backward completeness.

2.5. Link with geodesics of conic pseudo-Finsler metrics. We will say that a conic pseudo-Finsler metric is *non-degenerate* when the fundamental tensor defined in (4) is non-degenerate. In particular, by Proposition 2.3, the conic pseudo-Finsler metrics F and F_l associated with a wind Finslerian structure are non-degenerate. Our aim will be to justify that the non-boundary geodesics coincide with the geodesics for F or F_l . Now, on the one hand, the fundamental tensor of F_l is not positive definite and, on the other, the domains of F and F_l are only conic. So, we will make a brief study before arriving at Theorem 2.42.

Along this subsection, F will denote any non-degenerate conic pseudo-Finsler metric (with domain A), except if otherwise specified. Moreover, we will work with F -admissible vector fields and curves as in Definition 2.18-(i). The Cartan tensor of F is defined as:

$$C_v(w_1, w_2, w_3) = \frac{1}{4} \frac{\partial^3}{\partial s_3 \partial s_2 \partial s_1} F^2 \left(v + \sum_{i=1}^3 s_i w_i \right) \Big|_{s_1=s_2=s_3=0}$$

for $v \in A$ and $w_1, w_2, w_3 \in T_{\pi(v)}M$. Because of the non-degeneracy of g_v , it makes sense to consider the Chern connection and, thus, the formal Christoffel symbols that yield the geodesic equations. However, following [37, 58], it is especially convenient now to study it as a family of affine connections associated with F -admissible vector fields as follows.

Given an F -admissible vector field V on an open subset $\Omega \subset M$, we define ∇^V as the unique affine connection on Ω such that it is

- (1) *torsion-free*, namely,

$$\nabla_X^V Y - \nabla_Y^V X = [X, Y]$$

for every smooth vector fields X and Y on Ω ,

- (2) and *almost g -compatible*, namely,

$$X(g_V(Y, Z)) = g_V(\nabla_X^V Y, Z) + g_V(Y, \nabla_X^V Z) + 2C_V(\nabla_X^V V, Y, Z),$$

where X, Y and Z are smooth vector fields on Ω (recall that g is the fundamental tensor defined in (4)).

This approach to Chern connection is very suitable to compute the variations of the length and the energy functional as it was shown in [37, 58]. Given a chart $\varphi : \Omega \rightarrow \varphi(\Omega) \subset \mathbb{R}^m$, Ω open, $\varphi(p) = (x^1(p), x^2(p), \dots, x^m(p))$, we define the Christoffel symbols associated with φ and to the F -admissible vector field V , $\Gamma^k_{ij}(V)$, by means of the equation

$$\nabla_{\frac{\partial}{\partial x^i}}^V \left(\frac{\partial}{\partial x^j} \right) = \sum_{k=1}^m \Gamma^k_{ij}(V) \frac{\partial}{\partial x^k},$$

for $i, j = 1, \dots, m$. Observe that $\Gamma^k_{ij}(V)$ in $p \in \Omega$ depends only on V_p and not on the extension V (see for example [37, Proposition 2.6]) and therefore Γ^k_{ij} is a real function defined on $T\Omega \cap A$. Moreover, this connection induces a *covariant*

derivative with reference V along any curve $\gamma : [a, b] \rightarrow M$,

$$D_\gamma^V X = \sum_{i=1}^m \frac{dX^i}{dt} \frac{\partial}{\partial x^i} + \sum_{i,j,k=1}^m X^i \dot{\gamma}^j \Gamma_{ij}^k(V) \frac{\partial}{\partial x^k},$$

where (X^1, \dots, X^m) and $(\dot{\gamma}^1, \dots, \dot{\gamma}^m)$ are respectively the coordinates of X and $\dot{\gamma}$ in the coordinate basis of φ . Again, D_γ^V does not depend on the particular extension of V on a neighborhood of $\gamma([a, b])$; moreover, for any positive function λ on $[a, b]$ we have $\Gamma_{ij}^k(V) = \Gamma_{ij}^k(\lambda V)$, (see for example [37, Remark 2.4]). Then we define a geodesic of (M, F) as a (smooth) F -admissible curve $\gamma : [a, b] \rightarrow M$ satisfying the equation

$$D_\gamma^{\dot{\gamma}} \dot{\gamma} = 0. \quad (15)$$

As in the standard Finsler case, geodesics (resp. pregeodesics) are always critical points of the energy (resp. length) functional. Nevertheless, in order to ensure that a piecewise smooth curve which is a critical point of the energy (resp. length) functional becomes a geodesic (resp. pregeodesic), one should require that the Legendre transform is injective (the non-degeneracy of g_v implies that the Lagrangian $L = F^2/2$ is regular and thus, its Legendre transform is locally injective [1, Definition 3.5.8 and Proposition 3.5.10]), but global injectivity is naturally required to avoid problems in the breaks, see [42]). Nevertheless, this holds always in our case, as the following refinement of [62, Lemma 3.1.1] shows. Recall that the Legendre transform of F is defined as the fibre derivative of L . By homogeneity, it is shown that it coincides with the map $\mathcal{L}_F : A \rightarrow T^*M$, such that for every $v \in A$, $\mathcal{L}_F(v)$ is given by $\mathcal{L}_F(v)(u) = g_v(v, u)$, $u \in T_{\pi(v)}M$.

Proposition 2.40. *Let $F : A \rightarrow \mathbb{R}$ be a conic Finsler or a Lorentzian Finsler metric on a manifold M such that $A_p \cup \{0\}$ is a convex set for all $p \in M$. Then, its Legendre transform is injective (and, thus, a diffeomorphism onto its image).*

In particular, this happens for the conic Finsler metric and the Lorentzian Finsler metric associated with any wind Finslerian structure Σ .

Proof. Recall that by the hypotheses on A , the indicatrix of F at p , $(\Sigma_F)_p = \{v \in T_pM : F(v) = 1\}$, is a strongly convex hypersurface in T_pM (when F is a Lorentzian Finsler metric, this is understood in the sense that the opposite normal direction has been chosen in the computation of the second fundamental form). Hence if F is conic Finsler (resp. Lorentzian Finsler), the set $C_p = \{v \in A_p : F(v) \leq 1\} \cup \{0_p : \text{if } A_p = T_pM \setminus \{0\}\}$ (resp. $C_p = \{v \in A_p : F(v) \geq 1\}$) is convex. Assume by contradiction that there exist two different vectors $v_1, v_2 \in A$, such that $\mathcal{L}_F(v_1) = \mathcal{L}_F(v_2)$. Clearly, by homogeneity, v_1 and v_2 cannot be collinear. Then, the non-extreme points of the segment joining $v_1/F(v_1)$ and $v_2/F(v_2)$ are contained in the interior of C_p and the vector $v_1/F(v_1) - v_2/F(v_2)$ points outwards C_p in $v_1/F(v_1)$ but inwards in $v_2/F(v_2)$. This implies that $\mathcal{L}_F(v_1/F(v_1))(v_2/F(v_2) - v_1/F(v_1))$ and $\mathcal{L}_F(v_2/F(v_2))(v_2/F(v_2) - v_1/F(v_1))$ have different signs and so is, by homogeneity, for $\mathcal{L}_F(v_1)(v_2/F(v_2) - v_1/F(v_1))$ and $\mathcal{L}_F(v_2)(v_2/F(v_2) - v_1/F(v_1))$, a contradiction. \square

Let us denote by Ω_{x_0, x_1}^A the set of the piecewise smooth, F -admissible curves between x_0 and x_1 .

Lemma 2.41. *Assume that (M, F) is a non-degenerate pseudo-Finsler manifold, such that its Legendre transform \mathcal{L}_F is one-to-one. Then a curve $\gamma \in \Omega_{x_0, x_1}^A$ is a*

geodesic of (M, F) if and only if it is a critical point of the length functional and $F(\dot{\gamma})$ is constant.

Proof. Following the same lines as in [42, Proposition 3.1] we can deduce that a curve $\gamma \in \Omega_{x_0, x_1}^A$ is a critical point of the length functional if and only if it satisfies the equation

$$D_{\dot{\gamma}} \left(\frac{\dot{\gamma}}{F(\dot{\gamma})} \right) = 0, \quad (16)$$

on the interval $[a, b]$. Then any reparametrization σ of γ such that $F(\dot{\sigma}) = \text{const.}$ must be smooth and satisfy equation (15). \square

Theorem 2.42. *Let (M, Σ) be a wind Finslerian manifold and $\gamma : [a, b] \rightarrow M$ be a unit F -admissible geodesic of (M, Σ) . Then γ is a (unit) geodesic of one of the two conic pseudo-Finsler metrics associated with Σ .*

Proof. As γ is an F -admissible curve, $\dot{\gamma} \in A$ and, being also a unit geodesic of (M, Σ) , either (i) or (ii) of Proposition 2.34 holds locally. Then for each $t \in [a, b]$, there exists ε , depending on t , such that $\gamma|_{[a, b] \cap [t - \varepsilon, t + \varepsilon]}$ either minimizes ℓ_F or maximizes ℓ_{F_l} (recall Remark 2.35-(1)). By Lemma 2.41, this implies that γ satisfies (16) for F or F_l on $[a, b] \cap [t - \varepsilon, t + \varepsilon]$ and therefore, being t arbitrary, on all $[a, b]$. Indeed, observe that by Proposition 2.31 (i) (case (b)), when γ minimizes ℓ_F , then $F(\dot{\gamma}) \equiv 1$ and when γ maximizes ℓ_{F_l} , $F_l(\dot{\gamma}) \equiv 1$. As both subsets, $\{s \in [a, b] : F(\dot{\gamma}(s)) = 1\}$ and $\{s \in [a, b] : F_l(\dot{\gamma}(s)) = 1\}$, are closed and disjoint (because $\dot{\gamma}$ belongs to A), then one of them coincides with $[a, b]$ and the other is empty. \square

2.6. Wind Riemannian structures. Let us focus now on a particularly important case of wind Finslerian structures.

Definition 2.43. A *wind Riemannian structure* is a wind Finslerian structure Σ in TM such that $\Sigma_p = \Sigma \cap T_p M$ is a (real non-degenerate) ellipsoid for every $p \in M$.

Proposition 2.44. *Any wind Riemannian structure Σ can be constructed univocally as the displacement of the indicatrix of a smooth Riemannian metric g_R along a vector field W .*

Proof. From Proposition 2.13, the field W of the centers of the ellipsoids Σ_p is smooth and, by Proposition 2.12, the translated hypersurface $\Sigma - W$ is a wind Riemannian structure with centers at 0_p , for each $p \in M$. By Proposition 2.10, it defines a smooth Riemannian metric g_R on M . Hence Σ is defined by the equation $g_R(v - W, v - W) = 1$ in TM . Clearly, if for any other Riemannian metric h_0 and vector field V , Σ is defined by the equation $h_0(v - V, v - V) = 1$ then, necessarily, V must be the field of the centers of the ellipsoids Σ_p and then equal to W , so that h_0 must be equal to g_R . \square

In addition to the previous characterization, the definition of a wind Riemannian structure as a structure of ellipsoids suggests a second characterization in terms of the zeroes of a pointwise polynomial of degree two (defined up to a pointwise smooth non-vanishing factor). This second viewpoint will be interpreted in the next section in terms of the conformal class of an SSTK splitting, which will allow us to obtain a powerful characterization of the geometry of wind Riemannian structures.

The following elements equivalent to g_R, W will be used in the remainder and are adapted to the case of SSTK splittings.

Convention 2.45. Given a Riemannian metric g_R and a vector field W we will consider the triple (g_0, ω, Λ) where $g_0 = g_R$ and ω, Λ are the one-form and the function defined as $\omega = -g_0(\cdot, W)$, $\Lambda = 1 - g_0(W, W)$.

Thanks to Proposition 2.44, we will also say simply that Σ is the translation of a Riemannian metric, as in the case of Zermelo's navigation problem. In fact, in the case $g_0(W, W) < 1$, the so-obtained Σ yields a Randers metric Z , that is, $Z(v) = \alpha(v) + \beta(v)$ for every $v \in TM$, where $\alpha(v) = \sqrt{\tilde{h}(v, v)}$, being \tilde{h} a Riemannian metric on M and β a one-form such that its norm with respect to \tilde{h} satisfies $\|\beta\|_{\tilde{h}} < 1$ at every point. Indeed, Randers metrics are characterized by this property (see [4, Section 1.3], [24, §2.2] or the computations below). Let us determine all the cases that appear when considering wind Riemannian structures, refining Proposition 2.3.

Proposition 2.46. *Let (M, Σ) be a wind Riemannian structure. At each point $p \in M$, one of the following three exclusive cases holds for some one-form β , some scalar product \tilde{h} of index 0 or $m - 1$, and $\alpha(v) = \sqrt{|\tilde{h}(v, v)|}$:*

- (i) *if the zero vector 0_p belongs to the open unit ball B_p , then Σ_p determines a Randers norm, i.e., $F(v) = \alpha(v) + \beta(v)$, where \tilde{h} is positive definite and $\|\beta\|_{\tilde{h}} < 1$ on $A_p = T_p M$;*
- (ii) *if 0_p lies in Σ_p , then Σ_p determines a Kropina norm, i.e.,*

$$F(v) = \frac{\alpha(v)^2}{\beta(v)},$$

- for non-zero β and \tilde{h} positive definite, defined on $A_p = \{v \in T_p M : \beta(v) > 0\}$;*
- (iii) *if 0_p does not lie in $B_p \cup \Sigma_p$, then Σ_p determines a proper wind Riemannian structure, i.e., a pair of conic pseudo-Minkowski norms:*

$$\begin{aligned} F(v) &= -\alpha(v) + \beta(v), \\ F_l(v) &= \alpha(v) + \beta(v), \end{aligned}$$

defined on

$$A_p = \{v \in T_p M : \tilde{h}(v, v) > 0 \text{ and } \beta(v) > 0\},$$

where \tilde{h} has index $m - 1$ and β satisfies $\beta(v)^2 > \tilde{h}(v, v)$, for all $v \in T_p M \setminus \{0\}$, that is $\beta \otimes \beta - \tilde{h}$ is positive definite.

Moreover, in all the three cases the converse holds.

Proof. Let (g_0, ω, Λ) be the triple associated with Σ according to Proposition 2.44 and Convention 2.45. The conic pseudo-Finsler metrics F and F_l associated with Σ (see Proposition 2.10) are both determined by the equation

$$g_0\left(\frac{v}{Z(v)} - W, \frac{v}{Z(v)} - W\right) = 1$$

(recall (5)) which is equivalent to

$$g_0(v, v) + 2\omega(v)Z(v) - \Lambda Z(v)^2 = 0, \tag{17}$$

and, whenever $\Lambda \neq 0$,

$$Z(v) = \frac{\omega(v) \mp \sqrt{\Lambda g_0(v, v) + \omega^2(v)}}{\Lambda}.$$

We are interested only in the solutions that make $Z(v)$ positive.

Case (i). If $\Lambda(p) > 0$ ($0_p \in B_p$), then the unique positive value of $Z(v)$ is:

$$F(v) = \frac{\omega(v) + \sqrt{\Lambda g_0(v, v) + \omega^2(v)}}{\Lambda} \quad (18)$$

and the required \tilde{h}, β are then:

$$\tilde{h} = \frac{g_0}{\Lambda} + \frac{\omega}{\Lambda} \otimes \frac{\omega}{\Lambda}, \quad \beta = \frac{\omega}{\Lambda}. \quad (19)$$

Conversely, if $F = \alpha + \beta$, with α the norm of a Riemannian metric \tilde{h} and $\|\beta\|_{\tilde{h}} < 1$, we can reconstruct g_0, ω and Λ from \tilde{h}, β , just by using (19) and defining

$$\Lambda = \frac{1}{1 + \Delta}, \quad \text{where } \Delta := (\tilde{h} - \beta \otimes \beta)(\beta^\sharp, \beta^\sharp) \quad (20)$$

being β^\sharp the vector metrically equivalent to β for the metric $\tilde{h} - \beta \otimes \beta$. The restriction $\|\beta\|_{\tilde{h}} < 1$ forces $\Delta \geq 0$, i.e., $0 < \Lambda \leq 1$, which ensures the consistency of the reconstruction of g_0, W and Λ from α and β (in fact, a posteriori, $\beta^\sharp = -W$ and $\Lambda = 1 - g_0(W, W)$).

However, in order to understand better this reconstruction for later referencing, notice also that the vector B which is \tilde{h} -equivalent to β is proportional to β^\sharp (if $\tilde{h}(B, v) = \beta(v) = 0$ then $(\tilde{h} - \beta^2)(B, v) = 0$). More precisely, $\beta^\sharp = aB$ with $a = 1/(1 - \tilde{h}(B, B))$ and $1 - \tilde{h}(B, B) > 0$ (this follows equating the expressions $\Delta = \beta(\beta^\sharp) = a\beta(B) = a\tilde{h}(B, B)$ and $\Delta = a^2(\tilde{h} - \beta^2)(B, B)$, the latter greater than 0 whenever $B \neq 0$ and equal to $a^2\tilde{h}(B, B)(1 - \tilde{h}(B, B))$). Then, putting $\Delta = a\tilde{h}(B, B)$ in (20) one also has:

$$\Lambda = 1 - \tilde{h}(B, B) \quad (21)$$

(compare with [4, §1.3] and also [12, Proposition 3.1]).

Case (iii). If $\Lambda(p) < 0$, at $p \in M$, then there are two solutions, one given by (18) and the other by

$$F_l(v) = \frac{\omega(v) - \sqrt{\Lambda g_0(v, v) + \omega^2(v)}}{\Lambda} \quad (22)$$

both defined in the open domain

$$A_p = \{v \in T_p M : -\omega(v) > 0, \Lambda g_0(v, v) + \omega^2(v) > 0\}.$$

The required \tilde{h}, β are obtained by using again the expressions in (19). Observe that in this case, \tilde{h} is negative definite in the kernel of ω and $\tilde{h}(W, W) = \frac{g_0(W, W)}{\Lambda^2} > 0$, which implies that \tilde{h} has index $m - 1$.

For the converse, recall first that, if B is the vector h -metrically related to β , then by the hypotheses, B cannot be 0 and $(\tilde{h} - \beta^2)(B, B) < 0$, i.e.:

$$\tilde{h}(B, B)(1 - \tilde{h}(B, B)) < 0. \quad (23)$$

Moreover, $\tilde{h}(B, B)$ cannot be negative. Indeed, otherwise, B would be a spacelike vector for the Lorentzian scalar product $-\tilde{h}$. So, we could take a timelike vector v for $-\tilde{h}$ orthogonal to B and we would have $(\tilde{h} - \beta^2)(v, v) = \tilde{h}(v, v) > 0$, in contradiction with the hypotheses on \tilde{h}, β . Therefore, (23) forces $\tilde{h}(B, B) > 1$. This ensures that Λ, ω, g_0 can be reconstructed from (21) and (19) with $\Lambda(p) < 0$.

Case (ii). Now $\Lambda(p) = 0$ and from (17), we obtain only one metric

$$F(v) = -\frac{g_0(v, v)}{2\omega(v)}, \quad (24)$$

which is of the type in (ii) with α the norm associated with g_0 and $\beta = -2\omega$. For the converse, choose $g_0 = \frac{\tilde{h}}{4\tilde{h}(B, B)}$ and $W = \frac{1}{2}B$, and recall that $\tilde{h}(B, v) = \beta(v)$ for every $v \in TM$. \square

Remark 2.47. Observe that the analysis in Proposition 2.46 was accomplished in each single tangent space, while a wind Riemannian structure in a manifold M can attain all the three possible types. The standard expressions of the metrics given in the proposition do not allow us to give a unified expression on $TM \setminus \mathbf{0}$ of the metric F . This can be achieved by observing that the expressions in (18) and (24) coincide with

$$F(v) = \frac{g_0(v, v)}{-\omega(v) + \sqrt{\Lambda g_0(v, v) + \omega^2(v)}}, \quad (25)$$

defined, up to the zero section, in the *interior* of

$$\{v \in TM \setminus \mathbf{0} : -\omega(v) + \sqrt{\Lambda g_0(v, v) + \omega^2(v)} > 0\}.$$

In fact, the last inequality is fulfilled for all $v \in T_p M \setminus \{0\}$ whenever $\Lambda(p) > 0$, it reduces to $\{v \in T_p M : -\omega(v) > 0\}$ whenever $\Lambda(p) = 0$, and it includes implicitly the restrictions $\Lambda(p)g_0(v, v) + \omega^2(v) > 0$ plus $-\omega(v) > 0$ when $\Lambda(p) < 0$. One can rewrite these formulas in terms of \tilde{h}, β just substituting (19), whenever $\Lambda \neq 0$. Trivially, these expressions can be rewritten in terms of g_0, W (recall Convention 2.45).

The case $\Lambda \geq 0$ ($g_0(W, W) \leq 1$) makes possible a simple description of the wind Riemannian structure Σ , as it determines a unique conic Finsler metric F , which adopts either the Randers or the Kropina form in Proposition 2.46.

Definition 2.48. A *Randers-Kropina* metric on a manifold M is any wind Riemannian structure Σ such that $0_p \in \tilde{B}_p$ for all $p \in M$ so that $\Lambda \geq 0$ and the associated conic Finsler metric F is given by (25) with domain

$$A = \bigcup_{p \in M} A_p, \text{ where } A_p = \begin{cases} T_p M \setminus \{0\}, & \text{if } g_0(W_p, W_p) < 1, \\ \{v \in T_p M : g_0(W_p, v) > 0\}, & \text{if } g_0(W_p, W_p) = 1. \end{cases}$$

When the wind is strong $\Lambda < 0$ ($g_0(W, W) > 1$) or, simply, when one restricts to the region M_l , a specific property of the wind Riemannian case holds, namely, the Lorentzian Finsler metric F_l can be described formally in terms of F . In fact, notice that the expression (22) can be obtained from (18) just by applying F to $-v$ and reversing the sign, and analogously this happens with the expression of F_l and F in part (iii) of Proposition 2.46. Summing up, we have:

Proposition 2.49. *Let M_l be the strong wind region of a wind Riemannian structure, and F, F_l its associated conic pseudo-Finsler metrics. Then there exist a one-form β and a Lorentzian metric $-\tilde{h}$ such that $\beta \otimes \beta - \tilde{h}$ is Riemannian satisfying:*

(i) *the domain of F and F_l is*

$$A_l = \{v \in TM_l : \tilde{h}(v, v) > 0 \text{ and } \beta(v) > 0\}.$$

- (ii) $F = -\alpha + \beta$.
 (iii) $F_l = -F^{frev}$, where F^{frev} is the formal reverse of F , defined by:

$$F^{frev}(v) = F(-v), \quad \forall v \in A_l,$$

and $F(-v)$ is obtained by applying the expression (ii) to the vectors of $-A_l$.

Remark 2.50. Taking into account also the expressions for the conic pseudo-Finsler metrics \tilde{F}, \tilde{F}_l with domains associated with the reverse wind Finslerian structure $\tilde{\Sigma}$ we can write:

$$\tilde{F}(v) = F(-v), \quad \tilde{F}_l(v) = F_l(-v) = -F(v), \quad \forall v \in -A,$$

where $F(v)$ is computed by applying the expression (ii) in the previous proposition. So, the formal expression of F allows us to write easily \tilde{F}, F_l and \tilde{F}_l —these considerations can be extended naturally to the bigger domains A_E in Convention 2.17. This simplifies notations and makes clear that a piece of the indicatrix determines all of them. Even though we will work usually with F and F_l , some formulae will be written conveniently by using above expressions.

3. FERMAT STRUCTURES FOR SSTK SPLITTINGS

In a series of papers [18, 34, 17, 20, 16, 28], it has been developed a detailed correspondence between the geometric properties of Randers spaces and the conformal structure of stationary spacetimes, including: variational principles for geodesics of a Finsler metric vs. Fermat's principle for lightlike and timelike geodesics [18], links between the curvatures of Randers and stationary spaces [34], Morse theory for Finsler geodesics vs. Morse theory for lightlike and timelike geodesics [17, 19], Finslerian distances and geodesics vs. causal structure [20], convexity of hypersurfaces vs. visibility and gravitational lensing [16], Busemann plus Gromov boundaries vs. causal boundaries [28] and almost isometries vs. conformal maps [38]. As pointed out in [20], such a correspondence would be extendible to obtain further properties of general Finslerian manifolds suggested by the spacetime viewpoint, yielding so a broader relation between Lorentzian and Finslerian geometries. In the next section we consider the class of spacetimes that allows us to extend this relation to wind Riemannian structures.

3.1. Spacetimes with a space-transverse Killing field. We will follow [7] and [54] for the general background on spacetimes and causality. In particular, if (L, g) is an $(m + 1)$ -dimensional Lorentzian manifold (with signature $(-, +, \dots, +)$) we say, following [54], that a tangent vector $v \in TL$ is *timelike* (resp. *lightlike*; *causal*; *spacelike*; *non-spacelike*) if $g(v, v) < 0$ (resp. $g(v, v) = 0$ and $v \neq 0$; v is either timelike or lightlike; $g(v, v) > 0$; $g(v, v) \leq 0$). A *spacetime* is a connected time-oriented Lorentzian manifold, which is also denoted (L, g) ; the time orientation continuously selects a causal cone at each tangent space and it makes possible to distinguish between *future-pointing* causal vectors (namely, those in the selected cone) and *past-pointing* ones. We say that two points $p, q \in L$ are *chronologically related* (p is chronologically related to q or p lies in the chronological past of q), denoted $p \ll q$, if there exists a future-pointing timelike curve (i.e. its tangent vectors are always causal future-pointing) from p to q . The *chronological future* of p is defined as the subset $I^+(p) = \{q \in M : p \ll q\}$ and analogously the chronological past as $I^-(p) = \{q \in M : q \ll p\}$. Moreover, we say that p, q are *strictly causally related* (resp. *causally related*), denoted $p < q$ (resp. $p \leq q$), if

there exists a future-pointing causal curve from p to q (resp. either $p < q$ or $p = q$). The causal *future and past* of p are defined respectively as $J^+(p) = \{q \in M : p \leq q\}$ and $J^-(p) = \{q \in M : q \leq p\}$.

Remark 3.1. A well-known property to be used later is that, whenever $p \leq q \leq r$ ($p, q, r \in L$), either $p \ll r$ or the unique non-spacelike curves from p to r are null pregeodesics (with no conjugate points except, at most, the endpoints); other properties such as $p \leq q \ll r \Rightarrow p \ll r$ and the fact that the relation \ll is open are also well known.

Now, let us focus on the class of spacetimes relevant for our approach.

Definition 3.2. A spacetime (L, g) is *standard with a space-transverse Killing vector field* (SSTK) if it admits a (necessarily non-vanishing) complete Killing vector field K and a spacelike hypersurface S transverse to K which is crossed exactly once by all the integral curves of K .

Proposition 3.3. *A spacetime is SSTK if and only if it is isometric to a product manifold $\mathbb{R} \times M$ endowed with a Lorentzian metric g of the form*

$$g = -(\Lambda \circ \pi)dt^2 + \pi^*\omega \otimes dt + dt \otimes \pi^*\omega + \pi^*g_0, \quad (26)$$

where Λ , ω and g_0 are, respectively, a smooth real function, a one form and a Riemannian metric on M , $\pi : \mathbb{R} \times M \rightarrow M$ is the natural projection, and π^* the pullback operator, satisfying the following relation:

$$\Lambda + \|\omega\|_0^2 > 0, \quad (27)$$

being $\|\omega\|_0$ the pointwise g_0 norm of ω . In this case, the projection $t : \mathbb{R} \times M \rightarrow \mathbb{R}$ satisfies that $-\nabla t$ is a timelike vector field, which can be assumed future-pointing (i.e. time-orientating the spacetime) with no loss of generality.

Proof. Notice first that the bilinear form g given in (26) is a Lorentzian metric if and only if (27) is fulfilled at each $x \in M$. In fact, let e_1, e_2, \dots, e_m be an orthonormal basis for $(T_x M, g_0)$ such that $\omega(e_1) = \|\omega\|_0$ and $\omega(e_i) = 0$, for each $i = 2, \dots, m$. Let $B = \{(1, 0), (0, e_1), (0, e_2), \dots, (0, e_m)\}$ be the corresponding basis of $(\mathbb{R} \times T_x M, g)$ and $M_B(g)$ the matrix representation of g in B . The only non-diagonal elements different from 0 in this matrix come from the product of the first two elements of B and, thus

$$\det M_B(g) = -\Lambda - \omega(e_1)^2 = -\Lambda - \|\omega\|_0^2, \quad (28)$$

which must be negative to ensure the Lorentzian signature. Clearly, (26) defines an SSTK with $K = \partial_t$ and S equal to any slice $S_{t_0} := t^{-1}(t_0)$.

Conversely, given any non-vanishing Killing vector field K on a Lorentzian manifold (L, g) , and any choice of a spacelike hypersurface S transverse to K , a local expression of the metric as in (26) holds on some neighborhood $U = (a, b) \times U_0 \subset L$, $(a, b) \subset \mathbb{R}$, $U_0 \subset S$, with K identifiable to ∂_t . However, the global assumption on S plus the completeness of K ensure that the local expression can be obtained globally just by moving S (which would be identified to the slice $\{0\} \times M$) with the flow of K .

For the last assertion, observe that ∇t is timelike because it is orthogonal to the spacelike slices $\{t_0\} \times M$ and it does not vanish, as $g(\nabla t, \partial_t) = 1$. Finally, it is not a restriction that $-\nabla t$ time-orientates the spacetime as, otherwise, the change of K by $-K$ (or t by $-t$) yields the expression (26) with ω changed by $-\omega$. \square

Remark 3.4. (1) According to the well-known stuff about the causality of spacetimes (see [7] and [54]), a *temporal function* on a spacetime is a smooth function t with past-pointing timelike gradient ∇t , so that t is in particular a time function (i.e. a continuous function that increases on any future-pointing causal curve). The existence of the latter for a spacetime can be chosen as a definition of the step *stable causality* in the so-called causal ladder or hierarchy of spacetimes [54] (in particular, these spacetimes are *strongly causal*, i.e. all the causal curves that leave a fixed neighbourhood of a point cannot return arbitrarily near the same point).

The previous proposition shows that the constructed function t is a temporal one and, so, SSTK spacetimes are always stably causal. In Theorem 4.7 we will see that, whenever $\Lambda \geq 0$, they are also *causally continuous* (the subsequent step in the causal ladder which holds intuitively when, additionally, the chronological future $I^+(p)$ and past $I^-(p)$ of any point $p \in M$ vary continuously with p).

(2) The previous characterization of SSTK spacetimes can be refined for the case of *stationary* spacetimes, i.e. those spacetimes which admit a *timelike* Killing vector field K . It is known [39] that such a spacetime is *standard stationary* (i.e., an SSTK splitting with $\Lambda > 0$) iff K is a complete vector field and the spacetime is distinguishing (i.e., $p \neq q$ implies $I^+(p) \neq I^+(q)$ and $I^-(p) \neq I^-(q)$). The reader can check that all our approach is widely simplified for standard stationary spacetimes and agrees with [20].

Convention 3.5. Except if otherwise specified, in what follows we will assume that the Killing vector field K and the spacelike hypersurface S of an SSTK spacetime are prescribed and, so, an SSTK *splitting* will mean the product manifold $\mathbb{R} \times M$ endowed with the metric g in (26) and the (future) time-orientation provided by $-\nabla t$. Nevertheless, sometimes may be useful to consider the different splittings obtained by varying the hypersurface S , recall Proposition 6.8.

Moreover, since the metric g is independent of the time coordinate t , when there is no possibility of confusion, we will write a tangent vector to a point $(t_0, x_0) \in \mathbb{R} \times M$ simply as $(\tau, v) \in \mathbb{R} \times TM$.

3.2. Associated wind Riemannian structure. Next, our goal is to associate a natural wind Riemannian structure to any SSTK as in previous convention.

Proposition 3.6. *Let Λ, ω and g_0 be a function, a one-form, and a Riemannian metric on M . Then, the set $\Sigma \subset TM$ of solutions of*

$$-\Lambda + 2\omega(v) + g_0(v, v) = 0 \tag{29}$$

constitutes a wind Riemannian structure if and only if the inequality (27) holds. In this case, putting $\Omega = (\Lambda + \|\omega\|_0^2)^{-1}$, this wind Riemannian structure is the displacement of the indicatrix of the Riemannian metric $g_R = \Omega g_0$ along the vector field W which is g_0 -metrically equivalent to the one-form $-\omega$.

Proof. Notice first that, as g_0 is Riemannian, at each $p \in M$, $\Sigma \cap T_p M$ must be either the empty set or a point or an ellipsoid, and the last possibility holds if and only if (27) holds at p . In this case, the transversality of Σ is automatically satisfied. To check this plus the last assertion, multiply (29) by Ω and observe that Σ is the displacement of the indicatrix of g_R by W (in fact, $\Omega\Lambda = 1 - g_R(W, W)$ so that (29) becomes equivalent to $g_R(v - W, v - W) = 1$); in particular, Proposition 2.12 applies. \square

Lemma 3.7. *If a tangent vector $(a, v) \in \mathbb{R} \times TM$ is lightlike, then $a \neq 0$ and, in this case, it is future-pointing iff $a > 0$.*

Proof. Straightforward from the fact that the slices $t = \text{const.}$ are spacelike and t is a temporal function. \square

Proposition 3.8. *The set Σ of all the vectors $v \in TM$ such that $(1, v)$ is a future-pointing lightlike vector in $\mathbb{R} \times TM$ becomes a wind Riemannian structure on M . Moreover, the reverse wind Riemannian structure $\tilde{\Sigma} = -\Sigma$ contains all the vectors $w \in TM$ such that $(-1, w)$ is a past-pointing lightlike vector in $\mathbb{R} \times TM$.*

Proof. From the expression of the metric, $(1, v)$ is a lightlike vector iff v satisfies (29). Proposition 3.6 and the consistency of the causal characters in Lemma 3.7 yield the first assertion; the last one follows from Definition 2.15 and the fact that $(-1, -v)$ is lightlike iff so is $(1, v)$. \square

Notice that lightlike vectors are preserved by all the metrics pointwise conformal to g . When a conformal factor $\Omega > 0$ is invariant by the flow of $K = \partial_t$, it induces naturally a function also denoted by Ω which multiplies the three elements Λ, ω, g_0 .

Definition 3.9. The *Fermat structure* associated with (the conformal class of) an SSTK splitting is the wind Riemannian structure Σ obtained in Proposition 3.8.

Theorem 3.10. *The following statements hold:*

- (i) *Any wind Riemannian structure Σ is the Fermat structure associated with the conformal class of an SSTK spacetime with a representative (g_0, ω, Λ) , $\Lambda = 1 - g_0(W, W)$, W the vector field g_0 -metrically equivalent to $-\omega$.
Conversely, given the Fermat structure Σ associated with the conformal class of an SSTK splitting, there exists a unique representative (g_0, ω, Λ) of the class such that the vector field W , g_0 -associated with $-\omega$ satisfies $\Lambda = 1 - g_0(W, W)$ and Σ is the wind Riemannian structure defined by g_0 and the displacement W .*
- (ii) *Two Fermat structures Σ, Σ' associated with two SSTK splittings determined by the data $(g_0, \omega, \Lambda), (g'_0, \omega', \Lambda')$ on M are equal if and only if the two spacetimes are pointwise conformal, i.e., there exists some function $\Omega > 0$ on M such that $(g'_0, \omega', \Lambda') = (\Omega g_0, \Omega \omega, \Omega \Lambda)$.*

Proof. (i) It is an immediate consequence of Proposition 3.6.

(ii) Recall first that two pointwise conformal SSTK splittings as in (26) must differ in a conformal factor invariant by the flow of ∂_t and, so, they will induce a positive function Ω on M . So, use simply that two spacetimes are pointwise conformal iff they have the same lightlike vectors with the same time-orientations. \square

The regions of strong and weak wind can be easily determined (see Fig. 5).

Proposition 3.11. *Let (M, Σ) be a Fermat structure, $p \in M$ and $0_p \in T_p M$ the zero vector:*

- (i) $0_p \in B_p$ iff K_p is timelike ($\Lambda(p) > 0$). In this case, Σ_p determines a Randers norm.
- (ii) $0_p \in \Sigma_p$ iff K_p is lightlike ($\Lambda(p) = 0$). In this case, Σ_p determines a Kropina norm.
- (iii) $0_p \notin \bar{B}_p$ iff K_p is spacelike ($\Lambda(p) < 0$). In this case, Σ_p defines a strong wind Minkowskian structure.

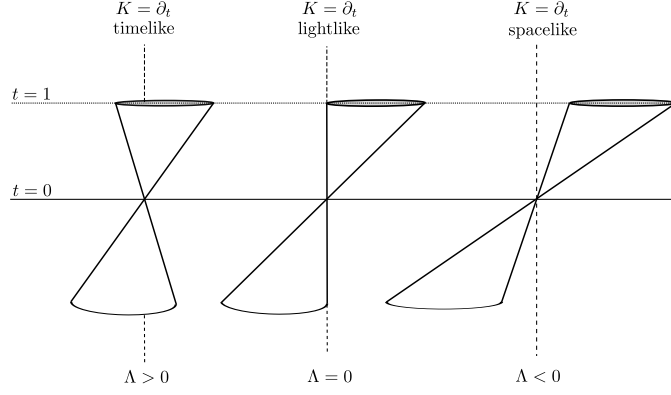

FIGURE 5. The time cone in an SSTK splitting

Proof. It is straightforward from the facts that 0_p satisfies (29) iff $\Lambda(p) = 0$ and the unit ball B_p defined by Σ_p is obtained replacing the equality in (29) by the inequality $<$. \square

3.3. Lightlike vectors and link with Zermelo metrics. Next, let us describe in a precise way the lightlike vectors of an SSTK splitting and write the Finslerian elements of the Fermat structure in terms of Λ, ω, g_0 .

Proposition 3.12. *Given an SSTK splitting determined by Λ, ω, g_0 as in (26), define, for each $x \in M$:*

$$A_x = \begin{cases} T_x M \setminus \{0\} & \text{if } \Lambda(x) > 0, \\ \{v \in T_x M : -\omega(v) > 0, \Lambda(x)g_0(v, v) + \omega(v)^2 > 0\} & \text{if } \Lambda(x) \leq 0. \end{cases}$$

Let $M_l = \{x \in M : \Lambda(x) < 0\}$ and put

$$A = \bigcup_{x \in M} A_x, \quad A_l = \bigcup_{x \in M_l} A_x,$$

as well as A_E (as defined in Definition 2.9). Define F and F_l as

$$F(v) = \frac{g_0(v, v)}{-\omega(v) + \sqrt{\Lambda g_0(v, v) + \omega(v)^2}}, \quad \forall v \in A, \quad (30)$$

where, when $\Lambda(x) = 0$, the previous expression is understood as

$$F(v) = -\frac{g_0(v, v)}{2\omega(v)}, \quad \forall v \in \{w \in T_x M : -\omega(w) > 0\}, \quad (31)$$

and

$$F_l(v) = (-F^{rev}(v) :=) -\frac{g_0(v, v)}{\omega(v) + \sqrt{\Lambda g_0(v, v) + \omega(v)^2}}, \quad \forall v \in A_l, \quad (32)$$

and extend them to $A \cup A_E$ as in Convention 2.17.

A tangent vector $(\tau, v) \in \mathbb{R} \times TM$ is a future-pointing lightlike vector if and only if $\tau > 0, v \in A \cup A_E$ and one of the three following cases holds:

- (i) When $\Lambda(x) > 0$, then $(\tau, v) = (F(v), v)$.
- (ii) When $\Lambda(x) = 0$, then

- $(\tau, v) = (\tau, 0_x)$, or
 - $v \in A_x$ and $(\tau, v) = (F(v), v)$.
- (iii) When $\Lambda(x) < 0$, (necessarily, $A_x \subsetneq (A_E)_x$), then
- $(\tau, v) = (F(v), v)$, iff $\tau\Lambda(x) - \omega(v) \geq 0$,
 - $(\tau, v) = (F_l(v), v)$, iff $\tau\Lambda(x) - \omega(v) \leq 0$.
 - $(\tau, v) = (F(v), v) = (F_l(v), v)$ iff $\tau\Lambda(x) - \omega(v) = 0$.
- Moreover, $0 < F(v) \leq F_l(v)$ and the equality holds iff $v \in (A_E)_x \setminus A_x$.

Proof. This can be computed directly by imposing that (τ, v) must be lightlike, i.e., $-\Lambda\tau^2 + 2\omega(v)\tau + g_0(v, v) = 0$ and thus

$$\tau = \frac{\omega(v) \pm \sqrt{\Lambda g_0(v, v) + \omega(v)^2}}{\Lambda} = \frac{g_0(v, v)}{-\omega(v) \pm \sqrt{\Lambda g_0(v, v) + \omega(v)^2}}, \quad (33)$$

the first equality whenever $\Lambda \neq 0$ and the last one valid even if Λ vanishes whenever $v \neq 0$. So, the result follows from a straightforward discussion of cases. \square

Remark 3.13. In the standard stationary case, $A = TM \setminus \mathbf{0}$, $A_t = \emptyset$ and F can be safely computed from any of the expressions in (33) just by choosing the sign $+$. So, F becomes a classical Finsler metric, the *Fermat metric* of the standard stationary spacetime, and the corresponding results can be checked in [20].

Proposition 3.14. *Let Σ be the Fermat structure associated with an SSTK splitting. Then the conic Finsler metric F and the Lorentzian Finsler metric F_l associated with Σ are those determined in Proposition 3.12.*

Proof. Taking into account the definition of the Fermat structure, if $(\tau, v) \in \mathbb{R} \times TM$ is a future-pointing lightlike vector, then $\tau > 0$ and $v/\tau \in \Sigma_x$. So, it is enough to use Proposition 3.12 with $\tau = 1$ (notice that the expressions for the conic pseudo-Finsler metrics F and F_l in (30) and (32) are invariant under the conformal change $(g_0, \omega, \Lambda) \mapsto (\Omega g_0, \Omega \omega, \Omega \Lambda)$, $\Omega: M \rightarrow (0, +\infty)$). \square

The equivalences in Theorem 3.10 plus Propositions 2.46, 3.6 and 3.14 extend the well-known ones existing between Randers, Zermelo and stationary metrics, [12, Proposition 3.1], and they are summarized in Fig. 6.

Remark 3.15. (*Future-pointing causal vectors looked from M , Fig. 7*). Take any $(t_0, x_0) \in \mathbb{R} \times M$ and $v \in T_{x_0}M \setminus \{0\}$. The following possibilities may occur:

- (a) $\Lambda(x_0) > 0$. In this case, $(F(v), v)$ (with F computed indistinctly either from (30) or from the first expression in (33) with the positive sign) is a future-pointing lightlike vector and all such vectors in $\mathbb{R} \times T_{x_0}M$ can be written in this way. Moreover, (τ, v) is a future-pointing timelike vector iff $F(v) < \tau$ and all such vectors can be written either in this way or as $(\tau, 0)$ with $\tau > 0$.
- (b) $\Lambda(x_0) = 0$. In this case, when $v \in A_{x_0}$, the vector $(F(v), v)$ (with F computed from (31)) is lightlike, future-pointing and all such vectors can be written in this way, except those positively proportional to $\partial_t|_{(t_0, x_0)}$ (they correspond to $v = 0_{x_0}$). Moreover, (τ, v) is a future-pointing timelike vector iff $F(v) < \tau$.
- (c) $\Lambda(x_0) < 0$. In this case, one of the following exclusive alternatives occurs:
 - (c1) $v \in A_{x_0}$. Then, there are exactly two future-pointing lightlike vectors $(F(v), v)$, $(F_l(v), v)$, $F(v) < F_l(v)$, in $\mathbb{R} \times T_{x_0}M$ (computed from (30) and (32)) that project onto v . Moreover, (τ, v) is a future-pointing timelike vector iff $F(v) < \tau < F_l(v)$ and all the future-pointing timelike vectors in this case can be written in this way.

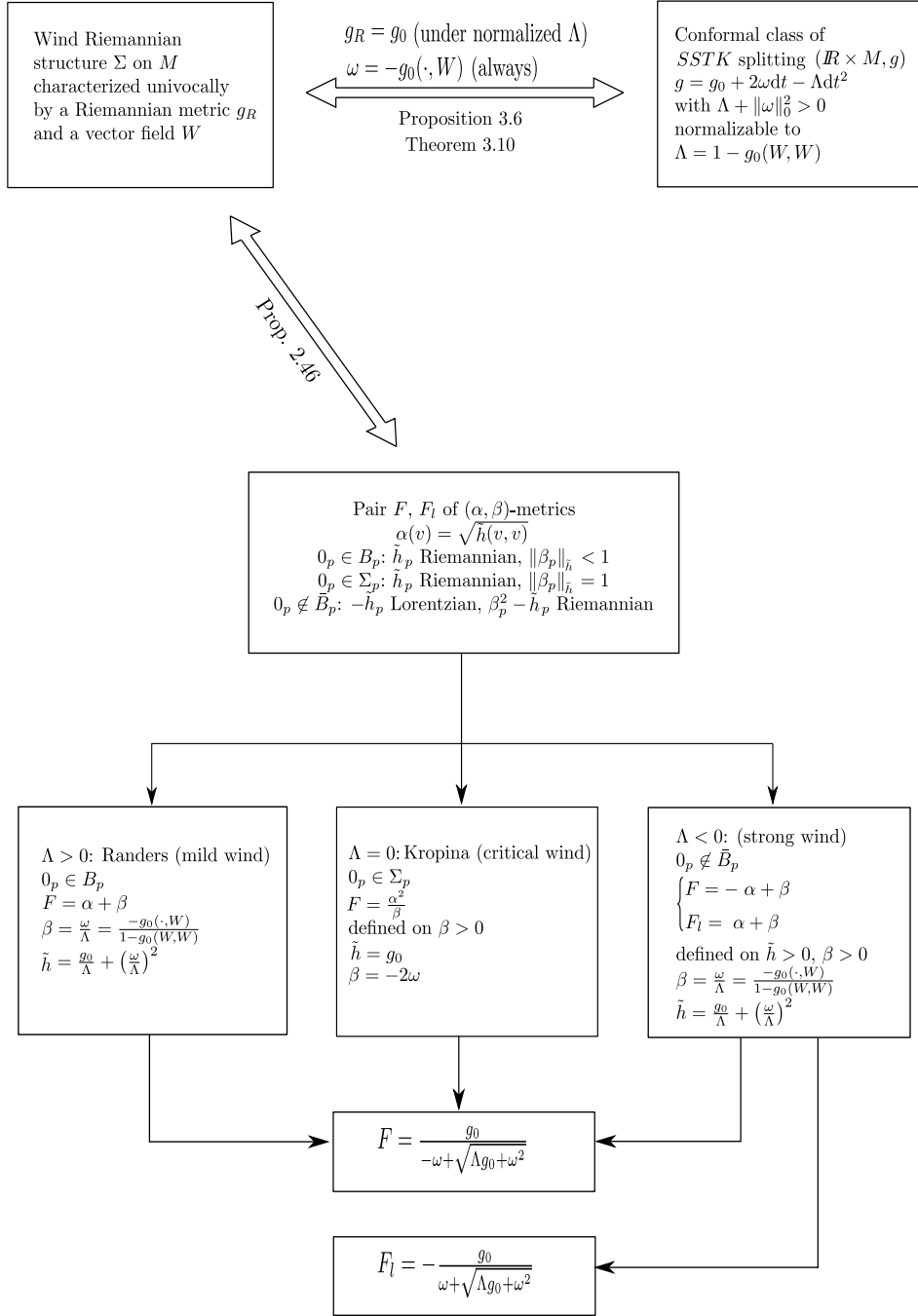

FIGURE 6. The equivalence between SSTK splittings, wind Riemannian and Zermelo structures

- (c2) v belongs to $(A_E)_{x_0} \setminus A_{x_0}$. Then, there is exactly one future-pointing lightlike vector in $\mathbb{R} \times T_{x_0}M$ and no timelike vector that projects onto

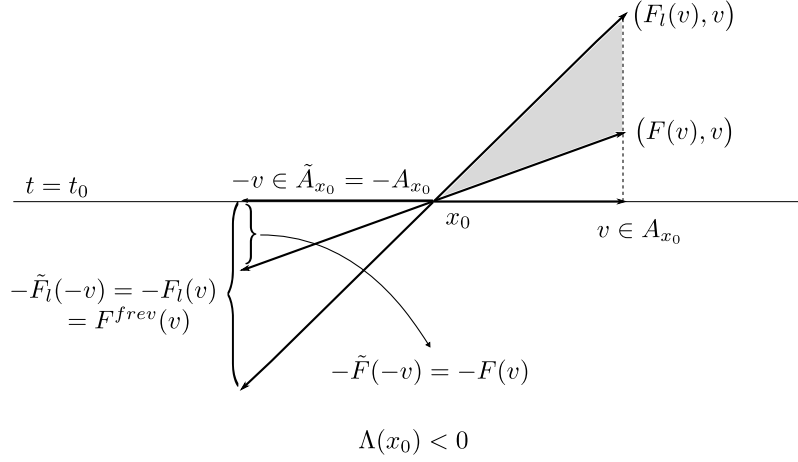

FIGURE 7. The shaded region represents, in the case where $\Lambda(x_0) < 0$, all the future-pointing timelike vectors (τ, v) , for $v \in A_{x_0}$. The lightlike vectors $(F(v), v)$ and $(F_l(v), v)$ yield the boundary of such a region.

v . The first component of this lightlike vector can be computed by using formally any of the two expressions (30) and (32), as they agree when computed on such a v (recall also that, as in the previous sub-case, $-\omega(v) > 0$ necessarily).

- (c3) v does not belong to $(A_E)_{x_0}$. Then, no future-pointing lightlike and no timelike vector in $\mathbb{R} \times M$ projects onto v .

Remark 3.16. (*Time reversal and past directions, Fig. 7*). Recall that in Theorem 3.10, one assumes implicitly that $-\nabla t$ is future-pointing (Convention 3.5). If we consider an SSTK splitting determined by the data (g_0, ω, Λ) in (26), and construct a new spacetime just reversing the time-orientation, the transformation $t \mapsto -t$ would allow one to express this second spacetime as an SSTK with data $(g_0, -\omega, \Lambda)$. Clearly, the Fermat structure of the latter will be the reverse $\tilde{\Sigma}$ of the original one.

This suggests that $\tilde{\Sigma}$ must be used to compute the past-pointing lightlike vectors, which can be done as follows. A vector $(-\tau, v)$ is past-pointing and lightlike if and only if $\tau > 0$ and $(\tau, -v)$ is future-pointing and lightlike. The latter will happen iff the last part of Proposition 3.12 holds replacing v with $-v$. This change of sign transforms the assertions on F and F_l in assertions on their reverse metrics \tilde{F} and \tilde{F}_l defined on $\tilde{A} = -A$ and $\tilde{A}_l = -A_l$ (and extendible to $\tilde{A}_E = -A_E$) as asserted in Proposition 2.16. Notice also that for any strong wind Riemannian structure, the metric F determines not only \tilde{F} but also formally F_l , which can be used to give expressions in terms of F instead of the quadruple $F, F_l, \tilde{F}, \tilde{F}_l$ (recall Proposition 2.49 and Remark 2.50).

Explicitly, the possibilities analogous to Remark 3.15 (only in the lightlike case) for $v \in T_{x_0}M \setminus \{0\}$ are the following:

- (a) $\Lambda(x_0) > 0$. Then $(-F(-v), v)$ (recall $\tilde{F}(v) = F(-v)$) is a past-pointing lightlike vector and all such vectors can be written in this way.

- (b) $\Lambda(x_0) = 0$. In this case when $v \in -A_{x_0}$, the vector $(-F(-v), v)$, is lightlike, past-pointing and all such vectors can be written in this way, except those positively proportional to $-\partial_t|_{(t_0, x_0)}$.
- (c) $\Lambda(x_0) < 0$. One of the following exclusive alternatives occurs:
- (c1) $v \in -A_{x_0}$. Then, there are exactly two past-pointing lightlike vectors $(-F(-v), v)$, $(-F_l(-v), v)$, $-F_l(-v) < -F(-v)$, in $\mathbb{R} \times T_{x_0}M$ (recall that $F(-v) = \tilde{F}(v)$ and, formally, $F_l(-v) = \tilde{F}_l(v) = -F^{\text{rev}}(-v) = -F(v)$) that project onto v .
- (c2) v belongs to $-(A_E)_{x_0} \setminus A_{x_0}$. Then, there is exactly one past-pointing lightlike vector in $\mathbb{R} \times T_{x_0}M$, namely, $(-F(-v), v)$ ($F(-v) = F_l(-v)$) that projects onto v .
- (c3) v does not belong to $-(A_E)_{x_0}$. Then, no past-pointing lightlike vector in $\mathbb{R} \times M$ projects onto v .

Remark 3.17. (The common boundary of the indicatrices of F and F_l on M_l , Fig. 8). Observe that, in the case $\Lambda(x_0) < 0$, the boundary of $(A_l)_{x_0}$ in $TM \setminus \mathbf{0}$ is given by the vectors $v \in T_{x_0}M$ such that $\Lambda(x_0)g_0(v, v) + \omega(v)^2 = 0$ and $-\omega(v) > 0$. In such a case, the vector $(1, v) \in \mathbb{R} \times T_{x_0}M$ is lightlike if and only if the system of equations

$$\Lambda(x_0)g_0(v, v) + \omega(v)^2 = 0, \quad g_0(v, v) + 2\omega(v) - \Lambda(x_0) = 0$$

is satisfied. These equations are equivalent to

$$g_0(v, v) = -\Lambda(x_0), \quad \omega(v) = \Lambda(x_0),$$

which give the intersection in $T_{x_0}M$ of a round g_0 -sphere and a hyperplane. These intersect transversely (because of the condition $\Lambda + \|\omega\|_0^2 > 0$) yielding an $(m-2)$ -sphere S_0^{m-2} . Denote by S_F^{m-1} and $S_{F_l}^{m-1}$ the indicatrices of F and F_l . It follows that $\Sigma_{x_0} = S_F^{m-1} \cup S_0^{m-2} \cup S_{F_l}^{m-1}$, see Fig. 8.

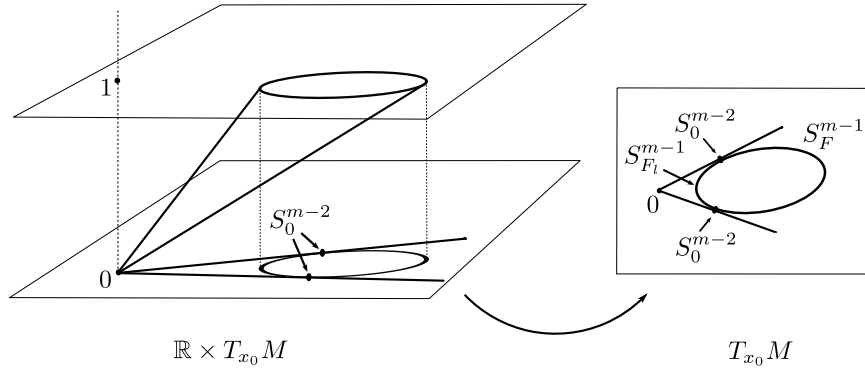

FIGURE 8. The intersection between the future-pointing light cone at (t_0, x_0) and the slice $\{1\} \times T_{x_0}M$ projects onto the wind Finslerian structure $\Sigma_{x_0} = S_F^{m-1} \cup S_0^{m-2} \cup S_{F_l}^{m-1}$, ($m = 2$)

3.4. Projection on ∂_t^\perp and interpretation of A_l, \tilde{A}_l . The fact that the radicand in the expressions of F and F_l (formulas (30) and (32)) may not be automatically positive has been interpreted above (possibilities (c2) in Remarks 3.15 and 3.16). Let us go a step further by analysing the metric tensor in this radicand, that is,

$$h := \Lambda g_0 + \omega \otimes \omega, \quad (34)$$

on M . The metric h admits the following interpretation on the open subset $M_{\Lambda \neq 0} = \{x \in M : \Lambda \neq 0\}$ where ∂_t is not lightlike.

Proposition 3.18. *Let $p_{\mathbb{R}}^\perp : \mathbb{R} \times TM_{\Lambda \neq 0} \rightarrow \mathbb{R} \times TM_{\Lambda \neq 0}$ the natural projection on the bundle ∂_t^\perp , g -orthogonal to ∂_t . Then, for any $v \in T_x M, x \in M_{\Lambda \neq 0}$:*

$$h(v, v) = \Lambda g(p_{\mathbb{R}}^\perp(0, v), p_{\mathbb{R}}^\perp(0, v)).$$

Proof. Just apply g to $p_{\mathbb{R}}^\perp(0, v) = (\omega(v)/\Lambda, v)$. \square

That is, the metric h on M can be identified with a metric conformal to the original one g restricted to ∂_t^\perp , being the conformal factor Λ such that h makes sense even in the limit case when ∂_t is lightlike. Recall that Λ and ω satisfy (27), then trivially:

Corollary 3.19. *The metric h on M is Riemannian when $\Lambda > 0$, degenerate when $\Lambda = 0$ and it has coindex 1 (i.e., $-h$ is Lorentzian) when $\Lambda < 0$.*

Remark 3.20. In the region M_l where $\Lambda < 0$, the expressions of F and F_l (resp. \tilde{F} and \tilde{F}_l) were well-defined on all A_E (resp. $\tilde{A}_E = -A_E$) in Convention 2.17. Then, one has the following characterizations of the lightlike vectors for the Lorentzian metric $-h$. For any $v \in TM_l \setminus \mathbf{0}$, the following properties are equivalent:

- (i) $h(v, v) = 0$, i.e., v is lightlike for $-h$.
- (ii) v belongs to the boundary of $A_E \cup \tilde{A}_E$ in $TM_l \setminus \mathbf{0}$,
- (iii) either $v \in A_E$ and $F(v) = F_l(v)$ or $v \in \tilde{A}_E$ and $\tilde{F}(v) = \tilde{F}_l(v)$, and
- (iv) either $v \in A_E$ and $F(v) = -\frac{g_0(v, v)}{\omega(v)}$ or $v \in \tilde{A}_E$ and $\tilde{F}(v) = \frac{g_0(v, v)}{\omega(v)}$.

Consistently, we will consider that a lightlike vector v for $-h$ is future-pointing (resp. past-pointing) if it belongs to the boundary of A_E (resp. \tilde{A}_E).

So, A_l (resp. \tilde{A}_l) can be interpreted as the set of all the future-pointing (resp. past-pointing) timelike vectors for $-h$; and analogously A_E (resp. \tilde{A}_E) is the set of all the future-pointing (resp. past-pointing) causal vectors.

Observe also, that in the region $\Lambda \neq 0$, one has $h(v, v)/\Lambda^2 = (F + F^{\text{rev}})^2(v)/4$ and h/Λ^2 is conformally invariant.

The following property of lightlike geodesics of $(\mathbb{R} \times M, g)$ in terms of h will be useful later. Notice first that if $\gamma = (\zeta, \sigma)$ is a lightlike curve in $(\mathbb{R} \times M, g)$ then

$$g(\dot{\gamma}, \partial_t) = -\Lambda \dot{\zeta} + \omega(\dot{\sigma}) = \begin{cases} \omega(\dot{\sigma}) & \text{if } \Lambda = 0 \\ \mp \sqrt{\Lambda g_0(\dot{\sigma}, \dot{\sigma}) + \omega(\dot{\sigma})^2} & \text{if } \Lambda \neq 0, \end{cases} \quad (35)$$

(take into account (33)). In particular, the lightlike vectors for $-h$ in the region M_l can be interpreted as the projection of lightlike vectors of the spacetime orthogonal to ∂_t , in addition to the characterizations in Remark 3.20. Now, recall that if γ is a geodesic of $(\mathbb{R} \times M, g)$, then $g(\dot{\gamma}, \partial_t)$ is constant along γ (as ∂_t is Killing).

Lemma 3.21. *For any lightlike geodesic $\gamma = (\zeta, \sigma)$ of $(\mathbb{R} \times M, g)$, the constant $C = g(\dot{\gamma}, \partial_t)$ satisfies $C^2 = h(\dot{\sigma}, \dot{\sigma})$. Moreover, if $C = 0$ either (i) σ is constant, $\sigma \equiv x_0 \in M$, and the integral curve of K that projects onto x_0 is a lightlike*

pregeodesic (that is, $d\Lambda$ vanishes on the kernel of ω_{x_0}) or (ii) σ remains in the closure \bar{M}_l of M_l (in particular, if $M_l = \emptyset$ this case cannot hold), σ can reach the boundary ∂M_l only at isolated points (where the g_0 -acceleration $D^{g_0}\dot{\sigma}/ds$ does not vanish) and, whenever σ remains in M_l ($-h$ is Lorentzian on σ), σ is a lightlike geodesic of h/Λ .

Proof. For the first assertion, recall that the expression (35) is equal to $\sqrt{h(\dot{\sigma}, \dot{\sigma})}$ up to a sign, i.e. $h(\dot{\sigma}, \dot{\sigma}) = C^2$.

For the last assertion, if σ is constantly equal to x_0 , then γ can be a geodesic if and only if the corresponding orbit of ∂_t can be reparametrized as a geodesic. This happens if and only if the gradient $\nabla^g \Lambda$ of Λ with respect to the metric g , when projected on TM by using the differential of $\pi : \mathbb{R} \times M \rightarrow M$, is 0. In fact, since for a Killing vector field K , $\nabla^g(g(K, K)) = -2\nabla_K K$, an orbit $\gamma(t) = (t, x_0)$ of ∂_t is a pregeodesic if and only if there exists a function λ such that $\nabla^g(g(\partial_t, \partial_t))|_{(t, x_0)} = \lambda(t)\partial_t|_{(t, x_0)}$, for all $t \in \mathbb{R}$. Recalling that $-g(\partial_t, \partial_t)(t, x_0) = \Lambda(x_0)$, for all $t \in \mathbb{R}$, and that ω_{x_0} is the one-form on M_0 g_0 -equivalent to the g -orthogonal projection of ∂_t on TM , this equation is equivalent to the condition that $d\Lambda(x_0)$ is proportional to ω_{x_0} , as required.

Finally, observe that a lightlike geodesic $\gamma = (\zeta, \sigma)$ with σ non-constant can have $C = 0$ only in \bar{M}_l and, if there exists some s_0 such that $\sigma(s_0) := x_0 \in \partial M_l$, then: (i) $\dot{\sigma}(s_0) = 0$ (otherwise, γ cannot be both, lightlike and orthogonal to ∂_t), (ii) $d\Lambda_{x_0}$ cannot be proportional to ω_{x_0} (otherwise, by uniqueness of geodesics γ would be an integral curve of ∂_t), and (iii) $(D^{g_0}\dot{\sigma}/ds)(s_0) \neq 0$. To see this, observe that γ is a geodesic of $(\mathbb{R} \times M, g)$ if and only if

$$\begin{aligned} \frac{D^{g_0}}{ds}\dot{\sigma} &= -\ddot{\zeta}\omega^\sharp + \dot{\zeta}\hat{\Omega}(\dot{\sigma}) - \frac{1}{2}\dot{\zeta}^2\nabla^{g_0}\Lambda, \\ \omega(\dot{\sigma}) - \Lambda\dot{\zeta} &= \text{const.} \end{aligned}$$

where D^{g_0}/ds and ∇^{g_0} are respectively the covariant derivative of (M, g_0) along σ and the gradient with respect to g_0 , ω^\sharp is the vector field g_0 -equivalent to ω and $g_0(w, \hat{\Omega}(v)) = d\omega(v, w)$ for every $v, w \in TM$. The above equations can be obtained for example using that the geodesics are the critical points of the energy functional (or using the explicit formulas (13) and (14) in [30], which are valid for arbitrary Λ). Then $(\frac{D^{g_0}}{ds}\dot{\sigma})(s_0) \neq 0$ because otherwise $\dot{\zeta}(s_0)\omega^\sharp_{x_0} = -\frac{1}{2}\dot{\zeta}^2(s_0)\nabla^{g_0}\Lambda(x_0)$. As $\dot{\zeta}^2(s_0) \neq 0$, because γ is lightlike, we conclude that σ is constant by (i). Now, in the region M_l , the map $\pi : (\mathbb{R} \times M_l, g) \rightarrow (M_l, h/\Lambda)$ is a semi-Riemannian submersion (see Proposition 3.18) and therefore, lightlike geodesics orthogonal to the fibers project into (and are all the lifts of) lightlike geodesics of $(M_l, h/\Lambda)$. \square

Stationary spacetimes have been studied in many mathematically oriented papers, see e.g. [31, 50, 39, 30, 18, 34, 20, 16], while the case $\Lambda \equiv 0$, which includes global Brinkmann decompositions [13], has been considered recently in [5], where the authors study geodesic connectedness.

3.5. Fundamental tensors for F, F_l . Recall that when $\Lambda > 0$, F is a Randers metric with a well-known positive definite fundamental tensor (see for example [40, Corollary 4.17]) and, when $\Lambda = 0$, then F is a Kropina metric with also a positive-definite fundamental tensor (see [40, Corollary 4.12]). Next, we focus on the region $\Lambda < 0$ and the domain A_l of TM .

The fundamental tensor of F and F_l can be computed explicitly from the expressions (30) and (32) by taking into account that these metrics can be regarded as canonical (F_0, ω) -ones, i.e. they can be written as $F_0 \cdot \phi(\omega/F_0)$ being F_0 the root of g_0 and

$$\phi(z) = \frac{1}{-z \pm \sqrt{z^2 + \Lambda}},$$

see [40, §4.2.1]. In any case, a simplified computation can be accomplished. In fact, it is enough to study the fundamental tensor of the Randers type metrics:

$$F^\epsilon = -\epsilon\sqrt{\tilde{h}} + \beta \quad \text{with } \tilde{h} = \beta \otimes \beta - \bar{g}_0,$$

where β is the one-form ω/Λ , and \bar{g}_0 the Riemannian metric $g_0/|\Lambda|$, so that \tilde{h} is Lorentzian with coindex 1 and $\beta(v) > 0$ on A_l . The value of ϵ is 1 for F and -1 for F_l .

Proposition 3.22. *Let G^ϵ , $\epsilon = \pm 1$, be the fundamental tensor of F^ϵ , i.e., of F for $\epsilon = 1$ and F_l for $\epsilon = -1$. Then, with the above notation for \tilde{h} and β :*

$$G_v^\epsilon(w, w) = -\epsilon F^\epsilon(\tilde{v}) \left(\tilde{h}(w, w) - \tilde{h}(\tilde{v}, w)^2 \right) + \left(-\epsilon \tilde{h}(\tilde{v}, w) + \beta(w) \right)^2 \quad (36)$$

for all $v \in A_l$ and $w \in T_{x_0}M$, where $\tilde{v} = v/\sqrt{\tilde{h}(v, v)}$ on A_l .

Proof. It is enough to observe that [40, Prop. 4.10], with $\phi(s) = -\epsilon + s$, holds also in this case. \square

Remark 3.23. Observe that (36) can be used to prove directly that F and F_l are, respectively, conic Finsler and Lorentzian Finsler in their domains A and A_l . Focusing on A_l , clearly $G_v^\epsilon(v, v) = F^\epsilon(v)^2 > 0$; therefore, the space of the vectors $u \in T_{x_0}M$ which are G_v^ϵ -orthogonal to v is transversal to v and has dimension $m - 1$. Moreover, setting $v \in A_l$:

$$G_v^\epsilon(v, u) = 0 \quad \Leftrightarrow \quad \beta(u) = \epsilon \tilde{h}(\tilde{v}, u) \quad \left(\Leftrightarrow \beta(u) = -\frac{\epsilon \bar{g}_0(\tilde{v}, u)}{1 - \epsilon \beta(\tilde{v})} \right).$$

By using repeatedly this equivalence, if u is G_v^ϵ -orthogonal to v , (36) becomes:

$$G_v^\epsilon(u, u) = -\epsilon F^\epsilon(\tilde{v}) \left(\tilde{h}(u, u) - \tilde{h}(\tilde{v}, u)^2 \right) = \epsilon F^\epsilon(\tilde{v}) \bar{g}_0(u, u),$$

and the result follows as $F^\epsilon(\tilde{v}) > 0$.

4. THE CASE OF CAUSAL K : RANDERS-KROPINA METRICS

Next, we focus on the case of an SSTK splitting when K is causal (i.e., $\Lambda \geq 0$), so that its Fermat structure becomes a Randers-Kropina metric F according to Definition 2.48. In particular, $A_l = \emptyset$, and $A_x = T_x M \setminus \{0\}$ iff $\Lambda(x) > 0$ while A_x is an open half-space in $T_x M$ iff $\Lambda(x) = 0$ (recall Definition 2.9 and Proposition 3.12). Therefore, F_l and A_E will not be used and we will consider F -admissibility rather than notions as wind curves —the wind balls will be also treated in a way similar to the classical Finslerian one. Our aim is to show that, on the one hand, F can be used to describe the causality of the spacetime $(\mathbb{R} \times M, g)$ and, on the other hand, the known properties on causality of spacetimes allow us to obtain properties of the associated Finslerian separation $d_F : M \times M \rightarrow [0, +\infty]$.

4.1. Characterization of the chronological relation. Following [40, Definition 3.6], for any conic pseudo-Finsler metric $F: A \subseteq TM \rightarrow [0, +\infty)$ on M and any $x, y \in M$, one says that x F -precedes y , written $x \prec y$, if there is an F -admissible curve from x to y . Here, a curve is said F -admissible consistently with Definition 2.18, i.e., if its velocity lies in the domain A of F , so that $x \prec y$ iff $\Omega_{x,y}^A \neq \emptyset$. The *Finslerian separation*, or just F -separation, from x to y , denoted $d_F(x, y)$, is

$$d_F(x, y) = \begin{cases} \inf_{\gamma \in \Omega_{x,y}^A} \ell_F(\gamma) & \text{if } x \prec y, \\ +\infty & \text{otherwise.} \end{cases}$$

Notice that, d_F is non-negative and satisfies a triangle inequality, namely, $d(x, z) \leq d(x, y) + d(y, z)$ for all $x, y, z \in M$, but it is non-symmetric and $d_F(x, x)$ can be positive. As in the classical Finsler case, given any point $x \in M$ and $r > 0$, two kind of balls centred at x can be defined: the *forward balls* $B_F^+(x, r) = \{y \in M : d_F(x, y) < r\}$ and the *backward* ones $B_F^-(x, r) = \{y \in M : d_F(y, x) < r\}$. In the case that a standard Finsler metric is regarded as the conic Finsler metric of a wind Finslerian structure Σ , as $F_l = +\infty$ in this case, the natural balls $B_F^+(x, r)$ and $B_F^-(x, r)$ will agree with the wind balls $B_\Sigma^+(x, r)$ and $B_\Sigma^-(x, r)$ of Σ (see Definition 2.21 and Propositions 4.1 and 5.1). Both of them are open subsets and constitute a basis for the topology of M in the standard Finsler case and this is generalizable to the wind Riemannian case (recall Remark 2.11 and [40, Proposition 3.13]).

Now, let us focus on the F -separation d_F of the conic Finsler metric F associated with an SSTK splitting with K causal. The chronological relation can be characterized in a simple way.

Proposition 4.1. *For any SSTK splitting with causal K :*

$$(t_0, x_0) \ll (t_1, x_1) \iff d_F(x_0, x_1) < t_1 - t_0,$$

for every $x_0, x_1 \in M$ and $t_0, t_1 \in \mathbb{R}$. Therefore:

$$\begin{aligned} I^+(t_0, x_0) &= \{(t, y) : d_F(x_0, y) < t - t_0\}, \\ I^-(t_0, x_0) &= \{(t, y) : d_F(y, x_0) < t_0 - t\}. \end{aligned} \tag{37}$$

Equivalently, considering d_F -forward and backward balls

$$I^+(t_0, x_0) = \cup_{s>0} \{t_0 + s\} \times B_F^+(x_0, s), \quad I^-(t_0, x_0) = \cup_{s>0} \{t_0 - s\} \times B_F^-(x_0, s).$$

Proof. Recall that a vector $(\tau, v) \in \mathbb{R} \times TM$ is timelike and future-pointing if and only if $\tau > F(v)$ (see Remark 3.15 cases (a) and (b)).

If $(t_0, x_0) \ll (t_1, x_1)$, then there exists a future-pointing timelike curve $\gamma = (t, \sigma) : [0, 1] \rightarrow \mathbb{R} \times M$ from (t_0, x_0) to (t_1, x_1) such that $\dot{t} > F(\dot{\sigma})$ and, perturbing the curve when needed, we can assume that $\dot{\sigma}(s) \neq 0$ for every $s \in [0, 1]$ ⁵. Then by integration, we get $t_1 - t_0 > \ell_F(\sigma)$, i.e. $d_F(x_0, x_1) < t_1 - t_0$.

Conversely, if $d_F(x_0, x_1) < t_1 - t_0$, choose an F -admissible curve $\sigma : [0, 1] \rightarrow M$ from x_0 to x_1 such that $d_F(x_0, x_1) \leq \ell_F(\sigma) < t_1 - t_0$. Then the curve $(t, \sigma) : [0, 1] \rightarrow \mathbb{R} \times M$, where $t(s) = t_0 + \ell_F(\sigma|_{[0,s]}) + \varepsilon s$ and $\varepsilon = t_1 - t_0 - \ell_F(\sigma)$, is a timelike future-pointing curve from (t_0, x_0) to (t_1, x_1) .

⁵This is necessary as we are assuming here that the speed of an F -admissible curve does not vanish (this is somewhat different to our approach in [20]). However, it is easy to check when the dimension $m + 1$ of the spacetime is ≥ 3 that σ can be chosen with always non-vanishing speed (for ex., see the proof of [29, Prop. 3.2]). For the case $m = 1$, this is obvious as piecewise smooth curves can be used here.

The remainder is then straightforward. \square

4.2. Continuity of the Finslerian separation for Randers-Kropina spaces.

Let us start with a general result.

Proposition 4.2. *The F -separation associated with any conic pseudo-Finsler metric F is upper semi-continuous, i.e., if $x_n \rightarrow x$, $y_n \rightarrow y$, then*

$$\limsup_n d_F(x_n, y_n) \leq d_F(x, y).$$

In particular, if $x \prec y$, then $x_n \prec y_n$ for large n .

Proof. Assume that $d_F(x, y) < +\infty$ and, by contradiction,

$$d_F(x_n, y_n) > d_F(x, y) + 3\varepsilon$$

for some $\varepsilon > 0$ and for some subsequences still denoted by x_n and y_n . Choose a curve γ from x to y with $\ell_F(\gamma) < d_F(x, y) + \varepsilon$ and choose \bar{x}, \bar{y} on γ such that $x \in B_F^-(\bar{x}, \varepsilon)$ and $y \in B_F^+(\bar{y}, \varepsilon)$. By [40, Prop. 3.9] these two balls are open and so, for large n , they contain all x_n and y_n . So, the curve ρ obtained by concatenating an F -admissible curve of length smaller than ε from x_n to \bar{x} with the piece of γ from \bar{x} to \bar{y} and with another F -admissible curve of length smaller than ε from \bar{y} to y_n yields the required contradiction $d_F(x_n, y_n) < d_F(x, y) + 3\varepsilon$. \square

Although lower semi-continuity may not hold even in the conic Finsler case (and even with points x, y at a finite F -separation, see [40, Example 3.18]), we will check that this semi-continuity does hold in the Randers-Kropina case.

Notice first the following straightforward consequence of Proposition 4.1.

Proposition 4.3. *For any SSTK splitting with causal K , the function*

$$\tau_F : M \times M \rightarrow [0, +\infty], \quad \tau_F(x, y) := \inf\{t \in \mathbb{R} : (0, x) \ll (t, y)\}$$

is equal to the F -separation function d_F .

The function τ_F will be called the (*future*) *arrival time function* and its definition on M instead of $\mathbb{R} \times M$ uses implicitly the invariance of the metric with t .

Next, we will prove the lower semi-continuity of d_F by using results of spacetimes (which, in particular, extend those in [59]). To this aim, we will use a well-known result on limit curves. The latter are defined as follows (see [7, Definition 3.28]).

Definition 4.4. A curve γ in a spacetime (L, g) is a limit curve of a sequence of curves $\{\gamma_k\}$, if there exists a subsequence $\{\gamma_m\}$ such that for all p in the image of γ , any neighborhood of p intersects all but a finite number of the curves in $\{\gamma_m\}$.

A standard result says that any sequence $\{\gamma_k\}$ of causal, future-pointing, future-inextendible causal curves whose images has an accumulation point p admits a limit curve through p which is also causal, future-pointing and future-inextendible (see [7, Proposition 3.31]; the same holds replacing “future” with “past” in the previous statement).

Theorem 4.5. *The F -separation $d_F : M \times M \rightarrow [0, +\infty]$ associated with any Randers-Kropina metric is continuous away from the diagonal $D = \{(x, x) : x \in M\} \subset M \times M$.*

Proof. From Proposition 4.3 and Proposition 4.2, it is enough to prove the lower semi-continuity of τ_F for the corresponding SSTK splitting.

Let $\{x_n\}$ and $\{y_n\}$ be converging sequences, $x_n \rightarrow x, y_n \rightarrow y \neq x$, and assume by contradiction that there exist subsequences, denoted again by $\{x_n\}, \{y_n\}$, such that $\{\tau_F(x_n, y_n)\}$ converges with

$$T_0 := \lim_n \tau_F(x_n, y_n) < \tau_F(x, y).$$

Choose $T_1 \in (T_0, \tau_F(x, y))$, and define $q_n := (T_1, y_n)$, $p_n := ((T_1 - T_0)/2, x_n)$. Each line $l_{y_n} = \{(s, y_n) : s \in \mathbb{R}\}$ is causal and, since $\tau_F(x_n, y_n)$ is finite for large n , necessarily $p_n \ll q_n$ for n big enough (recall $l_y \neq l_x$ and Remark 3.1). Thus, we can take a sequence of past-pointing timelike curves $\{\gamma_n\}$ connecting each q_n with p_n . Moreover, these curves are assumed to be inextendible to the past, by prolonging them with the lines l_{x_n} . As $\{q_n\} \rightarrow q_\infty := (T_1, y)$, the sequence $\{\gamma_n\}$ admits a causal, past-inextendible and past-pointing limit curve γ starting at q_∞ . Necessarily, γ must leave l_y at some point Q ; otherwise, as γ is inextendible, it must run all (t, q_∞) when $t \rightarrow -\infty$ (but this is absurd because the points in γ lie in the closure of the set of images of all γ_n , and the piece of such curves with $t \circ \gamma_n \leq (T_1 - T_0)/2$ lie in l_{x_n} , which accumulate at $l_x \neq l_y$). Notice also that if γ arrived at the limit $p_\infty := ((T_1 - T_0)/2, x)$ of $\{p_n\}$, a contradiction with the definition of $\tau_F(x, y)$ would be obtained. Now, choose $T_2 \in (T_1, \tau_F(x, y))$ and any point Q' on γ away from l_y ; necessarily $Q' < Q < (T_2, y)$ and, then, $Q' \ll (T_2, y)$ (recall Remark 3.1). But Q' lies in the closure of the images of the set of all γ_n and, thus, up to a subsequence, some point Q'_n on each γ_n satisfies $Q'_n \ll (T_2, y)$ for large n . Therefore, we can assume

$$p_n(\ll Q'_n) \ll (T_2, y),$$

and choose a future-inextendible timelike curve α_n from p_n to (T_2, y) and equal to l_y beyond this point. Consider the limit curve α of the sequence α_n departing from p_∞ . Reasoning as above, α leaves l_x at some point, and any point Q'' on α away from l_x satisfies $p = (0, x) \ll Q''$. Choose a point Q''_n , in a curve α_n , close enough to Q'' such that $p \ll Q''_n$. This concludes that

$$p \ll Q''_n \ll (T_2, y),$$

in contradiction with the definition of $\tau_F(x, y)$. \square

Remark 4.6. (1) The necessity of the exception on the diagonal D in the previous theorem comes from the following fact. Choosing any F -admissible curve γ starting at x , one constructs trivially a sequence $\{x_n\}$, $x_n \rightarrow x$ of points on γ with $d_F(x, x_n) \rightarrow 0$. But, as the constant curve is not F -admissible, when K is lightlike one may have $d_F(x, x) > 0$.

The last property holds for any Kropina norm. With more generality, it happens whenever there exists a neighborhood U such that K is lightlike in U and no F -admissible loop contained in U exists, i.e. $y \not\prec_U y$, for all $y \in U$. In fact, in this case any F -admissible loop starting at x (and leaving necessarily U) will have a length greater than some $\varepsilon > 0$ —to check this, notice that one can always obtain a Finsler metric F_0 in any compact neighborhood of x such that F_0 is smaller than 1 on the indicatrix of F . Recall that for a Kropina metric $F = \alpha^2/\beta$, the property $y \not\prec_U y$ for all $y \in U$ holds for any neighborhood U where $\beta|_U = \Omega df$ for some $\Omega > 0$ and f (the latter with no critical points on U).

(2) The possible discontinuity in the diagonal would not be removed if $d_F(x, x)$ were redefined as 0 (namely, regarding $\tau_F(x, y)$ as the infimum of the set $\{t \in \mathbb{R} : (0, x) \leq (t, y)\}$ and defining $d_F(x, y)$ as the new $\tau_F(x, y)$). Indeed, there might be points arbitrarily close to x at infinite F -separation.

(3) In any case, for any Randers-Kropina metric F , if K is timelike at $x \in M$ then $d_F(x, x) = 0$ and d_F is continuous at (x, x) .

4.3. Ladder of causality and properties for Randers-Kropina separation.

Next, we can go further into the causal structure of our class of spacetimes. As a previous technicality, recall that the possible discontinuity of d_F at the diagonal D leads us to define the *closed forward* (resp. *backward*) d_F -ball of center x and radius $r > 0$ as:

$$\bar{B}_F^+(x, r) := \{y \in M : d_F(x, y) \leq r\} \cup \{x\} = \text{closure of } B_F^+(x, r)$$

$$\text{(resp. } \bar{B}_F^-(x, r) := \{y \in M : d_F(y, x) \leq r\} \cup \{x\} = \text{closure of } B_F^-(x, r));$$

(the continuity of d_F away from D is used for the equality) and $\bar{B}_F^+(x, r = 0) := \{x\} =: \bar{B}_F^-(x, r = 0)$ (these choices are consistent with Definition 2.21 and Proposition 2.28). Then, the following relation between the position of the spacetime in the causal ladder and the properties of the Randers-Kropina metric appears.

Theorem 4.7. *Consider an SSTK splitting $(\mathbb{R} \times M, g)$ as in (26) with K causal and associated Randers-Kropina metric F on M . Then, $(\mathbb{R} \times M, g)$ is causally continuous, and*

(i) *the following assertions are equivalent:*

(i1) $(\mathbb{R} \times M, g)$ *is causally simple i.e., it is causal (which means that no closed smooth causal curve exists) and the sets $J^+(p)$, $J^-(p)$ are closed for all $p \in \mathbb{R} \times M$).*

(i2) (M, F) *is convex, in the sense that for every $x, y \in M$, $x \neq y$, with $d_F(x, y) < +\infty$, there exists a geodesic γ from x to y such that $\ell_F(\gamma) = d_F(x, y)$.*

(i3) $J^+(p)$ *is closed for all $p \in \mathbb{R} \times M$.*

(i4) $J^-(p)$ *is closed for all $p \in \mathbb{R} \times M$.*

(ii) $(\mathbb{R} \times M, g)$ *is globally hyperbolic (i.e. it is causal and all the intersections $J^+(p) \cap J^-(q)$ are compact) if and only if $\bar{B}_F^+(x, r_1) \cap \bar{B}_F^-(y, r_2)$ is compact (or empty) for every $x, y \in M$ and $r_1, r_2 > 0$.*

(iii) *The following assertions are equivalent:*

(iii1) *A slice $S_t = \{(t, x) : x \in M\}$ (and, then all the slices) is a space-like Cauchy hypersurface i.e., it is crossed exactly once by any inextendible timelike curve (and, then, also by any causal one).*

(iii2) *the closures $\bar{B}_F^+(x, r)$, $\bar{B}_F^-(x, r)$ are compact for all $r > 0$ and $x \in M$.*

(iii3) *F is forward and backward geodesically complete.*

Proof. First observe that, as $t : \mathbb{R} \times M \rightarrow \mathbb{R}$, $(t, x) \mapsto t$, is a temporal function, then $(\mathbb{R} \times M, g)$ is stably causal and, in particular, distinguishing (for the elements of causality to be used here, see [54] or [7, 11]). So, to prove causal continuity, it is enough to show that $(\mathbb{R} \times M, g)$ is future and past reflecting (see for example [54, Definition 3.59, Lemma 3.46] or [7, Theorem 3.25, Proposition 3.2]). Let us see that it is past reflecting (the other case is analogous), that is, $I^+(p) \supset I^+(q)$ implies $I^-(p) \subset I^-(q)$ for any $p = (t_0, x)$ and $q = (t_1, y)$. We can assume $x \neq y$ (otherwise it is obvious), and the inclusion $I^+(p) \supset I^+(q)$ implies that $d_F(x, y) \leq t_1 - t_0$. This

is a consequence of the continuity of d_F away from D proven in Theorem 4.5. In fact, consider a sequence $\{q_n = (t_1 + \varepsilon_n, y_n)\}$ contained in $I^+(q)$ and converging to q so that $\varepsilon_n \searrow 0, y_n \rightarrow y$. By (37), $d_F(x, y_n) < (t_1 - t_0) + \varepsilon_n$, and, by the continuity of d_F , the required inequality holds. But $d_F(x, y) \leq t_1 - t_0$ implies directly $I^-(p) \subset I^-(q)$ (use again (37) and the triangle inequality for d_F), as required.

Equivalences in (i) and (ii) can be proved formally as in the stationary case [20]. The proof of the equivalences in (iii) has some differences with respect to the stationary case due to the lack of a Hopf-Rinow theorem for Randers-Kropina metrics. The reader can check, however, that both, the equivalence between (iii1) and (iii3), and the implications (iii1) \Rightarrow (iii2) \Rightarrow (iii3) hold by means of simple modifications of the arguments in [20, Theorems 4.3 and 4.4]. In any case, a full proof can be obtained as a particular case of the most general Theorem 5.11 below. \square

As a straightforward consequence of Theorem 4.7 and the implications from causality theory (iii1) \Rightarrow global hyperbolicity \Rightarrow (i1), one has the following version of Hopf-Rinow theorem.

Corollary 4.8. *For any Randers-Kropina metric F on a manifold M , the forward (resp. backward) geodesic completeness of d_F is equivalent to the compactness of the forward closed balls $\bar{B}_F^+(x, r)$ (resp. backward closed balls $\bar{B}_F^-(x, r)$) for every $x \in M, r > 0$. Moreover, any of these properties implies the compactness of the intersection between any pair of forward and backward closed balls. Finally, the last property implies the convexity of (M, F) , in the sense of Theorem 4.7.*

Example 4.9. The so-called Brinkmann spaces are defined by the existence of a complete parallel lightlike vector field K , and they include many physical examples of interest, as wave-type spacetimes (plane waves, pp-waves etc.); a detailed study of these spaces is carried out in [13]. Under very general circumstances [29], they are stably causal. Thus, they become an SSTK (recall Definition 3.2 and Proposition 3.3) with lightlike K , and they determine a Kropina metric where all the previous results are applicable. We mention that they have been considered recently in [5], where their geodesic connectedness is studied.

5. THE CASE OF ARBITRARY K : GENERAL WIND RIEMANNIAN STRUCTURES

In this section we consider the general case of a Killing vector field K with no restriction on its pointwise causal character.

5.1. Causal futures and lightlike geodesics. For the study of the causality of a general SSTK splitting, we will use its Fermat structure Σ in Definition 3.9 and the notation for causal elements in Section 3.1.

We start with a characterization of the chronological relation which generalizes Proposition 4.1 for Randers-Kropina metrics with two remarkable differences: (a) now there is no natural Finslerian separation d_F but only the wind balls, and (b) a description of the causal futures and pasts is also provided, so that the interpretation of the c-balls will be clearer. Recall that the time coordinate of the SSTK splitting is a temporal function and every causal curve can be parametrized with the time.

Proposition 5.1. *Let $(\mathbb{R} \times M, g)$ be an SSTK splitting. Then:*

$$\begin{aligned} I^+(t_0, x_0) &= \cup_{s>0} \{t_0 + s\} \times B_{\Sigma}^+(x_0, s), \\ I^-(t_0, x_0) &= \cup_{s>0} \{t_0 - s\} \times B_{\Sigma}^-(x_0, s), \\ J^+(t_0, x_0) &= \cup_{s \geq 0} \{t_0 + s\} \times \hat{B}_{\Sigma}^+(x_0, s), \\ J^-(t_0, x_0) &= \cup_{s \geq 0} \{t_0 - s\} \times \hat{B}_{\Sigma}^-(x_0, s). \end{aligned}$$

Proof. Taking into account Remark 3.15 and Convention 2.17, a vector $(\tau, v) \in \mathbb{R} \times (TM \setminus \mathbf{0})$ with $\tau > 0$ is causal and future-pointing if and only if $v \in A_E \cup A \setminus \mathbf{0}$ and

$$F(v) \leq \tau \leq F_l(v); \quad (38)$$

moreover, it is timelike and future-pointing if and only if both inequalities hold strictly in (38) (and, thus, $v \in A$). Accordingly, a t -parametrized piecewise smooth curve $(t, x) : [t_0, t_1] \rightarrow \mathbb{R} \times M$ is causal (resp. timelike) and future-pointing if and only if x is Σ -admissible and

$$F(\dot{x}(t)) \leq \dot{t} \equiv 1 \leq F_l(\dot{x}(t)) \quad (39)$$

(resp. x is F -admissible and

$$F(\dot{x}(t)) < \dot{t} \equiv 1 < F_l(\dot{x}(t)) \quad (40)$$

thus, in particular, x is a wind curve. Now, reasoning for the future and the inclusions \subset , observe that if $(t_1, x_1) \in J^+(t_0, x_0)$, then there exists a future-pointing causal curve $\gamma = (t, x)$ joining (t_0, x_0) and (t_1, x_1) , with x being Σ -admissible (recall footnote 5) ⁶. So, integrating in (39) one has: if $(t_1, x_1) \in J^+(t_0, x_0)$ then $x_1 \in \hat{B}_{\Sigma}^+(x_0, t_1 - t_0)$ (resp. if $(t_1, x_1) \in I^+(t_0, x_0)$, then $x_1 \in B_{\Sigma}^+(x_0, t_1 - t_0)$), as required.

For the converse \supset , in the case J^+ , choose any $x_1 \in \hat{B}_{\Sigma}^+(x_0, s)$ and a wind curve $x : [0, s] \rightarrow M$ from x_0 to x_1 such that $\ell_F(x) \leq s \leq \ell_{F_l}(x)$ (which exists by definition of $\hat{B}_{\Sigma}^+(x_0, s)$). From (39), the curve $[t_0, t_0 + s] \ni t \mapsto (t, x(t - t_0))$ is the required causal curve from (t_0, x_0) to $(t_0 + s, x_1)$. Moreover, to check the inclusion \supset for I^+ , notice that if $x_1 \in B_{\Sigma}^+(x_0, s)$ then the inequalities (39) hold strictly at some point. If both of them hold at some point \bar{t} , then the causal curve becomes timelike at $(\bar{t}, x(\bar{t} - t_0))$ —so that the points (t_0, x_0) and $(t_0 + s, x_1)$ can be connected by means of a timelike curve, see for example [55, Proposition 10.46]. Otherwise, there must exist two disjoint intervals $[\bar{t}_1, \bar{t}_2], [\bar{t}_3, \bar{t}_4] \subset]0, s]$ such that in $[\bar{t}_1, \bar{t}_2]$ does hold the second strict inequality and in $[\bar{t}_3, \bar{t}_4]$ it holds the first one. Assume that $\bar{t}_2 < \bar{t}_3$ (the other case is analogous) and define the function

$$\rho(\mu) = \begin{cases} 0 & 0 \leq \mu \leq \bar{t}_1 \\ \varepsilon(\mu - \bar{t}_1) & \bar{t}_1 \leq \mu \leq \bar{t}_2 \\ \varepsilon(\bar{t}_2 - \bar{t}_1) & \bar{t}_2 \leq \mu \leq \bar{t}_3 \\ \varepsilon\left(\bar{t}_2 - \bar{t}_1 + \frac{\bar{t}_2 - \bar{t}_1}{\bar{t}_4 - \bar{t}_3}(\bar{t}_3 - \mu)\right) & \bar{t}_3 \leq \mu \leq \bar{t}_4 \\ 0 & \bar{t}_4 \leq \mu \leq s \end{cases}$$

⁶ In the particular case when $x_0 = x_1$, \dot{x} may be forced to vanish when the vertical line on x_0 is a lightlike pregeodesic but then $\Lambda(x_0) = 0$ (i.e. $0_{x_0} \in \Sigma_{x_0}$), and $x_0 \in \hat{B}_{\Sigma}^+(x_0, r)$, for all $r \geq 0$,

If $\varepsilon > 0$ is small enough, the curve $[0, s] \ni \mu \mapsto (\mu + \rho(\mu), x(\mu)) \in \mathbb{R} \times M$ is a causal curve from (t_0, x_0) to $(t_0 + s, x_1)$ which is timelike in some point. Then applying again [55, Proposition 10.46] we conclude. \square

Remark 5.2. As a straightforward consequence of the previous result, one obtains that, *for any wind Riemannian manifold, the wind balls are open*. In fact, this is a simple consequence of the fact that, from Proposition 5.1, $B_{\Sigma}^{\pm}(x_0, s)$ is homeomorphic to $I^{\pm}(t_0, x_0) \cap S_{t_0+s}$ and, for any spacetime, $I^{\pm}(t_0, x_0)$ is open. More precisely, the Lorentzian result [55, Proposition 10.46] claimed in the proof of Proposition 5.1 becomes crucial. As commented at the end of the Introduction, one expects that this and other results can be extended to all wind Finslerian manifolds, by developing more specific tools.

We recall that two points p and q in a spacetime are said *horismotically related* if $q \in J^+(p) \setminus I^+(p)$. This case can be characterized as follows.

Lemma 5.3. *Let $I \subset \mathbb{R}$ be an interval and $\rho: I \rightarrow \mathbb{R} \times M$ be a lightlike future-pointing pregeodesic of an SSTK splitting $(\mathbb{R} \times M, g)$. Then ρ can be reparametrized as $s \mapsto (s, x(s))$ on $[t(\rho(a)), t(\rho(b))]$ and the function $C_{\rho}(s) := g(\partial_t, \dot{\rho}(s))$ either has a definite sign on I or it vanishes everywhere.*

Proof. The possibility of the reparametrization follows because the projection $t: \mathbb{R} \times M \rightarrow \mathbb{R}$ is a temporal function (see part (1) of Remark 3.4). Moreover, since ∂_t is a Killing vector field, $g(\partial_t, \dot{\gamma})$ is constant for any geodesic γ of $(\mathbb{R} \times M, g)$, which implies that $g(\partial_t, \dot{\rho}(s))$ will preserve the sign in $s \in I$, as ρ is a reparametrization of a geodesic of $(\mathbb{R} \times M, g)$. \square

Corollary 5.4. *Two distinct points $(t_0, x_0), (t_1, x_1) \in \mathbb{R} \times M$ are horismotically related if and only if $x_1 \in \hat{B}_{\Sigma}^+(x_0, t_1 - t_0) \setminus B_{\Sigma}^+(x_0, t_1 - t_0)$.*

In this case, there exists a lightlike pregeodesic $\rho: [t_0, t_1] \rightarrow \mathbb{R} \times M$, $\rho(s) = (s, x(s))$ from (t_0, x_0) to (t_1, x_1) and such that x is a unit extremizing geodesic of Σ from x_0 to x_1 with $\ell_F(x) = t_1 - t_0$ or $\ell_{F_l}(x) = t_1 - t_0$ (or both). Moreover, when x is a constant curve (i.e. an extremizing exceptional geodesic), necessarily $\Lambda(x_0) = 0$ with $d\Lambda(\text{Ker } \omega_{x_0}) \equiv 0$; when x is not constant then it is a regular (in the sense of Definition 2.18-(iii)).

Proof. The first equivalence is straightforward from Proposition 5.1. More precisely, two horismotically related points are connected by a lightlike geodesic γ (see e.g. [55, Proposition 10.46]) and, applying Lemma 5.3, we can reparametrize γ as $\rho(s) = (s, x(s))$. Now, x is a wind curve connecting x_0 with x_1 , and horismoticity implies $x(s) \in \hat{B}_{\Sigma}^+(x_0, s - t_0) \setminus B_{\Sigma}^+(x_0, s - t_0)$, for all $s \in (t_0, t_1]$, so that x is a unit extremizing geodesic (Definition 2.30). The last assertions follow from Lemmas 3.21 and 5.3. \square

Remark 5.5. As any lightlike geodesic is locally horismotic, the previous corollary implies directly: *all the non-exceptional (non constant) geodesics of a wind Riemannian structure are regular*. Notice that the crucial step on the spacetime side is Lemma 3.21. In fact, that lemma allows us to give further information, namely: if x is a geodesic of a wind Riemannian structure then it is a smooth curve, its velocity can be zero only at isolated points and its acceleration (for one auxiliary Riemannian metric and, then, for any of them) does not vanish at those zeroes.

These relevant properties rely on the explicit form of the geodesic equation for an SSTK spacetime. Roughly speaking, they ensure that the set of zeroes in a geodesic can be easily controlled and, a posteriori, suggests that the wind restriction for curves, variations etc. can be simplified in Σ -admissibility (or just in F -admissibility). However, we have preferred to introduce the general wind framework because, from a Finslerian viewpoint, it makes possible a better understanding of the setting and it is also prepared for non-Riemannian wind Finslerian structures.

As in the case of other properties for wind Riemannian geodesics (see Remark 5.2), it would be interesting to check if regularity can be extended to the geodesics of any wind Finslerian structure.

The next result characterizes the lightlike geodesics of an SSTK spacetime in terms of the Finslerian elements. But, first, the following lemma points out some simple technical properties. Recall that a Lorentzian manifold (M, g) admits a convex neighborhood U at every point $p \in M$ (i.e., U is a normal neighborhood of all its points), [69].

Lemma 5.6. *Given an SSTK splitting $(\mathbb{R} \times M, g)$ and $z_0 = (t_0, x_0) \in \mathbb{R} \times M$ there exists a convex neighborhood U of z_0 , a neighborhood V of z_0 contained in U and some small $\varepsilon > 0$ such that $J^+(z) \cap \{(t, x) \in \mathbb{R} \times M : t \in [t(z), t_0 + \varepsilon]\} \subset U$ for every $z \in V$.*

Proof. Consider a chart $(U, y^0, y^1, \dots, y^m)$ around z_0 such that no causal curve starting at U will leave and return to U (this can be obtained as the SSTK spacetime is strongly causal, Remark 3.4 (1)) and with the coordinates adapted to the product structure ($y^0 = t, y^1, \dots, y^m$ coordinates on M). Choosing a smaller U , such that it is convex in $(\mathbb{R} \times M, g)$, define a (flat) Minkowski metric g^{flat} in these coordinates such that $\partial_i, i \in \{1, \dots, m\}$, span a spacelike hyperplane and the timecones of g^{flat} are wider than those of g (this can be obtained obviously at the point z_0 and, by continuity, in some small neighborhood). Then, the required property for g holds as it does trivially for g^{flat} . \square

Theorem 5.7. *Let $I \subset \mathbb{R}$ be an interval and $\rho(s) = (s, x(s)), s \in I$, be a (piecewise smooth) curve in an SSTK splitting $(\mathbb{R} \times M, g)$. Then ρ is a future-pointing lightlike pregeodesic of $(\mathbb{R} \times M, g)$ if and only if its projection $I \ni s \rightarrow x(s) \in M$ is a unit geodesic of (M, Σ) . Moreover, in this case:*

- (i) $C_\rho < 0$ iff x is a unit geodesic of F ($F(\dot{x}) \equiv 1$; x is F -admissible).
- (ii) $C_\rho > 0$ iff x is a unit geodesic of F_l ($F_l(\dot{x}) \equiv 1$; x is F -admissible).
- (iii) $C_\rho = 0$ iff one of the following two possibilities occurs:
 - (a) ρ is an integral curve of K which projects onto some x_0 with $\Lambda(x_0) = 0$ and $d\Lambda(\text{Ker } \omega_{x_0}) \equiv 0$ (so that γ_{x_0} is an exceptional geodesic, Definition 2.36), or
 - (b) x is contained in \overline{M}_l ; whenever it remains included in M_l , x is a lightlike pregeodesic of $-h$ parametrized with $F(\dot{x}) \equiv F_l(\dot{x}) \equiv 1$, and x can reach ∂M_l only at isolated points $s_j \in I, j = 1, 2, \dots$, where $\Lambda(x(s_j)) = 0, \dot{x}(s_j) = 0$ and $(D^{g_0} \dot{x}/ds)(s_j) \neq 0$.

Proof. Assume that ρ is a lightlike pregeodesic. For each $s_0 \in I$ (different from its endpoints, and with straightforward modifications otherwise), there exists $\varepsilon > 0$ such that $[s_0 - \varepsilon, s_0 + \varepsilon] \subset I$ and $\rho(s) \in J^+(\rho(s_0 - \varepsilon)) \setminus I^+(\rho(s_0 - \varepsilon))$, for all $s \in [s_0 - \varepsilon, s_0 + \varepsilon]$ (recall, for example, [55, Proposition 5.34] and use strong causality).

Thus, Corollary 5.4 can be applied locally (recall Lemma 5.6), and $x|_{[s_0-\varepsilon, s_0+\varepsilon]}$ is a unit extremizing geodesic of the Fermat structure (M, Σ) .

Conversely, if $x : I \rightarrow M$ is a unit geodesic of (M, Σ) , then it is locally a unit extremizing geodesic (recall Definitions 2.36, 2.30). So, by Proposition 5.1, every s_0 (as above) admits an $\varepsilon > 0$ such that $[s_0-\varepsilon, s_0+\varepsilon] \subset I$ and the curve $[s_0-\varepsilon, s_0+\varepsilon] \ni s \rightarrow (s, x(s)) \in \mathbb{R} \times M$ is contained in $J^+(s_0-\varepsilon, x(s_0-\varepsilon)) \setminus I^+(s_0-\varepsilon, x(s_0-\varepsilon))$; therefore, it is a lightlike pregeodesic (see [55, Proposition 10.46]).

For the last part, first notice that $C_\rho = -\Lambda(x(s)) + \omega(\dot{x}(s))$ and $C_\rho^2 = h(\dot{x}, \dot{x})$ (the latter follows as in the first part of the proof of Lemma 3.21). Thus, when $C_\rho \neq 0$, $\dot{x}(s)$ belongs to $A_{x(s)}$, for all $s \in I$. Hence, x is a unit and F -admissible geodesic of (M, Σ) and, then, from Theorem 2.42, a geodesic of F or F_l . Precisely, from part (iii) of Proposition 3.12, $F(\dot{x}) = 1$ iff $-C_\rho = \Lambda(x(s)) - \omega(\dot{x}(s)) \geq 0$ and $F_l(\dot{x}) = 1$ iff $-C_\rho = \Lambda(x(s)) - \omega(\dot{x}(s)) \leq 0$, i.e. x is a unit F -geodesic iff $C_\rho < 0$ and a unit F_l -geodesic iff $C_\rho > 0$. Finally, (iii) follows from Lemma 3.21. \square

As a straightforward consequence of Lemmas 3.21, 5.3 and Theorem 5.7 we get:

Corollary 5.8. *Let $\gamma : I \rightarrow \mathbb{R} \times M$, $\gamma(s) = (\zeta(s), \sigma(s))$ be a (piecewise smooth) curve in an SSTK splitting $(\mathbb{R} \times M, g)$, with σ non-constant. Then γ is a future-pointing lightlike geodesic if and only if σ is a pregeodesic of (M, Σ) parametrized with $h(\dot{\sigma}, \dot{\sigma}) = \text{const.}$, and one of the following three exclusive possibilities holds*

- (i) $C_\gamma < 0$ and σ is a pregeodesic of F and $\zeta(\bar{s}_0) - \zeta(s_0) = \ell_F(\sigma|_{[s_0, \bar{s}_0]})$ for any $s_0, \bar{s}_0 \in I$, $s_0 < \bar{s}_0$;
- (ii) $C_\gamma > 0$ and σ is a pregeodesic of F_l and $\zeta(\bar{s}_0) - \zeta(s_0) = \ell_{F_l}(\sigma|_{[s_0, \bar{s}_0]})$ for any $s_0, \bar{s}_0 \in I$, $s_0 < \bar{s}_0$;
- (iii) $C_\gamma = 0$, σ is smooth⁷, it is included in \overline{M}_l , it touches ∂M_l at most at isolated points s_j , $j = 1, 2, \dots$, such that $\dot{\sigma}(s_j) = 0$, σ is a lightlike geodesic of h/Λ whenever it remains in M_l , and also ζ is determined by

$$\zeta(\bar{s}_0) - \zeta(s_0) = \ell_{F_l}(\sigma|_{[s_0, \bar{s}_0]}) = \ell_F(\sigma|_{[s_0, \bar{s}_0]})$$

for any $s_0, \bar{s}_0 \in I$, $s_0 < \bar{s}_0$.

5.2. Characterization of the causal ladder. The following technical property concerns limit curves (recall Definition 4.4) in connection with time functions. It has interest in its own right and, so, we write it for any stably causal spacetime.

Lemma 5.9. *Let (L, g) be a spacetime endowed with a time function $t : L \rightarrow \mathbb{R}$.*

- (i) *Consider a sequence of inextendible causal curves $\{\gamma_n\}$ parametrized by the time t and assume that there exists a convergent sequence $\{t_n\}$ such that $\gamma_n(t_n)$ converges to z_0 . Then there exists an (inextendible, causal) limit curve γ through z_0 parametrized by the time t , and a subsequence γ_{n_k} such that, whenever the intersection of γ with the slice $S_{t_0} := \{z \in L : t(z) = t_0\}$ is not empty for $t_0 \in \mathbb{R}$, then all the curves γ_{n_k} but a finite number intersect S_{t_0} and $\gamma(t_0) = \lim_k \gamma_{n_k}(t_0)$.*
- (ii) *Let γ_n be a sequence of causal curves and, for each $n \in \mathbb{N}$, $z_n \leq w_n$ be two points on γ_n . If $z_n \rightarrow z$, $w_n \rightarrow w$, $z \neq w$, and the intersection of the slice S_{t_0} with the images of all γ_n lies in a compact subset for any $t_0 \in (t(z), t(w))$,*

⁷Notice that smoothness follows if we assume just that it is twice differentiable at the points where it touches ∂M_l .

then any (inextendible) limit curve γ of the sequence starting at z arrives at w .

Proof. (i) The existence of the limit curve follows from [7, Proposition 3.31]. Let $\{\gamma_{n_k}\}$ be any subsequence that converges to γ uniformly on compact subsets for some auxiliary complete Riemannian metric (up to a reparametrization, according to [7, Lemma 14.2]) and, so, such that some sequence $\{p_k := \gamma_{n_k}(t_{n_k})\}, t_{n_k} \in \mathbb{R}$, converges to $p := \gamma(t_0)$; in particular $t_{n_k} \rightarrow t_0$. Choose open neighborhoods V, U of p , with $V \subset U$, U convex and V having compact closure included in U and being globally hyperbolic with Cauchy hypersurface S_{t_0} .⁸ Due to the convergence to p , all γ_{n_k} but a finite number will enter in V and cross $V \cap S_{t_0}$ at a single point q_k . Reasoning by contradiction, if $\{q_k\}$ does not converge to p then, up to a subsequence, $\{q_k\}$ converges to some $q \in U \setminus \{p\}$. Assume that, up to a new subsequence, $p_k \leq q_k$ (otherwise we could assume $q_k \leq p_k$ up to a subsequence, and the reasoning would be analogous). By the convexity of U , $p \leq q$ but, as p and q lie in the acausal set⁹ $V \cap S_{t_0}$, one obtains the absurd $p = q$.

(ii) Let $t^* \in (t(z), t(w))$ and let us reparameterize all the curves with t . Assume that $\gamma : [t(z), t^*) \rightarrow L$ cannot be extended to t^* . Let $\{\gamma_{n_k}\}$ be any subsequence that converges to γ as in part (i) and such that $\{\gamma_{n_k}(t^*)\}$ converges to some point $z^* \in S_{t^*}$, the latter property by the assumption on compactness. Up to a subsequence, $\{\gamma_{n_k}\}$ admits a limit curve starting at z^* , say, $\rho : (t^* - \varepsilon, t^*) \rightarrow L$ for some $\varepsilon > 0$. Now, by part (i), necessarily $\{\gamma_{n_k}(t)\}$ converges to both $\gamma(t)$ and $\rho(t)$, for each $t \in (t^* - \varepsilon, t^*)$. So, γ admits z^* as a future limit point and it is then extendible, a contradiction. Thus γ is defined on $[t(z), t(w))$ and since $w_n \rightarrow w$ necessarily it arrives at w . \square

As a first consequence, we obtain characterizations of some causal properties, which will be related to the possible reflectivity and causal simplicity of the spacetime.

Proposition 5.10. *For any $p = (t_0, x_0), q = (t_1, x_1)$ in an SSTK splitting:*

- (i) $I^+(p) \supset I^+(q)$ if and only if $x_1 \in \bar{B}_\Sigma^+(x_0, t_1 - t_0)$, and
- (ii) $I^-(p) \subset I^-(q)$ if and only if $x_0 \in \bar{B}_\Sigma^-(x_1, t_1 - t_0)$.

Moreover,

$$\begin{aligned} \bar{J}^+(t_0, x_0) &= (\cup_{s>0} \{t_0 + s\} \times \bar{B}_\Sigma^+(x_0, s)) \cup \{(t_0, x_0)\} \\ \bar{J}^-(t_0, x_0) &= (\cup_{s>0} \{t_0 - s\} \times \bar{B}_\Sigma^-(x_0, s)) \cup \{(t_0, x_0)\} \end{aligned}$$

Proof. We consider the case (i), being part (ii) analogous.

(\Rightarrow) Choose $\{q_n\} \subset I^+(q)$, converging to q and inextendible future-pointing timelike curves γ_n through p and q_n . From part (i) of Lemma 5.9, there exists a subsequence γ_{n_k} that cuts the slice S_{t_1} in a sequence of points (t_1, y_{n_k}) , such that $y_{n_k} \rightarrow x_1$. By Proposition 5.1, $y_{n_k} \in B_\Sigma^+(x_0, t_1 - t_0)$ and, then, $x_1 \in \bar{B}_\Sigma^+(x_0, t_1 - t_0)$.

(\Leftarrow) As $x_1 \in \bar{B}_\Sigma^+(x_0, t_1 - t_0)$, take a sequence $\{\tilde{y}_n\}$ in $B_\Sigma^+(x_0, t_1 - t_0)$ converging to x_1 . The sequence $q_n = (t_1, \tilde{y}_n)$ converges to q and, by Proposition 5.1, is contained in $I^+(p)$. As the chronological relations are open, given $r \in I^+(q)$, then $r \in I^+(q_n)$ for n big enough. This implies that $r \in I^+(p)$ and then $I^+(p) \supset I^+(q)$, as required.

⁸Such a neighborhood V can be constructed easily by taken the Cauchy development of a small neighborhood in S_{t_0} of p , see [54, Theorem 2.14].

⁹A subset \mathcal{A} of a spacetime V is said *acausal* if no $p, q \in \mathcal{A}$ are causally related in V .

For the last assertion, recall first that, in any spacetime $\bar{J}^\pm(p) = \bar{I}^\pm(p)$ (see, e.g. [55, Lemma 14.6]) hence the inclusions \supset hold trivially from Proposition 5.1. For the converse in the case of \bar{J}^+ , let $q = (t_1, x_1) \in \bar{J}^+(p) = \bar{I}^+(p)$, and take $q_n \in I^+(p)$ such that $q_n \rightarrow q$. Apply part (i) of Lemma 5.9 to obtain a sequence $(t_1, y_{n_k}) \in I^+(p)$ such that $y_{n_k} \rightarrow x_1$, and conclude again from Proposition 5.1 that $y_{n_k} \in B_\Sigma^+(x_0, t_1 - t_0)$, so that $x_1 \in \bar{B}_\Sigma^+(x_0, t_1 - t_0)$. \square

Now, we can study the causal ladder of any SSTK splitting, extending the Randers-Kropina case in Theorem 4.7.

Theorem 5.11. *Consider an SSTK splitting $(\mathbb{R} \times M, g)$ as in (26) with associated Fermat structure Σ on M . Then, $(\mathbb{R} \times M, g)$ is stably causal and*

- (i) $(\mathbb{R} \times M, g)$ is causally continuous if and only if Σ satisfies the following property: given any pair of points x_0, x_1 in M and $r > 0$, $x_1 \in \bar{B}_\Sigma^+(x_0, r)$ if and only if $x_0 \in \bar{B}_\Sigma^-(x_1, r)$.
- (ii) $(\mathbb{R} \times M, g)$ is causally simple if and only if (M, Σ) is w-convex (according to Definition 2.37).
- (iii) The following assertions are equivalent:
 - (iii1) $(\mathbb{R} \times M, g)$ is globally hyperbolic.
 - (iii2) $\hat{B}_\Sigma^+(x, r_1) \cap \hat{B}_\Sigma^-(y, r_2)$ is compact for every $x, y \in M$ and $r_1, r_2 > 0$.
 - (iii3) $\bar{B}_\Sigma^+(x, r_1) \cap \bar{B}_\Sigma^-(y, r_2)$ is compact for every $x, y \in M$ and $r_1, r_2 > 0$.
- (iv) The following assertions are equivalent:
 - (iv1) A slice S_t (and, then every slice) is a spacelike Cauchy hypersurface.
 - (iv2) All the c-balls $\hat{B}_\Sigma^+(x, r)$ and $\hat{B}_\Sigma^-(x, r)$, $r > 0$, $x \in M$, are compact.
 - (iv3) All the (open) balls $B_\Sigma^+(x, r)$ and $B_\Sigma^-(x, r)$, $r > 0$, $x \in M$, are precompact.
 - (iv4) Σ is forward and backward geodesically complete (according to Definition 2.38).

Proof. (i) As the natural projection $t : \mathbb{R} \times M \rightarrow \mathbb{R}$ is a temporal function, Remark 3.4, the spacetime is stably causal. Thus, causal continuity becomes equivalent to past and future reflectivity. However, by Proposition 5.10, past reflectivity (i.e., $I^+(p) \supset I^+(q)$ implies $I^-(p) \subset I^-(q)$) becomes equivalent to the property

$$x_1 \in \bar{B}_\Sigma^+(x_0, t_1 - t_0) \Rightarrow x_0 \in \bar{B}_\Sigma^-(x_1, t_1 - t_0),$$

and future reflectivity is equivalent to the converse.

(ii) Assuming that $(\mathbb{R} \times M, g)$ is causally simple, for any $x_0 \in M$ and $t_0 < t_1$, the intersections $S_{t_1} \cap J^+(t_0, x_0)$ and $S_{2t_0 - t_1} \cap J^-(t_0, x_0)$ must be closed. By Proposition 5.1, these intersections are equal to $\{t_1\} \times \hat{B}_\Sigma^+(x_0, t_1 - t_0)$ and $\{2t_0 - t_1\} \times \hat{B}_\Sigma^-(x_0, t_1 - t_0)$, respectively, which means that Σ is w-convex. For the converse, just apply the last assertion of Proposition 5.10, plus Proposition 2.28 and Proposition 5.1.

(iii) ((iii1) \Rightarrow (iii2)) Assume that $(\mathbb{R} \times M, g)$ is globally hyperbolic and consider the points (r_1, x) and $(-r_2, y)$. By Proposition 5.1,

$$\{0\} \times \left(\hat{B}_\Sigma^+(x, r_1) \cap \hat{B}_\Sigma^-(y, r_2) \right) = (\{0\} \times M) \cap J^+(-r_1, x) \cap J^-(r_2, y),$$

and the right-hand side is compact by global hyperbolicity.

((iii2) \Rightarrow (iii3)) By Proposition 2.28, it is enough to prove that the property of compactness of the intersections implies the closedness of the c-balls. Reasoning

by contradiction, if, say, $z \in \bar{B}_\Sigma^+(x, r_1) \setminus \hat{B}_\Sigma^+(x, r_1)$, as z belongs always to some (open) ball $B_\Sigma^-(y, r_2)$ (recall that one can take any Σ -admissible curve through z in order to choose appropriate y and r_2), necessarily $\hat{B}_\Sigma^+(x, r_1) \cap \hat{B}_\Sigma^-(y, r_2)$ cannot be compact.

((iii3) \Rightarrow (iii1)) For any $(t_0, x_0), (t_1, x_1)$ in $\mathbb{R} \times M$, recalling Propositions 5.1 and 2.28, we get

$$J^+(t_0, x_0) \cap J^-(t_1, x_1) \subset \cup_{s \in (0, t_1 - t_0)} \{t_0 + s\} \times (\bar{B}_\Sigma^+(x_0, s) \cap \bar{B}_\Sigma^-(x_1, t_1 - t_0 - s)) \cup \{(t_0, x_0), (t_1, x_1)\}$$

and we have to check that the left hand side is compact. Indeed, for any sequence $\{z_n\} \subset J^+(t_0, x_0) \cap J^-(t_1, x_1)$ we can take a sequence of causal curves γ_n from (t_0, x_0) to (t_1, x_1) passing through z_n . By the hypothesis on the closures, part (ii) of Lemma 5.9 is applicable, and there exists a limit curve γ of $\{\gamma_n\}$ with the same endpoints. So, some subsequence $\{\gamma_{n_k}\}$ converges in the C^0 topology to γ (see [7, Proposition 3.34]) and, thus, $\{z_{n_k}\}$ lies in a compact subset, admitting so a convergent subsequence to a point in the image of γ .

(iv) ((iv1) \Rightarrow (iv2)) By Proposition 5.1,

$$J^+(0, x) \cap S_r = \{r\} \times \hat{B}_\Sigma^+(x, r), \quad J^-(0, x) \cap S_{-r} = \{-r\} \times \hat{B}_\Sigma^-(x, r)$$

and the left hand sides are compact as S_r, S_{-r} are Cauchy hypersurfaces (otherwise, the limit curve of the sequence of causal curves obtained by connecting $(0, x)$ with a diverging sequence of points would not cross the corresponding Cauchy hypersurface).

((iv2) \Rightarrow (iv3)) Just apply Proposition 2.28.

((iv3) \Rightarrow (iv1)) By using the one-parameter group of isometries generated by the complete Killing field ∂_t , one easily sees that if a slice S_{t_0} is a Cauchy hypersurface then all the slices S_t are Cauchy hypersurfaces. Thus, by contradiction, let us assume that S_0 is not Cauchy. Hence, there will exist some inextendible timelike curve $\rho : [0, t_0] \rightarrow \mathbb{R} \times M$, $\rho(s) = (s - t_0, x_\rho(s))$ or $\rho : (-t_0, 0] \rightarrow \mathbb{R} \times M$, $\rho(s) = (s + t_0, x_\rho(s))$, which does not cross it. We recall that any timelike vertical line $s \mapsto (s, \bar{x})$, $\bar{x} \in M$, always crosses once S_0 and that, for any subinterval $[s_1, s_2] \subset [0, t_0]$ (or $\subset (-t_0, 0]$) containing some point \bar{s} where $\dot{x}_\rho(\bar{s}) = 0$, $\rho|_{[s_1, s_2]}$ can be replaced by a timelike future-pointing curve $\tilde{\rho}(s) = (s, x_{\tilde{\rho}}(s))$, such that $\dot{x}_{\tilde{\rho}}(s) \neq 0$, for each $s \in [s_1, s_2]$ (see footnote 5). Summing up, we can assume, without losing generality, that $\dot{x}_\rho(s) \neq 0$, for all s . Thus, being ρ timelike and future-pointing, we have (recall (40)) $\ell_F(x_\rho) < t_0 < \ell_{F_1}(x_\rho)$. Then if $\epsilon > 0$ is small enough, $x_\rho(t_0 - \epsilon) \in B_\Sigma^+(x_\rho(0), t_0)$ or $x_\rho(-t_0 + \epsilon) \in B_\Sigma^-(x_\rho(0), t_0)$. As ρ cannot remain in a compact region of the spacetime (otherwise it would be extendible), either $B_\Sigma^+(x_\rho(0), t_0)$ in the first case, or $B_\Sigma^-(x_\rho(0), t_0)$ in the second one, is not precompact.

((iv1) \Leftrightarrow (iv4)) As the slices S_t are closed, spacelike and acausal, each one will be Cauchy if and only if it is crossed by any future-pointing inextendible lightlike pregeodesic ρ (see [55, Lemma 14.42 and Corollary 14.54]). So, let ρ be any inextendible future-pointing lightlike pregeodesic and let us parametrize it as $\rho(s) = (s, x_\rho(s))$ (recall Lemma 5.3). Hence S_t will be Cauchy if and only if ρ is defined on \mathbb{R} . From the first part of Theorem 5.7, this property is equivalent to saying that (M, Σ) is forward and backward geodesically complete. \square

Remark 5.12. In light of the equivalence (i) above, wind Finslerian structures where $x_1 \in \bar{B}_\Sigma^+(x_0, r)$ does not imply that $x_0 \in \bar{B}_\Sigma^-(x_1, r)$ do exist (in contrast with the Randers-Kropina case); in fact, it is not difficult to construct explicit examples, as the one in Fig. 9.

About the comparison with the Randers-Kropina case, it is also worth pointing out that Theorem 4.7 was stated by using only balls for the Finslerian separation d_F , as this notion has familiar similarities with a distance. Thus, the results stated here in terms of c-balls also extend those in that theorem.

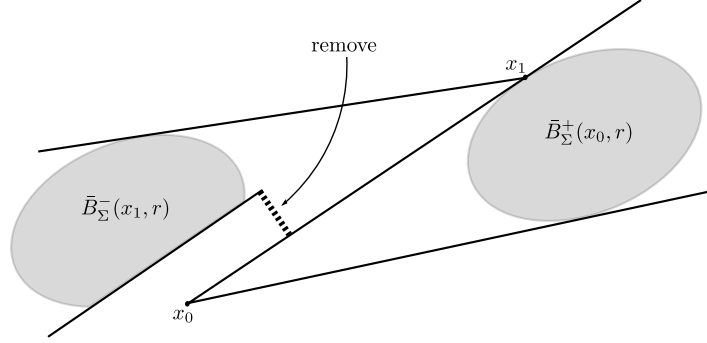

FIGURE 9. A wind Finslerian structure on \mathbb{R}^2 minus the bold dashed segment, where $x_1 \in \bar{B}_\Sigma^+(x_0, r)$ but $x_0 \notin \bar{B}_\Sigma^-(x_1, r)$

6. APPLICATIONS TO WIND RIEMANNIAN STRUCTURES AND NAVIGATION

As emphasized in Section 3, every wind Riemannian structure can be seen as the Fermat structure of a certain SSTK splitting (canonically chosen in a conformal class, see Theorem 3.10), which will be referred to as the SSTK *splitting associated with the wind Riemannian structure*.

Along this section, some results on wind Riemannian structures will be obtained by using the associated SSTK splitting. Some of these properties might be generalizable to any wind Finslerian structure, but this might be not straightforward and would require the extension of the techniques of classical (Lorentzian) spacetimes to more general Lorentz-Finsler spacetimes (about this possibility, see [41]).

6.1. Characterization of geodesics and Hopf-Rinow properties. One of the most relevant difficulties of arbitrary wind Finslerian structures in comparison with standard Finsler (or Riemannian) metrics is that the exponential map is not necessarily defined in all directions. Indeed, the second order differential equations defining the extremizing geodesics of the conic non-degenerate pseudo-Finsler metrics F and F_l associated with Σ have coefficients Γ_{ij}^k defined on a subset (A or A_l) of TM that, in general, does not contain a punctured neighborhood of the zero section (the most we could say was Theorem 2.42). In wind Riemannian structures, however, this difficulty can be overcome easily by using the associated SSTK splitting. Indeed recall that a triple (g_0, ω, Λ) is associated with any wind Riemannian structure (M, Σ) (Proposition 2.44 and Convention 2.45) and then an SSTK spacetime with Fermat structure Σ (Theorem 3.10). The following theorem characterizes

wind Riemannian geodesics and refines Theorem 2.42. The relations between lightlike geodesics on a SSTK slitting and geodesics of the associated Fermat structure are summarized in Fig. 10.

Theorem 6.1. *Let (M, Σ) be a wind Riemannian structure. For any Σ -admissible (piecewise smooth) curve $x : [a, b] \rightarrow M$, the following conditions are equivalent:*

- (i) x is a unit geodesic of Σ ,
- (ii) x satisfies one of the following three exclusive possibilities:
 - (a) x is a unit F -admissible geodesic of (M, F) and, then, locally, it minimizes the F -length
 - (b) x is a unit F -admissible geodesic of (M_l, F_l) and, then, locally, it maximizes the F_l -length,
 - (c) x is contained in \overline{M}_l and either (c1) x is constant, $\Lambda(x) = 0$ and $d\Lambda(\ker \omega_x) \equiv 0$ or (c2) x is smooth, whenever it remains included in M_l , x is a lightlike pregeodesic of the Lorentzian metric $-h$ in (34) parametrized with $F(\dot{x}) \equiv F_l(\dot{x}) \equiv 1$ (x is a boundary geodesic), and x can reach ∂M_l only at isolated points $s_j \in I, j = 1, 2, \dots$, where $\dot{x}(s_j) = 0$, $d\Lambda(\ker \omega_{x(s_j)}) \neq 0$ and its second derivative (in one and then any coordinates)¹⁰ does not vanish.

Proof. The implication (i) \Rightarrow (ii) follows by applying Theorem 5.7 to the SSTK splitting $(\mathbb{R} \times M, g)$ associated with (M, Σ) . For the extremal properties, apply Proposition 2.34 and Remark 2.35-(1). For the converse, in the cases (a) and (b), choose $s_0 \in [a, b]$ and take the future-pointing lightlike geodesic γ of the associated SSTK spacetime $(\mathbb{R} \times M, g)$, satisfying the initial conditions $((s_0, x(s_0)), (1, \dot{x}(s_0)))$. Let us reparametrize γ as $\rho(s) = (s, x_\rho(s))$. From Theorem 5.7, x_ρ is a unit geodesic of (M, Σ) and, as the vector $\dot{x}(s_0) \in A_{x(s_0)}$, $C_\rho \neq 0$. Thus x_ρ is, according to the sign of C_ρ , a unit F -admissible geodesic for F or F_l which coincides with x by existence and uniqueness of geodesic of a conic pseudo-Finsler metric. In the remaining case (c), whenever x is not constant, $j = 1, 2, \dots$, such that $\Lambda(x_\rho(s_j)) = 0$ and $\dot{x}_\rho(s_j) = 0$, the curve $\rho(s) = (s, x(s))$ is orthogonal to the Killing vector field (recall part (iii) of Proposition 3.12) and then a lightlike pregeodesic whenever x is contained in M_l (recall r from Lemma 6.25 that $\pi : (\mathbb{R} \times M_l, g) \rightarrow (M_l, \frac{1}{\lambda}h)$ r was a semi-Riemannian submersion, and also that lightlike pregeodesics were preserved by conformal changes of the metric); moreover, as x is smooth and its derivative vanishes at the points where it touches the boundary ∂M_l , we conclude that ρ is globally a lightlike pregeodesic. Then, again from Theorem 5.7, x is a unit geodesic of (M, Σ) . Finally, if $x \equiv x_0 \in M$, $\Lambda(x_0) = 0$ and $d\Lambda(\ker \omega_{x_0}) = 0$, then x is an exceptional geodesic of (M, Σ) . \square

Lemma 6.2. *For every neighborhood W_0 of $x_0 \in M$, there exists another neighborhood $U_0 \subset W_0$ and some $\varepsilon > 0$ such that $\hat{B}_\Sigma^\pm(x, r)$ is compact and contained in W_0 for every $r < \varepsilon$ and $x \in U_0$.*

Proof. The proof is a refinement of Lemma 5.6 obtained by taking into account that, given W_0 and considering the SSTK splitting $(\mathbb{R} \times M, g)$ associated with the wind Riemannian structure, then the convex neighborhood U provided by that lemma around $z_0 = (0, x_0)$ can be easily chosen satisfying the following properties: (i) U

¹⁰With natural identifications; this condition can be also formulated in terms of the 2-jet of x at each s_j .

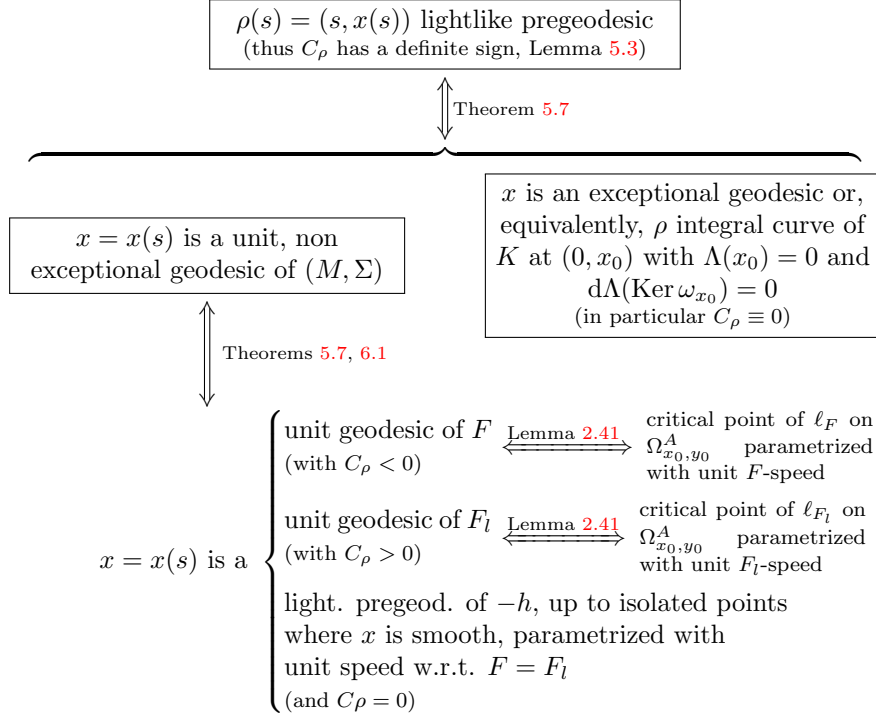

FIGURE 10. The relations between future-pointing lightlike pregeodesics of an SSTK splitting and geodesics of the associated Fermat structure. Here ρ is a t -parametrized curve in the SSTK splitting ($s \in [a, b]$, $x_0 = x(a)$, $y_0 = x(b)$). Moreover, maximizing lightlike pregeodesics (i.e., whose points are horismotically related) which are not reparametrizations of flow lines of K correspond to extremizing geodesics of the Fermat structure, Corollary 5.4.

is included in $\mathbb{R} \times W_0$, (ii) U is precompact and (iii) U contains the intersections $J^\pm(z) \cap ([-\varepsilon, \varepsilon] \times M)$ for some $\varepsilon > 0$ and all z in a smaller neighborhood $V \subset U$. Then, put $U_0 := V \cap S_0 \subset W_0$ and observe that, for any $r \in (0, \varepsilon)$, the set $J^+(0, x) \cap (\{\pm r\} \times M)$ is compact for all $x \in U_0$ (observe that it is a closed set, as U is normal, included in a compact set, also by hypothesis on U) and, by Proposition 5.1, it projects homeomorphically into $\hat{B}_\Sigma^\pm(x_0, r)$ and this projection is contained in W_0 as required. \square

The following local properties can also be proved by using the spacetime viewpoint. They are equivalent to saying that the exponential map of the conic pseudo-Finsler metrics associated with a wind Riemannian metric are defined in some small ball. In principle this cannot be guaranteed for arbitrary conic Finsler metrics because the exponential is not defined in a neighborhood of the zero vector and the inverse function theorem does not apply.

Proposition 6.3. *Let (M, Σ) be a wind Riemannian structure and $x_0 \in M$, then there exists $\varepsilon > 0$ such that the geodesics of F (resp. F_l) departing from x_0 and*

parametrized by the arc length are defined on $[0, \varepsilon)$ and they are minima (resp. maxima), with respect to F -admissible variations, of the length and, therefore, extremizing geodesics.

Proof. Let $\varepsilon > 0$ as in Lemma 6.2 and consider the SSTK splitting associated with (M, Σ) . Any geodesic $x: [0, a_x] \rightarrow M$, $a_x > 0$ of F or F_l , starting at x_0 and parametrized by the arc length, defines a lightlike pregeodesic $(s, x(s))$ (recall Theorems 5.7 and 6.1) which must be defined on $[0, r]$, for any $r < \varepsilon$. In fact, $(s, x(s)) \in J^+(0, x_0) \cap (\{s\} \times M)$ and, for $s \in [0, r]$, $J^+(0, x_0) \cap (\{s\} \times M)$ is contained in a precompact convex neighborhood of $(0, x_0)$ (see the proof of Lemma 6.2). Therefore $(s, x(s)) \in J^+(0, x_0) \setminus I^+(0, x_0)$ and x must also be an extremizing unit geodesic for Σ by Corollary 5.4 and then, being not a boundary geodesic, it must be a local minimum of ℓ_F or a local maximum of ℓ_{F_l} in the sense of Proposition 2.34. \square

Finally, the following result becomes straightforward from Theorem 5.11 and plays the role of Hopf-Rinow theorem for wind Finslerian structures (then generalizing Corollary 4.8).

Proposition 6.4. *Let (M, Σ) be a wind Riemann structure.*

- (i) *The following properties are equivalent:*
 - (a) Σ is geodesically complete,
 - (b) $B_\Sigma^+(x, r)$ and $B_\Sigma^-(x, r)$ are precompact for every $x \in M$ and $r > 0$.
 - (c) $\hat{B}_\Sigma^+(x, r)$ and $\hat{B}_\Sigma^-(x, r)$ are compact for every $x \in M$ and $r > 0$.*In particular, if M is compact then Σ is geodesically complete.*
- (ii) *The following properties are equivalent and imply the w -convexity (Definition 2.37) of (M, Σ) :*
 - (a) $\hat{B}_\Sigma^+(x, r_1) \cap \hat{B}_\Sigma^-(y, r_2)$ is compact for every $x, y \in M$ and $r_1, r_2 > 0$.
 - (b) $\bar{B}_\Sigma^+(x, r_1) \cap \bar{B}_\Sigma^-(y, r_2)$ is compact for every $x, y \in M$ and $r_1, r_2 > 0$.*Moreover, these conditions hold whenever the previous ones in (i) are satisfied.*
- (iii) *If (M, Σ) is w -convex, then $x_1 \in \bar{B}_\Sigma^+(x_0, r)$ if and only if $x_0 \in \bar{B}_\Sigma^-(x_1, r)$ for any $x_0, x_1 \in M$ and $r > 0$.*

Proof. Apply Theorem 5.11 to the associated SSTK splitting (see Theorem 3.10), and use the causal implications: existence of a Cauchy hypersurface \Rightarrow global hyperbolicity \Rightarrow causal simplicity \Rightarrow causal continuity. \square

6.2. Consequences of the different splittings of an SSTK spacetime. Observe that given an SSTK spacetime, for every spacelike hypersurface which intersects all the orbits of the Killing field there will exist a different splitting (26) as an SSTK (with the same Killing vector field). Let us characterize when a transversal hypersurface is spacelike in terms of the Fermat structure.

Lemma 6.5. *Let $(\mathbb{R} \times M, g)$ be an SSTK splitting with g given by (26) and $f: M \rightarrow \mathbb{R}$, a smooth function. Then $S^f = \{(f(x), x) \in \mathbb{R} \times M : x \in M\}$ is a spacelike hypersurface if and only if one of the following two exclusive possibilities occurs: either*

$$df(v) < F(v) \text{ for every } v \in A \cup A_E, \quad (41)$$

or the Killing field $K = \partial_t$ is spacelike everywhere and

$$df(v) > F_l(v) \text{ for every } v \in A \cup A_E. \quad (42)$$

Proof. Observe that the tangent space to S^f at $(f(x), x) \in S^f$ is given by

$$T_{(f(x), x)}S^f = \{(\mathrm{d}f(v), v) : v \in T_x M\},$$

and, then,

$$g((\mathrm{d}f(v), v), (\mathrm{d}f(v), v)) = g_0(v, v) + 2\omega(v)\mathrm{d}f(v) - \Lambda \mathrm{d}f(v)^2,$$

so that S^f is spacelike if and only if

$$g_0(v, v) + 2\omega(v)\mathrm{d}f(v) - \Lambda \mathrm{d}f(v)^2 > 0 \quad (43)$$

for every $v \in TM \setminus \mathbf{0}$. Now, if $\Lambda(x) > 0$, (43) is equivalent to $-\tilde{F}(v) < \mathrm{d}f(v) < F(v)$ for every $v \in T_x M \setminus \{0\}$, and this is equivalent to $\mathrm{d}f(v) < F(v)$ (because $-\tilde{F}(v) = -F(-v)$ for every $v \in T_x M \setminus \{0\}$, recall Remark 2.50). If $\Lambda(x) = 0$ then, (43) is equivalent to $\mathrm{d}f(v) < F(v) = -\frac{g(v, v)}{2\omega(v)}$, for all $v \in A_x = \{v \in T_x M : -\omega(v) > 0\}$, since it is satisfied for each $v \neq 0$ belonging to the kernel of ω , while on $-A_x$ it becomes $\mathrm{d}f(v) > -\frac{g(v, v)}{2\omega(v)} = -F(-v)$. Hence, we conclude that, when $\Lambda(x) \geq 0$, (43) is satisfied if and only if (41) holds on A .

If $\Lambda(x) < 0$, (43) is satisfied away from $\overline{A_x \cup (-A_x)} \setminus \{0\}$, while on $(A_E)_x (= \{v \in T_x M : -\omega(v) > 0, \Lambda(x)g_0(v, v) + \omega(v)^2 \geq 0\})$ it is equivalent either to

$$\mathrm{d}f(v) < F(v) \quad \text{or to} \quad \mathrm{d}f(v) > F_l(v). \quad (44)$$

On $-(A_E)_x$, the required conditions are satisfied iff they are satisfied on $(A_E)_x$, so that (44) suffices.

By a simple continuity argument, it follows that both conditions in (44) cannot hold for different tangent vectors (at the same or at different points). Then, if the second inequality holds, $\Lambda < 0$ in M and the Killing field is spacelike everywhere. \square

Remark 6.6. Geometrically, the meaning of the two possibilities in the lemma is the following. When the tangent space $T_x S^f$ is naturally included in $T_{(f(x), x)}L$, ($L = \mathbb{R} \times M$) the latter is divided in two open half spaces. If (41) holds, then the future-pointing vectors and the Killing ∂_t lie in the same half space, but when (42) holds they lie in different ones (see Fig. 11). In the latter case, we can follow the proof of Proposition 3.3 and choose S^f as the spacelike hypersurface S which allows us to write the spacetime as an SSTK splitting. Then the corresponding projection $t^f : L \rightarrow \mathbb{R}$ still satisfies that $-\nabla t^f$ is timelike, but we cannot assume that it is future-pointing (as the time-orientation had already been prescribed). Indeed, $-t^f$ (no t^f) is a temporal function now.

Now, let $(\mathbb{R} \times M, g)$ be an SSTK splitting and fix some $f : M \rightarrow \mathbb{R}$ under the hypotheses (41) or (42) of the lemma. Define the spacelike hypersurface S^f of $(\mathbb{R} \times M, g)$ and denote the new SSTK splitting as $(\mathbb{R} \times M, g^f)$, where

$$g^f((\tau, v), (\tau, v)) = g((\mathrm{d}f(v) + \tau, v), (\mathrm{d}f(v) + \tau, v)) \quad (45)$$

for $(\tau, v) \in \mathbb{R} \times TM$.

Convention 6.7. According to the remark above, Σ^f will denote the Fermat structure associated with $(\mathbb{R} \times M, g^f)$ when f lies in the case (41) and its reverse Fermat structure when f lies in the case (42).

Proposition 6.8. *With the above notation,*

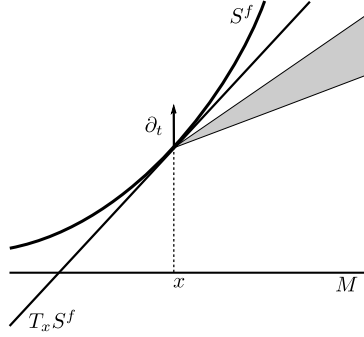

FIGURE 11. A hypersurface S^f in an SSTK splitting $L = \mathbb{R} \times M$ satisfying condition (42). The shaded region represents the future-pointing causal vectors in $T_{(f(x),x)}L$

- (i) if F and F_l are the conic pseudo-Finsler metrics associated with Σ , then $F^f = F - df$ and $F_l^f = F_l - df$ are the conic pseudo-Finsler metrics associated with Σ^f ,
- (ii) Σ^f has the same geodesics as Σ up to parametrization.

Proof. Observe that $g^f((\tau, v), (\tau, v)) = g_0^f(v, v) + 2\omega^f(v)\tau - \Lambda^f\tau^2$, where

$$\begin{aligned} g_0^f(v, v) &= g((df(v), v), (df(v), v)) = g_0(v, v) + 2\omega(v)df(v) - \Lambda df(v)^2, \\ \omega^f(v) &= g((df(v), v), (1, 0)) = \omega(v) - \Lambda df(v) \end{aligned} \quad (46)$$

and $\Lambda^f = \Lambda$; in particular, the metric h in (34) remains invariant:

$$\Lambda g_0^f(v, v) + \omega^f(v)^2 = \Lambda g_0(v, v) + \omega(v)^2. \quad (47)$$

(i) When $\Lambda(x) = 0$, the equality $F^f = F - df$ follows directly from (46) (recall (31)). For the case $\Lambda \neq 0$, just notice that the expressions of F, F_l in (30), (32) can be rewritten as in the first identity of (33), and use (47).

(ii) By Theorem 6.1, the geodesics of Σ^f are either geodesics of F^f , geodesics of F_l^f , lightlike pregeodesics of $\Lambda g_0^f(v, v) + \omega^f(v)^2$ (except at isolated points) or constant curves with $\Lambda^f(x) = 0$ and $d\Lambda^f(\text{Ker } \omega_x^f) \equiv 0$. In the two last cases, they are pregeodesics of Σ by (47) and because $d\Lambda(\text{Ker } \omega_x) \equiv 0$ if and only if $d\Lambda^f(\text{Ker } \omega_x^f) \equiv 0$ in the points where $\Lambda^f(x) (= \Lambda(x)) = 0$. In the other cases, the length functionals of $F^f = F - df$ and F (resp. F_l^f and F_l), when defined on the space of F -admissible (or equivalently F^f -admissible) curves connecting two prescribed points, are the same up to a constant. Therefore, both functionals have the same critical points and these critical points are pregeodesics of (M, Σ) by Theorem 6.1. \square

Previous interpretations allow us to refine the conclusions of Proposition 6.4 in the Randers-Kropina case.

Corollary 6.9. *Let (M, F) be a Randers-Kropina metric. If the intersection of any closed forward ball and any closed backward one is compact then there exists a new Randers-Kropina metric F^f which is geodesically complete and has the same pregeodesics of F .*

Proof. As the associated SSTK splitting $(\mathbb{R} \times M, g)$ is globally hyperbolic by part (ii) of Theorem 4.7, there exists a smooth spacelike Cauchy hypersurface S (see [10]). Necessarily, the integral curves of ∂_t must intersect S transversely and, so, S can be written as a graph S^f . By Proposition 6.8, the associated splitting $(\mathbb{R} \times M, g^f)$ has a Fermat structure Σ^f which must be associated with some Randers-Kropina metric $F^f = F - df$, and will have the same pregeodesics as F . By part (iii) of Theorem 4.7, Σ^f is geodesically complete. \square

Remark 6.10. In the stationary case $\Lambda > 0$, the function f can be explained physically as a (new) synchronization of the “observers” travelling along the integral curves of ∂_t , and Corollary 6.9 extends [20, Theorem 5.10] for Randers manifolds (namely, if R is a Randers metric and the closed symmetrized balls are compact then there exists a function f such that $R - df$ is also Randers, plus complete and with the same pregeodesics as R). As suggested in that reference and proved in [51], such a result can be extended to any Finsler manifold. It would be interesting to know if Corollary 6.9 could also be extended to more general wind Finslerian structures with strong wind. Notice that, in this case, the possibility that Cauchy hypersurfaces may not be graphs on M introduces an additional difficulty even in the wind Riemannian case. If the property of being a graph were admitted as a hypothesis, the technique would work for the wind Riemannian case even though, if the wind is strong on all the manifold, the Cauchy hypersurface might lie in the case (42) and the techniques would apply naturally to the reverse wind Finslerian structure.

6.3. Precedence relation and solutions of Zermelo’s navigation. In [40], the authors introduced a notion of *precedence*, \prec , for a conic pseudo-Finsler metric (see Section 4.1). This can be easily extended to any wind Finslerian structure (M, Σ) and, moreover, also a less restrictive relation \preceq appears naturally, so that \prec and \preceq resemble, respectively, the chronological and the causal relation in a Lorentzian manifold. Namely, for any $x, y \in M$, we say that $x \prec y$ (resp. $x \preceq y$) if there exists an F -wind (resp. wind) curve connecting x to y (i.e. $C_{x,y}^A \neq \emptyset$, resp. $C_{x,y}^\Sigma \neq \emptyset$). Moreover, for any $x \in M$, the F -future (resp. Σ -future, F -past, Σ -past) of x is the set $I_\Sigma^+(x)$ (resp. $J_\Sigma^+(x)$, $I_\Sigma^-(x)$, $J_\Sigma^-(x)$) defined as $I_\Sigma^+(x) = \{y \in M : x \prec y\}$ (resp. $J_\Sigma^+(x) = \{y \in M : x \preceq y\} \cup \{x\}$, $I_\Sigma^-(x) = \{y \in M : y \prec x\}$, $J_\Sigma^-(x) = \{y \in M : y \preceq x\} \cup \{x\}$). The following result summarizes the relations between the above-defined $I_\Sigma^\pm, J_\Sigma^\pm$, and the corresponding future or past sets for the Lorentzian metrics g in $\mathbb{R} \times M$ and $-h$ in M_t .

Proposition 6.11. *For a wind Riemannian structure with associated SSTK splitting $(\mathbb{R} \times M, g)$ and natural projection $\pi : \mathbb{R} \times M \rightarrow M$:*

$$\begin{aligned} I_\Sigma^+(x) &= \pi(I^+(0, x)), & I_\Sigma^-(x) &= \pi(I^-(0, x)), \\ J_\Sigma^+(x) &= \pi(J^+(0, x)), & J_\Sigma^-(x) &= \pi(J^-(0, x)), \end{aligned}$$

where $x \in M, (0, x) \in \mathbb{R} \times M$. In particular, $I_\Sigma^\pm(x)$ are open subsets.

In the case of strong wind ($M = M_t$), $I_\Sigma^+(x)$ and $I_\Sigma^-(x)$ coincide, resp., with the chronological future and past of x for the Lorentzian metric $-h$ on M endowed with a natural time-orientation.

Proof. We shall prove the proposition only for the future sets I_Σ^+ , being the proof for I_Σ^- completely analogous. Let $y \in I_\Sigma^+(x)$, $\sigma \in C_{x,y}^A$. As $\dot{\sigma}^\pm(t) \in A$, then

$F(\dot{\sigma}^\pm(t)) < F_l(\dot{\sigma}^\pm(t))$ and $y \in B_\Sigma^\pm(x, r)$, $r \in (\ell_F(\sigma), \ell_{F_l}(\sigma))$. Thus, Proposition 5.1 ensures that $(r, y) \in I^+(0, x)$. For the converse inclusion, just recall that if $(0, x) \ll (r, y) \in \mathbb{R} \times M$ then there exists a future-pointing timelike curve $\gamma(s) = (t(s), \sigma(s))$ between $(0, x)$ and (r, y) with $\dot{\sigma}(s) \neq 0$ for all s , see footnote 5. Reparametrizing γ with respect to t gives an F -wind curve between x and y and $y \in I_\Sigma^\pm(x)$.

The proof of the inclusions for J_Σ^\pm are analogous except for a slight difference. In fact, for the inclusion $\pi(J^+(0, x)) \subset J_\Sigma^+(x)$, observe that if $(0, x) < (r, y)$, the existence of a causal curve between $(0, x)$ and (r, y) , such that $\dot{\sigma}(s) \neq 0$ for all s , is guaranteed except when $x = y$ and γ is a lightlike pregeodesic, but in that case $y \in J_\Sigma^+(x)$, by definition. For the last assertion, recall Remark 3.20. \square

Remark 6.12. Of course, $\pi : \mathbb{R} \times M \rightarrow M$ is an open map and this agrees with the fact that $I_\Sigma^\pm(x)$ must be open as so are $I^\pm(0, x)$. However if, say, $J^+(0, x)$ is closed, then $J_\Sigma^+(x)$ is not necessarily closed. Typically, this happens for “black hole regions” even in globally hyperbolic SSTK splittings.

One could define the F -separation d_F in an analogous sense as in the Randers-Kropina case, by using the infimum of the lengths of the F -admissible (or Σ -admissible) curves connecting each two points, as well as a Lorentzian separation d^{F_l} by taking the supremum of the F_l -lengths. In fact, if F -admissible curves are taken, then d_F lies again in the case of the F -separation defined for any conic Finsler structure in [40]. However, as a difference with the Randers-Kropina case, now discontinuities of d_F may appear in non-trivial cases (typically, when $x \preceq y$ but $x \not\prec y$; such discontinuities would remain if Σ -admissible curves were used instead of F -admissible ones). As this would affect possible results involving boundary geodesics, we prefer not to follow this approach here. On the contrary, we ensure directly the existence of geodesics and their extremizing properties by using the previously introduced notions.

In the next theorem, recall that the hypothesis of w -convexity is fulfilled whenever one of the conditions in parts (i) and (ii) of Proposition 6.4 holds.

Theorem 6.13. *Let (M, Σ) be a w -convex wind Riemannian structure and let $x_0, y_0 \in M$ such that $y_0 \in J_\Sigma^\pm(x_0) \setminus \{x_0\}$. Then*

- (i) *there exists a global minimum on C_{x_0, y_0}^Σ of the length functional ℓ_F . Such a minimum σ is a pregeodesic of (M, Σ) and, when $y_0 \notin I_\Sigma^\pm(x_0)$, σ is also a lightlike pregeodesic of the Lorentzian metric $-h$ in (34), up to isolated points where its derivative vanishes;*
- (ii) *if $R(x_0, y_0) := \sup\{r > 0 : y_0 \in \hat{B}_\Sigma^\pm(x_0, r)\} < +\infty$, there exists a global maximum on C_{x_0, y_0}^Σ of the length functional ℓ_{F_l} . Such a maximum σ is a pregeodesic of (M, Σ) and, again, when $y_0 \notin I_\Sigma^\pm(x_0)$, σ is also a lightlike pregeodesic of the Lorentzian metric $-h$, up to isolated points where its derivative vanishes.*

Proof. (i) Consider the associated SSTK splitting $(\mathbb{R} \times M, g)$ and recall that w -convexity implies its causal simplicity (see Theorem 5.11). Given x_0, y_0 as above, denote $r(x_0, y_0) := \inf\{r > 0 : y_0 \in \hat{B}_\Sigma^\pm(x_0, r)\}$; notice that $0 < r(x_0, y_0) < +\infty$ (the first inequality follows from Proposition 5.1 and the acausality of S_0 , the second one trivially follows from $y_0 \in J_\Sigma^\pm(x_0)$). The definition of $r(x_0, y_0)$ and Proposition 5.1 imply that $(r_n, y_0) \in J^+(0, x_0)$ for some sequence $r_n \rightarrow r(x_0, y_0)$ with $r_n \geq r(x_0, y_0)$ and, moreover, $(r', y_0) \notin J^+(0, x_0)$ if $r' < r(x_0, y_0)$. So, $(r(x_0, y_0), y_0)$

lies in the boundary of $J^+(0, x_0)$ and causal simplicity implies that this boundary is contained in $J^+(0, x_0)$. Thus, $(0, x_0)$ and $(r(x_0, y_0), y_0)$ are horismotically related and any connecting causal curve from $(0, x_0)$ to $(r(x_0, y_0), y_0)$ must be a lightlike pregeodesic. The projection σ on M of such a pregeodesic is an extremizing pregeodesic of (M, Σ) (recall Corollary 5.4) and gives the required global minimum. In the case $y_0 \notin I_\Sigma^+(x_0)$, the velocity of any connecting Σ -admissible curve must lie in $A_E \setminus A$ at some point and, thus, Theorem 5.7 implies the last conclusion.

(ii) Notice that the additional hypothesis allows us to use the same technique as in the previous part. \square

From Proposition 6.4-(ii), we have that w-convexity is satisfied if M is compact, and then we get immediately:

Corollary 6.14. *Let (M, g_R) be a compact Riemannian manifold and W a vector field on M . Then for any couple of points $x_0, y_0 \in M$, $x_0 \neq y_0$, there exists a curve in C_{x_0, y_0}^Σ which is a minimum of ℓ_F (and so of the travel time between x_0 and y_0 in the Zermelo navigation problem defined by (M, g_R, W)) provided that at least a wind curve from x_0 to y_0 exists.*

Our methods can also be applied to find a solution of Zermelo navigation problem when considering an open subset of a wind Riemannian manifold (M, Σ) whose boundary satisfies a convexity assumption. Let us recall some notions and results about convexity of the boundary of an open subset which have been studied in [6]. Let D be an open subset of a Finsler manifold (M, F) with smooth boundary. We say that D has *locally convex* boundary if for each $x \in \partial D$ there exists some neighborhood of 0 in $T_x \partial D$ whose images by both the exponential maps of F and of its reverse Finsler metric $\tilde{F}(v) := F(-v)$ do not intersect D . This condition is equivalent to the infinitesimal convexity of ∂D (related to its normal curvature at any point $x \in \partial D$) and will be referred here just as the (extrinsic) *convexity* of ∂D . If ∂D is convex and $x \in \partial D$ then, [6, Lemma 3.5], there exists a small enough convex ball (of the metric F) $B^+(x, \delta)$ such that for each $x_1, x_2 \in D \cap B^+(x, \delta)$ the (unique) geodesic in $B^+(x, \delta)$ which connects x_1 with x_2 is included in D . The following lemma is a refinement of that result.

Lemma 6.15. *Let D be an open subset of a Finsler manifold (M, F) with smooth, convex boundary and $x \in \partial D$. Then for all $x_1, x_2 \in \bar{D} \cap B^+(x, \delta)$, $\delta > 0$ small enough, the (unique) geodesic in $B^+(x, \delta)$ which connects x_1 with x_2 is included in \bar{D} . In particular, if $x_1, x_2 \in \partial D$ then it is either contained in $\partial D \cap B^+(x, \delta)$ or it is contained in $D \cap B^+(x, \delta)$, except for its endpoints, and it is not tangent to ∂D in the endpoints. This last case always happens if at least one of the points x_1, x_2 belongs to D .*

Proof. Choosing δ as in the discussion above, only the case when at least one of the points x_1, x_2 belongs to ∂D must be taken into account. Take two sequences of points $\{x_k^1\}, \{x_k^2\} \subset D \cap B^+(x, \delta)$ converging resp. to x_1 and x_2 . Consider the geodesics γ_k connecting x_k^1 with x_k^2 which are contained in $D \cap B^+(x, \delta)$. By smooth dependence of geodesics in a convex neighborhood from endpoints, γ_k converges (in the C^2 -topology) to the geodesic γ connecting x_1 and x_2 in $B^+(x, \delta)$. Thus γ is contained in \bar{D} and it is tangent to ∂D when it touches the boundary away from the endpoints. By the definition of local convexity, this easily implies that γ is contained in the boundary or it touches the boundary transversally at most in the endpoints. \square

By using the above lemma and the correspondence between SSTK spacetimes and wind Riemannian structures, we can prove the existence of a solution to Zermelo navigation problem in an open subset $D \subset M$ such that ∂D is compact. To this end, we need to consider wind curves whose image is contained in \bar{D} and we will recall this by using the symbol $\Sigma|_{\bar{D}}$. For example, given $x_0, y_0 \in \bar{D}$, $C_{x_0, y_0}^{\Sigma|_{\bar{D}}}$ denotes the subset of wind curves from x_0 to y_0 with image in \bar{D} .

Theorem 6.16. *Let (M, Σ) be a wind Riemannian structure, $D \subset M$ be a pre-compact, open subset with smooth boundary ∂D , and let $x_0, y_0 \in \bar{D}$ such that $y_0 \in J_{\Sigma|_{\bar{D}}}^+(x_0) \setminus \{x_0\}$. Assume that the boundary ∂D is convex and the wind is mild on it. Then there exists a global minimum σ on $C_{x_0, y_0}^{\Sigma|_{\bar{D}}}$ of the length functional ℓ_F and it fulfils one of the following two possibilities:*

- (a) σ is fully contained in ∂D and, thus, it is a geodesic of both, F and the Finsler metric induced by F on ∂D ;
- (b) σ is contained in D except, at most, its endpoints.

In particular, this last case happens when one of the points x_0, y_0 belongs to D . Moreover if (b) occurs: (i) σ is a pregeodesic of (M, Σ) and (ii) when $y_0 \notin I_{\Sigma|_{\bar{D}}}^+(x_0)$, then σ is also a lightlike pregeodesic of the Lorentzian metric $-h$ in (34), up to isolated points where its derivative vanishes.

Proof. As $y_0 \in J_{\Sigma|_{\bar{D}}}^+(x_0) \setminus \{x_0\}$, the set of wind curves between x_0 and y_0 whose image is contained in \bar{D} is not empty. Let, then, $\sigma_n : [0, 1] \rightarrow \bar{D}$ be a sequence of wind curves such that

$$\lim_k \ell_F(\sigma_k) = \inf_{\sigma \in C_{x_0, y_0}^{\Sigma|_{\bar{D}}}} \ell_F(\sigma) := T_0(x_0, y_0).$$

Observe that, being F a non-negative function, $T_0(x_0, y_0) \geq 0$. Consider an SSTK spacetime $(\mathbb{R} \times M, g)$ associated with (M, Σ) (see part (i) of Theorem 3.10) and the lightlike curves of $(\mathbb{R} \times M, g)$ defined as $\gamma_k = (\rho_k, \sigma_k)$, where $\rho_k(s) = \int_0^s F(\dot{\sigma}_k) ds$. As $\gamma_k(0) = (0, x_0)$, for all $k \in \mathbb{N}$, and $\gamma_k(1) \rightarrow (T_0(x_0, y_0), y_0)$, by Lemma 5.9-(ii), there exists a limit curve γ of γ_k connecting $(0, x_0)$ to $(T_0(x_0, y_0), y_0)$. Being γ a future-pointing causal curve, we can reparameterize it with the t -coordinate (recall that t is a temporal function, Remark 3.4). Then its projection on M , $\sigma = \sigma(t)$, is a wind curve in \bar{D} (recall Proposition 6.11). Thus, σ is a minimum of ℓ_F on $C_{x_0, y_0}^{\Sigma|_{\bar{D}}}$. Assume first that σ is contained in ∂D and it is not a geodesic of F . Observe that, as the wind is mild on the boundary, F reduces to a classical Finsler metric of Randers type in a neighbourhood of ∂D . Then, by Lemma 6.15, any close enough couple of its points x_1, x_2 must be connected by a length minimizing geodesic of F contained in \bar{D} . Hence, replacing the arc of σ between x_1 and x_2 by this geodesic segment, we get a wind curve σ_1 in $C_{x_0, y_0}^{\Sigma|_{\bar{D}}}$ such that $\ell_F(\sigma_1) < \ell_F(\sigma)$, a contradiction. Let us assume now that at least one point of σ , different from its endpoints, belongs to ∂D , being σ not contained in ∂D . Let $x = \sigma(t_0) \neq x_0, y_0$ be either the first point where σ leaves ∂D , being contained in it for $t \in [0, t_0]$, or the first point where it touches ∂D . Then we can choose nearby points $x_1 = \sigma(t_0 - \epsilon), x_2 = \sigma(t_0 + \epsilon) \in \bar{D}$ such that, by Lemma 6.15, they can be connected by an F -geodesic segment of smaller length included in D except at most x_1 or x_2 , obtaining again a contradiction. This contradiction proves that if σ is not included in ∂D then it must be contained in D except, eventually, its endpoints. For the statements (i) and (ii), observe that the curve γ must be a lightlike pregeodesic, because otherwise there exists a timelike

curve γ_1 from $(0, x_0)$ to $(T_0(x_0, y_0), y_0)$ (see [55, Prop. 10.46]), arbitrarily near γ (hence, its projection on M has image contained in \bar{D}). Once parametrized with t , this projection gives a wind curve with F -length smaller than $T_0(x_0, y_0)$ (recall (40)), a contradiction. Thus, the results follow from Theorem 5.7. \square

Remark 6.17. The last result of convexity can be extended to more general cases as for example when the wind is mild outside a compact subset $K \subset D$, ∂D is convex, and $D \setminus K$ is forward (or backward) complete, in the sense that any F -geodesic $\gamma : [0, b) \rightarrow D \setminus K$ inextendible to b in $D \setminus K$, either converges to some point in $\partial D \cup K$ or satisfies $b = \infty$ (recall that another characterizations of this property can be easily obtained from Theorem 2.1 (a),(b) and (e) in [20]; this includes the compactness of the closed forward balls, which makes possible to reduce the non-compact case to the solved one in Theorem 6.16).

Remark 6.18. Theorem 6.13 gives the last step in the solution to Zermelo's navigation theorem under any type of (time-independent) wind W in a Riemannian background (M, g_R) . As far as we know, the description of the problem, when the wind is stationary and mild as a Finslerian geodesic connectedness problem appeared first in [63]. The case of a wind which is everywhere critical was considered recently in [70].

We emphasize that w-convexity is a global assumption on the wind Riemannian structure and it holds when Σ is geodesically complete, recall Proposition 6.4. On the other hand, the connectivity condition $y_0 \in J_\Sigma^+(x_0) \setminus \{x_0\}$ is an obviously necessary one as a solution γ must be a wind curve from x_0 and y_0 . We would like to point out that even on a compact manifold M there might exist points x_0, y_0 which are not connected by any wind curve. For example, consider a sphere S^2 with the natural metric induced by the Euclidean one and a smooth vector field which is given in spherical coordinates (θ, ϕ) by

$$W(\phi, \theta) = \begin{cases} 0 & \theta \in [0, \pi/6] \cup [\pi/2, \pi] \\ f(\theta)e_\theta & \theta \in (\pi/6, \pi/2) \end{cases}$$

where e_θ is the unit vector field associated with the latitude coordinate θ and the function $f : [\pi/6, \pi/2] \rightarrow [0, +\infty)$ is smooth, non-negative, equal to 0 at $\theta = \pi/6, \pi/2$, strictly increasing in $[\pi/6, \pi/4]$, strictly decreasing otherwise and such that $f(\pi/4) > 1$. Any wind curve from each point x_0 in the hemisphere containing the south pole cannot connect points in the open region containing the north pole and having as boundary the parallel of latitude $\bar{\theta}$, where $\bar{\theta} \in (\pi/4, \pi/2)$ is equal to $f^{-1}(1)$. Indeed along the line $p_\theta = \{(\phi, \theta) : \theta = \bar{\theta}\}$, the set of admissible velocities for wind curves belong to the tangent half-space containing e_θ plus the zero vectors and therefore any wind curve starting on the region $\Omega_S = \{(\phi, \theta) : \theta > \bar{\theta}\}$ must turn back into Ω_S when arriving to a point on p_θ .

However, it is easy to find conditions ensuring that any two points on a compact manifold M can be always connected by a wind curve when the wind is strong:

Proposition 6.19. *Let (M, Σ) be a wind Riemannian structure with strong wind. If M is compact and the Lorentzian metric $-h$ is endowed with a timelike conformal Killing vector field then, for any couple of points $x_0, y_0 \in M$, we have that $y_0 \in I_\Sigma^\pm(x_0)$. Therefore, Zermelo navigation problem has always a solution for any couple of points.*

Proof. By [60, Th. 1] a compact Lorentzian manifold M with a timelike conformal Killing vector field is totally vicious, i.e. the chronological future and past of every point $x_0 \in M$ are equal to M . Since for a strong wind the chronological relation on $(M, -h)$ coincides with the precedence relation on (M, Σ) (recall last part of Proposition 6.11) the result follows. For the last assertion, apply Theorem 6.13-(i). \square

Remark 6.20. Notice that when the strong wind data (g_R, W) of Σ satisfies that W is g_R -Killing then W is also timelike Killing for $-h$ (use (34) with $g_R = g_0$, $\Lambda = 1 - g_R(W, W)$ and $\omega = -g_R(\cdot, W)$) and Proposition 6.19 is directly applicable.

Remark 6.21. (*Summary of the solution of Zermelo's navigation*). Summing up, in order to analyse the navigation from some prescribed x_0 to y_0 :

- (a) One must check first whether a travel from x_0 to y_0 is possible, i.e., if $y_0 \in J_\Sigma^+(x_0)$ or not. This question is reduced to consider the Lorentzian metric $-h$ on M_l , and its causally related points plus, eventually, the precedence relation on $\{x \in M : \Lambda(x) = 0\}$ defined by the Kropina metric (from the spacetime perspective, all this is equivalent to the existence of a causal curve connecting $(0, x_0)$ to l_{y_0}).
- (b) In the case that the trip is possible, the implications in Fig. 10 ensure that, if a fastest trip exists, then it will correspond with either a geodesic for the conic Finsler structure F (and these geodesics are computable through the usual expressions for Finsler metrics) or a lightlike pregeodesic of $-h$, up to isolated points. Even more, in the case that one cannot remain standing at y_0 (i.e., if the wind is strong there), if there is a trip from x_0 which arrives at the maximum possible time at y_0 then it must be an F_l -geodesic. These maximizing geodesics correspond to travel time maximizing solutions of the navigation equations as pointed out by Caratheodory in [22, §282] for a stationary wind in a plane. He also mentioned the possibility of the existence of solutions which are limits of maximal and minimal ones and called “anomalous” their possible velocity vector fields. In a more modern language, these solutions are called abnormal extremals (compare, e.g., with [61, p.54-55], where the Zermelo navigation problem on a plane is analysed); we interpret them (up to a finite number of instants where the velocity vanishes) as lightlike pregeodesics of $-h$ or, equivalently, boundary geodesics of (M, Σ) .
- (c) Finally, the w-convexity condition in Theorem 6.13 is related to “metric” properties of the wind Riemannian structure (namely, the existence of trips/geodesics with a minimum or maximum arrival time). However, its interpretation as the causal simplicity of the associated SSTK splitting has a double interest: on the one hand, causal simplicity may be easier to compute in some cases, on the other, the causal relations in the SSTK splitting give exactly all the possible arrival times of the trips (namely, the t -coordinates of $I^+(0, x_0) \cap l_{y_0}$).

Remark 6.22. It is worth to stress that the dynamics of Zermelo's navigation is not equivalent to the one of a system defined by a Riemannian metric g_R and a one-form ω on manifold M (a particular case of the so-called *magnetic geodesic flow*),

except if $\|\omega\|_{g_R} < 1$ because in this case both problems are then described by standard Finsler geometry.¹¹ Nevertheless, one can find a parallelism between Zermelo navigation problem and the problem of the existence of timelike or causal curves ρ connecting two events z_0, w_0 in a spacetime L which are critical for the action functional associated with an electromagnetic field for some prescribed charge-to-mass ratio q/m (so that the timelike critical curves are solutions to the corresponding Euler-Lagrange equation, i.e., the Lorentz force equation for q/m , see e.g. [21, 52, 53]). These curves can be interpreted, say, in the case when $q/m > 0$, as those lightlike geodesics for a Kaluza-Klein spacetime $L \times \mathbb{R}$ which locally minimize the natural arrival coordinate at $\{w_0\} \times \mathbb{R}$, see [53, Theorem 4.1]. Even though the natural projection $y : L \times \mathbb{R} \rightarrow \mathbb{R}$ is not a temporal function for the Kaluza Klein metric, the natural vector field ∂_y is Killing. The similarities between the SSTK approach for Zermelo navigation and the Kaluza-Klein for electromagnetism suggests to pose the following navigation problem, whose electromagnetic analogous was solved in [53]: consider classes of wind curves from x_0 to y_0 which are homotopic through F - (resp. Σ -) wind curves. Now, determine when such a class admits an F -length minimizing (or F_t -length maximizing) curve. As mentioned above, this problem has a parallelism with the existence of critical points for the electromagnetic action in timelike or causal homotopy classes. Recall that there are very precise results on this topic and they ensure the existence of timelike critical curves, not only lightlike ones [53, Theorems 4.2 and 5.1]. Such technique seems translatable to our Zermelo problem, and they would yield minimizers of l_F which are F -admissible geodesics of F (and not lightlike pregeodesics of $-h$). However, as different tools are involved, such a study will not be carried out here.

The hypothesis in the last part of Theorem 6.13 is obviously necessary to ensure the existence of a maximizing geodesic, and never can hold if $y_0 \notin M_t$. However, the next lemma gives natural hypotheses that ensure it.

Lemma 6.23. *Let $x_0, y_0 \in M$ and assume that there exists $\bar{r} > 0$ such that $y_0 \in \hat{B}_\Sigma^\pm(x_0, \bar{r})$. Then $R(x_0, y_0) < +\infty$ whenever (i) the wind is strong (i.e. $M = M_t$), and (ii) the metric $-h$ is globally hyperbolic.*

Proof. As global hyperbolicity is preserved by conformal changes, $(M, \frac{1}{\Lambda}h)$ and $(M, -\frac{1}{\Lambda^2}h)$ are also globally hyperbolic (recall that $\Lambda < 0$ if $M = M_t$). Since $y_0 \in \hat{B}_\Sigma^\pm(x_0, \bar{r})$, x_0 and y_0 are causally related in $(M, -h)$. Thus, by global hyperbolicity, the length w.r.t. the Lorentzian metric $-\frac{1}{\Lambda^2}h$ of all the future-pointing $-h$ -causal curves between them is bounded (see [7, Lemma 4.5]). Moreover, since they are causal curves, the length w.r.t. the Riemannian metric $-\frac{1}{\Lambda}g_0$ is bounded as well (see [7, p. 76]). As, $\frac{1}{\Lambda^2}\omega(v)^2 = \frac{1}{\Lambda^2}h(v, v) - \frac{1}{\Lambda}g_0(v, v)$, then

$$\left| \frac{1}{\Lambda}\omega(v) \right| \leq \sqrt{\frac{1}{\Lambda^2}h(v, v)} + \sqrt{-\frac{1}{\Lambda}g_0(v, v)}$$

¹¹In fact, at the points $p \in M$ where $\|\omega_p\|_{g_R} > 1$, the Lagrangian for magnetic trajectories $L(v) = \sqrt{g_R(v, v)} + \omega(v)$, $v \in TM$, has “indicatrix” $\{v \in T_p M : L(v) = 1\}$ which is an unbounded hypersurface. Observe also that the Lagrangian F in the Zermelo navigation problem is formally identical to L in the regions of mild and strong wind, but the metric under the square root in F , namely \tilde{h} , is a signature-changing metric: concretely, it changes from Riemannian to Lorentzian (with signature $(+, -, \dots, -)$).

for every causal $v \in TM$, which implies that the F_l -length of all the Σ -admissible curves between those two points is bounded (recall that $F_l = \sqrt{h/\Lambda^2} + \omega/\Lambda$, Fig. 6) and consequently $R(x_0, y_0) < +\infty$. \square

Remark 6.24. The global hyperbolicity of $-h$ is *not* implied by the global hyperbolicity of the SSTK splitting. This can be easily checked by taking any SSTK splitting with compact slices such that K is spacelike (say, recall the Lorentzian cylinder $\mathbb{R} \times S^1$, $g = dt^2 - 4dtd\theta + d\theta^2$). However, the converse holds, as the next lemma shows.

Lemma 6.25. *In the case of strong wind, if $-h$ is globally hyperbolic then the associated SSTK splitting is also globally hyperbolic.*

Proof. Since $\pi : (\mathbb{R} \times M, g) \rightarrow (M, \frac{1}{\Lambda}h)$ is a Lorentzian submersion, one can easily check that a lift of any Cauchy hypersurface on $(M, \frac{1}{\Lambda}h)$ is also a Cauchy hypersurface of $(\mathbb{R} \times M, g)$. \square

Corollary 6.26. *Let (M, Σ) be a wind Riemannian structure with strong wind such that the Lorentzian metric $-h$ is globally hyperbolic. For any $x_0 \in M$, if $y_0 \in J_{\Sigma}^+(x_0) \setminus \{x_0\}$ then there exists a global maximum on C_{x_0, y_0}^{Σ} of the length functional ℓ_{F_l} .*

Proof. Apply Theorem 6.13 by taking into account that Lemma 6.25 ensures w-convexity and Lemma 6.23 ensures that the hypothesis in the last part of that theorem is fulfilled. \square

Finally, an application to the existence of closed geodesics¹² is obtained for strong wind. In this case, the differences in the causal properties of the Lorentzian metric $-h$ on all the manifold M , and the metric g of the associated SSTK splitting were pointed out in the Remark 6.24. They become especially apparent in the case that M_l is compact: $-h$ can never be chronological (it admits closed timelike curves) but g is always globally hyperbolic (part (iii) of Theorem 5.11). This is exploited to prove the following result.

Theorem 6.27. *Let (M, Σ) be a wind Riemannian structure with strong wind. If M is compact then (M, Σ) admits a closed (non-constant) geodesic.*

Proof. Consider the associated SSTK splitting and define:

$$T_0 = \inf_{x \in M} \{T_0(x)\} \quad \text{where} \quad T_0(x) = \inf\{T > 0 : (0, x) \ll (T, x)\}.$$

Notice that $T_0 < +\infty$. In fact, any closed timelike curve $\sigma : [0, 1] \rightarrow M$ for $-h$ provides an SSTK-timelike curve $\tilde{\sigma}(s) = (\eta(s), \sigma(s))$, $s \in [0, 1]$, $2\eta(s) = \int_0^s (F(\dot{\sigma}(\bar{s})) + F_l(\dot{\sigma}(\bar{s})))d\bar{s}$ from $(0, \sigma(0))$ to $(T = \eta(1), \sigma(0))$, so that $T_0(\sigma(0)) < +\infty$. Notice also that, as the associated SSTK splitting is strongly causal, $T_0(x) > 0$ for each $x \in M$ and, whenever $T_0(x) < +\infty$, $(0, x)$ and $(T_0(x), x)$ can be joined by a lightlike geodesic γ_x (since the associated SSTK splitting is globally hyperbolic, $J^+(0, x)$ is closed, so $(T_0(x), x) \in J^+(0, x) \setminus I^+(0, x)$). Now, consider a sequence $\{x_n\} \subset M$ such that $T_0(x_n) \rightarrow T_0$ and, with no loss of generality, assume that $x_n \rightarrow x_0$. We claim that $T_0 > 0$ (see below). Thus, a limit curve γ_0 (not reduced to a point) of

¹²As in the classical Riemannian case, *closed* is understood here in the sense of smooth *periodic*. In the Lorentzian case, closed non-periodic geodesics can exist (they are necessarily lightlike and incomplete) but, clearly, this possibility cannot occur for wind Riemannian structures.

the corresponding sequence of curves $\{\gamma_{x_n}\}$ will exist and connect $(0, x_0)$ to (T_0, x_0) (so that $T_0 = T_0(x_0)$) and it must be a lightlike pregeodesic too. Hence, being ∂_t spacelike, its image cannot be l_{x_0} and by Theorem 5.7, its projection $\sigma_0 = \pi \circ \gamma_0$ must be a pregeodesic of (M, Σ) with endpoints equal to x_0 . In order to check that σ_0 must be *closed*, assume that σ_0 and γ_0 are parametrized on $[0, 1]$, extend σ_0 periodically, and extend γ_0 accordingly by making it invariant under the translation $(t, x) \mapsto (t + T_0, x)$. If the velocities $\dot{\sigma}_0(0), \dot{\sigma}_0(1)$ do not match, then the points $x_- = \sigma_0(1 - \varepsilon), x_+ = \sigma_0(\varepsilon)$ on σ_0 for some $0 < \varepsilon < 1/2$ satisfy, by well known local causality properties of a Lorentzian manifold (applied to $(M, -h)$) $x_- \preceq x_0 \preceq x_+$. Accordingly, $\gamma_0(1 - \varepsilon) \leq \gamma_0(1) \leq \gamma_0(1 + \varepsilon)$. As γ_0 is a lightlike geodesic broken at $\gamma_0(1)$, we can modify it into a causal curve ρ by putting a timelike segment from $\gamma_0(1 - \varepsilon)$ to $\gamma_0(1 + \varepsilon)$ and making ρ invariant under the translation $(t, x) \mapsto (t + T_0, x)$ too. Then, there exists a point $\bar{x} \in M$ such that $\rho(0) = (0, \bar{x})$, $\rho(1) = (T_0, \bar{x})$ and $\rho|_{[0,1]}$ is not a lightlike pregeodesic. Therefore, for ε small enough $(0, \bar{x}) \ll (T_0 - \varepsilon, \bar{x})$, in contradiction with the definition of T_0 .

Claim: $T_0 > 0$.

Assume, by contradiction, that $T_0(x_n) \rightarrow 0$, $x_n \rightarrow x_0$, and choose a neighborhood $W_0 \subset M$ of x_0 such that $-h$ restricted to W_0 is causal. By Lemma 6.2, there exists a new neighborhood $U_0 \subset W_0$ and some $\varepsilon > 0$ such that any Σ -admissible closed curve starting at any $y \in U_0$ and leaving W_0 will leave $\hat{B}_\Sigma^+(y, r)$, for each $r \in [0, \varepsilon]$. Nevertheless, for large n one has $x_n \in U_0$ and $T_0(x_n) < \varepsilon$. So, the projection σ_n of the lightlike geodesic γ_{x_n} will be a Σ -admissible loop based at x_n (thus leaving W_0) with F -length smaller than ε . As $\ell_F(\sigma_n) \leq \ell_{F_i}(\sigma_n)$, each point of σ_n must belong to $B_\Sigma^+(x_n, r)$ for some $r \in [0, \varepsilon]$, a contradiction. \square

Remark 6.28. The closed geodesic in Theorem 6.27 corresponds, in the associated SSTK splitting, to a future-pointing, lightlike geodesic which has closed component x and connects the points $(0, x_0), (T_0, x_0) \in \mathbb{R} \times M$, for each x_0 belonging to the support of x (these geodesics are called *T_0 -periodic trajectories* in [15, 59, 12]). This extends to the case of a spacelike Killing vector field K (using the only topological assumption that M is compact) results on the existence of at least one geometrically non-trivial, lightlike, T -periodic trajectory, when K is timelike, obtained in [15, 50]. Indeed, the proof of Theorem 6.27 is inspired by a well known result by Tipler [65] as well as results on T -periodic trajectories in [59] –even though the reader will find quite a few non-trivial differences. Notice that if the wind were not strong at some point (non-spacelike K), previous proof would fail as T_0 would be equal to 0. Nevertheless, in the case of mild wind (timelike K) a closed (non-constant) geodesic must exist. In fact, this is known for any compact Finsler manifold [46] and, thus, for Randers ones. The question whether a closed geodesic must exist when K is allowed to be lightlike at some point may deserve a further study.

7. FERMAT'S PRINCIPLE AND GENERALIZED ZERMELO NAVIGATION PROBLEM.

7.1. A new problem: Fermat's principle for arbitrary arrival curves. In optics, Fermat's principle is a variational principle for light rays. Its formulations in general relativity, as e.g. in [43, 56, 33, 57], involves a prescribed event (a point p on the Lorentzian manifold L modelling the spacetime, which represents the event of light reception), the world-line of a light source (a timelike injective curve $\tau: (a, b) \rightarrow L$), intersecting the causal past of p , an "*arrival time functional*"

(the proper time in which the light source emitted the light signals), some matter distribution (one or more galaxies, dark matter, etc., encoded in the spacetime metric g) between the source and the observer responsible for the bending of light and, thus, for the multiple images effect.¹³ From a geometric point of view, this configuration is equivalent to the case to be considered here when the light source emits the signals at a given event p and the timelike curve τ , intersecting the causal future of p , is the world line of an observer (so that, the name “arrival time functional” is justified). From the properties of chronological and causal futures, it is easy to check that if there exists a lightlike (or causal) curve where the absolute maximum or minimum arrival time to τ is achieved, this curve must be a lightlike pregeodesic. This is a consequence of the fact that the arrival point would be horismotically related to p and this would hold even if τ is not timelike. However, Fermat’s principle states that the set of critical points of the arrival time is equal to the set of lightlike pregeodesics connecting p and τ and the timelike character of τ is required then. As emphasized by V. Perlick, no external notion of time is necessary, but just the arrival instants \bar{t} with respect to the proper time parametrization \bar{t} of τ . Nevertheless, in an SSTK splitting, it is natural to consider the temporal function t and then to ask if Fermat’s principle holds when considering a point and an integral line of the Killing field ∂_t (we recall that an integral curve l_x , $x \in M$, of ∂_t can be parametrized with the temporal function t of the SSTK splitting, so that the arrival time functional makes still sense). We emphasize that l_x can be spacelike or lightlike (the case when the Killing vector field is timelike is well known, see [31, 18]) and, although from the point of view of the gravitational lens effect the possibility that the curve τ is not timelike can be considered scarcely interesting, those cases become here interesting both mathematically (in all the proofs we are aware of, the assumption τ timelike is fundamental, compare [66, Lemma 2.5], [56, Lemma 3], [3, Lemma 2.1], [33, Remark 3.3]) and from the point of view of Zermelo’s navigation problem, since the travel time can be identified, up to an initial constant, with the arrival time functional of the associated SSTK splitting. Thus, Fermat’s principle in this context can be viewed as a variational principle for a generalized Zermelo’s navigation problem, in the sense that we look not only for the quickest navigation paths but also for any path that makes stationary the time of navigation between two given points $x_0, x_1 \in M$. These will be the projections on M of the stationary paths in $\mathbb{R} \times M$ of the arrival time functional defined on the set of the piecewise smooth future-pointing lightlike curves connecting $p_0 = (t_0, x_0)$ to l_{x_1} .

However, the previous physically well-motivated problem poses a very general question, at least from a mathematical viewpoint: when one considers the critical lightlike curves for the Fermat problem starting at a point p_0 and arriving at a curve α in an arbitrary spacetime, is it necessary to impose a prescribed causal character or any other hypotheses on α ? At first glance, two obvious restrictions appear: (a) a connecting lightlike curve γ that is orthogonal to α at the arrival point z_α would not be permitted (otherwise, γ could be a lightlike pregeodesic which coincided with α in a left neighborhood of the end-point and, thus, γ would not be a critical point) and (b) α must be an embedded curve, that is, on the one hand its velocity must not be zero (in order to avoid bothering requirements on the variations); on the other, self-intersections or cases where the induced topology on the image is

¹³Some causality conditions, as global hyperbolicity or stable causality are also usually assumed for Morse theory of light rays, compare e.g. [66, 32].

coarser than the one coming from an immersion should be excluded (in order to define properly the Fermat functional as the α -parameter at the arrival). Recall that these conditions are automatically satisfied in classical Fermat's principle (in fact, the requirement (a) holds classically as α is assumed to be a timelike curve).

In the next subsection we will check that, amazingly, these two conditions are enough for a consistent general Fermat's principle in spacetimes (Theorem 7.3). Moreover, in the last subsection we will check that the particular structure of SSTK spacetimes makes unnecessary previous restrictions when α is a line $l_x (\not\cong p_0)$ and sharper conclusions can be obtained (Theorem 7.8).

7.2. A general Fermat's Principle. Our aim is to establish a Fermat's principle between a point p_0 and an arbitrary smooth embedded curve $\alpha : (\bar{a}, \bar{b}) \rightarrow L$ for an arbitrary spacetime (L, g) .

For technical purposes, let us consider first manifolds which split as an SSTK spacetime but with *time-dependent* elements (locally, any Lorentzian manifold admits such a splitting). More precisely, consider any interval $(c, d) \subset \mathbb{R}$ and the product manifold $(c, d) \times \Omega$, where Ω is any smooth manifold (typically, some neighborhood of \mathbb{R}^n) endowed with the metric

$$g((\tau, v), (\tau, v)) = -\Lambda^t(x)\tau^2 + 2\omega^t(v)\tau + g_0^t(v, v) \quad (48)$$

where $(\tau, v) \in T_{(t,x)}((c, d) \times \Omega) \equiv \mathbb{R} \times T_x\Omega$ and for every $t \in (c, d)$, Λ^t , ω^t and g^t are respectively a function, a one-form and a Riemannian metric in Ω (under the analogous to (27)). Observe that the coordinate $t \in (c, d)$ also determines a temporal function of $((c, d) \times \Omega, g)$ as for an SSTK spacetime. Thus, this time-orientation and a notation consistent with the previously introduced for the SSTK case will be used; for example, the line $l_{x_1} = \{(s, x_1) : s \in (c, d)\}$ for every $x_1 \in \Omega$. Moreover, given a vector field $\xi = \xi(s)$ along a curve γ , we will denote by ξ' its covariant derivative $\frac{D\xi}{ds}$ with respect to the Levi-Civita connection of g .

Now, for any spacetime (L, g) , $p_0 \in L$, a fixed interval $[a, b]$ (which could be normalized to $[0, 1]$) and smooth embedded curve α , put

$$\begin{aligned} \mathcal{N}_{p_0, \alpha} = \{ \gamma : [a, b] \rightarrow L : \gamma \text{ piecewise smooth, future-directed lightlike,} \\ \text{and } \gamma(a) = p_0, \gamma(b) \in \text{Im}(\alpha) \} \quad (49) \end{aligned}$$

Next, a variation χ of $\gamma \in \mathcal{N}_{p_0, \alpha}$ will be any continuous map $\chi : (-\varepsilon, \varepsilon) \times [a, b] \rightarrow L$ which, at least, has continuous second order mixed derivatives $\frac{\partial^2 \chi}{\partial w \partial s}$, $\frac{\partial^2 \chi}{\partial s \partial w}$ on $(-\varepsilon, \varepsilon) \times [s_j, s_{j+1}]$ (so that, there, $\frac{D}{dw} \frac{\partial \chi}{\partial s} = \frac{D}{ds} \frac{\partial \chi}{\partial w}$), where $a = s_1 < s_2 < \dots < s_n = b$ is a subdivision of the interval $[a, b]$, and such that $\gamma_w := \chi_w = \chi(w, \cdot) \in \mathcal{N}_{p_0, \alpha}$, for all $w \in (-\varepsilon, \varepsilon)$, and $\chi_0 = \gamma$. In the case of the splitting (48), the so defined variational vector field Z (i.e. $Z(s) = \frac{\partial \chi}{\partial w}(0, s)$) can be denoted $Z(s) = (Y(s), W(s))$.

Lemma 7.1. *Let (L, g) , $\alpha : (\bar{a}, \bar{b}) \rightarrow L$ and p_0 be as above. Assume that $\gamma : [a, b] \rightarrow L$ is a piecewise smooth future-pointing lightlike curve from p_0 to $\text{Im}(\alpha)$, such that $\dot{\gamma}(b)$ is not orthogonal to α . Let Z be a piecewise smooth vector field along γ with $Z(a) = 0$ and $Z(b)$ proportional to $\dot{\alpha}$ on $\gamma(b)$. Then Z is the variational vector field of a variation by lightlike curves from p_0 to $\text{Im}(\alpha)$ if and only if $g(\dot{\gamma}, Z') = 0$.*

Proof. The implication to the right is immediate.

For the converse, observe that a finite number of open subsets U_1, U_2, \dots, U_n can be chosen such that, in each one of them, the metric g admits a splitting as in (48)

for which ∂_t is nowhere orthogonal to γ (see the remark below), ∂_t is proportional to $Z(b)$ in U_n and there exists a partition $s_0 = a < s_1 < s_2 < \dots < s_n = b$ in such a way that γ is smooth in $[s_i, s_{i+1}]$ with $\gamma([s_i, s_{i+1}]) \subset U_{i+1}$ for $i = 0, \dots, n-1$.

Let us make some previous considerations for the case of a smooth curve $\gamma : [a_1, b_1] \rightarrow L$ contained in one of those splittings with $g(\dot{\gamma}, Z') = 0$. Putting $Z = (Y, W)$ and given a curve $x : [a_1, b_1] \rightarrow \Omega$, one has $(t, x) : [a_1, b_1] \rightarrow (c, d) \times \Omega$ is a lightlike curve if and only if

$$-\Lambda^t(x)\dot{t}^2 + 2\omega^t(\dot{x})\dot{t} + g_0^t(\dot{x}, \dot{x}) = 0.$$

It follows that x can be lifted to a lightlike curve in $((c, d) \times \Omega, g)$ which whenever one of the differential equations

$$\dot{t} = \frac{g_0^t(\dot{x}, \dot{x})}{-\omega^t(\dot{x}) \pm \sqrt{\omega^t(\dot{x})^2 + \Lambda^t(x)g_0^t(\dot{x}, \dot{x})}} \quad (50)$$

has a solution in $[a_1, b_1]$ which takes values in (c, d) . Observe that, as the initial curve $\gamma(s) = (\theta(s), \sigma(s))$ is future-pointing, i.e., $\dot{\theta} > 0$, and nowhere orthogonal to ∂_t , i.e., $\omega^{\theta(s)}(\dot{\sigma}(s)) - \Lambda^{\theta(s)}(\sigma(s))\dot{\theta}(s) \neq 0$, for all $s \in [a_1, b_1]$, the same properties hold for nearby curves, and we will assume them for the curve constructed from $x(s)$ and the corresponding $t(s)$ whenever $x(s)$ is a longitudinal curve for some variation of σ . In particular, whenever Λ^t vanishes, \dot{x} cannot vanish and, moreover, (50) holds with $\omega^t(\dot{x}) < 0$ and the choice of sign $+$ in the denominator. Recall that neither \dot{x} can vanish when $\Lambda^t \neq 0$ (otherwise ∂_t would be non-null but proportional to the velocity (\dot{t}, \dot{x}) of the lifted lightlike curve). In conclusion, the right-hand side of (50) is well defined and smooth so that the lift can be carried out on all $[a_1, b_1]$ and its t -component remains C^1 close to the t -component of γ (in particular, the t -component is contained in (c, d)).

Consider now the general case for the original curve γ such that it might have breaks at $a = s_0 < s_1 < s_2 < \dots < s_n = b$. Moreover, write $\gamma|_{[a, s_1]}$ as $(\theta^{(1)}, \sigma^{(1)})$ on U_1 and write consistently $Z = (Y_1, W_1)$ along $[a, s_1]$. Consider a variation $\bar{\chi}_1 : (-\varepsilon, \varepsilon) \times [a, s_1] \rightarrow \Omega_1$ of σ with variational vector field W_1 and fixed initial point (the latter can be imposed as necessarily $W_1(a) = 0$). Thus, up to reducing ε , $\bar{\chi}_1 : (-\varepsilon, \varepsilon) \times [a, s_1] \rightarrow \Omega_1$ can be lifted to a (unique) variation $\tilde{\chi}_1 : (-\varepsilon, \varepsilon) \times [a, s_1] \rightarrow (c, d) \times \Omega_1$ by lightlike curves in $[a, s_1]$ with fixed initial point p_0 , and which has $\tilde{Z}_1 = (\tilde{Y}_1, W_1)$ as variational vector field. The fact that this variation is given by lightlike curves departing from p_0 implies that

$$g(\tilde{Z}_1', \dot{\gamma}) = 0 \text{ with } \tilde{Z}_1(a) = 0, \quad \text{on } [a, s_1]. \quad (51)$$

In particular, as W_1 was prescribed, the function \tilde{Y}_1 is determined by the differential equation (51). As Y_1 is also a solution of (51), we conclude that $\tilde{Y}_1 = Y_1$ on $[a, s_1]$, and therefore, $Z|_{[a, s_1]}$ is the variational vector of a variation by lightlike curves, as required. Finally, proceed inductively by considering analogously $\bar{\chi}_i : (-\varepsilon, \varepsilon) \times [s_{i-1}, s_i] \rightarrow \Omega_i$ with $\bar{\chi}_i(w, s_i) = \bar{\chi}_{i-1}(w, s_i)$ and, when $i = n$, with fixed endpoint at $\sigma(b)$. Recall that these variations are lifted to variations $\tilde{\chi}_i : (-\varepsilon, \varepsilon) \times [s_{i-1}, s_i] \rightarrow (c, d) \times \Omega_i$ by lightlike curves which match in the required one $\chi : (-\varepsilon, \varepsilon) \times [a, b] \rightarrow L$ after n steps, as $\tilde{\chi}_i(w, s_i) = \tilde{\chi}_{i-1}(w, s_i)$ for $w \in (-\varepsilon, \varepsilon)$. \square

Remark 7.2. The required open sets U_i and the splittings can be obtained as follows. First, choose a subdivision $a = s_0 < s_1 < \dots < s_k = b$ of the interval $[a, b]$ such that $\gamma|_{[s_{j-1}, s_j]}$ is a smooth embedding for each $j \in \{1, \dots, k\}$ and a vector field

field Y on all γ which satisfies: (i) $g(Y, \dot{\gamma}) < 0$ (in particular, Y is not orthogonal to γ) and (ii) $Y(b)$ is proportional to $\dot{\alpha}$. Now, for each $j \in \{1, \dots, k\}$, extend Y to a vector field Y^j in a tubular neighborhood of $\gamma|_{[s_{j-1}, s_j]}$ and choose, for each point $\gamma(s)$, $s \in [s_{j_1} - s_j]$, a small spacelike hypersurface Ω_s transverse to $Y(\gamma(s))$ and determining the same half-space of $T_{\gamma(s)}L$ than $\dot{\gamma}(s)$. Now, move Ω_s with the flow of Y^j and write down the metric in $(-\epsilon_s, \epsilon_s) \times \Omega_s$. Refine the subdivision $\{s_j\}$ of $[a, b]$ in such a way that the differences $s_{j+1} - s_j$ are smaller than a Lebesgue number for the covering $(-\epsilon_s, \epsilon_s) \times \Omega_s$, $s \in [a, b]$ of the image of γ .

The restrictions (i) and (ii) on Y can be easily fulfilled as the condition of non-orthogonality is open (make an algebraic computation for a parallelly propagated orthonormal frame along $\gamma|_{[s_{j-1}, s_j]}$ with its timelike vector in the same cone as $\dot{\gamma}(s)$). However, the reader can check that strong global results on splittings as (48) exist. For example, if one has a global splitting of the spacetime as in (48), the curves γ, α are as above, the splitting can be modified just in a small neighborhood of γ so that Y can be chosen as the restriction of the vector field ∂_t associated with the new splitting (restricted to γ). This is straightforward from the following result, which can be regarded as an exercise. Let N be a smooth manifold which admits a complete vector field X and a hypersurface S such that the map $\Phi^S : \mathbb{R} \times S \rightarrow N$, obtained by restricting the flow Φ of X , is a diffeomorphism. Let $t : N \rightarrow \mathbb{R}$ be the natural projection associated with $(\Phi^S)^{-1}$, and consider any vector field \tilde{X} satisfying: (i) $X = \tilde{X}$ outside some compact $C \subset N$, and (ii) $dt(\tilde{X}) > 0$. Then \tilde{X} is also complete and the map $\tilde{\Phi}^S$ constructed analogously by restricting the flow $\tilde{\Phi}$ of \tilde{X} is a diffeomorphism.

Now, we are ready to give the extension of Fermat's principle; our approach here has been inspired by [3]. Let us introduce first the *arrival functional* $T : \mathcal{N}_{p_0, \alpha} \rightarrow \mathbb{R}$ defined as

$$T(\gamma) = \alpha^{-1}(\gamma(b)) \quad (52)$$

(remember that α is always injective and notice that no time function is assumed to exist). A curve $z \in \mathcal{N}_{p_0, \alpha}$ is a *critical point of the arrival functional* if for every variation γ_w , we have that $\frac{d}{dw}T(\gamma_w)|_{w=0} = 0$.

Theorem 7.3. *Let (L, g) be any spacetime and $\alpha : (\bar{a}, \bar{b}) \rightarrow L$ an arbitrary smooth embedded curve. Assume that $\gamma : [a, b] \rightarrow L$ is a piecewise smooth future-directed lightlike curve from p_0 to $\text{Im}(\alpha)$, such that $\dot{\gamma}(b)$ is not orthogonal to α . Then, $\gamma : [a, b] \rightarrow L$ is a critical point of the arrival functional T if and only if it is a pregeodesic.*

Proof. Observe that γ is a critical point of T if and only if $\frac{d}{dw}T(\gamma_w)|_{w=0} = 0$ for every *admissible variation* γ_w (here, in the natural sense of a variation in the space of lightlike curves $\mathcal{N}_{p_0, \alpha}$ defined in (49)). By using Lemma 7.1 the corresponding *admissible* variational vector fields Z on γ are characterized as those satisfying $g(Z', \dot{\gamma}) = 0$, $Z(a) = 0$ with $Z(b)$ proportional to $\dot{\alpha}(T(\gamma))$. Moreover, γ is a critical point of T if and only if $Z(b) = 0$ for every variational vector field, since

$$Z(b) = \frac{d}{dw}\gamma_w(b)|_{w=0} = \frac{d}{dw}\alpha(T(\gamma_w))|_{w=0} = \frac{d}{dw}T(\gamma_w)|_{w=0} \cdot \dot{\alpha}(T(\gamma)).$$

Let U be a vector field along γ which is not orthogonal to γ at each point $\gamma(s)$ and it is proportional to $\dot{\alpha}(T(\gamma))$ at $s = b$ (recall Remark 7.2). Observe that, given

any vector field W along γ with $W(a) = W(b) = 0$, we can obtain a vector field corresponding to an admissible variation as

$$Z_W(s) = W(s) + f_W(s)U(s), \quad (53)$$

where

$$f_W(s) = -e^{-\rho(s)} \int_a^s \frac{g(W', \dot{\gamma})}{g(U, \dot{\gamma})} e^\rho d\mu \quad \text{and} \quad \rho(s) = \int_a^s \frac{g(U', \dot{\gamma})}{g(U, \dot{\gamma})} d\mu, \quad \forall s \in [a, b]. \quad (54)$$

Moreover, all the admissible vector fields can be obtained in this way. Indeed, assume that Z is admissible and consider $W(s) = Z(s) - (c(s-a)/(b-a))U$, where c is the constant that satisfies $Z(b) = cU(b)$. Now observe that the difference $Z_W(s) - Z(s) = (f_W(s) - c(s-a)/(b-a))U$ is also admissible, but it has to be zero. The reason is that any admissible vector field $p \cdot U$, with $p : [a, b] \rightarrow \mathbb{R}$ a smooth function such that $p(a) = 0$, has to be zero, since it must satisfy

$$\dot{p} \cdot g(U, \dot{\gamma}) + p \cdot g(U', \dot{\gamma}) = 0$$

and $g(U, \dot{\gamma})$ cannot vanish. So, $Z = Z_W$ follows, and γ will be a critical point if and only if $Z_W(b) = 0$ for every W as above. This is equivalent to $f_W(b) = 0$ or, from the explicit formula (54),

$$\int_a^b \frac{g(W', \dot{\gamma})}{g(U, \dot{\gamma})} e^\rho d\mu = 0. \quad (55)$$

Now, if γ is a critical point, we can choose W such that $W(s_i) = 0$ in all the breaks. Applying integration by parts,

$$\int_a^b g(W, (\varphi \dot{\gamma})') d\mu = 0 \quad (56)$$

where $\varphi = e^\rho/g(U, \dot{\gamma})$. Then $(\varphi \dot{\gamma})' = 0$ outside the breaks, which implies directly that γ is a piecewise pregeodesic. Moreover, if there were a break at some $s_i \in (a, b)$ then, for every $w \in T_{\gamma(s_i)}L$, one could choose a vector field W along γ such that $W(s_i) = w$ and W is zero in the other breaks (as well as in the endpoints). Then, consider Z_W given by (53) and apply integration by parts to (55) again in order to obtain

$$g \left(w, e^\rho(s_i) \left(\frac{\dot{\gamma}(s_i^+)}{g(U(s_i), \dot{\gamma}(s_i^+))} - \frac{\dot{\gamma}(s_i^-)}{g(U(s_i), \dot{\gamma}(s_i^-))} \right) \right) = 0$$

for all $w \in T_{\gamma(s_i)}L$. That is, $\dot{\gamma}(s_i^+)$ and $\dot{\gamma}(s_i^-)$ are proportional and γ could be reparametrized as a smooth lightlike pregeodesic.

Conversely, if γ is a pregeodesic, we can reparametrize it as a geodesic (with no breaks in the parametrization) as the value of the arrival time functional would remain unchanged. However, for a geodesic the function h is clearly a constant, which allows us to obtain (56) and, finally, (55). \square

Remark 7.4. Theorem 7.3 can be extended even to non time-orientable Lorentzian manifolds, just dropping the requirement of being *future-directed* for the lightlike curves in the space $\mathcal{N}_{p_0, \alpha}$ defined in (49) (so that the lateral velocities of the lightlike curves at the breaks might belong to different cones).

Indeed, this case would be proven if Lemma 7.1 holds for this general setting. To check this, modify its proof as follows. For each neighborhood U_i in the covering of the image of γ , choose the time orientation of the local splitting (48) such that

γ becomes future-pointing. Then, check the consistency of both, the construction in Remark 7.2 and the matching of the local variations of the $\tilde{\chi}_i$.

Observe that this general Fermat's principle can be applied even to get some results in a purely Riemannian setting. Given a Riemannian manifold (M, h) , $x_0 \in M$ and $\alpha : (\bar{a}, \bar{b}) \rightarrow M$ a smooth embedded curve, let us introduce the following two spaces of paths between x_0 and $\text{Im}(\alpha)$:

$$\begin{aligned} \mathcal{L}_{x_0, \alpha, c} &= \{x : [a, b] \rightarrow M : x \text{ piecewise smooth} \\ &\quad \text{and } x(a) = x_0, x(b) \in \text{Im}(\alpha) \text{ with } \ell_h(x) = c\}, \\ \mathcal{F}_{x_0, \alpha} &= \{x : [a, b] \rightarrow M : x \text{ piecewise smooth} \\ &\quad \text{and } x(a) = x_0, x(b) \in \text{Im}(\alpha) \text{ with } \ell_h(x) = \alpha^{-1}(x(b))\}, \end{aligned}$$

where $\ell_h(x) = \int_a^b \|\dot{x}\|_h ds$, $\|\dot{x}\|_h = \sqrt{h(\dot{x}, \dot{x})}$, and c is any constant greater than the distance between x_0 and $\text{Im}(\alpha)$. Let the arrival functional T defined as $T(x) = \alpha^{-1}(x(b))$.

Corollary 7.5. *Let (M, h) be a Riemannian manifold and $\alpha : (\bar{a}, \bar{b}) \rightarrow M$ a smooth embedded curve. Let $x : [a, b] \rightarrow M$ be a piecewise smooth curve with $x(a) = x_0$, $x(b) \in \text{Im}(\alpha)$. Then*

- (i) *if $x \in \mathcal{L}_{x_0, \alpha, c}$ and $\dot{x}(b)$ is not orthogonal to α , then x is a critical curve of the arrival functional T on the space $\mathcal{L}_{x_0, \alpha, c}$ if and only if x is a pregeodesic of (M, h) ;*
- (ii) *if $x \in \mathcal{F}_{x_0, \alpha}$ and*

$$h\left(\frac{\dot{x}(b)}{\|\dot{x}(b)\|_h}, \dot{\alpha}(T(x))\right) \neq 1, \quad (57)$$

then x is a critical curve of the arrival functional T on the space $\mathcal{F}_{x_0, \alpha}$ if and only if x is a pregeodesic of (M, h) .

Proof. It follows from Theorem 7.3 by considering the spacetime $(\mathbb{R} \times M, g)$ with $g((\tau, v), (\tau, v)) = -\tau^2 + h(v, v)$. Then any curve $x : [a, b] \rightarrow M$ lifts to a unique future-directed lightlike curve $(t, x) : [a, b] \rightarrow \mathbb{R} \times M$ with $t(s) = \int_a^s \sqrt{h(\dot{x}, \dot{x})} d\mu$. Moreover, lift α to the curve $(\bar{a}, \bar{b}) \ni \bar{t} \rightarrow \tilde{\alpha}(\bar{t}) = (c, \alpha(\bar{t})) \in \mathbb{R} \times M$ for statement (i) and to $(\bar{a}, \bar{b}) \ni \bar{t} \rightarrow \tilde{\alpha}(\bar{t}) = (\bar{t}, \alpha(\bar{t})) \in \mathbb{R} \times M$, for (ii). The conclusions are obtained by observing that $(\dot{t}(b), \dot{x}(b))$ is not orthogonal to $\tilde{\alpha}$ if and only if, (i), $\dot{x}(b)$ is not orthogonal to α and (ii) (57) holds. \square

Remark 7.6. While the result in (i) is immediately seen as a variational principle for geodesics with fixed length between a point and a curve, (ii) might require more explanation. In fact, it can be interpreted in the following (non-relativistic) way. The curve α is parametrized by a classical time t and then α describes the motion of some target vehicle with arbitrary (but non-vanishing) speed. The curves in $\mathcal{F}_{x_0, \alpha}$ are the trajectories followed by some tracker starting at x_0 . As the length of the trajectories is independent of the parametrization, one can assume (neglecting the curves with speed vanishing at non-isolated points) that the tracker moves at constant speed. As a first approach, this speed can be assumed to be equal to 1 so that each trajectory γ is parametrized by t in the interval $[0, \ell_h(\gamma)]$. Now, the space $\mathcal{F}_{x_0, \alpha}$ contains all the trajectories such that the tracker catches the target, being the arrival functional T just the exact time (or length of γ) necessary for this aim. The corollary asserts that the geodesics coincide with the critical points of T whenever

the inequality (57) holds. As an interpretation of this inequality, notice that, if the component of the velocity of the target at the instant of the meeting in the direction of $\dot{x}(b)$ were equal exactly to $\dot{x}(b)$ then, even if x were a geodesic, variations in the trajectory of the tracker might remain catching the target in subsequent instants. In particular, when the velocity of α were equal to $\dot{x}(b)$, these variations could be obtained simply by prolonging x with (a reparametrization of) α beyond b .

Similar variational principles hold also for timelike geodesics in a spacetime (L, g) . In this case, we consider the extended spacetime $(L \times \mathbb{R}, \tilde{g})$, $\tilde{g} = \pi_L^* g + du^2$, where π_L is the canonical projection of $L \times \mathbb{R}$ onto L . It can be easily seen that, for any lightlike geodesic $\tilde{\gamma} : [a, b] \rightarrow L \times \mathbb{R}$, $\tilde{\gamma}(s) = (\gamma(s), u(s))$, of the metric \tilde{g} , the component γ is a causal geodesic of (L, g) and the component u satisfies $\dot{u}^2 \equiv \text{const.} := c^2/(b-a)^2$. Thus, for any point $p_0 \in L$ and any smooth embedded curve α , Theorem 7.3 applied to the spacetime $(L \times \mathbb{R}, \tilde{g})$, the point $(p_0, 0)$ and the curve $\tilde{\alpha}(s) = (c, \alpha(s))$, $c > 0$, gives the following:

Corollary 7.7. *Let (L, g) be a spacetime and $\alpha : (\bar{a}, \bar{b}) \rightarrow L$ be a smooth embedded curve. Assume that $\gamma : [a, b] \rightarrow L$ is a piecewise smooth future-directed timelike curve from $p_0 \in L$ to $\text{Im}(\alpha)$, with Lorentzian length $\int_a^b \sqrt{-g(\dot{\gamma}, \dot{\gamma})} ds = c$, such that $\dot{\gamma}(b)$ is not orthogonal to α . Then, $\gamma : [a, b] \rightarrow L$ is a critical point of the arrival functional T defined on the set of the piecewise smooth timelike curves joining p_0 to $\text{Im}(\alpha)$ and having fixed Lorentzian length c if and only if it is a pregeodesic.*

7.3. Fermat's principle for SSTK spacetimes. For SSTK spacetimes, the curve α will be taken just equal to a line l_{x_1} parametrized with the global time function $t : \mathbb{R} \times M \rightarrow \mathbb{R}$ so that the space $\mathcal{N}_{p_0, \alpha}$ in (49) is written now $\mathcal{N}_{p_0, l_{x_1}}$ with $p_0 = (t_0, x_0)$. Moreover, the arrival functional (52) becomes now a true arrival time functional

$$T(\gamma) = t(\gamma(b)) \quad (58)$$

for future-pointing lightlike curves $\gamma \in \mathcal{N}_{p_0, l_{x_1}}$ ($\gamma : [a, b] \rightarrow L = \mathbb{R} \times M$). Notice that γ is a critical point for T on $\mathcal{N}_{p_0, l_{x_1}}$ if and only if

$$dt_{\gamma(b)}(Z(b)) (= Y(b)) = 0 \quad (59)$$

for the variational vector field $Z(s) = (Y(s), W(s))$ of any variation γ_w of γ in $\mathcal{N}_{p_0, l_{x_1}}$. We will assume the non-triviality assumption $p_0 \notin \text{Im}(\alpha)$ i.e. $x_0 \neq x_1$ (see Remark 7.9). Now, we are ready for the general version of Fermat's principle for SSTK spacetimes.

Theorem 7.8. *Let $(\mathbb{R} \times M, g)$ be an SSTK as in (26), $x_0, x_1 \in M$, $x_0 \neq x_1$, $p_0 = (t_0, x_0)$ and $\gamma \in \mathcal{N}_{p_0, l_{x_1}}$, $\gamma(s) = (\zeta(s), x(s))$. Then,*

- (1) *if γ is a critical point of the arrival time functional T on $\mathcal{N}_{p_0, l_{x_1}}$, then it is a lightlike pregeodesic of $(\mathbb{R} \times M, g)$;*
- (2) *if γ is a lightlike geodesic of $(\mathbb{R} \times M, g)$ and $C_\gamma = g(\partial_t, \dot{\gamma})$ then one of the following three exclusive possibilities occurs:*
 - (i) *$C_\gamma < 0$, \dot{x} lies in A , x is a pregeodesic of F parametrized with $h(\dot{x}, \dot{x}) = \text{const.}$, γ is a critical point of T and*

$$\zeta(s) = \zeta(a) + \int_a^s F(\dot{x}) d\tau.$$

- (ii) $C_\gamma > 0$, \dot{x} lies in A_l (so that $\Lambda < 0$ on all x), x is a pregeodesic of F_l parametrized with $h(\dot{x}, \dot{x}) = \text{const.}$, γ is a critical point of T and

$$\zeta(s) = \zeta(a) + \int_a^s F_l(\dot{x}) d\tau.$$

- (iii) $C_\gamma = 0$, \dot{x} lies in $A_E \setminus A$ (so that $\Lambda \leq 0$ on all x), whenever it remains in M_l , x is a lightlike geodesic of h/Λ such that $-\omega(\dot{x}) > 0$ and x lies in M_{crit} only at the isolated points where \dot{x} vanishes; moreover, ζ satisfies

$$\zeta(s) = \zeta(a) - \int_a^s \frac{g_0(\dot{x}, \dot{x})}{\omega(\dot{x})} d\tau,$$

for all $s \in [a, b]$.

Proof. (1) Let us distinguish three cases:

Case (a). Assume that there is an instant $s_0 \in (a, b)$ such that x is F -admissible. We can also assume that γ is smooth in s_0 , otherwise just choose a close instant to s_0 where γ is still F -admissible and smooth. Now, notice that the restriction $\gamma|_{[a, s_0]}$ must be a critical point of the arrival time functional on $\mathcal{N}_{p_0, l_x(s_0)}$. In fact, otherwise, take a variation $\gamma_w^{(s_0)}$ which contradicts the critical character of $\gamma|_{[a, s_0]}$ and put

$$t^{(r)}(w) = t(\gamma_w^{(s_0)}(r)) - t(\gamma(r)), \quad a \leq r \leq s_0$$

Taking into account that ∂_t is a Killing vector field, each curve $\gamma_w^{(s_0)}$ can be concatenated with the curve $s \mapsto (\zeta(s) + t^{(s_0)}(w), x(s))$, $s \in [s_0, b]$, in contradiction with the critical character of γ . Thus, Theorem 7.3 is applicable to $\gamma|_{[a, s_0]}$, and this piece of γ must be a pregeodesic. Now observe that we can consider the reverse problem because, reversing the parametrization of γ , it becomes a critical curve for the arrival time functional between $(t(\gamma(b)), x_1)$ and the line $l_{x(s_0)}$ (notice that all the longitudinal curves of a variation γ_w of γ can be shifted in $-t^{(b)}(w)$ by the flow of ∂_t). Then one also has that $\gamma|_{[s_0, b]}$ must be a pregeodesic (which matches smoothly with the first piece), as required.

Case (b). Assume that x is constant in an open interval $(s_0 - \delta, s_0 + \delta)$ (so that ∂_t is lightlike at $x(s_0)$). In this case, (ζ, x) cannot be a critical point of the arrival time. In fact, consider a variational vector field which is $Z(s) = f(s)\partial_t$ with $f(s) = 0$ for every $s \in [a, s_0 - \delta]$ and $f(s) = 1$ for every $s \in [s_0 + \delta, b]$ and the associated variation $x_w = x$ and $\zeta_w(s) = \zeta(s) + wf(s)$ for every $w \in (-\varepsilon, \varepsilon)$, being $\varepsilon > 0$ small enough in such a way that $\dot{\zeta}_w(s) = \dot{\zeta}(s) + w\dot{f}(s) > 0$ for every $s \in (s_0 - \delta, s_0 + \delta)$. Then $dT(Z) = dt_{\gamma(b)}(Z(b)) = 1 \neq 0$.

Case (c). The only case left is when $\dot{x}(s) \in (A_E \setminus A)$ for every $s \in [a, b]$ and it is not zero in any subinterval. Moreover, we can also assume that $\dot{x}(s)$ never vanishes and, so, $x(s)$ lies in M_l and it is a piecewise smooth lightlike curve of the Lorentzian metric $-h$. Indeed, if this case is solved, then, for any interval $J = [\bar{a}, \bar{b}] \subset [a, b]$ such that $x|_J$ is smooth and strictly regular ($\dot{x}(s) \neq 0$ for every $s \in J$) then $\gamma|_J$ will be a lightlike pregeodesic. As by Case (b), the set of zeroes does not contain intervals, then, the claimed case implies that γ fulfils the equation of the pregeodesics $D^g \dot{\gamma}/ds = f \cdot \dot{\gamma}$ in an open dense subset D of $[a, b]$, for some smooth function f on D . Being γ piecewise smooth and $\dot{\gamma}$ non-vanishing, f can be smoothly extended to all $[a, b]$ except at most to the breaks, and γ becomes a piecewise smooth lightlike pregeodesic. Moreover, if a break $s_0 \in (a, b)$ appeared,

the case $\dot{x}(s_0^+) = 0$ (or $\dot{x}(s_0^-) = 0$) could not hold. Indeed, otherwise $\Lambda(x(s_0)) = 0$, and this implies $(A_E \setminus A) \cap T_{x(s_0)}M = \{0\}$. Thus, $\dot{x}(s_0^-) = 0$ and $\dot{\gamma}(s_0^-)$ and $\dot{\gamma}(s_0^+)$ become proportional, which implies that γ admits a reparametrization as a smooth geodesic. Of course, the case when $\dot{x}(s_0^+)$, $\dot{x}(s_0^-)$ are both different from 0 can hold and will be taken into account (indeed, the solution in the smooth case would imply that γ is a piecewise pregeodesic with $C = 0$ and, thus, its projection $x(s)$ would be a piecewise lightlike pregeodesic of $(M, -h)$, recall Corollary 5.8). As a technical detail, the conformal Lorentzian metric $-\tilde{h} := -h/\Lambda^2$ will be used in the remainder (consistently with (19)). This is equivalent to the usage of $-h$ as only lightlike curves and pregeodesics will be concerned, and allows us to express easily the associated Fermat metrics

$$F = \frac{\omega}{\Lambda} + \sqrt{\tilde{h}} \quad F_l = \frac{\omega}{\Lambda} - \sqrt{\tilde{h}} \quad (60)$$

(recall Proposition 3.12 and equation (33)), where $\Lambda < 0$.

So, assume that x is a piecewise smooth lightlike curve in $(M_l, -\tilde{h})$. In particular, the lightlike curve γ is univocally reconstructed from x plus its initial point (Remark 3.15 (c2) is applicable to $\dot{x}(s)$) and $g(\dot{\gamma}, \partial_t) \equiv 0$ (from the interpretation of h , see (35)). In the case that x is also a (smooth) pregeodesic, Corollary 5.8 implies that γ is a lightlike pregeodesic too. Otherwise, we can find a variation x_w of x by means of timelike curves of $-\tilde{h}$ for every $w \in (0, \varepsilon)$ with variational vector field ξ such that $\tilde{h}(\xi', \dot{x}) > 0$ in two cases: when x is smooth but not a pregeodesic and when x is a piecewise pregeodesic (see case 2 and last part of the proof of [55, Proposition 10.46]). Our aim is to lift this variation (up to a subtle choice θ of the parameter) to a variation of γ in the spacetime. Concretely, the variation $\eta_\theta = \gamma_{w(\theta)}$ for $\theta \in (-\varepsilon', \varepsilon')$ will be written as

$$\gamma_{w(\theta)}(s) = (\zeta_{w(\theta)}(s), x_{w(\theta)}(s)) \quad (61)$$

and $\zeta_{w(\theta)}$ is defined on $[a, b]$ as

$$\zeta_{w(\theta)}(s) = \begin{cases} \zeta(a) + \int_a^s F(\dot{x}_{w(\theta)}) d\tau & \text{if } \theta \in [-\varepsilon', 0], \\ \zeta(a) + \int_a^s F_l(\dot{x}_{w(\theta)}) d\tau & \text{if } \theta \in [0, \varepsilon'], \end{cases} \quad (62)$$

for all $s \in [a, b]$. Notice that both expressions agree for $\theta = 0$, and the longitudinal curves at constant θ are lightlike.

The reparametrization $w(\theta)$ will be crucial because otherwise $\frac{\partial}{\partial w} \zeta_w(s_0)|_{w=0}$ might make no sense. Indeed, choose any $s_0 \in (a, b)$ and, for small $w \geq 0$, put:

$$\theta(w) = \int_0^w \frac{d\bar{w}}{\sqrt{\tilde{h}(\dot{x}_{\bar{w}}(s_0), \dot{x}_{\bar{w}}(s_0))}}$$

whenever $w \in (0, \varepsilon)$, which is well-defined and it can be extended continuously at $w = 0$ since $\tilde{h}(\dot{x}_w(s_0), \dot{x}_w(s_0)) > 0$, for $w > 0$, and

$$\frac{\partial}{\partial w} \tilde{h}(\dot{x}_w(s_0), \dot{x}_w(s_0))|_{w=0} = 2\tilde{h}(\xi'(s_0), \dot{x}(s_0)) > 0.$$

In fact, the latter implies

$$\sqrt{\tilde{h}(\dot{x}_w(s_0), \dot{x}_w(s_0))} \geq c\sqrt{w},$$

for some constant $c > 0$ and $0 < w \leq \varepsilon$, and consequently,

$$\theta(w) = \int_0^w \frac{d\bar{w}}{\sqrt{\tilde{h}(\dot{x}_{\bar{w}}(s_0), \dot{x}_{\bar{w}}(s_0))}} \leq \int_0^w \frac{d\bar{w}}{c\sqrt{\bar{w}}} = \frac{2}{c}\sqrt{w}.$$

So, put $\theta(0) = 0$ and let $w(\theta)$, $\theta \in [0, \varepsilon']$, be the inverse function of $\theta(w)$, $w \in [0, \varepsilon]$.

Observe that $\dot{w}(\theta) = \sqrt{\tilde{h}(\dot{x}_{w(\theta)}(s_0), \dot{x}_{w(\theta)}(s_0))}$, for $\theta > 0$, and $\lim_{\theta \rightarrow 0^+} \dot{w}(\theta) = 0$.

Thus w can be C^1 -extended evenly, that is, we write $w(-\theta) = w(\theta)$, on $(-\varepsilon', \varepsilon')$.

Once defined this (non-injective) function $w(\theta)$, our aim is to check the appropriate smoothness of the variation as well as to compute its variational vector field. As a previous technical computation, let us check that the function

$$(0, \varepsilon'] \times [a, b] \ni (\theta, s) \mapsto \frac{\dot{w}(\theta)}{\sqrt{\tilde{h}(\dot{x}_{w(\theta)}(s), \dot{x}_{w(\theta)}(s))}} = \sqrt{\frac{\tilde{h}(\dot{x}_{w(\theta)}(s_0), \dot{x}_{w(\theta)}(s_0))}{\tilde{h}(\dot{x}_{w(\theta)}(s), \dot{x}_{w(\theta)}(s))}}, \quad (63)$$

is bounded so that Lebesgue's theorem of dominated convergence can be used in the integrals below. Indeed, taking into account that, by assumption, $\tilde{h}(\dot{x}, \xi') > 0$ on $[a, b]$, consider the smooth function

$$u(s) := \sqrt{\frac{\tilde{h}(\dot{x}(s_0), \xi'(s_0))}{\tilde{h}(\dot{x}(s), \xi'(s))}} (> 0), \quad \forall s \in [a, b].$$

Now, applying L'Hopital's rule for fixed $s \in [a, b]$ in the radicand of (63):

$$\lim_{\theta \rightarrow 0^+} \frac{\dot{w}(\theta)}{\sqrt{\tilde{h}(\dot{x}_{w(\theta)}(s), \dot{x}_{w(\theta)}(s))}} = \lim_{\theta \rightarrow 0^+} \sqrt{\frac{\tilde{h}(\dot{x}_{w(\theta)}(s_0), \frac{D\dot{x}_w}{dw}|_{w=w(\theta)}(s_0))\dot{w}(\theta)}{\tilde{h}(\dot{x}_{w(\theta)}(s), \frac{D\dot{x}_w}{dw}|_{w=w(\theta)}(s))\dot{w}(\theta)}} = u(s) \quad (64)$$

and, up to consider a smaller ε' , the boundedness of (63) follows easily. Indeed,

observe that the assumption $\tilde{h}(\dot{x}, \xi')|_J > 0$ implies that the function $(\theta, s) \in [0, \varepsilon'] \times J \mapsto \frac{\tilde{h}(\dot{x}(s_0), \frac{D\dot{x}_w}{dw}|_{w=w(\theta)}(s_0))}{\tilde{h}(\dot{x}(s), \frac{D\dot{x}_w}{dw}|_{w=w(\theta)}(s))}$ is bounded on $[0, \varepsilon'] \times J$, for $0 < \varepsilon''$ small enough. Thus

by Cauchy's mean value theorem we also have that the function $(\theta, s) \in [0, \varepsilon'] \times J \mapsto \frac{\dot{w}(\theta)}{\sqrt{\tilde{h}(\dot{x}_{w(\theta)}(s), \dot{x}_{w(\theta)}(s))}}$ is bounded.

Consider now $\eta_\theta = \gamma_{w(\theta)}$ with $\theta \in (-\varepsilon', \varepsilon')$ as defined in (61), (62), with F, F_l as in (60), recalling that $\Lambda(x(s)) \neq 0$, for all $s \in [a, b]$. Then,

$$\begin{aligned} & \lim_{\theta \rightarrow 0^+} \frac{\zeta_{w(\theta)}(s) - \zeta_{w(0)}(s)}{\theta} \\ &= \lim_{\theta \rightarrow 0^+} \int_a^s \frac{\partial}{\partial w} F_l(\dot{x}_w) \Big|_{w=w(\theta)} \dot{w}(\theta) d\tau \\ &= \lim_{\theta \rightarrow 0^+} \int_a^s \left(\frac{\partial}{\partial w} \omega(\dot{x}_w) \Big|_{w=w(\theta)} + \frac{\tilde{h}(\frac{D\dot{x}_w}{dw}, \dot{x}_w)}{\sqrt{\tilde{h}(\dot{x}_w, \dot{x}_w)}} \Big|_{w=w(\theta)} \right) \dot{w}(\theta) d\tau \\ &= \int_a^s \tilde{h}(\xi', \dot{x}) u d\tau \end{aligned}$$

where $\lim_{\theta \rightarrow 0} \dot{w}(\theta) = 0$ and (64) are used in the last equality. Analogously,

$$\begin{aligned}
& \lim_{\theta \rightarrow 0^-} \frac{\zeta_{w(\theta)}(s) - \zeta_{w(0)}(s)}{\theta} \\
&= \lim_{\theta \rightarrow 0^-} \int_a^s \frac{\partial}{\partial w} F(\dot{x}_w) \Big|_{w=w(\theta)} \dot{w}(\theta) d\tau \\
&= - \lim_{\theta \rightarrow 0^+} \int_a^s \frac{\partial}{\partial w} F(\dot{x}_w) \Big|_{w=w(\theta)} \dot{w}(\theta) d\tau \\
&= - \lim_{\theta \rightarrow 0^+} \int_a^s \left(\frac{\partial}{\partial w} \frac{\omega(\dot{x}_w)}{\Lambda(x_w)} \Big|_{w=w(\theta)} - \frac{\tilde{h}(\frac{\tilde{D}\dot{x}_w}{dw}, \dot{x}_w)}{\sqrt{\tilde{h}(\dot{x}_w, \dot{x}_w)}} \Big|_{w=w(\theta)} \right) \dot{w}(\theta) d\tau \\
&= \int_a^s \tilde{h}(\xi', \dot{x}) u d\tau.
\end{aligned}$$

That is, it follows:

$$\frac{d\zeta_{w(\theta)}}{d\theta} \Big|_{\theta=0} (s) = \int_a^s \tilde{h}(\xi', \dot{x}) u d\tau \quad \forall s \in [a, b]$$

Moreover, as $\frac{dx_{w(\theta)}}{d\theta} \Big|_{\theta=0} (s) = \dot{w}(0)\xi(s) = 0$, we conclude that the variational vector field defining η_θ is $Z = (\frac{d\zeta_{w(\theta)}}{d\theta} \Big|_{\theta=0}, 0)$. Notice also that the corresponding variation $\gamma_{w(\theta)}$ (recall (61)) has continuous second order mixed derivatives on $(-\varepsilon, \varepsilon) \times [a, b]$. Thus, it is an admissible variation but

$$dt_{\gamma(b)}(Z(b)) = r \int_a^b \tilde{h}(\xi', \dot{x}) u d\tau = \sqrt{\tilde{h}(\xi'(s_0), \dot{x}(s_0))} \int_a^b \sqrt{\tilde{h}(\xi', \dot{x})} d\tau > 0,$$

in contradiction with (59).

Therefore, at the interval J where x is $(-\tilde{h})$ -lightlike, $x|_J$ cannot be neither a smooth curve that is not a $-\tilde{h}$ -lightlike pregeodesic nor a broken lightlike pregeodesic of $-\tilde{h}$, i.e., $x|_J$ has to be a lightlike pregeodesic of \tilde{h} and this concludes Case (c).

(2) Recall that, from Corollary 5.8, if γ is a future-pointing lightlike geodesic with $C_\gamma \neq 0$, then x is a pregeodesic of (M, F) or (M, F_l) according to $C_\gamma < 0$ or $C_\gamma > 0$. Now, any variation $\gamma_w = (\zeta_w, x_w)$ of γ , must satisfy $g(\partial_t, \dot{\gamma}_w) < 0$, in the first case, and $g(\partial_t, \dot{\gamma}_w) > 0$, in the second one, on all the interval $[a, b]$ and for w small enough. Hence, x_w defines an F -admissible variation of x . As $\zeta_w(s) = t_0 + \ell_F((x_w)|_{[a,s]})$ (resp. $\zeta_w(s) = t_0 + \ell_{F_l}((x_w)|_{[a,s]})$) we get that γ is a critical point of T (recall Lemma 2.41). Finally, the case when $C_\gamma = 0$ follows from Corollary 5.8-(iii). \square

Remark 7.9. (1) Comparing Theorems 7.3 and 7.8, one realizes that the more restrictive ambient of the latter makes possible both, an accurate description of the critical points and also to remove the condition of non-orthogonality at the endpoint in Theorem 7.3. Nevertheless, a condition of non-triviality $x_0 \neq x_1$ was assumed in Theorem 7.8. The role of this condition is apparent because if $x_0 \in l_{x_1}$ and this line is lightlike, then the case (b) in the proof of Theorem 7.8 shows that even if this curve is a geodesic it will not be a critical point. If l_{x_1} is a lightlike

curve then last-point non-orthogonality should be assumed as in Theorem 7.3 and if it is not lightlike then the hypothesis can be removed.

(2) Observe that the variation obtained in Case (c) of the above proof is not necessarily C^2 , because when one tries to compute the second partial derivative with respect to θ , some denominators tending to 0 appear. In any case, it is admissible because the second order mixed derivatives exist and are continuous. Moreover we can show that the function $w(\theta)$ is C^2 . As a matter of fact, denoting by $\frac{\tilde{D}\dot{x}_w}{dw}(s)$ the covariant derivative along the curve $w \mapsto x_w(s)$ associated with the Levi-Civita connection of \tilde{h} on M_l , we have for the chosen $s_0 \in (a, b)$ and each $\theta > 0$:

$$\ddot{w}(\theta) = \frac{\tilde{h}(\dot{x}_{w(\theta)}(s_0), \frac{\tilde{D}\dot{x}_w}{dw}|_{w=w(\theta)}(s_0))}{\sqrt{\tilde{h}(\dot{x}_{w(\theta)}(s_0), \dot{x}_{w(\theta)}(s_0))}} \dot{w}(\theta) = \tilde{h}(\dot{x}_{w(\theta)}(s_0), \frac{\tilde{D}\dot{x}_w}{dw}|_{w=w(\theta)}(s_0)).$$

As the limit at $\theta = 0$ of the right-hand side is well-defined, L'Hopital's rule ensures that $w(\theta)$ is a C^2 function on all $(-\varepsilon', \varepsilon')$ (recall that $w(-\theta) = w(\theta)$ and then $\dot{w}(-\theta) = \dot{w}(\theta)$).

Since the lightlike geodesics in $(\mathbb{R} \times M, g)$ that connect a point x_0 with a line l_{x_1} when at least one of the two points x_0, x_1 belongs to the region of mild wind where $\Lambda > 0$ are those projecting on pregeodesics of F (recall Corollary 5.8), from Theorem 7.8 we immediately get the following

Corollary 7.10. *Let $x_0, x_1 \in M$ be such that at least one of the two points belongs to the mild wind region. Then the critical points of the arrival time functional on $\mathcal{N}_{(t_0, x_0), l_{x_1}}$ are all and only the future-pointing lightlike curves connecting (t_0, x_0) to l_{x_1} , whose projections on M are pregeodesics of (M, F) and, vice versa, all the pregeodesics of (M, F) connecting x_0 to x_1 , when lifted on $(\mathbb{R} \times M, g)$ as lightlike curves starting at (t_0, x_0) , are critical points of T on $\mathcal{N}_{(t_0, x_0), l_{x_1}}$.*

As in Corollary 7.7, we can obtain a result for timelike geodesics by considering the extended spacetime $(\mathbb{R} \times M \times \mathbb{R}_u, \tilde{g})$. Notice that (27) is enough to ensure that $(\mathbb{R} \times M \times \mathbb{R}_u, \tilde{g})$ is also an SSTK splitting and the canonical projection $t: \mathbb{R} \times M \times \mathbb{R}_u \rightarrow \mathbb{R}$ is a temporal function.

The Fermat structure Σ_1 on $M \times \mathbb{R}_u$ carries two pseudo-Finsler metrics F_1 and $(F_1)_l$ given by (30) and (32) with g_0 replaced by the Riemannian metric on $M \times \mathbb{R}_u$, $g_1 := \pi_{M,u}^* g_0 + du^2$, where $\pi_{M,u}$ is the canonical projection of $M \times \mathbb{R}_u$ on M . Clearly also the domains A_1 and $(A_1)_E$ follow trivial modifications according to Proposition 3.12.

Then, Theorem 7.8 applied to $(\mathbb{R} \times M \times \mathbb{R}_u, \tilde{g})$ with its Fermat structure Σ_1 and the arrival time functional T , from a point $(p_0, 0) \in M \times \mathbb{R}_u$ to a line $l_{(x_1, \eta)} = \mathbb{R} \times \{(x_1, \eta)\}$ provides

Corollary 7.11. *If the curve γ_1 is a critical point of the arrival time functional T on $\mathcal{N}_{(p_0, 0), l_{(x_1, \eta)}}$, then, its projection $\pi_{\mathbb{R} \times M} \circ \gamma_1$ is a timelike pregeodesic of $(\mathbb{R} \times M, g)$ with length η . Conversely, if $\gamma = (\zeta, x): [0, 1] \rightarrow \mathbb{R} \times M$ is a timelike geodesic of $(\mathbb{R} \times M, g)$ (of length $\eta = \sqrt{-g(\dot{\gamma}, \dot{\gamma})}$) then, the lightlike geodesic of $(\mathbb{R} \times M \times \mathbb{R}_u, \tilde{g})$, $\gamma_1(s) = (\gamma(s), \eta s)$, satisfies $C = g(\partial_t, \dot{\gamma}) = \tilde{g}(\partial_t, \dot{\gamma}_1)$ and one of the following three exclusive cases holds*

- (i) $C < 0$, \dot{x} lies in A , $(x(s), \eta s)$ is a pregeodesic of F_1 , γ_1 is a critical point of T_1 and

$$\zeta(s) = \zeta(a) + \int_a^s F_1((\dot{x}(\bar{s}), \eta)) d\bar{s}.$$

- (ii) $C > 0$, \dot{x} lies in A_l (so that $\Lambda < 0$ on all x), $(x(s), \eta s)$ is a pregeodesic of $(F_1)_l$, γ_1 is a critical point of T_1 and

$$\zeta(s) = \zeta(a) + \int_a^s (F_1)_l((\dot{x}(\bar{s}), \eta)) d\bar{s}.$$

- (iii) $C = 0$, x remains in \bar{M}_l and, whenever $\Lambda < 0$ on x , necessarily $(x(s), \eta s)$ is a lightlike geodesic of the Lorentzian metric h_1/Λ on $M_l \times \mathbb{R}_u$, where $h_1 = \pi_{M,u}^* h + du^2 - \omega(\dot{x}) > 0$ and ζ satisfies

$$\zeta(s) = \zeta(a) - \int_a^s \frac{g_1((\dot{x}(\bar{s}), \eta), (\dot{x}(\bar{s}), \eta))}{\omega(\dot{x}(\bar{s}))} d\bar{s}.$$

8. FURTHER APPLICATIONS

Next, we give some simple applications to spacetimes (which, eventually, could be developed further in concrete cases of physical interest) in Subsections 8.1 and 8.3. An application to the differentiability of the Randers-Kropina separation in Subsection 8.2 is also provided. As in the case of other applications to wind Riemannian structures, this could eventually be also studied in the more general case of an arbitrary wind Finslerian manifold.

8.1. Cauchy developments. The description of the causal properties of an SSTK splitting in terms of its Fermat structure allows us to obtain also information about Cauchy developments (see [55, Ch. 14] for background and conventions used here). The notion of Cauchy development makes sense for any subset \mathcal{A} of a spacetime L that is *achronal* i.e. no $x, y \in \mathcal{A}$ are chronologically related (we will only consider subsets included in a slice of an SSTK splitting that are always acausal too, see footnote 9). For such an \mathcal{A} , the *future (resp. past) Cauchy development* of \mathcal{A} , denoted by $D^+(\mathcal{A})$ (resp. $D^-(\mathcal{A})$) is defined as the subset of the points y such that every past-inextendible (resp. future-inextendible) causal curve through y meets \mathcal{A} . The union of both $D^+(\mathcal{A}) \cup D^-(\mathcal{A})$ is simply called the *Cauchy development* of \mathcal{A} and it will be denoted by $D(\mathcal{A})$. The *future (resp. past) Cauchy horizon* $H^+(\mathcal{A})$ (resp. $H^-(\mathcal{A})$) is defined as

$$H^\pm(\mathcal{A}) = \{q \in \bar{D}^\pm(\mathcal{A}) : I^\pm(q) \cap D^\pm(\mathcal{A}) = \emptyset\}.$$

It is helpful to think that $D(\mathcal{A})$ is the region of the spacetime predictable from data in \mathcal{A} (in fact, the interior of $D(\mathcal{A})$ is globally hyperbolic when non-empty) and the horizon $H(\mathcal{A}) = H^+(\mathcal{A}) \cup H^-(\mathcal{A})$ can be thought as the boundary of this region. As an immediate consequence of the definition, $H^+(\mathcal{A}) = \bar{D}^+(\mathcal{A}) \setminus I^-(D^+(\mathcal{A}))$ and analogously for $H^-(\mathcal{A})$.

Proposition 8.1. *Let $(\mathbb{R} \times M, g)$ be an SSTK splitting as in (26), $\mathcal{A} \subset M$ and $\mathcal{A}_{t_0} = \{t_0\} \times \mathcal{A}$ the (necessarily achronal) subset of S_{t_0} . Then*

$$\begin{aligned} D^+(\mathcal{A}_{t_0}) &\subset \{(t, y) \in \mathbb{R} \times M : t \geq t_0 \text{ and } \hat{B}_\Sigma^-(y, t - t_0) \subset \mathcal{A}\}, \\ D^-(\mathcal{A}_{t_0}) &\subset \{(t, y) \in \mathbb{R} \times M : t \leq t_0 \text{ and } \hat{B}_\Sigma^+(y, t_0 - t) \subset \mathcal{A}\}. \end{aligned}$$

Moreover, if the spacetime is globally hyperbolic with S_0 a Cauchy hypersurface, then the reverse inclusions hold and:

$$H^+(\mathcal{A}_{t_0}) = \left\{ (t, y) \in \mathbb{R} \times M : t \geq t_0, y \in \bigcup_{x \in \partial \mathcal{A}} \hat{B}_\Sigma^+(x, t - t_0) \setminus \bigcup_{x \notin \mathcal{A}} B_\Sigma^+(x, t - t_0) \right\},$$

$$H^-(\mathcal{A}_{t_0}) = \left\{ (t, y) \in \mathbb{R} \times M : t \leq t_0, y \in \bigcup_{x \in \partial \mathcal{A}} \hat{B}_\Sigma^-(x, t_0 - t) \setminus \bigcup_{x \notin \mathcal{A}} B_\Sigma^-(x, t_0 - t) \right\}.$$

Proof. Reasoning always for the $+$ case, let $(t, y) \in D^+(\mathcal{A}_{t_0})$. As the time function of the SSTK splitting is decreasing on past-pointing causal curves, $t \geq t_0$. If $x \in \hat{B}_\Sigma^-(y, t - t_0)$, from Proposition 5.1, $(t_0, x) \in J^-(t, y)$ and there exists a past-pointing causal curve from (t, y) to (t_0, x) . Again by monotonicity of the time function, (t_0, x) is its unique point of intersection with \mathcal{A}_{t_0} , so that $x \in \mathcal{A}$.

Now let us assume that S_{t_0} is a Cauchy hypersurface.

Let $(t, y) \in \mathbb{R} \times M$ such that $\hat{B}_\Sigma^-(y, t - t_0) \subset \mathcal{A}$. From Proposition 5.1, any past-inextendible causal curve through (t, y) intersects S_{t_0} in a point (t_0, x) with $x \in \hat{B}_\Sigma^-(y, t - t_0)$, so that, $x \in \mathcal{A}$ and consequently $(t, y) \in D^+(\mathcal{A}_{t_0})$.

For the Cauchy horizons, consider the case $t > t_0$ and let us show the inclusion \subset . Let $(t, y) \in H^+(\mathcal{A}_{t_0})$. Assume that there exists $x \notin \mathcal{A}$ such that $y \in B_\Sigma^+(x, t - t_0)$. From Proposition 5.1 $(t_0, x) \ll (t, y)$; thus, $I^+(t_0, x)$ is a neighborhood of (t, y) which does not intersect $D^+(\mathcal{A}_{t_0})$, which is absurd. Therefore, $y \notin \cup_{x \notin \mathcal{A}} B_\Sigma^+(x, t - t_0)$. Now, let $\{(t_n^+, y_n^+)\}$ be a sequence in $I^+(t, y)$ converging to (t, y) such that, for each $n \in \mathbb{N}$, there exists a future-pointing causal curve γ_n which does not cross \mathcal{A}_{t_0} . However, as S_{t_0} is Cauchy, γ_n will cross S_{t_0} at some (t_0, x_n) with $x_n \notin \mathcal{A}$. The limit curve γ of the sequence $\{\gamma_n\}$ passing through (t, y) will also cross S_{t_0} at some point (t_0, x) and, by (i) in Lemma 5.9, $x = \lim_n x_n$. Therefore $x \in \overline{M \setminus \mathcal{A}}$ and $y \in \hat{B}_\Sigma^+(x, t - t_0)$. Moreover, x cannot belong to the interior of $M \setminus \mathcal{A}$. Otherwise, if V is a neighborhood of x in $M \setminus \mathcal{A}$, then, recalling that $J^-(t, y) = \bar{I}^-(t, y)$, $I^-(t, y)$ would intersect $\{t_0\} \times V$ and, reasoning as above, $(t, y) \notin \overline{D^+(\mathcal{A}_{t_0})}$.

For the inclusion \supset , notice first that, if $(t, y) \notin \overline{D^+(\mathcal{A}_{t_0})}$, then there exists (t', y') , with $t_0 < t' < t$, such that $\overline{D^+(\mathcal{A}_{t_0})} \not\ni (t', y') \ll (t, y)$. Taking an inextendible past-pointing causal curve starting at (t', y') which does not cross \mathcal{A}_{t_0} (but which will cross S_{t_0} necessarily), there exists $\tilde{x} \in M \setminus \mathcal{A}$ such that $(t_0, \tilde{x}) \leq (t', y') \ll (t, y)$ and, so, $y \in B_\Sigma^+(\tilde{x}, t - t_0)$. Thus, one has just to prove only for points $(t, y) \in \overline{D^+(\mathcal{A}_{t_0})}$ that (t, y) belongs to $H^+(\mathcal{A}_{t_0})$ whenever $y \in \hat{B}_\Sigma^+(\tilde{x}, t - t_0)$, for some $\tilde{x} \in \partial \mathcal{A}$. This hypothesis implies that $(t, y) \in J^+(t_0, \tilde{x})$ and, so, any $(t', x') \gg (t, y)$ also satisfies $(t', x') \gg (t_0, \tilde{x})$. As \tilde{x} lies in $\partial \mathcal{A}$, necessarily $(t', x') \in I^+(S_{t_0} \setminus \mathcal{A}_{t_0})$, i.e., $(t', x') \notin D^+(\mathcal{A}_{t_0})$, as required.

For the case $t = t_0$, the inclusion \subset is straightforward (the balls $B_\Sigma^+(x, 0)$ are empty and a simple local comparison with Lorentz Minkowski shows that (a) if x belongs to the interior of \mathcal{A} then $I^+(t_0, x)$ intersects $D^+(\mathcal{A}_{t_0})$ while (b) if x belongs to the interior of $M \setminus \mathcal{A}$ then (t_0, x) does not belong to the closure of $D^+(\mathcal{A}_{t_0})$). The converse inclusion follows because, clearly, (t_0, x) belongs to $\overline{D^+(\mathcal{A}_{t_0})}$ if $x \in \partial \mathcal{A}$ (as $\mathcal{A}_{t_0} \subset \overline{D^+(\mathcal{A}_{t_0})}$) and, if some $(t, y) \in I^+(t_0, x) \cap D^+(\mathcal{A}_{t_0})$ then a contradiction follows as above. \square

Remark 8.2. Notice that the previous result extends [20, Prop. 4.7]. When global hyperbolicity is assumed, one can use indistinctly closed or c-balls, even though extensions in the sense of [20, Remark 4.8] could be explored. To assume

that the spacelike slices S_t are Cauchy hypersurfaces is essential because otherwise none of the inclusions for H^+ would hold (a causally simple counterexample would be $\mathbb{R} \times (0, +\infty) \subset \mathbb{L}^2$, regarded as an SSTK, with $\mathcal{A} = (0, 2)$), see Fig. 12.

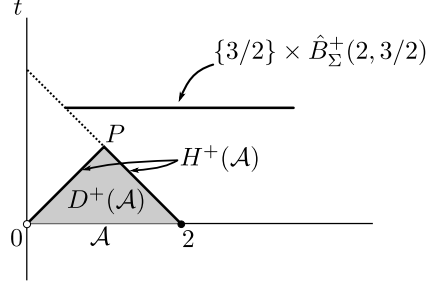

FIGURE 12. The points of the dashed line belong to $\cup_{t>0}\{t\} \times \hat{B}_\Sigma^+(2, t) \setminus B_\Sigma^+(2, t)$ but not to $H^+(\mathcal{A})$; the ones of the segment $\overline{0P}$, 0 excluded, are in $H^+(\mathcal{A})$ but not in $\cup_{t>0}\{t\} \times \hat{B}_\Sigma^+(2, t)$.

8.2. Differentiability of the Randers-Kropina separation. For an SSTK with a causal Killing vector field, we can use the Finslerian separation d_F of the associated Randers-Kropina metric to describe the future or the past Cauchy horizon of $\mathcal{A}_{t_0} = \{t_0\} \times \mathcal{A}$, at least when S_0 is Cauchy. Indeed, in this case, from Proposition 8.1, the set:

$$\begin{aligned} & \{(t, y) \in \mathbb{R} \times M : \exists x' \in M \setminus \mathcal{A} : d_F(x', y) < t - t_0 \text{ and} \\ & \text{either } y \in \partial\mathcal{A}, t \geq t_0 \text{ and } \Lambda(y) = 0 \text{ or } \exists x \in \partial\mathcal{A} \text{ s. t. } d_F(x, y) = t - t_0\} \\ & = \{(t, y) \in \mathbb{R} \times \bar{\mathcal{A}} : \inf_{x \in \mathcal{A}} d_F(x, y) = t - t_0\} \\ & \cup \{(t, x) : x \in \partial\mathcal{A}, \Lambda(x) = 0, t \geq t_0 \text{ and } \exists x' \in M \setminus \mathcal{A} : d_F(x', x) < t - t_0\} \end{aligned}$$

is equal to the horizon $H^+(\mathcal{A}_{t_0})$. Notice that, differently from the stationary case, $H^+(\mathcal{A}_{t_0})$ might also contain achronal arcs, included in integral curves of ∂_t , such that $x \in \partial\mathcal{A}$, $\Lambda(x) = 0$ and $d\Lambda(\text{Ker } \omega_x) = 0$. For example, consider \mathbb{R}^2 endowed with the flat metric $g = dx^2 - (dxdt + dt dx)/2$ and $\mathcal{A} = (0, 1) \subset \mathbb{R}$, so that $S_0 = \{0\} \times \mathbb{R}$ is spacelike and the segment connecting the points having coordinates $(0, 1)$ and $(1, 1)$ (the first coordinate is t) is contained in $H^+(\mathcal{A}_0)$. Clearly, these arcs cannot be described as points belonging to the graph (in $\mathbb{R} \times M$) of the function

$$\varphi := x \in \bar{\mathcal{A}} \mapsto d_F(M \setminus \mathcal{A}, x),$$

where $d_F(M \setminus \mathcal{A}, x) := \inf_{y \in M \setminus \mathcal{A}} d_F(y, x)$. Moreover, a straightforward generalization of the example above shows that, differently from the Riemannian or the Finslerian case, φ is not continuous on $\partial\mathcal{A}$.

Following [26], we introduce the notion of *future horizon* which encompasses some of the essential properties possessed by a Cauchy horizon. A future horizon is a topological, closed, achronal hypersurface ruled by future inextendible lightlike geodesics. This notion allows us to remove the assumption that S_0 must be a Cauchy hypersurface and, then, to extend to the Randers-Kropina separation d_F a result about differentiability of the distance function from a closed subset valid

for a Riemannian distance [26, Proposition 11] and for a distance associated with a Randers metric [20, Theorem 5.12].

Let (M, F) be a Randers-Kropina space and $C \subset M$ a closed subset. Let $(\mathbb{R} \times M, g)$ be the SSTK splitting associated with (M, F) and $((-\infty, 0) \times (M \setminus C), g)$ the spacetime obtained by considering the open subset $(-\infty, 0) \times (M \setminus C) \subset \mathbb{R} \times M$. Let us define $\rho: M \setminus C \rightarrow [-\infty, 0)$, $\rho(x) := -d_F(x, C)$, where, now, $d_F(x, C) := \inf_{y \in C} d_F(x, y)$. Notice that, similarly to Proposition 4.3, ρ is equal to the function

$$\begin{aligned} \tau(x) &:= \sup\{t \in \mathbb{R} : \exists y \in C \text{ such that } (t, x) \ll (0, y)\} \\ &= \sup\{t \in \mathbb{R} : (\{0\} \times C) \cap I^+(t, x) \neq \emptyset\} \\ &= \sup\{t \in \mathbb{R} : (t, x) \in I^-(\{0\} \times C)\}. \end{aligned}$$

Let us prove that ρ is a continuous function ($[-\infty, 0)$ is endowed with its natural order topology). Indeed, being ρ defined as minus the infimum of continuous functions, it is lower semi-continuous. Moreover, the following holds too:

Proposition 8.3. *The function $\rho: M \setminus C \rightarrow [-\infty, 0)$ is upper semi-continuous.*

Proof. Assume by contradiction that there exist $x \in M \setminus C$ and two sequences $\{y_n\} \subset C$ and $\{x_n\} \subset M \setminus C$ such that $x_n \rightarrow x$ and $t_n := -d_F(x_n, y_n)$ satisfy

$$T_0 := \lim_n t_n > \rho(x).$$

Then, take future-pointing timelike curves γ_n from $(t_n - 1/n, x_n)$ to $(0, y_n)$ and the limit curve γ of the sequence starting at (T_0, x) . As γ is inextendible and $x \in M \setminus C$, by a reasoning analogous to that in the proof of Theorem 4.5, we deduce that its support cannot be included in the line $l_x = \mathbb{R} \times \{x\}$. So, take a point Q of γ away from l_x and $T_1 \in (\rho(x), T_0)$. As the line l_x is causal, the segment with endpoints (T_1, x) and (T_0, x) glued with the arc of γ between (T_0, x) and Q gives a causal curve which cannot be a lightlike pregeodesic (otherwise the line l_x would be also a lightlike pregeodesic and, at the first point where γ leaves l_x , uniqueness of geodesics would be violated). Hence, from Remark 3.1, $(T_1, x) \ll Q$. Being γ a limit curve and the relation \ll open, there exists $Q_{\bar{n}}, \bar{n} \in \mathbb{N}$, belonging to the support of $\gamma_{\bar{n}}$ such that $(T_1, x) \ll Q_{\bar{n}}$. Therefore $(T_1, x) \ll (0, y_{\bar{n}})$ too, and then $T_1 \leq \rho(x)$, a contradiction. \square

For each closed set $C \subset M$ we can construct a future horizon by using the function ρ associated with C as follows.

Proposition 8.4. *Let $C \subset M$ be a closed set. Then the hypersurface $H = \{(\rho(x), x) : x \in M \setminus C, \rho(x) \neq -\infty\}$ is a future horizon in the spacetime $((-\infty, 0) \times (M \setminus C), g)$.*

Proof. Since $\rho: M \setminus C \rightarrow [-\infty, 0)$ is continuous we get that H is a topological closed hypersurface in $((-\infty, 0) \times M \setminus C, g)$. Moreover it is achronal, otherwise a timelike future-pointing curve would connect $(\rho(x_1), x_1)$ to $(\rho(x_2), x_2)$ and, by taking a sequence of points $\{y_n\} \subset C$ such that $(\rho(x_2) - 1/n, x_2) \ll (0, y_n)$ we would get $(\rho(x_1), x_1) \ll (0, y_n)$, for n big enough. Then, for $\varepsilon > 0$ small enough, $(\rho(x_1) + \varepsilon, x_1) \ll (0, y_{\bar{n}})$, for some $\bar{n} \in \mathbb{N}$, which, recalling that $\rho(x_1) = \tau(x_1)$, gives a contradiction.

Let us now prove the existence of a future-pointing, future-inextendible, geodesic $\gamma: [0, a) \rightarrow (-\infty, 0) \times M$ through any point of H and contained in H . Consider a sequence $\{\gamma_n\}$ of timelike future-pointing curves connecting $(\rho(x) - \frac{1}{n}, x)$ to $(0, y_n)$,

with $y_n \in C$, which we can assume parametrized by the time function t . Such a sequence admits a future-pointing limit curve $\gamma: [0, a) \rightarrow \mathbb{R} \times M$, such that $\gamma(0) = (\rho(x), x)$, and we can assume, by taking a smaller a if necessary, that the image of γ is contained in $\mathbb{R} \times (M \setminus C)$. Reasoning as in the proof of Theorem 4.5 and Proposition 8.3, γ cannot be contained in the line l_x (as $x \in M \setminus C$) and all the points in γ are horismotically related (otherwise, a point Q on γ would lie in the chronological future of $(\rho(x), x)$ and, being γ a limit curve, this also would imply that $(\rho(x), x)$ is in the chronological past of C). From Corollary 5.4, γ is a (future inextendible) lightlike pregeodesic which can be parametrized with t , i.e., $\gamma(t) = (t, \sigma(t))$, $t \in [\rho(x), t_1)$ for some $t_1 > 0$ and some unit minimizing F -geodesic σ . To check that γ is included in H , parametrize also the converging curves as $\gamma_n(t) = (t, x_n(t))$. Then, for each $t \in [\rho(x), t_1)$, $t \leq \tau(x_n(t)) = \rho(x_n(t))$ and by the continuity of ρ and Lemma 5.9, $\rho(x_n(t)) \rightarrow \rho(\sigma(t))$, hence $t \leq \rho(\sigma(t))$. If $t < \rho(\sigma(t))$, there would exist a timelike future-pointing curve connecting $(t + \rho(\sigma(t))/2, \sigma(t))$ to C and then, being the line $l_{\sigma(t)}$ causal, $(\rho(x), x)$ would be in the chronological past of C , which is impossible. Hence $\rho(\sigma(t)) = t$, so that $(t, \sigma(t)) \in H$. \square

Actually the proof of Proposition 8.4 shows also that the following extension to Randers-Kropina metrics of [26, Proposition 9] and [20, Proposition 5.11] holds.

Corollary 8.5. *Let (M, F) be a Randers-Kropina space and $C \subset M$ a closed subset. Then every point $x \in M \setminus C$, such that $d_F(x, C) < +\infty$, belongs to at least one geodesic segment σ which is minimizing, i.e. $d_F(\sigma(t), C) = t$, for all t in a certain interval $(t_0, t_1]$ with $\sigma(t_1) = x$.*

The correspondence between lightlike geodesics ruling H and $d_F(\cdot, C)$ - minimizing geodesics allows us to use [8, Theorem 3.5], which states that the differentiable points of a horizon are the points which are crossed by one and only one lightlike geodesic ruling the horizon, so that we immediately obtain the following.

Proposition 8.6. *Let (M, F) be a Randers-Kropina space and C a closed subset of M . A point $x \in M \setminus C$, such that $d_F(x, C) < +\infty$, is a differentiable point of the function $d_F(\cdot, C)$ if and only if there exists a unique minimizing geodesic segment of (M, F) through x .*

Remark 8.7. Another consequence of the results in [8] is that the set of the points in $M \setminus C$ where $d_F(x, C)$ fails to be differentiable is included in the set of the F -cut points of C , i.e. the points $x \in M \setminus C$ such that a minimizing geodesic through x cannot be extended beyond its beginning at x as a minimizing geodesic. The F -cut points of C correspond to the endpoints of H i.e. the points in H where the lightlike geodesics ruling H cease to belong to H . Moreover, the set of the points where $d_F(\cdot, C)$ is not differentiable corresponds with the crease set of H i.e. the subset of the endpoints of H belonging to two or more ruling lightlike geodesics.

8.3. K-horizons. When the Killing vector field K of an SSTK spacetime is timelike (i.e., in the stationary case), there are no restriction for the admissible curves on the associated Finsler structure; so, each point $p \in \mathbb{R} \times M$ and each integral curve of K can be joined by means of a timelike curve γ . Physically, this prevents the existence of horizons. In fact, if the spacetime admits a sensible notion of future infinity \mathcal{J}^+ (namely, by means of a conformal embedding [68] or by using the causal boundary [27]), the existence of the connecting curves γ , the invariance of

the metric with the flow of K , and the fact that this flow is composed by timelike curves, would imply $I^-(\mathcal{J}^+) = \mathbb{R} \times M$. Nevertheless, the situation is different when K changes from timelike to spacelike. This situation is natural in Mathematical Relativity; recall that this happens, for example, in the extension of the Schwarzschild spacetime through its *event horizon* (the hypersurface $r = 2m$, which coincides with the vanishing of $g(K, K)$ for its natural Killing $K = \partial_t$)¹⁴ as well as in Kerr spacetime, through the stationary limit hypersurface H that serves as a boundary for the ergosphere (the spacetime event horizon appears beyond H).

In general, an embedded hypersurface H invariant by the flow of a Killing vector field K which is tangent and lightlike on H is called a *Killing horizon*. The regularity of H depends on the context, typically, 0 would be a regular value of $g(K, K)$, and H would be a connected component of the preimage, but one may admit non-smooth H (see [25, §2.5], [23] and references therein). In the simple case that H is the preimage of a regular value, a naive justification of the name goes as follows. As all the future causal cones must lie on one side of H , given $(t_0, x_0) \in H$ (regarded as $H = \mathbb{R} \times N_H \subset \mathbb{R} \times M$) for some submanifold N_H) there is a neighborhood U of x_0 such that no points $p, q \in \mathbb{R} \times U$ with $g(K_p, K_p) > 0, g(K_q, K_q) < 0$, can be joined by means of a future-pointing (or past-pointing, depending of the time-orientations) timelike curve γ from p to q entirely contained in $\mathbb{R} \times U$, see Fig. 13 (γ could not cross H maintaining its timelike character).

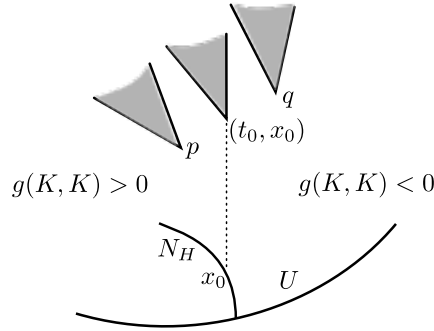

FIGURE 13. A Killing horizon $H = \mathbb{R} \times N_H$ with the lightlike cones at $(t_0, x_0) \in H$, p and q

However, even in this case, one can wonder if p and q could be joined by future-pointing causal curves which leave $\mathbb{R} \times U$.

By using the associated Fermat structure Σ , these considerations can be formulated from a global viewpoint, with independence of the existence of Killing horizons, by means of the following notion.

Definition 8.8. Let M be a manifold endowed with a wind Finslerian structure Σ , and let $\mathcal{A} \subset M$. The *K-horizon* for \mathcal{A} is the boundary $H_\Sigma(\mathcal{A})$ of the set $\{y \in M : \exists x \in \mathcal{A} \text{ s. t. } C_{y,x}^A \neq \emptyset\}$.

¹⁴Notice that the usual description of Schwarzschild spacetime in coordinates (t, r, θ, ϕ) fails in the hypersurface $r = 2m$ because the slices $t = \text{constant}$ are forced to be orthogonal to $K = \partial_t$ (i.e., the spacetime is being described as *static*); however, such a description can be extended beyond that hypersurface by regarding the spacetime as *stationary*.

Remark 8.9. When the wind Finslerian structure is a Randers-Kropina metric F with associated separation d_F , the K -horizon for \mathcal{A} can be written as

$$H_F(\mathcal{A}) = \partial(\{y \in M : d_F(y, \mathcal{A}) < +\infty\}).$$

When applied to SSTK spacetimes, this yields a natural concept:

Definition 8.10. Let $(\mathbb{R} \times M, g)$ be an SSTK splitting and $\mathcal{A} \subset M$. The K -horizon for $\mathbb{R} \times \mathcal{A}$, is the boundary $H(\mathcal{A})$ of the set of the points $(t, y) \in \mathbb{R} \times M$ such that there exists a future-pointing timelike curve from (t, y) to $\mathbb{R} \times \mathcal{A}$.

Notice that the K -horizons for \mathcal{A} (for both Σ and the SSTK splitting) are controlled by the admissible curves and, these, by the open domain A for Σ . The following results ensure the consistency of the previous two definitions.

Lemma 8.11. *Let L be an SSTK spacetime that splits in two different ways $(\mathbb{R} \times M, g)$, $(\mathbb{R} \times M^f, g^f)$ as in Lemma 6.5 and formula (45) for the same Killing vector field K , and let Σ , Σ^f be the corresponding wind Finslerian structures (according to Convention 6.7 and Proposition 6.8). Consider a subset $\mathcal{A}_L \subset L$ invariant by the flow of K , and let \mathcal{A} be its projection on M (by using either of the previous two splittings). Then, $H_\Sigma(\mathcal{A}) = H_{\Sigma^f}(\mathcal{A})$.*

Proof. Notice that the K -horizons for Σ and Σ^f depends exclusively on the set A of F -admissible directions, and these directions are equal for Σ and Σ^f , since they are the projections of causal vectors to M and M^f (recall that you can see $M^f \equiv S^f$ as a hypersurface in $\mathbb{R} \times M$ obtained as a graph, see (45)). \square

Proposition 8.12. *Let $(\mathbb{R} \times M, g)$ be an SSTK splitting and $\mathcal{A} \subset M$. Then:*

- (i) $H(\mathcal{A}) = \mathbb{R} \times H_\Sigma(\mathcal{A})$.
- (ii) The K -horizon $H(\mathcal{A})$ is included in the region $g(K, K) \geq 0$.

Proof. The part (i) is a straightforward consequence of the definitions (recall Proposition 5.1). For (ii), if $p \in H(\mathcal{A})$, $g(K_p, K_p)$ cannot be negative as, otherwise, one would have a stationary region $\mathbb{R} \times U$ around p ($U \ni p$ open and connected) and all pairs of integral curves of K in this region can be connected by both, future-pointing and past-pointing timelike curves. \square

Remark 8.13. (1) (*Asymptotic flatness.*) A natural choice of a subset \mathcal{A} for an SSTK splitting is the region $\Lambda > 0$, so that $H(\mathcal{A})$ can be understood as the limit of the region from which one can access to the stationary part $\mathbb{R} \times \mathcal{A}$. In fact, the standard situation of horizons (including Kerr or Schwarzschild spacetimes) is the following: one considers an SSTK splitting which is asymptotically flat, in the sense that, away from a compact subset, M has one or more *ends*, each one diffeomorphic to \mathbb{R}^m with a ball removed, and the associated wind Finslerian structure becomes a Randers metric F approaching asymptotically to the natural Euclidean metric (see [16, Sect. 2.4]). In this case, it is natural to take \mathcal{A} as the exterior of a large ball in one of the ends. Notice that Definition 8.10 gives a natural notion of *horizon* for that end (in the presence of a Killing field), extendible even when the standard notions of asymptotic flatness cannot be applied.¹⁵

¹⁵Recall that the classical notion of asymptotic flatness relies on the existence of a Penrose conformal embedding which makes possible to define the null infinity \mathcal{I}^+ ; see [27, Sect. 3.4] for extensions of this approach.

(2) (*K horizons vs. Killing horizons.*) Notice that the strict inequality may hold in the case (ii) of the previous proposition. In fact, this happens in Kerr spacetime for the K -horizon $H(\mathcal{A})$ of the asymptotic region with $\Lambda > 0$ (recall that K is spacelike in Kerr's ergosphere up to the poles). Remarkably, Kerr's horizon is a K -horizon but not a Killing horizon (the stationary limit surface is neither a K -horizon nor a Killing horizon).

But even when the equality to 0 holds in (ii), $H(\mathcal{A})$ can be strictly included in the region $g(K, K) = 0$ because of several reasons. First, this region may be not a hypersurface and, for example, it may contain an open subset; this happens in the case of pp-waves, recall Example 4.9. Moreover, when the zero level of $g(K, K)$ is a Killing horizon, the global behaviour of the metric may prevent even the existence of a K -horizon, see Fig. 14. Summing up, the physical interpretation of the K -

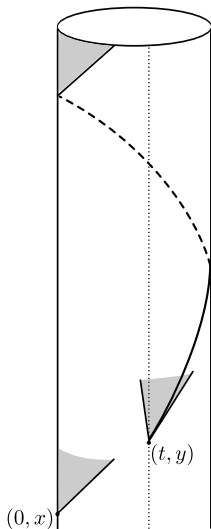

FIGURE 14. An SSTK cylinder $\mathbb{R} \times S^1$ with a Killing vector field which is timelike everywhere except at the points of the line passing through $(0, x)$ where it is lightlike; the K -horizon $H(\{x\})$ is empty

horizon for \mathcal{A} becomes apparent: $H(\mathcal{A})$ is the limit of the region R so that $\mathbb{R} \times \mathcal{A}$ is not accessible for particles starting beyond R . So, K -horizons are always associated with some concrete \mathcal{A} , and are clearly distinct to Killing horizons. Nevertheless, results on spacetimes and Killing horizons may be applicable to K -horizons (for example, to ensure that the Kropina part of a wind Finslerian structure appears on a smooth surface and, eventually, may be a K -horizon, see Lemma 7 or Proposition 3 in [23]).

APPENDIX: LIST OF SOME SYMBOLS AND CONVENTIONS

In order to avoid heavy notations, we have made some abuses of notation when there was no possibility of confusion. For the convenience of the reader, the main ingredients of the notation are listed here.

Symbol	Stays for	Reference
Σ	wind Minkowskian structure on a vector space V ; wind Finslerian structure on a manifold M ($\Sigma = \cup_p \Sigma_p$)	Def. 2.2 Def. 2.6
Σ_F	indicatrix of a Minkowski norm; indicatrix of a Finsler manifold	below Def. 2.1 Remark 2.7
$\tilde{\Sigma}$	reverse wind Finsler structure	Prop. 2.41
M_{mild}	region of mild wind	
M_{crit}	region of critical wind	Def. 2.9
M_l	region of strong wind	
F	(positively homogeneous) Minkowski norm; conic pseudo-Minkowski norm; conic Minkowski norm; Lorentzian norm; Finsler metric; conic pseudo-Finsler metric; Lorentzian Finsler metric; conic Finsler metric associated to a wind Finslerian manifold; conic Finsler metric associated to a wind Riemannian manifold	Def. 2.1 above Prop. 2.3 above Def. 2.6 Prop. 2.10 Eq. (18)
F_l	Lorentzian norm associated with a strong wind Minkowskian structure; Lorentzian Finsler metric associated to a wind Finslerian manifold; Lorentzian Finsler metric associated to a wind Riemannian manifold	Prop. 2.3 Prop. 2.10 Eq. (22)
A	(open) conic domain in a vector space; domain of a conic Minkowski and a Lorentzian norm associated with a wind Minkowskian structure; (open) domain of a wind Finslerian structure ($A = \cup_{p \in M} A_p$)	below Def. 2.2 Prop. 2.3 above Prop. 2.8
$A_l = \cup_{p \in M_l} A_p$	open domain of the conic Finsler metric F ; open domain of the Lorentzian Finsler metric F_l of a strong wind Finslerian structure	Def. 2.9
A_E	extended domain of a strong wind Minkowskian structure	Prop. 2.3
$A_E = \cup_p (A_E)_p$	extended domain of a wind Finslerian structure	Def. 2.9
	extended definition of F to A_E and F_l to $(A \setminus A_l) \cup A_E$	Conv. 2.17

Symbol	Stays for	Reference
B	(open) unit ball for a wind Minkowskian structure	Def. 2.2
B_p	unit ball for Σ_p	above Prop. 2.8
$B_\Sigma^\pm(x_0, r)$	forward/backward wind balls;	Def. 2.21
$\hat{B}_\Sigma^\pm(x_0, r)$	forward/backward c-balls	
	Σ -admissible curve;	Def. 2.18-(i)
	F -admissible curve	
	wind curve	Def. 2.18-(ii)
	(strictly) regular curve	Def. 2.18-(iii)
C_{x_0, x_1}^Σ	set of wind curves;	above Def. 2.21
C_{x_0, x_1}^A	set of F -wind curves	
$C_{x_0, x_1}^\Sigma[a, b]$	set of wind curves with domain $[a, b]$	below Prop. 2.31
Ω_{x_0, x_1}^A	set of F -admissible curves of a pseudo-Finsler metric	above Lem. 2.41
ℓ_F	wind lengths	Def. 2.18-(iv)
ℓ_{F_t}	unit extremizing (pre)geodesic	Def. 2.30
	minimizing, maximizing, boundary	Prop. 2.34
	(unit) (pre-) geodesic	Rem. 2.35-(3)
	(pre-) geodesic	Def. 2.36
γ_{x_0}	(extremizing) exceptional geodesic at x_0	Prop. 2.31 Def. 2.36
	w-convex	Def. 2.37
	geodesically convex	Prop. 2.29
(L, g)	Lorentzian $(m + 1)$ -manifold or spacetime	subsect. 3.1
g	metric of an SSTK	Def. 3.2
g_R	Riemannian metric on M	
g_0	Riemannian metric on M ;	Conv. 2.45
	spacelike metric of an SSTK	Prop. 3.3
Λ	function associated to a Riemannian manifold (M, g_R) and a vector field W ;	Conv. 2.45
	lapse of an SSTK spacetime;	Prop. 3.3
ω	one-form associated to a Riemannian manifold (M, g_R) and a vector field W ;	Conv. 2.45
	shift of an SSTK spacetime	Prop. 3.3
$S_t = \{t\} \times M$	slice of any SSTK spacetime	below Eq. (28)
$\mathbb{R} \times TM$	tangent space to $\mathbb{R} \times M$ when the t -component becomes irrelevant	Conv. 3.5

Symbol	Stays for	Reference
	limit curve	Def. 4.4 Lem. 5.9
	causal spacetime	Th. 4.7
	strongly causal spacetime; stably causal spacetime; temporal function	Rem. 3.4
	causally simple spacetime; globally hyperbolic spacetime; Cauchy hypersurface	Th. 4.7
h	signature changing metric on M	Eq. (34)
\tilde{h}	Lorentzian metric (of index $m-1$) on M_l equal to h/Λ^2	Eq. (19)
$M_{\Lambda \neq 0}$	region where Λ does not vanish	below Eq. (34)
$\mathcal{N}_{p_0, \alpha}$	space of lightlike curves from p to the curve α	Eq. (49)
$\mathcal{N}_{p_0, l_{x_1}}$	case when α is the line $l_{x_1} = \{(t, x_1) : t \in \mathbb{R}\}$	below Eq. (58)
T	arrival functional; arrival time functional	Eq. (52) above Eq. (58)

REFERENCES

- [1] R. ABRAHAM AND J. E. MARSDEN, *Foundations of Mechanics*, Benjamin/Cummings Publishing Co., Inc., Advanced Book Program, Reading, Mass., 1978.
- [2] A. A. AGRACHEV AND Y. L. SACHKOV, *Control Theory from the Geometric Viewpoint*, Encyclopaedia of Mathematical Sciences, 87. Control Theory and Optimization, II. Springer-Verlag, Berlin, 2004.
- [3] F. ANTONACCI AND P. PICCIONE, *A Fermat principle on Lorentzian manifolds and applications*, Appl. Math. Lett., 9 (1996), 91–95.
- [4] D. BAO, C. ROBLES AND Z. SHEN, *Zermelo navigation on Riemannian manifolds*, J. Differential Geom., 66 (2004), 377–435.
- [5] R. BARTOLO, A. M. CANDELA AND J. L. FLORES, *Connectivity by geodesics on globally hyperbolic spacetimes with a lightlike Killing vector field*, Rev. Mat. Iberoamericana, in press, arXiv:1405.0804.
- [6] R. BARTOLO, E. CAPONIO, A.V. GERMINARIO AND M. SÁNCHEZ, *Convex domains of Finsler and Riemannian manifolds*, Calc. Var. Partial Differential Equations, 40 (2011), 335–356.
- [7] J. K. BEEM, P. E. EHRLICH AND K. L. EASLEY, *Global Lorentzian Geometry*, Marcel Dekker Inc., New York, second ed., 1996.
- [8] J. K. BEEM AND A. KRÓLAK, *Cauchy horizon end points and differentiability*, J. Math. Phys., 39 (1998), 6001–6010.
- [9] R. BEIG AND P. T. CHRUSCIEL, *Killing initial data*, Classical Quantum Gravity, 14 (1997), A83–A92.
- [10] A. N. BERNAL AND M. SÁNCHEZ, *Smoothness of time functions and the metric splitting of globally hyperbolic spacetimes*, Comm. Math. Phys., 257 (2005), 43–50.
- [11] A. N. BERNAL AND M. SÁNCHEZ, *Globally hyperbolic spacetimes can be defined as ‘causal’ instead of ‘strongly causal’*, Classical Quantum Gravity, 24 (2007), 745–749.
- [12] L. BILIOTTI AND M. A. JAVALOYES, *t -periodic light rays in conformally stationary spacetimes via Finsler geometry*, Houston J. Math., 37 (2011), 127–146.
- [13] O. F. BLANCO, M. SÁNCHEZ AND J. M. M. SENOVILLA, *Structure of second-order symmetric Lorentzian manifolds*, J. Eur. Math. Soc., 15 (2013), 595–634.

- [14] R. L. BRYANT, *Some remarks on Finsler manifolds with constant flag curvature*, Houston J. Math., 28 (2002), 221–262.
- [15] A. M. CANDELA, *Lightlike periodic trajectories in space-times*, Ann. Mat. Pura Appl. (4), 171 (1996), 131–158.
- [16] E. CAPONIO, A. GERMINARIO AND M. SÁNCHEZ, *Convex regions of stationary spacetimes and Randers spaces. Applications to lensing and asymptotic flatness*, J. Geom. Anal., (2015), J. Geom. Anal., 26 (2016) 791–836.
- [17] E. CAPONIO, M. A. JAVALOYES AND A. MASIELLO, *Morse theory of causal geodesics in a stationary spacetime*, Ann. Inst. H. Poincaré Anal. Non Linéaire, 27 (2010), 857–876.
- [18] E. CAPONIO, M. A. JAVALOYES AND A. MASIELLO, *On the energy functional on Finsler manifolds and applications to stationary spacetimes*, Math. Ann., 351 (2011), 365–392.
- [19] E. CAPONIO, M. A. JAVALOYES AND A. MASIELLO, *Addendum to “Morse theory of causal geodesics in a stationary spacetime via Morse theory of geodesics of a Finsler metric” [Ann. I. H. Poincaré—AN 27 (3) (2010) 857–876]*, Ann. Inst. H. Poincaré Anal. Non Linéaire, 30 (2013), 961–968.
- [20] E. CAPONIO, M. A. JAVALOYES AND M. SÁNCHEZ, *On the interplay between Lorentzian causality and Finsler metrics of Randers type*, Rev. Mat. Iberoamericana, 27 (2011), 919–952.
- [21] E. CAPONIO AND E. MINGUZZI, *Solutions to the Lorentz force equation with fixed charge-to-mass ratio in globally hyperbolic spacetimes*, J. Geom. Phys., 49 (2004), 176–186.
- [22] C. CARATHÉODORY, *Calculus of Variations and Partial Differential Equations of the First Order*, Holden-Day Inc., San Francisco, Calif., 1967.
- [23] A. CARRASCO AND M. MARS, *On marginally outer trapped surfaces in stationary and static spacetimes*, Classical Quantum Gravity, 25 (2008), 055011, 19.
- [24] X. CHENG AND Z. SHEN, *Finsler Geometry. An approach via Randers spaces*, Science Press Beijing, Beijing; Springer, Heidelberg, 2012,
- [25] P. CHRUSCIEL, J. COSTA AND M. HEUSLER, *Stationary black holes: uniqueness and beyond*, Living Rev. Relativity, 15 (2012).
- [26] P. T. CHRUSCIEL, J. H. G. FU, G. J. GALLOWAY AND R. HOWARD, *On fine differentiability properties of horizons and applications to Riemannian geometry*, J. Geom. Phys., 41 (2002), 1–12.
- [27] J. L. FLORES, J. HERRERA AND M. SÁNCHEZ, *On the final definition of the causal boundary and its relation with the conformal boundary*, Adv. Theor. Math. Phys., 15 (2011), 991–1057.
- [28] J. L. FLORES, J. HERRERA AND M. SÁNCHEZ, *Gromov, Cauchy and causal boundaries for Riemannian, Finslerian and Lorentzian manifolds*, Mem. Amer. Math. Soc., 226 (2013), vi+76.
- [29] J. L. FLORES AND M. SÁNCHEZ, *The causal boundary of wave-type spacetimes*, J. High Energy Phys., (2008), no.3, 036, 43 pp.
- [30] J. L. FLORES AND M. SÁNCHEZ, *Geodesics in stationary spacetimes. Application to Kerr spacetime*, Int. J. Theor. Phys. 8 (2002) 319–336.
- [31] D. FORTUNATO, F. GIANNONI AND A. MASIELLO, *A Fermat principle for stationary spacetimes and applications to light rays*, J. Geom. Phys., 15 (1995), 159–188.
- [32] F. GIANNONI, A. MASIELLO AND P. PICCIONE, *A Morse theory for light rays on stably causal Lorentzian manifolds*, Annales de l’I.H.P., section A, 69 (1998), 359–412.
- [33] F. GIANNONI, A. MASIELLO AND P. PICCIONE, *The Fermat principle in General Relativity and applications*, J. Math. Phys., 43 (2002), 563–596.
- [34] G. GIBBONS, C. HERDEIRO, C. WARNICK AND M. WERNER: *Stationary metrics and optical Zermelo-Randers-Finsler geometry*, Phys. Rev. D, 79 (2009), 044022.
- [35] G. GIBBONS, AND C. WARNICK, *Traffic noise and the hyperbolic plane*, Annals of Physics, 325 (2010), 909–923.
- [36] G. GIBBONS, AND C. WARNICK, *The geometry of sound rays in a wind*, Contemporary Physics, 52 (2011), 197–209.
- [37] M. A. JAVALOYES, *Chern connection of a pseudo-Finsler metric as a family of affine connections*, Publ. Math. Debrecen, 84 (2014), 29–43.
- [38] M. A. JAVALOYES, L. LICHTENFELZ AND P. PICCIONE, *Almost isometries of non-reversible metrics with applications to stationary spacetimes*, J. Geom. Phys., 89 (2015), 38–49.
- [39] M. A. JAVALOYES AND M. SÁNCHEZ, *A note on the existence of standard splittings for conformally stationary spacetimes*, Classical Quantum Gravity, 25 (2008), 168001, 7.

- [40] M. A. JAVALOYES AND M. SÁNCHEZ, *On the definition and examples of Finsler metrics*, Ann. Scuola Norm. Sup. Pisa Cl. Sci. (5), 13 (2014), 813–858.
- [41] M. A. JAVALOYES AND M. SÁNCHEZ, *Finsler metrics and relativistic spacetimes*, Int. J. Geom. Methods Mod. Phys., 11 (2014), 1460032, 15 pp.
- [42] M. A. JAVALOYES AND B. SOARES, *Geodesics and Jacobi fields of pseudo-Finsler manifolds*, Publ. Math. Debrecen, 87 (2015), (5).
- [43] I. KOVNER, *Fermat principles for arbitrary space-times*, Astrophysical Journal, 351 (1990), 114–120.
- [44] T. LEVI-CIVITA, *Über Zermelo’s Luftfahrtproblem.*, Z. Angew. Math., 11 (1931), 314–322.
- [45] M. LUDVIGSEN, *General Relativity. A Geometric Approach.*, Cambridge Univ. Press, Cambridge, 2004.
- [46] L. A. LYUSTERNIK AND A. I. FET, *Variational problems on closed manifolds*, Doklady Akad. Nauk SSSR (N.S.), 81 (1951), 17–18.
- [47] D. MAERTEN, *Killing initial data revisited*, J. Math. Phys., 45 (2004), 2594–2599.
- [48] B. MANIÀ, *Sopra un problema di navigazione di Zermelo*, Math. Ann., 113 (1937), 584–599.
- [49] M. MARS AND M. REIRIS, *Global and uniqueness properties of stationary and static spacetimes with outer trapped surfaces*, Communications in Mathematical Physics, 322 (2013), 633–666.
- [50] A. MASIELLO AND P. PICCIONE, *Shortening null geodesics in Lorentzian manifolds. Applications to closed light rays*, Differential Geom. Appl., 8 (1998), 47–70.
- [51] V. S. MATVEEV, *Can we make a Finsler metric complete by a trivial projective change?*, in Recent trends in Lorentzian geometry, vol. 26 of Springer Proc. Math. Stat., Springer, New York, 2013, 231–242.
- [52] E. MINGUZZI, *On the existence of maximizing curves for the charged-particle action*, Class. Quantum Grav., 20 (2003) 4169–4175.
- [53] E. MINGUZZI AND M. SÁNCHEZ, *Connecting solutions of the Lorentz force equation do exist*, Comm. Math. Phys., 264 (2006), 349–370.
- [54] E. MINGUZZI AND M. SÁNCHEZ, *The causal hierarchy of spacetimes*, in Recent developments in pseudo-Riemannian geometry, ESI Lect. Math. Phys., Eur. Math. Soc., Zürich, 2008, 299–358.
- [55] B. O’NEILL, *Semi-Riemannian Geometry*, Academic Press Inc. [Harcourt Brace Jovanovich Publishers], New York, 1983.
- [56] V. PERLICK, *On Fermat’s principle in general relativity. I. The general case*, Classical Quantum Gravity, 7 (1990), 1319–1331.
- [57] V. PERLICK, *Gravitational lensing from a spacetime perspective*, Living Reviews in Relativity, (2004).
- [58] H.-B. RADEMACHER, *Nonreversible Finsler metrics of positive flag curvature*, in A sampler of Riemann-Finsler geometry, vol. 50 of Math. Sci. Res. Inst. Publ., Cambridge Univ. Press, Cambridge, 2004, 261–302.
- [59] M. SÁNCHEZ, *Timelike periodic trajectories in spatially compact Lorentz manifolds*, Proc. Amer. Math. Soc., 127 (1999), 3057–3066.
- [60] M. SÁNCHEZ, *On causality and closed geodesics of compact Lorentzian manifolds and static spacetimes*, Differential Geom. Appl. 24 (2006), 21–32.
- [61] U. SERRES, *Geometry and feedback classification of low-dimensional non-linear control systems*. Mathematics [math]. Université de Bourgogne, 2006. English. (tel-00172902). Available at <https://tel.archives-ouvertes.fr/tel-00172902>
- [62] Z. SHEN, *Lectures on Finsler Geometry*, World Scientific Publishing Co., Singapore, 2001.
- [63] Z. SHEN, *Finsler metrics with $\mathbf{K} = 0$ and $\mathbf{S} = 0$* , Canad. J. Math., 55 (2003), 112–132.
- [64] M. TANAKA AND S. V. SABAU, *The cut locus and distance function from a closed subset of a Finsler manifold*, arXiv:1207.0918 [math.DG], (2012).
- [65] F. J. TIPLER, *Existence of closed timelike geodesics in Lorentz spaces*, Proc. Amer. Math. Soc., 76 (1979), 145–147.
- [66] K. UHLENBECK, *A Morse theory for geodesics on a Lorentz manifold.*, Topology, 14 (1975), 69–90.
- [67] R. VON MISES, *Zum Navigationsproblem der Luftfahrt.*, Z. f. angew. Math., 11 (1931), 373–381.
- [68] R. M. WALD, *General Relativity*, University of Chicago Press, Chicago, IL, 1984.

- [69] J. WHITEHEAD, *Convex regions in the geometry of paths*, Q. J. Math., Oxf. Ser., 3 (1932), 33–42. with an addendum.
- [70] R. YOSHIKAWA AND S. V. SABAU, *Kropina metrics and Zermelo navigation on Riemannian manifolds*, Geom. Dedicata, 171 (2014), 119–148.
- [71] E. ZERMELO, *Über das Navigationsproblem bei ruhender oder veränderlicher Windverteilung.*, Z. Angew. Math. Mech., 11 (1931), 114–124.

DIPARTIMENTO DI MECCANICA, MATEMATICA E MANAGEMENT,
POLITECNICO DI BARI, VIA ORABONA 4,
70125, BARI, ITALY
E-mail address: `caponio@poliba.it`

DEPARTAMENTO DE MATEMÁTICAS,
UNIVERSIDAD DE MURCIA,
CAMPUS DE ESPINARDO,
30100 ESPINARDO, MURCIA, SPAIN
E-mail address: `majava@um.es`

DEPARTAMENTO DE GEOMETRÍA Y TOPOLOGÍA, FACULTAD DE CIENCIAS,
UNIVERSIDAD DE GRANADA,
CAMPUS FUENTENUEVA S/N,
18071 GRANADA, SPAIN
E-mail address: `sanchezm@ugr.es`