

SEIFERT FIBERED SURGERIES ON STRONGLY INVERTIBLE KNOTS WITHOUT PRIMITIVE/SEIFERT POSITIONS

MARIO EUDAVE-MUÑOZ, EDGAR JASSO, KATURA MIYAZAKI,
AND KIMIHIKO MOTEGI

Dedicated to Michel Boileau on the occasion of his 60th birthday

ABSTRACT. We find an infinite family of Seifert fibered surgeries on strongly invertible knots which do not have primitive/Seifert positions. Each member of the family is obtained from a trefoil knot after alternate twists along a pair of seiferters for a Seifert fibered surgery on a trefoil knot.

1. INTRODUCTION

A pair (K, m) of a knot K in the 3–sphere S^3 and an integer m is called a *Seifert fibered surgery* if the resulting manifold $K(m)$ obtained by m –surgery on K is a Seifert fiber space. For most known Seifert fibered surgeries (K, m) , K has a nice position on the boundary of a standard genus 2 handlebody in S^3 , which is called a “primitive/Seifert position”.

For a genus 2 handlebody H and a simple closed curve c in ∂H , we denote H with a 2–handle attached along c by $H[c]$. Let $S^3 = V \cup_F W$ be a genus 2 Heegaard splitting of S^3 , i.e. V and W are genus 2 handlebodies in S^3 with $V \cap W$ a genus 2 Heegaard surface F . We say that a Seifert fibered surgery (K, m) has a *primitive/Seifert position* if there is a genus 2 Heegaard surface F which carries K and satisfies the following three conditions.

- K is primitive with respect to V , i.e. $V[K]$ is a solid torus.
- K is Seifert with respect to W , i.e. $W[K]$ is a Seifert fiber space over the disk with two exceptional fibers.
- The surface slope of K with respect to F (i.e. the isotopy class in $\partial N(K)$ represented by a component of $\partial N(K) \cap F$) coincides with the surgery slope m .

Assume that a knot K has a primitive/Seifert position with surface slope m . Then $K(m) \cong V[K] \cup W[K]$ is a Seifert fiber space or a connected sum of lens spaces. Moreover, K has tunnel number one [2, 2.3], and hence strongly invertible [18, Claim 5.3]. By the positive solution to the cabling conjecture for strongly invertible knots [6], if K is hyperbolic, then $K(m)$ is a Seifert fiber space over S^2 with at most three exceptional fibers, so (K, m) is a Seifert fibered surgery.

1991 *Mathematics Subject Classification*. Primary 57M25, 57M50 Secondary 57N10.

Key words and phrases. Dehn surgery, hyperbolic knot, Seifert fiber space, primitive/Seifert position, seifert, Seifert Surgery Network, branched covering, Montesinos trick.

The first author was partially supported by PAPIIT-UNAM grant IN109811.

The last author has been partially supported by JSPS Grants-in-Aid for Scientific Research (C) (No.21540098), The Ministry of Education, Culture, Sports, Science and Technology, Japan and Joint Research Grant of Institute of Natural Sciences at Nihon University for 2013.

Primitive/Seifert positions, introduced by Dean [2], are variants of Berge’s primitive/primitive positions [1]. Although any lens surgery is conjectured to have a primitive/primitive position [1, 11], there are infinitely many Seifert fibered surgeries with no primitive/Seifert positions [17, 4, 22]. Knots yielding these Seifert fibered surgeries are not strongly invertible; the simplest example is 1–surgery on the pretzel knot $P(-3, 3, 5)$. So it is natural to ask:

Question 1.1. Let (K, m) be a Seifert fibered surgery on a strongly invertible knot K . Then, does it have a primitive/Seifert position?

However, Song [21] observed that 1–surgery on $P(-3, 3, 3)$ yields a Seifert fiber space. Since $P(-3, 3, 3)$ is a strongly invertible knot of tunnel number 2, that surgery gives the negative answer to Question 1.1. In [5] we construct a one–parameter family of Seifert fibered surgeries which answer Question 1.1 in the negative and contain Song’s example by using the Seifert Surgery Network introduced in [4]. In this paper, we construct a large family of Seifert fibered surgeries giving the negative answer to Question 1.1 by taking 2–fold branched covers of tangles. We then study these surgeries from a viewpoint of the Seifert Surgery Network, and find a path in the network from each surgery in our family to a surgery on a trefoil knot. Our family of Seifert fibered surgeries is a variant of families obtained in [8, 3]. In [8], by using 2–fold branched covers of tangles, the first author constructs 4 families of Seifert fibered surgeries having primitive/Seifert positions.

We briefly review the definitions of seiferters and the Seifert Surgery Network. For a knot $K \subset S^3$ and $m \in \mathbb{Z}$, the pair (K, m) is a *Seifert surgery* if $K(m)$ has a possibly degenerate Seifert fibration, i.e. a Seifert fibration which may contain an exceptional fiber of index 0. Let (K, m) be a Seifert surgery. A simple closed curve c in $S^3 - K$ is called a *seiferter* if c is a trivial knot in S^3 and a Seifert fiber in $K(m)$. Denoting by K_p and m_p the images of K and m under p –twist along the seiferter c , we see that (K_p, m_p) is a Seifert surgery with c a seiferter. If seiferters c_1, c_2 for (K, m) become fibers in a Seifert fibration of $K(m)$ simultaneously, then $\{c_1, c_2\}$ is a *pair of seiferters* for (K, m) . If a pair of seiferters cobound an annulus A in S^3 , the pair is an *annular pair of seiferters*. As is twisting along a seiferter, twisting (K, m) along the annulus A yields a Seifert surgery. *The Seifert Surgery Network* is the 1–dimensional complex such that its vertices are Seifert surgeries and two vertices are connected by an edge if one is obtained from the other by 1–twist along a seiferter or an annular pair of seiferters; see [4, Subsection 2.4]. Hence, a path in the Seifert Surgery Network tells how one Seifert surgery is obtained from another by twisting along seiferters and/or annular pairs of seiferters.

Our main result is as follows.

Theorem 1.2. *There are infinitely many Seifert fibered surgeries on strongly invertible hyperbolic knots $(K(l, m, n, p), \gamma_{l, m, n, p})$ ($m = 0$ or $p = 0$) with the following properties, where l, m, n, p satisfy more conditions given in Proposition 3.6.*

- (1) $(K(l, m, n, p), \gamma_{l, m, n, p})$ does not have a primitive/Seifert position.
- (2) The pair of knots c_a, c_b in Figure 1.1 is a pair of seiferters for $(l + 5)$ –surgery on the trefoil knot $T_{3,2}$. $(K(l, m, n, p), \gamma_{l, m, n, p})$ is obtained from $(T_{3,2}, l + 5)$ by applying a sequence of twists along c_a, c_b . Refer to Proposition 4.11 and also Corollary 4.14 for the details of the sequence.

PROOF OF THEOREM 1.2. The definition of $K(l, m, n, p)$ and $\gamma_{l, m, n, p}$ is given in Subsection 3.1. Proposition 3.2 shows that $K(l, m, n, p)(\gamma_{l, m, n, p})$ is a Seifert fiber

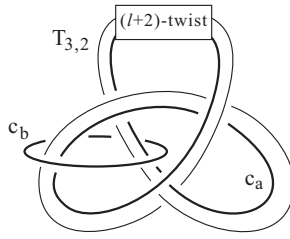
FIGURE 1.1. $\{c_a, c_b\}$ is a pair of seiferters for $(T_{3,2}, l + 5)$.

space. The hyperbolicity of $K(l, m, n, p)$ is proved in Proposition 3.11. Assertion (1) follows from Proposition 3.6 by showing that the tunnel number of $K(l, m, n, p)$ is 2. Assertion (2) follows from Proposition 4.11. \square (Theorem 1.2)

For all the known Seifert fibered surgeries (K, m) with no primitive/Seifert positions, K has tunnel number greater than one. We close with the following question.

Question 1.3. Let (K, m) be a Seifert fibered surgery on a tunnel number one knot K . Then, does it have a primitive/Seifert position?

2. TANGLES, BRANCHED COVERINGS AND SEIFERT FIBERED SURGERIES

Let B be a 3-ball and t a disjoint union of two arcs properly embedded in B and some simple closed curves. Then the pair (B, t) is called a *tangle*. A tangle (B, t) is trivial if there is a pairwise homeomorphism from (B, t) to $(D^2 \times I, \{x_1, x_2\} \times I)$, where x_1, x_2 are distinct points.

Let U be the unit 3-ball in \mathbb{R}^3 , and take 4 points NW, NE, SE, SW on the boundary of U so that NW = $(0, -\alpha, \alpha)$, NE = $(0, \alpha, \alpha)$, SE = $(0, \alpha, -\alpha)$, SW = $(0, -\alpha, -\alpha)$, where $\alpha = \frac{1}{\sqrt{2}}$. A tangle (U, t) is a *rational tangle* if it is a trivial tangle with $\partial t = \{\text{NW}, \text{NE}, \text{SE}, \text{SW}\}$. Two rational tangles (U, t) and (U, t') are *equivalent* if there is a pairwise homeomorphism $h : (U, t) \rightarrow (U, t')$ such that $h|_{\partial U}$ is the identity map. We can construct rational tangles from sequences of integers a_1, a_2, \dots, a_n as shown in Figure 2.1, where the last horizontal twist a_n may be 0. In our figure a horizontal rectangle (i.e. a rectangle intersecting arcs t on the left and right sides) with a label a_i represents a strand of a_i horizontal crossings, with the sign convention shown in Figure 2.1. Similarly, a vertical rectangle (i.e. a rectangle intersecting arcs t on the top and bottom sides) with a label a_i represents a strand of a_i vertical crossings, with the sign convention shown in Figure 2.1. We consider that the tangle diagrams in Figure 2.1 are drawn on the yz -plane. Denote by $R(a_1, a_2, \dots, a_n)$ the associated rational tangle.

Each rational tangle can be parametrized by $r \in \mathbb{Q} \cup \{\infty\}$, where the rational number r is given by the continued fraction below. Thus we denote the rational tangle corresponding to r by $R(r)$.

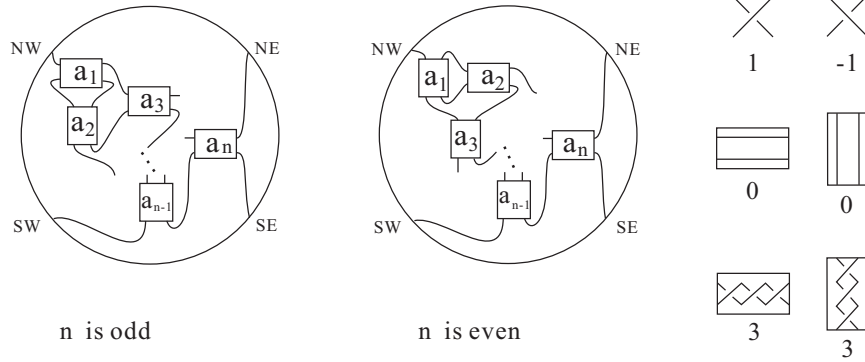

FIGURE 2.1. Rational tangles.

$$r = a_n + \frac{1}{a_{n-1} + \frac{1}{\ddots a_2 + \frac{1}{a_1}}}$$

Let (U, t) be the rational tangle $R(\infty)$. Considering t is embedded in the yz -plane, take the disk D in the yz -plane such that ∂D is the union of t and two arcs in ∂U : one connects NW and NE, and the other connects SW and SE. We call an arc in D connecting the components of the interior of t a *spanning arc*, and the arc $D \cap \partial U$ connecting NW and NE *the latitude of $R(\infty)$* . See Figure 2.2. The 2-fold cover \tilde{U} of U branched along t is a solid torus. Note that the preimages of the spanning arc and the latitude are the core and a longitude λ of the solid torus, respectively. A *meridian of a rational tangle $R(r) = (U, t')$* is a simple closed curve in $\partial U - t'$ which bounds a disk in $U - t'$ and a disk in ∂U meeting t' in two points. Let $\mu_r \subset \partial \tilde{U}$ be a lift of a meridian of $R(r)$; then μ_r is a meridian of the solid torus \tilde{U} . Furthermore, we note the following well-known fact.

Lemma 2.1. *Under adequate orientations we have $[\mu_r] = -p[\mu_\infty] + q[\lambda] \in H_1(\partial \tilde{U})$, where $r = \frac{p}{q}$ and $[\mu_\infty] \cdot [\lambda] = 1$.*

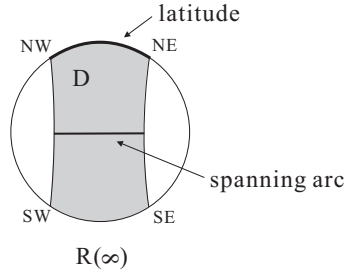

FIGURE 2.2

Let (B, t) be a tangle such that $B \subset S^3 (= \mathbb{R}^3 \cup \{\infty\})$ is the complement of the unit 3-ball U , and $\partial t = \{\text{NW}, \text{NE}, \text{SE}, \text{SW}\}$. We denote by $(B, t) + R(r)$ the knot or link in S^3 formed by the union of the strings of the tangles, and let $\pi_r : X_r \rightarrow S^3 = B \cup U$ be the 2-fold cover branched along $(B, t) + R(r)$. We say that (B, t) is *trivializable* if $(B, t) + R(\infty)$ is a trivial knot in S^3 . If $(B, t) + R(r)$ is a trivial knot for some $r \in \mathbb{Q}$, then an ambient isotopy of B changes (B, t) to a trivializable tangle.

Suppose that (B, t) is trivializable. Then the 2-fold branched cover X_∞ is the 3-sphere, and the preimage of the spanning arc κ for $R(\infty)$ is a knot in $X_\infty = S^3$, which we call the *covering knot* of (B, t) . Note that the covering knot is a strongly invertible knot whose strong inversion is the covering transformation of X_∞ . The exterior of the covering knot K is $\pi_\infty^{-1}(B)$. For $(B, t) + R(\infty)$ a replacement of $R(\infty)$ by a rational tangle $R(s)$ is called *s-untangle surgery* on $(B, t) + R(\infty)$. Performing untangle surgery downstairs corresponds to replacing the solid torus $\pi_\infty^{-1}(U)$ by $\pi_s^{-1}(U)$ upstairs, i.e. Dehn surgery on the covering knot K . We denote the surgery slope by γ_s ; it is represented by a lift of a meridian of $R(s)$. We say that γ_s is the *covering slope* of s . See the commutative diagram below.

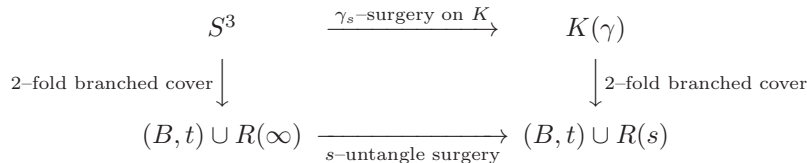

DIAGRAM 2. Montesinos trick

Remark 2.2. Suppose that the preimage of the latitude of $R(\infty)$ is a longitude of $\pi_\infty^{-1}(U)$ giving an n -framing. Then, by Lemma 2.1 the covering slope γ_s is $n - s$ in terms of a preferred meridian-longitude pair of K .

A *sum of two tangles* (B_1, t_1) and (B_2, t_2) is the knot or link obtained by attaching t_1 and t_2 via an orientation reversing homeomorphism $h : \partial B_1 \rightarrow \partial B_2$ with $h(\partial t_1) = \partial t_2$.

For rational tangles R_1, \dots, R_k , the tangle in Figure 2.3(1) is called a *Montesinos tangle* $M_T(R_1, \dots, R_k)$. The knot or link in Figure 2.3(2) is called a *Montesinos link* $M(R_1, \dots, R_k)$. We call the diagrams in Figure 2.3 *standard positions* of a Montesinos tangle and a Montesinos link. If R_i corresponds to $r_i \in \mathbb{Q} \cup \{\infty\}$ for $i = 1, \dots, k$, then we often write $M_T(r_1, \dots, r_k)$ and $M(r_1, \dots, r_k)$ for a Montesinos tangle and a Montesinos link, respectively.

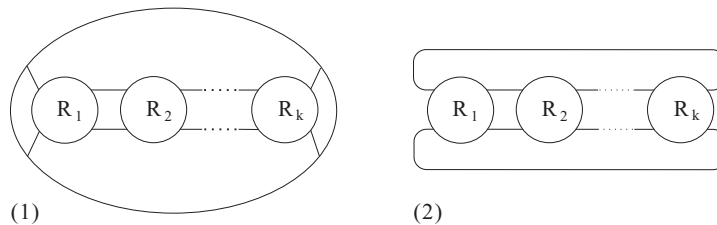

FIGURE 2.3. Montesinos tangle and Montesinos link.

Let X be the 2-fold branched cover of S^3 (resp. D^3) along a Montesinos link $M(R_1, \dots, R_k)$ (resp. a Montesinos tangle $M_T(R_1, \dots, R_k)$). Then X admits a Seifert fibration over S^2 (resp. D^2) in which the preimage of B_i , where $R_i = (B_i, \frac{p_i}{q_i})$, is a fibered solid torus and its core is an exceptional fiber of Seifert invariant $\frac{p_i}{q_i}$ and index $|q_i|$. Hence, X is a Seifert fiber space $S^2(r_1, \dots, r_k)$ (resp. $D^2(r_1, \dots, r_k)$), where $r_i = \frac{p_i}{q_i}$. Note that for the 2-fold branched cover of D^3 along $M_T(r_1, \dots, r_k)$, a lift of a simple closed curve $\alpha \subset \partial D^3$ in Figure 2.4(1) is a fiber of $X = D^2(r_1, \dots, r_k)$ up to isotopy. See [19].

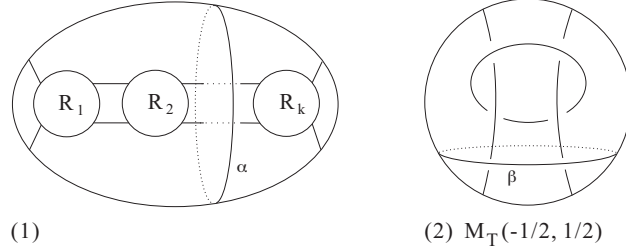

FIGURE 2.4

We have Lemma 2.3 below on Seifert fibrations of $D^2(r_1, \dots, r_k)$.

Lemma 2.3. *Let X be the 2-fold branched cover of the 3-ball along a Montesinos tangle $M_T(\frac{p_1}{q_1}, \dots, \frac{p_k}{q_k})$, where $|q_i| \geq 2$ for all i . Then the following hold.*

- (1) *X admits more than one Seifert fibrations up to isotopy if and only if $k = 2$ and $|q_1| = |q_2| = 2$.*
- (2) *Assume $k = 2$ and $|q_1| = |q_2| = 2$. Then, X is the twisted S^1 bundle over the Möbius band, and admits exactly two Seifert fibrations: one is over the disk, and the other is over the Möbius band with no exceptional fibers. In the latter fibration, a fiber on ∂X is isotopic in ∂X to a lift of a simple closed curve β on ∂B in Figure 2.4(2), where $(B, t) = M_T(-\frac{1}{2}, \frac{1}{2})$.*

PROOF OF LEMMA 2.3. We only prove the last statement of (2). Let $\pi : X \rightarrow B$ be the 2-fold cover branched along t , where $(B, t) = M_T(-\frac{1}{2}, \frac{1}{2})$. Let A be an annulus properly embedded in $B - t$ such that a component of ∂A is β and A separates the circle component from the two arcs of t . Then $\pi^{-1}(A)$ consists of two annuli and splits X into two solid tori. Each component of $\pi^{-1}(A)$ is a non-separating annulus in X , and thus a vertical annulus (i.e. a union of fibers) in a Seifert fibration of X over the Möbius band. This implies the claimed result. \square (Lemma 2.3)

Let (B, t) be a trivializable tangle such that $(B, t) + R(s)$ is a Montesinos link for some rational number s . The 2-fold branched cover X_s , which is a Seifert fiber space as shown above, is obtained from S^3 by γ_s -surgery on the covering knot K of (B, t) . In this manner, we obtain a Seifert fibered surgery (K, γ_s) .

3. NON PRIMITIVE/SEIFERT-FIBERED, SEIFERT FIBERED SURGERIES ON COVERING KNOTS

In Subsection 3.1, we construct Seifert surgeries $(K(l, m, n, p), \gamma_{l, m, n, p})$ ($m = 0$ or $p = 0$) by untangle surgeries of trivializable tangles. The knots $K(l, m, n, p)$ are

strongly invertible. In Subsection 3.2, these surgeries are shown to have no primitive/Seifert positions. In Subsection 3.3, $K(l, m, n, p)$ are shown to be hyperbolic knots.

3.1. Seifert fibered surgeries on knots $K(l, m, n, p)$. Let $B(l, m, n, p)$ be the tangle of Figure 3.1. Then we have Lemma 3.1 below.

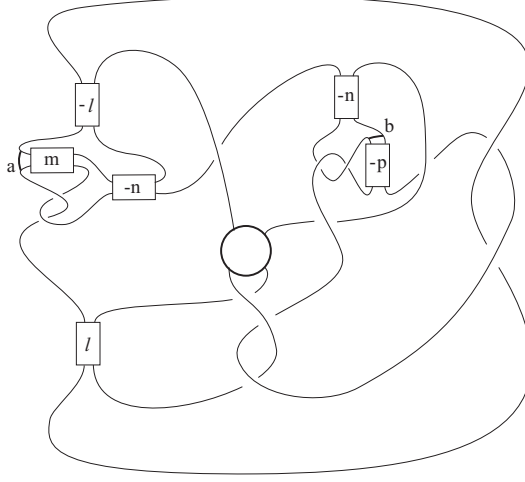

FIGURE 3.1. Tangle $B(l, m, n, p)$: m or p is zero.

Lemma 3.1. (1) *The tangle $B(l, m, n, 0)$ enjoys the following properties.*

- (i) $B(l, m, n, 0) + R(\infty)$ is a trivial knot.
- (ii) $B(l, m, n, 0) + R(1)$ is the Montesinos link $M\left(\frac{2lmn + lm - ln + 2mn + 3m - n - 1}{2l^2mn + l^2m - l^2n + 2lm - 2m - l + 1}, -\frac{n + 1}{4n + 3}, \frac{1}{2}\right)$.

(2) *The tangle $B(l, 0, n, p)$ enjoys the following properties.*

- (i) $B(l, 0, n, p) + R(\infty)$ is a trivial knot.
- (ii) $B(l, 0, n, p) + R(1)$ is the Montesinos link $M\left(\frac{ln + n + 1}{l^2n + l - 1}, \frac{-2np + n - p + 1}{8np - 4n + 2p - 3}, \frac{1}{2}\right)$.

PROOF OF LEMMA 3.1. (1) Figure 3.2 shows that $B(l, m, n, 0) + R(\infty)$ is a trivial knot in S^3 . In the Montesinos link of Figure 3.3, $R_1 = R(m, -2, -n, -l, -1, l, 0)$, $R_2 = R(-n, -1, -3, 0)$, $R_3 = R(2, 0)$. Assertion (1)(ii) is obtained by computing continued fractions.

(2) Figure 3.4 shows that $B(l, 0, n, p) + R(\infty)$ is a trivial knot in S^3 . In the Montesinos link of Figure 3.5, $R_1 = R(-n, -l, -1, l, 0)$, $R_2 = R(-p, 2, -n, -1, -3, 0)$, $R_3 = R(2, 0)$. Assertion (2)(ii) is obtained by computing continued fractions.

□(Lemma 3.1)

Let $K(l, m, n, p)$ be the covering knot of the trivializable tangle $B(l, m, n, p)$, and $\gamma_{l, m, n, p}$ the covering slope corresponding to 1-untangle surgery on $B(l, m, n, p) + R(\infty)$, where m or p is 0. As noticed in Section 2 the covering knot $K(l, m, n, p)$

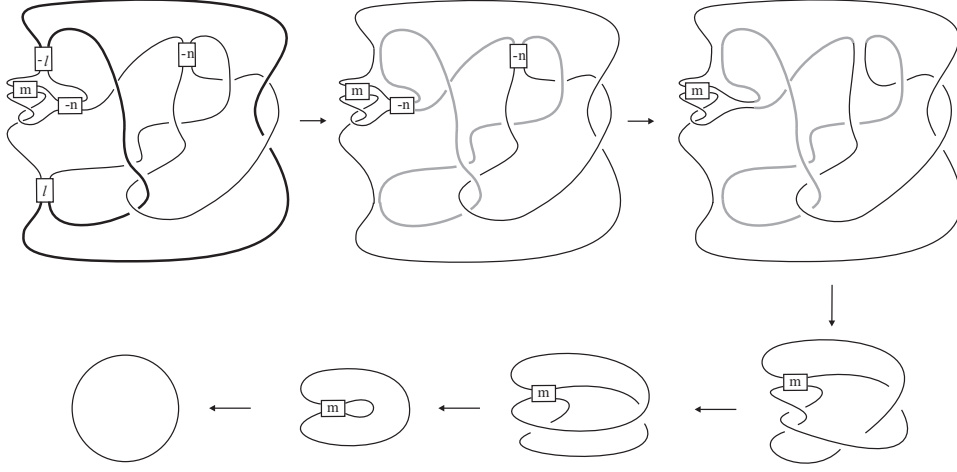
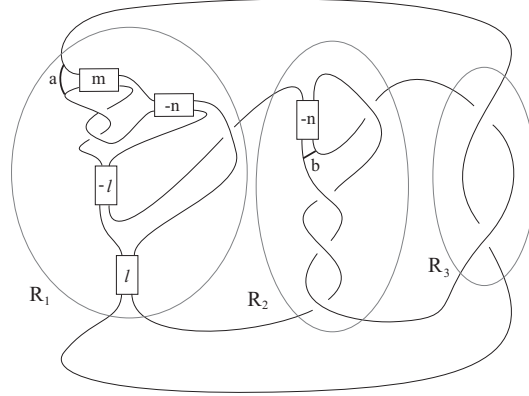
FIGURE 3.2. $B(l, m, n, 0) + R(\infty)$ is a trivial knot.FIGURE 3.3. $B(l, m, n, 0) + R(1)$ is a Montesinos link.

is strongly invertible. Then 0–untangle surgery on $B(l, m, n, p) + R(\infty)$ corresponds to $(\gamma_{l, m, n, p} + 1)$ –surgery on $K(l, m, n, p)$ by Remark 2.2. For brevity, we often write $(K(l, m, n, p), \gamma)$ and $(K(l, m, n, p), \gamma + 1)$ for $(K(l, m, n, p), \gamma_{l, m, n, p})$ and $(K(l, m, n, p), \gamma_{l, m, n, p} + 1)$, respectively. Lemma 3.1 shows that $(K(l, m, n, p), \gamma)$ is a Seifert fibered surgery, and the resulting manifold is given in Proposition 3.2 below. Refer to the proof of Corollary 4.14 for the calculation of $\gamma_{l, m, n, p}$.

Proposition 3.2. (1) $K(l, m, n, 0)(\gamma_{l, m, n, 0})$ is a Seifert fiber space

$$S^2\left(\frac{2lmn + lm - ln + 2mn + 3m - n - 1}{2l^2mn + l^2m - l^2n + 2lm - 2m - l + 1}, -\frac{n + 1}{4n + 3}, \frac{1}{2}\right).$$

(2) $K(l, 0, n, p)(\gamma_{l, 0, n, p})$ is a Seifert fiber space

$$S^2\left(\frac{ln + n + 1}{l^2n + l - 1}, \frac{-2np + n - p + 1}{8np - 4n + 2p - 3}, \frac{1}{2}\right).$$

Furthermore, $\gamma_{l, m, n, p} = 5 + l + n(l^2 + 8l + 12) + 2n^2(l + 2)^2 - m(2nl + 4n + l + 4)^2 - p(2nl + 4n + 2)^2$, where m or p is 0.

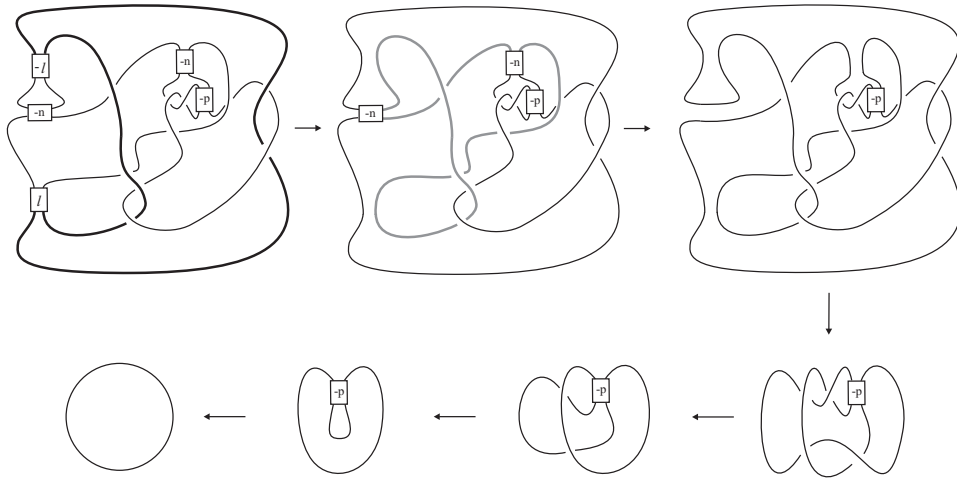

FIGURE 3.4. $B(l, 0, n, p) + R(\infty)$ is a trivial knot.

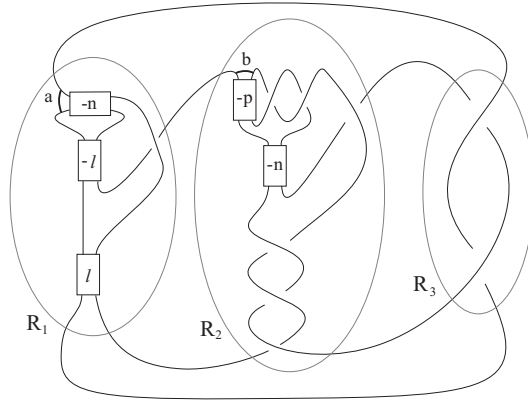

FIGURE 3.5. $B(l, 0, n, p) + R(1)$ is a Montesinos link.

3.2. $(K(l, m, n, p), \gamma_{l,m,n,p}+1)$ and primitive/Seifert positions. In this subsection, we show that the Seifert fibered surgery $(K(l, m, n, p), \gamma_{l,m,n,p})$ ($m = 0$ or $p = 0$) does not admit a primitive/Seifert position if l, m, n, p satisfy more conditions (Proposition 3.6). For this purpose we study $B(l, m, n, p) + R(0)$ and its 2-fold branched cover.

Let S be the 2-sphere $[\text{plane}] \cup \{\infty\}$ intersecting $B(l, m, n, p) + R(0)$ in 4 points as in Figure 3.6 or 3.7 according as $p = 0$ or $m = 0$. Let B_1 be the 3-ball bounded below by S , and B_2 the 3-ball bounded above by S .

Lemma 3.3. (1) $B(l, m, n, 0) + R(0)$ is a sum of Montesinos tangles

$$M_T\left(-\frac{2lmn + lm - ln + 2mn + 3m - n - 1}{2lmn + lm - ln + 2m - 1}, -\frac{n + 1}{2n + 1}\right) \text{ and } M_T\left(\frac{1}{l}, -\frac{1}{2}\right).$$

(2) $B(l, 0, n, p) + R(0)$ is a sum of Montesinos tangles

$$M_T\left(-\frac{ln+n+1}{ln+1}, -\frac{2np-n+p-1}{4np-2n-1}\right) \text{ and } M_T\left(\frac{1}{l}, -\frac{1}{2}\right).$$

PROOF OF LEMMA 3.3. For brevity denote the knot or link $B(l, m, n, p) + R(0)$ by K , where m or p is 0.

(1) Figure 3.6 shows that the tangle $(B_1, B_1 \cap K)$ is pairwise homeomorphic to $(B'_1, B'_1 \cap K) = M_T\left(-\frac{2lmn+lm-ln+2mn+3m-n-1}{2lmn+lm-ln+2m-1}, -\frac{n+1}{2n+1}\right)$ and $(B_2, B_2 \cap K)$ is pairwise homeomorphic to $(B'_2, B'_2 \cap K) = M_T\left(\frac{1}{l}, -\frac{1}{2}\right)$. It follows that K is a sum of these two Montesinos tangles.

(2) Figure 3.7 shows that $(B_1, B_1 \cap K)$ is pairwise homeomorphic to $(B'_1, B'_1 \cap K) = M_T\left(-\frac{ln+n+1}{ln+1}, -\frac{2np-n+p-1}{4np-2n-1}\right)$ and $(B_2, B_2 \cap K)$ is pairwise homeomorphic to $(B'_2, B'_2 \cap K) = M_T\left(\frac{1}{l}, -\frac{1}{2}\right)$. \square (Lemma 3.3)

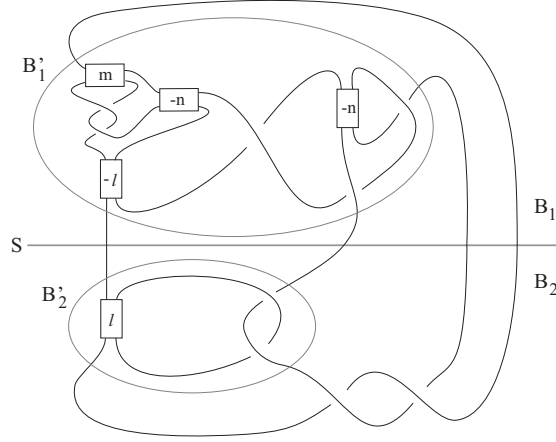

FIGURE 3.6. $B(l, m, n, 0) + R(0)$ is a sum of Montesinos tangles.

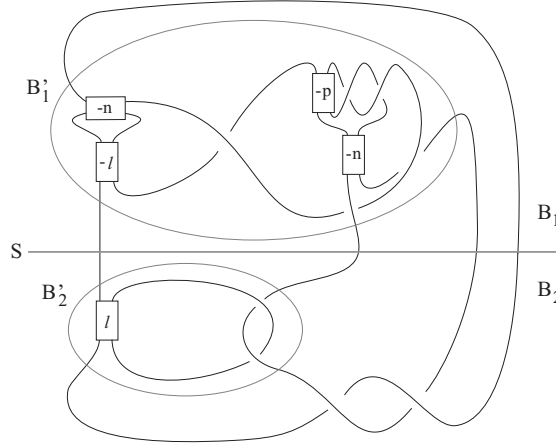

FIGURE 3.7. $B(l, 0, n, p) + R(0)$ is a sum of Montesinos tangles.

Let $\pi : K(l, m, n, p)(\gamma_{l, m, n, p} + 1) \rightarrow S^3$ be the 2-fold branched cover along $B(l, m, n, p) + R(0)$. Denote by M_i the preimage $\pi^{-1}(B_i)$ ($i = 1, 2$). By Lemma 3.3, M_1 and M_2 are Seifert fiber spaces as described in Proposition 3.4 below. Proposition 3.4 shows that the torus $\pi^{-1}(S)$ is an essential torus giving the torus decomposition $K(l, m, n, p)(\gamma + 1) = M_1 \cup M_2$.

Proposition 3.4. (1) *Assume that $l \neq \pm 1, 0$, $n \neq 0, -1$, $(l, m, n) \neq (-2, 0, 1)$, $(2, 1, -2)$. Then $\pi^{-1}(S)$ is a unique essential torus in $K(l, m, n, 0)(\gamma_{l, m, n, 0} + 1)$ up to isotopy, and gives the torus decomposition with decomposing pieces*

$$M_1 = D^2\left(-\frac{2lmn + lm - ln + 2mn + 3m - n - 1}{2lmn + lm - ln + 2m - 1}, -\frac{n + 1}{2n + 1}\right) \text{ and}$$

$$M_2 = D^2\left(\frac{1}{l}, -\frac{1}{2}\right).$$

(2) *Assume that $l \neq \pm 1, 0$, $n \neq 0$, $(l, n) \neq (\pm 2, \mp 1)$, $(n, p) \neq (-1, 0)$, $(1, 1)$. Then $\pi^{-1}(S)$ is a unique essential torus in $K(l, 0, n, p)(\gamma_{l, 0, n, p} + 1)$ up to isotopy, and gives the torus decomposition with decomposing pieces*

$$M_1 = D^2\left(-\frac{ln + n + 1}{ln + 1}, -\frac{2np - n + p - 1}{4np - 2n - 1}\right) \text{ and } M_2 = D^2\left(\frac{1}{l}, -\frac{1}{2}\right).$$

PROOF OF PROPOSITION 3.4. (1) We show that the Seifert fiber spaces M_1 and M_2 are boundary-irreducible (i.e. $\pi^{-1}(S)$ is an essential torus), and $M_1 \cup M_2$ is not a Seifert fiber space. Then the uniqueness of torus decomposition follows from [14, 15].

The 2-fold branched cover of a Montesinos tangle $M_T(\frac{p_1}{q_1}, \frac{p_2}{q_2})$ is a Seifert fiber space $D^2(\frac{p_1}{q_1}, \frac{p_2}{q_2})$. If $\frac{p_i}{q_i}$ is not an integer for $i = 1, 2$, then the Seifert fiber space is boundary-irreducible. We first show Claim 3.5 below.

Claim 3.5. $|2n + 1| \geq 3$, $|l| \geq 2$, and $|2lmn + lm - ln + 2m - 1| \geq 2$.

PROOF OF CLAIM 3.5. By the assumption of Proposition 3.4(1), $|2n + 1| \geq 3$ and $|l| \geq 2$, so let us show $2lmn + lm - ln + 2m - 1 \neq 0, \pm 1$. Assume for a contradiction that $2lmn + lm - ln + 2m = \delta$ for some $\delta \in \{0, 1, 2\}$. Then $m(2ln + l + 2) = ln + \delta$. Since $|2n + 1| \geq 3$, $2ln + l + 2 = l(2n + 1) + 2 \neq 0$. If $m = 0$, then $ln + \delta = 0$. This implies that $\delta \neq 0$ and $(l, m, n) = (\pm 1, 0, \mp \delta), (\pm \delta, 0, \mp 1)$. These are excluded by the assumption that $l \neq 0, \pm 1$, $n \neq -1$, $(l, m, n) \neq (-2, 0, 1)$. Hence, we have $m \neq 0$, so that (*) $|2ln + l + 2| \leq |ln + \delta|$ holds. Here we note that $ln, ln + \delta, l(2n + 1)$, and $l(2n + 1) + 2$ are of the same sign because $\frac{2ln+l}{ln} = 2 + \frac{1}{n} > 0$, $|l(2n + 1)| \geq 6$ and $|ln| \geq 2$ by the assumption. On the other hand, since $n \neq 0, -1$, it follows $|2n + 1| \geq |n| + 1$. Hence, $|l(2n + 1)| \geq |ln| + |l| \geq |ln| + 2$, so that $|l(2n + 1) + 2| \geq |ln + \delta|$. Therefore, (*) implies that the equality of (*) holds, i.e. $l = 2, n = -2, \delta = 0$. It follows $(l, m, n) = (2, 1, -2)$, which contradicts the assumption of Proposition 3.4(1). \square (Claim 3.5)

It follows from Claim 3.5 that M_2 is boundary-irreducible. Since $2lmn + lm - ln + 2mn + 3m - n - 1$ and $2lmn + lm - ln + 2m - 1$, and also $n + 1$ and $2n + 1$ are relatively prime, Claim 3.5 implies that none of $\frac{2lmn + lm - ln + 2mn + 3m - n - 1}{2lmn + lm - ln + 2m - 1}$ and $\frac{n + 1}{2n + 1}$ is an integer. Hence M_1 is also boundary-irreducible. It follows that $\pi^{-1}(S)$ is an essential torus in $K(l, m, 0, p)(\gamma_{l, m, 0, p} + 1) = M_1 \cup M_2$.

A Seifert fibration of M_1 is unique up to isotopy (Lemma 2.3), so that its fiber in $\partial M_1 = \pi^{-1}(S)$ is isotopic to a lift of $\alpha_1(\subset S)$ in Figure 3.8(1). If $M_1 \cup M_2$ admits a Seifert fibration \mathcal{F} , then the essential separating torus $\pi^{-1}(S)$ is a union of fibers in \mathcal{F} . This implies \mathcal{F} is an extension of fibrations of M_1 and M_2 . On the other hand, M_2 has a Seifert fibration over the disk, and if $l = \pm 2$, then M_2 has also a Seifert fibration over the Möbius band. In the former fibration, lifts of $\alpha'_2(\subset \partial B'_2)$ and thus $\alpha_2(\subset S)$ in Figure 3.9(1) are fibers in M_2 . In the latter fibration with $l = 2$, lifts of $\beta'_+(\subset \partial B'_2)$ and thus $\beta_+(\subset S)$ in Figure 3.10(1) are fibers in the Seifert fibration of M_2 over the Möbius band (Lemma 2.3). If $l = -2$, lifts of $\beta'_-(\subset \partial B'_2)$ and thus $\beta_-(\subset S)$ in Figure 3.11(1) are fibers in M_2 . Since a lift of α_1 is not isotopic in $\pi^{-1}(S)$ to any lift of α_2 or β_\pm , the fibrations of M_1 and M_2 do not match on their boundaries. Hence, $M_1 \cup M_2$ is not a Seifert fiber space.

(2) The assumption on l, n, p in Proposition 3.4(2) assures that $|l| \geq 2$, $|ln + 1| \geq 2$, and $|4np - 2n - 1| \geq 3$, hence M_1 and M_2 are boundary-irreducible Seifert fiber spaces. As in (1) we see that Seifert fibrations of M_1 and M_2 do not match on their boundaries; a lift of $\alpha_1(\subset S)$ is a fiber in M_1 in Figures 3.12(1), and a lift of α_2 , β_+ , or $\beta_-(\subset S)$ in Figures 3.13(1), 3.14(1), 3.15(1) is a fiber in M_2 . It follows that $M_1 \cup M_2$ is not a Seifert fiber space, as desired. \square (Proposition 3.4)

Now we are ready to state and prove the main result of this section: under some conditions on l, m, n, p slightly stronger than those in Proposition 3.4, the Seifert fibered surgery $(K(l, m, n, p), \gamma)$ does not have a primitive/Seifert position.

- Proposition 3.6.**
- (1) Assume that $l \neq \pm 1, 0$, $n \neq 0, -1$, $(l, m) \neq (-2, 0)$, $(-2, 2)$, $(l, m, n) \neq (2, 1, -2)$. Then the Seifert fibered surgery $(K(l, m, n, 0), \gamma_{l, m, n, 0})$ does not have a primitive/Seifert position.
 - (2) Assume that $l \neq \pm 1, 0$, $n \neq 0$, $(l, n) \neq (\pm 2, \mp 1)$, $(l, p) \neq (-2, 0)$, $(-2, 2)$, $(n, p) \neq (-1, 0)$, $(1, 1)$. Then the Seifert fibered surgery $(K(l, 0, n, p), \gamma_{l, 0, n, p})$ does not have a primitive/Seifert position.

PROOF OF PROPOSITION 3.6. If a Seifert fibered surgery on a knot K has a primitive/Seifert position, then K has a tunnel number one [2, 2.3]. Thus the result follows from Proposition 3.7 below. \square (Proposition 3.6)

- Proposition 3.7.**
- (1) Assume that l, m, n satisfy the condition in Proposition 3.6(1). Then the tunnel number of $K(l, m, n, 0)$ is two.
 - (2) Assume that l, n, p satisfy the condition in Proposition 3.6(2). Then the tunnel number of $K(l, 0, n, p)$ is two.

PROOF OF PROPOSITION 3.7. Assume for a contradiction that $K(l, m, n, p)$ (m or p is 0) has tunnel number one. Then $K(l, m, n, p)(r)$ admits a genus two Heegaard splitting for any slope r . Let $r = \gamma_{l, m, n, p} + 1$. We see from Proposition 3.4 that $K(l, m, n, p)(r)$ contains a unique essential torus up to isotopy, which decompose $K(l, m, n, p)(r)$ into two Seifert fiber spaces M_1, M_2 .

Kobayashi [16, Theorem] classifies toroidal 3-manifolds with genus two Heegaard splittings. In our setting, case (i), (ii), or (iii) in Theorem in [16] holds, and we see that $K(l, m, n, p)(r)$ is obtained by gluing pieces in classes $\mathcal{D}, \mathcal{M}, \mathcal{S}_K, \mathcal{L}_K$ defined below. The class \mathcal{D} is the set of Seifert fiber spaces over the disk with two exceptional fibers, and \mathcal{M} is the set of Seifert fiber spaces over the Möbius band with no exceptional fiber. The class \mathcal{S}_K is the set of the exteriors of 2-bridge knots

in the 3–sphere, and $\mathcal{L}_{\mathcal{K}}$ is the set of the exteriors of 1–bridge knots in lens spaces; a 1–bridge knot K in a lens space M is a knot intersecting a genus one Heegaard surface F of $M = V_1 \cup_F V_2$ in two points such that $K \cap V_i$ is a boundary parallel arc in V_i for $i = 1, 2$. Applying Theorem in [16], we obtain the following lemma on M_1, M_2 .

Lemma 3.8 ([16]). *There are the following four possibilities on M_1 and M_2 .*

- (1) $M_1 \in \mathcal{D}$, $M_2 \in \mathcal{L}_{\mathcal{K}} \cup \mathcal{S}_{\mathcal{K}}$
- (2) $M_1 \in \mathcal{L}_{\mathcal{K}} \cup \mathcal{S}_{\mathcal{K}}$, $M_2 \in \mathcal{D}$
- (3) $M_1 \in \mathcal{M}$, $M_2 \in \mathcal{S}_{\mathcal{K}}$
- (4) $M_1 \in \mathcal{S}_{\mathcal{K}}$, $M_2 \in \mathcal{M}$

Furthermore, in (1), (3) a regular fiber of M_1 is identified with a meridian of M_2 , and in (2), (4) a regular fiber of M_2 is identified with a meridian of M_1 .

We first assume $p = 0$. Let us derive a contradiction in each case of Lemma 3.8. For brevity denote $K = B(l, m, n, 0) + R(0)$.

Assume that case (1) in Lemma 3.8 occurs. A lift of the simple closed curve $\alpha_1(\subset S)$ in Figure 3.8(1) is a regular fiber of M_1 contained in the torus $\partial M_1 = \pi^{-1}(S)$. Replace the tangle $(B_1, B_1 \cap K)$ in Figure 3.8(1) with a trivial tangle (B, t) in which α_1 bounds a disk in $B - t$. Then the 2–fold branched cover of $(B, t) \cup (B_2, B_2 \cap K)$ is obtained by gluing a solid torus V to M_2 along its boundary ∂M_2 so that a meridian of V is identified with a lift of $\alpha_1(\subset S)$. Since the lift is a meridian of the exterior M_2 of a knot in a lens space or the 3–sphere by Lemma 3.8, $V \cup M_2$ is either a lens space or the 3–sphere. However, $(B, t) \cup (B_2, B_2 \cap K)$ is, as depicted in Figure 3.8(2), the Montesinos link $M(\frac{1}{l}, -\frac{1}{2}, \frac{1}{2})$, where $|l| \geq 2$. It follows that $V \cup M_2$ is a Seifert fiber space with three exceptional fibers, which is not a lens space or the 3–sphere. Hence, (1) in Lemma 3.8 does not occur.

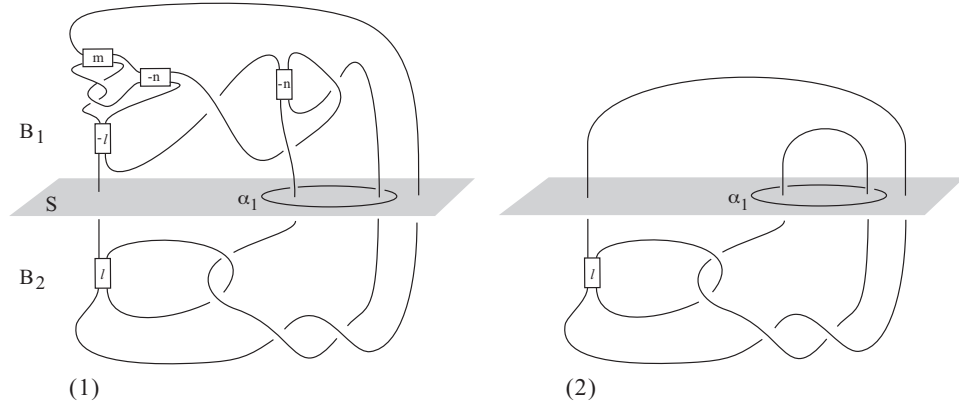

FIGURE 3.8. $B(l, m, n, 0) + R(0)$; $M_1 \in \mathcal{D}$, $M_2 \in \mathcal{L}_{\mathcal{K}} \cup \mathcal{S}_{\mathcal{K}}$.

Assume that case (2) in Lemma 3.8 occurs. Then, a lift of the simple closed curve $\alpha_2(\subset S)$ in Figure 3.9(1) is a regular fiber of the Seifert fibration of M_2 over the disk. Replacing $(B_2, B_2 \cap K)$ in Figure 3.9(1) with a trivial tangle (B, t) in which α_2 bounds a disk in $B - t$, we obtain the Montesinos link

$$M\left(-\frac{2lmn + lm - ln + 2mn + 3m - n - 1}{2lmn + lm - ln + 2m - 1}, -\frac{n + 1}{2n + 1}, \frac{1}{2}\right)$$

as depicted in Figure 3.9(2); note $|2lmn + lm - ln + 2m - 1| \geq 2$, $|2n + 1| \geq 3$ by Claim 3.5. The 2-fold branched cover along this Montesinos link is a Seifert fiber space with three exceptional fibers. However, since $M_1 \in \mathcal{L}_K \cup \mathcal{S}_K$ and a lift of α_2 is a meridian of the knot exterior M_1 , by the same arguments as in case (1) the 2-fold branched cover is a lens space or the 3-sphere. This is a contradiction.

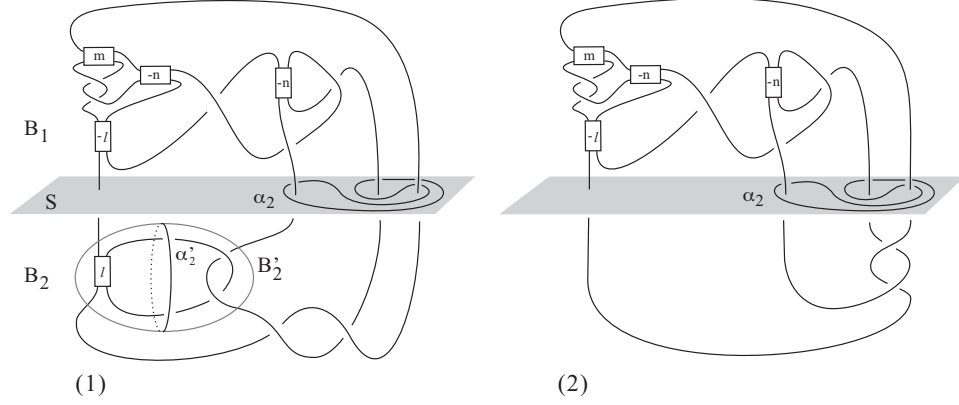

FIGURE 3.9. $B(l, m, n, 0) + R(0)$; $M_1 \in \mathcal{L}_K \cup \mathcal{S}_K$, $M_2 \in \mathcal{D}$.

Assume that case (3) in Lemma 3.8 occurs. By Proposition 3.4(1) M_1 has a Seifert fibration over the disk with an exceptional fiber of index $|2n + 1|$, an odd integer. Hence, $M_1 \notin \mathcal{M}$ by Lemma 2.3, a contradiction.

Assume that case (4) in Lemma 3.8 occurs. Then $l = \pm 2$, and $M_2 = D^2(\frac{1}{l}, -\frac{1}{2})$ has a Seifert fibration over the Möbius band. In this Seifert fibration, a regular fiber in ∂M_2 is isotopic to a lift of $\beta_+(\subset S)$ given in Figure 3.10(1) if $l = 2$, and a lift of $\beta_-(\subset S)$ in Figure 3.11(1) if $l = -2$.

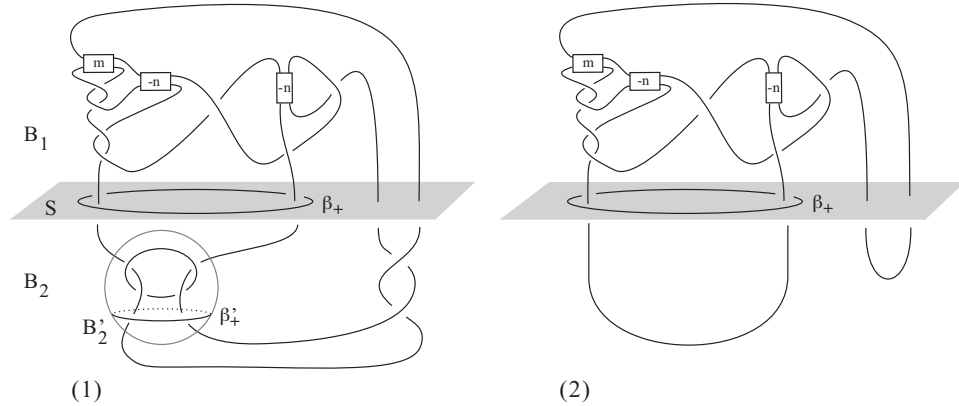
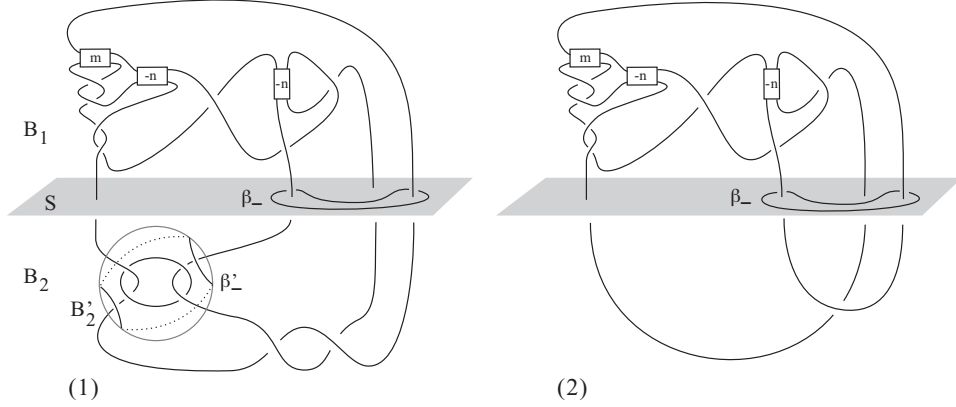

FIGURE 3.10. $B(2, m, n, 0) + R(0)$; $M_1 \in \mathcal{S}_K$, $M_2 \in \mathcal{M}$.

Replacing $(B_2, B_2 \cap K)$ with a trivial tangle (B, t) in Figure 3.10(1) (resp. 3.11(1)) with the rational tangle (B, t) in which β_+ (resp. β_-) bounds a disk in $B - t$, we

FIGURE 3.11. $B(-2, m, n, 0) + R(0)$; $M_1 \in \mathcal{S}_{\mathcal{K}}$, $M_2 \in \mathcal{M}$.

obtain the Montesinos link depicted in Figure 3.10(2) (resp. 3.11(2)). The 2-fold cover branched along this link is the Seifert fiber space $S_{\pm l, m, n}$ as follows:

$$S_{2, m, n} = S^2\left(\frac{-6mn - 5m + 3n + 1}{4mn + 4m - 2n - 1}, \frac{-n - 1}{2n + 1}\right) \text{ if } l = 2, \text{ and}$$

$$S_{-2, m, n} = S^2\left(\frac{-2mn + m + n - 1}{4mn - 2n + 1}, \frac{n}{2n + 1}\right) \text{ if } l = -2.$$

Since $M_1 \in \mathcal{S}_{\mathcal{K}}$ and a lift of β_{\pm} is a meridian of the exterior M_1 of a knot in S^3 , by the same argument as in case (1) the 2-fold branched cover $S_{\pm 2, m, n}$ is S^3 .

Claim 3.9. (1) If $S_{2, m, n}$ is S^3 , then $n = -1$.
 (2) $S_{-2, m, n}$ is S^3 if and only if $m = 0, 2$.

PROOF OF CLAIM 3.9. (1) Note that the first homology group of $S_{2, m, n}$ is the cyclic group of order $|(-6mn - 5m + 3n + 1)(2n + 1) + (-n - 1)(4mn + 4m - 2n - 1)| = |16mn^2 + 24mn - 8n^2 + 9m - 8n - 2|$. Assume that the order equals 1. Then, $(16n^2 + 24n + 9)m = 8n^2 + 8n + \delta$, where δ is 1 or 3. Note that $16n^2 + 24n + 9 > 0$ and $8n^2 + 8n + \delta > 0$ for any integer n . It follows that $16n^2 + 24n + 9 \leq 8n^2 + 8n + \delta$ for some integer n . This inequality has the only integral solution $n = -1$.

(2) The first homology of $S_{-2, m, n}$ has order $|(-2mn + m + n - 1)(2n + 1) + n(4mn - 2n + 1)| = |m - 1|$, which is 1 if and only if $m = 0, 2$. \square (Claim 3.9)

Claim 3.9, together with the assumption in Proposition 3.6(1), shows that $S_{\pm 2, m, n}$ is not S^3 . Thus case (4) in Lemma 3.8 does not occur. Hence, the tunnel number of $K(l, m, n, 0)$ is greater than one.

Assume $m = 0$. Using the above arguments for $p = 0$, we prove that cases (1), (2), (3), (4) in Lemma 3.8 do not occur. Follow the proof for $p = 0$ with Figures 3.8, 3.9, 3.10 and 3.11 replaced by Figures 3.12, 3.13, 3.14 and 3.15, respectively. Cases (1) and (2) in Lemma 3.8 do not occur, because the Montesinos links in Figures 3.12(2), 3.13(2) consist of three rational tangles and their 2-fold branched cover cannot be a lens space or the 3-sphere.

Case (3) in Lemma 3.8 does not occur. This is because the Seifert fibration of M_1 over the disk (Proposition 3.4(2)) contains an exceptional fiber of index $|4np - 2n - 1|$, an odd integer, and thus $M_1 \notin \mathcal{M}$.

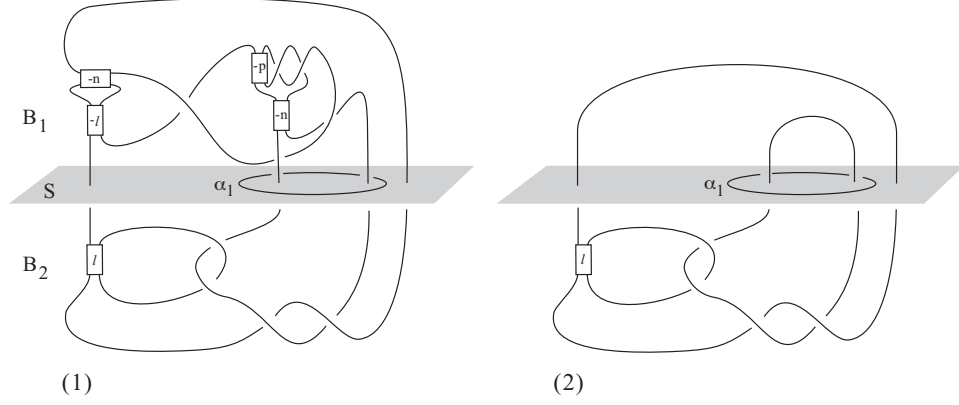
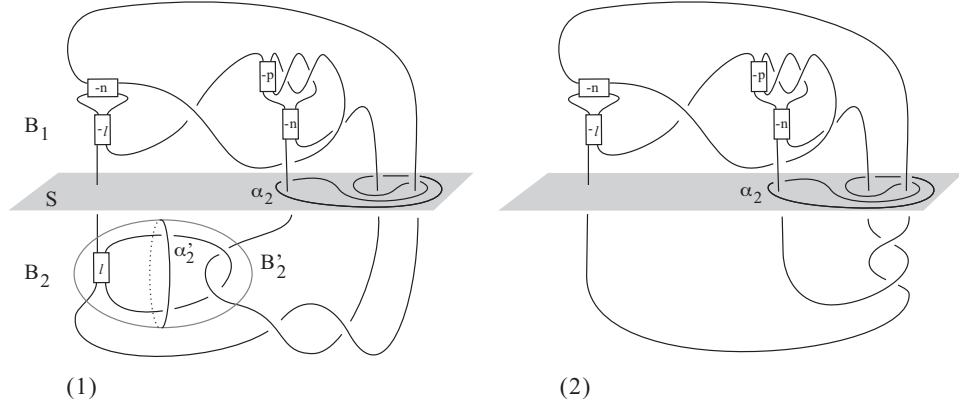
FIGURE 3.12. $B(l, 0, n, p) + R(0)$; $M_1 \in \mathcal{D}$, $M_2 \in \mathcal{L}_K \cup \mathcal{S}_K$.FIGURE 3.13. $B(l, 0, n, p) + R(0)$; $M_1 \in \mathcal{L}_K \cup \mathcal{S}_K$, $M_2 \in \mathcal{D}$

Assume case (4) in Lemma 3.8 occurs; then $l = \pm 2$ and the 2-fold cover branched along the link in Figure 3.14(2) or 3.15(2) is the 3-sphere. If $l = 2$, then the Montesinos link in Figure 3.14(2) is $M(-\frac{3n+1}{2n+1}, -\frac{2np-n+p-1}{4np-2n-1})$, and the first homology group of the 2-fold branched cover along this link has order $|16n^2p - 8n^2 + 8np - 8n + p - 2|$. If the order is 1, then $(16n^2 + 8n + 1)p = 8n^2 + 8n + \delta$ where δ is 1 or 3. Since $16n^2 + 8n + 1 > 0$ and $8n^2 + 8n + \delta > 0$ for any integer n , we obtain $16n^2 + 8n + 1 \leq 8n^2 + 8n + \delta$. Then $n = 0$. This contradicts the assumption $n \neq 0$. If $l = -2$, then the Montesinos link in Figure 3.15(2) is $M(\frac{n-1}{-2n+1}, \frac{2np-n-p}{4np-2n-1})$, and the first homology group of the 2-fold branched cover along this link has order $|p-1|$. By the arguments similar to above, we see that if the order is 1, then $p = 0$ or 2. This contradicts the assumption $(l, p) \neq (-2, 0), (-2, 2)$. So, case (4) does not occur and thus $K(l, 0, m, p)$ has tunnel number greater than one.

Let us show that the tunnel number of $K(l, m, n, p)$ equals 2, where m or p is 0. For brevity denote $K = B(l, m, n, p) + R(\infty)$. Let S be the 2-sphere [plane] $\cup \{\infty\}$

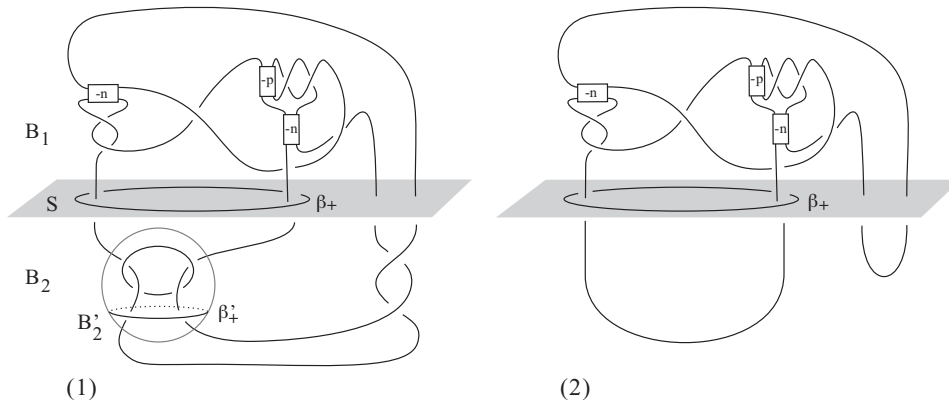

FIGURE 3.14. $B(2, 0, n, p) + R(0)$; $M_1 \in \mathcal{S}_\kappa$, $M_2 \in \mathcal{M}$.

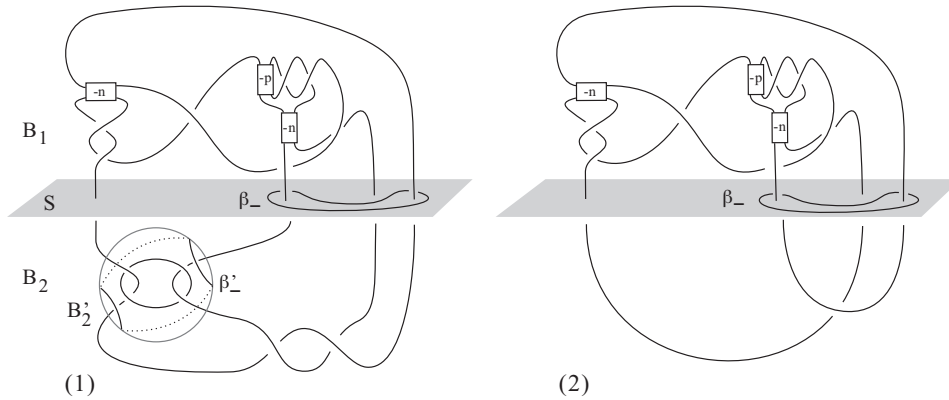
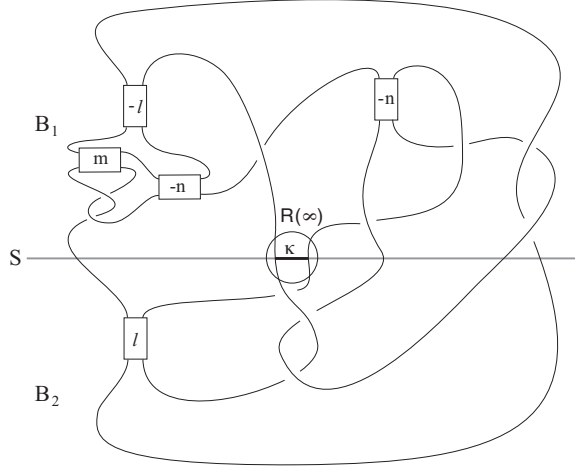

FIGURE 3.15. $B(-2, 0, n, p) + R(0)$; $M_1 \in \mathcal{S}_\kappa$, $M_2 \in \mathcal{M}$.

given in Figure 3.16, and B_1 (resp. B_2) the 3-balls bounded below (resp. above) by S . Then, each $(B_i, B_i \cap K)$ is a 3-string tangle pairwise homeomorphic to $(D^2 \times I, \{x_1, x_2, x_3\} \times I)$, where x_i are distinct points in D^2 . Let $\pi_\infty : S^3 \rightarrow S^3$ be the 2-fold cover branched along the trivial knot K . The preimage $\pi_\infty^{-1}(B_i)$ is a genus 2 handlebody for $i = 1, 2$, and thus $\pi_\infty^{-1}(S)$ is a genus 2 Heegaard surface of S^3 . Since S contains the spanning arc κ for $R(\infty)$ as described in Figure 3.16, the covering knot $K(l, m, n, p) = \pi_\infty^{-1}(\kappa)$ is contained in the genus 2 Heegaard surface $\pi_\infty^{-1}(S)$. Then, by [20, Fact on p.138] the tunnel number of $K(l, m, n, p)$ is at most 2, and so equals 2. □(Proposition 3.7)

3.3. Hyperbolicity of $K(l, m, n, p)$. We use the following lemma to detect hyperbolicity of knots.

Lemma 3.10. *Suppose that an r -surgery on a knot K in S^3 yields a 3-manifold $K(r)$ containing a separating incompressible torus. Suppose further that no separating incompressible torus in $K(r)$ is disjoint from the dual knot K^* of K , i.e. the core of the filled solid torus in $K(r)$. Then, K is a hyperbolic knot.*

FIGURE 3.16. Both sides of S are 3-string trivial tangles.

PROOF OF LEMMA 3.10. If K is not a hyperbolic knot, then it is either a torus knot or a satellite knot. If the result of a surgery on a torus knot contains an incompressible torus, then the surgery is longitudinal [13, VI. Example] and the torus is non-separating. Hence, K is not a torus knot because $K(r)$ contains a separating incompressible torus by the assumption. Now assume that K is a satellite knot with a companion knot k . Then K has a companion knot k which is either a torus knot or a hyperbolic knot; K is contained in a tubular neighborhood V of k . Since the separating torus ∂V is disjoint from K^* in $K(r)$, the assumption of the lemma implies that ∂V compresses after the r -surgery along $K(\subset V)$. By [9] K is a 0 or 1-bridge braid in V and winds $w(\geq 2)$ times in V . It follows that $K(r) = k(\frac{m}{nw^2})$ [10], where $r = \frac{m}{n}$, and m and w^2 are relatively prime. Since $k(\frac{m}{nw^2})$ contains a separating incompressible torus by the assumption, k is not a torus knot and thus a hyperbolic knot. However, [12] shows that if $k(\frac{m}{nw^2})$ is toroidal, then $|nw^2| \leq 2$, a contradiction. Hence, K is not a satellite but a hyperbolic knot. \square (Lemma 3.10)

Proposition 3.11. *The covering knot $K(l, m, n, p)$ (m or p is 0) is a hyperbolic knot if l, m, n, p satisfy the condition in Proposition 3.4.*

PROOF OF PROPOSITION 3.11. We prove that $K = K(l, m, n, p)$ and $r = \gamma_{l, m, n, p} + 1$ satisfy the assumption of Lemma 3.10. Proposition 3.4 shows that $\pi^{-1}(S)$ is a unique incompressible torus in $K(l, m, n, p)(\gamma_{l, m, n, p} + 1)$ up to isotopy, where $\pi : K(l, m, n, p)(\gamma_{l, m, n, p} + 1) \rightarrow S^3$ is the 2-fold cover branched along $B(l, m, n, p) + R(0)$. Thus, Claim 3.12 below shows that the assumption is satisfied when $p = 0$, so that $K(l, m, n, 0)$ is a hyperbolic knot. Claim 3.12 with $l, m, n, 0$ replaced by $l, 0, n, p$ also holds, and implies that $K(l, 0, n, p)$ is hyperbolic. \square (Proposition 3.11)

Claim 3.12. *In $K(l, m, n, 0)(\gamma_{l, m, n, 0} + 1)$, the incompressible torus $\pi^{-1}(S)$ intersects the dual knot K^* of $K(l, m, n, 0)$ minimally in two points.*

PROOF OF CLAIM 3.12. The arc κ_0 in Figure 3.17 is a spanning arc of $R(0)$. The preimage $\pi^{-1}(\kappa_0)$ is the dual knot K^* . In Figure 3.17, D_i is a disk which contains $\kappa_0 \cap B_i$ and splits the tangle $(B_i, B_i \cap B(l, m, n, 0) + R(0))$ into two nontrivial tangles. It follows that $A_i = \pi^{-1}(D_i)$ is an essential annulus in the Seifert fiber space $M_i = \pi^{-1}(B_i)$ over the disk with two exceptional fibers. Furthermore, the arc $\pi^{-1}(\kappa_0 \cap B_i) = K^* \cap M_i$ is an essential arc in the annulus A_i . Then, the desired result follows from the argument in [7, Example 1.4]. \square (Claim 3.12)

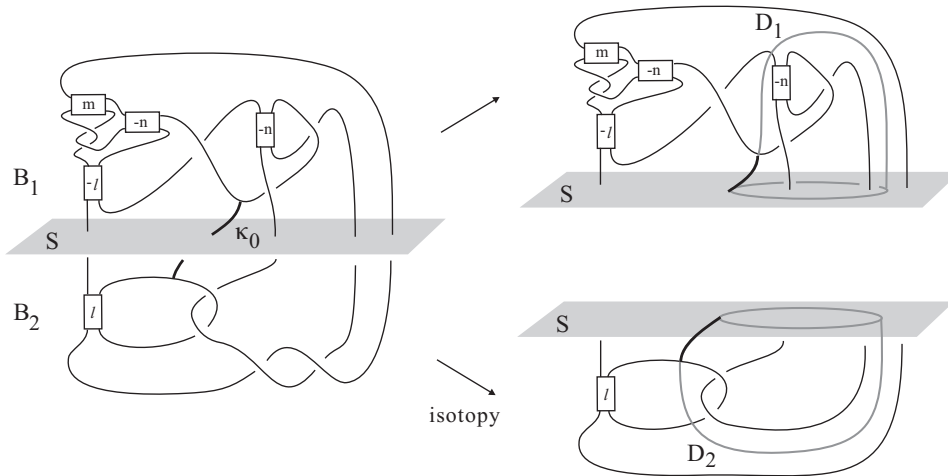

FIGURE 3.17. $B(l, m, n, 0) + R(0)$.

4. LOCATING $(K(l, m, n, p), \gamma_{l, m, n, p})$ IN THE SEIFERT SURGERY NETWORK

In Subsection 4.1, we review a method of finding seiferters for Seifert surgeries obtained by untangle surgeries. In Subsection 4.2, we find seiferters for the Seifert fibered surgeries $(K(l, m, n, p), \gamma_{l, m, n, p})$, and an explicit path to a Seifert surgery on a trefoil knot.

4.1. Seiferters and tangles. Assume that a tangle (B, t) , where B is the complement of the unit 3-ball in S^3 , satisfies the following conditions.

- $L_\infty = (B, t) + R(\infty)$ is a trivial knot in S^3 .
- $L_s = (B, t) + R(s)$ is a Montesinos link $M(R_1, \dots, R_k)$.

As in Section 2, let $\pi_\infty : S^3 \rightarrow S^3$ (resp. $\pi_s : X_s \rightarrow S^3$) be the 2-fold cover of S^3 branched along L_∞ (resp. L_s). We denote by K the covering knot of the trivializable tangle (B, t) , and by γ_s the covering slope of the s -untangle surgery on L_∞ . Then (K, γ_s) is a Seifert fibered surgery. The Montesinos link L_s can be deformed into a standard position as in Figure 2.3(2). We define a leading arc of a rational tangle. Then we show that the preimage of a leading arc becomes a Seifert fiber in X_s .

Definition 4.1 (leading arc). Let τ be an arc in a rational tangle $R = R(a_1, \dots, a_n)$ as depicted in Figure 4.1. Then we call τ a *leading arc* of R .

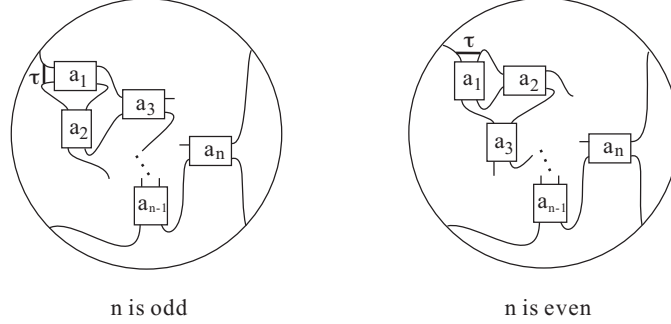

FIGURE 4.1. Leading arcs in rational tangles.

Lemma 4.2. *Let τ be a leading arc of a rational tangle $R_i = R(\frac{p_i}{q_i}) = (B_i, t_i)$ in a standard position of L_s . Then $c = \pi_s^{-1}(\tau)$ is the core of the solid torus $\pi_s^{-1}(B_i)$ and a fiber of index $|q_i|$ in a Seifert fibration of X_s .*

PROOF OF LEMMA 4.2. By an ambient isotopy of B_i we can deform (B_i, t_i) and τ to $R(\infty)$ and a spanning arc for $R(\infty)$ as in Figure 2.2. Hence c is the core of the solid torus $\pi_s^{-1}(B_i)$. This implies the desired result. \square (Lemma 4.2)

Remark 4.3. In Lemma 4.2, if $|q_i| = 1$, then c is a regular fiber in X_s . If $q_i = 0$ i.e. $R_i = R(\infty)$, then L_s is not a Montesinos link in the usual sense, and X_s is a connected sum of lens spaces having a Seifert fibration with c a degenerate fiber.

For an arc τ with $\tau \cap L_\infty = \partial\tau$ we perform an untangle surgery along τ as follows. First take a regular neighborhood $N(\tau)$ of τ so that $T = (N(\tau), N(\tau) \cap L_\infty)$ is a trivial tangle. Then, identifying T with the rational tangle $R(\infty)$, replace T by a rational tangle $R(s)$; this operation is called s -untangle surgery on L_∞ along τ . Then, performing s -untangle surgery along τ downstairs corresponds to performing Dehn surgery on the knot $\pi_\infty^{-1}(\tau)$ upstairs.

Theorem 4.4 ([3, Theorem 3.4]). *Let τ be an arc in $\text{int}B$ such that $\tau \cap t = \partial\tau$. Assume that after an isotopy of $\tau \cup L_s$, τ is a leading arc of some R_i in a standard position of L_s . Assume also that some nontrivial untangle surgery on L_∞ along τ preserves the triviality of L_∞ . Then the following hold.*

- (1) *The preimage $c = \pi_\infty^{-1}(\tau)$ is a seiferter for (K, γ_s) .*
- (2) *The above untangle surgery along τ corresponds to twisting along the seiferter c in S^3 .*

Remark 4.5. Assume that $\frac{1}{n_0}$ -untangle surgery along τ preserves the triviality of $(B, t) + R(\infty)$ for some integer n_0 with $|n_0| > 2$. Then the preimage of the latitude of $R(\infty) = (N(\tau), N(\tau) \cap L_\infty)$ is a preferred longitude of c [3, Remark 3.5]. Thus for any integer n , $\frac{1}{n}$ -untangle surgery along τ corresponds to $(-\frac{1}{n})$ -surgery on c , i.e. n -twist along c .

4.2. Locating $(K(l, m, n, p), \gamma_{l, m, n, p})$ in the Seifert Surgery Network. Let $B(l, m, n, p)$, where m or p is 0, be the trivializable tangle in Figure 3.1, and a and b the arcs depicted in Figure 3.1. Recall that $K(l, m, n, p)$ and $\gamma_{l, m, n, p} = \gamma$ are the covering knot of $B(l, m, n, p)$ in Figure 3.1 and the covering slope of 1-untangle

surgery on $B(l, m, n, p) + R(\infty)$ respectively, and $B(l, m, n, p) + R(1)$ is a Montesinos link (Lemma 3.1). We denote the 2-fold cover branched along $B(l, m, n, p) + R(\infty)$ (resp. $B(l, m, n, p) + R(1)$) by $\pi_\infty : S^3 \rightarrow S^3$ (resp. $\pi : K(l, m, n, p)(\gamma) \rightarrow S^3$). Set $c_a(l, m, n, p) = \pi_\infty^{-1}(a)$ and $c_b(l, m, n, p) = \pi_\infty^{-1}(b)$. For simplicity, we often write c_a, c_b for $c_a(l, m, n, p), c_b(l, m, n, p)$.

Proposition 4.6. (1) *If $p = 0$, then $c_a(l, m, n, 0)$ is a seifert for $(K(l, m, n, 0), \gamma)$.*
 (2) *If $m = 0$, then $c_b(l, 0, n, p)$ is a seifert for $(K(l, 0, n, p), \gamma)$.*

PROOF OF PROPOSITION 4.6. (1) Figure 3.3 gives a standard position of the Montesinos link $B(l, m, n, 0) + R(1)$ and shows that the arc a is a leading arc of $R_1 = (B_1, t_1)$. Apply $\frac{1}{m'}$ -untangle surgery on $B(l, m, n, 0) + R(\infty)$ along a as in Figure 4.2. We then obtain $B(l, m - m', n, 0) + R(\infty)$, which is a trivial knot by Lemma 3.1(1)(i). It follows from Theorem 4.4(1) that c_a is a seifert for $(K(l, m, n, 0), \gamma)$. In particular, by Lemma 4.2 c_a is the core of $\pi^{-1}(B_1)$ and an exceptional fiber in $K(l, m, n, 0)(\gamma)$.

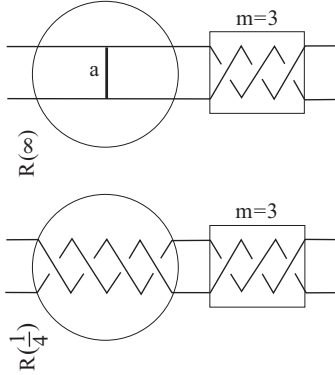

FIGURE 4.2. $\frac{1}{4}$ -untangle surgery along a .

(2) Figure 3.5 gives a standard position of the Montesinos link $B(l, 0, n, p) + R(1)$ and shows that the arc b is a leading arc of $R_2 = (B_2, t_2)$. Note that $\frac{1}{p'}$ -untangle surgery on $B(l, 0, n, p) + R(\infty)$ along the arc b as in Figure 4.2 yields the trivial knot $B(l, 0, n, p - p') + R(\infty)$ (Lemma 3.1(2)(i)). It follows from Theorem 4.4(1) that c_b is a seifert for $(K(l, 0, n, p), \gamma)$; in particular, c_b is the core of $\pi^{-1}(B_2)$ and an exceptional fiber in $K(l, m, 0, p)(\gamma)$. This establishes Proposition 4.6. \square (Proposition 4.6)

Remark 4.7. Figure 3.3 shows that the arc b is isotopic to a leading arc of R_2 in a standard position of the Montesinos link $B(l, m, n, 0) + R(1)$. This implies that c_a and c_b become fibers in $K(l, m, n, 0)(\gamma_{l, m, n, 0})$ simultaneously. However, if $m \neq 0$, c_b is not necessarily a trivial knot. If $m = p = 0$, then c_a and c_b are trivial knots, and $\{c_a, c_b\}$ is a pair of seiferters for $(K(l, 0, n, 0), \gamma_{l, 0, n, 0})$

Since $\frac{1}{m'}$ -untangle surgery on $B(l, m, n, 0) + R(\infty)$ along the arc a preserves the triviality for any m' , by Remark 4.5 the $\frac{1}{m'}$ -untangle surgery corresponds to m' -twist along the seifert c_a . Since untangle surgeries along the arc a do not affect the attached tangle $R(\infty)$ in $B(l, m, n, 0) + R(\infty)$, the image of the covering slope $\gamma_{l, m, n, 0}$ under m' -twist along c_a corresponds to 1-untangle surgery on

$B(l, m - m', n, 0) + R(\infty)$. Thus, m' -twist along c_a converts $(K(l, m, n, 0), \gamma_{l, m, n, 0})$ to $(K(l, m - m', n, 0), \gamma_{l, m - m', n, 0})$. Note also that m' -twist along $c_a(l, m, n, 0)$ converts the link $c_a(l, m, n, 0) \cup c_b(l, m, n, 0)$ to $c_a(l, m - m', n, 0) \cup c_b(l, m - m', n, 0)$. Similar results hold for p' -twist of $(K(l, 0, n, p), \gamma_{l, 0, n, p})$ along c_b . We thus have Lemma 4.8 below.

Lemma 4.8. (1) m -twist along c_a converts $(K(l, m, n, 0), \gamma_{l, m, n, 0})$ to $(K(l, 0, n, 0), \gamma_{l, 0, n, 0})$.
 (2) p -twist along c_b converts $(K(l, 0, n, p), \gamma_{l, 0, n, p})$ to $(K(l, 0, n, 0), \gamma_{l, 0, n, 0})$.

Lemma 4.8(1) and (2) give the horizontal line and the vertical line in Figure 4.3, respectively.

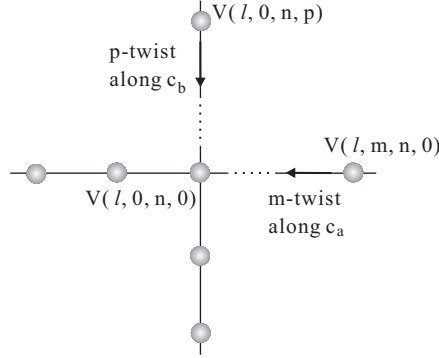

FIGURE 4.3. $V(l, m, n, p) = (K(l, m, n, p), \gamma_{l, m, n, p})$.

Lemma 4.9. (1) Set $B(l, 1, n - 1, 0) = (B, t_1)$ and $B(l, 0, n, 1) = (B, t_2)$. Then an ambient isotopy of B fixing ∂B sends t_1 to t_2 , and the arcs a, b to a, b , respectively.
 (2) $(K(l, 1, n - 1, 0), \gamma_{l, 1, n - 1, 0}) = (K(l, 0, n, 1), \gamma_{l, 0, n, 1})$. Moreover, the ordered link $K(l, 1, n - 1, 0) \cup c_a(l, 1, n - 1, 0) \cup c_b(l, 1, n - 1, 0)$ is isotopic to $K(l, 0, n, 1) \cup c_a(l, 0, n, 1) \cup c_b(l, 0, n, 1)$, so that $\{c_a, c_b\}$ is a pair of seiferters for $(K(l, 1, n - 1, 0), \gamma)$.

PROOF OF LEMMA 4.9. (1) We give a pictorial proof. The right-most figures in Figures 4.4 and 4.5 depict the same tangle with arcs a, b . Hence, the isotopies in Figures 4.4 and 4.5 imply that an ambient isotopy of B fixing ∂B converts $B(l, 1, n - 1, 0)$ to $B(l, 0, n, 1)$, and sends the arcs a, b to a, b , respectively.

(2) The isotopy in Assertion (1) extends to an ambient isotopy of S^3 which sends $B(l, 1, n - 1, 0) + R(\infty)$ to $B(l, 0, n, 1) + R(\infty)$, and the arcs a, b to a, b , respectively. Hence, there is an ambient isotopy of S^3 which sends the ordered link $K(l, 1, n - 1, 0) \cup c_a(l, 1, n - 1, 0) \cup c_b(l, 1, n - 1, 0)$ to $K(l, 0, n, 1) \cup c_a(l, 0, n, 1) \cup c_b(l, 0, n, 1)$, and the covering slope $\gamma_{l, 1, n, 0}$ to $\gamma_{l, 0, n, 1}$, as claimed. \square (Lemma 4.9)

Applying Lemmas 4.8, 4.9(2) repeatedly, we find a path from $(K(l, 0, n, 0), \gamma_{l, 0, n, 0})$ to $(K(l, 0, 0, 0), \gamma_{l, 0, 0, 0})$ as in Figure 4.6. Joining this path and the path in Figure 4.3 gives an explicit path from $(K(l, m, n, p), \gamma)$ (m or p is 0) to $(K(l, 0, 0, 0), \gamma)$.

Now we identify $(K(l, 0, 0, 0), \gamma)$ and its seiferters c_a, c_b .

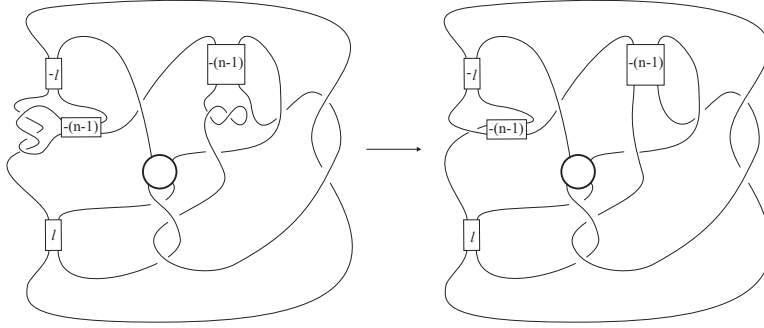

FIGURE 4.4. An isotopy of $B(l, 1, n - 1, 0)$.

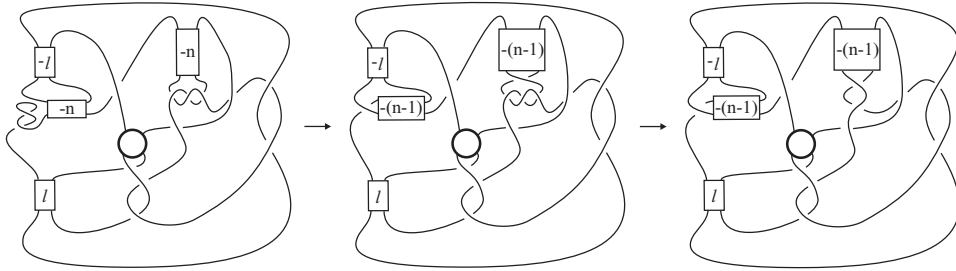

FIGURE 4.5. An isotopy of $B(l, 0, n, 1)$.

Lemma 4.10. $K(l, 0, 0, 0)$ is the trefoil knot $T_{3,2}$, $\gamma_{l,0,0,0} = l + 5$, and $\{c_a, c_b\}$ is an annular pair of seiferters for $(T_{3,2}, l + 5)$ which form the $(4, 2)$ torus link. Furthermore, the pair of seiferters $\{c_a, c_b\}$ is the mirror image of the pair of seiferters $\{c_1^m, s_{-3}\}$ for $(T_{-3,2}, m)$ given in [5, Figure 4.2] with $m = -l - 5$.

Combining Figures 4.3, 4.6, and Lemma 4.10, we obtain the following result.

Proposition 4.11. The Seifert fibered surgery $(K(l, m, n, p), \gamma_{l,m,n,p})$, where m or p is 0, is obtained from $(T_{3,2}, l + 5)$ by a sequence of twists along the pair of seiferters c_a, c_b depicted in Figure 4.10 as follows: alternate $2n$ twists (-1) -twist along c_a , 1 -twist along c_b , \dots , (-1) -twist along c_a , 1 -twist along c_b (Figure 4.6), and finally $(-m)$ -twist along c_a or $(-p)$ -twist along c_b according as $p = 0$ or $m = 0$ (Figure 4.3).

PROOF OF LEMMA 4.10. Figure 4.7 illustrates the trivial knot $B(l, 0, 0, 0) + R(\infty)$, the arcs a, b , and the band β ; $\partial\beta$ is the union of the spanning arc κ , the latitude of $R(\infty)$, and two subarcs of $B(l, 0, 0, 0) + R(\infty)$. Figure 4.8 gives an isotopy of $(B(l, 0, 0, 0) + R(\infty)) \cup \kappa \cup a \cup b$ so that $B(l, 0, 0, 0) + R(\infty)$ becomes a standardly embedded circle. Isotope also the band β in the same manner as in Figure 4.8. Then $(\frac{l}{2} + 1)$ -twist is added to the band. Now we consider the 2-fold branched cover $\pi_\infty : S^3 \rightarrow S^3$ along $B(l, 0, 0, 0) + R(\infty)$. The preimage $\pi_\infty^{-1}(\beta)$ is the twisted annulus in Figure 4.9. Note that the linking number of the parallelly oriented boundary components of the annulus is $2(\frac{l}{2} + 1) + 4 = l + 6$. That is, the preimage

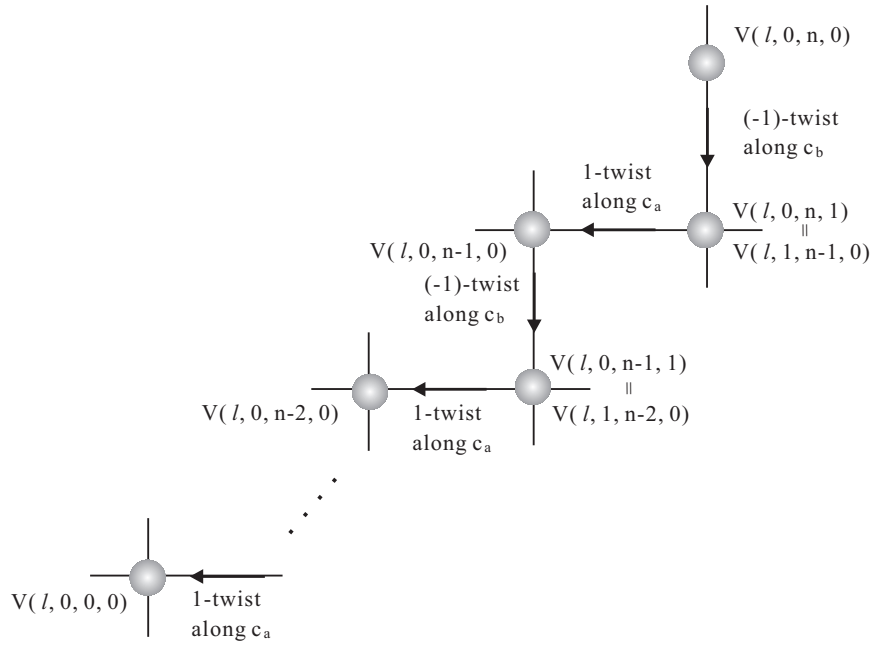

FIGURE 4.6. $V(l, m, n, p) = (K(l, m, n, p), \gamma_{l, m, n, p})$.

of the latitude of $R(\infty)$ is a longitude of the solid torus $N(\pi_\infty^{-1}(\kappa))$ giving $(l+6)$ -framing. Then, by Remark 2.2 the covering slope $\gamma_{l, 0, 0, 0}$ of 1-untangle surgery on $B(l, 0, 0, 0)$ equals $l+5$.

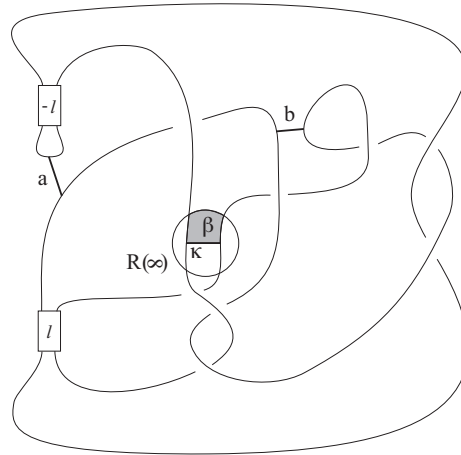

FIGURE 4.7. $B(l, 0, 0, 0) + R(\infty) \cup a \cup b \cup \kappa$ and band β .

The preimages of κ , a , and b become $K = K(l, 0, 0, 0)$, c_a , and c_b in the first figure of Figure 4.10. The covering knot K is the trefoil knot $T_{3,2}$, and $c_a \cup c_b$ is the $(4, 2)$ torus link bounding an annulus; $\{c_a, c_b\}$ is an annular pair of seiferters

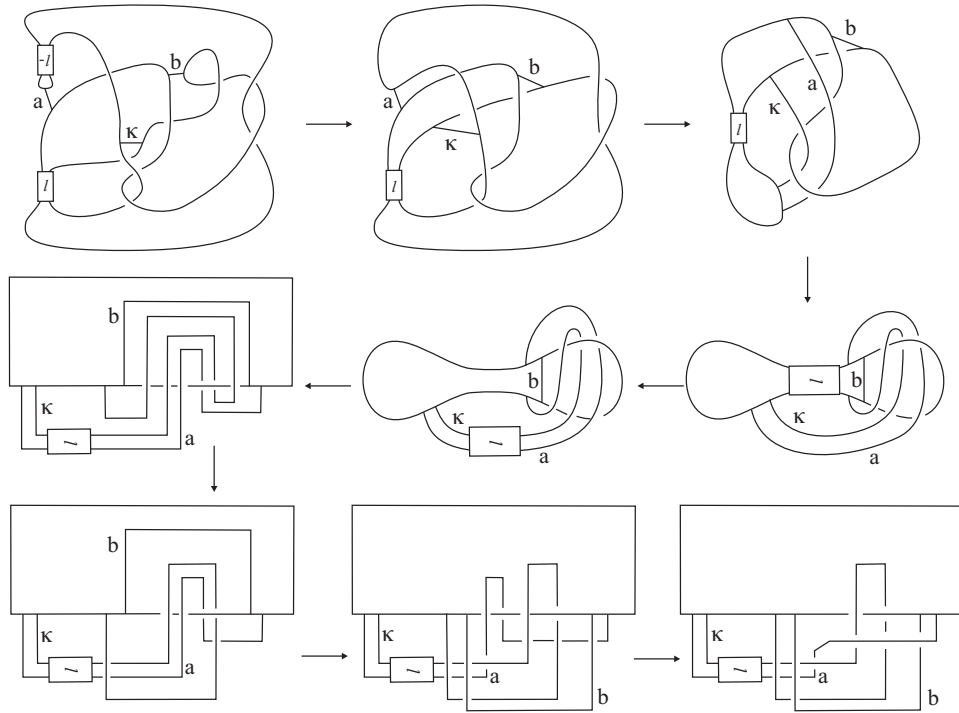

FIGURE 4.8. An isotopy of $B(l, 0, 0, 0) + R(\infty) \cup a \cup b \cup \kappa$.

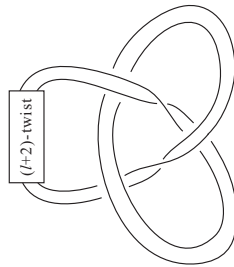
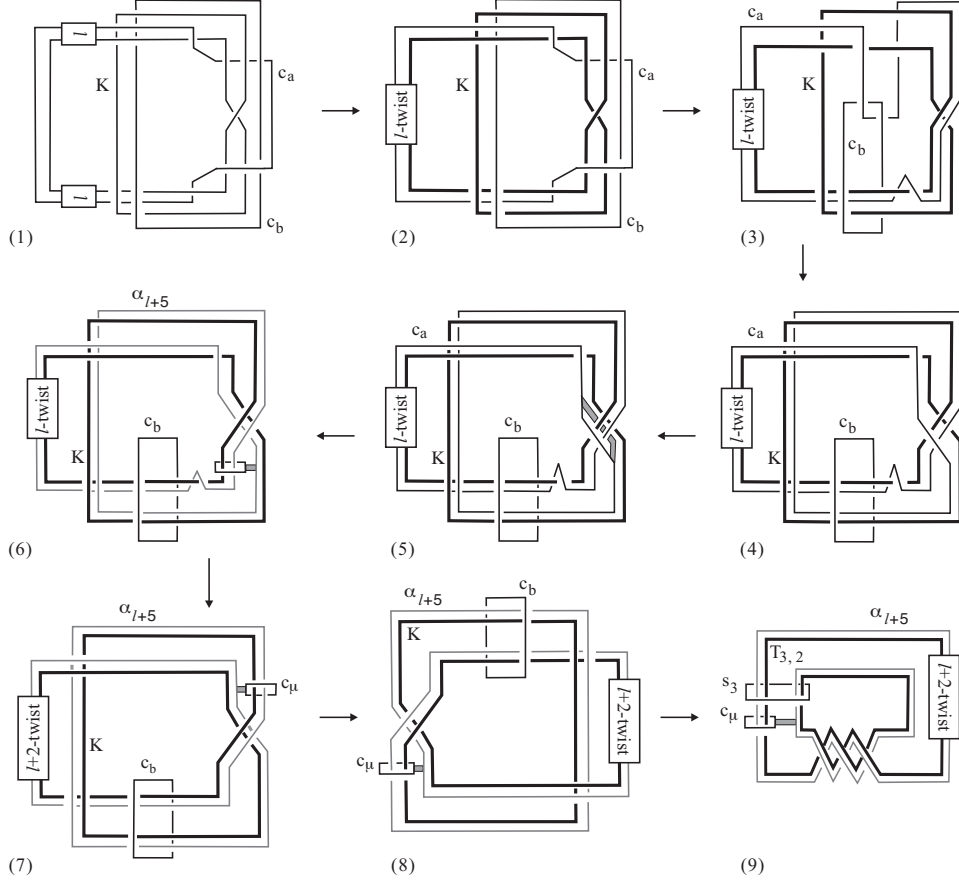

FIGURE 4.9. Twisted annulus $\pi_\infty^{-1}(\beta)$.

for $(T_{3,2}, l+5)$. We isotope $K \cup c_a \cup c_b$ as in Figure 4.10. Figure 4.10(4) shows that c_b is the exceptional fiber of index 3 in $S^3 - \text{int}N(T_{3,2})$. We see from (5) and (6) in Figure 4.10 that c_a is a band sum of a knot c_μ in $S^3 - N(T_{3,2})$ and a simple closed curve α_{l+5} in $\partial N(T_{3,2})$, where c_μ is parallel to a meridian of $N(T_{3,2})$ and the slope of α_{l+5} in $\partial N(T_{3,2})$ is $l+5$. The last figure of Figure 4.10 shows that the mirror image of the ordered link $T_{3,2} \cup c_a \cup c_b$ is $T_{-3,2} \cup c_1^m \cup s_{-3}$ depicted in [5, Figure 4.2] with $m = -l - 5$. \square (Lemma 4.10)

As Figure 4.6 shows, $K(l, 0, n, 0)$ is obtained from $K(l, 0, 0, 0)$ by applying a pair of successive twists (-1) -twist along c_a and 1 -twist along c_b , repeatedly n times. Under (-1) -twist along c_a and then 1 -twist along c_b the $(4, 2)$ torus link

FIGURE 4.10. $K = K(l, 0, 0, 0)$, c_a , and c_b .

$c_a \cup c_b$ changes first to the $(-4, 2)$ torus link and then to the $(4, 2)$ torus link. We show that applying this sequence of twists is equivalent to twisting along the annulus cobounded by $c_a \cup c_b$. Hence, the Seifert fibered surgery $(K(l, 0, n, 0), \gamma)$ is obtained from $(T_{3,2}, l + 5)$ by twisting along the annular pair of seiferters $\{c_a, c_b\}$.

Definition 4.12 (twist along an annular pair). Let c_1, c_2 be knots in S^3 cobounding an annulus A , and give orientations to c_1, c_2 so that they are homologous in A . We call the ordered pair (c_1, c_2) an *annular pair*. A p -twist along an annular pair (c_1, c_2) is defined to be performing $(-\frac{1}{p} + l)$ -surgery along c_1 and simultaneously $(\frac{1}{p} + l)$ -surgery along c_2 , where $l = \text{lk}(c_1, c_2)$.

Lemma 4.13. *Let $c_1 \cup c_2$ be the $(4, 2)$ torus link. Then, performing (-1) -twist along c_1 and then 1 -twist along c_2 is equivalent to 1 -twist along the annular pair (c_1, c_2) .*

PROOF OF LEMMA 4.13. The $(4, 2)$ torus link $c_1 \cup c_2$ cobound a unique annulus, and $l = \text{lk}(c_1, c_2)$ equals 2 when c_1 and c_2 are oriented so as to be homologous in the annulus. Let μ, λ be a preferred meridian-longitude pair of c_2 . The (-1) -twist along c_1 changes m -framing of c_2 to $(m - 2^2)$ -framing of c_2 , so that $\mu' = \mu$,

$\lambda' = \lambda + 4\mu$ become a preferred meridian–longitude pair of c_2 after the twist along c_1 . Hence, the surgery slope of (-1) –surgery along c_2 (i.e. 1–twist along c_2) after the twist along c_1 is $\lambda' - \mu' = \lambda + 3\mu$. Performing (-1) –twist along c_1 and then 1–twist along c_2 is then performing 1–surgery along c_1 and 3–surgery along c_2 simultaneously. Since $l = 2$, this shows that the sequence of twists is equivalent to 1–twist along the annular pair (c_1, c_2) . \square (Lemma 4.13)

Corollary 4.14. *The Seifert fibered surgery $(K(l, m, n, p), \gamma_{l, m, n, p})$, where m or p is 0, is obtained from $(T_{3,2}, l + 5)$ by applying n –twist along the annular pair of seiferters (c_a, c_b) depicted in Figure 4.10 and then $(-m)$ –twist along c_a or $(-p)$ –twist along c_b according as $p = 0$ or $m = 0$. Regarding the surgery slope $\gamma_{l, m, n, p}$, $\gamma_{l, 0, n, 0} = 5 + l + n(l^2 + 8l + 12) + 2n^2(l + 2)^2$ and $\gamma_{l, m, n, p} = \gamma_{l, 0, n, 0} - m(2nl + 4n + l + 4)^2 - p(2nl + 4n + 2)^2$.*

PROOF OF COROLLARY 4.14. The first statement follows from Proposition 4.11 and Lemma 4.13. To calculate the surgery slope $\gamma_{l, m, n, p}$ we use results in [4]. Using Proposition 2.33(2) in [4], we obtain $\gamma_{l, 0, n, 0} = \gamma_{l, 0, 0, 0} + n(l_1^2 - l_2^2) + 2n^2(l_1 - l_2)^2$, where $l_1 = \text{lk}(T_{3,2}, c_a) = l + 4$, $l_2 = \text{lk}(T_{3,2}, c_b) = 2$ under an adequate orientation of $T_{3,2}$. Twisting $(K(l, 0, n, 0), \gamma_{l, 0, n, 0})$ $-m$ times along c_a increases $\gamma_{l, 0, n, 0}$ by $-m(\text{lk}(K(l, 0, n, 0), c_a))^2$ [4, Proposition 2.6]. Take an annulus cobounded by $c_a \cup c_b$ whose boundary orientation coincides with c_a and the reversed orientation of c_b . Then the annulus is twisted twice, and intersects $T_{3,2}$ algebraically $l_1 - l_2 = l + 2$ times. Hence, after n –twist along the annular pair (c_a, c_b) , $\text{lk}(K(l, 0, 0, 0), c_a)$ increases by $2n(l + 2)$, so that $\text{lk}(K(l, 0, n, 0), c_a) = l + 4 + 2n(l + 2)$. This leads to $\gamma_{l, m, n, 0} = \gamma_{l, 0, n, 0} - m(2nl + 4n + l + 4)^2$. Similarly, we obtain the formula of $\gamma_{l, 0, n, p}$. \square (Corollary 4.14)

Acknowledgements

We would like to thank the referee for careful reading and useful suggestions. The first author was partially supported by PAPIIT-UNAM grant IN109811. The last author has been partially supported by JSPS Grants-in-Aid for Scientific Research (C) (No.21540098), The Ministry of Education, Culture, Sports, Science and Technology, Japan and Joint Research Grant of Institute of Natural Sciences at Nihon University for 2013.

REFERENCES

1. J. Berge; Some knots with surgeries yielding lens spaces, unpublished manuscript.
2. J. Dean; Small Seifert-fibered Dehn surgery on hyperbolic knots, Algebraic and Geometric Topology **3** (2003), 435–472.
3. A. Deruelle, M. Eudave-Muñoz, K. Miyazaki and K. Motegi; Networking Seifert Surgeries on Knots IV: Seiferters and branched coverings, Contemp. Math. Amer. Math. Soc. **597** (2013), 235–262.
4. A. Deruelle, K. Miyazaki and K. Motegi; Networking Seifert Surgeries on Knots, Mem. Amer. Math. Soc. **217** (2012), no. 1021, viii+130.
5. A. Deruelle, K. Miyazaki and K. Motegi; Neighbors of Seifert surgeries on a trefoil knot in the Seifert Surgery Network, preprint.
6. M. Eudave-Muñoz, Band sums of links which yield composite links. The cabling conjecture for strongly invertible knots, Trans. Amer. Math. Soc. **330** (1992), 463–501.

7. M. Eudave-Muñoz; 4-punctured tori in the exterior of knots, *J. Knot Theory Ramifications* **6** (1997), 659–676.
8. M. Eudave-Muñoz; On hyperbolic knots with Seifert fibered Dehn surgeries, *Topology Appl.* **121** (2002), 119–141.
9. D. Gabai; Surgery on knots in solid tori, *Topology* **28** (1989), 1–6.
10. C.McA. Gordon; Dehn surgery and satellite knots, *Trans. Amer. Math. Soc.* **275** (1983), 687–708.
11. C.McA. Gordon; Dehn surgery on knots, *Proceedings ICM Kyoto 1990*, (1991), 631–642.
12. C. McA. Gordon and J. Luecke; Dehn surgeries on knots creating essential tori, I, *Comm. Anal. Geom.* **4** (1995), 597–644.
13. W. Jaco; *Lectures on three manifold topology*, CBMS Regional Conference Series in Math., **43**, Amer. Math. Soc., 1980.
14. W. Jaco and P. Shalen; Seifert fibered spaces in 3-manifolds, *Mem. Amer. Math. Soc.* **21** (1979), no. 220, viii+192.
15. K. Johannson; *Homotopy equivalences of 3-manifolds with boundaries*, *Lect. Notes in Math.* vol. 761, Springer-Verlag, 1979.
16. T. Kobayashi; Structures of Haken manifolds with Heegaard splittings of genus two, *Osaka J. Math.* **21** (1984), 437–455.
17. T. Mattman, K. Miyazaki and K. Motegi; Seifert fibered surgeries which do not arise from primitive/Seifert-fibered constructions, *Trans. Amer. Math. Soc.* **358** (2006), 4045–4055.
18. K. Miyazaki and K. Motegi; On primitive/Seifert-fibered constructions, *Math. Proc. Camb. Phil. Soc.* **138** (2005), 421–435.
19. J. M. Montesinos; Variedades de Seifert que son recubridores cíclicos ramificados de dos hojas, *Bol. Soc. Mat. Mexicana (2)* **18** (1973), 1–32.
20. K. Morimoto; On the additivity of h-genus of knots, *Osaka J. Math.*, **31** (1994), 137–145.
21. H-J. Song; private communication.
22. M. Teragaito; A Seifert fibered manifold with infinitely many knot-surgery descriptions, *Int. Math. Res. Not.* **9** (2007), Art. ID rnm 028, 16 pp.

INSTITUTO DE MATEMATICAS, UNIVERSIDAD NACIONAL AUTÓNOMA DE MÉXICO, CIRCUITO EXTERIOR, CIUDAD UNIVERSITARIA 04510 MÉXICO DF, MEXICO, AND CIMAT, GUANAJUATO, MEXICO

E-mail address: mario@matem.unam.mx

MATHEMATICS DEPARTMENT, NORTH SEATTLE COMMUNITY COLLEGE, 9600 COLLEGE WAY N, SEATTLE, WA 98103, USA

E-mail address: ejasso@northseattle.edu

FACULTY OF ENGINEERING, TOKYO DENKI UNIVERSITY, 5 SENJU ASAHI-CHO, ADACHI-KU, TOKYO 120-8551, JAPAN

E-mail address: miyazaki@cck.dendai.ac.jp

DEPARTMENT OF MATHEMATICS, NIHON UNIVERSITY, 3-25-40 SAKURAJOSUI, SETAGAYA-KU, TOKYO 156-8550, JAPAN

E-mail address: motegi@math.chs.nihon-u.ac.jp