

Composing short 3-compressing words on a 2 letter alphabet

Alessandra Cherubini^{1*} and Achille Frigeri^{1†} and Zuhua Liu^{1,2‡}

¹*Dipartimento di Matematica “F.Brioschi”, Politecnico di Milano*

²*Department of Mathematics, Kunming University*

A finite deterministic (semi)automaton $\mathcal{A} = (Q, \Sigma, \delta)$ is k -compressible if there is some word $w \in \Sigma^+$ such that the image of the state set Q under the natural action of w is reduced by at least k states. Such word, if it exists, is called a k -compressing word for \mathcal{A} . A word is k -collapsing if it is k -compressing for each k -compressible automaton. We compute a set Γ of short words such that all 3-compressible automata on a two letter alphabet with a letter acting as a permutation are 3-compressed by a word in Γ . Then we construct a shortest common superstring of the words in Γ and we show that it is a 3-collapsing word of length 53. Moreover, as previously announced, we show that the shortest 3-synchronizing word is not 3-collapsing, illustrating the new bounds $34 \leq c(2, 3) \leq 53$ for the length $c(2, 3)$ of the shortest 3-collapsing word on a two letter alphabet.

Keywords: some well classifying words

1 Introduction

Let $\mathcal{A} = (Q, \Sigma, \delta)$ be a finite deterministic complete (semi)automaton with state set Q , input alphabet Σ , and transition function $\delta : Q \times \Sigma \rightarrow Q$. For any word $w \in \Sigma^+$, the deficiency of w is the difference between the cardinality of Q and the cardinality of the image of Q under the natural action of w . For a fixed $k \geq 1$, the word w is called k -compressing for \mathcal{A} if its deficiency is greater or equal to k . An automaton \mathcal{A} is k -compressible, if there exists a k -compressing word for \mathcal{A} . A word $w \in \Sigma^+$ is k -collapsing, if it is k -compressing for every k -compressible automaton with input alphabet Σ . A word $w \in \Sigma^+$ is called k -synchronizing if it is k -compressing for all k -compressible automata with $k + 1$ states and input alphabet Σ . Obviously each k -collapsing word is also k -synchronizing.

The concept of k -collapsing words arose (under a different name) in the beginning of the 1990s with original motivations coming from combinatorics and abstract algebra (Sauer and Stone (1991); Pöschel et al. (1994)). In Sauer and Stone (1991) it has been proved that k -collapsing words always exist, for

*Email: alessandra.cherubini@polimi.it

†Email: achille.frigeri@polimi.it

‡Email: liuzuhua@hotmail.com

§This work was completed during the third-named author’s visit to Politecnico di Milano which was supported by the CSC (China Scholarship Council), and acknowledges support from National Natural Science Foundation of China, grant No. 11261066.

any Σ and any $k \geq 1$, by means of a recursive construction which gives a k -collapsing word whose length is $O(2^{2^k})$. Better lower and upper bounds for $c(k, t)$ and $s(k, t)$, the length of the shortest k -collapsing and k -synchronizing words respectively, on an alphabet of cardinality t were given in Margolis et al. (2004). The bounds for $c(2, t)$ were slightly improved in Pribavkina (2005) and Cherubini et al. (2009), but the gaps from lower and upper bounds are quite large even for small values of k and t . Exact values of $s(k, t)$ and $c(k, t)$ are known for $k = 2$ and $t = 2, 3$ and are quite far from the theoretical upper bounds (Ananichev et al. (2005)). Moreover it is known that $s(3, 2) = 33$ and that the words $s_{3,2} = ab^2aba^3b^2a^2babab^2a^2b^3aba^2ba^2b^2a$ and its dual $\bar{s}_{3,2}$ are the unique shortest synchronizing words on $\{a, b\}$ (Ananichev and Petrov (2003)). Observing that $s(k, t) \leq c(k, t)$, and applying the construction in Margolis et al. (2004), one gets $33 \leq c(3, 2) \leq 154$.

The reader is referred to Ananichev et al. (2005); Cherubini (2007); Cherubini et al. (2009); Margolis et al. (2004) for references and connections to Theoretical Computer Science and Language Theory. The paper is organized as follows: in Section 2 we introduce some general concepts about 3-compressible automata, in Section 4 we give a complete characterization of proper 3-compressible automata on a two letter alphabet with a letter acting as a permutation. In Section 5 we describe how to use the previous characterization to obtain a short 3-collapsing word for automata with a permutation. In Section 6 we characterize all proper 3-compressible automata without permutations on a two letter alphabet, showing that the word found in the previous section also 3-compresses them, improving the known upper bound for $c(3, 2)$, as already announced in Cherubini et al. (2011). Section 7 ends the paper with some considerations about the quest for short 3-collapsing words in general and the relationship between 3-synchronizing and 3-collapsing words.

2 Background

Let $\mathcal{A} = (Q, \Sigma, \delta)$ be a finite deterministic complete semiautomaton with state set Q , input alphabet $\Sigma = \{a, b\}$, and transition function $\delta : Q \times \Sigma \rightarrow Q$. The action of Σ on Q given by δ extends naturally, by composition, to the action of any word $w \in \Sigma^+$ on $q \in Q$; we denote it by $qw = \delta(q, w)$, while the action of w on the entire state set Q is denoted by $Qw = \{qw | q \in Q\}$.

Definition 1 *The difference $|Q| - |Qw|$ is called the deficiency of the word w with respect to \mathcal{A} and denoted by $df_{\mathcal{A}}(w)$. For a fixed $k \geq 1$, a word $w \in \Sigma^+$ is called k -compressing for \mathcal{A} , if $df_{\mathcal{A}}(w) \geq k$. An automaton \mathcal{A} is k -compressible, if there exists a k -compressing word for \mathcal{A} . A word $w \in \Sigma^+$ is k -collapsing, if it is k -compressing for every k -compressible automaton with input alphabet Σ . A word w is called k -synchronizing if it is k -compressing for all k -compressible automata with $k + 1$ states and input alphabet Σ . Obviously each k -collapsing word is also k -synchronizing.*

Actually, we view the automaton \mathcal{A} as a set of *transformations* on Q induced via δ and labeled by letters of Σ , rather than as a standard triple. Indeed, in order to define an automaton, it is enough just to assign to every letter $a \in \Sigma$ the corresponding transformation $\tau_a : q \rightarrow \delta(q, a)$ on Q . Now, for $a \in \Sigma$, we get $df_{\mathcal{A}}(a) = |Q| - |\text{Im}(\tau_a)|$, hence $df_{\mathcal{A}}(a) = 0$ if and only if τ_a is a permutation on Q . If $df_{\mathcal{A}}(a) = m \geq 1$, then there are exactly m different states $y_1, y_2, \dots, y_m \notin \text{Im}(\alpha)$, and there are some elements of Q whose images under τ_a are equal.

Definition 2 *Let $\mathcal{P} = \{\{x_{1_1}, \dots, x_{j_1}\}, \dots, \{x_{1_r}, \dots, x_{j_r}\}\}$ be a partition of Q (where singleton sets are omitted), and $y_1, \dots, y_m \in Q$, we say that τ_a is a transformation of type $[x_{1_1}, \dots, x_{j_1}] \dots [x_{1_r}, \dots, x_{j_r}] \setminus y_1, \dots, y_m$ if \mathcal{P} is the partition induced by the kernel of τ_a and the states y_1, y_2, \dots, y_m do not belong to $\text{Im}(\tau_a)$.*

Remark 3 For instance, if \mathcal{A} has at least three states denoted by 1, 2 and 3, the transformation τ is of type $[1, 2] \setminus 3$, if and only if $\tau(1) = \tau(2)$, the preimage of 3 is empty, and for any $q, q' \notin \{1, 2\}$, $\tau(q) = \tau(q')$ if and only if $q = q'$.

Remark 4 In the sequel we will identify each letter of the input alphabet with its corresponding transformation.

Definition 5 Let $a \in \Sigma$, we say that a is a permutation letter if it induces a permutation on the set of states, i.e., it has deficiency 0. We assume that permutations on Q , viewed as elements of the symmetric group S_n with $|Q| = n$, are written in the factorization in disjoint cycles where sometimes also cycles of length 1 are explicitly written.

The notion of transformation induced by a letter naturally extends to words, and then the semigroup generated by the transformations of \mathcal{A} consists precisely of the transformations corresponding to words in Σ^+ . If \mathcal{A} is k -compressible at least one letter of its input alphabet has deficiency greater than 0. It is well known that each k -collapsing word over a fixed alphabet Σ is k -full (Sauer and Stone (1991)), i.e., contains each word of length k on the alphabet Σ among its factors. Hence, to characterize k -collapsing words it is enough to consider k -full words compressing all proper k -compressible automata, i.e., k -compressible automata which are not compressed by any word of length k .

Proposition 6 Let \mathcal{A} be a finite complete automaton on the alphabet $\{a, b\}$: it is 3-compressible and not proper if at least one letter, say a , fulfills one of the following conditions:

1. it has deficiency greater than 2;
2. it has deficiency 2 and is of type $[x, y, z] \setminus u, v$, with $\{u, v\} \not\subseteq \{x, y, z\}$;
3. it has deficiency 2 and is of type $[x, y][z, v] \setminus u, w$, with either $\{u, w\} = \{x, y\}$, or $\{u, w\} = \{z, v\}$, or $\{u, w\} \not\subseteq \{x, y, z, v\}$;
4. it has deficiency 1 and is of type $[x, y] \setminus u$, with $u \notin \{x, y\}$ and $ua \notin \{x, y\}$.

The proof of the previous proposition is trivial, indeed if the letter a fulfills one of the above conditions, then either a or a^2 or a^3 has deficiency 3. Since we are looking for a 3-compressible proper automaton we may assume that each letter of the alphabet either is a permutation or is of one of the following types (we assume different letters represent different states):

1. $[x, y, z] \setminus x, y$;
2. $[x, y][z, v] \setminus x, z$;
3. $[x, y] \setminus x$;
4. $[x, y] \setminus z$ with $za \in \{x, y\}$.

In the sequel we view the set Q of the states of \mathcal{A} as a set of natural numbers: $Q = \{1, 2, \dots, n\}$, so that, when no confusion arises, a letter a of types 1., 2., 3., 4. is denoted respectively by $[1, 2, 3] \setminus 1, 2$, $[1, 2][3, 4] \setminus 1, 3$, $[1, 2] \setminus 1$, $[1, 2] \setminus 3$ with $3a \in \{1, 2\}$.

Definition 7 Let $w \in \Sigma^+$, we call $\mathcal{M}(w) = Q \setminus Qw$ the missing set of w . Let $Q_1 \subseteq Q$, we denote by $\mathcal{M}(Q_1, w)$ the set $\mathcal{M}(w) \cup \{qw \mid q \in Q_1 \text{ and } \forall q' \in Q \setminus Q_1, qw \neq q'w\}$, i.e., the missing set of a having already missed Q_1 .

Remark 8 Observe that $\mathcal{M}(Q, w) = Q$, $\mathcal{M}(\emptyset, w) = \mathcal{M}(w)$, and if $a \in \Sigma$ is a permutation, $\mathcal{M}(Q_1, a) = Q_1a$. Moreover, $|\mathcal{M}(w)| \geq |\mathcal{M}(w_1)|$, whenever w_1 is a factor of w .

Definition 9 For a permutation letter a and $Q_1 \subseteq Q$, we call the orbit of a over Q_1 the set $Orb_a(Q_1) = \bigcup_{n=0}^{+\infty} Q_1a^n = \bigcup_{q \in Q_1} Orb_a(q)$.

We say that \mathcal{A} is a (\mathbf{i}, \mathbf{j}) -automaton, $1 \leq i, j \leq 4$, if it is an automata on a two letter alphabet $\{a, b\}$ and one letter is of type \mathbf{i} . and the other letter is of type \mathbf{j} . We say that \mathcal{A} is a (\mathbf{i}, \mathbf{p}) -automaton, with $1 \leq i \leq 4$, to denote that a letter is of type \mathbf{i} . and the other letter is a permutation. In the sequel, without loss of generality, we will always suppose that in a (\mathbf{i}, \mathbf{j}) -automaton (resp. (\mathbf{i}, \mathbf{p}) -automaton) the letter a is of type \mathbf{i} . and b is of type \mathbf{j} . (resp. a permutation).

3 3-Missing state automata

Per quel che ci serve introduciamo i 3MSA

Definition 10 3MSA

Definition 11 Conditional 3MSA

4 3-compressible (\mathbf{i}, \mathbf{p}) -automata

In this section we characterize all proper 3-compressible automata over the alphabet $\{a, b\}$ in which the letter b acts as a permutation on the set Q of states. In particular in the following four lemmata we give a small set of short 3-collapsing words when letter a is of type \mathbf{i} , $1 \leq i \leq 4$.

Proposition 12 Let \mathcal{A} be a $(\mathbf{1}, \mathbf{p})$ -automaton with $a = [1, 2, 3] \setminus 1, 2$. \mathcal{A} is proper and 3-compressible if, and only if, the following conditions hold:

1. $Orb_b(1, 2) \not\subseteq \{1, 2, 3\}$, and
2. $\{1, 2\}b \subset \{1, 2, 3\}$.

Proof: We start proving that a $(\mathbf{1}, \mathbf{p})$ -automaton that does not satisfies the conditions 1 and 2 is not proper or it is not 3-compressible.

1. Let $Orb_b(1, 2) \subseteq \{1, 2, 3\}$, then \mathcal{A} is not 3-compressible, indeed it is immediate to see that for all word $w \in \{a, b\}^*$, then $\mathcal{M}(wa) = \{1, 2\}$.
2. Let $\{1, 2\}b \not\subseteq \{1, 2, 3\}$, then $\mathcal{M}(a) = \{1, 2\}$, $\mathcal{M}(ab) = \{1b, 2b\} \not\subseteq \{1, 2, 3\}$, and $|\mathcal{M}(aba)| = 3$, so the automaton is not proper.

Conversely, we prove that an automaton satisfying conditions 1 and 3 is proper and 3-compressed by the word ab^2a . First observe that a 3-compressing word must have at least two non-consecutive occurrences of letter a , and the word aba is not 3-compressing. Moreover, $\{1, 2\}b^2 \not\subseteq \{1, 2, 3\}$, else $Orb_b(1, 2) \subseteq \{1, 2, 3\}$, against the hypothesis, and then the word ab^2a is 3-compressing. \square

Proposition 13 *Let \mathcal{A} be a $(\mathbf{2}, \mathbf{p})$ -automaton with $a = [1, 2][3, 4] \setminus 1, 3$. Then \mathcal{A} is 3-compressible if, and only if,*

1. $Orb_b(1, 3) \not\subseteq \{1, 2, 3, 4\}$, or
2. $\{1, 3\}b \in \{\{1, 2\}, \{3, 4\}\}$, or
3. $\{1, 3\}b \in \{\{1, 4\}, \{2, 3\}\}$ and $|Orb_b(1)| = 3$ or $|Orb_b(3)| = 3$.

Moreover, if \mathcal{A} is 3-compressible, then it is proper if and only if $\{1, 3\}b \in \{\{1, 4\}, \{2, 3\}, \{2, 4\}\}$, and in such case one of the words ab^2a , ab^3a 3-compresses \mathcal{A} .

Proof: We start proving that a $(\mathbf{2}, \mathbf{p})$ -automaton that does not satisfies the conditions 1 – 3 is not 3-compressible. So, let $Orb_b(1, 3) \subseteq \{1, 2, 3, 4\}$, then we have to consider only the following cases:

1. $\{1, 3\}b = \{1, 3\}$; in Fig. 1 we draw the complete 3-missing state automaton for this case, proving that the automaton is not 3-compressible.
2. $\{1, 3\}b = \{1, 4\}$ with $|Orb_b(1)| \neq 3$ or $|Orb_b(3)| \neq 3$, in this case we have this two subcases:
 - (a) $b = (1\ 4\ 2\ 3)\pi$;
 - (b) $b = (1)(3\ 4)\pi$;

and in Fig. 2 we draw the complete 3-missing state automata for this cases, proving that the automaton is not 3-compressible.

3. $\{1, 3\}b = \{2, 3\}$, which is analogous to the previous one;
4. $\{1, 3\}b = \{2, 4\}$, in this case we have this two subcases:
 - (a) $b = (1\ 2)(3\ 4)\pi$ or
 - (b) $b = (1\ 4)(3\ 2)\pi$.

and in Fig. 3 we draw the complete 3-missing state automaton for this cases, proving that the automaton is not 3-compressible.

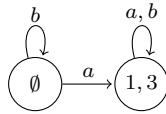

Fig. 1: 3MSA for the case $\{1, 3\}b = \{1, 3\}$

Conversely,

1. if $Orb_b(1, 3) \not\subseteq \{1, 2, 3, 4\}$, then there exists $n \in \mathbb{N}$ such that $\{1, 3\}b^n \not\subseteq \{1, 2, 3, 4\}$, hence $ab^n a$ 3-compresses \mathcal{A} .

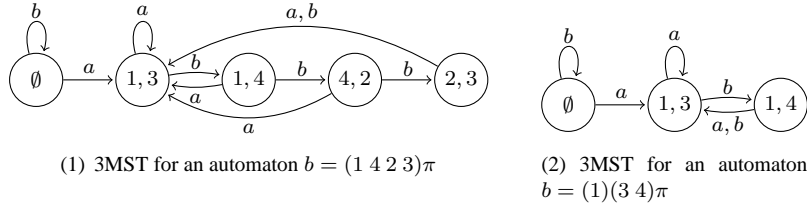

Fig. 2: 3MSA for the case $\{1, 3\}b = \{1, 4\}$ with $|Orb_b(1)| \neq 3$ or $|Orb_b(3)| \neq 3$.

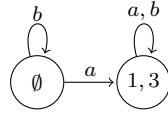
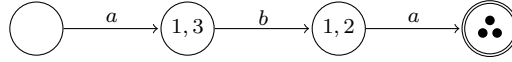

Fig. 3: 3MSA for the case $b = (1\ 2)(3\ 4)\pi$ or $b = (1\ 4)(3\ 2)\pi$

2. Without loss of generality, let us suppose $\{1, 3\}b = \{1, 2\}$. Then the partial missing state automaton is



and aba 3-compresses \mathcal{A} .

3. Suppose $\{1, 3\}b = \{1, 4\}$. If $|Orb_b(1)| = 3$, then $1b = 4$ and $3b = 1$, i.e., $b = (1\ 4\ 3)\pi$ for some permutation π disjoint from $(1\ 4\ 3)$. Then the partial missing state automaton is

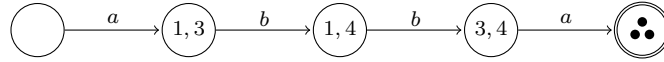

and ab^2a 3-compresses \mathcal{A} . If $|Orb_b(3)| = 3$, then or $b = (1\ 4\ 3)\pi$ for some permutation π disjoint from $(1\ 4\ 3)$, or b fixes 1 and is of the form $(3\ 4\ x)\pi$ for some $x \neq 1$ and for some permutation π disjoint from $(3\ 4\ x)$. Then the partial missing state automaton is

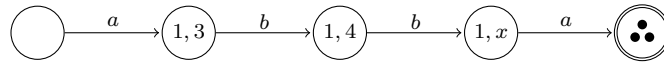

and again ab^2a 3-compresses \mathcal{A} .

From the previous analysis is clear that if \mathcal{A} is 3-compressible, it is also proper only if $\{1, 3\}b \in \{\{1, 4\}, \{2, 3\}, \{2, 4\}\}$. If $Orb_b(1, 3) \not\subseteq \{1, 2, 3, 4\}$ and $\{1, 3\}b \in \{\{1, 4\}, \{2, 3\}, \{2, 4\}\}$, then if $x \in \{1, 3\}b^2 \setminus \{1, 2, 3, 4\}$ or $\{1, 3\}b^2 \in \{\{1, 2\}, \{3, 4\}\}$ the word ab^2a 3-compresses \mathcal{A} while aba does not. Otherwise $\{1, 3\}b^2 \in \{\{1, 4\}, \{2, 3\}, \{2, 4\}\}$. If $\{1, 3\}b = \{2, 4\}$, then $\{1, 3\}b^2 = \{2, 4\}b$ does not belong to $\{\{1, 4\}, \{2, 3\}, \{2, 4\}\}$, against the hypothesis. If $\{1, 3\}b = \{1, 4\}$, then $\{1, 3\}b^2 = \{1, 4\}b = \{2, 4\}$ whence $1b = 4, 3b = 1, 4b = 2$, while if $\{1, 3\}b = \{2, 3\}$ then $\{1, 3\}b^2 = \{2, 3\}b = \{2, 4\}$ whence

$3b = 2, 1b = 3, 2b = 4$. As $Orb_b(1, 3) \not\subseteq \{1, 2, 3, 4\}$, in the former case we have $2b = 1b^3 \notin \{1, 2, 3, 4\}$, in the latter $4b = 3b^3 \notin \{1, 2, 3, 4\}$, and in both cases ab^3a 3-compresses \mathcal{A} while aba and ab^2a do not. \square

Proposition 14 *Let \mathcal{A} be a $(\mathbf{3}, \mathbf{p})$ -automaton with $a = [1, 2] \setminus 1$. Then \mathcal{A} is 3-compressible if and only if the following conditions holds:*

1. $1b \neq 1$, and
2. $\{1, 2\}b \neq \{1, 2\}$, and
3. if $b = (13)\pi$, then $3a \neq 3$, and
4. if $b = (13)(2)\pi$, or $b = (123)\pi$, or $b = (132)\pi$, then $\{2, 3\}a \neq \{2, 3\}$, and
5. if $b = (13)(24)\pi$, or $b = (1324)\pi$, then $\{3, 4\}a \neq \{3, 4\}$.

Proof: We start proving that a $(\mathbf{3}, \mathbf{p})$ -automaton that does not satisfies the conditions 1 – 5 is not 3-compressible.

1. Let $1b = 1$, then it is easy to see that for all $w \in b^*$, $\mathcal{M}(w) = \emptyset$, and for all $w \in \{a, b\}^* \setminus b^*$, $\mathcal{M}(w) = \{1\}$, so the automaton is not 3-compressible.
2. Let $\{1, 2\}b = \{1, 2\}$, then it is easy to see that for all $w \in \{a, b\}b$, $\mathcal{M}(w) \in \{\emptyset, \{2\}\}$, and for all $w \in \{a, b\}a$, $\mathcal{M}(w) = \{1\}$, so the automaton is not 3-compressible.
3. Let $b = (13)\pi$ and $3a = 3$; in Fig. 4 we draw the complete 3-missing state automaton for this cases, proving that the automaton is not 3-compressible.

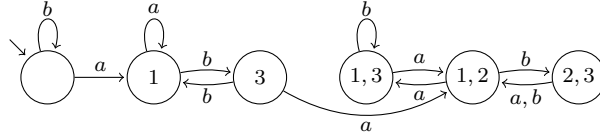

Fig. 4: P3MSA for the case

4. Let $b = (13)(2)\pi$, or $b = (123)\pi$, or $b = (132)\pi$, and $\{2, 3\}a = \{2, 3\}$; in Fig. 5 we draw the complete 3-missing state automata for these cases, proving that the automaton is not 3-compressible. Observe that when $b = (13)(2)\pi$ we assume $3a = 2$, otherwise the previous consideration applies.
5. Let $b = (13)(24)\pi$ or $b = (1324)\pi$, and $\{3, 4\}a = \{3, 4\}$; in figures 6 and 7 we draw the complete 3-missing state automata for these cases, proving that the automaton is not 3-compressible.

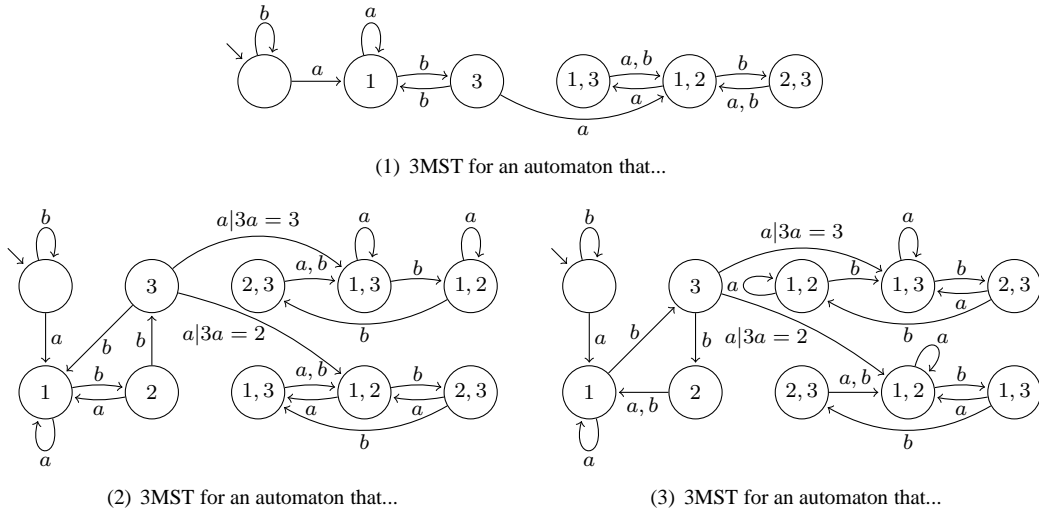

Fig. 5: 3-missing state automata for automata that satisfy ... of Proposition 14.

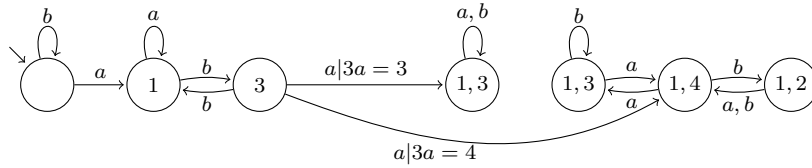

Fig. 6: P3MSA for the case

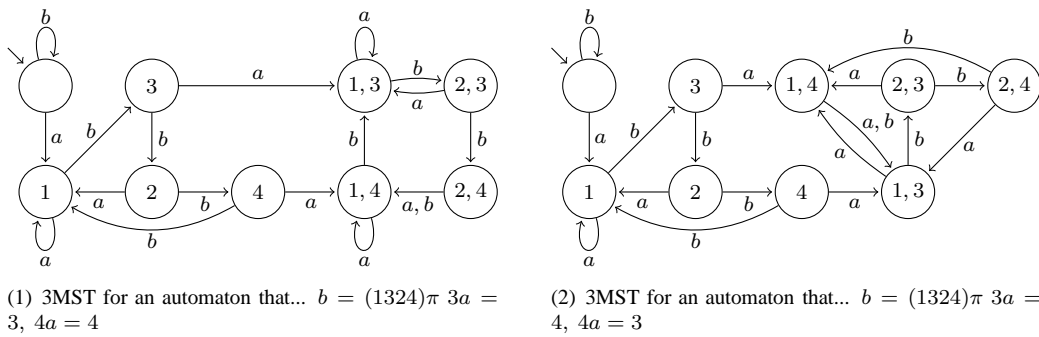

Fig. 7: 3-missing state automata for automata that satisfy ... of Proposition 14.

Conversely, we find for any automata satisfying conditions 1 – 5 a (short) 3-collapsing word. Recall That $1b \neq 1$ and $\{1, 2\}b \neq \{1, 2\}$, so $|Orb_b(1)| \geq 2$ and b is not of the form $(12)\pi$.

1. Let $|Orb_b(1)| = 2$, $b = (13)\pi$, and $3a \neq 3$, then there are three further subcases:
 - (a) if $|Orb_b(2)| = 1$, i.e., $b = (13)(2)\pi$, then $\{2, 3\}a \neq \{2, 3\}$ and in Fig. 8(1) we draw a partial conditional 3-missing state automaton for this case, proving that either the word $ababa$ or aba^2ba are 3-compressing.
 - (b) if $|Orb_b(2)| = 2$, i.e., $b = (13)(24)\pi$, then $\{3, 4\}a \neq \{3, 4\}$ and in Fig. 8(2) we draw a partial conditional 3-missing state automaton for this case, proving that either the word $ababa$ or aba^2ba are 3-compressing.
 - (c) if $|Orb_b(2)| \geq 3$, i.e., $b = (13)(245)\pi$, then in Fig. 8(3) we draw a partial conditional 3-missing state automaton for this case, proving that either the word $ababa$ or $abab^3a$ are 3-compressing.

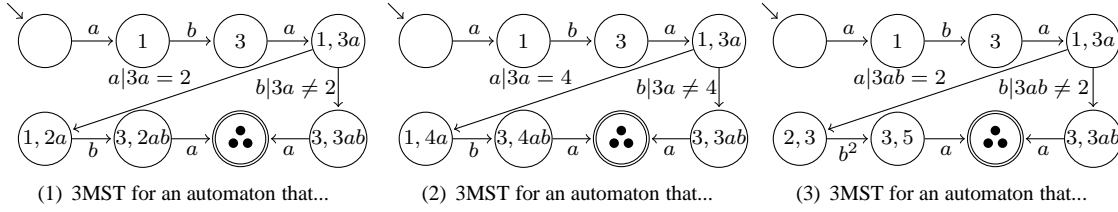
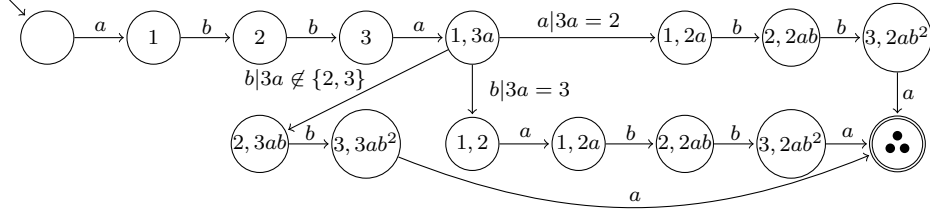
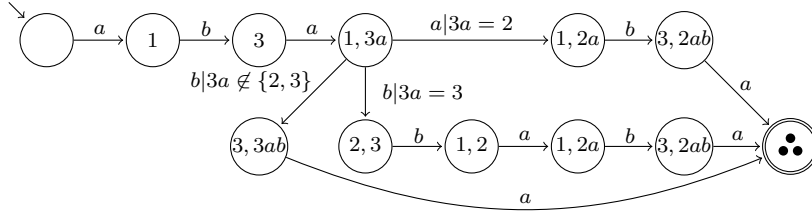

Fig. 8: 3-missing state automata for automata that satisfy ... of Proposition 14.

2. Let $|Orb_b(1)| = 3$, then there are three further subcases:
 - (a) if $b = (123)\pi$, then $\{2, 3\}a \neq \{2, 3\}$ and in Fig. 9 we draw a partial conditional 3-missing state automaton for this case, proving that either the word ab^2ab^2a or $ab^2a^2b^2a$ or ab^2abab^2a are 3-compressing.
 - (b) if $b = (132)\pi$, then $\{2, 3\}a \neq \{2, 3\}$ and in Fig. 10 we draw a partial conditional 3-missing state automaton for this case, proving that either the word or are 3-compressing.
 - (c) if $b = (134)\pi$, then in Fig. 11 we draw a partial conditional 3-missing state automaton for this case, proving that either the word are 3-compressing.
3. Let $|Orb_b(1)| = 4$, then there are three further subcases:
 - (a) if $b = (1234)\pi$, then in Fig. 12 we draw a partial conditional 3-missing state automaton for this case, proving that either the word ... are 3-compressing.
 - (b) if $b = (1324)\pi$, then $\{3, 4\}a \neq \{3, 4\}$ and in Fig. 13 we draw a partial conditional 3-missing state automaton for this case, proving that either the word ... or are 3-compressing. Observe that if $3ab = 1$, then $3a = 4$, $4a \neq 3$, and so $4ab \notin \{1, 2\}$, else if $3ab = 2$, then $3a = 3$, $4a \notin \{3, 4\}$, and again $4ab \notin \{1, 2\}$.

Fig. 9: P3MSA for the case ... $b = (123)$ Fig. 10: P3MSA for the case ... $b = (132)$

4. Let $|Orb_b(1)| \geq 5$, then there are three further subcases:

- (a) if $b = (12345\dots)\pi$, then $\{3ab^2, 4ab^3, 3abab^2, 3a^2b^2\} \not\subseteq \{1, 2\}$.
 Indeed suppose $\{3ab^2, 4ab^3, 3abab^2, 3a^2b^2\} \subseteq \{1, 2\}$, then we have the following possibilities.
- (1) $3ab^2 = 1$
 - (I) $4ab^3 = 1$, then $3a = 4ab$ and $3ab = 4ab^2$
 - (A) $3abab^2 = 1$, then $3a = 3aba$, $3 = 3ab$, and $3b = 3ab^2 = 1$, abs.
 - (B) $3abab^2 = 2$, then $3abab = 1 = 3ab^2 = 4ab^3$ and $3aba = 3ab = 4ab^2$
 - (i) $3a^2b^2 = 1$, then $3a^2b^2 = 3ab^2$, $3a^2 = 3a$, $3a = 3$ and $3b^2 = 1$, abs.
 - (ii) $3a^2b^2 = 2$, then $3a^2b^2 = 3abab^2$ and $3a^2 = 3aba$
 - (a) $3a = 3ab$, then $3a = 3$, and $3b^2 = 2$, abs.
 - (b) $3a = 1$, abs.
 - (c) $3a = 2$, then from $3abab^2 = 2$ follows $2b^2 = 2$, abs.
 - (II) $4ab^3 = 2$, then $4ab^2 = 1$ and $3a = 4a$, abs.
 - (2) $3ab^2 = 2$, then $3ab = 1$
 - (I) $4ab^3 = 1$, then $3ab = 4ab^3$ and $3a = 4ab^2$
 - (A) $3abab^2 = 1$, then $1ab^2 = 3ab$ and $1ab = 3a$
 - (i) $3a^2b^2 = 1$, then $3a^2 = 3aba$
 - (a) $3a = 3ab$, then $3a = 1$, abs.
 - (b) $3a = 1$, abs.
 - (c) $3a = 2$, then $3abab^2 = 1$, $2bab^2 = 1$, $3ab^2 = 1$, $2b^2 = 1$, abs.

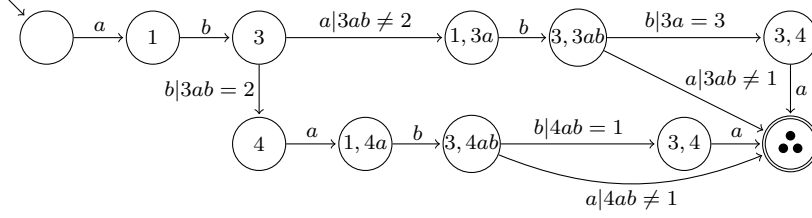
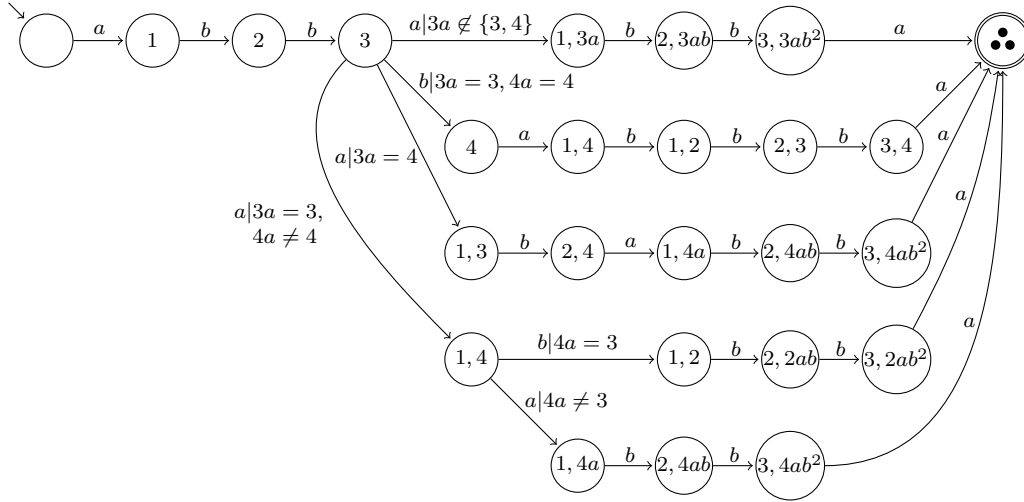
 Fig. 11: P3MSA for the case $b = (134)$

 Fig. 12: P3MSA for the case $b = (1234)$

- (ii) $3a^2b^2 = 2$, then $3a = 3a^2$
 - (a) $3a = 3$, then $3b^2 = 2$, abs.
 - (b) $3a = 1$, abs.
 - (c) $3a = 2$, then $3abab^2 = 1$, $2bab^2 = 1$, $3ab^2 = 1$, $2b^2 = 1$, abs.
- (B) $3abab^2 = 2$, then $3aba = 3a$ and $1a = 3a$, abs.
- (II) $4ab^3 = 2$, then $4ab = 3a$
 - (A) $3abab^2 = 1$, then $1ab^2 = 3ab = 4ab^2$, and then $1a = 4a$, abs.
 - (B) $3abab^2 = 2$, then $3aba = 3a$, and then $1a = 3a$, abs.

In any case we get a contradiction. Then, as $\mathcal{M}(ab^2ab^2) = \{3, 3ab^2\}$, $\mathcal{M}(ab^3ab^3) = \{4, 4ab^3\}$, $\mathcal{M}(ab^2abab^2) = \{3, 3abab^2\}$, and $\mathcal{M}(ab^2a^2b^2) = \{3, 3a^2b^2\}$, at least one of the word ab^2ab^2a , ab^3ab^3a , ab^2abab^2a or $ab^2a^2b^2a$ is 3-collapsing.

- (b) if $b = (13245\dots)\pi$, then in Fig. 14 we draw a partial conditional 3-missing state automaton for this case, proving that either the word ... or are 3-compressing.
- (c) if $b = (13425\dots)\pi$, then $\mathcal{M}(abab) = \{3, 3ab\}$. If $3ab \notin \{1, 2\}$, then the word $ababa$

Fig. 13: P3MSA for the case $b = (1324)$ 

Fig. 14: 3MSA for the case

is 3-compressing, else if $3ab = 1$, then $\mathcal{M}(ababb) = \{3, 4\}$ and the word $abab^2a$ is 3-compressing, else if $3ab = 2$, then $\mathcal{M}(ababb) = \{4, 5\}$ and again the word $abab^2a$ is 3-compressing.

□

Proposition 15 Let \mathcal{A} be a $(4, \mathbf{p})$ -automaton with $a = [1, 2] \setminus 3, 3a = 1$. Then \mathcal{A} is 3-compressible if and only if the following conditions holds:

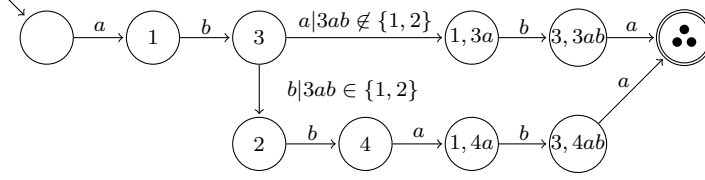
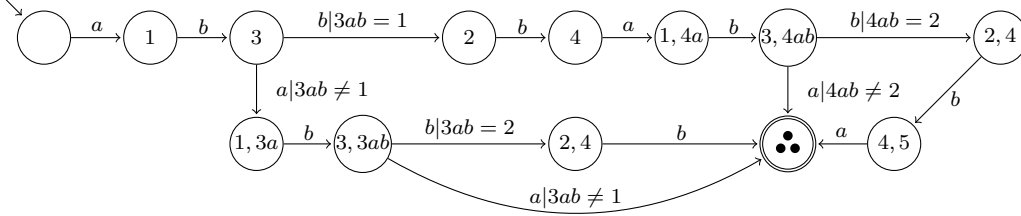
1. $\{1, 3\}b \neq \{1, 3\}$;
2. $b \neq (12)(3)\pi$;
3. if $b = (1)(23)\pi$, or $b = (123)\pi$, or $b = (132)\pi$, then $2a \neq 2$;
4. if $b = (1)(2)(34)\pi$, or $b = (12)(34)\pi$, or $b = (14)(23)\pi$, or $b = (1423)\pi$, or $b = (1324)\pi$, then $4a \neq 2$.

Proof: We start proving that a $(4, \mathbf{p})$ -automaton that does not satisfies the conditions 1 – 4 is not 3-compressible.

1. Let $\{1, 3\}b = \{1, 3\}$; in Fig. 15(1) we draw the complete 3-missing state automata for these cases, proving that if condition 1 is false, that the automaton is not 3-compressible.
2. Let $b \neq (12)(3)\pi$; in Fig. 15(2) we draw the complete 3-missing state automata for these cases, proving that if condition 1 is false, that the automaton is not 3-compressible.
3. We consider the three subcases separately.

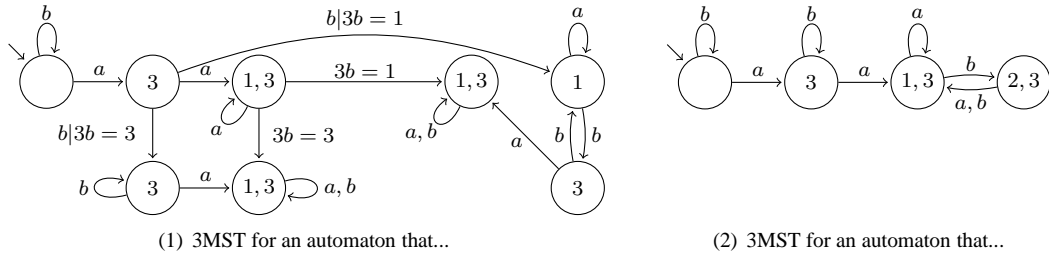

Fig. 15: 3-missing state automata for automata that satisfy ... of Proposition 15.

- (a) Let $b = (1)(23)\pi$ and $2a = 2$; in Fig. 16(1) we draw the complete 3-missing state automata proving that in this case the automaton is not 3-compressible.
- (b) Let $b = (123)\pi$ and $2a = 2$; in Fig. 16(2) we draw the complete 3-missing state automata proving that in this case the automaton is not 3-compressible.
- (c) Let $b = (132)\pi$ and $2a = 2$; in Fig. 16(3) we draw the complete 3-missing state automata proving that in this case the automaton is not 3-compressible.

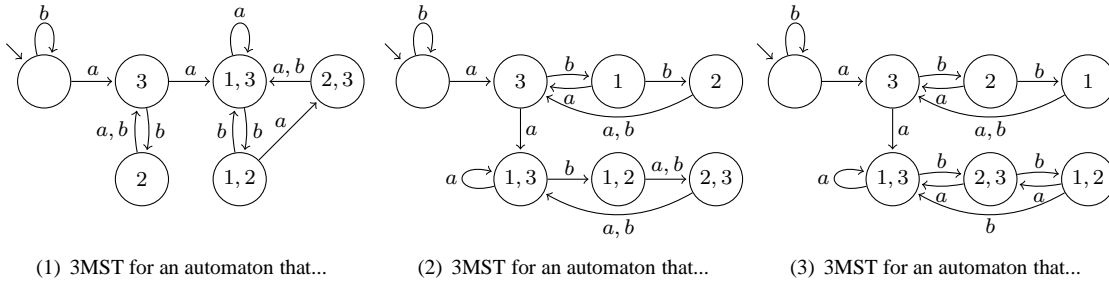

Fig. 16: 3-missing state automata for automata that satisfy ... of Proposition 15.

4. We consider four subcases.

- (a) Let $b = (1)(2)(34)\pi$ or $b = (12)(34)\pi$ and in both cases $4a = 2$; in Fig. 17(1) we draw the complete 3-missing state automata proving that in these case the automaton is not 3-compressible.
- (b) Let $b = (14)(23)\pi$ and $4a = 2$; in Fig. 17(2) we draw the complete 3-missing state automata proving that in this case the automaton is not 3-compressible.
- (c) Let $b = (1423)\pi$ and $4a = 2$; in Fig. 18(1) we draw the complete 3-missing state automata proving that in this case the automaton is not 3-compressible.
- (d) Let $b = (1324)\pi$ and $4a = 2$; in Fig. 18(2) we draw the complete 3-missing state automata proving that in this case the automaton is not 3-compressible.

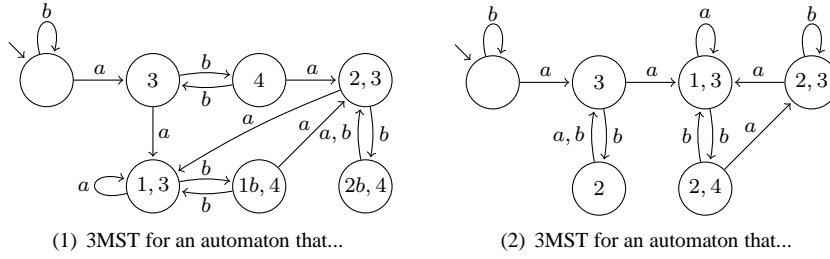

Fig. 17: 3-missing state automata for automata that satisfy ... of Proposition 15.

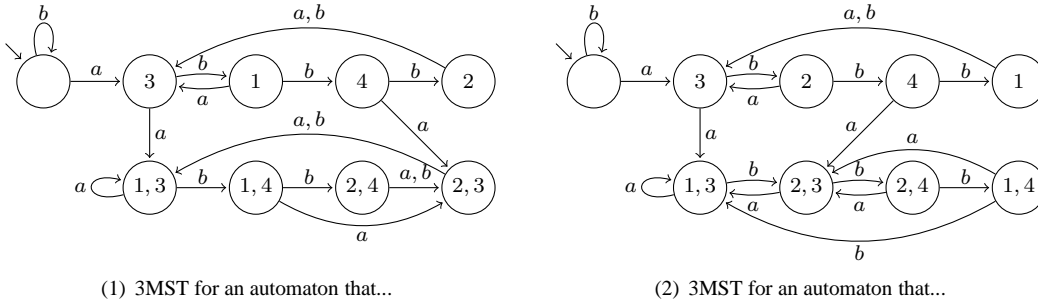

Fig. 18: 3-missing state automata for automata that satisfy ... of Proposition 15.

Conversely, we find for any automata satisfying conditions 1 – 4 a (short) 3-collapsing word. We distinguish the case $Orb_b(1, 3) \subseteq \{1, 2, 3\}$ from the case $Orb_b(1, 3) \not\subseteq \{1, 2, 3\}$.

If $Orb_b(1, 3) \subseteq \{1, 2, 3\}$, then $Orb_b(1, 3) = \{1, 2, 3\}$, as $\{1, 3\}b \neq \{1, 3\}$. There are two subcases:

1. if $b = (1)(23)\pi$ or $b = (123)\pi$, and $2a \neq 2$, then $\mathcal{M}(a) = \{3\}$, $\mathcal{M}(aa) = \{1, 3\}$, $\mathcal{M}(aab) = \{1, 2\}$, $\mathcal{M}(aaba) = \{2a, 3\}$, and $\mathcal{M}(aabaa) = \{1, 3, 2aa\}$, and the word $aabaa$ is 3-compressing;
2. if $b = (132)\pi$ and $2a \neq 2$, then $\mathcal{M}(a) = \{3\}$, $\mathcal{M}(aa) = \{1, 3\}$, $\mathcal{M}(aab) = \{2, 3\}$, $\mathcal{M}(aabb) = \{1, 2\}$, $\mathcal{M}(aabba) = \{2a, 3\}$, and $\mathcal{M}(aabbaa) = \{1, 3, 2aa\}$, and the word $aabbaa$ is 3-compressing.

Let now $Orb_b(1, 3) \not\subseteq \{1, 2, 3\}$, we distinguish four subcases by considering the cardinality of $Orb_b(3)$.

1. Let $Orb_b(3) = \{3\}$, then there are two further subcases:
 - (a) if $b = (14\dots)(3)\pi$, then $\mathcal{M}(a) = \{3\}$, $\mathcal{M}(aa) = \{1, 3\}$, $\mathcal{M}(aab) = \{3, 4\}$, $\mathcal{M}(aaba) = \{1, 3, 4a\}$, and the word $aaba$ is 3-compressing;
 - (b) if $b = (124\dots)(3)\pi$, then $\mathcal{M}(a) = \{3\}$, $\mathcal{M}(aa) = \{1, 3\}$, $\mathcal{M}(aab) = \{2, 3\}$, $\mathcal{M}(aabb) = \{3, 4\}$, $\mathcal{M}(aabba) = \{1, 3, 4a\}$, and the word $aabba$ is 3-compressing.
2. Let $Orb_b(3) = \{2, 3\}$, then there are two further subcases:

- (a) if $b = (14)(23)\pi$, and $4a \neq 2$, then $\mathcal{M}(a) = \{3\}$, $\mathcal{M}(aa) = \{1, 3\}$, $\mathcal{M}(aab) = \{2, 4\}$, $\mathcal{M}(aaba) = \{3, 4a\}$, $\mathcal{M}(aabaa) = \{1, 3, 4aa\}$, and the word $aabaa$ is 3-compressing;
- (b) if $b = (145 \dots)(23)\pi$, then $\mathcal{M}(a) = \{3\}$, $\mathcal{M}(aa) = \{1, 3\}$, $\mathcal{M}(aab) = \{2, 4\}$, $\mathcal{M}(aabb) = \{3, 5\}$, $\mathcal{M}(aabba) = \{1, 3, 5a\}$, and the word $aabba$ is 3-compressing.

3. Let $Orb_b(3) = \{3, 4\}$, then in Fig. 19 we draw a partial conditional 3-missing state automaton for this case, proving that either the word $abaa$ or $aaba$ or $aabbaa$ or $ababa$ are 3-compressing.

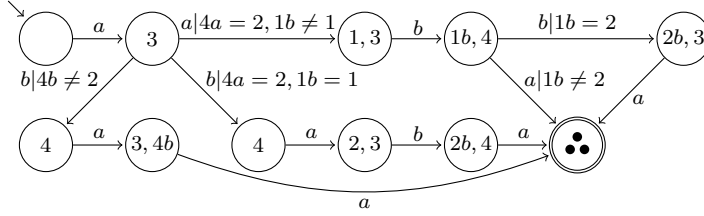

Fig. 19: P3MSA for the case

4. Let $|Orb_b(3)| \geq 3$, then there are three main subcases:

- (a) $3b = 1$.
 - i. If $b = (3124 \dots)\pi$, then $\mathcal{M}(a) = \{3\}$, $\mathcal{M}(\{3\}, a) = \{1, 3\}$, $\mathcal{M}(\{1, 3\}, b) = \{1, 2\}$, $\mathcal{M}(\{1, 2\}, b) = \{2, 4\}$, $\mathcal{M}(\{2, 4\}, b) = \{4, 4b\}$, $\mathcal{M}(\{4, 4b\}, a) = \{3, 4a, 4ba\}$ and the word a^2b^3a is 3-compressing.
 - ii. If $b = (314 \dots)\pi$, then in Fig. 20 we draw a partial conditional 3-missing state automaton for this case, proving that either the word a^2bab^2a or a^2b^2a or ab^2a^2 are 3-compressing. Observe that if $4a = 2$ and $4b = 2$, then b is of the form $(31425 \dots)$, otherwise condition 4 it is not satisfied.

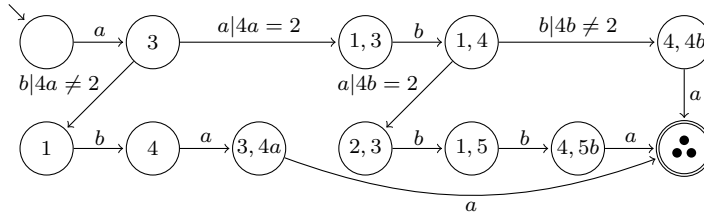

Fig. 20: P3MSA for the case

- (b) $3b = 2$.
 - i. If $b = (3214 \dots)\pi$, then in Fig. 21 we draw a partial conditional 3-missing state automaton for this case, proving that either the word a^2ba^2 or ab^3ab^3a are 3-compressing.

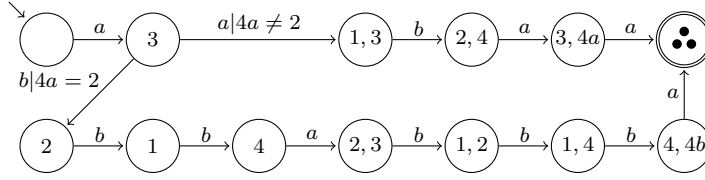

Fig. 21: P3MSA for the case

- ii. If $b = (324\dots)\pi$, then in Fig. 22 we draw a partial conditional 3-missing state automaton for this case, proving that either the word ab^2a^2 or a^2b^3a or a^2ba^2 are 3-compressing. Observe that when $4a = 2$ and $1b \neq 3$, then $1ba \notin \{1, 2\}$, otherwise either $1ba = 1 = 3a$ and then $1b = 3$, absurd, or $1ba = 2 = 4a$ and then $1b = 4$, absurd, as $2b = 4$.

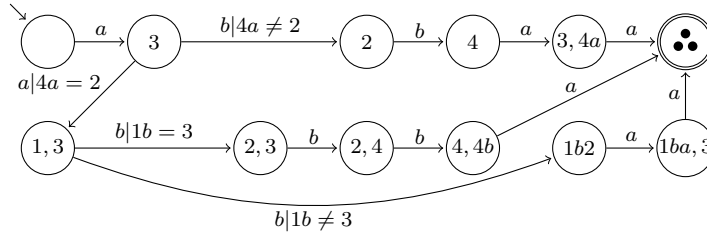

Fig. 22: P3MSA for the case

(c) $3b = 4$.

- i. If $1b \neq 2$, then $\mathcal{M}(a) = \{3\}$, $\mathcal{M}(\{3\}, a) = \{1, 3\}$, $\mathcal{M}(\{1, 3\}, b) = \{1b, 4\}$, $\mathcal{M}(\{1b, 4\}, a) = \{1ba, 3, 4a\}$, and the word a^2ba is 3-compressing.
- ii. If $1b = 2$ and $4b = 1$, i.e., $b = (3412\dots)\pi$ then $\mathcal{M}(a) = \{3\}$, $\mathcal{M}(\{3\}, b) = \{4\}$, and $\mathcal{M}(\{4\}, a) = \{3, 4a\}$. If $4a = 4$, then $\mathcal{M}(\{3, 4\}, a) = \{1, 3, 4a\}$, and the word aba^2 is 3-compressing; otherwise if $4a \neq 4$ (and $4a \notin \{1, 3\}$), then $\mathcal{M}(\{3, 4a\}, b) = \{4, 4ab\}$ (and $4ab \notin \{1, 2, 4\}$), $\mathcal{M}(\{4, 4ab\}, a) = \{3, 4a, 4aba\}$ and the word $ababa$ is 3-compressing.
- iii. If $1b = 2$ and $4b \neq 1$, i.e., $b = (345\dots)\pi$, then $\mathcal{M}(a) = \{3\}$ and $\mathcal{M}(\{3\}, b) = \{4\}$. If $5a = 2$, then $\mathcal{M}(\{4\}, a) = \{3, 4a\}$ (and $4a \notin \{1, 2, 3\}$), $\mathcal{M}(\{3, 4a\}, a) = \{1, 3, 4a^2\}$ and the word aba^2 is 3-compressing; otherwise if $5a \neq 2$, then $\mathcal{M}(\{4\}, b) = \{5\}$, $\mathcal{M}(\{5\}, a) = \{3, 5a\}$, $\mathcal{M}(\{3, 5a\}, a) = \{1, 3, 5a^2\}$ and the word ab^2a^2 is 3-compressing.

□

5 A short 3-compressing word automata for (i., p)-automata

From propositions 12, 13, 14 and 15, taking into account that the roles of letters a and b are interchangeable, the following corollary immediately follows:

Corollary 16 *Each 3-full word, containing as factors the following words is a 3-compressible word for each 3-compressible proper automaton on a 2 letter alphabet and a permutation:*

$$\begin{aligned} & abab^2aba, ab^2ab^2a, ab^2a^2b^2a, ab^2abab^2a, ab^3aba, abab^3a, ab^3ab^3a, a^2b^3a \\ & baba^2bab, ba^2ba^2b, ba^2b^2a^2b, ba^2baba^2b, ba^3bab, baba^3b, ba^3ba^3b, b^2a^3b. \end{aligned}$$

We find out that the length of a shortest common 3-full superstring for these words is 53, such word is for example

$$b^2a^3ba^3b^3aba^2baba^2ba^2b^2a^2b^2ab^2abab^2aba^3bab^3ab^3a.$$

6 3-compressible automata without permutations

In this section we characterize proper 3-compressible automata on 2-letter alphabet where no letter acts as permutation.

Proposition 17 *Let \mathcal{A} a (i, j) -automaton with $i \in \{1, 2\}$ and $j \in \{1, 2, 4\}$, then \mathcal{A} is either not 3-compressible or not proper.*

Proof: We have to consider five different cases.

1. Let \mathcal{A} be a $(1, 1)$ -automaton with $a = [1, 2, 3] \setminus 1, 2$ and $b = [x, y, z] \setminus x, y$:
 - (a) if $\{1, 2\} \subseteq \{x, y, z\}$ and $\{x, y\} \subseteq \{1, 2, 3\}$, then for any $w \in \{a, b\}^*$, we have $\mathcal{M}(wa) = \{1, 2\}$ and $\mathcal{M}(wb) = \{x, y\}$, so the automaton is not 3-compressible;
 - (b) if $\{1, 2\} \not\subseteq \{x, y, z\}$, then $\mathcal{M}(a) = \{1, 2\}$ and $|\mathcal{M}(ab)| \geq 3$, so the automaton is not proper;
 - (c) if $\{x, y\} \not\subseteq \{1, 2, 3\}$, then $\mathcal{M}(b) = \{x, y\}$ and $|\mathcal{M}(ba)| \geq 3$, so the automaton is not proper.
2. Let \mathcal{A} be a $(1, 2)$ -automaton with $a = [1, 2, 3] \setminus 1, 2$ and $b = [x, y][z, v] \setminus x, z$:
 - (a) if $\{1, 2\} \in \{\{x, z\}, \{x, v\}, \{y, z\}, \{y, v\}\}$ and $\{x, z\} \subseteq \{1, 2, 3\}$, then for any $w \in \{a, b\}^*$, we have $\mathcal{M}(wa) = \{1, 2\}$ and $\mathcal{M}(wb) = \{x, z\}$, so the automaton is not 3-compressible;
 - (b) if $\{1, 2\} \notin \{\{x, z\}, \{x, v\}, \{y, z\}, \{y, v\}\}$, then $\mathcal{M}(a) = \{1, 2\}$ and $|\mathcal{M}(ab)| \geq 3$, so the automaton is not proper;
 - (c) if $\{x, z\} \not\subseteq \{1, 2, 3\}$, then $\mathcal{M}(b) = \{x, z\}$ and $|\mathcal{M}(ba)| \geq 3$, so the automaton is not proper.
3. Let \mathcal{A} be a $(2, 2)$ -automaton with $a = [1, 2][3, 4] \setminus 1, 3$ and $b = [x, y][z, v] \setminus x, z$:
 - (a) if $\{1, 3\} \in \{\{x, z\}, \{x, v\}, \{y, z\}, \{y, v\}\}$ and $\{x, z\} \in \{\{1, 3\}, \{1, 4\}, \{2, 3\}, \{2, 4\}\}$, then for all $w \in \{a, b\}^*$, we have $\mathcal{M}(wa) = \{1, 3\}$ and $\mathcal{M}(wb) = \{x, z\}$, so the automaton is not 3-compressible;
 - (b) if $\{1, 3\} \notin \{\{x, z\}, \{x, v\}, \{y, z\}, \{y, v\}\}$, then $\mathcal{M}(a) = \{1, 3\}$ and $|\mathcal{M}(ab)| \geq 3$, so the automaton is not proper;
 - (c) if $\{x, z\} \notin \{\{1, 3\}, \{1, 4\}, \{2, 3\}, \{2, 4\}\}$, then $\mathcal{M}(b) = \{x, z\}$ and $|\mathcal{M}(ba)| \geq 3$, so the automaton is not proper.

4. Let \mathcal{A} be a $(1., 4.)$ -automaton with $a = [1, 2, 3] \setminus 1, 2$ and $b = [x, y] \setminus z, zb = x$:
- (a) if $\{x, z\} \not\subseteq \{1, 2, 3\}$, then $\mathcal{M}(b) = \{z\}$, $\mathcal{M}(bb) = \{x, z\}$ and $\mathcal{M}(bba) = \{1, 2, xa, za\}$, so the automaton is not proper;
 - (b) if $\{x, z\} = \{1, 2\}$, then for all $w \in \{a, b\}^+ \setminus \{b\}$, we have $\mathcal{M}(w) = \{1, 2\}$, so the automaton is not 3-compressible;
 - (c) if $\{x, z\} \in \{\{1, 3\}, \{2, 3\}\}$, let $w \in \{1, 2, 3\} \setminus \{x, z\}$. If $wb \neq w$, then $\mathcal{M}(a) = \{1, 2\}$, $\mathcal{M}(ab) = \{3, wb\}$ and $\mathcal{M}(aba) = \{1, 2, wba\}$, so the automaton is not proper. If $wb = w$ then the automaton is not 3-compressible, as shown in Fig. 23.

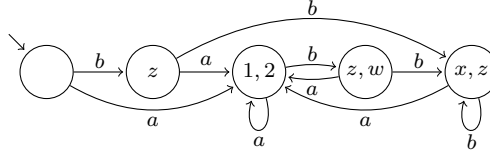

Fig. 23: P3MSA for the case

5. Let \mathcal{A} be a $(2., 4.)$ -automaton with $a = [1, 2][3, 4] \setminus 1, 3$ and $b = [x, y] \setminus z, zb = x$:
- (a) if $\{x, z\} \notin \{\{1, 3\}, \{1, 4\}, \{2, 3\}, \{2, 4\}\}$, then $\mathcal{M}(b) = \{z\}$, $\mathcal{M}(bb) = \{x, z\}$ and $|\mathcal{M}(bba)| \geq 3$, so the automaton is not proper;
 - (b) if $\{x, y\} \cap \{1, 3\} = \emptyset$ then $\mathcal{M}(a) = \{1, 3\}$ and $\mathcal{M}(ab) = \{1b, 3b, z\}$, so the automaton is not proper;
 - (c) if $\{x, z\} = \{1, 3\}$, then for all $w \in \{a, b\}^+ \setminus \{b\}$, we have $\mathcal{M}(w) = \{1, 3\}$, so the automaton is not 3-compressible;
 - (d) if $\{x, z\} = \{1, 4\}$, we consider various subcases:
 - i. if $x = 4$ and $z = 1$, then y must be equal to 3, otherwise $\{x, y\} \cap \{1, 3\} = \emptyset$ and the automaton is not proper. So let $b = [4, 3] \setminus 1$, the C3MSA in Fig. 24(1) proves that the automaton is not 3-compressible;
 - ii. if $x = 1$ and $z = 4$, then if $y \neq 2$, then the P3MSA in Fig. 24(2) proves that the automaton is not proper, else if $y = 2$, then the C3MSA in Fig. 24(3) proves that the automaton is not 3-compressible;
 - (e) if $\{x, z\} = \{2, 3\}$, then this case reduces to the previous applying the permutation $c = (1\ 3)(2\ 4)$;
 - (f) if $\{x, z\} = \{2, 4\}$, then $y \in \{1, 3\}$, otherwise $\{x, y\} \cap \{1, 3\} = \emptyset$ and the automaton is not proper.
 - i. Let $b = [2, 1] \setminus 4$ and $w = 3$, or $b = [4, 3] \setminus 2$ and $w = 1$, then, if $wb \neq y$ we have $\mathcal{M}(a) = \{1, 3\}$, $\mathcal{M}(ab) = \{z, wb\}$ and $\mathcal{M}(aba) = \{1, 3, wba\}$, so the automaton is not proper, else $wb = y$ the automaton is not 3-compressible, as shown in Fig. 25(1).
 - ii. Let $b = [2, 3] \setminus 4$ and $w = 1$, or $b = [4, 1] \setminus 2$ and $w = 3$, then either the word abb or aba is 3-compressing, so the automaton is not proper, as shown in Fig. 25(2).

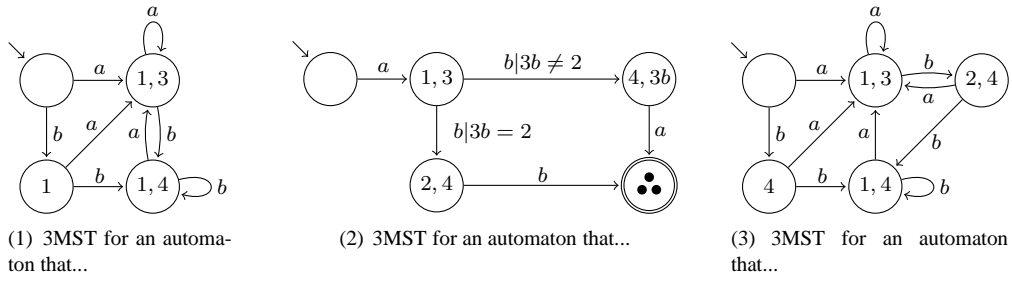

Fig. 24: 3-missing state automata for automata that satisfy ... of Proposition 17.

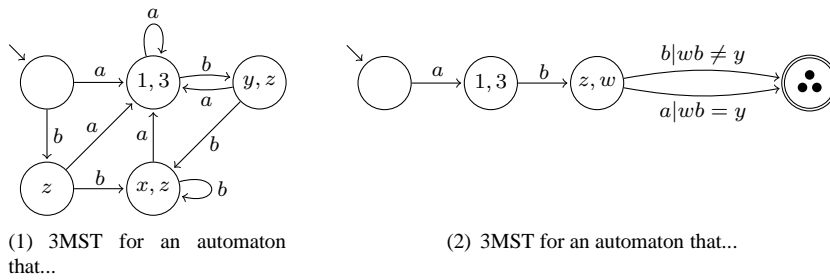

Fig. 25: 3-missing state automata for automata that satisfy ... of Proposition 17.

□

Proposition 18 *Let \mathcal{A} be a $(1., 3.)$ -automaton with $a = [1, 2, 3] \setminus 1, 2$ and $b = [x, y] \setminus x$. \mathcal{A} is proper and 3-compressible if, and only if, the following conditions hold:*

1. $x \in \{1, 2, 3\}$, and
2. $\{1, 2\} \cap \{x, y\} \neq \emptyset$, and
3. for all $z \in \{1, 2\} \setminus \{x\}$, $zb \in \{1, 2, 3\}$, and
4. for all $z \in \{1, 2\} \setminus \{x\}$, $Orb_b(z) \not\subseteq \{1, 2, 3\}$.

Proof: We start proving that a $(1., 3.)$ -automaton that does not satisfies the conditions 1 – 4 is not proper or it is not 3-compressible, in the latter case by exhibiting the (possibly conditional) complete 3-missing state automaton.

1. Let $x \notin \{1, 2, 3\}$, then it is immediate to observe that the word ba is 3-compressing, and so the automaton is not proper.
2. Let $\{1, 2\} \cap \{x, y\} = \emptyset$, then it is immediate to observe that the word ab is 3-compressing, and so the automaton is not proper.
3. Let for all $z \in \{1, 2\} \setminus \{x\}$ be $zb \notin \{1, 2, 3\}$, and $x \in \{1, 2, 3\}$, and $\{1, 2\} \cap \{x, y\} \neq \emptyset$.
 - If $x = 1$, then $\mathcal{M}(a) = \{1, 2\}$, $\mathcal{M}(ab) = \{2b, x\}$ and $\mathcal{M}(aba) = \{1, 2, 2ba\}$;
 - if $x = 2$, then $\mathcal{M}(a) = \{1, 2\}$, $\mathcal{M}(ab) = \{1b, x\}$ and $\mathcal{M}(aba) = \{1, 2, 1ba\}$;
 - if $x = 3$ and $y = 1$, then $\mathcal{M}(a) = \{1, 2\}$, $\mathcal{M}(ab) = \{2b, x\}$ and $\mathcal{M}(aba) = \{1, 2, 2ba\}$;
 - if $x = 3$ and $y = 2$, then $\mathcal{M}(a) = \{1, 2\}$, $\mathcal{M}(ab) = \{1b, x\}$ and $\mathcal{M}(aba) = \{1, 2, 1ba\}$;

and in any case the word aba is 3-collapsing and the automaton is not proper.

4. Let for all $z \in \{1, 2\} \setminus \{x\}$ be $Orb_b(z) \subseteq \{1, 2, 3\}$, and $x \in \{1, 2, 3\}$, $\{1, 2\} \cap \{x, y\} \neq \emptyset$ and $zb \in \{1, 2, 3\}$.
 - If $x \in \{1, 2\}$, then $zb \in \{z, 3\}$ and the automaton is not 3-compressible, as shown in Fig. 26(1).
 - If $x = 3$, then $y \in \{1, 2\}$ and $\{1b, 2b\} = \{1, 2\}$, and the automaton is not 3-compressible, as shown in Fig. 26(2), where $y \in \{1, 2\} \setminus \{y\}$.

Conversely, suppose $x \in \{1, 2, 3\}$, $\{1, 2\} \cap \{x, y\} \neq \emptyset$, and for all $z \in \{1, 2\} \setminus \{x\}$, $zb \in \{1, 2, 3\}$ and $Orb_b(z) \not\subseteq \{1, 2, 3\}$.

- If $x \in \{1, 2\}$, let $z \in \{1, 2\} \setminus \{x\}$, then $\mathcal{M}(a) = \{1, 2\}$, $\mathcal{M}(ab) = \{x, zb\}$, $\mathcal{M}(abb) = \{x, zb^2\}$, and, as $zb^2 \notin \{1, 2, 3\}$, $\mathcal{M}(abba) = \{1, 2, zb^2a\}$, and the word $abba$ is 3-collapsing.
- If $x = 3$, then $y \in \{1, 2\}$. Let $w \in \{1, 2\} \setminus \{y\}$, then $\mathcal{M}(a) = \{1, 2\}$, $\mathcal{M}(ab) = \{x, wb\}$, $\mathcal{M}(abb) = \{x, wb^2\}$, and, as $wb^2 \notin \{1, 2, 3\}$, $\mathcal{M}(abba) = \{1, 2, wb^2a\}$, and again the word $abba$ is 3-collapsing.

So in both cases the automaton is 3-compressible and the word $abba$ is 3-compressing. \square

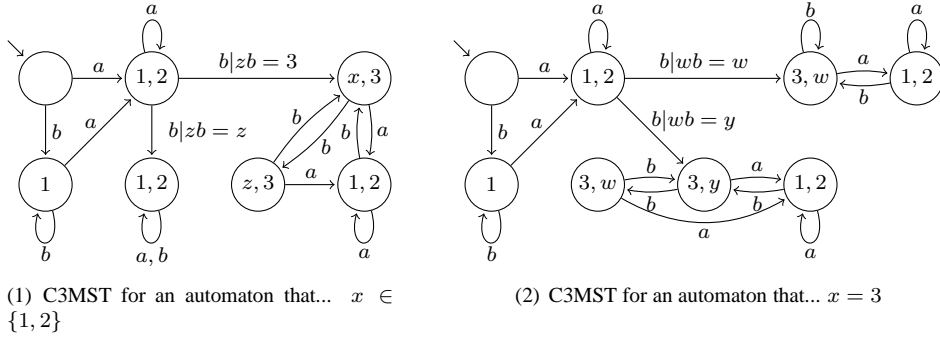

Fig. 26: Complete 3-missing state automata for automata that satisfy ... of Proposition 18.

Proposition 19 Let \mathcal{A} be a $(2, 3)$ -automaton with $a = [1, 2][3, 4] \setminus 1, 3$ and $b = [x, y] \setminus x$. \mathcal{A} is proper and 3-compressible if, and only if, the following conditions hold:

1. $x \in \{1, 2, 3, 4\}$, and
2. if $x = 1$, then $3b = 4$ and $\text{Orb}_b(3) \not\subseteq \{3, 4\}$, and
3. if $x = 2$, then $y \in \{1, 3\}$ and
 - 3'. if $y = 1$, then $3b = 4$ and $4b \neq 3$, and
 - 3''. if $y = 3$, then $1b \in \{3, 4\}$, and
4. if $x = 3$, then $1b = 2$ and $\text{Orb}_b(1) \not\subseteq \{1, 2\}$, and
5. if $x = 4$, then $y \in \{1, 3\}$ and
 - 5'. if $y = 1$, then $3b \in \{1, 2\}$, and
 - 5''. if $y = 3$, then $1b = 2$ and $2b \neq 1$.

Proof: We start proving that a $(2, 3)$ -automaton that does not satisfies the conditions 1 – 5 is not proper or it is not 3-compressible, in the latter case by exhibiting the (possibly conditional) complete 3-missing state automaton.

1. Let $x \notin \{1, 2, 3, 4\}$, then it is immediate to observe that the word ba is 3-compressing, and so the automaton is not proper.
2. Let $x = 1$,
 - 2'. if $3b \neq 4$, then if $3b = 3$ the automaton is not 3-compressible, while if $3b \neq 3$ the word aba is 3-compressing and the automaton is not proper, as shown in Fig. 27(1);
 - 2''. if $\text{Orb}_b(3) \subseteq \{3, 4\}$ and $3b = 4$, then the automaton is not 3-compressible, as shown in Fig. 27(2).

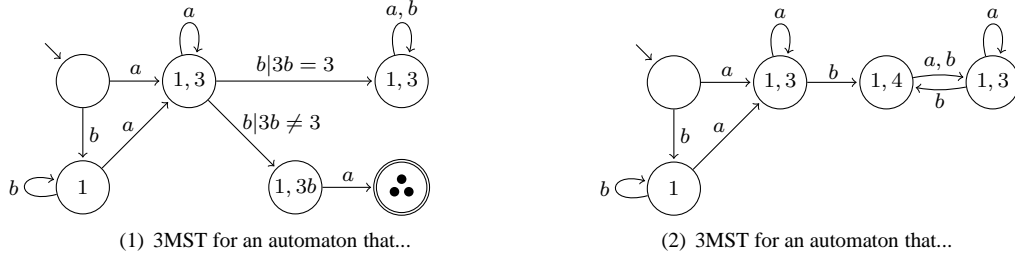

Fig. 27: 3-missing state automata for automata that satisfy ... of Proposition 19.

3. Let $x = 2$,

3'. if $y \notin \{1, 3\}$, then it is immediate to observe that the word ab is 3-compressing, and so the automaton is not proper;

3''. if $y = 1$, then

3''_a. if $3b \neq 4$, then the automaton is not 3-compressible, as shown in Fig. 28(1);

3''_a. if $3b = 4$ and $4b = 3$, then the automaton is not 3-compressible, as shown in Fig. 28(2);

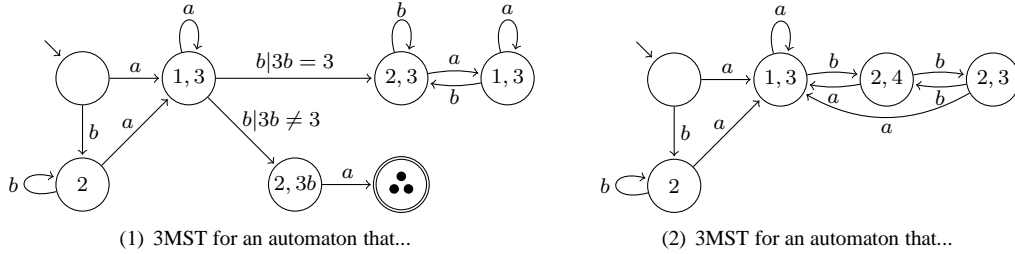

Fig. 28: 3-missing state automata for automata that satisfy ... of Proposition 19.

3'''. if $y = 3$ and $1b \neq \{3, 4\}$, then $\mathcal{M}(a) = \{1, 3\}$, $\mathcal{M}(ab) = \{2, 1b\}$, and $\mathcal{M}(aba) = \{1, 3, 1ba\}$, so the word aba is 3-compressing, and so the automaton is not proper.

4. Let $x = 3$. Then this case can be obtained applying the permutation $c = (1\ 3)(2\ 4)$ to the case 2., so if $1b \neq 2$, then if $1b = 1$ the automaton is not 3-compressible, and if $1b \neq 1$ the word aba is 3-compressing, while if $Orb_b(1) \subseteq \{1, 2\}$ and $1b = 2$, then again the automaton is not 3-compressible.

5. Let $x = 4$. As the previous, this case can be obtained applying the permutation $c = (1\ 3)(2\ 4)$ to the case 3.

Conversely, suppose $x \in \{1, 2, 3, 4\}$.

- Let $x = 1$, $3b = 4$ and $Orb_b(3) \not\subseteq \{3, 4\}$, observe that $4b = 3b^2 \notin \{3, 4\}$. Then $\mathcal{M}(a) = \{1, 3\}$, $\mathcal{M}(ab) = \{1, 4\}$, $\mathcal{M}(abb) = \{1, 4b\}$ and $\mathcal{M}(abba) = \{1, 3, 4ba\}$, so $abba$ is 3-collapsing.
- Let $x = 2$.
 - 2'. If $y = 1$, $3b = 4$ and $4b \neq 3$, then $\mathcal{M}(a) = \{1, 3\}$, $\mathcal{M}(ab) = \{2, 4\}$, $\mathcal{M}(abb) = \{2, 4b\}$ and $\mathcal{M}(abba) = \{1, 3, 4ba\}$, so $abba$ is 3-collapsing.
 - 2''. If $y = 3$ and $1b \in \{3, 4\}$, then either the word ab^2a or ab^3a are 3-collapsing, as shown in Fig. 29.

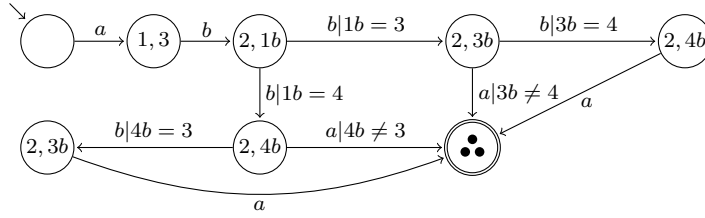

Fig. 29: P3MSA for the case

- Let $x = 3$. The case is identical to 1. applying the permutation $c = (1\ 3)(2\ 4)$, so the word $abba$ is 3-collapsing.
- Let $x = 4$. The case is identical to 4. applying the permutation $c = (1\ 3)(2\ 4)$, so either the word ab^2a or ab^3a are 3-collapsing.

□

Lemma 20 Let \mathcal{A} be a $(\mathbf{3}, \mathbf{3})$ 3-compressible automaton with $a = [1, 2] \setminus 1$ and $b = [x, y] \setminus x$. Then $x \neq 1$ and $\{x, y\} \neq \{1, 2\}$.

Lemma 21 Let \mathcal{A} be a $(\mathbf{3}, \mathbf{3})$ 3-compressible automaton with $a = [1, 2] \setminus 1$ and $b = [2, y] \setminus 2$ with $y \neq 1$. Then:

1. $\{1ba, 1b^2a, 1b^3a\} \not\subseteq \{2, y\}$, or
2. $Orb_a(1ba) \not\subseteq \{2, y\}$.

Proof: We prove that an automaton \mathcal{A} that does not satisfies the above conditions is not proper or not 3-compressible. We distinguish two main cases.

1. Let $1b = 1$. As we suppose $Orb_a(1ba) \subseteq \{2, y\}$, there are four subcases:
 - 1_a. for all $n \in \mathbb{N}$, $1ba^n = 2$, then the C3MSA in Fig. 30(1) proves that in such case the automaton is not 3-compressible;
 - 1_b. for all $n \in \mathbb{N}$, $1ba^{2n+1} = 2$ and $1ba^{2n} = y$, but this means $1b = y = 1$, an absurd;

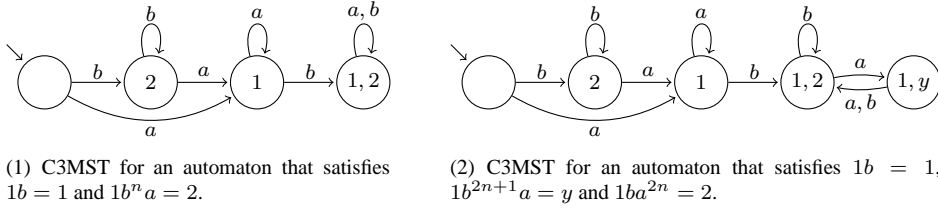

Fig. 30: Complete 3-missing state automata for automata that do not satisfy conditions 1 and 2 of Lemma 21 and $1b = 1$. All such automata are not proper.

- 1_c. for all $n \in \mathbb{N}$, $1b a^n = y$, but this means $1b = y = 1$, an absurd;
- 1_a. for all $n \in \mathbb{N}$, $1b a^{2n+1} = y$ and $1b a^{2n} = 2$, then $1a = y = 2a$ and $1a^2 = 2 = ya$. The C3MSA in Fig. 30(1) proves that in such case the automaton is not 3-compressible.
2. Let $1b \neq 1$. If $1ba = 1b^2 a$, as $1b \notin \{1, 2\}$, then $1b = 1b^2$, and then $1 = 1b$, against the hypothesis. If $1b^2 a = 1b^3 a$, as $1b^2 \neq 2$, then $1b^2 = 1b^3$, and then $1 = 1b$, against the hypothesis. So, as $|\{1ba, 1b^2 a, 1b^3 a\}| \leq 2$, $1ba = 1b^3 a$. Then we get $1b = 1b^3$ and $1 = 1b^2$. As we suppose $Orb_a(1ba) \subseteq \{2, y\}$, again there are four subcases:
- 2_a. for all $n \in \mathbb{N}$, $1b a^n = 2$. Then $1ba = 2$ and $1b^2 a = 1a = 2a = y$. But $Orb_a(1ba) = \{2\}$, so also $2a = 2$, and then $y = 2$, an absurd;
- 2_b. for all $n \in \mathbb{N}$, $1b a^{2n+1} = 2$ and $1b a^{2n} = y$. Observe that this means $ya = 2$ and $2a = y$. The C3MSA in Fig. 31(1) proves that in such case the automaton is not 3-compressible;
- 2_c. for all $n \in \mathbb{N}$, $1b a^n = y$. Observe that this means $1ba = y$ and $1b^2 a = 2 = 2a = 1a$. The C3MSA in Fig. 31(2) proves that in such case the automaton is not 3-compressible;

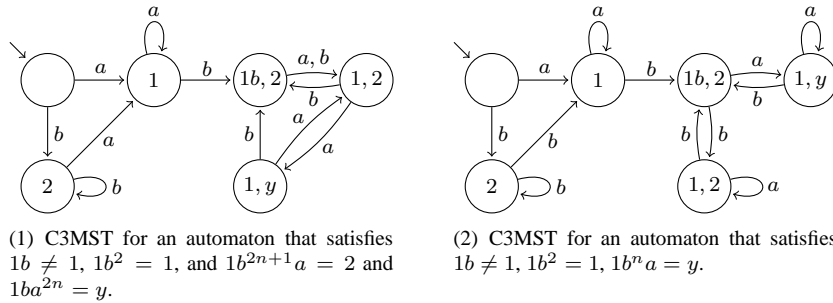

Fig. 31: Complete 3-missing state automata for automata that do not satisfy conditions 1 and 2 of Lemma 21 and $1b \neq 1$. All such automata are not proper.

- 2_a. for all $n \in \mathbb{N}$, $1b a^{2n+1} = y$ and $1b a^{2n} = 2$. Then $1ba = y$ and $1b^2 a = 2 = 1b^2 a$. From the last identity we get either $1ba = 1b^2 = 1$, an absurd, or $1ba = 2$, an absurd.

□

Corollary 22 Let \mathcal{A} be a $(\mathbf{3}, \mathbf{3})$ 3-compressible automaton with $a = [1, 2] \setminus 1$ and $b = [x, 1] \setminus x$ with $x \neq 2$. Then:

1. $\{xab, xa^2b, xa^3b\} \not\subseteq \{1, 2\}$, or
2. $Orb_b(xab) \not\subseteq \{1, 2\}$.

Proof: It is a straightforward consequence of the previous lemma, simply replace a with b , 1 with 2, 2 with y and x with 1. □

Lemma 23 Let \mathcal{A} be a proper $(\mathbf{3}, \mathbf{3})$ 3-compressible automaton with $a = [1, 2] \setminus 1$ and $b = [x, y] \setminus x$ with $x \notin \{1, 2\}$ and $y \neq 1$. Then all the following conditions hold:

1. $1b \in \{1, 2\}$, and
2. $xa \in \{x, y\}$, and
3. $Orb_b(1) \not\subseteq \{1, 2\}$ or $Orb_a(x) \not\subseteq \{x, y\}$.

Proof: We prove that an automaton \mathcal{A} that does not satisfies one of the above conditions is not proper or not 3-compressible.

1. Let $1b \notin \{1, 2\}$, then the automaton is not proper as shown in Fig. 32(1).
2. Let $1b \in \{1, 2\}$ and $xa \notin \{x, y\}$, then the automaton is not proper as shown in Fig. 32(2).

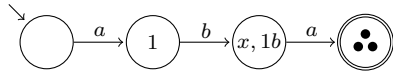

(1) P3MST for an automaton that does not satisfies condition 1 ($1b \notin \{1, 2\}$). The word aba 3-compresses it.

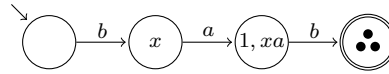

(2) P3MST for an automaton that does not satisfies condition 2 ($1b \in \{1, 2\}$ and $xa \notin \{x, y\}$). The word bab 3-compresses it.

Fig. 32: Partial 3-missing state automata for automata that do not satisfy conditions 1 and 2 of Lemma 23, i.e., $a = [1, 2] \setminus 1$, $b = [x, y] \setminus x$, $x \notin \{1, 2\}$, $y \neq 1$ and $1b \notin \{1, 2\}$ or $1b \in \{1, 2\}$ and $xa \notin \{x, y\}$. All such automata are not proper.

3. Let $1b \in \{1, 2\}$, $xa \in \{x, y\}$, $Orb_b(1) \subseteq \{1, 2\}$ and $Orb_a(x) \subseteq \{x, y\}$. In Fig. 33 we consider four subcases, namely
 - $1b = 1$ and $xa = x$ (Fig. 33(1));
 - $1b = 1$ and $xa = y$ (and then $ya = x$) (Fig. 33(2));
 - $1b = 2$ (and then $2b = 1$) and $xa = x$ (Fig. 33(3));
 - $1b = 2$ (and then $2b = 1$) and $xa = y$ (and then $ya = x$) (Fig. 33(4)).

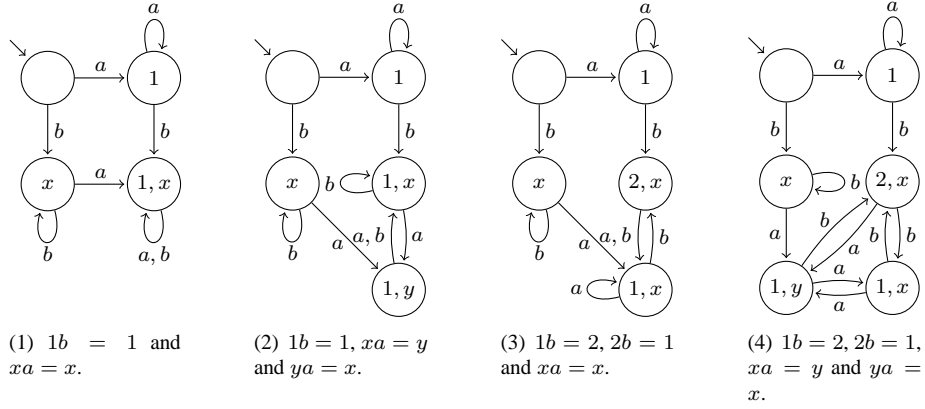

Fig. 33: Partial 3-missing state automata for automata that do not satisfy conditions 3 of Lemma 23. All such automata are not 3-compressible.

In all the subcases, the automaton results not 3-compressible.

□

Proposition 24 Let \mathcal{A} be a $(\mathbf{3}, \mathbf{3})$ -automaton with $a = [1, 2] \setminus 1$ and $b = [x, y] \setminus x$. \mathcal{A} is proper and 3-compressible if, and only if, one of the following conditions holds:

1. $b = [2, y] \setminus 2, y \neq 1$, and either $\{1ba, 1b^2a, 1b^3a\} \not\subseteq \{2, y\}$ or $\text{Orb}_a(1ba) \not\subseteq \{2, y\}$;
2. $b = [x, 1] \setminus x, x \neq 2$, and either $\{xba, xb^2a, xb^3a\} \not\subseteq \{1, 2\}$ or $\text{Orb}_b(xab) \not\subseteq \{1, 2\}$;
3. $b = [x, y] \setminus 2, x \notin \{1, 2\}, y \neq 1, 1b \in \{1, 2\}, xa \in \{x, y\}$, and either $\text{Orb}_b(1) \not\subseteq \{1, 2\}$ or $\text{Orb}_a(x) \not\subseteq \{x, y\}$.

Proof: If \mathcal{A} is a 3-compressible $(\mathbf{3}, \mathbf{3})$ -automaton with $a = [1, 2] \setminus 1$ and $b = [x, y] \setminus x$, then, from the previous lemmata and corollary, one of the above conditions must hold.

Conversely, we find for any automata satisfying conditions 1 – 3 a (short) 3-collapsing word.

1. Let $b = [2, y] \setminus 2, y \neq 1$,
 - 3'. if $\{1ba, 1b^2a, 1b^3a\} \not\subseteq \{2, y\}$, either the word $abab$ or ab^2ab or ab^3ab are 3-collapsing, as shown in Fig. 34(1);
 - 3''. if $\text{Orb}_a(1ba) \not\subseteq \{2, y\}$, either the word $abab$ or aba^2b are 3-collapsing, as shown in Fig. 34(2).
2. Let $b = [x, 1] \setminus x, x \neq 2$, and either $\{xba, xb^2a, xb^3a\} \not\subseteq \{1, 2\}$ or $\text{Orb}_b(xab) \not\subseteq \{1, 2\}$. The case reduces to the previous replacing a with b , 1 with 2, 2 with y and x with 1, then either the word $baba$ or ba^2ba or ba^3ba are 3-collapsing.

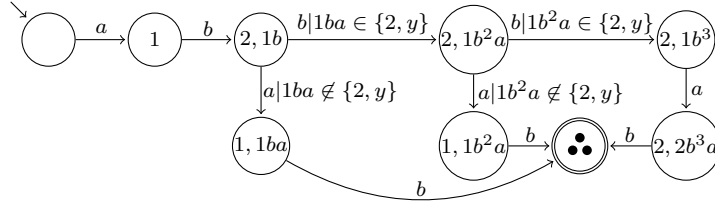

(1) P3MST for an automaton that...

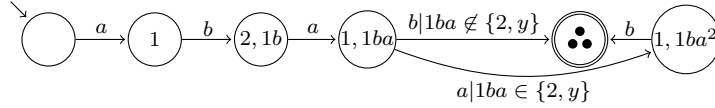

(2) P3MST for an automaton that...

Fig. 34: Partial 3-missing state automata for automata that satisfy conditions 1 of Proposition 24.

3. Let $b = [x, y] \setminus 2$, $x \notin \{1, 2\}$, $y \neq 1$, $1b \in \{1, 2\}$, $xa \in \{x, y\}$,

3'. if $Orb_b(1) \not\subseteq \{1, 2\}$, then $1b = 2$ and $2b \notin \{1, 2\}$, and so the word $abba$ is 3-collapsing, as shown in Fig. 35(1);

3''. if $Orb_a(x) \not\subseteq \{x, y\}$, then $xa = y$ and $ya \notin \{x, y\}$, and so the word $baab$ is 3-collapsing, as shown in Fig. 35(2).

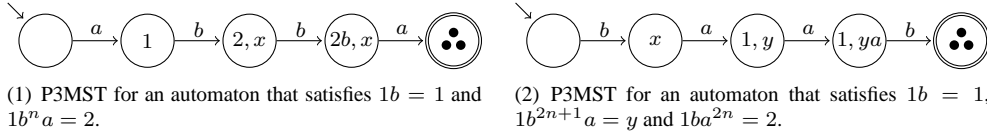

(1) P3MST for an automaton that satisfies $1b = 1$ and $1b^n a = 2$.

(2) P3MST for an automaton that satisfies $1b = 1$, $1b^{2n+1} a = y$ and $1ba^{2n} = 2$.

Fig. 35: Partial 3-missing state automata for automata that satisfy conditions 3 of Proposition 24.

□

Lemma 25 Let \mathcal{A} be a (3., 4.) 3-compressible automaton with $a = [1, 2] \setminus 1$ and $b = [x, y] \setminus z$, $zb = x$. If \mathcal{A} is proper then all the following conditions hold:

1. $\{1, 2\} \cap \{x, z\} \neq \emptyset$,
2. $z \in \{1, 2\}$ or $\{1, za\} \cap \{x, y\} \neq \emptyset$,
3. $\{1, 1b\} \cap \{x, y\} \neq \emptyset$,
4. $1 \in \{x, y\}$ or $\{z, 1b\} \cap \{1, 2\} \neq \emptyset$.

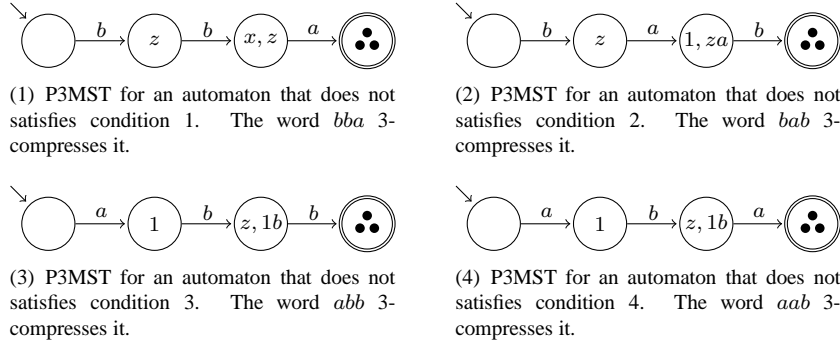

Fig. 36: Partial 3-missing state automata for automata that do not satisfy conditions 1-4 of Lemma 25. All such automata are not proper.

Proof: For each automaton \mathcal{A} that does not satisfy one of the above conditions we present in Fig. 36 a partial 3-missing state automaton $\mathcal{M}_{\mathcal{A}}$ proving the existence of a 3-collapsing word of length 3 for \mathcal{A} . \square

Corollary 26 *Let \mathcal{A} be a proper $(\mathbf{3}, \mathbf{4})$ 3-compressible automaton with $a = [1, 2] \setminus 1$ and $b = [x, y] \setminus z$, $zb = x$. The following conditions hold:*

1. $b = [x, y] \setminus 1$, or
2. $b = [x, y] \setminus 2$ and $\{1, 1b\} \cap \{x, y\} \neq \emptyset$, or
3. $b = [1, y] \setminus z$ or $b = [2, 1] \setminus z$ and in both cases $z \neq 2$.

Proof: It is a straightforward consequence of the previous lemma. Observe that the case $z \in \{1, 2\}$, $x = 2$ and $y \neq 1$ gives an absurd. \square

Proposition 27 *Let \mathcal{A} be a $(\mathbf{3}, \mathbf{4})$ -automaton with $a = [1, 2] \setminus 1$ and $b = [x, y] \setminus z$, $zb = x$. \mathcal{A} is proper and 3-compressible if, and only if, the following conditions hold:*

1. if $b = [x, y] \setminus 1$, then $Orb_a(x) \not\subseteq \{x, y\}$,
2. if $z = 2$ and
 - 2'. $b = [1, y] \setminus 2$, then $Orb_a(2) \not\subseteq \{2, y\}$ or $2ab \notin \{1, y\}$,
 - 2''. $b = [x, 1] \setminus 2$, then $\{2a, xa\} \neq \{2, x\}$ or $\{2ab, xab\} \neq \{1, x\}$
 - 2'''. $b = [x, y] \setminus 2$, $1b \in \{x, y\}$, and $1 \notin \{x, y\}$, then $\{xa, ya\} \neq \{x, y\}$,
3. if $z \notin \{1, 2\}$ and
 - 3'. $b = [1, y] \setminus z$ and $y \neq 2$, then $za \neq z$,
 - 3''. $b = [x, y] \setminus z$ and $\{x, y\} = \{1, 2\}$, then $|Orb_a(z)| > 2$ or $zab \notin \{1, 2\}$.

Proof: First observe that from the previous corollary a proper 3-compressible (3., 4.)-automaton always satisfies the antecedent of one of the above conditions, so all the possible cases are taken into account.

We start proving that a (3., 4.)-automaton that does not satisfies the conditions 1 – 3 is not 3-compressible by exhibiting the (possibly conditional) complete 3-missing state automaton.

1. Let condition 1 be false, i.e., $b = [x, y] \setminus 1$ and $Orb_a(x) \subseteq \{x, y\}$. In Fig. 37 we draw the complete 3-missing state automata for this case, proving that if condition 1 is false, then the automaton is not 3-compressible.

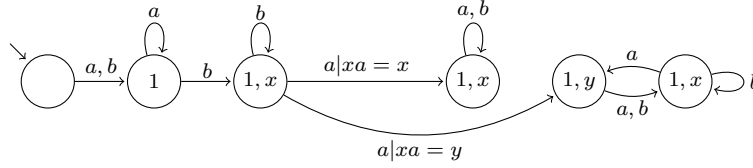
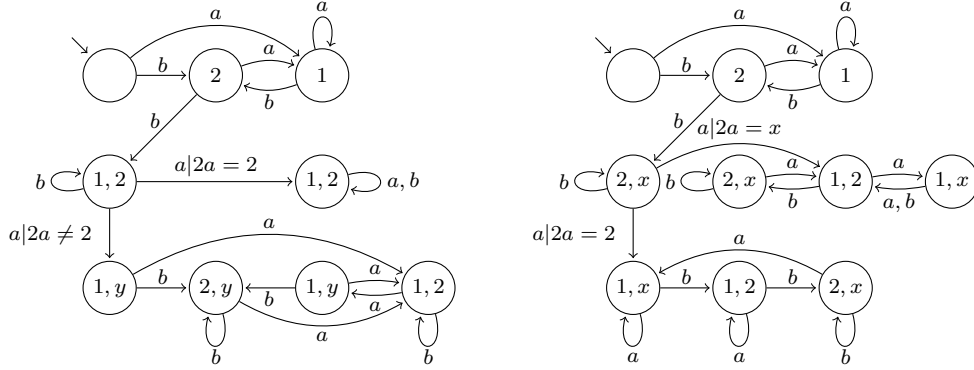

Fig. 37: C3MSA for the case in which condition 1 of Proposition 27 is false, i.e., $b = [x, y] \setminus 1$ and $Orb_a(x) \subseteq \{x, y\}$.

2. We consider the cases $x = 1, y = 1$ and $1 \notin \{x, y\}$ separately.
 - 2'. Let condition 2' be false, i.e., $b = [x, y] \setminus 2, Orb_a(x) \subseteq \{x, y\}$ and $2ab \in \{1, y\}$. Observe that if $2a \neq 2$, then $2a = y$ and $ya = 2$. Moreover, if $2ab = 1$, then $yb = 1$ and $y = 2$, an absurd, so it is $2ab = y$. In Fig. 38(1) we draw the complete 3-missing state automata for this case, proving that if condition 2' is false, then the automaton is not 3-compressible.
 - 2''. Let condition 2'' be false, i.e., $b = [x, 1] \setminus 2, \{2a, xa\} = \{2, x\}$ and $\{2ab, xab\} = \{1, x\}$. Observe that if $2a = 2$ and $xa = x$, then $2ab = 2b = x$ and so $xab = 1$. If $2a = x$ and $xa = 2$, then $xab = 2b = x$ and so $2ab = 1$. In Fig. 38(2) we draw the complete 3-missing state automata for this case, proving that if condition 2'' is false, then the automaton is not 3-compressible.
 - 2''' Let condition 2''' be false, i.e., $b = [x, y] \setminus 2, 1b \in \{x, y\}, 1 \notin \{x, y\}$ and $\{xa, ya\} = \{x, y\}$. Observe that if $1b = x$, from $2b = x$ we get $1 = 2$, an absurd, so it is $1b = y$. In Fig. 39 we draw the complete 3-missing state automata for this case, proving that if condition 2''' is false, then the automaton is not 3-compressible.
3. We consider the cases $\{x, y\} \neq \{1, 2\}$ and $\{x, y\} = \{1, 2\}$ separately.
 - 3'. Let condition 3' be false, i.e., $b = [1, y] \setminus z, y \neq 2$ but $za = z$. In Fig. 40 we draw the complete 3-missing state automata for this case, proving that if condition 3' is false, then the automaton is not 3-compressible.
 - 3''. Let condition 3'' be false, i.e., $b = [x, y] \setminus z$ and $\{x, y\} = \{1, 2\}$, but $|Orb_a(z)| \leq 2$ and $zab \notin \{1, 2\}$. We consider the case $x = 1$ and $y = 2$ separately from the case $x = 2$ and $y = 1$.



(1) C3MSA for the case in which condition 2' of Proposition 27 is false, i.e., $b = [1, y] \setminus 2$, $Orb_a(x) \subseteq \{x, y\}$ and $2ab \in \{1, y\}$.

(2) C3MSA for the case in which condition 2'' of Proposition 27 is false, i.e., $b = [x, 1] \setminus 2$, $\{2a, xa\} = \{2, x\}$ and $\{2ab, xab\} = \{1, x\}$.

Fig. 38: C3MSA for the case in which condition 2' and 2'' of Proposition 27 are false.

- 3''_a. $b = [1, 2] \setminus z$, $|Orb_a(z)| \leq 2$ and $zab \notin \{1, 2\}$. In Fig. 41(1) we draw the complete 3-missing state automata for this case, proving that in this case the automaton is not 3-compressible.
- 3''_b. $b = [2, 1] \setminus z$, $|Orb_a(z)| \leq 2$ and $zab \notin \{1, 2\}$. In Fig. 41(2) we draw the complete 3-missing state automata for this case, proving that in this case the automaton is not 3-compressible.

Conversely, we find for any automata satisfying conditions 1 – 3 a (short) 3-collapsing word.

1. Let $b = [x, y] \setminus 1$ and $Orb_a(x) \not\subseteq \{x, y\}$, in particular observe that $xa \neq x$. In Fig. 42 we draw a partial conditional 3-missing state automata proving that the word b^2ab or b^2a^2b are 3-collapsing word in this case.
2. Let $z = 2$, we consider various subcases.
 - 2'. Let $b = [1, y] \setminus 2$:
 - 2'_a. if $Orb_a(2) \not\subseteq \{2, y\}$, then $2a \neq 2$. Moreover, if $2ab = y$, then $2a^2b \neq y$. Indeed, $2a \neq 1$ (as a misses 1), and if $2a = 2a^2 = y$ then we get $Orb_a(2) = \{2, y\}$, against the hypothesis, so from $2ab = 2a^2b$ we get $2 = 2a$, an absurd. In Fig. 43(1) we draw a partial conditional 3-missing state automata proving that the word b^2ab^2 or $b^2a^2b^2$ are 3-collapsing word in this case;
 - 2'_b. if $2ab \notin \{1, y\}$, then $2a \neq 2$. In Fig. 43(2) we draw a partial conditional 3-missing state automata proving that the word b^2ab^2 is 3-collapsing word in this case.
 - 2''. Let $b = [x, 1] \setminus 2$:
 - 2''_a. if $2a \notin \{2, x\}$, then $2ab \neq x$. In Fig. 44 we draw a partial conditional 3-missing state automata proving that the word b^2ab^2 or $b^2a^2b^2$ or $b^2a^3b^2$ or b^2abab^2 are 3-collapsing word in this case;

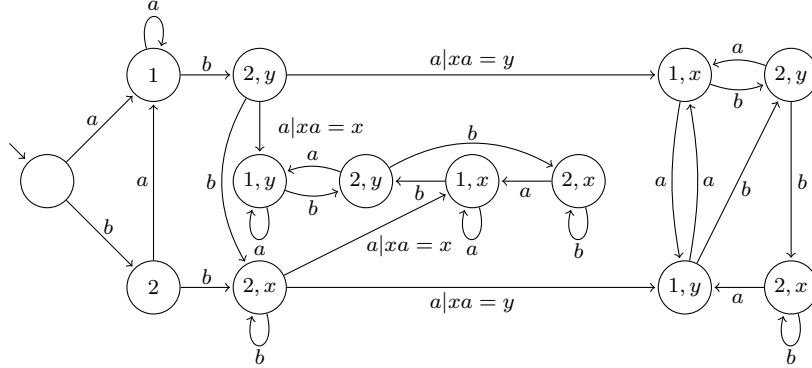

Fig. 39: C3MSA for the case in which condition 2''' of Proposition 27 is false, i.e., $b = [x, 1] \setminus 2$, $\{2a, xa\} = \{2, x\}$ and $\{2ab, xab\} = \{1, x\}$.

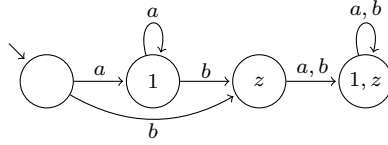

Fig. 40: C3MSA for the case in which condition 3' of Proposition 27 is false, i.e., $b = [1, y] \setminus z$, $y \neq 2$ and $za = z$.

- 2''_b. if $xa \notin \{2, x\}$, then $xab \neq x$. In Fig. 45(1) we draw a partial conditional 3-missing state automata proving that the word $b2ab^2$ or $b^2a^2b^2$ or $b^2a^3b^2$ are 3-collapsing word in this case.
- 2''_c. if $\{2ab, xab\} \neq \{1, y\}$, then in Fig. 45(2) we draw a partial conditional 3-missing state automata proving that the word b^2ab^2 or $b^2a^2b^2$ or b^2abab^2 are 3-collapsing word in this case.
- 2''' Let $b = [x, y] \setminus 2$, $1b \in \{x, y\}$, $1 \notin \{x, y\}$ and $\{xa, ya\} \neq \{x, y\}$. Observe that if $xa \in \{x, y\}$, then $ya \notin \{x, y\}$. In Fig. 46 we draw a partial conditional 3-missing state automata proving that the word b^2ab or b^2abab are 3-collapsing word in this case.

3. Let $z \notin \{1, 2\}$, we consider two main subcases.

- 3'. Let $b = [1, y] \setminus z$, $y \neq 2$ and $za \neq z$. In Fig. 47 we draw a partial conditional 3-missing state automata proving that the word bab^2 or $baba$ are 3-collapsing word in this case.
- 3''. Let $\{x, y\} = \{1, 2\}$. We consider two subcases.
 - 3''_a. $b = [x, y] \setminus z$, $\{x, y\} = \{1, 2\}$ and $|Orb_a(z)| > 2$. In particular $za \neq z$, $za \neq za^2b$ and $z \neq za^2$. If $zab = y$, then $za^2b \notin \{zb, zab\} = \{2, 1\}$. In Fig. 48(1) we draw a partial conditional 3-missing state automata proving that the word ba^2b^2 or bab^2 are 3-collapsing word in this case.

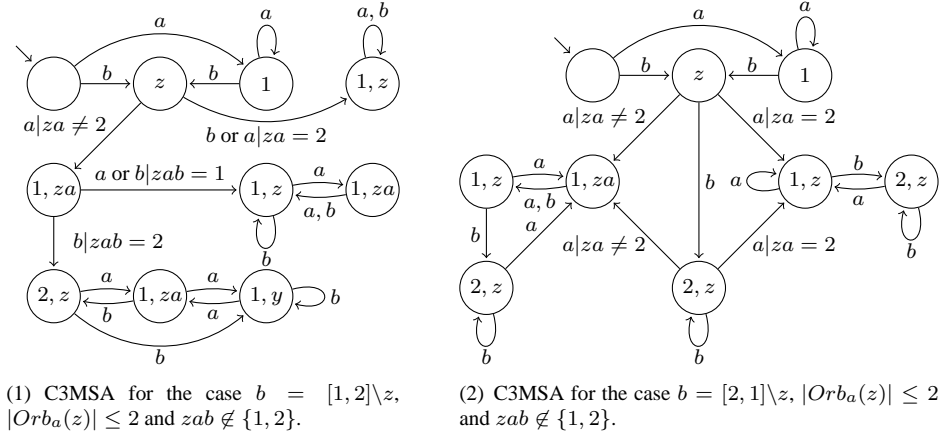

Fig. 41: C3MSA for the case in which condition 3'' of Proposition 27 is false.

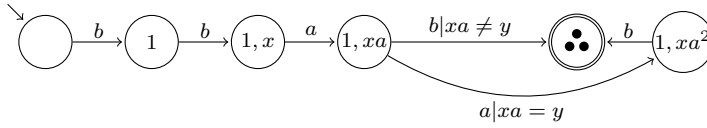

Fig. 42: P3MSA for the case $b = [x, y] \setminus 1$ and $Orb_a(x) \not\subseteq \{x, y\}$. Either the word $bbab$ or $bbaab$ are 3-collapsing.

3''_b. $b = [x, y] \setminus z$, $\{x, y\} = \{1, 2\}$ and $zab \notin \{1, 2\}$. In Fig. 48(2) we draw a partial conditional 3-missing state automata proving that the word bab^2 or $baba$ are 3-collapsing word in this case.

□

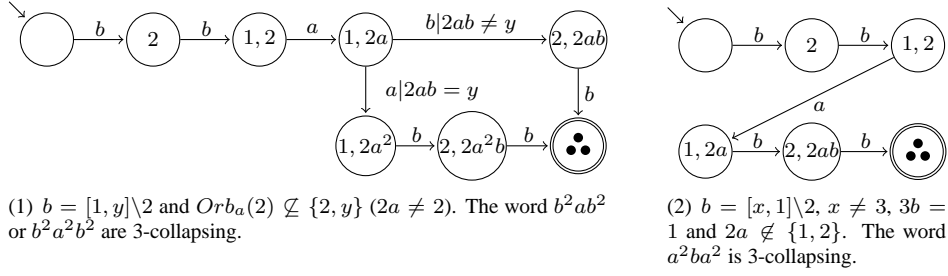

Fig. 43: P3MSA for the case $b = [1, y] \setminus 2$ and $2ab \in \{1, y\}$.

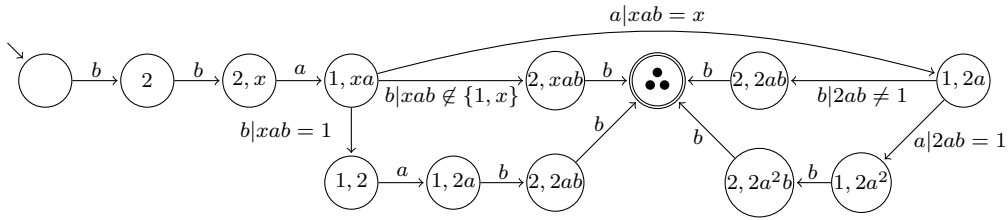

Fig. 44: P3MSA for the case $b = [x, 1] \setminus 2$ and $2a \notin \{2, y\}$. Either the word b^2ab^2 or $b^2a^2b^2$ or $b^2a^3b^2$ or b^2abab^2 are 3-collapsing.

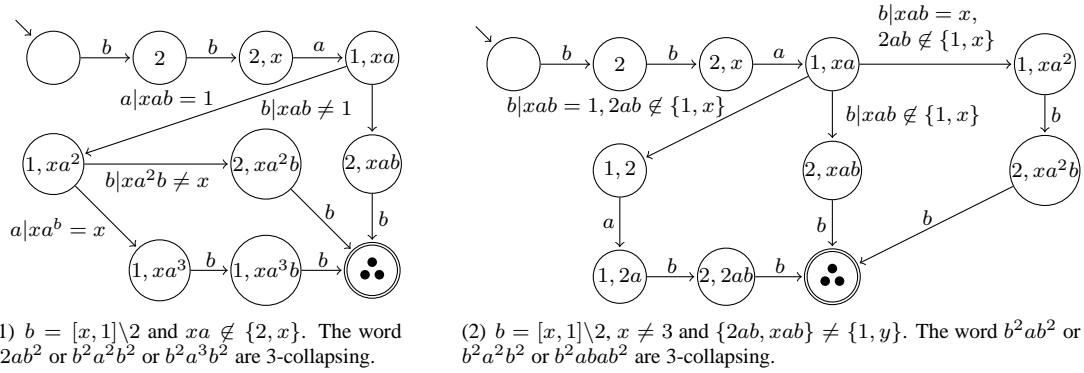

Fig. 45: P3MSA for the case $b = [x, 1] \setminus 2$, $xa \notin \{2, x\}$ or $\{2ab, xab\} \neq \{1, x\}$.

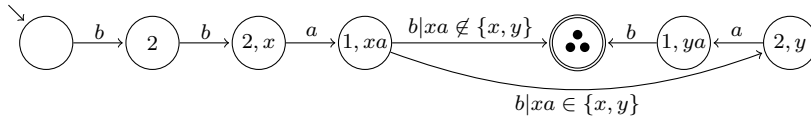

Fig. 46: P3MSA for the case $b = [x, y] \setminus 2$, $1b \in \{x, y\}$, $1 \notin \{x, y\}$ and $\{xa, ya\} \neq \{x, y\}$. Either the word b^2ab or b^2abab are 3-collapsing.

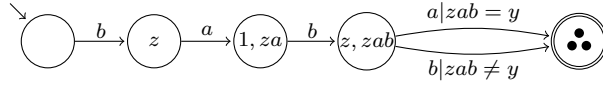
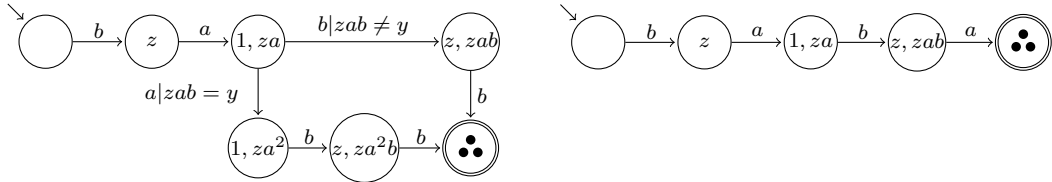

Fig. 47: P3MSA for the case $b = [1, y] \setminus z$, $y \neq 2$ and $za \neq z$. Either the word bab^2 or $baba$ are 3-collapsing.



(1) $b = [x, y] \setminus z$, $\{x, y\} = \{1, 2\}$ and $|Orb_a(z)| > 2$. The word b^2ab^2 or ba^2b^2 or bab^2 are 3-collapsing.

(2) $b = [x, y] \setminus z$, $\{x, y\} = \{1, 2\}$ and $zab \notin \{1, 2\}$. The words bab^2 or $baba$ are 3-collapsing.

Fig. 48: P3MSA for the case $b = [x, y] \setminus 2$ with $\{x, y\} = \{1, 2\}$.

Lemma 28 Let \mathcal{A} be a $(4., 4.)$ 3-compressible automaton with $a = [1, 2] \setminus 3$, $3a = 1$ and $b = [x, y] \setminus z$, $zb = x$. If \mathcal{A} is proper then all the following conditions hold:

1. $\{1, 2\} \cap \{x, z\} \neq \emptyset$,
2. $z \in \{1, 2\}$ or $\{3, za\} \cap \{x, y\} \neq \emptyset$,
3. $\{3, 3b\} \cap \{x, y\} \neq \emptyset$,
4. $\{1, 3\} \cap \{x, y\} \neq \emptyset$,
5. $3 \in \{x, y\}$ or $\{z, zb\} \cap \{1, 2\} \neq \emptyset$,
6. $\{z, za\} \cap \{1, 2\} \neq \emptyset$.

Proof: For each automaton \mathcal{A} that does not satisfies one of the above conditions we present in Fig. 49 a partial 3-missing state automaton $\mathcal{M}_{\mathcal{A}}$ proving the existence of a 3-collapsing word of length 3 for \mathcal{A} . \square

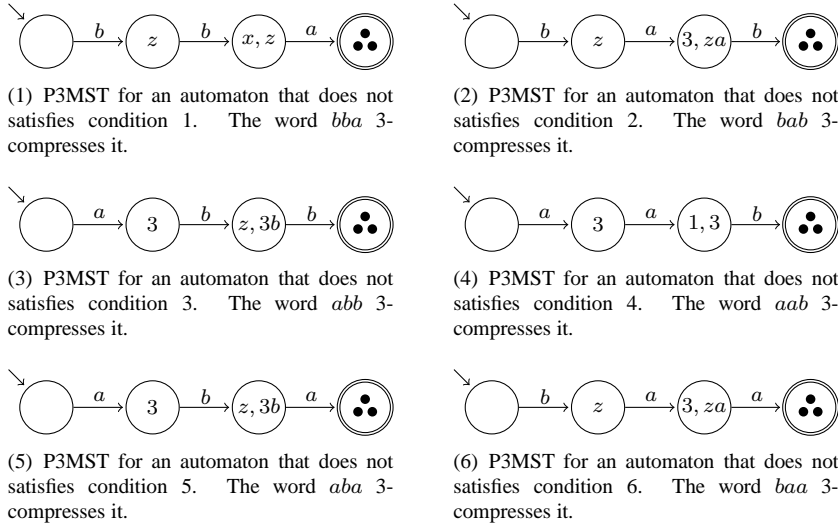

Fig. 49: Partial 3-missing state automata for automata that do not satisfy conditions 1-6 of Lemma 28. All such automata are not proper.

Corollary 29 Let \mathcal{A} be a proper $(4., 4.)$ 3-compressible automaton with $a = [1, 2] \setminus 3$, $3a = 1$ and $b = [x, y] \setminus z$, $zb = x$. The following conditions hold:

1. if $z = 1$, then $3 \in \{x, y\}$,
2. if $z = 2$, then $3 \in \{x, y\}$ or it is $1 \in \{x, y\}$ and $3b \in \{x, y\}$,

3. if $z \notin \{1, 2\}$, then $x \in \{1, 2\}$ and $za \in \{1, 2\}$.

Proof: It is a straightforward consequence of the previous lemma. Observe that not all the conditions of Lemma 28 are applied, so some automaton satisfying the conditions of the corollary could possibly be not proper or not 3-compressible. \square

Proposition 30 *Let \mathcal{A} be a $(4., 4.)$ -automaton with $a = [1, 2] \setminus 3$, $3a = 1$ and $b = [x, y] \setminus z$, $zb = x$. \mathcal{A} is proper and 3-compressible if, and only if, the following conditions hold:*

1. if $b = [x, y] \setminus 1$, then $y = 3$ and it is $xa \neq 2$ or $2b \neq 3$,
- 2'. if $b = [x, 3] \setminus 2$, then $xa \neq 2$ or $1b \neq 3$,
- 2''. if $b = [3, y] \setminus 2$, then $ya \neq 2$ or $1b \neq y$,
3. if $b = [x, y] \setminus 2$ and $3 \notin \{x, y\}$, then $1 \in \{x, y\}$ and $3b \in \{x, y\}$,
4. if $b = [x, y] \setminus z$, $z \notin \{1, 2\}$, $x \in \{1, 2\}$ and $za \in \{1, 2\}$, then $y = 3$.

Proof: First observe that from the previous corollary a proper 3-compressible $(4., 4.)$ -automaton always satisfies the antecedent of one of the above conditions, so all the possible cases are taken into account. We start proving that a $(4., 4.)$ -automaton that does not satisfies the conditions 1 – 4 is not proper or it is not 3-compressible, in the latter case by exhibiting the (possibly conditional) complete 3-missing state automaton.

1. Let condition 1 be false, *i.e.*, $b = [x, y] \setminus 1$ but either $y \neq 3$ or $xa = 2$ and $2b = 3$. Observe that if $y \neq 3$ then from the previous corollary we have $x = 3$. In Fig. 50 we draw the complete 3-missing state automata for these cases, proving that if condition 1 is false, that the automaton is not 3-compressible.
- 2'. Let condition 2' be false, *i.e.*, $b = [x, 3] \setminus 2$ but $xa = 2$ and $1b = 3$. In Fig. 51(1) we draw the complete 3-missing state automaton for this case, proving that if condition 2' is false, then the automaton is not 3-compressible.
- 2''. Let condition 2'' be false, *i.e.*, $b = [3, y] \setminus 2$ but $ya = 2$ and $1b = y$. In Fig. 51(2) we draw the complete 3-missing state automaton for this case, proving that if condition 2'' is false, then the automaton is not 3-compressible.
3. Let condition 3 be false, *i.e.*, $b = [x, y] \setminus 2$ and $3 \notin \{x, y\}$ but either $1 \notin \{x, y\}$ or $3b \notin \{x, y\}$. From condition 3 and 4 of Lemma 28 we have immediately that in this cases the automaton is not proper, as it is 3-compressed either by aab or by abb .
4. Let condition 4 be false, *i.e.*, $b = [x, y] \setminus z$, $z \notin \{1, 2\}$, $x \in \{1, 2\}$ and $za \in \{1, 2\}$, but $y \neq 3$. We have to consider four main subcases:
 - (a) $x = za = 1$. Then $z = 3$ and $3b = 1$, the complete 3MSA in Fig. 52 proves that in this case the automaton is not 3-compressible.

- (b) $x = 1$ and $za = 2$. Then $z \neq 3$ and $3b \neq 1$. There are two further subcases:
- $y = 3b = 2$. Then the complete 3MSA in Fig. 53 proves that in this case the automaton is not 3-compressible.
 - $y \neq 2$ or $3b \neq 2$. If $y \neq 2$, then condition 2 of Lemma 28 is not satisfied, and the automaton is not proper. If $y = 2$ and $3b \neq 2$, then condition 3 of Lemma 28 is not satisfied, and again the automaton is not proper.
- (c) $x = 2$ and $za = 1$. Then $z = 3$ and $3b = 2$. There are two further subcases:
- $y \neq 1$. Then condition 4 of Lemma 28 is not satisfied, and the automaton is not proper.
 - $y = 1$. Then the complete 3MSA in Fig. 53(1) proves that in this case the automaton is not 3-compressible.
- (d) $x = za = 2$. Then $z \neq 3$ and $3b \neq 2$. There are two further subcases:
- $y = 3b = 1$. Then the complete 3MSA in Fig. 53(2) proves that in this case the automaton is not 3-compressible.
 - $y \neq 1$ or $3b \neq 1$. If $y \neq 1$, then condition 4 of Lemma 28 is not satisfied, and the automaton is not proper. If $y = 1$ and $3b \neq 1$, then condition 3 of Lemma 28 is not satisfied, and again the automaton is not proper.

(1) $b = [x, y] \setminus 1$ and $y \neq 3$.(2) $b = [x, y] \setminus 1$, $xa = 2$ and $2b = 3$.

Fig. 50: C3MS automata for the case in which condition 1 of Proposition 30 is false, *i.e.*, $b = [x, y] \setminus 1$ but either $y \neq 3$ or $xa = 2$ and $2b = 3$.

Conversely, we find for any automata satisfying conditions 1 – 4 a (short) 3-collapsing word.

- Let $b = [x, 3] \setminus 1$ and $xa \neq 2$ or $2b \neq 3$. Observe that $xa \neq 1$, as $3a = 1$ and $x \neq 3$. In Fig. 54 we draw a partial conditional 3-missing state automata proving that the word b^2a^2 or b^2ab^2 are 3-collapsing word in this case.
- Let $b = [x, 3] \setminus 2$ and $xa \neq 2$ or $1b \neq 3$. Observe that $xa \neq 1$, as $3a = 1$ and $x \neq 3$. We distinguish the case $xa = 2$ and $1b \neq 3$ from the case $xa \neq 2$. In Fig. 55(1) we draw a partial conditional 3-missing state automata proving that the word a^2b^2 is a 3-collapsing word when $xa = 2$. In Fig. 55(2) we draw a partial conditional 3-missing state automata proving that the word b^2a^2 is a 3-collapsing word when $xa \neq 2$.

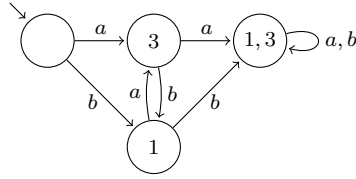
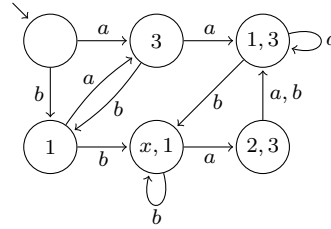
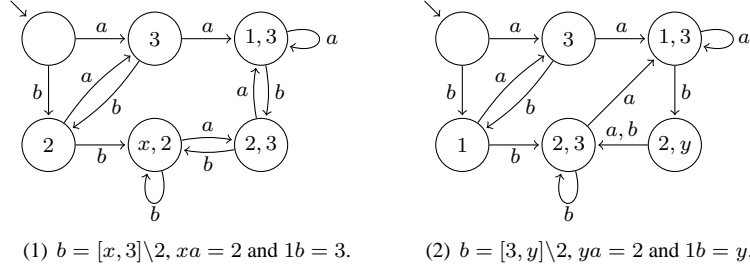

Fig. 51: C3MS automata for the case in which condition 2' or 2'' of Proposition 30 are false.

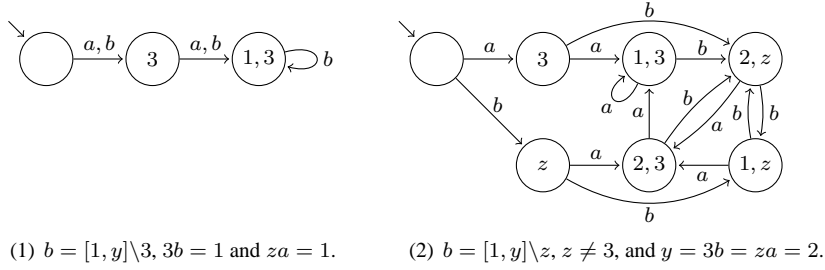

Fig. 52: C3MS automata for the case in which condition 4 of Proposition 30 is false and $x = 1$.

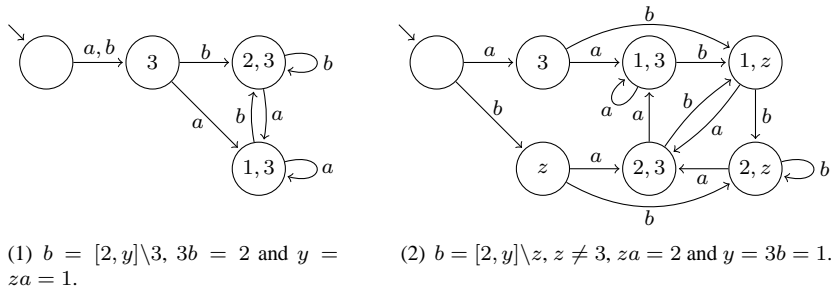

Fig. 53: C3MS automata for the case in which condition 4 of Proposition 30 is false and $x = 2$.

- 2". Let $b = [3, y] \setminus 2$ and $ya \neq 2$ or $1b \neq y$. Observe that $ya \neq 1$, as $3a = 1$ and $y \neq 3$. In Fig. 56 we draw a partial conditional 3-missing state automata proving that the word a^2b^2 or a^2ba^2 are 3-collapsing word in this case.
3. Let $b = [x, y] \setminus 2$, $3 \notin \{x, y\}$, $1 \in \{x, y\}$ and $3b \in \{x, y\}$. There are two subcases:
- (a) $x = 1$. Then $b = [1, y] \setminus 2$, $y \neq 3$, $3b = y$ (as $2b = 1$) and $2a \neq 1$ (as $3a = 1$). In Fig. 57(1) we draw a partial conditional 3-missing state automata proving that the word b^2a^2 or b^2ab are 3-collapsing word in this case.
 - (b) $y = 1$. Then $b = [x, 1] \setminus 2$, $x \neq 3$, $3b = 1$ (as $2b = x$) and $2a \neq 1$ (as $3a = 1$). We distinguish the case $2a = 2$ from the case $2a \neq 2$. In Fig. 57(2) we draw a partial conditional 3-missing state automata proving that the word b^2a^2 is a 3-collapsing word when $2a = 2$. In Fig. 57(3) we draw a partial conditional 3-missing state automata proving that the word a^2ba^2 is a 3-collapsing word when $2a \neq 2$.
4. Let $b = [x, 3] \setminus z$, $z \notin \{1, 2\}$, $x \in \{1, 2\}$ and $za \in \{1, 2\}$. Observe that $z \neq 3$ and $3a = 1$, so $za \neq 1$, and then it is always $za = 2$. We have to consider two subcases:
- (a) $x = 1$. Then $b = [1, 3] \setminus z$, $zb = 1$, $3b \neq 1$ and $2b \neq 1$. We distinguish the case $2b = 3$ from the case $2b \neq 3$. In Fig. 58(1) we draw a partial conditional 3-missing state automata proving that the word a^2b^2 is a 3-collapsing word when $2b = 3$. In Fig. 58(2) we draw a partial conditional 3-missing state automata proving that the word b^2ab^2 is a 3-collapsing word when $2b \neq 3$.
 - (b) $x = 2$. Then $b = [2, 3] \setminus z$, $za \neq 1$ (as $3a = 1$) and $3b \neq 2$ (as $zb = 2$). We distinguish the case $2b = 3$ from the case $2b \neq 3$. In Fig. 58(3) we draw a partial conditional 3-missing state automata proving that the word a^2b^2 is a 3-collapsing word when $3b = 3$. In Fig. 58(4) we draw a partial conditional 3-missing state automata proving that the word b^2ab^2 is a 3-collapsing word when $3b \neq 3$.

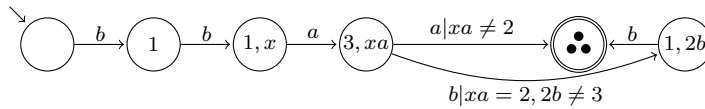

Fig. 54: P3MSA for the case $b = [x, 3] \setminus 1$ and $xa \neq 2$ or $2b \neq 3$. Either the word $bbaa$ or $bbabb$ are 3-collapsing.

□

Fig. 55: P3MSA for the case $b = [x, 3] \setminus 2$ and $xa \neq 2$ or $1b \neq 3$.Fig. 56: P3MSA for the case $b = [3, y] \setminus 2$ and $ya \neq 2$ or $1b \neq y$. Either the word a^2b^2 or a^2ba^2 are 3-collapsing.Fig. 57: P3MSA for the case $b = [x, y] \setminus 2$, $3 \notin \{x, y\}$, $1 \in \{x, y\}$ and $3b \in \{x, y\}$.

Fig. 58: A set of four subfigures: describes the first subfigure

7 Lower and upper bounds

From the previous propositions we obtain that each 3-full word, containing as factors the words

$$\begin{aligned}
 & abab^2aba, ab^2ab^2a, ab^2a^2b^2a, ab^2abab^2a, ab^3aba, abab^3a, ab^3ab^3a, a^2b^3a \\
 & baba^2bab, ba^2ba^2b, ba^2b^2a^2b, ba^2baba^2b, ba^3bab, baba^3b, ba^3ba^3b, b^2a^3b.
 \end{aligned}$$

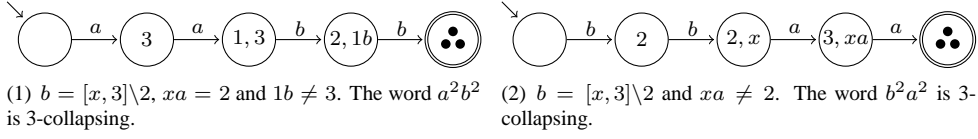
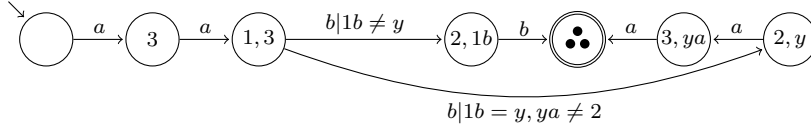
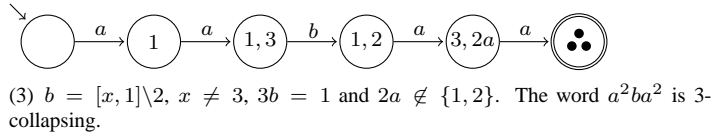
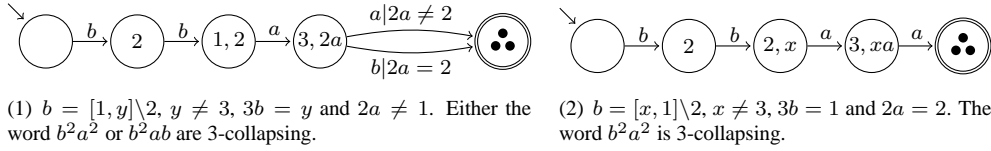
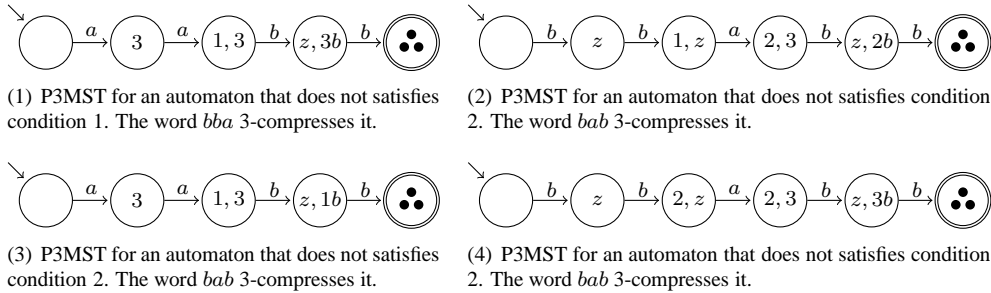
is a 3-collapsing word on a 2 letter alphabet. Then the the word

$$b^2a^3ba^3b^3aba^2baba^2ba^2b^2a^2b^2ab^2abab^2aba^3bab^3ab^3a.$$

obtained in Corollary 16 is actually 3-collapsing.

The 3-collapsing word above can be used to improve the procedure arising from (Margolis et al. (2004), Theorem 3.5) to obtain shorter k -collapsing words for $k \geq 4$. In particular it follows that $c(4, 2) \leq 1741$ and $c(5, 2) \leq 109941$. Though very lengthy, they can be effectively used in testing the compressibility of an automaton. In particular this can accelerate the algorithm presented in Ananichev and Petrov (2003); Petrov (2008) to find short (possibly shortest) 4- and 5-synchronizing words.

It is known that in general the language $\mathcal{C}_{k,t}$ of k -collapsing words on an alphabet of t letters differs from the language $\mathcal{S}_{k,t}$ of k -synchronizing words on the same alphabet. However, this not excludes that in some cases $c(k, t) = s(k, t)$. Up to now it was only know that $c(2, 2) = s(2, 2)$ (Sauer and Stone (1991)) and that $c(2, 3) \neq s(2, 3)$ (Ananichev and Petrov (2003)). We find a counterexample proving that also $c(3, 2) \neq s(3, 2)$ (and so $c(3, 2) \geq 34$). In fact, the automaton in Fig. 59 is 3-compressible (and also 3-synchronizing), but the word $s_{3,2}$ do not compresses it. On the other hand its dual $\bar{s}_{3,2}$ synchronizes it. We check with a computer calculation that any 3-compressible 5-states automaton over a two letter alphabet, is 3-compressed either by $s_{3,2}$ or by $\bar{s}_{3,2}$, so we believe interesting to understand if it is always the case for every 3-compressible automata.

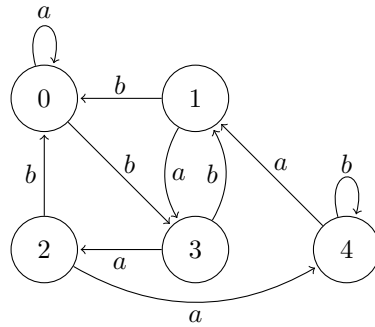

Fig. 59: An automaton which is not 3-compressed by $s_{3,2}$: $Q_{\bar{s}_{3,2}} = \{3\}$, $Q_{s_{3,2}} = \{0, 1, 3\}$.

References

D. S. Ananichev and I. V. Petrov. Quest for short synchronizing words and short collapsing words. In *WORDS. Proc. 4th Int. Conf.*, pages 411–418, 2003.

- D. S. Ananichev and M. V. Volkov. Collapsing words vs. synchronizing words. In *Developments in Language Theory*, volume 2295 of *LNCS*, pages 166–174, 2001.
- D. S. Ananichev, I. V. Petrov, and M. V. Volkov. Collapsing words: A progress report. In *Developments in Language Theory*, volume 3572 of *LNCS*, pages 11–21, 2005.
- A. Cherubini. Synchronizing and collapsing words. *Milan J. Math.*, 75:305–321, 2007.
- A. Cherubini and A. Kisielewicz. Collapsing words, permutation conditions and coherent colorings of trees. *Theor. Comput. Sci.*, 410(21-23):2135–2147, 2009.
- A. Cherubini, P. Gawrychowski, A. Kisielewicz, and B. Piochi. A combinatorial approach to collapsing words. In *MFCS*, pages 256–266, 2006.
- A. Cherubini, A. Kisielewicz, and B. Piochi. A bound for the length of shortest 2 collapsing words. *DMTCS*, 11(1):33–44, 2009.
- A. Cherubini, A. Frigeri, and B. Piochi. *Short 3-collapsing words over a 2-letter alphabet*, volume 6795 *LNCS of Lecture Notes in Computer Science*. 2011. URL www.scopus.com.
- S. W. Margolis, J.-E. Pin, and M. V. Volkov. Words guaranteeing minimum image. *Internat. J. Foundations Comp. Sci.*, 15:259–276, 2004.
- I. Petrov. An algorithm for recognition of n -collapsing words. *Theoret. Comput. Sci.*, 391(1-2):99–108, 2008.
- R. Pöschel, M. V. Sapir, N. W. Sauer, M. G. Stone, and M. V. Volkov. Identities in full transformation semigroups. *Algebra Universalis*, 31:580–588, 1994.
- E. V. Pribavkina. On some properties of the language of 2-collapsing words. In *Developments in Language Theory*, volume 3572 of *LNCS*, pages 374–384, 2005.
- N. Sauer and M. G. Stone. Composing functions to reduce image size. *Ars Combinatoria*, 1:171–176, 1991.