

Region Templates: Data Representation and Management for Large-Scale Image Analysis

George Teodoro^{3*}, Tony Pan¹, Tahsin Kurc^{1,2}, Jun Kong¹, Lee Cooper¹,
Scott Klasky², Joel Saltz¹

¹*Biomedical Informatics Department, Emory University, Atlanta, GA, USA*

²*Scientific Data Group, Oak Ridge National Laboratory, Oak Ridge, TN, USA*

³*Department of Computer Science, University of Brasília, Brasília, DF, Brazil*

Abstract

Distributed memory machines equipped with CPUs and GPUs (hybrid computing nodes) are hard to program because of the multiple layers of memory and heterogeneous computing configurations. In this paper, we introduce a region template abstraction for the efficient management of common data types used in analysis of large datasets of high resolution images on clusters of hybrid computing nodes. The region template provides a generic container template for common data structures, such as points, arrays, regions, and object sets, within a spatial and temporal bounding box. The region template abstraction enables different data management strategies and data I/O implementations, while providing a homogeneous, unified interface to the application for data storage and retrieval. The execution of region templates applications is coordinated by a runtime system that supports efficient execution in hybrid machines. Region templates applications are represented as hierarchical dataflow in which each computing stage may be represented as another dataflow of finer-grain tasks. A number of optimizations for hybrid machines are available in our runtime system, including performance-aware scheduling for maximizing utilization of computing devices and techniques to reduce impact of data transfers between CPUs and GPUs. An experimental evaluation on a state-of-the-art hybrid cluster using a microscopy imaging study shows that this abstraction adds negligible overhead (about 3%) and achieves good scalability. The implementations of global region templates storage achieved very high data transfer throughput (200GB/s). The optimizations proposed in the high speed disk based storage implementation to support asynchronous applications resulted in an application performance gain of about 1.13× as compared to a state-of-the-art system. Finally, the optimized cooperative execution in a cluster with 100 nodes (300 GPUs and 1,200 CPU

*Corresponding author

Email addresses: teodoro@cic.unb.br (George Teodoro³), tony.pan@emory.edu (Tony Pan¹), tkurc@emory.edu (Tahsin Kurc^{1,2}), jun.kong@emory.edu (Jun Kong¹), lee.cooper@emory.edu (Lee Cooper¹), klasky@ornl.org (Scott Klasky²), jhsaltz@emory.edu (Joel Saltz¹)

cores) attained a processing rate of 11,730 $4K \times 4K$ tiles per minute. This computation rate is enabling much larger studies, which we expect will also result into significant scientific discoveries.

Keywords: , GPGPU, Storage and I/O, Heterogeneous Environments, Image Analysis, Microscopy Imaging

1. Introduction

Distributed-memory computing systems consisting of multi-core CPUs and general purpose Graphics Processing Units (GPUs) provide large memory space and processing capacity for scientific computations. Leveraging these hybrid systems, however, is challenging because of multiple memory hierarchies and the different computation characteristics of CPUs and GPUs. Application developers have to deal with efficiently mapping and scheduling analysis operations onto multiple computing nodes and CPU cores and GPUs within a node, while enforcing dependencies between operations. They also need to implement mechanisms to stage, distribute, and manage large volumes of data and large numbers of data elements across memory/storage hierarchies.

We have developed an analytics framework that can be used by application developers and users for on-demand, high throughput processing of very large microscopy image datasets on a hybrid computation system [66, 64]. The analytics framework consists of a library of high performance image analysis methods, data structures and methods common in microscopy image analyses, and a middleware system. In earlier work [66, 64], we presented methods and their implementations at the middleware layer for scheduling data analysis operations and two-level analysis pipelines the computation system. In this paper, we investigate efficient data representations and the associated runtime support to minimize data management overheads of common data types consumed and produced in the analysis pipeline.

The primary motivation for this effort is the quantitative characterization of disease morphology at the sub-cellular scale using large numbers of whole slide tissue images (WSIs). This is an important and computationally expensive application in biomedical research. Investigations of tissue morphology using WSI data (also referred to here as microscopy image data) have huge potential to lead to a much more sophisticated understanding of disease subtypes and feature distributions and enable novel methods for classification of disease state. Biomedical researchers are now able to capture a highly detailed image of a whole slide tissue in a few minutes using state-of-the-art microscopy scanners. These devices are becoming more widely available at lower price points, making it feasible for research groups and organizations to collect large numbers of whole slide tissue images (WSIs) in human and animal studies. The Cancer Genome Atlas project, for instance, has more than 20,000 WSIs. We expect that in the next 3-5 years, research groups will be able to collect tens of thousands of digital microscopy images per study, and healthcare institutions will have repositories containing millions of images.

Over the past several years, a number of research groups, including our own, have developed and demonstrated a rich set of methods for carrying out quantitative microscopy image analyses and their applications in research [26, 53, 39, 20, 47, 25, 15, 16]. Scaling such analyses to large numbers of images (and patients) creates high end computing and big data challenges. A typical analysis of a single image of $10^5 \times 10^5$ pixel resolution involves extraction of millions of micro-anatomic structures and computation of 10-100 features per structure. This process may take several hours on a workstation.

Our earlier work has demonstrated that large numbers of images can be processed rapidly using distributed memory hybrid systems by carefully scheduling analysis operations across and within nodes in the system and that scheduling decisions can be pushed to the middleware layer, relieving the application developer of implementing complex, application-specific scheduling mechanisms. The work presented in this paper introduces an abstraction layer, referred to here as the region template framework, for management and staging of data during the execution of an analysis application and shows that the overhead of such an abstraction is small. Our contributions can be summarized as follows:

- A novel region template abstraction to minimize data management overheads of common data types in large scale WSI analysis. The region template provides a generic container template for common data structures, such as points, arrays, regions, and object sets, within a spatial and temporal bounding box. A *data region* object is a storage materialization of data types and stores the data elements in the region contained by a region template instance. A region template instance may have multiple data regions. The region template abstraction allows for different data I/O, storage, and management strategies and implementations, while providing a homogeneous, unified interface to the application developer.
- An efficient runtime middleware to support the definition, materialization, and management of region templates and data regions and execution of analysis pipelines using region templates on distributed-memory hybrid machines. Application operations interact with data regions and region templates to store and retrieve data elements, rather than explicitly handling the management, staging, and distribution of the data elements. This responsibility is pushed to the runtime system. Presently, the runtime system has implementations for memory storage on nodes with multi-core CPUs and GPUs, distributed memory storage, and high bandwidth disk I/O.
- An experimental evaluation of the region template framework on a distributed memory cluster system in which each compute node has 2 6-core CPUs and 3 NVIDIA GPUs. The results demonstrate that this level of abstraction is highly scalable and adds negligible overhead (about 3%).

While our target in this paper is large-scale microscopy analysis, there is a broader class of applications that have similar data processing patterns and

employ similar data structures (e.g., arrays, regions, and object sets within a spatial and temporal bounding box). This class includes applications for satellite data processing, subsurface and reservoir characterization, and analysis of astronomy telescope datasets [34, 41] [52, 6, 58, 14]. Thus, we expect that our work will be applicable in other application domains.

The rest of the paper is organized as follows. Section 2 provides an overview of the motivating scenario, and the use-case application for integrative microscopy image analysis. The region template framework is described in Section 3. Implementation of global region templates data storage, which are used for inter-machine data exchange is discussed in Section 4. Section 5 presents an experimental performance evaluation of the region template framework. The related work and conclusions are presented in Sections 6 and 7.

2. Background

2.1. Motivation

While our work is primarily motivated by studies that analyze and integrate morphological information from tissue specimens, these studies belong to a larger class of scientific applications that analyze and mine low-dimensional, spatio-temporal data. These datasets are characterized by elements defined as points in a multi-dimensional coordinate space with low dimensionality and at multiple time steps. A point is primarily connected to points in its spatial neighborhood. These properties are common in many datasets from sensors and generated from scientific simulations: satellite data in climate studies, seismic surveys and numerical simulations in subsurface characterization, and astronomical data from telescopes.

Rapid processing of data from remote sensors attached to earth orbiting satellites, for example, is necessary in weather forecasting and disaster tracking applications as well as for studying changes in vegetation and ocean ecosystems. Accurate prediction of weather patterns using satellite sensor data can assist a researcher to estimate where tornadoes may occur and their paths or where flooding because of heavy rain may take place. In this scenario, it is critical to analyze large volumes of data and corroborate the analysis results using multiple, complementary datasets (e.g., multiple types of satellite imagery). A dataset in this scenario may define regions of regular, lower resolution grids over the entire continent, while another may contain sensor readings on a higher resolution grid corresponding to a smaller spatial region. The researcher may perform a series of operations to (1) remove anomalous measurements and convert spectral intensities to value of interest; (2) map data elements in one dataset to another to create a mosaic of regions for full sensor coverage; (3) segment and classify regions with similar surface temperature; and (4) perform time-series calculations on land and air conditions; and (5) perform comparisons of land and air conditions over multiple time steps and across spatial regions to look for changing weather patterns.

In subsurface characterization, as another example, scientists carry out simulations of complex numerical models on unstructured, multi-resolution meshes,

which represent underground reservoirs being studied, to investigate long term changes in reservoir characteristics and examine what-if scenarios (e.g., for maximizing oil production by different placements of injection and production wells). Data are also obtained via multiple seismic surveys of the target region, albeit at lower spatial resolutions. A researcher may process, combine, and mine simulation and seismic datasets through a series of operations, including (1) selection of regions of interest from a larger spatio-temporal region; (2) mapping data elements from different datasets to a common coordinate system and resolution for analysis; (3) detecting, segmenting, and classifying pockets of subsurface materials (e.g., oil); (4) analyzing changes in segmented objects over time or under different initial conditions; and (5) correlating information obtained from one dataset with information obtained from another dataset (e.g., comparing segmented pockets from simulation datasets with those from seismic datasets to validate simulations).

2.2. Use Case: Integrative Microscopy Image Analysis

Microscopic examination of biopsied tissue reveals visual morphological information enabling the pathologist to render accurate diagnoses, assess response and guide therapy. Whole slide digital imaging enables this process to be performed using digital images instead of physical slides. The quantitative characterization of microscopy image data involves a process of [16, 37, 36]: (1) correcting for staining and imaging artifacts, (2) detection and extraction of microanatomic objects, such as nuclei and cells, (3) computing and characterizing their morphologic and molecular features, and (4) monitoring and quantifying changes over space and time. In some imaging studies, processing also includes 3-D and/or spatio-temporal reconstruction.

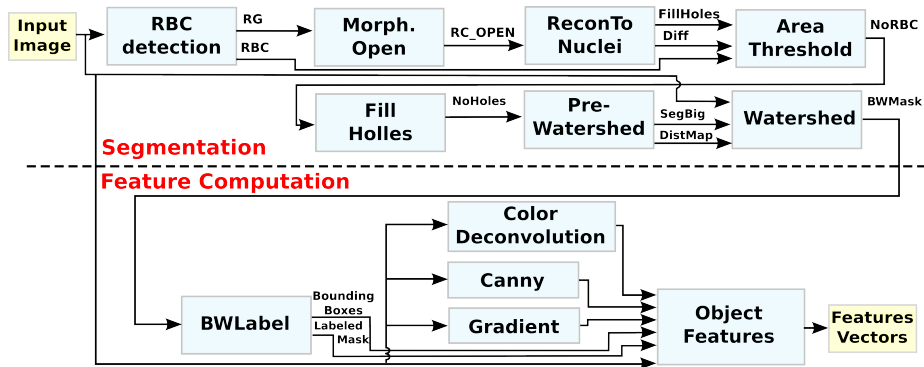

Figure 1: An example pipeline of the segmentation and feature computation stages. The segmentation phase identifies nuclei and cells in the input images, and defines a cytoplasmic region around each nucleus. The feature computation stage calculates a vector of 60-100 shape and texture features for each nucleus and cytoplasm found. Each stage is internally described as a complex workflow of fine-grain tasks.

In a typical analysis scenario, nuclei and cells are first segmented in each image, and a cytoplasmic space is defined around each nucleus in *the segmentation stage*. Features are calculated for each nucleus to describe its shape and texture in *the feature computation stage*. The properties of the "average" nucleus for each patient is calculated to generate a patient morphology profile. The patient morphology profiles are clustered using a machine-learning algorithm in *the classification stage*. The data are normalized and redundant features are eliminated using a feature selection process. The selected features are processed via statistical and machine learning algorithms to group patients into clusters with cohesive morphological characteristics. The patient clustering results are further processed to search for significant associations with clinical and genomics information in *the correlation stage*. The clusters are checked for differences in patient outcome, associations with the molecular subtypes defined in literature, human descriptions of pathologic criteria, and recognized genetic alterations.

In our current studies the most time consuming stages are the segmentation and feature computation stages. It is highly desirable in research studies to use large datasets in order to obtain robust, statistically significant results, but the scale of an image-based study is often limited by the computational cost of these stages. Modern scanners can generate a whole slide tissue image at up to 120Kx120K-pixel resolutions. An uncompressed, 4-channel representation of such an image is about 50GB. Image analysis algorithms segment 10^5 to 10^7 cells and nuclei in each virtual slide of size 10^5 by 10^5 pixels. For each segmented object 50-100 shape and texture features are computed in the feature computation phase. Figure 1 presents the computation graph for the segmentation and features computation stages. The graph of operations performed within each of these two stages is detailed. Processing a few hundred large resolution images on a workstation may take days. Distributed memory clusters of multi-core CPUs and modern GPUs can provide the computational capacity and memory space needed for analyses involving large numbers of images.

3. Region Templates

3.1. Region Templates Framework Architecture

This section presents an overview of the Region Templates framework. The main modules of the system are depicted in Figure 2: runtime system, region templates data abstraction, and implementations of data storage.

Region Templates applications are represented and executed as dataflows. It is responsibility of *the runtime system* module to manage execution on distributed environments. The runtime system instantiates the application components/stages, asserts dependencies among component instances are respected, optimizes execution on hybrid CPU-GPU equipped systems, and performs a multi-level task scheduling. Our runtime system implements a special type of dataflows representation called hierarchical dataflow. This model allows for an application to be described as a dataflow of coarse-grained components in which each component may be further implemented as a dataflow of fine-grained tasks.

This representation leads to flexibility and improved scheduling performance on hybrid systems, as detailed in Section 3.2,

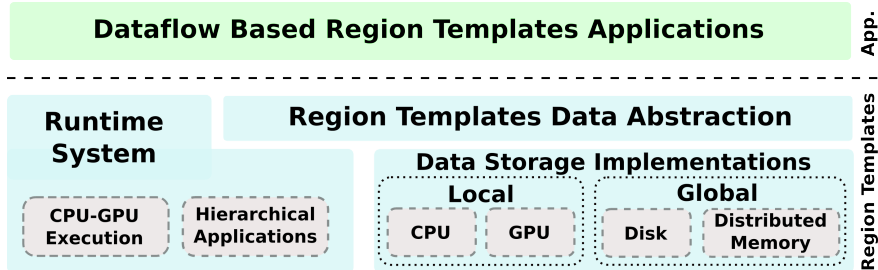

Figure 2: Architecture of the Region Templates framework: Region Templates supports representation and execution of applications using a hierarchical dataflow model with support for hybrid systems, equipped with CPUs and GPUs. The information read from/to application dataflow components are expressed using region templates data abstraction, which includes a template for data types commonly used in applications that process datasets represented in a spatial and temporal domain. Multiple implementations of the data abstractions are provided. These implementations include node local data instances stored in GPU and CPU memory, as well as global storage that makes region templates data regions visible for application components running in different nodes. Global data regions are used, i.e., to exchange data among application stages. The current implementations of the Global Data Storage include: (i) the high performance disk storage approach that is primarily used to efficient stage persistent data to disk; and, (ii) the distributed memory based storage that provides an efficient and transparent mechanism to transfers data among components of the application.

The data consumed and produced by the application components are stored using containers provided by the *Region Templates Data Abstraction*. The data types available with this abstraction include those that are commonly found in applications that process data represented in low-dimensional spaces (1D, 2D or 3D space) with a temporal component. Namely, some of the supported types are pixels, points, arrays, matrices, 3D volumes, objects and regions of interest that may be represented using polygons.

The region templates data abstraction implements efficient data transport mechanisms for moving data among region templates application components, which may run on different nodes of a distributed memory machine. Region templates exchanged among application coarse-grained stages are called global. Instead of writing data through streams as in a typical dataflow application, the components of a region templates application output region templates data instances (data regions) that are consumed by other components of the applications. The dependencies among component instances and data regions inputted/outputted by stages are provided to the runtime system by the application. It is responsibility of the runtime system to coordinate the transfers of data among stages. Data transfers are performed in background to useful computation by I/O threads, which interact with the appropriate implementations of the global data storage to retrieve/stage data. After transfers are done, the user component code is launched to perform the intended data transformations according to runtime system scheduling policies.

We currently provide implementations for global region templates storage

using high performance disks and distributed shared memory. We want to highlight that both implementations should coexist and that they are not necessarily competitors. There are cases in which the use of a high performance disk based mechanism is desirable, for instance, if the application needs to persist data exchanged among components for further analysis. If the goal is to transfer data as quickly as possible among application stages, using the distributed shared memory implementation tend to be the best choice. As such, we want to provide multiple global storage mechanisms, which could be interchanged by the end-user with minimum effort.

The description of the Region Templates framework is organized as follows: Section 3.2 presents the runtime system and the extensions implemented to execute region templates applications; Section 3.3 presents the region templates data abstraction; and, Section 3.4 describes the application composition process and interaction among region templates components in the execution. The storage implementations for region templates data abstractions are discussed in Section 4.

3.2. Runtime System Support

The runtime system used to coordinate the execution of region templates applications is built on top of our previous works [66, 64]. In this section, we present the core features of the runtime system that are inherited by region templates applications, as well as the extensions implemented to handle execution of region templates applications.

The application representation supported in the runtime system draws from filter-stream model implemented in DataCutter [6, 60]. Filter-stream applications are decomposed into components, connected to each other through logical streams; a component reads data from one or more streams, computes the data transformations, and writes the results to one or more streams. This model was adapted in our system in the following ways. This new framework supports hierarchical dataflow in that an operation can itself be made up of a dataflow of lower-level operations. It is described in the context of two dataflow levels for sake of presentation, but it allows for multiple levels of hierarchies. The first level is the coarse-grain operations level, which represents the main stages of an analysis application. The fine-grain operations level is the second level and represents lower-level operations, from which a main stage is created. Figure 3 illustrates the hierarchical pipeline representation of an analysis application.

The hierarchical dataflow representation allows for different scheduling strategies to be used at each level. Fine-grain tasks can be dispatched for execution with a scheduler in each node of the system, which is more flexible then describing each dataflow component as a single task that should be completely executed using a single device. With this strategy, it is possible to exploit performance variability across fine-grain tasks and to better use available devices.

The implementation of our runtime system is constructed using a Manager-Worker model, which combines a bag-of-tasks execution with the coarse-grain dataflow pattern. The application Manager creates instances of the coarse-grain stages that include *input data regions*, and exports the dependencies among the

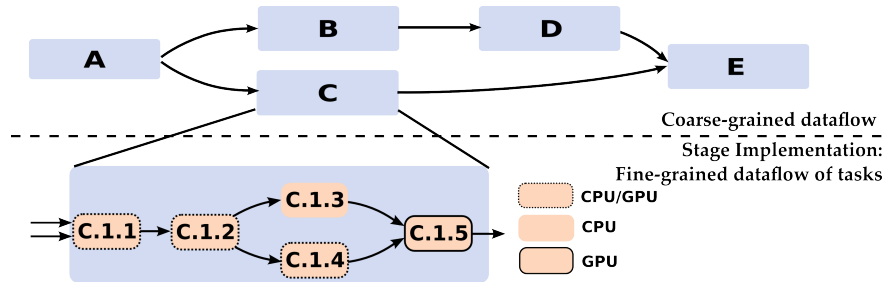

Figure 3: Hierarchical dataflow model. Each stage of an analysis pipeline may be expressed as another graph of fine-grain operations. This results in a hierarchical (two-level) computation graph. During execution stages are mapped to a computation node and fine-grain operations are dispatched as tasks and scheduled for execution with CPUs and GPUs on that node.

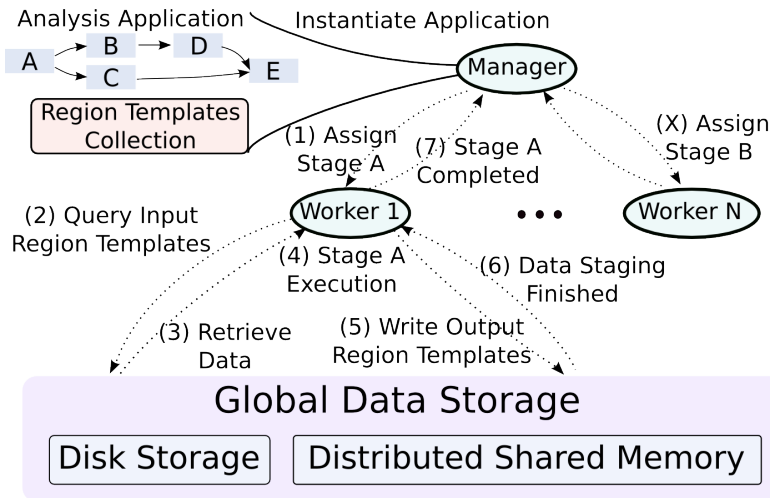

Figure 4: Overview of the framework execution model and architecture. The execution strategy of the system is built on top of a Manager-Worker model, which executes the coarse-grain dataflow model in a bag-of-tasks style. The application developer implements a part of the Manager module that instantiates the application workflow: creating as many instances of each stage as necessary and setting dependencies among them. At runtime, the Manager assigns stage instances for computation with Worker nodes in a demand-driven basis. Multiple stage instances may be active with a single Worker, which communicates with the global data region storage to retrieve data used by each stage instance. After a stage instance execution is completed, its output data regions are written to the adequate implementation of the global data storage, and Manager is notified. The Manager then releases appropriate dependencies, and may dispatch other stage instances for execution.

stage instances. The dependency graph is not necessarily known prior to execution, but may be built incrementally at runtime as a stage may create other stage instances. The assignment of work from the Manager to Worker nodes is performed at the granularity of a stage instance. The Manager schedules stage instances to Worker in a demand-driven basis, and Workers repeatedly

request work until all applications stage instances have been executed (See Figure 4). Each Worker may execute several stage instances concurrently in order to take advantage of multiple computing devices available in a node. The communication between Manager and Worker components of the runtime system is implemented using MPI. Data are read/written by stage components using global data regions, which are implemented as a module of the region templates framework and is responsible for inter-stage communication. Once a stage instance is received, the WCT identifies all region templates used by that stage, allocates memory locally on that node to store the regions, and communicates with the appropriate storage implementation to retrieve those regions. Only after data is ready in the node local memory, the stage instance may start executing. The process of reading data overlaps with useful computation, since tasks created by other stage instances may be concurrently executing with data movement of current stage.

As briefly discussed, each Worker process is able to use multiple computing devices in a node. The devices are used cooperatively by dispatching fine-grain tasks for execution in each CPU core or coprocessor. Because multiple stage instances may be active with a Worker, the tasks being computed may have been created by different application stages. In our implementation, fine-grain tasks created by a stage are dispatched for execution with the Worker Resource Manager (WRM) in each node (See Figure 5 for details). The WRM instantiates one computing thread for managing each CPU core or coprocessor. Whenever idle, those computing threads inform the WRM, which selects one of the tasks ready to execute with processing function implementation for the targeting processor. The scheduling policies used for selecting tasks are described in Section 3.2.1.

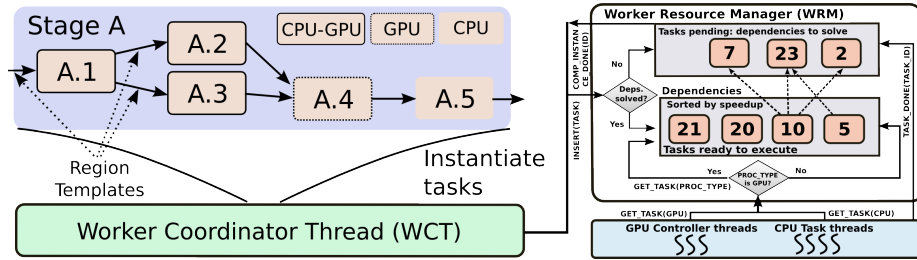

Figure 5: As described, each stage of an analysis application may be expressed as another graph of finer grain functions. Functions within a stage instance mapped to a computation node are dispatched as tasks and scheduled for execution by the Worker Resource Manager (WRM) on that node. The WRM creates one computing threads to manage each CPU core or coprocessor, and assigns tasks for concurrent execution in the available devices. Tasks ready for execution are placed into a queue, sorted by speedup if our performance aware scheduler described in Section 3.2.1 is used, and tasks with dependencies to be resolved stay on a list of pending tasks. As the computing threads become idle, a task ready to execute is assigned to that thread according to the scheduling policy used.

When all tasks dispatched for execution by a stage instance have finished, a callback function is invoked to notify the WCT. WCT executes data staging

and writes the outputted region templates to appropriate global data storage. A message is then sent to the manager process with the information about the completed stage. The Manager releases dependencies on that stage instance and, as a consequence, other stage instances may be dispatched for execution. The stages of region templates applications are developed in our framework as implementations of a special region templates stage abstract class. This class includes interfaces to insert, retrieve, and query region templates used by the application stage. The runtime system also uses this interface to access region templates associated to a given stage instance to (i) stage/read global data regions that are outputted/consumed and (ii) delete region templates that will not longer be used (input only and other regions after they are staged). Also, the region templates stage class needs to provide mechanisms for packing/unpacking itself to/from a data buffer when it is assigned to a Worker.

3.2.1. Optimized Execution on Hybrid Systems

This section details the optimizations implemented in our runtime system targeting hybrid systems, which include smart task scheduling and strategies to reduce impact of data transfers between CPUs and GPUs.

Performance Aware Task Scheduling (PATS). As previously discussed, the coarse-grain stages of the application may create several fine-grain task or operations, which are dispatched for execution with the WRM. In real-world data analysis applications, such as those that motivated the development of region templates, we expect that several fine-grain tasks will be use to compose the application. These tasks/operations tend to differ in terms of data access pattern and computation intensity, thus they are also likely to attain different speedups when executed on an accelerator. In order to take advantage of these performance variability, we have proposed and developed the PATS scheduling [66, 64] that is used with region templates. PATS assigns tasks to a CPU core or a GPU based on the tasks estimated acceleration on each device and on the processors load. Once tasks are dispatched for execution with the WRM, they are either inserted in a list of tasks pending or ready to execute. The pending tasks are those that do not have all dependencies resolved, and the ready tasks are prepared for execution. New tasks may be inserted in the ready tasks queue during the execution by the application or because they had the dependencies resolved. The PATS scheduler maintains the list of tasks ready for execution sorted according to the estimated speedup on a GPU, and the mapping of tasks to a CPU core or a GPU is performed in a demand-driven basis as these devices become idle. If the idle processor is a CPU core, the task with smallest speedup is selected for computation, whereas the task with maximum speedup is chosen when a GPU is available (See Figure 5).

The PATS scheduler only relies on tasks' speedup estimates that are accurate enough to maintain correct order of tasks in the queue. Thus, it will not suffer from inaccuracy in speedup estimates as long as it does high enough to affect the order of tasks. There are several recent efforts on task scheduling for hybrid systems [29, 43, 45, 5, 18, 8, 55, 31, 62, 11, 56, 61, 4, 67, 27, 28, 68, 30, 24]. Most

of the previous works deal with task mapping for applications in which operations attain similar speedups when executed on a GPU vs on a CPU. PATS, on the other hand, exploits performance variability to better use heterogeneous processors. Time-based schedulers (i.e., heterogeneous earliest finish time) have been successfully used in heterogeneous system for a long time. These class of schedulers, however, are very challenging to be employed in our application. Several operations (ReconToNuclei, AreaThreshold, FillHolles, PreWatershed, Watershed, etc) in our use case application have irregular data-access and computation patterns with execution times that are data-dependent. Thus, execution times of those operations can not be accurately estimated before execution. The speedup based scheduling used with PATS has shown to be easier to apply, because we observed smaller variation in speedups as consequence of input data variation.

Data Locality Conscious Task Assignment (DL). The time spent transferring data between CPU and GPU memories may have a great impact on the overall execution time of a computation carried out on a GPU. Thus, it is important for the scheduler to consider the location of the data used by a task (CPU or GPU memory) in order to maximize performance. However, it should minimize data movements without resulting in under utilization of a device, because executing a task in a device the computes it inefficiently. The data used as input or generated as output of each task executed in our runtime system are stored using region templates. In addition, region templates associated with a given task can be queried by the runtime system using the task class API. Using this API, we have extended the basic scheduler to incorporate data location awareness as an optional optimization. If it is enabled, the scheduler searches the dependency graph of each task executed on a GPU in order to identify tasks ready for execution that could reuse data generated by the current task. If the speedups of the tasks are not known (i.e., when First-Come, First-Served scheduler is used), DL forces the scheduler to select one task that reuses data for execution when one exists. In cases in which the speedup is known and PATS is used, it compares the performance of tasks that reuse data with those that do not reuse. The task with the best speedup in the queue (S_q) is compared to the task with the best speedup that reuses data (S_d). If ($S_d \geq S_q \times (1 - TransferImpact)$), the operation that reuses data is chosen. TransferImpact refers to the portion that the data transfer represents of the total task execution time. This value is currently provided by the user. The reasoning of this approach is that there may be operations that do not reuse data, but even paying an extra startup cost make better use of a device. Thus, it may be more appropriate to pay the data transfer costs than under utilizing a processor. This optimization is also utilized in CPU-based executions to allow for architecture-aware scheduling of tasks, which is an important optimization in the context of current non-uniform memory architectures (NUMA) machines. Thus, during the assignment of a new task for a CPU computation, the depending tasks of the previously computed task are given a priority for scheduling on that computing core. In our implementation, similarly to the case of a GPU, the dependency graph of

the current tasks is explored in order to find the depending task that maximizes the amount of data reuse. This strategy asserts good data reuse and reduces data movements.

Data Prefetching and Asynchronous Data Copy. Data prefetching and Asynchronous Data Copy are other techniques employed by our runtime system to mitigate the costs of data transfers. When DL is not able to avoid data movements, the runtime system will try to perform these operations in background to useful computation. In this approach, data used by tasks to be executed on a GPU or outputted by previous tasks are transferred to/from GPU memory concurrently to the computation of another task. In our implementation, the dataflow structure of the application is exploited once more to identify the data regions that need to be transferred, and the region templates API is used by the runtime system to perform the actual data transfers. The tasks executed on a GPU are then pipelined through three phases: uploading, processing, and downloading. In this way, data used by a task may be uploaded simultaneously to the computation of a second task, and to the download of data outputted by a third task.

3.3. Region Templates Data Abstraction

The region template abstraction provides a generic container template for common data types in microscopy image analysis, such as pixels, points, arrays (e.g., images or 3D volumes), segmented and annotated objects and regions, that are defined in a spatial and temporal domain. With this abstraction, the process of managing instances of the data types in a high performance computing environment is pushed to the middleware layer, allowing for implementations of different data storage and management capabilities, while providing a unified interface to applications read and write these data types. A region template instance represents a container for a region defined by a spatial and temporal bounding box. A *data region* object is a storage materialization of data types and stores the data elements in the region contained by a region template instance. A region template instance may have multiple data regions. Application operations interact with data region objects to retrieve and store data. That is, an application writes data outputs to data regions and reads data inputs from data regions, rather than reading from or writing directly to disk or directly receiving data from or sending data to another stage in the workflow.

Region templates and data regions can be related to other region templates and data regions. Data regions corresponding to the same spatial area may contain different data types and data products. For example, data regions can be related to each other to express structures at different scales that occupy the same space. Data regions can also be related to each other to express evolution of structures and features over time. The spatial and temporal relationship information may be used by the middleware layer to make decisions regarding distribution and management of data regions in a high performance computing environment. Data regions are identified by a *(namespace::key, type, timestamp,*

version number) tuple. This identifier intends to provide temporal relationships among data regions related to the same spatial area.

The region template library provides mechanisms for defining region templates and instantiating data regions with support for associative queries and direct access to data elements. A single region template instance may contain multiple data regions. A simplified version of the Region Template class definition is presented in Figure 6(a). Multiple data regions are stored into a map of data regions. Data regions with same name are stored into a list and they must differ by at least one of its identifiers: type, timestamp, and version number. A given region template instance also contains a bounding box with coordinates of the space it covers. As data regions are inserted into a region template, the bounding box of the region templates is be updated such that it remains the minimum bounding box to contain bounding boxes of data regions inserted.

```

class RegionTemplate {
private:
    // Data regions: 1D/2D/3D regular
    // or irregular, and polygons
    std::map<std::string,
    std::list<DataRegion*> >
    templateRegions;

    // Region template name identifier
    std::string name;

    // Region template coordinates
    BoundingBox bb;

    // If false, data are automatically
    // read during component creation
    bool lazyRead;
    ...
public:
    bool insertDataRegion(
        DataRegion *dataRegion);
    DataRegion *getDataRegion(
        std::string namespace,
        int timestamp=0, int version=0,
        int type);

    int getNumDataRegions();
    DataRegion *getDataRegion(int idx);
    void instantiateRegion();
    ...
};
(a) Region Templates Class.

```

```

class DataRegion {
private:
    // Type of each data element CHAR, UCHAR,...
    int elementType;
    // Dense, sparse, (2D/3D),...
    int regionType;
    int version, timestamp;
    // Name and instance identifier
    std::string name, id;
    // Resolution of the region
    int resolution;
    // BB surrounding domain and ROI
    BoundingBox bb, ROI;

    // Associates a given bounding box to an id,
    // for data that may be split into pieces.
    std::vector<std::pair<BoundingBox,
    std::string> > bb2Id;

    // Type of storage used to read: distributed
    //shared memory and high performance disk
    int inputDataSourceType, outputDataSourecetType;
    ...
public:
    DataRegion();
    virtual ~DataRegion();
    virtual bool instantiateRegion();
    virtual bool write();
    virtual bool empty();
    ...
};
(b) Data Region Abstract Class.

```

Figure 6: Simplified version of the Region Templates and Data Region Abstractions. A Region Template data structure may store several data regions, which are distinguished by their tuple identifier. The Data Region defines a base class that is inherited by concrete implementations of different data region types. Abstract methods in the Data Region class include those operations that are type specific and need to be implemented to create a new data region type. The system currently includes implementations of the following data region types: 1D, 2D, or 3D dense or sparse regions, polygons. These implementations also include node local implementations targeting shared memory hybrid machines, equipped with CPUs and accelerators.

The instantiation of the data regions stored in a region template used by an application stage instance may or may not be performed when that instance is received by the the Worker. If it is lazy, the actual data stored in each data region is only read when it is first accessed. Therefore, the data regions stored in a region template instance will only store the metadata describing the data regions, which are necessary and sufficient to retrieve the actual data

from a global data storage implementation. In the master component of a region templates application, for instance, the lazy mechanism is used by default, because we do not want to read the data at that level.

At the Worker level, our default strategy, as described in Section 3.2, is not to use lazy strategy and data used by a component instance is read by the Worker before the component execution. The user is able to subscribed this default rule, and request for data reading to be lazy. The latter approach is useful, for instance, if data accessed by a component does not fit entirely in memory or if the bounding box to be read is only known at runtime. In both cases, however, the data read during a data region instantiation are that within its Region of Interest (ROI) bounding box. This approach allows for a region template to store metadata of large data regions, which are split for parallel computation by simply modifying the ROI.

Access to a data region in a region template instance is performed through get/set operations and the data region tuple identifier. The different data regions types implemented must inherit from the DataRegion abstract class (presented in Figure 6(b)). In addition to the tuple identifier, the DataRegion class also includes attributes such as the type of elements stored, type of the region, etc. The type of the region, for instance, describes whether it stores 1D, 2D, or 3D dense or sparse regions, polygons, etc. For each of these types, we have a different implementation of the DataRegion class, because the methods for instantiating/writing those different types from/to the global storage differ from according to the data structure used. New data region types may be added by implementing the DataRegion class.

Most of the data regions currently supported are implemented using OpenCV [9] underneath. Such as ITK [32, 33], OpenCV supports a number of data types that include Points, Matrices, Sparse Matrices, etc, which are commonly used by image analysis applications. An additional feature of OpenCV that motivated its use is the support for GPUs, which includes some of the data structures and processing methods.

The currently supported data region types: 1D, 2D, or 3D dense or sparse regions, polygons, have implementations for local storage in a shared memory machine targeting hybrid systems. As such, the region templates data structures have both CPU and GPU based counterpart implementations, allowing for region templates instances and their data structures to resided into local the CPU or GPU memory of a node. It includes capabilities for moving the data structures between the CPU and GPU memories through data uploads and downloads interfaces. Data transfers in each direction may be carried synchronously or asynchronously. The region template interface includes blocking and non-blocking query operation to verify whether a transfer has finished. As discussed in Section 3.2.1, the runtime system takes advantage of asynchronous transfer mechanisms to overlap data transfers with useful computation.

Data regions exchanged among application components, which may run on different nodes of a distributed memory computed, are called global data regions. The current implementation of the system provides different implementations of *data storage* for global regions. The currently supported implementations are

detailed in Section 4, and include high performance disk and distributed shared memory storage.

3.4. An Example Region Templates Application Workflow

An application in our analytics framework consists of a manager component and the application stages that are executed with Workers. The manager (master) component specifies the analysis workflow and defines the region templates for the application. The application developer needs to provide a library of data analysis operations and to implement the portions of the manager that specify the analysis pipeline and region templates used in each stage. In this process, the manager component may need to partition each region encapsulated by the region templates among workflow stage instances for parallel execution. Our current implementation supports arbitrary partitions of the data regions.

Figure 8(a) presents a sketch of the manager code in our use case application. It defines the libraries in which the application stages are implemented. Further, in our specific application case, the manager component reads a list of image tile file names from an input folder and builds a single region template instance ("Patient") from all tiles. In this example, a data region ("RGB") is created and each image tile is inserted in the data region with appropriate bounding box of the subdomain it refers to. As presented in Section 3.3, a data region may be partitioned into several chunks of data with associated bounding box (See *bb2Id* structure in Figure 6(b)).

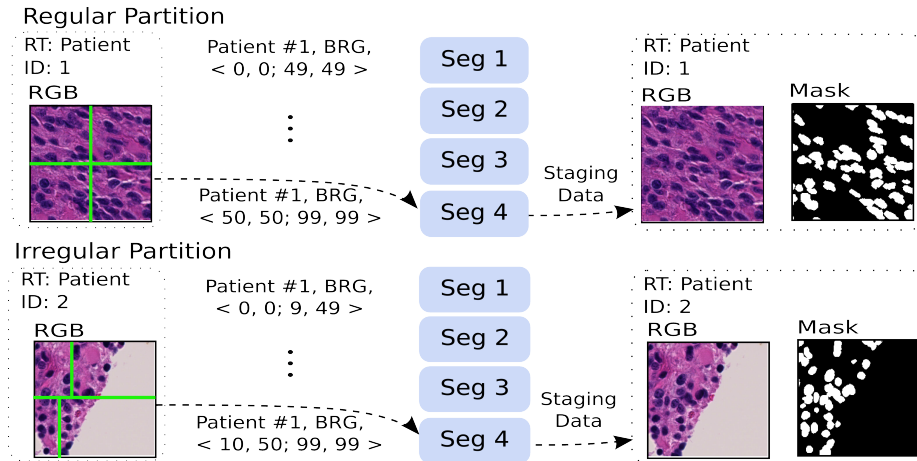

Figure 7: Two possible data partitions and instantiations of that stage, using regular (blocks of 50×50 pixels) and irregular blocks for better balancing of computational load. Irregular partitions would be useful, e.g., in computations of unstructured grids.

After the data region is created, our manager code partitions the data domain of the data region used as input. The user may create arbitrary partitions that are more appropriate for her application. As an example, two partition

approaches could be used with our application (See Figure 7) – the code segment that creates partitions is not shown. In the regular case, input data region are partitioned into 50×50 tiles. In the irregular data partition, a customized partition is implemented based on some metric provided, for instance, object or tissue density.

Further, the manager code creates a copy of each application stage per partition, and sets data regions used in each of them. The data region information includes the appropriate ROI of that instance, type of data region (input, output, input and output), and global storage used. During this process, the dependencies among stage must also be provided by the application developer. Finally, the stage instances are dispatched for execution with the runtime system, which waits until the application completes.

Figure 8(b) presents the code for the segmentation stage used in our example analysis application. A region template, called "Patient", defines a container for data regions "RGB" and "Mask". The data region "RGB" is specified as input and output, meaning it is read from a data region storage and written to a storage at the end of the stage. The data region "Mask" is specified as output, since it is produced by the segmentation stage. When a copy of the segmentation stage is executed on a node, it interacts with the runtime system through the region template. It requests the data region "RGB", creates the data region "Mask", associates "Mask" with data distributed memory storage implementation "DMS", and pushes it to the region template instance. We should note that the code in the figure is simplified for space reasons. As described earlier, the runtime system have access to the data regions and region templates used by a stage, and is able to instantiate the data region used and makes it available to the segmentation stage (see Figure 4).

In this example, a copy of each stage is executed per partition. Assume the bounding box of the entire region is $(< 0, 0; 99, 99 >)$. The bounding box of partition 4 of the data region "RGB" is defined as $(< 50, 50; 99, 99 >)$, a copy of the segmentation stage, e.g., "Seg 4" in Figure 8 is created to compute that region. Preserving the bounding box of the original region template is important to allow for the application to identify the location of the data regions in the original data domain. This information is useful, for instance, for computations involving overlapping borders. The case of ghost cells, for instance, may be handled in a region templates application by (i) creating ROIs that include the ghost cells during the process of reading data and (ii) shrink the ROIs of data regions to remove the ghost cells before they are staged.

As noted earlier, data regions can be associated with different data storage implementations. In the code segment in Figure 8(b), the data region "RGB" is read from the high performance disk ("DISK") and written to "DMS" storage implementation. If at least one of the tuple identifiers of the region is not modified, two copies of the same data region would exist in different global storage implementations after segmentation. In this case, unless otherwise specified by the user, the system will use the latest staged region in the remaining references to that data region. The case in which multiple stage instances reads and stages overlapping areas of a data region to the same data storage implementation may

```

int main (int argc, char **argv){
    ...
    RegionTemplate *rt;
    // Libraries that implement components
    SysEnv sysEnv(argc, argv, "libcomponentsrt.so");

    // Create a region templates instance. In this example, a single
    // input image is stored into multiple files. Each file is inserted
    // into the same data region with appropriate bounding box.
    rt = RTFromFiles(inputFolderPath);

    // Create partition of the RT for parallel execution
    vector<BoundingBox *> partitions = createPartition(rt);

    // Instantiate application dependency graph
    for(int i = 0; i < partition.size(); i++){
        // Create an instance of Segmentation stage
        Segmentation *seg = new Segmentation();
        // Insert region template to be used, with it ROI:partitions[i]
        seg->addRegionTemplateInstance(rt, "RGB", partitions[i], INPUT_OUTPUT, DISK);
        seg->addRegionTemplateInstance(rt, "Mask", partitions[i], OUTPUT, DMS);

        // Create instance of Feature Computation stage
        FeatureExtraction *fe = new FeatureExtraction();
        fe->addRegionTemplateInstance(rt, "RGB", partitions[i], INPUT, DMS);
        fe->addRegionTemplateInstance(rt, "Mask", partitions[i], INPUT, DMS);

        // Set stage dependencies
        fe->addDependency(seg);
        // Dispatch stages for execution
        sysEnv.executeComponent(seg);
        sysEnv.executeComponent(fe);
    }
    // Start Executing
    sysEnv.startupExecution();
    // Wait until application is done
    sysEnv.finalizeSystem();
    ...
}

```

(a) Manager component of the application.

```

int Segmentation::run()
{
    // Get region template (RT) handler
    RegionTemplate *inRT = getRegionTemplate("Patient");

    // Get data region inside that RT
    DenseDataRegion2D *rgb =
        dynamic_cast<...>(inRT->getDataRegion("RGB"));

    // Change version of the outputted region
    rgb->setVersion(rgb->getVersion()+1);

    // Create output data region
    DenseDataRegion2D *mask =
        new DenseDataRegion2D("Mask", DMS);
    mask->setBb(rgb->getBb());
    inRT->insertDataRegion(mask);

    // Create processing task
    Segmentation(rgb, mask);
}

```

(b) Simplified code for the segmentation stage.

Figure 8: Simplified code of (a) manager component and (b) segmentation stage in our example application. The manager component is responsible for setting up the runtime system, initializing the metadata of the region templates and data regions used, partitioning the data regions for parallel execution, and creating the application graph with appropriate dependencies among stage instances. The segmentation code represent the interactions of an application stage with region templates to retrieve data, and transform it. As discussed, the data staging of output data regions is handled by the runtime system.

also lead to synchronization problems. The global data storage implementation always keeps the last staged version of overlapping data regions. Therefore, the application developer should set dependencies among stages correctly to avoid such issues.

4. Global Storage Implementations for Data Regions

We have developed implementations of data regions that represent data structures used in the object segmentation and feature computation operations. Input to an object segmentation operation is an image tile, output from the segmentation operation is a mask array. Input to a feature computation operation is a pair of (image tile, mask array), while the output of a feature computation operation is a set of feature vectors. Each feature vector is associated with a distinct segmented object. The implementations include local and global storage. The local storage, detailed in Section 3.3, refers to region templates and data regions local to a node stored in CPU and/or GPU memories. The global storage is accessible by any node in the system and stores global regions that are used to exchange data among the analysis stages of an application. The storage implementations for global data regions are presented in Sections 4.1 and 4.2.

4.1. Distributed Memory Storage

The distributed memory storage (DMS) implementation is built on top of DataSpaces [19]. DataSpaces is an abstraction that implements a semantically specialized virtual shared space for a group of processes. It allows for data stored into this space to be indexed and queried using an interface that provides dynamic and asynchronous interactions. The data to be retrieved/stored is described through key-value pairs that define a bounding box within the application address space. DataSpaces is implemented as a collection of data storage servers running on a set of nodes. An important component of DataSpaces is its distributed hash table (DHT) presented in Figure 9, which has been designed as an indexing structure for fast lookup and propagation of metadata describing the data stored in the space. In multi-dimensional geometric domains, DataSpaces employs Hilbert space-filling curve (SFC) [7] to map n -dimensional points to an 1-dimensional domain for storage in the DHT. The resulting 1-dimensional SPC domain for an application data may not be contiguous and, as such, it mapped into a virtual domain before data is distributed among the storage nodes.

The systems is built using a layered architecture with communication, data storage, and data lookup layers. The communication layer provides a set of communication primitives, which are implemented on top of advance network technologies used in high-performance systems. It includes Remote Direct Memory Access (RDMA) and one-sided communication. This layer also defines protocols for communication between application and storage system, and between components of the storage system. The data storage layer is responsible for storing data received from the application and managing memory allocation and buffering. Data received from the application is stored in-memory. This layer complements the DHT that maintains metadata describing location of the data. Finally, the data lookup layer provides the mapping of application domain geometric descriptors in keys of the DHT (See Figure 9), as well as it coordinates the routing of queries to nodes containing the data.

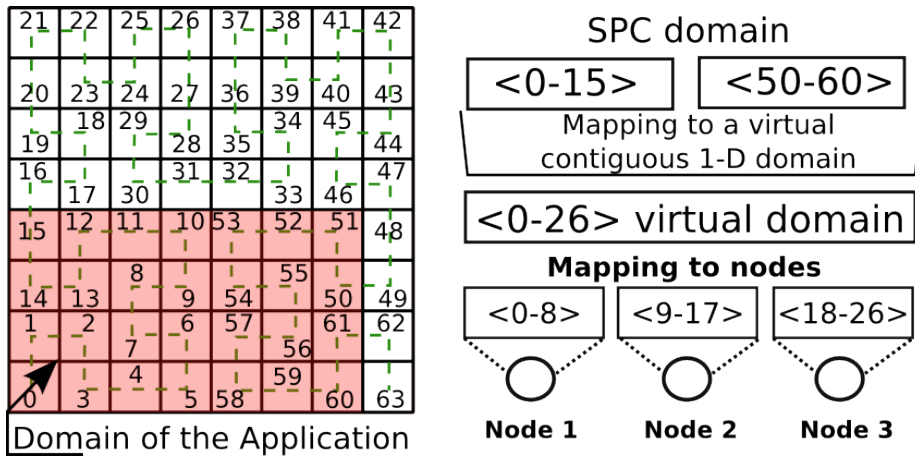

Figure 9: Space-filling curve based distributed hash table (DHT). The application 2-dimensional domain (highlighted) is first mapped in a contiguous virtual domain, and is further divided to be stored in multiple storage nodes.

Our implementation provides a specialized factory object, which can stage data regions from a region template instance to DataSpaces and retrieve data regions to create local instances of the data regions on a node. In the process of staging a region template instance (and the data regions it stores) to DataSpaces, a DataSpaces insertion request (formed using the data region tuple identifier and the data region bounding box) is created for each data region in the region template instance. Then, the data into the data regions are packed according to the application domain description and the system dispatches asynchronous insertion requests to the space. Similarly, in the read operation, the read requests are created from an identifier and bounding box describing the portion of the data domain to be retrieved and DataSpaces is queried in background. After data are returned, the system instantiates the application local CPU-based data regions and associates them to the region template instance being created. As discussed before, the computation stages are dispatched for execution only after the data is retrieved and the data regions are locally available. This allows for the data movement necessary for the execution of a stage instance to be performed in background to other stage instances execution.

4.2. High Performance Disk Storage

We have developed an implementation for disk storage based on a stream-I/O approach, drawing from filter-stream networks [3, 54, 40] and data staging [19, 1]. The storage implementation assumes that data will be represented and staged to disk in application-defined chunks. In our current implementation of image analysis pipelines, the processing of a set of images in the segmentation and feature computation stages is carried out in image tiles. Output from the segmentation stage is a set of mask arrays, each of which corresponds to an image

tile. A data region with *global* scope is used to store these mask arrays on a distributed memory machine. The I/O component provides the data storage abstraction associated with the data region. When a computation node finishes processing data associated with an image tile, it writes the mask array to the data region. The data region passes the output as a data chunk to the data storage abstraction layer. This approach allows us to leverage different I/O configurations and sub-systems. In the current implementation, in addition to POSIX I/O in which each I/O node can write out its buffers independent of other I/O nodes, we have integrated ADIOS [44] for data output. ADIOS is shown to be efficient, portable, and scalable on supercomputing platforms and for a range of applications.

In our implementation, I/O operations can be co-located with computation operations, and we have extended ADIOS to support the case in which a set of CPU cores can be designated as I/O nodes. In the co-located case, we have also developed support to allow for processors to be partitioned into I/O clusters, whereas in the original ADIOS implementation only a single I/O cluster is used for all processors. All the processors in the same I/O cluster use the same ADIOS group and may need to synchronize. Each I/O cluster can carry out I/O operations independent of other I/O clusters; there is no synchronization across I/O clusters. This clustering is aimed at reducing the synchronization overheads. In the separate I/O-computation configuration, the I/O nodes are coupled to the computation nodes via logical streams. The I/O nodes are further partitioned into groups of k I/O nodes – all the I/O nodes could be in the same group ($k = N$, where N is the number of I/O nodes), or each group could consist of a single I/O node ($k = 1$). In this setting, when a computation node is ready to output a data chunk, it writes the mask array to its output stream. The stream write operation invokes a scheduler which determines to which I/O node the data buffer should be sent, and sends the buffer to the respective I/O node. When an I/O node receives a buffer from its input stream, it puts the buffer into a queue. When the number of buffers in the queue in an I/O node reaches a predefined value, all the I/O nodes in the same group go into a write session and write the buffers out to disk. This implementation facilitates flexibility. The I/O nodes can be placed on different physical processors in the system. For example, if a system had separate machines for I/O purposes, the I/O nodes could be placed on those machines. Moreover, the separation of I/O nodes and computation nodes reduces the impact on computation nodes of synchronizations because of I/O operations and allows a scheduling algorithm to redistribute data across the I/O nodes for I/O balance. We have implemented round-robin and random distribution algorithms. In summary, this module of our system extends ADIOS to support (i) separated I/O cores and (ii) configurable I/O cluster/group sizes, since original ADIOS have a single cluster that contains all processes.

5. Experimental Results

We have evaluated the region template framework using the Keeneland distributed memory hybrid cluster [70]. Keeneland is a National Science Founda-

tion Track2D Experimental System and has 120 nodes in the current configuration. Each computation node is equipped with a dual socket Intel X5660 2.8 Ghz Westmere processor, 3 NVIDIA Tesla M2090 (Fermi) GPUs, and 24GB of DDR3 RAM (Figure 10). The nodes are connected to each other through a QDR Infiniband switch. The image datasets used in the evaluation were obtained from brain tumor studies [17]. Each image was partitioned into tiles of $4K \times 4K$ pixels, and the background only tiles were removed from the tile set. The codes were compiled using “gcc 4.4.6”, “-O3” optimization flag, OpenCV 2.3.1, and NVIDIA CUDA SDK 4.0. The experiments were repeated 5 times. The standard deviation in performance results was not observed to be higher than 3%. The input tiles were stored in the Lustre file system attached cluster.

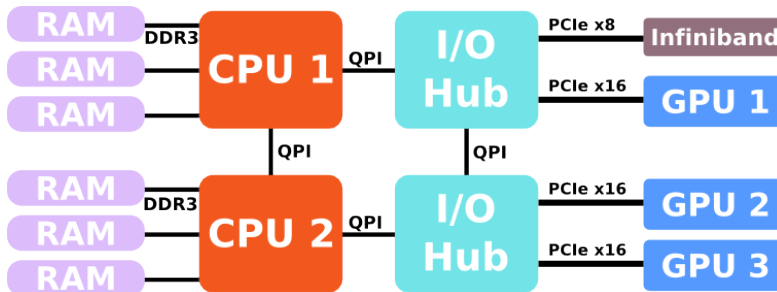

Figure 10: Keeneland computing node architecture.

5.1. Example Application

The example application implements a segmentation stage and a feature computation stage, as shown in Figure 1 (Section 2.2). The segmentation stage receives a RGB image as an input and produces a mask identifying segmented nuclei. The feature computation stage computes a set of shape and texture features for each segmented nucleus. Each stage is composed of a series of functions with the CPU and GPU implementations. For functions such as Morphological Open, Color deconvolution, Canny, and Gradient, we have used the implementations in OpenCV [9]. The GPU based version of Watershed is based on the implementation by Körbes et. al. [38]. The functions "ReconToNuclei", "FillHoles", and "Pre-Watershed" were implemented using the irregular wavefront propagation pattern (IWPP) optimized for GPU execution by our group [65]. The IWPP algorithms perform computation only on a subset of elements (active elements) from the input data domain, since other elements do not contribute to output. Our GPU implementation of the IWPP algorithms uses a hierarchical and scalable queue to store and manage active elements for high performance execution. We refer the reader to the earlier work for the implementation details [65]. The connected component labeling function (BWLabel) is implemented by us based on the union-find pattern described in [50]. This pattern creates a forest in which each pixel is a tree, and iteratively merges

adjacent trees with same mask pixel value. After the merging phase, labels can be extracted by flattening the trees.

The feature computation stage has relatively regular computation patterns and achieves better GPU acceleration overall than the segmentation stage does. For feature computations on objects, we restructured the computation into a set of smaller regions of interest: a set of minimum bounding boxes, each of which containing a nucleus. Since each bounding box can be processed independently, a large set of fine-grained tasks will be created in this strategy. By restructuring the computations in this way, we avoid unnecessary computation in areas that are not of interest (i.e., that do not have objects) and create a more compact representation of the data.

The parallel computation of object features using a GPU is organized in 2 steps. First we assign one GPU block of threads to each bounding box, and those threads in a block collectively compute the intermediate results, i.e., histograms and co-occurrence matrices of the corresponding nuclei. By structuring the computation in this way, we take advantage of a GPU's ability to dynamically assign thread blocks to GPU multiprocessors, in order to reduce load imbalance that may arise due to differences in sizes and, consequently, computation costs of different nuclei. In the second step, the nuclear feature values are calculated from intermediate results, which are now fixed sized per nucleus, and one GPU thread is executed per nucleus. A single step computation of intermediate results and features is in contrast less efficient because: (i) the number of threads needed for intermediate results computation is much higher than the number of features to compute, resulting in idle threads; and (ii) the computation of different features by threads in same block creates divergent branches. Both inefficiencies are resolved with the two-step approach.

5.2. Single Node Performance

These experiments intend to quantify the overhead of using the region template abstraction and the scalability of the example application on a single node of the cluster. The timings reported in our results are the end-to-end runs and, therefore, include the I/O costs of reading the input images from the file system.

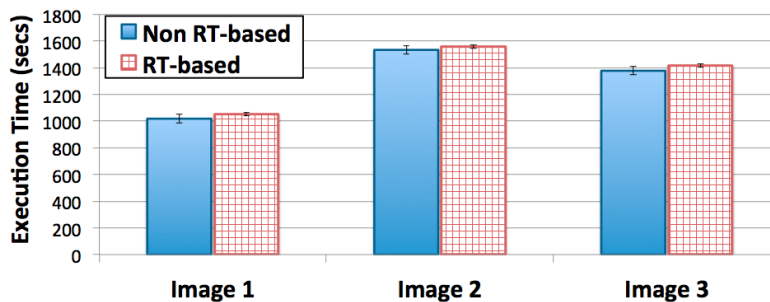

Figure 11: Comparison of the Non-RT-based and RT-based versions on a single CPU core.

We have developed a sequential single core version of the application (referred to as *non RT-based*) and compared its execution times with those of the single core version of the application using region templates (referred to as *RT-based*). Both implementations were executed using 3 randomly selected images: Image 1, Image 2, and Image 3, containing 108, 154, and 117 4K×4K tiles, respectively. As shown in Figure 11, the non RT-based version is only 1.03× and 1.02× faster, respectively, in the best and average cases. This shows the overhead of the region template abstraction is very small.

The speedup values for the RT-based version on multi-core CPU and multi-GPU executions, as compared to the single CPU core version, are presented in Table 1. We first evaluate the impact of using the Data Locality Conscious Task Assignment (DL) to the scalability. When this optimization (described in Section 3.2.1) is enabled, the system will preferably assign to a given CPU core tasks that are depending on the previously computed task on the same core, because those tasks will reuse data and avoid data movement in the memory hierarchy. As presented, the multi-core version of the application without DL achieved executions are slightly sub-linear, i.e., 10.1× for the 12 cores configuration. This is a consequence of the application’s high memory bandwidth demand, which limits the multi-core scalability as the threads compete for the shared memory subsystems, and the higher costs for reading data as the number of computing cores increase. Additionally, the use of DL to reduce the amount of that transfers resulted into an application speedup of 10.9× on top of the single core runs (with 12 cores used), and an improvement of about 1.08× as compared to the multi-core counterpart without this optimization.

(a) Parallel CPU-based executions with/without data locality conscious task assignment (DL).

# of CPU cores	1	2	4	6	8	10	12
Speedup	1	1.9	3.8	5.7	7.5	9.2	10.1
Speedup - DL	1	1.9	3.9	5.8	7.9	9.8	10.9

(b) Multi-GPU scalability

# of GPUs	1	2	3
Speedup	7.9	15.3	22.2

Table 1: Multi-core and multi-GPU scalability of the example application.

The speedups achieved by the multi-GPU executions of the RT-based version are also presented in Table 1. Speedups of 1.94× and 2.82× on two and three GPUs, respectively are achieved with respect to the single GPU version. The good scalability was obtained through a careful, architecture-aware placement of threads managing GPUs. In this placement, the GPU manager thread for a GPU is bound to the CPU core that is closest to the GPU in terms of number of links to be traversed when accessing that GPU. Without this placement, the speedup on 3 GPUs was only 2.27×.

5.3. Disk Storage: Region Template High Performance Staging to Disk

These experiments evaluate the disk storage implementation for high speed staging to disk. This module of our system is built on top of ADIOS, which is extended in the Region Templates implementation to include support for (i) separated I/O cores and (ii) configurable I/O group/cluster sizes.

The evaluation was carried out on a large scale cluster, called Titan. Titan is a US Department of Energy System with 18688 nodes, each with a 16-core AMD Opteron 6274 processor, and 32 GB of memory. Disk storage is provided through a shared Lustre file system. While the other experiments were carried out using Keeneland, this set of experiments used Titan because ADIOS is installed on Titan for production use, Titan is attached to a more scalable storage system, and we were able to use more CPU cores on Titan than on Keeneland.

We used two I/O configurations. In the first configuration, called *co-located I/O*, each CPU core is also an I/O node and performs both computation and I/O operations. In the second configuration, referred to here as *separated I/O*, each CPU core is designated as either a compute core or an I/O core; the compute cores send the output data to the I/O cores for file system writes. The co-located I/O configuration maximizes the number of cores performing I/O, but introduces synchronization during I/O operations. The separated I/O configuration insulates the compute cores from the synchronization overhead, but introduces additional communication costs. We investigated the effects of using each configuration along with different transport mechanisms. Three transport mechanisms were tested: POSIX, where the data are written to the file system independently via standard POSIX calls; MPI LUSTRE, where ADIOS is aware of the Lustre parameters for the file target; and MPI AMR, which is similar to MPI LUSTRE, but a staging layer is introduced to increase data size per I/O request. For each transport mechanism, we partitioned the set of cores participating in I/O into MPI groups of size 1, 15, or the full I/O core size (ALL) to balance between synchronization impact and transport mechanism requirements. For the Separated I/O configuration, we dedicated 60, 512, or 1536 cores for the I/O tasks. Each parameter combination was run in triplicate using 2048 cores with 10240 4K×4K input image tiles.

Figure 12 shows that the co-located I/O configuration performs better than the separated I/O configuration for all experiments. The experiments with the co-located I/O configuration experienced decreased performance when group size was increased for POSIX and MPI LUSTRE, showing that support for smaller I/O groups implemented as part of the Region Templates framework consistently improved the performance of the application – the default setup (originally implemented in ADIOS) supports only the configuration with All processors in an I/O group. For MPI AMR and co-located I/O, we have observed an opposite trend, as smaller groups would perform very poorly due to overheads introduced without staging benefits.

For MPI AMR in the separated I/O configuration, we excluded group size of 1 as this configuration produced extremely poor performance. For most of the separate I/O results, allocating 512 cores to I/O resulted in better performance

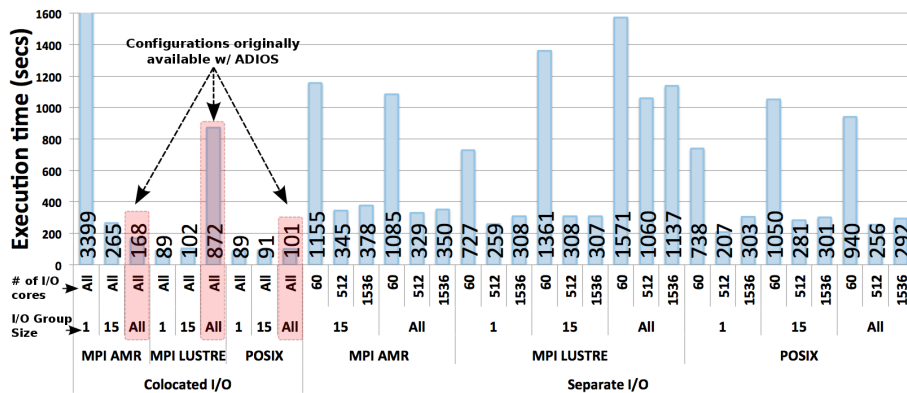

Figure 12: Evaluation of high performance disk staging implementation on Titan. Two configurations are tested for data staging: co-located I/O in which each computing core also performs I/O operations, and separated I/O in which each core is either a compute core or an I/O core. Different transport mechanisms may be used for each configuration: MPI AMR, MPI LUSTRE or POSIX. Further, Region Templates also implements the ability of using a configurable number of cores in I/O groups (ADIOS originally only supports the configuration with All cores in a single I/O group). The I/O group sizes evaluated are presented on top of the mechanism chosen. Finally, the number of cores used as I/O cores is presented in the labels closest to the X-axis. The configurations available with the original implementation of ADIOS are highlighted. The remaining of the configurations are a result of the extension implemented with Region Templates: separate I/O and flexible I/O group sizes. As presented, co-located I/O leads to better performance in all configuration. Further, The MPI LUSTRE and POSIX with co-located I/O attained to the best performance using small I/O group sizes. As compared to the best original ADIOS configurations (co-located and group size equals to All), the extensions with the Region Templates resulted into a speedup of $1.13\times$ in the application runtime.

than 60 or 1536 I/O cores, potentially due to better balancing between data generation rate at the compute cores, data transmission rate between cores, and data consumption rates at the I/O cores. The configurations with 60 cores for I/O resulted in lower performance, because of communication contention when sending data to the I/O cores. The MPI LUSTRE transport showed a significant decrease in performance with the ALL group size, since it incurs significant synchronization costs.

Even though the separated I/O attained lower performance than co-located I/O, we expect that it will improve the performance of the co-located I/O in other scenarios. For instance, if we were able to run the separated I/O nodes into the storage nodes, it would reduce the communication traffic. In that case, the application would benefit from the asynchronous I/O supported by separated I/O, because it caches data from I/O operations in memory, and performs the proper write operations to storage in background to the application execution.

The region template abstraction allows us to choose different I/O implementations and co-locate or separate the I/O nodes to achieve good performance. The use of small I/O group sizes supported by Region Templates resulted into a speedup of $1.13\times$ on the application execution time as compared to the best

configuration originally available in ADIOS (Co-located I/O, POSIX, and I/O group size All). We intend to examine in a future work methods for automating the choice of the I/O configuration through the integration with parameter auto-tuning systems [59, 71, 49].

5.4. Performance of Distributed Memory Storage Implementation

This section evaluates the performance of the distributed memory storage (DMS), and compares it to the high performance disk storage (DISK) to exchange data between the segmentation and feature computation stages. In the DISK storage, I/O nodes and compute nodes were co-located with a group size of 1 (i.e., each compute node performs I/O operations independently of the other nodes) and the POSIX I/O substrate was used for read and write operations. This configuration resulted in the disk storage best performance, as detailed in Section 5.3.

In these experiments, the segmentation stage receives a region template with a data region named “RGB” as input, and creates an additional data region named “Mask” that identifies segmented nuclei. The DISK version of the application reads the “RGB” from the file system and stages the “Mask” data region to the file system at the end of the segmentation stage. Both data regions are then read from the file system during the feature computation stage. The DMS version also reads the input “RGB” data region from the file system in the segmentation stage. At the end of the segmentation stage, however, the “RGB” data region is staged to DataSpaces along with the “Mask” (the “RGB” data region is marked as INPUT_OUTPUT as presented in Figure 8(b)). Therefore, in the DMS version, the feature computation stage reads both data regions directly from DMS. The results presented in this section are from strong scaling experiments, in which the size of the data used as input and the number of nodes are increased proportionally. A total of 10,800 4K×4K image tiles are used for the runs on 100 nodes.

The performance of the example application using the DISK and DMS based implementations is presented in Figure 13. As shown, the DMS version achieved better performance in the baseline configuration (4 nodes) and higher scalability when the number of nodes is increased. Figure 13 shows that the cost of writing the output of the segmentation phase (“Seg. staging”) using DMS is at least 10× smaller than that using the DISK based version. We should note that the DMS version writes the “Mask” and “RGB” data regions in this stage, while the DISK version writes out the “Mask” only, since the “RGB” data region is already stored in the file system. As a consequence, the amount of data staged in by the DMS version is 4× of the amount of data staged in by the DISK version.

Although the DISK and DMS versions of the application read the input data regions for the segmentation stage (“Seg. input read”) from the file system, the cost of this operation is cheaper in the DMS based executions. This better performance is a side effect of the DMS version not using the file system to exchange data between the segmentation and feature computation stages, which

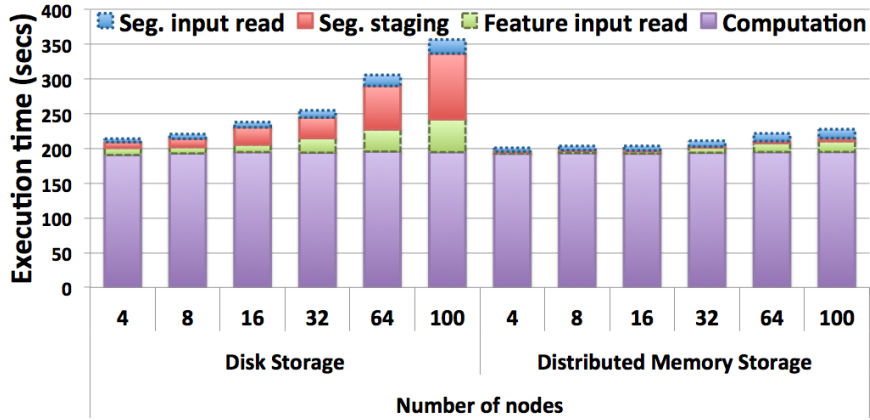

Figure 13: Efficiency and scalability of distributed memory storage and high performance disk storage implementations of Region Templates. In this evaluation, Region Templates is used to transfer data from Segmentation to Feature Extraction stages of our example application. As presented, the cost of the data transfers with the use of disk storage increases quickly as the number of nodes used grows, whereas the distributed memory storage based mechanism attains better efficiency and scalability.

leads to lower load on the file system, and hence to less expensive reading operations as compared to the DISK version.

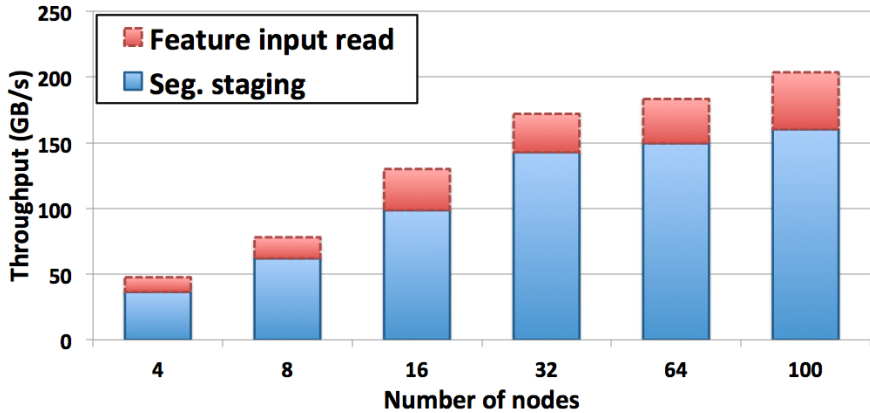

Figure 14: Data staging/reading throughput of the distributed memory storage (DMS) based global region templates implementation (built on top of DataSpaces) for the communication among the Segmentation and Feature Computation stages of the example application.

Further, the data transfers rates (GB/s) among the application stages for the DMS implementation are presented in Figure 14. The region templates achieves very high communication throughput among stages, reaching an aggregate transfer rate of about 200 GB/s. The process of reading the data regions for the feature computation stage (“Feature input read”) using the DMS version is about 3-4× faster than that using the DISK version. This performance im-

provement is a result of a DataSpaces (used by the DMS) implementation design decision that optimizes data insertion operations. When a process inserts data into DataSpaces, the data is stored on a single DataSpaces server (node) and only the metadata of the data is propagated to the other servers in the system. This scheme avoids data duplication and unnecessary data movement and split. The read operation, on the other hand, may result in a data movement that cannot be avoided and is more expensive.

5.5. Cooperative CPU-GPU Executions

In these experiments, we used a fixed set of 104 images (for a total of 6,212 $4K \times 4K$ tiles) as the number of nodes is varied. Four versions of the application were executed: (i) *CPUs-only* is the CPU multi-core version that uses all the 12 cores available in each node; (ii) *GPUs-only* uses only the 3 available GPUs in each machine for computation; (iii) *GPUs + CPUs (1L)* uses the CPUs and GPUs in coordination, but the application stages are represented as a single task that bundles all the internal operations; (iii) *GPUs + CPUs (2L)* utilizes CPUs and GPUs in coordination and represents the application as a hierarchical computation graph with two levels. Therefore, the fine grain operations in a stage are dispatched for computation as individual tasks. Both cooperative CPU and GPU versions (1L and 2L) can employ FCFS (First-Come, First-Served) or the PATS scheduling strategy. In addition, we also evaluate the performance benefits of employing data locality conscious tasks assignment (DL) and data prefetching and asynchronous data copy (Pref.) with the application version that attained best execution times.

Scalability and schedulers evaluation. The execution times for the various versions of the application are presented in Figure 15(a). All versions achieved good scalability – the efficiency of the CPUs-only version using 100 nodes was 90%. The GPUs-only version attained a speedup of about $2.25 \times$ on top of the CPUs-only, as shown in Figure 15(b). The cooperative CPU-GPU execution using a single level computation graph (GPUs + CPUs (1L)) and FCFS to distribute tasks among CPUs and GPUs attained a speedup of $2.9 \times$ on the CPUs-only version. Figure 15(a) also presents the results for the hierarchical version of the application (2L). As shown, the 2L configuration with the PATS scheduler was able to significantly (about $1.38 \times$) improve any other configuration that employs cooperative CPU-GPU execution. In addition, “GPUs + CPUs (2L PATS)” achieved a performance improvement of near $4 \times$ on top of the multi-core CPUs-only version. The best performance of PATS with 2L is the result of its ability to assign subtask in a stage to the most appropriate devices, instead of assigning an entire stage for execution with a single processor as in the 1L configuration. Figure 16 presents the GPU speedups of the individual operations in each stage. We observe that there is a strong variation in the amount of acceleration among the functions, because of their different computation patterns. This variation in functions attained acceleration, as discussed, is exploited by the performance-aware task scheduler (PATS) to attain better performance.

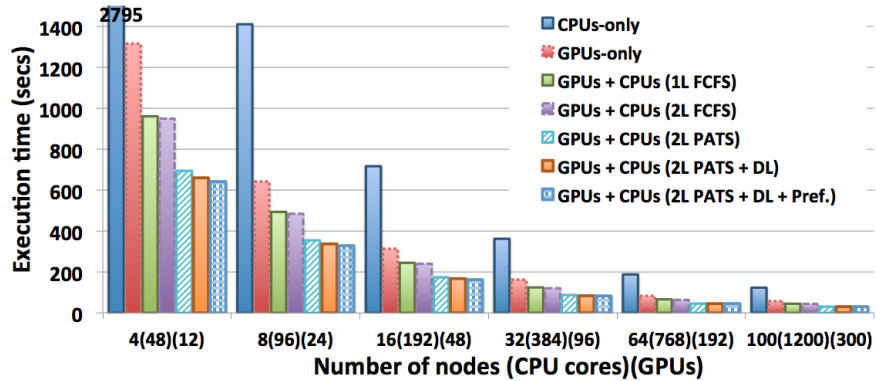

(a) RT execution time.

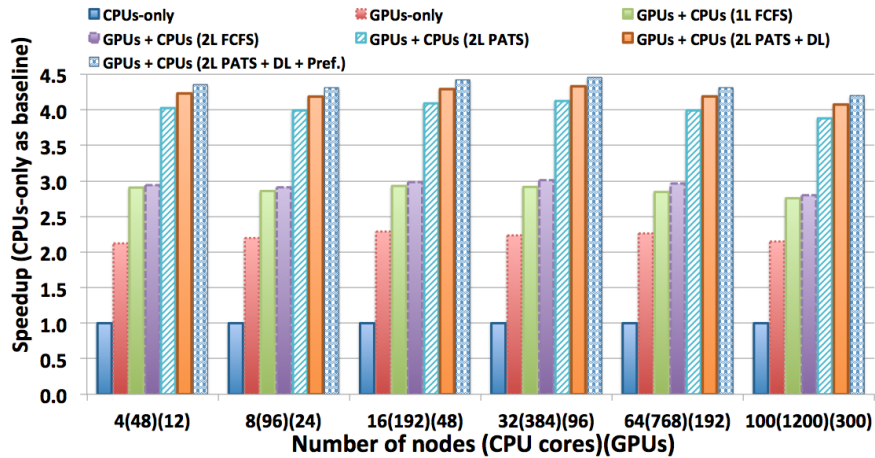

(b) Speedup on top of the multicore CPU-only version.

Figure 15: Performance of application using multiple versions: (i) *CPUs-only* is the CPU multi-core version that uses all the 12 cores available in each node; (ii) *GPUs-only* uses only the 3 available GPUs in each machine; (iii) *GPUs + CPUs (1L)* uses the CPUs and GPUs in coordination and the application stages are represented as using a single task that bundles all the internal operations; (iii) *GPUs + CPUs (2L)* utilizes CPUs and GPUs in coordination and represents the application as a hierarchical computation graph with two levels. FCFS and PATS scheduling strategies are used in cooperative executions, as well as locality conscious tasks assignment (DL) and data prefetching and asynchronous data copy (Pref.) optimizations are employed with the best cooperative version of the application. All configurations attain good scalability and cooperative executions resulted in significant improvements on CPUs-only or GPUs-only versions. Further, the 2L configuration with PATS achieved better performance than FCFS, because of its ability to exploit variability in speedups of individual tasks of the application (Figure 16) to optimize utilization of heterogeneous devices. Additionally, the combined use of DL and Pref. optimization resulted in a speedup of $1.08\times$.

Performance of data movement optimizations. Further, we evaluate the performance benefits of data locality conscious tasks assignment (DL) and data

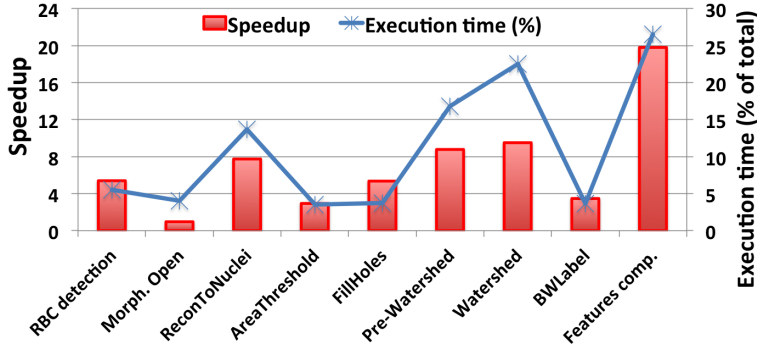
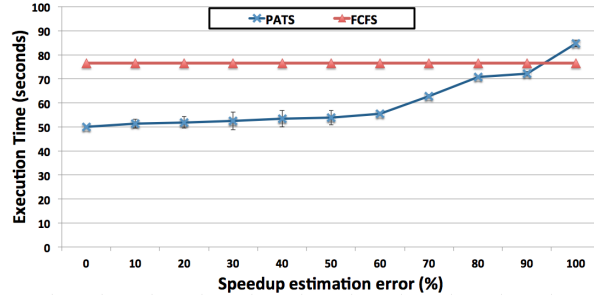

Figure 16: GPU speedup values for each function in the segmentation and feature computation stages. A strong variation on speedups values is observed due differences on individual operations computation and data access patterns, which make them more appropriate for different computing devices. PATS exploits this variation to better use available devices.

prefetching and asynchronous data copy (Pref.) with the 2L PATS version of the application. As presented in Figure 15(a), the use of DL improves the application performance in $1.05\times$, because of the reduction in data transfer volume attained by the scheduler with this optimization. Finally, the Pref. optimization is used with the previous version of the application, and a speedup of $1.03\times$ is achieved. For this use case application, the data transfers times represent 12% of the total execution time and, as presented, we attained combined improvement on the application execution time of about 8% ($1.08\times$). Therefore, our optimization techniques were able to eliminate near 66% of the data transfer costs, while we still able to employ efficient scheduling to optimize utilization of hybrid processors. Finally, the “GPUs + CPUs (2L PATS + DL + Pref.)” version of the application achieved the best performance with a speedup of $4.34\times$ on top of the multicore CPU-only version, as presented in Figure 15(b).

Sensitivity to inaccurate speedup estimation. We have also evaluated the impact of errors in speedup estimates to PATS performance. Since PATS relies on speedups to keep a sorted queue of tasks, we inserted errors by increasing tasks with lower speedup (RBC detection, Morph. Open, AreaThreshold, FillHoles, and BWLabel) and decreasing estimates for other tasks that have higher speedups. Our intention was to enforce that at a certain error level, tasks that are executed with a GPU without estimate errors would change positions with tasks that otherwise would be computed by a CPU using PATS sorted queue. The execution times of the application using PATS and FCFS schedulers, as the error inserted varies from 10% to 100%, are shown in Figure 17(a). As presented, the PATS is impacted by inaccurate speedup estimates, but performance changes are small until high levels of errors are inserted. For instance, if the error level is 50%, the overall performance of the application with PATS decreases only by 8% as compared to the configuration in which no error is inserted. In addition, PATS is only outperformed by FCFS in the configuration



(a) Impact of inaccurate speedup estimations.

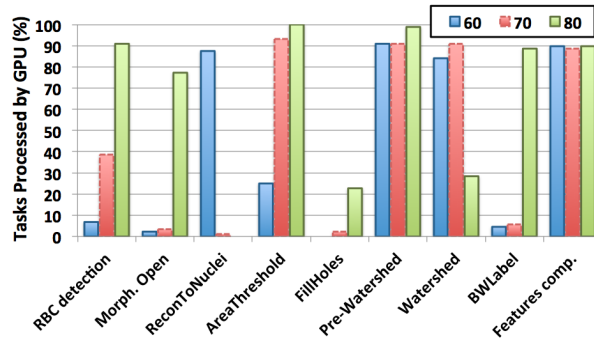

(b) PATS profile: % tasks executed by GPU vs error rate.

Figure 17: Evaluation of the PATS performance under different levels of inaccurate speedup estimates. To effectively confound the method and force wrong assignment of operations to processors, tasks with low speedups have their speedups increased by a given percentage, whereas tasks with high speedups have their estimates decreased. As shown, PATS performs well even with high speedup estimation error and, for instance, it suffers a performance degradation of only 8% when a percentage error of 50% is used. In addition, to understand how very high estimate errors affected the scheduling, we present the profile of tasks executed by the GPU as the error rate is varied from 60% to 80%, which refers to the first interval in which there is a significant performance degradation in PATS.

in which 100% of error is used, which in practice consists in an inversion of tasks in the sorted queue. In this configuration, CPU executes tasks that in have high speedup, whereas GPU processes tasks that with no error estimates would have the smaller speedups. In order to better understand performance of PATS scheduling with high percentage of estimate errors, we have collected the profile of the tasks executed by a GPU when errors of 60%, 70%, and 80% are used. Figure 17(b) presents the percentage of tasks computed by the GPU in each configuration. The results show a significant increasing in the number of tasks with low speedups executed by GPU as error grows. In addition, other tasks such as "ReconToNuclei" and "Watershed" follow an inverse trend and are assigned in a smaller number for GPU computation as error level is increase. Still, even with 80% of estimate speedup error PATS is faster than FCFS, since

some operations such as "Feature Computation" are correctly dispatched for execution with GPU.

6. Related Work

The Region Templates framework leverages data description concepts proposed by Baden et al. [35], as we allow for hierarchical representation of a low dimensional data domain as used in adaptive mesh methods. Other systems, such as Fortran D [21] and Vienna Fortran [73], propose frameworks for parallel execution of arrays of data elements associated with application specific phenomena. Recent projects have developed data management systems for array based multi-dimensional scientific datasets [10, 69, 51]. SciDB [10] implements several optimized query operations such as slicing, sub-sampling, and filtering to manipulate large datasets, as well as it performs multi-dimensional aware data striping and versioning. The Pyramid approach [69] includes similar data types, but is optimized for scalability of metadata management. It also introduces an array-oriented data access model with active storage support, which is very useful, for instance, to execute filtering operations or/and data aggregation closer to or in the data sources. Our framework differs from these systems in several ways. It enables association of data from multiple sources targeting the same spatial region, which is a common scenario in sensor data analysis where multiple data measurements may be taken for the same region, e.g., measurements of the humidity of certain region over time in monitoring and change detection analysis [13]. It provides a framework for automated management of data across several memory layers on a parallel system, including multiple implementations for efficient I/O, while providing a well-defined interface for data retrieval and storage. Also, different data types commonly used in microscopy image data are supported, as well as it incorporates the data management with a runtime system for efficient execution of dataflow application. Because of the increasing power of hybrid systems equipped with accelerators, the support for data structures with implementations for CPUs and GPUs and scheduling techniques for hybrid systems are other important feature included in region templates.

Efficient execution of applications on CPU-GPU equipped platforms has been an objective of several projects in the past years [29, 43, 45, 5, 18, 8, 55, 31, 62, 11, 56, 61, 4, 67, 28, 27, 57, 63, 68]. The EAVL system [46] is designed to take advantage of CPUs and GPUs for visualization of mesh based simulations. Ravi et al. [55, 31] propose techniques for automatic translation of generalized reductions. The OmpSs [11] supports efficient asynchronous execution of dataflow applications automatically generated by compiler techniques from annotated code. DAGuE [8] and StarPU [5, 4] are motivated by regular linear algebra applications on CPU-GPU machines. Applications in these frameworks are represented as a DAG of operations, and different scheduling policies are used for CPU and GPU task assignments. These solutions assume that the computation graphs are static and known prior to execution. This is a serious limitation to dynamic application such as ours, as the execution of the

next stage may be dependent on a computation result. Our framework allows for the dependency graph to be built at runtime.

KAAPI [23] is a programming framework that supports execution of dataflow applications on distributed memory systems. It is inspired on the Athapascan-1 [22] programming language that allows for a precise description of dependencies in dataflow graphs, and includes asynchronously spawned tasks with explicit shared variables to facilitate data dependency detection. The mapping of tasks onto processors is carried out dynamically employing work-stealing techniques. In [30], KAAPI was used and extended to parallelize an iterative physics simulations application in machines equipped with GPUs and CPUs. This work proposed novel scheduling strategies for dataflows in hybrid systems, which includes runtime load balance with initial workload partition that takes into consideration affinity to objects accessed. XKaapi [24] further extended KAAPI with support for execution on hybrid systems, equipped with CPUs and GPUs. In XKaapi, the programmer develops applications using a multi-versioning scheme in which a processing task may have multiple implementations targeting different computing devices. In order to efficiently execute dataflows in heterogeneous systems, it implements new scheduling strategies and optimizations for reducing impact of data transfers between devices, locality-aware work stealing, etc. XKaapi is also evaluated using regular linear algebra applications. More recently, XKaapi was deployed in new Intel Xeon Phi coprocessor [42]. XKaapi is contemporary to our runtime systems and, as such, they share a number of optimizations, including strategies for reducing impact of data transfers, locality-aware scheduling, etc. In special, the performance-aware scheduling strategy proposed in our work is not available in other systems, whereas we plan to incorporate the ideas of KAAPI application description to perform implicit calculation of data dependencies in dataflow graphs of region templates applications.

Systems such as Linda [12], ThreadMarks [2] and Global Arrays [48] were proposed to provide shared-memory programming model abstractions – typically using matrices to represent data – on distributed platforms with Non-Uniform Memory Access (NUMA). These systems have been very successful, because they simplify the deployment of applications on distributed memory machines and are efficient for applications that exhibit high data locality and access to independent data blocks of a matrix. Data access costs in these systems tend to increase for patterns involving frequent reads and writes of data elements that are not locally stored on a processor. The efficiency and applicability of these solutions is hindered in such cases. Like these systems, our framework provides an abstraction for the representation and computation of large volumes of data on distributed memory machines. However, we do not intend to provide a generic distributed shared memory in which several processes have access to the entire data domain and consistency is taken care by the system. In our case, data accessed are well defined in terms of input region templates, which allows for data to be moved ahead of computation and restricts data access to locally loaded data.

FlexIO [72] is a middleware that supports flexible data movement between

simulation and analytic components in large-scale computing systems. It implements an interface for passing data, originally proposed in ADIOS [44], that mimics "files" manipulations. Data are exchanged during I/O timesteps of simulation applications via either disk or memory-to-memory mechanisms. FlexIO supports several placement architectures, including (i) "Simulation core": I/O is performed by the application computing cores; (ii) "Helper Core": cores on the same node receive and stage data from computing cores; (iii) "Staging Core": I/O cores are placed in separate nodes; (iv) "Offline": output simulation data is moved to disk for further analysis. It also proposes automated heuristics to find the appropriate I/O placement of applications. Placement is static and remains the same during execution. Such as FlexIO, the global data storage module of region template supports multiple strategies for placement computing and I/O cores, which may be easily interchangeable by the application developer. However, region templates provides a richer set of data abstraction with data types such as sparse and regular arrays, matrices, and objects, which are managed by the system and may be staged to different storage mechanisms. ADIOS/FlexIO use a "file" like interface to write/read data in which variables are associated with data elements (scalar, arrays, etc). Multiple processes that manipulate the same file need to deal with low-level details, such as data packing, data offsets in global domains, process group data distribution and partition, etc, whereas it is abstracted in region templates. In addition, as discussed in Section 4, our implementation of global storage is optimized for asynchronous applications, which differently from simulation applications do not have synchronization points in which all processes synchronize to perform I/O operations. As presented in our experimental results, the use of flexible I/O groups lead to improved performance on our use case application as compared to the approach originally implemented in ADIOS for iterative simulations. Finally, as a future work we want to provide automated placement on distributed system, and the propositions of FlexIO may be integrated and optimized for our scenario.

7. Conclusions and Future Work

Researchers have an increasing array of imaging technologies to record detailed pictures of disease morphology at the sub-cellular levels, opening up new potentials for investigating disease mechanisms and improving health care delivery. Large clusters of GPU equipped systems, in which each *hybrid* node contains multiple CPUs and multiple GPUs, have the memory capacity and processing power to enable large imaging studies. However, these systems are generally difficult to program due to complexities arising from the heterogeneity of computation devices and multiple levels of memory/storage hierarchies (going from persistent disk-based storage on a parallel file system to distributed memory on the cluster to memories on CPUs and GPUs within a node).

The region template abstraction aims to hide the complexity of managing data across and within memory hierarchies on hybrid systems for microscopy image analysis applications. Some of the characteristics that allow for the efficient execution and data management of region templates are the following:

(1) region template applications are instantiated as a graph of computation stages and communication only exists among different stages of the application. Therefore, computation within a given stage uses exclusively local data received as input to the stage; (2) data chunks accessed within a given stage instance are exported to the runtime system, because they are accessed via the region templates interface. Therefore, the system knows in advance which data regions (or blocks of a data region) are accessed by a stage and can retrieve the data asynchronously, reducing the impact of data transfer costs; (3) the mapping of copies of the pipeline stages to computing nodes can be carried by the runtime system in a way to minimize data transfers.

The region template framework provides implementations for common data structures used in target applications; therefore, expect small overhead when developing and integrating new applications.

Our experimental evaluation shows that very high processing and data transfer rates can be achieved in our framework. The processing rate with cooperative CPU-GPU executions using the 2L PATS configuration and 100 nodes is 11,730 4K×4K tiles (about 117 whole image slides, 750GB of data) per minute. The combined data staging and reading rates between the computing stages are about 200GB/s when distributed memory storage is used. This level of performance will enable much larger imaging studies and is a very promising direction that should lead to better understanding of disease behavior.

We are currently deploying a new biomedical image analysis application on top of region templates. This application computes large-scale cell tracking to study of early stages of metastasis in cancer. The goal of the application is to correlate cell tracking information with other data sources, such as genetic information, in order to better understand the disease. Beyond the great potential science results, this application also brings a new challenging computational scenario. In object tracking, the application only accesses subsets of the data domain that are likely to contain objects of interest. In addition, the path followed by an object until the current timestamp tend to be very useful in identifying in which sub-domain it will be located in future. This context is motivating extensions in region templates to include smart spatial-temporal caching and data prefetching strategies, which could, for instance, anticipate the data reading process and reduce the impact of these operations to the application.

Acknowledgments. This work was supported in part by HHSN261200800001E from the NCI, R24HL085343 from the NHLBI, R01LM011119-01 and R01LM009239 from the NLM, RC4MD005964 from the NIH, PHS UL1RR025008 from the NIH CTSA, and CNPq (including projects 151346/2013-5 and 313931/2013-5). This research used resources of the Keeneland Computing Facility at the Georgia Institute of Technology, which is supported by the NSF under Contract OCI-0910735.

References

- [1] H. Abbasi, M. Wolf, G. Eisenhauer, S. Klasky, K. Schwan, and F. Zheng. Datastager: scalable data staging services for petascale applications. *Cluster Computing*, 13(3):277–290, 2010.
- [2] C. Amza, A. L. Cox, S. Dwarkadas, P. Keleher, H. Lu, R. Rajamony, W. Yu, and W. Zwaenepoel. TreadMarks: Shared Memory Computing on Networks of Workstations. *Computer*, 29(2):18–28, Feb. 1996.
- [3] R. H. Arpaci-Dusseau, E. Anderson, N. Treuhaft, D. E. Culler, J. M. Hellerstein, D. A. Patterson, and K. Yelick. Cluster I/O with River: Making the Fast Case Common. In *IOPADS '99: Input/Output for Parallel and Distributed Systems*, Atlanta, GA, May 1999.
- [4] C. Augonnet, O. Aumage, N. Furmento, R. Namyst, and S. Thibault. StarPU-MPI: Task Programming over Clusters of Machines Enhanced with Accelerators. In S. B. Jesper Larsson Träff and J. Dongarra, editors, *The 19th European MPI Users' Group Meeting (EuroMPI 2012)*, volume 7490 of *LNCS*, Vienna, Autriche, 2012. Springer.
- [5] C. Augonnet, S. Thibault, R. Namyst, and P.-A. Wacrenier. Starpu: A unified platform for task scheduling on heterogeneous multicore architectures. In *Euro-Par '09: Proceedings of the 15th International Euro-Par Conference on Parallel Processing*, pages 863–874, 2009.
- [6] M. D. Beynon, T. Kurc, U. Catalyurek, C. Chang, A. Sussman, and J. Saltz. Distributed processing of very large datasets with DataCutter. *Parallel Comput.*, 27(11):1457–1478, 2001.
- [7] T. Bially. *A class of dimension changing mapping and its application to bandwidth compression*. Phd thesis, Polytechnic Institute of Brooklyn, 1976.
- [8] G. Bosilca, A. Bouteiller, T. Herault, P. Lemarinier, N. Saengpatsa, S. Tomov, and J. Dongarra. Performance Portability of a GPU Enabled Factorization with the DAGuE Framework. In *2011 IEEE International Conference on Cluster Computing (CLUSTER)*, pages 395–402, sept. 2011.
- [9] G. Bradski. The OpenCV Library. *Dr. Dobb's Journal of Software Tools*, 2000.
- [10] P. G. Brown. Overview of sciDB: large scale array storage, processing and analysis. In *Proceedings of the 2010 ACM SIGMOD International Conference on Management of data*, SIGMOD '10, pages 963–968, New York, NY, USA, 2010. ACM.
- [11] J. Bueno, J. Planas, A. Duran, R. Badia, X. Martorell, E. Ayguade, and J. Labarta. Productive Programming of GPU Clusters with OmpSs. In *2012 IEEE 26th International Parallel Distributed Processing Symposium (IPDPS)*, pages 557–568, may 2012.

- [12] N. Carriero and D. Gelernter. Linda in context. *Commun. ACM*, 32(4):444–458, Apr. 1989.
- [13] V. Chandola and R. R. Vatsavai. A scalable gaussian process analysis algorithm for biomass monitoring. *Stat. Anal. Data Min.*, 4(4):430–445, Aug. 2011.
- [14] C. Chang, B. Moon, A. Acharya, C. Shock, A. Sussman, and J. H. Saltz. Titan: A High-Performance Remote Sensing Database. In *Proceedings of the Thirteenth International Conference on Data Engineering, ICDE '97*, pages 375–384, Washington, DC, USA, 1997. IEEE Computer Society.
- [15] L. Cooper, D. Gutman, Q. Long, B. Johnson, S. Cholleti, T. Kurc, J. Saltz, D. Brat, and C. Moreno. The Proneural Molecular Signature Is Enriched in Oligodendrogliomas and Predicts Improved Survival among Diffuse Gliomas. *PLoS ONE*, 5, 2010.
- [16] L. A. Cooper, J. Kong, D. A. Gutman, F. Wang, J. Gao, C. Appin, S. Cholleti, T. Pan, A. Sharma, L. Scarpace, T. Mikkelsen, T. Kurc, C. S. Moreno, D. J. Brat, and J. H. Saltz. Integrated morphologic analysis for the identification and characterization of disease subtypes. *J Am Med Inform Assoc.*, 19(2):317–323, 2012.
- [17] L. A. D. Cooper, J. Kong, D. A. Gutman, F. Wang, S. R. Cholleti, T. C. Pan, P. M. Widener, A. Sharma, T. Mikkelsen, A. E. Flanders, D. L. Rubin, E. G. V. Meir, T. M. Kurc, C. S. Moreno, D. J. Brat, and J. H. Saltz. An integrative approach for in silico glioma research. *IEEE Trans Biomed Eng.*, 57(10):2617–2621, 2010.
- [18] G. F. Diamos and S. Yalamanchili. Harmony: an execution model and runtime for heterogeneous many core systems. In *Proceedings of the 17th international symposium on High performance distributed computing, HPDC '08*, pages 197–200, New York, NY, USA, 2008. ACM.
- [19] C. Docan, M. Parashar, and S. Klasky. Dataspaces: an interaction and coordination framework for coupled simulation workflows. In *HPDC*, pages 25–36, 2010.
- [20] E. C. Filippi-Chiela, M. M. Oliveira, B. Jurkovski, S. M. Callegari-Jacques, V. D. da Silva, and G. Lenz. Nuclear Morphometric Analysis (NMA): Screening of Senescence, Apoptosis and Nuclear Irregularities. *PLoS ONE*, 7, 2012.
- [21] G. Fox, S. Hiranandani, K. Kennedy, C. Koelbel, U. Kremer, C.-W. Tseng, and M.-Y. Wu. Fortran D Language Specification. Technical report, Dept. of Computer Science, Rice Univ., 1990.
- [22] F. Galilee, G. Cavalheiro, J.-L. Roch, and M. Doreille. Athapascan-1: Online building data flow graph in a parallel language. In *Parallel Architectures and Compilation Techniques, 1998. Proceedings. 1998 International Conference on*, pages 88–95, Oct 1998.

- [23] T. Gautier, X. Besseron, and L. Pigeon. Kaapi: A thread scheduling runtime system for data flow computations on cluster of multi-processors. In *Proc. of the 2007 International Workshop on Parallel Symbolic Computation*, PASCOCO '07, pages 15–23, New York, NY, USA, 2007. ACM.
- [24] T. Gautier, J. V. F. Lima, N. Maillard, and B. Raffin. Xkaapi: A runtime system for data-flow task programming on heterogeneous architectures. In *IPDPS '13: Proceedings of the 2013 IEEE International Symposium on Parallel and Distributed Processing*, pages 1299–1308. IEEE Computer Society, 2013.
- [25] M. N. Gurcan, T. Pan, H. Shimada, and J. Saltz. Image analysis for neuroblastoma classification: segmentation of cell nuclei. *Conf Proc IEEE Eng Med Biol Soc*, pages 4844–4847, 2006.
- [26] J. Han, H. Chang, G. V. Fontenay, P. T. Spellman, A. Borowsky, and B. Parvin. Molecular bases of morphometric composition in Glioblastoma multiforme. *9th IEEE International Symposium on Biomedical Imaging (ISBI '12)*, pages 1631–1634, 2012.
- [27] T. D. Hartley, U. V. Catalyurek, A. Ruiz, M. Ujaldon, F. Igual, and R. Mayo. Biomedical image analysis on a cooperative cluster of gpus and multicores. In *22nd ACM Intl. Conference on Supercomputing*, Dec 2008.
- [28] T. D. R. Hartley, E. Saule, and Ü. V. Çatalyürek. Automatic dataflow application tuning for heterogeneous systems. In *HiPC*, pages 1–10. IEEE, 2010.
- [29] B. He, W. Fang, Q. Luo, N. K. Govindaraju, and T. Wang. Mars: A MapReduce Framework on Graphics Processors. In *Parallel Architectures and Compilation Techniques*, 2008.
- [30] E. Hermann, B. Raffin, F. Faure, T. Gautier, and J. Allard. Multi-gpu and multi-cpu parallelization for interactive physics simulations. In *Proceedings of the 16th International Euro-Par Conference on Parallel Processing: Part II*, Euro-Par'10, pages 235–246, Berlin, Heidelberg, 2010. Springer-Verlag.
- [31] X. Huo, V. Ravi, and G. Agrawal. Porting irregular reductions on heterogeneous CPU-GPU configurations. In *18th International Conference on High Performance Computing (HiPC)*, pages 1–10, dec. 2011.
- [32] L. Ibanez, W. Schroeder, L. Ng, and J. Cates. *The ITK Software Guide*. Kitware, Inc., first edition, 2003. ISBN 1-930934-10-6.
- [33] H. J. Johnson, M. McCormick, L. Ibáñez, and T. I. S. Consortium. *The ITK Software Guide*. Kitware, Inc., third edition, 2013. *In press*.
- [34] H. Klie, W. Bangerth, X. Gai, M. F. Wheeler, P. L. Stoffa, M. K. Sen, M. Parashar, Ü. V. Çatalyürek, J. H. Saltz, and T. M. Kurç. Models, methods and middleware for grid-enabled multiphysics oil reservoir management. *Eng. Comput. (Lond.)*, 22(3-4):349–370, 2006.

- [35] S. R. Kohn and S. B. Baden. A parallel software infrastructure for structured adaptive mesh methods. In *Proceedings of the 1995 ACM/IEEE conference on Supercomputing (CDROM)*, Supercomputing '95, New York, NY, USA, 1995. ACM.
- [36] J. Kong, L. Cooper, F. Wang, J. Gao, G. Teodoro, L. Scarpace, T. Mikkelsen, M. Schniederjan, C. Moreno, J. Saltz, et al. A novel paradigm for determining molecular correlates of tumor cell morphology in human glioma whole slide images. In *NEURO-ONCOLOGY*, volume 15, pages 158–159. OXFORD UNIV PRESS INC JOURNALS DEPT, 2001 EVANS RD, CARY, NC 27513 USA, 2013.
- [37] J. Kong, L. A. Cooper, F. Wang, J. Gao, G. Teodoro, L. Scarpace, T. Mikkelsen, M. J. Schniederjan, C. S. Moreno, J. H. Saltz, et al. Machine-based morphologic analysis of glioblastoma using whole-slide pathology images uncovers clinically relevant molecular correlates. *PloS one*, 8(11):e81049, 2013.
- [38] A. Körbes, G. B. Vitor, R. de Alencar Lotufo, and J. V. Ferreira. Advances on watershed processing on GPU architecture. In *Proceedings of the 10th International Conference on Mathematical Morphology*, ISMM'11, 2011.
- [39] S. Kothari, A. O. Osunkoya, J. H. Phan, and M. D. Wang. Biological interpretation of morphological patterns in histopathological whole-slide images. *The ACM Conference on Bioinformatics, Computational Biology and Biomedicine*, pages 218–225, 2012.
- [40] V. S. Kumar, P. Sadayappan, G. Mehta, K. Vahi, E. Deelman, V. Ratnakar, J. Kim, Y. Gil, M. W. Hall, T. M. Kurc, and J. H. Saltz. An integrated framework for performance-based optimization of scientific workflows. In *HPDC*, pages 177–186, 2009.
- [41] T. M. Kurç, Ü. V. Çatalyürek, X. Zhang, J. H. Saltz, R. Martino, M. F. Wheeler, M. Peszynska, A. Sussman, C. Hansen, M. K. Sen, R. Seifoullaev, P. L. Stoffa, C. Torres-Verdín, and M. Parashar. A simulation and data analysis system for large-scale, data-driven oil reservoir simulation studies. *Concurrency - Practice and Experience*, 17(11):1441–1467, 2005.
- [42] J. V. F. Lima, F. Broquedis, T. Gautier, and B. Raffin. Preliminary experiments with xkaapi on intel xeon phi coprocessor. In *25th International Symposium on Computer Architecture and High Performance Computing, SBAC-PAD*, pages 105–112, 2013.
- [43] M. D. Linderman, J. D. Collins, H. Wang, and T. H. Meng. Merge: a programming model for heterogeneous multi-core systems. *SIGPLAN Not.*, 43(3):287–296, 2008.
- [44] J. F. Lofstead, S. Klasky, K. Schwan, N. Podhorszki, and C. Jin. Flexible IO and integration for scientific codes through the adaptable IO system (ADIOS). In *CLADE*, pages 15–24, 2008.

- [45] C.-K. Luk, S. Hong, and H. Kim. Qilin: Exploiting parallelism on heterogeneous multiprocessors with adaptive mapping. In *42nd International Symposium on Microarchitecture (MICRO)*, 2009.
- [46] J. S. Meredith, S. Ahern, D. Pugmire, and R. Sisneros. EAVL: The Extreme-scale Analysis and Visualization Library. In H. Childs, T. Kuhlen, and F. Marton, editors, *EGPGV*, pages 21–30. Eurographics Association, 2012.
- [47] J. Monaco, J. Tomaszewski, M. Feldman, M. Moradi, P. Mousavi, A. Boag, C. Davidson, P. Abolmaesumi, and A. Madabhushi. Detection of prostate cancer from whole-mount histology images using Markov random fields. *Workshop on Microscopic Image Analysis with Applications in Biology (in conjunction with MICCAI)*, 2008.
- [48] J. Nieplocha and R. Harrison. Shared Memory Programming in Meta-computing Environments: The Global Array Approach. *The Journal of Supercomputing*, 11(2):119–136, 1997.
- [49] R. Nishtala, Y. Zheng, P. H. Hargrove, and K. A. Yelick. Tuning collective communication for Partitioned Global Address Space programming models. *Parallel Computing*, 37(9):576 – 591, 2011.
- [50] V. M. A. Oliveira and R. de Alencar Lotufo. A Study on Connected Components Labeling algorithms using GPUs. In *SIBGRAPI*, 2010.
- [51] S. Pallickara, M. Malensek, and S. Pallickara. Enabling access to timeseries, geospatial data for on-demand visualization. In *Large Data Analysis and Visualization (LDAV), 2011 IEEE Symposium on*, pages 141–142, 2011.
- [52] M. Parashar, V. Matossian, W. Bangerth, H. Klie, B. Rutt, T. M. Kurç, Ü. V. Çatalyürek, J. H. Saltz, and M. F. Wheeler. Towards Dynamic Data-Driven Optimization of Oil Well Placement. In *International Conference on Computational Science (2)*, pages 656–663, 2005.
- [53] J. Phan, C. Quo, C. Cheng, and M. Wang. Multi-scale integration of-omic, imaging, and clinical data in biomedical informatics. *IEEE Rev Biomed Eng*, 5:74–87, 2012.
- [54] B. Plale and K. Schwan. Dynamic Querying of Streaming Data with the dQUOB System. *IEEE Trans. Parallel Distrib. Syst.*, 14(4):422–432, 2003.
- [55] V. Ravi, W. Ma, D. Chiu, and G. Agrawal. Compiler and runtime support for enabling generalized reduction computations on heterogeneous parallel configurations. In *Proceedings of the 24th ACM International Conference on Supercomputing*, pages 137–146, 2010.
- [56] C. J. Rossbach, J. Currey, M. Silberstein, B. Ray, and E. Witchel. PTask: operating system abstractions to manage GPUs as compute devices. In *Proceedings of the Twenty-Third ACM Symposium on Operating Systems Principles, SOSP '11*, pages 233–248, 2011.

- [57] J. H. Saltz, G. Teodoro, T. Pan, L. A. Cooper, J. Kong, S. Klasky, and T. M. Kurc. Feature-based analysis of large-scale spatio-temporal sensor data on hybrid architectures. *International Journal of High Performance Computing Applications*, 27(3):263–272, 2013.
- [58] C. T. Shock, C. Chang, B. Moon, A. Acharya, L. Davis, J. Saltz, and A. Sussman. The design and evaluation of a high-performance earth science database. *Parallel Computing*, 24(1):65 – 89, 1998.
- [59] C. Tapus, I.-H. Chung, and J. K. Hollingsworth. Active harmony: towards automated performance tuning. In R. C. Giles, D. A. Reed, and K. Kelley, editors, *SC*, pages 1–11. ACM, 2002.
- [60] G. Teodoro, D. Fireman, D. Guedes, W. M. Jr., and R. Ferreira. Achieving multi-level parallelism in the filter-labeled stream programming model. *Parallel Processing, International Conference on*, 0:287–294, 2008.
- [61] G. Teodoro, T. Hartley, U. Catalyurek, and R. Ferreira. Optimizing dataflow applications on heterogeneous environments. *Cluster Computing*, 15:125–144, 2012.
- [62] G. Teodoro, T. D. R. Hartley, U. Catalyurek, and R. Ferreira. Run-time optimizations for replicated dataflows on heterogeneous environments. In *Proc. of the 19th ACM International Symposium on High Performance Distributed Computing (HPDC)*, pages 13–24, 2010.
- [63] G. Teodoro, T. Kurc, J. Kong, L. Cooper, and J. Saltz. Comparative performance analysis of intel xeon phi, gpu, and cpu. *arXiv preprint arXiv:1311.0378*, 2013.
- [64] G. Teodoro, T. M. Kurc, T. Pan, L. A. Cooper, J. Kong, P. Widener, and J. H. Saltz. Accelerating Large Scale Image Analyses on Parallel, CPU-GPU Equipped Systems. In *26th IEEE International Parallel and Distributed Processing Symposium (IPDPS)*, pages 1093–1104, 2012.
- [65] G. Teodoro, T. Pan, T. Kurc, J. Kong, L. Cooper, and J. Saltz. Efficient Irregular Wavefront Propagation Algorithms on Hybrid CPU-GPU Machines. *Parallel Computing*, 2013.
- [66] G. Teodoro, T. Pan, T. M. Kurc, J. Kong, L. A. Cooper, N. Podhorszki, S. Klasky, and J. H. Saltz. High-throughput Analysis of Large Microscopy Image Datasets on CPU-GPU Cluster Platforms. In *IPDPS '13: Proceedings of the 2013 IEEE International Symposium on Parallel and Distributed Processing*, 2013.
- [67] G. Teodoro, R. Sachetto, O. Sertel, M. Gurcan, W. M. Jr., U. Catalyurek, and R. Ferreira. Coordinating the Use of GPU and CPU for Improving Performance of Compute Intensive Applications. In *IEEE Cluster*, pages 1–10, 2009.

- [68] G. Teodoro, E. Valle, N. Mariano, R. Torres, J. Meira, Wagner, and J. Saltz. Approximate similarity search for online multimedia services on distributed CPUGPU platforms. *The VLDB Journal*, pages 1–22, 2013.
- [69] V.-T. Tran, B. Nicolae, and G. Antoniu. Towards scalable array-oriented active storage: the pyramid approach. *SIGOPS Oper. Syst. Rev.*, 46(1):19–25, Feb. 2012.
- [70] J. S. Vetter, R. Glassbrook, J. Dongarra, K. Schwan, B. Loftis, S. McNally, J. Meredith, J. Rogers, P. Roth, K. Spafford, and S. Yalamanchili. Keeneland: Bringing Heterogeneous GPU Computing to the Computational Science Community. *Computing in Science and Engineering*, 13, 2011.
- [71] Q. Yi, K. Seymour, H. You, R. W. Vuduc, and D. J. Quinlan. POET: Parameterized Optimizations for Empirical Tuning. In *IPDPS*, pages 1–8, 2007.
- [72] F. Zheng, H. Zou, G. Eisenhauer, K. Schwan, M. Wolf, J. Dayal, T.-A. Nguyen, J. Cao, H. Abbasi, S. Klasky, N. Podhorszki, and H. Yu. Flexio: I/o middleware for location-flexible scientific data analytics. In *Parallel Distributed Processing (IPDPS), 2013 IEEE 27th International Symposium on*, pages 320–331, May 2013.
- [73] H. Zima, P. Brezany, B. Chapman, P. Mehrotra, and A. Schwald. Vienna Fortran - A language specification version 1.1. Technical report, March 1992.