

THE ASYMPTOTIC COUPLE OF THE FIELD OF LOGARITHMIC TRANSSERIES

ALLEN GEHRET

ABSTRACT. The derivation on the differential-valued field \mathbb{T}_{\log} of logarithmic transseries induces on its value group Γ_{\log} a certain map ψ . The structure (Γ_{\log}, ψ) is a divisible asymptotic couple. We prove that the theory $T_{\log} = \text{Th}(\Gamma_{\log}, \psi)$ admits elimination of quantifiers in a natural first-order language. All models (Γ, ψ) of T_{\log} have an important discrete subset $\Psi := \psi(\Gamma \setminus \{0\})$. We give explicit descriptions of all definable functions on Ψ and prove that Ψ is stably embedded in Γ .

CONTENTS

1. Introduction	1
1.1. Conventions	2
2. Abstract Asymptotic Couples	3
3. Asymptotic Integration	5
4. The Embedding Lemma Zoo	8
5. The Theory T_{\log}	14
6. Definable functions on Ψ	17
7. Definable subsets of Ψ	22
8. Final Remarks	23
Acknowledgements	24
References	24

1. INTRODUCTION

The differential-valued field \mathbb{T}_{\log} of logarithmic transseries is conjectured to have good model theoretic properties. As a partial result in this direction, and as a confidence building measure we prove here that at least its *asymptotic couple* has a good model theory: quantifier elimination, and stable embeddedness of a certain discrete part. We now describe the relevant objects and results in more detail.

Throughout, m and n range over $\mathbb{N} = \{0, 1, 2, \dots\}$. See [AvdDvdH13] for a definition of the differential-valued field \mathbb{T}_{\log} of logarithmic transseries. It is a field extension of \mathbb{R} containing elements $\ell_0, \ell_1, \ell_2, \dots$, to be thought of as $x, \log x, \log \log x, \dots$, and the elements of \mathbb{T}_{\log} are formal series with real coefficients and monomials $\ell_0^{r_0} \ell_1^{r_1} \cdots \ell_n^{r_n}$ (with arbitrary real exponents r_0, \dots, r_n). For our purpose it is enough to know the following four things about \mathbb{T}_{\log} , its elements ℓ_n , and these monomials:

- (1) These monomials are the elements of a subgroup \mathfrak{L} of the multiplicative group of \mathbb{T}_{\log} , and their products are formed in the way suggested by their notation as power products. The elements of \mathfrak{L} are also known as *logarithmic monomials*. For $m \leq n$ we have $\ell_m = \ell_0^{r_0} \cdots \ell_n^{r_n}$ where $r_i = 0$ for all $i \neq m$ and $r_m = 1$.
- (2) The field \mathbb{T}_{\log} is equipped with a (Krull) valuation v that maps the group \mathfrak{L} isomorphically onto the (additively written) value group $v(\mathbb{T}_{\log}^\times) = \bigoplus_n \mathbb{R}e_n$, a vector space over \mathbb{R} with basis (e_n) , with

$$v(\ell_0^{r_0} \ell_1^{r_1} \cdots \ell_n^{r_n}) = -r_0 e_0 - \cdots - r_n e_n,$$

Date: June 24, 2018.

Key words and phrases. Asymptotic Couples; Logarithmic Transseries; Quantifier Elimination.

and made into an ordered group by requiring for nonzero $\sum_i r_i e_i$ that

$$\sum r_i e_i > 0 \iff r_n > 0 \text{ for the least } n \text{ such that } r_n \neq 0.$$

- (3) The field \mathbb{T}_{\log} is equipped with a derivation such that $\ell'_0 = 1, \ell'_1 = \ell_0^{-1}$, and in general $\ell'_n = \ell_0^{-1} \cdots \ell_n^{-1}$. Here $f^\dagger := f'/f$ denotes the logarithmic derivative of a nonzero element f of a differential field, obeying the useful identity $(fg)^\dagger = f^\dagger + g^\dagger$. In \mathbb{T}_{\log} ,

$$(\ell_0^{r_0} \ell_1^{r_1} \cdots \ell_n^{r_n})^\dagger = r_0 \ell_0^{-1} + r_1 \ell_0^{-1} \ell_1^{-1} + \cdots + r_n \ell_0^{-1} \cdots \ell_n^{-1}.$$

- (4) This derivation has the property that for nonzero $f \in \mathbb{T}_{\log}$ with $v(f) \neq 0$, the value $v(f')$, and thus $v(f^\dagger)$, depends only on $v(f)$.

Let Γ_{\log} be the above ordered abelian group $\bigoplus_n \mathbb{R}e_n$. For an arbitrary ordered abelian group Γ we set $\Gamma^\neq := \Gamma \setminus \{0\}$. By (4) the derivation of \mathbb{T}_{\log} induces maps

$$\gamma \mapsto \gamma' \text{ and } \gamma \mapsto \gamma^\dagger : \Gamma_{\log}^\neq \rightarrow \Gamma_{\log}$$

as follows: if $\gamma = v(f) \neq 0$ with $f \in \mathbb{T}_{\log}^\times$, then $\gamma' = v(f')$ and $\gamma^\dagger = v(f^\dagger)$. We have $\gamma' = \gamma + \gamma^\dagger$ for $\gamma \in \Gamma_{\log}^\neq$, and we follow Rosenlicht [Ros81] in taking the function

$$\psi : \Gamma_{\log}^\neq \rightarrow \Gamma_{\log}, \quad \psi(\gamma) := \gamma^\dagger$$

as a new primitive, calling the pair (Γ_{\log}, ψ) the **asymptotic couple of \mathbb{T}_{\log}** .

More generally, an **asymptotic couple** is a pair (Γ, ψ) where Γ is an ordered abelian group and $\psi : \Gamma^\neq \rightarrow \Gamma$ satisfies for all $\alpha, \beta \in \Gamma^\neq$,

- (AC1) $\alpha + \beta \neq 0 \implies \psi(\alpha + \beta) \geq \min(\psi(\alpha), \psi(\beta))$;
- (AC2) $\psi(r\alpha) = \psi(\alpha)$ for all $r \in \mathbb{Z}^\neq$, in particular, $\psi(-\alpha) = \psi(\alpha)$;
- (AC3) $\alpha > 0 \implies \alpha + \psi(\alpha) > \psi(\beta)$.

If in addition for all $\alpha, \beta \in \Gamma$,

$$(HC) \quad 0 < \alpha \leq \beta \implies \psi(\alpha) \geq \psi(\beta),$$

then (Γ, ψ) is said to be of **H -type**, or to be an **H -asymptotic couple**.

The notion of asymptotic couple is due to Rosenlicht [Ros81] who focused on the case where Γ has finite rank as an abelian group or is finite-dimensional as a vector space over \mathbb{Q} or \mathbb{R} . The asymptotic couple (Γ_{\log}, ψ) is of H -type, infinite-dimensional as vector space over \mathbb{R} , and the ordered subset $\Psi := \psi(\Gamma_{\log}^\neq)$ of Γ_{\log} is isomorphic to $(\mathbb{N}; <)$. We determine here the elementary (i.e., first-order) theory of (Γ_{\log}, ψ) , provide a quantifier elimination result in a natural language, and show that the induced structure on the set Ψ is just its structure as an ordered subset of Γ_{\log} (so Ψ is stably embedded in (Γ_{\log}, ψ)).

This paper is in the spirit of [AvdD00], which proves a quantifier elimination result for so-called *closed asymptotic couples*. That paper did for the asymptotic couple of the field \mathbb{T} of logarithmic-exponential transseries what is done here for the asymptotic couple of \mathbb{T}_{\log} . For an explicit construction of \mathbb{T} , see [vdDMM01]. The main difficulty in getting QE, compared to [AvdD00], was to find the right extra primitives, and to establish a new Embedding Lemma 4.12. Our choice of primitives here yields a *universal* theory with QE. This makes some things simpler than in [AvdD00], and has various other benefits, as we shall see.

1.1. Conventions. By ‘‘ordered set’’ we mean ‘‘totally ordered set’’.

Let S be an ordered set. Below, the ordering on S will be denoted by \leq , and a subset of S is viewed as ordered by the induced ordering. We put $S_\infty := S \cup \{\infty\}$, $\infty \notin S$, with the ordering on S extended to a (total) ordering on S_∞ by $S < \infty$. Occasionally, we even take two distinct elements $-\infty, \infty \notin S$, and extend the ordering on S to an ordering on $S \cup \{-\infty, \infty\}$ by $-\infty < S < \infty$. Suppose that B is a subset of S . We put $S^{>B} := \{s \in S : s > b \text{ for every } b \in B\}$ and we denote $S^{>\{a\}}$ as just $S^{>a}$; similarly for $\geq, <, \text{ and } \leq$ instead of $>$. For $a, b \in S \cup \{-\infty, \infty\}$ and $B \subseteq S$ we put

$$[a, b]_B := \{x \in B : a \leq x \leq b\}.$$

If $B = S$, then we usually write $[a, b]$ instead of $[a, b]_S$. A subset A of S is said to be a **cut** in S , or **downward closed** in S , if for all $a \in A$ and $s \in S$ we have $s < a \implies s \in A$. We say that an element x of an ordered set

extending S **realizes** the cut A if $A = S^{<x}$. We say that S is a **successor set** if every element $x \in S$ has an **immediate successor** $y \in S$, that is, $x < y$ and for all $z \in S$, if $x < z$, then $y \leq z$. For example, \mathbb{N} and \mathbb{Z} with their usual ordering are successor sets.

Suppose that G is an ordered abelian group. Then we set $G^\neq := G \setminus \{0\}$. Also, $G^< := G^{<0}$; similarly for \geq, \leq , and $>$ instead of $<$. We define $|g| := \max\{g, -g\}$ for $g \in G$. For $a \in G$, the **archimedean class** of a is defined by

$$[a] := \{g \in G : |a| \leq n|g| \text{ and } |g| \leq n|a| \text{ for some } n \geq 1\}.$$

The archimedean classes partition G . Each archimedean class $[a]$ with $a \neq 0$ is the disjoint union of the two convex sets $[a] \cap G^<$ and $[a] \cap G^>$. We order the set $[G] := \{[a] : a \in G\}$ of archimedean classes by

$$[a] < [b] : \iff n|a| < |b| \text{ for all } n \geq 1.$$

We have $[0] < [a]$ for all $a \in G^\neq$, and

$$[a] \leq [b] : \iff |a| \leq n|b| \text{ for some } n \geq 1.$$

We say that G is **archimedean** if $[G^\neq] := [G] \setminus \{[0]\}$ is a singleton.

2. ABSTRACT ASYMPTOTIC COUPLES

In this section we recall the basic theory of asymptotic couples, as defined in Section 1. We conclude the section with an important example $(\Gamma_{\log}^{\mathbb{Q}}, \psi)$, which will turn out to be a prime model of our theory T_{\log} . This example is essentially the same as (Γ_{\log}, ψ) , except with \mathbb{Q} everywhere instead of \mathbb{R} .

Let (Γ, ψ) be an asymptotic couple (not necessarily of H -type). By convention we extend ψ to all of Γ by setting $\psi(0) := \infty$. Then $\psi(\alpha + \beta) \geq \min(\psi(\alpha), \psi(\beta))$ holds for all $\alpha, \beta \in \Gamma$, and $\psi : \Gamma \rightarrow \Gamma_\infty$ is a (non-surjective) valuation on the abelian group Γ . In particular, the following is immediate:

Fact 2.1. If $\alpha, \beta \in \Gamma$ and $\psi(\alpha) < \psi(\beta)$, then $\psi(\alpha + \beta) = \psi(\alpha)$.

For $\alpha \in \Gamma^\neq$ we shall also use the following notation:

$$\alpha^\dagger := \psi(\alpha), \quad \alpha' := \alpha + \psi(\alpha).$$

The following subsets of Γ play special roles:

$$\begin{aligned} (\Gamma^\neq)' &:= \{\gamma' : \gamma \in \Gamma^\neq\}, & (\Gamma^>)' &:= \{\gamma' : \gamma \in \Gamma^>\}, \\ \Psi &:= \psi(\Gamma^\neq) = \{\gamma^\dagger : \gamma \in \Gamma^\neq\} = \{\gamma^\dagger : \gamma \in \Gamma^>\}. \end{aligned}$$

For an arbitrary asymptotic couple (Γ', ψ') we may occasionally refer to the set $\psi'((\Gamma')^\neq)$ as “the Ψ -set of (Γ', ψ') ”.

We say that an asymptotic couple (Γ, ψ) has **asymptotic integration** if

$$\Gamma = (\Gamma^\neq)'.$$

Note that by AC3 we have $\Psi < (\Gamma^>)'$.

The following is [AvdD02, Proposition 3.1] and generalizes [AvdD00, Proposition 3.1]. We repeat the proof here.

Lemma 2.2. There is at most one β such that

$$\Psi < \beta < (\Gamma^>)'.$$

If Ψ has a largest element, there is no such β .

Proof. If $\Psi \leq \alpha < \beta < (\Gamma^>)'$, then $\gamma := \beta - \alpha > 0$ gives

$$\gamma^\dagger \leq \alpha = \beta - \gamma < \gamma' - \gamma = \gamma^\dagger,$$

a contradiction. □

Definition 2.3. If (Γ, ψ) contains an element β as in Lemma 2.2, then we say that (Γ, ψ) **has a gap** and that β is the **gap**.

The existence of gaps is part of an important trichotomy for H -asymptotic couples:

Lemma 2.4. Suppose (Γ, ψ) is of H -type. Then (Γ, ψ) has exactly one of the following three properties:

- (i) (Γ, ψ) has a gap;
- (ii) Ψ has a largest element;
- (iii) $\Gamma = (\Gamma^\neq)'$, that is, (Γ, ψ) has asymptotic integration.

Moreover, Γ has at most one element outside $(\Gamma^\neq)'$.

Proof. This follows from [AvdD00, Lemma 3.1, Proposition 3.1]. See also [AvdDvdH15, Corollary 9.2.16]. \square

Note that if (Γ, ψ) is an H -asymptotic couple, then ψ is constant on archimedean classes of Γ : for $\alpha, \beta \in \Gamma^\neq$ with $[\alpha] = [\beta]$ we have $\psi(\alpha) = \psi(\beta)$. The function $\text{id} + \psi$ enjoys the following remarkable intermediate value property:

Lemma 2.5. Suppose (Γ, ψ) is of H -type. Then the functions

$$\gamma \mapsto \gamma' : \Gamma^> \rightarrow \Gamma, \quad \gamma \mapsto \gamma' : \Gamma^< \rightarrow \Gamma$$

have the intermediate value property.

Proof. [AvdD00, Lemma 2.2 and Property (3), p. 320]. See also [AvdDvdH15, Lemma 9.2.14]. \square

It is very useful to think of H -asymptotic couples in terms of the following geography:

$$\Psi < \text{possible gap} < (\Gamma^>)'$$

Let (Γ, ψ) and (Γ_1, ψ_1) be asymptotic couples. An **embedding**

$$h : (\Gamma, \psi) \rightarrow (\Gamma_1, \psi_1)$$

is an embedding $h : \Gamma \rightarrow \Gamma_1$ of ordered abelian groups such that

$$h(\psi(\gamma)) = \psi_1(h(\gamma)) \text{ for } \gamma \in \Gamma^\neq.$$

If $\Gamma \subseteq \Gamma_1$ and the inclusion $\Gamma \rightarrow \Gamma_1$ is an embedding $(\Gamma, \psi) \rightarrow (\Gamma_1, \psi_1)$, then we call (Γ_1, ψ_1) an **extension** of (Γ, ψ) .

Definition 2.6. Call an asymptotic couple (Γ, ψ) **divisible** if the abelian group Γ is divisible. If (Γ, ψ) is a divisible asymptotic couple, then we construe Γ as a vector space over \mathbb{Q} in the obvious way.

As a torsion-free abelian group, we will consider Γ as a subgroup of the divisible abelian group $\mathbb{Q}\Gamma := \mathbb{Q} \otimes_{\mathbb{Z}} \Gamma$ via the embedding $\gamma \mapsto 1 \otimes \gamma$. We also equip $\mathbb{Q}\Gamma$ with the unique linear order that makes it into an ordered abelian group containing Γ as an ordered subgroup. By [AvdD02, Proposition 2.3(2)], ψ extends uniquely to a map $(\mathbb{Q}\Gamma)^\neq \rightarrow \mathbb{Q}\Gamma$, also denoted by ψ , such that $(\mathbb{Q}\Gamma, \psi)$ is an asymptotic couple. We say that $(\mathbb{Q}\Gamma, \psi)$ is the **divisible hull** of (Γ, ψ) . Note that $\psi((\mathbb{Q}\Gamma)^\neq) = \Psi$ and $[\mathbb{Q}\Gamma] = [\Gamma]$. If $\dim_{\mathbb{Q}} \mathbb{Q}\Gamma$ is finite, then $\Psi = \psi(\Gamma^\neq)$ is a finite set. We summarize this as follows:

Lemma 2.7. Let (Γ, ψ) be an asymptotic couple. Then $(\mathbb{Q}\Gamma, \psi)$ is an extension of (Γ, ψ) such that

- (1) $(\mathbb{Q}\Gamma, \psi)$ is divisible,
- (2) $\psi((\mathbb{Q}\Gamma)^\neq) = \Psi$,
- (3) if $i : (\Gamma, \psi) \rightarrow (\Gamma_1, \psi_1)$ is an embedding and (Γ_1, ψ_1) is divisible, then i extends to a unique embedding $j : (\mathbb{Q}\Gamma, \psi) \rightarrow (\Gamma_1, \psi_1)$, and
- (4) if (Γ, ψ) is of H -type, then so is $(\mathbb{Q}\Gamma, \psi)$.

Remark 2.8. In terms of the trichotomy of asymptotic couples, (2) from Lemma 2.7 says that if $\max \Psi$ exists in (Γ, ψ) , then this property is preserved when passing to the divisible hull. However, it is entirely possible that (Γ, ψ) has asymptotic integration whereas $(\mathbb{Q}\Gamma, \psi)$ has a gap. For an example of this, see the remark after Corollary 2 in [Asc03]. We avoid this pathology in Section 5 by adding the unary function symbols $\delta_1, \delta_2, \delta_3, \dots$ to our language to ensure divisibility.

Example 2.9. In analogy with (Γ_{\log}, ψ) defined in Section 1, we now define $(\Gamma_{\log}^{\mathbb{Q}}, \psi)$. Let the underlying abelian group be $\bigoplus_n \mathbb{Q}e_n$, a vector space over \mathbb{Q} with basis (e_n) . We make $\Gamma_{\log}^{\mathbb{Q}}$ into an ordered group by requiring for nonzero $\sum_i r_i e_i$ that

$$\sum r_i e_i > 0 \iff r_n > 0 \text{ for the least } n \text{ such that } r_n \neq 0.$$

It is often convenient to think of an element $\sum r_i e_i$ as the vector (r_0, r_1, r_2, \dots) . Define $\psi : \Gamma_{\log}^{\mathbb{Q}, \neq} \rightarrow \Gamma_{\log}^{\mathbb{Q}}$ for nonzero $\alpha = (r_0, r_1, r_2, \dots)$ as follows:

(Step 1) Take the unique n such that $r_n \neq 0$ but $r_m = 0$ for $m < n$. Thus

$$\alpha = (\underbrace{0, \dots, 0}_n, \underbrace{r_n}_{\neq 0}, r_{n+1}, \dots)$$

(Step 2) Set $\psi(\alpha) := (\underbrace{1, \dots, 1}_{n+1}, 0, 0, \dots) = \sum_{k=0}^n e_k$.

The reader should verify the following properties:

- (1) $(\Gamma_{\log}^{\mathbb{Q}}, \psi)$ is a divisible H -asymptotic couple.
- (2) $(\Gamma_{\log}^{\mathbb{Q}}, \psi)$ has asymptotic integration: for any $\alpha = (r_0, r_1, r_2, \dots)$, take the unique n such that $r_n \neq 1$ and $r_m = 1$ for $m < n$. Thus

$$\alpha = (\underbrace{1, \dots, 1}_n, \underbrace{r_n}_{\neq 1}, r_{n+1}, \dots)$$

and then $\beta := (\underbrace{0, \dots, 0}_n, r_n - 1, r_{n+1}, \dots)$ is the unique element of $\Gamma_{\log}^{\mathbb{Q}}$ with $\beta' = \alpha$.

- (3) The set $\Psi = \psi(\Gamma_{\log}^{\mathbb{Q}, \neq})$ is a basis for $\Gamma_{\log}^{\mathbb{Q}}$ as a vector space over \mathbb{Q} .

3. ASYMPTOTIC INTEGRATION

In this section, (Γ, ψ) will be an H -asymptotic couple with asymptotic integration and α, β will range over Γ . By Lemma 2.7 we may assume that (Γ, ψ) is given as a substructure of some divisible H -asymptotic couple. Doing this allows us to multiply by $\frac{1}{n}$ in the proofs, for $n \geq 1$.

Definition 3.1. Given α we let $\int \alpha$ denote the unique $\beta \neq 0$ such that $\beta' = \alpha$ and we call $\beta = \int \alpha$ the **integral** of α . This gives us a function $\int : \Gamma \rightarrow \Gamma^{\neq}$ which is the inverse of $\gamma \mapsto \gamma' : \Gamma^{\neq} \rightarrow \Gamma$. We sometimes refer to the act of applying the function \int as **integrating**. Note that $\int \alpha < 0$ if $\alpha \in \Psi$.

We define the **successor function** $s : \Gamma \rightarrow \Psi$ by $\alpha \mapsto \psi(\int \alpha)$. The successor function gets its name from the observation that in many cases of interest, such as the asymptotic couple of \mathbb{T}_{\log} , the ordered subset Ψ of Γ is a successor set, and for $\alpha \in \Psi$, the immediate successor of α in Ψ is $s(\alpha)$. However in general, Ψ as an ordered subset of Γ is not a successor set; for example, if (Γ, ψ) is a so-called *closed asymptotic couple* considered in [AvdD00], then Ψ is a dense ordered set and hence not a successor set.

We also define the **contraction map** $\chi : \Gamma^< \rightarrow \Gamma^<$ by $\alpha \mapsto \int \psi(\alpha)$. The contraction map gets its name from the connection between asymptotic couples and contraction groups (for instance, see [Kuh94, Kuh95, Asc03]). We will only refer to χ in Section 4. Since χ can be defined in terms of ψ and \int , and \int can be defined in terms of s as we will see in Lemma 3.2, we choose to focus most of our attention on the function s .

Lemma 3.2 (Integral Identity). $\int \alpha = \alpha - s\alpha$.

Proof. Note that $(\int \alpha)' = \alpha$. Expanding this out gives $\psi(\int \alpha) + \int \alpha = s\alpha + \int \alpha = \alpha$. □

The next lemma tells us, among other things, that for each α , we get an increasing sequence:

$$s\alpha < s^2\alpha < s^3\alpha < s^4\alpha < \dots$$

in Ψ .

Lemma 3.3. If $\alpha \in (\Gamma^<)'$, then $\alpha < s(\alpha)$, and if $\alpha \in (\Gamma^>)'$, then $\alpha > s(\alpha)$. In particular, if $\alpha \in \Psi$, then $\alpha < s(\alpha)$.

Proof. If $\alpha \in (\Gamma^>)'$, then $\alpha > \psi(\int \alpha)$ by AC3. Thus assume that $\alpha \in (\Gamma^<)'$ and let $\alpha = \beta'$ with $\beta < 0$. Then

$$\begin{aligned} \alpha < s(\alpha) &\Leftrightarrow \alpha < \psi(\int \alpha) \\ &\Leftrightarrow \alpha < \psi(\beta) \\ &\Leftrightarrow \alpha - \psi(\beta) < 0 \end{aligned}$$

and the latter is true since $\alpha - \psi(\beta) = \beta' - \psi(\beta) = \beta$. \square

By HC, if $[\alpha] > [\beta]$ then $\psi(\beta - \alpha) = \psi(\alpha)$. In the case where $[\alpha] = [\beta]$ and α and β are both sufficiently far up the set $(\Gamma^<)'$, the following lemma can be very useful:

Lemma 3.4 (Successor Identity). If $s\alpha < s\beta$, then $\psi(\beta - \alpha) = s\alpha$.

Proof. Assume $s\alpha < s\beta$. We will prove that $[\beta - s\alpha] < [s\alpha - \alpha]$, and so $\psi(\beta - \alpha) = \psi(s\alpha - \alpha) = \psi(-\int \alpha) = s\alpha$. From $s\alpha < s\beta$ we get $\psi(\int \alpha) < \psi(\int \beta)$, which gives $[\int \beta] < [\int \alpha]$. First consider the case where $\alpha \in (\Gamma^<)'$ and $s\alpha < \beta$. Then $\int \alpha < 0$ and $s\alpha - \alpha > 0$. Note that

$$\begin{aligned} [\beta - s\alpha] < [s\alpha - \alpha] &\Leftrightarrow \beta - s\alpha < \frac{1}{n}(s\alpha - \alpha) \text{ for all } n \geq 1 \\ &\Leftrightarrow \beta < s\alpha + \frac{1}{n}(s\alpha - \alpha) \text{ for all } n \geq 1 \\ &\Leftrightarrow \beta < \psi(\int \alpha) + \frac{1}{n}(-\int \alpha) \text{ for all } n \geq 1 \\ &\Leftrightarrow \beta < \psi(-\frac{1}{n}\int \alpha) + (-\frac{1}{n}\int \alpha) \text{ for all } n \geq 1 \\ &\Leftrightarrow \beta < (-\frac{1}{n}\int \alpha)' \text{ for all } n \geq 1 \\ &\Leftrightarrow \int \beta < \frac{1}{n}(-\int \alpha) \text{ for all } n \geq 1, \end{aligned}$$

and the latter holds because $[\int \beta] < [\int \alpha]$. All other cases are similar. \square

It follows that s can be defined in terms of ψ if we allow a suitable ‘‘external parameter’’:

Corollary 3.5. Let (Γ^*, ψ^*) be an H -asymptotic couple with asymptotic integration that extends (Γ, ψ) . Suppose $\gamma^* \in \Psi^*$ is such that $\Psi < \gamma^*$. Then $s(\alpha) = \psi^*(\alpha - \gamma^*)$ for all $\alpha \in \Gamma$.

Since Ψ has no largest element, compactness yields an extension (Γ^*, ψ^*) of (Γ, ψ) with an element γ^* as in Corollary 3.5. In Section 4 we also give explicit constructions for extensions with this property in Lemma 4.10 and Lemma 4.11.

Since (Γ, ψ) has asymptotic integration, Corollary 2.4 tells us that (Γ, ψ) most definitely does not have a gap. However, it is fun (also useful) to summarize Corollary 3.5 with the following slogan:

$$‘‘s(x) = \psi(x - \text{gap that does not exist})’’$$

This fact is essential for Corollary 6.7 and a variant of this device allows the proof of Lemma 4.12 to be carried out. The following is immediate from Corollary 3.5 and HC for ψ :

Corollary 3.6. The function s has the following properties:

- (1) s is increasing on $(\Gamma^<)'$ and decreasing on $(\Gamma^>)'$,
- (2) if $\alpha \in s(\Gamma)$, then $s^{-1}(\alpha) \cap (\Gamma^>)'$ and $s^{-1}(\alpha) \cap (\Gamma^<)'$ are convex in Γ ,
- (3) if s is injective on Ψ , then s is strictly increasing on Ψ .

The following lemma is also useful in understanding s in terms of ψ .

Lemma 3.7 (Fixed Point Identity). $\beta = \psi(\alpha - \beta)$ iff $\beta = s(\alpha)$.

Proof. Applying ψ to $\int \alpha = \alpha - s\alpha$ gives $s\alpha = \psi(\alpha - s\alpha)$. Next, suppose that $\beta = \psi(\alpha - \beta)$. Then $\alpha = (\alpha - \beta) + \beta = (\alpha - \beta) + \psi(\alpha - \beta)$ and so $\int \alpha = \alpha - \beta$. Applying ψ yields $s\alpha = \psi(\alpha - \beta) = \beta$. \square

The following lemma is a more constructive version of [AvdD00, Lemma 4.6], but will not be used in the rest of this paper.

Lemma 3.8 (Limit Lemma). Let $\alpha \in \Gamma$. Then $\gamma_0 := s^2\alpha \in \Psi$ and $\delta_0 := s^2\alpha - \int s\alpha \in (\Gamma^>)'$ and the map

$$\gamma \mapsto \psi(\gamma - \alpha) : \Gamma \rightarrow \Gamma_\infty$$

takes the constant value $s\alpha$ on the set $[\gamma_0, \delta_0] := \{\gamma : \gamma_0 \leq \gamma \leq \delta_0\}$.

Proof. Define $\beta_0 := -\int \psi \int \alpha = -\int s(\alpha) > 0$. Then $\gamma_0 = \psi(\beta_0) = s^2(\alpha) \in \Psi$ and $\delta_0 = s^2\alpha - \int s\alpha = s^2\alpha + \beta_0 = \psi(\beta_0) + \beta_0 = \beta'_0 \in (\Gamma^>)'$. First we calculate the values of $\psi(\gamma_0 - \alpha)$ and $\psi(\delta_0 - \alpha)$:

$$\begin{aligned} \psi(\gamma_0 - \alpha) &= \psi(s^2\alpha - \alpha) \\ &= s\alpha \quad (\text{by Lemma 3.4}) \\ \psi(\delta_0 - \alpha) &= \psi(s^2\alpha - \int s\alpha - \alpha) \\ &= \psi((s^2\alpha - \alpha) - \int s\alpha) \\ &= s\alpha \quad (\text{because } \psi(s^2\alpha - \alpha) = s\alpha) \end{aligned}$$

Finally, we must show that $\psi(\gamma - \alpha)$ is constant as a function of $\gamma \in [\gamma_0, \delta_0]$. By HC, it is sufficient to show that either $\alpha < \gamma_0 < \delta_0$ or $\gamma_0 < \delta_0 < \alpha$. First suppose $\alpha \in (\Gamma^<)'$. By Lemma 3.3 it follows that $\alpha < s\alpha < s^2\alpha = \gamma_0 < \delta_0$. Otherwise suppose $\alpha \in (\Gamma^>)'$. Then $\gamma_0 < \delta_0$ and

$$\begin{aligned} \delta_0 < \alpha &\Leftrightarrow s^2\alpha - \int s\alpha < \alpha \\ &\Leftrightarrow -\int s\alpha < \alpha - s^2\alpha. \end{aligned}$$

The inequality on the last line holds by HC and the observation that

$$0 < -\int s\alpha < \alpha - s^2\alpha. \quad \square$$

Lemma 3.9. $s0 \neq 0$ and $s0$ is the unique element $x \in \Gamma^\neq$ for which $\psi(x) = x$.

Proof. By Lemma 3.3 we have $s0 \neq 0$, and by the Integral Identity $\int 0 = -s0$ and so $s0 = \psi(\int 0) = \psi(-s0) = \psi(s0)$. Uniqueness follows from the Fixed Point Identity: if $\psi(x) = x$, then $x = \psi(0 - x)$ and so $x = s0$. \square

Lemma 3.9 tells us that H -asymptotic couples with asymptotic integration come in two flavors: those with $s0 > 0$ and those with $s0 < 0$. The asymptotic couples (Γ_{\log}, ψ) and $(\Gamma_{\log}^{\mathbb{Q}}, \psi)$ are both of type “ $s0 > 0$ ”. In the literature, when $s0 > 0$, then the element $s0$ is often denoted by “1” and then (Γ, ψ) is said to **have a 1**. We will not use this notation since we have the function s at our disposal and we already will be making use of the rational number $1 \in \mathbb{Q}$.

Example 3.10. We return once again to the asymptotic couple $(\Gamma_{\log}^{\mathbb{Q}}, \psi)$ defined in Example 2.9. Property (2) in Example 2.9 already gives us the definition for the function $\int : \Gamma_{\log}^{\mathbb{Q}} \rightarrow \Gamma_{\log}^{\mathbb{Q}, \neq}$. Using $s = \psi \circ \int$, we can compute $s\alpha$ for $\alpha = (r_0, r_1, r_2, \dots) \in \Gamma_{\log}^{\mathbb{Q}}$. Take the unique n such that $r_n \neq 1$ and $r_m = 1$ for $m < n$. Thus

$$\alpha = (\underbrace{1, \dots, 1}_n, \underbrace{r_n}_{\neq 1}, r_{n+1}, \dots)$$

and then

$$s\alpha = (\underbrace{1, \dots, 1}_{n+1}, 0, 0, \dots).$$

In particular, note that for elements in Ψ , s acts as follows:

$$\begin{aligned} s(1, 0, 0, 0, 0, \dots) &= (1, 1, 0, 0, 0, \dots) \\ s(1, 1, 0, 0, 0, \dots) &= (1, 1, 1, 0, 0, \dots) \\ s(1, 1, 1, 0, 0, \dots) &= (1, 1, 1, 1, 0, \dots) \\ &\vdots \\ s(\underbrace{1, \dots, 1}_n, 0, 0, \dots) &= (\underbrace{1, \dots, 1}_{n+1}, 0, 0, \dots) \end{aligned}$$

Note that $s_0 = (1, 0, 0, \dots) = \min \Psi$ and $s_0 > 0$. It is clear that the function $\gamma \mapsto s\gamma : \Psi \rightarrow \Psi^{>s_0}$ is a bijection and $(\Psi; <)$ is a successor set such that for $\alpha < \beta \in \Psi$ we have $s\alpha \leq \beta$.

4. THE EMBEDDING LEMMA ZOO

In this section, (Γ, ψ) and (Γ_1, ψ_1) are divisible H -asymptotic couples. We include here many embedding results of the following form:

Embedding Lemma Template. Suppose (Γ, ψ) has property P . Then there is a divisible H -asymptotic couple (Γ', ψ') extending (Γ, ψ) such that:

- (1) (Γ', ψ') has property Q ;
- (2) if $i : (\Gamma, \psi) \rightarrow (\Gamma_1, \psi_1)$ is an embedding such that (Γ_1, ψ_1) has property Q , then i extends uniquely to an embedding $j : (\Gamma', \psi') \rightarrow (\Gamma_1, \psi_1)$.

More often than not, properties P and Q involve the trichotomy presented in Lemma 2.4. Recall that Lemma 2.4 states that (Γ, ψ) has exactly one of the following properties:

- (Γ, ψ) has a gap (“ \exists gap”);
- Ψ has a largest element (“ $\exists \max \Psi$ ”);
- $\Gamma = (\Gamma^\neq)'$, that is, (Γ, ψ) has asymptotic integration (“Asymptotic Integration”).

In light of this, the author thought it would be helpful to the reader to include Figure 1 as a roadmap for navigating the various embedding results in terms of the trichotomy of Lemma 2.4.

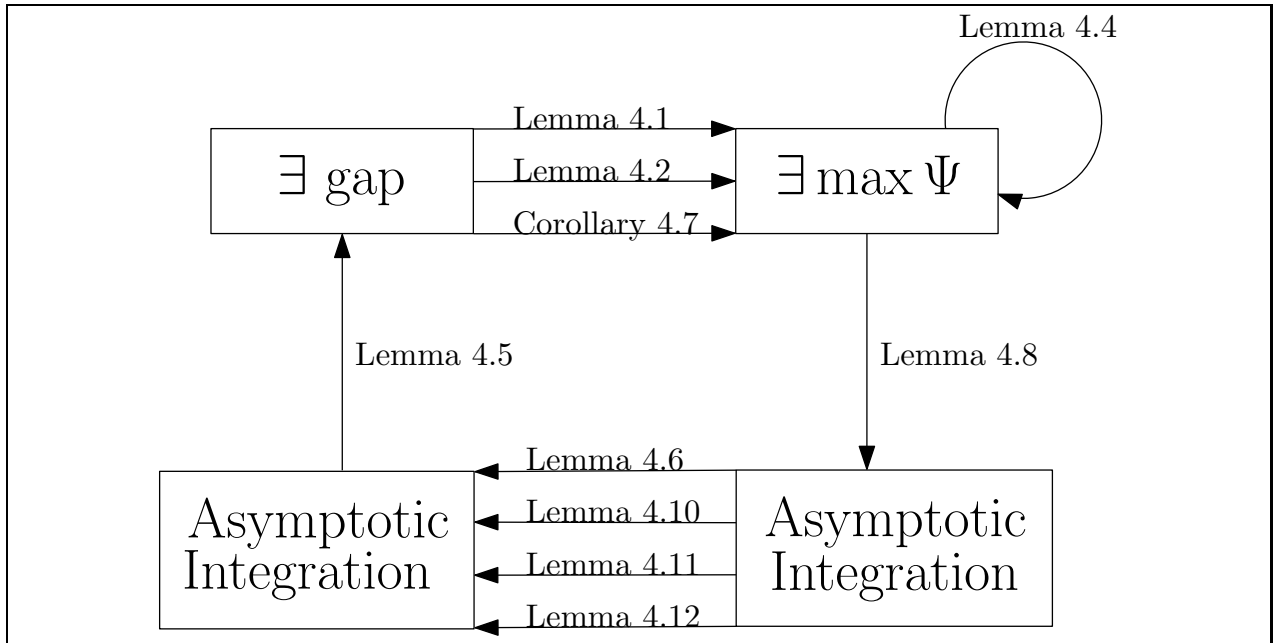

Figure 1: Embedding Lemmas for divisible H -asymptotic couples

The first two lemmas allow us to remove a gap by “adjoining an integral” for the gap. The first lemma shows that we can make the gap the derivative of a positive element; the lemma after that shows how to make the gap the derivative of a negative element.

Lemma 4.1 (Removing a gap, positive version). Let β be a gap in (Γ, ψ) . Then there is a divisible H -asymptotic couple $(\Gamma + \mathbb{Q}\alpha, \psi^\alpha)$ extending (Γ, ψ) such that:

- (1) $\alpha > 0$ and $\alpha' = \beta$;
- (2) if $i : (\Gamma, \psi) \rightarrow (\Gamma_1, \psi_1)$ is an embedding and $\alpha_1 \in \Gamma_1$, $\alpha_1 > 0$, $\alpha'_1 = i(\beta)$, then i extends uniquely to an embedding $j : (\Gamma + \mathbb{Q}\alpha, \psi^\alpha) \rightarrow (\Gamma_1, \psi_1)$ with $j(\alpha) = \alpha_1$.

Furthermore, $\psi^\alpha((\Gamma + \mathbb{Q}\alpha)^\neq) = \Psi \cup \{\beta - \alpha\}$ with $\Psi < \beta - \alpha$.

Proof. This is similar to [AvdD02, Lemma 2.10]. For the reader's convenience we mention that the ordering on $(\Gamma + \mathbb{Q}\alpha)$ is given by setting $0 < q\alpha < \Gamma^>$ for all $q > 0$ and $\psi^\alpha : (\Gamma + \mathbb{Q}\alpha)^\neq \rightarrow \Gamma + \mathbb{Q}\alpha$ is defined by

$$\psi^\alpha(\gamma + r\alpha) := \begin{cases} \psi(\gamma), & \text{if } \gamma \neq 0, \\ \beta - \alpha, & \text{otherwise,} \end{cases}$$

for $\gamma \in \Gamma$ and $r \in \mathbb{Q}$, with $\gamma + r\alpha \neq 0$. See also [AvdDvdH15, Lemma 9.8.2]. \square

Lemma 4.2 (Removing a gap, negative version). Let β be a gap in (Γ, ψ) . Then there is a divisible H -asymptotic couple $(\Gamma + \mathbb{Q}\alpha, \psi^\alpha)$ extending (Γ, ψ) such that:

- (1) $\alpha < 0$ and $\alpha' = \beta$;
- (2) if $i : (\Gamma, \psi) \rightarrow (\Gamma_1, \psi_1)$ is an embedding and $\alpha_1 \in \Gamma_1$, $\alpha_1 < 0$, $\alpha'_1 = i(\beta)$, then i extends uniquely to an embedding $j : (\Gamma + \mathbb{Q}\alpha, \psi^\alpha) \rightarrow (\Gamma_1, \psi_1)$ with $j(\alpha) = \alpha_1$.

Furthermore, $\psi^\alpha((\Gamma + \mathbb{Q}\alpha)^\neq) = \Psi \cup \{\beta - \alpha\}$ with $\Psi < \beta - \alpha$.

Proof. This is similar to [AvdD02, Lemma 2.11] and the construction of $(\Gamma + \mathbb{Q}\alpha, \psi^\alpha)$ is similar to Lemma 4.1 except we set $\Gamma^< < q\alpha < 0$ for all $q > 0$. \square

Remark 4.3. Lemmas 4.1 and 4.2 show us that there are essentially two ways to remove a gap. These two ways are incompatible in the sense that given (Γ, ψ) with gap β , we can obtain (Γ^+, ψ^+) from Lemma 4.1 and (Γ^-, ψ^-) from Lemma 4.2 and there is no common extension (Γ', ψ') in which these two can be amalgamated, i.e., the following configuration of embeddings is impossible:

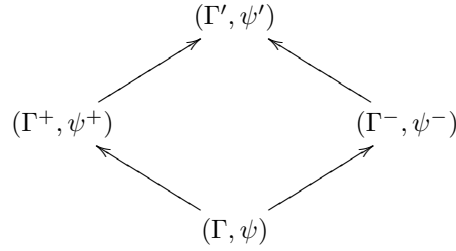

This issue is referred to as the “fork in the road” and is an obstruction to quantifier elimination. In [AvdD00] this issue is resolved by adding an additional predicate to the language that “decides” for a gap whether it is supposed to be the derivative of a positive or of a negative element. We avoid this obstacle in Section 5 by adding the function s to our language which ensures that all asymptotic couples considered already have asymptotic integration. The tradeoff in doing so is that we can only use embedding lemmas of the form

$$(\text{Asymptotic Integration}) \rightarrow (\text{Asymptotic Integration})$$

(in the sense of Figure 1) in our proof of quantifier elimination.

If (Γ, ψ) has a largest element β in its Ψ -set, then Theorem 2.4 tells us that there is no $\alpha \in \Gamma$ such that $\alpha' = \beta$. Lemma 4.4 tells us how to “adjoin an integral” for such an element β . It is important to note that the extension of (Γ, ψ) constructed in Lemma 4.4 also has a Ψ -set with a largest element.

Lemma 4.4 (Adjoining an integral for $\max \Psi$). Assume Ψ has a largest element β . Then there is a divisible H -asymptotic couple $(\Gamma + \mathbb{Q}\alpha, \psi^\alpha)$ extending (Γ, ψ) with $\alpha \neq 0$, $\alpha' = \beta$, such that for any embedding $i : (\Gamma, \psi) \rightarrow (\Gamma_1, \psi_1)$ and any $\alpha_1 \in \Gamma_1^\neq$ with $\alpha'_1 = i(\beta)$ there is a unique extension of i to an embedding $j : (\Gamma + \mathbb{Q}\alpha, \psi^\alpha) \rightarrow (\Gamma_1, \psi_1)$ with $j(\alpha) = \alpha_1$. Furthermore, $\psi^\alpha((\Gamma + \mathbb{Q}\alpha)^\neq) = \Psi \cup \{\beta - \alpha\}$ with $\Psi < \beta - \alpha$.

Proof. This is a variant of [AvdD02, Lemma 2.12]. \square

The next lemma allows us to add a gap to an asymptotic couple with asymptotic integration.

Lemma 4.5 (Adding a gap). Suppose (Γ, ψ) has asymptotic integration. Then there is a divisible H -asymptotic couple $(\Gamma + \mathbb{Q}\beta, \psi_\beta)$ extending (Γ, ψ) such that:

- (1) $\Psi < \beta < (\Gamma^>)'$;

- (2) for any (Γ_1, ψ_1) extending (Γ, ψ) and $\beta_1 \in \Gamma_1$ with $\Psi < \beta_1 < (\Gamma^>)'$ there is a unique embedding $(\Gamma + \mathbb{Q}\beta, \psi_\beta) \rightarrow (\Gamma_1, \psi_1)$ of asymptotic couples that is the identity on Γ and sends β to β_1 ;
- (3) the set Γ is dense in the ordered abelian group $\Gamma + \mathbb{Q}\beta$, so $[\Gamma] = [\Gamma + \mathbb{Q}\beta]$, $\Psi = \psi_\beta((\Gamma + \mathbb{Q}\beta)^\neq)$ and β is a gap in $(\Gamma + \mathbb{Q}\beta, \psi_\beta)$.

Proof. This is [AvdDvdH15, Lemma 9.8.4]. The proof uses a compactness argument. \square

Recall that a cut in an ordered set S is simply a downward closed subset of S , and an element a of an ordered set extending S is said to realize the cut C in S if $C < a < S \setminus C$. The following Lemma 4.6 is useful because it enables us to either:

- (1) add an element α witnessing $\psi(\alpha) = \beta$, if β is not already in the Ψ -set, but is not disqualified from being in a larger Ψ -set by satisfying $\beta \in (\Gamma^>)'$, or
- (2) add an additional archimedean class to $[\psi^{-1}(\beta)]$, if β is already in the Ψ -set.

Lemma 4.6. Let C be a cut in $[\Gamma^\neq]$ and let $\beta \in \Gamma$ be such that $\beta < (\Gamma^>)', \gamma^\dagger \leq \beta$ for all $\gamma \in \Gamma^\neq$ with $[\gamma] \notin C$, and $\beta \leq \delta^\dagger$ for all $\delta \in \Gamma^\neq$ with $[\delta] \in C$. Then there exists a divisible H -asymptotic couple $(\Gamma \oplus \mathbb{Q}\alpha, \psi^\alpha)$ extending (Γ, ψ) , with $\alpha > 0$, such that:

- (1) $[\alpha] \notin [\Gamma^\neq]$ realizes the cut C in $[\Gamma^\neq]$, $\psi^\alpha(\alpha) = \beta$;
- (2) given any embedding i of (Γ, ψ) into an H -asymptotic couple (Γ_1, ψ_1) and any element $\alpha_1 \in \Gamma_1^\neq$ such that $[\alpha_1] \notin [i(\Gamma^\neq)]$ realizes the cut $\{[i(\delta)] : [\delta] \in C\}$ in $[i(\Gamma^\neq)]$ and $\psi_1(\alpha_1) = i(\beta)$, there is a unique extension of i to an embedding $j : (\Gamma \oplus \mathbb{Q}\alpha, \psi^\alpha) \rightarrow (\Gamma_1, \psi_1)$ with $j(\alpha) = \alpha_1$.

If (Γ, ψ) has asymptotic integration, then $(\Gamma^\alpha, \psi^\alpha)$ has asymptotic integration.

Proof. This is a variant of [AvdD02, Lemma 2.15]. \square

For the special case of $C = \emptyset$ and β a gap in (Γ, ψ) , Lemma 4.6 gives:

Corollary 4.7 (Making the gap become $\max \Psi$). Let $\beta \in \Gamma$ be a gap in (Γ, ψ) . Then there exists an H -asymptotic couple $(\Gamma + \mathbb{Q}\alpha, \psi^\alpha)$ extending (Γ, ψ) , such that:

- (1) $0 < q\alpha < \Gamma^>$ for all $q > 0$, and $\psi^\alpha(\alpha) = \beta$;
- (2) for any embedding i of (Γ, ψ) into a divisible H -asymptotic couple (Γ_1, ψ_1) and any $\alpha_1 \in \Gamma_1^\neq$ with $\psi_1(\alpha_1) = i(\beta)$, there is a unique extension of i to an embedding $j : (\Gamma + \mathbb{Q}\alpha, \psi^\alpha) \rightarrow (\Gamma_1, \psi_1)$ with $j(\alpha) = \alpha_1$.

Note that Corollary 4.7 is compatible with Lemma 4.2 and incompatible with Lemma 4.1: if (Γ, ψ) has a gap β , then applying Corollary 4.7 “decides” that β will be the derivative of a negative element in any extension with asymptotic integration.

Lemma 4.8 (Divisible asymptotic integration closure). Let (Γ_0, ψ_0) be a divisible H -asymptotic couple such that Ψ has a largest element β_0 . Then there exists a divisible H -asymptotic couple

$$(\Gamma, \psi) = (\Gamma_0 \oplus \bigoplus_n \mathbb{Q}\alpha_{n+1}, \psi) = (\Gamma_0 \oplus \bigoplus_n \mathbb{Q}\beta_{n+1}, \psi)$$

extending (Γ_0, ψ) such that:

- (1) (Γ, ψ) has asymptotic integration;
- (2) $s(\beta_n) = \beta_{n+1}$ and $\int \beta_n = \alpha_{n+1}$ for all n ;
- (3) for any embedding i of (Γ_0, ψ_0) into a divisible H -asymptotic couple (Γ^*, ψ^*) with asymptotic integration, there is a unique extension of i to an embedding $(\Gamma, \psi) \rightarrow (\Gamma^*, \psi^*)$.

Proof. For $n \geq 0$, define $(\Gamma_{n+1}, \psi_{n+1})$ to be the asymptotic couple $(\Gamma_n + \mathbb{Q}\alpha_{n+1}, \psi_n^{\alpha_{n+1}})$ constructed in Lemma 4.4 as an extension of (Γ_n, ψ_n) . Set $\Psi_n := \psi_n(\Gamma_n^\neq)$ and note that $\Psi_{n+1} = \Psi_n \cup \{\beta_0 - \sum_{k=0}^n \alpha_{k+1}\}$ with $\max \Psi_{n+1} = \beta_0 - \sum_{k=0}^n \alpha_{k+1} =: \beta_{n+1}$. Let $(\Gamma, \psi) = \bigcup_n (\Gamma_n, \psi_n)$ and so $\Psi = \psi(\Gamma^\neq) = \bigcup_n \Psi_n$. Note that Ψ does not have a maximum element. Furthermore, (Γ, ψ) does not have a gap because it is the union of a chain of asymptotic couples which don't have gaps. Thus (Γ, ψ) has asymptotic integration.

For (3), assume by induction that we have an embedding $i_n : (\Gamma_n, \psi_n) \rightarrow (\Gamma^*, \psi^*)$. Since (Γ^*, ψ^*) has asymptotic integration, there is a unique extension of i_n to an embedding $i_{n+1} : (\Gamma_{n+1}, \psi_{n+1})$ such that

$i_{n+1}(\alpha_{n+1}) = \int(i_n(\beta_n))$ by the universal property from Lemma 4.4. Thus there is a unique embedding $\cup_n i_n : (\Gamma, \psi) \rightarrow (\Gamma^*, \psi^*)$. \square

Given (Γ_0, ψ_0) as in Lemma 4.8, the extension (Γ, ψ) constructed in this lemma is the unique divisible H -asymptotic couple with asymptotic integration extending (Γ_0, ψ_0) which has the universal property (3) in Lemma 4.8. We call this extension **the divisible asymptotic integration closure** of (Γ_0, ψ_0) . The following summarizes the relationship between the α 's and β 's in Lemma 4.8, with $\beta_0 = \max \Psi_0$.

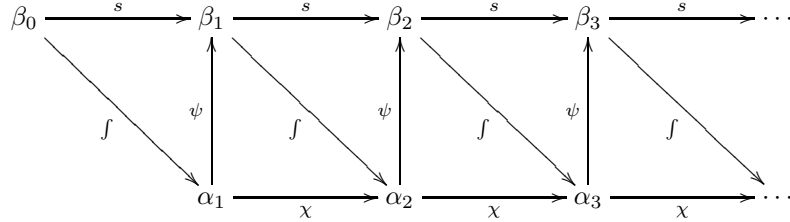

The diagram illustrates the manner in which we adjoined integrals at each stage of the construction.

Example 4.9. Let $(\Gamma_0, \psi_0) \subseteq (\Gamma_{\log}^{\mathbb{Q}}, \psi)$ be such that $\Gamma_0 = \mathbb{Q}e_0$. Then $e_0 = \max \psi(\Gamma_0^{\neq})$, and by the construction in Lemma 4.8, $(\Gamma_{\log}^{\mathbb{Q}}, \psi)$ is the divisible asymptotic integration closure of (Γ_0, ψ_0) . Thus if (Γ', ψ') is any divisible H -asymptotic couple with asymptotic integration such that $s_0 > 0$, then there is an embedding

$$i : (\Gamma_{\log}^{\mathbb{Q}}, \psi) \rightarrow (\Gamma', \psi').$$

Lemma 4.10. Let (Γ_0, ψ_0) be a divisible H -asymptotic couple with asymptotic integration. Then there exists a divisible H -asymptotic couple $(\Gamma, \psi) = (\Gamma_0 \oplus \mathbb{Q}\alpha_0 \oplus \bigoplus_n \mathbb{Q}\beta_n, \psi)$ extending (Γ_0, ψ_0) , such that:

- (1) (Γ, ψ) has asymptotic integration;
- (2) $\psi_0(\Gamma_0^{\neq}) < \beta_0 < (\Gamma_0^>)', \beta_0 = \psi(\alpha_0), \beta_{n+1} = s(\beta_n)$ for all n ;
- (3) for any embedding i of (Γ_0, ψ_0) into a divisible H -asymptotic couple (Γ^*, ψ^*) with asymptotic integration and any $\alpha^* \in (\Gamma^*)^<$ such that $i(\psi_0(\Gamma_0)) < \psi^*(\alpha^*) < (i(\Gamma_0^>))'$, there is a unique extension of i to an embedding $j : (\Gamma, \psi) \rightarrow (\Gamma^*, \psi^*)$ such that $j(\alpha_0) = \alpha^*, j(\beta_0) = \psi^*(\alpha^*)$ and $j(\beta_{k+1}) = s^k(\psi^*(\alpha^*))$.

Proof. By Lemma 4.5, we can extend (Γ_0, ψ_0) to an asymptotic couple $(\Gamma_0 \oplus \mathbb{Q}\beta_0, \psi)$ such that β_0 is a gap. Then by Corollary 4.7, we can extend $(\Gamma_0 \oplus \mathbb{Q}\beta_0, \psi)$ to an asymptotic couple $(\Gamma_0 \oplus \mathbb{Q}\beta_0 \oplus \mathbb{Q}\alpha_0, \psi)$ such that $\psi(\alpha_0) = \beta_0$. Thus $\beta_0 = \max \psi((\Gamma_0 \oplus \mathbb{Q}\beta_0 \oplus \mathbb{Q}\alpha_0)^{\neq})$. Finally, we apply Lemma 4.8 to this last asymptotic couple to obtain an asymptotic couple $(\Gamma, \psi) = (\Gamma_0 \oplus \mathbb{Q}\beta_0 \oplus \mathbb{Q}\alpha_0 \oplus \bigoplus_n \mathbb{Q}\beta_{n+1}, \psi)$ with the desired properties. \square

Setting $\alpha_{n+1} := \int \beta_n = \chi \alpha_n$ in Lemma 4.10, we have the following configuration of the elements we adjoined to (Γ_0, ψ_0) :

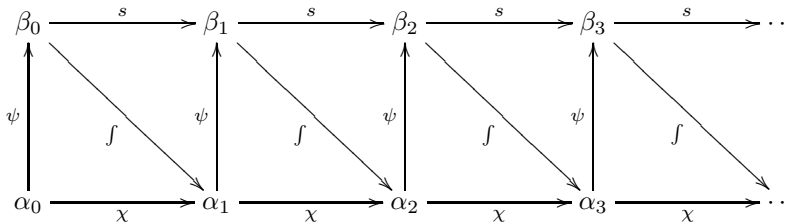

The top row of the above diagram is a “copy of \mathbb{N} ” that has been added to the top of Ψ_0 , i.e., $\Psi = \Psi_0 \cup \{\beta_0, \beta_1, \dots\}$ with $\Psi_0 < \beta_0 < \beta_1 < \beta_2 < \dots$. The bottom row is a sequence of increasingly smaller and smaller elements (in the sense that $[\Gamma_0^{\neq}] > [\alpha_0] > [\alpha_1] > \dots$) which serve as “witnesses to the top row”.

In the next lemma, we iterate the construction given by Lemma 4.10 to add a “copy of \mathbb{Z} ” to the top of the Ψ -set.

Lemma 4.11. Suppose (Γ, ψ) has asymptotic integration and Γ is divisible. Then there is a divisible H -asymptotic couple $(\Gamma_{\diamond}, \psi_{\diamond}) \supseteq (\Gamma, \psi)$ with a family $(\beta_k)_{k \in \mathbb{Z}}$ in Ψ_{\diamond} such that:

- (1) $(\Gamma_\diamond, \psi_\diamond)$ has asymptotic integration;
- (2) $\Psi < \beta_0$, and $s(\beta_k) = \beta_{k+1}$ for all k ;
- (3) for any embedding $i : (\Gamma, \psi) \rightarrow (\Gamma^*, \psi^*)$ into a divisible H -asymptotic couple with asymptotic integration and any family $(\beta_k^*)_{k \in \mathbb{Z}}$ in Ψ^* with $i(\Psi) < \beta_0^*$, and $s(\beta_k^*) = \beta_{k+1}^*$ for all k , there is a unique extension of i to an embedding $j : (\Gamma_\diamond, \psi_\diamond) \rightarrow (\Gamma^*, \psi^*)$ sending β_k to β_k^* for all k .

Proof. For each $k \geq 0$, let $(\Gamma, \psi) \subseteq (\Gamma_k, \psi_k)$ be the extension given by Lemma 4.10. In the terms of the diagram below the proof of Lemma 4.10, label the sequence of β 's and α 's in (Γ_k, ψ_k) as $\beta_0^k, \beta_1^k, \dots$ and $\alpha_0^k, \alpha_1^k, \dots$. By the universal property of Lemma 4.10, there is a unique embedding $j_k : (\Gamma_k, \psi_k) \rightarrow (\Gamma_{k+1}, \psi_{k+1})$ such that $\alpha_0^k \mapsto \alpha_1^{k+1}$.

$$\begin{array}{ccc} (\Gamma_k, \psi_k) & \xrightarrow{j_k} & (\Gamma_{k+1}, \psi_{k+1}) \\ \uparrow & \nearrow & \\ (\Gamma, \psi) & & \end{array}$$

This embedding results in identifications $\beta_l^k = \beta_{l+1}^{k+1}$ and $\alpha_l^k = \alpha_{l+1}^{k+1}$ for all $l \geq 0$. Thus we may define $(\Gamma_\diamond, \psi_\diamond)$ as the union of the increasing chain

$$(\Gamma, \psi) \subseteq (\Gamma_0, \psi_0) \subseteq (\Gamma_1, \psi_1) \subseteq (\Gamma_2, \psi_2) \subseteq \dots$$

In $(\Gamma_\diamond, \psi_\diamond)$, we define $\beta_k := \beta_k^0$ for $k \geq 0$ and $\beta_k := \beta_0^{-k}$ for $k < 0$. Furthermore we also define $\alpha_k := \int \beta_{k-1}$ for all k . The following table illustrates the identifications of the β 's in this increasing union, with elements in the same column being identified:

$$\begin{array}{cccccccc} \text{in } (\Gamma_\diamond, \psi_\diamond) : & \cdots & \beta_{-2} & \beta_{-1} & \beta_0 & \beta_1 & \beta_2 & \cdots \\ & \vdots & \vdots & \vdots & \vdots & \vdots & \vdots & \\ \text{in } (\Gamma_2, \psi_2) : & & \beta_0^2 & \beta_1^2 & \beta_2^2 & \beta_3^2 & \beta_4^2 & \cdots \\ \text{in } (\Gamma_1, \psi_1) : & & & \beta_0^1 & \beta_1^1 & \beta_2^1 & \beta_3^1 & \cdots \\ \text{in } (\Gamma_0, \psi_0) : & & & & \beta_0^0 & \beta_1^0 & \beta_2^0 & \cdots \end{array}$$

The asymptotic couple $(\Gamma_\diamond, \psi_\diamond)$ has asymptotic integration since each (Γ_k, ψ_k) has asymptotic integration. Furthermore, $\beta_0 = \beta_0^0 > \Psi$ by Lemma 4.10. Also $s(\beta_l) = \beta_{l+1}$ for all $l \in \mathbb{Z}$. Indeed, if $l \geq 0$, then this is evident already in (Γ_0, ψ_0) . If $l < 0$, then this can be observed in (Γ_{-l}, ψ_{-l}) as $s(\beta_0^{-l}) = \beta_1^{-l}$.

Next, suppose $i : (\Gamma, \psi) \rightarrow (\Gamma^*, \psi^*)$ is an embedding into a divisible H -asymptotic couple with asymptotic integration and there is a family $(\beta_k^*)_{k \in \mathbb{Z}}$ in Ψ^* with $i(\Psi) < \beta_0^*$ and $s(\beta_k^*) = \beta_{k+1}^*$ for all k . Since $si(\Psi) \subseteq i(\Psi)$, it follows that $i(\Psi) < \beta_k^*$ for all $k \in \mathbb{Z}$. Define the auxiliary $(\alpha_k^*)_{k \in \mathbb{Z}}$ in Γ^* by $\alpha_k^* := \int \beta_{k-1}^*$. Then we have $\psi(\alpha_k^*) = \beta_k^*$.

Next, for each $k \geq 0$, let $i_k : (\Gamma_k, \psi_k) \rightarrow (\Gamma^*, \psi^*)$ be the embedding given by Lemma 4.10 with $i_k(\alpha_0^k) = \alpha_{-k}^*$.

$$\begin{array}{ccc} (\Gamma_k, \psi_k) & \xrightarrow{i_k} & (\Gamma^*, \psi^*) \\ \uparrow & \nearrow & \\ (\Gamma, \psi) & & \end{array}$$

In order to show that this embedding extends to an embedding of $(\Gamma_\diamond, \psi_\diamond)$, we must show that $i_k \subseteq i_{k+1}$. It suffices to prove that $i_{k+1}(\beta_0^k) = i_k(\beta_0^k)$ and $i_{k+1}(\alpha_l^k) = i_k(\alpha_l^k)$ for all $l \geq 0$ which follows from a relatively straightforward diagram chase. Thus we get an embedding $j = \cup_k i_k : (\Gamma_\diamond, \psi_\diamond) \rightarrow (\Gamma^*, \psi^*)$.

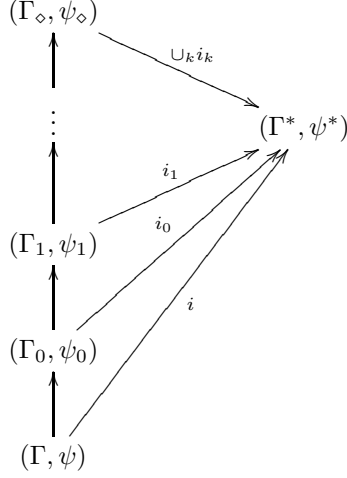

It remains to prove uniqueness of j . Suppose $j' : (\Gamma_\diamond, \psi_\diamond) \rightarrow (\Gamma^*, \psi^*)$ is an arbitrary embedding such that $j'(\beta_k) = \beta_k^*$ for all $k \in \mathbb{Z}$. It suffices to show that $j'|_{\Gamma_k} = i_k$ for all $k \geq 0$. I.e., $j'(\alpha_{-k}) = j'(\alpha_0^k) = i_k(\alpha_0^k) = \alpha_{-k}^*$. Integrating the expression $j'(\beta_{k-1}) = \beta_{k-1}^*$ yields

$$\alpha_k^* = \int j'(\beta_{k-1}) = j'(\int \beta_{k-1}) = j'(\alpha_k). \quad \square$$

The following lemma allows us to insert a “copy of \mathbb{Z} ” into the middle or bottom of the Ψ -set of a divisible H -asymptotic couple with asymptotic integration in a canonical way. This *was* the most tricky of the new embedding lemmas (4.8, 4.10, 4.11, 4.12) to establish; the decisive point in the proof is to pick an element $a^* \in \Psi \setminus B$ and use it as in that proof.

Lemma 4.12. Suppose (Γ, ψ) is an H -asymptotic couple with asymptotic integration and Γ is divisible. Let B be a nonempty downward closed subset of Ψ such that $s(B) \subseteq B$ and $B \neq \Psi$. Then there is a divisible H -asymptotic couple $(\Gamma_B, \psi_B) \supseteq (\Gamma, \psi)$ with a family $(\beta_k)_{k \in \mathbb{Z}}$ in Ψ_B satisfying the following conditions:

- (1) (Γ_B, ψ_B) has asymptotic integration;
- (2) $B < \beta_k < \Gamma^{>B}$, and $s(\beta_k) = \beta_{k+1}$ for all k ;
- (3) for any embedding $i : (\Gamma, \psi) \rightarrow (\Gamma^*, \psi^*)$ into a divisible H -asymptotic couple with asymptotic integration and any family $(\beta_k^*)_{k \in \mathbb{Z}}$ in Ψ^* such that $i(B) < \beta_k^* < i(\Gamma^{>B})$ and $s(\beta_k^*) = \beta_{k+1}^*$ for all k , there is a unique extension of i to an embedding $(\Gamma_B, \psi_B) \rightarrow (\Gamma^*, \psi^*)$ sending β_k to β_k^* for all k .

Proof. To motivate the construction of (Γ_B, ψ_B) as required, suppose $(\Gamma_B, \psi_B) \supseteq (\Gamma, \psi)$ is an H -asymptotic couple with asymptotic integration and $(\beta_k)_{k \in \mathbb{Z}}$ a family in Ψ_B such that $B < \beta_k < \Gamma^{>B}$ and $s(\beta_k) = \beta_{k+1}$ for all k . Fix any $a^* \in \Psi \setminus B$. Let $k \in \mathbb{Z}$ and note that by Corollary 3.4,

$$\psi_B(a^* - \beta_k) = s(\beta_k) = \beta_{k+1}.$$

Therefore setting $\alpha_k := \beta_{k-1} - a^*$, we have $\psi_B(\alpha_k) = \beta_k$. Then $\alpha_k < 0$ and

$$[\gamma_1] < [\alpha_k] < [\alpha_{k+1}] < [\gamma_2]$$

whenever $\gamma_1, \gamma_2 \in \Gamma$ such that $\psi(\gamma_1) \in B$ and $\psi(\gamma_2) \in \Psi \setminus B$. Thus it follows that for $\gamma \in \Gamma$, $i_1 < \dots < i_n$ and $q_1, \dots, q_n \in \mathbb{Q}$, we have

$$\gamma + q_1 \alpha_{i_1} + \dots + q_n \alpha_{i_n} >_B 0 \iff \begin{cases} \gamma > 0 & \text{if } \psi(\gamma) \in B, \\ \gamma > 0 & \text{if } \psi(\gamma) \notin B \text{ and } n = 0, \\ q_1 < 0 & \text{if } \psi(\gamma) \notin B \text{ and } n \geq 1. \end{cases}$$

and the ψ_B -value of such an element is uniquely determined:

$$\psi_B(\gamma + q_1 \alpha_{i_1} + \dots + q_n \alpha_{i_n}) := \begin{cases} \psi(\gamma) & \text{if } \psi(\gamma) \in B, \\ \psi(\gamma) & \text{if } \psi(\gamma) \notin B \text{ and } n = 0, \\ \beta_{i_1} & \text{if } \psi(\gamma) \notin B \text{ and } n \geq 1. \end{cases}$$

Furthermore, note that $\alpha_k + \psi(\alpha_k) = \alpha_k + \beta_k = \alpha_k + a^* + \alpha_{k+1}$. Rearranging terms gives us $\beta_{k-1} = a_k + a^* = \alpha_k - \alpha_{k+1} + \psi(\alpha_k)$. Since $[\alpha_k] > [\alpha_{k+1}]$, it follows that $\psi(\alpha_k - \alpha_{k+1}) = \psi(\alpha_k)$. Thus $\int \beta_{k-1} = \alpha_k - \alpha_{k+1}$, and so $s(\beta_{k-1}) = \psi(\alpha_k - \alpha_{k+1}) = \psi(\alpha_k) = \beta_k$. Furthermore, $\int \psi(\alpha_k - \alpha_{k+1}) = \int \psi(\alpha_k) = \alpha_{k+1} - \alpha_{k+2}$ implies that $\chi(\alpha_k - \alpha_{k+1}) = \chi(\alpha_k) = \alpha_{k+1} - \alpha_{k+2}$. Here is a picture of what is going on:

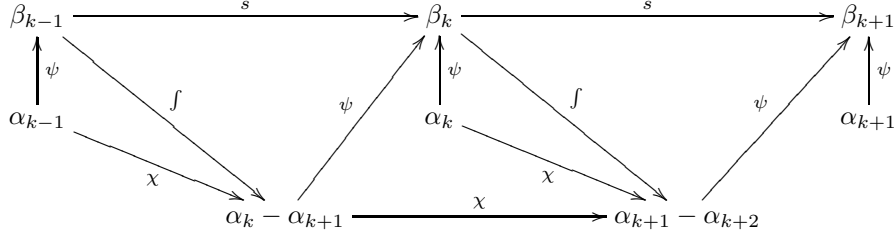

Next, to actually obtain (Γ_B, ψ_B) , by compactness we take an elementary extension (Γ_*, ψ_*) of (Γ, ψ) with a family $(\beta_k)_{k \in \mathbb{Z}}$ in Ψ_* such that $B < \beta_k < \Gamma^{>B}$ and $s(\beta_k) = \beta_{k+1}$ for all k . Take $a^* \in \Psi \setminus B$ and define $\alpha_k := \beta_{k-1} - a^*$. Set $\Gamma_B := \Gamma + \sum_k \mathbb{Q}\alpha_k$. By the above observations, $(\Gamma_B, \psi_*|_{\Gamma_B})$ is a divisible H -asymptotic couple with the desired properties. \square

Note that it follows from the proof of Lemma 4.12 that $\Psi_B = \Psi \cup \{\beta_k : k \in \mathbb{Z}\}$.

Lemma 4.13. Let $i : \Gamma \rightarrow G$ be an embedding of divisible ordered abelian groups inducing a bijection $[\Gamma] \rightarrow [G]$. Then there is a unique function $\psi_G : G^\neq \rightarrow G$ such that (G, ψ_G) is an H -asymptotic couple and $i : (\Gamma, \psi) \rightarrow (G, \psi_G)$ is an embedding.

Proof. [AvdD02, Lemma 2.14]. \square

Lemma 4.14. Suppose $(\Gamma_0, \psi_0) \subseteq (\Gamma_1, \psi_1)$ and (Γ^*, ψ^*) are divisible H -asymptotic couples, $i : (\Gamma_0, \psi_0) \rightarrow (\Gamma^*, \psi^*)$ is an embedding and $j : \Gamma_1 \rightarrow \Gamma^*$ is an ordered group embedding. Furthermore, suppose that $i = j|_{\Gamma_0}$ and $[\Gamma_0] = [\Gamma_1]$. Then j is also an embedding of asymptotic couples, i.e., $j(\psi_1(\gamma)) = \psi^*(j(\gamma))$ for all $\gamma \in \Gamma_1^\neq$.

Proof. Let $\gamma \in \Gamma_1^\neq$. Since $[\Gamma_0] = [\Gamma_1]$, there is $\gamma_0 \in \Gamma_0^\neq$ such that $[\gamma] = [\gamma_0]$. By HC $\psi_1(\gamma) = \psi_1(\gamma_0)$ and so $j(\psi_1(\gamma)) = j(\psi_1(\gamma_0)) = i(\psi_0(\gamma_0))$. Since j is an ordered group embedding, it also follows that $[j(\gamma)] = [i(\gamma_0)]$ in $[\Gamma^*]$. Thus $\psi^*(j(\gamma)) = \psi^*(i(\gamma_0))$. Since i is an embedding of asymptotic couples, $i(\psi_0(\gamma_0)) = \psi^*(i(\gamma_0))$ and we are done. \square

5. THE THEORY T_{\log}

Let L_0 be the “natural” language of asymptotic couples; $L_0 = \{0, +, -, <, \psi, \infty\}$ where $0, \infty$ are constant symbols, $+$ is a binary function symbol, $-$ and ψ are unary function symbols and $<$ is a binary relation symbol. We consider an asymptotic couple (Γ, ψ) as an L_0 -structure with underlying set Γ_∞ and the obvious interpretation of the symbols of L_0 , with ∞ as a default value:

$$-\infty = \gamma + \infty = \infty + \gamma = \infty + \infty = \psi(0) = \psi(\infty) = \infty$$

for all $\gamma \in \Gamma$.

Let T_0 be the L_0 -theory whose models are the divisible H -asymptotic couples with asymptotic integration such that

- Ψ as an ordered subset of Γ has a least element $s_0 > 0$,
- Ψ as an ordered subset of Γ is a successor set and each $\alpha \in \Psi$ has immediate successor $s\alpha$, and
- $\gamma \mapsto s\gamma : \Psi \rightarrow \Psi^{>s_0}$ is a bijection.

It is clear that (Γ_{\log}, ψ) and $(\Gamma_{\log}^{\mathbb{Q}}, \psi)$ are models of T_0 . For a model (Γ, ψ) of T_0 , we define the function $p : \Psi^{>s_0} \rightarrow \Psi$ to be the inverse to the function $\gamma \mapsto s\gamma : \Psi \rightarrow \Psi^{>s_0}$. We extend p to a function $\Gamma_\infty \rightarrow \Gamma_\infty$ by setting $p(\alpha) := \infty$ for $\alpha \in \Gamma_\infty \setminus \Psi^{>s_0}$.

Next let $L = L_0 \cup \{s, p, \delta_1, \delta_2, \delta_3, \dots\}$ where s, p and δ_n for $n \geq 1$ are unary function symbols. All models of T_0 are considered as L -structures in the obvious way, again with ∞ as a default value, and with δ_n interpreted as division by n .

We let T_{\log} be the L -theory whose models are the models of T_0 . By adding function symbols $s, p, \delta_1, \delta_2, \dots$ we have guaranteed the following:

Lemma 5.1. T_{\log} has a universal axiomatization.

Since T_{\log} has a universal axiomatization, if $(\Gamma_1, \psi_1) \models T_{\log}$ and (Γ_0, ψ_0) is an L -substructure of (Γ_1, ψ_1) , then $(\Gamma_0, \psi_0) \models T_{\log}$. This fact is very convenient for our proof of Quantifier Elimination in Theorem 5.2 below. In Theorem 5.2, we actually prove an algebraic variant of Quantifier Elimination, which is indeed equivalent to Quantifier Elimination in the presence of a universal axiomatization. See [Mar02, Prop 4.3.28] or [AvdDvdH15, Prop B.11.14] for details of this equivalence.

Theorem 5.2 (Quantifier Elimination for T_{\log}). Suppose that $(\Gamma_0, \psi_0) \subsetneq (\Gamma_1, \psi_1)$ and (Γ^*, ψ^*) are models of T_{\log} such that (Γ^*, ψ^*) is $|\Gamma_1|^+$ -saturated, and $i : (\Gamma_0, \psi_0) \rightarrow (\Gamma^*, \psi^*)$ is an embedding of L -structures. Then there is an element $\alpha \in \Gamma_1 \setminus \Gamma_0$ such that i extends to an embedding $(\Gamma, \psi) \rightarrow (\Gamma^*, \psi^*)$ where $(\Gamma_0, \psi_0) \subseteq (\Gamma, \psi) \subseteq (\Gamma_1, \psi_1)$ and $\alpha \in \Gamma$.

Proof. The general picture to keep in mind for this proof is the following:

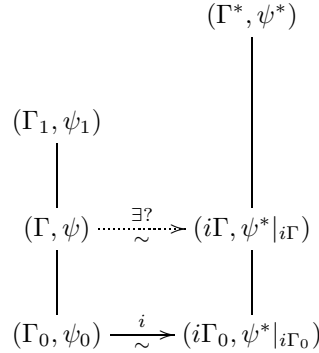

Let $\Psi_1 := \psi_1(\Gamma_1^\neq)$, $\Psi_0 := \psi_0(\Gamma_0^\neq)$ and $\Psi^* := \psi^*((\Gamma^*)^\neq)$. Note that $\Psi_0 \subseteq \Psi_1$. The first two cases deal with the situation that $\Psi_0 \neq \Psi_1$.

Case 1: there is $\beta \in \Psi_1 \setminus \Psi_0$ such that $\Psi_0 < \beta$. Take such β , and define the family $(\beta_k)_{k \in \mathbb{Z}}$ by $\beta_0 := \beta$, $\beta_n := s^n \beta$ and $\beta_{-n} := p^n \beta$. Note that $s\beta_k = \beta_{k+1}$ for all $k \in \mathbb{Z}$. By Lemma 4.11 we may assume that $(\Gamma_0, \psi_0) \subseteq (\Gamma_\diamond, \psi_\diamond) \subseteq (\Gamma_1, \psi_1)$ with $\beta \in \Gamma_\diamond$. By saturation of (Γ^*, ψ^*) , there is a family $(\beta_k^*)_{k \in \mathbb{Z}}$ in Γ^* such that $i(\Psi_0) < \beta_0^*$ and $s(\beta_k^*) = \beta_{k+1}^*$ for all $k \in \mathbb{Z}$. Thus there is a unique extension of i to an embedding $(\Gamma_\diamond, \psi_\diamond) \rightarrow (\Gamma^*, \psi^*)$ sending β_k to β_k^* for all $k \in \mathbb{Z}$.

Case 2: $\Psi_1 \neq \Psi_0$ and we are not in Case 1. Take $\beta_0 \in \Psi_1 \setminus \Psi_0$, and define the set $B := \{\alpha \in \Psi_0 : \alpha < \beta_0\}$. Note that $s(B) \subseteq B$. Also define the family $(\beta_k)_{k \in \mathbb{Z}}$ such that $\beta_n = s^n(\beta_0)$ and $\beta_{-n} = p^n(\beta_0)$ for $n > 0$. Note that $B < \beta_k < \Gamma_0^{>B}$ and $s(\beta_k) = \beta_{k+1}$ for all $k \in \mathbb{Z}$. Thus by Lemma 4.12 we may assume that $(\Gamma_0, \psi_0) \subseteq (\Gamma_{0,B}, \psi_{0,B}) \subseteq (\Gamma_1, \psi_1)$. Again, by Lemma 4.12 and saturation of (Γ^*, ψ^*) , there is a family $(\beta_k^*)_{k \in \mathbb{Z}}$ in Γ^* such that $i(B) < \beta_0^* < i(\Gamma_0^{>B})$ and $s\beta_k^* = \beta_{k+1}^*$, and so there is a unique extension of $i : (\Gamma_0, \psi_0) \rightarrow (\Gamma^*, \psi^*)$ to an embedding $(\Gamma_{0,B}, \psi_{0,B}) \rightarrow (\Gamma^*, \psi^*)$ that sends β_k to β_k^* for all $k \in \mathbb{Z}$.

Case 3: $\Psi_0 = \Psi_1$ but $[\Gamma_0] \neq [\Gamma_1]$. Take some $\alpha \in \Gamma_1$ such that $[\alpha] \notin [\Gamma_0]$. Let $\beta = \psi_1(\alpha) \in \Gamma_0$. Define C to be the cut in $[\Gamma_0]$ which is realized by $[\alpha]$ in $[\Gamma_1]$. By Lemma 4.6 there is an asymptotic couple $(\Gamma, \psi) = (\Gamma_0 + \mathbb{Q}\alpha, \psi_1|_{\Gamma_0 + \mathbb{Q}\alpha})$ extending (Γ_0, ψ_0) inside (Γ_1, ψ_1) and by saturation of (Γ^*, ψ^*) , the embedding i extends to an embedding $(\Gamma, \psi) \rightarrow (\Gamma^*, \psi^*)$.

Case 4: $[\Gamma_0] = [\Gamma_1]$ (and thus $\Psi_0 = \Psi_1$ by HC). By Quantifier Elimination for ordered divisible abelian groups, we get an extension $j : \Gamma_1 \rightarrow \Gamma^*$ of i as an embedding of ordered abelian groups:

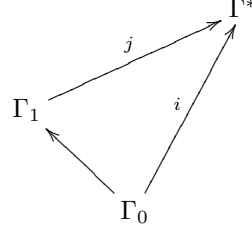

By Lemma 4.14, j is actually an embedding of asymptotic couples. Since $\Psi_0 = \Psi_1$ and i is an embedding of L -structures, it follows that in fact j also is an embedding of L -structures. \square

In the next corollary we collect the usual consequences of a quantifier elimination result:

Corollary 5.3. T_{\log} and T_0 are complete, decidable and model complete.

Proof. Model completeness of T_{\log} follows immediately from quantifier elimination, and completeness follows from the observation in Example 4.9 that $(\Gamma_{\log}^{\mathbb{Q}}, \psi)$ embeds into every model of T_{\log} .

For model completeness of T_0 , assume that (Γ, ψ) is a model of T_0 . Then it suffices to show that the graphs of the functions $s, p, \delta_1, \delta_2, \dots$ in (Γ, ψ) are existentially definable. For the δ_n 's we actually have quantifier-free definitions:

$$\delta_n(\alpha) = \beta : \iff n\beta = \alpha$$

Furthermore, by the Fixed Point Identity, Lemma 3.7, we also get a quantifier-free definition for the function s :

$$s(\alpha) = \beta : \iff (\alpha \neq \infty \wedge \beta = \psi(\alpha - \beta)) \vee (\alpha = \beta = \infty)$$

It remains to obtain an existential definition for the graph of the function p . We can define the graph of p as follows:

$$p(\alpha) = \beta : \iff \begin{aligned} &(\beta \in \Psi \wedge s(\beta) = \alpha) \vee \\ &(\beta = \infty \wedge \alpha \in \Gamma_{\infty} \setminus \Psi^{>s_0}) \end{aligned}$$

If $\alpha \in \Gamma_{\infty} \setminus \Psi^{>s_0}$, this can happen in one of four (not necessarily mutually exclusive) ways:

- (1) $\alpha = \infty$
- (2) $\alpha \in (\Gamma^{>})'$
- (3) $\alpha < s^2(0)$
- (4) there is a $\gamma \in \Gamma$ such that $\gamma^{\dagger} \neq \alpha$ and $s(\alpha) = s(\gamma^{\dagger})$.

Thus we have the following existential definition for the graph of the function p :

$$p(\alpha) = \beta : \iff \exists \gamma \text{ such that :} \\ \begin{aligned} &(\gamma \neq 0 \wedge \beta = \gamma^{\dagger} \wedge s(\beta) = \alpha) \text{ or} \\ &(\beta = \infty \wedge \alpha = \infty) \text{ or} \\ &(\beta = \infty \wedge \gamma > 0 \wedge \alpha = \gamma') \text{ or} \\ &(\beta = \infty \wedge \alpha < s^2(0)) \text{ or} \\ &(\beta = \infty \wedge \gamma \neq 0 \wedge \gamma^{\dagger} \neq \alpha \wedge s(\alpha) = s(\gamma^{\dagger})) \end{aligned}$$

Completeness for T_0 follows from model completeness the same way it does for T_{\log} .

Decidability for both theories follows from completeness and the fact that these theories are formulated in recursive languages (a finite language in the case of T_0) and that they have recursively enumerable axiomatizations. \square

Example 5.4. Below are some quantifier free definitions of several definable sets in models of T_{\log} .

- The set Ψ can be defined by the formula:

$$x = p(s(x))$$

- The set $(\Psi - \Psi)^{>0} := \{\alpha_1 - \alpha_2 : \alpha_1, \alpha_2 \in \Psi \text{ and } \alpha_1 > \alpha_2\}$ can be defined by the formula:

$$x = -p(\psi(x)) + p(s(-(x - p(\psi(x)))))) \wedge x \neq \infty$$

It is left as an exercise to the reader to verify that this last formula does indeed define the set $(\Psi - \Psi)^{>0}$. (Hint: Use results from Section 6).

6. DEFINABLE FUNCTIONS ON Ψ

For a (first-order) language L and an L -structure \mathcal{M} with underlying set M , we say that a set $D \subseteq M^m$ is **definable** if it is “definable with parameters”. I.e., there is some L -formula $\varphi(x_1, \dots, x_m, y_1, \dots, y_n)$ and tuple $b = (b_1, \dots, b_n) \in M^n$ such that

$$D = \{a \in M^m : \mathcal{M} \models \varphi(a, b)\}.$$

Given $A \subseteq M$, a subset of M^m is **definable over A** if the parameter b above can be taken from A^n . A function $X \rightarrow M^n$ ($X \subseteq M^m$) is definable (over A) if its graph is definable (over A).

In this section, we assume that $(\Gamma, \psi) \models T_{\log}$.

Definition 6.1. For $k < 0$ and $x \in \Psi$, we set $s^k(x) := p^{-k}(x) \in \Psi_\infty$. Also, $s^0(x) := x$ for all $x \in \Psi$. A function $F : \Psi \rightarrow \Gamma_\infty$ is an **s -function** if it is constant, or there are $n \geq 1, k_1 < \dots < k_n$ in $\mathbb{Z}, q_1, \dots, q_n \in \mathbb{Q}^\neq$ and $\beta \in \Gamma$ such that $F(x) = \sum_{j=1}^n q_j s^{k_j}(x) - \beta$ for all $x \in \Psi$.

For an s -function $F(x) = \sum_{j=1}^n q_j s^{k_j}(x) - \beta$ as above with $n \geq 1$, define the set $D_F \subseteq \Psi$ to be

$$D_F = \begin{cases} [s^{-k_1+1}0, \infty)_\Psi & \text{if } k_1 < 0 \\ \Psi & \text{if } k_1 \geq 0 \end{cases}$$

and the set $I_F \subseteq \Psi$ to be $\Psi \setminus D_F$.

Note that $I_F < D_F$, and $I_F \cup D_F = \Psi$. Furthermore, F takes the constant value ∞ on I_F and takes only values in Γ on D_F . It is also useful to note that for $x \in D_F$ and $l \in \mathbb{Z}$, if $l \geq k_1$, then $s^l(x) \in \Psi$.

By convention, if we refer to an s -function $F(x) = \sum_{j=1}^n q_j s^{k_j}(x) - \beta$, it is understood that $n \geq 1, k_1 < \dots < k_n$ in $\mathbb{Z}, q_1, \dots, q_n \in \mathbb{Q}^\neq$, and $\beta \in \Gamma$.

In general, the s -functions are rather well-behaved. To begin with, we get the following:

Lemma 6.2. Let $F : \Psi \rightarrow \Gamma_\infty$ be the s -function $F(x) = \sum_{j=1}^n q_j s^{k_j}(x) - \beta$. If $q_1 > 0$, then F is strictly increasing on D_F , otherwise F is strictly decreasing on D_F . In particular, the restriction of F to D_F is injective. Furthermore, if F changes sign on D_F , then there is $\alpha \in D_F$ such that $\text{sign}(F(\alpha)) \neq \text{sign}(F(s\alpha))$.

Proof. Let $\alpha_0, \alpha_1 \in D_F$ be such that $\alpha_0 < \alpha_1$. Then

$$F(\alpha_1) - F(\alpha_0) = q_1(s^{k_1}\alpha_1 - s^{k_1}\alpha_0) + q_2(s^{k_2}\alpha_1 - s^{k_2}\alpha_0) + \dots + q_n(s^{k_n}\alpha_1 - s^{k_n}\alpha_0).$$

By Lemma 3.4, we compute $\psi(s^{k_j}\alpha_1 - s^{k_j}\alpha_0) = s^{k_j+1}\alpha_0$ for $j = 1, \dots, n$, and thus

$$[s^{k_1}\alpha_1 - s^{k_1}\alpha_0] > [s^{k_2}\alpha_1 - s^{k_2}\alpha_0] > \dots > [s^{k_n}\alpha_1 - s^{k_n}\alpha_0].$$

Since $s^{k_1}\alpha_1 > s^{k_1}\alpha_0$, we get that

$$\text{sign}(F(\alpha_1) - F(\alpha_0)) = \text{sign}(q_1).$$

The second statement follows from an appeal to completeness of T_{\log} and the observation that it is obviously true in $(\Gamma_{\log}^{\mathbb{Q}}, \psi)$. \square

The following theorem is the main result of this section. It says that all definable functions $\Psi \rightarrow \Gamma_\infty$ are given piecewise by s -functions.

Theorem 6.3. Let $F : \Psi \rightarrow \Gamma_\infty$ be a definable function. Then there is an increasing sequence $s0 = \alpha_0 < \alpha_1 < \dots < \alpha_{n-1} < \alpha_n = \infty$ in Ψ_∞ such that for $k = 0, \dots, n-1$, the restriction of F to $[\alpha_k, \alpha_{k+1})_\Psi$ is given by an s -function.

We first prove that for an s -function $F(x)$, the compositions $\psi(F(x))$, $s(F(x))$ are given piecewise by s -functions.

The following lemma is a step in this direction.

Lemma 6.4. Let $n \geq 1$, $\alpha_1 < \dots < \alpha_n \in \Psi$, and let $\alpha = \sum_{j=1}^n q_j \alpha_j$ for $q_1, \dots, q_n \in \mathbb{Q}^\neq$. Then

- (1) $\sum_{j=1}^n q_j = 0 \implies \psi(\alpha) = s(\alpha_1)$,
- (2) $\sum_{j=1}^n q_j \neq 0 \implies \psi(\alpha) = s0$.

Proof. By completeness of T_{\log} , the lemma will follow from its validity for the case $(\Gamma, \psi) = (\Gamma_{\log}^{\mathbb{Q}}, \psi)$. In $(\Gamma_{\log}^{\mathbb{Q}}, \psi)$, we may take integers $0 \leq m_1 < \dots < m_n$ such that $\alpha_j = \sum_{i=0}^{m_j} e_i$, for $j = 1, \dots, n$. Then

$$\alpha = \sum_{j=1}^n q_j \left(\sum_{i=0}^{m_j} e_i \right) = \sum_{i=0}^{m_1} \left(\sum_{j=1}^n q_j \right) e_i + \sum_{i=m_1+1}^{m_2} \left(\sum_{j=2}^n q_j \right) e_i + \dots + \sum_{i=m_{n-1}+1}^{m_n} q_n e_i,$$

i.e., as an infinite tuple, α has the form:

$$\alpha = \left(\underbrace{\sum_{j=1}^n q_j, \dots, \sum_{j=1}^n q_j}_{m_1+1}, \underbrace{\sum_{j=2}^n q_j, \dots, \sum_{j=2}^n q_j}_{m_2-m_1}, \dots \right).$$

From this it is clear that if $\sum_{j=1}^n q_j \neq 0$, then $\psi(\alpha) = e_0 = s0$. Otherwise, if $\sum_{j=1}^n q_j = 0$, then $q_1 = -\sum_{j=2}^n q_j \neq 0$ and so

$$\psi(\alpha) = \sum_{i=1}^{m_1+1} e_i = \alpha_1 + e_{m_1+1} = s(\alpha_1). \quad \square$$

The Fixed Point Identity (Lemma 3.7) which relates ψ and s immediately gives us an s -analogue of Lemma 6.4.

Corollary 6.5. Let $n \geq 1$, $\alpha_1 < \dots < \alpha_n \in \Psi$, and let $\alpha = \sum_{j=1}^n q_j \alpha_j$ for $q_1, \dots, q_n \in \mathbb{Q}^\neq$. Then

- (1) $\sum_{j=1}^n q_j \neq 1 \implies s(\alpha) = s0$,
- (2) $\sum_{j=1}^n q_j = 1 \implies s(\alpha) = s(\alpha_1)$.

Proof. Suppose that $\sum_{j=1}^n q_j \neq 1$. Then $\sum_{j=1}^n q_j - 1 \neq 0$, so by Lemma 6.4, $\psi(\alpha - s0) = s0$. Thus $s\alpha = s0$ by Lemma 3.7.

Next, suppose that $\sum_{j=1}^n q_j = 1$. Then $\sum_{j=1}^n q_j - 1 = 0$, so by Lemma 6.4, $\psi(\alpha - s\alpha_1) = s\alpha_1$. Thus $s\alpha = s\alpha_1$ by Lemma 3.7. \square

In Theorem 6.6 below we give an explicit description of how compositions $\psi(F(x))$ behave in all possible cases.

Theorem 6.6. Let $F : \Psi \rightarrow \Gamma_\infty$ be the s -function $F(x) = \sum_{j=1}^n q_j s^{k_j}(x) - \beta$. Define the function $G : \Psi \rightarrow \Gamma_\infty$ by $G(x) = \psi(F(x))$. If $x \in I_F$, then $G(x) = \infty$. Otherwise, if $x \in D_F$, then the values $G(x)$ are given in the following table (with $q := \sum_{j=1}^n q_j$):

β	$G(x) = \psi(\sum_{j=1}^n q_j s^{k_j}(x) - \beta)$ (assuming $x \in D_F$)
if $\psi(\beta) > s0$	$G(x) = \begin{cases} s0 & \text{if } q \neq 0 \\ s^{k_1+1}(x) & \text{if } q = 0 \text{ and } s^{k_1+1}(x) < \psi(\beta) \\ G(s^{-k_1-1}(\psi(\beta))) & \text{if } q = 0 \text{ and } s^{k_1+1}(x) = \psi(\beta) \\ \psi(\beta) & \text{if } q = 0 \text{ and } s^{k_1+1}(x) > \psi(\beta) \end{cases}$
if $\psi(\beta) = s0$	$G(x) = \begin{cases} G(s^{-k_1} s0) & \text{if } s^{k_1}(x) = s0 \\ s0 & \text{if } s^{k_1}(x) > s0 \text{ and } q = 0 \\ s^{k_1+1}(x) & \text{if } s^{k_1}(x) > s0, q \neq 0, \text{ and } s^{k_1+1}(x) < s(q^{-1}\beta) \\ G(s^{-k_1-1} s(q^{-1}\beta)) & \text{if } s^{k_1}(x) > s0, q \neq 0, \text{ and } s^{k_1+1}(x) = s(q^{-1}\beta) \\ s(q^{-1}\beta) & \text{if } s^{k_1}(x) > s0, q \neq 0, \text{ and } s^{k_1+1}(x) > s(q^{-1}\beta) \end{cases}$

Proof. In the third, fifth and eighth cases in the table the computation is immediate since we are able to solve for x in terms of β . For example, in the third case the assumption $s^{k_1+1}(x) = \psi(\beta)$ implies that $x = s^{-k_1-1}(\psi(\beta))$ and so the function takes the value $G(s^{-k_1-1}(\psi(\beta)))$.

Otherwise, the idea is to do a computation of the form $\psi(\alpha - \beta)$ where $\alpha = \sum_{j=1}^n q_j s^{k_j}(x)$. In the first, second, fourth and fifth cases, we can compute the ψ -value of α by Lemma 6.4 and the assumptions are such that the ψ -values of α and β will be different so the ψ -value of their difference is immediate from Fact 2.1.

For the seventh and ninth case, we have to compute

$$\psi\left(\underbrace{q_1 s^{k_1}(x) + \dots + q_n s^{k_n}(x)}_{\alpha} - \beta\right)$$

where by assumption $\psi(\beta) = \psi(\alpha) = s0$ since $q \neq 0$. Using (AC2), we can pivot to a situation where we can use Lemma 3.4 and Corollary 6.5 to do the computation. I.e., by dividing by q we reduce to computing

$$\psi\left(\underbrace{q^{-1}(q_1 s^{k_1}(x) + \dots + q_n s^{k_n}(x))}_{q^{-1}\alpha} - q^{-1}\beta\right).$$

By Corollary 6.5, we know that $s(q^{-1}\alpha) = s^{k_1+1}(x)$. Our assumptions in cases seven and nine say precisely that the s -values of $q^{-1}\alpha$ and $q^{-1}\beta$ are different. From that point, it suffices to just use Lemma 3.4. \square

Corollary 3.5 allows us to easily transform Theorem 6.6 into an s -analogue. In the proof of Corollary 6.7 below we perform this transformation.

Corollary 6.7. Let $F : \Psi \rightarrow \Gamma_\infty$ be the s -function $F(x) = \sum_{j=1}^n q_j s^{k_j}(x) - \beta$. Define the function $G : \Psi \rightarrow \Gamma_\infty$ by $G(x) = s(F(x))$. If $x \in I_F$, then $G(x) = \infty$. Otherwise, if $x \in D_F$, then the values $G(x)$ are given in the following table:

β	$G(x) = s(\sum_{j=1}^n q_j s^{k_j}(x) - \beta)$ (assuming $x \in D_F$)
if $s(-\beta) > s0$	$G(x) = \begin{cases} s0 & \text{if } q \neq 0 \\ s^{k_1+1}(x) & \text{if } q = 0 \text{ and } s^{k_1+1}(x) < s(-\beta) \\ G(s^{-k_1-1}(s(-\beta))) & \text{if } q = 0 \text{ and } s^{k_1+1}(x) = s(-\beta) \\ s(-\beta) & \text{if } q = 0 \text{ and } s^{k_1+1}(x) > s(-\beta) \end{cases}$
if $s(-\beta) = s0$	$G(x) = \begin{cases} G(s^{-k_1} s0) & \text{if } s^{k_1}(x) = s0 \\ s0 & \text{if } s^{k_1}(x) > s0 \text{ and } q = 0 \\ s^{k_1+1}(x) & \text{if } s^{k_1}(x) > s0, q \neq 0 \text{ and } s^{k_1+1}(x) < \gamma_0 \\ G(s^{-k_1-1} \gamma_0) & \text{if } s^{k_1}(x) > s0, q \neq 0 \text{ and } s^{k_1+1}(x) = \gamma_0 \\ \gamma_0 & \text{if } s^{k_1}(x) > s0, q \neq 0 \text{ and } s^{k_1+1}(x) > \gamma_0 \end{cases}$

where $q := \sum_{j=1}^n q_j$ and for $q \neq 0$,

$$\gamma_0 := \begin{cases} s0 & \text{if } \beta = 0, q \neq 1 \\ \infty & \text{if } \beta = 0, q = 1 \\ s\left(\frac{1}{1-q}\beta\right) & \text{if } \beta \neq 0, q \neq 1 \\ \psi(\beta) & \text{if } \beta \neq 0, q = 1. \end{cases}$$

Proof. It is clear that if $x \in I_F$, then $s^{k_1}(x) = \infty$ and so $G(x) = \infty$ as a result. Thus, from now on we will assume that $x \in D_F$ and we think of D_F as a fixed subset of the Ψ -set of Γ . Next we will take an elementary extension (Γ', ψ) of (Γ, ψ) with an element $\gamma \in \Psi_{\Gamma'}$ such that $\gamma > \Psi$. Now, if we take the table from Theorem 6.6, but we replace β with $\beta + \gamma$ and have x range over $D_F \subseteq \Gamma$, then we get the following table, computed in (Γ', ψ) :

β	$G(x) = \psi(\sum_{j=1}^n q_j s^{k_j}(x) - \beta - \gamma)$ (assuming $x \in D_F \subseteq \Gamma$)
if $\psi(\beta + \gamma) > s0$	$G(x) = \begin{cases} s0 & \text{if } q \neq 0 \\ s^{k_1+1}(x) & \text{if } q = 0 \text{ and } s^{k_1+1}(x) < \psi(\beta + \gamma) \\ G(s^{-k_1-1}(\psi(\beta + \gamma))) & \text{if } q = 0 \text{ and } s^{k_1+1}(x) = \psi(\beta + \gamma) \\ \psi(\beta + \gamma) & \text{if } q = 0 \text{ and } s^{k_1+1}(x) > \psi(\beta + \gamma) \end{cases}$
if $\psi(\beta + \gamma) = s0$	$G(x) = \begin{cases} G(s^{-k_1} s0) & \text{if } s^{k_1}(x) = s0 \\ s0 & \text{if } s^{k_1}(x) > s0 \text{ and } q = 0 \\ s^{k_1+1}(x) & \text{if } s^{k_1}(x) > s0, q \neq 0, \text{ and } s^{k_1+1}(x) < s(q^{-1}(\beta + \gamma)) \\ G(s^{-k_1-1} s(q^{-1}(\beta + \gamma))) & \text{if } s^{k_1}(x) > s0, q \neq 0, \text{ and } s^{k_1+1}(x) = s(q^{-1}(\beta + \gamma)) \\ s(q^{-1}(\beta + \gamma)) & \text{if } s^{k_1}(x) > s0, q \neq 0, \text{ and } s^{k_1+1}(x) > s(q^{-1}(\beta + \gamma)) \end{cases}$

Since we are assuming that $x \in D_F \subseteq \Gamma$, we can apply Corollary 3.5 to replace $\psi(\sum_{j=1}^n q_j s^{k_j}(x) - \beta - \gamma)$ with $s(\sum_{j=1}^n q_j s^{k_j}(x) - \beta)$ and also $\psi(\beta + \gamma) = \psi(-\beta - \gamma)$ with $s(-\beta)$. Finally, we set $\gamma_0 := s(q^{-1}(\beta + \gamma))$ when $q \neq 0$. This gives us the desired table:

β	$G(x) = s(\sum_{j=1}^n q_j s^{k_j}(x) - \beta)$ (assuming $x \in D_F \subseteq \Gamma$)
if $s(-\beta) > s0$	$G(x) = \begin{cases} s0 & \text{if } q \neq 0 \\ s^{k_1+1}(x) & \text{if } q = 0 \text{ and } s^{k_1+1}(x) < s(-\beta) \\ G(s^{-k_1-1}(s(-\beta))) & \text{if } q = 0 \text{ and } s^{k_1+1}(x) = s(-\beta) \\ s(-\beta) & \text{if } q = 0 \text{ and } s^{k_1+1}(x) > s(-\beta) \end{cases}$
if $s(-\beta) = s0$	$G(x) = \begin{cases} G(s^{-k_1} s0) & \text{if } s^{k_1}(x) = s0 \\ s0 & \text{if } s^{k_1}(x) > s0 \text{ and } q = 0 \\ s^{k_1+1}(x) & \text{if } s^{k_1}(x) > s0, q \neq 0, \text{ and } s^{k_1+1}(x) < \gamma_0 \\ G(s^{-k_1-1} \gamma_0) & \text{if } s^{k_1}(x) > s0, q \neq 0, \text{ and } s^{k_1+1}(x) = \gamma_0 \\ \gamma_0 & \text{if } s^{k_1}(x) > s0, q \neq 0, \text{ and } s^{k_1+1}(x) > \gamma_0 \end{cases}$

However we are not done yet; currently γ_0 is still an external parameter. We will show (or arrange) that $\gamma_0 \in \Psi_\infty$ (and give an explicit formula for it), which will then yield the corollary. First, we assume that $\beta = 0$. If $q \neq 1$, then $\gamma_0 = s(q^{-1}\gamma) = s0$ by Corollary 6.5. If $q = 1$, then $\gamma_0 = s(\gamma) > \Psi$ and so $\gamma_0 \notin \Gamma$. However, in this case, $s^{k_1+1}(x) \star \gamma_0$ iff $s^{k_1+1}(x) \star \infty$ for $\star \in \{<, =, >\}$ because $s^{k_1+1}(x) \in \Psi$ and both $s(\gamma)$ and ∞ are $> \Psi$. Thus we redefine $\gamma_0 := \infty$ if $\beta = 0$ and $q = 1$. Now we assume that $\beta \neq 0$ and we take yet another elementary extension (Γ'', ψ) of (Γ', ψ) with an element $\tilde{\gamma} \in \Psi_{\Gamma''}$ such that $\tilde{\gamma} > \Psi_{\Gamma'}$. If $q = 1$, then we have

$$\gamma_0 = s(\beta + \gamma) = \psi(\beta + \gamma - \tilde{\gamma}) = \psi(\beta)$$

by Fact 2.1 and Lemma 3.4 because $\psi(\gamma - \tilde{\gamma}) = s\gamma > \psi(\beta) \in \Psi$. Otherwise, assume that $q \neq 1$ (and thus $q^{-1} - 1 \neq 0$). Then we can multiply on the inside by $(q^{-1} - 1)^{-1}$ to compute

$$\gamma_0 = s(q^{-1}(\beta + \gamma)) = \psi(q^{-1}(\beta + \gamma) - \tilde{\gamma}) = \psi(q^{-1}\beta + q^{-1}\gamma - \tilde{\gamma}) = \psi\left(\frac{1}{1-q}\beta + \frac{q}{1-q}(q^{-1}\gamma - \tilde{\gamma})\right).$$

Next note that $s((1-q)^{-1}\beta) \in \Psi$ whereas $s(\frac{q}{1-q}(q^{-1}\gamma - \tilde{\gamma})) = s\gamma > \Psi$ by Corollary 6.5. Thus $\gamma_0 = s((1-q)^{-1}\beta)$ by Lemma 3.4. \square

Theorem 6.6 and Corollary 6.7 are the heart of the proof of Theorem 6.3. To round things out, we need to make a few more minor observations before proceeding with our proof of Theorem 6.3.

Lemma 6.8. Ψ is a linearly independent subset of Γ as a vector space over \mathbb{Q} .

Proof. Let $\alpha = \sum_{j=1}^n q_j \alpha_j$, $\alpha_1 < \dots < \alpha_n \in \Psi$ and $q_1, \dots, q_n \in \mathbb{Q}^\neq$. By Lemma 6.4, either $\psi(\alpha) = s0$, or $\psi(\alpha) = s\alpha_1$, and so $\alpha \neq 0$. \square

Lemma 6.9 below describes the values of an s -function in the set Ψ .

Lemma 6.9. Let an s -function $F(x) = \sum_{j=1}^n q_j s^{k_j}(x) - \beta$ be given and let F^* be its restriction to D_F . Then exactly one of the following is true:

- (1) $\text{image } F^* \subseteq \Psi$, $\beta = 0$, $n = 1$ and $q_1 = 1$,
- (2) $|(\text{image } F^*) \cap \Psi| = 2$,
- (3) $|(\text{image } F^*) \cap \Psi| = 1$,
- (4) $|(\text{image } F^*) \cap \Psi| = 0$.

Proof. If $\beta \notin \text{span}_{\mathbb{Q}} \Psi \subseteq \Gamma$, then $(\text{image } F^*) \cap \Psi = \emptyset$. Thus assume for the rest of the proof that

$$\beta = q'_1 \alpha_1 + \cdots + q'_m \alpha_m$$

for $\alpha_1 < \cdots < \alpha_m \in \Psi$ and $q'_1, \dots, q'_m \in \mathbb{Q}^\neq$.

The idea is that we are interested in which values of x will put the expression

$$\underbrace{q_1 s^{k_1}(x) + \cdots + q_n s^{k_n}(x)}_{\alpha(x)} - \underbrace{(q'_1 \alpha_1 + \cdots + q'_m \alpha_m)}_{\beta}$$

into the set Ψ . By the \mathbb{Q} -linear independence of Ψ , it is necessary that nearly all of the components of $\alpha(x)$ and β will cancel. We will do this by a case distinction.

If $m > n + 1$ or $m < n - 1$, then for all $x \in D_F$, the value of $F^*(x)$ will be a linear combination of two or more elements of Ψ with nonzero coefficients so $(\text{image } F^*) \cap \Psi = \emptyset$. Thus further assume that $n - 1 \leq m \leq n + 1$. If $m = 0$ (so $\beta = 0$), then $F^*(x) \in \Psi$ iff $n = 1$ and $q_1 = 1$, by the linear independence of Ψ . So further assume that $m > 0$. Now we look at three subcases:

(Case 1: $m = n - 1$, $m > 0$) In this case we can expand out $F^*(x)$ as follows:

$$F^*(x) = q_1 s^{k_1}(x) + \cdots + q_n s^{k_n}(x) - q'_1 \alpha_1 - \cdots - q'_{n-1} \alpha_{n-1}.$$

In order for $F^*(x)$ above to be an element of Ψ , it is necessary that either $s^{k_1}(x) = \alpha_1$ or $s^{k_n}(x) = \alpha_n$, otherwise the value of $F(x)$ will be a linear combination of two or more elements of Ψ . Thus $|(\text{image } F^*) \cap \Psi| \leq 2$ in this case.

(Case 2: $m = n + 1$, $m > 0$) This case is similar to Case 1 and $|(\text{image } F^*) \cap \Psi| \leq 2$.

(Case 3: $m = n$) We can expand $F^*(x)$ as follows:

$$F^*(x) = q_1 s^{k_1}(x) + \cdots + q_n s^{k_n}(x) - q'_1 \alpha_1 - \cdots - q'_n \alpha_n.$$

In order for $F^*(x) \in \Psi$, it is necessary that $s^{k_j}(x) = \alpha_j$ for $j = 1, \dots, n$. Otherwise the value of $F^*(x)$ will be a linear combination of two or more elements of Ψ . Thus $|(\text{image } F^*) \cap \Psi| \leq 1$ in this case. \square

Lemma 6.10. Let $t(x) : \Gamma_\infty \rightarrow \Gamma_\infty$ be an L -term and let $F : \Psi \rightarrow \Gamma_\infty$ be the restriction $t|_\Psi$ of t to Ψ . Then there is an increasing sequence $s_0 = \alpha_0 < \alpha_1 < \cdots < \alpha_{n-1} < \alpha_n = \infty$ in Ψ_∞ such that for $k = 0, \dots, n - 1$, the restriction of F to $[\alpha_k, \alpha_{k+1})_\Psi$ is given by an s -function.

Proof. We do this by induction on the complexity of the L -terms.

(Easy Cases) By definition the constant term β for $\beta \in \Gamma_\infty$ is an s -function, and it's clear that the set of s -functions is closed under $+$, $-$ and δ_n for $n \geq 1$.

(ψ Case) Let $F(x) = \sum_{j=1}^n q_j s^{k_j}(x) - \beta$ be an s -function. Then we can determine the value of $\psi(F(x))$ from Theorem 6.6. Note that whenever the expression $s^l(x) < \delta$ is not vacuous in the table of Theorem 6.6, then it is equivalent to $x < s^{-l}\delta$ (similarly for $=$ and $>$).

(s Case) This is similar to the ψ case, except we use Corollary 6.7.

(p Case) Let $F(x) = \sum_{j=1}^n q_j s^{k_j}(x) - \beta$ be an s -function. By Lemma 6.9, if $\beta = 0$, $n = 1$, $q_1 = 1$, then F^* is of the form $s^k(x)$ and so

$$p(F(x)) = \begin{cases} \infty & \text{if } x \in I_F \\ \infty & \text{if } x = \min D_F \text{ and } k \leq 0 \\ s^{k-1}(x) & \text{if } x > \min D_F \text{ or } k > 0 \end{cases}$$

Otherwise, $F(x) \in \Psi$ for 0, 1 or 2 values of x , so $p(F(x)) = \infty$ for all $x \in \Psi$ with at most 0, 1 or 2 exceptions. \square

We say that a set $I \subseteq \Psi$ is an **interval in Ψ** if there are $\alpha, \beta \in \Psi_\infty$ with $\alpha < \beta$ such that $I = [\alpha, \beta)_\Psi$. The following is immediate from Theorem 5.2, and Lemmas 6.2 and 6.10:

Corollary 6.11. Every definable $A \subseteq \Psi$ is a finite union of intervals in Ψ and singletons.

Proof of Theorem 6.3. It follows from quantifier elimination and the fact that T_{\log} has a universal axiomatization that there are L -terms $t_1(x), \dots, t_n(x)$ such that on Ψ we have $F(x) = t_k(x)$, for some $i \in \{1, \dots, k\}$. By Corollary 6.11, the set

$$D_i := \{x \in \Psi : F(x) = t_k(x)\} \subseteq \Psi$$

will be a finite union of intervals and singletons. Furthermore, by Lemma 6.10, the restriction of $F(x)$ to D_i will be given piecewise by s -functions in the desired way. \square

Corollary 6.12 (Characterization of definable functions $\Psi \rightarrow \Psi$). Let $F : \Psi \rightarrow \Psi$ be definable in (Γ, ψ) . Then there is an increasing sequence $s_0 = \alpha_0 < \alpha_1 < \dots < \alpha_{n-1} < \alpha_n = \infty$ in Ψ_∞ such that for $k = 1, \dots, n$, the restriction of F to $[\alpha_{k-1}, \alpha_k)_\Psi$ is either constant or of the form $x \mapsto s^l(x)$ for some $l \in \mathbb{Z}$.

Proof. This follows from Theorem 6.3 and Lemma 6.9. \square

7. DEFINABLE SUBSETS OF Ψ

In this section we assume that (Γ, ψ) is a model of T_{\log} .

It is clear from Corollary 6.11 that each nonempty definable $A \subseteq \Psi$ has a least element. This gives us definable Skolem functions for definable subsets of Ψ^n (see, for example, [vdD98b, p. 94]).

The following Theorem 7.1 follows immediately from Corollary 6.11 and the main result of [PS87]. For the reader's convenience we supply a more direct and self-contained proof. It is a variant of [vdD98a, Lemma 4.7], which itself is a variant of [Hru92, Lemma 1].

Theorem 7.1. Let $n \geq 1$ and suppose that $f : \Psi^n \rightarrow \Psi$ is a definable function. Then f is definable in the structure $(\Psi; <)$.

Proof. We can arrange that (Γ, ψ) is \aleph_0 -saturated.

The case $n = 1$ follows from Corollary 6.12.

Let $n > 1$. Let A be the finite set of parameters from Γ used to define f . For each $a \in \Psi$ we can define the function $f_a : x \mapsto f(a, x) : \Psi^{n-1} \rightarrow \Psi$. By induction, f_a is definable in the structure $(\Psi; <)$, so we have $c_a \in \Psi^{N_a}$ and a set $\Phi_a \subseteq \Psi^{N_a + (n-1) + 1}$ definable in $(\Psi; <)$ such that $\Phi_a(c_a) = \Gamma(f_a)$. We can arrange that Φ_a is the graph of a function $F_a : \Psi^{N_a + (n-1)} \rightarrow \Psi$ such that $F_a(c_a, x) = f_a(x)$ for all $x \in \Psi$. Next let $\Delta_a \subseteq \Psi$ be the A -definable set of all $b \in \Psi$ such that the function $f_b : \Psi^{n-1} \rightarrow \Psi$ occurs as a section of F_a . Note that $a \in \Delta_a$ since $F_a(c_a, x) = f(a, x)$. Thus

$$\Psi = \bigcup_{a \in \Psi} \Delta_a$$

By saturation there are $a_1, \dots, a_k \in \Psi$ such that:

$$\Psi = \bigcup_{j=1}^k \Delta_j$$

where $\Delta_j := \Delta_{a_j}$ for $j = 1, \dots, k$. Let $F_j := F_{a_j}$, $\Phi_j := \Phi_{a_j}$, $c_j := c_{a_j}$ and $N_j := N_{a_j}$ for $j = 1, \dots, k$ and let $N = \max_{1 \leq j \leq k} N_j$. Extend each function $F_j : \Psi^{N_j + (n-1)} \rightarrow \Psi$ to a function $F'_j : \Psi^{N + (n-1)} \rightarrow \Psi$ by setting

$$F'_j(w_1, \dots, w_N, x) := F_j(w_1, \dots, w_{N_j}, x) \text{ for all } (w_1, \dots, w_N, x) \in \Psi^{N + (n-1)}$$

so the last $N - N_j$ variables before x are dummy variables. Next define a function $F : \Psi^{1 + N + (n-1)} \rightarrow \Psi$ by

$$F(v, w_1, \dots, w_N, x) = \begin{cases} F'_1(w_1, \dots, w_N, x) & \text{if } v = s_0 \\ F'_2(w_1, \dots, w_N, x) & \text{if } v = s^2_0 \\ \vdots & \\ F'_{k-1}(w_1, \dots, w_N, x) & \text{if } v = s^{k-1}_0 \\ F'_k(w_1, \dots, w_N, x) & \text{if } v \geq s^k_0 \end{cases}$$

Finally, we note the following:

$$\begin{aligned}
\Psi = \bigcup_{j=1}^n \Delta_j &\Rightarrow \text{for every } a \in \Psi \text{ there is } j \in \{1, \dots, k\} \text{ such that } a \in \Delta_j \\
&\Rightarrow \text{for every } a \in \Psi \text{ there is } j \in \{1, \dots, k\} \text{ and } c \in \Psi^{N_j} \\
&\quad \text{such that } f(a, x) = F_j(c, x) \text{ for every } x \in \Psi \\
&\Rightarrow \text{for every } a \in \Psi \text{ there is } j \in \{1, \dots, k\} \text{ and } c \in \Psi^N \\
&\quad \text{such that } f(a, x) = F'_j(c, x) \text{ for every } x \in \Psi \\
&\Rightarrow \text{for every } a \in \Psi \text{ there is } v \in \Psi \text{ and } c \in \Psi^N \\
&\quad \text{such that } f(a, x) = F(v, c, x) \text{ for every } x \in \Psi \\
&\Rightarrow \text{for every } a \in \Psi \text{ there is } c \in \Psi^{1+N} \\
&\quad \text{such that } f(a, x) = F(c, x) \text{ for every } x \in \Psi \\
&\Rightarrow \forall a \in \Psi \exists c \in \Psi^{1+N} \forall x \in \Psi (f(a, x) = F(c, x))
\end{aligned}$$

By definability of Skolem functions, there is a definable function $c = (c_0, \dots, c_N) : \Psi \rightarrow \Psi^{1+N}$ such that

$$\forall a \in \Psi \forall x \in \Psi (f(a, x) = F(c(a), x))$$

From the base case of this lemma, we may assume that $c_i : \Psi \rightarrow \Psi$ is definable in $(\Psi; <)$ for $i = 0, \dots, N$. Thus $f(z, x) : \Psi^n \rightarrow \Psi$ agrees with the function $F(c(z), x) : \Psi^n \rightarrow \Psi$, which is definable in $(\Psi; <)$. This concludes the proof of the induction step. \square

Corollary 7.2. The subset Ψ of Γ is stably embedded in (Γ, ψ) .

8. FINAL REMARKS

In this section we assume that (Γ, ψ) is a model of T_{log} . In contrast to the o-minimality of Ψ (Corollary 6.11), it is important to note that (Γ, ψ) is not even weakly o-minimal because the definable set $\Psi \subseteq \Gamma$ is infinite and discrete. In fact, (Γ, ψ) is not even *locally o-minimal* (in the sense of [TV09]) because the definable set $(\Psi - \Psi)^{>0} \subseteq \Gamma$ does not have the local o-minimality property at 0.

However, (Γ, ψ) is “o-minimal at infinity” in the following sense:

Lemma 8.1. If $X \subseteq \Gamma$ is definable in (Γ, ψ) , then there is $a \in \Gamma$ such that $(a, \infty) \subseteq X$ or $(a, \infty) \cap X = \emptyset$.

This is immediate from the following claim:

Claim 8.2. Let $F : \Gamma \rightarrow \Gamma_\infty$ be a definable function. Then there is some $a \in \Gamma$ such that on the restriction (a, ∞) , F is either constant, or of the form $x \mapsto qx + \beta$ for $q \in \mathbb{Q}^\neq$ and $\beta \in \Gamma$.

Proof. By quantifier elimination and universal axiomatization of T_{log} , it follows that F is given piecewise by L -terms. In particular, there is some $a \in \Gamma$ such that F is equal to an L -term $t(x)$ on (a, ∞) . Thus we can prove this by induction on the complexity of $t(x)$.

The cases $t(x) = \beta$ for some $\beta \in \Gamma_\infty$ is clear since this is already a constant function. The cases $t(x) = t_1(x) + t_2(x)$, $t(x) = -t_1(x)$, $t(x) = \delta_n t_1(x)$ are also clear.

If $t(x)$ is constant on (b, ∞) for some $b \in \Gamma$, then so are $\psi(t(x))$, $s(t(x))$ and $p(t(x))$. If $t(x)$ is $qx + \beta$ on (b, ∞) , then $t(x)$ is either strictly increasing and cofinal in Γ , or strictly decreasing and coinitial in Γ . Thus $\psi(t(x))$ and $s(t(x))$ will eventually be the constant value s_0 and $p(t(x))$ will eventually be the constant value ∞ . \square

We conclude with a list of unresolved issues and things left to do:

- (1) Describe more explicitly the subsets of Γ that are definable in (Γ, ψ) .
- (2) Describe all definable functions $\Gamma \rightarrow \Gamma_\infty$.
- (3) Describe all possible simple extensions $\Gamma \preceq \Gamma\langle c \rangle$.
- (4) Does T_{log} have NIP (the Non-Independence Property)?
- (5) Is T_{log} *distal*? Distal theories form a subclass of NIP theories which in some sense are purely unstable. See [Sim13] for a definition of distality.

- (6) Is (Γ, ψ) *quasi-weakly-o-minimal*, i.e., any definable subset is a finite boolean combination of convex sets and 0-definable sets? For more information on this property in the o-minimal setting, see [BPW00].
- (7) Is (Γ, ψ) *d-minimal*, i.e., any definable subset of Γ is a union of an open set and finitely many discrete sets? See [Mil05, §3.4] for a discussion of d-minimality in the context of expansions of the real field.

Items (3) and (4) are addressed in a future paper, [Geh15].

ACKNOWLEDGEMENTS

This material is based upon work supported by the National Science Foundation under Grant No. 0932078000 while the author was in residence at the Mathematical Sciences Research Institute in Berkeley, California, during the Spring 2014 semester. The author would like to thank the referee for the very careful reading of the manuscript and many helpful suggestions, and would also like to thank Lou van den Dries for his guidance and numerous discussions around the topics of this paper.

REFERENCES

- [Asc03] Matthias Aschenbrenner, *Some remarks about asymptotic couples*, Valuation theory and its applications, Vol. II (Saskatoon, SK, 1999), Fields Inst. Commun., vol. 33, Amer. Math. Soc., Providence, RI, 2003, pp. 7–18. MR 2018547 (2004j:03043)
- [AvdD00] Matthias Aschenbrenner and Lou van den Dries, *Closed asymptotic couples*, J. Algebra **225** (2000), no. 1, 309–358. MR 1743664 (2001g:03065)
- [AvdD02] ———, *H-fields and their Liouville extensions*, Math. Z. **242** (2002), no. 3, 543–588. MR 1985465 (2004f:12002)
- [AvdDvdH13] Matthias Aschenbrenner, Lou van den Dries, and Joris van der Hoeven, *Toward a model theory for transseries*, Notre Dame J. Form. Log. **54** (2013), no. 3-4, 279–310. MR 3091660
- [AvdDvdH15] ———, *Asymptotic differential algebra and model theory of transseries*, arXiv preprint arXiv:1509.02588 (2015), 703 pp.
- [BPW00] Oleg Belegradek, Ya’acov Peterzil, and Frank Wagner, *Quasi-o-minimal structures*, J. Symbolic Logic **65** (2000), no. 3, 1115–1132. MR 1791366 (2001k:03079)
- [Geh15] Allen Gehret, *Nip for the asymptotic couple of the field of logarithmic transseries*, arXiv preprint arXiv:1503.06496 (2015), (submitted).
- [Hru92] Ehud Hrushovski, *Strongly minimal expansions of algebraically closed fields*, Israel J. Math. **79** (1992), no. 2-3, 129–151. MR 1248909 (95c:03078)
- [Kuh94] Franz-Viktor Kuhlmann, *Abelian groups with contractions. I*, Abelian group theory and related topics (Oberwolfach, 1993), Contemp. Math., vol. 171, Amer. Math. Soc., Providence, RI, 1994, pp. 217–241. MR 1293144 (95i:03079)
- [Kuh95] ———, *Abelian groups with contractions. II. Weak o-minimality*, Abelian groups and modules (Padova, 1994), Math. Appl., vol. 343, Kluwer Acad. Publ., Dordrecht, 1995, pp. 323–342. MR 1378210 (97g:03044)
- [Mar02] David Marker, *Model theory*, Graduate Texts in Mathematics, vol. 217, Springer-Verlag, New York, 2002, An introduction. MR 1924282 (2003e:03060)
- [Mil05] Chris Miller, *Tameness in expansions of the real field*, Logic Colloquium ’01, Lect. Notes Log., vol. 20, Assoc. Symbol. Logic, Urbana, IL, 2005, pp. 281–316. MR 2143901 (2006j:03049)
- [PS87] Anand Pillay and Charles Steinhorn, *Discrete o-minimal structures*, Ann. Pure Appl. Logic **34** (1987), no. 3, 275–289, Stability in model theory (Trento, 1984). MR 899083 (88j:03023)
- [Ros81] Maxwell Rosenlicht, *On the value group of a differential valuation. II*, Amer. J. Math. **103** (1981), no. 5, 977–996. MR 630775 (83d:12013)
- [Sim13] Pierre Simon, *Distal and non-distal NIP theories*, Ann. Pure Appl. Logic **164** (2013), no. 3, 294–318. MR 3001548
- [TV09] Carlo Toffalori and Kathryn Vozoris, *Notes on local o-minimality*, MLQ Math. Log. Q. **55** (2009), no. 6, 617–632. MR 2582162 (2011g:03089)
- [vdD98a] Lou van den Dries, *Dense pairs of o-minimal structures*, Fund. Math. **157** (1998), no. 1, 61–78. MR 1623615 (2000a:03058)
- [vdD98b] ———, *Tame topology and o-minimal structures*, London Mathematical Society Lecture Note Series, vol. 248, Cambridge University Press, Cambridge, 1998. MR 1633348 (99j:03001)
- [vdDMM01] Lou van den Dries, Angus Macintyre, and David Marker, *Logarithmic-exponential series*, Proceedings of the International Conference “Analyse & Logique” (Mons, 1997), vol. 111, 2001, pp. 61–113. MR 1848569 (2002i:12007)

E-mail address: agehret2@illinois.edu

DEPARTMENT OF MATHEMATICS, UNIVERSITY OF ILLINOIS AT URBANA-CHAMPAIGN, URBANA, ILLINOIS 61801