

MINIMAL SURFACES WITH ARBITRARY TOPOLOGY IN $\mathbb{H}^2 \times \mathbb{R}$

BARIS COSKUNUZER

ABSTRACT. We show that any open orientable surface S can be properly embedded in $\mathbb{H}^2 \times \mathbb{R}$ as an area minimizing surface. We obtained this result by proving a bridge principle at infinity for $\mathbb{H}^2 \times \mathbb{R}$ for vertical bridges in $\partial_\infty \mathbb{H}^2 \times \mathbb{R}$. Furthermore, we studied the asymptotic Plateau problem in $\mathbb{H}^2 \times \mathbb{R}$, and gave a fairly complete solution.

1. INTRODUCTION

Minimal surfaces in $\mathbb{H}^2 \times \mathbb{R}$ has been an attractive topic for the last decade. After Nelli and Rosenberg's seminal results [NR] on minimal surfaces in $\mathbb{H}^2 \times \mathbb{R}$ in 2002, the theory has been developed very quickly by the substantial results on the existence of many different types of minimal surfaces in $\mathbb{H}^2 \times \mathbb{R}$ and their properties, e.g. [CR, HRS, Mo, MoR, MRR, Py, PR, Sa, ST].

In this paper, we are interested in the question of "What type of surfaces can be embedded into $\mathbb{H}^2 \times \mathbb{R}$ as a complete minimal surface?" The references above showed the existence of many different type of surfaces which can be embedded into $\mathbb{H}^2 \times \mathbb{R}$ as a complete proper (or nonproper [RT]) minimal surface. In particular, Martin and Rodriguez showed that any connected planar domain Σ_k^0 can be properly embedded in $\mathbb{H}^2 \times \mathbb{R}$ as a complete minimal surface [MR]. Furthermore, Martin, Mazzeo and Rodriguez recently showed that for any $g \geq 0$, there exists a complete, finite total curvature, embedded minimal surface Σ_k^g in $\mathbb{H}^2 \times \mathbb{R}$ with genus g and k ends for sufficiently large k [MMR].

Ros conjectured that any open orientable surface can be properly embedded in $\mathbb{H}^2 \times \mathbb{R}$ as a minimal surface [MR]. In this paper, we prove this conjecture by giving a general method to construct complete, properly embedded minimal surfaces in $\mathbb{H}^2 \times \mathbb{R}$ with arbitrary topology, i.e. any (finite or infinite) number of genus and ends. Our main result is as follows:

Theorem 1.1. *Any open orientable surface S can be properly embedded in $\mathbb{H}^2 \times \mathbb{R}$ as a complete area minimizing surface.*

The author is supported by Fulbright Grant, and TUBITAK 2219 Grant.

In particular, this shows that any open orientable surface S can be realized as a complete minimal surface in $\mathbb{H}^2 \times \mathbb{R}$. The outline of the method is as follows. We start with a simple exhaustion of the open orientable surface S , i.e. $S_1 \subset S_2 \dots S_n \subset ..$ where $S = \bigcup_{n=1}^{\infty} S_n$ [FMM]. In particular, the surface S is constructed by starting with a disk $D = S_1$, and by adding 1-handles iteratively, i.e. $S_{n+1} - \text{int}(S_n)$ is either a pair of pants or a cylinder with a handle (See Figure 4). Then by using the vertical bridges and the simple exhaustion, we inductively construct a sequence of area minimizing surfaces $\{\Sigma_n\}$ in $\mathbb{H}^2 \times \mathbb{R}$ which converges to an area minimizing surface Σ in $\mathbb{H}^2 \times \mathbb{R}$ homeomorphic to S .

On the other hand, when proving the theorem above, we needed the positive solutions to the asymptotic Plateau problem in $\mathbb{H}^2 \times \mathbb{R}$ for certain curves. In particular, unlike \mathbb{H}^3 case, there are some curves Γ in $\partial_{\infty}\mathbb{H}^2 \times \mathbb{R}$ where there is no minimal surface Σ in $\mathbb{H}^2 \times \mathbb{R}$ with $\partial_{\infty}\Sigma = \Gamma$ [ST]. We gave a fairly complete solution to the asymptotic Plateau problem in $\mathbb{H}^2 \times \mathbb{R}$ with the following result.

Theorem 1.2. *Let Γ be a collection of disjoint simple closed curves in $\partial_{\infty}\mathbb{H}^2 \times \mathbb{R}$ with $h(\Gamma) \neq \pi$. Then, there exists an area minimizing surface Σ in $\mathbb{H}^2 \times \mathbb{R}$ with $\partial_{\infty}\Sigma = \Gamma$ if and only if Γ is a tall curve.*

Furthermore, we show that a generic tall curve bounds a unique area minimizing surface (See Corollary 2.21).

On the other hand, we observe that the asymptotic Plateau problem for area minimizing surfaces and for minimal surfaces are quite different. While there is no area minimizing surface for short curves, we show that there are short curves of any height, bounding complete embedded minimal surfaces in $\mathbb{H}^2 \times \mathbb{R}$ (Theorem 5.1).

The organization of the paper is as follows. In the next section, we study the asymptotic Plateau problem in $\mathbb{H}^2 \times \mathbb{R}$, and prove Theorem 1.2. In Section 3, we show the bridge principle at infinity in $\mathbb{H}^2 \times \mathbb{R}$ for sufficiently long vertical bridges. In Section 4, we prove the main result (Theorem 1.1), the existence of properly embedded, area minimizing surfaces in $\mathbb{H}^2 \times \mathbb{R}$ of arbitrary topological type. In Section 5, we discuss the asymptotic Plateau problem for minimal surfaces, and construct examples for short curves. Finally in section 6, we give some concluding remarks, and mention some interesting open problems in the subject. We postpone some technical steps to the appendix section at the end.

1.1. Acknowledgements. Part of this research was carried out at Max-Planck Institute for Mathematics during my visit. I would like to thank them for their great hospitality. I would like to thank the referee for very valuable comments and suggestions.

2. ASYMPTOTIC PLATEAU PROBLEM IN $\mathbb{H}^2 \times \mathbb{R}$

In this section, we will study the existence of a complete area minimizing surface Σ in $\mathbb{H}^2 \times \mathbb{R}$ with $\partial_\infty \Sigma = \Gamma$ for a given collection of simple closed curves Γ in $\partial_\infty \mathbb{H}^2 \times \mathbb{R}$.

Definition 2.1. A compact surface with boundary Σ is called *area minimizing surface* if Σ has the smallest area among surfaces with the same boundary. A noncompact surface is called *area minimizing surface* if any compact subsurface is an area minimizing surface.

In particular, we will be interested in the following question:

Asymptotic Plateau Problem for $\mathbb{H}^2 \times \mathbb{R}$: *Let Γ be a collection of simple closed curves in $\partial_\infty \mathbb{H}^2 \times \mathbb{R}$. Does there exist an area minimizing surface Σ in $\mathbb{H}^2 \times \mathbb{R}$ with $\partial_\infty \Sigma = \Gamma$?*

Here, Σ is an open, complete surface in $\mathbb{H}^2 \times \mathbb{R}$, and $\partial_\infty \Sigma$ represents the asymptotic boundary of Σ in $\partial_\infty \mathbb{H}^2 \times \mathbb{R}$. In particular, if $\overline{\mathbb{H}^2 \times \mathbb{R}} = \mathbb{H}^2 \times \mathbb{R} \cup \partial_\infty \mathbb{H}^2 \times \mathbb{R}$ is the natural compactification of $\mathbb{H}^2 \times \mathbb{R}$, and $\overline{\Sigma}$ is the closure of Σ in $\overline{\mathbb{H}^2 \times \mathbb{R}}$, then $\partial_\infty \Sigma = \overline{\Sigma} \cap \partial_\infty \mathbb{H}^2 \times \mathbb{R}$.

When Γ is an essential smooth simple closed curve in $\partial_\infty \mathbb{H}^2 \times \mathbb{R}$ which is a vertical graph over $\partial_\infty \mathbb{H}^2$, then the vertical graphs over \mathbb{H}^2 gives a positive answer to this existence question [NR]. However, for nonessential (nullhomotopic) simple closed curves in $\partial_\infty \mathbb{H}^2 \times \mathbb{R}$, the situation is quite different. Unlike the \mathbb{H}^3 case [An], Sa Earp and Toubiana recently showed that there are some simple closed curves Γ in $\partial_\infty \mathbb{H}^2 \times \mathbb{R}$ where there is no minimal surface Σ in $\mathbb{H}^2 \times \mathbb{R}$ with $\partial_\infty \Sigma = \Gamma$ [ST].

Definition 2.2. [Thin Tail] Let γ be an arc in $\partial_\infty \mathbb{H}^2 \times \mathbb{R}$. Assume that there is a vertical straight line L_0 in $\partial_\infty \mathbb{H}^2 \times \mathbb{R}$ such that

- $\gamma \cap L_0 \neq \emptyset$ and $\partial \gamma \cap L_0 = \emptyset$,
- γ stays in one side of L_0 ,
- $\gamma \subset \partial_\infty \mathbb{H}^2 \times (c, c + \pi)$ for some $c \in \mathbb{R}$.

Then, we call γ a *thin tail* in Γ (See Γ_1 in Figure 8).

Theorem 2.3. [ST] *Let Γ be a simple closed curve in $\partial_\infty \mathbb{H}^2 \times \mathbb{R}$. If Γ contains a thin tail, then there is no properly immersed minimal surface Σ in $\mathbb{H}^2 \times \mathbb{R}$ with $\partial_\infty \Sigma = \Gamma$.*

More generally, if we allow minimal surfaces with boundary, there is no minimal surface in S in $\mathbb{H}^2 \times \mathbb{R}$ with $\partial_\infty S = \gamma$ where γ is a thin tail [ST, Theorem 2.1]. In particular, this result implies that if Γ is a nullhomotopic simple closed curve in $\partial_\infty \mathbb{H}^2 \times \mathbb{R}$ which is contained in a slab of height π (i.e. $\Gamma \subset \partial_\infty \mathbb{H}^2 \times (c, c + \pi)$), then there is no complete minimal surface Σ in

$\mathbb{H}^2 \times \mathbb{R}$ with $\partial_\infty \Sigma = \Gamma$. On the other hand, if you remove the nullhomotopic condition on the curve Γ contained strictly in a slab of height π , Collin, Hauswirth and Rosenberg have recently obtained interesting results on the minimal surfaces they bound in $\mathbb{H}^2 \times \mathbb{R}$ [CHR].

Hence, the following question becomes very interesting: *For which simple closed curves Γ in $\partial_\infty \mathbb{H}^2 \times \mathbb{R}$, there exists an area minimizing surface Σ in $\mathbb{H}^2 \times \mathbb{R}$ with $\partial_\infty \Sigma = \Gamma$. In other words, "When do we have a solution to the asymptotic Plateau problem in $\mathbb{H}^2 \times \mathbb{R}$?"*

In this section, we answer this question by proving the existence of area minimizing surfaces for tall curves, and the nonexistence for the short curves (Theorem 2.13). This result gives a fairly complete solution to the asymptotic Plateau Problem in $\mathbb{H}^2 \times \mathbb{R}$ (See Remark 2.16). Note also that the existence result will be a key component for the construction of minimal surfaces with arbitrary topology in Section 4.

2.1. Tall Curves. Now, we define the tall curves.

Definition 2.4. [Tall Curves] Consider $\partial_\infty \mathbb{H}^2 \times \mathbb{R}$ with the coordinates (θ, t) where $\theta \in [0, 2\pi)$ and $t \in \mathbb{R}$. We will call the rectangle $R = [\theta_1, \theta_2] \times [t_1, t_2] \subset \partial_\infty \mathbb{H}^2 \times \mathbb{R}$ as *tall rectangle* if $t_2 - t_1 > \pi$.

We call a finite collection of disjoint simple closed curves Γ in $\partial_\infty \mathbb{H}^2 \times \mathbb{R}$ *tall curve* if the region $\Gamma^c \subset \partial_\infty \mathbb{H}^2 \times \mathbb{R}$ can be written as a union of tall rectangles R_i , i.e. $\Gamma^c = \bigcup_i R_i$ (See Figure 1).

We will call a region Ω in $\partial_\infty \mathbb{H}^2 \times \mathbb{R}$ a *tall region*, if Ω can be written as a union of tall rectangles, i.e. $\Omega = \bigcup_i R_i$ where R_i is a tall rectangle.

On the other hand, by using the idea above, we can define a notion called *height of a curve* as follows:

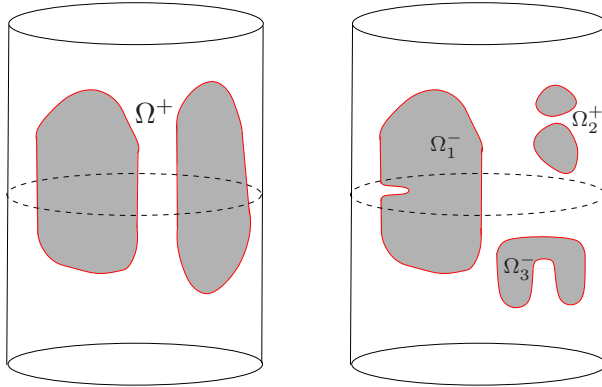

FIGURE 1. In the left, Γ is a tall curve with two components. In the right, there are three nonexamples of tall curves. Shaded regions describe the Ω_i^- where $\partial_\infty \mathbb{H}^2 \times \mathbb{R} - \Gamma_i = \Omega_i^+ \cup \Omega_i^-$.

Definition 2.5. [Height of a Curve] Let Γ be a collection of simple closed curves in $\partial_\infty \mathbb{H}^2 \times \mathbb{R}$, and let $\Omega = \partial_\infty \mathbb{H}^2 \times \mathbb{R} - \Gamma$. For any $\theta \in [0, 2\pi)$, let $L_\theta = \{\theta\} \times \mathbb{R}$ be the vertical line in $\partial_\infty \mathbb{H}^2 \times \mathbb{R}$. Let $L_\theta \cap \Omega = l_\theta^1 \cup \dots \cup l_\theta^{i_\theta}$ where l_θ^i is a component of $L_\theta \cap \Omega$. Define the height $h(\Gamma) = \inf_\theta \{|l_\theta^i|\}$.

Notice that Γ is a tall curve if and only if $h(\Gamma) > \pi$. Now, we say Γ is a *short curve* if $h(\Gamma) < \pi$.

Remark 2.6. Notice that if Γ is a finite collection of disjoint simple closed curves in $\partial_\infty \mathbb{H}^2 \times \mathbb{R}$, then we can write $\Gamma^c = \Omega^+ \cup \Omega^-$ where Ω^\pm are tall regions with $\partial \overline{\Omega^+} = \partial \overline{\Omega^-} = \Gamma$.

Note also that any curve containing a thin tail is short curve by definition. However, there are some short curves with no thin tails, like Γ_3 in Figure 1-right and Figure 7-right.

Notice also that for each component γ_i of a tall curve Γ , if θ_i^+ and θ_i^- are the leftmost and rightmost coordinates of γ_i , then $L_{\theta_i^\pm} \cap \gamma_i$ must be a pair of vertical line segments of length greater than π (See Figure 1 left). Also, in Figure 1 right, three non-tall curves Γ_1, Γ_2 and Γ_3 are pictured as examples. If we name the shaded regions as Ω_i^- , Γ_1 is not tall as Ω_1^+ is not tall because of the small cove. Γ_2 has two components, and it is not tall as Ω_2^+ is not tall (The two components are very close to each other). Finally, Γ_3 is not tall as Ω_3^- is not tall region because of the short neck.

Remark 2.7. (Exceptional Curves) We will call a short curve Γ *exceptional* if $\overline{\Omega^+}$ or $\overline{\Omega^-}$ can be written as a union of closed tall rectangles ($[\theta_1, \theta_2] \times [t_1, t_2]$) but not a union of open tall rectangles ($(\theta_1, \theta_2) \times (t_1, t_2)$). As an example, consider $R_1 = [0, \frac{\pi}{3}] \times [-1, 5]$ and $R_2 = [\frac{\pi}{3}, \frac{2\pi}{3}] \times [-5, 1]$. Let $\gamma_i = \partial R_i$. Let $l = \{\frac{\pi}{3}\} \times (-1, 1)$ be a line segment of length 2. Define $\Gamma = \gamma_1 \cup \gamma_2 - l$. Clearly, $h(\Gamma) = 2$. However, the line segment l makes Γ an exceptional curve. These curves are very small set of curves among the closed curves in $\partial_\infty \mathbb{H}^2 \times \mathbb{R}$, however they will have a problematic feature with barrier argument we will give later on this section. So, throughout the paper, we will assume that closed curves in $\partial_\infty \mathbb{H}^2 \times \mathbb{R}$ are not exceptional unless otherwise stated. We would like to thank Laurent Mazet for pointing out the exceptional curves.

Now, we state the convergence theorem for area minimizing surfaces, which will be used throughout the paper.

Lemma 2.8. [Convergence] Let $\{\Sigma_i\}$ be a sequence of complete area minimizing surfaces in $\mathbb{H}^2 \times \mathbb{R}$ where $\Gamma_i = \partial_\infty \Sigma_i$ is a finite collection of simple closed curves. If Γ_i converges to a finite collection of simple closed curves $\widehat{\Gamma}$, then there exists a subsequence $\{\Sigma_{n_j}\}$ such that Σ_{n_j} converges to an area minimizing surface $\widehat{\Sigma}$ (possibly empty) with $\partial_\infty \widehat{\Sigma} \subset \widehat{\Gamma}$. In particular, the convergence is smooth on compact subsets of $\mathbb{H}^2 \times \mathbb{R}$.

Proof: Let $\Delta_n = \mathbf{B}_n(0) \times [-C, C]$ be convex domains in $\mathbb{H}^2 \times \mathbb{R}$ where $\mathbf{B}_n(0)$ is the closed disk of radius n in \mathbb{H}^2 with center 0, and $\Gamma \subset \partial_\infty \mathbb{H}^2 \times (-C, C)$. For n sufficiently large, consider the surfaces $S_i^n = \Sigma_i \cap \Delta_n$. Since the area of the surfaces $\{S_i^n \subset \Delta_n\}$ is uniformly bounded by $|\partial \Delta_n|$, and ∂S_i^n can be bounded by using standard techniques, if $\{S_i^n\}$ is an infinite sequence, then we get a convergent subsequence of $\{S_i^n\}$ in Δ_n with nonempty limit S^n which is an area minimizing surface in Δ_n by the compactness theorem [Fe]. If the sequence $\{S_i^n\}$ is an infinite sequence for every n , by using diagonal sequence argument, we can find a subsequence of $\{\Sigma_i\}$ converging to an area minimizing surface $\widehat{\Sigma}$ with $\partial_\infty \widehat{\Sigma} \subset \widehat{\Gamma}$ as $\Gamma_i \rightarrow \widehat{\Gamma}$. Note also that for fixed n , the curvatures of $\{S_i^n\}$ are uniformly bounded by curvature estimates for area minimizing surfaces. Hence, with the uniform area bound, we get smooth convergence on compact subsets of $\mathbb{H}^2 \times \mathbb{R}$. For further details, see [MW, Theorem 3.3]. \square

Remark 2.9. In the above proof, there might be cases like $\{S_i^n\}$ is a finite sequence for any n . In particular, if for every n , there exists C_n with $\Sigma_i \cap \Delta_n = \emptyset$ for every $i > C_n$, then the limit is empty, and we say $\{\Sigma_i\}$ *escapes to infinity*. An example to this case is a sequence of rectangles R_i in $\partial_\infty \mathbb{H}^2 \times \mathbb{R}$ with $h(R_i) \searrow \pi$ and $R_i \rightarrow \widehat{R}$ where \widehat{R} is a rectangle of height π . Then, the sequence of area minimizing surfaces P_i with $\partial_\infty P_i = R_i$ escapes to infinity, as there is no area minimizing surface Σ with $\partial_\infty \Sigma = \widehat{\Gamma}$. Note also that if $\widehat{\Gamma}$ is a tall curve, by proof of the Theorem 2.13, the limit is nonempty, and Σ_{n_j} converges to a nonempty area minimizing surface $\widehat{\Sigma}$ with $\partial_\infty \widehat{\Sigma} \subset \widehat{\Gamma}$.

For the boundaries of tall rectangles, Sa Earp and Toubiana proved the following:

Lemma 2.10. [ST] *If R is a tall rectangle in $\partial_\infty \mathbb{H}^2 \times \mathbb{R}$, then there exists a minimal surface P in $\mathbb{H}^2 \times \mathbb{R}$ with $\partial_\infty P = \partial R$. In particular, P is a graph over R .*

Let $h = t_2 - t_1$ be the height of the tall rectangle $R = [\theta_1, \theta_2] \times [t_1, t_2]$ in $\partial_\infty \mathbb{H}^2 \times \mathbb{R}$. They also showed that $P \cap \mathbb{H}^2 \times \{\frac{t_2+t_1}{2}\}$ is an equidistant curve γ_h from the geodesic γ in $\mathbb{H}^2 \times \{\frac{t_2+t_1}{2}\}$ with $\partial_\infty \gamma = \{\theta_1, \theta_2\}$. Let $d_h = \text{dist}(\gamma_h, \gamma)$. Then, they also show that if $h \rightarrow \infty$ then $d_h \rightarrow 0$ and if $h \rightarrow \pi$ then $d_h \rightarrow \infty$. Moreover, $P \cap \mathbb{H}^2 \times [\frac{t_2+t_1}{2}, t_2]$ is a graph over the component of $\mathbb{H}^2 - \gamma_h$ in R side.

Now, we will show that these minimal surfaces are the unique area minimizing surfaces spanning their asymptotic boundaries.

Lemma 2.11. *If R is a tall rectangle in $\partial_\infty \mathbb{H}^2 \times \mathbb{R}$, then there exists a unique minimal surface P in $\mathbb{H}^2 \times \mathbb{R}$ with $\partial_\infty P = \partial R$. Furthermore, P is also an area minimizing surface in $\mathbb{H}^2 \times \mathbb{R}$.*

Proof: Let $R_h = [-\theta_1, \theta_1] \times [-h, h]$ be a tall rectangle in $\partial_\infty \mathbb{H}^2 \times \mathbb{R}$, i.e. $h > \frac{\pi}{2}$ and $0 < \theta_1 < \pi$. By Lemma 2.10, for any $h > \frac{\pi}{2}$, there exists a minimal surface P_h with $\partial_\infty P_h = \partial R_h$. Moreover, by the construction [ST], $\{P_h\}$ is a continuous family of complete minimal planes with $P_h \cap P_{h'} = \emptyset$ for $h \neq h'$. Now, fix $h_0 > \frac{\pi}{2}$, and let $R_{h_0} = [-\theta_1, \theta_1] \times [-h_0, h_0]$

Let τ be geodesic in \mathbb{H}^2 with $\partial_\infty \tau = \{0, \pi\} \subset \partial_\infty \mathbb{H}^2$. Let ψ_t be the hyperbolic isometry of \mathbb{H}^2 which fixes τ , where t is the translation parameter along τ . In particular, in the upper half plane model $\mathbb{H}^2 = \{(x, y) \mid y > 0\}$, $\tau = \{(0, y) \mid y > 0\}$ and $\psi_t(x) = tx$. Then, let $\theta_t = \psi_t(\theta_1)$. Then for $0 < t < \infty$, $0 < \theta_t < \pi$. Hence, $\theta_t < \theta_1$ when $0 < t < 1$, and $\theta_t > \theta_1$ when $1 < t < \infty$. In particular, this implies $[-\theta_1, \theta_1] \subset [-\theta_t, \theta_t]$ for $t > 1$, and $[-\theta_1, \theta_1] \supset [-\theta_t, \theta_t]$ for $t < 1$. For notation, let $\theta_0 = 0$ and let $\theta_\infty = \pi$.

Now, define a continuous family of rectangles \widehat{R}_h which foliates an infinite vertical strip in $\partial_\infty \mathbb{H}^2 \times \mathbb{R}$ as follows. For $\frac{\pi}{2} < h < \infty$, let $s : (\frac{\pi}{2}, \infty) \rightarrow (0, 2)$ be a smooth monotone increasing function such that $s(h) \nearrow 2$ when $h \nearrow \infty$, and $s(h) \searrow 0$ when $h \searrow \frac{\pi}{2}$. Furthermore, let $s(h_0) = 1$.

Now, define \widehat{R}_h be the rectangle in $\partial_\infty \mathbb{H}^2 \times \mathbb{R}$ with $\widehat{R}_h = [-\theta_{s(h)}, \theta_{s(h)}] \times [-h, h]$. Hence, $\widehat{R}_{h_0} = R_{h_0}$, and for any $h \in (\frac{\pi}{2}, \infty)$, \widehat{R}_h is a tall rectangle with height $2h > \pi$. Let $\widehat{\Gamma}_h = \partial \widehat{R}_h$. Then, the family of simple closed curves $\{\widehat{\Gamma}_h\}$ foliates the vertical infinite strip $\Omega = ((-\theta_2, \theta_2) \times \mathbb{R}) - (\{0\} \times [-\frac{\pi}{2}, \frac{\pi}{2}])$ in $\partial_\infty \mathbb{H}^2 \times \mathbb{R}$.

Recall that $R_h = [-\theta_1, \theta_1] \times [-h, h]$ for any $h > \pi/2$, and the planes P_h are minimal surfaces with $\partial_\infty P_h = \partial R_h$. Let $\widehat{\psi}_t$ be the isometry of $\mathbb{H}^2 \times \mathbb{R}$ with $\widehat{\psi}_t(p, s) = (\psi_t(p), s)$ where $p \in \mathbb{H}^2$ and $s \in \mathbb{R}$. Then clearly $\widehat{R}_h = \widehat{\psi}_{s(h)}(R_h)$. Define $\widehat{P}_h = \widehat{\psi}_{s(h)}(P_h)$. Hence, \widehat{P}_h is a complete minimal plane with $\partial_\infty \widehat{P}_h = \widehat{\Gamma}_h = \partial \widehat{R}_h$. Notice that \widehat{P}_∞ is the geodesic plane $\eta \times \mathbb{R}$ in $\mathbb{H}^2 \times \mathbb{R}$ where η is a geodesic in \mathbb{H}^2 with $\partial_\infty \eta = \{-\theta_2, \theta_2\}$. Let Δ be the component of $\mathbb{H}^2 \times \mathbb{R} - \widehat{P}_\infty$ containing P_{h_0} , i.e. $\partial \Delta = \widehat{P}_\infty$ and $\partial_\infty \Delta = \overline{\Omega}$. We claim that the family of complete minimal planes $\{\widehat{P}_h \mid h \in (\frac{\pi}{2}, \infty)\}$ foliates Δ .

Notice that as $\{P_h\}$ is a continuous family of minimal planes, and $\{\widehat{\psi}_t\}$ is a continuous family of isometries, then by construction $\widehat{P}_h = \widehat{\psi}_{s(h)}(P_h)$ is a continuous family of minimal planes, and $\Delta = \bigcup_{h \in (\frac{\pi}{2}, \infty)} \widehat{P}_h$. Hence, all we need to show that $\widehat{P}_h \cap \widehat{P}_{h'} = \emptyset$ for $h < h'$. First notice that $P_h \cap P_{h'} = \emptyset$ by [ST]. Hence, $\widehat{\psi}_{s(h)}(P_h) \cap \widehat{\psi}_{s(h)}(P_{h'}) = \emptyset$. Let $s' = s(h')/s(h) > 1$.

Notice that both planes $\widehat{\psi}_{s(h)}(P_h)$ and $\widehat{\psi}_{s(h)}(P_{h'})$ are graphs over rectangles $[-\theta_{s(h)}, \theta_{s(h)}] \times [-h, h]$ and $[-\theta_{s(h)}, \theta_{s(h)}] \times [-h', h']$ respectively. For any $c \in (-h, h)$, the line $l_c^{h'} = \widehat{\psi}_{s(h)}(P_{h'}) \cap \mathbb{H}^2 \times \{c\}$ is on far side ($\pi \in \partial_\infty \mathbb{H}^2$ side) of the line $l_c^h = \widehat{\psi}_{s(h)}(P_h) \cap \mathbb{H}^2 \times \{c\}$ in $\mathbb{H}^2 \times \{c\}$. Hence, for any c , $\psi_{s'}(l_c^{h'}) \cap l_c^h = \emptyset$ since $\psi_{s'}$ pushes \mathbb{H}^2 toward $\pi \in \partial_\infty \mathbb{H}^2$ as $s' > 1$. As $\widehat{\psi}_{s'} \circ \widehat{\psi}_s(h) = \widehat{\psi}_{s'.s(h)} = \widehat{\psi}_{s(h')}$, then $\widehat{\psi}_{s(h)}(P_h) \cap \widehat{\psi}_{s(h')}(P_{h'}) = \emptyset$. In other words, $\widehat{P}_h \cap \widehat{P}_{h'} = \emptyset$ for $h < h'$. This shows that the family of planes $\{\widehat{P}_h \mid h \in (\frac{\pi}{2}, \infty)\}$ foliates Δ .

Now, we show that P_{h_0} is the unique minimal surface with asymptotic boundary ∂R_{h_0} in $\partial_\infty \mathbb{H}^2 \times \mathbb{R}$. If there was another minimal surface Σ in $\mathbb{H}^2 \times \mathbb{R}$ with $\partial_\infty \Sigma = \partial R_{h_0}$, then Σ must belong to Δ by the convex hull principle. In particular, one can easily see this fact by foliating $\mathbb{H}^2 \times \mathbb{R} - \Delta$ by the geodesic planes $\{\widehat{\psi}_t(\widehat{P}_\infty) \mid t > 1\}$. Hence, if $\Sigma \not\subset \Delta$, then for $t_0 = \sup_t \{\Sigma \cap \widehat{\psi}_t(\widehat{P}_\infty) \neq \emptyset\}$, Σ would intersect the geodesic plane $\widehat{\psi}_{t_0}(\widehat{P}_\infty)$ tangentially with lying in one side. This contradicts to maximum principle as both are minimal surfaces.

Now, since $\Sigma \subset \Delta$ and Δ is foliated by \widehat{P}_h , if $\Sigma \neq P_{h_0}$, then $\Sigma \cap P_h \neq \emptyset$ for some $h \neq h_0$. Then, either $h_1 = \sup\{h > h_0 \mid \Sigma \cap \widehat{P}_h \neq \emptyset\}$ or $h'_1 = \inf\{h < h_0 \mid \Sigma \cap \widehat{P}_h \neq \emptyset\}$ exists. In either case, Σ would intersect \widehat{P}_{h_1} or $\widehat{P}_{h'_1}$ tangentially by lying in one side. Again, this contradicts to maximum principle as both are minimal surfaces. Hence, such a Σ cannot exist, and the uniqueness follows.

Now, we will finish the proof by showing that P_{h_0} is indeed an area minimizing surface in $\mathbb{H}^2 \times \mathbb{R}$. Let B_n be the n -disk in \mathbb{H}^2 with the center origin O in the Poincare ball model, i.e. $B_n = \{x \in \mathbb{H}^2 \mid d(x, O) < n\}$. Let $\widehat{B}_n = B_n \times [-h_0, h_0]$ in $\mathbb{H}^2 \times \mathbb{R}$. We claim that $P_{h_0}^n = P_{h_0} \cap \widehat{B}_n$ is an area minimizing surface, i.e. $P_{h_0}^n$ has the smallest area among the surfaces S in $\mathbb{H}^2 \times \mathbb{R}$ with the same boundary, i.e. $\partial P_{h_0}^n = \partial S \Rightarrow |P_{h_0}^n| \leq |S|$ where $|\cdot|$ represents the area.

Let $\Omega_n = \widehat{B}_n \cap \overline{\Delta}$ be the compact, convex subset of $\mathbb{H}^2 \times \mathbb{R}$. Let $\beta_n = \partial P_{h_0}^n$ be the simple closed curve in $\partial \Omega_n$. Notice that by the existence theorem of area minimizing surfaces [Fe], there exists an area minimizing surface Σ in $\mathbb{H}^2 \times \mathbb{R}$ with $\partial \Sigma = \beta_n$. Furthermore, as Ω_n is convex, $\Sigma \subset \Omega_n$. However, as $\{\widehat{P}_h \mid h \in (\frac{\pi}{2}, \infty)\}$ foliates Δ , $\{\widehat{P}_h \cap \Omega_n\}$ foliates Ω_n . Similar to above argument, if Σ is not a leaf of this foliation, there must be a last point of contact with the leaves, which gives a contradiction with the maximum principle. Hence, $\Sigma = P_{h_0}^n$, and $P_{h_0}^n$ is an area minimizing surface. This shows that any compact subsurface of P_{h_0} is an area minimizing surface as it must belong to $P_{h_0}^n$ for sufficiently large $n > 0$. This proves P_{h_0} is an area minimizing surface with $\partial_\infty P_{h_0} = \partial R_{h_0}$, and it is the unique minimal

surface in $\mathbb{H}^2 \times \mathbb{R}$ with asymptotic boundary ∂R_{h_0} in $\partial_\infty \mathbb{H}^2 \times \mathbb{R}$. As any tall rectangle in $\partial_\infty \mathbb{H}^2 \times \mathbb{R}$ is isometric image of R_h for some $\frac{\pi}{2} < h < \infty$, the proof follows. \square

Now, we will show that for any tall curve Γ in $\partial_\infty \mathbb{H}^2 \times \mathbb{R}$, the asymptotic Plateau problem has a solution.

Remark 2.12. We will use the standard technique for this construction. In particular, we will construct a sequence of compact area minimizing surfaces $\{\Sigma_n\}$ in $\mathbb{H}^2 \times \mathbb{R}$ with $\partial \Sigma_n \rightarrow \Gamma$, and in the limit, we aim to obtain an area minimizing surface Σ with $\partial_\infty \Sigma = \Gamma$. Notice that the main issue here is not to show that Σ is an area minimizing surface, but to show that Σ is not escaping to infinity, i.e. $\Sigma \neq \emptyset$ and $\partial_\infty \Sigma = \Gamma$. Recall that by Theorem 2.3, if a nullhomotopic simple closed curve γ in $\partial_\infty \mathbb{H}^2 \times \mathbb{R}$ has height $< \pi$ (i.e. $\gamma \subset \partial_\infty \mathbb{H}^2 \times (c, c + \pi)$), then there is no minimal surface S in $\mathbb{H}^2 \times \mathbb{R}$ with $\partial_\infty S = \gamma$. This means that if you similarly construct area minimizing surfaces S_n with $\partial S_n \rightarrow \gamma$, then either $S = \lim S_n = \emptyset$ or $\partial_\infty S \neq \gamma$, i.e. the sequence S_n escapes to infinity completely ($S = \emptyset$), or some parts of the sequence S_n escapes to infinity ($\partial_\infty S \neq \gamma$). See Final Remarks and Conjecture 6.1 for further discussion.

Theorem 2.13. *[Asymptotic Plateau Problem for $\mathbb{H}^2 \times \mathbb{R}$] Let Γ be a collection of disjoint simple closed curves in $\partial_\infty \mathbb{H}^2 \times \mathbb{R}$ with $h(\Gamma) \neq \pi$. Then, there exists an area minimizing surface Σ in $\mathbb{H}^2 \times \mathbb{R}$ with $\partial_\infty \Sigma = \Gamma$ if and only if Γ is a tall curve.*

Proof: We prove the theorem in two steps.

Step 1: [Existence] If Γ is tall ($h(\Gamma) > \pi$), then there exists an area minimizing surface Σ in $\mathbb{H}^2 \times \mathbb{R}$ with $\partial_\infty \Sigma = \Gamma$.

Proof: Since Γ is a tall curve, by definition, $\Gamma^c = \Omega^+ \cup \Omega^-$ where Ω^\pm is a tall region with $\partial \overline{\Omega^\pm} = \Gamma$. Then, let $\Omega^+ = \bigcup_\alpha R_\alpha$ and $\Omega^- = \bigcup_\beta R_\beta$ where R_α, R_β are tall rectangles in $\partial_\infty \mathbb{H}^2 \times \mathbb{R}$. For each tall rectangle R_α , by Lemma 2.11, there exists a unique area minimizing surface P_α with $\partial_\infty P_\alpha = \partial R_\alpha$.

Let $C > 0$ be sufficiently large that $\Gamma \subset \partial_\infty \mathbb{H}^2 \times [-C, C]$. Let B_n be the n -disk in \mathbb{H}^2 with the center origin, and $\widehat{B}_n = B_n \times [-C, C]$ is a compact solid cylinder in $\mathbb{H}^2 \times \mathbb{R}$. Let Γ_n be the radial projection of Γ into the cylinder $\partial B_n \times [-C, C]$. Then, Γ_n is a simple closed curve in $\partial \widehat{B}_n$. Let Σ_n be the area minimizing surface in $\mathbb{H}^2 \times \mathbb{R}$ with $\partial \Sigma_n = \Gamma_n$ [Fe]. Then, as \widehat{B}_n is convex, $\Sigma_n \subset \widehat{B}_n$.

We claim that $\Sigma_n \rightarrow \Sigma$ where Σ is an area minimizing surface with $\partial_\infty \Sigma = \Gamma$. By Remark 2.12, first we need to guarantee that the sequence $\{\Sigma_n\}$ is not escaping to infinity, i.e. $\lim \Sigma_n = \Sigma \neq \emptyset$.

Now, we show that Σ is not empty. Let R_{α_o} be a tall rectangle with $R_{\alpha_o} \subset \Omega^+$. Let P_{α_o} be the unique area minimizing surface with $\partial_\infty P_{\alpha_o} = \partial R_{\alpha_o}$. We claim that $\Sigma_n \cap P_{\alpha_o} = \emptyset$ for any n . Let $P_{\alpha_o}^n = P_{\alpha_o} \cap \widehat{B}_n$. By construction, $\partial P_{\alpha_o}^n = \eta_n$ and $\partial \Sigma_n = \Gamma_n$ are disjoint simple closed curves in $\partial \widehat{B}_n$. Assume that $\Sigma_n \cap P_{\alpha_o}^n \neq \emptyset$. Then, as both are separating in \widehat{B}_n , the intersection must consist of a collection of closed curves $\{\mu_1, \dots, \mu_k\}$ (no isolated points in the intersection because of the maximum principle). Let T_n be a component of $\Sigma_n - P_{\alpha_o}^n$ with $\Gamma_n \not\subset \partial T_n$. Let $Q_n \subset P_{\alpha_o}^n$ be the collection of disks with $\partial Q_n = \partial T_n$. Since both Σ_n and $P_{\alpha_o}^n$ are area minimizing, then so are T_n and Q_n . Hence, they have the same area $|T_n| = |Q_n|$ as $\partial T_n = \partial Q_n$. Let $\Sigma'_n = (\Sigma_n - T_n) \cup Q_n$. Then, since $\partial \Sigma_n = \partial \Sigma'_n$ and $|\Sigma_n| = |\Sigma'_n|$, Σ'_n is also area minimizing surface. However, Σ'_n is not smooth along ∂Q_n which contradicts to the interior regularity of area minimizing surfaces [Fe]. This shows that $\Sigma_n \cap P_{\alpha_o} = \emptyset$ for any n .

Let Σ be the limit of Σ_n . In particular, by the convergence theorem (Theorem 2.8), for any compact solid cylinder \widehat{B}_m , the sequence $\{\Sigma_n \cap \widehat{B}_m\}$ has a convergent subsequence with limit $\Sigma^m \subset \widehat{B}_m$. By using the diagonal sequence argument, in the limit, we get an area minimizing surface Σ with $\Sigma \cap \widehat{B}_m = \Sigma^m$. Notice also that Σ^m separates \widehat{B}_m where the component near boundary contains $P_{\alpha_o}^m$ as $\Sigma_n \cap P_{\alpha_o} = \emptyset$ for any n . Hence, if $P_{\alpha_o} \cap \widehat{B}_m \neq \emptyset$, then $\Sigma \cap \widehat{B}_m = \Sigma^m \neq \emptyset$, which implies Σ is not empty. In particular, for any n , Σ_n stays in one side (far side from infinity) of P_{α_o} , and P_{α_o} acts as a barrier which prevents the sequence $\{\Sigma_n\}$ escaping to infinity.

Now, we will show that $\partial_\infty \Sigma = \Gamma$. First, we show that $\partial_\infty \Sigma \subset \Gamma$. In other words, $\partial_\infty \Sigma \cap \Gamma^c = \emptyset$. In order to see this, fix $q \in \Gamma^c$. Then, by definition, there exists a tall rectangle $R_q \subset \Gamma^c$ such that $q \in \text{int}(R_q)$. Let P_q be the unique area minimizing surface in $\mathbb{H}^2 \times \mathbb{R}$ with $\partial_\infty P_q = \partial R_q$. Then, by the arguments above, for any n , $\Sigma_n \cap P_q = \emptyset$. Let Δ_q be the component of $\mathbb{H}^2 \times \mathbb{R} - P_q$ with $\partial_\infty \Delta_q = \text{int}(R_q)$. Since $\Sigma_n \cap P_q = \emptyset$, then $\Sigma_n \cap \Delta_q = \emptyset$, and hence $\Sigma \cap \Delta_q = \emptyset$. Note that $\partial_\infty \Sigma = \overline{\Sigma} \cap \partial_\infty \mathbb{H}^2 \times \mathbb{R}$ where $\overline{\Sigma}$ is the closure of Σ in the compactification of $\mathbb{H}^2 \times \mathbb{R}$, i.e. $\overline{\mathbb{H}^2 \times \mathbb{R}} = \mathbb{H}^2 \times \mathbb{R} \cup \partial_\infty \mathbb{H}^2 \times \mathbb{R}$. Hence, as $\Sigma \cap \Delta_q = \emptyset$, this implies $\partial_\infty \Sigma \cap \text{int}(R_q) = \emptyset$, and $q \notin \partial_\infty \Sigma$.

We finish the proof by showing that $\partial_\infty \Sigma \supset \Gamma$. Let $p \in \Gamma$. We will prove that $p \in \overline{\Sigma}$. Let p be in the component γ in Γ . As $\Gamma^c = \Omega^+ \cup \Omega^-$, let $\{p_i^\pm\} \subset \Omega^\pm$ be two sequences in opposite sides of γ with $\lim p_i^\pm = p$. Let α_i be a small circular arc in $\overline{\mathbb{H}^2 \times \mathbb{R}}$ with $\partial \alpha_i = \{p_i^+, p_i^-\}$ and $\alpha_i \perp \partial_\infty \mathbb{H}^2 \times \mathbb{R}$. Then, for any i , there exists N_i such that for any $n > N_i$, Γ_n links α_i , i.e. Γ_n is not nullhomologous in $\mathbb{H}^2 \times \mathbb{R} - \alpha_i$. Hence, for any $n > N_i$, $\alpha_i \cap \Sigma_n \neq \emptyset$. This implies $\Sigma \cap \alpha_i \neq \emptyset$ by construction. Like above,

let $R_i^\pm \subset \Omega^\pm$ be the tall rectangle with $p_i^\pm \subset R_i^\pm$. Similarly, let P_i^\pm be the unique area minimizing surface with $\partial_\infty P_i^\pm = \partial R_i^\pm$. Let $\alpha'_i \subset \alpha_i$ be a subarc with $\partial\alpha'_i \subset P_i^+ \cup P_i^-$. Hence, α'_i is a compact arc in $\mathbb{H}^2 \times \mathbb{R}$. Moreover, as $\Sigma \cap P_i^\pm = \emptyset$, then there exists a point x_i in $\Sigma \cap \alpha'_i$ for any i . By construction, $\lim x_i = p$. This shows that $p \in \overline{\Sigma}$, and $\partial_\infty \Sigma = \Gamma$. Step 1 follows. \square

Step 2: [Nonexistence] If Γ is short ($h(\Gamma) < \pi$), then there is no area minimizing surface Σ in $\mathbb{H}^2 \times \mathbb{R}$ with $\partial_\infty \Sigma = \Gamma$.

Proof: Assume that there exists an area minimizing surface Σ in $\mathbb{H}^2 \times \mathbb{R}$ with $\partial_\infty \Sigma = \Gamma$. Since Γ is a short curve in $\partial_\infty \mathbb{H}^2 \times \mathbb{R}$, there is a $\theta_0 \in [0, 2\pi)$ with $(\theta_0, c_1), (\theta_0, c_2) \in \Gamma$ where $0 < c_1 - c_2 < \pi - 2\epsilon$ for some $\epsilon > 0$. Let $c^+ = c_2 + \epsilon$ and $c^- = c_1 - \epsilon$. Let $p^+ = (\theta_0, c_1 + \epsilon)$ and $p^- = (\theta_0, c_2 - \epsilon)$ where $p^\pm \notin \Gamma$. Note that we a priori assume that Γ is not an exceptional curve (See Remark 2.7).

Since $\partial_\infty \Sigma = \Gamma$, this implies $\overline{\Sigma} = \Sigma \cup \Gamma$ in $\overline{\mathbb{H}^2 \times \mathbb{R}}$, the compactification of $\mathbb{H}^2 \times \mathbb{R}$, i.e. $\overline{\mathbb{H}^2 \times \mathbb{R}} = \mathbb{H}^2 \times \mathbb{R} \cup \partial_\infty \mathbb{H}^2 \times \mathbb{R}$. Let $O^\pm = \{p \in \overline{\mathbb{H}^2 \times \mathbb{R}} \mid d(p, p^\pm) < \delta_1\}$ is an open neighborhood of p^\pm in $\overline{\mathbb{H}^2 \times \mathbb{R}}$ with $O^\pm \cap \overline{\Sigma} = \emptyset$. Let $D^\pm = (\mathbb{H}^2 \times \{c^\pm\}) \cap O^\pm$. By construction, D^\pm contains a half plane in the hyperbolic plane $\mathbb{H}^2 \times \{c^\pm\}$.

Consider the area minimizing catenoid S of height $c^+ - c^- < \pi$ given in the Appendix (Lemma 7.1 and Lemma 7.3). We can assume that $\partial S \subset \mathbb{H}^2 \times \{c^+\} \cup \mathbb{H}^2 \times \{c^-\}$. In other words, ∂S consists of two curves γ^+ and γ^- where γ^\pm is a round circle of $\widehat{\rho}(d)$ in $\mathbb{H}^2 \times \{c^\pm\}$ centered at the origin. Let θ_1 be the antipodal point of θ_0 in S^1 . Let ψ_t be the hyperbolic isometry fixing the geodesic between θ_0 and θ_1 . In particular, ψ_t corresponds to $\psi_t(x, y) = (tx, ty)$ in the upper half space model where θ_1 corresponds to origin, and θ_0 corresponds to the point at infinity. Let $\widehat{\psi}_t : \mathbb{H}^2 \times \mathbb{R} \rightarrow \mathbb{H}^2 \times \mathbb{R}$ be the isometry of $\mathbb{H}^2 \times \mathbb{R}$ where $\widehat{\psi}_t(p, t) = (\psi_t(p), t)$.

Let $S_t = \widehat{\psi}_t(S)$ be the isometric image of the minimal catenoid S in $\mathbb{H}^2 \times \mathbb{R}$. Let $\partial S_t = \gamma_t^+ \cup \gamma_t^-$ where $\gamma_t^\pm = \psi_t(\gamma^\pm)$. Then, $\gamma_t^\pm \subset \mathbb{H}^2 \times \{c^\pm\}$ and hence $\partial S_t \subset \mathbb{H}^2 \times \{c^+\} \cup \mathbb{H}^2 \times \{c^-\}$ for any $t > 0$. Notice that as $t \rightarrow \infty$, $\gamma_t^\pm \rightarrow \theta_0$.

Now, let $N_o > 0$ be sufficiently large that $\gamma_t^+ \subset D^+$ and $\gamma_t^- \subset D^-$ for any $t > N_o$. Then, for any $t > N_o$, $\partial S_t \subset D^+ \cup D^-$, and $\partial S_t \cap \overline{\Sigma} = \emptyset$.

Let $\partial_\infty \mathbb{H}^2 \times \mathbb{R} - \Gamma = \Omega_1 \cup \Omega_2$ where $\partial\Omega_1 = \partial\Omega_2 = \Gamma$. Let $\overline{\mathbb{H}^2 \times \mathbb{R}} - \overline{\Sigma} = \Delta_1 \cup \Delta_2$ where $\partial_\infty \Delta_i = \Omega_i$. Let $\beta = \{\theta_0\} \times (c^-, c^+)$ be the vertical line segment in $\partial_\infty \mathbb{H}^2 \times \mathbb{R}$, and let $\beta \subset \Omega_1$. Since Δ_1 is an open subset in $\overline{\mathbb{H}^2 \times \mathbb{R}}$ and $\beta \subset \Delta_1$, then an open neighborhood O_β in $\mathbb{H}^2 \times \mathbb{R}$ must belong to Δ_1 . Then, by construction, we can choose $t_o > N_o$ sufficiently large that $S_{t_o} \cap O_\beta \neq \emptyset$ and $S_{t_o} \cap O_\beta$ is connected. This shows that $S_{t_o} \cap \Sigma \neq \emptyset$. Let

$S_{t_o} \cap \Sigma = \alpha$. Notice that as both Σ and S_{t_o} are area minimizing surfaces, α is a collection of closed curves, and contains no isolated points because of the maximum principle.

Let E be the compact subsurface of Σ with $\partial E = \alpha$. In other words, S_{t_o} separates E from Σ . Similarly, let T be the subsurface of S_{t_o} with $\partial T = \alpha$. In particular, $T = S_{t_o} \cap \overline{\Delta}_1$. Since S_{t_o} and Σ are area minimizing surfaces, so are T and E . As $\partial T = \partial E = \alpha$, and both are area minimizing surfaces, both have the same area, i.e. $|E| = |T|$.

Let $S' = (S_{t_o} - T) \cup E$. Then, clearly $\partial S_{t_o} = \partial S'$ and $|S_{t_o}| = |S'|$. Hence, as S_{t_o} is an area minimizing surface, so is S' . However, S' has singularity along α . This contradicts to the regularity of area minimizing surfaces [Fe]. Step 2 follows. \square

\square

Definition 2.14 (Mean Convex Hull). Let Γ be a tall curve in $\partial_\infty \mathbb{H}^2 \times \mathbb{R}$. Let $\Gamma^c = \bigcup R_\alpha$ where R_α are tall rectangles. Let P_α be the unique area minimizing surfaces in $\mathbb{H}^2 \times \mathbb{R}$ with $\partial_\infty P_\alpha = \partial R_\alpha$. Let Δ_α be the components of $\mathbb{H}^2 \times \mathbb{R} - P_\alpha$ with $\partial_\infty \Delta_\alpha = \text{int}(\mathcal{R}_\alpha)$. Define the *mean convex hull* of Γ in $\mathbb{H}^2 \times \mathbb{R}$ as $MCH(\Gamma) = \mathbb{H}^2 \times \mathbb{R} - (\bigcup \Delta_\alpha)$.

Remark 2.15. Notice that by construction $\partial_\infty MCH(\Gamma) = \Gamma$ for a tall curve Γ . Moreover, if Σ is an area minimizing surface with $\partial_\infty \Sigma = \Gamma$, then by the proof of the theorem above, $\Sigma \subset MCH(\Gamma)$. Hence, in a way, we replace the convex hulls in Anderson's approach to solve Asymptotic Plateau Problem in \mathbb{H}^3 with the mean convex hulls in order to get suitable barriers to prevent that the limit escapes to infinity.

Remark 2.16. Notice that the theorem finishes off the asymptotic Plateau problem for $\mathbb{H}^2 \times \mathbb{R}$ except the case $h(\Gamma) = \pi$. Note that this case is delicate as there are curves Γ_1 and Γ_2 in $\partial_\infty \mathbb{H}^2 \times \mathbb{R}$ with $h(\Gamma_i) = \pi$ such that Γ_1 bounds an area minimizing surface Σ_1 in $\mathbb{H}^2 \times \mathbb{R}$ while Γ_2 bounds none. For example, if Γ_2 is a rectangle in $\partial_\infty \mathbb{H}^2 \times \mathbb{R}$ with height π , then the discussion in Remark 2.9 (by using Lemma 2.18) shows that there is no area minimizing surface Σ with $\partial_\infty \Sigma = \Gamma_2$. On the other hand, in Theorem 5.1, if we take $h_0 = \pi$ and use the parabolic catenoid, it is not hard to show that the constructed surface is also area minimizing in $\mathbb{H}^2 \times \mathbb{R}$ since the parabolic catenoid is also area minimizing (See Figure 7-right). These two examples show that the case $h(\Gamma) = \pi$ is very delicate. Note also that Sa Earp and Toubiana studied a relevant problem in [ST, Cor. 2.1].

Remark 2.17 (Minimal vs. Area Minimizing). Notice that the theorem above does not say that *If γ is a short curve, then there is no minimal surface S in $\mathbb{H}^2 \times \mathbb{R}$ with $\partial_\infty S = \gamma$* . There are many examples of complete

embedded minimal surfaces S in $\mathbb{H}^2 \times \mathbb{R}$ where the asymptotic boundary γ is a short curve. We postpone this question to Section 5 to discuss in detail.

2.2. Generic Uniqueness of Area Minimizing Surfaces.

Now, we will prove some lemmas which will be used in the following sections. As a byproduct, we obtain a generic uniqueness result for tall curves in $\partial_\infty \mathbb{H}^2 \times \mathbb{R}$. We start with a lemma which roughly says that disjoint curves in $\partial_\infty \mathbb{H}^2 \times \mathbb{R}$ bounds disjoint area minimizing surfaces in $\mathbb{H}^2 \times \mathbb{R}$.

Lemma 2.18 (Disjointness). *Let Ω_1 and Ω_2 be two closed regions in $\partial_\infty \mathbb{H}^2 \times \mathbb{R}$ where $\partial\Omega_i = \Gamma_i$ is a finite collection of disjoint simple closed curves. Further assume that $\Omega_1 \cap \Omega_2 = \emptyset$ or $\Omega_1 \subset \text{int}(\Omega_2)$. If Σ_1 and Σ_2 are area minimizing surfaces in $\mathbb{H}^2 \times \mathbb{R}$ with $\partial_\infty \Sigma_i = \Gamma_i$, then $\Sigma_1 \cap \Sigma_2 = \emptyset$.*

Proof: Assume that $\Sigma_1 \cap \Sigma_2 \neq \emptyset$. As $\Gamma_1 \cap \Gamma_2 = \emptyset$, then $\Sigma_1 \cap \Sigma_2 = \alpha$ which is collection of closed curves (By maximum principle, there is no isolated point).

Since $\mathbb{H}^2 \times \mathbb{R}$ is topologically a ball, any surface would be separating. Let Δ_i be the components of $\mathbb{H}^2 \times \mathbb{R} - \Sigma_i$ with $\partial_\infty \overline{\Delta}_i = \Omega_i$. In other words, as $\Sigma_i \cup \Omega_i$ is a closed surface in the contractible space $\overline{\mathbb{H}^2 \times \mathbb{R}}$, it bounds a region Δ_i in $\overline{\mathbb{H}^2 \times \mathbb{R}}$.

If $\Omega_1 \subset \text{int}(\Omega_2)$, let $S_1 = \Sigma_1 - \Delta_2$ and let $S_2 = \Sigma_2 \cap \overline{\Delta}_1$. Then, as $\Omega_1 \subset \text{int}(\Omega_2)$, $\partial_\infty S_1 = \partial_\infty S_2 = \emptyset$ and both S_1 and S_2 are compact surfaces with $\partial S_1 = \partial S_2 = \alpha$.

If $\Omega_1 \cap \Omega_2 = \emptyset$, let $S_1 = \Sigma_1 \cap \overline{\Delta}_2$ and let $S_2 = \Sigma_2 \cap \overline{\Delta}_1$. Again, as $\Omega_1 \cap \Omega_2 = \emptyset$, $\partial_\infty S_1 = \partial_\infty S_2 = \emptyset$ and both S_1 and S_2 are compact surfaces with $\partial S_1 = \partial S_2 = \alpha$.

As Σ_1 and Σ_2 are area minimizing surfaces, so are $S_1 \subset \Sigma_1$ and $S_2 \subset \Sigma_2$. Hence, as $\partial S_1 = \partial S_2$, $|S_1| = |S_2|$ where $|\cdot|$ represents the area. Let T_1 be a compact subsurface in Σ_1 containing S_1 , i.e. $S_1 \subset T_1 \subset \Sigma_1$. Consider $T'_1 = (T_1 - S_1) \cup S_2$. Since T_1 is area minimizing and $|T'_1| = |T_1|$, so is T'_1 . However, T'_1 is not smooth along α which contradicts to the regularity of area minimizing surfaces [Fe]. The proof follows. \square

Now, we show that if a tall curve $\Gamma \subset \partial_\infty \mathbb{H}^2 \times \mathbb{R}$ does not bound a unique area minimizing surface in $\partial_\infty \mathbb{H}^2 \times \mathbb{R}$, it bounds two canonical area minimizing surfaces Σ^\pm where any other area minimizing surface Σ' with $\partial_\infty \Sigma' = \Gamma$ must be "between" Σ^+ and Σ^- .

Lemma 2.19 (Canonical Surfaces). *Let Γ be a tall curve in $\partial_\infty \mathbb{H}^2 \times \mathbb{R}$. Then either there exists a unique area minimizing surface Σ in $\mathbb{H}^2 \times \mathbb{R}$ with $\partial_\infty \Sigma = \Gamma$, or there are two canonical disjoint extremal area minimizing surfaces Σ^+ and Σ^- in $\mathbb{H}^2 \times \mathbb{R}$ with $\partial_\infty \Sigma^\pm = \Gamma$.*

Proof: We will mainly adapt the techniques of [Co2, Lemma 4.3] (Similar result for \mathbb{H}^3) to $\mathbb{H}^2 \times \mathbb{R}$ context. Let Γ be a tall curve in $\partial_\infty \mathbb{H}^2 \times \mathbb{R}$, and let $\Gamma^c = \Omega^+ \cup \Omega^-$ where Ω^\pm are two tall regions in $\partial_\infty \mathbb{H}^2 \times \mathbb{R}$ with $\partial \overline{\Omega^+} = \partial \overline{\Omega^-} = \Gamma$. Let $N_\epsilon(\Gamma)$ be a small open neighborhood of Γ in $\partial_\infty \mathbb{H}^2 \times \mathbb{R}$. Let $N^+ = N_\epsilon(\Gamma) \cap \Omega^+$ and let $N^- = N_\epsilon(\Gamma) \cap \Omega^-$. Let the family of curves $\{\Gamma_t^\pm\}$ foliate the region N^\pm . Let $\Gamma_n^\pm = \Gamma_{t_n}^\pm$ for $t_n \searrow 0$. By choosing $\epsilon > 0$ sufficiently small, we can assume Γ_n^\pm is tall for any $n > 0$. Let Σ_n^\pm be an area minimizing surface in $\mathbb{H}^2 \times \mathbb{R}$ with $\partial_\infty \Sigma_n^\pm = \Gamma_n^\pm$ by Theorem 2.13.

By replacing the sequence Σ_n with $\widehat{B}_n \cap \Sigma_n^\pm$ in the proof of Theorem 2.13, we can show that Σ_n^+ converges (up to a subsequence) to an area minimizing surface Σ^+ with $\partial_\infty \Sigma^+ = \Gamma$. Similarly, Σ_n^- converges to an area minimizing surface Σ^- with $\partial_\infty \Sigma^- = \Gamma$.

Assume that $\Sigma^+ \neq \Sigma^-$, and they are not disjoint. Since these are area minimizing surfaces, nontrivial intersection implies some part of Σ^- lies above Σ^+ by maximum principle. Then, since $\Sigma^+ = \lim \Sigma_n^+$, Σ^- must also intersect some Σ_n^+ for sufficiently large n . However by Lemma 2.18, Σ_n^+ is disjoint from Σ^- as $\partial_\infty \Sigma_n^+ = \Gamma_n^+$ is disjoint from $\partial_\infty \Sigma^- = \Gamma$. This is a contradiction. This shows Σ^+ and Σ^- are disjoint. By using similar techniques to [Co2, Lemma 4.3], it can be showed that Σ^\pm are canonical, i.e. independent of the sequences $\{\Sigma_n^\pm\}$.

Similar arguments show that Σ^\pm are disjoint from any area minimizing hypersurface Σ' with $\partial_\infty \Sigma' = \Gamma$. As the sequences of Σ_n^+ and Σ_n^- forms a barrier for other area minimizing hypersurfaces asymptotic to Γ , any such area minimizing hypersurface must lie in the region bounded by Σ^+ and Σ^- in $\mathbb{H}^2 \times \mathbb{R}$. This shows that if $\Sigma^+ = \Sigma^-$, then there exists a unique area minimizing hypersurface asymptotic to Γ . The proof follows. \square

Remark 2.20. Notice that if a finite collection of simple closed curves Γ is not assumed to be tall in the lemma above, the same proof is still valid. Hence, for any such Γ , either there is either no solution ($\nexists \Sigma$), or a unique solution ($\exists! \Sigma$), or two canonical solutions ($\exists \Sigma^\pm$) for asymptotic Plateau problem for Γ ($\partial_\infty \Sigma = \Gamma$).

Now, by using the lemma above, we show a generic uniqueness result for tall curves.

Theorem 2.21 (Generic Uniqueness). *A generic tall curve in $\partial_\infty \mathbb{H}^2 \times \mathbb{R}$ bounds a unique area minimizing surface in $\mathbb{H}^2 \times \mathbb{R}$.*

Proof: Let Γ_0 be a tall curve in $\partial_\infty \mathbb{H}^2 \times \mathbb{R}$. Let $N(\Gamma)$ be a small open neighborhood of Γ in $\partial_\infty \mathbb{H}^2 \times \mathbb{R}$ which is a finite collection of annuli. Let $\{\Gamma_t \mid t \in (-\epsilon, \epsilon)\}$ be a foliation of $N(\Gamma)$. In particular, for any $-\epsilon < t_1 < t_2 < \epsilon$, $\Gamma_{t_1} \cap \Gamma_{t_2} = \emptyset$. We can assume $N(\Gamma)$ sufficiently thin that Γ_t is a tall

curve for any $t \in (-\epsilon, \epsilon)$. Let Σ_t be an area minimizing surface in $\mathbb{H}^2 \times \mathbb{R}$ with $\partial_\infty \Sigma_t = \Gamma_t$.

As in the proof of the lemma above, let $\Gamma_t^c = \Omega_t^+ \cup \Omega_t^-$ with $\partial \overline{\Omega_t^+} = \partial \overline{\Omega_t^-} = \Gamma_t$. Then, $\Omega_t^+ \subset \Omega_s^+$ for $t < s$. Hence by Lemma 2.18, $\Sigma_t \cap \Sigma_s = \emptyset$ for $t < s$. Furthermore, by Lemma 2.19, if Γ_s does not bound a unique area minimizing surface Σ_s , then we can define two disjoint canonical minimizing Σ_s^+ and Σ_s^- with $\partial_\infty \Sigma_s^\pm = \Gamma_s$. Hence, $\Sigma_s^+ \cup \Sigma_s^-$ separates a region V_s in $\mathbb{H}^2 \times \mathbb{R}$. If Γ_s bounds a unique area minimizing surface Σ_s , then let $V_s = \Sigma_s$. Notice that by lemma 2.18, $\Sigma_t \cap \Sigma_s = \emptyset$ for $t \neq s$, and hence $V_t \cap V_s = \emptyset$ for $t \neq s$.

Now, consider a short arc segment η in $\mathbb{H}^2 \times \mathbb{R}$ with one endpoint is in Σ_{t_1} and the other end point is in Σ_{t_2} where $-\epsilon < t_1 < 0 < t_2 < \epsilon$. Hence, η intersects all area minimizing surfaces Σ_t with $\partial_\infty \Sigma_t = \Gamma_t$ where $t_1 \leq t \leq t_2$. Now for $t_1 < s < t_2$, define the *thickness* λ_s of V_s as $\lambda_s = |\eta \cap V_s|$, i.e. λ_s is the length of the piece of η in V_s . Hence, if Γ_s bounds more than one area minimizing surface, then the thickness is not 0. In other words, if $\lambda_s = 0$, then Γ_s bounds a unique area minimizing surface in $\mathbb{H}^2 \times \mathbb{R}$.

As $V_t \cap V_s = \emptyset$ for $t \neq s$, $\sum_{t_1}^{t_2} \lambda_s < |\eta|$. Hence, as $|\eta|$ is finite, for only countably many $s \in [t_1, t_2]$, $\lambda_s > 0$. This implies for all but countably many $s \in [t_1, t_2]$, $\lambda_s = 0$, and hence Γ_s bounds a unique area minimizing surface. Similarly, this implies for all but countably many $s \in (-\epsilon, \epsilon)$, Γ_s bounds a unique area minimizing surface. Then, by using the techniques in [Co2, Lemma 3.2], the generic uniqueness in Baire Sense follows. \square

3. VERTICAL BRIDGES AT INFINITY

In this section, we will prove a bridge principle at infinity for vertical bridges with height greater than π . Then, by using these bridges, we will construct area minimizing surfaces of arbitrary topology in $\mathbb{H}^2 \times \mathbb{R}$ in the next section.

Definition 3.1. Let Γ be a collection of disjoint simple closed curves in $\partial_\infty \mathbb{H}^2 \times \mathbb{R}$. If Γ bounds a unique area minimizing surface Σ in $\mathbb{H}^2 \times \mathbb{R}$, we call Σ a *uniquely minimizing surface*, and we call Γ a *uni-curve*.

Notation and Setup: Let L_{θ_0} be a vertical line in $\partial_\infty \mathbb{H}^2 \times \mathbb{R}$, i.e. $L_{\theta_0} = \{\theta_0\} \times \mathbb{R}$. Let Γ be a smooth tall uni-curve in $\partial_\infty \mathbb{H}^2 \times \mathbb{R}$ with $\Gamma \cap L_{\theta_0} = \emptyset$. Let Ω^\pm be the tall regions in $\partial_\infty \mathbb{H}^2 \times \mathbb{R}$ with $\Gamma^c = \Omega^+ \cup \Omega^-$ and $\partial \overline{\Omega^\pm} = \Gamma$.

Let α be a vertical line segment in $\partial_\infty \mathbb{H}^2 \times \mathbb{R}$, i.e. $\alpha = \{\theta_1\} \times [c_1, c_2]$. Also, let $\alpha \cap \Gamma = \partial \alpha$ and $\alpha \perp \Gamma$. Notice that as Γ is tall, this implies $|c_1 - c_2| > \pi$, and $\alpha \subset \overline{\Omega^+}$ or $\alpha \subset \overline{\Omega^-}$.

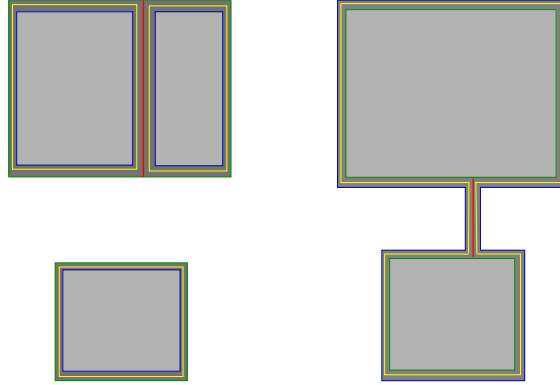

FIGURE 2. In the figure, $\Gamma = \partial\Omega^\pm$ is the green curves with two components. Light shaded regions (in the right) represent Ω^+ . In the left, we picture the case when the bridge α (red vertical line segment) is in Ω^+ . In the right, we picture the case when α is in Ω^- . The family $\{\Gamma_t\}$ (yellow curves) foliate \widehat{N} (dark shaded region). Here, $\Gamma_\epsilon \subset \partial\widehat{N}$ is the blue curves.

Consider a small open neighborhood $N(\Gamma \cup \alpha)$ of $\Gamma \cup \alpha$ in $\partial_\infty\mathbb{H}^2 \times \mathbb{R}$. If $\alpha \subset \Omega^+$, let $\widehat{N} = N(\Gamma \cup \alpha) \cap \Omega^+$. If $\alpha \subset \Omega^-$, let $\widehat{N} = N(\Gamma \cup \alpha) \cap \Omega^-$. Foliate \widehat{N} by the smooth curves $\{\Gamma_t \mid t \in (0, \epsilon)\}$ with $\Gamma_\epsilon \subset \partial\widehat{N}$, and $\Gamma_0 = \Gamma \cup \alpha$ (See Figure 2). By taking a smaller neighborhood $N(\Gamma \cup \alpha)$ to start if necessary, we can assume that Γ_t is a smooth tall curve for any t .

Let S_α be a thin strip along α in $\partial_\infty\mathbb{H}^2 \times \mathbb{R}$. In particular, if $N(\alpha)$ is a small neighborhood of α in $\partial_\infty\mathbb{H}^2 \times \mathbb{R}$, then S_α is the component of $N(\alpha) - \Gamma$ containing α , i.e. $S_\alpha \sim [\theta_1 - \delta, \theta_1 + \delta] \times [c_1, c_2]$. In Figure 2, a tall curve Γ with two components is pictured. In the left figure, the bridge α is in Ω^+ , while in the right, α is in Ω^- . Notice that if $\partial\alpha$ is in the same component of Γ , then $\sharp(\Gamma_t) = \sharp(\Gamma) + 1$ where $\sharp(\cdot)$ represents the number of components (Figure 2 Left). Similarly, if $\partial\alpha$ is in the different components of Γ , then $\sharp(\Gamma_t) = \sharp(\Gamma) - 1$ (Figure 2 Right).

Now, consider the upper half plane model for $\mathbb{H}^2 \simeq \{(x, y) \mid y > 0\}$. Without loss of generality, let $\theta_0 \in S_\infty^1(\mathbb{H}^2)$ corresponds to the point at infinity in the upper half plane model. We will use the upper half space model for $\mathbb{H}^2 \times \mathbb{R}$ with the identification $\mathbb{H}^2 \times \mathbb{R} = \{(x, y, z) \mid y > 0\}$ where \mathbb{H}^2 corresponds the xy -half plane, and \mathbb{R} corresponds to z coordinate. Hence, the xz -plane will correspond to $\partial_\infty\mathbb{H}^2 \times \mathbb{R}$. By using the isometries of the hyperbolic plane and the translation along \mathbb{R} direction, we will assume that $\theta_1 \in S_\infty^1(\mathbb{H}^2)$ will correspond to 0, and the vertical line segment $\alpha \subset \partial_\infty\mathbb{H}^2 \times \mathbb{R}$ above will have $\alpha = \{(0, 0)\} \times [-c, c]$ and $S_\alpha = [-\delta, \delta] \times \{0\} \times [-c, c]$ in (x, y, z) coordinates.

With this notation, we can state the bridge principle at infinity for vertical bridges in $\partial_\infty \mathbb{H}^2 \times \mathbb{R}$ as follows.

Theorem 3.2 (Vertical Bridges at Infinity). *Let $\Gamma, \alpha, \Gamma_t, S_\alpha$ as above. Let Σ be the uniquely minimizing surface in $\mathbb{H}^2 \times \mathbb{R}$ where $\partial_\infty \Sigma = \Gamma$. Assume also that $\bar{\Sigma}$ has finite genus. Then, there exists a sufficiently small $t > 0$ such that Γ_t bounds a unique area minimizing surface Σ_t where Σ_t is homeomorphic to $\Sigma \cup S_\alpha$, i.e. $\Sigma_t \simeq \Sigma \cup S_\alpha$.*

Proof: First, by Theorem 2.13, for any $\Gamma_t \subset \partial_\infty \mathbb{H}^2 \times \mathbb{R}$, there exists an area minimizing surface Σ_t with $\partial_\infty \Sigma_t = \Gamma_t$.

Step 1: For sufficiently small $t > 0$, $\Sigma_t \simeq \Sigma \cup S_\alpha$.

Proof: As $t_n \searrow 0$, $\Gamma_{t_n} \rightarrow \Gamma \cup \alpha$. Since Γ_{t_n} is a tall curve, there exists an area minimizing surface Σ_{t_n} in $\mathbb{H}^2 \times \mathbb{R}$ with $\partial_\infty \Sigma_{t_n} = \Gamma_{t_n}$ by Theorem 2.13. By Lemma 2.8, there exists a convergent subsequence, say Σ_n , converging to an area minimizing surface T with $\partial_\infty T \subset \Gamma \cup \alpha$. The limit T is nonempty as $\Gamma \cup \alpha$ is a tall curve by the proof of Theorem 2.13.

Now, we claim that $\partial_\infty T = \Gamma$. Since Γ bounds a unique area minimizing surface Σ , this would imply $T = \Sigma$.

Claim 1: $\partial_\infty T = \Gamma$.

Proof of Claim 1. By above, we know that $\partial_\infty T \subset \Gamma \cup \alpha$. Assume that there is a point $p \in \alpha - \partial\alpha$ such that $p \in \partial_\infty T$. By using notation and the upper half space model described before the theorem, recall that $\alpha = \{(0, 0)\} \times [-c, c]$, and without loss of generality, assume $p = (0, 0, 0) \in \alpha \subset \partial_\infty \mathbb{H}^2 \times \mathbb{R}$. Consider the hyperbolic plane $P = \mathbb{H}^2 \times \{0\} = \{(x, y, 0) \mid y > 0\}$ in $\mathbb{H}^2 \times \mathbb{R}$. Since $p \in \partial_\infty T$, $T \cap P \neq \emptyset$. Furthermore, let γ_i be the geodesic arc in P with $\partial_\infty \gamma_i = \{(-r_i, 0, 0), (+r_i, 0, 0)\}$ where $r_i \searrow 0$. Then, $\gamma_i \cap T \neq \emptyset$ as $T \cup \partial_\infty T$ separates $\mathbb{H}^2 \times \mathbb{R}$.

Now, let φ_i be the isometry of $\mathbb{H}^2 \times \mathbb{R}$ with $\varphi_i(x, y, z) = (\frac{1}{r_i}x, \frac{1}{r_i}y, z)$. Define a sequence of area minimizing surfaces $T_i = \varphi_i(T)$. Let $\hat{\gamma}$ be the geodesic in P with $\partial_\infty \hat{\gamma} = \{(-1, 0, 0), (1, 0, 0)\}$. Hence, by construction, for any $i > 0$, $\hat{\gamma} \cap T_i \neq \emptyset$. Again by using the convergence theorem (Theorem 2.8), we get a subsequence of $\{T_i\}$ which converges to an area minimizing surface \hat{T} . Let R^+ and R^- be two tall rectangles in opposite sides of α disjoint from $\Gamma \cup \alpha$, and let P^\pm be the unique area minimizing surfaces with $\partial_\infty P^\pm = R^\pm$. By Lemma 2.18, $T_i \cap P^\pm = \emptyset$ for any i . Hence, if η is a finite segment in $\hat{\gamma}$ with $\partial\eta \subset P^+ \cup P^-$, then any $T_i \cap \eta \neq \emptyset$ for any i by construction. This proves that the limit area minimizing surface \hat{T} does not escape to infinity as $\hat{T} \cap \eta \neq \emptyset$.

By construction of the sequence $\{T_i\}$, $\partial_\infty \hat{T} = \hat{\Gamma}$ where $\hat{\Gamma} = \alpha \cup L_1 \cup \dots \cup L_k \cup \beta_1 \cup \dots \cup \beta_l$ where L_i are horizontal lines in $\partial_\infty \mathbb{H}^2 \times \mathbb{R}$ with $L_i =$

$\{(t, 0, c_i) \mid t \in \mathbb{R}\}$, and β_j is a vertical line segments with x -coordinate 0, and β_j belongs to original curve Γ . In cylindrical model for $\mathbb{H}^2 \times \mathbb{R}$, $\widehat{\Gamma}$ is a collection of horizontal circles $\{L_i\}$, and vertical segments $\{\beta_j\}$. Since Γ is tall, the distance between the horizontal circles is greater than π . Hence, if S is the component of T with $p \in \partial_\infty S$, then $\partial_\infty S = L_1 \cup \alpha \cup L_2$ where L_1 and L_2 are horizontal lines in $\partial_\infty \mathbb{H}^2 \times \mathbb{R}$ through the endpoints of α . i.e. $L_1 = \{(t, 0, +c) \mid t \in \mathbb{R}\}$ and $L_2 = \{(t, 0, -c) \mid t \in \mathbb{R}\}$.

In cylindrical model for $\mathbb{H}^2 \times \mathbb{R}$, S is the area minimizing surface with $\partial_\infty S = \tau_1 \cup \tau_2 \cup \alpha$ where $\tau_1 = \partial_\infty \mathbb{H}^2 \times \{c\}$ and $\tau_2 = \partial_\infty \mathbb{H}^2 \times \{-c\}$ corresponding the horizontal lines L_i in the upper half space model. Now, we will show that there is no area minimizing surface S in $\mathbb{H}^2 \times \mathbb{R}$ with $\partial_\infty S = \tau_1 \cup \tau_2 \cup \alpha$ and get a contradiction. Let R_i be the tall rectangle $\partial[\theta_1 + \epsilon_i, \theta_1 - \epsilon_i + 2\pi] \times [-c + \rho_i, c - \rho_i]$ in $\partial_\infty \mathbb{H}^2 \times \mathbb{R}$. Clearly, R_i is disjoint from $\tau_1 \cup \tau_2 \cup \alpha$ for any i , and $R_i \rightarrow \tau_1 \cup \tau_2 \cup \alpha$ as $i \rightarrow \infty$. Let P_i be the unique area minimizing surface in $\mathbb{H}^2 \times \mathbb{R}$ with $\partial_\infty P_i = R_i$. By Lemma 2.18, $S \cap P_i = \emptyset$ for any i . On the other hand, the explicit description of P_i in [ST] shows that P_i is foliated by horizontal equidistant curves to the geodesic with endpoints $\{\theta_1 + \epsilon_i, \theta_1 - \epsilon_i + 2\pi\}$. Hence, P_i converges to two horizontal geodesic planes $\mathbb{H}^2 \times \{c\} \cup \mathbb{H}^2 \times \{-c\}$ as $i \rightarrow \infty$. However, this implies if there was an area minimizing surface S with $\partial_\infty S = \tau_1 \cup \tau_2 \cup \alpha$, $S \cap P_i \neq \emptyset$ for sufficiently large i . This is a contradiction. This proves $\partial_\infty T = \Gamma$ and the Claim 1 follows. \square

Since Σ is uniquely minimizing surface with $\partial_\infty \Sigma = \Gamma$, this implies $T = \Sigma$. Hence $\Sigma_{t_n} \rightarrow \Sigma$ and the convergence is smooth on compact sets.

Now, we will show that for sufficiently small $t > 0$, Σ_t is homeomorphic to $\Sigma \cup S_\alpha$. Assume that for $\epsilon_n \searrow 0$, there exists $0 < t_n < \epsilon_n$ such that Σ_{t_n} , say Σ_n , is not homeomorphic to $\widehat{\Sigma} = \Sigma \cup S_\alpha$. Since the number of ends are same, this means Σ_n and $\widehat{\Sigma}$ have different genus.

Let $\mathcal{R}_a = \{0 \leq y \leq a\}$ in $\overline{\mathbb{H}^2 \times \mathbb{R}}$. Now, we claim that there exists $a_\Gamma > 0$ such that for sufficiently large n , $\Sigma_n \cap \mathcal{R}_{a_\Gamma}$ has no genus, i.e. no genus developed near infinity.

Assuming this claim, we finish the proof as follows. Let $\mathcal{K}_a = \{y \geq a\}$ and let $\Sigma^a = \Sigma \cap \mathcal{K}_a$. Then, since $\Sigma_n \rightarrow \Sigma$ converge smoothly on compact sets, $\Sigma_n^a \rightarrow \Sigma^a$ smoothly. Hence, by Gauss-Bonnet, Σ_n^a and Σ^a must have same genus. By above, this implies for sufficiently large n , Σ_n and Σ must have the same genus. However, this contradicts with our assumption that Σ_n and Σ have different genus for any n . Therefore, this implies that for sufficiently small $\epsilon' > 0$, Σ_t is homeomorphic to $\Sigma \cup S_\alpha$ for $0 < t < \epsilon'$. Hence, the proof of Step 1 follows assuming the following claim.

Claim 2: There exists $a_\Gamma > 0$ such that for sufficiently large n , $\Sigma_n \cap R_{a_\Gamma}$ has no genus, i.e. $\Sigma_n \cap R_{a_\Gamma} \simeq \Gamma \times (0, a_\Gamma)$.

Proof of the Claim 2: Assume on the contrary that for $a_n \searrow 0$, there exists a subsequence $\overline{\Sigma_n \cap R_{a_n}}$ with positive genus. Recall that $\overline{\Sigma_n} = \Sigma_n \cup \Gamma_n$ is separating in $\mathbb{H}^2 \times \mathbb{R}$, and let Δ_n be the component of $\mathbb{H}^2 \times \mathbb{R} - \overline{\Sigma_n}$ which contains the bridge α . Since $\Sigma_n \cap R_{a_n}$ has positive genus, then $\Delta_n \cap R_{a_n}$ must be a nontrivial handlebody, i.e. not a 3-ball. Hence, there must be a point p_n in $\Sigma_n \cap R_{a_n}$ where the normal vector $v_{p_n} = \langle 0, 1, 0 \rangle$ pointing inside Δ_n by Morse Theory. By genericity of Morse functions, we can modify the ∞ point in $\partial_\infty \mathbb{H}^2$ if necessary, to get y -coordinate as a Morse function.

Let $p_n = (x_n, y_n, z_n)$. By construction $y_n \rightarrow 0$ as $y_n < a_n$. Consider the isometry $\psi_n(x, y, z) = (\frac{x-x_n}{y_n}, \frac{y}{y_n}, z - z_n)$ which is a translation by $-(x_n, 0, 0)$ first by a parabolic isometry of \mathbb{H}^2 , and translation by $-(0, 0, z_n)$ in \mathbb{R} direction. Then, by composing with the hyperbolic isometry $(x, y, z) \rightarrow (\frac{x}{y_n}, \frac{y}{y_n}, z)$, we get the isometry ψ_n of $\mathbb{H}^2 \times \mathbb{R}$. Then, consider the sequence of area minimizing surface $\Sigma'_n = \psi_n(\Sigma_n)$ and $p'_n = \psi_n(p_n) = (0, 1, 0)$. Let $\Gamma'_n = \psi_n(\Gamma_n) = \partial_\infty \Sigma'_n$. After passing to a subsequence, we get the limits $\Sigma'_n \rightarrow \Sigma'$, $p'_n \rightarrow p' = (0, 1, 0) \in \Sigma'$, and $\Gamma'_n \rightarrow \Gamma'$. Note also that by construction the normal vector to area minimizing surface Σ' at p' is $v_{p_n} \rightarrow v'_p = \langle 0, 1, 0 \rangle$ pointing inside Δ' .

Consider $\Gamma' = \lim \Gamma'_n$. Let L_z be the z -axis in $\partial_\infty \mathbb{H}^2 \times \mathbb{R}$, i.e. $L_z = \{(0, 0, t) \mid t \in \mathbb{R}\}$. Let $\Gamma' \cap L_z = \{(0, 0, -c), (0, 0, +c), (0, 0, c_1), \dots, (0, 0, c_k)\}$. Notice that as Γ tall curve, $|c_i - c_j| > \pi$ for any $i \neq j$. Recall that $\partial\alpha = \{(0, 0, -c), (0, 0, +c)\}$. Hence, by construction of Γ'_n , we get $\Gamma' = \beta \cup L_{c_1} \cup \dots \cup L_{c_k}$ where L_{c_i} is the horizontal line in $\partial_\infty \mathbb{H}^2 \times \mathbb{R}$ with L_{c_i} , and β is the components of Γ' near α (See Figure 3 left). In particular, in

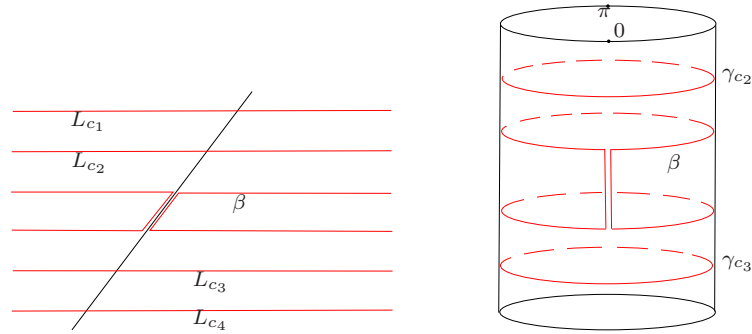

FIGURE 3. $\Gamma' \subset \partial_\infty \mathbb{H}^2 \times \mathbb{R}$ is pictured in upper half space model and cylinder model for $\mathbb{H}^2 \times \mathbb{R}$.

cylinder model for $\mathbb{H}^2 \times \mathbb{R}$, L_{c_i} is the horizontal circle $\gamma_{c_1} = S^1 \times c_1$ in $\partial_\infty \mathbb{H}^2 \times \mathbb{R}$, and β is a tall rectangle $\beta = \partial R$ where $R = [\delta, 2\pi - \delta] \times [-c, c]$ assuming $\alpha = \{0\} \times [-c', c']$ (See Figure 3 right). Here, the limit area minimizing surface Σ' is nonempty, as $(0, 0, 1) \in \Sigma'$ by construction. δ depends on the comparison between $y_n \searrow 0$ and $d(\Gamma_n, \alpha) \searrow 0$. As Σ' does not escape infinity, we make sure that such a $\delta < \pi$ exists. Indeed, $\delta > 0$ can be explicitly computed by using the fact that there is a unique minimal surface P_β in $\mathbb{H}^2 \times \mathbb{R}$ containing $(0, 0, 1)$ with $\partial_\infty P_\beta = \beta = \partial R$ where $R = [\delta, 2\pi - \delta] \times [-c, c]$ is a rectangle in $\partial_\infty \mathbb{H}^2 \times \mathbb{R}$ with height $2c > \pi$ by Lemma 2.11.

Σ' bounds a unique area minimizing surface with $\Sigma' = P_\beta \cup P_{c_1} \cup \dots \cup P_{c_k}$ where P_β is the unique area minimizing surface with $\partial_\infty P_\beta = \beta$ by Lemma 2.11, and P_{c_i} is the horizontal plane $\mathbb{H}^2 \times \{c_i\}$ in $\mathbb{H}^2 \times \mathbb{R}$ with $\partial_\infty P_{c_i} = \gamma_{c_i}$. This is because $|c_i - c_j| > \pi$, there is no connected minimal surface with asymptotic boundary contains more than one component of Γ' [NSSST]. This implies each component of Γ' bounds a component of Σ' . Since each component is uniquely minimizing, Σ' is a uniquely minimizing surface with $\partial_\infty \Sigma' = \Gamma'$.

Hence, by construction $p' = (0, 0, 1)$ is on P_β component of Σ' . Recall that the normal vector v'_p points inside of Δ' which is the component of $\mathbb{H}^2 \times \mathbb{R} - \Sigma'$ containing α . However, P_β is a plane, and the normal vector v'_p points outside Δ' not inside. This is a contradiction. The proof of the Claim 2 follows. \square

Step 2: For all but countably many $0 < t < \epsilon'$, Γ_t bounds a unique area minimizing surface in $\mathbb{H}^2 \times \mathbb{R}$.

Proof: We will adapt the proof of Theorem 2.21 to this case. The family of tall curves $\{\Gamma_t \mid t \in (0, \epsilon)\}$ foliates \widehat{N} where $\partial \widehat{N} = \Gamma_\epsilon \cup \Gamma$, and $\Gamma_0 = \Gamma \cup \alpha$. In particular, for any $0 < t_1 < t_2 < \epsilon$, $\Gamma_{t_1} \cap \Gamma_{t_2} = \emptyset$. If Σ_t is an area minimizing surface in $\mathbb{H}^2 \times \mathbb{R}$, then $\Sigma_{t_1} \cap \Sigma_{t_2} = \emptyset$ too, by Lemma 2.18. By Lemma 2.19, if Γ_s does not bound a unique area minimizing surface Σ_s , then we can define two disjoint canonical minimizing Σ_s^+ and Σ_s^- with $\partial_\infty \Sigma_s^\pm = \Gamma_s$. Then, by the proof of Theorem 2.21, for all but countably many $s \in [0, \epsilon']$, Γ_s bounds a unique area minimizing surface. Step 2 follows. \square

Steps 1 and 2 implies the existence of smooth curve Γ_t with $0 < t < \epsilon'$ for any ϵ' , where Γ_t bounds a unique area minimizing surface Σ_t , and Σ_t has the desired topology, i.e. $\Sigma_t \simeq \Sigma \cup S_\alpha$. \square

4. THE CONSTRUCTION OF AREA MINIMIZING SURFACES OF ARBITRARY TOPOLOGY IN $\mathbb{H}^2 \times \mathbb{R}$

Now, we are going to prove the main existence result for properly embedded area minimizing surfaces in $\mathbb{H}^2 \times \mathbb{R}$ with arbitrary topology. In this part, we will mainly follow the techniques in [MW] and [Co1]. In particular, for a given surface S , we will start with a compact exhaustion of S , $S_1 \subset S_2 \subset \dots \subset S_n \subset \dots$, and by using the bridge principle proved in the previous section, we inductively construct the area minimizing surface with the desired topology.

In particular, by [FMM], for any open orientable surface S , there exists a simple exhaustion. A simple exhaustion $S_1 \subset S_2 \subset \dots \subset S_n \subset \dots$ is the compact exhaustion with the following properties: S_1 is a disk, and $S_{n+1} - S_n$ would contain a *unique nonannular piece* which is either a cylinder with a handle, or a pair of pants by [FMM] (See Figure 4).

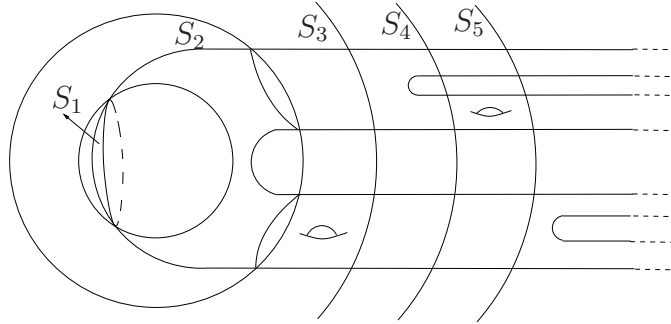

FIGURE 4. In the simple exhaustion of S , S_1 is a disk, and $S_{n+1} - S_n$ contains a unique nonannular part, which is a pair of pants (e.g. $S_4 - S_3$), or a cylinder with a handle (e.g. $S_3 - S_2$).

First, we need a lemma which will be used in the construction.

Lemma 4.1. *Let $R = [-1, 1] \times [-4\pi, 4\pi]$ and $R_c = [-c, c] \times [-2\pi, 2\pi]$ be rectangles in $\partial_\infty \mathbb{H}^2 \times \mathbb{R}$ where $0 < c < 1$. Let $\gamma = \partial R$, $\gamma_c = \partial R_c$ and $\Gamma_c = \gamma \cup \gamma_c$. Then, there exists $\rho > 0$ such that for any $0 < c \leq \rho$, the area minimizing surface Σ_c with $\partial_\infty \Sigma_c = \Gamma_c$ is $P \cup P_c$ where P and P_c are the unique area minimizing surfaces with $\partial_\infty P = \gamma$ and $\partial_\infty P_c = \gamma_c$.*

Proof: If the area minimizing surface Σ_c is not connected, then it must be $P \cup P_c$ because the rectangles γ and γ_c bounds a unique area minimizing surfaces P and P_c respectively by Lemma 2.11. Hence, we assume on the contrary that the area minimizing surface Σ_c is connected for any $0 < c < 1$. We abuse the notation and say $\Sigma_n = \Sigma_{\frac{1}{n}}$. Consider the sequence $\{\Sigma_n\}$. By Lemma 2.8, we get a convergent subsequence, and limiting area minimizing surface Σ .

Let $Q = [-\frac{1}{2}, \frac{1}{2}] \times [-3\pi, 3\pi]$ be another rectangle in $\partial_\infty \mathbb{H}^2 \times \mathbb{R}$, and let T be the unique area minimizing surface in $\mathbb{H}^2 \times \mathbb{R}$ with $\partial_\infty T = \partial Q$. Since by assumption, Σ_n is connected, and \bar{T} separates the boundary components of Σ_n , γ_n and γ , then $T \cap \Sigma_n \neq \emptyset$ for any $n > 2$. By construction, this implies $\Sigma \cap T \neq \emptyset$. However, when $n \rightarrow \infty$, $\Gamma_n \rightarrow \gamma$, and γ bounds a unique area minimizing surface P . In other words, Σ must be P and $P \cap T = \emptyset$. This is a contradiction. \square

Remark 4.2 (Euler Characteristics). Recall that if T_k^g is an orientable surface of genus g , and k boundary components, then $\chi(T_k^g) = 2 - 2g - k$. Adding a bridge (a 1-handle in topological terms) to a surface decrease the Euler Characteristics by one. On the other hand, if you add a bridge to a surface where the endpoints of the bridge are in the same boundary component, then the number of boundary components increases by one. If you add a bridge whose endpoints are in the different boundary components, then the number of boundary components decreases by one (See Figure 2).

Now, adding a bridge to the same boundary component of a surface would increase the number of ends. In other words, let S_{n+1} obtained from S_n by attaching a bridge (1-handle) to S_n whose endpoints are in the same boundary component of ∂S_n . Then, $\chi(S_{n+1}) = \chi(S_n) - 1$, $g(S_n) = g(S_{n+1})$ and $\sharp(\partial S_{n+1}) = \sharp(\partial S_n) + 1$ where \sharp represent the number of components.

If we want to increase the genus, first add a bridge α_n whose endpoints are in the same component of ∂S_n , and get $S'_n \simeq S_n \natural S_{\alpha_n}$ where $S_n \natural S_{\alpha_n}$ represents the surface obtained by adding a bridge (thin strip) to S_n along α_n . Then, by adding another bridge α'_n whose endpoints are in different components of S'_n , one get $S_{n+1} \simeq S'_n \natural S_{\alpha'_n}$. Hence, $\chi(S_{n+1}) = \chi(S_n) - 2$, and the number of boundary components are same. This implies if $S_n \simeq T_k^g$, then $S_{n+1} \simeq T_k^{g+1}$. This shows that S_{n+1} is obtained by attaching a cylinder with handle to S_n , i.e. $S_{n+1} - S_n$ is a cylinder with handle.

Now, we are ready to prove the existence result for properly embedded area minimizing surfaces in $\mathbb{H}^2 \times \mathbb{R}$ with arbitrary topology.

Theorem 4.3. *Any open orientable surface S can be embedded in $\mathbb{H}^2 \times \mathbb{R}$ as an area minimizing surface Σ .*

Proof: Let S be an open orientable surface. Now, we inductively construct an area minimizing surface Σ in $\mathbb{H}^2 \times \mathbb{R}$ which is diffeomorphic to S . Let $S_1 \subset S_2 \subset \dots \subset S_n \subset \dots$ be a simple exhaustion of S , i.e. $S_{n+1} - S_n$ contains a unique nonannular piece which is either a cylinder with a handle, or a pair of pants.

By following the simple exhaustion, we will define a sequence of area minimizing surfaces Σ_n so that Σ_n is homeomorphic to S_n . Furthermore,

the sequence Σ_n will induce the same simple exhaustion for the limiting surface Σ . Hence, we will get an area minimizing surface Σ which is homeomorphic to the given surface S .

Now, we will follow the idea described in Remark 4.2. Note that we are allowed to use only vertical bridges.

Let $R = [-\frac{\pi}{2}, +\frac{\pi}{2}] \times [0, 10]$ be a tall rectangle in $\partial_\infty \mathbb{H}^2 \times \mathbb{R}$ and let Σ_1 be the unique area minimizing surface with $\partial_\infty \Sigma_1 = \partial R$. Clearly, $\Sigma_1 \simeq S_1$.

By Remark 4.2, adding one bridge β_{n+1} to Σ_n where the endpoints of β_{n+1} are in the same component of $\Gamma_n = \partial_\infty \Sigma_n$ would suffice to increase the number of ends of Σ_n by one. This operation corresponds to *adding a pair of pants to the surface*. Similarly by Remark 4.2, adding two bridges successively so that the endpoints of the first bridge are in the same component, and the endpoints of the second bridge are different components (components containing the opposite sides of the first bridge), will increase the genus, and keep the number of the ends same. This operation will correspond to *adding a cylinder with handle to the surface*.

Now, we continue inductively to construct the sequence $\{\Sigma_n\}$ dictated by the simple exhaustion (See Figure 4). There are two cases: $S_{n+1} - S_n$ contains a pair of pants, or a cylinder with handle.

Pair of pants case. Assume that $S_{n+1} - S_n$ contains a pair of pants. Let the pair of pants attached to the component γ in ∂S_n . Let γ' be the corresponding component of $\Gamma_n = \partial_\infty \Sigma_n$. By construction, γ' bounds a disk D in $\partial_\infty \mathbb{H}^2 \times \mathbb{R}$ with $D \cap \Gamma_n = \gamma'$. Let $\beta_n = \{c_n\} \times [0, 10]$ be a vertical segment where $\beta_n \subset D$. Since Σ_n bounds a unique area minimizing surface by construction, and $\beta_n \perp \Gamma_n$, we can apply Theorem 3.2, and get an area minimizing surface Σ_{n+1} where Σ_{n+1} is homeomorphic to S_{n+1} . \square

Cylinder with handle case. Assume that $S_{n+1} - S_n$ contains a cylinder with handle. Again, let the pair of pants attached to the component γ in ∂S_n . Let γ' be the corresponding component of $\Gamma_n = \partial_\infty \Sigma_n$. By construction, γ' bounds a disk D in $\partial_\infty \mathbb{H}^2 \times \mathbb{R}$ with $D \cap \Gamma_n = \gamma'$. Let β_n be a vertical segment $\{c_n\} \times [0, 10]$ such that $(c_n - \epsilon_n, c_n + \epsilon_n) \times \mathbb{R} \cap D \subset R$ for some $\epsilon_n > 0$. Again, we apply Theorem 3.2 for β_n and Σ_n , and get an area minimizing surface Σ'_{n+1} . Say $\Gamma'_{n+1} = \partial_\infty \Sigma'_{n+1}$. We can choose the thickness of the bridge along β_n as small as we want. So, we can assume that the thickness of the bridge along β_n is smaller than $\frac{\rho \cdot \epsilon_n}{4}$ where $\rho > 0$ is the constant in Lemma 4.1.

Now, consider the rectangle $Q_n = [c_n - \frac{\rho \cdot \epsilon_n}{2}, c_n + \frac{\rho \cdot \epsilon_n}{2}] \times [-6\pi, -4\pi]$ (See Figure 5). Let T_n be the unique area minimizing surface in $\mathbb{H}^2 \times \mathbb{R}$ with $\partial_\infty T_n = \partial Q_n$ by Lemma 2.11. Let $\hat{\Gamma}_{n+1} = \Gamma'_{n+1} \cup \partial Q_n$. We claim that $\hat{\Gamma}_{n+1}$ bounds a unique area minimizing surface $\hat{\Sigma}_{n+1}$ in $\mathbb{H}^2 \times \mathbb{R}$ and

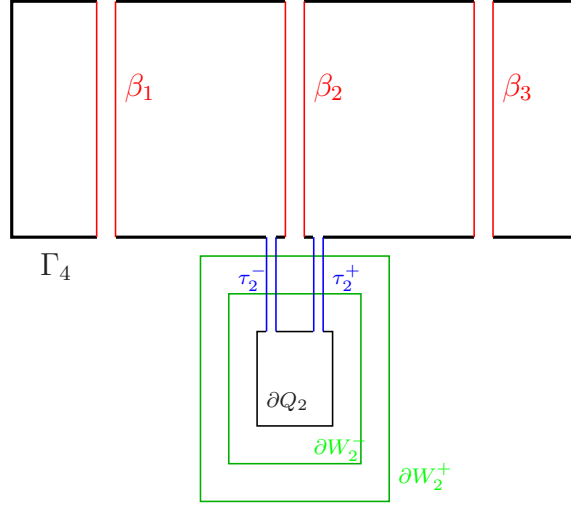

FIGURE 5. In the figure above, $S_2 - S_1$ is a pair of pants, and $S_3 - S_2$ is a cylinder with handle. When constructing Σ_3 , β_2 is attached to the corresponding component in Γ_2 , then a hanger, the pair of vertical bridges τ_2^\pm and a thin rectangle Q_n , is added to obtain the cylinder with handle. ∂W_2^\pm is needed to show that $\Sigma_2' \cup T_2$ is uniquely area minimizing surface to apply Theorem 3.2.

$\widehat{\Sigma}_{n+1} = \Sigma'_{n+1} \cup T_n$. Notice that Σ'_{n+1} and T_n are uniquely minimizing surfaces. Hence, if we show that $\widehat{\Gamma}_{n+1}$ cannot bound any connected area minimizing surface, then we are done.

Assume that $\widehat{\Gamma}_{n+1}$ bounds a connected area minimizing surface $\widehat{\Sigma}_{n+1}$. Consider the pair of rectangles $W_n^+ = [c_n - \epsilon_n, c_n + \epsilon_n] \times [-9\pi, -\pi]$ and $W_n^- = [c_n - \rho.\epsilon_n, c_n + \rho.\epsilon_n] \times [-7\pi, -3\pi]$. Let $\Upsilon_n = \partial W_n^+ \cup \partial W_n^-$. Then, by Lemma 4.1, the uniquely minimizing surface F_n with $\partial_\infty F_n = \Upsilon_n$ must be $P_n^+ \cup P_n^-$ where P_n^\pm is the unique area minimizing surface with $\partial_\infty P_n^\pm = \partial W_n^\pm$. As $\widehat{\Gamma}_{n+1} \cap \Upsilon_n = \emptyset$, the area minimizing surfaces $\widehat{\Gamma}_{n+1}$ and F_n must be disjoint by Lemma 2.18 (See Figure 5). On the other hand, the area minimizing surface $F_n = P_n^+ \cup P_n^-$ separates the components, Γ'_{n+1} and ∂Q_n , of $\widehat{\Gamma}_{n+1}$. Since $\widehat{\Gamma}_{n+1} \cap F_n = \emptyset$, this implies $\widehat{\Sigma}_{n+1}$ disconnected. This proves that $\widehat{\Sigma}_{n+1} = \Sigma'_{n+1} \cup T_n$ is the unique area minimizing surface with $\partial_\infty \widehat{\Sigma}_{n+1} = \widehat{\Gamma}_{n+1}$.

Now, let $\tau_n^+ = \{c_n + \frac{\rho.\epsilon_n}{4}\} \times [-4\pi, 0]$ be the vertical arc segment in $\partial_\infty \mathbb{H}^2 \times \mathbb{R}$. When we apply Theorem 3.2 to the uniquely minimizing surface $\widehat{\Sigma}_{n+1}$ and the arc τ_n^+ , we obtain a new uniquely minimizing surface $\widehat{\Sigma}'_{n+1}$. Similarly, let $\tau_n^- = \{c_n - \frac{\rho.\epsilon_n}{4}\} \times [-4\pi, 0]$. Again, we apply Theorem 3.2 for $\widehat{\Sigma}'_{n+1}$ and τ_n^- , we obtain another uniquely minimizing surface Σ_{n+1} .

Furthermore, we will assume that the both bridges along τ_n^+ and τ_n^- have thickness less than $\frac{\rho \cdot \epsilon_n}{4}$. The pair of vertical bridges along τ_n^\pm with the thin rectangle Q_n looks like a hanging picture frame (See Figure 5).

By construction, Σ_{n+1} is homeomorphic to S_{n+1} . In particular, we achieved to add a cylinder with handle to Σ_n along the corresponding component γ' in Γ_n . This finishes the description of the inductive step, when $S_{n+1} - S_n$ contains a cylinder with handle. \square

The Limit and the Properly Embeddedness: Notice that in the bridge principle at infinity (Theorem 3.2), as the thickness of the bridge α goes to 0, the height of the strip S_α goes to 0, too. In particular, let $\Gamma, \Sigma, \alpha, \Gamma_t, \Sigma_t$ be as in the statement of Theorem 3.2. Let $S_\alpha^t = \Sigma_t \cap N_\epsilon(\alpha)$ where $N_\epsilon(\alpha)$ is the sufficiently small neighborhood of α in the compactification $\overline{\mathbb{H}^2 \times \mathbb{R}}$. Then, as $t \searrow 0$, then $d(L_z, S_\alpha^t) \rightarrow \infty$ where L_z is the vertical line through origin in $\mathbb{H}^2 \times \mathbb{R}$, i.e. $L_z = \{0\} \times \mathbb{R}$. This is because as $t \searrow 0$, $\Sigma_t \rightarrow \Sigma$.

Let $\widehat{B}_r = B_r(0) \times [-20, 20]$ be compact region in $\mathbb{H}^2 \times \mathbb{R}$ where $B_r(0)$ is the r ball around origin in \mathbb{H}^2 . As $t_n \searrow 0$, then the thickness of the bridge in Σ_n near β_n (or τ_n^\pm) goes to 0. Hence, by choosing $t_n < \frac{1}{10n^2}$ sufficiently small, we can make sure that $d(L_z, S_{\beta_n}^{t_n}) > r_n$ and $d(L_z, S_{\tau_n^\pm}^{t_n}) > r_n$ for a sequence $r_n \nearrow \infty$. This implies that for $m \geq n$, $\widehat{B}_{r_n} \cap \Sigma_m \simeq S_n$, as the thickness (and hence height) of the bridges β_n and ζ_n goes to 0.

Now, Σ_n is a sequence of absolutely area minimizing surfaces in $\mathbb{H}^2 \times \mathbb{R}$. Let $\Sigma'_n = \widehat{B}_{r_n} \cap \Sigma_n$. Like in Theorem 2.8, by using a diagonal sequence argument, we get a limiting surface Σ in $\mathbb{H}^2 \times \mathbb{R}$ where the convergence is smooth on compact sets [Fe]. Σ is an area minimizing surface in $\mathbb{H}^2 \times \mathbb{R}$ as it is the limit of area minimizing surfaces. Notice that for $m \geq n$, $\widehat{B}_{r_n} \cap \Sigma_m \simeq S_n$ and the convergence is smooth on compact sets. This implies $\Sigma \cap \widehat{B}_{r_n} \simeq S_n$ for any n , and hence $\Sigma \simeq S$.

Finally, Σ is properly embedded in $\mathbb{H}^2 \times \mathbb{R}$ as for any compact set $K \subset \mathbb{H}^2 \times \mathbb{R}$, there exists $r_n > 0$ with $K \subset \widehat{B}_{r_n}$, and $\widehat{B}_{r_n} \cap \Sigma \simeq S_n$ which is compact. The proof of the theorem follows. \square

Remark 4.4 (Alternative construction for finite topology). There is a simpler construction for open orientable surfaces of finite topology as follows: Let S be open orientable surface of genus g and k ends. Construct the area minimizing surface Σ_1 which is topologically a disk as in Figure 6-Left. For $k+1$ ends, add k vertical bridges $\beta_1, \beta_2, \dots, \beta_k$ to Σ_1 as in the Figure 6-Right. Then, for genus g , add g pairs of vertical bridges ζ_i and ζ'_i successively as in Figure 6-Right. Hence, the final surface Σ is an area minimizing surface of genus g and $k+1$ ends.

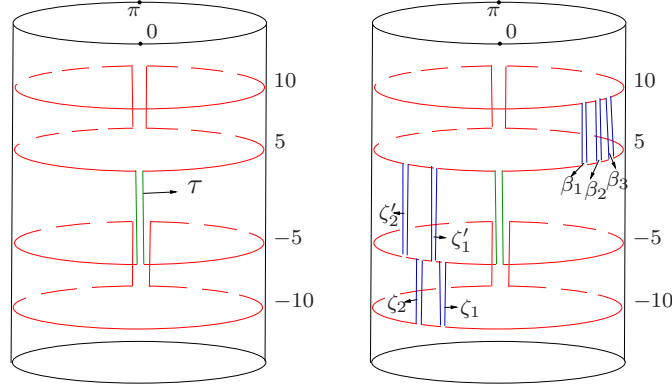

FIGURE 6. In the left, we have the tall curve Γ_1 which bounds the area minimizing surface $\Sigma_1 \sim P^+ \cup P^- \cup S_\tau$. In the right, we first add bridges β_1, \dots, β_k to Σ to increase the number of ends by k (here for $k = 3$). Then, we add g pairs of bridges $\zeta_1, \zeta_1', \dots, \zeta_g, \zeta_g'$ to increase the genus (here $g = 2$). Hence, Σ is a genus 2 surface with 4 ends.

5. ASYMPTOTIC PLATEAU PROBLEM FOR MINIMAL SURFACES

So far, we dealt with the questions on area minimizing surfaces in $\mathbb{H}^2 \times \mathbb{R}$. If we relax the question from "existence of area minimizing surfaces" to "existence of minimal surfaces", the picture completely changes. A simple example to show this change is the following: Let $\Gamma = \gamma_1 \cup \gamma_2$ where $\gamma_i = \partial_\infty \mathbb{H}^2 \times \{c_i\}$ and $|c_1 - c_2| < \pi$. Then clearly, Γ is a short curve and it bounds a complete minimal catenoid \mathcal{C}_d by [NSST] (See also appendix for further discussion on catenoids). On the other hand, the pair of geodesic planes, $\mathbb{H}^2 \times \{c_1\} \cup \mathbb{H}^2 \times \{c_2\}$, also bounds $\Gamma = \gamma_1 \cup \gamma_2$. However, there is no area minimizing surface Σ with $\partial_\infty \Sigma = \gamma_1 \cup \gamma_2$ by Theorem 2.13. This means neither catenoid, nor pair of geodesic planes are area minimizing, but just minimal surfaces. Hence, the following question becomes very interesting.

Question: [Asymptotic Plateau Problem for Minimal Surfaces]

For which curves Γ in $\partial_\infty \mathbb{H}^2 \times \mathbb{R}$, there exists a minimal surface S in $\mathbb{H}^2 \times \mathbb{R}$ with $\partial_\infty S = \Gamma$.

Recall that by Theorem 2.3, for any short curve γ in $\partial_\infty \mathbb{H}^2 \times \mathbb{R}$ containing a thin tail, there is no complete minimal surface S in $\mathbb{H}^2 \times \mathbb{R}$ with $\partial_\infty S = \gamma$. So, this result suggest that the minimal surface case is similar to the area minimizing surface case.

On the other hand, unlike the area minimizing surface case, it is quite easy to construct short curves with more than one component, bounding minimal surfaces in $\mathbb{H}^2 \times \mathbb{R}$. Let $\Gamma = \gamma_1 \cup \dots \cup \gamma_n$ be a finite collection

of disjoint tall curves γ_i . Even though every component γ_i is tall, because of the vertical distances between the components γ_i and γ_j , the height $h(\Gamma)$ can be very small. So, Γ itself might be a short curve, even though every component is a tall curve. For each component γ_i , our existence theorem (Theorem 2.13) already gives an area minimizing surface Σ_i with $\partial_\infty \Sigma_i = \gamma_i$. Hence, the surface $\widehat{S} = \Sigma_1 \cup \dots \cup \Sigma_n$ is automatically a minimal surface with $\partial_\infty \widehat{S} = \Gamma$. By using this idea, for any height $h_0 > 0$, we can trivially produce short curves Γ with height $h(\Gamma) = h_0$ by choosing the components sufficiently close. e.g. the pair of horizontal geodesic planes $\mathbb{H}^2 \times \{c_1\} \cup \mathbb{H}^2 \times \{c_2\}$ with $|c_1 - c_2| = h_0$.

Naturally, next question would be what if Γ has only one component. Does Γ need to be a tall curve to bound a minimal surface in $\mathbb{H}^2 \times \mathbb{R}$? The answer is again no. Now, we will also construct *simple closed short curves* which bounds complete minimal surfaces in $\mathbb{H}^2 \times \mathbb{R}$. The following result with the observation above shows that the asymptotic Plateau problem for minimal surfaces is very different from the asymptotic Plateau problem for area minimizing surfaces. Indeed, this more general question seems rather difficult.

Theorem 5.1. *For any $h_0 > 0$, there exists a nullhomotopic simple closed curve Γ with height $h(\Gamma) = h_0$ such that there exists a minimal surface S in $\mathbb{H}^2 \times \mathbb{R}$ with $\partial_\infty S = \Gamma$.*

Proof: For $h_0 > \pi$, we have tall rectangles with height h_0 . So, we will assume $0 < h_0 \leq \pi$. Consider the rectangles $R^+ = [s, \frac{\pi}{2}] \times [-10, 10]$ and $R^- = [-\frac{\pi}{2}, -s] \times [-10, 10]$. Consider another rectangle $Q = [-s, s] \times [0, h_0]$. Consider the area minimizing surfaces P^+ and P^- with $\partial_\infty P^\pm = \partial R^\pm$. Let $\Gamma = (\partial R^+ \cup \partial R^-) \Delta \partial Q$ where Δ represents symmetric difference (See Figure 7). Notice that $h(\Gamma) = h_0$. We claim that there exists a complete embedded minimal surface S in $\mathbb{H}^2 \times \mathbb{R}$ with $\partial_\infty S = \Gamma$.

Consider the minimal catenoid C_{h_0} with asymptotic boundary $S^1 \times \{0\} \cup S^1 \times \{h_0\}$ (If $h_0 = \pi$, take C_{h_0} to be the parabolic catenoid). Let φ_t be the isometry of $\mathbb{H}^2 \times \mathbb{R}$ which keeps \mathbb{R} coordinates same, fixes the geodesic l in \mathbb{H}^2 with $\partial_\infty l = \{0, \pi\}$. In particular, $\varphi_t|_{\mathbb{H}^2 \times \{c\}} : \mathbb{H}^2 \times \{c\} \rightarrow \mathbb{H}^2 \times \{c\}$. Furthermore, for any $p \in \mathbb{H}^2 \times \{c\}$, $\varphi_t(p) \rightarrow (0, c) \in \partial_\infty \mathbb{H}^2 \times \mathbb{R}$ as $t \searrow 0$ and $\varphi_t(p) \rightarrow (\pi, c) \in \partial_\infty \mathbb{H}^2 \times \mathbb{R}$ as $t \searrow \infty$. Now, we can choose sufficiently small $t > 0$, and $s > 0$ so that P^+ separates $\varphi_t(C_{h_0}) = C_{h_0}^t$ into 4 disks (See Figure 7). In other words, there is a component Δ in $\mathbb{H}^2 \times \mathbb{R} - (P^+ \cup P^- \cup C_{h_0}^t)$ such that $\partial_\infty \Delta = Q$.

Now, let Ω^+ be the component of $\mathbb{H}^2 \times \mathbb{R} - P^+$ such that $\partial_\infty \Omega^+ = R^+$. Similarly, let Ω^- be the component of $\mathbb{H}^2 \times \mathbb{R} - P^-$ such that $\partial_\infty \Omega^- = R^-$. Let $X = \mathbb{H}^2 \times \mathbb{R} - (\Omega^+ \cup \Omega^- \cup \Delta)$. Hence, X is a mean convex domain in $\mathbb{H}^2 \times \mathbb{R}$ with $\partial_\infty X = \partial_\infty \mathbb{H}^2 \times \mathbb{R} - \text{int}(R^+ \cup R^- \cup Q)$. Hence, $\Gamma \subset \partial_\infty X$.

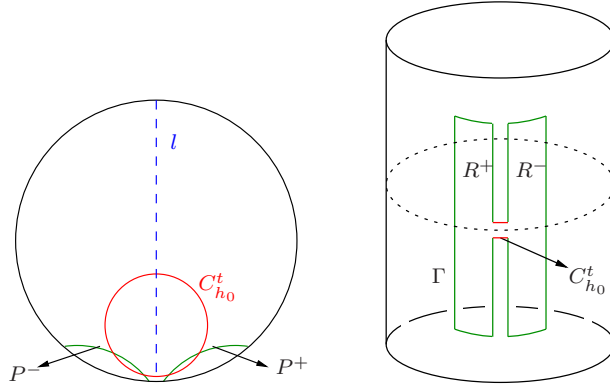

FIGURE 7. In the left, the horizontal slice $\mathbb{H}^2 \times \{\frac{h_0}{2}\}$ is given. In the right, $\Gamma \subset \partial_\infty \mathbb{H}^2 \times \mathbb{R}$ is pictured.

Now, let $B_n(0)$ be the ball of radius n in \mathbb{H}^2 with center 0. Let $D_n = B_n(0) \times [-20, 20]$. Let $\widehat{D}_n = D_n \cap X$. Let Γ_n be the radial projection of Γ to $\partial \widehat{D}_n$. Let S_n be the area minimizing surface in \widehat{D}_n with $\partial S_n = \Gamma_n$. Since \widehat{D}_n is mean convex, S_n is a smooth embedded surface in \widehat{D}_n . Again by using Lemma 2.8, we get an area minimizing surface S in X . By using similar ideas in Theorem 2.13 - Step 1, it can be showed that $\partial_\infty S = \Gamma$. While S is an area minimizing surface in X , it is just a minimal surface in $\mathbb{H}^2 \times \mathbb{R}$. The proof follows. \square

6. FINAL REMARKS

6.1. Area Minimizing Surfaces.

In Section 2, we studied the asymptotic Plateau problem in $\mathbb{H}^2 \times \mathbb{R}$ for a finite collection of disjoint simple closed curves Γ in $\partial_\infty \mathbb{H}^2 \times \mathbb{R}$, and gave a fairly complete solution. By following the standard method [An], we defined a sequence of compact area minimizing surfaces $\{\Sigma_n\}$ in $\mathbb{H}^2 \times \mathbb{R}$ with $\partial \Sigma_n = \Gamma_n \rightarrow \Gamma$. Then like in \mathbb{H}^3 case, we aimed to get a limit area minimizing surface Σ with $\partial_\infty \Sigma = \Gamma$. However, as Theorem 2.3 points out, some parts of Σ_n might escape to infinity [ST]. On the other hand, when Γ is a tall curve, by using a barrier argument in Theorem 2.13, we were able to make sure that no piece of Σ_n sequence escapes to infinity, and Σ_n converges to an area minimizing surface Σ with $\partial_\infty \Sigma = \Gamma$. Hence, the following question becomes very interesting:

Question: *Let Γ be a finite collection of disjoint simple closed curves in $\partial_\infty \mathbb{H}^2 \times \mathbb{R}$. Let Σ_n be a sequence of compact area minimizing surfaces in $\mathbb{H}^2 \times \mathbb{R}$ with $\partial \Sigma_n \rightarrow \Gamma \subset \partial_\infty \mathbb{H}^2 \times \mathbb{R}$. If Γ is not a tall curve, what can be said about the limit area minimizing surface $\Sigma = \lim \Sigma_n$ and $\partial_\infty \Sigma$?*

Let Γ , Σ_n , and Σ be as in the question above. By [ST], thin tails obstruct a curve Γ to bound a minimal surface Σ in $\mathbb{H}^2 \times \mathbb{R}$. Hence, at first glance, one might think that if we trim out the *thin tails* from Γ , we get a collection of curves $\widehat{\Gamma}$ with $\partial_\infty \Sigma = \widehat{\Gamma}$. This is because by following the methods of [ST], it might be possible to show that near the thin tails of Γ , the sequence $\{\Sigma_n\}$ escapes to infinity (See Figure 8). Hence, we pose the following conjecture:

Conjecture 6.1. *Let Γ be a finite collection of disjoint simple closed curves in $\partial_\infty \mathbb{H}^2 \times \mathbb{R}$. Let Σ_n be a sequence of compact area minimizing surfaces in $\mathbb{H}^2 \times \mathbb{R}$ with $\partial \Sigma_n = \Gamma_n \rightarrow \Gamma$. If the area minimizing surface $\Sigma = \lim \Sigma_n$ is nonempty, then $\widehat{\Gamma} = \partial_\infty \Sigma$ is a tall curve with $\Gamma \Delta \widehat{\Gamma}$ is a collection of nullhomotopic short curves.*

Here, Δ represents the symmetric difference of sets, i.e. $A \Delta B = (A - B) \cup (B - A)$ and $\Gamma \Delta \widehat{\Gamma} = \gamma_1 \cup \dots \cup \gamma_n$ where $\gamma_i \subset \partial_\infty \mathbb{H}^2 \times (c_i, c_i + \pi)$ (See Figure 8). Intuitively, $\widehat{\Gamma}$ is *nearest tall curve* to Γ .

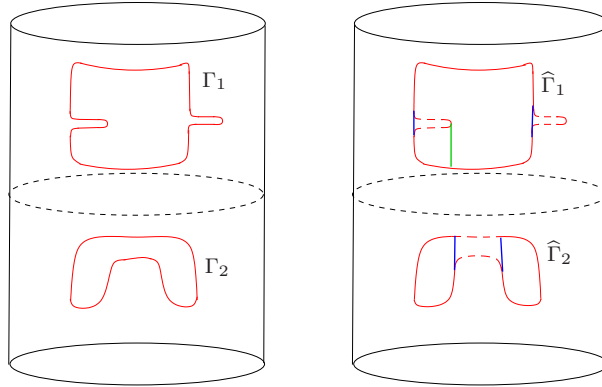

FIGURE 8. In the left, there are two curves Γ_1 and Γ_2 which are not tall. In the right, we give two examples tall curves $\widehat{\Gamma}_1$ and $\widehat{\Gamma}_2$ (blue modifications) obtained by removing thin tails (red dashes) from Γ_1 and Γ_2 . Notice that $\widehat{\Gamma}_1$ is not unique as there might be other modifications (green) to get a tall curve from Γ_1 .

6.2. Minimal Surfaces.

In Section 5, when we relax the question from "existence of area minimizing surfaces" to "existence of minimal surfaces", we see that the picture completely changes. While Theorem 2.13 shows that if $h(\Gamma) < \pi$, there is no area minimizing surface Σ in $\mathbb{H}^2 \times \mathbb{R}$ with $\partial_\infty \Sigma = \Gamma$, for any $h_0 > 0$, we constructed many examples of short curves Γ in $\partial_\infty \mathbb{H}^2 \times \mathbb{R}$ bounding complete embedded minimal surface in $\mathbb{H}^2 \times \mathbb{R}$ in Section 5.

Again, by Sa Earp and Toubiana's nonexistence theorem (Theorem 2.3), if Γ contains a thin tail, then there is no minimal surface S in $\mathbb{H}^2 \times \mathbb{R}$ with $\partial_\infty S = \Gamma$. Hence, the following classification problem is quite interesting and wide open.

Question: [Asymptotic Plateau Problem for Minimal Surfaces]

For which curves Γ in $\partial_\infty \mathbb{H}^2 \times \mathbb{R}$, there exists a minimal surface S in $\mathbb{H}^2 \times \mathbb{R}$ with $\partial_\infty S = \Gamma$.

6.3. H-surfaces.

The constant mean curvature surfaces could be considered as a natural candidate to generalize our results. Hence, consider the following question:

Question: *What kind of surfaces can be embedded in $\mathbb{H}^2 \times \mathbb{R}$ as a complete H -surface for $0 < H < \frac{1}{2}$?*

In other words, is it possible to embed any open orientable surface S in $\mathbb{H}^2 \times \mathbb{R}$ as a complete H -surface for $0 < H < \frac{1}{2}$? A positive answer to these question would be a generalization of Theorem 4.3 to H -surfaces.

Unfortunately, it is hardly possible to generalize our methods to this problem. By [NSST], if Σ is an H -surface with $\partial_\infty \Sigma \neq \emptyset$ and $\Sigma \cup \partial_\infty \Sigma$ is a C^1 surface up to the boundary, then $\partial_\infty \Sigma$ must be a collection of a vertical line segments in $\partial_\infty \mathbb{H}^2 \times \mathbb{R}$. In particular, this implies the asymptotic Plateau problem practically has no solution for H -surfaces in $\mathbb{H}^2 \times \mathbb{R}$ since if Γ is a C^1 simple closed curve in $\partial_\infty \mathbb{H}^2 \times \mathbb{R}$, there is no H -surface Σ in $\mathbb{H}^2 \times \mathbb{R}$ where $\Sigma \cup \Gamma$ is a C^1 surface up to the boundary. Hence, because of this result, our methods for Theorem 4.3 cannot be generalized to this case. However, it might be possible to construct a complete H -surface Σ of any finite topology with only vertical ends, i.e. $\partial_\infty \Sigma$ consists of only vertical lines in $\partial_\infty \mathbb{H}^2 \times \mathbb{R}$.

6.4. Finite Total Curvature.

Our construction for area minimizing surfaces in $\mathbb{H}^2 \times \mathbb{R}$ with arbitrary topology produces surfaces of infinite total curvature. In [MMR], Martin, Mazzeo and Rodriguez recently showed that for any $g \geq 0$, there exists a complete, finite total curvature, embedded minimal surface Σ_{g,k_g} in $\mathbb{H}^2 \times \mathbb{R}$ with genus g and k_g ends for sufficiently large k_g . Even though this result is a great progress to construct examples of minimal surfaces of finite total curvature, the question of existence (or nonexistence) of minimal surfaces of finite total curvature with any finite topology is still a very interesting open problem.

It is well known that a complete, properly embedded, minimal surface in $\mathbb{H}^2 \times \mathbb{R}$ with finite total curvature has also finite topology [HR]. On the other hand, there are surfaces with finite topology which cannot be embedded in $\mathbb{H}^2 \times \mathbb{R}$ as a complete minimal surface with finite total curvature.

For example, by [HNST], a twice punctured torus cannot be embedded as a complete minimal surface with finite total curvature into $\mathbb{H}^2 \times \mathbb{R}$. Hence, the following question becomes very interesting:

Question: For which $g \geq 0$, and $k \geq 0$, there exists a complete embedded minimal surface S_k^g in $\mathbb{H}^2 \times \mathbb{R}$ with finite total curvature where S_k^g is an orientable surface of genus g with k ends?

7. APPENDIX: AREA MINIMIZING CATENOIDS IN $\mathbb{H}^2 \times \mathbb{R}$

In this section, we study the family of minimal catenoids \mathcal{C}_d described in [NSST], and show that for sufficiently large $d > 0$, a compact subsurface $S_d \subset \mathcal{C}_d$ near girth of the catenoid \mathcal{C}_d is an area minimizing surface.

First, we recall some results on the rotationally symmetric minimal catenoids \mathcal{C}_d [NSST, Prop.5.1]. Let (ρ, θ, z) represents the coordinates on $\mathbb{H}^2 \times \mathbb{R}$ with the metric $ds^2 = d\rho^2 + \sinh \rho d\theta^2 + dz^2$. Then

$$\mathcal{C}_d = \{(\rho, \theta, \pm \lambda_d(\rho)) \mid \rho \geq \sinh^{-1} d\} \text{ with } \lambda_d(\rho) = \int_{\sinh^{-1} d}^{\rho} \frac{d}{\sqrt{\sinh^2 x - d^2}} dx$$

Clearly, \mathcal{C}_d is obtained by rotating the generating curve γ_d about z -axis where $\gamma_d = \{(\rho, 0, \pm \lambda_d(\rho)) \mid \rho \geq \sinh^{-1} d\}$. The distance of the rotation axis to the catenoid \mathcal{C}_d is $\sinh^{-1} d$.

On the other hand, the asymptotic boundary of the catenoid \mathcal{C}_d is the a pair of circles of height $\pm h(d)$, i.e. $\partial_\infty \mathcal{C}_d = S^1 \times \{h(d)\} \cup S^1 \times \{-h(d)\} \subset \partial_\infty \mathbb{H}^2 \times \mathbb{R}$. Here, $h(d) = \lim_{\rho \rightarrow \infty} \lambda_d(\rho)$. By [NSST], $h(d)$ is monotone increasing function with $h(d) \searrow 0$ when $d \searrow 0$, and $h(d) \nearrow \frac{\pi}{2}$ when $d \nearrow \infty$. Hence, for any $d > 0$, the catenoid \mathcal{C}_d has height $2h(d) < \pi$ (See Figure 9).

Consider the minimal catenoid \mathcal{C}_d . We claim that for sufficiently large $d > 0$, the compact subsurfaces of \mathcal{C}_d near the girth of the catenoid is area minimizing. In particular, we prove the following:

Lemma 7.1. *Let $S_d^\rho = \mathcal{C}_d \cap \mathbb{H}^2 \times [-\lambda_d(\rho), +\lambda_d(\rho)]$ be a compact subsurface of \mathcal{C}_d . Then, for sufficiently large $d > 0$, there is a $\hat{\rho}(d)$ such that S_d^ρ is area minimizing surface where $\sinh^{-1} d < \rho < \hat{\rho}(d)$.*

Proof: Consider the upper half of the minimal catenoid \mathcal{C}_d with the following parametrization, $\varphi_d(\rho, \theta) = (\rho, \theta, \lambda_d(\rho))$ where $\rho \geq \sinh^{-1} d$. Hence, the area of S_d^ρ can be written as

$$|S_d^\rho| = 2 \int_0^{2\pi} \int_{\sinh^{-1} d}^{\rho} \sinh x \sqrt{1 + \frac{d^2}{\sinh^2 x - d^2}} dx d\theta$$

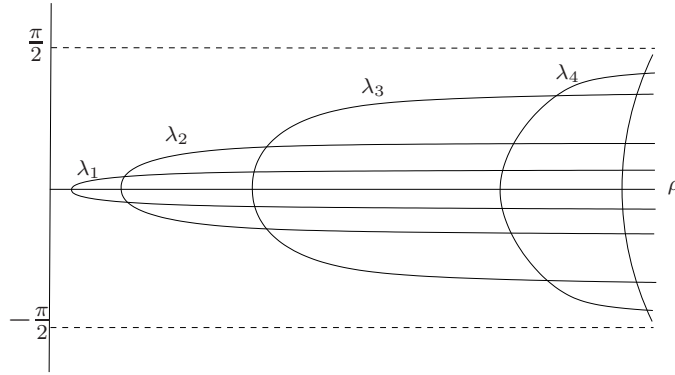

FIGURE 9. For $d_i < d_{i+1}$, λ_i represents the graphs of functions $\lambda_{d_i}(\rho)$ which are generating curves for the minimal catenoids \mathcal{C}_{d_i} . If $h(d) = \lim_{\rho \rightarrow \infty} \lambda_d(\rho)$, then $h(d)$ is monotone increasing with $h(d) \nearrow \frac{\pi}{2}$ as $d \rightarrow \infty$.

Notice that $\partial S_d^{\rho_o} = \gamma_{d,\rho_o}^+ \cup \gamma_{d,\rho_o}^-$ is a pair of round circles of radius ρ_o in \mathcal{C}_d where $\gamma_{d,\rho_o}^\pm = \{(\rho_o, \theta, \pm \lambda_d(\rho_o)) \mid 0 \leq \theta \leq 2\pi\}$. By [NSST], only minimal surfaces bounding $\gamma_{d,\rho_o}^+ \cup \gamma_{d,\rho_o}^-$ in $\mathbb{H}^2 \times \mathbb{R}$ are subsurfaces of minimal catenoids \mathcal{C}_d and a pair of closed horizontal disks $D_{d,\rho_o}^+ \cup D_{d,\rho_o}^-$ where $D_{d,\rho_o}^\pm = \{(\rho, \theta, \pm \lambda_d(\rho_o)) \mid 0 \leq \rho \leq \rho_o, 0 \leq \theta \leq 2\pi\}$. In other words, D_{d,ρ_o}^\pm is an hyperbolic disk of radius ρ_o with $z = \pm \lambda_d(\rho_o)$ in $\mathbb{H}^2 \times \mathbb{R}$. Recall that the area of an hyperbolic disk of radius ρ is equal to $2\pi(\cosh \rho - 1)$.

Hence, if we can show that $|S_d^\rho| < 2|D_\rho| = 4\pi(\cosh \rho - 1)$ for some $\rho > \sinh^{-1} d$, this implies $S_d^\rho \subset \mathcal{C}_d$ is an area minimizing surface in $\mathbb{H}^2 \times \mathbb{R}$, and we are done. Hence, we claim that there is a $\hat{\rho}(d) > \sinh^{-1} d$ such that $|S_d^\rho| < 2|D_\rho| = 4\pi(\cosh \rho - 1)$ where $\sinh^{-1} d < \rho < \hat{\rho}(d)$. In other words, we claim the following inequality:

$$I = \int_{\sinh^{-1} d}^{\rho} \sinh x \sqrt{1 + \frac{d^2}{\sinh^2 x - d^2}} dx < \cosh \rho - 1$$

Now, we separate the integral into two parts: $\int_{\sinh^{-1} d}^{\rho} = \int_{\sinh^{-1} d}^{\sinh^{-1}(d+1)} + \int_{\sinh^{-1}(d+1)}^{\rho}$, i.e. $I = I_1 + I_2$

For the first part, clearly

$$I_1 = \int_{\sinh^{-1} d}^{\sinh^{-1}(d+1)} \sinh x \sqrt{1 + \frac{d^2}{\sinh^2 x - d^2}} dx < d+1 \int_{\sinh^{-1} d}^{\sinh^{-1}(d+1)} \frac{\sinh x dx}{\sqrt{\sinh^2 x - d^2}}$$

By substituting $u = \cosh x$, we get

$$I_1 < (d+1) \int_{\sqrt{1+d^2}}^{\sqrt{1+(d+1)^2}} \frac{du}{\sqrt{u^2 - (1+d^2)}} = (d+1) \log [u + \sqrt{u^2 - (1+d^2)}] \Big|_{\sqrt{1+d^2}}^{\sqrt{1+(d+1)^2}}$$

This implies

$$I_1 < (d+1) \log \frac{\sqrt{1+(d+1)^2} + \sqrt{2d+1}}{\sqrt{1+d^2}}$$

For large $d \gg 0$, we obtain

$$(d+1) \log \frac{\sqrt{1+(d+1)^2} + \sqrt{2d+1}}{\sqrt{1+d^2}} \sim (d+1) \log \frac{(\sqrt{d} + \frac{1}{\sqrt{2}})^2}{d}$$

where $f(d) \sim g(d)$ represents $\frac{f(d)}{g(d)} \rightarrow 1$. After substituting $s = \sqrt{d}$ in the expression above, we get

$$\sim 2s^2 \log \frac{s + 1/\sqrt{2}}{s} \sim 2s \log(1 + \frac{1}{\sqrt{2}s})^s \sim \sqrt{2}s = \sqrt{2d}$$

Hence, $I_1 < \sqrt{2d}$ for large $d \gg 0$.

For the second integral, we have $I_2 = \int_{\sinh^{-1}(d+1)}^{\rho} \sinh x \sqrt{1 + \frac{d^2}{\sinh^2 x - d^2}} dx$.

Notice that the integrand $\sinh x \sqrt{1 + \frac{d^2}{\sinh^2 x - d^2}} = \frac{\sinh^2 x}{\sqrt{\sinh^2 x - d^2}}$. Hence, as

$\sinh x < \frac{e^x}{2}$ and $\sinh^2 x > \frac{e^{2x}-2}{4}$, we obtain

$$\int \frac{\sinh^2 x}{\sqrt{\sinh^2 x - d^2}} dx < \int \frac{e^{2x}}{2\sqrt{e^{2x} - (2+4d^2)}} dx = \frac{\sqrt{e^{2x} - (2+4d^2)}}{2}$$

As $\sinh^{-1} y = \log(y + \sqrt{1+y^2})$, after cancellations, we get

$$I_2 < \frac{\sqrt{e^{2\rho} - (2+4d^2)} - \sqrt{8d+2}}{2} \sim \frac{\sqrt{e^{2\rho} - (2+4d^2)}}{2} - \sqrt{2d}$$

This implies for large $d \gg 0$

$$I = I_1 + I_2 < \sqrt{2d} + \left(\frac{\sqrt{e^{2\rho} - (2+4d^2)}}{2} - \sqrt{2d} \right) = \frac{\sqrt{e^{2\rho} - (2+4d^2)}}{2}$$

Now by taking $\rho = \frac{3}{2} \log d$ for large $d \gg 0$, we obtain

$$I < \frac{\sqrt{e^{2\rho} - (2+4d^2)}}{2} \sim \frac{\sqrt{d^3 - (2+4d^2)}}{2} \sim \frac{(d^{\frac{3}{2}} - 2\sqrt{d})}{2} \sim \frac{d^{\frac{3}{2}}}{2} - \sqrt{d}$$

On the other hand,

$$\cosh \rho - 1 = \cosh\left(\frac{3}{2} \log d\right) - 1 = \frac{d^{\frac{3}{2}} + d^{-\frac{3}{2}}}{2} - 1 \sim \frac{d^{\frac{3}{2}}}{2}$$

This shows that for $\widehat{\rho}(d) = \frac{3}{2} \log d$, $I < \cosh \widehat{\rho}$ and hence $|S_d^{\widehat{\rho}(d)}| < 2|D_{\widehat{\rho}(d)}|$. Hence, the compact catenoid $S_d^{\widehat{\rho}(d)}$ is an area minimizing surface in $\mathbb{H}^2 \times \mathbb{R}$. The proof follows. \square

Remark 7.2. Notice that in the lemma above for $\widehat{\rho}(d)$ is $\frac{3}{2}$ times the radius of the girth of the catenoid \mathcal{C}_d , we showed that the the slice $S_d^{\widehat{\rho}(d)} \subset \mathcal{C}_d$ is an area minimizing surface. However, the comparison between $\frac{\sqrt{e^{2\rho} - (2+4d^2)}}{2}$ and $\cosh \rho$ indicates that if $\widehat{\rho}(d)$ is greater than twice the radius of the girth of the catenoid \mathcal{C}_d (or $\rho > 2 \log(d)$), the estimates above become very delicate, and the area minimizing statement is no longer true. See Remark 7.5 for further discussion.

Now, we will show that as $d \rightarrow \infty$ the height $2\widehat{h}(d)$ of the compact area minimizing catenoids $S_d^{\widehat{\rho}(d)}$ goes to π , i.e. $\widehat{h}(d) \rightarrow \frac{\pi}{2}$.

Lemma 7.3. *Let $\widehat{h}(d) = \lambda_d(\widehat{\rho}(d))$. Then, $\lim_{d \rightarrow \infty} \widehat{h}(d) = \frac{\pi}{2}$.*

Proof: By [NSST, Prop 5.1],

$$\lim_{d \rightarrow \infty} \widehat{h}(d) = \int_0^{s(\widehat{\rho}(d))} \frac{dt}{\cosh t}$$

By the same proposition, $s(\rho) = \cosh^{-1}(\frac{\cosh \rho}{\sqrt{1+d^2}})$. As $\widehat{\rho}(d) = \frac{3}{2} \log d$, then $s(\widehat{\rho}(d)) \sim \sqrt{d}$. This implies

$$\lim_{d \rightarrow \infty} \widehat{h}(d) = \int_0^\infty \frac{dt}{\cosh t} = \int_0^\infty \frac{du}{u^2 + 1} = \frac{\pi}{2}$$

\square

Remark 7.4. Notice that this lemma implies that for any height $0 < h_o < \pi$, there exists an area minimizing compact catenoid S_d^ρ of height h_o . In other words, for any $0 < h_o < \pi$, there exists $d > 0$ with $h(d) > h_o$ such that $\mathcal{C}_d \cap \mathbb{H}^2 \times [-\frac{h_o}{2}, \frac{h_o}{2}]$ is an area minimizing compact catenoid in $\mathbb{H}^2 \times \mathbb{R}$. Recall also that any subsurface of area minimizing surface is also area minimizing.

Remark 7.5. [Intersections of Minimal Catenoids \mathcal{C}_d]

With these results on the area minimizing subsurfaces S_d^ρ in the minimal catenoids \mathcal{C}_d in the previous part, a very interesting point deserves a brief discussion. Notice that by definition [NSST], for $d_1 < d_2$, the graphs of the monotone increasing functions $\lambda_{d_1} : [\sinh^{-1} d_1, \infty) \rightarrow [0, h(d_1))$ and $\lambda_{d_2} : [\sinh^{-1} d_2, \infty) \rightarrow [0, h(d_2))$ intersect at a unique point $\rho_o \in (\sinh^{-1} d_2, \infty)$, i.e. $\lambda_{d_1}(\rho_o) = \lambda_{d_2}(\rho_o)$ (See Figure 9).

This implies the minimal catenoids \mathcal{C}_{d_1} and \mathcal{C}_{d_2} intersects at two round circles of radius ρ_o , $\alpha^\pm = (\rho_o, \theta, \pm \lambda_{d_1}(\rho_o))$, i.e. $\mathcal{C}_{d_1} \cap \mathcal{C}_{d_2} = \alpha^+ \cup \alpha^-$.

Recall the well-known fact that two area minimizing surfaces with disjoint boundaries cannot "separate" a compact subsurface from interiors of each other. In other words, let Σ_1 and Σ_2 be two area minimizing surfaces with disjoint boundaries. If $\Sigma_1 - \Sigma_2$ has a compact subsurface S_1 with $\partial S_1 \cap \partial \Sigma_1 = \emptyset$ and similarly $\Sigma_2 - \Sigma_1$ has a compact subsurface S_2 with $\partial S_2 \cap \partial \Sigma_2 = \emptyset$, then $\Sigma'_1 = (\Sigma_1 - S_1) \cup S_2$ is an area minimizing surface with a singularity along ∂S_1 , which contradicts to the regularity of area minimizing surfaces [Fe].

This argument shows that if both \mathcal{C}_{d_1} and \mathcal{C}_{d_2} were area minimizing surfaces, then they must be disjoint. Hence, both \mathcal{C}_{d_1} and \mathcal{C}_{d_2} cannot be area minimizing surfaces at the same time. In particular, the compact area minimizing surfaces $S_{d_1}^{\rho_1} \subset \mathcal{C}_{d_1}$ and $S_{d_2}^{\rho_2} \subset \mathcal{C}_{d_2}$ must be disjoint, too.

This observation suggest an upper bound for $\widehat{\rho}(d)$ we obtained in the previous part. Let $\iota(d)$ be the *intersection number* for \mathcal{C}_d defined as follows:

$$\iota(d) = \inf_{t>d} \{\rho_t \mid \lambda_d(\rho_t) = \lambda_t(\rho_t)\} = \sup_{t<d} \{\rho_t \mid \lambda_d(\rho_t) = \lambda_t(\rho_t)\}$$

The discussion above implies that $\widehat{\rho}(d) < \iota(d)$ as the area minimizing surfaces $S_{d_1}^{\rho_1} \subset \mathcal{C}_{d_1}$ and $S_{d_2}^{\rho_2} \subset \mathcal{C}_{d_2}$ must be disjoint.

REFERENCES

- [An] M. Anderson, *Complete minimal varieties in \mathbb{H}^n* , Invent. Math. (1982) 477–494.
- [CHR] P. Collin, L. Hauswirth and H. Rosenberg, *Properly immersed minimal surfaces in a slab of $\mathbb{H}^2 \times \mathbb{R}$* , arXiv:1304.1923.
- [CR] P. Collin and H. Rosenberg, *Construction of harmonic diffeomorphisms and minimal graphs*, Annals of Math. **172** (2010) 1879–1906.
- [Co1] B. Coskunuzer, *H-Surfaces with Arbitrary Topology in \mathbb{H}^3* , arXiv:1311.4629.
- [Co2] B. Coskunuzer, *On the number of solutions to the asymptotic Plateau problem*, J. Gokova Geom. Top. **5** (2011) 1–19.
- [Fe] H. Federer, *Geometric measure theory*, Springer-Verlag, New York 1969.
- [FMM] L. Ferrer, F. Martin and W. H. Meeks III, *Existence of proper minimal surfaces of arbitrary topological type*, Advances in Mathematics **231** (2012) 378–413.
- [HR] L. Hauswirth, and H. Rosenberg, *Minimal surfaces of finite total curvature in $\mathbb{H}^2 \times \mathbb{R}$* , Mat. Contemp. **31** (2006) 65–80.
- [HRS] L. Hauswirth, H. Rosenberg, and J. Spruck, *Infinite boundary value problems for CMC graphs in $\mathbb{H}^2 \times \mathbb{R}$ and $S^2 \times \mathbb{R}$* , Amer. J. Math. **131** (2009) 195–226.
- [HNST] L. Hauswirth, B.Nelli, R. Sa Earp, and E. Toubiana, *Minimal ends in $\mathbb{H}^2 \times \mathbb{R}$ with finite total curvature and a Schoen type theorem*, arXiv:1111.0851
- [MMR] F. Martin, R. Mazzeo, and M. Rodriguez, *Minimal surfaces with positive genus and finite total curvature in $\mathbb{H}^2 \times \mathbb{R}$* , Geometry & Topology **18** (2014) 141–177.
- [MW] F. Martin and B. White, *Properly Embedded Area Minimizing Surfaces in Hyperbolic 3-space*, J. Differential Geom. **97** (2014) 515–544.
- [Mo] F. Morabito, *A Costa-Hoffman-Meeks type surface in $\mathbb{H}^2 \times \mathbb{R}$* , Trans. Amer. Math. Soc. **363** (2011) 1–36.
- [MoR] F. Morabito and M. Rodriguez, *Saddle towers and minimal k-noids in $\mathbb{H}^2 \times \mathbb{R}$* , J. Inst. Math. Jussieu, **11** (2012) 333–349.

- [MR] F. Martin, and M. Rodriguez, *Non-simply connected minimal planar domains in $\mathbb{H}^2 \times \mathbb{R}$* , Trans. Amer. Math. Soc. **12** (2013) 6167–6183.
- [MRR] L. Mazet,, M.M. Rodriguez, and H. Rosenberg, *The Dirichlet problem for the minimal surface equation*, Proc. Lond. Math. Soc. **102** (2011) 985–1023.
- [NSST] B.Nelli, R. Sa Earp, W. Santos, and E. Toubiana, *Uniqueness of H -surfaces in $\mathbb{H}^2 \times \mathbb{R}$, $|H| \leq 1/2$* , Ann. Global Anal. Geom. **33** (2008) 307–321.
- [NR] B. Nelli and H. Rosenberg, *Minimal surfaces in $\mathbb{H}^2 \times \mathbb{R}$* , Bull. Braz. Math. Soc. **33** (2002) 263–292.
- [Py] J. Pyo, *New complete embedded minimal surfaces in $\mathbb{H}^2 \times \mathbb{R}$* , Ann. Global Anal. Geom. **40** (2011) 167–176.
- [PR] J. Pyo and M. Rodriguez, *Simply-connected minimal surfaces with finite total curvature in $\mathbb{H}^2 \times \mathbb{R}$* , to appear in IMRN.
- [RT] M.M. Rodriguez, and G. Tinaglia, *Non-proper complete minimal surfaces embedded in $\mathbb{H}^2 \times \mathbb{R}$* , to appear in IMRN.
- [Sa] R. Sa Earp, *Uniqueness of minimal surfaces whose boundary is a horizontal graph and some Bernstein problems in $\mathbb{H}^2 \times \mathbb{R}$* . Math. Z. **273** (2013) 211–217.
- [ST] R. Sa Earp and E. Toubiana, *An asymptotic theorem for minimal surfaces and existence results for minimal graphs in $\mathbb{H}^2 \times \mathbb{R}$* . Math. Ann. **342** (2008) 309–331.

MIT, MATHEMATICS DEPARTMENT, CAMBRIDGE, MA 02139

KOC UNIVERSITY, MATHEMATICS DEPARTMENT, ISTANBUL TURKEY
E-mail address: bcoskunuzer@ku.edu.tr