

An Institutional Framework for Heterogeneous Formal Development in UML

Alexander Knapp¹, Till Mossakowski², and Markus Roggenbach³

¹ Universität Augsburg, Germany

² Otto-von-Guericke Universität Magdeburg, Germany

³ Swansea University, UK

Abstract. We present a framework for formal software development with UML. In contrast to previous approaches that equip UML with a formal semantics, we follow an institution based heterogeneous approach. This can express suitable formal semantics of the different UML diagram types directly, without the need to map everything to one specific formalism (let it be first-order logic or graph grammars). We show how different aspects of the formal development process can be coherently formalised, ranging from requirements over design and Hoare-style conditions on code to the implementation itself. The framework can be used to verify consistency of different UML diagrams both horizontally (e.g., consistency among various requirements) as well as vertically (e.g., correctness of design or implementation w.r.t. the requirements).

1 Introduction

Historically, industrial standards on software quality merely mentioned formal methods for the sake of completeness. Nowadays, each new (edition of a) standard brings formal methods more to the fore. Thanks to this trend, current standards elaborate on formal methods and often recommend their use as an important means to establish a design's correctness and robustness. Recent examples include the 2011 version of the CENELEC standard on Railway applications, the 2011 ISO 26262 automotive standard, or the 2012 Formal Methods Supplement to the DO-178C standard for airborne systems.

In industrial software design, the Unified Modeling Language (UML) is the predominately used development mechanism. In aerospace industry, e.g., the company AEC uses the UML to define the software architecture of aeroplane engine controllers through various levels of abstraction from a layered architecture overview to a detailed class, operation and attribute definition of the software components. This model is then used for code generation. Typically, the software components developed are either reactive in nature or the components are logic-based and/or stateful in nature, where notations such as UML state diagrams are used to define the required behaviour. Similarly, the UML is used in micro-controller development in the automotive sector. An example out of the medical sector is the development of ventricular assist devices, to name just a few uses of UML for the development of critical systems.

The UML is an OMG standard [20], which describes a family of languages. It offers 14 types of diagrams of both structural and behavioural nature. A typical development by AEC easily involves eight different UML diagrams. The OMG specification provides an informal semantics of nine sub-languages in isolation. The languages are mostly linked through a common meta-model, i.e., through abstract syntax only. This

situation leads to a gap between standards' recommendation to apply formal methods, and current industrial practice, which by using the UML lacks the semantic foundations to apply such methods. One common approach to deal with this gap is to define a comprehensive semantics for the UML using a system model, e.g., [2,3]. However, such an approach is a thorny business, as every detail has to be encoded into one, necessarily quite complex semantics. Furthermore, UML's widespread adoption in industry is primarily due to its versatility; it lends itself to variations of usage, and different subsets of the UML tend to be used in different ways by different companies, leading to company or domain-specific variations.

In this paper, we outline a competing approach by providing a heterogeneous semantics. In this approach, we express the meaning of a model in a sub-language/diagram directly in an appropriate semantic domain and look for connections given by the abstract syntax of the UML specification or which can be gleaned from its semantic description. This separation between the meaning of the individual diagrams and how they are related allows our approach to adopt to different methodologies, for instance an object-oriented approach or a component-based one.

2 Methodology

Our overall aim is to providing Qualified Formal Methods for dependable software design for critical systems, especially embedded, reactive systems. This will cover requirements, design, code and deployment.

2.1 ATM case study

In order to illustrate our heterogeneous semantics, we present as a running example the design of a traditional automatic teller machine (ATM) connected to a bank. For simplicity, we only describe the handling of entering a card and a PIN with the ATM. After entering the card, one has three trials for entering the correct PIN (which is checked by the bank). After three unsuccessful trials the card is kept.

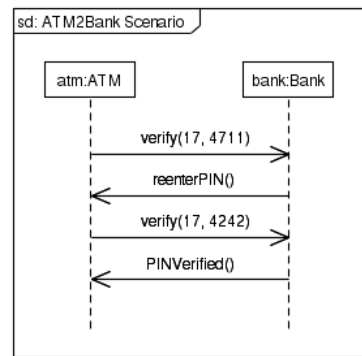

Fig. 1. Interaction.

Requirements. Figure 1 shows a possible *interaction* between an atm and a bank object, which consists out of four messages: the atm requests the bank to verify if a card and PIN number combination is valid, in the first case the bank requests to reenter the PIN, in the second case the verification is successful. This interaction presumes that the system has atm and a bank objects. This can, e.g., be ensured by a *composite structure diagram*, see Fig. 5, which — among other things — specifies the objects in the initial system state. In order to communicate with a bank object, we assume the atm object to have a *behaviour port* called bankCom. This port's dynamic behaviour is captured with a protocol state machine, see Fig. 2.

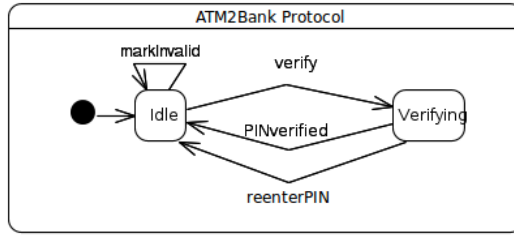

Fig. 2. Protocol state machine.

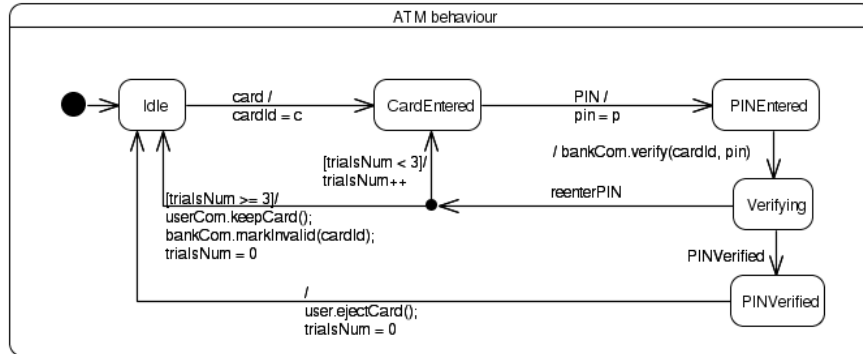

Fig. 3. State machine.

Design. The dynamic behaviour of the atm object is specified by the *state machine* shown in Fig. 3. The machine consists of five states including Idle, CardEntered, etc. Beginning in the initial Idle state, the user can *trigger* a state change by entering the card. This has the *effect* that the parameter *c* from the card event is assigned to the cardId in the atm object (parameter names are not shown in a state machine diagram). Entering a PIN triggers another transition to PINEntered. Then the ATM requests verification from the bank using its bankCom port. The transition to Verifying uses a *completion event*: No explicit trigger is declared and the machine autonomously creates such an event whenever a state is completed, i.e., all internal activities of the state are finished (in our example there are no such activities). In case the interaction with the bank results in reenterPIN, and the *guard* trialsNum < 3 is true, the user can again enter a PIN.

Figure 4 provides structural information in form of an interface diagram for the userCom port of the atm object. An interface is a set of operations that other model elements have to implement. In our case, the interface takes the form of a *class diagram*. Here, the operation keepCard is enriched with the OCL constraint trialsNum > 3, which refines its semantics: keepCard can only be invoked if the OCL constraints holds.

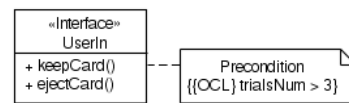

Fig. 4. Interface.

Code. The state machine shown in Fig. 3 can be implemented in the programming language C, enriched with pre-/post-conditions written in the ANSI/ISO C Specification Language (ACSL). The below code example shows how the event card is encoded as C

function, where the ACSL annotations ensure that the system is in some defined state and that the number of trials to re-enter the PIN is smaller than three.

```

typedef enum states {
    EMPTY = 0,      IDLE = 1,      CARDENTERED = 2,
    PINENTERED = 3, VERIFYING = 4, PINVERIFIED = 5
} states_t;
int cardId = 0; int pin = 0; int trialsNum = 0;
states_t state = EMPTY;

/*@
    requires state != EMPTY; requires trialsNum <= 3;
    ensures state != EMPTY; ensures trialsNum <= 3;
@*/
void card(int c) {
    switch (state) {
        case IDLE:
            cardId = c;
            state = CARDENTERED;
            break;
        default:
    }
}
...

```

Deployment. Finally, the *composite structure diagram* in Fig. 5 shows the initial state of our ATM system, in which an atm object and a bank object collaborate, where the atm has a bankCom port, whilst the bank has an atmCom port.

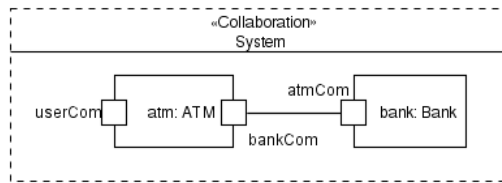

Fig. 5. Composite structure.

2.2 From Requirements to Design to Code

The languages and UML diagram types that we consider are shown in Fig. 6. On the *modelling level* we use parts of the UML and the Object Constraint Language (OCL). On the *implementation level* we currently employ the programming language C and ACSL. It is left for future work to also include a proper object-oriented language such as Java together with some specification formalism. In the *types view* of the modelling level we look at class diagrams for modelling data; component diagrams for modelling components; and state machines for specifying dynamic behaviour. These diagrams can be instantiated in the *instance view* using composite structure diagrams for showing component configurations; and object diagrams for showing concrete data. Although they are not present in UML 2, we also have added state machine instances (in a dashed box). Requirements on the models can be specified in the *properties view* using interactions, i.e., sequence diagrams or communication diagrams, for prescribing message exchanges between components and objects; protocol state machines for specifying port behaviour; and the Object Constraint Language for detailing the behaviour of components and objects in terms of invariants and method pre-/post-conditions.

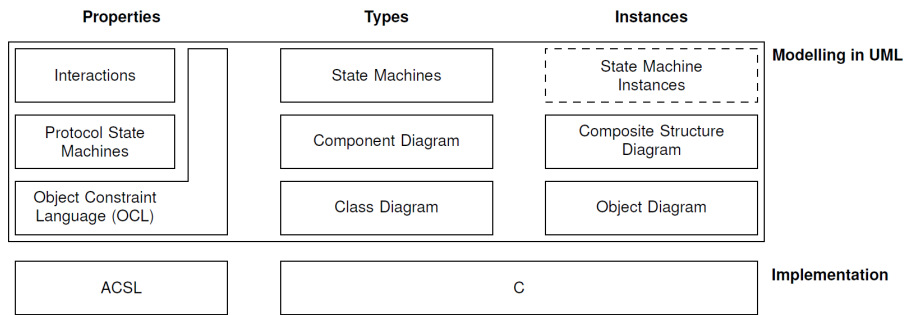

Fig. 6. Languages and diagrams considered

2.3 Consistency and Satisfiability

During a model-driven development, it is desirable to detect inconsistencies at an early stage in order to ease corrections and avoid costly re-engineering at a late stage (e.g. during the implementation phase). While there are some tools providing static inconsistency checks based on UML's meta-model, only few works consider dynamic checks, and generally only for specific UML diagram types, e.g. [14].

We will now outline a systematic method for the analysis of UML models and their interrelation to code. The analysis of UML models can proceed either horizontally within the requirements or within the design level checking for consistency within the level, or vertically checking for satisfaction between these two levels. A typical horizontal consistency check on the requirements level would ask if the sequential composition of actions in an interaction diagram is justified by an accompanying OCL specification. A typical vertical satisfiability check between the requirements and the design level would ask if the behaviour prescribed in an interaction diagram is realisable by several state machines cooperating according to a composite structure diagram. Code generation transforms a UML logical design to code templates with semantic annotations in the form of pre/post conditions and invariants. If the templates are completed satisfying the semantic annotations, it is guaranteed that the resulting code is a correct model of the logical design and therefore, by the vertical checks, also for the requirements.

3 UML as a Heterogeneous Formal Method, Using Institutions

In this section, we will provide semantic foundations for model based specification and design using a heterogeneous framework based on Goguen's and Burstall's theory of institutions [11]. We handle the complexity of giving a coherent semantics to UML by providing several institutions formalising different diagrams of UML, and several institution translations (formalised as so-called institution morphisms and comorphisms) describing their interaction and information flow. The central advantage of this approach over previous approaches to formal semantics for UML (e.g. [14]) is that each UML diagram type can stay "as-is", without the need of a coding using graph grammars (as in [9]) or some logic (as in [14]). This also keeps full flexibility in the choice of verification mechanisms. The formalisation of UML diagrams as institutions has the additional benefit that a notion of refinement comes for free, see [19,6].

This systematic coverage in a single semantic based Meta-formalism is unique. We provide semantic links in the form of institution (co-)morphisms, that, on the one hand, provide the basis for correct model transformations and validations, and on the other hand give rise to an integrated semantic view (via the so-called Grothendieck institution [7,15]) on the identified UML subset as well as the target implementation languages. Institution theory provides an adequate abstraction level for such a semantic integration. The framework is flexible enough to support various development paradigms as well as different resolutions of UML's semantic variation points. This is the crucial advantage of the proposed approach to the semantics of UML, compared to existing approaches in the literature which map UML to a specific global semantic domain in a fixed way.

3.1 Heterogeneous Formal Semantics of Languages and Diagrams

To carry out this program of institutionalising UML in all detail goes beyond scope and space limits of this paper. We only present some cornerstones and sketch how this can be extended to all diagrams in Fig. 6.

For substantial fragments of several UML diagram types, we have already provided a formalisation as institutions:

Class diagrams in [5], we have sketched an institution for class diagrams, which has been detailed in [12]. It includes a construction for stereotypes.

Component diagrams form an institution similar to that for class diagrams. The main difference are the connector types, which however are quite similar to associations.

Object diagrams are essentially reifications of models of class diagrams.

Composite structure diagrams are similar to object diagrams. The main difference are the connectors, which however are quite similar to the links of object diagrams.

Interactions in [5], we have sketched an institution for interactions, as well as their interconnection (also with class diagrams) via institution comorphisms.

OCL in [5], we have sketched institutions for OCL. In [4], the OCL semantics is presented in more detail. An institution based on this is in preparation.

Thus, the central remaining challenge for institutionalising UML are **state machines** and **protocol state machines**. Below, we sketch institutions for these, which are very similar. Only their sentences differ in that protocol state machines have a post condition instead of an action. Post conditions can also speak about messages being sent (using OCL). Formalising both **C** and **ACSL** as institutions is future work.

3.2 Institutions and Their (Co)Morphisms

Institutions are an abstract formalisation of the notion of logical system. Informally, institutions provide four different logical notions: signatures, sentences, models and satisfaction. Signatures provide the vocabulary that may appear in sentences and that is interpreted in models. The satisfaction relation determines whether a given sentence is satisfied in a given model. The exact nature of signatures, sentences and models is left unspecified, which leads to a great flexibility. This is crucial for the possibility to model UML diagrams (which in the first place are not “logics”) as institutions.

An important feature of institutions is the presence of signature morphisms, which can be seen as mappings between signatures. Sentences can be translated along signature morphisms, and models reduced *against* signature morphisms. The satisfaction

condition states that satisfaction is invariant under change of notation (along a signature morphism).

We briefly recall the formal definition of institutions from [11]. An institution $\mathcal{I} = (\text{Sig}^{\mathcal{I}}, \text{Sen}^{\mathcal{I}}, \text{Mod}^{\mathcal{I}}, \models^{\mathcal{I}})$ consists of (i) a category of *signatures* $\text{Sig}^{\mathcal{I}}$; (ii) a *sentence functor* $\text{Sen}^{\mathcal{I}} : \text{Sig}^{\mathcal{I}} \rightarrow \text{Set}$, where Set is the category of sets; (iii) a contra-variant *model functor* $\text{Mod}^{\mathcal{I}} : (\text{Sig}^{\mathcal{I}})^{\text{op}} \rightarrow \text{Class}$, where Class is the category of classes; and (iv) a family of *satisfaction relations* $\models_{\Sigma}^{\mathcal{I}} \subseteq |\text{Mod}^{\mathcal{I}}(\Sigma)| \times \text{Sen}^{\mathcal{I}}(\Sigma)$ indexed over $\Sigma \in |\text{Sig}^{\mathcal{I}}|$, such that the following *satisfaction condition* holds for every signature morphism $\sigma : \Sigma \rightarrow \Sigma'$ in $\text{Sig}^{\mathcal{I}}$, every sentence $\varphi \in \text{Sen}^{\mathcal{I}}(\Sigma)$ and for every Σ' -model $M' \in |\text{Mod}^{\mathcal{I}}(\Sigma')|$:

$$\text{Mod}^{\mathcal{I}}(\sigma)(M') \models_{\Sigma}^{\mathcal{I}} \varphi \Leftrightarrow M' \models_{\Sigma'}^{\mathcal{I}} \text{Sen}^{\mathcal{I}}(\sigma)(\varphi).$$

$\text{Mod}^{\mathcal{I}}(\sigma)$ is called the *reduct functor* (also written $-|\sigma$), $\text{Sen}^{\mathcal{I}}(\sigma)$ the *translation function* (also written $\sigma(-)$).

It is possible to define standard logical notions like logical consequence, logical theory, satisfiability etc. as well as languages for structured specification and refinement in an institution-independent way [21].

For relating institutions in a semantics preserving way, we consider institution morphisms. Given institutions \mathcal{I} and \mathcal{J} , an *institution morphism* $\mu = (\Phi, \alpha, \beta) : \mathcal{I} \rightarrow \mathcal{J}$ consists of (i) a functor $\Phi : \text{Sig}^{\mathcal{I}} \rightarrow \text{Sig}^{\mathcal{J}}$; (ii) a natural transformation $\alpha : \text{Sen}^{\mathcal{I}} \circ \Phi \rightarrow \text{Sen}^{\mathcal{J}}$; and (iii) a natural transformation $\beta : \text{Mod}^{\mathcal{I}} \rightarrow \text{Mod}^{\mathcal{J}} \circ \Phi^{\text{op}}$, such that the following *satisfaction condition* is satisfied for all $\Sigma \in |\text{Sig}^{\mathcal{I}}|$, $M \in |\text{Mod}^{\mathcal{I}}(\Sigma)|$, and $\varphi' \in \text{Sen}^{\mathcal{J}}(\Phi(\Sigma))$:

$$M \models_{\Sigma}^{\mathcal{I}} \alpha_{\Sigma}(\varphi') \Leftrightarrow \beta_{\Sigma}(M) \models_{\Phi(\Sigma)}^{\mathcal{J}} \varphi'.$$

Dually, we consider institution comorphisms. Given institutions \mathcal{I} and \mathcal{J} , a *simple institution comorphism* $\rho = (\Phi, \alpha, \beta) : \mathcal{I} \rightarrow \mathcal{J}$ consists of (i) a functor $\Phi : \text{Sig}^{\mathcal{I}} \rightarrow \text{Sig}^{\mathcal{J}}$; (ii) a natural transformation $\alpha : \text{Sen}^{\mathcal{I}} \rightarrow \text{Sen}^{\mathcal{J}} \circ \Phi$; and (iii) a natural transformation $\beta : \text{Mod}^{\mathcal{I}} \circ \Phi^{\text{op}} \rightarrow \text{Mod}^{\mathcal{J}}$, such that the following *satisfaction condition* is satisfied for all $\Sigma \in |\text{Sig}^{\mathcal{I}}|$, $M' \in |\text{Mod}^{\mathcal{I}}(\Phi(\Sigma))|$, and $\varphi \in \text{Sen}^{\mathcal{I}}(\Sigma)$:

$$M' \models_{\Phi(\Sigma)}^{\mathcal{I}} \alpha_{\Sigma}(\varphi) \Leftrightarrow \beta_{\Sigma}(M') \models_{\Sigma}^{\mathcal{J}} \varphi.$$

The methodological need for these two kinds of mappings between institutions will be explained in Sect. 3.4 below.

3.3 Towards an Institution for UML State Machines

We will now formalise a simplified version of UML state machines as institutions. In particular, we omit hierarchical states. We start with an institution for the *environment* of a state machine. This environment fixes the conditions which can be used in guards of transitions, the actions for the effects of transitions, and also the messages that can be sent from a state machine. The source of this information typically is a class or a component diagram: The conditions and actions involve the properties available in the classes or components, the messages are derived from the available signals and operations. The sentences of this environment institution form a simple dynamic logic

(inspired by OCL) which can express that if a guard holds as pre-condition, when executing an action, a certain set of messages has been sent out, and another guards holds as post-condition. We then build a family of institutions for *state machines* over this environment institution, which is parameterised in the environment. A state machine adds the events and states that are used. The events comprise the signals and operations that can be accepted by the machine; some of these will, in general, coincide with the messages from the environment. Additionally, the machine may react to completion events, i.e., internal events that are generated when a state of the machine has been entered and which trigger those transitions that do not show an explicit event as their trigger in the diagrammatic representation (we use the states as the names of these events). The initial state as well as the transitions of the machine are represented as sentences in the institution. In a next step, we combine the family of state machine institutions parameterised over the environments into a single institution. Finally, we present a product construction on the combined institution that captures communicating state machines from a composite structure diagram.

Environment institution. An object of the category of environment *signatures* Sig^{Env} is a triple of sets

$$H = (G_H, A_H, M_H)$$

of guards, actions, and messages; and a morphism $H \rightarrow H'$ of Sig^{Env} is a triple of functions $\eta : (\eta_G : G_H \rightarrow G_{H'}, \eta_A : A_H \rightarrow A_{H'}, \eta_M : M_H \rightarrow M_{H'})$. The class of environment *structures* $\text{Mod}^{\text{Env}}(H)$ for an environment signature H consists of the triples

$$\Omega = (|\Omega|, \gamma_\Omega : G_H \rightarrow \wp|\Omega|, \alpha_\Omega : A_H \rightarrow (|\Omega| \rightarrow |\Omega| \times \wp(M_H))),$$

where $|\Omega|$ is a set of data states, $\omega \in \gamma_\Omega(g)$ expresses that the state $\omega \in |\Omega|$ satisfies guard g , and $(\omega', \bar{m}) = \alpha_\Omega(a)(\omega)$ that action a leads from state $\omega \in |\Omega|$ to state $\omega' \in |\Omega|$ producing the set of messages $\bar{m} \subseteq M_H$. The *reduct* $\Omega'|\eta$ of an H' -environment structure Ω' along the morphism $\eta : H \rightarrow H'$ is given by $(|\Omega'|, \gamma_{\Omega'}|\eta, \alpha_{\Omega'}|\eta)$ where $(\gamma_{\Omega'}|\eta)(g) = \gamma_{\Omega'}(\eta_G(g))$ and $(\alpha_{\Omega'}|\eta)(a)(\omega') = (\omega'', \eta_M^{-1}(\bar{m}'))$ if, and only if $\alpha_{\Omega'}(\eta_A(a))(\omega') = (\omega'', \bar{m}')$. The set of environment *sentences* $\text{Sen}^{\text{Env}}(H)$ for an environment signature H comprises the expressions

$$g_{\text{pre}} \rightarrow [a]\bar{m} \triangleright g_{\text{post}}$$

with $g_{\text{pre}}, g_{\text{post}} \in G_H$, $a \in A_H$, and $\bar{m} \subseteq M_H$, intuitively meaning (like an OCL constraint) that if the pre-condition g_{pre} currently holds, then, after executing a , the messages \bar{m} are produced and the post-condition g_{post} holds. The *translation* $\eta(g_{\text{pre}} \rightarrow [a]\bar{m} \triangleright g_{\text{post}})$ of a sentence $g_{\text{pre}} \rightarrow [a]\bar{m} \triangleright g_{\text{post}}$ along the signature morphism $\eta : H \rightarrow H'$ is given by $\eta_G(g_{\text{pre}}) \rightarrow [\eta_A(a)]\wp\eta_M(\bar{m}) \triangleright \eta_G(g_{\text{post}})$. Finally, the satisfaction relation $\Omega \models_H^{\text{Env}} g_{\text{pre}} \rightarrow [a]\bar{m} \triangleright g_{\text{post}}$ holds if, and only if, for all $\omega \in |\Omega|$, if $\omega \in \gamma_\Omega(g_{\text{pre}})$ and $(\omega', \bar{m}') = \alpha_\Omega(a)(\omega)$, then $\omega' \in \gamma_{\Omega'}(g_{\text{post}})$ and $\bar{m} \subseteq \bar{m}'$. Then the *satisfaction condition* is shown easily.

Example 1. Consider the UML component ATM with its properties `cardId`, `pin`, and `trialsNum`, its ports `userCom` and `bankCom`, and its outgoing operations `ejectCard()` and

keepCard() to userCom, and verify() and markInvalid() to bankCom. An environment signature for ATM is derived by forming guards, actions, and messages over this information, such that it will contain the guards true and trialsNum == 0, the actions user.ejectCard(); trialsNum = 0 and trialsNum++, as well as the messages user.ejectCard() and bank.markInvalid(cardId). Environment sentence over such an environment signature could be (for $n \in \mathbb{N}$)

$$\begin{aligned} \text{true} &\rightarrow [\text{user.ejectCard()}; \text{trialsNum} = 0] \{ \text{user.ejectCard()} \} \triangleright \text{trialsNum} == 0 \quad \text{or} \\ \text{trialsNum} == n &\rightarrow [\text{trialsNum}++] \emptyset \triangleright \text{trialsNum} == n + 1 . \end{aligned}$$

State machine institution. The institution of state machines is now built over the environment institution. Let H be an environment signature and Ω an environment structure over H . An object of the category of state machine *signatures* $\text{Sig}^{\text{SM}(H, \Omega)}$ over H and Ω is given by the pairs

$$\Sigma = (E_\Sigma, S_\Sigma)$$

of events and states with $E_\Sigma \cap S_\Sigma = \emptyset$; and a morphism $\sigma : \Sigma \rightarrow \Sigma'$ of $\text{Sig}^{\text{SM}(H, \Omega)}$ is a pair of injective functions $\sigma = (\sigma_E : E_\Sigma \rightarrow E_{\Sigma'}, \sigma_S : S_\Sigma \rightarrow S_{\Sigma'})$. The class of state machine *structures* $\text{Mod}^{\text{SM}(H, \Omega)}(E, S)$ for a state machine signature (E, S) over H and Ω consists of the pairs

$$\Theta = (I_\Theta, \Delta_\Theta)$$

where $I_\Theta \in \wp|\Omega| \times S_\Sigma$ represents the initial configurations, fixing the initial control state; and $\Delta_\Theta \subseteq C \times \wp(M_H) \times C$ with $C = |\Omega| \times \wp(E_\Sigma \cup S_\Sigma) \times S_\Sigma$ represents a transition relation from a configuration, consisting of an environment state, an event pool, and a control state, to a configuration, emitting a set of messages. The event pool may contain both events declared in the signature (from signals and operations) and completion events (represented by states). The *reduct* $\Theta'|\sigma$ of a state machine structure Θ' along the morphism $\sigma : \Sigma \rightarrow \Sigma'$ is given by the structure $(\{(\omega, s) \mid (\omega, \sigma_S(s)) \in I'\}, \{(c_1, \bar{m}, c_2) \mid (\sigma_C(c_1), \bar{m}, \sigma_C(c_2)) \in \Delta'\})$ where $\sigma_C(\omega, \bar{p}, s) = (\omega, \wp\sigma_P(\bar{p}), \sigma_S(s))$ and $\sigma_P(p) = \sigma_E(p)$ if $p \in E_\Sigma$ and $\sigma_P(p) = \sigma_S(p)$ if $p \in S_\Sigma$. The set of state machine *sentences* $\text{Sen}^{\text{SM}(H, \Omega)}(\Sigma)$ for a state machine signature Σ over H and Ω consists of the pairs

$$(s_0 \in S_\Sigma, T \subseteq S_\Sigma \times (E_\Sigma \cup S_\Sigma) \times G_H \times A_H \times S_\Sigma)$$

where s_0 means an initial state and T represents the transitions from a state with a triggering event (either a declared event or a completion event), a guard, and an action to another state. The translation $\sigma(s_0, T)$ of a sentence (s_0, T) along the signature morphism $\sigma : \Sigma \rightarrow \Sigma'$ is given by $(\sigma_S(s_0), \{(\sigma_S(s_1), \sigma_P(p), g, a, \sigma_S(s_2)) \mid (s_1, p, g, a, s_2) \in T\})$. Finally, the *satisfaction relation* $\Theta \models_\Sigma^{\text{SM}(H, \Omega)} (s_0, T)$ holds if, and only if $\pi_2(I_\Theta) = s_0$ and

$$\begin{aligned} \Delta_\Theta = \{ & \{(\omega, p \uplus \bar{p}, s), \bar{m} \cap (M_H \setminus E_\Sigma), (\omega', \bar{p} \triangleleft ((\bar{m} \cap E_\Sigma) \cup \{s'\}), s') \mid \\ & \omega \in \gamma_\Omega(g), (\omega', \bar{m}) = \alpha_\Omega(a)(\omega), (s, p, g, a, s') \in T\} \cup \\ & \{(\omega, p \triangleleft \bar{p}, s), \emptyset, (\omega, \bar{p}, s) \mid \forall (s, p', g, a, s') \in T . p \neq p' \vee \omega \notin \gamma_\Omega(g)\} \end{aligned}$$

where $p \uplus \bar{p}$ expresses that p is the next event to be processed by the machine according to some selection scheme from the pool (where completion events are prioritized), and $\bar{p} \triangleleft \bar{p}'$ adds the events in \bar{p}' to the pool \bar{p} . The messages on a transition in the structure Θ are only those that are not accepted by the machine itself, i.e., not in E_Σ . The accepted events in E_Σ as well as the completion event when entering state s' are added to the event pool of the target configuration. When no transition is triggered by the current event, the event is discarded (this will happen, in particular, to all superfluously generated completion events). With these definitions, checking the satisfaction condition

$$\Theta' | \sigma \models_{\Sigma}^{\text{SM}(H, \Omega)} (s_0, T) \Leftrightarrow \Theta \models_{\Sigma'}^{\text{SM}(H, \Omega)} \sigma(s_0, T)$$

for a state machine signature morphism $\sigma : \Sigma \rightarrow \Sigma'$ is straightforward.

Example 2. Consider the state machine of Fig. 3 defining the behaviour of ATM. It works over the environment signature sketched in the previous example, and its signature is $(E_{\text{ATM}}, S_{\text{ATM}})$ with

$$\begin{aligned} E_{\text{ATM}} &= \{\text{card}, \text{PIN}, \text{reenterPIN}, \text{PINVerified}\} \cup S_{\text{ATM}}, \\ S_{\text{ATM}} &= \{\text{Idle}, \text{CardEntered}, \text{PINEntered}, \text{Verifying}, \text{PINVerified}\}. \end{aligned}$$

The state machine can be represented as the following sentence over this signature:

$$\begin{aligned} &(\text{Idle}, \{(\text{Idle}, \text{card}, \text{true}, \text{cardId} = c, \text{CardEntered}), \\ &\quad (\text{CardEntered}, \text{PIN}, \text{true}, \text{pin} = p, \text{PINEntered}), \\ &\quad (\text{PINEntered}, \text{PINEntered}, \text{true}, \text{bank.verify}(\text{cardId}, \text{pin}), \text{Verifying}), \\ &\quad (\text{Verifying}, \text{reenterPIN}, \text{trialsNum} < 2, \text{trialsNum}++, \text{CardEntered}), \dots\}). \end{aligned}$$

In particular, PINEntered occurs both as a state and as a completion event in the third transition. The junction pseudostate for making the decision whether $\text{trialsNum} < 2$ or $\text{trialsNum} \geq 2$ has been resolved by combining the transitions.

Protocol state machine institution. Protocol state machines differ from behavioural state machines by not mandating a specific behaviour but just monitoring behaviour: They do not show guards and effects, but a pre- and a postcondition for the trigger of a transition. Moreover, protocol state machines do not just discard an event that currently does not fire a transition; it is an error when such an event occurs.

For adapting the state machine institution to protocol state machines we thus change the *sentences* to

$$(s_0 \in S_\Sigma, T \subseteq S_\Sigma \times G_H \times E_\Sigma \times G_H \times \wp(M_H) \times S_\Sigma)$$

where the two occurrences of G_H represent the pre- and the post-conditions, and $\wp(M_H)$ represents the messages that have to be sent out in executing the triggering event (protocol state machines typically do not show completion events). The *satisfaction relation* now requires that when an event e is chosen from the event pool the pre-condition of some transition holds in the source configuration, its post-condition holds in the target configuration, and that all messages have been sent out. Instead of the second clause of Δ_Θ , discarding an event, a dedicated error state is targeted when no transition is enabled. color=gray,size=]We could claim that there is a co-morphism from the protocol state machine to the environment institution and/or the OCL institution — but this seems to be quite bold.

Flat state machine institution. We now flatten the institutions $\text{SM}(H, \Omega)$ for each environment signature H and each environment structure Ω over H into a single institution SM .⁴ The signatures $\langle H, \Sigma \rangle$ consist of an environment signature H and a state machine signature Σ , similarly for signature morphisms as well as for structures $\langle \Omega, \Theta \rangle$. As $\langle H, \Sigma \rangle$ -sentences we now have both dynamic logic formulas (over H), as well as control transition relations (over H and Σ). Also satisfaction is inherited. Only the definition of reducts is new, because they need to reduce state machine structures along more complex signature morphisms: $\langle \Omega', \Theta' \rangle | (\eta, \sigma) = \langle \Omega' | \eta, \Theta' | \sigma | \eta \rangle$ where $\Theta'' | \eta = (\{c_1'', \eta_M^{-1}(\bar{m}''), c_2''\} | (c_1'', \bar{m}'', c_2'') \in \Delta_{\Theta''}\}, I_{\Theta''})$.

Inside the flat state machine institution SM we can consider the composition of state machines over different environments. These different environments represent the local views of the state machines. Given two state machine signatures $\langle H_1, \Sigma_1 \rangle$ and $\langle H_2, \Sigma_2 \rangle$ of SM with $G_{H_1} \cap G_{H_2} = \emptyset$, $A_{H_1} \cap A_{H_2} = \emptyset$, $E_{\Sigma_1} \cap E_{\Sigma_2} = \emptyset$, and $S_{\Sigma_1} \cap S_{\Sigma_2} = \emptyset$, we combine these into a single signature $\langle \hat{H}, \hat{\Sigma} \rangle$ of SM by taking the component-wise union for the guard, actions, and messages, the union of events and states for the events, and the product for the states component.⁵ Now, consider two state machine structures (Ω_1, Θ_1) over $\langle H_1, \Sigma_1 \rangle$ and (Ω_2, Θ_2) over $\langle H_2, \Sigma_2 \rangle$, respectively. Their *interleaving product* is given by

$$\begin{aligned} \langle \Omega_1, \Theta_1 \rangle \parallel \langle \Omega_2, \Theta_2 \rangle &= (\Omega_1 \parallel \Omega_2, \Theta_1 \parallel \Theta_2) \\ - \Omega_1 \parallel \Omega_2 &= (|\Omega_1| \times |\Omega_2|, \gamma_{\Omega_1} \parallel \gamma_{\Omega_2}, \alpha_{\Omega_1} \parallel \alpha_{\Omega_2}) \text{ where } (\omega_1, \omega_2) \in (\gamma_{\Omega_1} \parallel \gamma_{\Omega_2})(\hat{g}) \\ &\text{ if } \hat{g} \in G_{H_i} \text{ and } \omega_i \in \gamma_{\Theta_i}(\hat{g}) \text{ for } i \in \{1, 2\}; \text{ and } (\alpha_{\Omega_1} \parallel \alpha_{\Omega_2})(\hat{a})(\omega_1, \omega_2) = \\ &((\omega'_1, \omega'_2), \bar{m}) \text{ if } \hat{a} \in A_{H_i} \text{ and } \alpha_{\Omega_i}(\hat{a})(\omega_i) = (\omega'_i, \bar{m}) \text{ and } \omega'_j = \omega_j \text{ for } i \neq j \in \{1, 2\}. \\ - \Theta_1 \parallel \Theta_2 &= (I_{\Theta_1} \parallel I_{\Theta_2}, \Delta_{\Theta_1} \parallel \Delta_{\Theta_2}) \text{ with } I_{\Theta_1} \parallel I_{\Theta_2} = ((s_1, s_2), \Omega_1 \times \Omega_2) \text{ for } \\ &I_{\Theta_i} = (s_i, \Omega_i), \text{ and} \\ \Delta_{\Theta} \parallel \Delta_{\Theta'} &= \{((\omega_1, \omega_2), e \uplus (\bar{e}_1 \cup \bar{e}_2), (s_1, s_2)), \bar{m} \cap (M_{\hat{H}} \setminus E_{\hat{\Sigma}}), \\ &((\omega'_1, \omega'_2), (\bar{e}_1 \cup \bar{e}_2) \triangleleft (\bar{e}' \cap E_{\hat{\Sigma}}), (s'_1, s'_2))\} | \\ &\exists i \in \{1, 2\}. ((\omega_i, e \uplus \bar{e}_i, s_i), \bar{m}, (\omega'_i, \bar{e}_i \triangleleft \bar{e}', s'_i)) \in \Delta_{\Theta_i}\}. \end{aligned}$$

Example 3. Consider the composite structure diagram in Fig. 5, showing instances atm and bank of the ATM and Bank components, respectively, that are connected through their bankCom and atmCom ports. In execution, atm and bank will exchange messages, as prescribed by their state machines, and this exchange is reflected by the interleaving product which internalises those events that are part of the common signature. On the other hand, messages to the outside, i.e., through the userCom port are still visible.

3.4 Transformations Among UML institutions

Figure 7 gives an overview of the transformations between the modeling languages, diagram types, and additional languages. The transformations in the figure can be formalised as institution morphisms and comorphisms. An institution morphism (represented by a solid line in the figure) roughly corresponds to a projection from a “richer” to a “poorer” logic, expressing that the “richer” logic has some more features, which are forgotten by the morphism. The main purpose of the institution morphisms is the ability

⁴ This is an instance of a general construction, namely the Grothendieck institution [7].

⁵ The sharing of guards and actions could also be covered by a push-out construction.

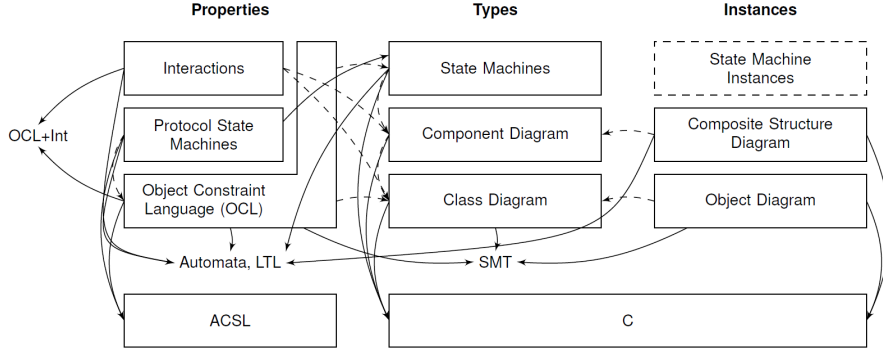

Fig. 7. Institution morphisms (dashed arrows) and institution co-morphisms (solid arrows) between the languages and diagrams

to express, e.g., that an interaction diagram and a state machine are compatible because they are expressed over the same class diagram. Institution morphisms thus enable the formalisation of heterogeneous UML specifications as structured specifications over the Grothendieck institution, a flattening of the diagram of institutions and morphisms [7]. Practically, these structured Grothendieck specifications can be formulated in the distributed ontology, modeling and specification language (DOL), which currently is being standardized in the OMG (see ontoiop.org and [17]).

By contrast, institution comorphisms (represented by dashed lines in the figure) are often more complex. Roughly, a comorphism corresponds to an encoding of one logic into a another one. The purpose of institution comorphisms is threefold: **(1)** to provide a means for expressing the dynamic checks (see below) in the institutional framework, **(2)** to obtain tool support for the various UML diagrams by using comorphisms into tool-supported institutions, and **(3)** to transform UML diagrams into ACSL specifications and C programs.

Dynamic checks and tool support involve additional institutions (also depicted in Fig. 7, but not formalised in detail here) for certain automata, like those used in the model checker SPIN, and satisfiability modulo theories (SMT) provers, as well as linear temporal logic. The modeling language institutions can be embedded into these, paving the way for tool and prover support.

3.5 Consistency and Satisfiability, Revisited

The horizontal dimension of the relationship between the different models has to ensure *consistency* of the models, i.e., that the models fit together and describe a coherent system. The same has to be checked on the implementation level for the consistency between the C program and the ACSL specification; however, here we can reuse existing theory and tools.

There are different kinds of consistency checks on the modelling level: Static checks ensuring type consistency and type correctness between types and instances. Dynamic checks include the properties and one or several cooperating instances or types. Most of the dynamic checks are theoretically undecidable, thus fully automatic tools will not be able to answer all instances. However, in many cases, useful automatic approximations are possible, while in other cases, manual effort may be involved.

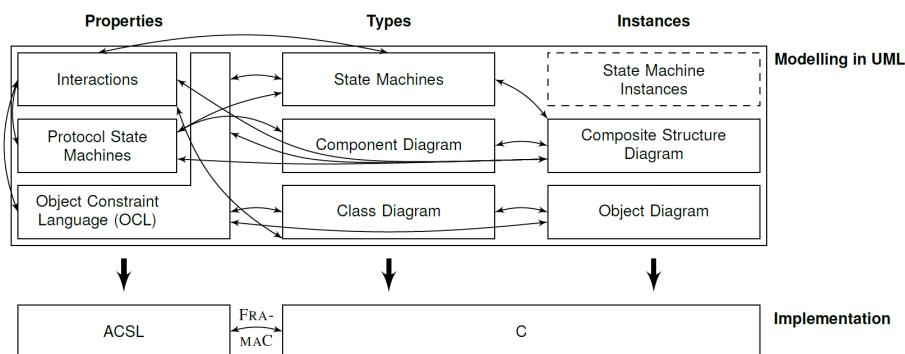

Fig. 8. Consistency relations (double-headed arrows) on the modelling and the implementation level; the bold arrows represent the model transformations.

Figure 8 gives an overview of useful relations between different kinds of diagrams, along which consistency checks are possible. We here only list a few of these. Some useful static checks are:

1. Does an OCL specification or a composite structure diagram only use the methods of a class diagram?
2. Does a state machine or an interaction comply with the interfaces in a composite structure diagram?
3. Does an instance diagram (an object or a composite structure diagram) comply to its corresponding type diagram (a class or a component diagram)?

Here are some useful dynamic checks:

1. Does a state machine satisfy an OCL invariant or an OCL pre-/post-condition?
2. Do the protocol state machines at the ends of a connector of a composite structure diagram fit together?
3. Is the sequential composition of methods in an interaction diagram justified by the state machines and/or the OCL specification?

For tackling question 1, we can use a semi-comorphism from the OCL institution to the state machines institution that selects those states and transitions that are relevant for the invariant or the method with pre-/post-conditions. However, the UML does not specify the time point when the OCL post-condition should be evaluated; one possibility is to choose the finishing of the fired transition.

For question 2, we can use a comorphism from the protocol state machine institution into a temporal logic institution [10], where we can form the product of the protocol state machines (as detailed in Sect. 3.3) along the connector. However, the precise nature of compatibility may be seen as a “semantic variation point”. Two important examples are the absence of deadlocks and buffer overruns.

Concerning question 3, for the relation to an OCL specification we use a co-span of institution comorphisms between the interactions institution and the OCL institution [5]. At least two links are possible: In a strict interpretation, for each pair of successive methods in the interaction there must be a state meeting the post-condition of the first method and the pre-condition of the second method. In a more loose interpretation, a sequence of additional method calls, not prescribed but also not excluded by the interaction, must be possible to reach the pre-condition of the second method from

the post-condition of the first method. For also considering state machines, the co-span approach is extended by also involving the state machines institution.

4 Tools

The Heterogeneous Tool Set (Hets) [16,18] provides analysis and proof support for multi-logic specifications. The central idea of Hets is to provide a general framework for formal methods integration and proof management that is equipped with a strong semantic (institution-based) backbone. One can think of Hets acting like a motherboard where different expansion cards can be plugged in, the expansion cards here being individual institutions (with their analysis and proof tools) as well as institution (co)morphisms. The Hets motherboard already has plugged in a number of expansion cards (e.g., SAT solvers, automated and interactive theorem provers, model finders, model checkers, and more). Hence, a variety of tools is available, without the need to hard-wire each tool to the logic at hand. Via suitable translations, new formalisms can be connected to existing tools.

We have just started to integrate first institutions for UML, such as class diagrams, into Hets. In order to obtain proof support for the methodology presented in this paper, beyond the individual institutions, also the morphisms and comorphisms need to be implemented in Hets. Moreover, we plan to connect Hets to the tool HugoRT [13]. HugoRT can, on the one hand, perform certain static checks on UML diagrams. Moreover, it provides transformations of UML diagrams to automata and linear temporal logic formulas, which can then be fed into model checkers like SPIN in order to check certain properties. The crucial benefit of our approach is a clear separation of concerns: verification conditions for consistency and satisfiability checks can be formulated abstractly in terms of the UML institutions and (co)morphisms described above. In a second step, these checks can then be reformulated in terms of specific logics and tools that have been connected to Hets.

5 Conclusion

We have outlined an institution-based semantics for the main UML diagrams, and in particular have provided an initial institution for UML state machines as the main previously missing bit in the overall picture. Moreover, we have sketched a methodology have consistency among UML diagrams and with implementation languages can be modeled at the institutional level and supported with tools.

Much remains to be done to fill in the details. The greatest missing bit is certainly the institutional formalisation of programming languages and their Hoare logics, like C and ACSL, or Java and JML. Here, we want to follow the ideas sketched by A. Tarlecki and D. Sannella [21, Ex. 4.1.32, Ex. 10.1.17] for rendering an imperative programming language as an institution. The semantic basis could be a simplified version of the operational semantics of C. Ellison and G. Rosu [8]. The concepts for institutionalising a Hoare logic like ACSL on the basis of its specification [1] can be similar as for OCL.

References

1. P. Baudin, P. Cuoq, J.-C. Filliâtre, C. Marché, B. Monate, Y. Moy, and V. Prevosto. ACSL: ANSI/ISO C Specification Language. Report, CEA, 2012.

2. M. Broy, M. V. Cengarle, H. Grönniger, and B. Rumpe. Considerations and Rationale for a UML System Model. In Lano [14], chapter 3, page 43–60.
3. M. Broy, M. V. Cengarle, H. Grönniger, and B. Rumpe. Definition of the System Model. In Lano [14], chapter 4, page 61–93.
4. M. V. Cengarle and A. Knapp. OCL 1.4/5 vs. 2.0 Expressions — Formal Semantics and Expressiveness. *Softw. Syst. Model.*, 3(1):9–30, 2004.
5. M. V. Cengarle, A. Knapp, A. Tarlecki, and M. Wirsing. A Heterogeneous Approach to UML Semantics. In P. Degano, R. De Nicola, and J. Meseguer, editors, *Concurrency, Graphs and Models*, volume 5065 of *Lect. Notes Comp. Sci.*, pages 383–402. Springer, 2008.
6. M. Codescu, T. Mossakowski, D. Sannella, and A. Tarlecki. Specification Refinements: Calculi, Tools, and Applications, 2014. Submitted.
7. R. Diaconescu. Grothendieck Institutions. *Applied Cat. Struct.*, 10:383–402, 2002.
8. C. Ellison and G. Roşu. An Executable Formal Semantics of C With Applications. In J. Field and M. Hicks, editors, *Proc. 39th ACM SIGPLAN-SIGACT Symp. Principles of Programming Languages (POPL’12)*, pages 533–544. ACM, 2012.
9. G. Engels, R. Heckel, and J. M. Küster. The Consistency Workbench: A Tool for Consistency Management in UML-Based Development. In P. Stevens, J. Whittle, and G. Booch, editors, *Proc. 6th Int. Conf. Unified Modeling Language (UML’03)*, volume 2863 of *Lect. Notes. Comp. Sci.*, pages 356–359. Springer, 2003.
10. J. L. Fiadeiro. *Categories for Software Engineering*. Springer, 2005.
11. J. A. Goguen and R. M. Burstall. Institutions: Abstract model theory for specification and programming. *J. ACM*, 39:95–146, 1992.
12. P. James, A. Knapp, T. Mossakowski, and M. Roggenbach. Designing Domain Specific Languages — A Craftsman’s Approach for the Railway Domain Using CASL. In N. Martí-Oliet and M. Palomino, editors, *Rev. Sel. Papers 21st Int. Wsh. Recent Trends in Algebraic Development Techniques (WADT’12)*, volume 7841 of *Lect. Notes Comp. Sci.*, pages 178–194. Springer, 2013.
13. A. Knapp, S. Merz, and C. Rauh. Model Checking Timed UML State Machines and Collaborations. In W. Damm and E.-R. Olderog, editors, *Proc. 7th Int. Symp. Formal Techniques in Real-Time and Fault-Tolerant Systems (FTRTFT’02)*, volume 2469 of *Lect. Notes Comp. Sci.*, pages 395–416. Springer, 2002.
14. K. Lano, editor. *UML 2 — Semantics and Applications*. Wiley, 2009.
15. T. Mossakowski. Comorphism-based Grothendieck Logics. In K. Diks and W. Rytter, editors, *Proc. 27th Int. Symp. Mathematical Foundations of Computer Science (MFCS’02)*, volume 2420 of *Lect. Notes Comp. Sci.*, pages 593–604. Berlin, 2002. Springer.
16. T. Mossakowski, S. Autexier, and D. Hutter. Development Graphs — Proof Management for Structured Specifications. *J. Log. Alg. Program.*, 67(1–2):114–145, 2006.
17. T. Mossakowski, O. Kutz, M. Codescu, and C. Lange. The Distributed Ontology, Modeling and Specification Language. In C. D. Vescovo, T. Hahmann, D. Pearce, and D. Walther, editors, *Proc. 7th Int. Wsh. Modular Ontologies (WoMO-13)*, volume 1081 of *CEUR-WS*. CEUR, 2013.
18. T. Mossakowski, C. Maeder, and K. Lüttich. The Heterogeneous Tool Set. In O. Grumberg and M. Huth, editors, *Proc. 13th Int. Conf. Tools and Algorithms for the Construction and Analysis of Systems (TACAS’07)*, volume 4424 of *Lect. Notes Comp. Sci.*, pages 519–522. Springer, 2007.
19. T. Mossakowski, D. Sannella, and A. Tarlecki. A Simple Refinement Language for CASL. In J. L. Fiadeiro, P. D. Mosses, and F. Orejas, editors, *Rev. Sel. Papers 17th Int. Wsh. Recent Trends in Algebraic Development Techniques (WADT’04)*, volume 3423 of *Lect. Notes Comp. Sci.*, pages 162–185. Springer, 2005.
20. Object Management Group. Unified Modeling Language. Standard, OMG, 2011.
21. D. Sannella and A. Tarlecki. *Foundations of Algebraic Specification and Formal Software Development*. EATCS Monographs in Theoretical Computer Science. Springer, 2012.