

# F-theory Family Unification

---

S. Mizoguchi<sup>a</sup>

<sup>a</sup>*Theory Center, Institute of Particle and Nuclear Studies, KEK,  
Tsukuba, Ibaraki, 305-0801, Japan*

*E-mail:* [mizoguch@post.kek.jp](mailto:mizoguch@post.kek.jp)

ABSTRACT:

We propose a new geometric mechanism for naturally realizing unparallel three families of flavors in string theory, using the framework of F-theory. We consider a set of coalesced local 7-branes of a particular Kodaira singularity type and allow some of the branes to bend and separate from the rest, so that they meet only at an intersection point. Such a local configuration can preserve supersymmetry. Its matter spectrum is investigated by studying string junctions near the intersection, and shown to coincide, after an orbifold projection, with that of a supersymmetric coset sigma model whose target space is a homogeneous Kähler manifold associated with a corresponding painted Dynkin diagram. In particular, if one starts from the  $E_7$  singularity, one obtains the  $E_7/(SU(5) \times U(1)^3)$  model yielding precisely three generations with an unparallel family structure. Possible applications to string phenomenology are also discussed.

---

## Contents

<b>1</b>	<b>Introduction</b>	<b>1</b>
<b>2</b>	<b>Coset space family unification</b>	<b>4</b>
<b>3</b>	<b>F-theory/heterotic duality, string junctions and the correspondence to homogeneous Kähler manifolds</b>	<b>6</b>
3.1	Review of F-theory/heterotic duality in six dimensions	6
3.2	Matter from string junctions—Tani’s argument	9
3.3	The correspondence to homogeneous Kähler manifolds and the $E_7/(SU(5) \times U(1)^3)$ model	14
<b>4</b>	<b>Holomorphic deformation of 7-branes</b>	<b>15</b>
4.1	The stringy-cosmic-string solution	15
4.2	A supersymmetric deformation of 7-branes	17
<b>5</b>	<b>Orbifolds and anomalies</b>	<b>22</b>
<b>6</b>	<b>The explicit expression for the curve of the brane configuration</b>	<b>23</b>
<b>7</b>	<b>Summary and discussion</b>	<b>29</b>
<b>A</b>	<b>The explicit forms of <math>A_{(n,\bar{n})}</math> up to <math>n + \bar{n} \leq 3</math></b>	<b>30</b>
<b>B</b>	<b><math>J</math>-function and monodromy</b>	<b>31</b>

---

## 1 Introduction

The LHC experiments finally found [1, 2] the long sought-for elementary particle that was able to complete the Standard Model, the Higgs boson. They have also shown that the scale of any new physics beyond the Standard Model must be pretty much higher than the electro-weak scale. We are now more and more seriously interested in why the Standard Model is as it is: Why is the top quark so heavy? Why is the lepton-flavor mixing so large? And in the first place, why are there three generations of quarks and leptons?

In the past 30 years after the discovery of superstring theories, an enormous amount of knowledge on elementary particles has been accumulated. Requirements, or expectations, for realistic string-phenomenology models have become more and more demanding. Indeed, the top quark was finally found [3, 4] in 1995 at Tevatron, and the mass turned out to be about  $10^5$  times heavier than the up quark. In 1998, the zenith angle dependence of the muon atmospheric neutrino was discovered at SuperKamiokande [5], where the  $\theta_{23}$  lepton

$SU(5)$	$\mathbf{10}_1$	$\mathbf{10}_2$	$\mathbf{10}_3$
			$\mathbf{5}$
		$\bar{\mathbf{5}}_1$	$\bar{\mathbf{5}}_2$
			$\bar{\mathbf{5}}_3$
	$U(1)_3$	$\mathbf{1}_1$	$\mathbf{1}_2$
		$U(1)_2$	$\mathbf{1}_3$
			$U(1)_1$

**Figure 1.** The  $E_7/(SU(5) \times U(1)^3)$  model. The next larger square than the shaded “ $SU(5)$ ” represents  $SO(10)$ , the next to next is  $E_6$ , and the whole square is  $E_7$ . Exactly three sets of  $SU(5)$  multiplets for quarks and leptons perfectly fit (except one  $\mathbf{5}$ ) in the coset. The  $E_7/(SU(5) \times SU(3) \times U(1))$  model consists of only the non-singlets.

flavor mixing angle was revealed to be almost maximal,  $\sim 45^\circ$ . Later neutrino experiments [6, 7] also confirmed that another mixing angle  $\theta_{12}$  was large, and  $\theta_{13}$  was also nonzero [8–11]—all these undeniable experimental data point to a single fact: *The three flavors are not on equal footing.*

Superstring theory, however, has developed almost independently of these experimental discoveries. To say the least, even though it could contrive to achieve such hierarchical structures (which should be different between the quark and lepton sectors, and also between the up and down types) by more or less ad-hoc assumptions and/or fine tunings, it has never been able to explain them. Of course, it would be easy to close our eyes to all these facts and dismiss everything as an accident; this is not our attitude in this paper.

There have been numerous efforts to understand the hierarchical family structure of quarks and leptons. Particularly interesting among them is the idea of *family unification*. Family unification is the idea that the quarks and leptons are the fermionic partners of the scalars of some *coset* supersymmetric nonlinear sigma model [12–20]. A remarkable observation made by Kugo and Yanagida was that [16] the supersymmetric sigma model based on  $E_7/(SU(5) \times SU(3) \times U(1))$  had precisely *three* sets of  $\mathbf{10} \oplus \bar{\mathbf{5}}$  of  $SU(5)$ , in addition to a single  $\mathbf{5}^1$ , as its target space. What is special here is that the three generations are asymmetrically embedded into  $E_7$  as  $SU(5)$  multiplets. Indeed, the two  $\bar{\mathbf{5}}$ ’s, identified as the second and third generations of the  $SU(5)$  GUT multiplets [22, 23] containing the down-type quarks, come with the “symmetry breaking” from  $E_7$  to  $E_6$ , whereas the last  $\bar{\mathbf{5}}$  arises when  $E_6$  “breaks” to  $SO(10)$ . In contrast, a  $\mathbf{10}$  representation arises at each step when the rank of the “symmetry group” is reduced by one (Figure 1)<sup>2</sup>. This was called the

<sup>1</sup>and hence it is anomalous both as a gauge theory and as a nonlinear sigma model. It was pointed out [21] that these anomalies were removed by introducing matter chiral-multiplets. This issue is further discussed in section 5.

<sup>2</sup> If one considers  $E_7/(SU(5) \times U(1)^3)$  instead, then one has (with an appropriate choice of the complex structure) three sets of  $\mathbf{10} \oplus \bar{\mathbf{5}} \oplus \mathbf{1}$  and one  $\mathbf{5}$ . The fact that the coset  $E_7/SU(5)$  accommodates three

“unparallel” family structure by Yanagida [24, 25].

Therefore, a natural question to ask is: Can one get such a coset family structure in string theory? So far, very few attempts have been made to obtain Kugo-Yanagida-type models in string theory, and the few have met with only partial success [26, 27].

In this paper, we take a modest step towards realizing this unparallel family structure in string theory. We will show that such a structure can in fact naturally arise in string theory, in the framework of local F-theory. The study of phenomenological applications of F-theory [28, 29] has been of much interest in the past several years [30–59], but in this paper we will bring a slightly different perspective. We show that a certain local 7-brane system in F-theory can realize, already at the level of six dimensions, the same quantum numbers as that of the SUSY nonlinear sigma model considered in family unification. Our key observation is that the representations of the charged matter hypermultiplets arising at the singularity are precisely (as far as the enhanced singularity is of the split type [60]) the ones consisting of a homogeneous Kähler manifold of the corresponding painted Dynkin diagram. In particular, if one starts from the  $E_7$  singularity, one obtains a set of *six*-dimensional massless matter which have the same quantum numbers as those of the  $E_7/(SU(5) \times U(1)^3)$  Kugo-Yanagida model.

We should note that our mechanism itself does not yet ensure three generations of  $\mathbf{10} \oplus \bar{\mathbf{5}}$  in a *four*-dimensional F-theory compactification as it is still a six-dimensional analysis. The most modern and common way of achieving a chiral spectrum is to turn on so-called G-fluxes [30]. Alternatively, however, a practical approach to get a four-dimensional chiral theory is to compactify two of the the six dimensions on a two-torus and project out half of the spectrum by taking an orbifold. This is discussed in section 5. We also note that the requisite quantum numbers are already obtained in six dimensions, and there is no need for contrived assumptions to get the desired spectrum here.

Although these rules themselves must have been known for some time, the relation to homogeneous Kähler spaces or nonlinear sigma models seems to have never been discussed in the literature <sup>3</sup>. Indeed, as of writing this article, there is only one paper [63] in the INSPIRE database that cites both Katz-Vafa [64] and Kugo-Yanagida [16], and in [63] such a connection was not mentioned.

We are interested in some *local* geometric structure that can realize precisely three unparallel families. This is because if the realization of the SM were a consequence of the global details of the entire compactification space, it would be very hard, if not impossible, to find any reason or explanation for what we observe now.

---

generations of quarks and leptons was already noted in [12], but the  $U(1)$  factors (relevant to the Kähler structure) in the denominator group were not specified. The  $E_7$  coset model was also mentioned in [14]. The importance of the coset  $E_7/(SU(5) \times U(1)^3)$  as well as  $E_7/(SU(5) \times SU(3) \times U(1))$  was emphasized in [21], where the issue of anomaly cancellation in these models was also addressed. In this paper, we also call the  $E_7/(SU(5) \times U(1)^3)$  (as well as  $E_7/(SU(5) \times SU(3) \times U(1))$  model *the Kugo-Yanagida model* as it is obvious that the former differs from the latter only by some singlets.

<sup>3</sup>The coset structure of chiral matter was already implied in [30, 37], but the relevance of string junctions to *matter* generation or the possible application to family unification was not discussed. The relevance of string junctions for the chiral matter generation was first emphasized in [61], and also more recently in [62].

The plan of the rest of this paper is as follows: In section 2, we give a brief review of the basic idea of coset space family unification. In section 3, we first recall the known results of F-theory/heterotic duality in six dimensions, and then explain Tani’s argument of how the chiral matter at the extra zeroes of the discriminant can be understood in terms of string junctions. We are naturally led to the coset structure of the chiral matter, and propose the 7-brane configuration for the  $E_7/(SU(5) \times U(1)^3)$  model. In section 4, we prove that the 7-brane configuration can preserve SUSY. Section 5 is devoted to a brief discussion on how we can derive a four-dimensional model from the six-dimensional one obtained from the configuration. It is also pointed out that in our setup there is a possibility for the anomalies of the original model to cancel due to the anomaly inflows. In section 6, we present the explicit local expression for the curve of the brane configuration. Finally, we conclude in section 7 with a summary and discussion. Appendix A contains the explicit result of the recursion relation in section 4, whereas Appendix B is a brief explanation of how the monodromy is read off by tracing the value of the  $J$  function.

## 2 Coset space family unification

We begin with a review of the basic idea of coset space family unification, which is what we want to achieve in string theory. We will be brief, and for more detailed discussion we refer the reader to [20], and also [65].

As we already mentioned in Introduction, family unification is the idea that the quarks and leptons can be understood as quasi-Nambu-Goldstone fermions [13] of a supersymmetric *coset* nonlinear sigma model [12, 15–18, 20]. This means that the target space of the sigma model is some homogeneous space  $G/H$  associated with a Lie group  $G$  and its closed subgroup  $H$ . The idea of identifying all the three families as being a part of some group is an old one [66–77], going back before the superstring theories were found, but it is important to note that being a coset is essential for the chiral nature of the spectrum, which is in contrast to the models in the earlier literature.

Originally, such a nonlinear sigma model was thought of as arising from a spontaneous supersymmetry breaking of some global symmetry caused by a strong gauge dynamics of the underlying “preon” theory [12]. Later, we will show an alternative, geometric origin of these sigma models in F-theory.

To characterize  $D = 4$ ,  $\mathcal{N} = 1$  supersymmetric sigma models the following two facts are essential: The first fact is that, in order to have  $D = 4$ ,  $\mathcal{N} = 1$  SUSY, the scalar manifold must be Kähler [78, 79], which is well-known. The second is a classic result due to Borel [80]: Let  $G$  and  $H$  be a semi-simple Lie group and its closed subgroup, then the coset space  $G/H$  is Kähler if and only if  $H$  is the group consisting of all elements that commute with some  $U(1)^n$  subgroup of  $G$ . Thus it follows that every element in  $G/H$  has a nonzero charge for some  $U(1)$  subgroup, since otherwise such an element must belong to  $H$  by construction. Borel’s theorem also states that the set of all  $G$ -invariant complex structures correspond one-to-one to that of all Weyl chambers of the Lie algebra. This statement can be translated into a useful way of distinguishing different complex structures as follows [20]:

**Table 1.**  $U(1)$  charges of the  $SU(5)$  multiplets in  $E_7/(SU(5) \times U(1)^3)$  [25].

$SU(5)$ representation	$U(1)_1$ charge(= $Q_1$ )	$U(1)_2$ charge(= $Q_2$ )	$U(1)_3$ charge(= $Q_3$ )
$\mathbf{10}_1$	0	0	4
$\mathbf{10}_2$	0	3	-1
$\mathbf{10}_3$	2	-1	-1
$\bar{\mathbf{5}}_1$	0	3	3
$\bar{\mathbf{5}}_2$	2	-1	3
$\bar{\mathbf{5}}_3$	2	2	-2
$\mathbf{1}_1$	0	3	-5
$\mathbf{1}_2$	2	-1	-5
$\mathbf{1}_3$	2	-4	0
$\mathbf{5}$	2	2	2

Suppose that we have chosen some  $U(1)$  generator  $Y$ <sup>4</sup> which commutes with any generator of  $H$ . We can decompose the Lie algebra of  $G$  into a direct sum of eigenspaces of  $\text{ad}Y$ , that is, into a sum of spaces of “states” with different  $U(1)$  “ $Y$ -charges”. Then  $G/H$  consists of the spaces with negative  $Y$ -charges. If the charge vector of  $Y$  is varied so that it passes across into the next Weyl chamber, then one of the signs of the  $Y$ -charges flips, and this corresponds to the change of the complex structure.

Let us illustrate the above with an example, which is the main focus of the subsequent discussion. The Lie algebra  $E_7$  is decomposed into a sum of irreducible representations of  $SU(5) \times SU(3)$  as:

$$\begin{aligned} \mathbf{133} = & (\mathbf{24}, \mathbf{1})_0 \oplus (\mathbf{1}, \mathbf{8})_0 \oplus (\mathbf{1}, \mathbf{1})_0 \oplus (\mathbf{5}, \bar{\mathbf{3}})_4 \oplus (\bar{\mathbf{5}}, \mathbf{3})_{-4} \\ & \oplus (\mathbf{5}, \mathbf{1})_{-6} \oplus (\bar{\mathbf{5}}, \mathbf{1})_6 \oplus (\mathbf{10}, \bar{\mathbf{3}})_{-2} \oplus (\bar{\mathbf{10}}, \mathbf{3})_2. \end{aligned} \quad (2.1)$$

The  $U(1)$  subgroup that commutes with  $SU(5) \times SU(3)$  is uniquely determined, and its charges are indicated as subscripts. Collecting only the representations that have negative charges, we find that the homogeneous space  $E_7/(SU(5) \times SU(3) \times U(1))$  consists of

$$(\bar{\mathbf{5}}, \mathbf{3})_{-4} \oplus (\mathbf{10}, \bar{\mathbf{3}})_{-2} \oplus (\mathbf{5}, \mathbf{1})_{-6} \quad (2.2)$$

as advocated. On the other hand, for  $E_7/(SU(5) \times U(1)^3)$  the  $SU(3)$  multiplets in (2.2) are further decomposed, and besides, three more singlets emerges from the  $SU(3)/U(1)^2$  piece. Their  $U(1)$  charges are summarized in Table 1 [25], where the three  $U(1)$ ’s are such that  $E_7 \supset E_6 \times U(1)_1$ ,  $E_6 \supset SO(10) \times U(1)_2$  and  $SO(10) \supset SU(5) \times U(1)_3$ . Let  $Q_i$  be the  $U(1)_i$  charge for  $i = 1, 2, 3$ , then the  $U(1)$   $Y$ -charge (determining the complex structure) in the previous  $E_7/(SU(5) \times SU(3) \times U(1))$  case is given by the linear combination

$$Y_{E_7/(SU(5) \times SU(3) \times U(1))} = -\frac{1}{6}(10Q_1 + 5Q_2 + 3Q_3). \quad (2.3)$$

<sup>4</sup>Note that, despite its notation, “ $Y$ -charge” here is *not* the weak hypercharge of the SM. We use this term following [20].

In the present  $E_7/(SU(5) \times U(1)^3)$  case, the  $Y$ -charge can be a linear combination of the form

$$Y_{E_7/(SU(5) \times U(1)^3)} = sQ_1 + t(2Q_1 + Q_2) + u(10Q_1 + 5Q_2 + 3Q_3) \quad (2.4)$$

for any *negative*  $s, t$  and  $u$ .

As we said, the target space of a coset supersymmetric nonlinear sigma model is a homogeneous Kähler manifold. There is available a useful representation of homogeneous Kähler manifolds in terms of painted Dynkin diagrams [65]; their “cook-book recipe” states that [65] one first draws the Dynkin diagram for the numerator Lie group, paints a subset of the vertices (note that the roles of the black (painted) and white nodes are traded here) for the denominator  $U(1)$  subgroups so that the remaining white Dynkin diagrams correspond to the semi-simple part of the denominator group. In this way all homogeneous Kähler manifolds are classified [65]. The corresponding painted Dynkin diagrams for  $E_7/(SU(5) \times SU(3) \times U(1))$  and  $E_7/(SU(5) \times U(1)^3)$  are shown in Figure 2.



**Figure 2.** Painted Dynkin diagrams. Left:  $E_7/(SU(5) \times SU(3) \times U(1))$ , right:  $E_7/(SU(5) \times U(1)^3)$ .

Basically, this kind of family unification models utilize the Froggatt-Nielsen mechanism [81] to account for the origin of the hierarchical family structure. The  $E_7/(SU(5) \times SU(3) \times U(1))$  or  $E_7/(SU(5) \times U(1)^3)$  model has been investigated by many authors from various points of view [82–92]<sup>5</sup>.

### 3 F-theory/heterotic duality, string junctions and the correspondence to homogeneous Kähler manifolds

#### 3.1 Review of F-theory/heterotic duality in six dimensions

In this section we recall the beautiful results on F-theory/heterotic duality in six dimensions. Although this has already been well known for some time, it is useful to review the original discussion because thereby its connection to homogeneous Kähler manifolds can be uncovered.

The proposal of [93] was that the  $K3$  compactification of the  $E_8 \times E_8$  heterotic string with instanton numbers  $(12 - n, 12 + n)$  is dual to F-theory compactified on an elliptic Calabi-Yau three-fold over the base space being the Hirzebruch surface  $\mathbf{F}_n$ . More precisely, the dual Calabi-Yau manifold was given in the Weierstrass form as [93, 94]

$$y^2 = x^3 + x \sum_{i=0}^8 z^i f_{8+(4-i)n}(w) + \sum_{j=0}^{12} z^j g_{12+(6-j)n}(w), \quad (3.1)$$

<sup>5</sup>Also related is the idea of “ $E_6$  unification” [66, 127–142], where the origin of the difference between the flavor structures of quarks and leptons is attributed to the asymmetry between the  $\mathbf{10}$  and  $\bar{\mathbf{5}}$  representations in a  $\mathbf{27}$  multiplet of  $E_6$ .

where  $z$  is the coordinate for the  $\mathbf{P}^1$  fiber of  $\mathbf{F}_n$ , and  $w$  is the one for the  $\mathbf{P}^1$  base of  $\mathbf{F}_n$ .  $f_k(w)$ ,  $g_k(w)$  are  $k$ -th order polynomials of  $w$ . Intuitively, this six-dimensional duality is understood as the fiber-wise duality in eight dimensions [28] further compactified and fibered over  $\mathbf{P}^1$ .

This proposed duality was examined in detail in [60]. In particular, the dimensions of the neutral hypermultiplet moduli spaces were compared between the two, and a perfect match was found in various cases of unbroken gauge symmetries. It was also found there [60] that the charged matter arose at “extra zeroes” of the discriminant of the curve (3.1) at particular values of  $w$ , where the singularities of the coinciding gauge 7-branes were (more) enhanced.

For example, let us consider

$$y^2 = x^3 + z^3 f_{8+n}(w)x + z^5 g_{12+n}(w). \quad (3.2)$$

The discriminant is

$$\Delta = 108z^9(f_{8+n}^3 + g_{12+n}^2z). \quad (3.3)$$

There is (generically) an  $E_7$  singularity at  $z = 0$  since  $ord(\Delta) = 9$ ,  $ord(\text{coefficient of } x^1) = 3$  and  $ord(\text{coefficient of } x^0) = 5$ . Here  $ord(\dots)$  denotes the order of  $\dots$  as a polynomial of  $z$ . (3.2) is the curve for the F-theory dual to heterotic on  $K3$  with unbroken  $E_7$  gauge symmetry with  $12 + n$  instantons embedded in  $SU(2)$ .

On the heterotic side, the number of neutral hypermultiplets is  $2n + 21$  [94, 95], whereas on the F-theory side, it is determined by the dimensions of the complex structure moduli. The latter is the number of coefficients of the polynomials up to an overall rescaling:  $(9 + n) + (13 + n) - 1$ , which indeed coincides with the heterotic computation.

On the other hand, charged matter in this heterotic compactification is found to be [94, 95]  $8 + n$  half-hypermultiplets in  $\mathbf{56}$  of  $E_7$ . Since  $8 + n$  is the number of zeroes  $f_{8+n}(w)$ , these “extra” zeroes in the discriminant implied the appearance of charged matter in F-theory. Indeed, this was confirmed in [60] in various patterns of gauge symmetry breaking. Their results are summarized <sup>6</sup> in the first three columns of Table 2 (together with the corresponding set of coalesced 7-branes and associated homogeneous Kähler manifolds, which are explained shortly).

Note that at  $8 + n$  zero loci of  $f_{8+n}(w)$ , the discriminant of the first term vanishes, becoming a tenth-order polynomial in  $z$ . Again, this means that the singularity is enhanced from  $E_7$  to  $E_8$  at these “extra zeroes”.

Another example is the dual curve with an  $E_6$  unbroken gauge symmetry:

$$y^2 = x^3 + z^3 f_{8+n}(w)x + z^4 g_{12+2n}(w) + z^5 g_{12+n}(w). \quad (3.4)$$





The difference from (3.2) is that it contains a  $z^4$  term, and also  $g_{12+2n}(w)$  must be in the split form [60], that is

$$g_{12+2n}(w) = q_{6+n}(w)^2 \quad (3.5)$$

---

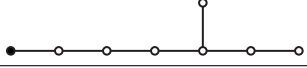
<sup>6</sup>We only consider the split case [60] here.

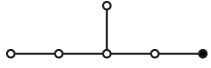
**Table 2.** Summary of matter fields in F-theory/heterotic duality in six dimensions. Only the cases for the split type with  $\text{rank} \geq 2$  are listed, where  $n$  is  $\pm$ (the number of instantons  $-12$ ) in one of  $E_8$ 's on the heterotic side, and  $r$  specifies how they are distributed when the commutant group is a direct product [60]. In addition to the data shown in [60], the corresponding 7-brane configurations as well as the homogeneous Kähler manifolds are also displayed.

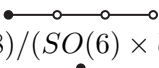
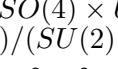
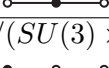
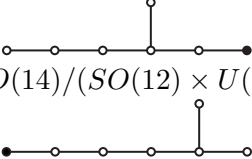
Gauge group	Neutral hypers	Charged matter	7-branes	Homogeneous Kähler manifold
$E_7$	$2n + 21$	$\frac{n+8}{2}\mathbf{56}$	$\mathbf{A} + \mathbf{A}^6\mathbf{BCC}$	$E_8/(E_7 \times U(1))$ 
$E_6$	$3n + 28$	$(n + 6)\mathbf{27}$	$\mathbf{A} + \mathbf{A}^5\mathbf{BCC}$	$E_7/(E_6 \times U(1))$ 
$SO(10)$	$4n + 33$	$(n + 4)\mathbf{16}$ $(n + 6)\mathbf{10}$	$\mathbf{A}^5\mathbf{BC} + \mathbf{C}$ $\mathbf{A} + \mathbf{A}^5\mathbf{BC}$	$E_6/(SO(10) \times U(1))$ $SO(12)/(SO(10) \times U(1))$ 
$SO(8)$	$6n + 44$	$(n + 4)\mathbf{8}_c$ $(n + 4)\mathbf{8}_s$ $(n + 4)\mathbf{8}_v$	$\mathbf{A}^4\mathbf{BC} + \mathbf{C}$ $\mathbf{A} + \mathbf{A}^4\mathbf{BC}$	$E_5/(SO(8) \times U(1))$ $(= SO(10)/(SO(8) \times U(1)))$ $SO(10)/(SO(8) \times U(1))$ 
$SU(4)$	$8n + 51$	$(4n + 16)\mathbf{4}$ $(n + 2)\mathbf{6}$	$\mathbf{A}^3\mathbf{BC} + \mathbf{C}$ $\mathbf{A} + \mathbf{A}^3\mathbf{BC}$	$E_4/(SO(6) \times U(1))$ $(= SU(5)/(SU(4) \times U(1)))$ $SO(8)/(SO(6) \times U(1))$ 
$SO(4)$	$10n + 54$	$(4n + 16)((\mathbf{1}, \mathbf{2}) + (\mathbf{2}, \mathbf{1}))$ $n(\mathbf{2}, \mathbf{2})$	$\mathbf{A}^2\mathbf{BC} + \mathbf{C}$ $\mathbf{A} + \mathbf{A}^2\mathbf{BC}$	$E_3/(SO(4) \times U(1))$ $(= SU(3)/(SU(2) \times U(1)))$ $SO(6)/(SO(4) \times U(1))$ 
$SU(3)$	$12n + 66$	$(6n + 18)\mathbf{3}$	$\mathbf{A} + \mathbf{A}^3$	$SU(4)/(SU(3) \times U(1))$ 
$SO(12)$	$2n + 18$	$\frac{r}{2}\mathbf{32} + \frac{n+4-r}{2}\mathbf{32}'$ $(n + 8)\mathbf{12}$	$\mathbf{A}^6\mathbf{BC} + \mathbf{C}$ $\mathbf{A} + \mathbf{A}^6\mathbf{BC}$	$E_7/(SO(12) \times U(1))$ $SO(14)/(SO(12) \times U(1))$ 



for some  $q_{6+n}(w)$ . Then the discriminant becomes

$$\Delta = 27z^8 q_{6+n}^4 + z^9 (4f_{8+n}^3 + 54g_{12+n} q_{6+n}^2), \quad (3.6)$$

showing that there is an  $E_6$  singularity at  $z = 0$ . The neutral moduli counting is

$$n + 7 + n + 9 + n + 13 - 1 = 3n + 28, \quad (3.7)$$

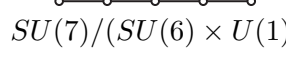
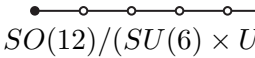
**Table 2.** (Cont'd)

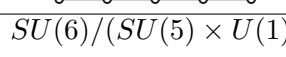
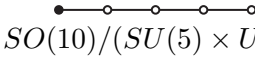
$SU(6)$	$3n - r + 21$	$\frac{r}{2}\mathbf{20}$ $(2n + 16 + r)\mathbf{6}$ $(n + 2 - r)\mathbf{15}$	$\mathbf{A}^6 + \mathbf{X}_{[2,-1]} + \mathbf{C}$  $\mathbf{A} + \mathbf{A}^6$  $\mathbf{A}^6 + \mathbf{B} + \mathbf{C}$	$E_6/(SU(6) \times U(1))$  $SU(7)/(SU(6) \times U(1))$  $SO(12)/(SU(6) \times U(1))$ 
$SU(5)$	$5n + 36$	$(3n + 16)\mathbf{5}$ $(n + 2)\mathbf{10}$	$\mathbf{A} + \mathbf{A}^5$  $\mathbf{A}^5 + \mathbf{B} + \mathbf{C}$	$SU(6)/(SU(5) \times U(1))$  $SO(10)/(SU(5) \times U(1))$  

which again agrees with the heterotic result. Also the heterotic prediction of the charge matter is  $n + 6$  hypermultiplets in **27**, which is certainly implied by the extra zeroes of the discriminant (3.6).

At this point, looking at the charged matter contents in the two examples, we notice an interesting fact: They are precisely the ones found in the homogeneous Kähler manifolds  $E_8/(E_7 \times U(1))$  and  $E_7/(E_6 \times U(1))$ , respectively. In fact, as shown in Table 2, *they all correspond to a homogeneous Kähler manifold of the relevant type*. As explained in subsequent sections, the latter are classified and labeled by “painted” Dynkin diagrams [65]. The corresponding diagrams are also shown together in Table 2.

Why does such a relationship exist? A geometric explanation has been given [64] on how the charged matter arises at the extra singularities by utilizing the Cartan deformation of the singularity. There is, however, another alternative argument using string junctions [61, 62] that is more convenient to establish the connection between the charged matter spectrum at an extra zero and a homogeneous Kähler manifold. This is the main theme of the next section.

### 3.2 Matter from string junctions—Tani’s argument

We will now explain how the chiral matter spectrum is determined by investigating string junctions near the enhanced singularity, following [61] (see also [62] for a more recent discussion). In F-theory, singularity enhancement occurs associated with a singularity of an elliptic manifold on which F-theory is compactified [28]. Singularities of elliptic fibrations were classified according to their types investigated by Kodaira [96]. Technology was developed [97] to describe these Kodaira singularities in terms of coalesced  $[p, q]$  7-branes and string junctions stretched between them (see [98–107] for more works on string junctions in F theory). We will first briefly summarize the salient features of their description, referring to [97] for more detail.

One of the characteristic features of F-theory is that 7-branes are allowed to change their types ( $= (p, q)$   $SL(2, \mathbb{Z})$  charges) as they wander about among themselves. More precisely, a 7-brane background is only single-valued up to  $SL(2, \mathbb{Z})$  transformations [108].

**Table 3.** Collapsible set of 7-branes and Kodaira's classification [97].

Fiber type	Singularity type	7-branes	Brane type
$I_n$	$A_{n-1}$	$\mathbf{A}^n$	$A_{n-1}$
$II$	$A_0$	$\mathbf{AC}$	$H_0$
$III$	$A_1$	$\mathbf{A}^2\mathbf{C}$	$H_1$
$IV$	$A_2$	$\mathbf{A}^3\mathbf{C}$	$H_2$
$I_0^*$	$D_4$	$\mathbf{A}^4\mathbf{BC}$	$D_4$
$I_n^*$	$D_{n+4}$	$\mathbf{A}^{n+4}\mathbf{BC}$	$D_{n+4}$
$II^*$	$E_8$	$\mathbf{A}^7\mathbf{BC}^2$	$E_8$
$III^*$	$E_7$	$\mathbf{A}^6\mathbf{BC}^2$	$E_7$
$IV^*$	$E_6$	$\mathbf{A}^5\mathbf{BC}^2$	$E_6$

Such a path-dependent transformation is called *monodromy*. For instance, as we will see in section 4, in the single D7-brane solution the type IIB scalar  $\tau$  behaves like  $\sim \frac{1}{2\pi i} \log z$  near the brane locus on the complex  $z$  plane. So if one traces the value of  $\tau$  as one moves around the locus,  $\tau$  gets transformed to  $\tau + 1$ . Thus the monodromy in this case is a fractional linear transformation specified by

$$\begin{pmatrix} 1 & 1 \\ 0 & 1 \end{pmatrix} \equiv T. \quad (3.8)$$

More generally, taking the convention that a  $[1,0]$ -brane means a D-brane, the monodromy matrix for a  $[p,q]$  brane is given by a similarity transformation of  $T$  as

$$\begin{aligned} \begin{pmatrix} p & r \\ q & s \end{pmatrix} \begin{pmatrix} 1 & 1 \\ 0 & 1 \end{pmatrix} \begin{pmatrix} p & r \\ q & s \end{pmatrix}^{-1} &= \begin{pmatrix} 1 - pq & p^2 \\ -q^2 & pq + 1 \end{pmatrix} \\ &\equiv \mathbf{X}_{[p,q]}, \end{aligned} \quad (3.9)$$

where  $p, q, r, s$  are all integers satisfying  $ps - qr = 1$ .  $\mathbf{X}_{[p,q]}$  does not depend on the choice of  $r$  or  $s$ .

What has been shown in [97] is that Kodaira's classification of singularities of elliptic fibrations can be expressed by the joining/parting of several 7-branes, each of which is of the simplest ( $I_1$ ) singularity type with a (relative) monodromy of either <sup>7</sup>

$$\mathbf{A} = \mathbf{X}_{[1,0]} = T, \quad \mathbf{B} = \mathbf{X}_{[1,-1]} = \begin{pmatrix} 2 & 1 \\ -1 & 0 \end{pmatrix} \quad \text{or} \quad \mathbf{C} = \mathbf{X}_{[1,1]} = \begin{pmatrix} 0 & 1 \\ -1 & 2 \end{pmatrix}. \quad (3.10)$$

The correspondence is summarized in Table 3 [97].

String junctions are basically the  $(p,q)$  analogues of open strings. As before, let  $[1,0]$  7-brane be an ordinary D-brane, and let us now define  $(1,0)$  string to be the fundamental open string. Then one can say that a  $(1,0)$  string can end on a  $[1,0]$  7-brane. Likewise, by the  $SL(2, \mathbb{Z})$  S-duality, a  $(p,q)$  string can end only on a  $[p,q]$  7-brane. However, as we remarked at the beginning of this section, a  $(p,q)$  string undergoes in general a monodromy

<sup>7</sup>In this paper we identify the labels of the branes (such as  $\mathbf{A}$ ) with its monodromy matrices. Also  $\mathbf{X}_{[p,q]}$  is  $= K_{[p,q]}^{-1}$  in [97]. Since the ordering of  $\mathbf{A}, \mathbf{B}, \dots$  is reversed for  $K_A, K_B, \dots$ , this is consistent. We should also note that the choice of  $\mathbf{A}, \mathbf{B}$  and  $\mathbf{C}$  branes does not reproduce the most general (or natural) set of vanishing cycles from the point of view of a deformed geometry.

transformation after circling around the locus of another 7-brane. In that case the string is not of the  $(p, q)$  type any more but becomes a different  $(p', q')$  string. If  $(p', q')$  is proportional to  $(p, q)$ , the string can still end on  $[p, q]$  brane, but it creates a different state than that of the string directly connected between the two  $[p, q]$  branes. For example, if a fundamental  $(= (1, 0))$  string circles around a **C**-brane and a **B**-brane, then

$$\mathbf{BC} \begin{pmatrix} 1 \\ 0 \end{pmatrix} = \begin{pmatrix} 2 & 1 \\ -1 & 0 \end{pmatrix} \begin{pmatrix} 0 & 1 \\ -1 & 2 \end{pmatrix} \begin{pmatrix} 1 \\ 0 \end{pmatrix} = \begin{pmatrix} -1 \\ 0 \end{pmatrix}, \quad (3.11)$$

so it turns into a  $(-1, 0)$  string. This can still end on another **A** brane but its sign of the charge is inverted. A pair of **B** and **C** branes are necessary elements to constitute a *D*-type singularity, identified as an orientifold plane [29]. As shown in Figure 3, there are branch cuts extending from the **B** and **C** branes, and the string that experiences the monodromy cuts across them. But if the path of the string is deformed so that the 7-branes pass across the string, then the path runs in the region where there are no cuts, so in order for the charge conservation to be satisfied, some new strings with appropriate charges need to emerge out of the 7-branes (the Hanany-Witten effect) (Figure 3). Such a multi-pronged

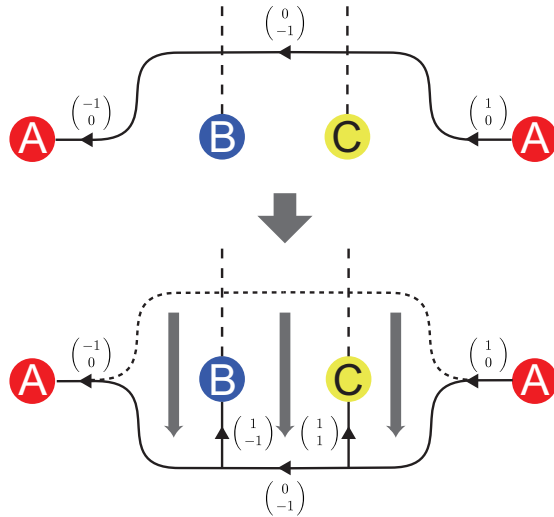

**Figure 3.** A string junction.

string is called a string junction. In this example, a  $(1, 1)$  string is coming into the **C** brane, and a  $(1, -1)$  string into the **B** brane. The original  $(1, 0)$  string then turns into a  $(-1, 0)$  string, and the charge conservation at each junction point is satisfied.

String junctions are conveniently represented in the “divisor-like” form [97]; if  $n$   $(p, q)$  strings come into a  $[p, q]$  7-brane for a given multi-pronged string, then one associates them with the monomial  $n\mathbf{x}_{[p,q]}$ . Summing up these monomials over all the prongs, one obtains the expression for the string junction as a formal sum of monomials with integer coefficients. For the example of Figure 3, this is

$$-\mathbf{a}_2 + \mathbf{b} + \mathbf{c} - \mathbf{a}_1, \quad (3.12)$$

where  $\mathbf{a} = x_{[1,0]}$ ,  $\mathbf{b} = \mathbf{x}_{[1,-1]}$  and  $\mathbf{c} = \mathbf{x}_{[1,1]}$ . On the other hand, an ordinary fundamental string directly connecting the two  $D(=\mathbf{A})$ -branes is represented as

$$\mathbf{a}_2 - \mathbf{a}_1. \quad (3.13)$$

In [97], it was proved that the 7-brane configuration

$$\mathbf{E}_N = \mathbf{A}^{N-1} \mathbf{B} \mathbf{C}^2 \quad (3.14)$$

for the  $E_N$  algebra for  $N \geq 2$  is equivalent to

$$\tilde{\mathbf{E}}_N = \mathbf{A}^N \mathbf{X}_{[2,-1]} \mathbf{C} \quad (3.15)$$

since they are made identical by the use of monodromy transformations and an  $SL(2, \mathbb{Z})$  conjugation. In fact, the string junctions representing the  $E_8$  roots are most conveniently described in terms of Freudenthal's realization of  $E_8$  [109–111]; the exceptional Lie algebra  $E_8$  is known to be generated by traceless  $E^I{}_J$  ( $I, J = 1, \dots, 9$ ;  $I \neq J$ ) and antisymmetric tensors  $E^{IJK}$  and  $E_{IJK}^*$  ( $1 \leq I \neq J \neq K \leq 9$ ) with the commutation relations

$$\begin{aligned} [E^I{}_J, E^K{}_L] &= \delta_J^K E^I{}_L - \delta_L^I E^K{}_J, \\ [E^I{}_J, E^{KLM}] &= 3\delta_I^{[M} E^{KL]J}, \\ [E^I{}_J, E_{KLM}^*] &= -3\delta_{[M}^I E_{KL]J}^*, \\ [E^{IJK}, E^{LMN}] &= -\frac{1}{3!} \sum_{P,Q,R=1}^9 \epsilon^{IJKLMNPQR} E_{PQR}^*, \\ [E_{IJK}^*, E_{LMN}^*] &= +\frac{1}{3!} \sum_{P,Q,R=1}^9 \epsilon_{IJKLMNPQR} E^{PQR}, \\ [E^{IJK}, E_{LMN}^*] &= 6\delta_{[M}^J \delta_N^K E^I{}_L] \quad (\text{if } I \neq L, M, N), \\ [E^{IJK}, E_{IJK}^*] &= E^I{}_I + E^J{}_J + E^K{}_K - \frac{1}{3} \sum_{L=1}^9 E^L{}_L, \end{aligned} \quad (3.16)$$

where  $\epsilon^{123456789} = \epsilon_{123456789} = +1$ . The string junctions for the  $E_8$  roots corresponding to these generators are summarized in Table 4.

The fact that the Kodaira singularities are described by coinciding 7-branes, and the existence of varieties of string junctions which correspond to the roots of the exceptional group, offer a natural explanation [98] for the origin of the exceptional group gauge symmetry in F-theory. When  $N$  D-branes come on top of each other, one gets  $U(N)$  gauge symmetry [112]. In this case the relevant massless ‘‘W-bosons’’ are supplemented by the excitations of light open strings ending on different D-branes. Likewise, the extra massless fields needed for the gauge symmetry enhancement to an exceptional group can be thought of as coming from the string junctions connecting the collapsing 7-branes nontrivially [98].

Having reviewed the 7-brane technology, we are now in a position to explain the argument by Tani on the emergence of matter at the extra zeroes in terms of string junctions. As we saw before, the singularity of elliptic fibers is more enhanced at an extra zero than

**Table 4.** String junctions for the  $E_8$  roots corresponding to generators in Freudenthal's realization.

Generator	String junction
$E^I_J (I, J = 1, \dots, 8)$	$\mathbf{a}_I - \mathbf{a}_J$
$E^{IJK} (1 \leq I < J < K \leq 8)$	$\mathbf{a}_I + \mathbf{a}_J + \mathbf{a}_K - \mathbf{x}_{[2,-1]} - \mathbf{c}$
$E^*_{IJK} (1 \leq I < J < K \leq 8)$	$-(\mathbf{a}_I + \mathbf{a}_J + \mathbf{a}_K - \mathbf{x}_{[2,-1]} - \mathbf{c})$
$E^9_J (J = 1, \dots, 8)$	$-\sum_{K=1}^8 \mathbf{a}_K - \mathbf{a}_J + 3(\mathbf{x}_{[2,-1]} + \mathbf{c})$
$E^I_9 (I = 1, \dots, 8)$	$-\left(-\sum_{K=1}^8 \mathbf{a}_K - \mathbf{a}_I + 3(\mathbf{x}_{[2,-1]} + \mathbf{c})\right)$
$E^{IJ9} (1 \leq I < J \leq 8)$	$-\sum_{K=1}^8 \mathbf{a}_K + \mathbf{a}_I + \mathbf{a}_J + 2(\mathbf{x}_{[2,-1]} + \mathbf{c})$
$E^*_{IJ9} (1 \leq I < J \leq 8)$	$-\left(-\sum_{K=1}^8 \mathbf{a}_K + \mathbf{a}_I + \mathbf{a}_J + 2(\mathbf{x}_{[2,-1]} + \mathbf{c})\right)$

elsewhere around the point. In the 7-brane picture, this means that another 7-brane comes into join the bunch of coincident 7-branes to meet at that point. This is illustrated in Figure 4.

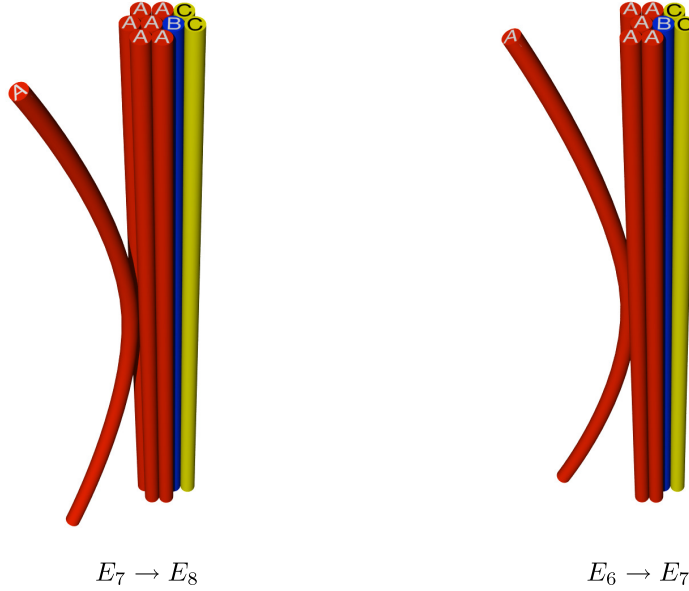

**Figure 4.** Extra zeroes and bending branes. Left: The  $E_7$  singularity is enhanced to  $E_8$  at the extra zero. Right: Similarly the  $E_6$  is enhanced to  $E_7$ .

The string junctions at the extra zero are divided into two different classes. The junctions which do not have an end on the bending brane can move apart from the extra zero without any loss of energy, and hence create a massless gauge multiplet similarly to the above. Let  $\mathfrak{h}$  be the Lie algebra of this gauge multiplet. On the other hand, those which *do* have an end on the bending brane cannot move away from there but localized near that point. Let  $\mathfrak{g}$  be the Lie algebra of the enhanced singularity at the extra zero, then they correspond to the elements of  $\mathfrak{g}$  that do not belong to  $\mathfrak{h} \oplus U(1)$ . They consist of a pair of representations of  $\mathfrak{h}$  that are complex conjugate to each other, so the states they create

must be hypermultiplets. But since a half of the supersymmetries are broken, these states do not necessarily have the same mass but it is possible that only a half of them remains massless. (The condition for half of the SUSY to be preserved will be discussed in detail in section 4.) In the intersecting D-brane systems, where the explicit quantization is possible, this is a familiar phenomenon [113]. So if one assumes that this is also true in the general case when the singularity contains not only D-branes but other  $[p, q]$  branes, then one can get a perfectly consistent picture of the chiral matter generation [61]. The relevant set of coalesced 7-branes and the extra brane(s) coming to join are shown in Table 2 for each case of unbroken gauge symmetry.

### 3.3 The correspondence to homogeneous Kähler manifolds and the $E_7/(SU(5) \times U(1)^3)$ model

In particular, it can readily explain why the coset structure arises at the extra zeroes. For example, on the left of Figure 4, the string junctions localized at the intersection span  $E_8$ , and among them only those corresponding to  $E_7$  can freely move along the bunch of coalesced branes. Thus the states created by the junctions with an end on the bending **A** brane are in  $E_8$  but not in the  $E_7$  subalgebra of it. Taking either of the complex conjugate pair, one gets  $E_8/(E_7 \times U(1))$  and hence a **56** of  $E_7$ . Similarly, on the right of Figure 4, the junctions at the intersection point give  $E_7$ , and those do not have a leg on the **C** brane are the  $E_6$  part of it. Taking a half of the rest, one obtains  $E_7/(E_6 \times U(1))$ , that is, a **27** of  $E_6$ .

At this point it is now obvious what 7-brane configuration would yield the spectrum of

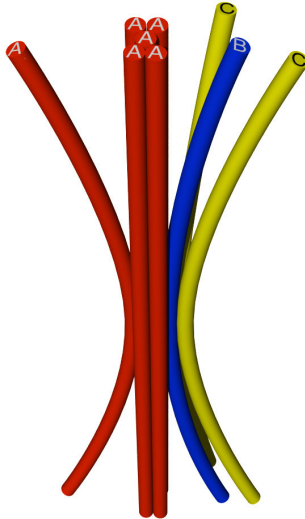

**Figure 5.** The 7-brane configuration for the  $E_7/(SU(5) \times U(1)^3)$  model.

the Kugo-Yanagida  $E_7/(SU(5) \times U(1)^3)$  model. All we need is a set of six **A** branes, one **B** brane and two **C** branes, such that at a generic position along some complex dimension ( $w$ ) only five of the **A** branes are collapsed while all the other branes are apart, but at a certain juncture point they all join together (Figure 5). If such a brane configuration exists and preserves half of the supersymmetries, then the string junctions that have an end on the bending **A** brane will produce six-dimensional hypermultiplets transforming in  $\mathbf{10} \oplus \mathbf{5} \oplus \bar{\mathbf{5}} \oplus \bar{\mathbf{5}} \oplus \mathbf{1} \oplus \mathbf{1}$  of  $SU(5)$  from  $\mathbf{27}$  of  $E_6$ , the junctions with an end on one of the **C** branes (but not on the **A** brane bending away from the juncture) will create  $\mathbf{10} \oplus \bar{\mathbf{5}} \oplus \mathbf{1}$  from  $\mathbf{16}$  of  $SO(10)$ , and those ending on the remaining **B** and **C** branes (not connected to the **A** and **C** branes above) will yield  $\mathbf{10}$  of  $SU(5)$ . They have exactly the same quantum numbers as those of the  $E_7/(SU(5) \times U(1)^3)$  model, except that they are still six-dimensional supermultiplets. So in order to get the four-dimensional  $\mathcal{N} = 1$  family unification model we will need to further compactify two of the spatial dimensions, reduce the number of supersymmetries and project out one half of the four-dimensional chiral multiplets with either of the chiralities. But before we discuss how to do that we would like to consider the more fundamental question: Can the 7-brane configuration as described above preserve SUSY? This is because, if not, our proposal of how to achieve supersymmetric family unification in F-theory would break down. Fortunately, however, we can prove that it indeed can, as we show in the next section.

## 4 Holomorphic deformation of 7-branes

### 4.1 The stringy-cosmic-string solution

Let us first recall the 7-brane solution of type IIB supergravity on  $\mathbb{P}^1$  obtained long time ago by Greene et.al.[108]. Although this is also a well-known material, we will take a different route to it, examining the SUSY conditions; our approach is more convenient and can be directly extended to the deformed case discussed in the next section.

The metric ansatz is

$$ds^2 = -dt^2 + e^{\varphi(z, \bar{z})} dzd\bar{z} + (dx^i)^2 \quad (i = 1, \dots, 7). \quad (4.1)$$

The type IIB complex scalar field  $\tau = C_0 + ie^{-\phi}$ , where  $C_0$  and  $\phi$  are the RR scalar and the dilaton, respectively, is assumed to be a holomorphic function depending only on  $z$ :

$$\tau = \tau(z). \quad (4.2)$$

The other supergravity fields are set to zero. In this case the supersymmetry variations of the gravitino and the dilatino are [114, 115]

$$\delta\psi_\mu = \frac{1}{\kappa} \left( \partial_\mu - \frac{1}{4} \omega_{\mu\alpha\beta} \gamma^{\alpha\beta} - \frac{i}{2} Q_\mu \right) \epsilon, \quad (4.3)$$

$$\delta\lambda = \frac{i}{\kappa} P_\mu \gamma^\mu \epsilon^*, \quad (4.4)$$

where  $P_\mu$  and  $Q_\mu$  are well-known  $SU(1,1)$ -invariant connections given by

$$P_\mu = -\frac{\partial_\mu \tau}{\tau - \bar{\tau}}, \quad (4.5)$$

$$Q_\mu = -\frac{i \partial_\mu (\tau + \bar{\tau})}{2 \tau - \bar{\tau}}. \quad (4.6)$$

Since we have assumed that  $\tau$  is holomorphic, we have

$$P_{\bar{z}} = 0. \quad (4.7)$$

Let  $z, \bar{z}$  be complex linear combinations of real coordinate  $x^{\dot{8}}$  and  $x^{\dot{9}}$ :<sup>8</sup>

$$z = x^{\dot{8}} + ix^{\dot{9}}, \quad \bar{z} = x^{\dot{8}} - ix^{\dot{9}} \quad (4.8)$$

and take the two-dimensional gamma matrices

$$\gamma^{\dot{8}} = \sigma_1, \quad \gamma^{\dot{9}} = \sigma_2, \quad (4.9)$$

where each component is understood to act on spinors in the eight-dimensional space-time. Then

$$\begin{aligned} \delta\lambda &\propto P_z \gamma^z \epsilon^* \\ &= \begin{pmatrix} 0 & * \\ 0 & 0 \end{pmatrix} \epsilon^*, \end{aligned} \quad (4.10)$$

so  $\delta\lambda$  vanishes for  $\epsilon$  of the form  $\begin{pmatrix} * \\ 0 \end{pmatrix}$ .

On the other hand, the gravitino variation  $\delta\psi_\mu$  depends on the spin connections and  $Q_\mu$ . The only nontrivial components of the spin connection are

$$\omega_{z89} = \frac{i}{2} \partial_z \varphi = -\omega_{z98}, \quad (4.11)$$

$$\omega_{\bar{z}89} = -\frac{i}{2} \partial_{\bar{z}} \varphi = -\omega_{\bar{z}98}, \quad (4.12)$$

while

$$\begin{aligned} Q_z &= -\frac{i}{2} \frac{\partial_z \tau}{\tau - \bar{\tau}} = -\frac{i}{2} \frac{\partial_z (\tau - \bar{\tau})}{\tau - \bar{\tau}}, \\ Q_{\bar{z}} &= -\frac{i}{2} \frac{\partial_{\bar{z}} \bar{\tau}}{\tau - \bar{\tau}} = +\frac{i}{2} \frac{\partial_{\bar{z}} (\tau - \bar{\tau})}{\tau - \bar{\tau}} \end{aligned} \quad (4.13)$$

since  $\tau$  is assumed to be holomorphic. Let

$$\epsilon = \begin{pmatrix} \tilde{\epsilon} \\ 0 \end{pmatrix}, \quad (4.14)$$

---

<sup>8</sup>The dots indicate that those indices are curved ones.

then

$$\begin{aligned} \left( \partial_z - \frac{1}{4} \omega_{z\alpha\beta} \gamma^{\alpha\beta} - \frac{i}{2} Q_z \right) \epsilon &= \begin{pmatrix} \partial_z \tilde{\epsilon} + \frac{1}{4} \partial_z (\varphi - \log(\tau - \bar{\tau})) \cdot \tilde{\epsilon} \\ 0 \end{pmatrix}, \\ \left( \partial_{\bar{z}} - \frac{1}{4} \omega_{\bar{z}\alpha\beta} \gamma^{\alpha\beta} - \frac{i}{2} Q_{\bar{z}} \right) \epsilon &= \begin{pmatrix} \partial_{\bar{z}} \tilde{\epsilon} - \frac{1}{4} \partial_{\bar{z}} (\varphi - \log(\tau - \bar{\tau})) \cdot \tilde{\epsilon} \\ 0 \end{pmatrix}. \end{aligned} \quad (4.15)$$

Therefore, if  $\varphi = \log \frac{\tau - \bar{\tau}}{2i}$ , a Killing spinor (which is constant in this case) exists and half the supersymmetries are preserved. More generally, if

$$\varphi = \log \frac{\tau - \bar{\tau}}{2i} + F(z) + \bar{F}(\bar{z}) \quad (4.16)$$

for some holomorphic function  $F(z)$ , then  $\epsilon$  with

$$\tilde{\epsilon} = e^{\frac{1}{4}(F - \bar{F})} \times \text{const.} \quad (4.17)$$

is a Killing spinor.  $F(z)$  is chosen to be [108]

$$F(z) = 2 \log \eta(\tau(z)) + f(z). \quad (4.18)$$

The first term is for the modular (or S-duality) invariance, while  $f(z)$  is some function of  $z$  to compensate the zeroes at the 7-brane loci. For instance, for a single D7-brane at  $z = 0$  we have locally [108]

$$\tau \sim \frac{1}{2\pi i} \log z, \quad f(z) \sim -\frac{1}{12} \log z. \quad (4.19)$$

## 4.2 A supersymmetric deformation of 7-branes

In the previous section we have reviewed the 7-brane solutions in eight dimensions—in modern terminology this is a codimension-one singularity. We now turn to a codimension-two singularity, that is, we deform  $\tau$  so that it also varies over another holomorphic coordinate  $w = x^6 + ix^7$ :

$$\tau = \tau(z, w). \quad (4.20)$$

Note that we do not specify any particular *global* geometry. We will show that, for any such holomorphic deformation <sup>9</sup> of the modulus function  $\tau$ , there exists, at least *locally*, some Kähler metric such that it preserves a quarter of supersymmetries.

We focus on the four-dimensional part of the ten-dimensional metric, which we assume to be hermitian:

$$ds_4^2 = e^\Phi dz d\bar{z} + e^\Psi (dw + \xi dz)(d\bar{w} + \bar{\xi} d\bar{z}). \quad (4.21)$$

Any hermitian metric can be written in this form with two real functions  $\Phi$ ,  $\Psi$  and a complex function  $\xi$ . The vierbein of this subspace is block diagonal:

$$e_\mu^\alpha = \begin{pmatrix} e_i^a & 0 \\ 0 & e_{\bar{i}}^{\bar{a}} \end{pmatrix}, \quad (4.22)$$

---

<sup>9</sup>up to some 7-brane loci where  $\tau$  diverges logarithmically.

where  $\mu = i, \bar{i}; i = z, w; \bar{i} = \bar{z}, \bar{w}; \alpha = a, \bar{a}; a = 1, 2; \bar{a} = \bar{1}, \bar{2}$  with

$$\begin{aligned} e_i^a &\equiv (e_i^8 + i e_i^9, e_i^6 + i e_i^7) = \begin{pmatrix} e^{\frac{\Phi}{2}} & e^{\frac{\Psi}{2}} \xi \\ 0 & e^{\frac{\Psi}{2}} \end{pmatrix}, \\ e_{\bar{i}}^{\bar{a}} &\equiv (e_{\bar{i}}^8 - i e_{\bar{i}}^9, e_{\bar{i}}^6 - i e_{\bar{i}}^7) = \begin{pmatrix} e^{\frac{\Phi}{2}} & e^{\frac{\Psi}{2}} \bar{\xi} \\ 0 & e^{\frac{\Psi}{2}} \end{pmatrix}. \end{aligned} \quad (4.23)$$

In our convention the flat metric is

$$\eta_{\alpha\beta} = \begin{pmatrix} & \frac{1}{2} \mathbb{I} \\ \frac{1}{2} \mathbb{I} & \end{pmatrix}, \quad \mathbb{I} = \begin{pmatrix} 1 & 0 \\ 0 & 1 \end{pmatrix}, \quad (4.24)$$

so that

$$g_{\mu\nu} = e_\mu^\alpha \eta_{\alpha\beta} e_\nu^\beta, \quad ds_4 = g_{\mu\nu} dx^\mu dx^\nu. \quad (4.25)$$

We take

$$\begin{aligned} \gamma^8 &= \sigma_1 \otimes \mathbb{I}, & \gamma^9 &= \sigma_2 \otimes \mathbb{I} \\ \gamma^6 &= \sigma_3 \otimes \sigma_1, & \gamma^7 &= \sigma_3 \otimes \sigma_2, \end{aligned} \quad (4.26)$$

so that

$$\begin{aligned} \gamma^1 &\equiv \gamma^8 + i\gamma^9 = \begin{pmatrix} & 2 \\ 0 & \end{pmatrix} \otimes \mathbb{I} = \begin{pmatrix} & 2 & \\ 0 & & 2 \end{pmatrix}, \\ \gamma^{\bar{1}} &\equiv \gamma^8 - i\gamma^9 = \begin{pmatrix} & 0 \\ 2 & \end{pmatrix} \otimes \mathbb{I} = \begin{pmatrix} & 0 & \\ 2 & & 0 \end{pmatrix}, \\ \gamma^2 &\equiv \gamma^6 + i\gamma^7 = \sigma_3 \otimes \begin{pmatrix} & 2 \\ 0 & \end{pmatrix} = \begin{pmatrix} & 2 & \\ & & -2 \\ 0 & & \end{pmatrix}, \\ \gamma^{\bar{2}} &\equiv \gamma^6 - i\gamma^7 = \sigma_3 \otimes \begin{pmatrix} & 0 \\ 2 & \end{pmatrix} = \begin{pmatrix} & 0 & \\ 2 & & \\ & & -2 \end{pmatrix}. \end{aligned} \quad (4.27)$$

Due to the holomorphic assumption (4.20), we have, again,

$$P_{\bar{i}} = 0 \quad (\bar{i} = \bar{z}, \bar{w}). \quad (4.28)$$

The dilatino variation thus reads

$$\delta\lambda \propto P_i e_a^i \gamma^a \epsilon^*. \quad (4.29)$$

Since the leftmost columns of  $\gamma^a$  ( $a = 1, 2$ ) are zero as displayed in (4.27),  $\delta\lambda$  vanishes for a SUSY variation parameter of the form

$$\epsilon = \begin{pmatrix} \bar{\epsilon} \\ 0 \\ 0 \\ 0 \end{pmatrix}. \quad (4.30)$$

We will now examine under what conditions the gravitino variation  $\delta\psi_\mu$  also vanishes for  $\epsilon$  (4.30). Since the nonzero component is only the first one, we are only concerned with the first columns of  $\omega_{\gamma\alpha\beta}\gamma^{\alpha\beta}$ :

$$\begin{aligned}
\omega_{1\alpha\beta}\gamma^{\alpha\beta} &= \begin{pmatrix} -e^{-\frac{\Phi}{2}}(\partial_w\xi - \xi\partial_w\Phi + \partial_z\Phi) & * & * & * \\ 0 & * & * & * \\ 0 & * & * & * \\ 2e^{-\Phi-\frac{\Psi}{2}}(e^\Psi(\bar{\xi}\partial_{\bar{w}}\xi - \partial_{\bar{z}}\xi) + e^\Phi\partial_{\bar{w}}\Phi) & * & * & * \end{pmatrix}, \\
\omega_{2\alpha\beta}\gamma^{\alpha\beta} &= \begin{pmatrix} e^{-\frac{\Psi}{2}}(e^{\Psi-\Phi}(\xi\partial_w\bar{\xi} - \partial_z\bar{\xi}) - \partial_w\Psi) & * & * & * \\ 0 & * & * & * \\ 0 & * & * & * \\ 2e^{-\frac{\Phi}{2}}(\partial_{\bar{w}}\bar{\xi} + \bar{\xi}\partial_{\bar{w}}\Psi - \partial_{\bar{z}}\Psi) & * & * & * \end{pmatrix}, \\
\omega_{\bar{1}\alpha\beta}\gamma^{\alpha\beta} &= \begin{pmatrix} -\overline{((1,1) \text{ component of } \omega_{1\alpha\beta}\gamma^{\alpha\beta})} & * & * & * \\ 0 & * & * & * \\ 0 & * & * & * \\ 0 & * & * & * \end{pmatrix}, \\
\omega_{\bar{2}\alpha\beta}\gamma^{\alpha\beta} &= \begin{pmatrix} -\overline{((1,1) \text{ component of } \omega_{2\alpha\beta}\gamma^{\alpha\beta})} & * & * & * \\ 0 & * & * & * \\ 0 & * & * & * \\ 0 & * & * & * \end{pmatrix}. \tag{4.31}
\end{aligned}$$

Since the ‘‘Bismut-like’’ connection (4.3) contains, besides the spin (=Levi-Civita) connection, only  $Q_\mu$  which is  $U(1)$ , the gravitino variations vanish only if the off-diagonal components (of the first columns) do. Taking their complex conjugates, the conditions are

$$e^\Psi(\xi\partial_w\bar{\xi} - \partial_z\bar{\xi}) + e^\Phi\partial_w\Phi = 0 \quad \text{and} \tag{4.32}$$

$$\partial_w\xi + \xi\partial_w\Psi - \partial_z\Psi = 0. \tag{4.33}$$

It is easy to see that they are equivalent to

$$\partial_w(e^\Psi\xi\bar{\xi} + e^\Phi) = \partial_z(e^\Psi\bar{\xi}) \quad \text{and} \tag{4.34}$$

$$\partial_w(e^\Psi\xi) = \partial_z e^\Psi, \tag{4.35}$$

or

$$\partial_i g_{j\bar{i}} = \partial_j g_{i\bar{i}}, \quad \partial_{\bar{i}} g_{j\bar{i}} = \partial_{\bar{j}} g_{i\bar{i}}, \tag{4.36}$$

which are satisfied if the metric is Kähler. Conversely, if the conditions (4.32),(4.33) are satisfied, then the spin connection turns out to be a  $U(2)$  connection and hence the metric is Kähler.

Suppose that we have a solution to the conditions (4.32),(4.33). Such a solution exists, at least locally, as we will show in a moment. Then using them in (4.31), we find

$$\omega_{i\alpha\beta}\gamma^{\alpha\beta} = \begin{pmatrix} -\partial_i(\Phi + \Psi) & * & * & * \\ 0 & * & * & * \\ 0 & * & * & * \\ 0 & * & * & * \end{pmatrix}, \quad \omega_{\bar{i}\alpha\beta}\gamma^{\alpha\beta} = \begin{pmatrix} +\partial_{\bar{i}}(\Phi + \Psi) & * & * & * \\ 0 & * & * & * \\ 0 & * & * & * \\ 0 & * & * & * \end{pmatrix}. \tag{4.37}$$

On the other hand,  $Q_\mu$ 's are given by

$$\begin{aligned} Q_i &= -\frac{i}{2}\partial_i \log(\tau - \bar{\tau}), \\ Q_{\bar{i}} &= +\frac{i}{2}\partial_{\bar{i}} \log(\tau - \bar{\tau}). \end{aligned} \quad (4.38)$$

Therefore, similarly to the previous section, we have a Killing spinor if

$$\Phi + \Psi = \log \frac{\tau - \bar{\tau}}{2i} + F(z^i) + \bar{F}(\bar{z}^{\bar{i}}) \quad (4.39)$$

for some holomorphic function  $F$  of  $z^i = z, w$ . Again, we can set  $F(z)$  similarly to (4.18) for some  $f(z)$  which compensates the zeroes of the brane loci, then the metric is positive and modular invariant.

Now what remains to be done is to show the existence of  $\Phi$ ,  $\Psi$  and  $\xi$  that satisfy (4.32), (4.33) with the constraint (4.39) for a given  $\tau(z^i)$ . First we note that, if  $\tau$  is only a function of  $z$  and does not depend on  $w$ , then the problem reduces to that discussed in the previous section with

$$\Phi = \varphi, \quad \Psi = \xi = 0, \quad (4.40)$$

which obviously satisfy (4.32), (4.33) and (4.39). So for given

$$\begin{aligned} \tau(z, w) &= \sum_{n, \bar{n}=0}^{\infty} \tau_{(n, \bar{n})}(z) w^n \bar{w}^{\bar{n}} \\ F(z, w) &= \sum_{n, \bar{n}=0}^{\infty} F_{(n, \bar{n})}(z) w^n \bar{w}^{\bar{n}}, \end{aligned} \quad (4.41)$$

we determine

$$\begin{aligned} \Phi(z, w) &= \sum_{n, \bar{n}=0}^{\infty} \Phi_{(n, \bar{n})}(z) w^n \bar{w}^{\bar{n}} \\ &= \Phi_{(0,0)}(z) + \Phi_{(1,0)}(z)w + \Phi_{(0,1)}(z)\bar{w} + \Phi_{(1,1)}(z)w\bar{w} + \dots, \\ \Psi(z, w) &= \sum_{n, \bar{n}=0}^{\infty} \Psi_{(n, \bar{n})}(z) w^n \bar{w}^{\bar{n}} \\ &= \Psi_{(0,0)}(z) + \Psi_{(1,0)}(z)w + \Psi_{(0,1)}(z)\bar{w} + \Psi_{(1,1)}(z)w\bar{w} + \dots, \\ \xi(z, w) &= \sum_{n, \bar{n}=0}^{\infty} \xi_{(n, \bar{n})}(z) w^n \bar{w}^{\bar{n}} \\ &= \xi_{(0,0)}(z) + \xi_{(1,0)}(z)w + \xi_{(0,1)}(z)\bar{w} + \xi_{(1,1)}(z)w\bar{w} + \dots, \end{aligned} \quad (4.42)$$

with

$$\Psi_{(0,0)}(z) = \xi_{(0,0)}(z) = 0. \quad (4.43)$$

To do this it is more convenient to write

$$e^\Psi = A, \quad e^\Psi \xi = B, \quad e^\Psi \bar{\xi} = \bar{B}. \quad (4.44)$$

$A$  is a real, while  $B$  is a complex function of  $z, w, \bar{z}$  and  $\bar{w}$ . Then

$$\begin{aligned} e^\Psi \xi \bar{\xi} + e^\Phi &= e^{-\Psi} (B\bar{B} + e^{\Phi+\Psi}) \\ &= A^{-1} (B\bar{B} + \frac{\tau - \bar{\tau}}{2i} e^{F+\bar{F}}), \end{aligned} \quad (4.45)$$

where we have used (4.39) in the last line. Let us also set

$$\frac{\tau - \bar{\tau}}{2i} e^{F+\bar{F}} = h(z, w, \bar{z}, \bar{w}), \quad (4.46)$$

where the real function  $h(z, w, \bar{z}, \bar{w})$  is determined by the given holomorphic functions  $\tau$  and  $F$ . The system of equations is now

$$\partial_w B = \partial_z A, \quad (4.47)$$

$$\partial_w (A^{-1} (B\bar{B} + h)) = \partial_z \bar{B}, \quad (4.48)$$

which can be solved by iteration. We expand

$$A = \sum_{n, \bar{n}=0}^{\infty} w^n \bar{w}^{\bar{n}} A_{(n, \bar{n})}(z, \bar{z}), \quad (4.49)$$

$$h = \sum_{n, \bar{n}=0}^{\infty} w^n \bar{w}^{\bar{n}} h_{(n, \bar{n})}(z, \bar{z}), \quad (4.50)$$

$$B = \sum_{\substack{n, \bar{n}=0 \\ (n, \bar{n}) \neq (0, 0)}}^{\infty} w^n \bar{w}^{\bar{n}} B_{(n, \bar{n})}(z, \bar{z}), \quad (4.51)$$

$$\bar{B} = \sum_{\substack{n, \bar{n}=0 \\ (n, \bar{n}) \neq (0, 0)}}^{\infty} w^n \bar{w}^{\bar{n}} \bar{B}_{(n, \bar{n})}(z, \bar{z}). \quad (4.52)$$

Since  $A$  is real, we have

$$\overline{A_{(n, \bar{n})}} = A_{(\bar{n}, n)}, \quad (4.53)$$

whereas

$$\overline{B_{(n, \bar{n})}} = \bar{B}_{(\bar{n}, n)}. \quad (4.54)$$

Plugging the expansions in (4.47) and (4.48), we find

$$n B_{(n, \bar{n})} = \partial_z A_{(n-1, \bar{n})}, \quad (4.55)$$

$$n (A^{-1} (B\bar{B} + h))_{(n, \bar{n})} = \partial_z \bar{B}_{(n-1, \bar{n})}, \quad (4.56)$$

where, as obviously,  $(A^{-1} (B\bar{B} + h))_{(n, \bar{n})}$  is the coefficient of  $w^n \bar{w}^{\bar{n}}$  in the expansion of  $A^{-1} (B\bar{B} + h)$ . Using (4.54), (4.55) and (4.53), (4.56) is further written as

$$n \bar{n} (A^{-1} (B\bar{B} + h))_{(n, \bar{n})} = \partial_z \partial_{\bar{z}} A_{(n-1, \bar{n}-1)}. \quad (4.57)$$

Using (4.55) and (4.56) with the initial conditions

$$A_{(0,0)} = 1, \quad B_{(0,0)} = \bar{B}_{(0,0)} = 0 \quad (4.58)$$

and arbitrary functions  $B_{(0,\bar{n})}$  ( $\bar{n} = 1, 2, \dots$ ),  $A_{(n,\bar{n})}$  and  $B_{(n,\bar{n})}$  (and hence  $\bar{B}_{(n,\bar{n})}$ ) can be determined iteratively. Thus we have shown that the equations (4.32) and (4.33) with (4.39) have a solution, at least locally near  $z = w = 0$ . This completes the proof of the existence of a local supersymmetric solution for any given holomorphic complex scalar function  $\tau(z, w)$ .

The explicit forms of  $A_{(n,\bar{n})}$  obtained as a result of the iteration are given in Appendix A up to  $n + \bar{n} \leq 3$ .

Finally, since the  $J$  function is also holomorphic, holomorphic deformations of the coefficient functions in the Weierstrass form lead to a local supersymmetric solution of type IIB supergravity.

## 5 Orbifolds and anomalies

Thus the 7-branes described in 3.3 (the ones like a bunch of raw spaghetti) preserve SUSY. So if we compactify two more dimensions to reduce the SUSY to  $\mathcal{N} = 1$  and drop one half of the chiral supermultiplets with a definite chirality, then we end up with precisely the  $E_7/(SU(5) \times U(1)^3)$  supersymmetric family unification model. This could be done in a variety of ways. The most modern way to do this is to turn on (after compactifying to four dimensions) ‘‘G-fluxes’’ or some appropriate vortex Higgs field [30]. Then depending on the sign of the charge, similarly to the  $Y$ -charge explained in section 2, a half of the solutions of the Dirac equation would become nonnormalizable and one is left with a chiral spectrum. Alternatively, one could simply compactify two of the six dimensions on a two torus  $T^2$ , wrap the 7-branes around it and take an orbifold (see e.g. [116, 117] and references therein) to reduce the SUSY, thereby imposing a boundary condition such that the massless fields with, say, positive  $Y$ -charges are projected out. This would lead to the same effect as turning on a Higgs field, and hence is an effective and efficient way. It will be a bit ad hoc, but we emphasize that the necessary set of fields with correct gauge quantum numbers are already fixed before the projection; there is no need to adjust anything but is only need to eliminate a half to get them. More concrete discussion on this part of the construction will be given elsewhere.

There is one more thing to be discussed at this point: The  $E_7/(SU(5) \times H)$  models are anomalous, in the senses of both the gauge anomaly and the sigma-model anomaly. This problem has been for a long time [21]: The  $E_7/(SU(5) \times H)$  model includes a single **5** representation, and there is nothing else in the sigma model itself to cancel its anomaly.

In six dimensions there is no problem; the six-dimensional heterotic spectrum on K3 is of course anomaly-free, and so is it for F-theory. If one focuses on a particular extra zero point, then the anomaly balance will be lost, but upon compactification to four dimensions, they become non-chiral and hence have no anomaly. Therefore, this is the issue only after the chiral projection.

There are at least two ways out of this problem. One is the idea that there arises some extra matter from the orbifold. This idea has already been pointed out by several authors.

Another, more interesting possibility is that extra anomalous contribution to the effective action on the brane might come in from the bulk, known as the anomaly inflow mechanism [118–120], [26, 62, 121, 122]. This is an interesting possibility, but if this is true, then it would lead to a non-trivial prediction in the Higgs sector, since it is not the quantum effect of some  $\bar{\mathbf{5}}$  field, but some other effective contribution induced from the bulk, that cancels the anomaly of the  $\mathbf{5}$  field of the model. We postpone a more concrete analysis to future work.

## 6 The explicit expression for the curve of the brane configuration

Going back to the brane configuration in section 3.3, we present in this section the explicit local expression for the curve that represents the brane configuration as shown in Figure 5 discussed at the end of section 3, which is to realize (after the compactification and projection) the  $E_7/(SU(5) \times U(1)^3)$  model. As we have shown in the last section, there exists a local supersymmetric solution for a holomorphically varying scalar function  $\tau(z, w)$ . Therefore, since the  $J$  function is holomorphic, we have only to consider the Weierstrass form

$$y^2 = x^3 + f(z, w)x + g(z, w) \quad (6.1)$$

for holomorphic functions  $f(z, w)$ ,  $g(z, w)$  such that they develop an  $E_7$  singularity at  $z = w = 0$ , and vary over  $w$  according to Tate’s algorithm [123] so that the singularity is relaxed to  $A_4$ . The result is <sup>10</sup>

$$f(z, w) = -3z^4 + z^3 + (a\epsilon - 3b^2)z^2 + 6b\epsilon^2z - 3\epsilon^4, \quad (6.2)$$

$$g(z, w) = 2z^6 + \left(\frac{a^2}{12} + 3\epsilon^2 + b\right)z^4 + (-2b^3 + a\epsilon b - \epsilon^2)z^3 \\ + (6b^2\epsilon^2 - a\epsilon^3)z^2 - 6b\epsilon^4z + 2\epsilon^6, \quad (6.3)$$

where  $a = a(w)$ ,  $b = b(w)$  and  $\epsilon = \epsilon(w)$  are smooth functions only of  $w$  such that

$$a(0) = b(0) = \epsilon(0) = 0. \quad (6.4)$$

If one resorts to the general argument [97, 98] on the 7-brane realization of the Kodaira singularities, it may easily be guessed what types of 7-branes are separating from the rest of coalesced branes. We can, however, directly see this by tracing the value of the  $J$  function (see Appendix B). This technology was developed by Tani [61]. For the purpose of illustration let us consider some special cases:

**Case I :**  $a(w) = b(w) = \epsilon(w) = 0$ , **unbroken  $E_7$**  In this case (6.2) and (6.3) become simply

$$f(z, w) = -3z^4 + z^3, \quad (6.5)$$

$$g(z, w) = 2z^6. \quad (6.6)$$

---

<sup>10</sup>Note that this is not the most general equation for the curve. For instance  $f(z, w)$  may contain a  $z^5$  term but here it is set to zero for simplicity. Also the coefficient of the  $z^3$  term needs not be 1.

The discriminant is

$$\Delta = 4z^9 - 36z^{10} + 108z^{11}, \quad (6.7)$$

indicating that the curve has an  $E_7$  singularity at  $z = 0$  for arbitrary  $w$ . This is a coalesced 7-brane configuration realizing unbroken  $E_7$  gauge symmetry. The monodromy around these collapsed branes can be found by tracing the value of the  $J$  function. The plot on the left of Figure 6 shows the locations of the roots of the discriminant  $\Delta$  (6.7), and the plot on the right shows the contour of the value of the  $J$  function when  $z$  moves around the origin along the circle of radius = 0.002. The latter shows that the value of  $J$  moves three times around  $J = 1$  anti-clockwise, so the monodromy is

$$S^{-3} = S, \quad (6.8)$$

where

$$S \equiv \begin{pmatrix} 0 & -1 \\ 1 & 0 \end{pmatrix} \quad (6.9)$$

and  $T$  (3.8) are the fundamental generators of the  $SL(2, \mathbb{Z})$  group (see Appendix B). On the other hand,

$$\mathbf{A}^6 \mathbf{B} \mathbf{C}^2 = \mathbf{A}^2 (\mathbf{A}^4 \mathbf{B} \mathbf{C}^2 \mathbf{A}^2) \mathbf{A}^{-2}, \quad (6.10)$$

$$\mathbf{A}^4 \mathbf{B} \mathbf{C}^2 \mathbf{A}^2 = S, \quad (6.11)$$

which agrees with the monodromy read off from the behavior of the  $J$  function.

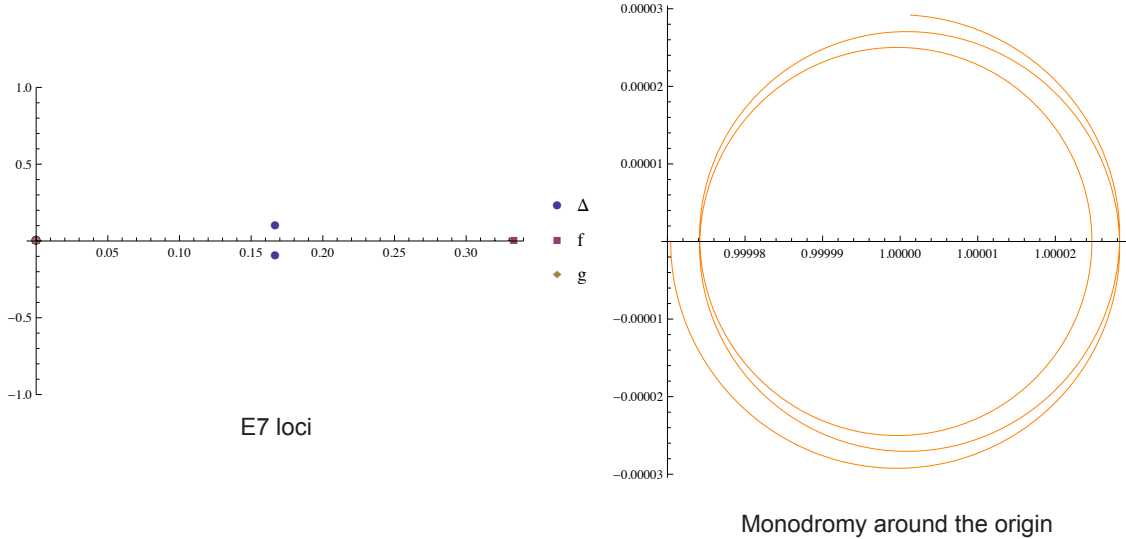

**Figure 6.**  $E_7$  loci ( $a = b = \epsilon = 0$ ). The monodromy is computed along a circle of radius = 0.01 around the origin with the angle varying from 0 to  $2\pi - \frac{\pi}{6}$  (and not to full  $2\pi$ , so that we may distinguish clockwise or anti-clockwise). This is anti-clockwise.

**Case II :**  $b(w) = \epsilon(w) = 0$  and  $a(w) \neq 0$ ,  $E_7/(E_6 \times U(1))$  In this case the equations (6.2), (6.3) read

$$f(z, w) = -3z^4 + z^3, \quad (6.12)$$

$$g(z, w) = 2z^6 + \frac{a(w)^2}{12}z^4, \quad (6.13)$$

which gives an  $E_6$  singularity at  $z = 0$  for generic  $w$  but it is enhanced to  $E_7$  at  $w = 0$  since  $a(0) = 0$  as we assumed. The discriminant in this case is

$$\Delta = 108z^{11} + 9(a(w)^2 - 4)z^{10} + 4z^9 + \frac{3a(w)^4z^8}{16}, \quad (6.14)$$

whose roots are

$$z = 0(\text{multiplicity eight}), \left(\frac{1}{6} \pm \frac{i}{6\sqrt{3}}\right) + \left(-\frac{1}{24} \pm \frac{i}{8\sqrt{3}}\right)a^2 + O(a^4), -\frac{3a^4}{64} + O(a^8) \quad (6.15)$$

The second to last complex conjugate pair is the loci of the 7-branes which were already separated from the coalesced branes in Case I, while the last one is the position of the 7-brane bending into the transverse space. They are depicted in the left plot of Figure 7 for  $a = 1, b = \epsilon = 0$ .

The monodromies around the origin and the locus of the separated brane are shown in the right plots. From these we can see that the former is  $T^{-1}S$  as an  $SL(2, \mathbb{Z})$  conjugacy class, and the latter is  $T$ . Thus the separating brane is an  $\mathbf{A}$  brane, and the monodromy around the origin agrees with the fact that

$$\mathbf{A}^3\mathbf{B}\mathbf{C}^2\mathbf{A}^2 = T^{-1}S. \quad (6.16)$$

**Case III :**  $\epsilon(w) = 0$  and  $a(w)b(w) \neq 0$ ,  $E_7/(SO(10) \times U(1)^2)$  If we also allow  $b$  to take nonzero value, then we have

$$f(z, w) = -3z^4 + z^3 - 3b^2z^2, \quad (6.17)$$

$$g(z, w) = 2z^6 + \left(\frac{a^2}{12} + b\right)z^4 - 2b^3z^3. \quad (6.18)$$

The discriminant takes the form

$$\begin{aligned} \Delta = & 108u^{11} + 9(a^2 - 36b^2 + 12b - 4)u^{10} + (-216b^3 + 216b^2 + 4)u^9 \\ & + \left(\frac{3a^4}{16} + \frac{9ba^2}{2} - 9(36b^4 + b^2)\right)u^8 - 9a^2b^3u^7. \end{aligned} \quad (6.19)$$

The new discriminant locus is

$$\frac{48b^3}{a^2} + \text{higher order in } b, \quad (6.20)$$

which is shown in the plot on the left of Figure 8 as a blue circle near the origin ( $a = 1, b = 0.1$ ).

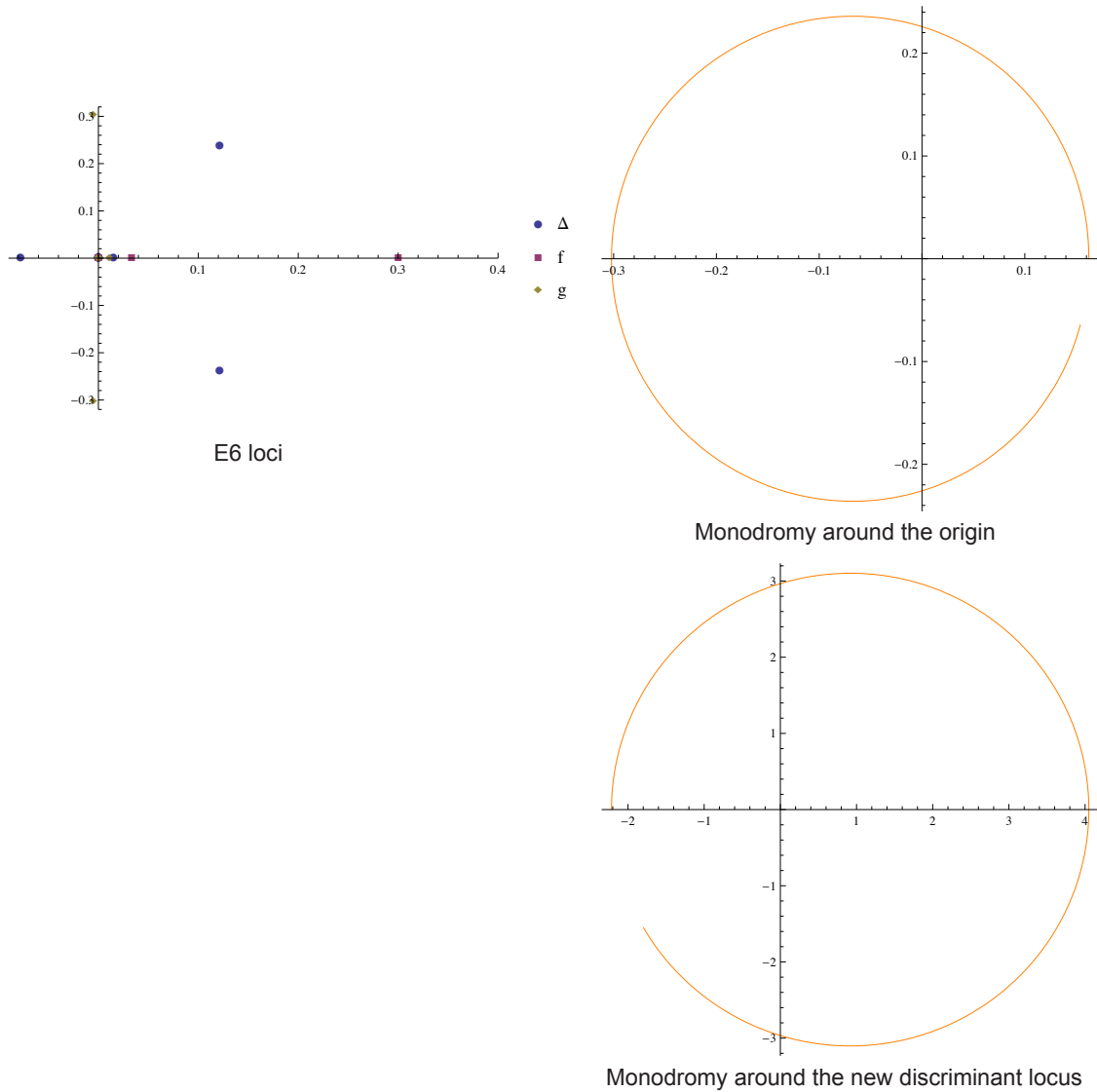

**Figure 7.**  $E_6$  loci ( $a = 1, b = \epsilon = 0$ ). The radius of the circle around each point is 0.01. The range of the angle is from 0 to  $2\pi - \frac{\pi}{6}$ .

The monodromies around the origin and the locus (6.20) are shown in the plots on the right. They tell us that both are  $T$ . However, we note that there is a locus of  $g(z)$  (the yellow diamond) between the two discriminant loci (blue circles), as shown in the enlarged figure. So if the reference point of the monodromy is taken near the origin, then to circle around the discriminant locus away from the origin one first needs to pass by the locus of  $g(z)$  beforehand. Since the total monodromy around a locus of  $g(z)$  is  $S^{-2} = -1$ , one gets  $S^{-1}$  through a half rotation (anti-clockwise). Thus the actual monodromy around the discriminant locus is the one obtained by the similarity transformation of the above:  $STS^{-1}$ , which is equal to  $T^{-1}S^{-1}T^{-1}$ . Multiplying the monodromy around the origin  $T$ ,

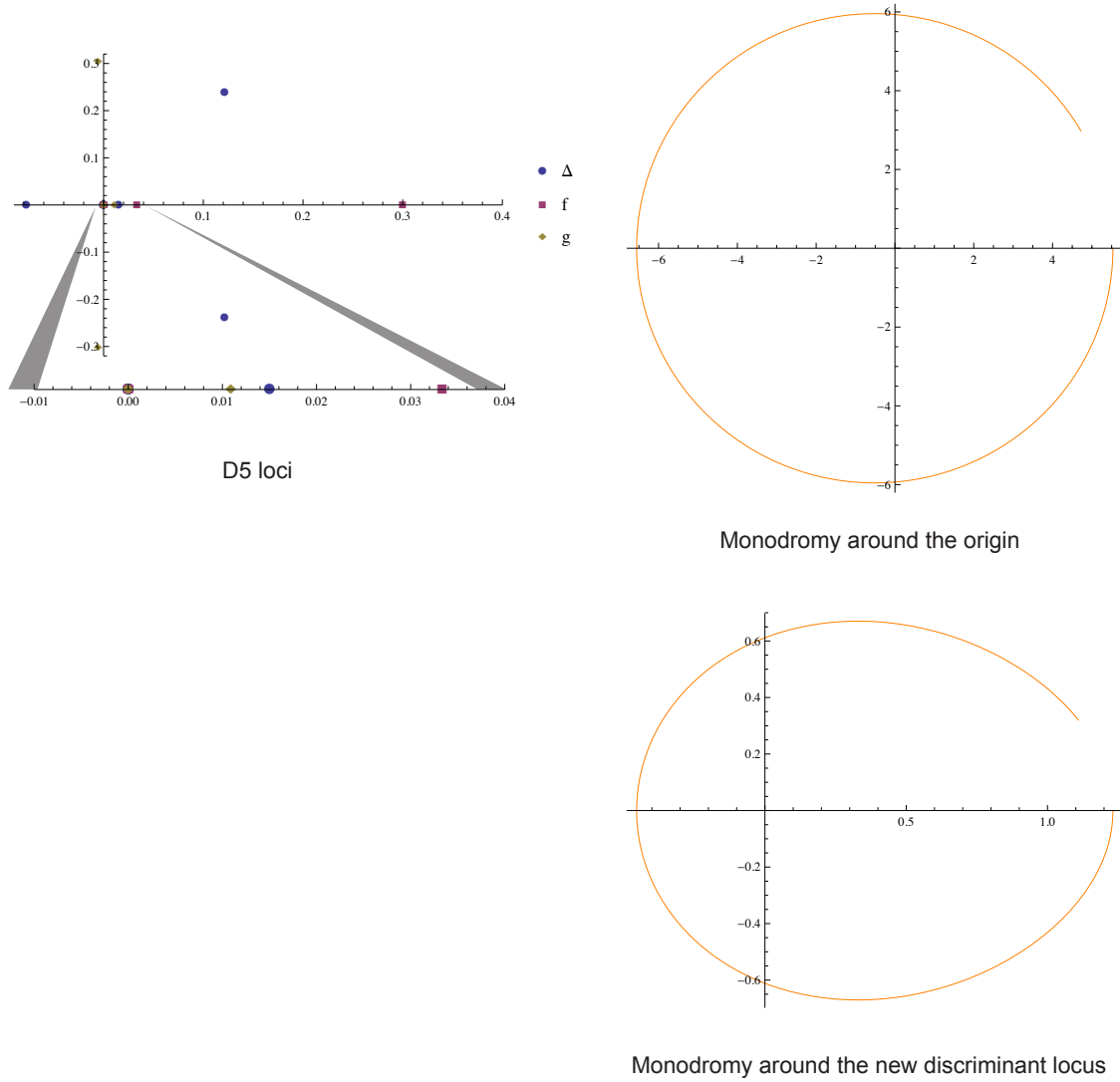

**Figure 8.**  $D_5$  loci ( $a = 1, b = 0.1, \epsilon = 0$ ). The radius is taken to be 0.002 for both points. The angle for the origin is the same as before, and that for the new locus is taken from  $-\pi$  to  $\pi - \frac{\pi}{6}$ .

we have

$$T^{-1}S^{-1}T^{-1} \cdot T = T^{-1}S^{-1}, \quad (6.21)$$

which is the same thing as  $T^{-1}S$  in  $PSL(2, \mathbb{Z})$  and hence is consistent with Case II. On the other hand,

$$\begin{aligned} \mathbf{A}^5 \mathbf{BC} &\sim \mathbf{A}^{-1}(\mathbf{A}^5 \mathbf{BC})\mathbf{A} \\ &= -T \end{aligned} \quad (6.22)$$

which is equal to  $T$  in  $PSL(2, \mathbb{Z})$ , whereas

$$\mathbf{A}^{-1} \mathbf{CA} = \mathbf{STS}^{-1}, \quad (6.23)$$

so the separating brane is indeed identified as the **C** brane.

**Case IV :**  $a(w)b(w)\epsilon(w) \neq 0$ ,  $E_7/(SU(5) \times U(1)^3)$  The final case is when any of  $a(w)$ ,  $b(w)$  or  $\epsilon(w)$  does not vanish. The functions  $f$  and  $g$  are given by (6.2) and (6.3), respectively, and the discriminant is

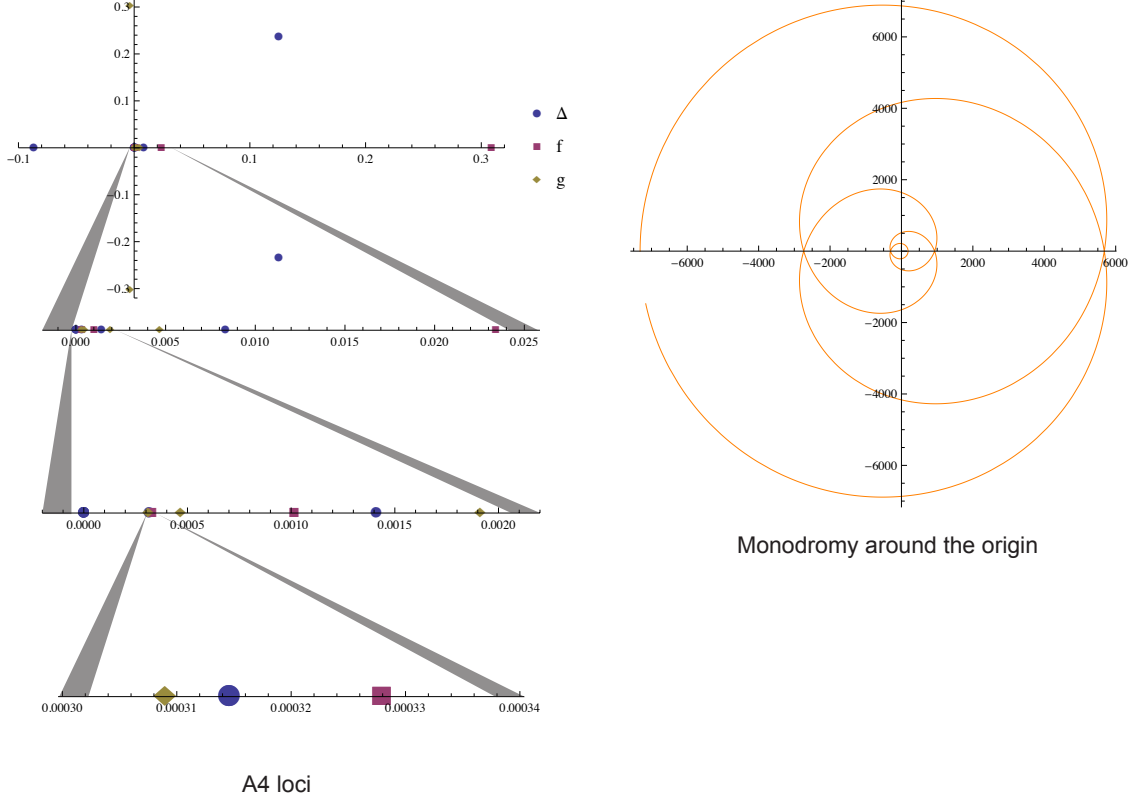

**Figure 9.**  $A_4$  loci ( $a = 1, b = 0.1, \epsilon = 0.007$ ). The radius is 0.0002, and the angle is from  $-\pi$  to  $\pi - \frac{\pi}{60}$ .

$$\begin{aligned}
\Delta = & 108u^{11} + 9(a^2 + 12\epsilon a + 4(-9b^2 + 3b + 9\epsilon^2 - 1))u^{10} \\
& + 4(-54b^3 + 54b^2 + 27\epsilon(a + 6\epsilon)b - 27\epsilon^2 - 18a\epsilon + 1)u^9 \\
& + \left( \frac{3a^4}{16} + \frac{9}{2}(b - 5\epsilon^2)a^2 - 12\epsilon(-18b^2 + 9\epsilon^2 - 1)a \right. \\
& \quad \left. - 9(36b^4 + (1 - 72\epsilon^2)b^2 + 30\epsilon^2b + 9\epsilon^4) \right) u^8 \\
& + \frac{3}{2}(3bea^3 + (5\epsilon^2 - 6b^3)a^2 - 12b\epsilon(15\epsilon^2 + b)a + 12\epsilon^2(54b^3 - 36\epsilon^2b + b + 3\epsilon^2))u^7 \\
& + \left( 9(-108b^2 + 24\epsilon^2 - 1)\epsilon^4 - \frac{a^3\epsilon^3}{2} + 18a^2b^2\epsilon^2 + 18a(3\epsilon^5 + 2b\epsilon^3) \right) u^6 \\
& - 9\epsilon^4(ba^2 + 2\epsilon a - 36b\epsilon^2)u^5, \tag{6.24}
\end{aligned}$$

which is of order 5 as arranged for an  $A_4$  singularity. There appear two new nonzero discriminant loci; their positions are  $\frac{\epsilon^2}{b}$  for both to leading order in  $\epsilon$ , but different in their higher order terms. The monodromy around the origin is  $T^5$  as shown in Figure 9, indicating the existence of five collapsed  $\mathbf{A}$  branes. On the other hand, the monodromy around each discriminant locus is  $T$  for both. Again, as shown in Figure 9, there is a locus of  $g$  between the origin and the closer locus, and there are two loci of  $f$  and another locus of  $g$  between the origin and the farther one. Therefore we must do the corresponding similarity transformations. It can be shown that the monodromy is  $S^{-1}$  for the former, and  $T^2S^{-1}TST^{-2}$  for the latter. Thus the monodromy matrix for the closer locus is

$$STS^{-1} = \mathbf{A}^{-1}\mathbf{C}\mathbf{A}, \quad (6.25)$$

and that for the farther locus is

$$\begin{aligned} (T^2S^{-1}TST^{-2})^{-1}T(T^2S^{-1}TST^{-2}) &= TS^{-1}T^{-3} \\ &= \mathbf{A}^{-1}(\mathbf{C}^{-1}\mathbf{B}\mathbf{C})\mathbf{A}. \end{aligned} \quad (6.26)$$

Changing their positions with each other in such a way that the farther brane passes through the branch cut of the closer brane, their monodromies become  $\mathbf{A}^{-1}\mathbf{B}\mathbf{A}$  and  $\mathbf{A}^{-1}\mathbf{C}\mathbf{A}$ , so they are a  $\mathbf{B}$  and a  $\mathbf{C}$  brane, respectively, as expected.

## 7 Summary and discussion

Using Tani's argument to account for the chiral matter generation at extra zeroes, we have proposed a natural geometric mechanism for realizing the coset family structure in F-theory. Tani's argument uses string junctions connecting the various gathering 7-branes meeting at that point and is a direct generalization of [113] for the intersecting D-brane systems. It offers a perfectly consistent picture of the chiral matter generation in six dimensions for the split-type singularities, and we have pointed out that their relations to homogeneous Kähler manifolds are readily explained in this picture. Note that these rules are not just a kind of "trick" as has been known in the literature, but can be deduced by the concrete entities responsible for the symmetry enhancement: the string junctions.

In particular, we have proposed a local 7-brane system as shown in Figure 5 which would yield the set of supermultiplets in six dimensions with exactly the same gauge quantum numbers as those in the three-generation  $E_7/(SU(5) \times U(1)^3)$  coset family unification model. We have proved that for a given holomorphically varying type IIB scalar field configuration in six dimensions, there exists at least locally a Kähler metric such that a half of the supersymmetries are preserved. We have further discussed how this local model is compactified to four dimensions and half of the spectrum is projected out on orbifolds, and also suggested how the anomalies of the original models can be canceled. The last point is still incomplete and we leave this issue to future work.

One of the nice features of our mechanism is that such a gathering brane system is a local one and could emerge independently of the every global detail of the ambient space. Meanwhile, given the experimental data, several authors have recently pointed out the

possible existence of the “desert”, the absence of new physics between the electro-weak and string scales [124–126]. If this is true, and if string theory is really the theory beyond the Standard Model, then it must have a mechanism to realize close to what we observe now already at the string scale. Our proposal fits with this requirement.

It is interesting to speculate how this configuration might come to exist: Suppose that there were, perhaps in the very early universe, some set of 7-branes, and assume some attractive force to be somehow generated between them. Then such 7-branes might have become closer and closer until they collide with each other. This can happen only if they are a collapsable set of 7-branes which must be one of the types of the Kodaira classification. If these branes were the ones that could constitute the  $E_7$  singularity, then just after they made a collision and at the last minute before they were completely separated, they would have looked like Figure 5. This story is of course just a speculation at this moment, but it would be an interesting scenario to study.

## Acknowledgments

I wish to thank T. Higaki, K. Igi, S. Iso, H. Otsuka, N. Sakai, Y. Sakamura, T. Yukawa and Y. Yasui for useful discussions. My special thanks go to T. Tani who explained his work. I also thank M. Yata for his advices in generating the figures. The work of S. M. is supported by Grant-in-Aid for Scientific Research (A) #22244430-0007 and (C) #25400285 from The Ministry of Education, Culture, Sports, Science and Technology of Japan.

## A The explicit forms of $A_{(n,\bar{n})}$ up to $n + \bar{n} \leq 3$

The result of solving the recursion relations (4.55), (4.56) is as follows:

$$\begin{aligned}
A_{(0,1)} &= \frac{h_{(0,1)}}{h_{(0,0)}}, \\
A_{(0,2)} &= \frac{2h_{(0,2)} - B_{(0,1)}^{(0,1)}}{2h_{(0,0)}}, \\
A_{(1,1)} &= \frac{B_{(0,1)}\overline{B_{(0,1)}} + h_{(1,1)}}{h_{(0,0)}}, \\
A_{(0,3)} &= \frac{1}{6(h_{(0,0)})^3} \left( -2B_{(0,2)}^{(0,1)}(h_{(0,0)})^2 - 3B_{(0,1)}^{(0,1)}h_{(0,1)}h_{(0,0)} + 3B_{(0,1)}h_{(0,1)}^{(0,1)}h_{(0,0)} \right. \\
&\quad \left. - 3B_{(0,1)}h_{(0,1)}h_{(0,0)}^{(0,1)} + 6h_{(1,0)}(h_{(0,0)})^2 \right), \\
A_{(1,2)} &= \frac{1}{2(h_{(0,0)})^4} \left( 2B_{(0,2)}(h_{(0,0)})^3\overline{B_{(0,1)}} \right. \\
&\quad \left. - (h_{(0,0)})^2 \left( B_{(0,1)}^{(0,1)}h_{(1,0)} - 2B_{(0,1)}h_{(1,0)}^{(0,1)} + h_{(0,1)}^{(1,1)} \right) \right. \\
&\quad \left. + h_{(0,0)} \left( -2B_{(0,1)}h_{(1,0)}h_{(0,0)}^{(0,1)} + h_{(0,1)}^{(1,0)}h_{(0,0)}^{(0,1)} + h_{(0,1)}^{(0,1)}h_{(0,0)}^{(1,0)} + h_{(0,1)}h_{(0,0)}^{(1,1)} \right) \right. \\
&\quad \left. + 2h_{(1,2)}(h_{(0,0)})^3 - 2h_{(0,1)}h_{(0,0)}^{(0,1)}h_{(0,0)}^{(1,0)} \right).
\end{aligned}$$

$h_{(n,\bar{n})}^{(p,q)} \equiv \partial_z^p \partial_{\bar{z}}^q h_{(n,\bar{n})}$ .  $B_{(0,\bar{n})}$ 's are arbitrary functions of  $z$  and  $\bar{z}$ , and  $B_{(0,\bar{n})}^{(p,q)} \equiv \partial_z^p \partial_{\bar{z}}^q B_{(0,\bar{n})}$ .  $A_{(\bar{n},n)}$  is equal to the complex conjugate of  $A_{(n,\bar{n})}$ . Once  $A_{(n,\bar{n})}$ 's are determined, then so are  $B_{(n,\bar{n})}$ 's by the equation (4.55).

## B $J$ -function and monodromy

Klein's  $J$ -function is a modular invariant holomorphic function from the upper-half plane  $\mathbb{H}$  to the complex plane  $\mathbb{C}$ , and maps one-to-one the fundamental region of the modular group to the complex plane. The definition in terms of theta functions is

$$J(\tau) = \frac{(\vartheta_2(\tau)^8 + \vartheta_3(\tau)^8 + \vartheta_4(\tau)^8)^3}{54\vartheta_2(\tau)^8\vartheta_3(\tau)^8\vartheta_4(\tau)^8},$$

so that

$$J(e^{\frac{2\pi i}{3}}) = 0, \quad J(i) = 1.$$

Suppose that  $\tau \in \mathbb{H}$  changes its value from some  $\tau_0$  in the standard fundamental region to  $\tau_0 + 1$ , which belongs to another fundamental region next to it. Then the trajectory of  $J(\tau)$  circles clockwise around 1 and 0 (Figure 10). On the other hand, if  $\tau \in \mathbb{H}$  changes from  $\tau_0$  to  $-\frac{1}{\tau_0}$ , then  $J(\tau)$  only circles around 1, counter-clockwise (Figure 11).

Note that since  $J(\tau)$  has a triple zero at  $\tau = e^{\frac{2\pi i}{3}}$ ,  $J(\tau)$  moves three times around 0 when  $\tau$  moves along a small circle around  $e^{\frac{2\pi i}{3}}$  and back to the original fundamental region.

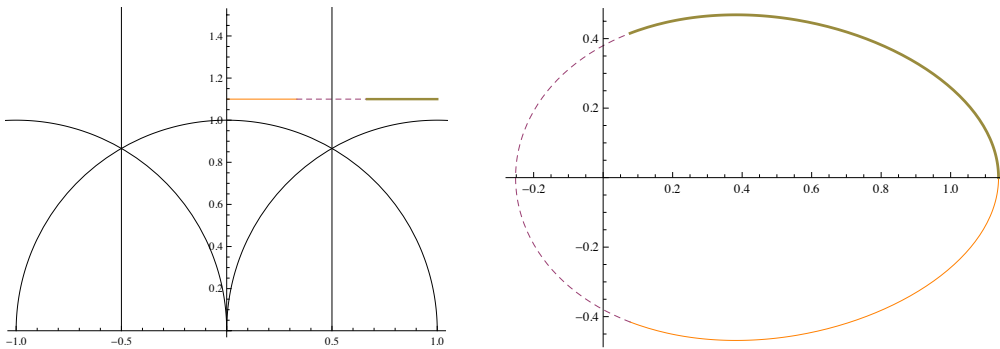

**Figure 10.** A trajectory of  $J(\tau)$  under the  $T$  transformation ( $\tau_0 = 1.1i$ ).

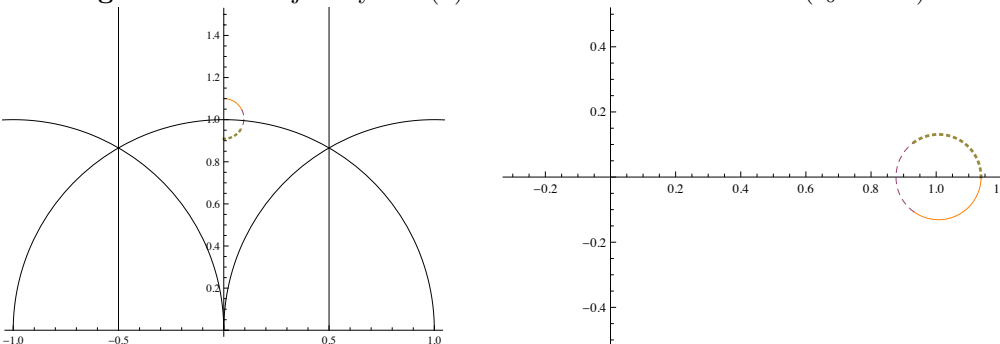

**Figure 11.** A trajectory of  $J(\tau)$  under the  $S$  transformation ( $\tau_0 = 1.1i$ ).

Likewise  $J(\tau) - 1$  has a double zero at  $\tau = i$ , so  $J(\tau)$  goes twice around 1 when  $\tau$  does once around  $i$ .

## References

- [1] G. Aad *et al.* [ATLAS Collaboration], Phys. Lett. B **716**, 1 (2012) [arXiv:1207.7214 [hep-ex]].
- [2] S. Chatrchyan *et al.* [CMS Collaboration], Phys. Lett. B **716**, 30 (2012) [arXiv:1207.7235 [hep-ex]].
- [3] F. Abe *et al.* [CDF Collaboration], Phys. Rev. Lett. **74**, 2626 (1995) [hep-ex/9503002].
- [4] S. Abachi *et al.* [D0 Collaboration], Phys. Rev. Lett. **74**, 2632 (1995) [hep-ex/9503003].
- [5] Y. Fukuda *et al.* [Super-Kamiokande Collaboration], Phys. Lett. B **436**, 33 (1998) [hep-ex/9805006].
- [6] A. Gando *et al.* [KamLAND Collaboration], Phys. Rev. D **88**, 033001 (2013) [arXiv:1303.4667 [hep-ex]].
- [7] B. Aharmim *et al.* [SNO Collaboration], Phys. Rev. C **88**, 025501 (2013) [arXiv:1109.0763 [nucl-ex]].
- [8] K. Abe *et al.* [T2K Collaboration], Phys. Rev. Lett. **107**, 041801 (2011) [arXiv:1106.2822 [hep-ex]].
- [9] Y. Abe *et al.* [DOUBLE-CHOOZ Collaboration], Phys. Rev. Lett. **108**, 131801 (2012) [arXiv:1112.6353 [hep-ex]].
- [10] F. P. An *et al.* [DAYA-BAY Collaboration], Phys. Rev. Lett. **108**, 171803 (2012) [arXiv:1203.1669 [hep-ex]].
- [11] J. K. Ahn *et al.* [RENO Collaboration], Phys. Rev. Lett. **108**, 191802 (2012) [arXiv:1204.0626 [hep-ex]].
- [12] W. Buchmuller, R. D. Peccei and T. Yanagida, Phys. Lett. B **124**, 67 (1983); Nucl. Phys. B **227**, 503 (1983).
- [13] W. Buchmuller, S. T. Love, R. D. Peccei and T. Yanagida, Phys. Lett. B **115**, 233 (1982).
- [14] C. -L. Ong, Phys. Rev. D **27**, 911 (1983).;
- [15] C. -L. Ong, Phys. Rev. D **27**, 3044 (1983); Phys. Rev. D **31**, 3271 (1985).
- [16] T. Kugo and T. Yanagida, Phys. Lett. B **134**, 313 (1984).
- [17] M. Bando, T. Kuramoto, T. Maskawa and S. Uehara, Phys. Lett. B **138**, 94 (1984); Prog. Theor. Phys. **72**, 313 (1984); Prog. Theor. Phys. **72**, 1207 (1984).
- [18] S. Irié and Y. Yasui, Z. Phys. C **29** (1985), 123.
- [19] W. Buchmuller and O. Napoly, Phys. Lett. B **163**, 161 (1985).
- [20] K. Itoh, T. Kugo and H. Kunitomo, Nucl. Phys. B **263**, 295 (1986); Prog. Theor. Phys. **75**, 386 (1986).
- [21] T. Yanagida and Y. Yasui, Nucl. Phys. B **269**, 575 (1986).
- [22] S. Dimopoulos and H. Georgi, Nucl. Phys. B **193**, 150 (1981).
- [23] N. Sakai, Z. Phys. C **11**, 153 (1981).

- [24] T. Yanagida, “*Large lepton mixing in seesaw models: Coset space family unification*”, Talk given at Neutrino 98, Takayama, Japan, 4-9 June, 1998;
- [25] T. Yanagida and J. Sato, Nucl. Phys. Proc. Suppl. **77**, 293 (1999) [hep-ph/9809307].
- [26] T. Kimura and S. Mizoguchi, JHEP **1004**, 028 (2010) [arXiv:0912.1334 [hep-th]].
- [27] S. Mizoguchi and M. Yata, PTEP **2013**, no. 5, 053B01 (2013) [arXiv:1211.6135 [hep-th]].
- [28] C. Vafa, Nucl. Phys. B **469**, 403 (1996) [hep-th/9602022].
- [29] A. Sen, Nucl. Phys. B **475**, 562 (1996) [hep-th/9605150].
- [30] R. Donagi and M. Wijnholt, Adv. Theor. Math. Phys. **15**, 1237 (2011) [arXiv:0802.2969 [hep-th]].
- [31] C. Beasley, J. J. Heckman and C. Vafa, JHEP **0901**, 058 (2009) [arXiv:0802.3391 [hep-th]].
- [32] C. Beasley, J. J. Heckman and C. Vafa, JHEP **0901**, 059 (2009) [arXiv:0806.0102 [hep-th]].
- [33] J. J. Heckman, J. Marsano, N. Saulina, S. Schafer-Nameki and C. Vafa, arXiv:0808.1286 [hep-th].
- [34] J. Marsano, N. Saulina and S. Schafer-Nameki, Phys. Rev. D **80**, 046006 (2009) [arXiv:0808.1571 [hep-th]].
- [35] R. Donagi and M. Wijnholt, Adv. Theor. Math. Phys. **15**, 1523 (2011) [arXiv:0808.2223 [hep-th]].
- [36] J. J. Heckman and C. Vafa, JHEP **0909**, 079 (2009) [arXiv:0809.1098 [hep-th]].
- [37] M. Wijnholt, arXiv:0809.3878 [hep-th].
- [38] A. Font and L. E. Ibanez, JHEP **0902**, 016 (2009) [arXiv:0811.2157 [hep-th]].
- [39] J. J. Heckman and C. Vafa, Nucl. Phys. B **837**, 137 (2010) [arXiv:0811.2417 [hep-th]].
- [40] R. Blumenhagen, Phys. Rev. Lett. **102**, 071601 (2009) [arXiv:0812.0248 [hep-th]].
- [41] H. Hayashi, T. Kawano, R. Tatar and T. Watari, Nucl. Phys. B **823**, 47 (2009) [arXiv:0901.4941 [hep-th]].
- [42] B. Andreas and G. Curio, J. Geom. Phys. **60**, 1089 (2010) [arXiv:0902.4143 [hep-th]].
- [43] R. Donagi and M. Wijnholt, Commun. Math. Phys. **326**, 287 (2014) [arXiv:0904.1218 [hep-th]].
- [44] J. Marsano, N. Saulina and S. Schafer-Nameki, JHEP **0908**, 030 (2009) [arXiv:0904.3932 [hep-th]].
- [45] J. Jiang, T. Li, D. V. Nanopoulos and D. Xie, Nucl. Phys. B **830**, 195 (2010) [arXiv:0905.3394 [hep-th]].
- [46] R. Blumenhagen, T. W. Grimm, B. Jurke and T. Weigand, JHEP **0909**, 053 (2009) [arXiv:0906.0013 [hep-th]].
- [47] J. J. Heckman, A. Tavanfar and C. Vafa, JHEP **1008**, 040 (2010) [arXiv:0906.0581 [hep-th]].
- [48] J. Marsano, N. Saulina and S. Schafer-Nameki, JHEP **0908**, 046 (2009) [arXiv:0906.4672 [hep-th]].
- [49] R. Blumenhagen, T. W. Grimm, B. Jurke and T. Weigand, Nucl. Phys. B **829**, 325 (2010) [arXiv:0908.1784 [hep-th]].
- [50] S. Cecotti, M. C. N. Cheng, J. J. Heckman and C. Vafa, arXiv:0910.0477 [hep-th].

- [51] K. -S. Choi, JHEP **1002**, 004 (2010) [arXiv:0910.2571 [hep-th]].
- [52] J. Marsano, N. Saulina and S. Schafer-Nameki, JHEP **1004**, 095 (2010) [arXiv:0912.0272 [hep-th]].
- [53] T. W. Grimm, S. Krause and T. Weigand, JHEP **1007**, 037 (2010) [arXiv:0912.3524 [hep-th]].
- [54] J. J. Heckman, Ann. Rev. Nucl. Part. Sci. **60**, 237 (2010) [arXiv:1001.0577 [hep-th]].
- [55] M. Cvetič, I. Garcia-Etxebarria and J. Halverson, JHEP **1101**, 073 (2011) [arXiv:1003.5337 [hep-th]].
- [56] T. W. Grimm and T. Weigand, Phys. Rev. D **82**, 086009 (2010) [arXiv:1006.0226 [hep-th]].
- [57] T. Weigand, Class. Quant. Grav. **27**, 214004 (2010) [arXiv:1009.3497 [hep-th]].
- [58] K. -S. Choi and B. Kyae, Nucl. Phys. B **855**, 1 (2012) [arXiv:1102.0591 [hep-th]].
- [59] K. -S. Choi, arXiv:1309.7297 [hep-th].
- [60] M. Bershadsky, K. A. Intriligator, S. Kachru, D. R. Morrison, V. Sadov and C. Vafa, Nucl. Phys. B **481**, 215 (1996) [hep-th/9605200].
- [61] T. Tani, Nucl. Phys. B **602**, 434 (2001).
- [62] M. Cvetič, I. Garcia Etxebarria and J. Halverson, JHEP **1111**, 101 (2011) [arXiv:1107.2388 [hep-th]].
- [63] R. Tatar and T. Watari, Nucl. Phys. B **747**, 212 (2006) [hep-th/0602238].
- [64] S. H. Katz and C. Vafa, Nucl. Phys. B **497**, 146 (1997) [hep-th/9606086].
- [65] M. Bordemann, M. Forger and H. Romer, Commun. Math. Phys. **102**, 605 (1986).
- [66] P. Ramond, “The Family Group in Grand Unified Theories,” Invited talk at the Sanibel Symposia, Feb 1979 Report-no: CALT-68-709 p.265-280. hep-ph/9809459.
- [67] R. N. Mohapatra and B. Sakita, Phys. Rev. D **21**, 1062 (1980).
- [68] I. Bars and M. Gunaydin, Phys. Rev. Lett. **45**, 859 (1980).
- [69] S. E. Konshtein and E. S. Fradkin, JETP Lett. **32**, 557 (1981) [Pisma Zh. Eksp. Teor. Fiz. **32**, 575 (1980)].
- [70] H. Sato, Phys. Rev. Lett. **45**, 1997 (1980). Phys. Lett. B **101**, 233 (1981);
- [71] M. Ida, Y. Kayama and T. Kitazoe, Prog. Theor. Phys. **64**, 1745 (1980).
- [72] M. Koca, Phys. Lett. B **107**, 73 (1981).
- [73] F. Wilczek and A. Zee, Phys. Rev. D **25**, 553 (1982).
- [74] A. Masiero, M. Roncadelli and T. Yanagida, Phys. Lett. B **117**, 291 (1982).
- [75] P. B. Arnold, Phys. Lett. B **149**, 473 (1984).
- [76] G. Senjanovic, F. Wilczek and A. Zee, Phys. Lett. B **141**, 389 (1984).
- [77] J. Bagger and S. Dimopoulos, Nucl. Phys. B **244**, 247 (1984).
- [78] B. Zumino, Phys. Lett. B **87**, 203 (1979).
- [79] L. Alvarez-Gaume and D. Z. Freedman, Commun. Math. Phys. **80**, 443 (1981).
- [80] A. Borel, Proc. Natl. Acad. Sci. **40** (1954) 11.

- [81] C. D. Froggatt and H. B. Nielsen, Nucl. Phys. B **147**, 277 (1979).
- [82] Y. Yasui, Prog. Theor. Phys. **76**, 238 (1986).
- [83] A. C. W. Kotcheff and G. M. Shore, Int. J. Mod. Phys. A **4**, 4391 (1989); Nucl. Phys. B **333**, 701 (1990).
- [84] A. M. Perelomov, Phys. Rept. **174**, 229 (1989).
- [85] T. Goto, K. Inoue, Y. Okada and T. Yanagida, Phys. Rev. D **46**, 4808 (1992).
- [86] J. Sato and T. Yanagida, Phys. Lett. B **430**, 127 (1998) [hep-ph/9710516].
- [87] M. Nitta, hep-th/9903174.
- [88] S. Aoyama, Nucl. Phys. B **578**, 449 (2000) [hep-th/0001160].
- [89] T. Watari and T. Yanagida, Phys. Lett. B **532**, 252 (2002) [hep-ph/0201086].
- [90] T. Kugo and T. T. Yanagida, Prog. Theor. Phys. **124**, 555 (2010) [arXiv:1003.5985 [hep-th]].
- [91] M. Endo, S. Shirai and T. T. Yanagida, Prog. Theor. Phys. **125**, 921 (2011) [arXiv:1009.3366 [hep-ph]].
- [92] J. L. Evans, K. A. Olive, M. Ibe and T. T. Yanagida, Eur. Phys. J. C **73**, 2611 (2013) [arXiv:1305.7461 [hep-ph]].
- [93] D. R. Morrison and C. Vafa, Nucl. Phys. B **473**, 74 (1996) [hep-th/9602114]; Nucl. Phys. B **476**, 437 (1996) [hep-th/9603161].
- [94] S. Kachru and C. Vafa, Nucl. Phys. B **450**, 69 (1995) [hep-th/9505105].
- [95] M. B. Green, J. H. Schwarz and P. C. West, Nucl. Phys. B **254**, 327 (1985).
- [96] K. Kodaira, Ann. of Math. **77**, 563 (1963).
- [97] O. DeWolfe, T. Hauer, A. Iqbal and B. Zwiebach, Adv. Theor. Math. Phys. **3**, 1785 (1999) [hep-th/9812028].
- [98] M. R. Gaberdiel and B. Zwiebach, Nucl. Phys. B **518**, 151 (1998) [hep-th/9709013].
- [99] M. R. Gaberdiel, T. Hauer and B. Zwiebach, Nucl. Phys. B **525**, 117 (1998) [hep-th/9801205].
- [100] O. DeWolfe and B. Zwiebach, Nucl. Phys. B **541**, 509 (1999) [hep-th/9804210].
- [101] O. DeWolfe, Nucl. Phys. B **550**, 622 (1999) [hep-th/9809026].
- [102] O. DeWolfe, T. Hauer, A. Iqbal and B. Zwiebach, Adv. Theor. Math. Phys. **3**, 1835 (1999) [hep-th/9812209].
- [103] M. Fukae, Y. Yamada and S. -K. Yang, Nucl. Phys. B **572**, 71 (2000) [hep-th/9909122].
- [104] K. Mohri, Y. Ohtake and S. -K. Yang, Nucl. Phys. B **595**, 138 (2001) [hep-th/0007243].
- [105] L. Bonora and R. Savelli, JHEP **1011**, 025 (2010) [arXiv:1007.4668 [hep-th]].
- [106] A. Grassi, J. Halverson and J. L. Shaneson, JHEP **1310**, 205 (2013) [arXiv:1306.1832 [hep-th]].
- [107] A. Grassi, J. Halverson and J. L. Shaneson, arXiv:1402.5962 [hep-th].
- [108] B. R. Greene, A. D. Shapere, C. Vafa and S. -T. Yau, Nucl. Phys. B **337**, 1 (1990).
- [109] H. Freudenthal, Proc. Kon. Ned. Akad. Wet. A56 (Indagationes Math. 15) (1953) 95-98 (French).

- [110] S. Mizoguchi, Nucl. Phys. B **528**, 238 (1998) [hep-th/9703160].
- [111] S. Mizoguchi and G. Schroder, Class. Quant. Grav. **17**, 835 (2000) [hep-th/9909150].
- [112] E. Witten, Nucl. Phys. B **460**, 335 (1996) [hep-th/9510135].
- [113] M. Berkooz, M. R. Douglas and R. G. Leigh, Nucl. Phys. B **480**, 265 (1996) [hep-th/9606139].
- [114] P. S. Howe and P. C. West, Nucl. Phys. B **238**, 181 (1984).
- [115] J. H. Schwarz, Nucl. Phys. B **226**, 269 (1983).
- [116] Y. Kawamura, T. Kinami and K. -y. Oda, Phys. Rev. D **76**, 035001 (2007) [hep-ph/0703195 [HEP-PH]].
- [117] Y. Goto, Y. Kawamura and T. Miura, Phys. Rev. D **88**, 055016 (2013) [arXiv:1307.2631].
- [118] J. M. Izquierdo and P. K. Townsend, Nucl. Phys. B **414**, 93 (1994) [arXiv:hep-th/9307050].
- [119] J. D. Blum and J. A. Harvey, Nucl. Phys. B **416**, 119 (1994) [arXiv:hep-th/9310035].
- [120] M. J. Duff, J. T. Liu and R. Minasian, Nucl. Phys. B **452**, 261 (1995) [hep-th/9506126].
- [121] S. Mizoguchi and N. Ohta, Phys. Lett. B **441**, 123 (1998) [hep-th/9807111].
- [122] H. Imazato, S. Mizoguchi and M. Yata, Int. J. Mod. Phys. A **26**, 5143 (2011) [arXiv:1107.3557[hep-th]].
- [123] J. H. Silverman, Advanced topics in the arithmetic of elliptic curves (Graduate texts in mathematics, 151), Springer-Verlag (1994)
- [124] S. Iso and Y. Orikasa, PTEP **2013**, 023B08 (2013) [arXiv:1210.2848 [hep-ph]].
- [125] Y. Hamada, H. Kawai and K. -y. Oda, Phys. Rev. D **87**, no. 5, 053009 (2013) [arXiv:1210.2538 [hep-ph]].
- [126] H. Kawai, Int. J. Mod. Phys. A **28**, 1340001 (2013).
- [127] F. Gursev, P. Ramond and P. Sikivie, Phys. Lett. B **60**, 177 (1976).
- [128] Y. Achiman and B. Stech, Phys. Lett. B **77**, 389 (1978).
- [129] R. Barbieri and D. V. Nanopoulos, Phys. Lett. B **91**, 369 (1980).
- [130] T. Kugo and J. Sato, Prog. Theor. Phys. **91**, 1217 (1994) [hep-ph/9402357].
- [131] N. Irges, S. Lavignac and P. Ramond, Phys. Rev. D **58**, 035003 (1998) [hep-ph/9802334].
- [132] J. K. Elwood, N. Irges and P. Ramond, Phys. Rev. Lett. **81**, 5064 (1998) [hep-ph/9807228].
- [133] N. Haba, C. Hattori, M. Matsuda and T. Matsuoka, Prog. Theor. Phys. **96**, 1249 (1996) [hep-ph/9605238].
- [134] M. Bando and T. Kugo, Prog. Theor. Phys. **101**, 1313 (1999) [hep-ph/9902204].
- [135] N. Maekawa, Prog. Theor. Phys. **112**, 639 (2004) [hep-ph/0402224].
- [136] N. Maekawa and K. Takayama, Phys. Rev. D **85**, 095015 (2012) [arXiv:1202.5816 [hep-ph]].
- [137] H. Kawase and N. Maekawa, Prog. Theor. Phys. **123**, 941 (2010) [arXiv:1005.1049 [hep-ph]].
- [138] M. Ito, S. Kuwakino, N. Maekawa, S. Moriyama, K. Takahashi, K. Takei, S. Teraguchi and T. Yamashita, JHEP **1112**, 100 (2011) [arXiv:1104.0765 [hep-th]].; Phys. Rev. D **83**, 091703 (2011) [arXiv:1012.1690 [hep-ph]].

- [139] M. Ishiduki, S. -G. Kim, N. Maekawa and K. Sakurai, Phys. Rev. D **80**, 115011 (2009)  
[Erratum-ibid. D **81**, 039901 (2010)] [arXiv:0910.1336 [hep-ph]].
- [140] M. Asano, T. Kikuchi and S. -G. Kim, arXiv:0807.5084 [hep-ph].
- [141] B. Stech and Z. Tavartkiladze, Phys. Rev. D **77**, 076009 (2008) [arXiv:0802.0894 [hep-ph]].
- [142] M. Bando, T. Kugo and K. Yoshioka, Prog. Theor. Phys. **104**, 211 (2000) [hep-ph/0003220].