Bayesian Nonparametric Multilevel Clustering with Group-Level Contexts

Vu Nguyen¹
 Dinh Phung¹
 XuanLong Nguyen²
 Svetha Venkatesh¹
 Hung Hai Bui³

TVNGUYE@DEAKIN.EDU.AU
 DINH.PHUNG@DEAKIN.EDU.AU
 XUANLONG@UMICH.EDU
 SVETHA.VENKATESH@DEAKIN.EDU.AU
 BUI.H.HUNG@GMAIL.COM

¹Center for Pattern Recognition and Data Analytics (PRaDA), Deakin University, Australia

²Department of Statistics, University of Michigan, Ann Arbor, USA

³Laboratory for Natural Language Understanding, Nuance Communications, Sunnyvale, USA

Abstract

We present a Bayesian nonparametric framework for multilevel clustering which utilizes group-level context information to simultaneously discover low-dimensional structures of the group contents and partitions groups into clusters. Using the Dirichlet process as the building block, our model constructs a product base-measure with a nested structure to accommodate content and context observations at multiple levels. The proposed model possesses properties that link the nested Dirichlet processes (nDP) and the Dirichlet process mixture models (DPM) in an interesting way: integrating out all contents results in the DPM over contexts, whereas integrating out group-specific contexts results in the nDP mixture over content variables. We provide a Polya-urn view of the model and an efficient collapsed Gibbs inference procedure. Extensive experiments on real-world datasets demonstrate the advantage of utilizing context information via our model in both text and image domains.

1. Introduction

In many situations, content data naturally present themselves in groups, e.g., students are grouped into classes, classes grouped into schools, words grouped into documents, etc. Furthermore, each content group can be associated with additional context information (teachers of the class, authors of the document, time and location stamps).

Dealing with grouped data, a setting known as *multi-level analysis* (Hox, 2010; Diez-Roux, 2000), has diverse application domains ranging from document modeling (Blei et al., 2003) to public health (Leyland & Goldstein, 2001).

This paper considers specifically the multilevel clustering problem in multilevel analysis: to jointly cluster both the content data and their groups when there is group-level context information. By *context*, we mean a secondary data source attached to the group of primary *content* data. An example is the problem of clustering documents, where each document is a group of words associated with group-level context information such as time-stamps, list of authors, etc. Another example is image clustering where visual image features (e.g. SIFT) are the content and image tags are the context.

To cluster groups together, it is often necessary to perform dimensionality reduction of the content data by forming content topics, effectively performing clustering of the content as well. For example, in document clustering, using bag-of-words directly as features is often problematic due to the large vocabulary size and the sparsity of the in-document word occurrences. Thus, a typical approach is to first apply dimensionality reduction techniques such as LDA (Blei et al., 2003) or HDP (Teh et al., 2006b) to find word topics (i.e., distributions on words), then perform document clustering using the word topics and the document-level context information as features. In such a cascaded approach, the dimensionality reduction step (e.g., topic modeling) is not able to utilize the context information. This limitation suggests that a better alternative is to perform context-aware document clustering and topic modeling jointly. With a joint model, one can expect to obtain improved document clusters as well as context-guided content topics that are more predictive of the data.

Recent work has attempted to jointly capture word topics and document clusters. Parametric approaches (Xie & Xing, 2013) are extensions of the LDA (Blei et al., 2003) and require specifying the number of topics and clusters in advance. Bayesian nonparametric approaches including the nested Dirichlet process (nDP) (Rodriguez et al., 2008) and the multi-level clustering hierarchical Dirichlet Process (MLC-HDP) (Wulsin et al., 2012) can automatically adjust the number of clusters. We note that none of these methods can utilize context data.

This paper propose the *Multilevel Clustering with Context* (MC²), a Bayesian nonparametric model to jointly cluster both content and groups while fully utilizing group-level context. Using the Dirichlet process as the building block, our model constructs a product base-measure with a nested structure to accommodate both content and context observations. The MC² model possesses properties that link the nested Dirichlet process (nDP) and the Dirichlet process mixture model (DPM) in an interesting way: integrating out all contents results in the DPM over contexts, whereas integrating out group-level context results in the nDP mixture over content variables. For inference, we provide an efficient collapsed Gibbs sampling procedure for the model.

The advantages of our model are: (1) the model automatically discovers the (unspecified) number of groups clusters and the number of topics while fully utilizing the context information; (2) content topic modeling is informed by group-level context information, leading to more predictive content topics; (3) the model is robust to partially missing context information. In our experiments, we demonstrate that our proposed model achieves better document clustering performances and more predictive word topics in real-world datasets in both text and image domains.

2. Related Background

There have been extensive works on clustering documents in the literature. Due to limited scope of the paper, we only describe works closely related to probabilistic topic models. We note that standard topic models such as LDA (Blei et al., 2003) or its nonparametric Bayesian counterpart, HDP (Teh et al., 2006b) exploits the group structure for word clustering. However these models do not cluster documents.

An approach to document clustering is to employ a two-stage process. First, topic models (e.g. LDA or HDP) are applied to extract the topics and their mixture proportion for each document. Then, this is used as feature input to another clustering algorithm. Some examples of this approach include the use of LDA+Kmeans for image clustering (Xuan et al., 2011; Elango & Jayaraman, 2005) and

HDP+Affinity Propagation for clustering human activities (Nguyen et al., 2013).

A more elegant approach is to simultaneously cluster documents and discover topics. The first Bayesian nonparametric model proposed for this task is the nested Dirichlet Process (nDP) (Rodriguez et al., 2008) where documents in a cluster share the same distribution over topic atoms. Although the original nDP does not force the topic atoms to be shared across document clusters, this can be achieved by simply introducing a DP prior for the nDP base measure. The same observation was also made by (Wulsin et al., 2012) who introduced the MLC-HDP, a 3-level extension to the nDP. This model thus can cluster words, documents and document-corpora with shared topic atoms throughout the group hierarchy. Xie et al (Xie & Xing, 2013) recently introduced the Multi-Grain Clustering Topic Model which allows mixing between global topics and document-cluster topics. However, this is a parametric model which requires fixing the number of topics in advance. More crucially, all of these existing models do not attempt to utilize group-level context information.

Modelling with Dirichlet Process

We provide a brief account of the Dirichlet process and its variants. The literature on DP is vast and we refer to (Hjort et al., 2010) for a comprehensive account. Here we focus on DPM, HDP and nDP which are related to our work.

Dirichlet process (Ferguson, 1973) is a basic building block in Bayesian nonparametrics. Let (Θ, \mathcal{B}, H) be a probability measure space, and γ is a positive number, a Dirichlet process DP (γ, H) is a distribution over discrete random probability measure G on (Θ, \mathcal{B}) . Sethuraman (Sethuraman, 1994) provides an alternative constructive definition which makes the discreteness property of a draw from a Dirichlet process explicit via the stick-breaking representation: $G = \sum_{k=1}^{\infty} \beta_k \delta_{\phi_k}$ where $\phi_k \stackrel{\text{iid}}{\sim} H, k = 1, \dots, \infty$ and $\beta = (\beta_k)_{k=1}^{\infty}$ are the weights constructed through a ‘stick-breaking’ process $\beta_k = v_k \prod_{s < k} (1 - v_s)$ with $v_k \stackrel{\text{iid}}{\sim} \text{Beta}(1, \gamma)$. It can be shown that $\sum_{k=1}^{\infty} \beta_k = 1$ with probability one, and as a convention (Pitman, 2002), we hereafter write $\beta \sim \text{GEM}(\gamma)$.

Due to its discrete nature, Dirichlet process has been widely used in Bayesian mixture models as the prior distribution on the mixing measures, each is associated with an atom ϕ_k in the stick-breaking representation of G above. A likelihood kernel $F(\cdot)$ is used to generate data $x_i | \phi_k \stackrel{\text{iid}}{\sim} F(\cdot | \phi_k)$, resulting in a model known as the *Dirichlet process mixture model* (DPM), pioneered by the work of (Antoniak, 1974) and subsequently developed by many others. In section 3 we provide a precise definition for

DPM.

While DPM models exchangeable data within a *single* group, the Dirichlet process can also be constructed hierarchically to provide prior distributions over *multiple* exchangeable groups. Under this setting, each group is modelled as a DPM and these models are ‘linked’ together to reflect the dependency among them – a formalism which is generally known as dependent Dirichlet processes (MacEachern, 1999). One particular attractive approach is the *hierarchical Dirichlet processes* (Teh et al., 2006b) which posits the dependency among the group-level DPM by another Dirichlet process, i.e., $G_j | \alpha, G_0 \sim \text{DP}(\alpha, G_0)$ and $G_0 | \gamma, H \sim \text{DP}(\gamma, H)$ where G_j is the prior for the j -th group, linked together via a discrete measure G_0 whose distribution is another DP.

Yet another way of using DP to model multiple groups is to construct random measure in a nested structure in which the DP base measure is itself another DP. This formalism is the *nested Dirichlet Process* (Rodriguez et al., 2008), specifically $G_j \stackrel{\text{iid}}{\sim} U$ where $U \sim \text{DP}(\alpha \times \text{DP}(\gamma H))$. Modeling G_j (s) hierarchically as in HDP and nestedly as in nDP yields different effects. HDP focuses on exploiting statistical strength across groups via sharing atoms ϕ_k (s), but it does not partition groups into clusters. This statement is made precisely by noting that $P(G_j = G_{j'}) = 0$ in HDP. Whereas, nDP emphasizes on inducing clusters on both observations and distributions, hence it partitions groups into clusters. To be precise, the prior probability of two groups being clustered together is $P(G_j = G_{j'}) = \frac{1}{a+1}$. Finally we note that this original definition of nDP in (Rodriguez et al., 2008) does not force the atoms to be shared across clusters of groups, but this can be achieved by simply introducing a DP prior for the nDP base measure, a modification that we use in this paper. This is made clearly in our definition for nDP mixture in section 3.

3. Multilevel Clustering with Contexts

3.1. Model description and stick-breaking

Consider data presented in a two-level group structure as follows. Denote by J the number of groups; each group j contains N_j exchangeable data points, represented by $\mathbf{w}_j = \{w_{j1}, w_{j2}, \dots, w_{jN_j}\}$. For each group j , the group-specific context data is denoted by x_j . Assuming that the groups are exchangeable, the overall data is $\{(x_j, \mathbf{w}_j)\}_{j=1}^J$. The collection $\{\mathbf{w}_1, \dots, \mathbf{w}_J\}$ represents observations of the group contents, and $\{x_1, \dots, x_J\}$ represents observations of the group-level contexts.

We now describe the generative process of MC² that generates a two-level clustering of this data. We use a group-level DP mixture to generate an infinite cluster model for

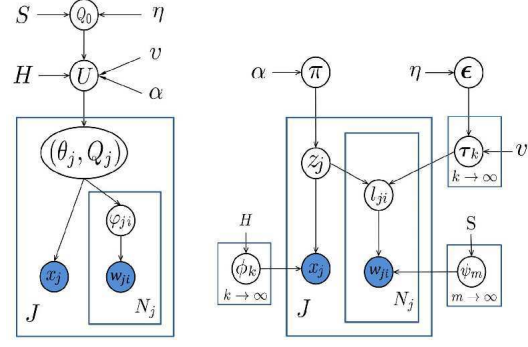

Figure 1. Graphical model representation for the proposed model. Right figure illustrates a stick breaking representation.

groups. Each group cluster k is associated with an atom having the form of a pair (ϕ_k, Q_k^*) where ϕ_k is a parameter that generates the group-level contexts within the cluster and Q_k^* is a measure that generates the group contents within the same cluster.

To generate atomic pairs of context parameter and measured content parameter, we introduce a product base-measure of the form $H \times \text{DP}(vQ_0)$ for the group-level DP mixture. Drawing from a DP mixture with this base measure, each realization is a pair (θ_j, Q_j) ; θ_j is then used to generate the context x_j and Q_j is used to repeatedly produce the set of content observations w_{ji} within the group j . Specifically,

$$U \sim \text{DP}(\alpha(H \times \text{DP}(vQ_0))) \text{ where } Q_0 \sim \text{DP}(\eta S)$$

$$(\theta_j, Q_j) \stackrel{\text{iid}}{\sim} U \text{ for each group } j \quad (1)$$

$$x_j \sim F(\cdot | \theta_j), \quad \varphi_{ji} \stackrel{\text{iid}}{\sim} Q_j, \quad w_{ji} \sim Y(\cdot | \varphi_{ji})$$

In the above, H and S are respectively base measures for context and content parameters θ_j and φ_{ji} . The context and content observations are then generated via the likelihood kernels $F(\cdot | \theta_j)$ and $Y(\cdot | \varphi_{ji})$. To simplify inference, H and S are assumed to be conjugate to F and Y respectively. The generative process is illustrated in Figure 1.

STICK-BREAKING REPRESENTATION

We now derive the stick-breaking construction for MC² where all the random discrete measures are specified by a distribution over integers and a countable set of atoms. The random measure U in Eq. (7) has the stick-breaking form:

$$U = \sum_{k=1}^{\infty} \pi_k \delta_{(\phi_k, Q_k^*)} \quad (2)$$

where $\pi \sim \text{GEM}(\alpha)$ and $(\phi_k, Q_k^*) \stackrel{\text{iid}}{\sim} H \times \text{DP}(vQ_0)$. Equivalently, this means ϕ_k is drawn i.i.d. from H and Q_k^* drawn i.i.d. from $\text{DP}(vQ_0)$. Since $Q_0 \sim \text{DP}(\eta S)$, Q_0 and Q_k^* have the standard HDP (Teh et al., 2006b)

stick-breaking forms: $Q_0 = \sum_{m=1}^{\infty} \epsilon_m \delta_{\psi_m}$ where $\epsilon \sim \text{GEM}(\eta)$, $\psi_m \stackrel{\text{iid}}{\sim} S$; $Q_k^* = \sum_{m=1}^{\infty} \tau_{k,m} \delta_{\psi_m}$ where $\tau_k = (\tau_{k1}, \tau_{k2}, \dots) \sim \text{DP}(v, \epsilon)$.

For each group j we sample the parameter pair $(\theta_j, Q_j) \stackrel{\text{iid}}{\sim} U$; equivalently, this means drawing $z_j \stackrel{\text{iid}}{\sim} \pi$ and letting $\theta_j = \phi_{z_j}$ and $Q_j = Q_{z_j}^*$. For the i -th content data within the group j , the content parameter φ_{ji} is drawn $\stackrel{\text{iid}}{\sim} Q_j = Q_{z_j}^*$; equivalently, this means drawing $l_{ji} \stackrel{\text{iid}}{\sim} \tau_{z_j}$ and letting $\varphi_{ji} = \psi_{l_{ji}}$. Figure 1 presents the graphical model of this stick-breaking representation.

3.2. Inference and Polya Urn View

We use collapsed Gibbs sampling, integrating out $\phi_k(s)$, $\psi_m(s)$, π and $\tau_k(s)$. Latent variables z , \mathbf{l} , ϵ and the hyper-parameters α , v , η will be resampled. We only describe the key inference steps in sampling z , \mathbf{l} and ϵ here and refer to Appendix A.2 for the rest of the details (including how to sample the hyper-parameters).

Sampling z . The required conditional distribution is $p(z_j = k \mid \mathbf{z}_{-j}, \mathbf{l}, \boldsymbol{\alpha}, H)$

$$p(z_j = k \mid \mathbf{z}_{-j}, \alpha) p(x_j \mid z_j = k, \mathbf{z}_{-j}, \mathbf{x}_{-j}, H) \\ \times p(l_{j*} \mid z_j = k, \mathbf{l}_{-j*}, \mathbf{z}_{-j}, \boldsymbol{\epsilon}, v)$$

The first term can be recognized as a form of the Chinese restaurant process (CRP). The second term is the predictive likelihood for the context observations under the component ϕ_k after integrating out ϕ_k . This can be evaluated analytically due to conjugacy of F and H . The last term is the predictive likelihood for the group content-index $l_{j*} = \{l_{ji} \mid i = 1 \dots N_j\}$. Since $l_{ji} \mid z_j = k \stackrel{\text{iid}}{\sim} \text{Mult}(\tau_k)$ where $\tau_k \sim \text{Dir}(v\epsilon_1, \dots, v\epsilon_M, \epsilon_{\text{new}})$, the last term can also be evaluated analytically by integrating out τ_k using the Multinomial-Dirichlet conjugacy property.

Sampling \mathbf{l} . Let w_{-ji} be the same set as \mathbf{w} excluding w_{ji} , let $w_{-ji}(m) = \{w_{j'i'} \mid (j'i') \neq (ji) \wedge l_{j'i'} = m\}$ and $\mathbf{l}_{-ij}(k) = \{l_{j'i'} \mid (j'i') \neq (ji) \wedge z_{j'} = k\}$. Then $p(l_{ji} = m \mid \mathbf{l}_{-ji}, z_j = k, \mathbf{z}_{-j}, v, \mathbf{w}, \boldsymbol{\epsilon}, S) \propto$

$$p(w_{ji} \mid \mathbf{l}, w_{-ji}, S) p(l_{ji} = m \mid \mathbf{l}_{-ji}, z_j = k, \mathbf{z}_{-j}, \boldsymbol{\epsilon}, v) \\ = p(w_{ji} \mid w_{-ji}(m), S) p(l_{ji} = m \mid \mathbf{l}_{-ji}(k), \boldsymbol{\epsilon}, v)$$

The first term is the predictive likelihood under mixture component ψ_m after integrating out ψ_m , which can be evaluated analytically due to the conjugacy of Y and S . The second term is in the form of a CRP similar to the one that arises during inference for HDP (Teh et al., 2006b).

Sampling ϵ . Sampling ϵ requires information from both z and \mathbf{l} .

$$p(\epsilon \mid \mathbf{l}, \mathbf{z}, v, \eta) \propto p(\mathbf{l} \mid \epsilon, v, \mathbf{z}, \eta) \times p(\epsilon \mid \eta) \quad (3)$$

Using a similar strategy in HDP, we introduce auxiliary variables (o_{km}) , then alternatively sample together with ϵ :

$$p(o_{km} = h \mid \cdot) \propto \text{Stirl}(h, n_{km}) (v\epsilon_m)^h, \quad h = 0, 1, \dots, n_{km} \\ p(\epsilon \mid \cdot) \propto \epsilon_{\text{new}}^{\eta-1} \prod_{m=1}^M \sum_k \epsilon_m^{o_{km}-1}$$

where $\text{Stirl}(h, n_{km})$ is the Stirling number of the first kind, n_{km} is the count of seeing the pair $(z_j = k, l_{ji} = m) : \forall i, j$, and finally M is the current number of active content topics. It clear that o_{km} can be sampled from a Multinomial distribution and ϵ from an $(M+1)$ -dim Dirichlet distribution.

POLYA URN VIEW

Our model exhibits a Polya-urn view using the analogy of a fleet of buses, driving customers to restaurants. Each bus represents a group and customers on the bus are data points within the group. For each bus j , z_j acts as the index to the restaurant for its destination. Thus, buses form clusters at their destination restaurants according to a CRP: a new bus drives to an existing restaurant with the probability proportional to the number of other buses that have arrived at that restaurant, and with probability proportional to α , it goes to a completely new restaurant.

Once all the buses have delivered customers to the restaurants, *all customers at the restaurants start to behave in the same manner as in a Chinese restaurant franchise (CRF) process*: customers are assigned tables according to a restaurant-specific CRP; tables are assigned with dishes ψ_m (representing the content topic atoms) according to a global franchise CRP. In addition to the usual CRF, at restaurant k , a single dessert ϕ_k (which represents the context-generating atom, drawing $\stackrel{\text{iid}}{\sim}$ from H) will be served to all the customers at that restaurant. Thus, every customer on the same bus j will be served the same dessert ϕ_{z_j} . We observe three sub-CRPs, corresponding to the three DP(s) in our model: the CRP at the dish level is due to the DP(ηS), the CRP forming tables inside each restaurant is due to the DP(vQ_0), and the CRP aggregating buses to restaurants is due to the DP($\alpha(H \times \text{DP}(vQ_0))$).

3.3. Marginalization property

We study marginalization property for our model when either the content topics $\varphi_{ji}(s)$ or context topics $\theta_j(s)$ are marginalized out. Our main result is established in Theorem 9 where we show an interesting link to nested DP and DPM via our model.

Let H be a measure over some measurable spaces (Θ, Σ) . Let \mathbb{P} be the set of all measures over (Θ, Σ) , suitably endowed with some σ -algebra. Let $G \sim \text{DP}(\alpha H)$ and

$\theta_i \stackrel{\text{iid}}{\sim} G$. The collection (θ_i) then follows the DP mixture distribution which is defined formally below.

Definition 1. (DPM) A DPM is a probability measure over $\Theta^n \ni (\theta_1, \dots, \theta_n)$ with the usual product sigma algebra Σ^n such that for every collection of measurable sets $\{(S_1, \dots, S_n) : S_i \in \Sigma, i = 1, \dots, n\}$:

$$\begin{aligned} \text{DPM}(\theta_1 \in S_1, \dots, \theta_n \in S_n | \alpha, H) \\ = \int \prod_{i=1}^n G(S_i) \text{DP}(dG | \alpha H) \end{aligned}$$

We now state a result regarding marginalization of draws from a DP mixture with a joint base measure. Consider two measurable spaces (Θ_1, Σ_1) and (Θ_2, Σ_2) and let (Θ, Σ) be their product space where $\Theta = \Theta_1 \times \Theta_2$ and $\Sigma = \Sigma_1 \times \Sigma_2$. Let H^* be a measure over the product space $\Theta = \Theta_1 \times \Theta_2$ and let H_1 be the marginal of H^* over Θ_1 in the sense that for any measurable set $A \in \Sigma_1$, $H_1(A) = H^*(A \times \Theta_2)$. Then drawing $(\theta_i^{(1)}, \theta_i^{(2)})$ from a DP mixture with base measure αH and marginalizing out $(\theta_i^{(2)})$ is the same as drawing $(\theta_i^{(1)})$ from a DP mixture with base measure H_1 . Formally

Proposition 2. Denote by θ_i the pair $(\theta_i^{(1)}, \theta_i^{(2)})$, there holds

$$\begin{aligned} \text{DPM}(\theta_1^{(1)} \in S_1, \dots, \theta_n^{(1)} \in S_n | \alpha H_1) \\ = \text{DPM}(\theta_1 \in S_1 \times \Theta_2, \dots, \theta_n \in S_n \times \Theta_2 | \alpha H^*) \end{aligned}$$

for every collection of measurable sets $\{(S_1, \dots, S_n) : S_i \in \Sigma_1, i = 1, \dots, n\}$.

Proof. see Appendix 7. \square

Next we give a formal definition for the nDP mixture: $\varphi_{ji} \stackrel{\text{iid}}{\sim} Q_j$, $Q_j \stackrel{\text{iid}}{\sim} U$, $U \sim \text{DP}(\alpha \text{DP}(vQ_0))$, $Q_0 \sim \text{DP}(\eta S)$.

Definition 3. (nested DP Mixture) An nDPM is a probability measure over $\Theta^{\sum_{j=1}^J N_j} \ni (\varphi_{11}, \dots, \varphi_{1N_1}, \dots, \varphi_{JN_J})$ equipped with the usual product sigma algebra $\Sigma^{N_1} \times \dots \times \Sigma^{N_J}$ such that for every collection of measurable sets $\{(S_{ji}) : S_{ji} \in \Sigma, j = 1, \dots, J, i = 1, \dots, N_j\}$:

$$\begin{aligned} \text{nDPM}(\varphi_{ji} \in S_{ji}, \forall i, j | \alpha, v, \eta, S) \\ = \int \int \left\{ \prod_{j=1}^J \int \prod_{i=1}^{N_j} Q_j(S_{ji}) U(dQ_j) \right\} \\ \times \text{DP}(dU | \alpha \text{DP}(vQ_0)) \text{DP}(dQ_0 | \eta, S) \end{aligned}$$

We now have the sufficient formalism to state the marginalization result for our model.

Theorem 4. Given α, H and α, v, η, S , let $\theta = (\theta_j : \forall j)$ and $\varphi = (\varphi_{ji} : \forall j, i)$ be generated as in Eq (7). Then, marginalizing out φ results in $\text{DPM}(\theta | \alpha, H)$, whereas marginalizing out θ results in $\text{nDPM}(\varphi | \alpha, v, \eta, S)$.

Proof. We sketch the main steps, Appendix 9 provides more detail. Let $H^* = H_1 \times H_2$, we note that when either H_1 or H_2 are random, a result similar to Proposition 7 still holds by taking the expectation on both sides of the equality. Now let $H_1 = H$ and $H_2 = \text{DP}(vQ_0)$ where $Q_0 \sim \text{DP}(\eta S)$ yields the proof for the marginalization of φ ; let $H_1 = \text{DP}(vQ_0)$ and $H_2 = H$ yields the proof for the marginalization of θ . \square

4. Experiments

We first evaluate the model via simulation studies, then demonstrate its applications on text and image modeling using three real-world datasets. Throughout this section, unless explicitly stated, discrete data is modeled by Multinomial with Dirichlet prior, while continuous data is modeled by Gaussian (unknown mean and unknown variance) with Gaussian-Gamma prior.

4.1. Simulation studies

The main goal is to investigate the posterior consistency of the model, i.e., its ability to recover the true group clusters, context distribution and content topics. To synthesize the data, we use $M = 13$ topics which are the 13 unique letters in the ICML string ‘‘INTERNATIONAL CONFERENCE MACHINE LEARNING’’. Similar to (Griffiths & Steyvers, 2004), each topic ψ_m is a distribution over 35 words (pixels) and visualized as a 7×5 binary image. We generate $K = 4$ clusters of 100 documents each. For each cluster, we choose a set of topics corresponding to letters in the each of 4 words in the ICML string. The topic mixing distribution τ_k is an uniform distribution over the chosen topic letters. Each cluster is also assigned a context-generating univariate Gaussian distribution. These generating parameters are shown in Figure 2 (left). Altogether we have $J = 400$ documents; for each document we sample $N_j = 50$ words and a context variable x_j drawing from the cluster-specific Gaussian.

We model the word w_{ji} with Multinomial and Gaussian for context x_j . After 100 Gibbs iterations, the number of context and content topics ($K = 4, M = 13$) are recovered correctly: the learned context atoms ϕ_k and topic ψ_m are almost identical to the ground truth (Figure 2, right) and the model successfully identifies the 4 clusters of documents with topics corresponding to the 4 words in the ICML string.

To demonstrate the importance of context observation, we

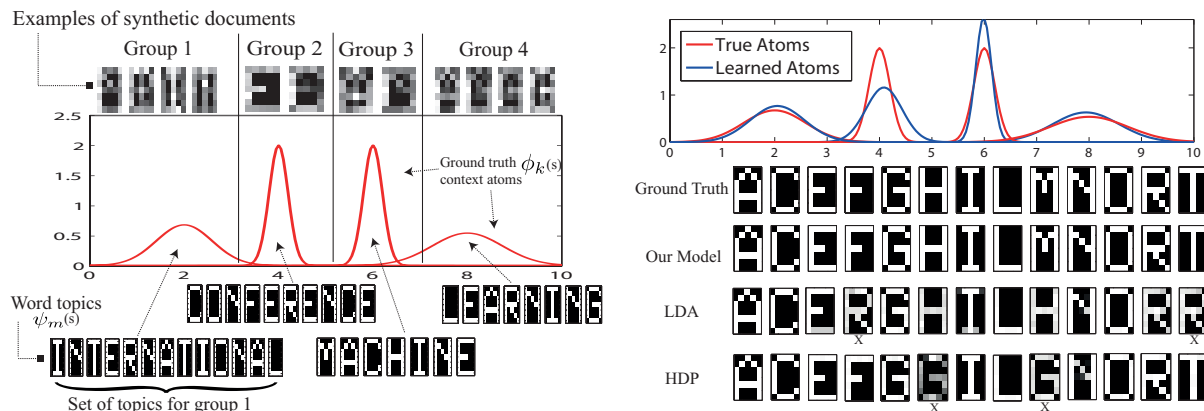

Figure 2. Results from simulation study. Left: illustration of data generation with ground truth for context atoms are 4 univariate Gaussians centered at 2, 4, 6 and 8 respectively (different variances). Right: Our model recovers the correct 4 group clusters, their context distributions and the set of shared topics. LDA and HDP are unable to recover the true content topics without using contexts.

then run LDA and HDP with only the word observations (ignoring context) where the number of topic of LDA is set to 13. As can be seen from Figure 2 (right), LDA and HDP have problems in recovering the true topics. They cannot distinguish small differences between the overlapping character topics (e.g M vs N, or I vs T). Further analysis of the role of context in MC² is provided in Appendix A.3.

4.2. Experiments with Real-World Datasets

We use two standard NIPS and PNAS text datasets, and the NUS-WIDE image dataset.

NIPS contains 1,740 documents with vocabulary size 13,649 (excluding stop words); timestamps (1987-1999), authors (2,037) and title information are available and used as group-level context. *PNAS* contains 79,800 documents, vocab size = 36,782 with publication timestamp (915-2005). For *NUS-WIDE* we use a subset of the 13-class animals¹ comprising of 3,411 images (2,054 images for training and 1357 images for testing) with off-the-shelf features including 500-dim bag-of-word SIFT vector and 1000-dim bag-of-tag annotation vector.

Text Modeling with Document-Level Contexts

We use NIPS and PNAS datasets with 90% for training and 10% for held-out perplexity evaluation. We compare the perplexity with HDP (Teh et al., 2006b) where no group-level context can be used, and npTOT (Dubey et al., 2012) where only timestamp information can be used. We note that unlike our model, npTOT requires replication of document timestamp for *every* word in the document, which is somewhat unnatural.

We use perplexity score (Blei et al., 2003) on

held-out data as performance metric, defined as² $\exp \left\{ - \sum_{j=1}^J \log p(\mathbf{w}_j^{\text{test}} | \mathbf{x}^{\text{train}}, \mathbf{w}^{\text{train}}) / \left(\sum_j N_j^{\text{test}} \right) \right\}$. To ensure fairness and comparable evaluation, *only words* in held-out data is used to compute the perplexity. We use univariate Gaussian for timestamp and Multinomial distributions for words, tags and authors. We ran collapsed Gibbs for 500 iterations after 100 burn-in samples.

Table 1 shows the results where MC² achieves significant better performance. This shows that group-level context information during training provide useful guidance for the modelling tasks. Regarding the informative aspect of group-level context, we achieve better perplexity with timestamp information than with titles and authors. This may be explained by the fact that 1361 authors (among 2037) show up only once in the data while title provides little additional information than what already in that abstracts. Interestingly, without the group-level context information, our model still predicts the held-out words better than HDP. This suggests that inducing partitions over documents simultaneously with topic modelling is beneficial.

Beyond the capacity of HDP and npTOT, our model can induce clusters over documents (value of K in Table 1). Figure 3 shows an example of one such document cluster discovered from NIPS data with authors as context.

Our proposed model also allows flexibility in deriving useful understanding into the data and to evaluate on its predictive capacity (e.g., who most likely wrote this article, which authors work in the same research topic and so on). Another possible usage is to obtain *conditional* distributions among context topics $\phi_k(s)$ and content topics $\psi_m(s)$. For example if the context information is timestamp, the model immediately yields the distribution over time for

¹downloaded from <http://www.ml-thu.net/~jun/data/>

²Appendix A.4 provides further details on how to derive this score from our model

Method	Perplexity (<i>on words only</i>)				Feature used
	PNAS	(K,M)	NIPS	(K,M)	
HDP (Teh et al., 2006b)	3027.5	(-, 86)	1922.1	(-, 108)	words
npTOT (Dubey et al., 2012; Phung et al., 2012)	2491.5	(-, 145)	1855.33	(-, 94)	words+timestamp
MC ² without context	1742.6	(40, 126)	1583.2	(19, 61)	words
MC ² with titles	-	-	1393.4	(32, 80)	words+title
MC ² with authors	-	-	1246.3	(8, 55)	words+authors
MC ² with timestamp	895.3	(12, 117)	984.7	(15, 95)	words+timestamp

Table 1. Perplexity evaluation on PNAS and NIPS datasets. (K,M) is (#cluster,#topic). (Note: missing results are due to title and author information not available in PNAS dataset).

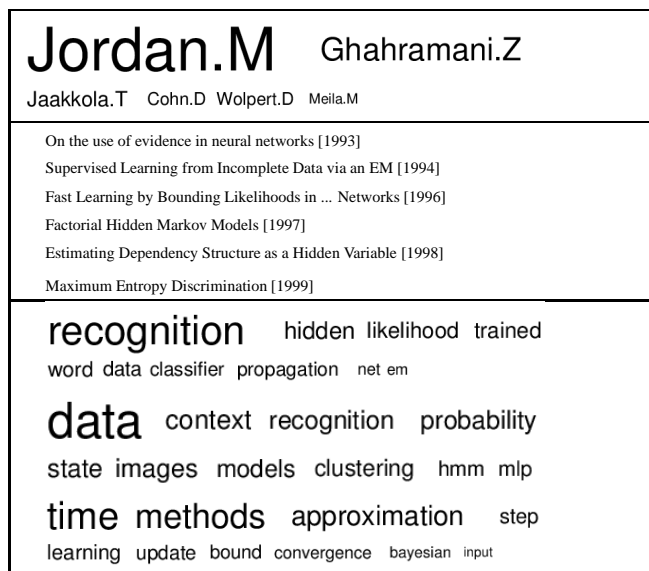

Figure 3. An example of document cluster from NIPS. Top: distribution over authors. Middle: examples of paper titles. Bottom: examples of word topics in this cluster.

a topic, showing when the topic rises and falls. Figure 4 illustrates an example of a distribution over time for a content topic discovered from PNAS dataset where timestamp was used as context. This topic appears to capture a congenital disorder known as *Albinism*. This distribution illustrates research attention to this condition over the past 100 years from PNAS data. To seek evidence for this result, we search the term “Albinism” in Google Scholar, using the top 50 searching results and plot the histogram over time in the same figure. Surprisingly, we obtain a very close match between our results and the results from Google Scholar as evidenced in the figure.

Image Clustering with Image-Level Tags

We evaluate the clustering capacity of MC² using contexts on an image clustering task. Our dataset is NUS-WIDE described earlier. We use bag-of-word SIFT features from each image for its content. Since each image in this dataset

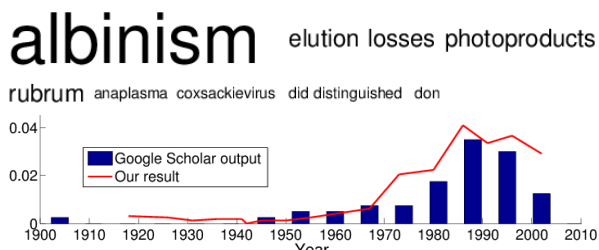

Figure 4. Topic *Albinism* discovered from PNAS dataset and its conditional distribution over time using our model; plotted together with results independently searched from Google Scholar using the top 50 hits.

Method	Perplexity	Feature used
HDP	175.62	SIFT
MC ² without context	162.74	SIFT
MC ² with context	152.32	Tags+SIFT

Table 2. NUS-WIDE dataset. Perplexity is evaluated on SIFT feature.

comes with a set of tags, we exploit them as context information, hence each context observation x_j is a bag-of-tag annotation vector.

First we perform the perplexity evaluation for this dataset using a similar setting as in the previous section. Table 2 presents the results where our model again outperforms HDP even when no context (tags) is used for training.

Next we evaluate the clustering quality of the model using the provided 13 classes as ground truth. We report performance on four well-known clustering evaluation metrics: Purity, Normalized Mutual Information (NMI), Rand-Index (RI), and Fscore (detailed in (Rand, 1971; Cai et al., 2011)). We use the following baselines for comparison:

- Kmeans and Non-negative Matrix Factorization (NMF)(Lee & Seung, 1999). For these methods, we need to specify the number of clusters in advance, hence we vary this number from 10 to 40. We then report the min, max, mean and standard deviation.
- Affinity Propagation (AP) (Frey & Dueck, 2007): AP

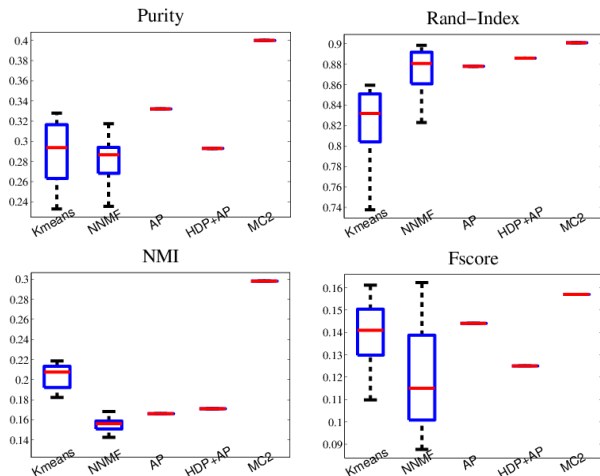

Figure 5. Clustering performance measured in purity, NMI, Rand-Index and F-score using NUS-WIDE dataset.

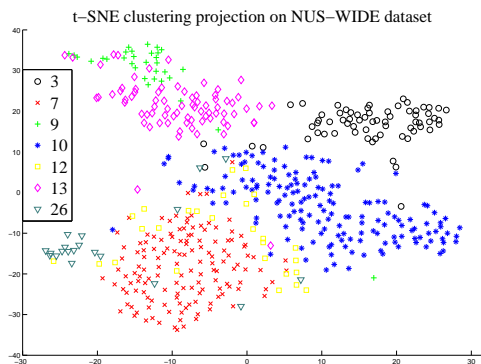

Figure 6. Projecting 7 discovered clusters (among 28) on 2D using t-SNE (Van der Maaten & Hinton, 2008).

requires a similarity score between two documents and we use the Euclidean distance for this purpose.

- Hierarchical Dirichlet Process (HDP) + AP: we first run HDP using content observations, and then apply Affinity Propagation with similarity score derived from the symmetric KL divergence between the mixture proportions from two documents.

Figure 5 shows the result in which our model consistently delivers highest performance across all four metrics. For purity and NMI, our model beats all by a wide margin.

To gain some understanding on the clusters of images induced by our model, we run t-SNE (Van der Maaten & Hinton, 2008), projecting the feature vectors (both content and context) onto a 2D space. For visual clarity, we randomly select 7 out of 28 clusters and display in Figure 6 where it can be seen that they are reasonably well separated.

Effect of partially observed and missing data

Missing and unlabelled data is commonly encountered in

practical applications. Here we examine the effect of context observability on document clustering performance. To do so, we again use the NUS-WIDE 13-animal subset as described previously, then vary the amount of observing context observation x_j with missing proportion ranges from 0% to 100%.

Missing (%)	Purity	NMI	RI	F-score
0 %	0.407	0.298	0.901	0.157
25 %	0.338	0.245	0.892	0.149
50 %	0.320	0.236	0.883	0.137
75 %	0.313	0.187	0.860	0.112
100 %	0.306	0.188	0.867	0.119

Table 3. Clustering performance with different missing proportion of context observation x_j .

Table 3 reports the result. We make two observations: a) utilizing context results in a big performance gain as evidenced in the difference between the top and bottom row of the table, and b) as the proportion of missing context starts to increase, the performance degrades gracefully up to 50% missing. This demonstrates the robustness of model against the possibility of missing context data.

5. Conclusion

We have introduced an approach for multilevel clustering when there are group-level context information. Our MC² provides a single joint model for utilizing group-level contexts to form group clusters while discovering the shared topics of the group contents at the same time. We provide a collapsed Gibbs sampling procedure and perform extensive experiments on three real-world datasets in both text and image domains. The experimental results using our model demonstrate the importance of utilizing context information in clustering both at the content and at the group level. Since similar types of contexts (time, tags, locations, ages, genres) are commonly encountered in many real-world data sources, we expect that our model will also be further applicable in other domains.

Our model contains a novel ingredient in DP-based Bayesian nonparametric modeling: we propose to use a base measure in the form of a product between a context-generating prior H and a content-generating prior $DP(vQ_0)$. Doing this results in a new model with one marginal being the DPM and another marginal being the nDP mixture, thus establishing an interesting bridge between the DPM and the nDP. Our product base measure construction can be generalized to yield new models suitable for data presenting in more complicated nested group structures (e.g., more than 2-level deep).

References

- Antoniak, C.E. Mixtures of Dirichlet processes with applications to Bayesian nonparametric problems. *The Annals of Statistics*, 2(6):1152–1174, 1974.
- Asuncion, A., Welling, M., Smyth, P., and Teh, Y. W. On smoothing and inference for topic models. In *Proceedings of the International Conference on Uncertainty in Artificial Intelligence*, 2009.
- Blei, D.M., Ng, A.Y., and Jordan, M.I. Latent Dirichlet allocation. *Journal of Machine Learning Research*, 3: 993–1022, 2003. ISSN 1533-7928.
- Cai, Deng, He, Xiaofei, and Han, Jiawei. Locally consistent concept factorization for document clustering. *Knowledge and Data Engineering, IEEE Transactions on*, 23(6):902–913, 2011.
- Diez-Roux, Ana V. Multilevel analysis in public health research. *Annual review of public health*, 21(1):171–192, 2000.
- Dubey, Avinava, Hefny, Ahmed, Williamson, Sinead, and Xing, Eric P. A non-parametric mixture model for topic modeling over time. *arXiv preprint arXiv:1208.4411*, 2012.
- Elango, Pradheep K and Jayaraman, Karthik. Clustering images using the latent dirichlet allocation model. *University of Wisconsin*, 2005.
- Escobar, M.D. and West, M. Bayesian density estimation and inference using mixtures. *Journal of the american statistical association*, 90(430), 1995.
- Ferguson, T.S. A Bayesian analysis of some nonparametric problems. *The Annals of Statistics*, 1(2):209–230, 1973.
- Frey, B.J. and Dueck, D. Clustering by passing messages between data points. *Science*, 315:972–976, 2007. doi: 10.1126/science.1136800.
- Gelman, Andrew, Carlin, John B, Stern, Hal S, and Rubin, Donald B. *Bayesian data analysis*. CRC press, 2003.
- Griffiths, Thomas L and Steyvers, Mark. Finding scientific topics. *Proceedings of the National academy of Sciences of the United States of America*, 101(Suppl 1): 5228–5235, 2004.
- Hjort, N.L., Holmes, C., Müller, P., and Walker, S.G. *Bayesian nonparametrics*. Cambridge University Press, 2010.
- Hox, Joop. *Multilevel analysis: Techniques and applications*. Routledge, 2010.
- Lee, Daniel D and Seung, H Sebastian. Learning the parts of objects by non-negative matrix factorization. *Nature*, 401(6755):788–791, 1999.
- Leyland, Alastair H and Goldstein, Harvey. *Multilevel modelling of health statistics*. Wiley, 2001.
- MacEachern, S.N. Dependent nonparametric processes. In *ASA Proceedings of the Section on Bayesian Statistical Science*, pp. 50–55, 1999.
- Nguyen, T.C., Phung, D., Gupta, S., and Venkatesh, S. Extraction of latent patterns and contexts from social honest signals using hierarchical dirichlet processes. *IEEE International Conference on Pervasive Computing and Communications*, 2013.
- Phung, D., Nguyen, X., Bui, H., Nguyen, T.V., and Venkatesh, S. Conditionally dependent Dirichlet processes for modelling naturally correlated data sources. Technical report, Pattern Recognition and Data Analytics, Deakin University, 2012.
- Pitman, J. Poisson–Dirichlet and GEM invariant distributions for split-and-merge transformations of an interval partition. *Combinatorics, Probability and Computing*, 11(05):501–514, 2002. ISSN 1469-2163.
- Rand, William M. Objective criteria for the evaluation of clustering methods. *Journal of the American Statistical association*, 66(336):846–850, 1971.
- Rodriguez, A., Dunson, D.B., and Gelfand, A.E. The nested Dirichlet process. *Journal of the American Statistical Association*, 103(483):1131–1154, 2008.
- Sethuraman, J. A constructive definition of Dirichlet priors. *Statistica Sinica*, 4(2):639–650, 1994.
- Teh, Yee W, Newman, David, and Welling, Max. A collapsed variational bayesian inference algorithm for latent dirichlet allocation. In *Advances in neural information processing systems*, pp. 1353–1360, 2006a.
- Teh, Y.W., Jordan, M.I., Beal, M.J., and Blei, D.M. Hierarchical Dirichlet processes. *Journal of the American Statistical Association*, 101(476):1566–1581, 2006b.
- Van der Maaten, Laurens and Hinton, Geoffrey. Visualizing data using t-sne. *Journal of Machine Learning Research*, 9(2579-2605):85, 2008.
- Wulsin, D., Jensen, S., and Litt, B. A hierarchical dirichlet process model with multiple levels of clustering for human eeg seizure modeling. *Proceedings of the 29th International Conference on Machine learning*, 2012.
- Xie, Pengtao and Xing, Eric P. Integrating document clustering and topic modeling. 2013.

Xuan, Wen-Feng, Liu, Bing-Quan, Sun, Cheng-Jie, Zhang, De-Yuan, and Wang, Xiao-Long. Finding main topics in blogosphere using document clustering based on topic model. 4:1902–1908, 2011.

A. Appendix

This note provides supplementary information for the main paper. It has three parts: a) the proof for the marginalization property of our proposed model, b) detailed derivations for our inference, and c) equations to show how the perplexity in the experiment was computed.

A.1. Proof for Marginalization Property (Theorem 4)

We start with a proposition on the marginalization result for DPM with the product measure then move on the final proof for our proposed model.

A.1.1. MARGINALIZATION OF DPM WITH PRODUCT MEASURE

Let H be a measure over some measurable space (Θ, Σ) . Let \mathbb{P} be the set of all measures over (Θ, Σ) , suitably endowed with some σ -algebra. Let $G \sim \text{DP}(\alpha H)$ be a draw from a Dirichlet process.

Lemma 5. *Let $S_1 \dots S_n$ be n measurable sets in Σ . We form a measurable partition of Θ , a collection of disjoint measurable sets, that generate S_1, \dots, S_n as follows. If S is a set, let $S^1 = S$ and $S^{-1} = \Theta \setminus S$. Then $S^* = \{\bigcap_{i=1}^n S_i^{c_i} | c_i \in \{1, -1\}\}$ is a partition of Θ into a finite collection of disjoint measurable sets with the property that any S_i can be written as a union of some sets in S^* . Let the element of S^* be $A_1 \dots A_{n^*}$ (note $n^* \leq 2^n$). Then the expectation*

$$\mathbb{E}_G [G(S_1), \dots, G(S_n)] = \quad (4)$$

$$\int \prod_{i=1}^n G(S_i) \text{DP}(dG | \alpha H) \quad (5)$$

depends only on α and $H(A_i)$. In other words, the above expectation can be written as a function $E_n(\alpha, H(A_1), \dots, H(A_{n^}))$.*

It is easy to see that since S_i can always be expressed as the sum of some disjoints A_i , $G(S_i)$ can respectively be written as the sum of some $G(A_i)$. Furthermore, by definition of a Dirichlet process, the vector $(G(A_1), \dots, G(A_{n^*}))$ distributed according to a finite Dirichlet distribution $(\alpha H(A_1), \dots, \alpha H(A_{n^*}))$, therefore the expectation $\mathbb{E}_G [G(S_i)]$ depends only on α and $H(A_i)$ (s).

Definition 6. (DPM) A DPM is a probability measure over $\Theta^n \ni (\theta_1, \dots, \theta_n)$ with the usual product sigma algebra Σ^n such that for every collection of measurable sets $\{(S_1, \dots, S_n) : S_i \in \Sigma, i = 1, \dots, n\}$:

$$\text{DPM}(\theta_1 \in S_1, \dots, \theta_n \in S_n | \alpha, H) = \quad (6)$$

$$\int_G \prod_{i=1}^n G(S_i) \text{DP}(dG | \alpha H)$$

Consider two measurable spaces (Θ_1, Σ_1) and (Θ_2, Σ_2) and let (Θ, Σ) be their product space where $\Theta = \Theta_1 \times \Theta_2$ and $\Sigma = \Sigma_1 \times \Sigma_2$. We present the general theorem that states the marginal result from a product base measure.

Proposition 7. *Let H^* be a measure over the product space $\Theta = \Theta_1 \times \Theta_2$. Let H_1 be the marginal of H^* over Θ_1 in the sense that for any measurable set $A \in \Sigma_1$, $H_1(A) = H^*(A \times \Theta_2)$. Denote by θ_i the pair $(\theta_i^{(1)}, \theta_i^{(2)})$, then:*

$$\begin{aligned} \text{DPM}(\theta_1^{(1)} \in S_1, \dots, \theta_n^{(1)} \in S_n | \alpha H_1) \\ = \text{DPM}(\theta_1 \in S_1 \times \Theta_2, \dots, \theta_n \in S_n \times \Theta_2 | \alpha H^*) \end{aligned}$$

for every collection of measurable sets $\{(S_1, \dots, S_n) : S_i \in \Sigma_1, i = 1, \dots, n\}$.

Proof. Since $\{(S_1, \dots, S_n) : S_i \in \Sigma_1, i = 1, \dots, n\}$ are rectangles, expanding the RHS using Definition 6 gives:

$$\text{RHS} = \int G(S_1 \times \Theta_2) \dots G(S_n \times \Theta_2) d\text{DP}(dG | \alpha, H^*)$$

Let $T_i = S_i \times \Theta_2$, the above expression is the expectation of $\prod_i G(T_i)$ when $G \sim \text{DP}(\alpha H^*)$. Forming collection of the disjoint measurable sets $T^* = (B_1 \dots B_{n^*})$ that generates T_i , then note that $B_i = A_i \times \Theta_2$, and $S^* = (A_1 \dots A_{n^*})$ generates S_i . By definition of H_1 , $H_1(A_i) = H^*(A_i \times \Theta_2) = H^*(B_i)$. Using the Lemma 5 above, $\text{RHS} = E_n(\alpha, H^*(B_1) \dots H^*(B_{n^*}))$, while $\text{LHS} = E_n(\alpha, H_1(A_1) \dots H_1(A_{n^*}))$ and they are indeed the same. \square

We note that H^* can be any arbitrary measure on Θ and, in general, we do not require H^* to factorize as product measure.

A.1.2. MARGINALIZATION RESULT FOR OUR PROPOSED MODEL

Recall that we are considering a product base-measure of the form $H^* = H \times \text{DP}(vQ_0)$ for the group-level DP mixture. Drawing from a DP mixture with this base measure, each realization is a pair (θ_j, Q_j) ; θ_j is then used to generate the context x_j and Q_j is used to repeatedly generate the

set of content observations w_{ji} within the group j . Specifically,

$$\begin{aligned} U &\sim \text{DP}(\alpha(H \times \text{DP}(vQ_0))) \quad \text{where } Q_0 \sim \text{DP}(\eta S) \\ (\theta_j, Q_j) &\stackrel{\text{iid}}{\sim} U \text{ for } j = 1, \dots, J \\ \varphi_{ji} &\stackrel{\text{iid}}{\sim} Q_j, \quad \text{for each } j \text{ and } i = 1, \dots, N_j \end{aligned} \quad (7)$$

In the above, H and S are respectively base measures for context and content parameters θ_j and φ_{ji} . We start with a definition for nested Dirichlet Process Mixture (nDPM) to proceed further.

Definition 8. (nested DP Mixture) An nDPM is a probability measure over $\Theta^{\sum_{j=1}^J N_j} \ni (\varphi_{11}, \dots, \varphi_{1N_1}, \dots, \varphi_{JN_J})$ equipped with the usual product sigma algebra $\Sigma^{N_1} \times \dots \times \Sigma^{N_J}$ such that for every collection of measurable sets $\{(S_{ji}) : S_{ji} \in \Sigma, j = 1, \dots, J, i = 1, \dots, N_j\}$:

$$\begin{aligned} \text{nDPM}(\varphi_{ji} \in S_{ji}, \forall i, j | \alpha, v, \eta, S) \\ = \int \int \left\{ \prod_{j=1}^J \int \prod_{i=1}^{N_j} Q_j(S_{ji}) U(dQ_j) \right\} \\ \times \text{DP}(dU | \alpha \text{DP}(vQ_0)) \text{DP}(dQ_0 | \eta, S) \end{aligned}$$

We now state the main marginalization result for our proposed model.

Theorem 9. Given α, H and α, v, η, S , let $\theta = (\theta_j : \forall j)$ and $\varphi = (\varphi_{ji} : \forall j, i)$ be generated as in Eq (7). Then, marginalizing out φ results in DPM($\theta | \alpha, H$), whereas marginalizing out θ results in nDPM($\varphi | \alpha, v, \eta, S$).

Proof. First we make observation that if we can show Proposition 7 still holds when H_1 is random with H_2 is fixed and vice versa, then the proof required is an immediate corollary of Proposition 7 by letting $H^* = H_1 \times H_2$ where we first let $H_1 = H, H_2 = \text{DP}(vQ_0)$ to obtain the proof for the first result, and then swap the order $H_1 = \text{DP}(vQ_0), H_2 = H$ to get the second result.

To see that Proposition 7 still holds when H_2 is a random measure and H_1 is fixed, we let the product base measure $H^* = H_1 \times H_2$ and further let μ be a prior probability measure for H_2 , i.e., $H_2 \sim \mu(\cdot)$. Denote by θ_i the pair $(\theta_i^{(1)}, \theta_i^{(2)})$, consider the marginalization over H_2 :

$$\begin{aligned} \int_{H_2} \text{DPM}(\theta_1 \in S_1 \times \Theta_2, \dots, \theta_n \in S_n \times \Theta_2 | \alpha, H^*) \mu(H_2) \\ = \int_{\Sigma_2} \underbrace{\text{DPM}(\theta_1^{(1)} \in S_1, \dots, \theta_n^{(1)} \in S_n | \alpha, H_1)}_{\text{constant w.r.t } H_2} \mu(H_2) \\ = \text{DPM}(\theta_1^{(1)} \in S_1, \dots, \theta_n^{(1)} \in S_n | \alpha, H_1) \int_{\Sigma_2} \mu(H_2) \\ = \text{DPM}(\theta_1^{(1)} \in S_1, \dots, \theta_n^{(1)} \in S_n | \alpha, H_1) \end{aligned}$$

When H_1 is random and H_2 is fixed. Let $\lambda(\cdot)$ be a prior probability measure for H_1 , i.e., $H_1 \sim \lambda(\cdot)$. It is clear that Proposition 7 holds for each draw H_1 from $\lambda(\cdot)$. This complete our proof. \square

A.1.3. ADDITIONAL RESULT FOR CORRELATION ANALYSIS IN NDPM

We now consider the correlation between φ_{ik} and $\varphi_{jk'}$ for arbitrary i, j, k and k' , i.e., we need to evaluate:

$$P(\varphi_{ik} \in A_1, \varphi_{jk'} \in A_2 | \alpha, \eta, v, S)$$

for two measurable sets $A_1, A_2 \in \Sigma$ by integrating out over all immediate random measures. We use an explicit stick-breaking representation for U where $U \sim \text{DP}(\alpha \text{DP}(vQ_0))$ as follows

$$U = \sum_{k=1}^{\infty} \pi_k \delta_{Q_k^*} \quad (8)$$

where $\pi \sim \text{GEM}(\alpha)$ and $Q_k^* \stackrel{\text{iid}}{\sim} \text{DP}(vQ_0)$. We use the notation $\delta_{Q_k^*}$ to denote the atomic measure on measure, placing its mass at measure Q_k^* .

For $i = j$, we have:

$$P(\varphi_{ik} \in A_1, \varphi_{jk'} \in A_2 | Q_1, \dots, Q_J) = Q_i(A_1) Q_i(A_2)$$

Sequentially take expectation over Q_i and U :

$$\begin{aligned} \int_{Q_i} Q_i(A_1) Q_i(A_2) dU(Q_i) &= \\ \int_{Q_i} Q_i(A_1) Q_i(A_2) d\left(\sum_{k=1}^{\infty} \pi_k \delta_{Q_k^*}\right) &= \\ \sum_k \pi_k [Q_k^*(A_1) Q_k^*(A_2)] &= \\ \int_U \sum_{k=1}^{\infty} \pi_k [Q_k^*(A_1) Q_k^*(A_2)] d\text{DP}(U | \alpha \text{DP}(vQ_0)) &= \\ \mathbb{E} \left\{ \sum_k \pi_k [Q_k^*(A_1) Q_k^*(A_2)] \right\} &= \\ \sum_k \mathbb{E}[\pi_k] \mathbb{E}[Q_k^*(A_1) Q_k^*(A_2)] &= \\ \frac{Q_0(A_1 \cap A_2) + Q_0(A_1) Q_0(A_2)}{v(v+1)} \left(\sum_k \mathbb{E}[\pi_k] \right) &= \\ \frac{Q_0(A_1 \cap A_2) + Q_0(A_1) Q_0(A_2)}{v(v+1)} & \end{aligned}$$

Integrating out $Q_0 \sim \text{DP}(vS)$ we get:

$$\begin{aligned}
 & P(\varphi_{ik} \in A_1, \varphi_{jk'} \in A_2 \mid \alpha, v, \eta, S) = \\
 & \mathbb{E}_{Q_0 \mid \eta, S} \left[\frac{Q_0(A_1 \cap A_2) + Q_0(A_1)Q_0(A_2)}{v(v+1)} \right] = \\
 & \frac{1}{v(v+1)} \left\{ S(A_1 \cap A_2) + \frac{S(A_1 \cap A_2) + S(A_1)S(A_2)}{\eta(\eta+1)} \right\} = \\
 & \frac{S(A_1 \cap A_2)}{v(v+1)} + \frac{S(A_1 \cap A_2) + S(A_1)S(A_2)}{v(v+1)\eta(\eta+1)}
 \end{aligned}$$

For $i \neq j$, since Q_i and Q_j are conditionally independent given U , we get:

$$P(\varphi_{ik} \in A_1, \varphi_{jk'} \in A_2 \mid Q_1, \dots, Q_J) = Q_i(A_1)Q_j(A_2)$$

Let $a_k = Q_k^*(A_1)$, $b_k = Q_k^*(A_2)$ and using Definition (8), integrating out U conditional on Q_0 with the stick-breaking representation in Eq (8):

$$\begin{aligned}
 & P(\varphi_{ik} \in A_1, \varphi_{jk'} \in A_2 \mid vQ_0) = \\
 & \left(\int_U Q_i(A_1) dU \right) \left(\int_U Q_j(A_2) dU \right) = \\
 & \mathbb{E} \left[\sum_k \pi_k Q_k^*(A_1) \right] \left[\sum_{k'} \pi_{k'} Q_{k'}^*(A_2) \right] = \\
 & \mathbb{E}(\pi_1 a_1 + \pi_2 a_2 + \dots) (\pi_1 b_1 + \pi_2 b_2 + \dots) = \\
 & \mathbb{E} \left(\sum_k \pi_k^2 a_k b_k \right) + \mathbb{E} \left(\sum_{k \neq k'} \pi_k \pi_{k'} a_k b_{k'} \right) = \\
 & A \mathbb{E} \left(\sum_k \pi_k^2 \right) + B \mathbb{E} \left(\sum_{k \neq k'} \pi_k \pi_{k'} \right) = \\
 & A \sum_k \mathbb{E}[\pi_k^2] + B \left(1 - \sum_k \mathbb{E}[\pi_k^2] \right)
 \end{aligned}$$

where

$$\begin{aligned}
 A &= \mathbb{E}[a_k b_k] \\
 &= \mathbb{E}[Q_k^*(A_1) Q_k^*(A_2)] \\
 &= \frac{Q_0(A_1 \cap A_2) + Q_0(A_1)Q_0(A_2)}{v(v+1)}
 \end{aligned}$$

and since Q_k^* (s) are iid draw from $DP(vQ_0)$ we have:

$$\begin{aligned}
 B &= \mathbb{E}[a_k b_{k'}] \\
 &= \mathbb{E}[Q_k^*(A_1) Q_{k'}^*(A_2)] \\
 &= \mathbb{E}[Q_k^*(A_1)] \mathbb{E}[Q_{k'}^*(A_2)] \\
 &= Q_0(A_1) Q_0(A_2)
 \end{aligned}$$

Lastly, since $(\pi_1, \pi_2, \dots) \sim \text{GEM}(\alpha)$, using the property of its stick-breaking representation $\sum_k \mathbb{E}[\pi_k^2] = \frac{1}{1+\alpha}$. Put

things together we obtain the expression for the correlation of φ_{ik} and $\varphi_{jk'}$ for $i \neq j$ conditional on Q_0 as:

$$\begin{aligned}
 & P(\varphi_{ik} \in A_1, \varphi_{jk'} \in A_2 \mid vQ_0) = \\
 & \frac{Q_0(A_1 \cap A_2) + Q_0(A_1)Q_0(A_2)}{(1+\alpha)v(v+1)} \\
 & + \frac{\alpha}{1+\alpha} Q_0(A_1)Q_0(A_2) \\
 & = \\
 & \frac{Q_0(A_1 \cap A_2)}{(1+\alpha)v(v+1)} \\
 & + \frac{\alpha v(v+1) + 1}{(1+\alpha)v(v+1)} Q_0(A_1)Q_0(A_2)
 \end{aligned}$$

Next, integrating out $Q_0 \sim DP(vS)$ we get:

$$\begin{aligned}
 & P(\varphi_{ik} \in A_1, \varphi_{jk'} \in A_2 \mid \alpha, v, \eta, S) = \\
 & \frac{\alpha v(v+1) + 1}{(1+\alpha)v(v+1)} \mathbb{E}[Q_0(A_1)Q_0(A_2)] \\
 & + \frac{\mathbb{E}[Q_0(A_1 \cap A_2)]}{(1+\alpha)v(v+1)} \\
 & = \\
 & \frac{\alpha v(v+1) + 1}{(1+\alpha)v(v+1)} \frac{S(A_1 \cap A_2) + S(A_1)S(A_2)}{\eta(\eta+1)} \\
 & + \frac{S(A_1 \cap A_2)}{(1+\alpha)v(v+1)}
 \end{aligned}$$

A.2. Model Inference Derivations

We provide detailed derivations for model inference with the graphical model displayed in Fig 1. The variables ϕ_k , ψ_m , π , τ_k are integrated out due to conjugacy property. We need to sample these latent variables z , l , ϵ and hyper parameters α , v , η . For convenience of notation, we denote z_{-j} is a set of latent context variable z in all documents excluding document j , l_{j*} is all of hidden variables l_{ji} in document j , and l_{-j*} is all of l in other documents rather than document j -th.

SAMPLING z

Sampling context index z_j needs to take into account the influence of the corresponding context topics:

$$\begin{aligned}
 p(z_j = k \mid \mathbf{z}_{-j}, \mathbf{l}, \mathbf{x}, \alpha, H) &\propto \underbrace{p(z_j = k \mid \mathbf{z}_{-j}, \alpha)}_{\text{CRP for context topic}} \quad (9) \\
 &\times \underbrace{p(x_j \mid z_j = k, \mathbf{z}_{-j}, \mathbf{x}_{-j}, H)}_{\text{context predictive likelihood}} \\
 &\times \underbrace{p(l_{j*} \mid z_j = k, \mathbf{l}_{-j*}, \mathbf{z}_{-j}, \epsilon, v)}_{\text{content latent marginal likelihood}}
 \end{aligned}$$

The first term can easily be recognized as a form of Chinese Restaurant Process (CRP):

$$p(z_j = k \mid \mathbf{z}_{-j}, \alpha) = \begin{cases} \frac{n_{-j}^k}{n_{-j}^* + \alpha} & \text{if } k \text{ old} \\ \frac{\alpha}{n_{-j}^* + \alpha} & \text{if } k \text{ new} \end{cases}$$

where n_{-j}^k is the number of data $z_j = k$ excluding z_j , and n_{-j}^* is the count of all \mathbf{z} , except z_j .

The second expression is the predictive likelihood from the context observations under the context component ϕ_k . Specifically, let $f(\cdot \mid \phi)$ and $h(\cdot)$ be respectively the density function for $F(\phi)$ and H , the conjugacy between F and H allows us to integrate out the mixture component parameter ϕ_k , leaving us the conditional density of x_j under the mixture component k given all the context data items exclude x_j :

$$\begin{aligned} p(x_j \mid z_j = k, \mathbf{z}_{-j}, \mathbf{x}_{-j}, H) &= \\ \frac{\int_{\phi_k} f(x_j \mid \phi_k) \prod_{j' \neq j, z_{j'} = k} f(x_{j'} \mid \phi_k) h(\phi_k) d\phi_k}{\int_{\phi_k} \prod_{j' \neq j, z_{j'} = k} f(x_{j'} \mid \phi_k) h(\phi_k) d\phi_k} &= f_k^{-x_j}(x_j) \end{aligned}$$

Finally, the last term is the contribution from the multiple latent variables of corresponding topics to that context. Since $l_{ji} \mid z_j = k \stackrel{\text{iid}}{\sim} \text{Mult}(\boldsymbol{\tau}_k)$ where $\boldsymbol{\tau}_k \sim \text{Dir}(v\epsilon_1, \dots, v\epsilon_M, \epsilon_{\text{new}})$, we shall attempt to integrate out $\boldsymbol{\tau}_k$. Using the Multinomial-Dirichlet conjugacy property we proceed to compute the last term in Eq (9) as following:

$$p(\mathbf{l}_{j*} \mid z_j = k, \mathbf{z}_{-j}, \mathbf{l}_{-j*}, \epsilon, v) = \int_{\boldsymbol{\tau}_k} p(\mathbf{l}_{j*} \mid \boldsymbol{\tau}_k) \quad (10)$$

$$\times p(\boldsymbol{\tau}_k \mid \{l_{j'i} \mid z_{j'} = k, j' \neq j\}, \epsilon, v) d\boldsymbol{\tau}_k$$

Recognizing the term $p(\boldsymbol{\tau}_k \mid \{l_{j'i} \mid z_{j'} = k, j' \neq j\}, \epsilon, v)$ is a posterior density, it is Dirichlet-distributed with the updated parameters

$$\begin{aligned} p(\boldsymbol{\tau}_k \mid \{l_{j'i} \mid z_{j'} = k, j' \neq j\}) & \quad (11) \\ = \text{Dir}(v\epsilon_1 + c_{k,1}^{-j}, \dots, v\epsilon_M + c_{k,M}^{-j}, v\epsilon_{\text{new}}) \end{aligned}$$

where $c_{k,m}^{-j} = \sum_{j' \neq j} \sum_{i=1}^{N_{j'}} \mathbb{I}(l_{j'i} = m, z_{j'} = k)$ is the count of topic m being assigned to context k excluding document j . Using this result, $p(\mathbf{l}_{j*} \mid \boldsymbol{\tau}_k)$ is a predictive likelihood for \mathbf{l}_{j*} under the posterior Dirichlet parameters

$\boldsymbol{\tau}_k$ in Eq 11 and therefore can be evaluated to be:

$$\begin{aligned} p(\mathbf{l}_{j*} \mid z_j = k, \mathbf{z}_{-j}, \mathbf{l}_{-j*}, \epsilon, v) &= \\ = \int_{\boldsymbol{\tau}_k} p(\mathbf{l}_{j*} \mid \boldsymbol{\tau}_k) & \times \text{Dir}(v\epsilon_1 + c_{k,1}^{-j}, \dots, v\epsilon_M + c_{k,M}^{-j}, v\epsilon_{\text{new}}) d\boldsymbol{\tau}_k \\ = \int_{\boldsymbol{\tau}_k} \prod_{m=1}^M \tau_{k,m}^{c_{k,m}^j} \times \frac{\Gamma(\sum_{m=1}^M (v\epsilon_m + c_{k,m}^{-j}))}{\prod_{m=1}^M \Gamma(v\epsilon_m + c_{k,m}^{-j})} & \\ \times \prod_{m=1}^M \tau_{k,m}^{v\epsilon_m + c_{k,m}^{-j} - 1} d\boldsymbol{\tau}_k &= \\ = \frac{\Gamma(\sum_{m=1}^M (v\epsilon_m + c_{k,m}^{-j}))}{\prod_{m=1}^M \Gamma(v\epsilon_m + c_{k,m}^{-j})} \int_{\boldsymbol{\tau}_k} \prod_{m=1}^M \tau_{k,m}^{v\epsilon_m + c_{k,m}^{-j} + c_{k,m}^j - 1} d\boldsymbol{\tau}_k & \\ = \frac{\Gamma(\sum_{m=1}^M (v\epsilon_m + c_{k,m}^{-j}))}{\prod_{m=1}^M \Gamma(v\epsilon_m + c_{k,m}^{-j})} \times \frac{\prod_{m=1}^M \Gamma(v\epsilon_m + c_{k,m}^{-j} + c_{k,m}^j)}{\Gamma(\sum_{m=1}^M (v\epsilon_m + c_{k,m}^{-j} + c_{k,m}^j))} & \\ = \frac{\Gamma(\sum_{m=1}^M (v\epsilon_m + c_{k,m}^{-j}))}{\prod_{m=1}^M \Gamma(v\epsilon_m + c_{k,m}^{-j})} \times \prod_{m=1}^M \frac{\Gamma(v\epsilon_m + c_{k,m}^{-j} + c_{k,m}^j)}{\Gamma(v\epsilon_m + c_{k,m}^{-j})} & \\ = \begin{cases} A = \frac{\Gamma(\sum_m [v\epsilon_m + c_{k,m}^{-j}])}{\Gamma(\sum_m [v\epsilon_m + c_{k,m}^{-j}])} \prod_m \frac{\Gamma(v\epsilon_m + c_{k,m}^{-j} + c_{k,m}^j)}{\Gamma(v\epsilon_m + c_{k,m}^{-j})} & \text{if } k \text{ old} \\ B = \frac{\Gamma(\sum_m v\epsilon_m)}{\Gamma(\sum_m v\epsilon_m + N_j)} \prod_m \frac{\Gamma(v\epsilon_m + c_{k,m}^j)}{\Gamma(v\epsilon_m)} & \text{if } k \text{ new} \end{cases} \end{aligned}$$

note that $\epsilon = (\epsilon_1, \epsilon_2, \dots, \epsilon_M, \epsilon_{\text{new}})$, here $\epsilon_{1:M} = (\epsilon_1, \epsilon_2, \dots, \epsilon_M)$, when sampling z_j we only use M active components from the previous iteration. In summary, the conditional distribution to sample z_j is given as:

$$\begin{aligned} p(z_j = k \mid \mathbf{z}_{-j}, \mathbf{l}, \mathbf{x}, \alpha, H) & \propto \\ \begin{cases} n_{-j}^k \times f_k^{-x_j}(x_j) \times A & \text{if } k \text{ previously used} \\ \alpha \times f_{k_{\text{new}}}^{-x_{j_i}}(x_{j_i}) \times B & \text{if } k = k_{\text{new}} \end{cases} \end{aligned}$$

Implementation note: to evaluate A and B, we make use of the marginal likelihood resulted from a Multinomial-Dirichlet conjugacy.

SAMPLING l

Let w_{-ji} be the same set as w excluding w_{ji} , i.e $w_{-ji} = \{w_{uv} : u \neq j \cap v \neq i\}$, then we can write

$$p(l_{ji} = m \mid l_{-ji}, z_j = k, v, w, S) \propto$$

$$\underbrace{p(w_{ji} \mid w_{-ji}, l_{ji} = m, \rho)}_{\text{content predictive likelihood}} \times \underbrace{p(l_{ji} = m \mid l_{-ji}, z_j = k, \epsilon_m, v)}_{\text{CRF for content topic}} \quad (12)$$

The first argument is computed as log likelihood predictive of the content with the component ψ_m

$$p(w_{ji} \mid w_{-ji}, l_{ji} = m, \rho) =$$

$$\frac{\int_{\lambda_m} s(w_{ji} \mid \lambda_m) \left[\prod_{u \in w_{-ji}(m)} y(u \mid \lambda_m) \right] s(\lambda_m) d\lambda_m}{\int_{\lambda_m} \left[\prod_{u \in w_{-ji}(m)} y(u \mid \lambda_m) \right] s(\lambda_m) d\lambda_m} \triangleq y_m^{-w_{ji}}(w_{ji}) \quad (13)$$

And the second term is inspired by Chinese Restaurant Franchise (CRF) as:

$$p(l_{ji} = m \mid l_{-ji}, \epsilon_m, v) = \begin{cases} c_{k,m} + v\epsilon_m & \text{if } m \text{ old} \\ v\epsilon_{\text{new}} & \text{if } m \text{ new} \end{cases} \quad (14)$$

where $c_{k,m}$ is the number of data point $|\{l_{ji} \mid l_{ji} = m, z_j = k, 1 \leq j \leq J, 1 \leq i \leq N_j\}|$. The final form to sample l_{ji} is given as:

$$p(l_{ji} = m \mid l_{-ji}, z_j = k, w, v, \epsilon) \propto \begin{cases} (c_{k,m} + v\epsilon_m) \times y_m^{-w_{ji}}(w_{ji}) & \text{if } m \text{ is used previously} \\ v\epsilon_{\text{new}} \times y_m^{-w_{ji}}(w_{ji}) & \text{if } m = m_{\text{new}} \end{cases}$$

Sampling ϵ

Note that sampling ϵ require both z and l .

$$p(\epsilon \mid \mathbf{l}, \mathbf{z}, v, \eta) \propto p(\mathbf{l} \mid \epsilon, v, z, \eta) \times p(\epsilon \mid \eta) \quad (15)$$

Isolating the content variables l_{ji}^k generated by the same context $z_j = k$ into one group

$l_j^k = \{l_{ji} : 1 \leq i \leq N_j, z_j = k\}$ the first term of 15 can be expressed following:

$$\begin{aligned} p(l \mid \epsilon, v, z, \eta) &= \prod_{k=1}^K \int_{\tau_k} p(l_{**}^k \mid \tau_k) p(\tau_k \mid \epsilon) d\tau_k \\ &= \prod_{k=1}^K \frac{\Gamma(v)}{\Gamma(v + n_{k*})} \prod_{m=1}^M \frac{\Gamma(v\epsilon_m + n_{km})}{\Gamma(v\epsilon_m)} \end{aligned}$$

where $n_{k*} = |\{w_{ji} \mid z_j = k, i = 1, \dots, N_j\}|$ and $n_{km} = |\{w_{ji} \mid z_j = k, l_{ji} = m, 1 \leq j \leq J, 1 \leq i \leq N_j\}|$.

Let $\eta_r = \frac{\eta}{R}$, $\eta_{\text{new}} = \frac{R-M}{R}\eta$ and recall that $\epsilon \sim \text{Dir}(\eta_r, \dots, \eta_r, \eta_{\text{new}})$, the last term of Eq 15 is a Dirichlet density:

$$\begin{aligned} p(\epsilon \mid \eta) &= \text{Dir} \left(\underbrace{\eta_1, \eta_2, \dots, \eta_M}_M, \eta_{\text{new}} \right) \\ &= \frac{\Gamma(M \times \eta_r + \eta_{\text{new}})}{[\Gamma(\eta_r)]^M \eta_{\text{new}}} \prod_{m=1}^M \epsilon_m^{\eta_r - 1} \epsilon_{\text{new}}^{\eta_{\text{new}} - 1} \end{aligned}$$

Using the result:

$$\frac{\Gamma(v\epsilon_m + n_{km})}{\Gamma(v\epsilon_m)} = \sum_{o_{km}=0}^{n_{km}} \text{Stirl}(o_{km}, n_{km}) (v\epsilon_m)^{o_{km}}$$

Thus, Eq 15 becomes:

$$\begin{aligned} p(\epsilon \mid \mathbf{l}, \mathbf{z}, v, \eta) &= \epsilon_{\text{new}}^{\eta_{\text{new}} - 1} \prod_{k=1}^K \frac{\Gamma(v)}{\Gamma(v + n_{k*})} \\ &\times \prod_{m=1}^M \epsilon_m^{\eta_m - 1} \sum_{o_{km}=0}^{n_{km}} \text{Stirl}(o_{km}, n_{km}) (v\epsilon_m)^{o_{km}} \\ &= \epsilon_{\text{new}}^{\eta_{\text{new}} - 1} \sum_{o_{km}=0}^{n_{km}} \prod_{k=1}^K \frac{\Gamma(v)}{\Gamma(v + n_{k*})} \\ &\times \prod_{m=1}^M \epsilon_m^{\eta_m - 1} \text{Stirl}(o_{km}, n_{km}) (v\epsilon_m)^{o_{km}} \\ p(\epsilon, \mathbf{o} \mid \mathbf{l}, \mathbf{z}, v, \eta) &= \epsilon_{\text{new}}^{\eta_{\text{new}} - 1} \prod_{k=1}^K \frac{\Gamma(v)}{\Gamma(v + n_{k*})} \\ &\times \prod_{m=1}^M \epsilon_m^{\eta_m - 1} \text{Stirl}(o_{km}, n_{km}) (v\epsilon_m)^{o_{km}} \end{aligned}$$

The probability of the auxiliary variable o_{km} is computed as:

$$p(o_{km}) = \sum_{o_{km}=0}^{n_{km}} \text{Stirl}(o_{km}, n_{km}) (v\epsilon_m)^{o_{km}}$$

Now let $\mathbf{o} = (o_{km} : \forall k, m)$ we derive the following joint distribution:

$$p(\epsilon \mid \mathbf{o}, \mathbf{l}, \mathbf{z}, v, \eta) = \epsilon_{\text{new}}^{\eta_{\text{new}} - 1} \prod_{m=1}^M \epsilon_m^{\sum_K o_{km} + \eta_m - 1}$$

As $R \rightarrow \infty$, we have

$$p(\epsilon \mid \mathbf{o}, \mathbf{l}, \mathbf{z}, v, \eta) \propto \epsilon_{\text{new}}^{\eta-1} \prod_{m=1}^M \epsilon_m^{\sum_K o_{km}-1}$$

Finally, we sample ϵ jointly with the auxiliary variable o_{km} by:

$$p(o_{km} = h \mid \cdot) \propto \text{Stirl}(h, n_{km}) (v\epsilon_m)^h, \quad h = 0, 1, \dots, n_{km}$$

$$p(\epsilon) \propto \epsilon_{\text{new}}^{\eta-1} \prod_{m=1}^M \epsilon_m^{\sum_K o_{km}-1}$$

Sampling hyperparameters

In the proposed model, there are three hyper-parameters which need to be sampled : α, v and η .

SAMPLING η

Using similar strategy and using technique from Escobar and West (Escobar & West, 1995), we have

$$p(M \mid \eta, u) = \text{Stirl}(M, u) \eta^M \frac{\Gamma(\eta)}{\Gamma(\eta + u)}$$

where $u = \sum_m u_m$ with $u_m = \sum_K o_{km}$ is in the previous sampling ϵ and M is the number of active content atoms. Let $\eta \sim \text{Gamma}(\eta_1, \eta_2)$. Recall that:

$$\frac{\Gamma(\eta)}{\Gamma(\eta + u)} = \int_0^1 t^\eta (1-t)^{u-1} \left(1 + \frac{u}{\eta}\right) dt$$

that we have just introduced an auxiliary variable t

$$p(t \mid \eta) \propto t^\eta (1-t)^{u-1} = \text{Beta}(\eta + 1, u)$$

Therefore,

$$\begin{aligned} p(\eta \mid t) &\propto \eta^{\eta_1-1+M} \exp\{-\eta\eta_2\} \times t^\eta (1-t)^{u-1} \left(1 + \frac{u}{\eta}\right) \\ &= \eta^{\eta_1-1+M} \times \exp\{-\eta(\eta_2 - \log t)\} \times (1-t)^{u-1} \\ &+ \eta^{\eta_1-1+M-1} \exp\{-\eta(\eta_2 - \log t)\} \times (1-t)^{u-1} u \\ &\propto \eta^{\eta_1-1+M} \exp\{-\eta(\eta_2 - \log t)\} \\ &+ u \eta^{\eta_1-1+M-1} \exp\{-\eta(\eta_2 - \log t)\} \\ &= \pi_t \text{Gamma}(\eta_1 + M, \eta_2 - \log t) \\ &+ (1 - \pi_t) \text{Gamma}(\eta_1 + M - 1, \eta_2 - \log t) \end{aligned} \quad (16)$$

where π_t satisfies this following equation to make the above expression a proper mixture density:

$$\frac{\pi_t}{1 - \pi_t} = \frac{\eta_1 + M - 1}{u(\eta_2 - \log t)} \quad (17)$$

To re-sample η , we first sample $t \sim \text{Beta}(\eta + 1, u)$, compute π_t as in equation 17, and then use π_t to select the correct Gamma distribution to sample η as in Eq. 16.

SAMPLING α

Again sampling α is similar to Escobar et al (Escobar & West, 1995). Assuming $\alpha \sim \text{Gamma}(\alpha_1, \alpha_2)$ with the auxiliary variable t :

$$p(t \mid \alpha, K) \propto t^{\alpha_1-1} (1-t)^{J-1}$$

$$p(t \mid \alpha, K) \propto \text{Beta}(\alpha_1 + 1, J)$$

J : number of document

$$p(\eta \mid t, K) \sim \pi_t \text{Gamma}(\alpha_1 + K, \alpha_2 - \log(t))$$

$$+ (1 - \pi_t) \text{Gamma}(\alpha_1 + K - 1, \alpha_2 - \log(t))$$

where c, d are prior parameter for sampling η following Gamma distribution and $\frac{\pi_t}{1-\pi_t} = \frac{\alpha_1+K-1}{J(\alpha_2-\log t)}$

SAMPLING v

Sampling v is similar to sampling concentration parameter in HDP (Teh et al., 2006b). Denote $o_{k*} = \sum_m o_{km}$, where o_{km} is defined previously during the sampling step for ϵ , $n_{k*} = \sum_m n_{km}$, where n_{km} is the count of $|\{l_{ji} \mid z_{ji} = k, l_{ji} = m\}|$. Using similar technique in (Teh et al., 2006b), we write:

$$p(o_{1*}, o_{2*}, \dots, o_{K*} \mid v, n_{1*}, \dots, n_{K*}) = \prod_{k=1}^K \text{Stirl}(n_{k*}, o_{k*}) \alpha_0^{o_{k*}}$$

$$\times \frac{\Gamma(v)}{\Gamma(v + n_{k*})}$$

where the last term can be expressed as

$$\frac{\Gamma(v)}{\Gamma(v + n_{k*})} = \frac{1}{\Gamma(n_{k*})} \int_0^1 b_k^v (1 - b_k)^{n_{k*}-1} \left(1 + \frac{n_{k*}}{v}\right) db_k$$

Assuming $v \sim \text{Gamma}(v_1, v_2)$, define the auxiliary variables $b = (b_k \mid k = 1, \dots, K)$, $b_k \in [0, 1]$ and $t = (t_k \mid k = 1, \dots, K)$, $t_k \in \{0, 1\}$ we have

$$q(v, b, t) \propto v^{v_1-1+\sum_k M_k} \exp\{-vv_1\} \\ \times \prod_{k=1}^K b_k^v (1-b_k)^{M_k-1} \left(\frac{M_k}{v}\right)^{t_k}$$

We will sample the auxiliary variables b_k, t_k in accordance with v that are defined below:

$$q(b_k | v) = \text{Beta}(v+1, o_{k*}) \\ q(t_k | \cdot) = \text{Bernoulli}\left(\frac{o_{k*}/v}{1+o_{k*}/v}\right) \\ q(v | \cdot) = \text{Gamma}\left(v_1 + \sum_k (o_{k*} - t_k), v_2 - \sum_k \log b_k\right)$$

A.3. Relative Roles of Context and Content Data

Regarding the inference of the cluster index z_j (Eq. 9), to obtain the marginal likelihood (the third term in Eq. 9) one has to integrate out the words' topic labels l_{ji} . In doing so, it can be shown that the *sufficient* statistics coming from the content data toward the inference of the topic frequencies and the clustering labels will just be the empirical word frequency from each document. As each document becomes sufficiently long, the empirical word frequency quickly concentrates around its mean by the central limit theorem (CLT), so as soon as the effect of CLT kicks in, increasing document length further will do very little in improving this sufficient statistics.

Increasing the document length will probably not hurt, of course. But to what extent it contributes relative to the number of documents awaits a longer and richer story to be told.

We confirm this argument by varying the document length and the number of documents in the synthetic document and see how they affect the *posterior* of the clustering labels. Each experiment is repeated 20 times. We record the mean and standard deviation of the clustering performance by NMI score. As can be seen from Fig 7, using context observation makes the model more robust in recovering the true document clusters.

A.4. Perplexity Evaluation

The standard perplexity proposed by Blei et al (Blei et al., 2003), used to evaluate the proposed model as following:

$$\text{perplexity}(w^{\text{Test}}) = \exp\left\{-\frac{\sum_{j=1}^{J_{\text{Test}}} \log p(w_j^{\text{Test}})}{\sum_{j=1}^{J_{\text{Test}}} N_j^{\text{Test}}}\right\}$$

During individual sampling iteration t , we utilize the important sampling approach (Teh et al., 2006a) to compute $p(w^{\text{Test}})$. The posterior estimation of ψ_m in a Multinomial-Dirichlet case is defined below, note that it can be in other types of conjugacies (Gelman et al., 2003) (e.g. Gaussian-Wishart, Binomial-Poisson):

$$\psi_{m,v}^t = \frac{n_{m,v}^t + \text{smooth}}{\sum_{u=1}^V n_{m,v}^t + V \times \text{smooth}}$$

$$\tau_{k,m}^t = \frac{c_{k,m} + vv \times \epsilon_m}{\sum_{m=1}^M (c_{k,m} + vv \times \epsilon_m)}$$

where $n_{m,v}^t$ is number of times a word v , $v \in \{1, \dots, V\}$ is assigned to context topic ψ_m in iteration t , and $c_{k,m}$ is the count of the set $\{w_{ji} | z_j = k, l_{ji} = m, 0 \leq j \leq J, 0 \leq i \leq N_j\}$. There is a constant smooth parameter (Asuncion et al., 2009) that influence on the count, roughly set as 0.1. Supposed that we estimate $z_j^{\text{Test}} = k$ and $l_{ji}^{\text{Test}} = m$, then the probability $p(w_j^{\text{Test}})$ is computed as:

$$p(w_j^{\text{Test}}) = \prod_{i=1}^{N_j^{\text{Test}}} \frac{1}{T} \sum_{t=1}^T \tau_{k,m}^t \psi_{m,w_{ji}^{\text{Test}}}^t$$

where T is the number of collected Gibbs samples.

J: number of document.
 NJ: number of word per document.
 NMI: normalized mutual information.

MC2 on Synthetic Data

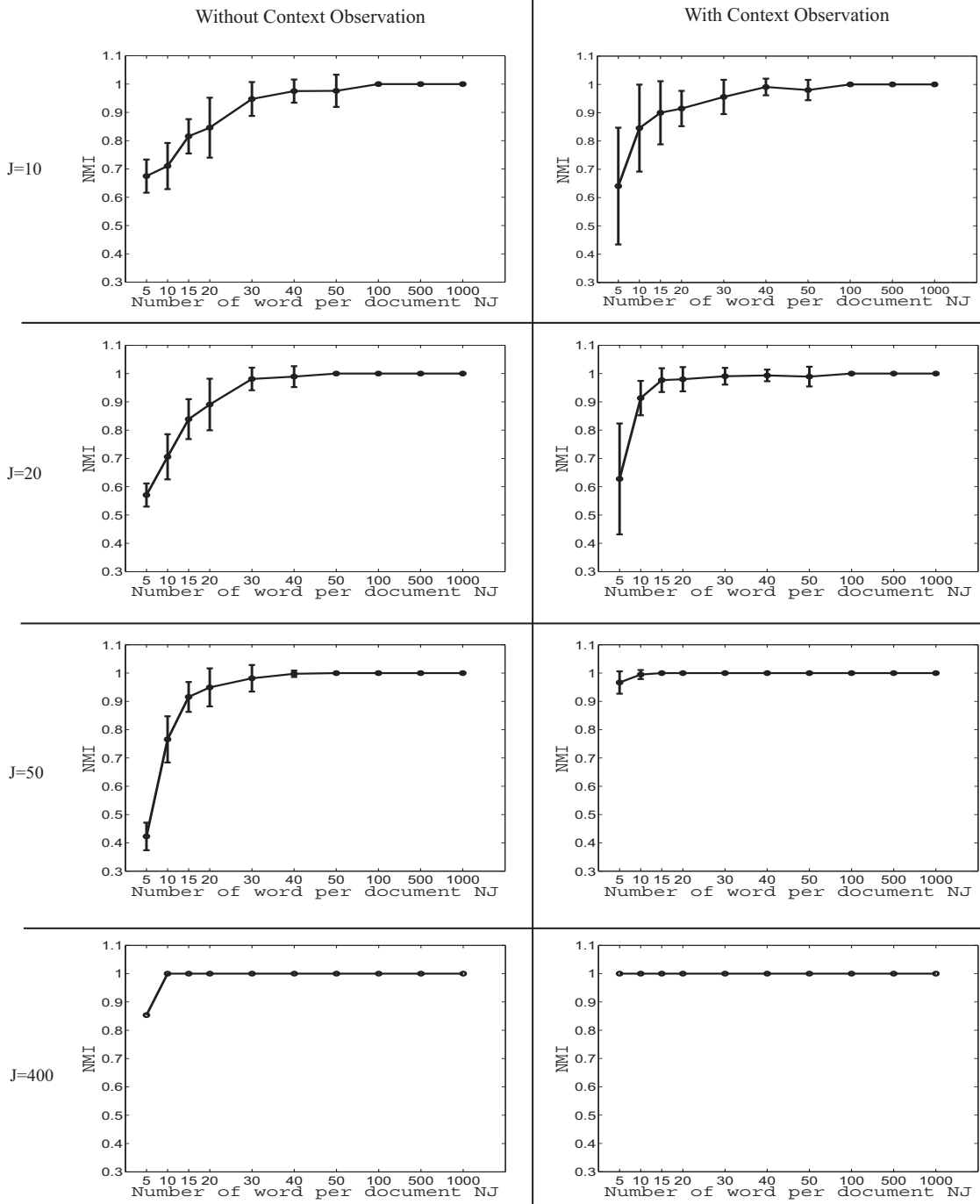

Note: Document clustering performance is evaluated on the estimated document cluster z_j vs their groundtruth.

Figure 7. Document clustering performance with different numbers of observed words and documents.