

Hierarchical complexity of 2-clique-colouring weakly chordal graphs and perfect graphs having cliques of size at least 3*

Hélio B. Macêdo Filho^{†1}, Raphael C. S. Machado^{‡2},
Celina M. H. de Figueiredo^{*1}

¹COPPE, Universidade Federal do Rio de Janeiro

²Inmetro — Instituto Nacional de Metrologia, Qualidade e Tecnologia

Abstract

A clique of a graph is a maximal set of vertices of size at least 2 that induces a complete graph. A k -clique-colouring of a graph is a colouring of the vertices with at most k colours such that no clique is monochromatic. Défossez proved that the 2-clique-colouring of perfect graphs is a Σ_2^P -complete problem [J. Graph Theory 62 (2009) 139–156]. We strengthen this result by showing that it is still Σ_2^P -complete for weakly chordal graphs. We then determine a hierarchy of nested subclasses of weakly chordal graphs whereby each graph class is in a distinct complexity class, namely Σ_2^P -complete, \mathcal{NP} -complete, and \mathcal{P} . We solve an open problem posed by Kratochvíl and Tuza to determine the complexity of 2-clique-colouring of perfect graphs with all cliques having size at least 3 [J. Algorithms 45 (2002), 40–54], proving that it is a Σ_2^P -complete problem. We then determine a hierarchy of nested subclasses of perfect graphs with all cliques having size at least 3 whereby each graph class is in a distinct complexity class, namely Σ_2^P -complete, \mathcal{NP} -complete, and \mathcal{P} .

Keywords: clique-colouring; hierarchical complexity; perfect graphs; weakly chordal graphs; (alpha beta)-polar graphs.

1 Introduction

Let $G = (V, E)$ be a simple graph with $n = |V|$ vertices and $m = |E|$ edges. A *clique* of G is a maximal set of vertices of size at least 2 that induces a complete graph. A k -*clique-colouring* of a graph is a colouring of the vertices with at most k colours such that no clique is monochromatic. Any undefined notation concerning complexity classes follows that of Marx [9].

*Partially supported by CNPq and FAPERJ.

[†]{helio, celina}@cos.ufrj.br

[‡]rcmachado@inmetro.gov.br

An extended abstract of this work was accepted for presentation at Latin 2014, the 11th Latin American Symposium on Theoretical Informatics. October 31, 2018

A *cycle* is sequence of vertices starting and ending at the same vertex, with each two consecutive vertices in the sequence adjacent to each other in the graph. A *chord* of a cycle is an edge joining two nodes that are not consecutive in the cycle.

The *clique-number* $\omega(G)$ of a graph G is the number of vertices of a clique with the largest possible size in G . A *perfect graph* is a graph in which every induced subgraph H needs exactly $\omega(H)$ colours in its vertices such that no K_2 (not necessarily clique) is monochromatic. The celebrated *Strong Perfect Graph Theorem* of Chudnovsky et al. [3] says that a graph is perfect if neither it nor its complement contains a chordless cycle with an odd number of vertices greater than 4. A graph is *chordal* if it does not contain a chordless cycle with a number of vertices greater than 3, and a graph is *weakly chordal* if neither it nor its complement contains a chordless cycle with a number of vertices greater than 4.

Both clique-colouring and perfect graphs have attracted much attention due to a conjecture posed by Duffus et al. [5] that *perfect graphs are k -clique-colourable for some constant k* . This conjecture has not yet been proved. Following the chronological order, Kratochvíl and Tuza gave a framework to argue that 2-clique-colouring is \mathcal{NP} -hard and proved that 2-clique-colouring is \mathcal{NP} -complete for K_4 -free perfect graphs [7]. Notice that K_3 -free perfect graphs are bipartite graphs, which are clearly 2-clique-colourable. Moreover, 2-clique-colouring is in Σ_2^P , since it is $\text{co}\mathcal{NP}$ to check that a colouring of the vertices is a clique-colouring. A few years later, the 2-clique-colouring problem was proved to be a Σ_2^P -complete problem by Marx [9], a major breakthrough in the clique-colouring area. Défossez [4] proved later that 2-clique-colouring of perfect graphs remained a Σ_2^P -complete problem.

When restricted to chordal graphs, 2-clique-colouring is in \mathcal{P} , since all chordal graphs are 2-clique-colourable [11]. Notice that chordal graphs are a subclass of weakly chordal graphs, while perfect graphs are a superclass of weakly chordal graphs. In contrast to chordal graphs, not all weakly chordal graphs are 2-clique-colourable (see Fig. 1a).

We show that 2-clique-colouring of weakly chordal graphs is a Σ_2^P -complete problem, improving the proof of Défossez [4] that 2-clique-colouring is a Σ_2^P -complete problem for perfect graphs. As a remark, Défossez [4] constructed a graph which is not a weakly chordal graph as long as it has chordless cycles with even number of vertices greater than 5 as induced subgraphs. We determine a hierarchy of nested subclasses of weakly chordal graphs whereby each graph class is in a distinct complexity class, namely Σ_2^P -complete, \mathcal{NP} -complete, and \mathcal{P} .

A graph is (α, β) -*polar* if there exists a partition of its vertex set into two sets A and B such that all connected components of the subgraph induced by A and of the complementary subgraph induced by B are complete graphs. Moreover, the order of each connected component of the subgraph induced by A (resp. of the complementary subgraph induced by B) is upper bounded by α (resp. upper bounded by β) [2]. A *satellite* of an (α, β) -polar graph is a connected component of the subgraph induced by A (see Fig. 1b). In this work, we restrict ourselves to the (α, β) -*polar* graphs with $\beta = 1$, so the subgraph induced by B is complete and the order of each satellite is upper bounded by α (see Fig. 1c). Clearly, $(\alpha, 1)$ -polar graphs are perfect, since they do not contain chordless cycles with an odd number of vertices greater than 4 nor their complements.

A *generalized split graph* is a graph G such that G or its complement is an $(\infty, 1)$ -polar graph [12]. See Fig. 1c for an example of a generalized split graph, which is a $(2, 1)$ -polar graph. The class of generalized split graphs plays an important role in the areas of perfect graphs and clique-colouring. This class was introduced by Prömel and Steger [12] to show that the strong perfect graph conjecture is at least asymptotically true by proving that almost all C_5 -

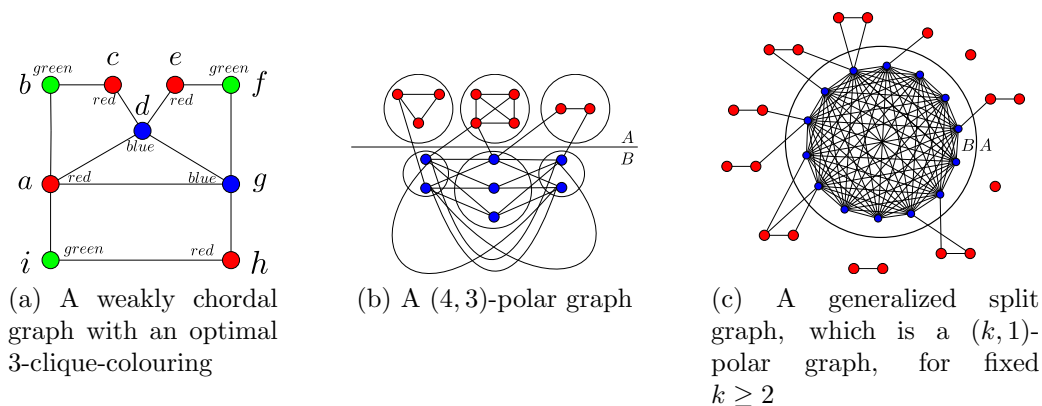

Figure 1: Examples of (α, β) -polar graphs

free graphs are generalized split graphs. Approximately 14 years later the strong perfect graph conjecture became the *Strong Perfect Graph Theorem* by Chudnovsky et al. [3]. Regarding clique-colouring, Bacsó et al. [1] proved that generalized split graphs are 3-clique-colourable and concluded that almost all perfect graphs are 3-clique-colourable [1]. This conclusion supports the conjecture due to Duffus et al. [5]. In fact, there is no example of a perfect graph where more than three colors would be necessary to clique-colour. Surprisingly, after more than 20 years, relatively little progress has been made on the conjecture.

The class of $(k, 1)$ -polar graphs, for fixed $k \geq 3$, is incomparable to the class of weakly chordal graphs. Indeed, a chordless path with seven vertices P_7 and a complement of a chordless cycle with six vertices \overline{C}_6 are witnesses. Nevertheless, $(2, 1)$ -polar graphs are a subclass of weakly chordal graphs, since they do not contain a chordless cycle with an even number of vertices greater than 5. We show that 2-clique-colouring of $(2, 1)$ -polar graphs is a \mathcal{NP} -complete problem. Finally, the class of $(1, 1)$ -polar graphs is precisely the class of split graphs. It is interesting to recall that 2-clique-colouring of $(1, 1)$ -polar graphs is in \mathcal{P} , since $(1, 1)$ -polar are a subclass of chordal graphs, which are 2-clique-colourable.

Giving continuity to our results, we investigate an open problem left by Kratochvíl and Tuza [7] to determine the complexity of 2-clique-colouring of perfect graphs with all cliques having size at least 3. Restricting the size of the cliques to be at least 3, we first show that 2-clique-colouring is still \mathcal{NP} -complete for $(3, 1)$ -polar graphs, even if it is restricted to weakly chordal graphs with all cliques having size at least 3. Subsequently, we prove that the 2-clique-colouring of $(2, 1)$ -polar graphs becomes polynomial when all cliques have size at least 3. Recall that the 2-clique-colouring of $(2, 1)$ -polar graphs is \mathcal{NP} -complete when there are no restrictions on the size of the cliques.

We finish the paper answering the open problem of determining the complexity of 2-clique-colouring of perfect graphs with all cliques having size at least 3 [7], by improving our proof that 2-clique-colouring is a Σ_2^P -complete problem for weakly chordal graphs. We replace each K_2 clique by a gadget with no clique of size 2, which forces distinct colours into two given vertices.

The paper is organized as follows. In Section 2, we show that 2-clique-colouring is still Σ_2^P -complete for weakly chordal graphs. We then determine a hierarchy of nested subclasses of weakly chordal graphs whereby each graph class is in a distinct complexity class, namely Σ_2^P -complete, \mathcal{NP} -complete, and \mathcal{P} . In Section 3, we determine the complexity of 2-clique-colouring

of perfect graphs with all cliques having size at least 3, answering a question of Kratochvíl and Tuza [7]. We then determine a hierarchy of nested subclasses of perfect graphs with all cliques having size at least 3 whereby each graph class is in a distinct complexity class. We refer the reader to Table 1 for our results and related work about 2-clique-colouring complexity of perfect graphs.

2 Hierarchical complexity of 2-clique-colouring of weakly chordal graphs

Défossez proved that 2-clique-colouring of perfect graphs is a Σ_2^P -complete problem [4]. In this section, we strengthen this result by showing that it is still Σ_2^P -complete for weakly chordal graphs. We show a subclass of perfect graphs (resp. of weakly chordal graphs) in which 2-clique-colouring is neither a Σ_2^P -complete problem nor in \mathcal{P} , namely (3, 1)-polar graphs (resp. (2, 1)-polar graphs). Recall that 2-clique-colouring of (1, 1)-polar graphs is in \mathcal{P} , since (1, 1)-polar are a subclass of chordal graphs, thereby 2-clique-colourable. Notice that weakly chordal, (2, 1)-polar, and (1, 1)-polar (resp. perfect, (3, 1)-polar, and (1, 1)-polar) are nested classes of graphs.

Given a graph $G = (V, E)$ and adjacent vertices $a, g \in V$, we say that we add to G a copy of an auxiliary graph $AK(a, g)$ of order 7 – depicted in Fig. 2a – if we change the definition of G by doing the following: we first change the definition of V by adding to it copies of the five vertices b, \dots, f of the auxiliary graph $AK(a, g)$; then we change the definition of E , adding to it copies of the eight edges (u, v) of $AK(a, g)$. Similarly, given a graph $G = (V, E)$ and non-adjacent vertices $a, j \in V$, we say that we add to G a copy of an auxiliary graph $NAS(a, j)$ of order 10 – depicted in Fig. 2b – if we change the definition of G by doing the following: we first change the definition of V by adding to it eight copies of the vertices b, \dots, i of the auxiliary graph $NAS(a, j)$; then we change the definition of E , adding to it copies of the thirteen edges (u, v) of $NAS(a, j)$.

The auxiliary graph $AK(a, g)$ is constructed to force the same colour (in a 2-clique-colouring)

Table 1: 2-clique-colouring complexity of perfect graphs and subclasses.

Class		2-clique-colouring complexity	
-	Perfect	-	Σ_2^P -complete [4]
		K_4 -free	\mathcal{NP} -complete [7]
		K_3 -free (Bipartite)	\mathcal{P}
	Weakly chordal	-	Σ_2^P -complete
	(3, 1)-polar	-	\mathcal{NP} -complete
	(2, 1)-polar	-	
	Chordal (includes Split)	-	\mathcal{P} [11]
All cliques having size at least 3	Perfect	-	Σ_2^P -complete
	Weakly chordal	-	\mathcal{NP} -complete
		(3, 1)-polar	
(2, 1)-polar	-	\mathcal{P}	

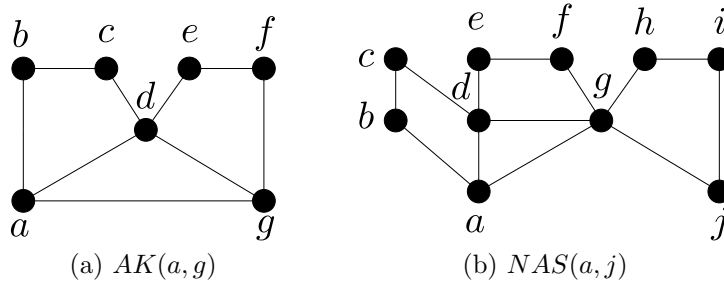

Figure 2: Auxiliary graphs $AK(a, g)$ and $NAS(a, j)$

to adjacent vertices a and g , while the auxiliary graph $NAS(a, j)$ is constructed to force distinct colours (in a 2-clique-colouring) to non-adjacent vertices a and j (see Lemmas 1 and 2).

Lemma 1. *Let G be a graph and a, g be adjacent vertices in G . If we add to G a copy of an auxiliary graph $AK(a, g)$, then in any 2-clique-colouring of the resulting graph, adjacent vertices a and g have the same colour.*

Proof. Follows from the fact that in $AK(a, g)$ there exists a path $abc\dots g$ such that no edge lies in a triangle of G . \square

Lemma 2. *Let G be a graph and a, j be non-adjacent vertices in G . If we add to G a copy of an auxiliary graph $NAS(a, j)$, then in any 2-clique-colouring of the resulting graph, non-adjacent vertices a and j have distinct colours.*

Proof. Follows from the fact that in $NAS(a, j)$ there exists a path $abc\dots j$ such that no edge lies in a triangle of G . \square

We improve the proof of Défossez [4], in order to determine the complexity of 2-clique-colouring for weakly chordal graphs. Consider the QSAT2 problem, which is the Σ_2^P -complete canonical problem [9], as follows.

Problem 1. QUANTIFIED 2-SATISFIABILITY (QSAT2)

Instance: A formula $\Psi = (X, Y, D)$ composed of a disjunction D of implicants (that are conjunctions of literals) over two sets X and Y of variables.

Question: Is there a truth assignment for X such that for every truth assignment for Y the formula is true?

We prove that 2-clique-colouring weakly chordal graphs is Σ_2^P -complete by reducing the Σ_2^P -complete canonical problem QSAT2 to it. For a QSAT2 formula $\Psi = (X, Y, D)$, a weakly chordal graph G is constructed such that graph G is 2-clique-colourable if, and only if, there is a truth assignment of X , such that Ψ is true for every truth assignment of Y .

Theorem 3. *The problem of 2-clique-colouring is Σ_2^P -complete for weakly chordal graphs.*

Proof. A 2-partition of the graph is a certificate to decide whether a graph has a 2-clique-colouring. Moreover, a monochromatic clique is a certificate to check whether a 2-partition is not a 2-clique-colouring. Finally, it is easy to describe a polynomial-time algorithm to check

whether a complete set is monochromatic and maximal. Hence, 2-clique-colouring is a Σ_2^P problem.

We prove that 2-clique-colouring weakly chordal graphs is Σ_2^P -hard by reducing QSAT2 to it. Let n , m , and p be the number of variables X , Y , and implicants, respectively, in formula Ψ . We define graph G , as follows.

- for each variable x_i , we create vertices x_i and \bar{x}_i ;
- for each variable y_j , we create vertices y_j , y'_j , and \bar{y}_j and edges $y_j y'_j$, and $y'_j \bar{y}_j$;
- we create a vertex v and edges so that the set $\{x_1, \bar{x}_1, \dots, x_n, \bar{x}_n, y_1, \bar{y}_1, \dots, y_m, \bar{y}_m, v\}$ induces a complete subgraph of G minus the matching $\{\{x_1, \bar{x}_1\}, \dots, \{x_n, \bar{x}_n\}, \{y_1, \bar{y}_1\}, \dots, \{y_m, \bar{y}_m\}\}$;
- add copies of the auxiliary graph $NAS(x_i, \bar{x}_i)$, for $i = 1, \dots, n$;
- add copies of the auxiliary graph $AK(\bar{y}_j, y_{j+1})$, for $j = 1, \dots, m - 1$;
- add a copy of $AK(\bar{y}_m, v)$; and
- for each implicant d_k , we create vertices d_k, d'_k, d''_k , and we add the edges $d_k d'_k, d'_k d''_k, d''_k v$, and $d_k v$. Moreover, each vertex d_k is adjacent to a vertex l in $\{x_1, \bar{x}_1, \dots, x_n, \bar{x}_n, y_1, \bar{y}_1, \dots, y_m, \bar{y}_m, v\}$ if, and only if, the literal correspondent to \bar{l} is not in the implicant correspondent to vertex d_k .

Refer to Fig. 3 for an example of such construction, given a formula $\Psi = (x_1 \wedge \bar{x}_2 \wedge y_2) \vee (x_1 \wedge x_3 \wedge \bar{y}_2) \vee (\bar{x}_1 \wedge \bar{x}_2 \wedge y_1)$.

We claim that graph G is 2-clique-colourable if, and only if, Ψ has a solution. For every i , the vertices x_i and \bar{x}_i have opposite colours in any 2-clique-colouring of G (see Lemma 2). The set $\{y_1, y_2, \dots, y_m, \bar{y}_1, \bar{y}_2, \dots, \bar{y}_m, v\}$ is monochromatic. Indeed, y_j, \bar{y}_j, y_{j+1} have the same colour, since $y_j y'_j, y'_j \bar{y}_j$ are cliques and, by Lemma 1, $\bar{y}_j y_{j+1}$ as well as $\bar{y}_m v$ have the same colour. Finally, d_1, d_2, \dots, d_p all have the same colour, which is the opposite to the colour of v .

Assume there exists a valuation v_X of X such that Ψ is satisfied for any valuation of Y . We give a colouring to the graph G , as follows.

- assign colour 1 to y_j, \bar{y}_j, d'_k , and v ,
- assign colour 2 to y'_j, d_k and d''_k ,
- extend the unique 2-clique-colouring to the $m-1$ copies of the auxiliary graph $AK(\bar{y}_j, y_{j+1})$ and $AK(\bar{y}_m, v)$,
- assign colour 1 to x_i if the corresponding variable is *true* in v_X , otherwise we assign colour 2 to it,
- assign colour 2 to \bar{x}_i if the corresponding variable is *true* in v_X , otherwise we assign colour 1 to it,
- extend the unique 2-clique-colouring to the n copies of the auxiliary graph $NAS(x_i, \bar{x}_i)$.

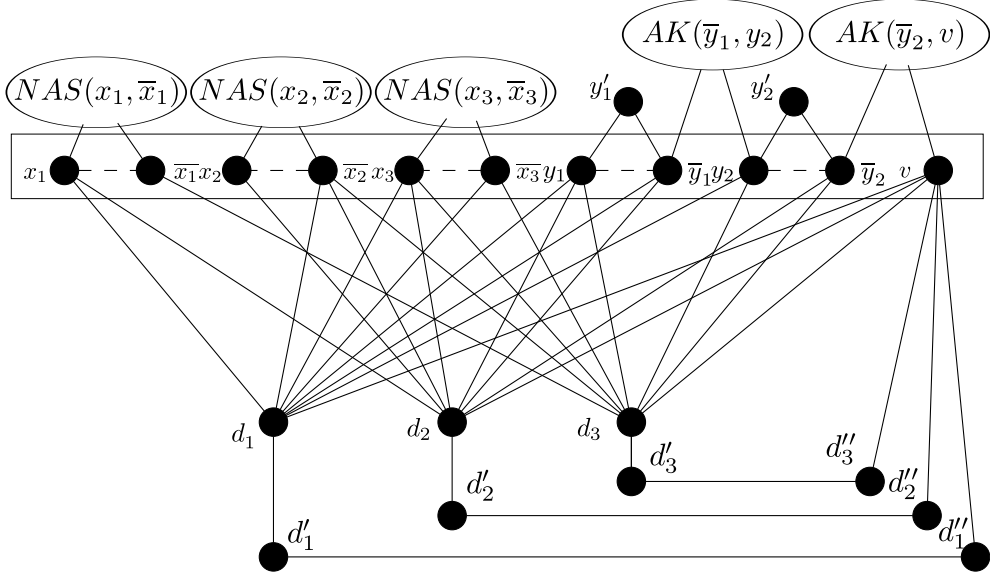

(a) Graph constructed for a QSAT2 instance $\Psi = (x_1 \wedge \bar{x}_2 \wedge y_2) \vee (x_1 \wedge x_3 \wedge \bar{y}_2) \vee (\bar{x}_1 \wedge \bar{x}_2 \wedge y_1)$

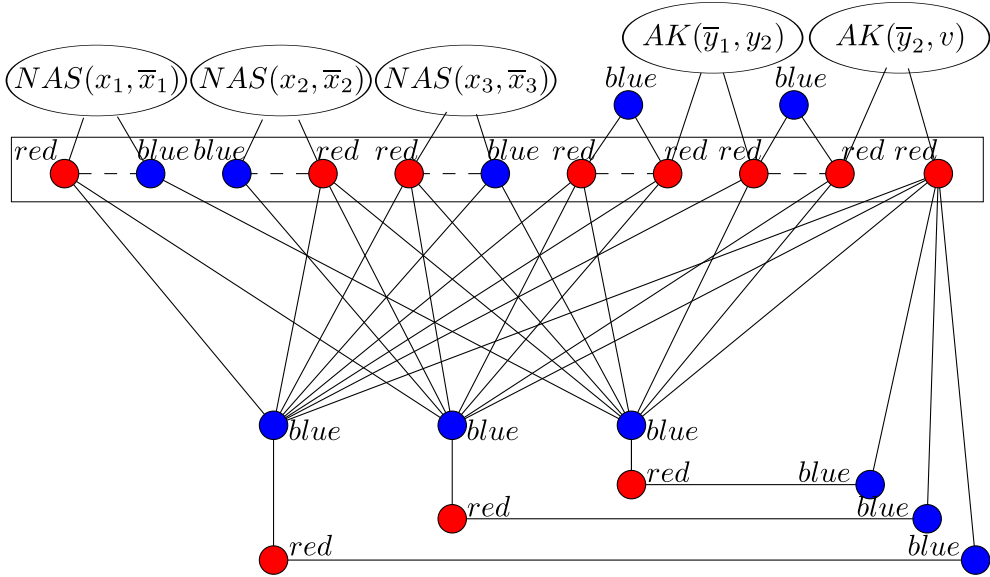

(b) A satisfying truth assignment of $x_1 = \bar{x}_2 = x_3 = T$

Figure 3: Example of a graph constructed for a QSAT2 instance, where *NAS* and *AK* denote the respectively auxiliary graphs

It still remains to be proved that this is indeed a 2-clique-colouring. Let us assume that it is not the case and that there exists a maximal clique K of G that is monochromatic. Clearly, K is not contained in a copy of any auxiliary graph, and that it does not contain any vertex of type y'_j , d'_k , or d''_k . As v is adjacent to all other vertices (which are the x_i , \bar{x}_i , y_j , \bar{y}_j , and d_k), we deduce that $v \in K$ and, subsequently, that all vertices of K have colour 1. Moreover, K contains exactly one vertex among x_i and \bar{x}_i , i.e. the one corresponding to the literal which is *true* in v_X , and similarly exactly one vertex among y_j and \bar{y}_j . We remark that K does not contain any d_k since they have colour 2. Then we define a valuation v_Y in the following way.

If $y_j \in K$, then v_Y assigns value *true* to the corresponding variable, otherwise v_Y assigns the value *false*. Thus, the literals corresponding to the vertices of $K \setminus \{v\}$ are exactly those that are *true* in the total valuation (v_X, v_Y) . Let us consider now any d_k . Since K is maximal, each d_k is not adjacent to at least one vertex of K . By construction of G , this means that all implicants are *false*, which contradicts the definition of v_X . Hence, there is no monochromatic clique and we have a 2-clique-colouring.

For the converse, we now assume that G is 2-clique-colourable and we consider any 2-clique-colouring with colours 1 and 2. Without loss of generality, we can assume that v has colour 1. Then, y_j and \bar{y}_j have colour 1 and d_k has colour 2. Vertices x_i and \bar{x}_i have opposite colours and we define v_X in the following way. The literal x_i is assigned *true* in v_X if the corresponding vertex has colour 1 in the clique-colouring, otherwise it is assigned *false* in v_X . Let v_Y be any valuation of Y . Consider the clique K that contains v and the vertices corresponding to literals which are *true* in the total valuation (v_X, v_Y) . Since all those vertices have colour 1 and we have a 2-clique-colouring, it follows that K cannot be maximal. As a consequence, there exists some d_k which is adjacent to all vertices of K . Thus, the corresponding implicant is *true* in that valuation and this proves that Ψ is satisfied for any valuation v_Y and that v_X has the right property.

It now remains to be proved that G is a weakly chordal graph. Fixing edge vd_i as an edge of a cycle, one can check that G has no chordless cycle of size greater than 5 as an induced subgraph. Now, we prove that G has no complement of a chordless cycle of size greater than 4 as an induced subgraph.

Let \bar{H} be the complement of a chordless cycle of size greater than 5. Clearly, any vertex of H has degree at least 3. Hence, we analyse the vertices of G with degree at least 3. Let $S = \{x_i, \bar{x}_i, y_j, \bar{y}_j, v \mid 1 \leq i \leq n, 1 \leq j \leq m\}$ and let $R = \{d_k \mid 1 \leq k \leq p\}$. All vertices of G with degree at least 3 are precisely the vertices of the auxiliary graphs, S , and R . We invite the reader to check that any vertex of an auxiliary graph that is not in S does not belong to H . Hence, every vertex of H belongs to S or R . First, we claim that R has at most 2 vertices of H . Indeed, 3 vertices of R induce a \bar{K}_3 . Second, we claim that S has at most 2 vertices. Notice that $|R \cap H| > 0$, since a vertex in S has at most one non-neighbor in S and every neighbor of H has at least two non-neighbors in H . If $|R \cap H| = 1$, then $|S \cap H| \leq 2$, since a vertex in S has at most one non-neighbor in S and the unique vertex of $R \cap H$ has at most two non-neighbors in $S \cap H$. If $|R \cap H| = 2$, then $|S \cap H| \leq 2$, since a vertex in S has at most one non-neighbor in S and each vertex of $R \cap H$ has at most one non-neighbor in S . Hence, at most two vertices of H are in R and at most two vertices of H are in S , i.e. $|H| \leq 4$, which is a contradiction. \square

Now, our focus is on showing a subclass of weakly chordal graphs in which 2-clique-colouring is \mathcal{NP} -complete, namely (3, 1)-polar and (2, 1)-polar graphs.

Complements of bipartite graphs are a subclass of $(\infty, 1)$ -polar graphs. Indeed, let $G = (V, E)$ be a complement of a bipartite graph, where (A, B) is a partition of V into two disjoint complete sets. Clearly, G is a $(\infty, 1)$ -polar graph. Défossez [4] showed that it is $\text{co}\mathcal{NP}$ -complete to check whether a 2-colouring of a complement of a bipartite graph is a 2-clique-colouring [4]. Hence, it is $\text{co}\mathcal{NP}$ -hard to check if a colouring of the vertices of a $(\infty, 1)$ -polar graph is a 2-clique-colouring. On the other hand, we show next that, if k is fixed, listing all cliques of a $(k, 1)$ -polar graph and checking if each clique is polychromatic can be done in polynomial-time, although the constant behind the big O notation is impracticable. The outline of the algorithm follows. We create a subroutine in which, given a satellite K of G , we check whether every clique

of G containing a subset of K is polychromatic. Lemma 4 determines the complexity of the subroutine and proves its correctness. The algorithm runs the subroutine for each satellite of G and, as a final step, check whether partition B is polychromatic if, and only if, partition B is a clique of G . Theorem 5 determines the complexity of the algorithm and prove its correctness.

Lemma 4. *There exists an $O(n)$ -time algorithm to check whether every clique that contains a subset of a satellite S of a $(k, 1)$ -polar graph, for a fixed $k \geq 1$, is polychromatic.*

Proof. We prove the correctness of Algorithm 1 by induction. Let $A_1 = S$ and $B_1 = \bigcap_{v \in A_1} (N(v) \cap B)$.

Notice that $A_1 \cup B_1$ is the unique clique of graph G that contains S . If $A_1 \cup B_1$ is monochromatic, then π is not a 2-clique-colouring of G . Otherwise, i.e. $A_1 \cup B_1$ is polychromatic, we are done. Now, we need to check whether every clique of G containing a proper subset of S is polychromatic.

Let $A_{i+1} = A_1 \setminus \{x_1, \dots, x_i\}$ and $B_{i+1} = \bigcap_{v \in A_{i+1}} (N(v) \cap B)$, for some $\{x_1, \dots, x_i\} \subset A_1$. As an induction hypothesis, suppose that every clique of G containing A_j , for every $1 \leq j \leq i$, is polychromatic.

For the induction step, consider a clique K of graph G containing A_{i+1} . By induction hypothesis, if K contains A_j , for some $1 \leq j \leq i$, then K is polychromatic. Now, consider that K does not contain A_j , for any $1 \leq j \leq i$. Then, $K = A_{i+1} \cup B_{i+1}$. If K is monochromatic, then π is not a 2-clique-colouring of G . Otherwise, i.e. K is polychromatic, then every clique containing A_{i+1} is polychromatic and the proof of the correctness of Algorithm 1 is done.

Now, we give the time-complexity of Algorithm 1. First, there are at most $k!$ recursive calls. Second, the number of steps in an iteration of the algorithm is upper bounded by the complexity of calculating B_i . One can design an $O(|B| \log k)$ -time algorithm to calculate B_i . Then, the algorithm is executed in $O(n)$ steps, since k is a constant and $|B|$ is upper bounded by n . \square

Theorem 5. *There exists an $O(n^2)$ -time algorithm to check whether a colouring of the vertices of a $(k, 1)$ -polar graph, for a fixed $k \geq 1$, is a clique-colouring.*

Proof. The correctness of Algorithm 2 follows. A clique of G contains at least one vertex of a satellite of G or it is B . The first loop of Algorithm 2 checks whether all cliques in the former case are polychromatic. The second loop of Algorithm 2 checks whether B is a clique. If B is a clique, then we check whether B is polychromatic.

Now, we give the time-complexity of Algorithm 2. The first loop of Algorithm 2 runs at most n times the Algorithm 1, which runs in $O(n)$ -time. The second loop of Algorithm 2 runs at most n times one comparison, which runs in $O(n)$ -time. Then, Algorithm 2 is executed in at most $O(n^2)$ steps. \square

Consider the NAE-SAT problem, known to be \mathcal{NP} -complete [13].

Problem 2. NOT-ALL-EQUAL SATISFIABILITY (NAE-SAT)

Instance: *A set X of boolean variables and a collection C of clauses (set of literals over U), each clause containing at most three different literals.*

Question: *Is there a truth assignment for X such that every clause contains at least one true and at least one false literal?*

Algorithm 1: $O(n)$ -time algorithm to output *yes*, if every clique of a $(k, 1)$ -polar graph containing a subset of a satellite of G is polychromatic, for a fixed $k \geq 1$.

input : $G = (A, B)$, a $(k, 1)$ -polar graph

π , a 2-colouring of G

A_i , a satellite of G

output: *yes*, if every clique of G containing a subset of a satellite A_i is polychromatic

```

1 begin
2   if  $|\pi(A_i)| \geq 2$  then
3     for  $i = 1$  to  $|A_i|$  do
4        $answer \leftarrow recursive(A_i \setminus \{x_i\})$ ;
5       if  $answer = no$  then
6         return no;
7     return yes;
8   else
9      $B_i \leftarrow \bigcap_{v \in A_i} (N(v) \cap B)$ ;
10    if  $|\pi(A_i \cup B_i)| \geq 2$  then
11      return yes;
12    else
13      return no;
14 end

```

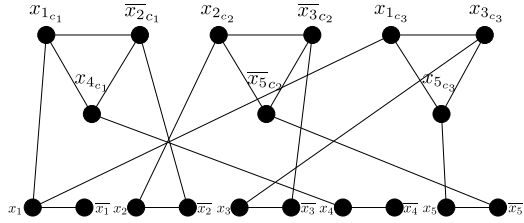

(a) Graph constructed for a NAE-SAT instance $\phi = (x_1 \vee \bar{x}_2 \vee x_4) \wedge (x_2 \vee \bar{x}_3 \vee \bar{x}_5) \wedge (x_1 \vee x_3 \vee x_5)$

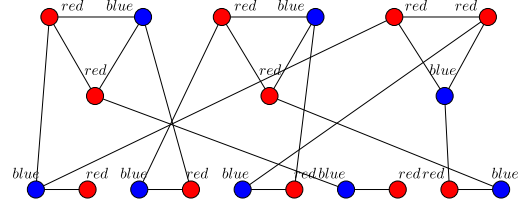

(b) A satisfying truth assignment of $x_1 = x_2 = x_3 = x_4 = \bar{x}_5 = T$ implies a 2-clique-colouring of G , where $x_1, x_2, x_3, x_4, \bar{x}_5$ receive blue colour

Figure 4: Example of a graph constructed following the framework given by Kratochvíl and Tuza [7] for a NAE-SAT instance ϕ

We first illustrate the framework of Kratochvíl and Tuza [7] to argue that 2-clique-colouring is \mathcal{NP} -hard with a reduction from NAE-SAT, as follows. Consider an instance ϕ of NAE-SAT. We construct a graph G , as follows. For every variable x , add an edge between vertices x and \bar{x} . For every clause c , add a triangle on vertices ℓ_c for all literals ℓ occurring in c . To finish the construction of G , for every literal ℓ and for every clause c containing ℓ , add an edge between ℓ and ℓ_c . The (maximal) cliques of G are the edges $x\bar{x}$, $\ell\ell_c$, and triangles $\{\ell_c \mid \ell \in c\}$. Hence, G is 2-clique-colourable if, and only if, ϕ is not-all-equal not-all-equal satisfiable. Refer to Fig. 4 for an example of such construction, given a formula $\phi = (x_1 \vee \bar{x}_2 \vee y_2) \wedge (x_1 \vee x_3 \vee \bar{y}_2) \wedge (\bar{x}_1 \vee \bar{x}_2 \vee y_1)$.

We apply the ideas of the framework of Kratochvíl and Tuza [7] to determine the complexity

Algorithm 2: $O(n^2)$ -time algorithm to output *yes*, if π is a clique-colouring of a $(k, 1)$ -polar graph, for a fixed $k \geq 1$.

input : $G = (A, B)$, $(k, 1)$ -polar graph
 π , a 2-colouring of G
output: *yes*, if π is a 2-clique-colouring of G .

```

1 begin
2   foreach maximal complete set  $A' \in A$  do
3      $answer \leftarrow \text{Algorithm 1}(G, \pi, A')$ ;
4     if  $answer = no$  then
5       return no;
6   foreach maximal complete set  $A' \in A$  do
7     foreach  $v \in A'$  do
8       if  $|N_B(v)| = |B|$  then
9         return yes;
10  if  $|\pi(B)| \geq 2$  then
11    return yes;
12  else
13    return no;
14 end

```

of 2-clique-colouring of $(3, 1)$ -polar graphs. We prove that 2-clique-colouring $(3, 1)$ -polar graphs is \mathcal{NP} -complete by reducing the NAE-SAT problem to it. For a NAE-SAT formula ϕ , a $(3, 1)$ -polar graph G is constructed such that graph G is 2-clique-colourable if, and only if, ϕ is not-all-equal satisfiable. This is an intermediary step to achieve the complexity of 2-clique-colouring of $(2, 1)$ -polar graphs, which are a subclass of weakly chordal graphs.

Theorem 6. *The problem of 2-clique-colouring is \mathcal{NP} -complete for $(3, 1)$ -polar graphs.*

Proof. The problem of 2-clique-colouring a $(3, 1)$ -polar graph is in \mathcal{NP} : Theorem 5 confirms that to check whether a colouring of a $(3, 1)$ -polar graph is a 2-clique-colouring is in \mathcal{P} .

We prove that 2-clique-colouring $(3, 1)$ -polar graphs is \mathcal{NP} -hard by reducing NAE-SAT to it. The outline of the proof follows. For every formula ϕ , a graph G is constructed such that ϕ is not-all-equal satisfiable if, and only if, graph G is 2-clique-colourable. We finish the proof showing that G is $(3, 1)$ -polar. Let n (resp. m) be the number of variables (resp. clauses) in formula ϕ . We define graph G , as follows.

- for each variable x_i , $1 \leq i \leq n$, we create four vertices x_i , x'_i , x''_i , and \bar{x}_i with edges $x_i x'_i$, $x'_i x''_i$, and $x''_i \bar{x}_i$. Notice that vertices x_i and \bar{x}_i correspond to the literals of variable x_i . Moreover, we create edges so that the set $\{x_1, \bar{x}_1, \dots, x_n, \bar{x}_n\}$ induces a complete subgraph of G ;
- for each clause $c_j = (l_a, l_b, l_c)$, $1 \leq j \leq m$, we create a triangle c_j with three vertices $l_{a_{c_j}}$, $l_{b_{c_j}}$, and $l_{c_{c_j}}$. Notice that vertices $l_{a_{c_j}}$, $l_{b_{c_j}}$, and $l_{c_{c_j}}$ correspond to the literals of clause c_j . Moreover, each vertex $l \in \{l_{a_{c_j}}, l_{b_{c_j}}, l_{c_{c_j}}\}$ is adjacent to a vertex \bar{l} in $\{x_1, \bar{x}_1, \dots, x_n, \bar{x}_n\}$ if, and only if, the literals correspondent to l and \bar{l} are distinct literals of the same variable.

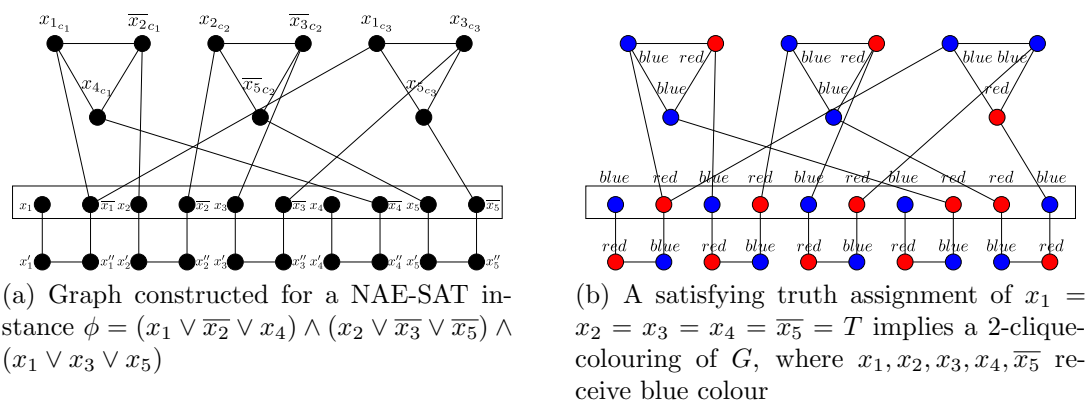

Figure 5: Example of a $(3, 1)$ -polar graph constructed for a NAE-SAT instance

Refer to Fig. 5 for an example of such construction, given a formula $\phi = (x_1 \vee \bar{x}_2 \vee x_4) \wedge (x_2 \vee \bar{x}_3 \vee \bar{x}_5) \wedge (x_1 \vee x_3 \vee x_5)$.

We claim that there exists a 2-clique-colouring in G if, and only if, formula ϕ is satisfiable. Assume that there exists a valuation v_ϕ such that ϕ is not-all-equal satisfied. We give a colouring to graph G , as follows.

- assign colour 1 to $l \in \{x_1, \bar{x}_1, \dots, x_n, \bar{x}_n\}$ if it corresponds to the literal which receives the *true* value in v_ϕ , otherwise we assign colour 2 to it,
- extend the unique 2-clique-colouring to vertices x'_i and x''_i , for each $1 \leq i \leq n$, i.e. assign colour 2 to x'_i and colour 1 to x''_i if the corresponding literal of x_i is *true* in v_ϕ . Otherwise, we assign colour 2 to x'_i and colour 1 to x''_i ,
- extend the unique 2-clique-colouring to vertices $l_{a_{c_j}}, l_{b_{c_j}}$, and $l_{c_{c_j}}$, for each triangle $c_j = \{l_{a_{c_j}}, l_{b_{c_j}}, l_{c_{c_j}}\}$, $1 \leq j \leq m$, i.e. assign colour 1 to $l \in \{l_{a_{c_j}}, l_{b_{c_j}}, l_{c_{c_j}}\}$ if the corresponding opposite literal of the same variable is *false* in v_ϕ , or else we assign colour 2 to l .

It still remains to be proved that this is indeed a 2-clique-colouring.

The cliques of size 2 are $x_i x'_i$, $x'_i x''_i$, and $x''_i \bar{x}_i$ and $\bar{l} \bar{l}$, where $l \in c_j$ and \bar{l} correspond to distinct literals of the same variable. The above colouring gives distinct colours to each vertex of a clique of size 2.

The cliques of size at least 3 are $\{x_1, \bar{x}_1, \dots, x_n, \bar{x}_n\}$ and triangle c_j . The former is polychromatic, since two vertices which represent distinct literals of the same variable receive distinct colours. The latter is also polychromatic, since (i) every vertex of triangle c_j represents a literal of some variable in ϕ , (ii) each clause c_j has at least one literal that receives the *true* value and at least one literal that receives the *false* value (recall we are reducing from NAE-SAT problem), and (iii) a vertex in triangle c_j receives colour 1 if it corresponds to the literal in which the opposite literal of the same variable receives the *false* value in v_ϕ . Otherwise, we assign colour 2 to it.

For the converse, we now assume that G is 2-clique-colourable and we consider any 2-clique-colouring. Recall the vertices x_i and \bar{x}_i have distinct colours, since $x_i x'_i$, $x'_i x''_i$, and $x''_i \bar{x}_i$ are cliques. Hence, we define v_ϕ as follows. The literal x_i is assigned *true* in v_ϕ if the corresponding vertex has colour 1 in the clique-colouring, otherwise it is assigned *false*. Since we are considering a 2-clique-colouring, every triangle c_j is polychromatic. As a consequence,

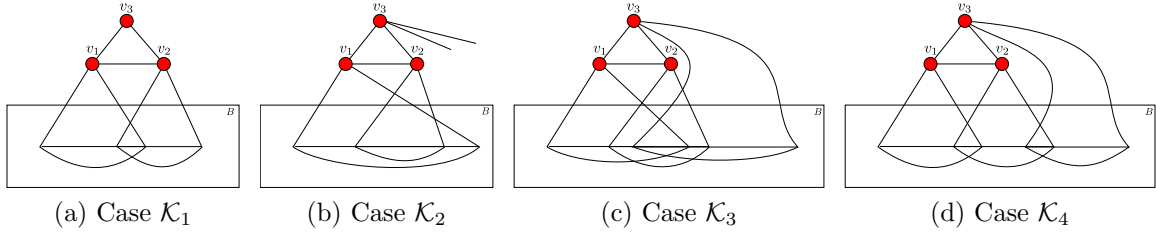

Figure 6: A triangle satellite of an (α, β) -polar graph

there exists at least one literal with *true* value in c_j and at least one literal with *false* value in every clause c_j . This proves that ϕ is satisfied for valuation v_ϕ .

It now remains to be proved that G is a $(3, 1)$ -polar graph. Let $A = \left(\bigcup_{i=1}^n \{x'_i, x''_i\} \right) \cup \left(\bigcup_{j=1}^m V(c_j) \right)$ and $B = \{x_1, \bar{x}_1, \dots, x_n, \bar{x}_n\}$ be the partition of $V(G)$ into two sets. Notice that each satellite is either a triangle or an edge. Hence, G is a $(3, 1)$ -polar graph. \square

An additional requirement to the NAE-SAT problem is that all variables must be positive (no negated variables). This defines the known variant POSITIVE NAE-SAT [10, Chapter 7]. The variant POSITIVE NAE-SAT is \mathcal{NP} -complete and the proof is by reduction from NAE-SAT. Replace every negated variable \bar{l}_i by a fresh variable l_j , and add a new clause (l_i, l_j) , to enforce the complement relationship. Notice that the new clause has only two literals. Hence, all that is needed here is (i) duplicate a clause with a negated variable, say \bar{l}_i , (ii) replace negated variable \bar{l}_i by fresh variables l_j and l_k , respectively, and (iii) add a new clause (l_i, l_j, l_k) , to enforce the complement relationship. An alternative proof that 2-clique-colouring is \mathcal{NP} -complete for $(3, 1)$ -polar graphs can be obtained by a reduction from POSITIVE NAE-SAT. The proof is analogous, but the constructed graph is as simple as the input (in contrast to NAE-SAT input).

We use a reduction from 2-clique-colouring of $(3, 1)$ -polar graphs to determine the complexity of 2-clique-colouring of $(2, 1)$ -polar graphs. In what follows, we provide some notation to classify the structure of 2-clique-colouring of $(2, 1)$ -polar graphs and of $(3, 1)$ -polar graphs. We capture their similarities and make it feasible a reduction from 2-clique-colouring $(3, 1)$ -polar graphs to 2-clique-colouring $(2, 1)$ -polar graphs.

Let $G = (V, E)$ be a $(3, 1)$ -polar graph. Let K be a satellite of G . Consider the following four cases: (\mathcal{K}_1) there exists a vertex of K such that none of its neighbors is in partition B ; (\mathcal{K}_2) the complementary case of \mathcal{K}_1 , where there exists a pair of vertices of K , such that the closed neighborhood of one vertex of the pair is contained in the closed neighborhood of the other vertex of the pair; (\mathcal{K}_3) the complementary case of \mathcal{K}_2 , where the intersection of the closed neighborhood of the vertices of K is precisely K ; and (\mathcal{K}_4) the complementary case of \mathcal{K}_3 . Clearly, any satellite K is either in case \mathcal{K}_1 , \mathcal{K}_2 , \mathcal{K}_3 , or \mathcal{K}_4 . Refer to Fig. 6 (resp. Fig. 7) for an example of each case of a triangle (resp. edge) satellite.

The following lemma is an important step to understand the role of triangles and edges that are either in case \mathcal{K}_1 , \mathcal{K}_2 , \mathcal{K}_3 , or \mathcal{K}_4 in a 2-clique-colouring of $(3, 1)$ -polar and of $(2, 1)$ -polar graphs. The following lemma is also important towards the modification of a $(3, 1)$ -polar graph to obtain a $(2, 1)$ -polar graph, which is closely related to Theorem 8.

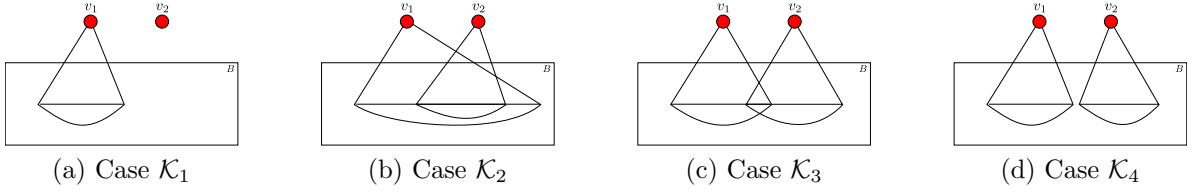

Figure 7: An edge satellite of an (α, β) -polar graph

Lemma 7. *Let $G = (V, E)$ be a $(3, 1)$ -polar graph, \mathcal{K} be the set of satellites of G in case \mathcal{K}_4 , and $K \in \mathcal{K}$.*

- *If G has a 2-clique-colouring, then $\bigcup_{v \in K} N_B(v)$ is polychromatic.*
- *If B has a 2-colouring that, for every $K' \in \mathcal{K}$, $\bigcup_{v \in K'} N_B(v)$ is polychromatic, then G is 2-clique-colourable.*

Proof. We begin by proving the former assertion. For the sake of contradiction, suppose $\bigcup_{v \in K} N_B(v)$ is monochromatic for some 2-clique-colouring of G . Without loss of generality,

suppose that all vertices in $\bigcup_{v \in K} N_B(v)$ have colour 1. Hence, every vertex $v \in K$ has colour 2, otherwise $\{v\} \cup N_B(v)$ is a monochromatic clique. On the other hand, if every vertex $v \in K$ has the same colour, then K is a monochromatic clique, which is a contradiction.

Now, we prove the latter assertion. For each singleton satellite K , we extend the 2-colouring of B , as follows. Assign colour 1 to the vertex v of K if there exists a vertex of $N_B(v)$ with colour 2. Otherwise, assign colour 2 to v . For each edge satellite K , we extend the 2-colouring of G , as follows.

1. K is in case \mathcal{K}_1 . Let u be a vertex of K , such that $N_B(u) = \emptyset$. Let v be a vertex of K , $u \neq v$. If $N_B(v) = \emptyset$, then assign colour 1 to v and colour 2 to u . Otherwise, i.e. $N_B(v) \neq \emptyset$, assign colour 1 to v if there exists a vertex in $N_B(v)$ with colour 2, otherwise assign colour 2 to v . Moreover, give colour 1 to u , if vertex v has colour 2, or else we assign colour 1 to u .
2. K is in case \mathcal{K}_2 . Let v, w be distinct vertices of K , such that $N_B(v) \subseteq N_B(w)$. Assign colour 1 to v if there exists a vertex of $N_B(v)$ with colour 1, otherwise assign colour 2 to v . Assign colour 2 to w if vertex v received colour 1, otherwise assign colour 1 to w .
3. K is in case \mathcal{K}_3 . Assign colour 1 to every vertex of K , if there exists a vertex in $\bigcap_{v \in K} N_B(v)$ with colour 2, otherwise assign colour 2 to every vertex of K .
4. K is in case \mathcal{K}_4 . Let u, v be distinct vertices of K . Suppose $N_B(u)$ and $N_B(v)$ are monochromatic. Assign colour 1 to u if the vertices of $N_B(u)$ have colour 2. Otherwise, assign colour 2 to u . Assign colour 1 to v if the vertices of $N_B(v)$ have colour 2. Otherwise, assign colour 2 to v . Now, suppose, without loss of generality, that $N_B(u)$ is polychromatic. Then, assign colour 1 to v if there exists a vertex of $N_B(v)$ with colour 2,

otherwise assign colour 2 to v . Moreover, assign colour 2 to u if vertex v received colour 1, otherwise assign colour 2 to u .

For each triangle satellite K , we extend the 2-colouring of B , as follows.

1. K is in case \mathcal{K}_1 . Let u, v, w be the distinct vertices of K , such that $N_B(u) = \emptyset$. If $N_B(v) \cup N_B(w) = \emptyset$, then assign colours 1, 1, and 2 to u, v , and w respectively. Now, if $N_B(v) \cup N_B(w)$ is monochromatic, then assign colour 1 to v and w if the colour assigned to every vertex of $N_B(v) \cup N_B(w)$ is 2, otherwise we assign colour 1 to v and w . Moreover, assign colour 1 to u if v and w have colour 2, otherwise assign colour 2 to u . Now, if $N_B(v) \cup N_B(w)$ is polychromatic, we have two cases. If $N_B(v) \cap N_B(w) \neq \emptyset$, then assign colour 1 to v and w if there exists a vertex in $N_B(v) \cap N_B(w)$ with colour 2, otherwise assign colour 1 to v and w . Moreover, assign colour 1 to u if v and w have colour 2, otherwise assign colour 2 to u . If $N_B(v) \cap N_B(w) = \emptyset$, assign colour 1 to v (resp. to w) if there exists a vertex of $N_B(v)$ (resp. $N_B(w)$) with colour 2, otherwise assign colour 2 to v (resp. w). Moreover, assign colour 1 to u if v or w have colour 2, otherwise assign colour 2 to u .
2. K is in case \mathcal{K}_2 . Let v, w be distinct vertices of K , such that $N_B(v) \subseteq N_B(w)$. Assign colour 1 to v if there exists a vertex in $N_B(v)$ with colour 1, otherwise assign colour 2 to v . Assign colour 2 to w if vertex v received colour 1, otherwise assign colour 1 to w . Let $u \in K \setminus \{v, w\}$. By hypothesis, $N_B(u) \neq \emptyset$. Assign colour 1 to u if there exists a vertex of $N_B(u)$ with colour 2, otherwise assign colour 2 to u .
3. K is in case \mathcal{K}_3 . Assign colour 1 to every vertex of K , if there exists a vertex of $\bigcap_{v \in K} N_B(v)$ with colour 2, otherwise assign colour 2 to every vertex of K .
4. K is in case \mathcal{K}_4 . Let u, v, w be distinct vertices of K . Suppose $N_B(u)$, $N_B(v)$, and $N_B(w)$ are monochromatic. Assign colour 1 to u if the vertices of $N_B(u)$ have colour 2. Otherwise, assign colour 2 to u . Assign colour 1 to v if the vertices of $N_B(v)$ have colour 2. Otherwise, assign colour 2 to v . Assign colour 1 to w if the vertices of $N_B(w)$ have colour 2. Otherwise, assign colour 2 to w . Now, suppose, without loss of generality, that $N_B(u)$ is polychromatic. Assign colour 1 to v if there exists a vertex of $N_B(v)$ with colour 2, otherwise assign colour 2 to v . Assign colour 1 to w if there exists a vertex of $N_B(w)$ with colour 2, otherwise assign colour 2 to w . Finally, assign colour 2 to u if vertex v and w received colour 1, otherwise assign colour 2 to u .

We invite the reader to check that the given colouring is a 2-clique-colouring to graph G . \square

For a given a $(3, 1)$ -polar graph G , we proceed to obtain a $(2, 1)$ -polar graph G' that is 2-clique-colourable if, and only if, G is 2-clique-colourable, as follows. For each triangle satellite, if it is in case \mathcal{K}_4 , we replace it by an edge in which (i) both complete sets have the same neighborhood contained in B and (ii) the edge is also in case \mathcal{K}_4 , otherwise we just delete triangle K . See Fig. 8 for examples. Such construction is done in polynomial-time and we depict it as Algorithm 3. See Fig. 9 for an application of Algorithm 3 given as input a $(3,1)$ -polar graph, which is not $(2,1)$ -polar, with clique-chromatic number 3. Algorithm 3 and Theorem 5 imply the following theorem.

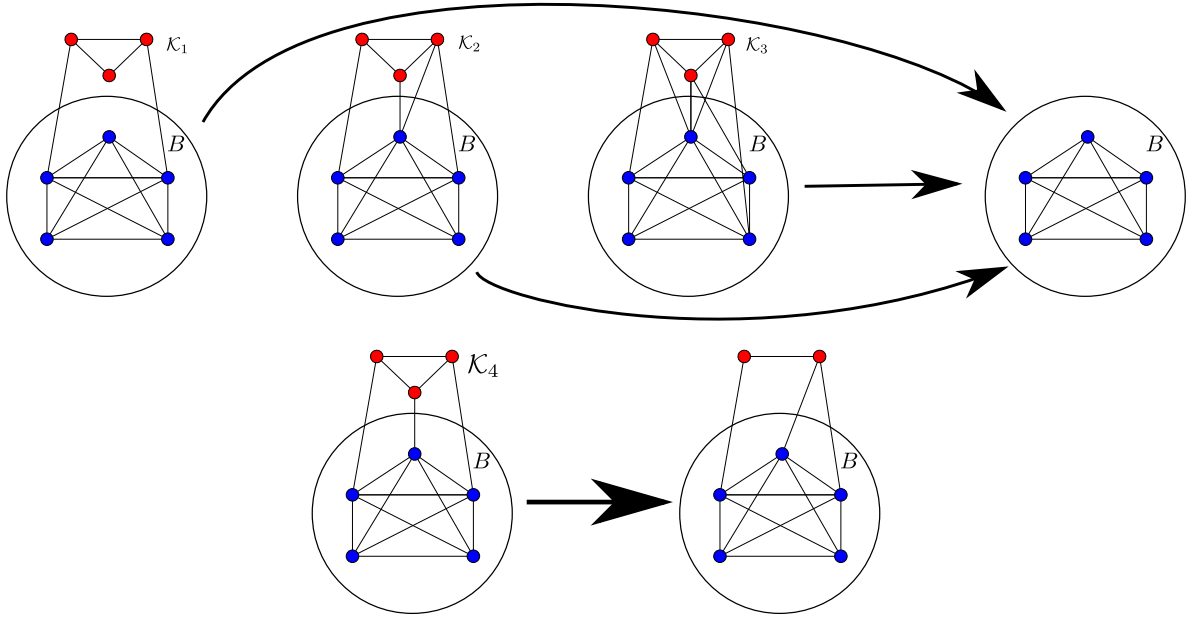

Figure 8: An iteration to obtain a $(2, 1)$ -polar graph G' , given a $(3, 1)$ -polar graph G , such that G is 2-clique-colourable if and only if G' is 2-clique-colourable

Theorem 8. *The problem of 2-clique-colouring is \mathcal{NP} -complete for $(2, 1)$ -polar graphs.*

Proof. The problem of 2-clique-colouring a $(2, 1)$ -polar graph is in \mathcal{NP} : Theorem 5 confirms that it is in \mathcal{P} to check whether a colouring of a $(2, 1)$ -polar graph is a 2-clique-colouring.

We claim that Algorithm 3 is an $O(n^2)$ -time algorithm to output a $(2, 1)$ -polar graph G' , given a $(3, 1)$ -polar graph G , such that G' is 2-clique-colourable if, and only if, graph G is 2-clique-colourable.

Without loss of generality, suppose that B is a (maximal) clique of the graph. We use induction on the number of triangle satellites of G in order to prove that G is 2-clique-colourable if, and only if, G' is 2-clique-colourable. For the sake of conciseness, we prove only one way of the basis induction. The converse and the step induction follows analogously.

Suppose that there exists only one triangle satellite $K = \{v_1, v_2, v_3\}$ of G . Let $K' = \{u_1, u_2\}$ be the edge that replaced satellite K to obtain graph G' . Suppose that there exists a 2-clique-colouring π of G . Every clique of G containing a subset of a satellite $S \neq K$ of G is polychromatic. Let π' be a 2-colouring of G' , such that $\pi'(v) = \pi(v)$, for each $v \in V(G) \cap V(G')$. Hence, every clique of G' containing a subset of a satellite $S' \neq K'$ of G is polychromatic. If $B(G)$ is a clique of G , then B is polychromatic. Clearly, $B(G')$ is polychromatic. Hence, we are left to prove that every clique of G' containing a subset of K' is polychromatic. If K is either in case \mathcal{K}_1 , \mathcal{K}_2 or \mathcal{K}_3 , then we are done. If K is in case \mathcal{K}_4 , then $\bigcup_{v \in K} N_B(v)$ is polychromatic.

Since $\bigcup_{v \in K} N_B(v) = \bigcup_{v \in K'} N_B(v)$ and $\pi'(v) = \pi(v)$, for each $v \in B$, $\bigcup_{v \in K'} N_B(v)$ is polychromatic. By Lemma 7, G' is 2-clique-colourable. \square

As a remark, we noticed strong connections between hypergraph 2-colorability and 2-clique-colouring $(2, 1)$ -polar graphs. Indeed, we have a simpler alternative proof showing that 2-clique-colouring $(2, 1)$ -polar graphs is \mathcal{NP} -complete by a reduction from hypergraph 2-colouring. In

Algorithm 3: An $O(n^2)$ -time algorithm to output a $(2, 1)$ -polar graph G' , such that graph G is 2-clique-colourable if, and only if, graph G' is 2-clique-colourable.

input : $G = (A, B)$, a $(3, 1)$ -polar graph.

output: G' , a $(2, 1)$ -polar graph that is 2-clique-colourable if, and only if, G is 2-clique-colourable.

```

1 begin
2   foreach satellite  $K = \{v_1, v_2, v_3\}$  do
3      $V' \leftarrow \emptyset$ ;
4      $E' \leftarrow \emptyset$ ;
5     if  $K$  is in case  $\mathcal{K}_4$  then
6        $V' \leftarrow \{u_1, u_2\}$ ;
7        $E' \leftarrow \{(u_1, u_2)\}$ ;
8        $E' \leftarrow E' \cup \{(u_1, x) \mid x \in N_B(v_1)\}$ ;
9        $E' \leftarrow E' \cup \{(u_2, x) \mid x \in ((N_B(v_2) \cup N_B(v_3)) \setminus N_B(v_1))\}$ ;
10     $G \leftarrow G[V(G) \setminus K]$ ;
11     $V(G) \leftarrow V(G) \cup V'$ ;
12     $E(G) \leftarrow E(G) \cup E'$ ;
13  return  $G$ ;
14 end

```

contrast to graphs, deciding if a given hypergraph is 2-colourable is an \mathcal{NP} -complete problem, even if all edges have cardinality at most 3 [8]. The reader may ask why we did not exploit only the alternative proof that is quite shorter than the original proof. The reason is related to be consistent with the next section, where we show that even restricting the size of the cliques to be at least 3, the 2-clique-colouring of $(3, 1)$ -polar graphs is still \mathcal{NP} -complete, while 2-clique-colouring of $(2, 1)$ -polar graphs becomes a problem in \mathcal{P} .

Alternative proof of Theorem 8. The problem of 2-clique-colouring a $(2, 1)$ -polar graph is in \mathcal{NP} : Theorem 5 confirms that it is in \mathcal{P} to check whether a colouring of a $(2, 1)$ -polar graph is a 2-clique-colouring.

We prove that 2-clique-colouring $(2, 1)$ -polar graphs is \mathcal{NP} -hard by reducing hypergraph 2-colouring to it. The outline of the proof follows. For every hypergraph \mathcal{H} , a $(2, 1)$ -polar graph G is constructed such that \mathcal{H} is 2-colourable if, and only if, graph G is 2-clique-colourable. Let n (resp. m) be the number of hypervertices (resp. hyperedges) in hypergraph \mathcal{H} . We define graph G , as follows.

- for each hypervertex v_i , $1 \leq i \leq n$, we create a vertex v_i in G , so that the set $\{v_1, \dots, v_n\}$ induces a complete subgraph of G , which is the partition B of graph G ;
- for each hyperedge $e_j = \{v_1, \dots, v_l\}$, $1 \leq j \leq m$, we create two vertices u_{j_1} and u_{j_2} . Moreover, we create edges $u_{j_1}v_1, \dots, u_{j_1}v_{l-1}$, and $u_{j_2}v_l$ so that $\{u_{j_1}u_{j_2}\}$ is a satellite in case \mathcal{K}_4 .

Clearly, G is a $(2, 1)$ -polar graph and such construction is done in polynomial-time. Refer to Fig. 10 for an example of such construction.

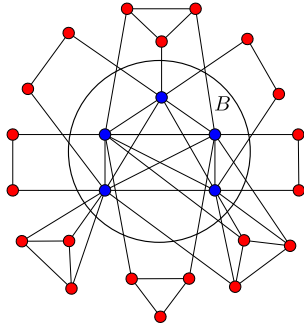

(a) A (3,1)-polar graph, which is not (2,1)-polar, with clique-chromatic number 3.

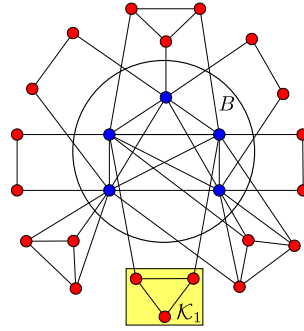

(b) A satellite K_1 that belongs to \mathcal{K}_1 .

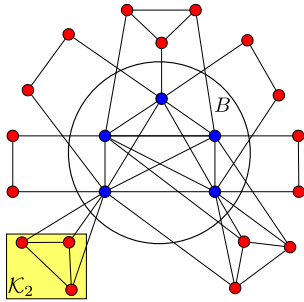

(c) A satellite K_2 that belongs to \mathcal{K}_2 .

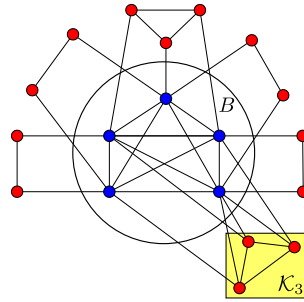

(d) A satellite K_3 that belongs to \mathcal{K}_3 .

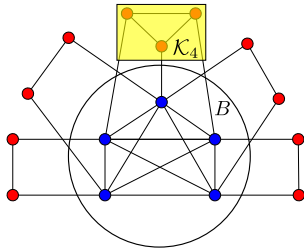

(e) A satellite K_4 that belongs to \mathcal{K}_4 .

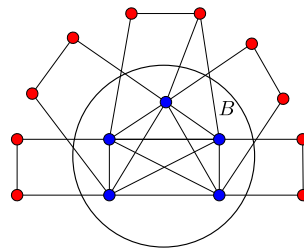

(f) A (2,1)-polar graph with clique-chromatic number 3.

Figure 9: Application of Algorithm 3 given as input a (3,1)-polar graph, which is not (2,1)-polar, with clique-chromatic number 3.

We claim that hypergraph \mathcal{H} is 2-colourable if, and only if, graph G is 2-clique-colourable. Assume that there exists a proper 2-colouring π of \mathcal{H} . We give a colouring to the graph G , as follows.

- assign colour $\pi(v)$ for each v of partition B ,
- extend the 2-clique-colouring for each clique $(\{u_{j_1}, u_{j_2}\})$ that is a satellite of G .

It still remains to be proved that this is indeed a 2-clique-colouring. Consider the partition $B = \{x_1, \bar{x}_1, \dots, x_n, \bar{x}_n\}$. Clearly, the above colouring assigns 2 colours to this set. Each satellite

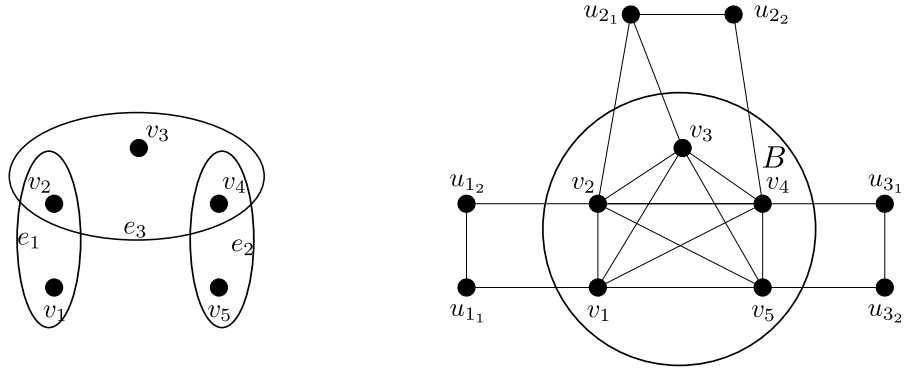

(a) Hypergraph instance and its corresponding constructed (2, 1)-polar graph

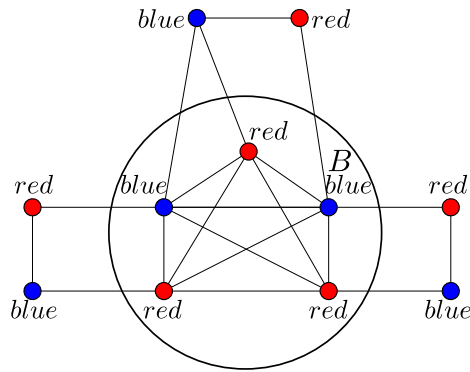

(b) A proper 2-colouring assignment of the hypergraph and its corresponding 2-colouring assignment of the constructed graph, as well as a 2-clique-colouring assignment of the constructed graph and its corresponding 2-colouring assignment of the hypergraph

Figure 10: Example of a (2, 1)-polar graph constructed for a given hypergraph instance

K of G is in case \mathcal{K}_4 and $\bigcup_{v \in K} N_B(v)$ is polychromatic, since $\bigcup_{v \in K} N_B(v) = e_j$. By Lemma 7, graph G is 2-clique-colourable.

For the converse, we now assume that G is 2-clique-colourable and we consider any 2-clique-colouring π' of G . We give a colouring to hypergraph \mathcal{H} , as follows. Assign colour $\pi'(v)$ for each hypervertex v . By Lemma 7 $\bigcup_{v \in K} N_B(v)$ is polychromatic for each satellite K of G . Then, hypergraph \mathcal{H} is 2-colourable, since $\bigcup_{v \in K} N_B(v) = e_j$ for every hyperedge e_j . \square

3 Restricting the size of the cliques

Kratochvíl and Tuza [7] are interested in determining the complexity of 2-clique-colouring of perfect graphs with all cliques having size at least 3. We determine what happens with the complexity of 2-clique-colouring of (2, 1)-polar graphs, of (3, 1)-polar graphs, and of weakly chordal graphs, respectively, when all cliques are restricted to have size at least 3. The latter result address Kratochvíl and Tuza's question.

Given graph G and $b_1, b_2, b_3 \in V(G)$, we say that we add to G a copy of an auxiliary graph

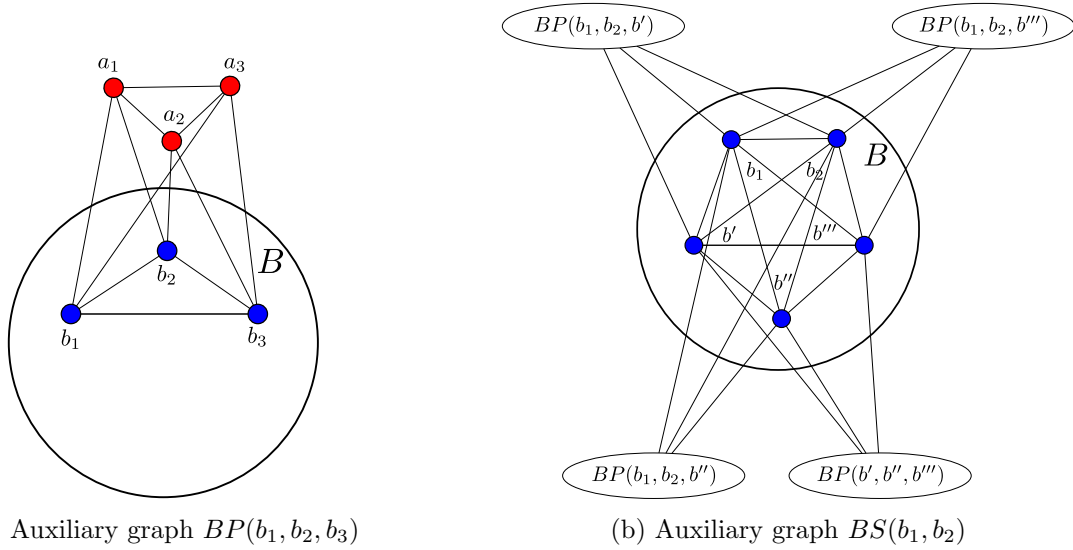

Figure 11: Auxiliary graphs $BP(b_1, b_2, b_3)$ and $BS(b_1, b_2)$

$BP(b_1, b_2, b_3)$ of order 6 – depicted in Fig. 11a – if we change the definition of G by doing the following: we first change the definition of V by adding to it copies of the vertices a_1, a_2, a_3 of the auxiliary graph $BP(b_1, b_2, b_3)$; second, we change the definition of E by adding to it copies of the edges (u, v) of $BP(b_1, b_2, b_3)$.

Similarly, given a graph G and $b_1, b_2 \in V(G)$, we say that we add to G a copy of an auxiliary graph $BS(b_1, b_2)$ of order 17 – depicted in Fig. 11b – if we change the definition of G by doing the following: we first change the definition of V by adding to it copies of the vertices b', b'', b''' of the auxiliary graph $BS(b_1, b_2)$; second, we change the definition of E by adding to it edges so that $B(G) \cup \{b_1, b_2, b', b'', b'''\}$ is a complete set; finally, we add copies of the auxiliary graphs $BP(b_1, b_2, b'), BP(b_1, b_2, b''), BP(b_1, b_2, b'''), BP(b', b'', b''')$.

Lemma 9. *Let G be a weakly chordal graph (resp. $(3, 1)$ -polar graph) and $b_1, b_2, b_3 \in V(G)$ (resp. $b_1, b_2, b_3 \in B(G)$). If we add to G a copy of an auxiliary graph $BP(b_1, b_2, b_3)$, then the following assertions are true.*

- *The resulting graph G' is weakly chordal (resp. $(3, 1)$ -polar).*
- *If all cliques of G have size at least 3, then all cliques of G' have size at least 3.*
- *Any 2-clique-colouring of G' assigns at least 2 colours to b_1, b_2, b_3 .*
- *G is 2-clique-colourable if G' is 2-clique-colourable.*
- *G' is 2-clique-colourable if there exists a 2-clique-colouring of G that assigns at least 2 colours to b_1, b_2, b_3 .*

Proof. Let G be a weakly chordal graph and $b_1, b_2, b_3 \in V(G)$. Add to G a copy of an auxiliary graph $BP(b_1, b_2, b_3)$ in order to obtain graph G' .

Suppose, by contradiction, that G' has a chordless cycle H with an odd number of vertices greater than 4 or the complement \overline{H} of a chordless cycle with an odd number of vertices greater

than 5. Clearly, $BP(b_1, b_2, b_3)$ is a weakly chordal graph. Since G and $BP(b_1, b_2, b_3)$ are weakly chordal graphs, H and \overline{H} contains a vertex of $BP(b_1, b_2, b_3) \setminus G$ and a vertex of $G \setminus BP(b_1, b_2, b_3)$. Since $\{b_1, b_2, b_3\}$ is a complete set that is a cutset of G' that disconnects $BP(b_1, b_2, b_3) \setminus G$ from $G \setminus BP(b_1, b_2, b_3)$. Then, every cycle with vertices of $BP(b_1, b_2, b_3) \setminus G$ and of $G \setminus BP(b_1, b_2, b_3)$ contains a chord, i.e. there is no such H . Since a_1, a_2 , and a_3 have at most 3 neighbors, $|\overline{H}| \leq 6$. If \overline{H} has only vertex a_i of $BP(b_1, b_2, b_3) \setminus G$, then a_i has at most 2 neighbors in \overline{H} , which is a contradiction. If \overline{H} has only vertices $a_i, a_j, i \neq j$, of $BP(b_1, b_2, b_3) \setminus G$, then \overline{H} contains $\{b_1, b_2, b_3\}$, otherwise a_i or a_j have at most 2 neighbors in \overline{H} . Let u be a vertex of $G \setminus BP(b_1, b_2, b_3)$ in \overline{H} . Since a_i and a_j are not neighbors of u and a vertex in \overline{H} has at most two non-neighbors in \overline{H} , $\{u, b_1, b_2, b_3\}$ is a complete set, which is a contradiction. If \overline{H} has all three vertices of $BP(b_1, b_2, b_3) \setminus G$, then a vertex of $G \setminus BP(b_1, b_2, b_3)$ in H has 3 non-neighbors in \overline{H} , which is a contradiction. Hence, there is no such \overline{H} . Finally, G' is weakly chordal. If G is a $(3, 1)$ -polar graph and $b_1, b_2, b_3 \in B(G)$, then G' is a $(3, 1)$ -polar graph with $A(G') = A(G) \cup \{a_1, a_2, a_3\}$ and $B(G') = B(G)$ as the partition of $V(G')$ into two sets. Notice that the added satellite is a triangle. Hence, G' is a $(3, 1)$ -polar graph.

Let $\mathcal{C}(G)$ be the set of cliques of graph G . We have $\mathcal{C}(G) \cap \mathcal{C}(G') = \mathcal{C}(G)$ and $\mathcal{C}(G') \setminus \mathcal{C}(G) = \{\{a_1, b_1, b_2\}, \{a_2, b_2, b_3\}, \{a_3, b_1, b_3\}, \{a_1, a_2, b_2\}, \{a_2, a_3, b_3\}, \{a_1, a_3, b_1\}, \{a_1, a_2, a_3\}\}$. Clearly, if all cliques of G have size at least 3, then all cliques of G' have size at least 3.

Since $\{a_1, a_2, a_3\}$ is a clique of G' , any 2-clique-colouring π' of G' assigns at least 2 colours to a_1, a_2, a_3 . Let $i, j, k, \ell \in \{1, 2, 3\}$ and $\pi'(a_i) \neq \pi'(a_j)$. Since $\{a_i, b_i, b_k\}$ (resp. $\{a_j, b_j, b_\ell\}$) is a clique of G' , π' assigns a colour which is not $\pi'(a_i)$ to b_i or b_k (resp. π' assigns a colour which is not $\pi'(a_j)$ to b_j or b_ℓ). Hence, π' assigns 2 distinct colours to b_1, b_2, b_3 .

Finally, $\pi'(G)$ is a 2-clique-colouring of G , since $\mathcal{C}(G) \subset \mathcal{C}(G')$. Now, consider a 2-clique-colouring of G that assigns 2 colours to b_1, b_2, b_3 . It is easy to extend π in order to assign colours to the vertices of $BP(b_1, b_2, b_3) \setminus G$, such that all cliques of $\mathcal{C}(G') \setminus \mathcal{C}(G)$ are polychromatic. \square

Lemma 10. *Let G be a weakly chordal graph (resp. $(3, 1)$ -polar graph) and $b_1, b_2 \in V(G)$ (resp. $b_1, b_2 \in B(G)$). If we add to G a copy of an auxiliary graph $BS(b_1, b_2)$, then the following assertions are true.*

- *The resulting graph G' is weakly chordal (resp. $(3, 1)$ -polar).*
- *If all cliques of G have size at least 3, then all cliques of G' have size at least 3.*
- *Any 2-clique-colouring of G' assigns 2 colours to b_1 and b_2 .*
- *G is 2-clique-colourable if G' is 2-clique-colourable.*
- *G' is 2-clique-colourable if there exists a 2-clique-colouring of G that assigns 2 colours to b_1 and b_2 .*

Proof. Let G be a weakly chordal graph and $b_1, b_2 \in V(G)$. Add to G a copy of an auxiliary graph $BS(b_1, b_2)$ in order to obtain graph G' .

Suppose, by contradiction, that G' has a chordless cycle H with an odd number of vertices greater than 4 or the complement \overline{H} of a chordless cycle with an odd number of vertices greater than 5. First, we prove that $BS(b_1, b_2)$ is a weakly chordal $(3, 1)$ -polar graph. A complete graph K_5 with vertices b_1, b_2, b', b'', b''' is a weakly chordal $(3, 1)$ -polar graph with $A(K_5) = \emptyset$ and $B(K_5) = \{b_1, b_2, b', b'', b'''\}$. By Lemma 9, if we add copies of the auxiliary graphs $BP(b_1, b_2, b')$,

$BP(b_1, b_2, b'')$, $BP(b_1, b_2, b''')$, and $BP(b', b'', b''')$, then we have a (weakly chordal) $(3, 1)$ -polar graph that corresponds to $BS(b_1, b_2)$. Hence, $BS(b_1, b_2)$ is a (weakly chordal) $(3, 1)$ -polar graph. Since G and $BS(b_1, b_2)$ are weakly chordal graphs, H and \overline{H} contains a vertex of $BS(b_1, b_2) \setminus G$ and a vertex of $G \setminus BS(b_1, b_2)$. Since $\{b_1, b_2, b', b'', b'''\}$ is a complete set that is a cutset of G' that disconnects $BS(b_1, b_2) \setminus G$ from $G \setminus BS(b_1, b_2)$. Then, every cycle with vertices of $BS(b_1, b_2) \setminus G$ and of $G \setminus BS(b_1, b_2)$ contains a chord, i.e there is no such H . Subgraph \overline{H} have vertices b_1 or b_2 , otherwise \overline{H} is disconnected. Hence, \overline{H} has a 1-cutset or a 2-cutset, which is a contradiction since the complement of a chordless cycle is triconnected. Hence, G' is weakly chordal. If G is a $(3, 1)$ -polar graph and $b_1, b_2 \in B(G)$, then G' is a $(3, 1)$ -polar graph with $A(G') = A(G) \cup (V(BS(b_1, b_2)) \setminus \{b_1, b_2, b', b'', b'''\})$ and $B(G') = B(G) \cup \{b', b'', b'''\}$ as the partition of $V(G')$ into two sets. Notice that all added satellites are triangles. Hence, G' is a $(3, 1)$ -polar graph.

Let $\mathcal{C}(G)$ be the set of cliques of graph G . If $B(G) = \emptyset$, then we have $\mathcal{C}(G) \cap \mathcal{C}(G') = \mathcal{C}(G) \setminus \{b_1, b_2\}$ and $\mathcal{C}(G') \setminus \mathcal{C}(G)$ is precisely $\{b_1, b_2, b', b'', b'''\}$, and all cliques added by the inclusion of copies of the auxiliary graphs $BP(b_1, b_2, b')$, $BP(b_1, b_2, b'')$, $BP(b_1, b_2, b''')$, and $BP(b', b'', b''')$. Otherwise, i.e. $B(G) \neq \emptyset$, then we have $\mathcal{C}(G) \cap \mathcal{C}(G') = \mathcal{C}(G) \setminus \{B(G)\}$ and $\mathcal{C}(G') \setminus \mathcal{C}(G)$ is precisely $B(G')$, and all cliques added by the inclusion of copies of the auxiliary graphs $BP(b_1, b_2, b')$, $BP(b_1, b_2, b'')$, $BP(b_1, b_2, b''')$, and $BP(b', b'', b''')$. By Lemma 9, all cliques added by the auxiliary graphs have size at least 3. Then, all cliques of G' have size at least 3.

Consider any 2-clique-colouring π' of G' . Since we added a copy of the auxiliary graph $BP(b', b'', b''')$, Lemma 9 states that π' assigns at least 2 colours to b', b'', b''' . Without loss of generality, suppose that π' assigns distinct colours to b' and b'' . Since we added copies of the auxiliary graphs $BP(b', b_1, b_2)$ and $BP(b'', b_1, b_2)$, Lemma 9 states that π' assigns at least 2 colours to $\{b', b_1, b_2\}$ and at least 2 colours to $\{b'', b_1, b_2\}$, i.e. π' assigns a colour which is not $\pi'(b')$ to b_1 or b_2 and a colour which is not $\pi'(b'')$ to b_1 or b_2 . Hence, π' assigns 2 distinct colours to b_1, b_2 .

If $B(G) = \emptyset$, then $\pi'(G)$ is a 2-clique-colouring of G , since $\mathcal{C}(G) \setminus \mathcal{C}(G') = \mathcal{C}(G) \setminus \{b_1, b_2\}$ and π' assigns distinct colours to b_1, b_2 . Otherwise, i.e. $B(G) \neq \emptyset$, $\pi'(G)$ is a 2-clique-colouring of G since π' assigns at least 2 colours to $\{b_1, b_2\} \subset B(G)$ and to every clique of $\mathcal{C}(G) \cap \mathcal{C}(G') = \mathcal{C}(G) \setminus B(G)$.

Now, consider a 2-clique-colouring of G that assigns 2 colours to b_1, b_2 . Assign the same colour of b_1 to b' and b'' . Assign the same colour of b_2 to b''' . The sets $\{b_1, b_2, b'\}$, $\{b_1, b_2, b''\}$, $\{b_1, b_2, b'''\}$, and $\{b', b'', b'''\}$ have 2 colours each. By Lemma 9, all cliques added by the inclusion of copies of the auxiliary graphs $BP(b_1, b_2, b')$, $BP(b_1, b_2, b'')$, $BP(b_1, b_2, b''')$, and $BP(b', b'', b''')$ are polychromatic. Hence, we have a 2-clique-colouring of G' . \square

We strengthen the result that 2-clique-colouring of $(3, 1)$ -polar graphs is \mathcal{NP} -complete, now even restricting all cliques to have size at least 3, which gives a subclass of weakly chordal graphs.

Theorem 11. *The problem of 2-clique-colouring is \mathcal{NP} -complete for (weakly chordal) $(3, 1)$ -polar graphs with all cliques having size at least 3.*

Proof. The problem of 2-clique-colouring a $(3, 1)$ -polar graph with all cliques having size at least 3 is in \mathcal{NP} : Theorem 5 confirms that to check whether a colouring of a $(3, 1)$ -polar graph is a 2-clique-colouring is in \mathcal{P} .

We prove that 2-clique-colouring $(3, 1)$ -polar graphs with all cliques having size at least 3 is \mathcal{NP} -hard by reducing NAE-SAT to it. The outline of the proof follows. For every formula ϕ ,

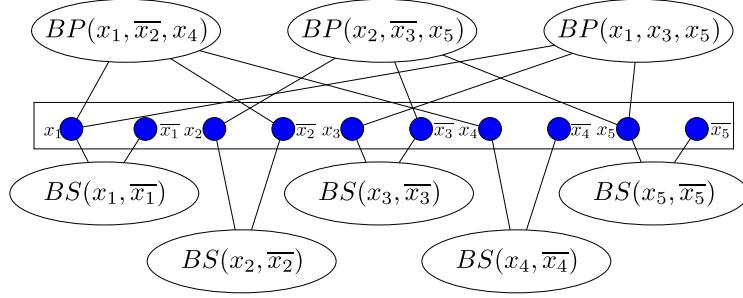

Figure 12: Example of a $(3, 1)$ -polar graph with all cliques having size at least 3 constructed for a NAE-SAT instance $\phi = (x_1 \vee \bar{x}_2 \vee x_4) \wedge (x_2 \vee \bar{x}_3 \vee \bar{x}_5) \wedge (x_1 \vee x_3 \vee x_5)$

a $(3, 1)$ -polar graph G with all cliques having size at least 3 is constructed such that ϕ is satisfiable if, and only if, graph G is 2-clique-colourable. Let n (resp. m) be the number of variables (resp. clauses) in formula ϕ . We define graph G as follows.

- for each variable x_i , $1 \leq i \leq n$, we create two vertices x_i and \bar{x}_i . Moreover, we create edges so that the set $\{x_1, \bar{x}_1, \dots, x_n, \bar{x}_n\}$ induces a complete subgraph of G .
- for each variable x_i , $1 \leq i \leq n$, add a copy of the auxiliary graph $BS(x_i, \bar{x}_i)$. Vertices x_i and \bar{x}_i correspond to the literals of variable x_i .
- for each clause $c_j = (l_a, l_b, l_c)$, $1 \leq j \leq m$, we add a copy of the auxiliary graph $BP(l_a, l_b, l_c)$.

Refer to Fig. 12 for an example of such construction, given a formula $\phi = (x_1 \vee \bar{x}_2 \vee x_4) \wedge (x_2 \vee \bar{x}_3 \vee \bar{x}_5) \wedge (x_1 \vee x_3 \vee x_5)$.

First, we prove that the graph G is a $(3, 1)$ -polar graph with all cliques having size at least 3.

Consider the set $\{x_1, \bar{x}_1, \dots, x_n, \bar{x}_n\}$. Clearly, this set is a clique with size at least 3 and also a $(3, 1)$ -polar graph. Lemma 10 states that, for each added auxiliary graph $BS(x_i, \bar{x}_i)$ to a $(3, 1)$ -polar graph with all cliques having size at least 3, every obtained graph remains in the class. Lemma 9 states that, for each added auxiliary graph $BP(l_{a_{c_j}}, l_{b_{c_j}}, l_{c_{c_j}})$ to a $(3, 1)$ -polar graph with all cliques having size at least 3, every obtained graph remains in the class. Hence, G is a $(3, 1)$ -polar graph with all cliques having size at least 3.

Such construction is done in polynomial-time. One can check with Lemmas 9 and 10 that G has $3m + 17n$ vertices.

We claim that formula ϕ is satisfiable if, and only if, there exists a 2-clique-colouring of G . Assume there exists a valuation v_ϕ such that ϕ is satisfied. We give a colouring to graph G , as follows.

- assign colour 1 to $l \in \{x_1, \bar{x}_1, \dots, x_n, \bar{x}_n\}$ if it corresponds to the literal which receives the *true* value in v_ϕ , otherwise we assign colour 2 to it.
- extend the 2-clique-colouring to the copy of the auxiliary graph $BS(x_i, \bar{x}_i)$, for each variable x_i , $1 \leq i \leq n$, according to Lemma 10. Notice that the necessary condition to extend the 2-clique-colouring is satisfied.

- extend the 2-clique-colouring to the copy of the auxiliary graph $BP(l_a, l_b, l_c)$, for each triangle $c = \{l_a, l_b, l_c\}$, $1 \leq j \leq m$, according to Lemma 9. Notice that the necessary condition to extend the 2-clique-colouring is satisfied.

It still remains to be proved that this is indeed a 2-clique-colouring.

Consider the set $\{x_1, \bar{x}_1, \dots, x_n, \bar{x}_n\}$. Clearly, the above colouring assigns 2 colours to this set. Lemma 10 states that, for each added auxiliary graph $BS(x_i, \bar{x}_i)$ to a 2-clique-colourable weakly chordal (3, 1)-polar graph, we obtain a 2-clique-colourable graph. Lemma 9 states that, for each added auxiliary graph $BP(l_a, l_b, l_c)$ to a 2-clique-colourable weakly chordal (3, 1)-polar graph, we obtain a 2-clique-colourable graph. Hence, graph G is 2-clique-colourable.

For the converse, we now assume that G is 2-clique-colourable and we consider any 2-clique-colouring. Recall that the vertices x_i and \bar{x}_i have distinct colours, since we added the auxiliary graph $BS(x_i, \bar{x}_i)$, for each variable x_i . Hence, we define v_ϕ as follows. The literal x_i is assigned *true* in v_ϕ if the corresponding vertex has colour 1 in the clique-colouring, otherwise it is assigned *false*. Since we are considering a 2-clique-colouring, every triangle (clique) c_j , $1 \leq j \leq m$, is polychromatic. As a consequence, there exists at least one literal with *true* value in c_j and at least one literal with *false* value in every clause c_j . This proves that ϕ is satisfied for valuation v_ϕ . \square

As an remark, a shorter alternative proof that 2-clique-colouring is \mathcal{NP} -complete for weakly chordal (3, 1)-polar graphs with all cliques having size at least 3 can be obtained by a reduction from POSITIVE NAE-SAT. The alternative proof follows analogously to alternative proof of Theorem 6.

On the other hand, we prove that 2-clique-colouring (2, 1)-polar graphs becomes polynomial when all cliques have size at least 3.

Theorem 12. *The problem of 2-clique-colouring is polynomial for (2, 1)-polar graphs with all cliques having size at least 3.*

Proof. Let S be a satellite of G . First, S is an edge, since G is a (2, 1)-polar graph. Second, every clique of G has size at least 3. Then, there is a vertex of partition B that is a neighbor of both vertices of S . This implies that every satellite of G is in case \mathcal{K}_3 . Notice that Algorithm 3 outputs a complete graph, when G is given as input. Hence, G is 2-clique-colourable (see Theorem 8).

The polynomial-time algorithm to give a 2-clique-colouring for (2, 1)-polar graphs with all cliques having size at least 3 follows. Give any 2-colouring to the vertices of B . For each satellite S , assign colour 1 to a vertex of S , if it has a neighbor in B with colour 2, otherwise assign colour 2. It is easy to check that it is a 2-clique-colouring of G , since every satellite of G is in case \mathcal{K}_3 . \square

In the proof that 2-clique-colouring weakly chordal graphs is a Σ_2^P -complete problem (Theorem 3), we constructed a weakly chordal graph with K_2 cliques to force distinct colours in their extremities (in a 2-clique-colouring). We can obtain a weakly chordal graph with no cliques of size 2 by adding copies of the auxiliary graph $BS(u, v)$, for every K_2 clique $\{u, v\}$. Auxiliary graphs AK and NAS become AK' and NAS' , both depicted in Fig. 13.

Finally, the weakly chordal graph constructed in Theorem 3 becomes a weakly chordal graph with no K_2 clique, depicted in Fig. 14.

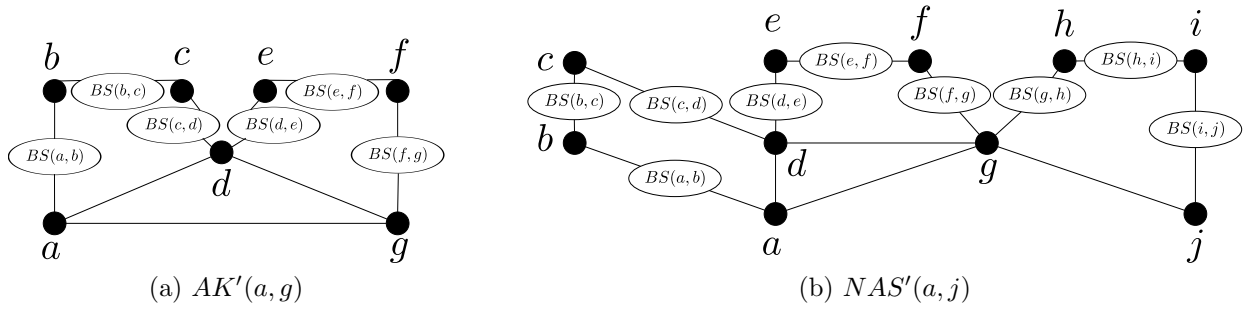

Figure 13: Auxiliary graphs $AK'(a, g)$ and $NAS'(a, j)$

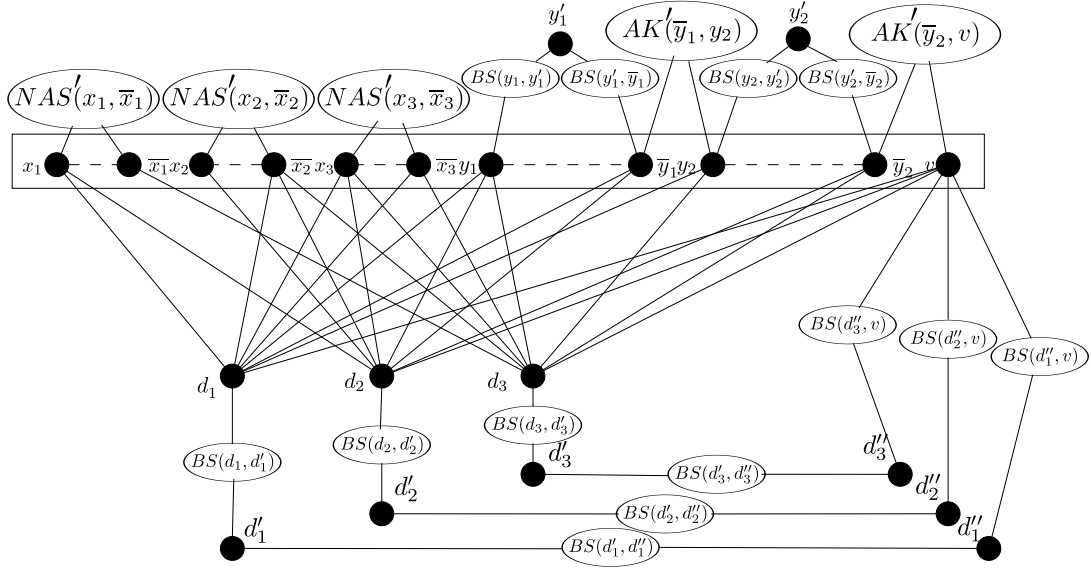

Figure 14: Graph constructed for a QSAT2 instance $\Psi = (x_1 \wedge \bar{x}_2 \wedge y_2) \vee (x_1 \wedge x_3 \wedge \bar{y}_2) \vee (\bar{x}_1 \wedge \bar{x}_2 \wedge y_1)$

Such construction is done in polynomial-time. Notice that, in the constructed graph of Theorem 3, every K_2 clique $\{u, v\}$ has 2 distinct colours in a clique-colouring. Hence, one can check with Lemmas 9 and 10 that the obtained graph is weakly chordal and it is 2-clique-colourable if, and only if, the constructed graph of Theorem 3 is 2-clique-colourable. This implies the following theorem.

Theorem 13. *The problem of 2-clique-colouring is Σ_2^P -complete for weakly chordal graphs with all cliques having size at least 3.*

As a direct consequence of Theorem 13, we have that 2-clique-colouring is Σ_2^P -complete for perfect graphs with all cliques having size at least 3.

Corollary 14. *The problem of 2-clique-colouring is Σ_2^P -complete for perfect graphs with all cliques having size at least 3.*

4 Final considerations

Marx [9] proved complexity results for k -clique-colouring, for fixed $k \geq 2$, and related problems that lie in between two distinct complexity classes, namely Σ_2^P -complete and Π_3^P -complete.

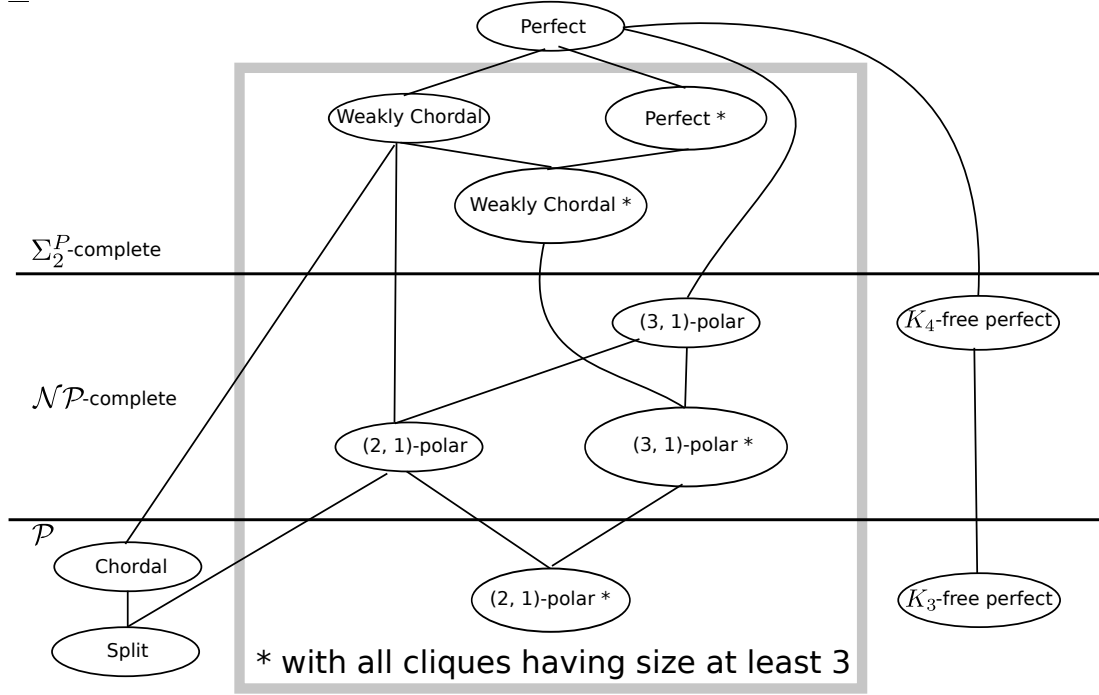

Figure 15: 2-clique-colouring complexity of perfect graphs and subclasses.

Marx approaches the complexity of clique-colouring by fixing the graph class and diversifying the problem. In the present work, our point of view is the opposite: we rather fix the (2-clique-colouring) problem and we classify the problem complexity according to the inputted graph class, which belongs to nested subclasses of weakly chordal graphs. We achieved complexities lying in between three distinct complexity classes, namely Σ_2^P -complete, \mathcal{NP} -complete and \mathcal{P} . Fig. 15 shows the relation of inclusion among the classes of graphs of Table 1. The 2-clique-colouring complexity for each class is highlighted.

Notice that the perfect graph subclasses for which the 2-clique-colouring problem is in \mathcal{NP} mentioned so far in the present work satisfy that the number of cliques is polynomial. We remark that the complement of a matching has an exponential number of cliques and yet the 2-clique-colouring problem is in \mathcal{NP} , since no such graph is 2-clique-colourable. Now, notice that the perfect graph subclasses for which the 2-clique-colouring problem is in \mathcal{P} mentioned so far in the present work satisfy that all graphs in the class are 2-clique-colourable. Macêdo Filho et al. [6] have proved that unichord-free graphs are 3-clique-colourable, but a unichord-free graph is 2-clique-colourable if and only if it is perfect. As a future work, we aim to find subclasses of perfect graphs where not all graphs are 2-clique-colourable and yet the 2-clique-colouring problem is in \mathcal{P} when restricted to the class.

Acknowledgments

We are grateful to Jayme Szwarcfiter for introducing us the class of (α, β) -polar graphs.

References

- [1] Gábor Bacsó, Sylvain Gravier, András Gyárfás, Myriam Preissmann, and András Sebő. Coloring the maximal cliques of graphs. *SIAM J. Discrete Math.*, 17(3):361–376, 2004. ISSN 0895-4801. doi: 10.1137/S0895480199359995.
- [2] Zh. A. Chernyak and A. A. Chernyak. About recognizing (α, β) classes of polar graphs. *Discrete Math.*, 62(2):133–138, 1986. ISSN 0012-365X.
- [3] Maria Chudnovsky, Neil Robertson, Paul Seymour, and Robin Thomas. The strong perfect graph theorem. *Ann. of Math. (2)*, 164(1):51–229, 2006. ISSN 0003-486X. doi: 10.4007/annals.2006.164.51.
- [4] David Défossez. Complexity of clique-coloring odd-hole-free graphs. *J. Graph Theory*, 62(2):139–156, 2009. ISSN 0364-9024. doi: 10.1002/jgt.20387.
- [5] D. Duffus, B. Sands, N. Sauer, and R. E. Woodrow. Two-colouring all two-element maximal antichains. *J. Combin. Theory Ser. A*, 57(1):109–116, 1991. ISSN 0097-3165. doi: 10.1016/0097-3165(91)90009-6.
- [6] Hélio B. Macêdo Filho, Raphael C. S. Machado, and Celina M. Herrera de Figueiredo. Clique-colouring and biclique-colouring unichord-free graphs. In *Proc. 10th Latin American Symposium on Theoretical Informatics (LATIN'12)*, pages 530–541, Arequipa, Peru, 2012.
- [7] Jan Kratochvíl and Zsolt Tuza. On the complexity of bicoloring clique hypergraphs of graphs. *J. Algorithms*, 45(1):40–54, October 2002. ISSN 0196-6774. doi: 10.1016/S0196-6774(02)00221-3.
- [8] L. Lovász. Coverings and coloring of hypergraphs. In *Proc. Fourth Southeastern Conference on Combinatorics, Graph Theory, and Computing*, pages 3–12, 1973.
- [9] Dániel Marx. Complexity of clique coloring and related problems. *Theoret. Comput. Sci.*, 412(29):3487–3500, 2011. ISSN 0304-3975. doi: 10.1016/j.tcs.2011.02.038.
- [10] M. Moret. *The Theory of Computation*. Addison Wesley Longman, first edition, 1998. ISBN 0-201-25828-5.
- [11] Hoifung Poon. Coloring clique hypergraphs. Master’s thesis, West Virginia University, 2000.
- [12] Hans Jürgen Prömel and Angelika Steger. Almost all Berge graphs are perfect. *Combin. Probab. Comput.*, 1(1):53–79, 1992. ISSN 0963-5483.
- [13] Thomas J. Schaefer. The complexity of satisfiability problems. In *Proc. Tenth Annual ACM Symposium on Theory of Computing*, pages 216–226. 1978.