

Notes on Hilbert's 16th: experiencing Viro's theory

Alexandre Gabard

October 31, 2018

Nihil est in infinito quod non prius fuerit in finito.
André Bloch 1926 [167], [168].

ABSTRACT. This text is intended to become in the long run Chapter 3 of our long saga dedicated to Riemann, Ahlfors and Rohlin. Yet, as its contents evolved as mostly independent (due to our inaptitude to interconnect both trends as strongly as we wished), it seemed preferable to publish it separately. More factually, our account is an attempt to get familiarized with the current consensus about Hilbert's 16th in degree 8. This is a nearly finished piece of mathematics, thanks heroic breakthroughs by Viro, Fiedler, Korchagin, Shustin, Chevallier, Orevkov, yet still leaving undecided six tantalizing bosons among a menagerie of 104 logically possible distributions of ovals (respecting Bézout, Gudkov periodicity, and the Fiedler-Viro imparity law sieving away 4+36 schemes). This quest inevitably involves glimpsing deep into the nebula referable to as Viro's patchworking, and the likewise spectacular obstructional laws of Fiedler, Viro, Shustin, Orevkov. In the overall, the game is much comparable to a pigeons hunting video-game, where 144 birds are liberated in nature, with some of them strong enough to fly higher and higher in the blue sky as to rejoin the stratospheric paradise of eternal life (construction of a scheme in the algebro-geometric category). Some other, less fortunate, birds were killed (a long time ago) and crashed down miserably over terrestrial crust (prohibition). Alas, the hunt is unfinished with still six birds, apparently too feeble to rally safely the paradise, yet too acrobatic for any homosapiens being skillful enough to shoot them down.

Contents

1 Hilbert's 16th in degree 8	3
1.1 List of questions for Russian or Toulouse colleagues	4
1.2 More shameful points that I could not yet clarify	8
1.3 Oracle Orevkov: periodicity modulo 3	8
1.4 Fixing our jargon	12
1.5 A loose idea of maltese singularities	13
1.6 Correspondence	13
2 Getting started	16
2.1 Hilbert's 16th for M -octics: Harnack 76, Hilbert 91, Wiman 23, Gudkov 71, Rohlin 72, Fiedler 79, Viro 1980(=Gold medal=42 schemes), Shustin 85/87/88 (=Bronze medal=7 schemes), Korchagin 78/88/89 (Silver medal=20 schemes), Chevallier 02 (4 schemes), Orevkov 02 (1 scheme and 2 prohibited)	17
2.2 Viro's method for M -octics	22
3 Flexible exotic patchworking	24
3.1 Bosonic smoothing of the mandarine	24
3.2 Extended Viro's composition table	25
3.3 What if Viro's imparity law is false: the big decongestion	32
3.4 Exotic patches	32
3.5 Working more systematically	39

4	Toward sophisticated Bézout obstructions	50
4.1	Speculating about obstructions	50
4.2	The method of the deepest penetration	54
4.3	More total reality: new higher superconductivity cases	57
4.4	Total reality as a cosmic censorship	64
4.5	Some conjectures à la Rohlin-Le Touzé implying a completion of Hilbert-Viro's 16th problem	67
4.6	The dream/nightmare of a world with censorship	75
4.7	Patchwork vs. Artwork	84
5	Viro's construction of the patches for X_{21} (=quadruple rainbow)	92
5.1	The method employing hyperbolisms (Huyghens, Newton, . . . , Viro)	92
5.2	On a bending principle for patches	99
5.3	Speculating about a global bending: alias the NAS= Neuaufstehung	105
5.4	Trying (but failing) to extend duality outside the subnested realm	106
5.5	Overview	107
5.6	Some new artwork hybridizing Viro and Shustin (gorillas, yetis, etc)	109
5.7	$C4+F3+F3$: one candelabrum and two flat triple points	118
5.8	The singular Harnack bound argument	122
5.9	Sidetracked to $C4+C4$: two candelabrams	123
5.10	On the fake-medusa	125
5.11	Falling back to the method of deep penetration with salesman travelling	126
5.12	$F4+F4$	130
5.13	Some general ideas: Stonehenge alinement of all Gudkov pyramids	130
5.14	Dissipation of the candelabrum via the theory of septics	131
5.15	Dissipation of X_{21} via septics	131
5.16	Sequel of old text	133
6	Viro's vibratory method	135
6.1	Viro's trick for patches of type E (trinstested lune)	136
6.2	Study of the contact $3 + 1$	147
6.3	Falling in love with Oleg Yanovich	149
6.4	Toward a classification of all patches for X_{21} via knot theory	154
6.5	A naive idea for prohibitions via satellites	156
6.6	The Hawaiian earring of Chevallier	158
6.7	Viro vs. le Chevallier du temple solaire, or monotheism vs. the necessity of several Gurus (Luc de Jouret et son charisme extraordinaire) as to account the full morphogenetic freedom of algebraic curves	161
6.8	More bosonic embryology as applied to Hilbert's 16th	171
6.9	Irrational thinking and morphogenesis	175
6.10	More embryos	176
6.11	Non-maximal dissipation of the mandarine	176
6.12	An error to avoid	176
6.13	Discrepancy between Viro and our homemade patchwork (our mistake)	178
7	Artwork (Viro, Shustin)	179
7.1	Viro's twisted constructions (beaver)	179
7.2	Viro's 2nd construction (horse)	184
7.3	Some messy ideas of Gabard	188
7.4	Shustin's constructions	190
7.5	Shustin's last construction: $4\frac{5}{1}\frac{5}{1}\frac{5}{1}$	192
7.6	Digressing on Orevkov's hypothetic curve	195
8	Decomposing curves: loose constructions via freehand drawings	197
8.1	A messy idea à la Wiman and decomposing octics	197
8.2	Degree $3+5$	197
8.3	Degree $2+6$	197
8.4	Degree $4+4$	204
8.5	Degree $3+5$ (revisited)	204
8.6	Degree $1+7$	204

9	More artwork via other distributions of singularities	208
9.1	Switching to affine sextics	208
9.2	Smoothing M_{25} ($=O_6$ =ordinary sextuple point): after Korchagin, Orevkov, Le Touzé	212
9.3	$8=1+7$	218
9.4	$8=2+2+2+2$, $8=3+5$	220
9.5	Reflex de Pavlov vs. complex de Gromov	231
9.6	Interlude: impact upon the Wiman-Rohlin-Gabard dream of satellites (le théorème de Riemann rendu synthétique)	233
9.7	Temptation of free-hand drawing	233
10	Post-Viro neoconstructivism: the latest tricks by Korchagin, Cheval- lier, Orevkov	234
10.1	Korchagin's tsunami of 19 new M -schemes	234
10.2	Shustin's 5 new prohibitions of M -schemes	234
10.3	21st century heroes: Chevallier and Orevkov	234
10.4	Naive questions on T -curves	238
10.5	Riemann's gyroscopic total reality	239
10.6	The extended Polotovskii tables of octics (deposited in VINITI? ca. 1985)	240
10.7	Enlarged plates I, II and III	242
10.8	Shustin's fifty $(M - 2)$ -obstructions	247
10.9	Hilbert's 16th for all septics (Viro 1979)	249
10.10	Acknowledgements	253
11	Bibliographic comments	254

1 Hilbert's 16th in degree 8

[29.09.13] Hilbert's problem in degree 8 (the present frontier of knowledge) is a puzzling piece of mathematics much revolutionized by Oleg Yanovich Viro (1948– ∞) in the early 1980's, yet by now stagnating along a fairly complex motion of vortex-tube, especially when it comes to the six *bosons* not yet elucidated. Those elusive objects—not yet detected nor prohibited—are located by black holes of concentric circles on Fig. 1 below, which synthesizes—in one *Überblick*—all what mankind (and machines?) knows about the problem (of predicting the different shapes of M -octics). The puzzle (albeit seeming close to completion) seems resisting all assaults since circa one decade, when the last progresses were scored by Orevkov ca. 2002. It is presently unclear if the field requests completely novel ideas, or just sharpening old weapons already available.

Hilbert's 16th video-game is much akin to a pigeons or ducks hunting: from 144 birds left free in nature, many could escape, while flying higher and higher up to reaching the paradise of eternal life (when constructed). Some other (less chanceful) birds were killed, and felt dramatically on terrestrial ground (when definitively prohibited). Alas, the hunt is still open, as it remains in the blue sky, six birds seemingly too weak to reach safely the paradise, yet too vigorous for any homosapiens being skillful enough to shoot them down.

Our own level of understanding (after ca. 4 months of work) stays very low, in part because the combinatorics is pretty overwhelming, but also because the main results (especially those of prohibitive character) are quite hard stuff to digest. Personally, we confess to have not yet been able to digest even the first generation ($4+36$ =forty many) prohibitions coming from the Fiedler-Viro era in the early 80's. Besides, the proofs of eight pivotal (sporadic) Viro obstructions (ca. 1984/86) were apparently never clearly published¹. Thus, a certain aptitude, somewhat between prediction ability à la Nostradamus and deep devotion to the algebro-geometric crystal, seems requested to crack the problem. This will surely not occur as an isolated prowess specific to degree 8 but probably as a novel method (constructional or prohibitionary, possibly a cocktail

¹Added in proof [06.10.13].—According to a recent e-mail by Viro, cf. Sec. 1.6, it seems that those sporadic prohibitions (by Viro) were integrated in a paper by Shustin. Alas, for the moment, we lack a precise reference.

of both) spreading over all other degrees, while offering new insights about the enigmatic morphogeneses of *all* algebraic curves, conceived as an organic (indestructible) entity. Besides, through their physical incarnations, either as trajectories of planetary systems (Kepler-Newton for conics), caustics in optics (Huyghens-Newton-Thom, etc.), periodic atomic systems (as posited in Gabard 2012 [470]), or whatever else (spectral curves in ferromagnetic percolation à la Kenyon-Oukunkov-Cimasoni), algebraic curves seem to interact widely with the natural world (assuming its existence of course).

1.1 List of questions for Russian or Toulouse colleagues

[29.09.13] This section gathers some basic questions, we could not settle alone. Our jargon is hopefully self-explanatory (otherwise browse quickly through Sec. 1.4).

• (VSO)=(Viro's sporadic obstructions).—*Is a proof of Viro's eight sporadic obstructions available in print?* Those were first announced in Viro 1986 survey [1534], but as far as we know never published in detail. The best information we could glean is from Orevkov 2002 [1129], where it is remarked that the proofs are similar to those implemented in Korchagin-Shustin 88/89 [861]. If unavailable in print, who is competent enough to write them down explicitly? Obvious candidates: Viro, Fiedler, Shustin, Korchagin, Orevkov, Le Touzé, who else? Can someone include this didactic duty in his agenda as to make the technique available to a broader spectrum of workers? If difficult, is it legitimate to start doubting about all (or at least some) of those sporadic prohibitions?

If politically correct, the present (mostly Soviet) census reports 83 octic M -schemes constructed (by the following authors listed chronologically, plus counting their prolixity: Harnack 1876=Ha=2, Hilbert 1891=Hi=4, Wiman 1923=W=1, Gudkov 1971=G=2, Korchagin 78=K78=1, Viro 80=V=42(!), Shustin 87/89=S=6+1=7, Korchagin 89=K=19, Chevallier 02=C=4, Orevkov 02=O=1) and 15 prohibited (Viro 84/86=V=8, Shustin 89=S=5, Orevkov 99/02=O=2). This leaves *six* cases undecided among the universe of 104, as it stabilized after the Fiedler-Viro law of imparity (reigning in the trinested case). This striking result is quite akin to a 2nd law of thermodynamics, being the *first* nontrivial prohibition beyond Gudkov-Rohlin periodicity. Without Fiedler-Viro, the universe would include 144 schemes (like the Tupolev), all respecting Gudkov periodicity. All terrestrial knowledge in degree 8 is summed up in the following catalogue (Fig. 1), whose ground architecture (mostly governed by Gudkov periodicity) is stable despite possible errors in the decoration of the building.

Notational conventions.—Each symbol of the table encodes a distribution of 22 ovals (the maximum possible in degree 8) respecting evident Bézout obstructions for line and conics (but not more!²), and Gudkov periodicity $\chi \equiv k^2 \pmod{8}$, where χ is the characteristic of the Ragsdale membrane bounding the curve from inside, and k the semi-degree (here $k = 4$). Our symbolism is basically that of Gudkov (as opposed say to that of Viro), which in our opinion overuses brackets, whence a typographical handicap when it comes to represent all symbols on a single page. It was often criticized that Gudkov symbols have the sibylline drawback of not standing on a single line. Yet the usual typographical trick (used e.g. with continuous fractions) permits one to write down the subnested scheme also on a single line. For instance, instead of writing $1 \frac{2\frac{17}{1}}{1}$ we may use the condensed notation $1(1, 2\frac{17}{1})$ (also due to Gudkov) as encoding the distribution with one outer oval, one large oval enclosing simultaneously 2 ovals plus one oval surrounding 17 mini-ovals. As indicated by our table this scheme was first constructed by Hilbert (and then re-accessed by Viro's method).

Of course it is hoped, that all those (Soviet) results are correct. Having personally not yet assimilated all of them, we keep open the option of some mistakes needing revision. This is merely a subjective incertitude allied to our own incompetence. Evidently, we have no serious objections against the actual

²Do not forget asking Séverine (Le Touzé) if her cubics technique for M -nonics adapts to octics, and if so which sort of results does it reproduce.

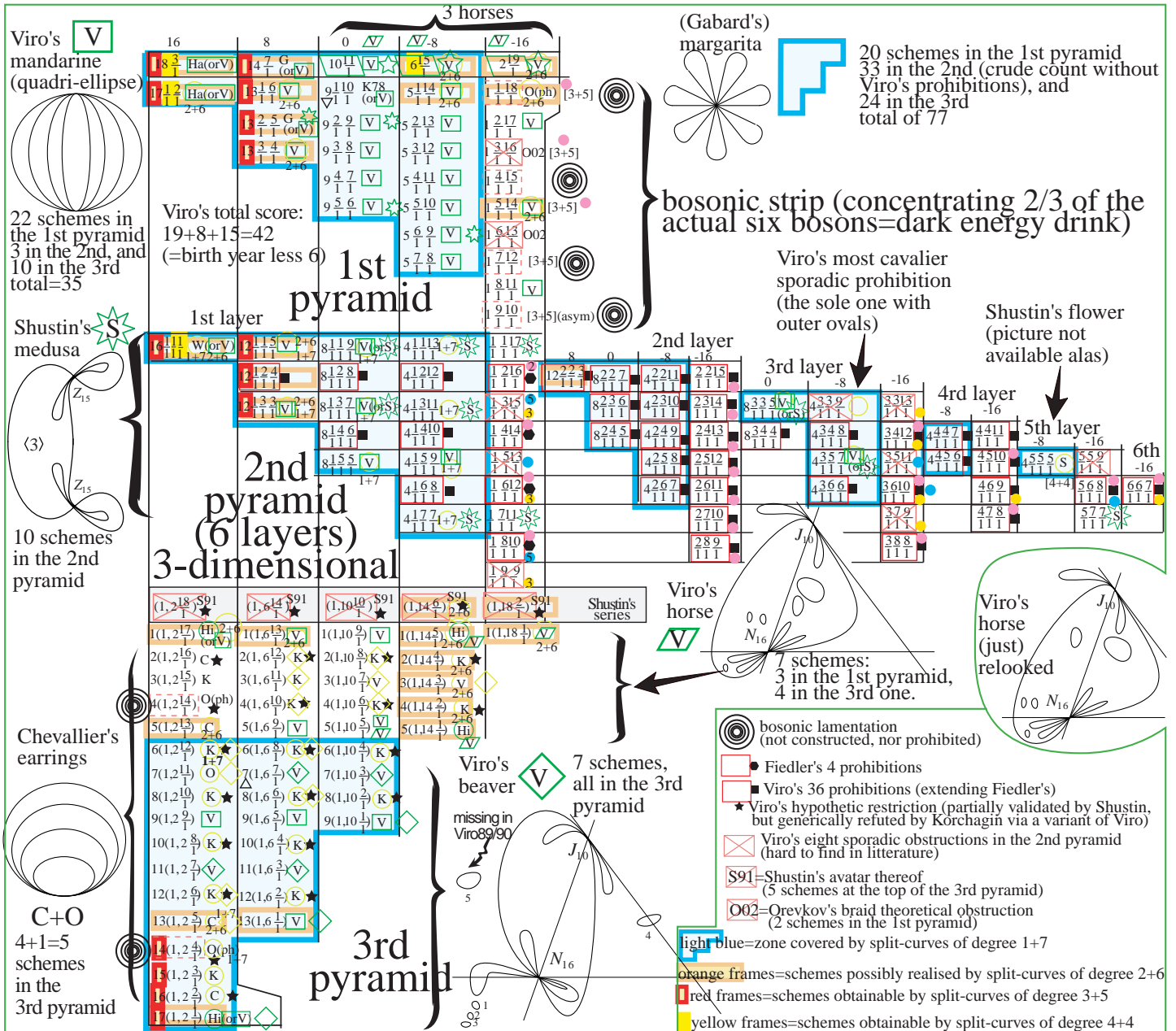

Figure 1: The periodic table of elements (of all octic M -schemes).

consensus, which looks logically robust (noncontradictory) and plausible (yet not omniscient, hence unsatisfactory). Further, as we already said, one of the deplorable issue is that some of the most formidable results (especially Viro's eight sporadic laws (=eight commandments) are not yet available in print. This seems especially deplorable, as it is the natural sequel to Oleg Yanovich's heroic saga, implying in particular some limits to the patchworking method as a purely combinatorial/random fabric of curves. Of course, not all published results are true (nor are all truths published), yet the public-domain seems a prerequisite toward checking (resp. assimilating) truths.

- Patch mirabilis $C2(9, 0, 0)$.—On studying Viro's method with extended parameters (counting micro-ovals), one notices the strategical role of the patch $C2(9, 0, 0)$ (i.e. lateral binested lune with 9 ovals in the interstice, cf. Fig. 2). If this patch exists, then two new bosons are (spontaneously) created without any pain. So our question is *whether anybody on this planet ever succeeded to prohibit this patch*. As a small indicator of the difficulty, neither Viro's imparity law nor Orevkov's deep obstructions accomplish this job. Cross-link to our text=Question 3.5.

UPGRADE [06.10.13].—Actually this patch (C2(9,0,0)) was prohibited in Shustin’s PhD Thesis, compare his recent e-mail in Sec. 1.6 which supplies also another argument. We acknowledge very much Shustin for communicating us this precious information.

- (Census of all E-patches for $X_{21} =: F4$.)—In the same vein there is the question whether the patch family $E=V1$ (trimested lune, cf. Fig. 2) is complete under Viro’s theory. Here again we are not aware of prohibitions, leaving open the opportunity to construct both subnested bosons via an enriched family of patches extending Viro’s. This does not necessarily mean that there is a method more puissant than Viro’s, but rather that it might be strengthened along twists not yet explored (e.g., by futurist artists of the Moscow school).

We could then solve Hilbert’s 16th purely in the vicinity of the quadri-ellipse at least if Orevkov obstructions are false. (If Orevkov is wrong, all four binested bosons could be small perturbations of the quadri-ellipse, cf. Fig. 10.) In contrast, it may be true that Viro’s actual census of patches has already reached its ultimate crystallization (i.e. no more patches than those constructed by Viro are available), in which case we really need Viro’s zoo (beaver+horse), Shustin’s art (medusa+?), plus eventually some of your own do-it-yourself creatures to create additional M -schemes. In this scenario, Hilbert’s puzzle of isotopic classification requests insufflating more artistic freedom (which as we know since Sebastian Bach often reduces to finitary combinatorics intermingled with sensations of infinity). Paraphrasing, if Viro’s theory of X_{21} -patches is already frozen as it stands, then more flexibility may come from global patterns of artwork, rather than through (optical) dissipations of the (quadruple) rainbow X_{21} as a rigid (unimaginative) form of patchwork exploiting only the quadri-ellipse.

- (VCP)=(Viro’s census of patches is trivially uncomplete?).—While studying Viro’s proof via his own and our pictures, we noted slight divergences summarizable by saying that there is in our opinion besides Viro’s double-lunes with ovals injected in the lateral simple lune (=C2 in our catalogue=Fig. 2 below), also perfect avatars where micro-ovals are pullulating instead in the inner simple-lune (cf. class-C1 in the same catalogue). We would like to ask Viro (or some other expert), if he believes our patches being also legal despite not catalogued in Viro 89/90 [1535].

- (BS)=Bending symmetry.—A somewhat related question is an experimental observation that the (extended) catalogue of all patches looks stable under the symmetry of bending amounting to invaginate the patch via a motion of horseshoe (compare Fig. 48 or its copy right below=Fig. 2). Can someone (probably fluent with hyperbolisms or other Cremona transformations) explain theoretically the presence of such a symmetry if real at all? If yes, this could be an important tool toward finishing the exact classification of all X_{21} -patches.

Upgrade [06.10.13]. An e-mail by Viro (cf. Sec. 1.6) seems to answer this question completely, via a very simple quadratic transformation.

Prohibitions.—Another possibility is that all six bosons (or a portion thereof) will never materialize so that actually no more constructions are possible, but pure art of prohibition is requested at some highbrow level of excellence à la Viro, Orevkov, etc. How will those look alike is difficult for us to predict.

- One may guess elementary techniques of interpolation by “adjoint” curves salesman travelling through the deepest ovals in a sufficiently complicated way as to exasperate Bézout. This we call basically the method of DEEpest Penetration (DEPP, like the German word for “idiot” or the US-amerindian actor). Alas, we were not able as yet to implement it in any successful way, but expect a giant spectrum of applicability and variability of this method. Very crudely put, the intuition amounts saying that algebraic curves can nest, yet the intricacy of the nesting is inherently bounded by the degree (as we daily experiment with lines and conics). In this respect, it may be noted that all known prohibitions (Fiedler’s four, Viro’s 36, Viro’s 8 sporadic, Shustin’s five, Orevkov’s two) all pertain to curves which are somehow over-nested. For instance, all but one of Viro’s eight sporadic obstructions pertain to trimested schemes without outer ovals, and Shustin’s five kill exactly the subnested schemes lacking outer ovals.

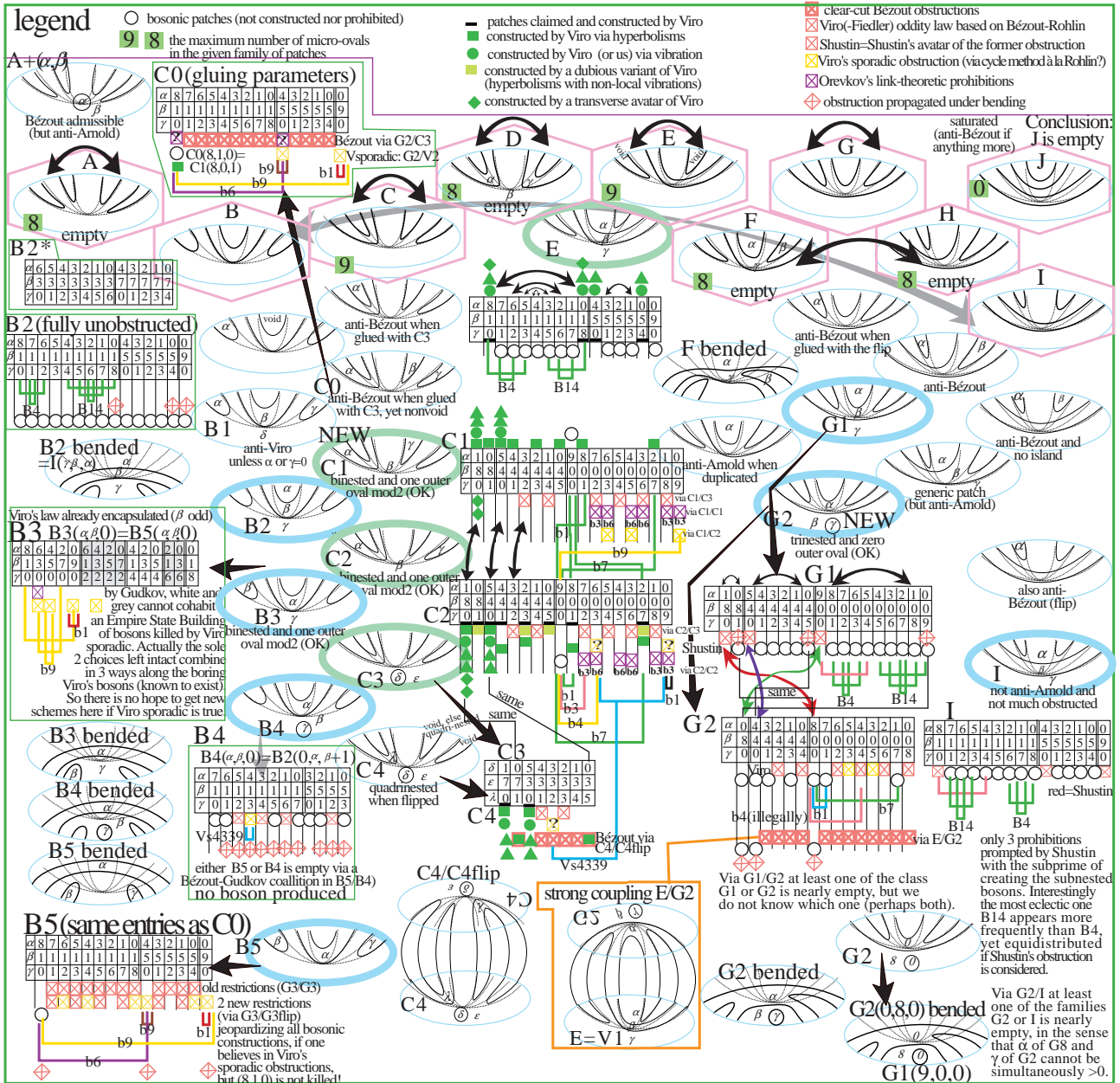

Figure 2: Catalogue of all patches under bending duality

• Another promising method (but also miserably ineffective in our fingers) is that of *total reality* allied to the conformal maps of Riemann-Ahlfors. Here, we claim that our short article Gabard 2013B [471] (inspired by Le Touzé) shows how to render purely synthetical (via Möbius-von Staudt) the Riemann-Ahlfors map in the schlichtartig case corresponding to Harnack-maximality (due say to Schottky-Bieberbach-Grunsky). So we can proudly speak about le *théorème de Riemann rendu synthétique*, since the rôle of analysis has been completely banished. Alas, it must be confessed that this trivial result is probably just the first stone toward understanding concretely how it restricts the distribution of ovals. In the case at hand (optics), this involves a pencil of sextics perhaps already difficult to visualize. Loosely put, the Riemann-Ahlfors map may be interpreted as a dynamique de l'électron (or dextrogyration), and so brings a certain dynamical flavor into the static loci traced by the algebraic orthosymmetric equation. Hence at the vegetative level at least, one gets another sort of symbiosis between both parts of Hilbert's 16th. More recently (see (5.19)) we noted the usefulness of a sort of Poincaré-Bendixson trapping argument to rule out the *fake-medusa* (as a hypothetical avatar of Shustin's medusa, whose exist-

tence would have seriously jeopardized Viro’s sporadic rules). So again, there is a germ of loose overlap between the qualitative theory of differential equations and the arrangements of algebraic ovals.

- Of course one may also imagine that new prohibitions may follow patterns of “old” methods by Fiedler, Viro, Shustin, Orevkov, where tools like Fiedler’s alternating rule, complex orientations, clever 2-cycles in $\mathbb{C}P^2$, or Orevkov link theory came to the forefront. And what about Hilbert-Rohn? Is it in full desuetude, or does it request a serious rehabilitation as suggested by Orevkov-Shustin in a relatively recent paper (ca. 2002). Alas, we confess as yet to have not studied nor assimilated any of those deep works, and so have nothing more precise to say.

- (Cubics as tool to prohibit M -schemes).—As noted above, the periodic table of 144 octic M -schemes already takes into account basic Bézout obstructions by lines (standard bound on the depths of nests) and conics (impeding quadri-nested schemes). One can wonder about the rôle of cubics, especially in reference to Séverine Le Touzé prowess in degree 9 (prohibition of 223 many M -nonics, see Le Touzé 2002 [424], as well as the subsequent 2009 paper). So the question is whether cubics afford novel proofs of (old) octic prohibitions originally found by Fiedler, Viro, Shustin, Orevkov. In our opinion, this natural passage to degree 3 does not exclude the option that already conics may supply prohibitions (old or novel) if one is able to implement colorful interpolations by conics salesman-travelling between the nests. Besides, the method of total reality suggests that degree 6 is the critical degree where to arrange total reality of a pencil. Yet, as we said, it looks extremely hard to extract concrete prohibitive statements.

Besides, it seems hard to claim that all constructions have been explored. Crudely put, we see a confrontation between patchwork (using the quadri-ellipse) and artwork (using more imaginative curves as initiated by Viro, Shustin, etc.), the former being rather local while the 2nd being more global, yet ultimately also depending on semi-local patches, yet possibly for other singularities than X_{21} .

1.2 More shameful points that I could not yet clarify

[02.10.13]

- As yet I never managed to trace (if possible at all?) the ground curve (if any?) employed by Shustin to create his last-discovered scheme $4\frac{5}{1}\frac{5}{1}\frac{5}{1}$. If my question is meaningful (amounting roughly to say that Shustin does not employ a more general method than the naive version of Viro’s method which I am able to understand, where the Newton polygon is banished!?), I would be extremely grateful if someone can send me the photo-portrait of this Shustin curve (in scanned pdf format).

1.3 Oracle Orevkov: periodicity modulo 3

- *Toward an Orevkov periodicity modulo 3.*—[03.10.13] As already noted a long time ago, but deciphered more deeply this night (ca. 03h12), it seems that there is a certain periodicity by 3 for binested bosons. This is primarily motivated by Orevkov’s obstructions of b_3 and b_6 , where $bn = 1\frac{n}{1}\frac{19-n}{1}$. If we extend the passage from b_3 to b_6 along a progression by 3, we get b_9 (a boson not yet constructed, and now posited as nonexistent), and then $b_{12} = b_7$ (another boson that would also dematerialize), next $b_{15} = b_4$ (also a boson not yet constructed, but that we posit as nonexistent by propagating Orevkov), and finally $b_{18} = b_1$, the last boson in this series, which would also not exist. The moral is that what looks fairly chaotic in the bosonic strip of Fig. 1 becomes perfectly regular under the palindromic symmetry allied to the permutability of both Gudkov fractions due to the evident shuffling isotopy of both nests.

The sole (very little) trouble is that extending the Orevkov pair $b_3 \rightarrow b_6$ backwardly we get $b_0 = 1\frac{0}{1}\frac{19-0}{1} = 2\frac{19}{1}$, which is constructed by Viro (via the

horse curve). There is surely a way to exclude this case, as it really lives outside the binested realm.

On the basis of this experimental observation (extrapolating widely Orevkov) there is two questions:

(1).—We seems to be in a situation a bit akin to the love-story Gudkov/Arnold(+Rohlin), where an experimentalist detect a periodicity that only abstract freethinkers are able to reckon as deep 4D-topology. If an Orevkov-Gabard periodicity modulo 3 governs the extremal bosonic strip of Gudkov’s pyramid, its seems natural to wonder which topology governs it (vague guess: link theory, slice genuses, and the well-known yoga between 3D- and 4D-topology via membranes bounding the link). In the situation of an algebraic (plane) curve there must be (starting with the link of a singularity) varied ways to get such a setting. More seriously, look also at Orevkov proofs.

(2).—It would be nice if this threefold periodicity (or another of another period) also holds in the trinested context as to supply more order in the apparent chaos reigning around Viro’s sporadic obstructions. Here the story may start with Fiedler’s scheme $f6 := 1 \frac{6}{1} \frac{12}{1}$, where in general we set $f_n := \frac{1}{1} \frac{n}{1} \frac{18-n}{1}$. Propagating this modulo 3, gives $f3$ prohibited by Viro sporadic, and forwardly gives $f9$ (also Viro sporadic), then $f12 = f6$ (Fiedler regular), and $f15 = f3$ (again the same Viro sporadic), and finally $f18 = b1$.

One objection is that if we start instead with Fiedler’s $f2 = 1 \frac{2}{1} \frac{16}{1}$, propagation modulo 3 gives $f5$ (Viro sporadic), then $f8$ (Fiedler regular), but then $f11$ (constructible by Shustin’s medusa), hence periodicity looks disrupted. Yet, continuing gives $f14$ (Fiedler), and finally $f17 = f1$, which is also constructible by Shustin. So one could argue that for this initial condition there is no lovely coincidence with the binested case, hence we cannot posit threefold periodicity.

However starting with $f2$, we can join the binested realm via a period of 2 transforming $f2$ backwardly to $\frac{1}{1} \frac{0}{1} \frac{18}{1} = b1$ which we assume now as prohibited (by our postulation of threefold periodicity). Next, propagating $f2$ forwardly by this novel twofold periodicity gives $f4, f6, f8, f10 = f8, f12 = f6, f14 = f4$, etc., and those guys are simply prohibited by Fiedler.

So there is a biperiodic structure with period 2,3 regulating at least the 1st layer of the trinested pyramid, and this bi-periodicity explains all of Fiedler and Viro (otherwise sporadic) prohibitions. To extend the picture one should inspect the other layers of the trinested pyramid.

We may start with Viro’s $\frac{3}{1} \frac{3}{1} \frac{13}{1}$. To rally (join) the binested realm, suffice to apply 3-periodicity leading back to $\frac{3}{1} \frac{0}{1} \frac{16}{1} = b3$, which is Orevkov’s anti-scheme. It may aver useful setting $v_k(\ell) = \frac{k}{1} \frac{\ell}{1} \frac{19-(k+\ell)}{1}$, yet let us try to avoid boring notation (where our v obviously stands for Viro). Our scheme above $\frac{3}{1} \frac{3}{1} \frac{13}{1} = v_3(3)$ propagates modulo 3 to $\frac{3}{1} \frac{6}{1} \frac{10}{1} = v_3(6)$ (Viro regular), and then $\frac{3}{1} \frac{9}{1} \frac{7}{1} = v_3(9) = v_3(7)$ (Viro sporadic), and next $\frac{3}{1} \frac{12}{1} \frac{4}{1} = v_3(12) = v_3(4)$ (Viro regular), and finally $\frac{3}{1} \frac{15}{1} \frac{1}{1}$, where we rally the 1st layer, exactly at the place of Viro’s “1st” sporadic obstruction ($f3$). Besides, the symbol may also bifurcate when operating on the 1st fraction, to $\frac{0}{1} \frac{15}{1} \frac{4}{1}$ rallying/fitting/joining thereby the binested realm along prohibited schemes (under our hypothetic threefold periodicity).

So the philosophy is a bit as follows: as we know Gudkov fourfold periodicity is governed by fourfold extended (spin) manifolds à la Rohlin, while it seems that on the boundary case of the Gudkov pyramids there is reigning a periodicity modulo 3 (suggested by Orevkov, but also Viro, and even Fiedler), which by analogy might be governed by 3D-topology.

We may now experiment 3-fold periodicity (3-periodicity) higher in the telescopic layers forming the trinested pyramid. Specifically, we may start from $\frac{4}{1} \frac{4}{1} \frac{11}{1}$ (which is Viro regularly prohibited). If we move “backwardly” along 3-fold periodicity may give Shustin’s (constructible) scheme $\frac{1}{1} \frac{7}{1} \frac{11}{1}$, and one gets a bad feeling of periodicity breaking. But as we know this Shustin’s scheme is not in phase with the binested obstructions, and therefore our starting place ($\frac{4}{1} \frac{4}{1} \frac{11}{1}$) is not adequate to 3-fold periodicity. Actually, it must be subsumed to a 2-fold periodicity explaining all nearby prohibitions, mostly of Viro’s regular

sort.

So where is the next place to look for 3-fold propagation? If we start with say $4\frac{2}{1}\frac{3}{1}\frac{10}{1}$, we get $4\frac{5}{1}\frac{0}{1}\frac{10}{1} = 5\frac{5}{1}\frac{10}{1}$ (constructed by Viro) or $4\frac{2}{1}\frac{0}{1}\frac{13}{1} = 5\frac{2}{1}\frac{13}{1}$ (likewise constructed by Viro). This is troubling but maybe again explainable by arguing that our starting position is not adequate for triple periodicity (triperiodicity).

Of course the biggest puzzle is to explain why Viro's most sporadic obstruction $4\frac{3}{1}\frac{3}{1}\frac{9}{1}$ ought to be predicted in terms of the (2,3)-biperiodicity.

[10h43:03.10.13] If we start with $\frac{5}{1}\frac{5}{1}\frac{9}{1}$ we find under 3-periodicity $\frac{5}{1}\frac{8}{1}\frac{6}{1}$ (Viro regularly prohibited), next—while jumping over Shustin's construction $\frac{5}{1}\frac{7}{1}\frac{7}{1}$ —we get $\frac{5}{1}\frac{11}{1}\frac{3}{1}$ (Viro sporadic). This becomes next $\frac{5}{1}\frac{14}{1}\frac{0}{1} = 1\frac{5}{1}\frac{14}{1}$ (constructed by Viro). If we operation modulo 3 on the last numerator of the initial scheme $\frac{5}{1}\frac{5}{1}\frac{9}{1}$, we also arrive at $\frac{5}{1}\frac{14}{1}\frac{0}{1}$, which is the same scheme of Viro. Thus we look again disphased (out phased). So it seems that the sole way to salvage our postulation of periodicity (while staying politically correct, i.e. without conflicting with the actual consensus) is to operate on the 1st numerator to get $\frac{2}{1}\frac{8}{1}\frac{9}{1}$ (Viro regularly prohibited), but then again acting mod 3 on the 3rd coefficient bring us to $\frac{2}{1}\frac{17}{1}\frac{0}{1}$, which is Viro-constructed. Hence we are again out of phase.

Finally, starting with $\frac{6}{1}\frac{6}{1}\frac{7}{1}$ triperiodicity bring us to $\frac{0}{1}\frac{12}{1}\frac{7}{1}$ or $\frac{0}{1}\frac{6}{1}\frac{13}{1}$ (when trading in favor of the 3rd numerator), and now we are in good prohibitive phase.

So what is the conclusion? Obviously our understanding of triperiodicity is nor perfectly translucent, yet this is maybe our due to our own stubbornness.

Another related way to pose the question of a periodicity would be to define another invariant φ beside the Euler-Ragsdale characteristic $\chi = p - n$, somehow transverse to the latter in the sense that it would vary along the vertical strips of the pyramid (Fig. 1). Then we expect φ to be predestined modulo 3, while explaining all Fiedler, Viro, Orevkov prohibitions (plus all the dematerialization of all 4 binested bosons).

More naively, we may return to our old viewpoint, yet more systematically by starting from the bottom while elevating progressively into higher layers, as opposed to starting from a random high-position but often landing down along an out phased regime (jet-lag).

So the story starts in the bosonic strip (binested with one outer oval) where it seems perfectly coherent to posit triperiodicity. This postulation—basically anchored in Orevkov—would kill all four bosons. Next we move to the 2nd pyramid, starting with Fiedler's (anti)-scheme $\frac{1}{1}\frac{2}{1}\frac{16}{1}$. Modulo two, while acting on the 2nd coefficient, this may be connected to the boson $b1$, and also be dragged down as to cover all four Fiedler's prohibitions. Besides, acting on the 1st and 3rd coefficient gives $\frac{3}{1}\frac{2}{1}\frac{14}{1}$ (aV:=anti-Viro regular, i.e. imparity law), $\frac{5}{1}\frac{2}{1}\frac{12}{1}$ (aV), $\frac{7}{1}\frac{2}{1}\frac{10}{1}$ (aV), $\frac{9}{1}\frac{2}{1}\frac{8}{1}$ (aV), $\frac{11}{1}\frac{2}{1}\frac{6}{1}$ (aV), $\frac{13}{1}\frac{2}{1}\frac{4}{1}$ (aV), and finally $\frac{15}{1}\frac{2}{1}\frac{2}{1}$, sweeping thereby the full extreme-right row of the 2nd layer (in accordance Viro regular). Next, turning back to $\frac{3}{1}\frac{2}{1}\frac{14}{1}$, we may move right to $\frac{3}{1}\frac{4}{1}\frac{12}{1}$ (aV), and then $\frac{3}{1}\frac{6}{1}\frac{10}{1}$ (aV), $\frac{3}{1}\frac{8}{1}\frac{8}{1}$ (aV), followed by a palindromic repetition. Further, from $\frac{3}{1}\frac{4}{1}\frac{12}{1}$ we may expand the prohibited territory right to $\frac{5}{1}\frac{4}{1}\frac{10}{1}$ (aV), and its downwards companion $\frac{7}{1}\frac{4}{1}\frac{8}{1}$, or alternatively climb further to $\frac{5}{1}\frac{6}{1}\frac{8}{1}$ (aV), from which place it remains only the possibility to reach the very summit of the pyramid with $\frac{7}{1}\frac{6}{1}\frac{6}{1}$ (aV). In conclusion we got a big armada of obstruction explained by periodicity mod 2 starting from Fiedler's 1st scheme $\frac{1}{1}\frac{2}{1}\frac{16}{1}$ (aF), in turn allied to the first boson $b1$.

By analogy starting from $b1$, triperiodicity explains Orevkov (plus killing all binested bosons), and then elevates to the 1st layer as $\frac{1}{1}\frac{3}{1}\frac{15}{1}$ (aVs=Viro sporadic obstruction), and then propagating properly in this layer, while jumping correctly over the construction of Eugenio Shustin. The next sort of transformation mod 3 makes the move $\frac{1}{1}\frac{3}{1}\frac{15}{1} \mapsto \frac{4}{1}\frac{3}{1}\frac{12}{1}$ from which position we may explain many prohibitions of the right-row of the 3rd layer. At this stage, we traced orange versus lilac bubbles on Fig. 1 as to show the propagation of prohibition under resp. double and triple periodicity (with initial condition $b1$). This permits to keep in memory schemes already prohibited, and we note that only Viro's $\frac{3}{1}\frac{5}{1}\frac{11}{1}$ is missed by our biperiodicity. Finally, via triperiodicity we may climb to the

4th and even 6th layer via the moves $\frac{3}{1} \frac{4}{1} \frac{12}{1} \mapsto \frac{4}{1} \frac{6}{1} \frac{9}{1} \mapsto \frac{6}{1} \frac{6}{1} \frac{7}{1}$.

All this is pretty coherent and noncontradictory with the actual census, but alas some prohibitions are missed by our recursive bi-propagation, namely $\frac{1}{1} \frac{5}{1} \frac{13}{1}$ in the 1st layer, and some other few schemes in the higher layers (compare the pyramid-figure to get the exact enumeration). As just said, we miss $\frac{1}{1} \frac{5}{1} \frac{13}{1}$ and it seems natural getting it by the principle of reductionism to the 1st boson $b1$. This forces introducing another fivefold periodicity effecting the move $b1 = \frac{1}{1} \frac{0}{1} \frac{18}{1} \mapsto \frac{1}{1} \frac{5}{1} \frac{13}{1}$. On the diagram (always in reference to Fig.1), this prompt introducing a third blue color for this fivefold periodicity. (Of course one is pleased to appeal to 5 after 2 and 3 since we seems moving along the natural sequence of prime numbers, aber Hallo!) At any rate, five-propagation along the 1st layer looks in phase with the consensus. Actually, we may climb to $\frac{3}{1} \frac{6}{1} \frac{10}{1}$ which maybe altered to $\frac{3}{1} \frac{11}{1} \frac{5}{1}$ (which we missed as yet). From either one of those positions we may elevate to $\frac{8}{1} \frac{6}{1} \frac{5}{1} = \frac{5}{1} \frac{6}{1} \frac{8}{1}$ (alas not new but already covered by 2-periodicity).

As yet we still do not have a completely recursive law explaining all Viro prohibitions (we miss $\frac{4}{1} \frac{4}{1} \frac{11}{1}$ and $\frac{5}{1} \frac{5}{1} \frac{9}{1}$, not to mention the sporadic obstruction with outer ovals $4 \frac{3}{1} \frac{3}{1} \frac{9}{1}$).

Meanwhile, we may ask if we overlooked the period four, which albeit not a prime number seems in accordance with the thesis of reductionism to the 1st boson $b1$, in view of Fiedler's 2nd prohibition, i.e. $\frac{1}{1} \frac{4}{1} \frac{14}{1}$. Ouh sorry, of course such a periodicity will be coarser than that by 2, and so will add no novel information.

So the next step is a periodicity by seven, but this looks incompatible with Shustin (construction of $\frac{1}{1} \frac{7}{1} \frac{11}{1}$).

Of course we could inspect higher primes period, but first make a puzzling remark. If we look at the schemes not yet covered by our triple periodicity (with period 2,3,5), we have first $\frac{4}{1} \frac{4}{1} \frac{11}{1}$. Applying a direct move to the bosonic strip, we get either $\frac{8}{1} \frac{0}{1} \frac{11}{1}$, or $\frac{4}{1} \frac{0}{1} \frac{15}{1}$, which is puzzling as the 1st is constructed while the other we expect prohibited.

Actually, if we take as ground principle that of starting systematically from $b1$ we see that there is no periodicity by seven as it would land on $b8$ (constructed by Viro).

But working so, we get a problem with 2-periodicity already. Indeed the passage $b1 \rightarrow b3$ (the latter prohibited by Orevkov) suggests periodicity by 2, yet when propagated further to $b5$ this conflicts with Viro's construction of this scheme. So one must dictate somewhat artificially an absence of periodicity in the 1st pyramid.

Next, for $\frac{4}{1} \frac{4}{1} \frac{11}{1}$, we could tabulate on a periodicity mod 11, transforming it into $\frac{4}{1} \frac{15}{1} \frac{0}{1}$, which is the boson $b4$. Further the later is self-dual under 11-periodicity. The moral of this (and the previous paragraph) it that periodicity might not always be starting from $b1$, but maybe for certain other initial conditions.

Last for $\frac{5}{1} \frac{5}{1} \frac{9}{1}$, we may attempt a reduction to the binested realm by emptying a nest via 5-fold periodicity. Alas, this leads either to $\frac{10}{1} \frac{0}{1} \frac{9}{1}$ (boson forbidden by triperiodicity), or to $\frac{5}{1} \frac{0}{1} \frac{14}{1}$ (constructed by Viro).

In conclusion, we were close to decipher a hidden periodicity explaining all the apparent reigning around the Viro, Fiedler, Orevkov prohibitions while jumping acrobatically over the constructivist mines posed by Shustin, but alas this turns out to cover not exactly all cases, while being a somewhat ad-hoc rafistolage. We expect to address this question more successfully at the occasion, yet it must be confessed that the overall approach is not extremely deep, while being logically founded on the truth of several deep works, we had not yet the occasion to check the geometric foundation.

[04.10.13] Actually, by our periodicities (mod 2,3,5) we could explain all prohibitions safe two with $\chi = -16$, namely $\frac{4}{1} \frac{4}{1} \frac{11}{1}$ and $\frac{6}{1} \frac{6}{1} \frac{7}{1}$. The former may be excluded as it is covered by Viro's imparity law which is very regular. So it seems that in the all (χ arbitrary) there is only two Viro prohibitions not covered by periodicity, namely $4 \frac{3}{1} \frac{3}{1} \frac{9}{1}$ and $\frac{5}{1} \frac{5}{1} \frac{9}{1}$. Of course one expediting solution would be

that those two sporadic obstructions to be wrong, yet this request a construction that presently nobody is able to make.

1.4 Fixing our jargon

[29.09.13] Here we define some terminology and abbreviations of our own cooking, that we shall constantly use without extra reference. This requests special boring attention as our terminology is nonstandard and highly improvised.

- the main contributors to the field are the following geometers whose name are often abridged by sole initials especially on combinatorial tables, where little room is left to write in extenso the original constructor (or prohibitor): Harnack=Ha (1876), Hilbert=Hi (1891), Wiman=W (1923), G=Gudkov (1969–72), K78=Korchagin 1978 (variant of Brusotti), F=Fiedler, Viro=V, S=shustin, K=Korchagin (later), C=Chevallier, O=Orevkov. On tables an “a”-privative, like aB, aG, aF, aV, aVs usually means anti-Bézout, anti-Gudkov, anti-Fiedler, anti-Viro, or anti-Viro sporadic.

- a *nest* is an oval (of an algebraic curve or an abstract scheme) which is nonempty in the sense that inside the unique bounding disc for the oval there appear other ovals of the curve. An *egg* is an oval which is empty, i.e. no other oval inside of it.

- (uninested, binested, trinested, subnested).—As a trivial consequence of Bézout, schemes in degree 8 can have one, two, three or four nests, but not more than that. Actually, in case of four nests the configuration collapse to the doubled quadrifolium $\frac{1}{1}\frac{1}{1}\frac{1}{1}\frac{1}{1}$. The corresponding Gudkov symbols are $x\frac{y}{1}$ (*uninested*), $x\frac{y}{1}\frac{z}{1}$ (*binested*), $x\frac{y}{1}\frac{z}{1}\frac{w}{1}$ (*trinested*). Besides an octic scheme is the first degree where apart from the trivial deep nest case appears the option of a subnest where a little bird (moineau=Jack Sparrow) constructs a little nest squatting one of a larger bird (crow). Such schemes we call subnested and the have a Gudkov symbol of the form $x(1, y\frac{z}{1})$ where x counts the outer ovals, the first 1 stands for the big nest of the crow, y is the number of *big eggs* in the big “crow” nest, and z is the number of (little) sparrow eggs at depth 2.

- Viro’s *imparity law* (or oddness/oddity law) refers to the result ca. 1980/83 (extending an earlier one by Fiedler) that each nest of a trinested M -scheme contain an odd number of ovals. This is a spectacular result yet not the *dernier mot* of the story, since there is also:

- Viro’s *sporadic obstruction* of eight schemes first listed in Viro’s seminal survey on progresses over the past six years. Alas, those do not seem to have been explicitly proven in literature and therefore we deliberately—to accuse this lamentable state-of-affairs—adhere to a doubtful attitude against them, whence our terminology *sporadic*. To caricature at the extreme (at the risk of being unfair), one could say that Viro stated those as prohibitions not so much because he was able to prohibit them, but merely because he was not able to construct them. As a sibylline avatar, remind that Viro apparently baffled himself when conjecturing nonexistence of many octic M -schemes subsequently constructed by Korchagin. Our “apparently” is just an incertitude principle allied to Korchagin’s construction, which we could not follow.

- (Boson).—A *boson* is one of the six M -schemes in degree 8 not yet known to exist. This ignorance is a dramatic cliff between human brains versus arithmetical (capitalistic) unpitying law of higher computation. Nonetheless the game looks still worth studying as algebra seems to embody a principle of economical depiction of marvellous algebraic drawings. In fact 4 bosons are binested and two are subnested. So sometimes we abuse terminology by calling boson, any binested scheme. This lack of imagination from our side allied to a parsimony of jargon should not cause any confusion.

- (Macro, quantum and micro-ovals).—We distinguish along any method of patchworking three kind of ovals: macro-ovals visible on the curve right after the dissipation, quantum-ovals placed on the singular artwork but whose exact location is not exactly known, and micro-oval which are those pullulating in the vicinity of the singularity damping during the dissipation process.

- (Quadri-ellipse).—Viro’s method of gluing (patchworking) primarily involves a very basic singular octic composed of four ellipses each pairwise bitangent at the same two points.

1.5 A loose idea of maltese singularities

[30.09.13] So for instance new schemes not realized (realizable?) nearby the quadri-ellipse (F4+F4) went constructed via Viro’s beaver (O5+F3), horse (O5+F3), and Shustin’s medusa (C4+C4) (cf. Fig.95). Those employ different kind of singularities catalogued by Arnold, but we use here or own coding where e.g. O5 means an ordinary quintuple point with five distinct tangents, Fk means a “flat” point (or rainbow) with k branches entertaining 2nd order tangency between themselves, and C4 is a candelabrum consisting of F3 plus a fourth transverse branch.

As a striking example of “artwork” Shustin’s medusa gave six new M -schemes (in degree $m = 8$), and one may wonder about the existence of other singular curve creating the bosons not yet known to exist. Reading all of our text there should be candidate, yet we should at the occasion make a census of all candidate. For the moment we just mention one example of the margarita curve (Fig.95) with a septuple ordinary point O7, which could create the boson $14(1, 2\frac{4}{1})$ upon using a suitable affine M -septic.

As it stands, the example of Shustin’s medusa raises the question if the more transverse version of the candelabrum where two flat points (F2) of order 2 cross transversally (maltese cross) also lead to new M -curves. First, by comparison to the case of F4 and C4 where the number of micro-ovals pullulating is three unit less that the numbers of crossings of a generic perturbation of the singularity, we infer (loosely?) that the maltese M4 should produce 5 micro-ovals. Next on using the singular Harnack bound we see that a curve with two M4 (each eating eight units to the genus) have 5 quantum ovals (whose exact location is not yet known.) After few trials, we also arrived at the shape of the medusa, yet using different singularities. Then maybe the obstruction plaguing fake-medusas (see 5.19) vanish by chance, and so an opportunity to corrupt Viro’s sporadic rules. Specifically, arranging the quantum ovals as 1+2+2 (central+peripheral+peripheral) we get the singular octic termed the langouste, whose dissipation (admittedly improvised along mere arithmetic Gudkov periodicity) could create some of Viro’s sporadic obstructions. In defense of Viro, it may however noticed that different pasting yields schemes violating the more established Viro (regular) parity law. So our construction is only a pseudo-counterexample to Viro, but it seems to us still interesting as the trapping obstruction disappears in contrast to the fake-medusa based on 2 candelabrams C4 (see again (5.19)).

- Another loose question concerns the ubiquity of the patchwork method as we conceive it. In a perhaps limited sense (yet broad enough to include all construction by Viro, and Shustin) we may interpret patchwork as the data of a guru (GroUnd singulaR cUrve), e.g. quadri-ellipse, etc., plus some patch prescriptions yielding an M -scheme by gluing the patches in place of the singularities. One naive question is whether all the more recent constructions of Korchagin, Chevallier, Orevkov (using as a rule more the story of the Newton polygon) are likewise interpretable in our narrow sense. If so, make explicit in each case which is the GroUnd singulaR cUrve (GURU).

1.6 Correspondence

- [03.10.13] Some news from Alex and question on the Hilbert-Viro problem in degree=8

Dear Colleagues,

I was much fascinated to explore during now ca. 4 months the fantastic achievements of Oleg Yanovich and all the other experts around it. I focused especially on Hilbert’s problem in degree 8, but feel now somehow blocked by

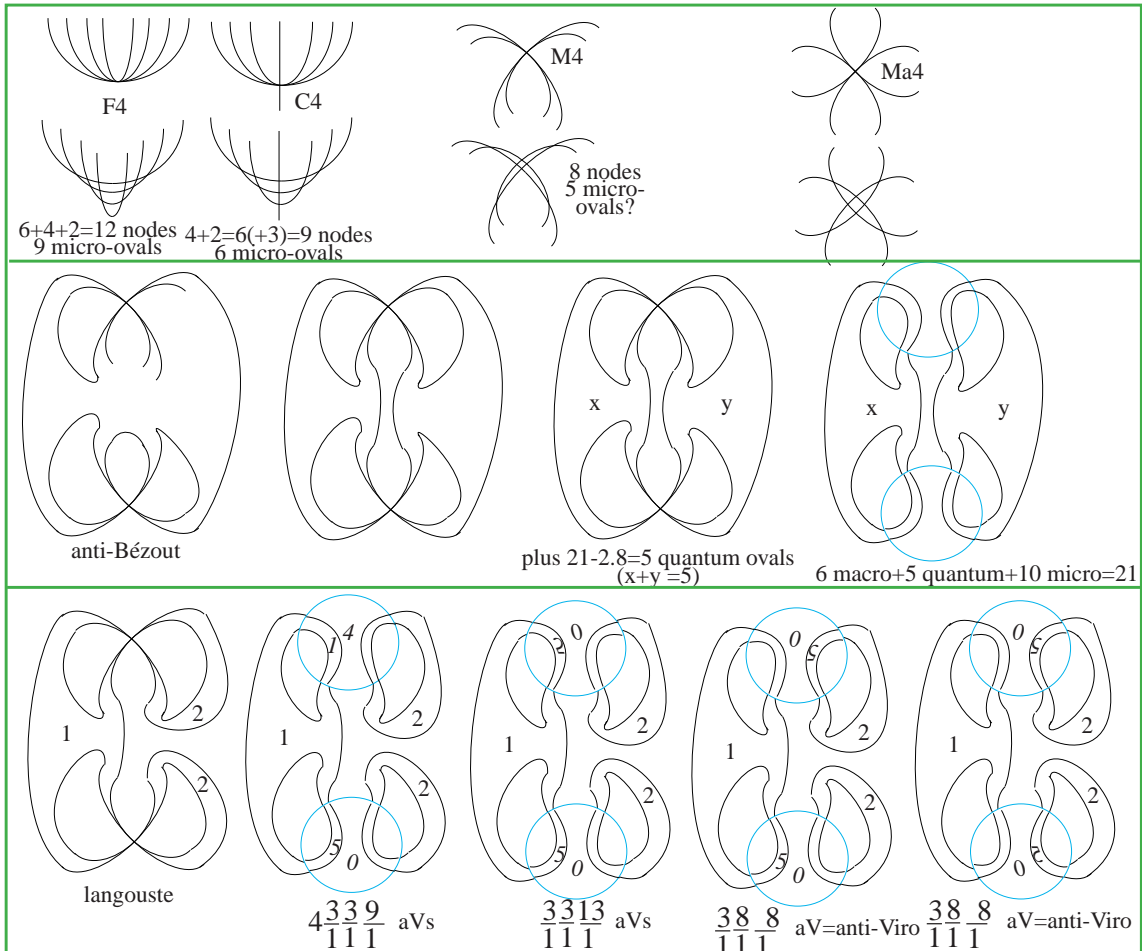

Figure 3: Maltese as a transversalization of Shustin's medusa

certain questions, notably on the patches for X_{21} (quadruple point with 2nd order tangency as appearing on the quadri-ellipse). I send you only the new portion of my text as it is already quite heavy. (418 pages and many figures: this material is intended to be v3 of my long arXiv article on Ahlfors, Rohlin and now Viro).

In Sec. 2.2 there is a list of questions (summarized below) which I would be very happy to submit to your attention, in case you are not overwhelmed by other duties. Alas, on my side I must start anew a boring editorial duty for our Math. Journal in Geneva for a period of about 2 weeks.

Maybe the most clear-cut question I have is whether there is a complete classification of all dissipations of X_{21} , or at least more detailed information than I was presently able to compile. Referring for concreteness to my Figure 2 on page 7 (the catalogue of "all" graphically possible patches), I think that I found with the class C1 nearby the center of that plate "new" patches that were not explicitly mentioned in the article Viro 1989/90 (Leningrad Math. J.). Of course those patches are so much akin to Viro's (C2 in my notation) that they yield no new schemes (and were therefore probably deliberately omitted by Oleg 89/90 for page-making convenience). Yet I was still wondering if they really do exist. (I think that they can be constructed by slight variants of Viro's purely geometric methods.)

Somewhat more conceptually, it seems to me that there is a global symmetry of bending regulating the catalogue of all patches, and amounting to invaginate a patch along a horseshoe motion inverting all curvatures so-to-speak. (See for instance F and F bended on that plate). Observationally, all of the available data (to me, via the reading of Viro) seem to respect this symmetry. It would be nice if there is a theoretical justification of this "hidden" symmetry (maybe

via a sort of hyperbolism?). This bending symmetry could perhaps help in classifying all patches.

As a more specific question, I wonder if Viro's E-patch involving a trined lune (near the middle-top of the figure 2) has been fully classified (especially since it gives opportunities to create new bosons=[M-schemes]). Likewise I wonder if anybody ever succeeded to prohibit the patch C2(9,0,0) [which after Orevkov seems to be the sole undecided patch]. This patch would permit the creation of the bosons b1 and b7, where bn is the binested scheme $1n/1(19-n)/1$ having n ovals inside a nest.

Last but not least, it seems to me that Viro's eight sporadic prohibitions (1984, but first announced in the 1986 survey) have not yet been fully demonstrated in print. So I wonder if anyone is still able to write down the details. As a question for Séverine, I wonder if those (or other octic prohibitions) follow from your methods with cubics (as implemented to kill ca. 220 nonics in the 2002 and 2009 papers).

Very finally, being not so skilled with Newton polygons I missed to understand Shustin's last construction of $4\ 5/1\ 5/1\ 5/1$. If someone know the picture of the singular curve leading to this scheme, I would be very grateful to receive a photo-portrait of this curve. Sorry if this question is ill-posed???

Many thanks for all your attention, and I apologize for disturbing you with my modest questions. Albeit 250 pages long my text contains nothing original (apart boring tabulations showing all possible patchworks). So I merely attempted to get familiarized with the basic combinatorial aspects of patchworking, yet without being able to discuss properly the prohibitions. So let me know if there is any readable source available, especially on Viro sporadic. (I heard by citation about a Texas survey by Korchagin ca. 1998, which I could not find as yet. If there is an electronic copy available, it would be excellent...)

All the best, Alex

PS: I added Korchagin and Chevallier to the mailing list, and send them my best greetings, while apologizing that my text does not properly reflect their deep contributions.

●●● [05.10.13] Viro's answer

Dear Alexandre,

C1 and C2 are diffeomorphic by a quadratic transformation $(x, y) \mapsto (x, y + ax^2)$ with appropriate a . This is local diffeomorphism. This is probably what you are looking for in your attempt to understand "duality".

Shustin's PhD was devoted to smoothings of X21. So it's better to ask him. He wrote about "sporadic" prohibitions. My prohibitions have been published in his paper. I have no references right away.

All the best, Oleg

● [06.10.13] Gabard's reply

Dear Oleg and the other colleagues,

Many thanks, Oleg, for your prompt answer about the duality I was expecting. This certainly explains everything I was looking for. Of course, there is still some questions about special patches (like C2(9,0,0)), and so I should really take a look to Shustin's PhD as you suggest (published in VINITI?). This looks extremely exciting, but alas I need now to work for two weeks for our Journal L'Enseign. Math. in Geneva.

I will send to the arXiv my notes today, right after integrating your answer.

All the very best, Alex

●●● [06.10.13] Shustin's brilliant answer:

Dear Alex,

The patch C2(9,0,0) you asked for indeed has been prohibited in my PhD thesis by means of a version of the Hilbert-Rohn method. Another way to prohibit it is (as you mention in the table in page 7) is to glue up it with itself and come to a non-existing curve. Indeed, scanning the patch by a pencil of real lines through the singular point one can join each of the 9 odd ovals to its neighbors and one extreme oval with the interior loop by imaginary discs. In the pathworking procedure these discs persist, and hence, in the double cover

of the plane branches along the obtained non-singular curve of degree 8 and type 2+1(19), one observes a sequence of 37 spheres realizing a sublattice A_{37} in the invariant part of the second homology contrary to the negative signature $s_- = 35$. I believe a similar prohibition can be obtained for the original patch when considering it on F_2 , and as I remember, Oleg Viro did this a long ago.

With best wishes, Eugenii

- [06.10.13] Gabard's (modest) reply

Dear Eugenii (and the other colleagues), many thanks for this beautiful answer I look forward to digest in two weeks, but which sounds extremely elegant. Meanwhile, my arXiv submission is still much jeopardized due to the arXiv compiler being very sensitive to coherent cross-links between all the figures. So I had to work hard adjusting all this. This difficulty leaves me now the opportunity to include your letter in the text. I hope my subsequent attempt to compile the file within the arXiv interface will succeed.

Many many thanks again to Eugenii for this fantastic answer! All the best, Alex

2 Getting started

Terminology [28.08.13].—Quite typical to Hilbert's 16th [in its Russian cultivation] is the issue that several configurations (of the theory, or the Praxis if you prefer German realism) are not yet constructed nor prohibited (despite the intrinsic triviality of the algebraico-arithmetical realm making the whole “Zeuthen-Klein-Hilbertian” question a Godd-given tautology alike). This puzzling state-of-affairs reminisces the high-energy quest of fundamental particles in natural sciences (CERN[=Centre Uropéen pour la Recherche Nucléaire en Gaspésie], etc., i.e. the US and Chinese competitors if any?). By analogy, call any *undecided* distribution of ovals (i.e., not yet known to exist nor to be prohibited) a *boson*. As we shall, explain in the sequel the actual Russian census posits (or demonstrates? if one is clever enough) that there is actually (after Orevkov 2002) six M -bosons in degree 8, where M refers as usual to Harnack maximality (in the stenography of Academician Ivan Georgievich Petrovskii). The question of knowing of many bosons live at the other levels may be considered as anecdotic but is probably essentially subsumed to the M -case (granting Hilbertio-Russian-Chevalleresque superstition of longstanding, where the latter refer to Chevallier, a well-known expert from Toulouse).

Digressing a bit this invites to the following:

Definition 2.1 *A mathematical problem is trivial if it merely requests immortality of the investigator. For instance, the distribution of primes is a trivial problem (Eratosthenes's cribble), and—by way of consequence—so is probably Riemann's hypothesis on the zeroes of the zeta function $\zeta(s) = \sum_{n=1}^{\infty} n^{-s}$. Probably Hilbert's 16th problem is likewise trivial, but as yet we lack (despite the efforts of Klein, Hilbert, Petrovskii, Arnold, Rohlin, Fiedler, Viro, Korchagin, Shustin, Gabard???) any clear-cut algorithm reducing this geometrical story to a boring matter of arithmetics. Of course it is also permitted to dream of a world (à la Riemann-Klein-Thom-Gabard) where geometry is stronger than arithmetics (anti-Gauss-Kervaire, etc.), since the latter discipline is merely discrete geometry alias combinatorics. This is why Christian Wütrich (just to name one among many anti-geometer) is not the master of the world, as he likes to joke, about English pseudo-Scholars capitalizing his own progeniture.*

[03.06.13] This section presents a self-contained essay to reach the actual frontier of knowledge when it comes to octics which is the first degree where the problem of the distribution of ovals of algebraic curves is not yet completely settled.

As we shall see, Viro's method of construction is one of the big breakthrough allowing one to get fairly close to a complete understanding. The power of his method supersedes violently all what what was possible by older perturbation

methods à la Harnack, Hilbert or even Gudkov! Interestingly Viro’s method is not a closed machine but one developing further through the fingers of other experts like Shustin, Korchagin, Chevallier, Orevkov. So many new curves were obtained by reworking (or twisting) Viro’s method.

At the level of prohibitions also, Viro’s role is again fairly prominent though being based on ideas of Rohlin, Fiedler, etc. Developing all this in full details should occupy at least something like 50 pages, so we ask for the reader’s patience. Our intention is to present the theory in its full details so we shall start slowly by the trivialities, and progressively try to carry out the big rocks.

Maybe a fairly original result of us (but based on Shustin) is Theorem 7.4 below which seems to disprove Rohlin’s maximality conjecture (even the sense thereof which remained open after the Shustin/Polotovski disproof).

2.1 Hilbert’s 16th for M -octics: Harnack 76, Hilbert 91, Wiman 23, Gudkov 71, Rohlin 72, Fiedler 79, Viro 1980(=Gold medal=42 schemes), Shustin 85/87/88 (=Bronze medal=7 schemes), Korchagin 78/88/89 (Silver medal=20 schemes), Chevallier 02 (4 schemes), Orevkov 02 (1 scheme and 2 prohibited)

[29.04.13] This is a big story, not yet completely elucidated. Among a menagerie of 104 permissible in the Rohlin-Fiedler-Viro era of complex orientations, it remains now 6 schemes left undecided after the last advances due to Orevkov 2002 [1129]. This still crystallizes the present frontier of knowledge as about of 2013. This affords a nearly complete solution, yet it is not clear how much time consuming it will be until completing the full programme. The 6 bastions de résistance seems quite hard to crack (and now resisting 11 years of efforts). Looping back to Viro 1989/90 [1535, p.1126], the incontestable master of the theory wrote: “The isotopy classification of nonsingular real projective algebraic plane curves of degree 8 has not yet been completed, although it is reasonable to think that it will be completed within the next few years. In any case, the last ten years have seen much progress [starting with Viro 1980], and no diminishing of the intensity of work on the subject.” Now in 2013, it seems evident that Viro’s agenda was a bit overoptimistic but in substance he might be right that we are close to the goal, primarily thanks to his revolutionary insights and many aficionados (Shustin, Korchagin, Chevallier, Orevkov, etc.) that joined the brèche which he created. However at the methodological level, Fiedler, Viro or Shustin deep prohibitions are often poorly published and some work is required to make their results more accessible to the grand public.

Our naive idea could be that the method of total reality (involving here pencil of sextics could help to crack the problem). Alas, presently we are not even able to tackle the Hilbert-Rohn obstruction in degree 6, cf. Gabard 2013B [471] for a failing attempt. However it may be suspected that this was due to lack of cleverness of us, while Riemann’s method of total reality could be the key to the problem.

[28.04.13] One get a nearly clean view of what happens in degree 8 (say focusing first on M -curves) via Viro’s seminal breakthrough 1980 [1527]. There a table of 52 isotopy types (=schemes) are effectively constructed by Viro’s method of perturbation of complicated singularities when not already realized by a more ancient device, like Harnack 1876, Hilbert 1891, Wiman 1923, Gudkov 1971, Korchagin 1978. On this table of 52 schemes the ubiquity of Viro’s method is already demonstrated, since the older methods only realize a marginal portion of isotopy types, namely each method scores so many schemes as tabulated below:

- Harnack=2; Hilbert=4³; Wiman=1; Gudkov=2; Korchagin=1; Viro=the rest=42. (This yields a total of 52 schemes that were known to be realized in

³[29.04.13] In Orevkov 2002 [1129, p. 726, table] Hilbert only scores 3 schemes. We do not know who between Viro and Orevkov is right.

1980, among a total of 104 logically possible schemes permissible by the Gudkov congruence and the advanced Bézout-style prohibition of Viro-Fiedler 1980, cf. Viro 1983/84 [1532] for the proof.) To understand why 104 schemes are logically possible, compare our Fig. 154.

This little count explains Viro’s prose announcing proudly in 1980 (*loc. cit.*): “In this article we formulate a definitive answer for $m = 7$ and some new results on curves of higher degree. Among these results are the construction of M -curves refuting the well-known Ragsdale conjecture [6](=Ragsdale 1906 [1238]), the realization of 42 new isotopy types of M -curves of degree 8 ([only] 10 types were realized earlier), and a theorem on M -curves of degree 8 with three nests that excludes 36 isotopy types not previously excluded.” To visualize the 36 schemes prohibited by Viro (and the 4 prohibited by Fiedler somewhat earlier) compare our Fig. 5.)

All this is excellent but it does not tell really what remains to be done. After this tour-de-force of Viro (and other workers), exactly 6 types of M -octics remains now undecided. It would be interesting to see if those schemes can be prohibited by the method of total reality. Alas, presently we are not even clever enough to recover the basic Hilbert-Rohn prohibition in degree 6 (cf. Gabard 2013B [471]). So the case of degree 8, is the ideal terrain in the long-run to test our philosophy (sketched in the Introd.) that all obstructions of Hilbert’s 16th can be explained via the method of total reality (and the felicity of pure orthosymmetry à la Felix Klein and concomitantly Rohlin’s maximality conjecture).

In fact on reading better Viro 1980 (p. 569) one sees that the obvious restrictions (i)-(ii)-(iii) listed on p. 568 (namely (i) the definition of an M -curve; (ii) Gudkov’s congruence $\chi \equiv_8 k^2 = 16 \equiv 0$); (iii) the obvious consequences of Bézout’s theorem restricting the schemes to one of the following list (given in Gudkov’s notation):

$$\alpha \frac{\beta}{1}, \quad \alpha \frac{\beta \gamma}{1 \ 1}, \quad \alpha \frac{\beta \gamma \delta}{1 \ 1 \ 1}, \quad \alpha(1, \beta \frac{\gamma}{1}).$$

This conjointly with Viro’s extension of Fiedler’s prohibition (cf. (??)) stating that in the case of 3 nests (the 3rd kind listed above) all parameters β, γ, δ have to be odd (if nonzero), leaves 104 logically possible schemes, of which Viro’s method (with forerunners—like Harnack, Hilbert, Wiman, Gudkov—probably always subsumed to Viro’s method as in degree 6) realize 52 types, i.e. exactly the half number, so that the *question of the realizability of 52 types remains open*. This was the state of the art in Viro 1980. Meanwhile only six M -schemes are in suspense. The key reference, surveying all what was done previously, is Orevkov 2001/02 [1129] where it is also supplied a complete classification in the case of pseudo-holomorphic M -curves.

Theorem 2.2 (Hilbert’s 16th nearly settled for $m = 8$ safe 6 questionable schemes).—*Since 2002 (Orevkov) and still in 2008 (e.g., Viro’s Japanese survey [1539]) (and probably still in 2013, April) there remains exactly six M -schemes of degree 8 (among the 104 logically possible) spoiling the completion of Hilbert’s 16th. Those are the following 6 schemes called (by us) the Hilbert-Viro bosons which are not yet known to be prohibited nor to be constructible:*

$$4(1, 2 \frac{14}{1}), 14(1, 2 \frac{4}{1}), \quad \text{and} \quad 1 \frac{1 \ 18}{1 \ 1}, 1 \frac{4 \ 15}{1 \ 1}, 1 \frac{7 \ 12}{1 \ 1}, 1 \frac{9 \ 10}{1 \ 1},$$

with respectively $\chi = 16$ and $\chi = -16$. In fact the first three are known to admit a pseudo-holomorphic realization, but the 3 remaining ones are more mysterious in this respect. As another naive remark if we permute both fractions of the last symbol (to read $1 \frac{10 \ 9}{1}$), we observe a certain arithmetic progression by 3 unities.

More precisely among the 104 logically possible schemes (after Bézout, Gudkov-Rohlin, Fiedler-Viro), the following scorings of schemes were constructed by:

- *Harnack=2 (1876), Hilbert=3/4 (1891) [WARNING: in our opinion this is 4, and there is a misprint in Orevkov 02, but not in Viro 80], Wiman=1*

(1923), Gudkov=2 (1971), Korchagin=1 + 19 = 20 (78/88–89), Viro=42 (80), Shustin=7 = 6 + 1 (85/87/88), Chevallier=4 (02), Orevkov=1 (02); yielding a total of $2 + 4 + 1 + 2 + 20 + 42 + 7 + 4 + 1 = 83$ schemes which are effectively constructed.

On the other hand post Gudkov-Rohlin, and Fiedler-Viro it remained 104 schemes and further “sporadic” prohibitions were detected by:

- Viro=−8 (1984/86 proof unpublished), Shustin=−5 (90/91), Orevkov=−2 (02). At this stage it remains exactly 6 schemes left questionable. Compare our Table below (Fig. 154) for the exact diagrammatic showing the state-of-the-art at the time of Orevkov 2002, which still represents the actual state of affairs. Our table is essentially Orevkov’s 2002 table, less some (minor) misprints and an improved diagrammatic showing also the prohibitions (entirely due to Fiedler, Viro, Shustin and Orevkov).

Before embarking on the proof which is long (ca. 20 pages and not yet completed) let us philosophize a bit. As joked in Chevallier 1997 [281, p. 4–6], it is widely accepted that the case of M -curves should govern the pyramid and mark the completion of the full Hilbert’s 16th without discriminating non-maximal curves (by a simple combinatorial descent along the pyramid that could be implemented by the conjectural Itenberg-Viro contraction of empty ovals). It can however be remembered that (like in degree 6) there are more curves which are say $(M - 2)$ -curves, and actually Polotovskii 1983 [1203] exhibited 327 many $(M - 2)$ -schemes of degree 8 using Viro’s method. This should be compared with our main-table=Fig. 155 where from we totalize 419 many logically possible $(M - 2)$ -schemes. Indeed $(M - 2)$ -elements of the 1st pyramid may be ranged as $1 + 3 + 5 + \dots + 15 + 17 + 19(+1) = \frac{(19+1)^2}{2} (+1) = 100(+1)$ many schemes. In the 2nd pyramid we have a complicated count involving the 6 layers. In the first layer we count $1 + 3 + 5 + \dots + 15 = (16/2)^2 = 64$ schemes; in the 2nd layer we count $2 + 4 + 6 + \dots + 12 = 2(1 + 2 + 3 + \dots + 6) = 2[(7 \cdot 6)/2] = 42$ schemes; in the 3rd layer we have $1 + 3 + 5 + \dots + 9 = \frac{(9+1)^2}{2} = 5^2 = 25$; in the 4th layer we have $2 + 4 + 6 = 12$ schemes; in the 5th layer we see $3 + 1 = 4$ schemes, and finally in the 6th layer contributes for nothing. Totalizing gives $64 + 42 + 25 + 12 + 4 = 147$ schemes. Finally the 3rd pyramid gives $1 + 2 + 3 + \dots + 18 = \frac{19 \cdot 18}{2} = 19 \cdot 9 = 171$ many schemes. Therefore the total of (logically possible) $(M - 2)$ -schemes is exactly $101 + 147 + 171 = 419$ and a good portion thereof is constructed by Polotovskii. As shown on the main table (Fig. 155 and zoomed as Fig. 156), there are $6 + 3 = 9$ many $(M - 2)$ -schemes which are prohibited by an obstruction of Viro. It would be an interesting task to know exactly which $(M - 2)$ -schemes are realized. This question albeit more massive by a factor of about 4, is perhaps easier to complete than for M -curves.

Albeit the title of Polotovskii’s article contains the (ambitious) word classification, it is probably not a *complete* census. So the full Hilbert problem in degree 8 can probably occupies several decades until being completed. Actually even the M -case is far from settled and progressing very slowly—not to say stagnating—since 2002 (last advance due to Orevkov). Then one would like as well a classification according to the types (as did Rohlin 1978 for $m = 6$), this can perhaps take another couple of decades (or follows instantly as it was the case for $m = 6$ where the $(M - 2)$ -scheme $\frac{5}{1}3$ was actually not easier to construct than Gudkov’s M -scheme $\frac{5}{1}5$). More naively one may wonder about the altitude $r = M - i$ (number of ovals) which produces the largest number (bio-diversity) of schemes. For $m = 6$, a look at Gudkov’s table prompts that the record is scored by $(M - 2)$ -curves (with 9 schemes so thrice as many as M -schemes). This proportion looks nearly respected when $m = 8$. Probably this abundance of $(M - 2)$ -schemes is a general feature (at least when m is even) since there is not reigning the congruences mod 8 of Gudkov-Rohlin resp. Gudkov-Krakhnov-Kharlamov. On the other hand, 171 realizations of $(M - 1)$ -schemes were worked out by Goryacheva-Polotovskii 1985 [535], cf. also Polotovskii 1988 [1209] for a general survey. We shall describe some of them just by adapting Viro’s construction to non-maximal dissipation (yet understanding precisely which values of the accessory parameters of the dissipation is a bit heuristic in our treatment.)

Proof of theorem 2.2. First we learned from Orevkov 19XX [1125] that 2 of these six schemes (resisting to the settlement of Hilbert’s 16th) are explicitly listed as $4(1, 2\frac{14}{1})$ and $14(1, 2\frac{4}{1})$. Actually at the time of the cited Orevkov’s article 9 bosons were not yet known to be either realized or prohibited. A naive idea would be to prohibit them by the method of total reality via a pencil of sextics as described in Gabard 2013B [471]. Of course this is presumptuous as we are not yet even able to reassess the Hilbert-Rohn prohibitions in degree 6 by this method, but the technique seems worth exploring further.

Then in Orevkov 2002 [1129, p. 725] a very detailed survey is given involving the following methods of prohibitions:

- the Gudkov-Rohlin congruence $\chi \equiv_8 k^2$ for M -curves;
- the obvious Bézout obstructions (à la Zeuthen-Hilbert);
- Viro’s theorem 1980 (published 1983/84 [1532]) forcing oddity of the contents of a trinested M -curve (generalizing an earlier weaker result of Fiedler);
- another subsequent (unpublished) result of Viro (1984), yet to be found in Korchagin-Shustin 1989 [861]. This is first reported in print in Viro 1986 [1534, p. 67] where we read: “In 1984 I found a new possibility of obtaining restrictions of non-topological origin. It is based on the construction of membranes in $\mathbb{C}P^2$ with boundaries in S^1P^1A . Here I announce one special restriction obtained by this method.—(4.12) If $\frac{\alpha}{1} \frac{\beta}{1} \frac{\gamma}{1}$ is the real scheme of an M -curve of degree 8 then the triple (α, β, γ) cannot be $(1, 3, 15)$, $(1, 5, 11)$ [WARNING: here $\alpha + \beta + \gamma \neq 19$ so this should probably be $(1, 7, 11)$ as I thought first, but in fact it is rather $(1, 5, 13)$, DOUBLE-WARNING: the same misprint is reproduced in Viro 1989/90 [1535, p. 1126, 5.3.G.], where Polotovskii 1988 [1209] is cited who probably gives no proof], $(1, 9, 9)$, $(3, 3, 13)$, $(3, 5, 11)$, $(3, 7, 9)$, or $(5, 5, 9)$. [Further] There does not exist a curve of degree 8 with the real scheme $4\frac{3}{1}\frac{3}{1}\frac{9}{1}$.” So 8 schemes are prohibited by this Viro method (compare again Fig. 154 to appreciate their location or even better look at Fig. 5). Alas, Viro has so many methods on his active, that the term “method” looks very unappropriate, and we shall speak of Viro’s (membranoid or 2nd/sporadic) obstruction, to distinguish it from the 1st obstruction (partially due to Fiedler). While the 1st Viro obstruction has a clear-cut statement (and published proof), the 2nd Viro obstruction looks more mystical, less available in print, and looks at first sight fairly random. However on using the right diagrammatic (Fig. 5), we observe some biperiodic pattern emerging on the right-part where $\chi = -16$. Alas some 3 schemes constructed by Shustin interrupt slightly the symmetric reproduction of Viro’s 2nd obstruction. Additionally, Viro’s 2nd obstruction also includes one scheme with $\chi = -8$, namely $4\frac{3}{1}\frac{3}{1}\frac{9}{1}$ and the latter also causes a *brisure* of bi-periodicity on the sub-plate where $\chi = -8$ (cf. again Fig. 5). So it is slightly puzzling to decipher the exact harmony of the geometry (*Harmonices Mundi* à la Kepler). It may be observed that in the Fiedler-Viro/Viro era all prohibitions were concentrated on 3-nested schemes. The situation will change slightly with the next contributor, Shustin and also more recently with Orevkov (compare Fig. 154).

- the result of Shustin 1990/91 [1419] excluding $(1, (20 - a)\frac{a}{1})$ with $a > 0$; a priori this prohibits circa 20 schemes but by virtue of Gudkov’s hypothesis imposing periodicity modulo 4 on the parameter a this prohibits only 5 new schemes. For their exact geography we refer again to our Fig. 154.

- Orevkov’s (2002) pseudo-holomorphic prohibition of the 2 schemes $1\frac{3}{1}\frac{16}{1}$ and $1\frac{6}{1}\frac{13}{1}$. Prior to that work of Orevkov (2002) it remained nine M -schemes whose realizability was in doubt. This was the result of centennial efforts involving the studies of:

- Harnack 1876 [607] (construction of 2 schemes all with $\chi = 16$, via the so-called Harnack method); those are the schemes $18\frac{3}{1}$ and $17(1, 2\frac{1}{1})$ (make a figure at the occasion). This is just a matter of extending the classical picture of Harnack that we traced only up to degree 6. Alternatively one might try to find a realization à la Hilbert which is a quicker method. In degree $m = 6$, Harnack’s original method can be dispensed at least for M -curves, yet in degree 8 it is not clear to me if the same ubiquity of Hilbert’s method is also valid. Of course,

the schemes in questions are not explicitly listed in Harnack’s paper (1876), but Russian scholars are generous enough to ascribe schemes to the inventor of the method. As we shall see both of Harnack’s two schemes will be phagocytized as very special of Viro’s method that we will expose subsequently.

- Hilbert 1891 [661] (construction of 4 schemes, via a variant of Harnack’s vibration known as Hilbert method); this includes the scheme $1(1, 2\frac{17}{1})$ and $17(1, 2\frac{1}{1})$ plus 2 other schemes not constructed in this text (but which we will recover along Viro’s method). Warning at this place Orevkov’s table of 2002 [1129, p. 726] contains a slight mistake by accrediting to Viro instead of Hilbert the last mentioned scheme. Compare our table Fig. 154 or rather Viro’s original table in 1980 [1527] (which alas is far from complete, and contains another little bug, namely the 8 last schemes of the series with $\chi = 16$ or $p = 19, n = 3$ are misplaced and should be in the series $p = 11, n = 11$).

- Wiman 1923 [1595] (construction of one scheme, via a method of his own, namely $16\frac{1}{1}\frac{1}{1}\frac{1}{1}$). Actually this scheme belongs to a series of M -schemes of even degree $m = 2k$ with an especially pleasant distribution of ovals involving a square of outer unnested k^2 ovals, plus a “triangular number” of $\frac{(k-1)(k-2)}{2} = 1 + 2 + \dots + (k-2)$ many nests of depth 2 (Fig. 4). Of course this series of curves like Hilbert’s series also adds some slight evidence toward the truth of Ragsdale’s conjecture $\chi \leq k^2$ for M -curves. Although Wiman’s method is surely a jewel it is not worth exposing here as this scheme will be subsumed to the much more powerful method of Viro, who like his predecessor also worked in Upsala (after leaving Leningrad). Apparently as pointed in Polotovskii 1988 [1209, p. 459]: “Speaking about classical methods we mean the methods by Harnack, Hilbert, Brusotti, and Wiman of construction of M -curves. All these methods are based on smoothing of non-degenerate double points by small perturbations. These methods except for Wiman’s method are organized recurrently, so that they give series of M -curves of degrees increasing as arithmetic progression. [...]”.

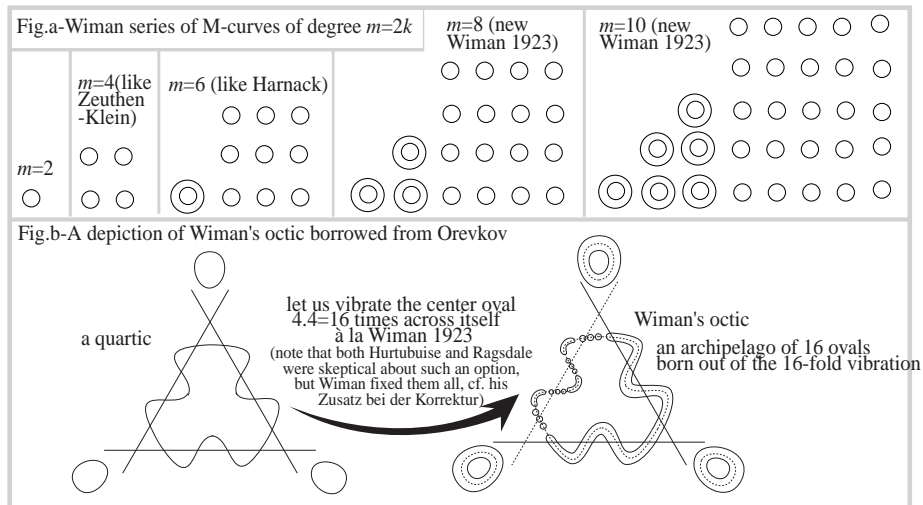

Figure 4: Wiman’s series of new M -schemes as soon as $m \geq 8$.

For a less schematic depiction of Wiman’s curve compare Orevkov’s picture above (Fig. 4b) borrowed from Orevkov 200X [1136]. On the next page (p. 4) Orevkov depicts the next step of a Wiman iteration which however deviate from our interpretation of Wiman’s scheme, so that perhaps our Fig.a is faulty for large $m \geq 10$.

- Gudkov 1971 [576] (construction of 2 schemes, via his own method involving Cremona transformations); namely $14\frac{7}{1}$ and $13\frac{3}{1}\frac{4}{1}$. (Both those schemes will later be recovered via Viro’s method so that it is not necessary to pay special attention at Gudkov’s realizations.)

- Rohlin 1972 (proof of the Gudkov congruence, with correction in Marin 1979 [963]) ruling out (statistically) one-quarter of the schemes;

- Korchagin 1978 [850] construction of one scheme (namely $9\frac{1}{1}\frac{10}{1}$, cf. e.g. Viro 1980 [1527] table, p. 568) by a variant of Brusotti. This will also be sub-

sumed to Viro's method.

- Fiedler ca. 1979 (published 1982/83 [415]) (prohibition of 4 schemes, cf. e.g. Viro 1983/84 [1532, p. 416]) (published later and englobed in:

- Viro 1980 who establishes an imparity law for 3-nested M -octics, which prohibits 36 additional schemes (proof in Viro 1983/84 [1532]). As observed in *loc. cit.*(p. 416) it seems that Korchagin had some decisive influence in conjecturing on the basis of specimens generated by Viro's method the right extension of Fiedler's obstruction. To visualize the 4 schemes prohibited by Fiedler cf. the hexagons on our Fig. 154 (or better Fig. 5 right-below). To visualize the 36 new obstructions of Viro cf. again on the same table the squares.

Understanding the Fiedler-Viro proof is fairly tricky. The best proof is in principle that of Viro 1983/84 [1532], which is however fairly undigest. If our philosophy of total reality is the right viewpoint (to obtain even obstruction on some of the six unsettled cases), it may perhaps recover the Fiedler-Viro obstruction. In particular, it may be a wrong idea wasting energy in trying understanding their proof. As a last remark it seems that Viro's proof differs from Fiedler's [alternating orientations] in using an idea due Rohlin (cf. p. 414, footnote in Viro 83/84 and p. 66 in Viro 86 [1534] where Rohlin's formula for a pair of curves is employed). So all this is a bit tricky and deserves a separate treatment or approached upon differently via the total reality of M -curves.

X	16	8	0	-8	-16												
	16 $\begin{smallmatrix} 111 \\ 111 \end{smallmatrix}$ w	12 $\begin{smallmatrix} 115 \\ 111 \end{smallmatrix}$ v	12 $\begin{smallmatrix} 223 \\ 111 \end{smallmatrix}$ v	8 $\begin{smallmatrix} 119 \\ 111 \end{smallmatrix}$ v	8 $\begin{smallmatrix} 227 \\ 111 \end{smallmatrix}$ v	8 $\begin{smallmatrix} 335 \\ 111 \end{smallmatrix}$ v	4 $\begin{smallmatrix} 113 \\ 111 \end{smallmatrix}$ s	4 $\begin{smallmatrix} 221 \\ 111 \end{smallmatrix}$ v	4 $\begin{smallmatrix} 339 \\ 111 \end{smallmatrix}$ v	4 $\begin{smallmatrix} 447 \\ 111 \end{smallmatrix}$ v	4 $\begin{smallmatrix} 555 \\ 111 \end{smallmatrix}$ s	1 $\begin{smallmatrix} 117 \\ 111 \end{smallmatrix}$ s	2 $\begin{smallmatrix} 215 \\ 111 \end{smallmatrix}$ v	3 $\begin{smallmatrix} 313 \\ 111 \end{smallmatrix}$ v	4 $\begin{smallmatrix} 411 \\ 111 \end{smallmatrix}$ v	5 $\begin{smallmatrix} 59 \\ 111 \end{smallmatrix}$ v	6 $\begin{smallmatrix} 67 \\ 111 \end{smallmatrix}$ v
		12 $\begin{smallmatrix} 124 \\ 111 \end{smallmatrix}$ v	8 $\begin{smallmatrix} 128 \\ 111 \end{smallmatrix}$ v	8 $\begin{smallmatrix} 236 \\ 111 \end{smallmatrix}$ v	8 $\begin{smallmatrix} 344 \\ 111 \end{smallmatrix}$ v	4 $\begin{smallmatrix} 122 \\ 111 \end{smallmatrix}$ v	4 $\begin{smallmatrix} 230 \\ 111 \end{smallmatrix}$ v	4 $\begin{smallmatrix} 348 \\ 111 \end{smallmatrix}$ v	4 $\begin{smallmatrix} 456 \\ 111 \end{smallmatrix}$ v	1 $\begin{smallmatrix} 216 \\ 111 \end{smallmatrix}$ v	2 $\begin{smallmatrix} 314 \\ 111 \end{smallmatrix}$ v	3 $\begin{smallmatrix} 342 \\ 111 \end{smallmatrix}$ v	4 $\begin{smallmatrix} 450 \\ 111 \end{smallmatrix}$ v	5 $\begin{smallmatrix} 568 \\ 111 \end{smallmatrix}$ v	6 $\begin{smallmatrix} 676 \\ 111 \end{smallmatrix}$ v		
		12 $\begin{smallmatrix} 133 \\ 111 \end{smallmatrix}$ v	8 $\begin{smallmatrix} 137 \\ 111 \end{smallmatrix}$ v	8 $\begin{smallmatrix} 245 \\ 111 \end{smallmatrix}$ v	8 $\begin{smallmatrix} 353 \\ 111 \end{smallmatrix}$ v	4 $\begin{smallmatrix} 131 \\ 111 \end{smallmatrix}$ s	4 $\begin{smallmatrix} 249 \\ 111 \end{smallmatrix}$ v	4 $\begin{smallmatrix} 357 \\ 111 \end{smallmatrix}$ v	1 $\begin{smallmatrix} 217 \\ 111 \end{smallmatrix}$ v	2 $\begin{smallmatrix} 315 \\ 111 \end{smallmatrix}$ v	3 $\begin{smallmatrix} 343 \\ 111 \end{smallmatrix}$ v	4 $\begin{smallmatrix} 451 \\ 111 \end{smallmatrix}$ v	5 $\begin{smallmatrix} 569 \\ 111 \end{smallmatrix}$ v	6 $\begin{smallmatrix} 677 \\ 111 \end{smallmatrix}$ v			
			8 $\begin{smallmatrix} 146 \\ 111 \end{smallmatrix}$ v			4 $\begin{smallmatrix} 140 \\ 111 \end{smallmatrix}$ v	4 $\begin{smallmatrix} 258 \\ 111 \end{smallmatrix}$ v	4 $\begin{smallmatrix} 366 \\ 111 \end{smallmatrix}$ v		1 $\begin{smallmatrix} 414 \\ 111 \end{smallmatrix}$ v	2 $\begin{smallmatrix} 512 \\ 111 \end{smallmatrix}$ v	3 $\begin{smallmatrix} 360 \\ 111 \end{smallmatrix}$ v	4 $\begin{smallmatrix} 478 \\ 111 \end{smallmatrix}$ v				
			8 $\begin{smallmatrix} 155 \\ 111 \end{smallmatrix}$ v			4 $\begin{smallmatrix} 159 \\ 111 \end{smallmatrix}$ v	4 $\begin{smallmatrix} 267 \\ 111 \end{smallmatrix}$ v			1 $\begin{smallmatrix} 513 \\ 111 \end{smallmatrix}$ v	2 $\begin{smallmatrix} 261 \\ 111 \end{smallmatrix}$ v	3 $\begin{smallmatrix} 379 \\ 111 \end{smallmatrix}$ v					
						4 $\begin{smallmatrix} 168 \\ 111 \end{smallmatrix}$ v				1 $\begin{smallmatrix} 612 \\ 111 \end{smallmatrix}$ v	2 $\begin{smallmatrix} 270 \\ 111 \end{smallmatrix}$ v	3 $\begin{smallmatrix} 388 \\ 111 \end{smallmatrix}$ v					
						4 $\begin{smallmatrix} 177 \\ 111 \end{smallmatrix}$ s				1 $\begin{smallmatrix} 711 \\ 111 \end{smallmatrix}$ s	2 $\begin{smallmatrix} 289 \\ 111 \end{smallmatrix}$ v						
										1 $\begin{smallmatrix} 810 \\ 111 \end{smallmatrix}$ v							
										1 $\begin{smallmatrix} 909 \\ 111 \end{smallmatrix}$ v							

Prohibitions

- ⊗ 4 schemes ruled out by Fiedler ca.79
- ⊠ 36 new schemes ruled out by Viro 80/83
- ⊠ V84=Viro's new prohibitions 1984/86

Constructions

- V=Viro80
- S=Shustin85/89
- W=Wiman23

the first octic is optional and just to note periodicity: ...most+.

modules a misprint prohibited in Viro86 [p.67, Art.(4.12)].

Here we a sporadic Viro prohibition breaking biperiodicity

those 3 Shustin's constructions are already announced in Viro86(p.67) Notice that if those Shustinian schemes would not exist then the Viro prohibition would propagate along a biperiodic lattice. Of course we are accustomed to such symmetry-breaking cf. e.g. the Rohlin table in degree 6.

Figure 5: Diagrammatic of the Fiedler-Viro prohibition for M -curves with 3 nests (4 schemes are obstructed by Fiedler 1982/83 and 36 by Viro 1980

- Viro 1980 [1527] where 52 types remained open among 104 logically possible (compare our Table=Fig. 154 to check this count which is not detailed in Viro's original 1980 paper). In this article both the Fiedler obstruction is boosted so as to exclude 36 types not previously excluded and a revolutionary method of construction is employed to realize 42 new schemes (probably encompassing all the previously known constructions but Viro is modest enough to count just the newcomers); the impressive list of 42 schemes obtained by Viro is resumed either on our Table 154 or on Viro's original table in 1980 [1527] (which as we said contains only a little mistake of 8 schemes which are misplaced in the series $p = 19, n = 3$). Viro's table contains additionally the information of which singularities X_{21}, J_{10}, N_{16} are dissipated. Some details of Viro's construction are presented in Viro 89/90 [1535]. Here we learn the issue that in contrast to degree 6 where nearly all schemes could be obtained by perturbing a triplets of 3 coaxial ellipses, the quadri-axial configuration of 4 ellipses (*Viro's earrings* for short) leads only to a special class of M -curves and create "only" 47 of them. Once we are given the dissipation of the fourfold X_{21} singularity (4 branches with 2nd order tangency), compare Fig. 55 in Viro 89/90, or our figure below (Fig. 6), it is merely a matter of patchworking to construct the corresponding curves, yet this is so pleasant that it is worth being published once in full details. As far as we know this was never exposed in full for typographical reasons (apart probably in Polotovskii 1988) and so let us for convenience work out the relevant picture leading to Viro's breakthrough.

2.2 Viro's method for M -octics

[04.05.13] First, one of Viro's pivotal idea is to smooth a configuration of 4 coaxial ellipses (Fig. 6b). Here appears Hawaiian-earring singularities (or of type

X_{21} in Arnold's catalogue of 1975 [61]). (Remind Thom's influence upon Arnold in 1965 and probably also some overall influence of Klein upon Arnold.) We confess not being acquainted with Arnold's classification (for the moment), yet this is no obstacle for understanding the sequel (i.e. Viro's fable).

The next duty is to understand (the maximal) smoothing of this singularity, those being depicted on Fig. 6a. We see clearly how the 4 branches are reconnected among themselves, while the Greek letters in bracket denotes pululation of newly created ovals emerging through dissipation of the singularity in quantity specified by the table below each picture. On the right dissipation (V3=Viro3), there is additionally a little circle which is an enveloping oval. We personally do not checked (nor do we understand this result), but again this is no obstacle to understand the sequel. (Full details seems to be given in Viro 89/90 [1535] but the method dates back from the announcement in 1980 [1527].)

The details we give now, albeit elementary, require some tedious combinatorics that is (never?) user-friendly presented. The idea is to glue (or patchwork) independently (like in Brusotti 1921) both singularities so as to create (many) global curves of degree 8. First we can choose any one of the 3 smoothings V1,V2,V3, and glue it with itself after rotating (and translating) the pattern by 180 degree. So we get Fig. 6c, which are only $(M - 2)$ -curves. The reason is fairly simple, namely that 2 large ovals are created while the number of micro-ovals $\alpha + \beta + \gamma$ is always 9, even in the case of $\delta + \varepsilon = 8$ (but keep in mind the micro-circle). To get better curves we must somehow twist (say) the upper dissipation by a reflection (symmetry along the vertical axis) to get "starred" Viro's smoothing $V1^*$, etc., those being depicted on Fig.d. Then we see 4 large ovals reminding Viro's funny-face (to everyone knowing him personally) to which are added $2 \cdot 9$ micro-ovals reaching therefore Harnack's bound at $4 + 18 = 22 = M$. It is then only a matter of combining all possible smoothings, creating thereby the table below each picture of Fig. d. Here symbols are written along the Gudkov-Polotovskii as opposed to Viro's symbolism which contains too much symbols without real significance (like squarecups and angled-brackets). With Viro's cumbersome symbolism it would never have been possible to represent everything on a single page as compactly as we do on Fig. 6d.

A minority of those schemes were already obtained by forerunners of Viro (Harnack76=Ha, Hilbert91=Hi, Wiman23=W, Gudkov72=G, Korchagin78=K78), but now there is a plethora of new schemes (marked by "V" on the tables). Those are apparently completely inaccessible to the classical methods, even when twisted by Cremona transformations like in Gudkov's trick (fixing Hilbert's 16th in degree 6), or in Korchagin's variant of Brusotti. Of course we cannot exclude that a clever variant of Brusotti being able to create one or two sporadic schemes, yet Viro's method affords a whole series of them with comparatively little efforts.

Working out this table requires some few minutes of concentration. One trick is to find a general formula for the resulting Gudkov symbol by contemplating the curve traced on Fig. d. After some few items are calculated, one can propagate the symbols by looking at increments undergone by the parameters (α, β, γ) and the story reduces to pure arithmetics without having to refer back to the picture. This is extremely pleasant to work out and one can hardly underestimate the level of ecstasy in which Viro must have been when discovering this ca. 1979/80.

A further pleasant duty is to report all schemes so generated upon the table (Fig. 154) by marking with little green-squared letters "V" the schemes so obtained by Viro. The first curves involving $V1/V1^*$ fills 10 schemes in the lowest row of the table, the 2nd curves involving $V2/V2^*$ runs through 22 distinct schemes (duplicata being ignored) in the highest row of the table, while the 3rd curves involving $V3/V3^*$ create only 3 schemes in the middle row of the table.

At this stage we have realized many schemes (precisely $10 + 22 + 3 = 35$ maximal schemes) arising through perturbation of 4 coaxial ellipses. This is perhaps worth stating as a separate statement regardless of the fact that a minority of those were obtained by $Ha=2, Hi=2, W=1, G=2, K78=1$ (yielding

It seems of interest—from a naive standpoint at least—to look at what Viro’s method generates when allowing exotic parameters (α, β, γ) of smoothing. First, in order to land in the bosonic strip we choose twice $\beta = 0$ on Fig. d. Then we reproduce the above table yet with extended (unrestricted) parameters of bubbling $\alpha, \beta = 0, \gamma$. (The bold faced characters are the permissible parameters). This gives the large table of Fig. 7 below with obvious regularity (i.e. each horizontal row is self-reproduced via a diagonal translation along the South-West direction). All the other six tables are just replicas of the upper table safe for the position of the red-crosses. Interestingly the two prohibitions of Orevkov (namely $1\frac{3}{1}\frac{16}{1}$ and $1\frac{6}{1}\frac{13}{1}$) forbid conjointly all the crossed dissipations, i.e. $(7, 0, 2)$, $(6, 0, 3)$, $(4, 0, 5)$, $(3, 0, 6)$, $(1, 0, 8)$, $(0, 0, 9)$. In some more details we can inspect for each bosonic curve, which dissipation are killed by an oracle (an Orevkoracle say) proclaiming the nonexistence of the boson in question. Actually, the boson $1\frac{1}{1}\frac{18}{1}$ kills only two dissipations, $(9, 0, 0)$ and $(0, 0, 9)$. The pseudo-boson $1\frac{3}{1}\frac{16}{1}$ (whose nonexistence is due to Orevkov) kills the 3 dissipations $(7, 0, 2)$, $(1, 0, 8)$, $(0, 0, 9)$. Next, the boson $1\frac{4}{1}\frac{15}{1}$ kills the 3 dissipations: $(7, 0, 2)$, $(6, 0, 3)$, and $(1, 0, 8)$. Then, the pseudo-boson $1\frac{6}{1}\frac{13}{1}$ (ruled out by Orevkov) kills 3 dissipations $(6, 0, 3)$, $(4, 0, 5)$ and $(3, 0, 6)$. Thereafter, the boson $1\frac{7}{1}\frac{12}{1}$ (positing its nonexistence) kills the 3 dissipations $(9, 0, 0)$, $(4, 0, 5)$ and $(3, 0, 6)$. Finally, the boson $1\frac{9}{1}\frac{10}{1}$ (positing its nonexistence) kills 5 dissipations, namely $(7, 0, 2)$, $(6, 0, 3)$, $(4, 0, 5)$, $(1, 0, 8)$ and $(0, 0, 9)$. It may be observed that nobody succeeds to kill the dissipation $(5, 0, 4)$, whose existence would however not produce new schemes. Also it is quite puzzling to try a measurement of the eccentricity of a boson via the number of crime it effects via Viro’s method of gluing. Naively they more criminal a boson is, the more mysterious and difficult to catch it should be. So perhaps if the criminality index is ≥ 4 , then the boson does not exist, whereas if it is low ≤ 2 the boson exist. Perhaps, when this index is 3 then both cases could occur, but we are rambling into pure speculations due to a lack of geometric understanding.

It is also tempting to speculate about a soft-universe in which the dissipation obstructions implied by Orevkov’s 2 prohibitions are the sole ones. In this world, the permissible dissipation would be $(9, 0, 0)$, $(8, 0, 1)$, $(5, 0, 4)$, $(2, 0, 7)$. Then, Viro’s method would materialize the 3 bosons $1\frac{1}{1}\frac{18}{1}$, $1\frac{4}{1}\frac{15}{1}$, $1\frac{7}{1}\frac{12}{1}$, but not the last one $1\frac{9}{1}\frac{10}{1}$ as shown by a quick inspection of the table. Of course in principle Viro’s theory is complete for the singularity X_{21} and thus we have just the two bold-faced dissipation available, and accordingly only the solitary scheme listed by Viro. Here a solitary scheme means a doubly nested scheme with only one outer oval so as to be in the bosonic strip.

Alas, we lack a direct geometric interpretation of the dissipation of X_{21} as a global geometric object, akin to the smoothing of an ordinary multiple point (say m -fold point) directly interpretable as an affine curve of degree m . With such an analogy available, probably that most restriction could reduce to Hilbert-Gudkov’s classification of M -sextics.

Added[06.08.13].—Actually it seems worthwhile to tabulate as well the mixed dissipation V2/V3 which still leads to M -schemes. We had not the time to complete this, but probably we do it more systematically elsewhere in this text.

3.2 Extended Viro’s composition table

[06.08.13] It seems important to work out extended tables of compositions as to understand which dissipations are forbidden for global reasons. We shall construct four large tables extending Viro’s composition (Fig. 6) by allowing all logically permissible values of the parameters. As a result, we shall either get new schemes (in case Viro’s patches list was too confined), or, patch censorship whenever the resulting global scheme is prohibited.

Those extended tables appeal the following comments.

[V1/V1] Schemes of this table V1/V1 land in the sub-nested realm while realizing both bosons. The structure of this table is very simple, e.g. invariant along all anti-diagonals. In particular, the quadri-ellipse could create all schemes

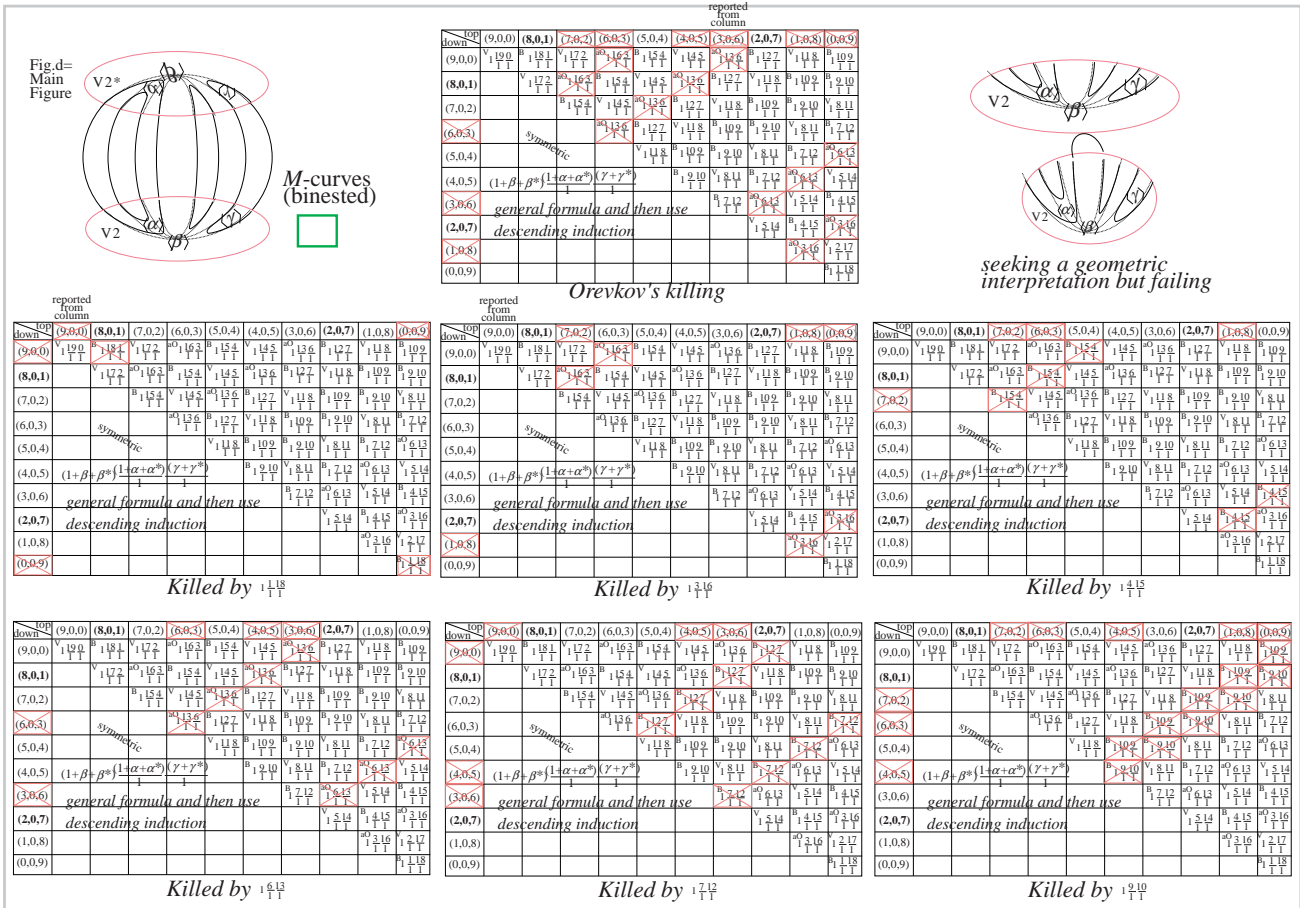

Figure 7: Viro's extended bosonic patchwork, yet no serious foundations

of the 3rd pyramid in a very continuous fashion safe those of Shustin's strip (zero outer ovals). This could trivialize all M -species cooked by Korchagin (19 many), Chevallier (4 many), Orevkov (one), constructed along more tricky procedures. Alas, it seems that there is more rigidity in the dissipation of singularity X_{21} (alias quadruple flat point). Since none of the subnested schemes is presently known to be prohibited, we cannot exclude any of the 15 logically possible dissipations of X_{21} compatible with Gudkov periodicity. It can be remarked that the number of big eggs is quantified as 2,6,10,14,18 (fourfold periodicity), and this forces β to be 1 or its companions modulo 4 (i.e., 5, 9).

[V2/V2] On this 2nd table we land in the binested realm, where reigns deep braid-theoretic obstructions of Orevkov. This rules out six patches: (7, 0, 2), (6, 0, 3), (4, 0, 5), (3, 0, 6), (1, 0, 8) and (0, 0, 9). However two patches with $\beta = 0$ are left intact (namely (9, 0, 0) and (5, 0, 4)). Those are enough to create all binested bosons safe one, within Viro's simplest method of the quadri-ellipse.

Added [07.08.13].—On the central table of crosses and circles (sembling the famous game of life/go), crosses indicate patches killed by dematerialization of a boson (scheme). Circles indicates pseudo-kills of a pair of patches (Heisenberg incertitude). One remarks quickly that pseudo-bosons known to exist (three of them thanks to Viro) kill relatively few patches if they would dematerialize: b_2 kills only one patch and so does b_8 (yet killing twice his victim). As to b_5 it kills only 2 patches. In contrast, the 2 anti-bosons of Orevkov (known to dematerialize!) kills both 3 patches. Positing that nature dislikes criminals, we may expect the following moral akin to *Kant's imperative (moral) law*:

Scholium 3.1 *As soon as a (bosonic) scheme kills 3 or more patches, then it is highly criminal. Nature cannot tolerate such serial killers. From this standpoint, both bosons b_4 and b_9 are criminal (with resp. 3 and 5(!) murders) hence judged impossible. Instead, the bosons b_1 and b_7 kill only two patches hence tolerated by society and more likely to exist. Concretely it suffices for the patch (9, 0, 0)*

(As a matter of fuck, if the double point is dissipated while creating a micro-oval then Harnack would be foiled by the way.) We can still imagine and trace with our heuristic embryo method complicated singular octics with a singular point X_{21} plus another distribution of triple points while expecting to get curves obstructed by Viro's imparity law, say.

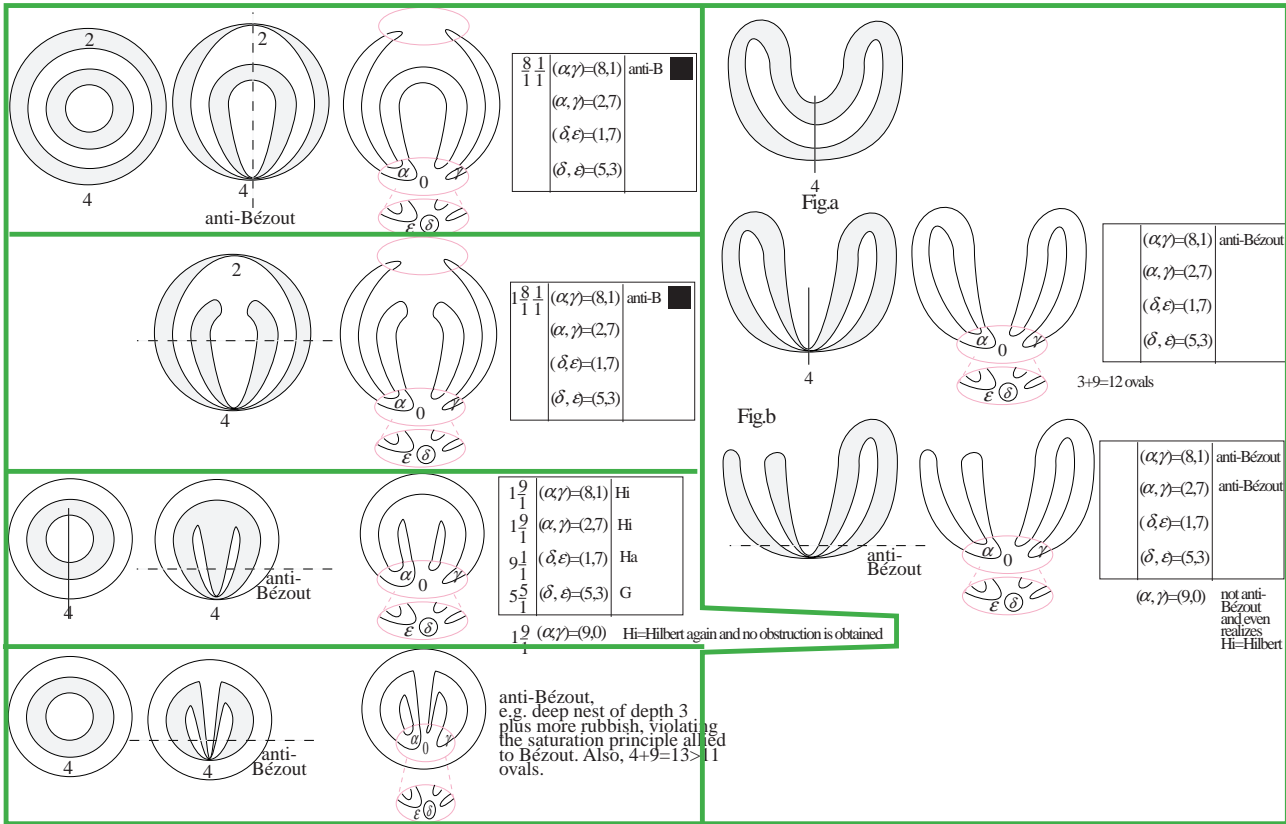

Figure 9: Testing the patch $V3(9,0,0)$ in degree 6 (but completely erroneous)

Scholium 3.2 *Even under Orevkov's prohibitions (only 2 schemes yet severe damages over 6 patches), it is still possible for Viro's simplest method to create 3 among the 4 binested octic M-schemes, namely all but $1 \frac{9}{1} \frac{10}{1}$, which deserves perhaps the name of Higgs boson. Yet, a closer look to the table V2/V3 shows that Viro's imparity law kills the patch $V2(5,0,4)$, and thus the hope to get $b4 := 1 \frac{4}{1} \frac{15}{1}$.*

Proof. Look at the grid, and see that all red-colored rows are killed by Orevkov. Propagating anti-diagonally the Gudkov symbols we see that each of our bosons can only be realized once on the upper row of the bosonic submatrix (yellow framed). This holds true with the exception of Higgs boson which lacks any such realization. ■

More information comes from the combined smoothing $V2/V3$, landing in the trinested realm interspersed by a myriad of Fiedler/Viro prohibitions. This supplies additional information. Perhaps we should stay critical about those highbrow prohibitions, which eventually falsify the definitive solution of Hilbert's 16th problem in degree 8.

[07.08.13] Now let us tabulate the $V2/V3$ composition of patches. From the scratch we observe that $V3$ -list is very short, yet perhaps it could be enlarged by introducing a 3rd parameter φ counting ovals at other places, e.g. in the strip of the two nested arcs, i.e. like the α -position of the patch $V2$. Yet let us skip this difficulty for the moment.

On doing this table (Fig. 8) we see that the patches $(3,4,2)$ and (Tupolev) $(1,4,4)$ are prohibited by Viro's imparity law (VIL). Contrarily, the patch $(9,0,0)$ is left intact as it creates admissible schemes. Then, $(7,0,2)$ is killed

by VIL, but was already by Orevkov. Next, $(6, 0, 3)$ is not killed by Viro, but was by Orevkov. Then, $(5, 0, 4)$ is killed by Viro but was not by Orevkov. The sequel is perfectly regular obeying an evident periodicity of two. So, $(4, 0, 5)$ is not prohibited by Viro, but was by Orevkov. As to $(3, 0, 6)$ it is prohibited by both Viro and Orevkov, and idem for $(1, 0, 8)$. Finally, agent $(0, 0, 9)$ is not killed by Viro but was by Orevkov.

This may be summarized

Scholium 3.3 *Many, but by far not all, restrictions on Viro's diagram of dissipations for V2 are explained by Viro's imparity law. Compare the red crosses on Fig. 8V2/V3 leaving open the patches $(9, 0, 0)$, $(6, 0, 3)$, $(4, 0, 5)$ and $(0, 0, 9)$. After finer sieving under Orevkov's behalf, from those only survives $(9, 0, 0)$ (apart of course the patches declared existing because constructed by Viro).*

Reporting those Viro obstructions on the former table V2/V2 via black bullets we see that only $(5, 0, 4)$ is additionally killed in the bosonic range ($\beta = 0$), yet the hypothetic smoothing $(9, 0, 0)$ still leaves open the realizability of two bosons via Viro's simplest method (quadri-ellipse=quadri-lips), namely $b1 := 1\frac{1}{1}\frac{18}{1}$ and $b7 := 1\frac{7}{1}\frac{12}{1}$. So:

Scholium 3.4 *The simplest bosons are perhaps $b1$ and $b7$. (Compare eventually with Scholium 6.15 which gave exactly the same conclusion.)*

Could it be that experts missed to mention this miraculous patch $(9, 0, 0)$? If not, what is the reason prohibiting it? As far as we know this question is still open today. For cross-reference, let us formulate this separately:

Question 3.5 (Patch mirabilis) *Consider the patch V2(9, 0, 0) as defined by Fig. 8. If someone succeeds constructing this patch, then two new bosons are materialized, and so Hilbert's 16th is advanced. So our question is whether anybody on the planet knows about a technique to forbid this patch. (Remind that neither Viro's imparity law nor Orevkov impeded this patch.)*

Another question, is how would the world looks alike if Orevkov's link theoretic obstruction(s) collapse(s), yet Viro's imparity law persists true. In this scenario, the periodic table of elements becomes Fig. 10. Let us call for simplicity a *boson* just a binested M -scheme with the minimum possible of one outer oval (as imposed by Gudkov periodicity, i.e. Rohlin's signature theorem modulo 16). On reporting on the table V2/V2 the obstruction coming from Viro's oddity law on the table V2/V3, we get the red colored strip obstructed. Then for each boson (each appearing twice palindromically in the upper-right strip of the bosonic sub-matrix) we may extend its symbol anti-diagonally while avoiding the red-strips forbidden by Viro. Encoding by bn the boson with symbol $1\frac{n}{1}\frac{19-n}{1}$ we see that the zeroth boson $b0 = 2\frac{19}{1}$ admits one realization nearby the quadri-ellipse. Remind at this stage that there is only one (known) construction of this scheme via Viro's horse. For the 1st boson $b1 = 1\frac{1}{1}\frac{18}{1}$ it admits 2 realizations, etc.

In the hypothetical scenario that all Viro admissible patches are practicable we see that *all* bosons would be constructible, and Hilbert's 16th puzzle would be settled (modulo an understanding of the 2 bosons in the subnested case).

It remains next to analyze what happens if we introduces an extra parameter λ in the patch V3. Here the relevant table is given in Fig. 11. First, when introducing this extra parameter it is not clear where to place it: either in the doubly nested lune on the left part of the patch or in the two simple lunes on the right side. Of course, it cannot be nested inside the double lune without troubleshooting Bézout. Further it could be placed in the inner simple lune, yet by analogy with V2, micro-ovals tend perhaps to be spread along the main tangential direction so that they are rather distributed in the lateral simple lune on the extreme-right of Fig. V3. Apart from this, we could a priori imagine that micro-ovals can appear in both the double and simple lunes on the extreme left-

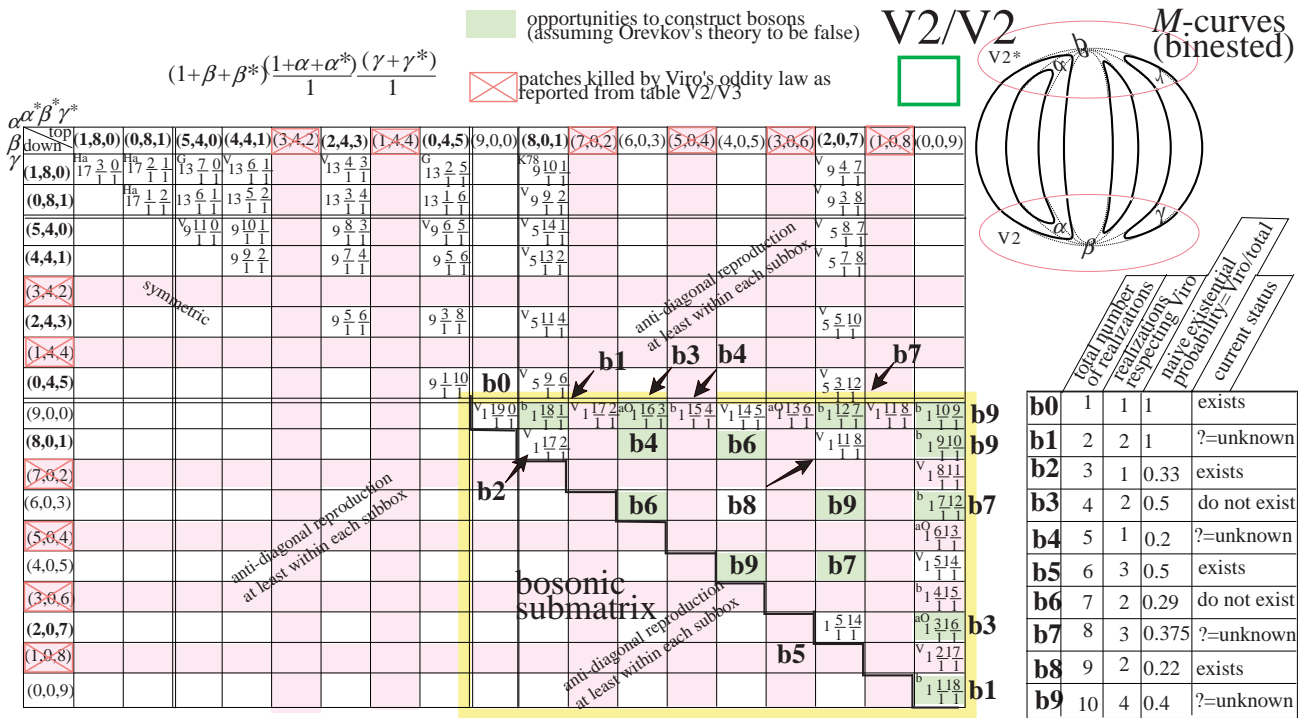

Figure 10: In a world where Orevkov's obstructions are wrong, all binested bosons could be (spontaneously) created out of Viro's quadri-ellipse

and right parts of the patch V3. If so is the case, we need a 4th parameter (say ρ) to describe the generic patch V3. So (λ, ρ) stand for left and right.

One important remark is that if glue V3 with itself symmetrically, then the scheme will be quadruply-nested (quadri-nested) at least for generic values of $\delta > 0$ and $\rho > 0$. Accordingly, it seems realist to set $\rho = 0$ throughout, safe when $\delta = 0$ but then maybe Gudkov periodicity is not fulfilled, or alternatively the patch V3 degenerates to the patch V2.

Hoping not to miss something essential, let us first work out a table with only 3 parameters $\delta, \varepsilon, \lambda$. Now the basic idea is that the δ many micro-ovals are Swiss-cheese holes white colored in the Ragsdale membrane and those holes may be transmuted to the position λ without changing the Euler characteristic. So of each of the God-Viro's given parameters generate a little cascade of new parameters, where δ is successively diminished by one unit. In contrast it seems that ε is predestined by Gudkov periodicity, and cannot do small fluctuations without changing χ . For ε -ovals, the main option would be to jump in the inside of the doubled lune, yet this causes troubles with Bézout unless $\delta = 0$.

On composing V3 with itself we see that Viro's imparity law kills the dissipation $(4, 3, 1)$ and $(2, 3, 3)$, but not all the others. However it must be remarked that the schemes so created are all fairly standard, in particular never conflict with Viro's sporadic obstructions. It may be hoped that the true secrets will be revealed in the composition table of V2/V3. Here when filling along vertical lines the 1st surprise comes when composing $(6, 0, 3)$ with $(3, 3, 2)$ as we meet then Viro's sporadic obstruction (those being represented by orange crosses, as they are more likely to be false than the red crosses materializing Viro's imparity law). Completing this table shows that Viro's imparity law prohibits only the V3-patches $(4, 3, 1)$ and $(2, 3, 3)$, hence actually exactly the same as those ruled out by the V3/V3 table. Of course, it should be no surprise that we never visited the bosonic strip, since looking at the scheme of V2/V3, for it to be binested requires $\gamma = 0$ but then we see 2 outer ovals (and not just one as in the bosonic strip). It seems strange that we only met one of Viro's sporadic obstruction; yet, contemplating once more the table of elements (e.g. Fig. 95) one sees that all of Viro's sporadic obstructions (safe one) concerns trinested schemes without outer ovals, while our gluing V2/V3 exhibits at least one such

(at least formally, i.e. via basic patchwork and his oddity law). Hence one could speculate that at least the half of Orevkov's obstruction pertaining to b_6 is wrong.

Proof. Just look at the tables (especially Fig. 8 and 11). ■

3.3 What if Viro's imparity law is false: the big decongestion

[08.08.13] Speculating that even Viro's oddity law is wrong, the dissipation theory of X_{21} could be much richer and the world would be a completely different smooth porridge, with Hilbert's 16th in degree 8 (potentially) much more trivial. Even if this scepticism about Viro's oddity law may look retrograde, we remark two interesting points. First, it seems important to appreciate exactly the shape of this simplified world with an abundance of patches. Second, it may be remembered that without Viro's oddity law, Shustin's disproof of Klein's (pseudo)-Ansatz (Klein vache) as well as his disproof of one half of Rohlin's maximality principle would be ruined.

We may fix as ground postulate that the dissipation theory of X_{21} is unobstructed, i.e. all values permissible with Gudkov hypothesis are realized.

First, notice that the upper right corners of the table V1/V1 (Fig. 8) fills out with perfection the five rows of the 3rd subnested pyramid, safe for the schemes with zero outer ovals where reigns a Shustin obstruction. Could Shustin's obstruction be false as well? This looks a serious challenge because as yet we never succeeded to reach this zone even under dubious flexible pseudo-construction. At least it is noteworthy that since the mandarine's range fails exploring Shustin's strip, the latter fails inducing patches obstructions. (Added in proof: We shall see later that this is not perfectly true, if we work more liberally by allowing all patches). So let us state this as follows:

Lemma 3.7 *If the dissipation theory of V1 is unobstructed then all schemes of the 3rd pyramid are created in a very continuous fashion via table V1/V1 of Fig. 8. In particular many tricky constructions of Viro (horse and beaver), Korchagin, Chevallier, Orevkov could be relegated and everything could be accessed from the mandarine (alias quadri-ellipse). In particular the 2 subnested bosons $B4 := 4(1, 2\frac{1}{1})$ and $B14 := 14(1, 2\frac{1}{1})$ would be created.*

It is important to notice that the patches V2 and V3 are somehow coupled, i.e. can be married in the joy of Harnack maximality, whereas V1 is isolated. Of course we can imagine an avatar of V1 (say V0) with a micro-nest outside, but when gluing V0 with itself produce a nest of depth 3 plus one of depth 2 creating thereby 10 intersections with the line through their centers.

One of the most important paradigm of the theory is independency of smoothings. Perhaps this has to be revised as well, or requests hardwork à la Viro/Shustin, etc.

Finally one may wonder why Viro does not mention the option of a 4th patch V4 with 2 nested lunes, or even 4 unnested lunes. Actually one can also have an external branch and three lunes inside. This latter patch looks especially important as it lands in Shustin's range (subnested but no outer ovals). This leads us to the next section of exotic patches, not listed by Viro but logically possible at least a priori. This will sidetrack us into the combinatorial study of all those patches.

3.4 Exotic patches

[14.08.13] The goal of this section is to prove:

Theorem 3.8 *Singularity X_{21} (flat quadruple point with 4 branches lying in the same half-plane and having 2nd order contacts between themselves) can be maximally dissipated (with nine micro-ovals bubbling out) along any one of the 14 ways described by Viro ranked into three classes V1, V2, V3. Together with*

the symmetric patches yields a total of 28 smoothings of X_{21} (as many as those of the 7-sphere according to Milnor-Kervaire).

Yet, there is maybe more “exotic” dissipations, potentially as many as the white circles of Fig. 12. Along their hypothetic existence, one could primarily construct some few new bosons (perhaps all of them!), and secondarily recreate old schemes (especially those of Korchagin, Chevallier) via the most basic Viro method, thereby gaining a discriminantal kinship (Verwandschaft) limitropheness between such schemes and the quadri-ellipse.

Finally, in principle all patches crossed off on Fig. 12 are prohibited.

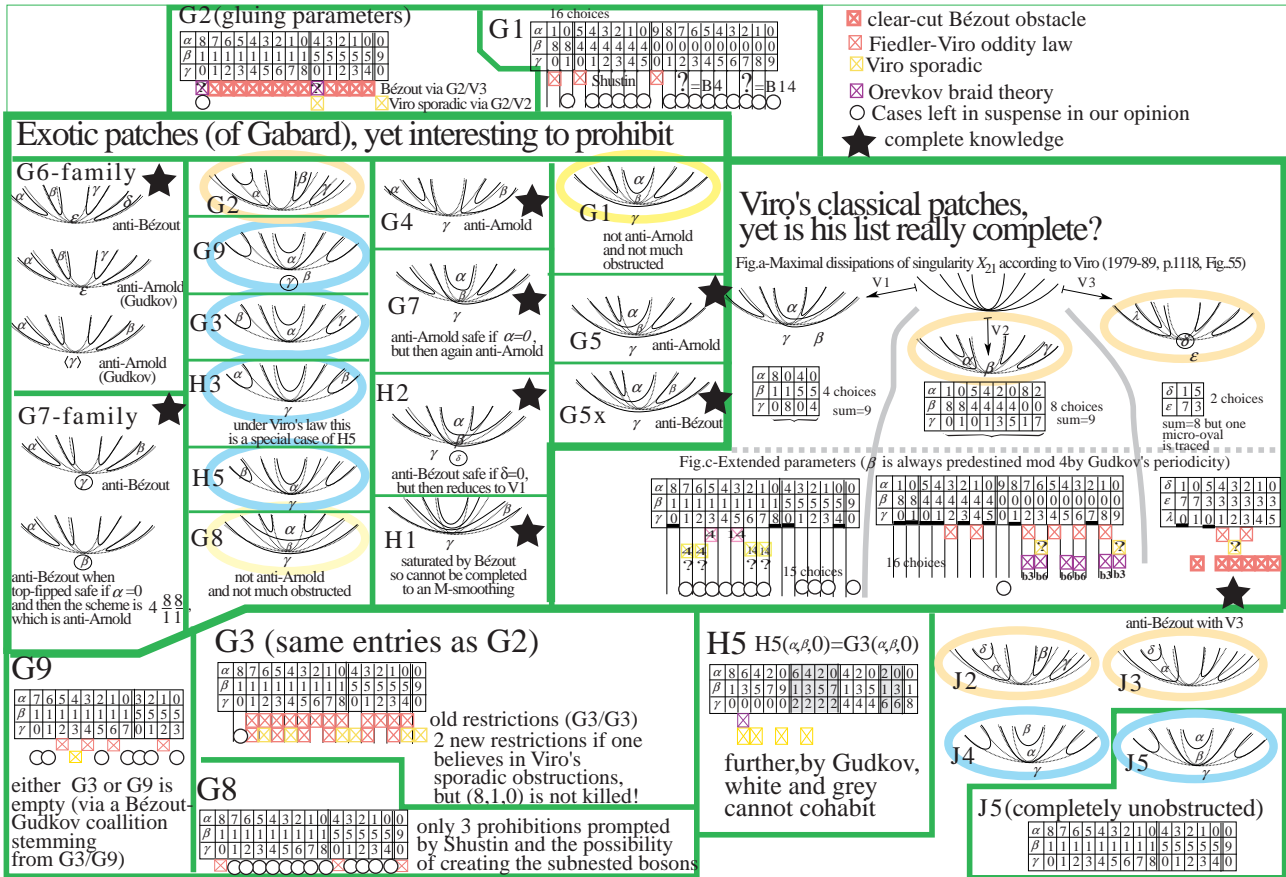

Figure 12: A mess of exotic patches (cf. also Fig. 18 for a rationalization)

[08.08.13] We look first at the patch G1 (for Gabard) on Fig. 12 albeit Viro certainly thought about it yet without listing it as he was probably not able to construct it (or maybe knew obstructions as early as 1980). Then we glue the patch with a symmetric replica and contemplate the resulting patchwork. On it we see two big eggs are traced. The table of elements (Fig. 95) reminds us that Gudkov periodicity predestines this number to be precisely 2 modulo four-fold periodicity (6, 10, 14, 18). Therefore we choose $\beta = 0$ modulo a periodicity of 4. Then, we can build the table of parameters (α, β, γ) for the number of micro-ovals bubbling in the G1-patch, whose (extended) parameters are actually the same as for V2. Next, we build the composition table by dissipating independently both singularities. The schemes so obtained are essentially the same as for V1/V1, modulo the crucial difference that we now obtain the schemes prohibited by Shustin. Few basic remarks on the table: the evolution is same horizontally as vertically, with quantum jumps across double bars. Therefore the table propagates anti-diagonally and we need just writing the symbols occurring in the upper-right corners of each sub-boxes. Remarkably, each of those corner-strips fills precisely one row of the 3rd pyramid so that the last item is actually on the top of the 1st pyramid. Also, the first element of each corner-strip is prohibited by Shustin. Of course globally the whole is diagonally symmetric.

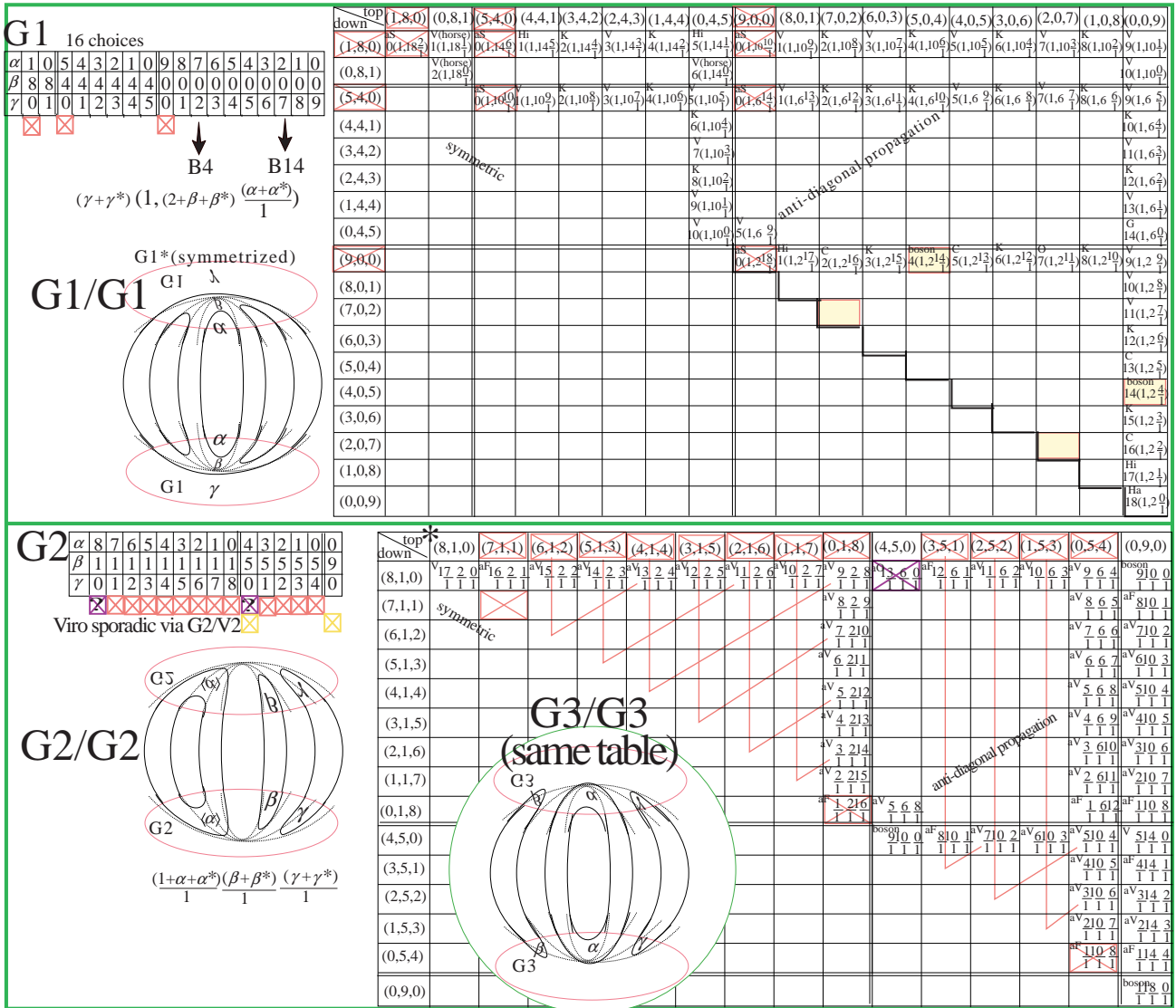

Figure 13: Patchworking exotic patches

Granting Shustin's obstructions as correct, each anti-Shustinian scheme situated on the main diagonal kills the corresponding patch-parameter. So, Shustin's prohibition of $(1, 18\frac{2}{1})$ kills $(1, 8, 0)$, $(1, 10\frac{10}{1})$ kills $(5, 4, 0)$, $(1, 2\frac{18}{1})$ kills $(9, 0, 0)$. The two other obstructions by Shustin not directly situated on the diagonal kills no definite patches but a pair of patches with quantum incertitude about who is exactly killed. For instance the anti-scheme $S_{14} := (1, 14\frac{8}{1})$ kills either $(1, 8, 0)$ or $(5, 4, 0)$, yet without precisizing which one. Actually due to the alinement of all this table, it turns out that both patches are killed by schemes situated on the diagonal. Yet we could imagine a world where the diagonal Shustin obstructions are true but not the others. Further it can be speculated about the dematerialization of the two bosons and taking the diagonal representative it results a destruction of a patch, namely $(7, 0, 2)$ and $(2, 0, 7)$ respectively.

Starting from zero knowledge (e.g. ignoring Shustin) we do not know even which patches actually exist. If so then we could have more destruction of patches than those merely coming from item on the diagonal.

In reality, it seems that all the G1-series of patch is empty as it is not listed in Viro 89. It is not clear if Viro just dresses a list of patch (he is able to construct) or if he is claiming completeness. A priori, G1 could lead to monsters (e.g. corrupting Bézout) when glued with other V-patches. Yet, we doubt this to be the case. So the scholium is:

Scholium 3.9 *Could it be that Russian scholars missed some patches so that*

series, namely $(8, 1, 0)$, $(4, 5, 0)$ and $(0, 9, 0)$. Postulating their (collective) existence would create a simple scheme by Viro, a corruption of Orevkov and two bosons including Higgs's one $1\frac{9}{1}\frac{10}{1}$, which is perhaps the most elusive of all. Of course to be politically correct (joke of Viro, in Geneva ca. 2010) w.r.t. Orevkov we could only activate sub-collection of patches. As $(8, 1, 0)$ self-combined with itself yields a known scheme of Viro it is the most likely to exist, yet we may imagine that the 2 others exists individually as well, and this would create new bosons. Now assume that $(8,1,0)$ exists, and thrusting in Orevkov's anti-scheme then $(4, 5, 0)$ is killed yet we could still posit existence of $(0, 9, 0)$ and thereby materialize Higgs boson $b9$ and $b1$. All this without conflicting with factual knowledge.

Update [01.10.13].—In fact the opportunities to get those bosons via G3, are killed if one considers the symmetry of bending discussed on Fig. 48. Indeed bending the patch yields one with a double couche (class I in the catalogue) and those corrupt Bézout even when $\gamma = 0$ since flipping the patch creates two subnets. The sole case actually is when both lateral parameters (β, γ) vanish, yet this is not in line with Gudkov periodicity.

Maybe composing G1 with another patch we can really visit Viro's sporadic obstructions and so rule out more G2-patches. Yet this deserves to be studied tomorrow.

Added [14.08.13].—It seems that we missed to combine G2/V2 and G2/V3. From the latter it is inferred that G2 is nearly empty safe 3 places without recourse to Viro's oddity law but just Bézout. Precisely, G2/V3 is quadri-nested (because $\delta > 0$) unless β or γ is zero. Yet $\beta \equiv 1 \pmod{4}$, so that $\gamma = 0$. This leaves only the three values $(8, 1, 0)$, $(4, 5, 0)$, and $(0, 9, 0)$. Next, we may dress the G2/V2-table hoping to get more obstacles, yet this expectation is probably not borne out. Actually it suffices to fill the table along rows not yet prohibited. Along the first horizontal row we meet Viro's imparity law yet at a V2-entry not existing hence no destruction of G2(8,1,0) is inferrable. On filling more the table a 1st surprise occurs with entry G2/V2= $(4,5,0)/(8,0,1)$ where a sporadic Viro obstruction kills G2(4,5,0). The next surprise occurs when Viro's most sporadic obstruction on the apocalyptic symbol (year) $4\frac{3}{1}\frac{3}{1}\frac{9}{1}$ kills the patch G2(0,9,0). A 3rd surprise comes when Viro's anti-scheme $\frac{1}{1}\frac{9}{1}\frac{9}{1}$ kills a second time G2(0,9,0), yet still through a sporadic obstruction. A 4th surprise occurs when Viro's anti-scheme $\frac{3}{1}\frac{7}{1}\frac{9}{1}$ kills once more again our patch G2(0,9,0), hence accusing triple mutilation. At the end, it seems still worth looking explicitly at the table G2/V3, which is microscopic if we restrict attention to the sole entry in doubts. This mini-table yields no (supplementary) obstruction, as all tabulated schemes are either due to Viro or Shustin. Let us resume this with a:

Lemma 3.10 *Provided a suitable sub-collection of Viro's sporadic obstructions is true, the patch family G2 collapses to a single representative G2(8,1,0) whose existence is not even granted. It could be imagined that even if this patch existed it would result no news on Hilbert's problem. This is in part true, since through the table G2/G2, the patch in question $(8, 1, 0)$ only produces the boring scheme $1\frac{2}{1}\frac{17}{1}$ due to Viro, but also in part false because via the table G2/V2, G2(8,1,0) glued with the hypothetical V2(9,0,0) creates the boson $1\frac{1}{1}\frac{18}{1}$ not yet known.*

Added [14.08.13] It seems that we missed a discussion of the patch H3 of Fig. 12. First it seems advisable to consider directly the more general patch H4. On gluing H4 with a symmetric copy (our notation H4/H4) we see that Viro's law forces at least one of the parameter β or γ being zero. By symmetry of the patch we may w.l.o.g. assume $\gamma = 0$, and so we arrive at the new patch H5, where we just relabelled according to alphabetic order. We may allow a parameter quantified by 2 and not 4 yet still respecting Gudkov periodicity. Note that we already normed β odd not to conflict with Viro's law. The table H5/H5 shows that we find no *pure* obstruction (along the diagonal), safe one implied by Orevkov's (anti)-boson $b6 := 1\frac{6}{1}\frac{13}{1}$. In contrast the other Orevkov's boson $b3 := 1\frac{3}{1}\frac{16}{1}$ misses his chance to hit properly the diagonal (under anti-

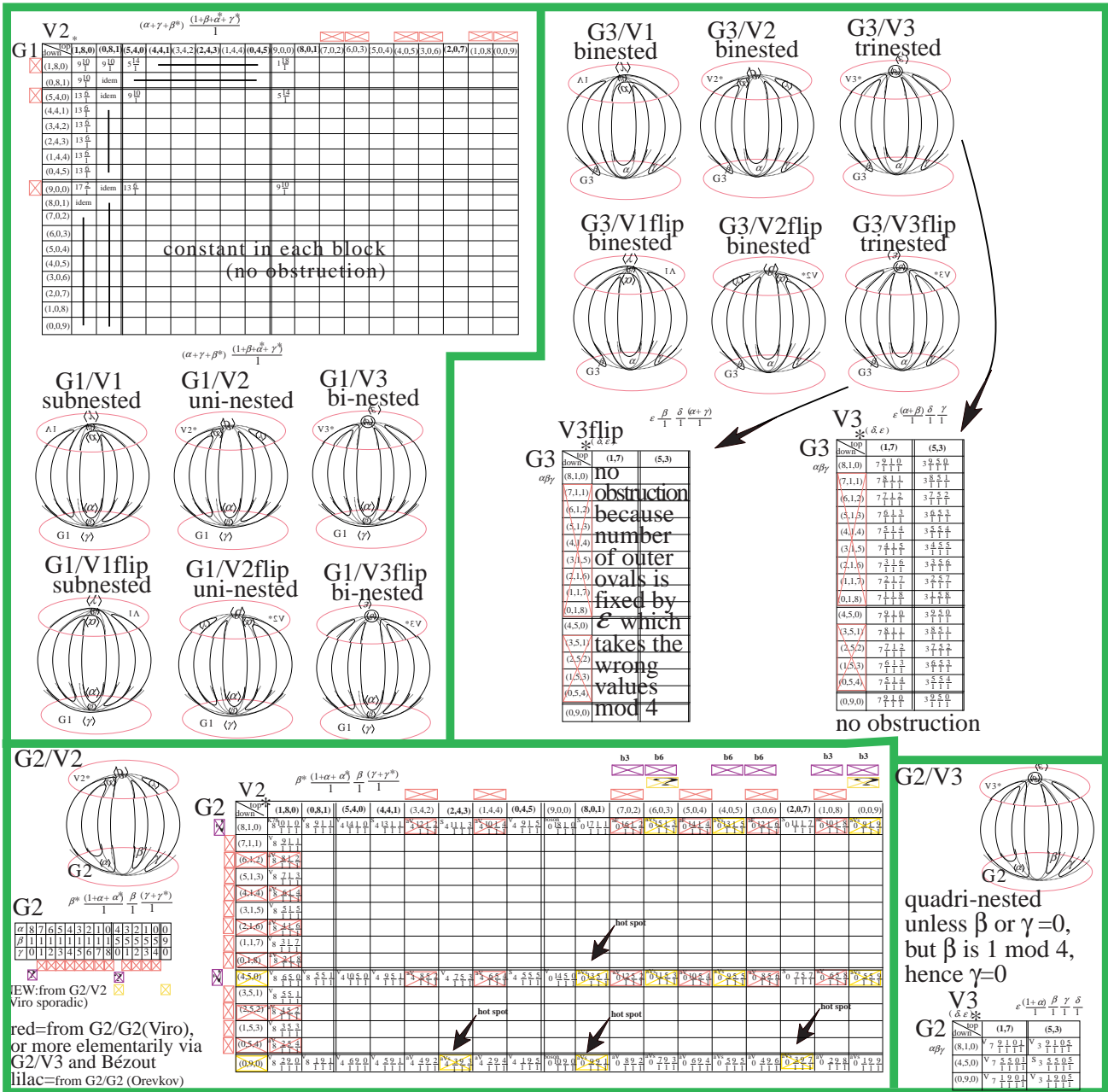

G2/V2

G2 $\beta^* \quad (1+\alpha+\alpha^2) \quad \beta \quad (\gamma+\gamma^2)$

down	(1,8,0)	(0,8,1)	(5,4,0)	(4,4,1)	(3,4,2)	(2,4,3)	(1,4,4)	(0,4,5)	(0,0,0)	(8,0,1)	(7,0,2)	(6,0,3)	(5,0,4)	(4,0,5)	(3,0,6)	(2,0,7)	(1,0,8)	(0,0,9)
(1,8,0)	8	2	1	1	1	1	1	1	0	1	1	1	1	1	1	1	1	1
(0,8,1)	8	idem	8	1	1	1	1	1	0	1	1	1	1	1	1	1	1	1
(5,4,0)	8	2	1	1	1	1	1	1	0	1	1	1	1	1	1	1	1	1
(4,4,1)	8	2	1	1	1	1	1	1	0	1	1	1	1	1	1	1	1	1
(3,4,2)	8	2	1	1	1	1	1	1	0	1	1	1	1	1	1	1	1	1
(2,4,3)	8	2	1	1	1	1	1	1	0	1	1	1	1	1	1	1	1	1
(1,4,4)	8	2	1	1	1	1	1	1	0	1	1	1	1	1	1	1	1	1
(0,4,5)	8	2	1	1	1	1	1	1	0	1	1	1	1	1	1	1	1	1
(9,0,0)	8	2	1	1	1	1	1	1	0	1	1	1	1	1	1	1	1	1
(8,0,1)	8	idem	8	1	1	1	1	1	0	1	1	1	1	1	1	1	1	1
(7,0,2)	8	2	1	1	1	1	1	1	0	1	1	1	1	1	1	1	1	1
(6,0,3)	8	2	1	1	1	1	1	1	0	1	1	1	1	1	1	1	1	1
(5,0,4)	8	2	1	1	1	1	1	1	0	1	1	1	1	1	1	1	1	1
(4,0,5)	8	2	1	1	1	1	1	1	0	1	1	1	1	1	1	1	1	1
(3,0,6)	8	2	1	1	1	1	1	1	0	1	1	1	1	1	1	1	1	1
(2,0,7)	8	2	1	1	1	1	1	1	0	1	1	1	1	1	1	1	1	1
(1,0,8)	8	2	1	1	1	1	1	1	0	1	1	1	1	1	1	1	1	1
(0,0,9)	8	2	1	1	1	1	1	1	0	1	1	1	1	1	1	1	1	1

EW—from G2/V2
Viro sporadic
red—from G2/G2(Viro), or more elementarily via G2/V3 and Bézout
lilac—from G2/G2 (Orevkov)

Figure 15: Patchworking exotic patches (continued)

diagonal propagation), thereby failing to induce a direct patch prohibition. Still, it implies that at least one of $(2,7,0)$ or $(0,9,0)$ is killed.

On filling the table H5/H5flip—which really lands in the trinested realm—we see that Viro’s sporadic obstruction kills with certitude $(6,3,0)$. We merely try to complete the table along the diagonal where we have a simple crescendo dynamics of both lateral coefficients. We see a hecatomb of patches killed by sporadic obstructions, namely $(4,5,0)$ and $(0,9,0)$. In the second diagonal box, Viro’s most sporadic obstruction kills $(4,3,2)$. After this 2nd diagonal sub-box passed, we never meet again sporadic obstructions and nothing more is killed. So what is proved? Answer is given by the:

Lemma 3.11 *Among all patches in the H5-class, only $(6,3,0)$, $(4,5,0)$, $(0,9,0)$, $(4,3,2)$ are directly prohibited by Viro’s sporadic obstructions (and Orevkov does not give additional prohibitions).*

Next it is tempting to see if Viro’s V_i -patches induce restrictions on H5. A little table of patchworks prompts that only H5/V3flip lands in the trinested

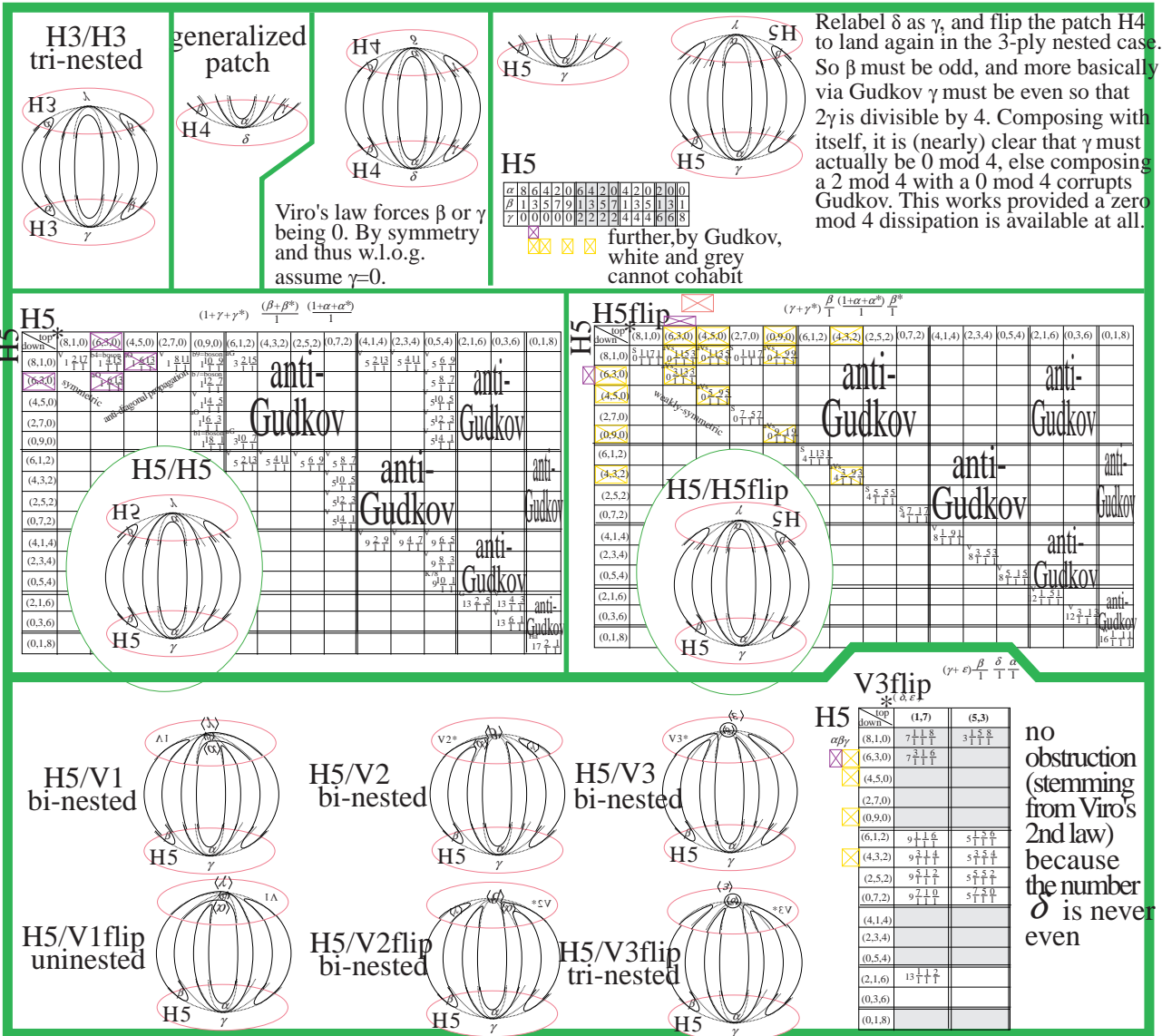

Figure 16: Patchworking exotic patches (continued): H3/H3, etc.

realm where there is some chance to interact with Viro's 2nd law (of thermodynamics). Alas, the schemes landing in the grey-shaded subregions have the wrong number of outer ovals to interact with Viro's law. So we tabulate only the others, but we see quickly that we never meet Viro's $(M - 2)$ -obstruction impeding an RKM-scheme to have only even numerators. This is just because δ is one of the numerator and is odd. Of course, roughly speaking it seems that the reason of this is that we already arranged Viro's law at the M -level, so it is not much surprising that it is likewise respected at level $(M - 2)$. Unfortunately we are not much advanced on our problem.

Further it is perhaps pleasant to note that the first box of table H5/H5 produce all four unknown (binested) bosons $b_1 = 090 \times 090$, $b_4 = 810 \times 630$, $b_7 = 630 \times 090 = 450 \times 270$ (with obvious abridged notations), yet all patches used in those bosonic constructions are destructed by Viro's sporadic obstructions. So the scholium seems to be that Viro's sporadic obstructions freeze the boiling formation of bosons and keeps cold the temperature of the algebraic universe. Notwithstanding the creationism of any boson is still not intrinsically prohibited by Viro's sporadic amendments. Perhaps there is a statement of the shape:

If all of Viro’s sporadic laws are true then no boson can be created out of the quadri-ellipse⁴. At least this phenomenon was true for the patch G2. In contrast, for the subnested bosons B4 and B14 accessible e.g. via G2 (or even V1), it seems that Viro’s sporadic rules have no prohibitive impact upon the bosonic formation out of the quadri-ellipse.

From this basic composition method (of which Viro surely carefully examined the combinatorics ca. 3 decades ago) it emerges the following (seemingly paradoxical) principle: The more a patch resembles those of Viro, the more he will interact with them at the (maximum) M -level and so more the patch will be prohibited. This is best exemplified by the patch G2. In contrast if the patch exploits a totally different geometry then it will not much be attacked by Viro’s prohibitions (typical examples G1 and G8, yet then slightly attacked by Shustin’s rules). Perhaps a patch like H5 is the medium range (liquid phase) where there is not too much prohibitions (=cold regulated world).

Next we imagined further the patch J2 (Fig.12). The latter cannot exist with $\delta > 0$ unless $\beta = \gamma = 0$ (just by Bézout). So the patch becomes J3 which is still anti-Bézout when patched with V3.

3.5 Working more systematically

[14.08.13] It is clear that our random exploration must be rationalized by doing a more proper census of all patches. Basically this involves first the ground *dessin* (involving four arcs), and then the labels counting micro-ovals (topological circles bubbling out of the blue). Many configurations are just ruled out by Bézout and then sometimes Arnold, or Gudkov=Rohlin’s periodicity. It seems now a vital task to get a more lucid classification of all logically possible patches than what we presented before. Each patch has 4 ground branches traversing the disc (local neighborhood of the patching-surgery). So there is by Jordan separation, five distinct zones where to assign the labels. Location which are too deep tend being prohibited by Bézout. For each dessin we shall list all its incarnations, ideally interpreted as a morphogenetic process akin to bifurcations of species (under “Darwinistic” evolution). Having done this properly we should arrive at a more rational way to enumerate first the dessins, and then all the patches. In addition each dessin can acquire an island like the patch V3 of Viro. Evidently the number of island is ≤ 1 , because if 2, then Bézout for conics is foiled having already the doubled quadrifolium when doubling the patch.

Scholium 3.12 *To enumerate properly (à la Newton, Hilbert, Polotovskii, etc.) one can only be guided by a true understanding of the inherent geometry of the world, which is often akin to morphogenetic rules of evolutions transcending Darwinism, and hopefully still available in our aged brains.*

All this requests boring hygienical work, yet necessary as it seems that we as yet missed the patch J4 of Fig. 12, which is Bézout admissible and not corrupted by a gluing with V3.

[15.08.13] Gluing J4 with itself yields a subnested scheme with 2α big eggs (=oval at depth one). By Gudkov periodicity this number has to be 2 modulo 4, and so we choose α as being one mod 4. (Warning: maybe there is more choices like in our study of H5.) Finally as in our patch parameters it is β which is quantified by fourfold periodicity, it looks desirable to relabel α, β by permuting them. (This yields the patch J5.) The composition J5/J5 will land in the subnested realm exempt of all obstructions apart those of Shustin pertaining to the absence of outer ovals. Those will not concern us as J5/J5 has at least 2 outer ovals. Hence filling the table of Fig. 17 is almost unnecessary, as we know a priori not getting any obstruction except perhaps hypothetical destructions of the patches 711 and 216 in case of a hypothetical destruction of the bosons $B4 := 4(1, 2\frac{14}{1})$ and $B14 := 14(1, 2\frac{4}{1})$. Further, even when composing with

⁴[01.10.13].—This is not quite true, because even within Viro’s patches family $C2=V2$, there is via the patch mirabilis $C2(9, 0, 0)$ a chance to get both bosons $b1$ and $b7$.

Viro's patches V1, V2, V3 no obstruction results as the produced $(M - 2)$ -scheme are never trinedsted. So as far as we can see:

Lemma 3.13 *The patch J5 in completely unobstructed.*

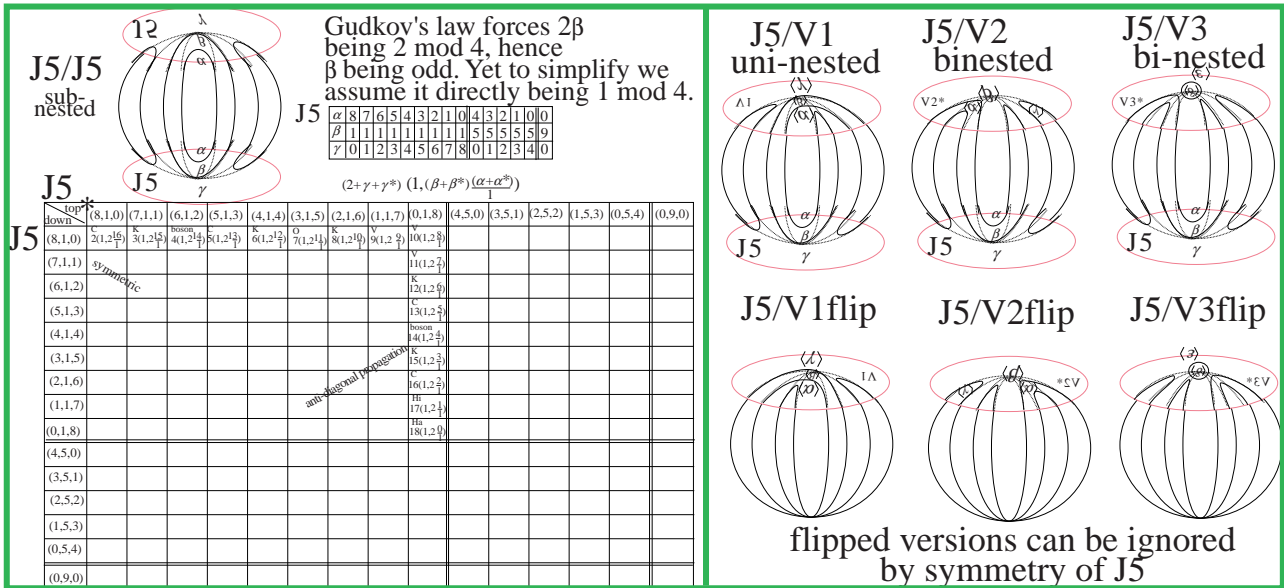

Figure 17: Patchworking exotic patches (continued)

One radical obstruction arises if the patch G9 admits a representant with $\gamma > 0$, in which case the family J5 collapses to its 3 items with $\alpha = 0$.

Now we decided to work out a more systematic table of patches. The idea is to start with a list A, B, C, . . . , J of ground dessins (ordered from unnested to much nested) which is obviously exhaustive. For each of them, we have then to imagine the different places where to put (Greek) label measuring the number of (bubbling) micro-ovals. On doing this plate we discovered a new species namely C1, admittedly much akin to Viro's patch C2=V2, and therefore creating the same schemes. Yet it seems still of independent interest to know exactly which patches are realized. Further the type B1 seems to depend on 4 parameters and we probably only studied it unsystematically as yet. Of course by symmetry one could normalize so that $\alpha \leq \gamma$. However, we remind that under Viro's law at least one of α or γ must vanish. As another recompense of our more systematic work, we discovered another new patch namely G2 of Fig. 18. Of course there will be frictions between G1 and G2, yet maybe at least one of the patch could support many representatives.

As usual, we compose this (new) patch G2 with itself. Of course we can by Viro's law rules out those values of γ which are even (and positive) without having to work out the full tabulation. Still, on the diagonal we meet two sporadic obstructions (due to Viro). One could hope to get more obstructions via G2/V3, but those schemes have the wrong periodicity on χ to interact with Viro's 2nd law. More simply, as δ is odd in our schemes (so no interaction with Viro's 2nd law which forbids all numerators being even for an RKM-scheme). Paraphrasing in more geometric fashion, the $(M - 2)$ -schemes generated by our table lands below the M -peaks of Fig. 155 as opposed to the depressions (valleys) where Viro's 2nd law is reigning.

Hence, the dissipation theory of the patch G2 is not so much obstructed as being de facto empty (like in Viro's census). To know precisely which schemes could result from G2-patches we must fill more the table away from the diagonal. Our interest was to measure the degradations effected by Viro's very sporadic obstruction $(4 \begin{smallmatrix} 3 & 3 & 9 \\ 1 & 1 & 1 \end{smallmatrix})$. The answer is disappointingly that this adds no new obstructions as those already read out from the diagonal. Green frames shows opportunities to construct *new* bosons (not yet obtained by Russian scholars).

that Viro's imparity law does not add new restrictions yet a first one arises with Viro's sporadic anti-scheme $4\frac{3}{1}\frac{3}{1}\frac{9}{1}$ which kills the C1-patches (6, 0, 3) and (0, 0, 9). On the vertical row indexed by entry (9, 0, 0) we get opportunities for bosons b_1 and b_7 , and even b_9 if not obstructed by the side-effect of Viro's sporadic obstruction on $4339 := 4\frac{3}{1}\frac{3}{1}\frac{9}{1}$ (the year of the apocalypse according to orthodox calendars?). So quite interestingly the boson b_9 appears as more accessible than b_4 . Yet if Viro is true, only b_1 and b_7 have real chances getting materialized via the quadri-ellipse. From the next vertical row (8, 0, 1), we see that Viro's (sporadic) prohibition $\frac{1}{1}\frac{5}{1}\frac{13}{1}$ kills (4, 0, 5). In the 603 row we meet again obstruction 4339, yet in such a fashion that it induces only a probabilistic murder of either C1(2,4,3) or C2(6,0,3). Next, row 207 gives a real chance to materialize the boson b_7 , but otherwise not more murders of patches (essentially thanks to the presence of Shustin's schemes). Finally the last 2 rows affords no principally new information safe for a possible boson b_9 (granting Orevkov to be false), and semi-obstructions induced by sporadic obstructions.

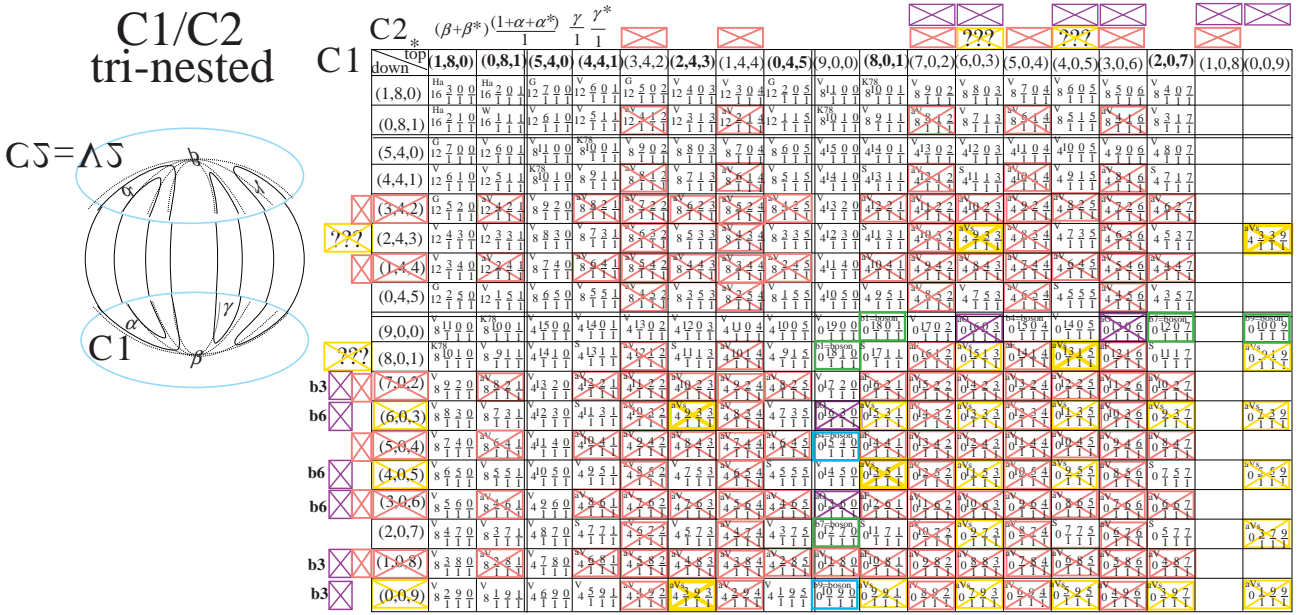

Figure 20: Patchworking exotic patches (continued)

In summary the C1/C2 table affords only moderate obstructions on patches of the class C1 and offers pseudo-construction of the bosons b_1 and b_7 (but not the others). When reporting the patches obstructions on the C1-table (Fig. 18) we see that the cumulative effect of Viro's law plus his sporadic obstructions covers all of Orevkov's prohibitions (while forbidding actually one more patch, namely C1(5,0,4)). So even if Orevkov is false but all of Viro is true then the patch C1 is at least as restricted as indicated by crosses on that table.

Then again we wondered if V2/V3flip(=C2/C3flip) produces obstructions on V2, but apparently not according to the corresponding table.

One could try to use the C1/C2-table to complete our knowledge of C2=V2. Remind that only the patch C2(9,0,0) is in in doubt (accepting the Viro+Orevkov theories).

Added [02.10.13].—As a little detail, we could dispense Orevkov by using Viro sporadic, provided we can construct the same C1-patches as Viro constructs in the C2-class. This holds true in our opinion quite trivially by a simple variation of Viro's construction (as we shall see later in Sec. 5).

Hence constructing a patch by C1 could de-construct(=destroy) one by C2. Alas the vertical row (9,0,0) contains few schemes known to be prohibited actually solely the 2 Orevkov schemes yet at heights which are not constructible. Indeed the horizontal line (3, 0, 6) is not constructible by Fiedler-Viro, whereas (6, 0, 3) is only killed by sporadic obstructions. Positing those to be wrong, while declaring that C1(6,0,3) exists we deduce (granting Orevkov's b_3 to be an anti-scheme) that C2(9,0,0) do *not* exist, completing thereby the dissipation

theory of C2. Remember that C1(6,0,3) is killed by disintegration of b6, so in our scenario (existence of C1(6,0,3)) the boson b6 must materialize and so one half of Orevkov is wrong.

All this is just sterile logical speculation yet it seems still puzzling to treat in a systematic way the problem of deciding which constellation of patches are logically compatible granting the many interferences between the varied tables.

To summarize, an aspect of the game is to know precisely which opportunities of creating new bosons arise within the context of the most basic Viro method (quadri-ellipse). Answering this should by now be nearly complete via our new table of patches.

[17.08.13] Next we observe that C0 is forced to have $\gamma = 0$ and therefore may be seen as a subclass of the type C1. Actually, in the patch C0 (upon gluing with V3 and using Bézout) at least one of β or γ must vanish (whatever the value of α is), and therefore the patch family C bifurcates into the two subspecies C1 and C2.

It seems also pleasant to combine the ground dessins in all possible ways to visualize the ground shape of octics in the vicinity of the quadri-ellipse (see Fig. 21). Of course D is empty safe perhaps if $\alpha = 1$, in which case the doubled patch is the quadri-bifolium $\frac{1}{1}\frac{1}{1}\frac{1}{1}\frac{1}{1}$ but with only 8 ovals. The hope is that some combination yields $(M - 1)$ -curves where we could exploit Gudkov-Krakhnov-Kharlamov periodicity. We find then many interesting combinations that could induce additional obstructions. For instance C/G can be trinested and then we have $(M - 2)$ -curves possibly interacting with Viro's 2nd law (impeding a trinested RKM-scheme to have all its numerators even).

In fact if only interested in M -curves, we may restrict attention to patches (potentially) admitting a maximal dissipation (namely B, C, E, G, I, as we saw earlier as a simple consequence of Arnold weak-version of Gudkov periodicity). For each combination we may study the resulting patchworks and obstructions. This restricted table there is either 4 or 2 macro-circuits (with 3 not occurring anymore). This is a bit disappointing yet there is still some chance to get obstructions from Viro's 2nd law. Of course the table is symmetric about the diagonal and so only the upper-half triangle deserves attention.

[18.08.13] The combination B/B has already been studied, yet perhaps not in all declinations B2/B2, B2/B3, B2/B4, B2/B5, B3/B3, B3/B4, B3/B5, B4/B4, B4/B5, B5/B5; and additionally there is B3/B3flip (which was already considered). However it must be reminded that from mixed composition of virtual patches no precise obstructions can be derived. Hence our analysis of cases looks already complete.

For B/C, it can be trinested in the declination B4/C3 which was already considered as table G9/V3 which offered no obstruction (viz. interaction with Viro's 2nd law). But also B3flip/C3 is trinested. However even without filling the table the presence of δ odd excludes any interaction with Viro's 2nd law (forbidding all numerators of the Gudkov symbol being even).

Next we have B/E which is never trinested, even not in the declination B4/E.

For B/G it is trinested in the declination B4/G2, but as either γ is odd or δ congruent to 1 mod 4 no interaction with Viro's 2nd law can be expected.

For B/I, it is trinested in (and only in) the declination B4/I, but as γ is already restricted to being odd (at least when not zero), no interaction with Viro's 2nd law can be expected.

Next we analyze the C-row. First we have C/C which declines into C1/C1, C1/C2, C1/C3, C2/C2, C2/C3, C3/C3. All diagonal combinations were studied a long time ago. C1/C2 was recently tabulated as Fig. 20 offering 3 new (sporadic) obstructions on C1. C1/C3 offers the same obstructions on C1 than those coming from C2/C3, studied earlier. C3/C3 was also taken into account but gave little information. Next there is also in C/C flipped versions C/Cflip which are $(M - 2)$ -curves. This becomes trinested in the case C1/C3 or C2/C3, but δ 's oddity (even 1 mod 4) impedes any direct interaction with Viro's 2nd law. Finally, the case C3/C3flip was already considered and yielded the strong (and complete) Bézout restrictions upon C3.

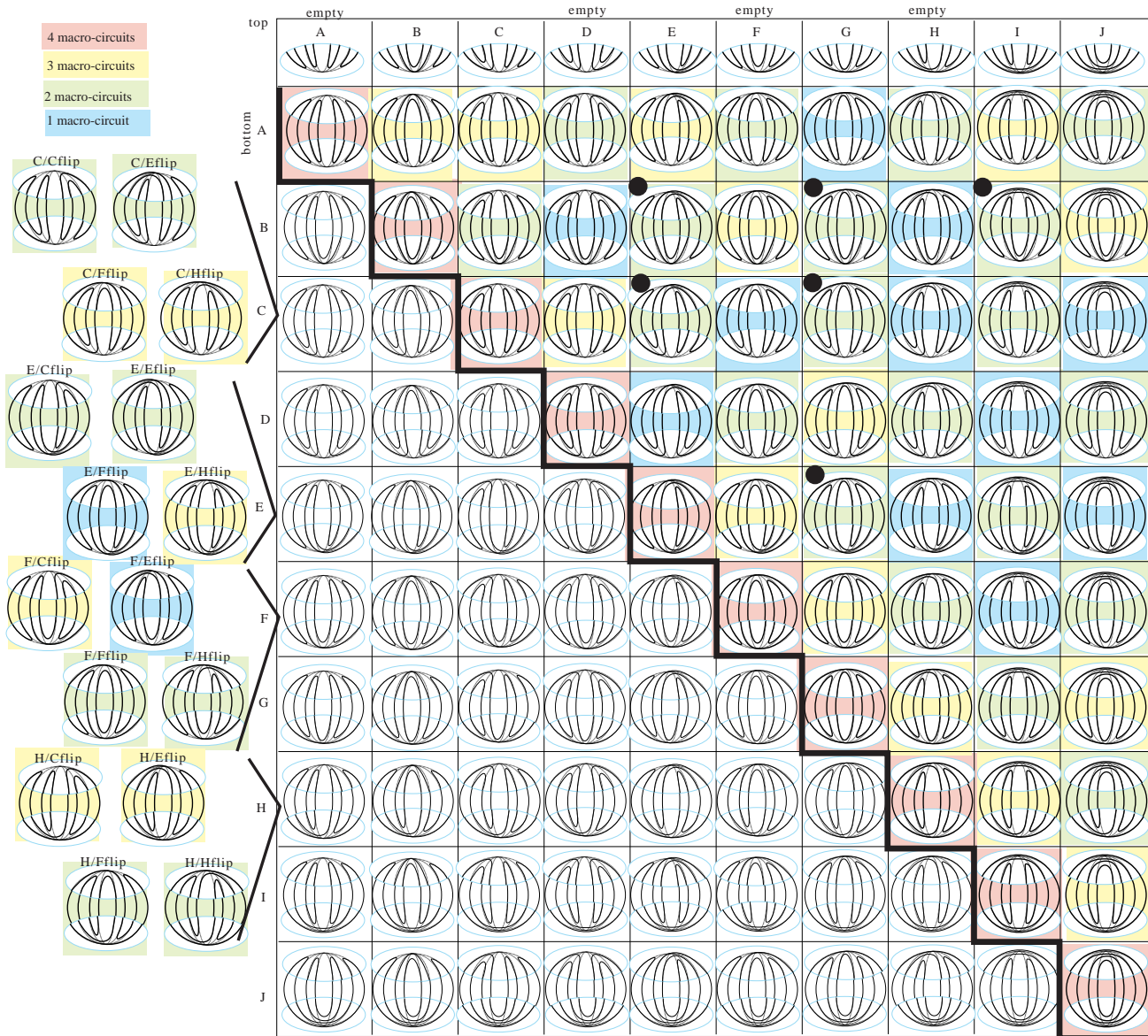

Figure 21: Patchworking classic (Viro's=CE) and exotic patches

Next we have to worry about C/E which is trinested in the specialization C3/E, but as usual we cannot expect an additional interaction with Viro's law. Further we must not forget the flipped version C/Eflip, but this never becomes trinested even when specialized as C3/Eflip (as there is no micro-oval population the right lune of C3/Eflip).

For C/G it becomes trinested only in the declination C3/G2, but as usual as both δ and γ were already calibrated to odd there is no hope to get further obstruction from Viro's 2nd law.

As to C/I it never becomes trinested.

Next we have E/E. Remind that E admits a sole declination namely E=E(=V1) Viro's 1st dissipation mode. This was studied long ago, and offers no obstruction as we land in the subnested real free of all obstructions according to present knowledge. Of course we must not miss the flipped variant E/Eflip, yet as E cannot form a micro-island the scheme E/Eflip stays binested, and thus no interaction with Viro's (trinested) 2nd law is expectable.

As to E/G it is at most binested in the coloration E/G2, and thus nothing can be inferred from Viro's law. As G is symmetric (in any coloration G1 or G2), there is no need to consider the flipped version.

Finally (as long as E is concerned), we have E/I which is also at most binested since the I-class cannot produce an island.

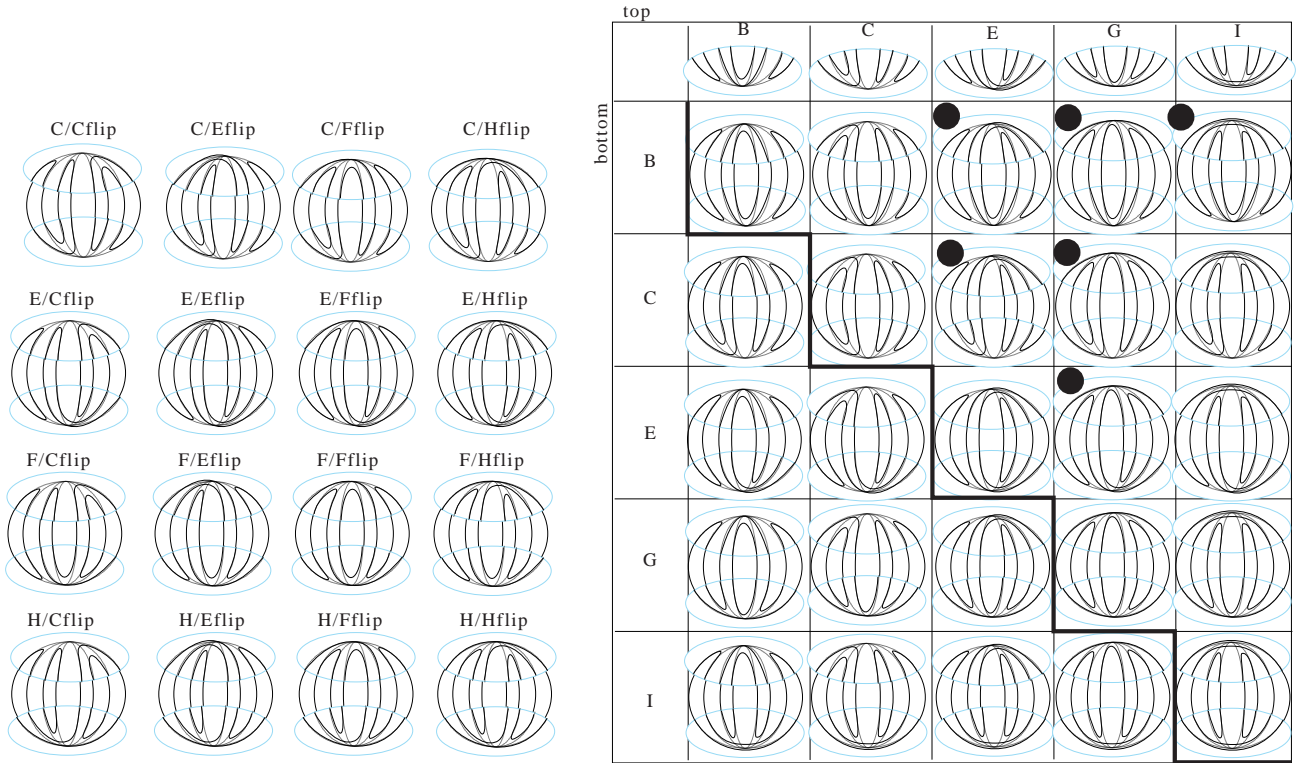

Figure 22: (Potentially) maximal patches

Next we have G/G where G admits 2 colorations G_1 and G_2 . Each pure table G_1/G_1 and G_2/G_2 were already considered, yet one must not miss the mixed table G_1/G_2 . Denote as usual with stars the top parameters corresponding to G_2 . We meet a Bézout obstruction whenever $\gamma^* > 0$ and at least one of both α 's is positive. Can we deduce that G_2 has no patch with γ positive, and that G_1 has no patch with $\alpha > 0$? Nearly but actually, it is only a simultaneous realization of both conditions that would violates Bézout. So the impact of G_1/G_2 is hard to quantify yet it means roughly speaking that at least one of the family is empty safe perhaps for degenerate parameters (i.e. $\alpha = 0$ in G_1 and $\gamma = 0$ in G_2). So we can say that G_1 and G_2 are coupled against Bézout, but alas we do not know how to extract concrete information from this. Of course a construction in any one of the category G_1 vs. G_2 should be the real opportunity to fix the question of deciding if the patch is rather subnested (G_1 with α positive) or insulated (G_2 with γ positive), but alas it could of course be that G is none of both. Then the patch G would reduce to $G_1(\alpha, \beta\gamma)$ for $(\alpha, \beta\gamma)$ equal to $(0, 8, 1)$, $(0, 4, 5)$ and $(0, 0, 9)$ or eventually be even smaller (perhaps even empty).

Next we have G/I which is at most binested in the coloration G_2/I . No, actually, G_2/I is anti-Bézout provided $\gamma > 0$ and α or α^* is positive. Hence we have (warning skip this lemma where there is a mistake, but look at the next version):

Lemma 3.15 *It suffices the patch family I containing a single representant to force the family G_2 being nearly empty. Precisely γ and α should be both zero and therefore G_2 reduces to the single patch $(0, 8, 0)$. Caution: this is a mistake as we misplaced the parameters α, β, γ of G_2 .*

Likewise we can reformulate the previous token involving G_1/G_2 , as follows:

It suffices the family G_1 being nonempty (or rather to contain a representant with $\alpha > 0$) to force a collapse of G_2 to the patch $(0, 8, 0)$. (Of course $G_2(0, 8, 0) = G_1(0, 0, 9)$ so that G_2 can be considered as empty.)

But now the "clou" of the argument is that the hypothetical G_2 -patch can serve as the G_1 -patch effecting the closing and therefore it is deduced that G_2 contains at most $(0, 8, 0)$. Sorry, it seems that this is rather a misconception (due to the fact that I misplaced the micro parameters).

Now the corrected lemma is as follows and should be interpreted as a reciprocity law between patches:

Lemma 3.16 *It suffices for the family G1 to contain a single representant with $\alpha > 0$ to force a collapse of G2 to the patches with $\gamma = 0$, i.e. $(0, 8, 0)$, $(4, 4, 0)$ or $(8, 0, 0)$. (Of course $G2(0, 8, 0) = G1(0, 0, 9)$, $G2(4, 4, 0) = G1(0, 4, 5)$ and $G2(8, 0, 0) = G1(0, 8, 1)$ so that G2 can be considered as empty.)*

Reciprocally, it suffices for the family G2 to contain a single patch with $\gamma > 0$ to force a collapse of G1 to the patches with $\alpha = 0$, namely $(0, 8, 1)$, $(0, 4, 5)$, and $(0, 0, 9)$. All those patches can be considered as element of G2 via the formula $G1(0, \beta, \gamma) = G2(\beta, \gamma - 1, 0)$.

Hence as the intersection $G1 \cap G2$ reduces to the three patches listed above ($G2(0, 8, 0) = G1(0, 0, 9)$, $G2(4, 4, 0) = G1(0, 4, 5)$ and $G2(8, 0, 0) = G1(0, 8, 1)$) we deduce that at least one of both families G1 and G2 can be considered as empty.

Likewise there is a reciprocity law between G2 and I.

Lemma 3.17 *It suffices for the family I to contain a single representant with $\alpha > 0$ to force a collapse of G2 to the patches with $\gamma = 0$, i.e. $(0, 8, 0)$, $(4, 4, 0)$ or $(8, 0, 0)$. (Of course $G2(0, 8, 0) = G1(0, 0, 9)$, $G2(4, 4, 0) = G1(0, 4, 5)$ and $G2(8, 0, 0) = G1(0, 8, 1)$ so that G2 can be considered as empty.)*

Reciprocally, it suffices for the family G2 to contain a single patch with $\gamma > 0$ to force a collapse of I to the patches with $\alpha = 0$, namely $(0, 1, 8)$, $(0, 5, 4)$, and $(0, 9, 0)$.

Hence at least one of both families G2 and I can be considered as nearly empty.

In summary, either G2 contains a non trivial patch (with $\gamma > 0$), in which case both G1 and I collapse to their 3 representatives with $\alpha = 0$, or alternatively G2 reduces to a subcollection of G1 and then there is no strong coupling and in both families G1 and I could flourish many patches of potential sub-nested bosonic interest. The first scenario (G2 non trivial) seems to favor the materialization of the binested bosons $b1$ and $b7$, while the second scenario (G2 trivial) corroborates rather existence of the subnested bosons $B4$ and $B14$.

Very finally, we have I/I which only produces prohibitions already analyzed.

It seems further that strong coupling occurs at other places like with B2/G2, C1/G2 and C2/G2, or also E/G2. But now by Viro's theory we know that E has patches with positive α 's and thus the patchwork E/G2 shows the:

Theorem 3.18 *The patch G2 does not admit representatives with $\gamma > 0$, i.e. insulated patches.*

We have also a weak coupling B4/G1 from which however no tangible obstruction can be drawn due to a sterile lack of construction à la Viro in those patch classes. More generally similar couplings arise whenever the ground curve of Fig. 23 contains a nest and the corresponding patch can inject ovals in the nest while the other patch creating an island. So we have a coupling B2/B4 from which no concrete information can be extracted due to the merely formal stature of our patches. Next B/G suggests two couplings, namely B2/G2 and B4/G1. But both are only weak couplings, from which no concrete information can be drawn. Naively, the recent collapse of G2 (in the above theorem), suggests that in the most plastic world there is a series of patches flourishing in G1 which being coupled with B4 will kill many patches there (those with $\gamma > 0$). In turn plasticity and the coupling B4/B2 suggest many patches in B2 and via the coupling B2/G2 many patches are killed in G2, in accordance with the theorem above. Of course the circle is now complete.

Let us continue our analysis of all couplings. The next case of nesting occurs with C/C and so we have couplings C1/C3 and C2/C3 which are precisely forcing extinction of the micro-ovals in the nested lune of both C1 and C2.

Further we have the coupling C4/C4flip (Fig. 18) which produces the collapse from C4 to the restricted family C3.

Added [02.10.13].—This looks true provided both δ, λ are positive. So we erroneously ruled out the patches C4(0,7,1) and C4(0,3,5). But, those patches are respectively equal to C2(1,8,0) and C2(5,4,0), which are both constructed by Viro. Thus we had to make a little correction on our catalogue (as yet only refreshed on Fig. 48). Of course this mistake has little impact since those patches were already catalogued in the C2-family.

Next we have C/G, but alas this does not create couplings because neither C nor G injects ovals in the nest (compare sub-figure C/G e.g. on Fig. 18).

The next case of nesting concerns E/E, and here the coupling basically prevents the patch E to form an island, so that actually E reduces to the single incarnation E=E=V1 (i.e. Viro's 1st family). Note also that the flipped version E/Eflip kills the nesting, and therefore nothing tangible can be inferred from it.

The case to come next is E/G, where we have the strong coupling already discussed yielding all the severe obstructions on G2 incarnated by the above theorem.

Then we have G/G whose couplings implies the evident restrictions that there cannot be micro-ovals in the lateral lunes, and also that if there is an island growing then the central lune becomes void too. Paraphrasing this is the basic splitting in classes G1 and G2. Further we have the coupling G1/G2 from which we above failed to derive decent information, which we have now gained via the coupling with Viro's E-family. Actually, now we have the perfect circular circuit of couplings. First, G1/G2 (with G2 nearly empty via E), then G2/B2 (with plastically B2 nearly full), and then via the coupling B2/B4, B4 would be nearly empty, and finally, the closing coupling B4/G1 plus plasticity would make G1 nearly full.

Next we have G/I which induces a coupling G2/I, which as G2 is nearly empty could make I nearly full (by hypothetical plasticity).

Lastly, I/I produces no coupling due the inability of I to form an island.

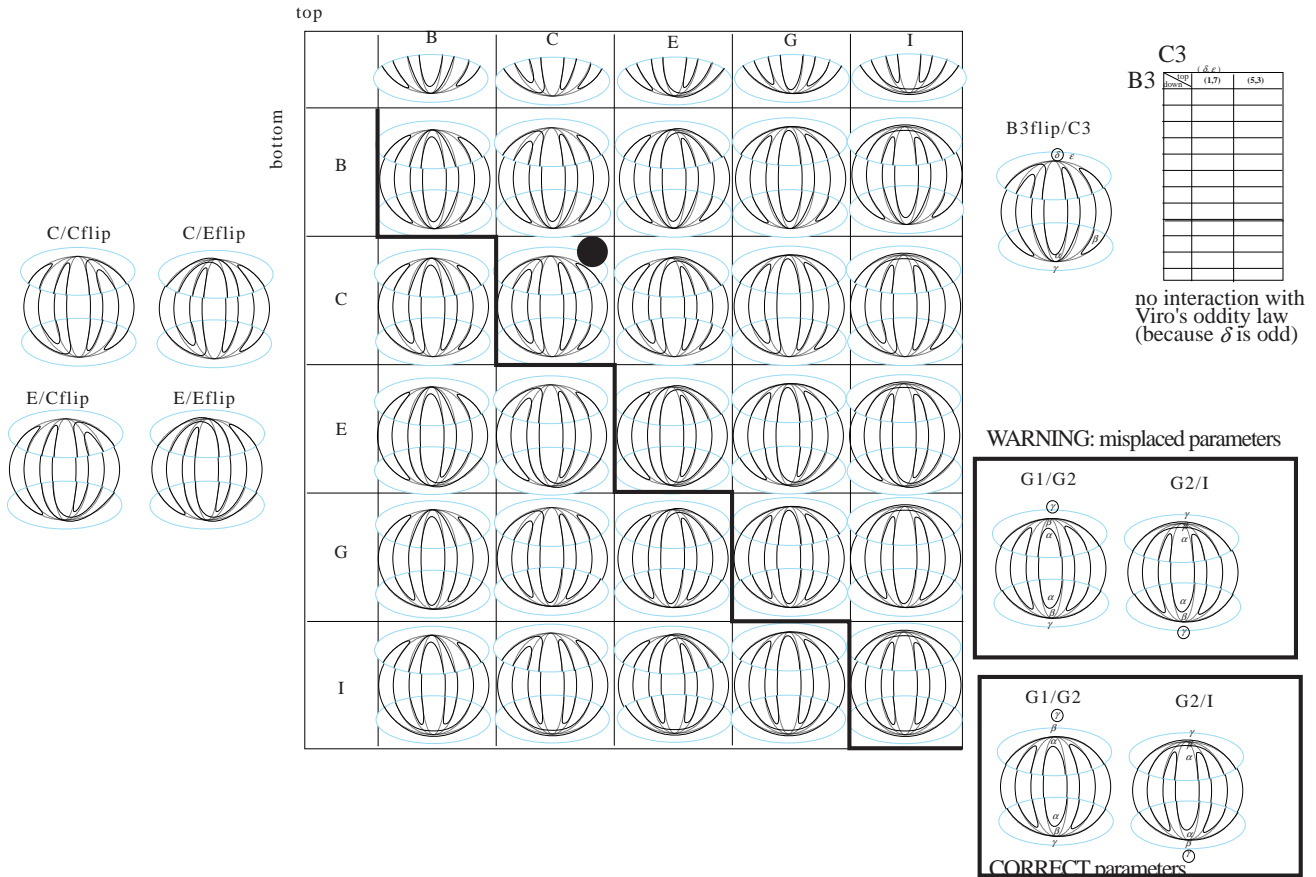

Figure 23: Admissible patches

At this stage it seems that we have analyzed all logically possible couplings, and thus established an exhaustive list of patch restrictions derivable by the naive composition method (i.e. formal patchwork based on the superstition of independency of smoothing of both singularities of the quadri-ellipse). From this analysis, it results one major prohibition on G2, as well a cyclic structure on couplings along which the density of patches could alternate with periodicity two. This is just to say, one is nearly empty and the successor nearly full, and so on. In particular G2 is nearly empty and so would be B4 (yet which produced no bosons). In contrast we expect that G1, B2, and I are nearly full thereby contributing to the materialization of the boson B4 and B14 in the subnested realm where many constructions post-Viro were supplied by Korchagin, Chevalier, Orevkov, and where up-to-date nobody could find any obstruction except Shustin in the case of zero outer ovals.

So despite the recent basic Bézoutian destruction of bosons via G2/G2 (notably $b1$ and $b7$), there is still some hope for their realizations via C1/C1 (whose composition table is the same as C2/C2 via an evident isotopy), or C2/C2, or even via C1/C2.

Further there is also a coupling C0/C3 forcing $\gamma = 0$ on C0=G2 yielding some other opportunities for bosons (yet violating some of Viro's sporadic obstructions). Actually the few surviving C0-patch are readily covered by family C1 so that we cannot speak of a principally new realization.

[19.08.13] Interestingly, simple Bézout obstructions often recover all the deep Fiedler-Viro obstructions, as for instance with $C4 \approx C3$ or G2-patches (compare Fig. 18). One may wonder if all patches obstructions (about X_{21}) can be subsumed to Bézout directly, yet this looks quite unlikely as we proposed (we believe) an exhaustive search of all couplings relation entertained by patches.

Further we remind that there is another anti-Bézout coupling with B4/B5 which is generically quadri-nested, and when not it turns anti-Gudkov as we saw in an earlier table (G3/G9 in older notation). Unfortunately this coupling relates exotic patches and therefore there is not enough grip to infer any concrete information from it.

Next, there is also the coupling B2/B5 and even B2/B3, yet all those are weak couplings and it looks hard to infer any concrete information. So actually B2 is coupled with all others B's, i.e. B3, B4, and B5. But it seems that the loose (sparse) information we have is caused by the fact (compare Fig. 23) that the patch B does not interact in a nested way with the real patches of Viro (letters C and E in our catalogue). This absence of nest on the ground figure explains why we fail meeting a Bézout obstruction involving a nest of depth 3 plus one of depth 2. In the case of no nest on the ground naked figure (prior to the addition of islands and micro-ovals, cf. again Fig. 23) we can still expect to find a Bézout obstruction involving saturation of the bi-quadrifolium $\frac{1}{1} \frac{1}{1} \frac{1}{1}$ (i.e. 4 nests of depth 2). So for instance there could be a coupling between B with an island and C insulated as well, that is between B4 and C3, but as B4 has empty lateral lunes (Bézout applied to B4/B4flip) it is seen that the right lune of B/C stays empty and the full scheme becomes generically trinested, yet not quadri-nested as initially expected.

A similar discussion shows that there is no conical (equivalently quadri-nested) coupling when pairing B with E whose ground figure is a lune plus a snail (cf. still Fig. 23). Here E cannot produce an island nor fill the unnested lune with micro-ovals, and so fails to do the insulated incarnation of the patch B. Hence B/E is at most binested.

So it seems that our poor understanding of the B-patches is caused by a lamentable geometric interaction of the B-patch with both C and E the (fundamentally European) collections of Viro. (Memnotechnic trick: CE=communauté européenne.)

Also at this stage we enumerated Bézout obstruction for lines and conics, and one may wonder if there are obstructions induced by auxiliary cubics.

4 Toward sophisticated Bézout obstructions

4.1 Speculating about obstructions

[19.08.13] Perhaps one could so (via cubics) obstruct some of the bosons yet we believe that the general method of total reality (alias the Riemann-Schottky-Bieberbach-Grunsky theorem, perhaps in the synthetic variant of Gabard 2013B [471]) should be the true weapon to detect additional prohibitions if there is any (in degree $m = 8$). Of course this has to be mixed perhaps with standard homological methods (construction of 2-cycles \approx membranes) designed by Arnold, Rohlin, Viro, Fiedler, etc. or link theory à la Gilmer, Orevkov. For instance beside Arnold's surface which can fail to be orientable there is a myriad of natural membranes, e.g. the Rohlin surface obtained by filling all ovals by their bounding disc. This is in the M -curve case represented by a singular sphere, whose self intersection yields Rohlin's complex orientation formula. As we said often, it seems that total reality offers a sort of transverse structure (a bit like Haefliger, etc.) and so perhaps a good deal of Hilbert's puzzle can be tractable in the context of holomorphic foliation theory à la Painlevé et alii (i.e. Brazil and Dijon, like Cerveau, Camacho, etc.).

An idea (that flashed us ca. 1 month ago) is that given an M -curve of degree m (say $m = 8$) we can look at all pencils of $(m - 2)$ -tics, which have degree 2 less and which we shall call of co-degree 2, hence co-conics (so coconuts or just nics). By the elementary argument in Gabard 2013B [471], we know that there is always such a pencil which is totally real. So we could look in the Grassmannian parametrizing all those pencils at the sub-body consisting of total pencils. This must have a marvellous geometry, especially when it comes to look at the boundary of the body.

Added [02.10.13].—Consider the trivial case ($m = 3$) of an M -cubic ($r = 2$ circuits) swept out by a pencil of lines. Then total reality holds iff the center of perspective is located inside the oval of the cubic, or its boundary. In the latter case the degree of the total map lowers to 2 (instead of 3 when looking from inside). In general, it seems evident by analogy that low degree total maps will emerge along the boundary of the body of all total pencils. Okay but actually the recipe of total reality on plane M -curves (as in Gabard 2013B [471]) readily gives such maps of lowest possible degree. So it seems natural to expect that those maps describes explicitly the boundary of the body of all total maps.

Studying all this very precisely should perhaps advance the resolution of Hilbert's problem in degree $m = 8$ and higher. Alas, it is also evident that several tour de forces are requested.

It is only now that a basic aspect came transparent to us. It is clear that real algebraic curves like nesting but not excessive nesting as there is evident Bézout bounds upon the nesting complexity. So an octic cannot be quadri-nested, and when it is it reduces to the quadri-nest (alias bi-quadrifolium). Likewise when trinested the schemes suffer severe Fiedler-Viro prohibitions. In the binested case there is only for the moment two (striking) prohibitions of Orevkov upon b_3 and b_6 , which less surprisingly pertains to curves with the minimum number of outer ovals. It is clear that one could hope to attack the problem via Bézout for cubics (a bit like along the strategies of Le Touzé).

The basic idea is that if the octic is much nested (e.g. in the binested bosonic range $1 \frac{x}{1} \frac{y}{1}$ with $x + y = 19$ in order to have a total number of $M = 22$ ovals) then one could select in both nests a quadruplets of points and let pass through the resulting 8 points a connected rational cubics. Remember that through 8 points there is a pencil of cubics containing among the 12 complex singular curve at least 8 which are real, and so we find a curve of the desired type. The trick would be then to control somehow a salesman travelling between those group of 4 points so as to create excessive intersection. For instance if we could arrange 8 transitions from white to black (being the colors of both nests) then it would result $8 \cdot 4 = 32$ intersections overwhelming Bézout's $3\delta = 24$. Seven transitions would be enough, but looks hard to have an odd number of transition.

Six instead would not be enough to corrupt Bézout. It would be of paramount importance to understand if some obstruction in the bosonic range can be drawn from this simple device, especially if it recover the Orevkov obstructions on b_3 and b_6 (i.e. $x = 3$ and 6 respectively).

The point is that the rational cubic creates 4 intersections when it salesman travels from black to white, but still create 2 intersections when linking monochromatic points (i.e. in the same nest). Thus six transitions is enough, affording $4.6 + 2.2 = 24 + 4 = 28$ intersections, while 4 transitions produce only $4.4 + 2.4 = 16 + 8 = 24$ intersections without corrupting Bézout.

Then one can imagine the 8 basepoints colored black and white according to the splitting $8 = 3 + 5$ instead of $4 + 4$. Then there is still enough room to get 6 transitions and we could so perhaps reprove Orevkov's obstruction of $1 \frac{3}{1} \frac{16}{1}$. Indeed the technique would be to choose 3 points inside the ovals of the small nest and to choose 5 of them inside the big nest containing 16 eggs(=empty ovals), and to pass a connected cubic through those 8 points in such a way that there is 6 transitions from black to white. Then as before $4.6 + 2.2 = 28$ many intersections are granted in $C_3 \cap C_8$ and Bézout is overwhelmed.

But of course in this sort of games the crude theory is very easy yet the practice is very hard to polish. We mean of course that the argument should not rules out schemes constructed by Viro.

The method could equally apply to the trinedest case, in principle more elementary just for historical reasons (Fiedler-Viro came prior to Orevkov). Here we have three colors say black, white and red. The 8 points are distributed along the cubic circuit and since more color are available there should also be more transitions, while having 6 of them would suit our desire. Of course in the worst case it is possible for this distribution of colors to be very monotonic and forcing only 3 color changes.

It would be fascinating if it is so possible to reprove the Fiedler-Viro oddity law, or some of Viro's sporadic rules (or decree) (e.g. the famous $4339 := 4 \frac{3}{1} \frac{3}{1} \frac{9}{1}$).

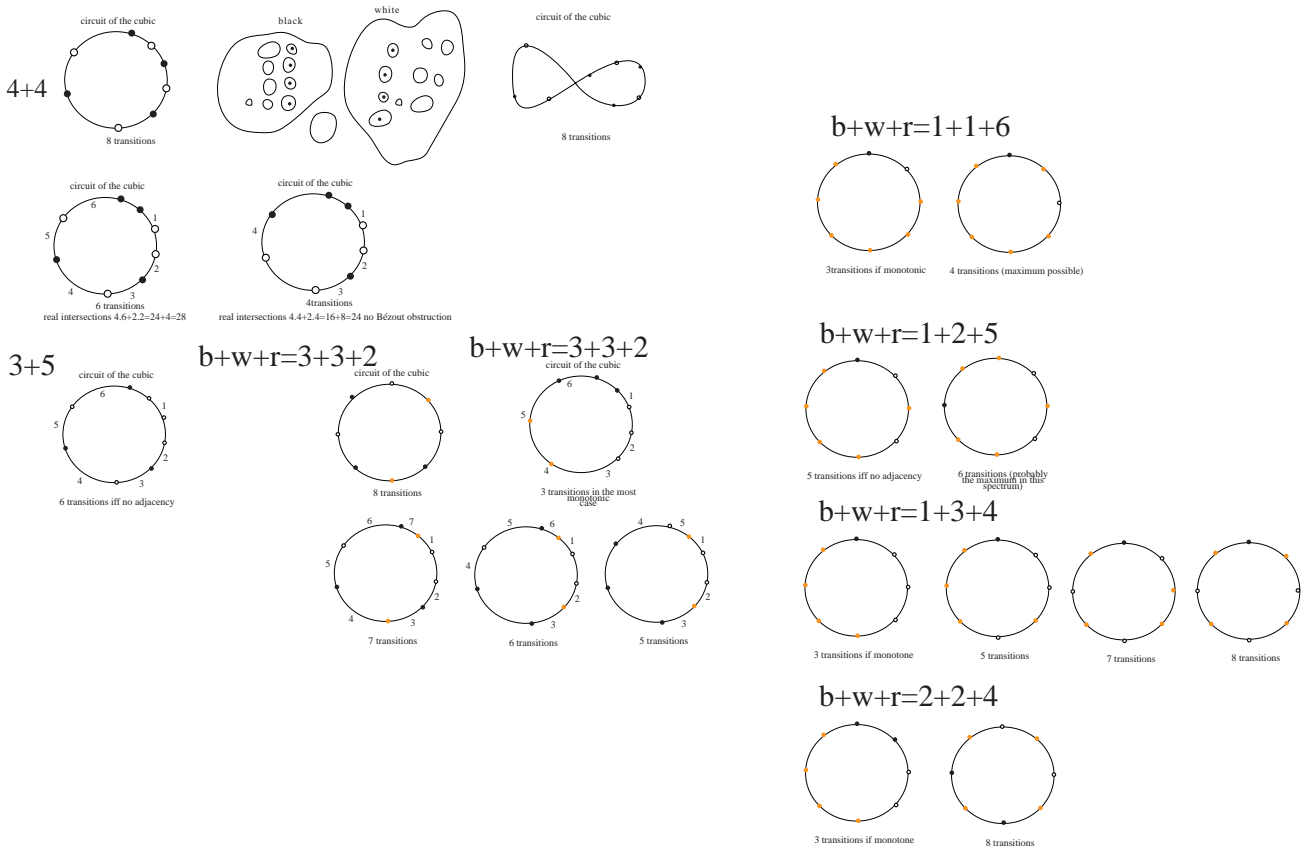

Figure 24: Salesman travelling with cubics
First the 8 points may be partitioned into the 3 colors as $1 + 1 + 6$, $1 + 2 + 5$,

$1 + 3 + 4$, $2 + 2 + 4$, $2 + 3 + 3$ (alias color spectrum). In each case the monotonic distribution of colors implies only 3 transitions, hence only $4.3 + 2.5 = 12 + 10 = 22 < 24 = 3.8$ intersections. What about 5 transitions? Then there is $4.5 + 2.3 = 26$ intersections and this is the minimal number corrupting Bézout (as 25 is not possible being odd while the octic circuit is even by the Möbius-von Staudt law). So in the case of 3 colors we can observe an odd number of transitions the minimal of them corrupting Bézout being 5.

Now given an M -scheme of degree $m = 8$ which is trinested one can choose 8 basepoints among the deepest ovals, and in such a clever way as to maximize the number of transition. Of course by Bézout the number of transition is bounded by 4, yet we may hope that topological reasons makes this sometimes higher.

Let us assume the M -scheme $t \frac{x}{1} \frac{y}{1} \frac{z}{1}$ to have one even numerator (number of eggs in a nonempty oval). Then one other numerator has to be even (and nonzero), thus we can employ the painting $2 + 2 + 4$, except on the 1st layer of the pyramid (Fig. 95). In fact $1 + 2 + 5$ can be injected in all trinested schemes safe $12 \frac{1}{1} \frac{2}{1} \frac{4}{1}$.

Of course the (color) spectrum $1 + 1 + 6$ admits at most 4 transitions and so is useless to corrupt Bézout. The spectrum $1 + 2 + 5$ can have 5 and even 6 transitions (which is probably the maximum possible). Similarly the spectrum $1 + 3 + 4$ can reach 8 transitions, and so do its companions $2 + 2 + 4$ and $2 + 3 + 3$.

So as soon as we can employ the color spectrum $1 + 2 + 5$ or the higher more colorful avatars, we can expect that for a suitable rational member of the pencil of cubics assigned to visit the 8 basepoints the allied colorimetry (induced by the 3 nests of the M -octic) will assume high chromodynamic level, and so Bézout will be corrupted.

Basically this is rather plausible just for statistical reason that the distribution of colors (on the ground circle) will be fairly random and so likely to exhibit 5 or more transitions.

One possible scenario could be that for the first spectrum admitting 5 transitions, namely $1 + 2 + 5$ one can always find a singular cubic with (at least) 5 transitions through any 8 points colored along this spectrum. If true, this would explain Viro's oddity law safe apparently for $12 \frac{1}{1} \frac{2}{1} \frac{4}{1}$. Alas, our hypothesis would also destroy the scheme $8 \frac{1}{1} \frac{3}{1} \frac{7}{1}$ (the first constructible into which $1 + 2 + 5$ may be injected). This being constructed by Viro we see that our hypothesis is just superstition.

Let us look at the next spectra $1 + 3 + 4$, $2 + 2 + 4$, $2 + 3 + 3$. Assume again for this first one $1 + 3 + 4$, a universal law (involving merely configuration of 8 points and cubics) of chromodynamics telling that there is, for any distribution of 8 basepoints colored in this fashion, a rational connected cubic interpolating the eight points with at least 5 transitions (of colors). If true universally this would also kill Viro's scheme $8(1, 3, 7) := 8 \frac{1}{1} \frac{3}{1} \frac{7}{1}$.

Positing the same law for $2 + 2 + 4$ would kill Viro's scheme $8(3, 3, 5)$ or $4(3, 5, 7)$. Finally, this bad state-of-affairs is not arranged when looking at the last spectrum available $2 + 3 + 3$.

So it seems that there is no universal law of chromodynamical excitation, at least in the vacuum, i.e. regardless of the distribution of 8 basepoints.

So we seems blocked. One reaction could be that cubics are not flexible enough with their 8 basepoint assignable to visit maximally the 19 empty ovals of a trinested M -octic. Especially important is the case where there is no outer ovals, because it is maximally obstructed apart from 3 constructions due to Shustin. For such schemes it seems natural to impose 19 basepoints. To lines we can impose 2 points, to conics $5=2+3$ points, to cubics $9=5+4$ points, to quartics $9+5=14$ points and to quintics $14+6=20$ point. However for a pencil we have precisely 19 basepoints and so we can expect a singular quintic with less ovals than $M_5 = 7$.

Then we apply the same methodology. We split first the 19 points in three colors. Here there is plenty of such partitions. First $19 = 1 + 1 + 17$ up to $19 = 6 + 6 + 7$ which the most energetical one, i.e. anti-capitalist and best distributed. Now the problem is that the singular quintic of the pencil has 6

circuits, and a priori the 19 colored points can land monochromatically into those circuits. In this case there is no transition and only $19 \cdot 2 = 38$; $5 \cdot 8 = 40$ real intersections are granted. Yet, we see that if we manage to gain a bit more chromatism we are going to violate Bézout.

Again we assume the scheme trinested without outer ovals (i.e. Gudkov symbol $\frac{x}{1} \frac{y}{1} \frac{z}{1}$ with $x + y + z = 19$). We consider the corresponding spectrum $x + y + z$, and distribute the 19 basepoints among the 19 empty ovals of the C_8 . We have a corresponding pencil of quintics interpolating those 19 points, and $3(5 - 1)^2 = 3 \cdot 16 = 48$ members of it will hit the discriminant (over the complexes at least). It seems evident that there is at least one real singular member in the pencil, and let us assume that there is even one member which is dichromatic in the sense that two different colors lands in the same oval of the C_5 . Then we have two transitions at least and so $2 \cdot 4 + 17 \cdot 2 = 8 + 34 = 42 > 40$ real intersections and Bézout is corrupted.

Of course this scenario in abstracto would conflict with Shustin's 3 constructions which are perhaps wrong albeit this is quite unlikely.

The methodology employed here is just the classical trick of "interpolation through the deep nests" and was used systematically by Zeuthen, Harnack, Hilbert. We are just now trying to see if it can explain most of Viro's sporadic prohibitions. So our strategy is quintic as tool to interpolate deep nest of M-octics.

First it should be noted that the number of transition of 19 points distributed on the at most 7 (6 if singular) circuits of the quintics will be equal to the number of points regardless of the fact that C_5 is not anymore a single circle like our previous cubic. A transition can of course just be interpreted as the arc resulting from cutting along the points; and in a (triangulated) circle (or more generally a compact Hausdorff one-manifold) there is always a bijection between edges and vertices given e.g. by an orientation.

Actually, it seems therefore not even indispensable to lower the number of ovals of the interpolating quintic by acquisition of a singular point. What is crucial is rather the dichromatism effecting that 2 points belonging to different nests of the C_8 lands in the same component of a suitable C_5 . Actually if this is not the case then all quintics of the pencil (considered as a dynamical Ölfleck) would effect (Morse) juncture only between themselves. Imagine so 3 groups of x , y and z many points summing to $19 (= x + y + z)$ and the corresponding pencil of quintics through them (which is unique under harmless genericity assumptions). Then as time evolves the initial (say smooth) quintic C_5 is deformed and at some stage it seems forced that there is a conjunction of 2 ovals coalescing together in which case we would have right after the critical level a quintic curve with dichromatism.

Of course this looks the psychologically simplest phenomenon, yet perhaps it is not a necessity. (Actually, the existence of Shustin's three maximally trinested curves, i.e. no outer ovals, incarnates an obstacle along our scenario of forced collision between ovals belonging to different colors).

Finally the method adapts (nearly mutatis mutandis) to the binested case where the game is still open (as we are in the bosonic strip of Fig. 95). Here we just have to split the 19 basepoints in two colors instead of 3, and the same dichromatism phenomenon would an obstruction of the corresponding schemes. Yet all the art is to do this without conflicting with the 3 schemes constructed by Viro in this bosonic range. So as before the method need to be refined, or perhaps it is true in brute force generality in which case few of Viro's and Shustin's constructions would be erroneous. As to Viro it is even more unlikely as his construction relies on the quadri-ellipse, yet for patches coming from the C/C combination (as E/E is subnested as seen on Fig. 22), especially as C2/C2 for the 2 admissible parameters with $\beta = 0$. Can we imagine that this parameters are killed (i.e. that Viro is wrong when claiming their existence)? Probably, not yet our understanding is so weak that we cannot exclude this option for the moment.

The philosophical principle that could make some of the above argument

work, is that *any pencil is color-mixing* (like in fine arts).

4.2 The method of the deepest penetration

[20.08.13] It is clear that the previous method can be declined in several contexts depending on the degree of the interpolating curves. Basically, we can fix our attention on the case of M -octics, and look at varied interpolating curves of degree either 1, 2, 3, 4, 5, 6. Degree 1, and 2 yields basic Bézout obstructions on the depth of nest and the maximality of the bi-quadrifolium. Degree 3 was as far as we know never successfully exploited to draw an obstruction on octic.

In the former section, we explained how this could be used by imposing 8 basepoints while still having a pencil. Now one can also impose directly 9 basepoints inside the deepest ovals. One get then (generically) a smooth cubic with 2 circuits. If our octic is purely trineded (i.e. no outer ovals) then we have 3 colors corresponding to the three nests. By the pigeonhole principle two distinct colors must land in the same circuit of the cubic. Therefore we have two color-transitions, at least, and therefore $7.2 + 2.4 = 14 + 8 = 22 < 24 = 3.8$ intersection granted. So we need more chromatism.

So assume given 9 points. We suppose given a color-spectrum of 3 colors B, W, R (black, white, red, say). Those are in correspondence with partitions of nine of length three, i.e.: $9 = 1 + 1 + 7$, $9 = 1 + 2 + 6$, $9 = 1 + 3 + 5$, $9 = 1 + 4 + 4$, $9 = 2 + 2 + 5$, $9 = 2 + 3 + 4$, $9 = 3 + 3 + 3$. One must imagine those nine colors falling into the 2 circuits of the C_3 . As three of them are distinct, at least two must land in the same circuit creating two color-shift (transition). However we need more than that to corrupt Bézout, namely four shifts as then we have $5.2 + 4.4 = 10 + 16 = 26 > 24 = 3.8$ many intersections.

We could posit that any purely-trineded M -octic admits a distribution of 9 points among the deepest 19 ovals which has at least 4 color-transitions. Even more than that we could suppose that the four-color principle holds true universally for cubics without reference to any octic, but this looks hazardous as we may choose the 9 points on a given cubic while choosing the coloration very monotonically e.g. one black and one white point on the oval of C_3 , and all remaining 7 red points on the pseudoline: then there is only 2 color-changes, instead of the 4 desired.

By the way even the version conditioned by an octic cannot be true universally at least without conflicting with 3 of Shustin's constructions.

Further as an additional technical difficulty, it seems that if one of the (nine) points lands alone on a circuit then this means roughly that the cubic has a micro-oval visiting only one inner basepoint without having to cross necessarily the oval to salesman travel in another oval. So we can even loose one of the weighted-by-2 intersection, and all our count can be jeopardized. This phenomenon is a traditional difficulty in the field (which we call the *traquenard of mini-ovals*).

Next, the method of the cubics can be adapted to the case of 2 colors, and then we may expect to derive old (Orevkov's) or new obstructions in the bosonic strip (Fig. 95). Again we need now 4 color-shift to corrupt Bézout, and this cannot hold universally without corrupting three constructions by Viro.

Next we can augment the degree of the interpolating curve, first to 4 and the 5 or 6. The gain is that we can penetrate through more basepoint as we have with increasing degree more freedom in assigning basepoints, or should perhaps rather say anchor points when we choose so many as to have a single curve. (This is the statical penetration method as opposed to the dynamical one using a whole pencil.) Of course the price to pay is that with increasing degree the interpolating curve has a priori more ovals (potentially as many as Harnack's bound), and it becomes harder to ensure chromatism, i.e. color changes can be vacant in case all three colors lands in different circuits.

For an interpolating quartic, we may impose $2 + 3 + 4 + 5 = 14$ points distributed among the 19 deep ovals of a trineded M -octic. If the latter is purely trineded (i.e. no outer ovals) then we get so, assuming τ many transitions,

$(14 - \tau).2 + \tau.4$ intersections which exceeds Bézout's $32 = 4.8$ as soon as $(14 - \tau).2 + \tau.4 = 34$, i.e. $2\tau = 34 - 28 = 6$, that is $\tau = 3$ transitions. Alas, a priori the 3 colors can fall apart in the 4 ovals of the C_4 without any chromatic interaction, and then τ is as low as zero.

In contrast we can posit some higher intelligence able to show the existence of at least 3 color-changes. Yet, as before the trick of choosing the 14 points on a given M -quartic in a very monochromatic fashion (say 1 black point on one oval and one white point on another oval, plus the 12 remaining ones on the same oval), yields a distribution for which the interpolating quartic has zero color-change.

Then we can move to quintics. There the space of coefficients has dimension $\binom{5+2}{2} = \frac{7.6}{2} = 7.3 = 21$, and we can impose 20 anchor points. In first approximation, we may choose them inside the 19 deep ovals, but there is now one more point available for which there is no preferred position. Here it may seem that the dynamical variant involving a pencil was better suited as we used the idea that any pencil is color-mixing. Maybe the 20-th (twentieth) point should be chosen externally of the 3 nests of the C_8 , and it may thus be considered as belonging to a 4th color (say G=green). A color-transition to green imposes only 2 (instead of 4) real intersections, and so out twenty points grants only $20.2 = 40 = 5.8$ intersections without provoking Bézout.

Actually this count ignore the traquenard, and can be cleaned by imposing the anchor points on the C_8 as opposed to inside their ovals. Then as all circuits of an octic are even (null-homotopic) we gain one more intersection on each twenty marked ovals and so a total of 40. Now this holds true for any choice of 20 points (injectively) distributed on the 22 ovals regardless of marking primordially the 19 deep ovals. One could hope that there is a special turbo-injection of 20 such points such that more intersection are gained.

Maybe first note that the interpolating quintic cannot intercept the two unmarked ovals, because the maximum number of 40 is already reached by the boni intersections given Möbius-von Staudt. So if we suppose given a purely trined M -octic (visualizable as 3 Swiss cheeses of the type Emmenthal) and if we fix the marking of 20 on all 19 empty ovals plus one nonvoid oval, we see that the 2 remaining nonvoid ovals are trapping the quintic ovals which cannot intersect them. We call them therefore fundamental barriers to the proliferation of ovals. We can now imagine that the 20 points are dragged inside their respective ovals moving therefore in a 20-dimensional torus. It can be imagined that for some special position the constellation of 20 points fails to impose independent conditions upon quintics, or paraphrasing that we have suddenly a pencil of quintics through our twenty points. (Observationally this is somehow reminiscent of the solar magneto-hydrodynamics with flow lines becoming so distorted that a finally violent global rupture is then necessary causing explosions, which forms the famous auroras borealis when reaching the terrestrial atmosphere.) If so is the case, we can further impose our quintic to visit one of the two barrier ovals and we get a contradiction with Bézout.

If this argument works universally then we get a proof of most of Viro's sporadic obstructions but alas also a disproof of 3 of Shustin's constructions. A little look at Fig. 95 shows that there is exactly $9 + 7 + 6 + 4 + 3 + 1 = 30$ purely trined M -schemes, of which—according to the Germano-Russian pact (Fiedler-Viro-Shustin)—only 3 of them are constructible: all the others being prohibited. So in some probabilistic sense our argument is true with probability of 90 percents, or universally true in case Shustin's constructions are wrong (albeit the seem rather plausible, compare our Fig. 121).

If we assume that each twenty-points g_{20} on the C_8 determines a unique quintic we get a continuous mapping to $|5H|$ the hyperspace of all quintics isomorphic to \mathbb{P}^{20} . The source of the mapping is essentially a torus once we restrict the location of the marking on some definite 20 ovals among the 22 available. Naively one could expect the mapping $T^{20} \rightarrow \mathbb{R}P^{20}$ being surjective, but then all quintics are swept out: so in particular one visiting the barrier-ovals and we corrupt Bézout.

Of course if there is at least two quintics interpolating the group of 20 points $g = g_{20}$, then the spanned pencil is also interpolating the same data.

So again, given a purely trined M -octic we mark 20 ovals on it (e.g. by omitting two nonempty ovals, which we call the barriers). We consider for each 20-tuple distribution on those ovals, a quintic interpolating them (which exists by basic linear algebra). We would like to show that this C_5 is not always unique. If so, then we can impose—additionally to the already 40 granted intersections situated on the 20 marked ovals—one more intersection by forcing to visit one of the two available barriers. Bézout is then contradicted.

Assume the contrary (i.e. perpetual uniqueness). Then we can define a mapping $T^{20} \rightarrow |5H| \approx \mathbb{R}P^{20}$, which cannot be surjective (else we could impose a visit of the barrier). On the other hand it could be hoped that a homological mapping degree argument à la Brouwer prompts surjectivity of the mapping in case the top-dimensional representation H_{20} on homology is non-zero. Of course as $\mathbb{R}P^{20}$ is nonorientable we must confine on homology modulo 2. Alas, it seems hard to tell anything on this mapping degree without penetrating better into the geometry of the map. We can still try to imagine each interpolating quintic through the g_{20} as this group of 20 points varies along the 20 marked ovals. One could argue that the subset of $\mathbb{R}P^2$ swept out by the collection of all those quintics is open (by a balayage argument) and compact (by general topology, plus a simple fibering argument) and therefore a nonvoid clopen (=closed open set) in the connected set $\mathbb{R}P^2$. Therefore the sweeping set is full yet this contradicts the fact that the barriers cannot be visited (by interpolating quintics).

This contradiction would prove the:

Scholium 4.1 *The interpolating quintic cannot be perpetually unique for any location of the group g_{20} of twenty markers distributed on the ovals of a purely trined M -octics. But then we can impose a visit through the barrier and Bézout is foiled. In conclusion there would be not a single trined M -octics, jeopardizing thereby construction by Shustin.*

In fact, the argument would nearly work as well regardless of the ovals distribution. It is only essential to be able to mark 20 ovals, and thus our scholium seems to kill all M -octics which seems a bit too apocalyptic if one believes in the elementary construction of Harnack/Hilbert.

Of course it could be that there is a basic mistake in what we called above the balayage argument. A priori as parameters varies the curve C_5 moves, but it can move like a wave front coming back and forth and thereby not sweeping an open domain, but doing rather what Whitney calls a fold.

Actually, it seems that the stable portion of our reasoning gives the:

Lemma 4.2 *Any group of 20 points injectively distributed on twenty ovals of an M -octic imposes independent conditions on quintics, and therefore determines unambiguously a unique quintic interpolating those points. Actually the assertion holds as well for $(M - 1)$ -curves.*

Proof. Choose a C_5 through the 20 points of the C_8 . By Möbius-von Staudt there is one more intersection on each of the 20 ovals reaching thereby already the maximum permissible of 40. But there is one more (so-called barrier) oval on the C_8 (provided it is at least an $(M - 1)$ -curve), and so we can—in case of non-uniqueness—impose additionally to the interpolating quintics to visit one of the barrier ovals, but then Bézout is contradicted. ■

Intuitively this means that everything is very stable and there is no solar irruption causing sudden jumps in the dimension of the space of interpolating quintic.

Note this being valid universally independently of the oval distributions. Yet, through the work of Fiedler-Viro-Orevkov we expect severe prohibitions in the maximally nested cases (i.e. binested with one outer oval and trined without outer oval). Can we detect them by our naive Bézout style approach, i.e. via an elaboration of the above lemma?

By the lemma (uniqueness of the quintic interpolating a distribution) we have a continuous mapping from varied tori (amounting to the $22 \cdot 21 / 2 = 11 \cdot 21 = 231$ markings of twenty ovals among the 22) to $|5H|$ the hyperspace of quintics. Further each of the interpolating quintics avoids two barrier-ovals.

It may be observed that given any group g_{20} of twenty point injectively distributed on the ovals (i.e no two lands on the same oval), we have a unique quintic through them and therefore also a dual group of 20 points cut by the same quintic, and which is still an injective distribution among the same twenty ovals as those where g_{20} lives. So we obtain an involution on G_{20} the variety of all distributions of 20 points preserving its (toric) components, and whose operation leaves the interpolating map invariable. Actually if one imagine a 20-tuple and the corresponding (interpolating) quintic each points has a unique companion of the same oval of the C_8 , and we can flip each of them independently to gain 2^{20} many 20-tuple inducing the same quintic.

It is fairly puzzling to imagine that as the 20 points moves along their respective ovals the corresponding quintic can never cross the 2 barriers. So the variability of the C_5 is much hindered by the 2 barrier ovals. So for instance if we imagine Fiedler's prohibited curve $\frac{1}{1} \frac{2}{1} \frac{16}{1}$ and we choose as marked 20 ovals all but the two containing an even number of ovals we get qualitatively the following picture. There we switched to dashed the 2 ovals which we decreed as being barriers (i.e. just those ovals where we choose no marking). On the remaining 20 ovals we choose one point on each and trace then (in red) the unique quintic interpolating them. (By the lemma it is unique, otherwise we can violate Bézout, et "ça baise tout" as we say in French). Now whatever the position of the 20 points the corresponding quintic will never sweep across the two barriers into and outside of which it stays confined perpetually. This seems a rather strong property, but alas we do not know if one can derive from this the Fiedler-Viro regular obstructions (oddity law) and perhaps the sporadic avatars too, along a purely elementary Bézout line of thoughts.

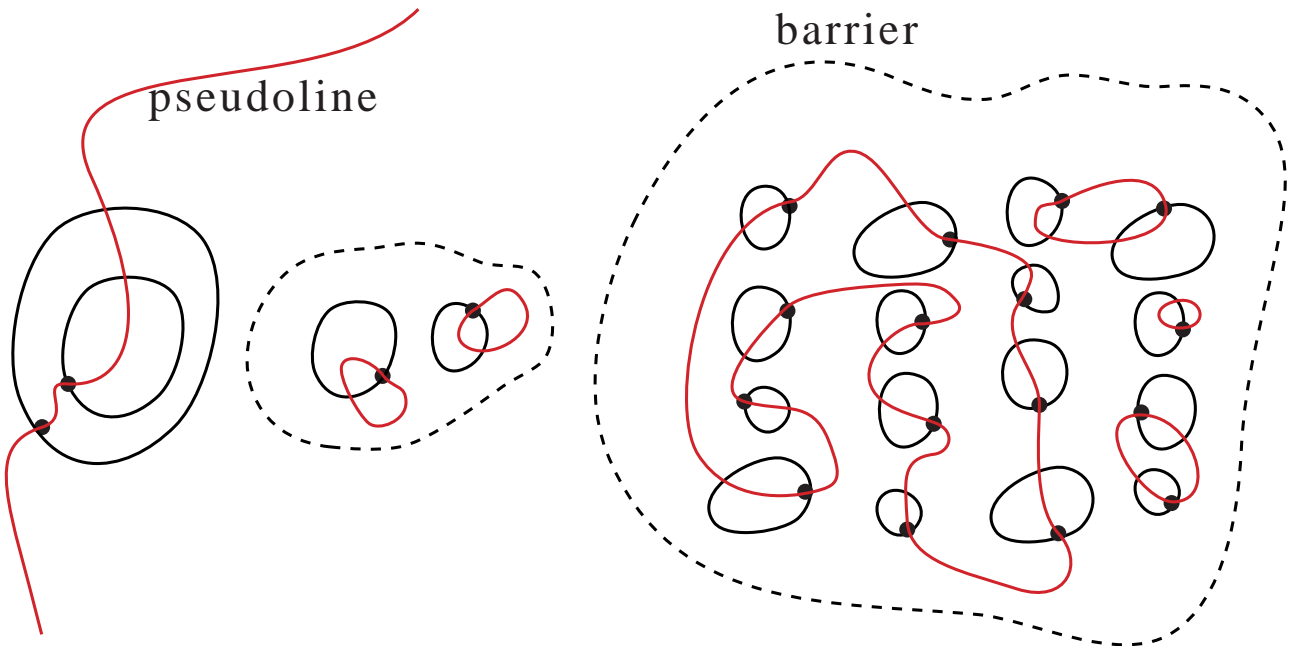

Figure 25: Confinements by the barriers (on the Fiedler anti-curve $\frac{1}{1} \frac{2}{1} \frac{16}{1}$)

4.3 More total reality: new higher superconductivity cases

[21.08.13] Albeit unfinished and promising, we leave now the quintics to move to interpolating sextic. Here we have the basic phenomenon of total reality à la Riemann made synthetical as in Gabard 2013B [471]. We recall briefly how it works on the case at hand of octics. We look in codegree 2, here to sextics

with $\binom{6+2}{2} = 4.7 = 28$ free coefficients so that we may impose 26 basepoints to a pencil. On an M -octic we therefore impose 22 basepoints (injectively) distributed on the 22 ovals and we choose the remaining 4 points either as a tower of 4 concentrated on one oval or as two little towers of height 2 dispatched on two different ovals. In both case by the Möbius-von Staudt principle of intersection we have one bonus intersection gained by continuity on each oval bringing the total number to $26 + 22 = 48$, which is miraculously equal to 6.8, whence the total reality of the considered pencils.

It may perhaps be argued that total reality can merely reassess Harnack's bound (think e.g. with the total reality of an M -quartic via a pencil of conics, also of co-degree 2, i.e. 2 units less than the curve under inspection). If so, maybe this total reality is not a serious weapon toward inspecting the distribution of ovals of curve. Yet we believe that via the pencil one should be able to draw by the dextrogyration principle some valuable information upon complex orientations, and this should in turn make possible further advances on Hilbert's problem.

Next why stopping at degree 6? In higher degrees one can imagine again imposing (more) basepoints and eventually several layers (couche in French) of basepoints imagines as eggs ranged in the ovals conceived as pigeonholes. Perhaps provided we take care imposing an odd number of them on each oval, Möbius-von Staudt will still create for us one boni intersection on each oval and it remains merely to count at what happens, i.e. the net profit of hanseatic capitalism.

So assume auxiliary degree $k = 7$ to study (absolute) degree $m = 8$. We have then $\binom{7+2}{2} - 2 = 9.4 - 2 = 34$ basepoints assignable. We distribute them on the 22 ovals, while dispatching the 12 remaining ones as 6 pairs either horizontally or as vertical towers. All combinatorial possibilities are accepted a priori. By evenness of the ovals, we gain one more bonus intersection on each oval and thus the total number of intersection is $34 + 22 = 56$ which is again equal to 7.8, and total reality is obtained anew. It is clear that this miracle must reproduce in (all) higher degrees $m \geq 8$.

Besides, for $k = 8$ the miracle probably holds as well. We have then $\binom{8+2}{2} - 2 = 5.9 - 2 = 43$ basepoints assignable. We distribute them on the 22 ovals, while dispatching the 21 remaining ones as 10 pairs interpreted as towers, but there is one extra point left alone. By evenness of the ovals, we gain one more bonus intersection on each oval but one and thus the total number of intersection is $43 + 21 = 64$ which is again equal to 8.8, and total reality is granted anew.

All this looks quite formidable but it remains to inspect if this can be employed as a tool to investigate distributions of ovals.

Let us consider finally $k = 9$. We have then $\binom{9+2}{2} - 2 = 11.5 - 2 = 53$ basepoints assignable. We distribute them on the 22 ovals, while dispatching the 31 remaining ones as 15 pairs interpreted as towers, but there is one extra point left alone. By evenness of the ovals, we gain one more bonus intersection on each oval but one, and thus the total number of intersection is $53 + 21 = 74$ which is again equal to 9.8, and total reality is granted anew.

So we have (modulo a trivial arithmetical check) an infinity of ways to exhibit total reality of M -curves, which are perhaps relevant to the problem of the distribution of ovals.

For concreteness, we must concentrate on degree $m = 8$. The challenge would be to recover the Fiedler, Viro, Shustin and Orevkov obstructions (assuming them to be all correct) while also possibly discovering new obstructions on the six bosons not yet realized. A priori the game can be dangerous as even the most basic looking obstruction of Fiedler-Viro could be completely erroneous. For instance remember from our earlier composition table that patchwork with extended patches could easily produce all the schemes prohibited by the Fiedler-Viro oddity law. Notwithstanding, let us hope that this law is true and then the question becomes: how to prove it in the most elementary way and ideally in such a fashion that the new bosonic obstructions (yet unknown) appear as likewise trivial consequences of Bézout. This we call the principle of the Grande

Nation, i.e. French post-revolutionaries annexing all Prussia and Russia with a single pseudo-hero, Napoléon.

As we see there is many experiments that can be imagined by studying varied auxiliary curves of possibly very high degree. Of course if we look say at (absolute) quartics (i.e. $m = 4$) then auxiliary curves of degree 1 gives the classical obstructions (no nesting for M -quartics), and those of degree 2 produces Harnack's bound. So it seems that all information is obtained by looking at adjoint curve of co-degree $k = m - 2$. Whether this is a general principle is not clear to us but perhaps quite likely even for $m = 8$. Maybe the situation is just opposite and one can infer information from higher order $k > m - 2$ curves. We shall loosely refer to them as cases of superconductivity.

Alas, apart from the just observed extension of total reality to all higher degrees we have not yet a single concrete manifestation of the principle that superconductivity should afford new information. Yet, this seems quite likely.

Basically, all those superconductions incarnates total reality hence implies Harnack's bound, but perhaps with increasing energetic levels so has to contain additional information upon the distribution of ovals themselves. This basic idea looks plausible yet needs to be substantiate with more tangible evidence.

Concretely we look again at $k = 6$, then we have 4 extra basepoints, and it is not clear how to choose them. We suppose given a trinested M -curve with an even number of ovals in one nest. Then there is actually two such even nests and one which is even (compare the pyramid Fig.95, which is merely a combinatorial traduction of Gudkov periodicity). Maybe we should distribute the 2 extra pairs of basepoints on the two even nests.

For $k = 7$, we had $\binom{7+2}{2} - 2 = 9.4 - 2 = 34$ basepoints assignable, and distributed them on the 22 ovals, while dispatching the 12 remaining ones as 6 pairs either horizontally or as vertical towers. All combinatorial possibilities are accepted a priori. By evenness of the ovals, we gain one more bonus intersection on each oval and thus the total number of intersections is $34 + 22 = 56$ which is again equal to 7.8, and total reality is obtained anew. Maybe here we can infer Viro's sporadic obstructions for judicious choices of the 6 extra pairs.

Next we have $k = 8$, where we had $\binom{9+2}{2} - 2 = 11.5 - 2 = 53$ basepoints assignable. We distribute them on the 22 ovals, while dispatching the 31 remaining ones as 15 pairs interpreted as towers, but there is one extra point left alone. By evenness of the ovals, we gain one more bonus intersection on each oval but one, and thus the total number of intersections is $53 + 21 = 74$ which is again equal to 9.8 (NO SORRY this is 72), and total reality is granted anew. Since this is the maximum possible, we see that the one oval where we assigned only one extra basepoint is so-to-speak just a double couche, and on it no new intersections can be created, because the boni intersections gained outside of this oval already saturate Bézout's hospitality. Hence it is quite puzzling to see a total pencil where there is no mobile point circulating on one oval. This seems to contradict all what we knew about the Riemann-Ahlfors map, since Riemann, Schottky, Bieberbach, Grunsky, etc. Of course one trivial explanation could be that the pencil degenerate somehow by splitting off the ground octic as a subfactor, yet then our pencil would be a very statical object. Of course the same phenomenon occurs when $k = 9$, then perhaps in a less statical incarnation.

Then with $k = 10$ evenness of the excess is restored again. Precisely, we have then $\binom{10+2}{2} - 2 = 6.11 - 2 = 64$ basepoints assignable. We distribute them on the 22 ovals, while dispatching the 42 remaining ones as 21 pairs interpreted as towers. By evenness of the ovals, we gain one more bonus intersection on each oval, and thus the total number of intersections is $64 + 22 = 86$ which is larger than 10.8, and total reality is lost. Presumably due to the excess intersection the decaics (degree 10) have to split off the ground octic. Yet it is curious that as we have a triple couche on all ovals but one (in simple couche), it seems that we have a decent circulation à la Riemann-Bieberbach, but apparently Bézout is unhappy. Naively it seems nearly that this reasoning shows that there in not a single M -octic in degree 8, which is blatantly false (in principle).

At least, it seems that our expectation of the phenomenon of total reality as admitting infinite repetition in all higher degrees is foiled, but seems to appear only at degrees $k = m - 2, m - 1$ and perhaps $m, m + 1$.

Next with $k = 11$ evenness of the excess is still conserved. We have then $\binom{11+2}{2} - 2 = 13.6 - 2 = 76$ basepoints assignable. We distribute one of them on each of the 22 ovals, while dispatching the 54 remaining ones as 27 pairs interpreted as towers. By evenness of the ovals, we gain one more bonus intersection on each oval, and thus the total number of intersections is $76 + 22 = 98$ which is larger than 11.8 (as $k = 10$ the excess $80 < 86$ was of six and now it is larger by 4), and total reality is lost.

Of course in the cases where we get excess intersections (over Bézout), we could change the distributions of basepoints as to produce less boni intersections.

Next we noted that due to a sordid arithmetical mistake of us ($9.8 = 74$ instead of 72) already the case $k = 8$ presents excess intersection, and geometrically this should mean that the pencil must split off the ground octic. Yet by linear algebra the points are interpolated by a pencil (at least or some linear series of higher dimension), yet this sounds quite paradoxical because as no residual curve is available, we really seems to face a paradox of the sort quite common to algebraic geometers (compare Enriques-Chisini's discussion of MacLaurin, or so).

So it seems important to settle the paradox, as there is some hope to derive from it a tension potentially valuable to Hilbert's 16th. Alternatively we can ignore this and hope that the real information on Hilbert's problem is stocked in the cases $k = 6$ and 7 where total reality works well without overheating Bézout. Of course the genuine information is perhaps also stocked by using lower order curves with $k = 3, 4, 5$ as we tried unsuccessfully to sketch some few days (or pages) ago.

For $k = 7$, we had $\binom{7+2}{2} - 2 = 9.4 - 2 = 34$ basepoints assignable, and distributed them on the 22 ovals, while dispatching the 12 remaining ones as 6 pairs either horizontally or as vertical towers. All combinatorial possibilities are accepted a priori. By evenness of the ovals, we gain one more bonus intersection on each oval and thus the total number of intersections is $34 + 22 = 56$ which is again equal to 7.8, and total reality is obtained anew. Maybe here we can infer Viro's sporadic obstructions for judicious choices of the 6 extra pairs. As we reach Bézout's bound no more intersection exist than those imposed and the single one created by continuity on each oval. This seems to be a strong constraint, and maybe there is a clever way to deduce something out of it. Where to choose the 6 extra pairs for a given M -scheme (which is prohibited)? Perhaps the simplest prohibition (at least historically) seems to be Fiedler's prohibition of 4 purely trined M -schemes, starting say with $\frac{1}{1} \frac{2}{1} \frac{16}{1}$ which as an anecdote contains also Hilbert's beloved number 16 in the 3rd numerator.

So imagine Fiedler's (anti) curve as on Fig. 26 below where we already imposed a basepoint on each ovals but we are still free to place 6 pairs of basepoint. Naively it could seem that the best choice is to impose them on the deep ovals so that the septics being assigned to visit those deep ovals more frequently there will be a higher probability that a certain curve of the pencil will cross the separating nests too often. (Recall that each curve of the pencil can cross only once each oval outside of the imposed basepoints.) So if we can force more intersections Bézout is corrupted and the scheme prohibited. However on doing a qualitative picture we see that even with this deep assignment there is no difficulty to trace by free hand a curve visiting all basepoints while crossing each oval at most once. Of course as we in reality a pencil we should trace not just a single curve but worry about the whole induced foliation (with mild singularities at the base point or at the critical curves). The point is that the pseudo line will intersect itself and so contributes to the creation of unassigned basepoint. But of course it can also be the case that the pseudo-line visits assigned basepoints.

So the problem looks fairly difficult, yet perhaps trivial once one has the right idea. Actually, unclever peoples just needs a lot of time to test all ideas (=possibilities) until finding the true argument (reminds Poincaré's story about

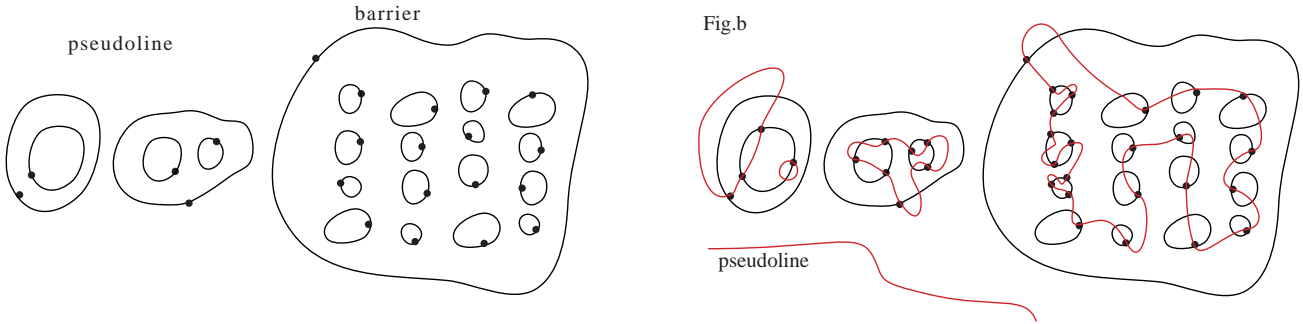

Figure 26: Confinements by the barriers (on the Fiedler anti-curve $\frac{1}{1} \frac{2}{1} \frac{16}{1}$)

les combinaisons stables).

At any rate, it is clear that we are in realm quite fascinating (Hilbert, Rohlin, Fiedler, Viro) becoming even more so once the connection with conformal mapping is noticed (Riemann, Bieberbach, Grunsky, Ahlfors, etc.), yet it is still very hard to understand properly the Fiedler-Viro obstruction in the most synthetic way. Of course their proofs might be the correct one yet we may expect a simpler argument leading perhaps to new insights (i.e. new restrictions that as far as we can judge where not yet derived by the methods of Fiedler, Viro, Shustin, Orevkov) which are methodologically a bit disparate and loosely unified. One could dream that very simple Bézout style arguments do obstructs some of the octic schemes. The difficulty is that there are several fronts where to attack the problem $k = 3, 4, 5, 6, 7$ and perhaps higher so that once energy is much dissipated by the variety of situation to analyze. Further each situation request long hours of concentrations to get mentally familiar with and looks like a big Eiger Nordwand face hard-to-climb upon. So a human intelligence is quickly desperate by the duty, and the sole consolation is that the proof must be trivially beautiful once found.

So one can hope to have a reliable geometric flair of where to find the argument without wasting to much energy. On the one hand using say the case of degree $m = 4$ as prototype, we see that once Harnack's bound is known curve of degree 1 (lines) suffice to settle the isotopy classification of (in particular) M -curves. Those having co-degree $m - k = 4 - 1 = 3$, we may expect that in degree 8 similar information (isotopic classification) is gained by curves of degree 5. Another sloppy reason would be the role of the canonical class which for plane curves of degree m is cut out by adjoint of degree $m - 3$. However when it comes to $m = 5$, the crucial role should be played by conics, yet it seems to be still played by lines. Even when $m = 6$, curves of co-degree 3 i.e. cubics plays a little role safe in the fundamental Rohlin-Le Touzé phenomenon which explains all of Gudkov's prohibitions in some ad hoc way.

Maybe this gives the following idea: to get obstruction on M -curves one must look lower at $(M - 2)$ -curves of the RKM type (hence universally orthosymmetric) and tabulating upon Rohlin's maximality conjecture this would kill new schemes. One problem with this approach is that Rohlin's maximality principle looks severely foiled in degree $m = 8$ (compare our counter-examples 7.1 via Viro's 1st curve (beaver) or 7.4 via Shustin's medusa).

Of course, it would be perhaps of interest to see if our naive methods (deepest penetration=DEPP, or total reality=TOR) do work in degree 6 already to get the classical prohibitions of Hilbert, Rohn, Gudkov. This is already a (ingrate) nontrivial exercise, yet perhaps necessary to prepare further progresses, or gain confidence in the method: notably, to decide the question if it is better to work with codegree 3 (DEPP) or codegree 2 (TOR).

Through 8 points we can pass a pencil of cubics in particular a connected cubics. Through 9 points we can pass a cubic. So imposing 9 points on the 11 ovals of an M -sextic we get twice so many intersection granted, i.e. 18 by Möbius-von Staudt principle of evenness, which is the maximum permissible. So if we impose those 9 points on the 10 deep ovals of the M -sextic we see that

the nonempty oval of the C_6 will act as a barrier upon the situation of the cubic (since the intersection $C_3 \cap C_6$ is already saturated to 18), and will actually fall it apart

Fig. 27. One sees in particular that any such distribution of 9 points impose independent conditions on cubics. Else if there would be a pencil freedom we could impose visiting the barrier and Bézout is corrupted. We recognize here a perfect analogy with the situation $(m, k) = (8, 5)$ studied earlier. In particular, we see again the phenomenon of confined thermo-excitation, namely: whatsoever the position given to the nine anchors the unique cubic through them avoids the barrier. Now we can additionally infer that it must be smooth, otherwise it is connected and so hit the barrier or possess a solitary node but then cannot fulfill its interpolating duties inside the C_6 's nonempty oval (except perhaps for Harnack's scheme $9\frac{1}{1}$).

Philosophically, we see that an M -curve of degree m constitutes a strong trap for curves of codegree 3, i.e. degree $m - 3$. From this principle one would lie to deduce the classical prohibitions (Hilbert, Rohn, Gudkov as done without the simplifying assistance of Arnold-Rohlin using systematically homology).

Let us assume that we have Rohn's scheme $\frac{10}{1}$. Then we may impose 9 basepoints inside the nonempty oval and the resulting cubic has to be trapped in it (because the intersection is already saturated to 18 by topology), but this is impossible as the cubical circuit cannot be null-homotopic. This contradiction supplies a very elementary proof of Rohn's prohibition. (Discovery of us at [14h24, 21.08.13]). So:

Theorem 4.3 *There is a completely trivial proof of Rohn's prohibition using just Möbius-von Staudt principle of intersection (you cannot penetrate in an oval along a recurrent motion without escaping once of it). This proof is one just given!*

Yet, Fig. c kills our pseudo-proof, since our argument overlooked the option that it is just the oval of the cubic which visits the 9 basepoints.

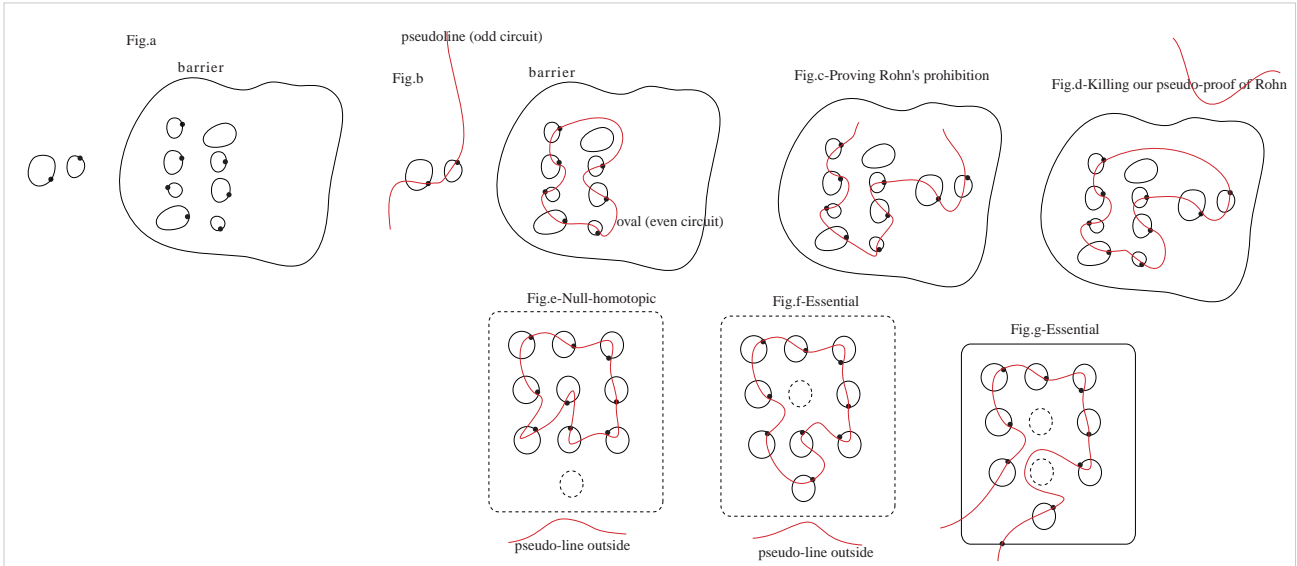

Figure 27: XXX

[22.08.13] Nonetheless, we see that if we impose 9 points on the ovals (injectively), then the cubic has by Möbius-von Staudt already 18 intersection with the C_6 and therefore we deduce that the two remaining ovals are not intercepted. In case the sextic has a non-empty oval, and we distribute the 9 points outside of it, then the interpolating cubic cannot meet the nonempty oval nor the other oval left unmarked. Thus provided points are marked inside of the *nonempty oval* (barrier for short), the latter acts as a separator splitting the cubic into 2 pieces. If the cubic would be connected, then it would be trapped inside the

barrier, forcing it to be null-homotopic, which is impossible. Incidentally, we see also that the cubic must be smooth and forced to have two components. Moreover we see that the 9 points imposes independent conditions on the cubic, since there were 2 of them we could impose to visit a point on the barrier (and Bézout is corrupted).

So we really get a stringent context, where we can drag all 9 points on their respective ovals while seeing always a unique corresponding (split) cubic whose oval stays confined inside the barrier. Alas, we do not know how to draw a contradiction under the standard hypotheses (i.e. outside of the Harnack, Hilbert, and Gudkov curves).

Several ideas are as follows.

First, one could expect the mapping assigning to each 9-distribution the unique interpolating cubic to be étale or just open, in which case the image would be a clopen hence full. (Remind, indeed, that the source is a compact finite union of tori, whence closed-ness of the image.) Yet this violates the issue that the interpolating cubics are always split, i.e. smooth with 2 components (hence confined in one chamber past the discriminant). Hence it seems that there is no chance for the canonical map being open.

Next, one can observe that the cubic's oval will belong to a unique homotopy class past the 2 barriers ovals which are unmarked, just because we can deform along the 9-torus of all distributions. To be more concrete, if we assume Rohm's type $\frac{10}{1}$ and the 9 marked ovals to be inside then the resulting cubics cannot meet the nonempty oval nor the little empty oval left unmarked. Thus the cubic's oval is either null-homotopic or winding once around the hole formed by the little unmarked oval. Probably both cases are possible upon varying the marking (cf. Figs. e, f). Further one can of course also mark the nonempty oval (Fig. g) but then it cannot be anymore guaranteed that the interpolating cubic is split.

It is clear that the strategy looks hard to complete.

Again, in degree 6 most obstructions can be inferred from the Rohlin-Le Touzé total reality of the two $(M-2)$ -schemes which are RKM hence universally orthosymmetric. One can wonder if this method applies as well in degree 8, as to re-explain the obstructions of Fiedler, Viro, Shustin, Orevkov lying beyond Gudkov periodicity. A loose counter indication from the scratch is that in degree 6, the Rohlin-Le Touzé phenomenon explains only (as it should since there are no more obstructions) Gudkov periodicity. Still one could expect that a total reality at level $(M-2)$ could kill M -schemes. So $(M-2)$ -total reality acts as a cosmic censorship over M -schemes, exactly as the Gürtelkurve of degree 4 explains the classification of M -quartics as being necessarily unnested.

Now looking at the main pyramid (Fig. 155 or its enlargement Fig. 156) we can try to speculate of where to locate totally real $(M-2)$ -schemes so as to induce the known obstructions.

For instance to explain Orevkov's obstructions, we could imagine that the scheme $T_1 := \frac{3}{1} \frac{15}{1}$ is totally real (under a pencil of quintics, i.e. co-degree 3 like by Rohlin-Le Touzé). As good news our map remembers us that this scheme easily exist via Viro's simplest method. Albeit not RKM, we posit that this scheme is totally real. Quintics have 19 basepoint assignable for a pencil, and so 38 intersections are granted and we need just a miracle of 2 to reach total reality at $40 = 5.8$. Now what are the enlargements of this scheme. First there is $1 \frac{3}{1} \frac{15}{1}$ which is dominated by Viro's anti-scheme $\frac{1}{1} \frac{3}{1} \frac{15}{1}$, and this is another good news as our supposition of total reality would kill this scheme too. Next on the right wing there is the scheme $\frac{3}{1} \frac{16}{1}$ that would be killed as well, and this does not contradict experimental data available to us. As another enlargement of T_1 we have $\frac{4}{1} \frac{15}{1}$ and $1 \frac{4}{1} \frac{15}{1}$ and this would explain the disintegration of the boson b_4 too.

Likewise Orevkov's 2nd obstruction on $b_6 := 1 \frac{6}{1} \frac{13}{1}$ could be explained by a total reality of the $(M-2)$ -scheme lying below it, namely $\frac{6}{1} \frac{12}{1} =: T_2$. This would kill the boson b_7 . Alas as yet our table does not report a realization of T_2 . Additionally, our scheme T_2 is dominated by Fiedler's scheme $\frac{1}{1} \frac{6}{1} \frac{12}{1}$ whose

prohibition would be derived anew.

Likewise we can imagine a total reality killing the boson $b1 := 1\frac{1}{1}\frac{18}{1}$, hence concerning the scheme $1\frac{1}{1}\frac{17}{1} =: T_3$. Alas, this would kill also Viro's scheme $1\frac{2}{1}\frac{17}{1}$ which exist however, and also Shustin's scheme $1\frac{1}{1}\frac{17}{1}$. Hence total reality at T_3 is unlikely.

Finally, we can imagine a total reality killing the boson $b9 := 1\frac{9}{1}\frac{10}{1}$, hence concerning the scheme $\frac{9}{1}\frac{9}{1} =: T_4$. A first good news is that T_4 exists by a simple Viro method. In view of its extremal position our scheme as no enlargement in the first pyramid safe those readily visualized above it. However an enlargement occur in the 2nd pyramid where we find $1\frac{9}{1}\frac{9}{1}$, which is prohibited by a Viro sporadic obstruction. In conclusion total reality at T_4 is fairly likely, and compatible with Russian knowledge/folklore.

In contrast, we expect now total reality below the boson $b7 = 1\frac{7}{1}\frac{12}{1}$, i.e. at $T_5 := 1\frac{7}{1}\frac{11}{1}$ as this would kill Viro's scheme $b8 = 1\frac{8}{1}\frac{11}{1}$.

4.4 Total reality as a cosmic censorship

[22.08.13] Can we continue this game (of total reality as a cosmic censorship) as to explain also the other Fiedler, Viro obstructions. Yes, we can; it seems at least worth trying to elucidate this.

First, below Fiedler's obstruction of $1\frac{2}{1}\frac{16}{1}$ we find $1\frac{2}{1}\frac{14}{1}$ which we posit totally real. The impact would be to kill $1\frac{3}{1}\frac{14}{1}$ and $1\frac{3}{1}\frac{15}{1}$, in accordance with prohibitions by Shustin and Viro respectively. A third enlargement involves $1\frac{2}{1}\frac{14}{1}$ and $1\frac{2}{1}\frac{15}{1}$ also prohibited by Shustin and Viro respectively.

Next, below Viro's obstruction of $1\frac{3}{1}\frac{15}{1}$ we find $1\frac{3}{1}\frac{13}{1}$ which kills the way right above it (Shustin, Viro), also that one in front of it (Shustin, Fiedler), and that in the shifted layer (Shustin, Viro).

Next, below Fiedler's obstruction of $1\frac{4}{1}\frac{14}{1}$ we find $1\frac{4}{1}\frac{12}{1}$ which kills the way right above it (Shustin, Fiedler), also that one in front of it (Shustin, Viro sporadic), and that in the shifted layer (Shustin, Viro regular).

Next, below Viro's obstruction of $1\frac{5}{1}\frac{13}{1}$ we find $1\frac{5}{1}\frac{11}{1}$ which kills the way right above it (Shustin, Viro sporadic), also that one in front of it but this time conflicting with a construction claimed by Polotovskii namely $1\frac{6}{1}\frac{11}{1}$. So either Polotovskii is wrong or so is our censorship principle. Eventually our censorship could still be true, but our scheme ($1\frac{5}{1}\frac{11}{1}$) would lack total reality. This is a possible scenario, yet would be annoying because then total reality would not explain all prohibitions. However $1\frac{5}{1}\frac{13}{1}$ could be prohibited by $1\frac{4}{1}\frac{12}{1}$ as we saw, and this restores the hope to explain everything via total reality. On the shifted layer our scheme kills dully schemes prohibited by Shustin and Viro.

Next, below Fiedler's obstruction of $1\frac{6}{1}\frac{12}{1}$ we find $1\frac{6}{1}\frac{10}{1}$ which overkills the way right above it (Polotovskii, Fiedler), and also makes conflicting damages in front of it (Polotovskii, Shustin), but in the shifted layer we recover known obstructions (Shustin, Viro). Yet, in summary it seems that we cannot expect total reality for this $(M - 2)$ -scheme.

At this stage no more comments should be necessary, and it suffices to mark on the table (Fig. 155) by TOR schemes susceptible of total reality and by NIET those for for which there there is "No Instinctive Evidence for Total reality". It should be noted that contrary to what we said there is no conflict between our principle of censorship and Polotovskii's constructions.

Next we move to the 2nd layer of the 2nd pyramid. First we meet the scheme $12\frac{2}{1}\frac{2}{1}\frac{3}{1}$. If censorship is a universal reason for M -prohibitions, one would naively posit total reality for the scheme below it $11\frac{2}{1}\frac{2}{1}\frac{2}{1}$. Actually there is other $(M - 2)$ -schemes in the first layer dominated by $12\frac{2}{1}\frac{2}{1}\frac{3}{1}$, yet positing their total reality (TOR) would corrupt a construction by Polotovskii. Still we can in the 1st layer posit TOR for $10\frac{1}{1}\frac{2}{1}\frac{4}{1}$, and several other schemes marked by TOR on the main table (all this being consistent with Polotovskii and re-explaining Viro's law). Now back to the 2nd layer, our TOR-postulation on $11\frac{2}{1}\frac{2}{1}\frac{2}{1}$ would via censorship prohibit $12\frac{2}{1}\frac{2}{1}\frac{2}{1}$ (a question left in suspense in Shustin 90/91 [1419]).

Next we have $8\frac{2}{1}\frac{2}{1}\frac{7}{1}$ which as before cannot be prohibited from the 1st layer (without conflicting with Polotovskii), and so we put a TOR-tag right below it. Note at this stage that in this 2nd layer we have $(M - 2)$ -schemes prohibited by Viro, and to rules them out via our method we should posit certain total realities at the $(M - 4)$ -level running thereby out of our tabulation. Maybe we should content to explain only M and $(M - 1)$ -prohibitions.

The next interesting case is $\frac{2}{1}\frac{2}{1}\frac{15}{1}$ which as we saw can be ruled out by a TOR-prescription below the appropriate Fiedler's scheme ($\frac{1}{1}\frac{2}{1}\frac{14}{1}$), hence there is no need to impose a TOR-tag on $\frac{2}{1}\frac{2}{1}\frac{13}{1}$. Beside an obvious principle of economy the net bonus is that we get so a very regular distribution of TOR's on the first layer (on the first row at least as examined up to now). It should be remarked however that other more frequent distributions of TOR's could explain the same prohibitions: so we could instead of TORing the central item of each monticulus we could TOR the two lateral items at the basis of the triangle. In that case Shustin's uncertain scheme $12\frac{2}{1}\frac{2}{1}\frac{2}{1}$ would not be killed except if we TORize the left basis $12\frac{2}{1}\frac{2}{1}\frac{1}{1}$, which is however a ghost copy of a scheme in the 1st layer below a Polotovskii trademark (construction). Hence Shustin's incertitude remains very vivid, and not easy to settle even after acceptance of our censorship principle.

Next we arrive at $8\frac{2}{1}\frac{3}{1}\frac{6}{1}$. This prohibition cannot be explained by TOR in the 1st layer, and so we are forced to put a TOR at $6\frac{2}{1}\frac{3}{1}\frac{6}{1}$. Alas, this breaks our central positioning of TOR's in first row (of the 2nd layer). One checks quickly that this causes no undue damage in the 3rd layer. (This is because the right basis of a monticulus=triangle has no superior in the upper layer, as a consequence of GKK-periodicity=Gudkov, Krakhnov, Kharlamov).

Next we have $4\frac{2}{1}\frac{3}{1}\frac{10}{1}$. One can of course impose a TOR on $3\frac{2}{1}\frac{3}{1}\frac{9}{1}$ to explain the 3 prohibitions right above, and in the 3rd layer this implies 2 additional prohibitions namely $3\frac{3}{1}\frac{3}{1}\frac{9}{1}$ (Shustin) and $4\frac{3}{1}\frac{3}{1}\frac{9}{1}$ (Viro's most sporadic). Alternatively one can fix TOR's at the 2 corners of the triangle ($4\frac{2}{1}\frac{3}{1}\frac{8}{1}$ and $2\frac{2}{1}\frac{3}{1}\frac{10}{1}$) to get the same censorship on the 2nd layer, yet now causing different damages on the 3rd layer namely killing rather the left versant of the monticulus. This is to say that $4\frac{3}{1}\frac{3}{1}\frac{8}{1}$ and $4\frac{3}{1}\frac{3}{1}\frac{9}{1}$ are now killed.

Next we examine $8\frac{2}{1}\frac{4}{1}\frac{5}{1}$. There is no way to eliminate it by a TOR in the 1st layer (due to a construction of Polotovskii, that we checked via Viro), and so we are forced to place the TOR at the natural location $7\frac{2}{1}\frac{4}{1}\frac{4}{1}$. This kill besides 2 schemes in the 3rd layer (Shustin and Viro).

Next we examine $4\frac{2}{1}\frac{4}{1}\frac{9}{1}$. Again there is no way to eliminate it by a TOR in the 1st layer (due to a construction of Polotovskii, that we did not checked but probably just as a consequence of the fact that we initially missed all combinations of Viro's method). So we are forced to place the TOR at the natural location $3\frac{2}{1}\frac{4}{1}\frac{8}{1}$. This kill besides 2 schemes in the 3rd layer (Shustin and Viro).

The next case of interest arises with $\frac{2}{1}\frac{5}{1}\frac{12}{1}$ where there is not anymore a reduction to the 1st layer, and thus it seems now necessary to impose a TOR on the 2nd layer at the natural place, namely $\frac{2}{1}\frac{5}{1}\frac{10}{1}$.

Next we can move to the 3rd layer. First, albeit not completely necessary (depending on what we did on the 2nd layer) we are invited to put a TOR at $3\frac{3}{1}\frac{3}{1}\frac{8}{1}$.

Next we inclined to put a TOR on $\frac{3}{1}\frac{3}{1}\frac{11}{1}$ albeit this could be dispensed if we had introduced one at $\frac{2}{1}\frac{3}{1}\frac{12}{1}$. Our idea of looking at totally real $(M - 2)$ -schemes as a trick to find the true reason behind the seemingly chaotic distribution of prohibitions is only half efficient. Yet our Rohlin-style philosophy that total reality should regulate the distribution of ovals looks to us an extremely appealing law that the divine nature is probably following. Of course it can be that all our discussion is biased by Viro's theory in case he used anomalous patching parameters. Of course the censorship principle is merely a strong form of total reality permitting one to sweep out the curve by a totally real pencil, hence forbidding the presence of any additional ovals. We think it is easy to justify theoretically. Philosophically, it seems that total reality is fairly ubiquitous and therefore explaining the many prohibitions of Fiedler, Viro et cie (Shustin, Orevkov). So we

imagined that prohibition are bad, but in reality they are the reverberation of the goodness of total reality. Furthermore the presence of many prohibition in low degree will permit (via the satellite principle) the presence of more schemes in higher degrees multiple of 8 (since an M -scheme is totally real and so will kill all extensions of its satellites).

Next a TOR at $6\frac{3}{1}\frac{4}{1}\frac{4}{1}$ is not even requested. For $4\frac{3}{1}\frac{4}{1}\frac{8}{1}$ and its $(M-1)$ -companion $3\frac{3}{1}\frac{4}{1}\frac{8}{1}$ we do not need to place a TOR at $2\frac{3}{1}\frac{4}{1}\frac{8}{1}$ since $3\frac{2}{1}\frac{4}{1}\frac{8}{1}$ does already the killing-job.

For $\frac{3}{1}\frac{4}{1}\frac{12}{1}$ we need a TOR, in case we did not placed one in the 2nd layer. So the discussio can be continued in a quite tricky way. When reaching $\frac{3}{1}\frac{8}{1}\frac{8}{1}$ it seems necessary to introduce a TOR at $\frac{3}{1}\frac{7}{1}\frac{7}{1}$, yet this not even needed as we “TORed” $\frac{2}{1}\frac{7}{1}\frac{8}{1}$. We can remark that it must be nearly possible to avoid any TOR in the 3rd layer if we distribute them suitably on the 2nd layer. This request to be better analyzed.

Despite tired and poorly organized, our troupes can now enchain with an attack of the 4th layer. A construction of Polotovskii in the 3rd layer forces us to tag (by a TOR) the scheme $3\frac{4}{1}\frac{4}{1}\frac{6}{1}$.

Actually we remark that in the 3rd layer $\frac{3}{1}\frac{7}{1}\frac{7}{1}$ cannot be TOR as it is dominated by schemes of Polotovskii and Shustin in the 4th resp. 5th layer. Our thesis is really that all prohibitions of Hilbert’s 16th (in degree 8 those being due to Fiedler, Viro, Shustin, Orevkov) can in reality be reduced and uniformized through a Rohlin-Le Touzé series of phenomena of total reality. This is an unifying theme as to comprehend whole of them in as single soup incarnating the telluric plasm behind each little volcanic irruptions (seemingly completely random), yet governed reality by a deep flow at the $(M-2)$ -level and not just by the little summit of volcanos at the M -level. So we a perfect metaphor with the famous geological story about the foss Marianes where much terrestrial crust goes absorbed by tectonic translation, resulting thereby in the chain of volcanoes.

It is at this stage that we discovered the curvy arrows of domination moving two rows upwards as depicted on Fig. 155. With those even less TORs are required to explain all prohibitions. For instance $\frac{2}{1}\frac{7}{1}\frac{8}{1}$ does not seem to request anymore a TOR, since all its prohibited entourage can be reduced to other TORs. Of course it is then requested that $\frac{3}{1}\frac{6}{1}\frac{8}{1}$ is a TOR.

So it seems that to approach the problem more systematically we need first to look at construction (e.g. Shustin), accept them as legal, and then look at all arrows (magma motions of the telluric flow) and put NIETs whenever we are the endpoint of an arrow issuing from a constructible M -scheme. We see then that Hilbert’s problem is an organic whole not concerning isolated 6 schemes but there is global coherence and potentially everything Viro included must revised from the very beginning. Then by wondering where those curvy arrows lands when approaching the top we discovered the green curvy-arrow, of which there is a menagerie not all traced on our diagram.

At this stage it seems wise to rationalize the diagrammatic by new figure with less curvy arrows. With the new algorithm in mind namely by flowing from the constructible M -curves we can sharpen information for instance via the curvy arrow from Viro’s $4\frac{3}{1}\frac{5}{1}\frac{7}{1}$ we move down to $4\frac{3}{1}\frac{3}{1}\frac{7}{1}$ which is therefore NIET, i.e. no total reality (or as we say German “eine Niete”). Alas we must change NIET to NOT to save room (abridging still no total reality).

Next we realized (aided by this better diagrammatic) that the scheme 7.2.3.6 (abridged notation for $7\frac{2}{1}\frac{3}{1}\frac{6}{1}$) via 7.2.2.6 without that it it necessary to impose a TOR on 6.2.3.6. As a consequence we can impose a more regular distribution of TOR’s on the 2nd layer. It seemed also at this stage advisable to change the whole diagrammatic by interpreting the 1st pyramid as the ground-zero layer (0th layer). With this better diagrammatic it also apparent that Orevkov’s obstructions when interpreted via an underlying total reality one sporadic obstruction of Viro (on 1.3.15) and one obstruction by Fiedler (namely 1.6.12).

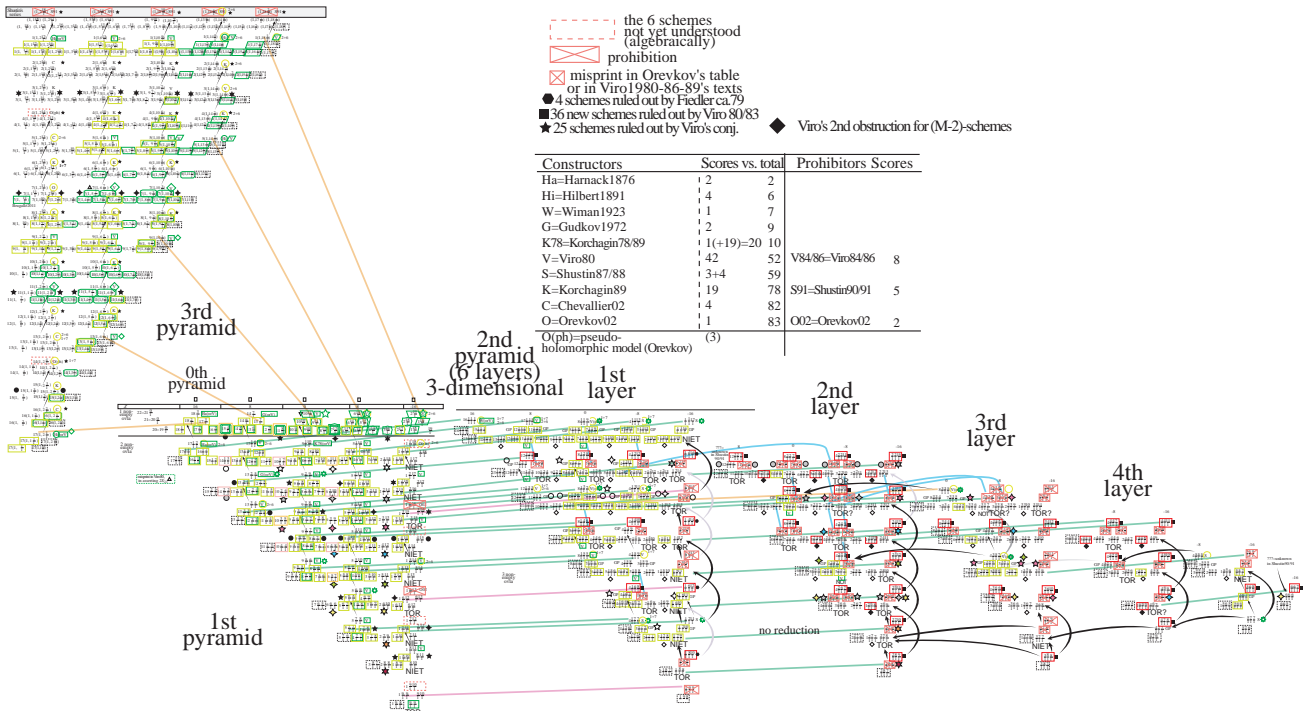

Figure 28: Yet another view of the pyramid

4.5 Some conjectures à la Rohlin-Le Touzé implying a completion of Hilbert-Viro's 16th problem

[22.08.13] At this stage we started to get some understanding in Orevkov and Viro's sporadic obstruction by gaining an understanding of their magmatic coherence (despite apparent randomness when one does not take care sufficiently about the architecture/combinatorics of the pyramid). In particular it seems that there is a natural distribution of TOR at the $(M - 2)$ -level explaining via total reality and the allied Rohlinian phenomenon of censorship (i.e. a scheme totally flashed by a pencil of curves cannot be augmented without corrupting Bézout) all prohibition in an uniform fashion. In particular extrapolating a bit and hoping that the distribution of TOR is uniquely determined on the basis of (already) available constructional knowledge (i.e. Viro's theory and his many companions), we shall get a complete resolution of Hilbert's 16th. Of course the solution remains heuristic unless we are able: first to establish the requested TOR by synthetical algebraic geometry (i.e. Rohlin-Le Touzé type theorems) and second to establish rigorously the principle of censorship (that must be easy).

At this stage it seemed advisable to improve the overall architecture by shifting the layers diagonally. Perhaps the whole exercise should from the top of the telescope of the pyramid where Shustinian information is reigning. Actually at the very summit of the telescope we have Viro's anti-scheme 6.6.7. Looking at what is below we find 5.6.7 (constructed by Polotovskii via Viro) and 4.6.7 which must therefore be TOR. Notice that 5.5.7 is also constructed by PV(=Polotovskii-Viro) or can be interpreted loosely as a double contraction of Shustin's 5.7.7. Hence it seems that we are really forced to put a TOR on 4.6.7. Yet this has the disastrous effect of killing 5.6.7 which is constructed by PV. So:

Scholium 4.4 *There is noway to explain all prohibition of the actual census in a fashion respecting Rohlin-Gabard's desideratum of total reality and censorship.*

By the way the domination of Shustin's 5.7.7 over 4.6.7 forces the latter to be NIET. In our opinion this sad issue incarnates a severe anomaly in the architecture of the pyramid. Did God constructed such a disgraceful world? Maybe Shustin is again responsible of the turmoil of the business?? Of course

in principle be shrunk, but not so with nonempty ovals which can instead be eversed. Under this operation, all what what inside the oval appears outside of it and viceversa the outside of the oval is now captured in the inside of the eversed oval. Of course this is much akin to Steiner's Wiedergeburt und Neuaufstehung, when it comes to inversion. If we imagine a trinested scheme then its eversion will be binested. If we evert an non empty oval of a trinested scheme then the result will have 2 subnests and so violates Bézout. Hence eversion cannot be performed on trinested curves. Also, we can imagine to evert unnested curves, naturally turning to themselves. Yet, starting with say Harnack's scheme $18\frac{3}{1}$ we would get $3\frac{18}{1}$ which does not verify Gudkov periodicity (even in the simple version of Arnold). So unlike the case $m = 6$, the case $m = 8$ has some asymmetry in its Gudkovian structure, yet this is probably restored in degree $m = 10$, etc.

Notwithstanding eversions could give some secret passage to travel in the pyramid and so perhaps aid to guess the isotopic classification, especially that of the still open bosons. For instance let us consider the boson $14(1, 2\frac{4}{1})$. On everting the biggest nest we get the scheme $2\frac{4}{1}\frac{14}{1}$ which does not satisfy Gudkov periodicity. Okay, but maybe it is possible for the oval to evert as to capture only one outer oval, but the Fig. 30 prompts rather the contrary intuition. Hence it seems that in degree 8 Gudkov periodicity forbids all form of eversions.

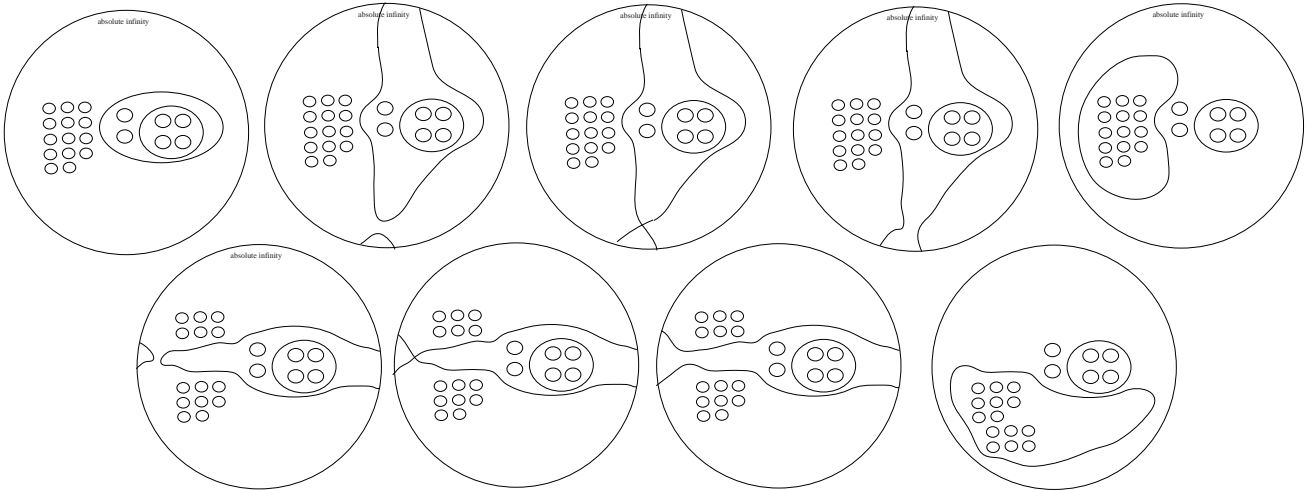

Figure 30: Eversion

Now it remains to tackle the problem of speculating about the falsity of Shustin's construction as to see if—using only Viro's potentially stabler construction (as using only the quadri-ellipse as ground curve)—it is possible to distribute TOR in such a way that censorship explains all prohibitions of Fiedler, Viro, Shustin, Orevkov and perhaps some few more not yet known to exist.

Of course another option would be that the Fiedler-Viro oddity law is wrong and then we would have less obstructions and virtually no obstructions, as Gudkov somehow conjectured at the end of his 1974 survey. (Curiously, there, Gudkov seems to count 102 schemes instead of the ca. $104+40=144$ that exists prior to applying the Fiedler-Viro amendment (which kill forty guys).

Now we first try to mistrust Shustin's constructions involving the medusa (Fig. 121), plus the other construction of Shustin ($4\frac{5}{1}\frac{5}{1}\frac{5}{1}$) which we failed as yet to understand. Killing all those Shustin's scheme or perhaps keeping the last one, causes a little trouble because right below Shustin's schemes there are schemes constructed by Polotovskii, and so it looks hard to explain our postulated prohibition of Shustin via censorship, without killing simultaneously Polotovskii's scheme. In fact we constructed most of Polotovskii's schemes just by extrapolating Viro's M -parameters to $(M - 1)$ -parameters, i.e. with 8 micro-ovals nascent instead of 9.

[25.08.13] Crudely put, we may accept as valid only those of Viro's construction attained by the most basic recipe of the quadri-ellipse, considering e.g. Viro's more exotic constructions as fallacious too (like Shustin's).

to the black-circled schemes in the binested and trinested realms. Especially we reinterpreted 3 of Viro’s oddity law via Rohlin’s maximality principle. However this cannot be done in an uniform fashion because of the extensions $13\frac{2}{1}\frac{4}{1}$, hence $15\frac{4}{1}$ despite being RKM lacks total reality, and must be ascribed the (poor-quality) label “NIET”.

The same rating (ranking) “NIET” must be given (for the same reason) to $11\frac{8}{1}$, $7\frac{12}{1}$ and $3\frac{16}{1}$.

A “NIET” must also be given to $14\frac{1}{1}\frac{3}{1}$, $10\frac{1}{1}\frac{7}{1}$. When it comes to $6\frac{1}{1}\frac{11}{1}$ we find 3 extensions in the 1st layer yet all dominated by Shustin’s M -schemes, so that if the latter are erroneously constructed we could posit TOR for $6\frac{1}{1}\frac{11}{1}$. But of course if Shustin’s construction are solid this scheme should be assigned a NIET. Alas as we said Shustin’s construction cannot hold true in a way compatible with TOR and censorship.

For $2\frac{1}{1}\frac{15}{1}$ we have only one extension in the 1st layer which correctly prohibited by Shustin and Fiedler. Due to the binesting there is no extensions in the subnested realm. Hence it seems that the scheme $2\frac{1}{1}\frac{15}{1}$ is the first deserving the label “TOR”.

Then $14\frac{2}{1}\frac{2}{1}$ has several extensions in the 2nd layer, all prohibited by either Shustin or Viro’s law, safe for the $(M - 1)$ -scheme $12\frac{2}{1}\frac{2}{1}\frac{2}{1}$ (of Shustinian uncertainty). Accordingly it seems plausible to ascribe a TOR to scheme under inspection.

The same verdict—with more certitude even—can be applied to $10\frac{2}{1}\frac{6}{1}$.

For $6\frac{2}{1}\frac{10}{1}$ we have likewise a TOR. For $2\frac{2}{1}\frac{14}{1}$ we have only one extension, which is prohibited by Shustin and so we can expect a TOR.

In contrast for $10\frac{3}{1}\frac{5}{1}$ we have extensions below a Viro’s M -scheme and so we must impose a NIET.

For $6\frac{3}{1}\frac{9}{1}$ we have 2 (pure) extensions in the 3rd layer, which are (correctly?) prohibited by Viro-sporadic and Shustin, and Viro-regular. So it seems advisable to ascribe a TOR to the scheme under scrutiny.

For $2\frac{3}{1}\frac{13}{1}$ we have one pure extension in the 2nd layer (Shustin prohibited) and one more (impure) in the 3rd layer (Viro’s sporadic). Hence the label TOR seems conceivable for the scheme investigated.

Then it comes to $\frac{3}{1}\frac{15}{1}$ —which albeit not RKM—has only one extensions in the 1st layer (Viro sporadic), and thus we may expect the TOR label. *Warning:* one should not miss two extensions in the 0th layer, including the boson $1\frac{4}{1}\frac{15}{1}$ which is therefore virtually prohibited. Of course there are also 2 direct extensions abutting to Orevkov’s anti-scheme $1\frac{3}{1}\frac{16}{1}$ via the $(M - 1)$ -scheme $\frac{3}{1}\frac{16}{1}$ which to the best of our knowledge is not yet realized nor prohibited (i.e. bosonic for short).

The story continues with $10\frac{4}{1}\frac{4}{1}$ where we have extensions in the 4th layer all prohibited by Viro’s law or Shustin’s $(M - 1)$ -avatars. Actually one must not miss extensions in the 2nd and 3rd layers, yet all prohibited, and thus we may ascribe TOR to the scheme inspected.

For $6\frac{4}{1}\frac{8}{1}$ we have 3 extensions (in the 2nd, 3rd and 4th layers) all prohibited by Shustin or Viro’s regular law, so that the TOR label is expectable.

The scheme $2\frac{4}{1}\frac{12}{1}$ permits only one pure extension in the 2nd layer and one impure one in the 3rd layer. Those being prohibited either by Shustin or Viro regular, the TOR label at the position inspected is expectable.

For $6\frac{5}{1}\frac{7}{1}$ it has an extension in the 3rd layer subsumed to a Viro M -construction, and this suffices to prevent a TOR at the inspected place. So the rating agency ascribes a NIET to the scheme inspected.

For $2\frac{5}{1}\frac{11}{1}$ we find extensions in the 2nd and 3rd layers (all prohibited) so that a TOR label is expectable.

For $6\frac{6}{1}\frac{6}{1}$, we find extensions in the 2nd, 3rd and 6th layers. The first two are prohibited while the 3rd is still-open in Shustin 90/91 [1419]. Accordingly, it is not easy to make a decision yet the TOR label is likely.

For $2\frac{6}{1}\frac{10}{1}$ we have extensions in the 2nd and 3rd layers all prohibited by either Viro or Shustin. Thus a TOR label is quite likely.

Then we have $\frac{6}{1}\frac{12}{1}$, which admits only one extension in the 1st layer ($\frac{1}{1}\frac{6}{1}\frac{12}{1}$), yet prohibited by Fiedler's special case of Viro. *Warning*: actually, one should not miss two extensions in the 0th layer, including a possible prohibition of the boson $1\frac{7}{1}\frac{12}{1}$.

Next we must examine $2\frac{7}{1}\frac{9}{1}$, which admits extensions (only) in the 2nd and 3rd layers (all prohibited by Viro sporadic or Shustin). Hence, the TOR-label is expectable.

As to $2\frac{8}{1}\frac{8}{1}$, we detect 3 extensions in the 2nd and 3rd layers (all prohibited by Shustin or Viro regular), so that the TOR-label is probable.

Finally, for $\frac{9}{1}\frac{9}{1}$ we have extensions in the 0th layer (all bosonic, i.e. unknown) or in the 1st layer (Viro sporadic). Thus, it is plausible (despite sparse experimental and theoretical knowledge) that a TOR label is present on this scheme.

Curiously enough, it seems that there is no way to rule out the boson $b1 := 1\frac{1}{1}\frac{18}{1}$ via censorship unless one puts a TOR on $1\frac{18}{1}$ but this would (by censorship) jeopardize Viro's horse construction of $2\frac{19}{1}$.

DO-NOT-FORGET: Noémie Combe showed me today a set of notes by Viro where in ca. Chap. 4 by page ca. 60 Fiedler's alternation rule is explained in (seemingly) full details. I cannot remember if I cited this or analyzed properly this source which is perhaps superior than the original papers (Fiedler 83, Viro 83).

[28.08.13] *Little side-remark*: As we know since a long time (cf. e.g. 7.1) Rohlin's maximality conjecture is trivially foiled by Viro's construction. To be specific the RKM-scheme $15\frac{4}{1}$ admits an extension as the M -scheme $13\frac{2}{1}\frac{5}{1}$ which is actually even constructed by Gudkov (and arguably in a more elementary/versatile way by Viro). This explains why Viro was in his letter (cf. Sec. ??) fairly sure that Ahlfors' theorem cannot prove Rohlin's maximality conjecture, just because the latter false. So:

Scholium 4.5 *Rohlin's maximality conjecture is trivially false because of Viro's method, yet the latter is too polite to attack frontally his teacher leaving thus in literature a little cloud of unclarity (apart from the little critiques expressed by Shustin, yet not explicit enough regarding the direct sense of Rohlin's conjecture: type I scheme is maximal). Actually, it suffices even to know Gudkov's construction of the M -scheme $13\frac{2}{1}\frac{5}{1}$ to corrupt Rohlin's maximality conjecture in view of the enlargements $15\frac{4}{1} < 13\frac{2}{1}\frac{4}{1} < 13\frac{2}{1}\frac{5}{1}$.*

Back to the main diagrammatic.—Yesterday, we traced the faisceaux of all strokes emanating from the uninnested RKM-scheme (e.g. $15\frac{4}{1}$). Here there is a bunch of extensions radiating in higher layers but all those rays abut always (as we comprehend the sub-symbol $\frac{4}{1}$) to schemes prohibited by Viro's oddity law. As a moral imposing a TOR on such schemes ($15\frac{4}{1}$, $11\frac{8}{1}$, $7\frac{12}{1}$, $3\frac{16}{1}$) would explain a substantial part (all?) of Viro's law but alas in a way not defensible since by Viro's method there is also extensions in the 1st pyramid=0th layer.

Let us now continue our game of rating-agency for the labels NIET and TOR granting Viro's model of the theory as being the reliable one. Yesterday we rambled the whole 1st layer and it remains now to elevate to the higher layers.

The 1st case of interest is the RKM-scheme $13\frac{1}{1}\frac{2}{1}$. Surprisingly, the latter lacks any extension in the pyramid (just because of Gudkov and GKK essentially). Therefore the TOR-label looks amply merited.

The same applies to the other RKM-schemes in the 1st row of the 1st layer (i.e. $9\frac{1}{1}\frac{6}{1}$, $5\frac{1}{1}\frac{10}{1}$, $1\frac{1}{1}\frac{14}{1}$). The basic reason seems to be that the double occurrence of ones forces any extension to stay in the 1st layer, except if we increase both one numerators simultaneously, e.g. as $9\frac{2}{1}\frac{6}{1}$ yet this lands outside the range specified by Gudkov periodicity. In conclusion, all those RKM schemes can be ascribed the label TOR yet it does not result any prohibition beyond Gudkov periodicity.

The next case of interest is $10\frac{1}{1}\frac{2}{1}\frac{4}{1}$. Augmenting successively each coefficient of this symbol we always get schemes out of GKK-periodicity, so that the scheme

admits only those extensions immediately visible above it, but prohibited by Shustin and Viro's oddity law. Hence the TOR-label is likely. Additionally, it may be noted that those 2 prohibitions (above this scheme) cannot be induced from one of the 3 schemes of the 1st layer below $11\frac{1}{1}\frac{2}{1}\frac{4}{1}$, obtained by conserving two subfraction of the symbol.

For $9\frac{1}{1}\frac{2}{1}\frac{5}{1}$ we find again no extension and thus the TOR-label is likely.

The same holds for $6\frac{1}{1}\frac{2}{1}\frac{8}{1}$ and $5\frac{1}{1}\frac{2}{1}\frac{9}{1}$.

Next it comes to $4\frac{1}{1}\frac{2}{1}\frac{10}{1}$ whose status becomes ambiguous as we reject Shustin's construction. Nonetheless it can be that a Viro construction from the quadri-ellipse produces the $(M-1)$ -scheme $4\frac{1}{1}\frac{2}{1}\frac{11}{1}$ as asserted by Polotovskii. In that case we must assign the NIET-label to both $4\frac{1}{1}\frac{2}{1}\frac{10}{1}$ and $3\frac{1}{1}\frac{2}{1}\frac{11}{1}$. Actually, we realized $4\frac{1}{1}\frac{2}{1}\frac{11}{1}$ via a damped version of Shustin's construction (see Fig. 123b2). However one could expect that there is a cleaner version via Viro's quadri-ellipse. At any rate it seems worth expanding the case of Viro's construction that we missed. However it seems that all extensions of the scheme $4\frac{1}{1}\frac{2}{1}\frac{11}{1}$ never interacts with a Viro M -scheme, so that it seems unlikely that this $(M-1)$ -scheme can be constructed by Viro's method involving the quadri-ellipse (at least for the small collection of patches available to Viro). Hence it seems plausible that discrediting Shustin's construction discredits as well Polotovskii's construction of $4\frac{1}{1}\frac{2}{1}\frac{11}{1}$ although it is not clear whether Polotovskii's work is logically subsumed to Shustin's. Using our exotic variant of Viro's method there is some hope to get $(M-1)$ -scheme by using maximal dissipation of an exotic sort. For a catalogue of such opportunities cf. the yellow shaded combination of patches shown on Fig. 21, but alas none of which is readily accessible to Viro's confined toolkit of patches.

Nonetheless, it seems clear that the resulting $(M-1)$ -patchwork will often conflict with Shustin's $(M-1)$ -obstructions so that we should discover new patching obstructions. Looking at Fig. 21 we see four tri-ovals curves on the 1st A-row, but as A is an empty patch family we will not be able to extract any obstruction. Likewise the B-row will not be much instructive say just because we lack any concrete patch in the B-family. More promising is the C-row, which interact in the yellow-way (3 macro-ovals) with the D-patch (which is already known to be empty via Bézout and Arnold). In the C-row one must not forget the flipped combination (in the margin of Fig. 21), but those interacts with patches F and H, already known to be void families. Next for the D-row we have a yellow interaction with column G, but as D is empty this will not supply any bit of information. Next we arrive at Viro's inhabited row E, where we get yellow $(M-1)$ -interaction with column F (which is already known to be empty). As to the flipped versions we get an interaction with H, which is actually already known to be empty. Hence:

Scholium 4.6 *The many Shustin's $(M-1)$ -obstructions do not cause any damage upon (exotic) patches that could not already have been drawn from Bézout or Arnold.*

This is quite disappointing, but in reality is not as it leaves room for more patches than in Viro's theory, and so perhaps the materialization of some bosons not yet known to exist.

Let us return to $4\frac{1}{1}\frac{2}{1}\frac{11}{1}$. Can we construct it by Viro's quadri-ellipse? A priori there are two ways. Either one uses maximal dissipation yet not optimally reglued so as to have only 3 macro-ovals like on the yellow cases of Fig. 21. (As we just saw this variant leads nowhere because Viro's patches only interacts in the appropriate $(M-1)$ -way with patches families known to be empty). Alternatively one can use an optimal gluing (red on the same Fig.), but with a damped dissipation with only 8 instead of 9 micro-ovals. This is a sort of social dumping that could maybe create new-or-old $(M-1)$ -schemes. For instance one may start with the B-patches and glue it with themselves modulo a social dumping. A priori it could seem that if the patches are already restricted according to Viro's law, it will appear as difficult to reach Shustin-prohibited $(M-1)$ -scheme as the latter often lies below those excluded by Viro. However

a more systematic search deserves to be done. So the philosophy is always the alienating “patchworker de toutes les manières possibles et imaginables”. So for instance we may try to consider B3/B3flip with one factor damped and the resulting table will be essentially the same as that of H5/H5flip modulo the damping. Evidently a priori we may draw little information from the experiments unless we suppose a strong correlation principle akin to the Viro-Itenberg principle of contraction of empty ovals (in a germinal version for patches). So we shall assume that whenever a patch exists, its versions where empty ovals are imploded also exist, and then we expect additional prohibitions coming from Shustin’s $(M - 1)$ -prohibitions (thought the latter look merely a compromise between Viro-Shustin constructions and Viro’s prohibitions).

On working the table, we can comment as follows. On composing $(8,1,0)$ with $(5,3,0)$ we find an anti-Shustin scheme. So if one could prove existence of the patch B3(5,3,0), this would rule out the M -patch B3(8,1,0) (a task we are as yet unable to complete).

[29.08.13] It is evident that Hilbert’s 16th problem is completely determinist, but nobody understand the determinism. Now continuing our boring task of filling that table it seems evident at an early stage already that as Shustin’s prohibitions are much dominated by those of Viro’s that no new patch obstructions will be derived.

However as a little surprise the entry $(2, 3, 4) \times (5, 3, 0)$ creates an anti-Shustin scheme so that one can infer:

Lemma 4.7 *Either the M -dissipation B3(2, 3, 4) or the damped $(M-1)$ -dissipation B3(5, 3, 0) is prohibited provided Shustin’s $(M-1)$ -avatar of Viro’s most sporadic obstruction is true. Similarly, via $(2, 3, 4) \times (6, 2, 0)$, either the M -dissipation B3(2, 3, 4) or the damped $(M-1)$ -dissipation B3(6, 2, 0) is prohibited provided a Shustin obstruction (below a Viro regular one) is right.*

Alas, it must be confessed that unless one is able to construct the damped patches this supplies no additional information on the M -dissipation of type B3. Further, our initial hope to meet Shustin’s obstruction along the diagonal (or pseudo-diagonal we should say in view of the damping) is not borne out, or rather when it occurs it is already covered by Viro’s M -obstructions. So in conclusion it seems that nothing tremendously new follows from Shustin.

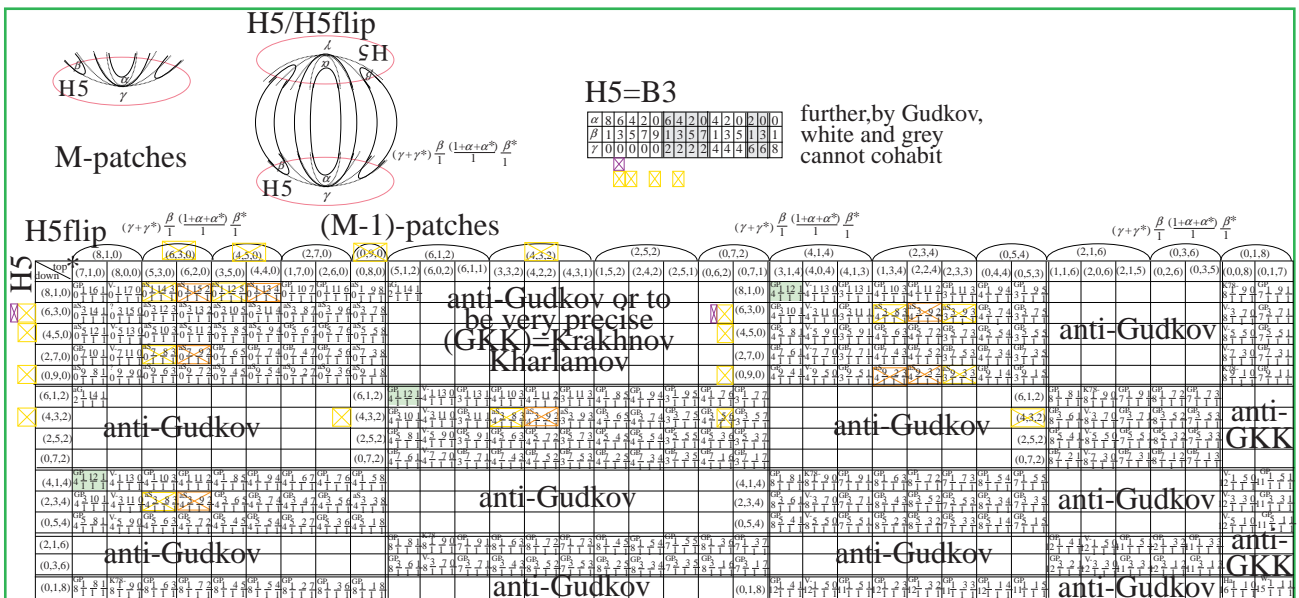

Figure 32: Patchworking exotic patches at the $(M - 1)$ -level: B3/B3flip

On the other hand we are not much advanced on the question of deciding if there is a construction of the $(M - 1)$ -scheme $4\frac{1}{1}\frac{12}{1}$ à la Viro (quadri-ellipse) independent of Shustin’s tricky medusa. Of course this scheme appears on our

table (Fig. 32) but is by no mean a regular construction unless one is able to prove existence of the involved patches.

Now let us take again a global look at the pyramid (Fig. 31). On it we already experimented that not all RKM-schemes seems to be capable of the phenomenon of total reality at least in the strong way implying censorship of all enlargements (i.e. maximality of the scheme in the sense of Rohlin). For instance $10\frac{3}{1}\frac{5}{1}$ cannot be TOR (so is NIET) because there exist extension by Viro’s method (in the 2nd and 3rd layers, subordinated to Viro’s M -schemes 8.3.3.5 and 4.3.5.7). So in a very radical world where much importance is given to our Rohlin-style maximality principle it could be that even Viro’s constructions must be revised.

Loosely out it seems that the architecture of the Gudkov-Viro pyramid in degree 8 (alias the Grand-Pyramid of Gizeh) and more generally any Gudkov pyramid of higher degree is governed by two principle a bit akin to the well-known inclusion-exclusion of rudimentary combinatorics. One the one side there is a principle of inclusion saying roughly that whenever we have a scheme algebraically realized all smaller schemes will also be present. This means roughly that a stone of the pyramid (or cathedral if you prefer Judeo-Christianism over Egyptian civilization) cannot stay in the air in levitation without supporting elements. This intuition is sustained by the Viro-Itenberg contraction principle for empty oval.

On the other hand there is—Rohlin’s intuition, and to some extend also Wiman 1923 [1595]—a dual principle of exclusion that whenever a scheme is subsumed to total reality it should kill all its enlargements. This we call the censorship principle. It imposes roughly the architecture of the cathedral being pure, i.e. without too much “fioritures”=embelishments à la Gaudi (in Barcelona). Alas it seems that this principle cannot hold at all RKM-positions (i.e. $(M-2)$ -schemes with $\chi \equiv_8 k^2 + 4$) in view essentially of Viro’s rich method of construction. Actually, even more basically the RKM-scheme $15\frac{4}{1}$ violates already the censorship principle (interpreted as a sort of denuded Roman architecture) since it accepts the M -enlargement $13\frac{2}{1}\frac{5}{1}$ due to Gudkov (showing incidentally that the “direct sense” of Rohlin’s maximality conjecture is foiled). Could it be that this construction of Gudkov is erroneous (and so are many of Viro construction) in order to restore Rohlin’s exclusion principle (censorship).

4.6 The dream/nightmare of a world with censorship

[29.08.13] We can dream of a world where Rohlin’s maximality principle is true in the strong form of its original formulation, any RKM-scheme is of type I (true theorem of Rohlin-Kharlamov-Marin), and therefore maximal=saturated in the sense of Rohlin. (This last clause is in principle false, as we just noted and actually was first disproved by Gudkov prior than Rohlin formulated his conjecture). So rating-agency conclusion: Rohlin did not perfectly his homework in 1978 but is completely excused as he already endured an hearth attack ca. 1976 (compare Vershik’s obituary ca. 1986). Notwithstanding we may adhere to the radical position that Rohlin’s principle is universally true, in which case there would be much less M -curves than in the politically correct world (where all published results are considered as true). Of course in reality, we may have a more nuance landscape where the censorship principle applies only to a sub-collection of RKM-schemes and perhaps other $(M-2)$ -schemes, typically if the are subsumed to the phenomenon of total reality of a pencil which via Bézout should prevent any extension of the scheme, whence the censorship.

In this section we adopt the most radical attitude, in order to see which M -schemes are really resistant.

First, the uni-nested RKM-schemes admits many extensions in the 3rd=subnested pyramid killing thereby many M -schemes claimed by Korchagin, Viro, Orevkov-Viro, Korchagin-Viro (compare the red faisceaux on Fig. 33). Diagrammatically, it seems more efficient to just use our circles, stars, etc. propagation of symbols along the extension of a given RKM-scheme. Positing Rohlin’s maximality principle causes then a hecatomb of M -scheme also in the 1st pyramid, all marked

by a red rectangle.

Along the RKM-scheme $15\frac{4}{1}$ would kill a plethora of M -schemes (marked by black circles on the figure), and so on for all other RKM-schemes. One could expect that this hecatomb forced by a strong Rohlin's maximality principle is still compatible with Viro's theory in the sense that the last survivals M -schemes (which are easy to list explicitly) are all constructible via Viro's method for a subcollection of his patches (taking for granted that he may have had a too liberal acceptance of patches based upon fraudulent constructions).

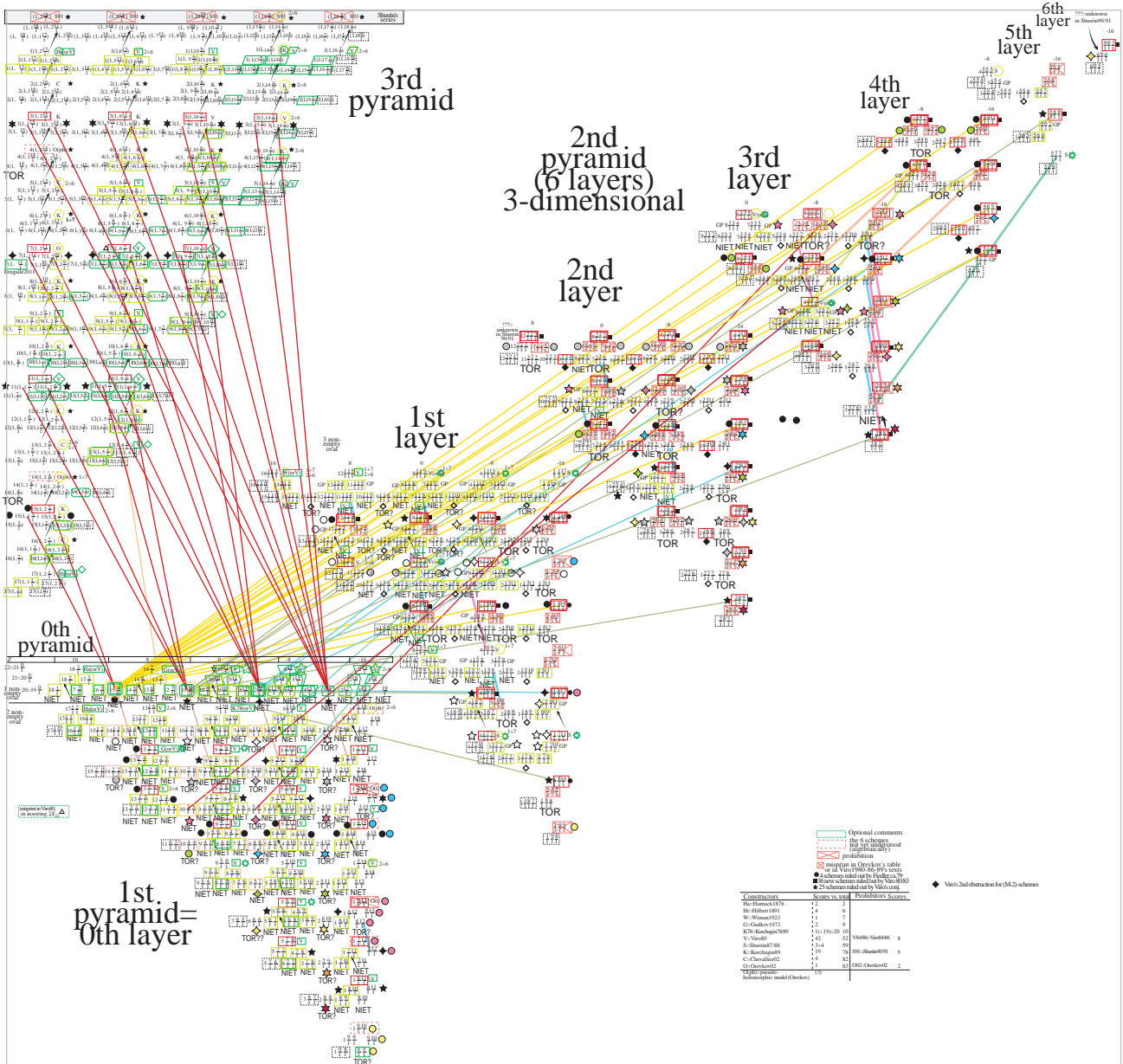

Figure 33: Assuming the truth of Rohlin's maximality principle: an epured architecture killing Gudkov, Viro, etc.

At this stage one loose a lot of energy due to spatial distantness, hence it seemed advisable to manufacture a colimasson depiction to save space. This representation permits one to save much energy dispensed in scrolling the windows in the computer.

Of course albeit our scenario of Rohlin maximality is quite apocalyptic for Viro (even Gudkov) it is much in line with our paradigm of total reality and the parsimony of M -schemes prior to Viro's intervention.

[30.08.13] So now we hope to have detected all extensions of RKM-schemes and it is time to look at a restricted Viro theory that would corroborate this.

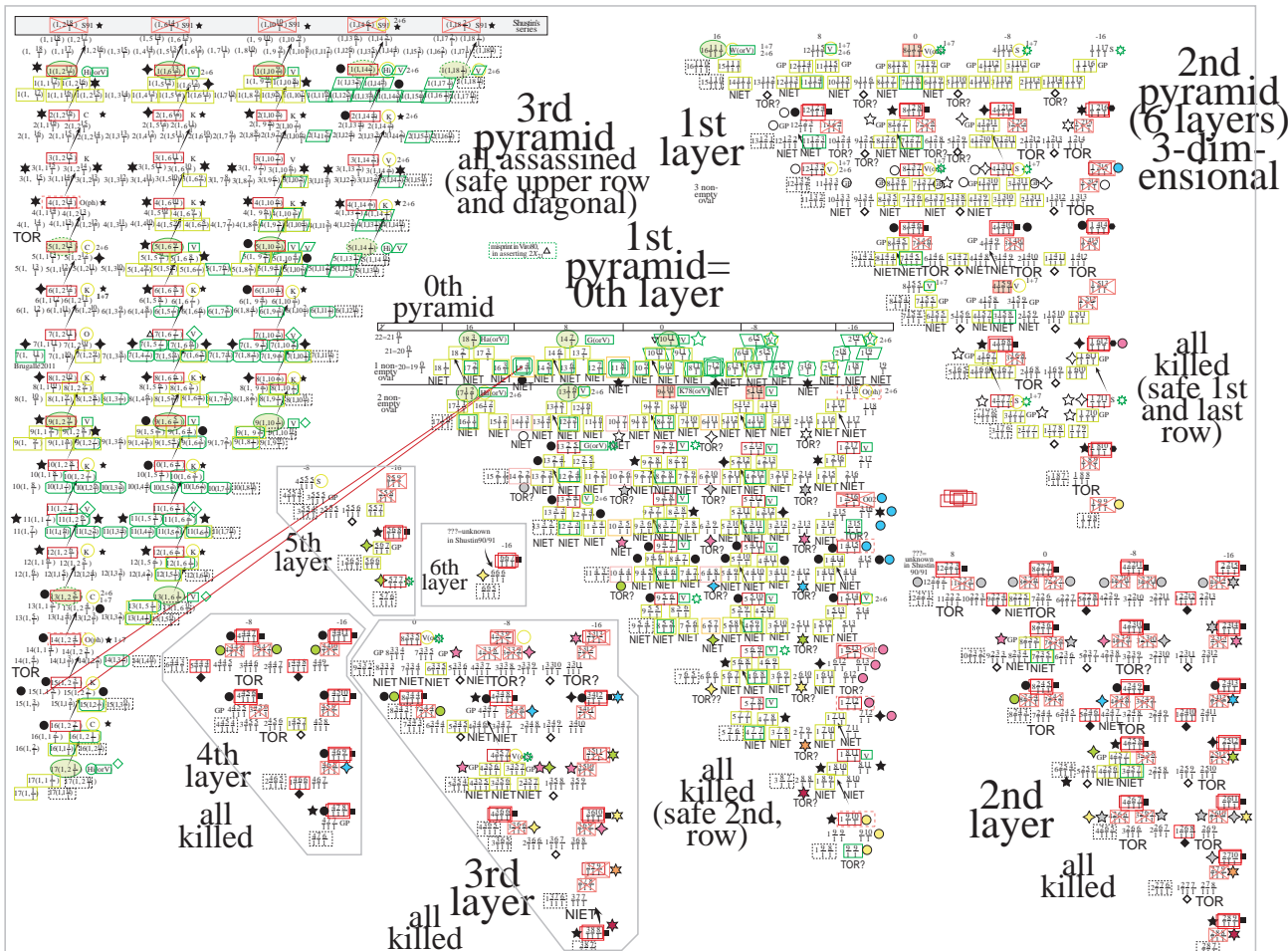

Figure 34: Assuming the truth of Rohlin’s maximality principle: an epured architecture killing Gudkov, Viro, etc.

For this it suffices to take Viro’s original table of compositions (patchwork) and censure what is forbidden by Rohlin’s maximality principle. We find that the first frank obstruction (along the diagonal) occurs in the V_2/V_2 -table with the entry $(4, 4, 1)$ which is forbidden. It results a destruction of all shaded schemes, which all admits a replica so that they are definitely killed (or rather lost). The next serious damage occurs along the diagonal entry $(8, 0, 1)$, which is therefore killed, and it results severe loss of schemes on the corresponding row. Namely it seems that we lose the K_{78} -scheme of Korchagin 1978, and the scheme $5\frac{1}{1}\frac{14}{1}$ of Viro. Of course crosses not situated on the diagonal also cause collateral damages yet of an indefinite nature. Notwithstanding there is latent patch damage impeding that the patch list stabilizes to a sole censorship of $V_2(4, 4, 1)$ and $V_2(8, 0, 1)$.

Then the table V_2/V_3 only gives uncertain patch damages and also jeopardizes some of Viro’s constructions, namely of $8\frac{1}{1}\frac{9}{1}$ and $4\frac{1}{1}\frac{5}{1}$.

To explain the collateral damages it seems likely to abandon the patch $V_2(2, 4, 3)$ which has well on V_2/V_2 as on V_2/V_3 monopolize many Rohlin-forbidden schemes. The sole negative side-effect is a loss of Viro’s realization of $5\frac{5}{1}\frac{10}{1}$; not in contrast that $9\frac{5}{1}\frac{6}{1}$ is not lost as it admits another realization as $V_2(5, 4, 0) \times V_2(0, 4, 5)$.

For the same reasons (concentration of anti-schemes) so as to minimize the number of patches killed it seems wise to abandon the patch $V_2(2, 0, 7)$, and the sole side-effect is an inhibition of Viro’s construction of $1\frac{5}{1}\frac{14}{1}$. At this stage all of Rohlin-style prohibitions have been taken into account safe for Gudkov’s scheme $13\frac{2}{1}\frac{5}{1}$ occurring in both tables. So we must either abandon $V_2(1, 8, 0)$ or $V_2(0, 4, 5)$. Killing $(1, 8, 0)$ would have the effect that Viro’s method would not any more cover Harnack’s elementary construction of $18\frac{3}{1}$, and accordingly

extended table V1/V1 we get the following table (Fig. 36). This employs the usual method of destruction along the diagonal, or diagonal destruction along constructed rows. We see that Rohlin's maximality principle of type I schemes rules out all patches not constructed by Viro, yet leaves moreover intact the patches (4, 1, 4) and (0, 9, 0), which could exist. In that case both Hilbert's schemes with 14 big eggs would be accessible to Viro's method. Actually for this to be the case it suffices to have the patch (0,9,0). Adding this create no more schemes except Viro's horse-type $1(1, 18\frac{1}{1})$. Adding instead the patch (4,1,4) create two schemes by Chevallier but otherwise nothing new to Viro. So perhaps it quite likely that Viro's list of patches for V1 is a bit overcautious and frozen (even under the stringent Rohlin's maximality principle). On reporting the so-constructed schemes on Fig. 34 (with dashed ellipses) we get a very regular pattern of fourfold periodicity, yet with half of the rows not constructed nor prohibited.

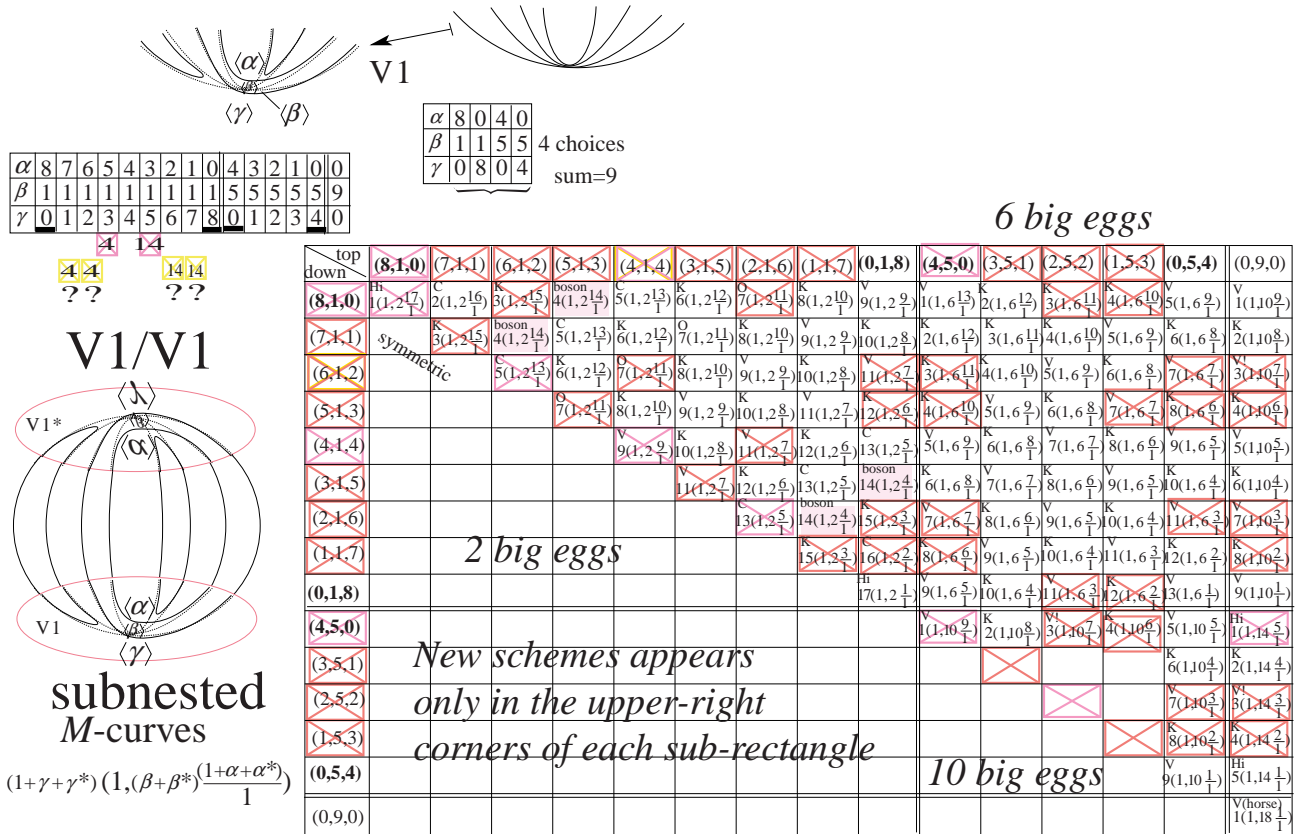

Figure 36: Extended table V1/V1 and patches selection dictated by Rohlin's maximality principle

Apart from detail in the finishing it is already clear that positing Rohlin's maximality principle leads to a strong deviation from the actual state of knowledge (assuming the latter to be true). Thus it is probably more likely that a refined version of Rohlin's maximality principle which we shall call censorship induced by total reality holds true. Actually as we saw even that is not really compatible with Shustin's construction.

Then we noted that we forgot to notice that the boson $b9 = 1\frac{9}{1}\frac{10}{1}$ is killed by a black star (extension of $11\frac{8}{1}$) and likewise we omitted many black-circles on the row of $9\frac{5}{1}\frac{6}{1}$. So we had to correct much of our token. We also forgot initially all those extensions indicated by the thin arrows in the 3rd pyramid (subnested case), and so we get considerably more prohibitions in the 3rd pyramid. Yet, upgrading those on the table V1/V1 (Fig. 36) does not cause any additional patch damages (quite surprisingly).

Further it seems puzzling that Rohlin's maximality principle says nothing on Shustin's scheme $4\frac{5}{1}\frac{5}{1}\frac{5}{1}$, and more generally tells us little about the 5th layer (apart of two prohibitions including one aggressing Shustin's medusa construc-

tion of $\frac{5}{1}\frac{7}{1}\frac{7}{1}$). Basically the reason for little information on Shustin's 4.5.5.5 seems to be the fact its primitive antecedent in the 0th layer is $8\frac{5}{1}\frac{5}{1}$ which fails being RKM.

Further starting from the scheme $3\frac{16}{1}$, one may add an all enclosing oval phagocytizing the whole configuration. Alas this violates Gudkov periodicity, but we may correct the situation by leaving one oval outside. So we find the extension $1(1, 2\frac{16}{1})$, which was not reported as yet on our tabulation. Alas the impact is rather dramatic, as Rohlin's principle would then kill a scheme due to Hilbert. Hence:

Scholium 4.9 *Rohlin's maximality principle is not even compatible with Hilbert's method of construction.*

Continuing we find analogous extensions for the other RKM-schemes, e.g. $7\frac{12}{1}$ extends to $1(1, 6\frac{12}{1})$, but also as $5(1, 2\frac{12}{1})$. Likewise $11\frac{8}{1}$ admits the 3 extensions $1(1, 10\frac{8}{1})$, $5(1, 6\frac{8}{1})$ and $9(1, 2\frac{8}{1})$. This continue along the obvious way, and it results a generalized hecatomb of M -schemes in the 3rd layer, apart few schemes resisting along the diagonal of this pyramid. Actually two schemes of Hilbert are killed by Rohlin's maximality principle which is therefore (granting the evident absence of mistakes in Hilbert) trivially false. Of course in this scenario, Viro's patches collection for V3 shrinks considerably, yet could stabilize to the pair $(0, 1, 8)$ and $(0, 5, 4)$, in which case still some 3 subnested M -schemes would be accessible to Viro's method (namely the three on the bottom part of the diagonal): that is Hilbert's $17(1, 2\frac{1}{1})$, and Viro's $13(1, 6\frac{1}{1})$ and $9(1, 10\frac{1}{1})$.

All this looks very claustrophobic and apocalyptic, yet it is just the combinatorial/rude consequence of Rohlin's (otherwise lovely) principle pushed to its ultimate retrenchment.

It now of course time to better understand the substance of Viro's method to check its truth, and potential extensions of its flexibility. This is another topic that we shall try to analyze in Sec. 5.

Of course in the previous token about Rohlin's maximality as corrupting even Hilbert's method, it is tacitly supposed by us that the RKM-schemes are realized algebraically. This is not completely obvious from zero knowledge, but we had somewhere in this text vague realizations of those schemes via suitable variants of Viro's method (hopefully hygienical). Compare for this Lemma 7.1 which is a construction via Viro's beaver of $15\frac{4}{1}$, $11\frac{8}{1}$ and $7\frac{12}{1}$. It would be interesting to know if there is a simpler construction say via Viro's quadri-ellipse. This seems to be the case according to the green-rectangle on our table. Alas browsing through our old tables (especially Fig. 160) we did not found the requested schemes.

In fact looking at Fig. 21, we see that using Viro's patches there is several ways to get $(M - 2)$ -schemes via the gluing C/E, C/Cflip, C/Eflip (or equivalently E/Cflip) or finally E/Eflip. It remains to check that we tabulated all those patchworks. The figure below gathering all relevant information seems to show that we missed as yet to tabulate the combination C/Eflip, actually not since it corresponds to Fig. d. Inspecting carefully the tables it seems however that we never get the uni-nested RKM-schemes.

[31.08.13] In fact it seems that we may also interpret Rohlin's maximality principle in a more restricted sense, namely by considering only extensions by a circle bounding a disc disjoint from the rest of the curve so that the initial scheme can be thought of as resulting by shrinking an empty oval. This interpretation is more in line with the contraction principle for empty ovals (Klein-Viro-Itenberg), but apparently so trivially true that it seems of little predictive significance when it comes to explain prohibitions beyond Gudkov periodicity and its Krakhnov-Kharlamov $(M - 1)$ -avatar.

Also puzzling are Viro's $(M - 2)$ -obstructions on RKM-schemes in the 2nd and 4rt layers (black rhombs on the main-table). If those are correct and interpretable in terms of a censorship allied to total reality it would involve (at least) a scheme lying deep at the $(M - 4)$ -level (recall Klein's obvious congruence $r \equiv_2 g + 1 =: M$), and somewhat along Arnold's philosophy of the mushroom

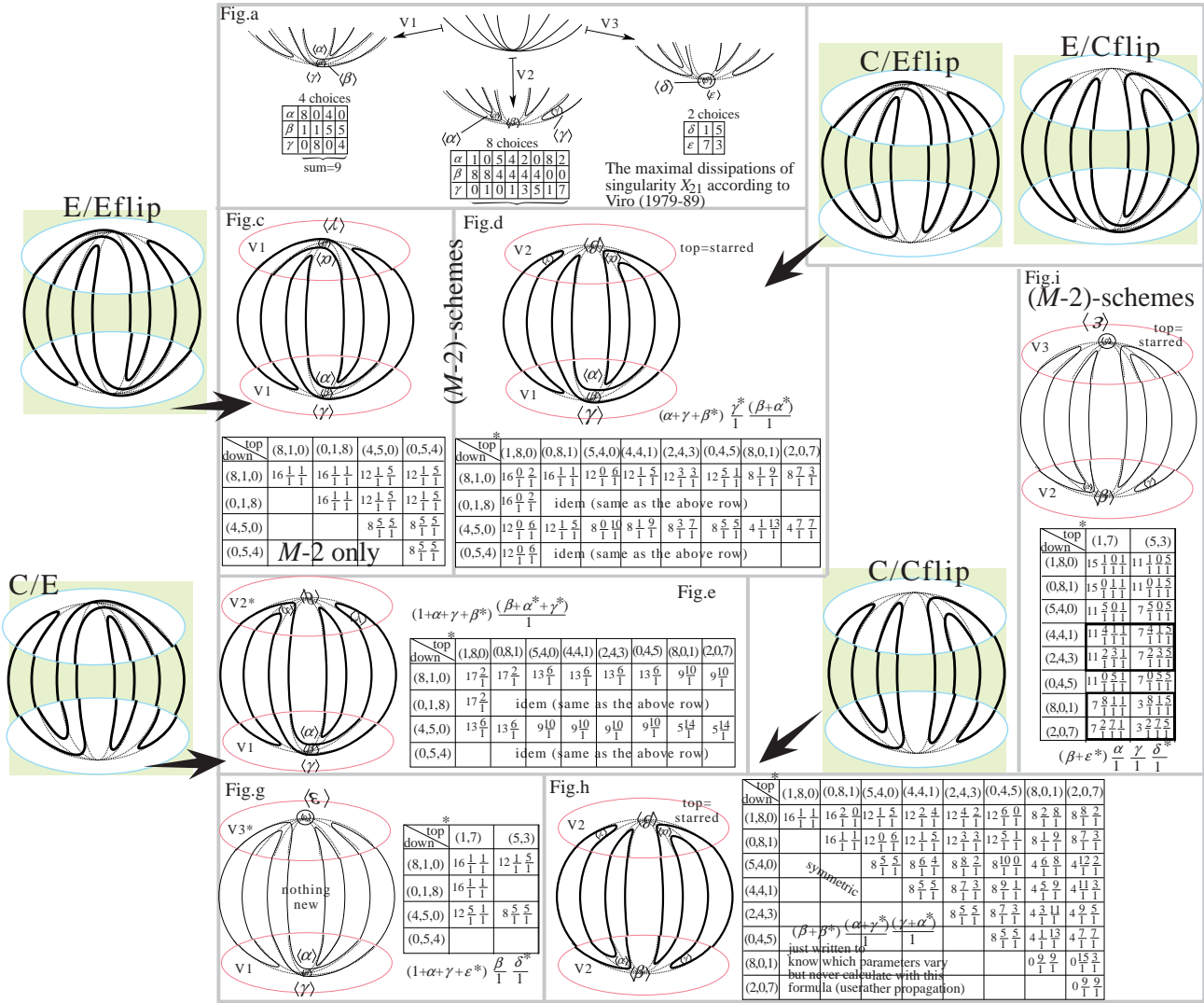

Figure 37: Trying to get the RKM-schemes via Viro standard

we could expect these as being very deep mushrooms explaining all other prohibitions by resurfacing along some unexpected (but completely deterministic) paths of the pyramid. To speculate about this issue it seems necessary to scroll out more the diagrammatic up the $(M-4)$ -level. This requests a new depiction. As shown below there is actually two scenarios depending on whether we fix the phenomenon of total reality. Perhaps the most likely variant involves fixing total reality (TOR) of the RKM $(M-4)$ -schemes, i.e. those with $\chi \equiv_8 k^2+4$. However if we put a TOR on $8\frac{2}{1}\frac{2}{1}\frac{3}{1}$, we kill $8\frac{2}{1}\frac{2}{1}\frac{5}{1}$, which is dominated by Viro's M -scheme $8\frac{3}{1}\frac{3}{1}\frac{5}{1}$. Hence Scenario A with a TOR on $9\frac{2}{1}\frac{2}{1}\frac{2}{1}$ is more likely to be correct, and by periodicity we have a TOR on $5\frac{2}{1}\frac{2}{1}\frac{6}{1}$, and then the sawtooth climbing up to $4\frac{2}{1}\frac{2}{1}\frac{9}{1}$ somewhat uselessly as the scheme is not derived from an M -scheme in view of Viro's sporadic obstruction. Much more importantly, it should be noted that Scenario A (somehow forced by Viro's construction of $8\frac{3}{1}\frac{3}{1}\frac{5}{1}$) looks much incompatible with Arnold's periodicity for dividing curves forcing them to live in the 2-by-2 lattice centered at M -schemes and propagating downwards through RKM-schemes. So Scenario B is much forced by Arnold's will (congruence), and therefore the censorship principle looks once more jeopardized, except if one of Viro's construction is foiled due to over-liberal patchworking. Of course another option is that the principle of contraction is false so that $8\frac{2}{1}\frac{2}{1}\frac{5}{1}$ does not exist, yet we would then still have $8\frac{3}{1}\frac{3}{1}\frac{5}{1}$ in the censorship cone above $8\frac{2}{1}\frac{2}{1}\frac{3}{1}$.

We emphasize once more that by virtue of Arnold's periodicity for dividing curves it is quite likely that there is a phenomenon of total reality at the (non RKM) scheme $6\frac{12}{1}$ that would sustain Orevkov's obstruction of $1\frac{6}{1}\frac{13}{1}$ and si-

multaneously kill the boson $1\frac{7}{1}\frac{12}{1}$. Likewise it is likely that a TOR phenomenon is active on the scheme $\frac{3}{1}\frac{15}{1}$.

When we arrive to the 4th layer it seems natural (to explain all of Viro's prohibitions) to put a TOR on $\frac{4}{1}\frac{4}{1}\frac{7}{1}$, and by periodicity likewise on $4\frac{4}{1}\frac{4}{1}\frac{3}{1}$. However the normalized representative of this scheme lives in the 3rd layer under the guise $4\frac{3}{1}\frac{4}{1}\frac{4}{1}$ and there would kill a scheme by Polotovskii subsumed to Viro's M -scheme $4\frac{3}{1}\frac{5}{1}\frac{7}{1}$.

At this stage it seems also of some relevance to see what Viro's method produce at the $(M-3)$ -level. However a look at Fig. 21 shows that configuration with only one macro-circuit occurs only when combining patches one of whose member is empty, so that no $(M-3)$ -scheme can be created out of Viro's maximal dissipations.

For instance it is puzzling whether the $(M-1)$ -scheme exist. In principle it is via a contraction of an empty oval on Viro's M -scheme $1\frac{2}{1}\frac{17}{1}$. We could expect getting it by a Viro patchwork with 3 macro-circuit, yet referring back once more to Fig. 21 we see that Gods leave no room for such a construction as all those tri-macro-oval combination involve a foolish (faul) empty patch collection.

Now as to the 1st layer it could be posited that the bosonic obstructions are caused by a mushroom of total reality at level $(M-4)$. The most plausible for this to occur would be to place a TOR on $1\frac{1}{1}\frac{14}{1}$, yet destroying thereby also Viro's M -scheme $5\frac{1}{1}\frac{14}{1}$, however this need perhaps just to amputate suitably Viro's list of patches. Of course it is more politically correct (for Viro) to place the TOR only at $\frac{1}{1}\frac{17}{1}$, yet doing so would also ill Viro's scheme $1\frac{2}{1}\frac{17}{1}$, except if we imagine that $\frac{1}{1}\frac{17}{1}$ causes only a degenerate censorship cone, killing only what is lying immediately above it (in our depiction mode which contains admittedly some arbitrariness). In this scenario of course we would have counterexample to the Viro-Itenberg contraction principle, or speak heuristically Viro's M -scheme would be an instable clef-de-voute of the cathedral, i.e. sitting firmly but only supported through a thin collection of stones.

As we saw one important question (in order to refute Rohlin's maximality conjecture) is the constructibility of the uni-nested RKM-schemes. are not readily accessed through asymmetric gluings of M -dissipation (M =maximal number of nine micro-ovals) it is reasonable to expect that Viro's method yields all of them when using non-maximal dissipation where the patches collection is anymore severely restricted by Gudkov periodicity. Nonetheless Viro's M -patches are sufficiently restricted to fail getting all uni-nested M -schemes (only $18\frac{3}{1}$, $14\frac{7}{1}$ and $10\frac{11}{1}$ being realized by Viro's purest method of the quadri-ellipse). Therefore it is not completely clear that all uni-nested RKM-schemes should succumb to Viro's quadri-ellipse (VQE). It seems yet that the first three such schemes ($15\frac{4}{1}$, $11\frac{8}{1}$ and $7\frac{12}{1}$) are coverable by VQE modulo sloppy extrapolation of Viro's M -parameters (compare Fig. 104f).

In contrast it is perhaps even more obscure if VQE can reach the scheme $3\frac{16}{1}$. Of course, this is quite likely if Viro's M -parameters can attain the M -schemes $6\frac{15}{1}$ and $2\frac{19}{1}$. As shown by the composition table with extended parameters (Fig. 8) $2\frac{19}{1}$ can be obtained as $(9, 0, 0) \times (9, 0, 0)$, and $6\frac{15}{1}$ is obtained as $(5, 4, 0) \times (9, 0, 0)$. Moreover we remind (see Fig. 18) that to the best of our knowledge the patch $V2(9, 0, 0)$ is still non-obstructed so that there is a little chance that Viro's method (especially VQE) has more swing than presently known. Remind also that this patch $V2(9, 0, 0)$ implies directly the materialization of the boson $b1$ and $b7$ (see the cited composition table).

Thus with the patch $(9,0,0)$ we may reach the extreme right of the 1st pyramid and thus for damped parameters we may also reach the yet unrealized scheme $\frac{19}{1}$. However the picture of the patchwork $V2/V2$ shows that there is at least one outer ovals so that the scheme $\frac{19}{1}$ remains unattained by Viro's method albeit diagrammatically dominated by Viro's M -scheme $2\frac{19}{1}$. Hence speculating about an intrinsic obstruction against existence of $\frac{19}{1}$ (Petrovskii's bound fails doing this), then this scheme could be a possible counterexample to the Viro-Itenberg contraction principle of empty ovals.

[01.09.13] It is maybe worth noting that the purely nested uni-nested $(M-2)$ -

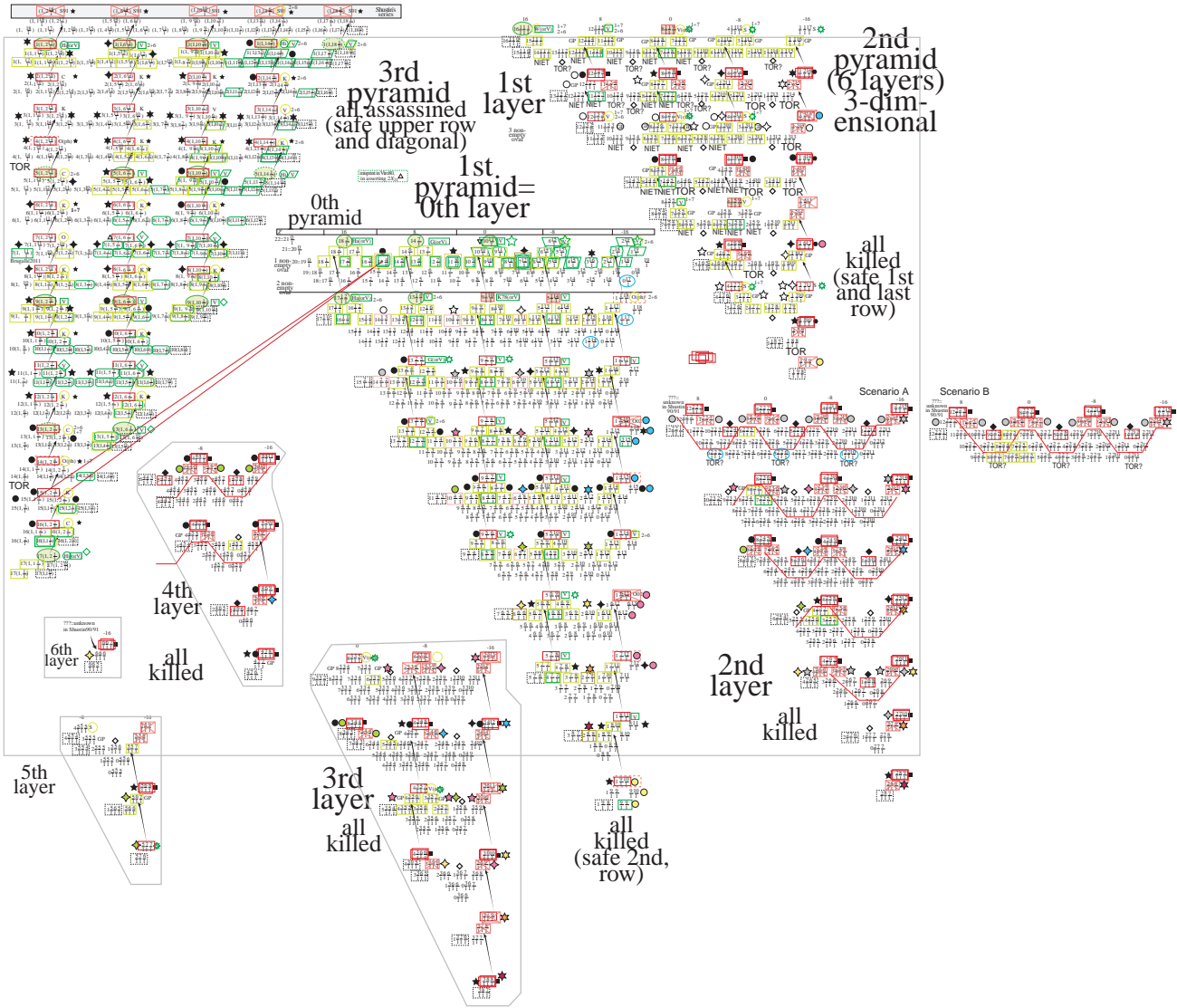

Figure 38: Trying to interpret obstructions via censorship above mushrooms situated at the $(M - 4)$ -level

scheme $\frac{19}{1}$ admits many $(M - 1)$ -extensions below Shustin series (subnested case without outer ovals). Alas $\frac{19}{1}$ has wrong Euler-Ragsdale characteristic for being of type I, and also it is for all those sub-Shustinian scheme to be prohibited since half of them are deducible as shadows of the subnested M -scheme with one outer oval constructed by either Hilbert or Viro.

Of course, we can imagine that Shustin's M -obstruction are interpretable as a censorship to a total reality reality concentrated on the $(M - 2)$ -schemes below it (e.g., $(1, 1\frac{17}{1})$, $(1, 5\frac{13}{1})$, etc.), but then both $(M - 1)$ -schemes below Shustin's scheme (which admits only two ways of contraction in view of the absence of outer ovals) are killed, and so the contraction principle is jeopardized again. As a conclusion, it seems that there is no way to explain Shustin's M -prohibitions via censorship (at least in a way respecting the Viro-Itenberg contraction principle).

Otherwise we can imagine a deep mushroom of total reality reigning for the Arnold-congruent $\chi \equiv_4 k^2$ scheme $\frac{17}{1}$ lying at level $(M - 4)$. Of course this deep mushroom would cause serious damages in the uni-nested pyramid (more than Viro's beaver construction permits, yet this is perhaps erroneous), and collaterally it would explain Shustin's obstructions.

The question about $\frac{19}{1}$ is rather puzzling. As an attempt to get it via Viro's method (with extended parameters) we may first take a look on the gluing-table (=Fig. 21). As the scheme as $r = M - 2$ many ovals we confine our attention (using Viro's maximal dissipation) to the gluings with 2 macro-ovals (green-

colored on the gluing table). The amendment of pure nesting inherent in $\frac{19}{1}$ forces limiting attention to the cases where the 2 macro-ovals are nested, and a short inspection of the table leaves only the few possibilities: B/G, C/G, D/F (alas this is a no-mans-land because F is empty), D/H (also empty), D/J (cannot reach sufficiently many ovals because J is saturated), E/G, F/H (empty), F/J (too small because J is saturated), G/I, H/J (not good as H is empty and J is saturated). So it remains a good deal of candidates. Additionally, one must not forget the gluings with flipped version in the margin of Fig. 21 (specifically F/Fflip, F/Hflip, H/Fflip symmetric, and H/Hflip), but all those of interest involve an empty family of patches (specifically F or H) and so those gluings can ultimately be discarded.

First for B/G, we see that we may specialize to B2/G1 and to control the topology we choose $(\alpha, \beta, \gamma) = (0, 9, 0)$ at B2 and $(\alpha^*, \beta^*, \gamma^*) = (0, 9, 0)$ above at G1. Controlling in the table of patches (Fig. 18) we see that B2(0,9,0) is unobstructed, but alas G1(0,9,0) is not adjusted to Gudkov periodicity (hence an illegal patch).

It remains to browse the other options. The next opportunity is C/G, but again whatsoever we choose below (C1 or C2, where γ is just transplanted in the more internal lune), we are forced to select the same upper patch as before G1(0,9,0), which is an illegal move.

Our next chance involves E/G, but again the prescribed target-topology of $\frac{19}{1}$ forces us to employ the illegal patch G1(0,9,0), while on the bottom we use the potential patch E(0,9,0) not given by Viro's theory (yet not prohibited too). Of course this no consolation and there is no opportunity to get the requested scheme in this flavor E/G.

The next (and last) opportunity is G/I, and once more it is clear that we are forced to appeal to the same illegal patch G1(0,9,0) to get the desired curve.

We have proven the following:

Lemma 4.10 *Even with extended parameters Viro's method of the quadri-ellipse will never succeed in constructing the extreme right uninvested scheme $\frac{19}{1}$ at least by using M -dissipations. However it remains the hope that it is accessed via non-maximal dissipation.*

It remains to analyze if it is possible to realize the scheme by using non-maximal dissipation. Again we look at the ground-shapes of gluings, and we may first consider those with 4 macro-circuits. The absence of outer ovals and presence of a single nest restrict our attention to the sole option of G/G. Then our sole chance to realize the given scheme is via $G1(0,8,0) \times G1(0,8,0)$.

Of course the next reflex is to compose this patch with those of Viro (C,E), but alas the morphogenetic table shows that those patchworks (C/G and E/G) have only 2 macro-ovals, so that the resulting schemes have $M - 3$ ovals.

A further possibility is to exploit the ground curves with 3 macro-ovals. We can then focus attention to the yellow cases of the table, especially the combinations D/G (like David Gauld!), F/G and G/H. First, as to D/G we can only take $G=G1(0,8,0)$ (granting existence of this patch) but then we are forced to take an M -patch for D and those are known to be prohibited (Arnold's weak version of Gudkov periodicity). For F/G we can tell the same story, and likewise for G/H. This proves the following:

Lemma 4.11 *There is one and only one chance to realize the extreme-right uni-nested scheme $\frac{19}{1}$ via Viro's method of the small perturbation of a quadri-ellipse, und zwar als $G1(0,8,0) \times G1(0,8,0)$. Whether this opportunity is actually realized is unknown to us. (If it is not we get maybe a counter-example to the contraction conjecture of Viro-Itenberg.)*

4.7 Patchwork vs. Artwork

[09.08.13] Next we see that the defect of the patch G2 is that to glue it maximally with itself we necessarily create doubletons of β and γ in the same lunes. if take

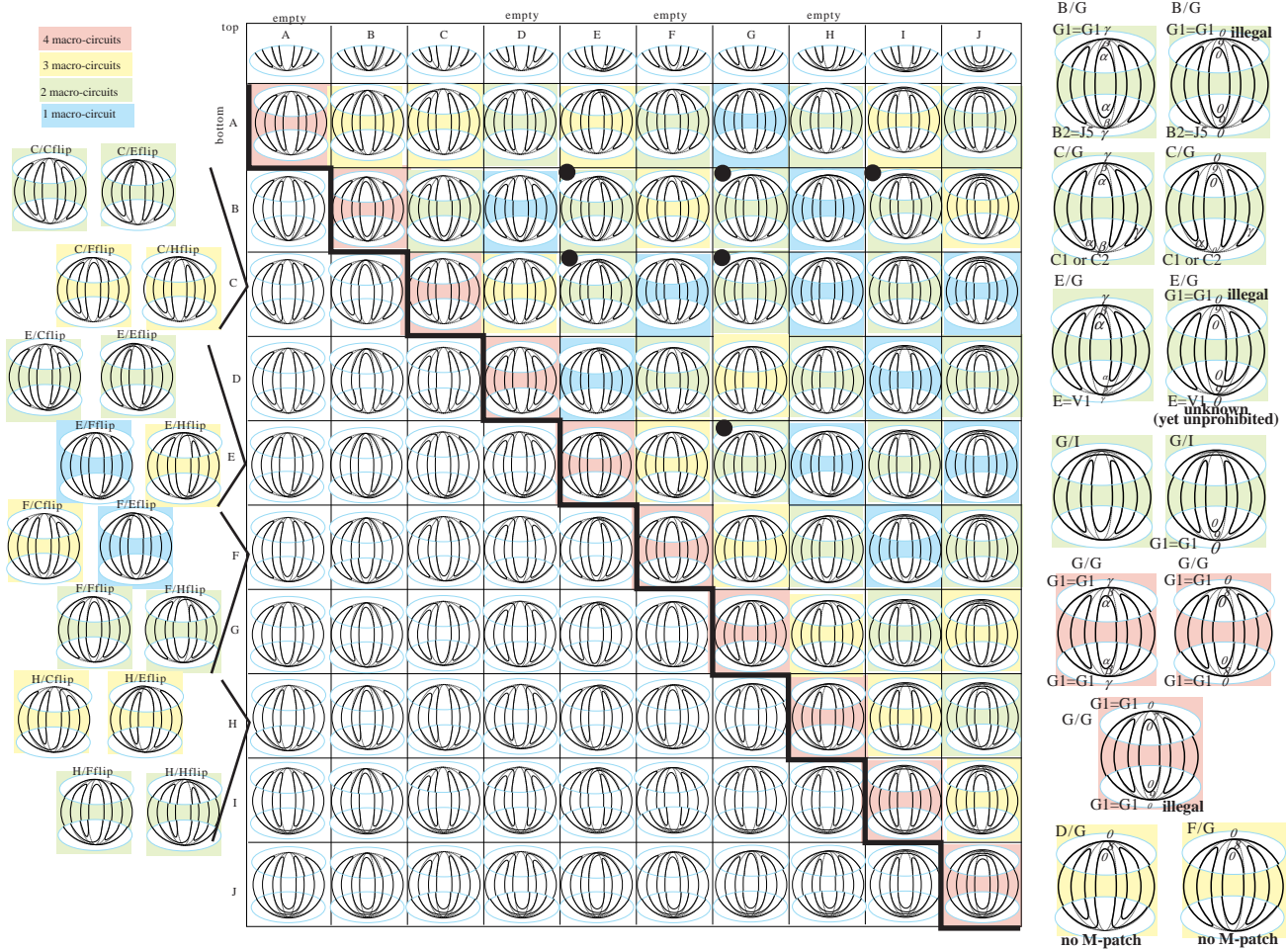

Figure 39: Trying to get $\frac{19}{1}$ (via M -patches)

G_3 the avatar of G_2 yet with bifolium at the center then we will dispose of one more way to self glue the patch with itself by adding a vertical symmetry. So we will also be able to exploit Viro's sporadic law and more patching obstacles will be gained than for G_2 .

Initially we wanted to compose as shown on Fig. pre G_3/G_3 where α, β, γ appears along the "natural" left-right sense of reading. Yet, as a trick, it seems advisable to permute the parameters in order that G_3/G_3 involves the same table as G_2/G_2 , and so we changed the labelling of ovals as β, α and γ when read from left-to-right (compare Fig. G_3/G_3). Hence as before the same patches as in the G_2/G_2 -table are killed. Now the quick is that G_3 can be composed with itself plus an additional vertical symmetry so that both parameters are not anymore in the same lune creating thereby evenness of the content of an oval. Alas, we realize only now that even before (e.g. for G_2), it is actually β and β^* which can vary independently so that no parity of the content is forced. The real reason is actually that β is fixed to $1 \pmod 4$ and therefore all schemes of the table have even content on the central nest. Yet, it is precisely this consanguinity that we can now jeopardize by symmetrizing the patch G_3 . This gives us the table G_3/G_3B where B stands for bis. Actually as most patches are already prohibited we do not even need to feel carefully that table, but can restrict at the nodes of where there are quantum jump which are the white patches in suspense (doubt). Then we see that Viro's sporadic obstructions (it is enough to consider them along the diagonal) kills the G_3 -patches $(4, 5, 0)$ and $(0, 9, 0)$, but however $(8, 1, 0)$ is not killed since it creates a Shustin's scheme accessible via the medusa. Even if modest, this would be an interesting result, for it would provide a more elementary construction of Shustin's scheme. At any rate, we see that if the three patches not forbidden by Fiedler-Viro's oddity law are available then we could refute some of Viro's sporadic obstructions, and

we would so-to-speak raise the death (i.e. schemes prematurely killed by Viro). So:

Scholium 4.12 *Could it be that Viro’s presentation of the dissipation theory of $X_{21} = F4$ —(in Arnold vs. Gabard’s notation), i.e. quadruple flat point with 4 branches having a 2nd order tangency (with all branches curved in the same half-plane (by the way it would be interesting to study the other cases sembling chromosomes, where some of the 4 branches lies in different half-planes, as those could admit realization in degree 6 as well at least from the naive real viewpoint)—is too rigid or frigid?? That is to say did Viro missed certain patches? And if yes this can be done in varied level of dequantization sometimes by attacking Viro’s sporadic obstructions. In contrast if all of Viro’s sporadic obstruction are correct (actually two of them suffices, namely prohibition of $\frac{5}{1}\frac{5}{1}\frac{9}{1}$ and $\frac{1}{1}\frac{9}{1}\frac{9}{1}$), then the patch G3 still admits the dissipation $(8, 1, 0)$, which is not listed on Viro’s table (=Figure 55 on p. 1118 of Viro 89 [1535]).*

Again at this stage it seems worth reading once more Viro’s remark (p. 1119 of *loc. cit.*):

“We do not yet have a complete topological classification of the dissipations of X_{21} singularities. Shustin [32] proved that all dissipations of type X_{21} singularities with a given number of real branches have the same topological type; however there is still a big gap between what is given by the constructions and the prohibitions. Curiously, the problem has been completely solved for dissipations that can occur in the construction of nonsingular M -curves. These dissipations are considered in the next theorem. It can be shown that any dissipation of an X_{21} singularity with four real branches in the course of which nine new small ovals appear (this is the maximum possible number) is topologically equivalent to one of the dissipation in Theorem 4.5.A.” [Gabard’s addition: Incidentally it seems that there is a misprint here and that one should read Theorem 4.7.A.]

GABARD’s comment on this prose. Personally, we do not see how to prove this and believe that the “it can be shown” of Viro is hazardous or presumptuous/arrogant (as we are unable to reprove it). As we said the point is that even when admitting Viro’s sporadic obstructions it does not result a prohibition of the patch G3(8,1,0). Question: how can Viro rules out this patch?

Next it is evident that this sort of argument via composition table can be multiplied to other exotic patches (exotic in the sense that Viro claims their nonexistence).

So for instance the patch G4 when self-glued with itself (with or without an additional vertical flip) will produces a scheme with invariably $\gamma + \gamma^*$ outer ovals which will therefore be even when evaluated along the diagonal of the composition table. However Gudkov periodicity tells us this number of outer ovals being 1 modulo 4 in the doubly-nested case (compare e.g. the pyramid). Hence all the G4-patches are prohibited merely by Gudkov periodicity (even in the weak version of Arnold).

The patch G5 will conflict with Shustin’s restrictions, yet probably for only few values of the parameters. Hence, we do not see how Viro is able to prohibit all those patches. On gluing G5 with itself, we note that the number of big eggs (i.e. craw’s eggs at depth 1 is $1 + \beta + \beta^*$ hence always odd along the diagonal of the composition table). However Gudkov periodicity imposes this number as being congruent to 2 mod 4. Actually Arnold’s weaker version would actually suffices for our purpose of inferring therefore, that all patches of the family G5 are killed. So in principle it not even worth tabulating the G5/G5, yet let us do it just for the fun of being a “angst Hase”. So let us choose $\beta = 0$ as initial value, albeit this is not satisfactory when $\beta^* = 0$ too, and so it is really not worth doing any tabulation.

Next we have a menagerie of patches involving 4 unnested lunes (the G6-family on Fig. 12), and some similar thinking based Gudkov periodicity (often in the simple variant of Arnold) suffices to kill all those patches. Indeed the most universal G6-type involves parameters $\alpha, \beta, \gamma, \delta, \varepsilon$. If all first four of those

are positive then Bézout for conics is violated via the saturation of doubled quadrifolium. So we may assume one of them zero. Without much loss of generality, assume $\delta = 0$ (compare picture right below), then when gluing with a symmetric replica we land in the trinested realm where the number of outer ovals is $0 \pmod 4$ and not $1 + \varepsilon + \varepsilon^*$ which is odd when the patch is self-composed with itself, hence violating even Arnold's version of Gudkov. So we may assume one more parameter zero and this yields e.g. the picture just right below the former one. But again the same argument shows that it is anti-Gudkov in the version of Arnold, since in the doubly nested case there is one outer oval $\pmod 4$ (or $\pmod 2$ suffice). Finally we must analyze variant were there is additionally a micro-nest (see G7-family on the figure). Of course if there is too much parameters α, β positive, we can corrupt the bound of 4 nests, and so we are led to patches with only one of the 4 "semi-lune" inhabited, yet even in this case an additional vertical flip of the upper (replicated) patch will corrupt the saturation of the doubled quadrifolium, and so independently of α 's position which cannot be central! Accordingly the sole issue is to have all semi-lunes empty, but then the resulting curve has the scheme $4\frac{8}{1}\frac{8}{1}$, with number of outer ovals improper for Gudkov (even Arnold's) periodicity. So we have more or less proved:

Lemma 4.13 *Arnold's periodicity implies that there is no dissipation of X_{21} such that the perturbed germ exhibits 4 unnested semi-lunes (compare G6-family on Fig. 12).*

Philosophically it is quite remarkable that all those patches are killed albeit they look decent traffic transition from the real viewpoint (of traffic circulation). Yet, the reason behind this rigidity is Arnold's deep insights on the complexification and 4-manifold. Therefore those prohibition reduce essentially to the basic algebraic fact that an even unimodular integral quadratic form has signature divisible by 8 (due to old arithmeticians like Zolotarev, etc.), while Rohlin's deepens this by a factor 2 if the form arise as the intersection form of a smooth spin 4-manifolds.

Yet, in contrast to all this our patch G1 is nearly unprohibited even under Shustin's obstructions. So how can Viro claim that his list of patches is exhaustive!?? Maybe we should try to compose G1 with other patches and exploit other obstructions of Viro relative to $(M - 2)$ -curves. We recall therefore Viro's corresponding statement (Theorem ??) but which we reproduce now for convenience, and of which we shall try to exploit the 2nd clause.

Theorem 4.14 (Viro 1983 [1532])

- (M) —If $\frac{\alpha}{1}\frac{\beta}{1}\frac{\gamma}{1}\delta$ is the real scheme of an M -curve of degree 8 with α, β and γ nonzero, then α, β and γ are odd.
- $(M - 2)$ —If $\frac{\alpha}{1}\frac{\beta}{1}\frac{\gamma}{1}\delta$ is the real scheme of an $(M - 2)$ -curve of degree 8 with α, β and γ nonzero and with $\alpha + \beta + \gamma \equiv 0 \pmod 4$, then two of the numbers α, β, γ are odd and one is even.

(Remind that albeit a bit undigest, this 2nd clause has a clear-cut diagrammatic impact, compare Fig. 155).

The idea is that if we compose G1 with V1 (or some other patch) then we hope to land in the trinested realm where there are serious prohibitions. Actually this is not readily the case, yet we can try first V1/V2 etc, or V2/V2fipped, etc, and hope thereby to get the restriction that we were as yet not able to explain by looking merely at M -curves. After drawing some combination of patches we realize that combination V2/V3flip yields trinested $(M-2)$ -schemes.

[10.08.13] However upon working out the table it is clear that we never interact with Viro's $(M - 2)$ -obstruction. Indeed the latter concerns schemes with number of outer ovals equal to 1 $\pmod 4$, whereas those just created have this number equal to 3 $\pmod 4$. Therefore, we are a bit disappointed to get no new obstructions but perhaps should not as it is precisely our secret dream that Viro's dissipation theory was over-atrophied, i.e. handicapped by too many restrictions, exacerbating thereby the difficulty of $Hi(8)$, Hilbert's in degree 8.

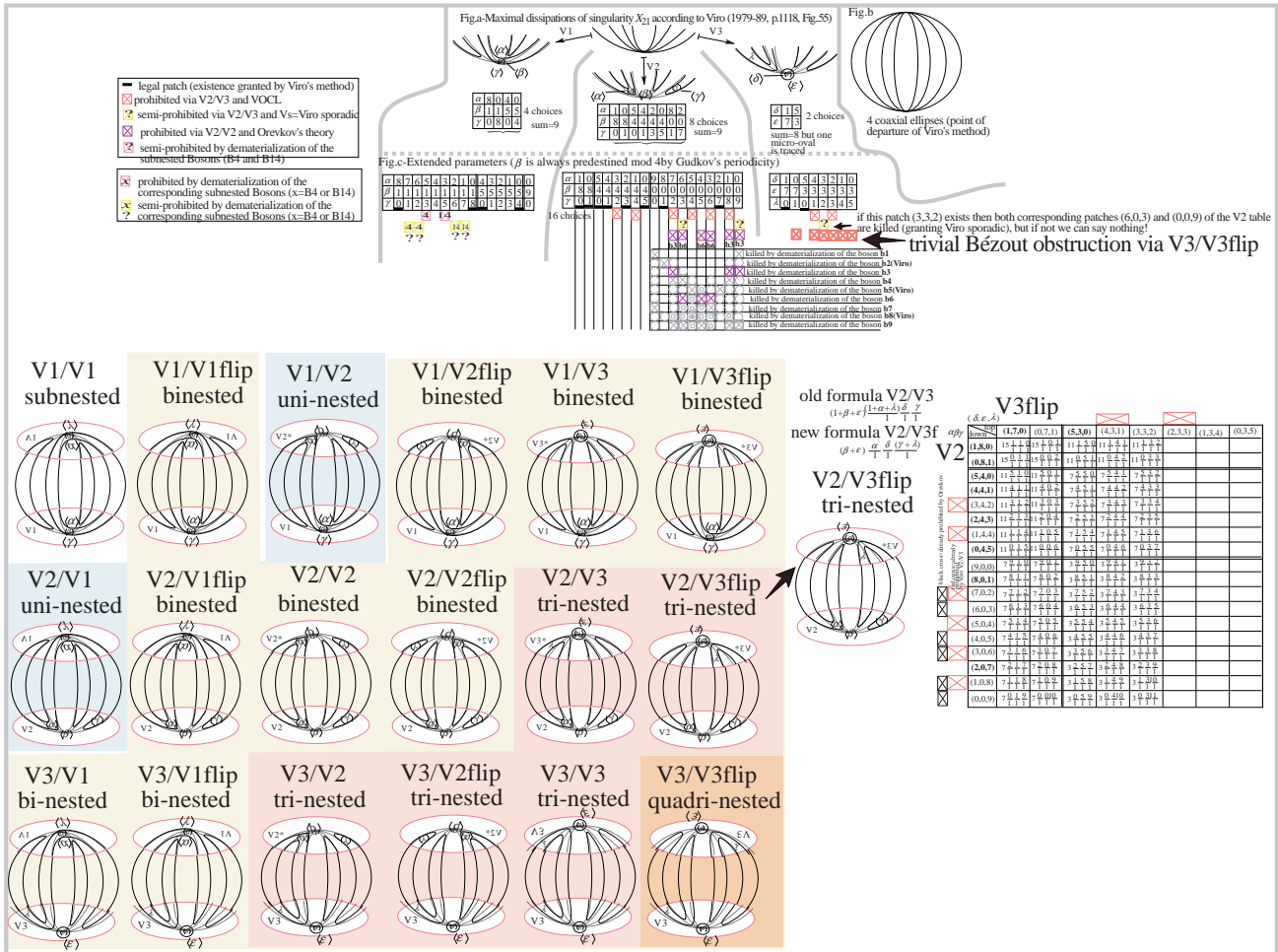

Figure 40: Nonmaximal $(M - 2)$ -gluings of $V1/V2$, etc. yet no direct patchwork obstruction are gained from Viro's $(M - 2)$ -law.

What to do next? After some sleep, we realized that one must always think in a structured fashion, and so arranged the super-table of composition in an array with double entry. Doing this we discovered the type $V3/V2$ flip also leading to the trinested realm. Yet it seems clear that this is just the earlier one rotated. Finally, working systematically we find the combination $V3/V3$ flip which is even quadri-nested, hence Bézout (or saturation allied to total reality) implies that $\lambda = 0$, and so:

Lemma 4.15 *The dissipations of type $V3$ really reduces to Viro's list of two.*

Alas, it seems then that we have exhausted all combinations, because $V3/V2$ is isotopic to $V2/V3$ via a reflection (recall optionally that the mapping class group of $\mathbb{R}P^2$ is trivial). In conclusion, we still do not understand why some of Viro's patches (especially $V1$ and $V2$) list are so restricted.

[11.08.13] So we have to continue this boring game of tabulation. For instance we tabulated the $G3/V3$ and $G3/V3$ flip combination on Fig. 15, yet it resulted schemes with the wrong number of outer ovals.

Next we analyzed $G7/G7$ and it seems clear that there is an evident Gudkov-Arnold obstruction killing the full $G7$ -family. Indeed when the patch $G7$ is glued with itself (modulo horizontal reflection), we get Fig. 14($G7/G7$), where we see $1+2\beta$ big eggs thereby violating the Gudkov-Arnold periodicity since the scheme belongs to the subnested case. The only way to resolve the contradiction is to impose $\alpha = 0$, but then the scheme is simply-nested with an odd number $1+2\gamma$ of outer ovals, jeopardizing again Gudkov-Arnold periodicity.

Eventually one can expect that some combination yields $(M - 1)$ -curves where there is the GKK-prohibition, but as yet we could never arrange this.

Next, we worked out more carefully the G3/G3flip-table of Fig. 14, but this is a bit anecdotic because we can surely rules out two more patches if we believe in Viro's sporadic obstruction, but still cannot exclude the G3-patch (8, 1, 0).

Eventually, we imagined also the patch G8 (of Fig. 12). On gluing G8 with itself under a horizontal symmetry we get the combination G8/G8 and a corresponding table.

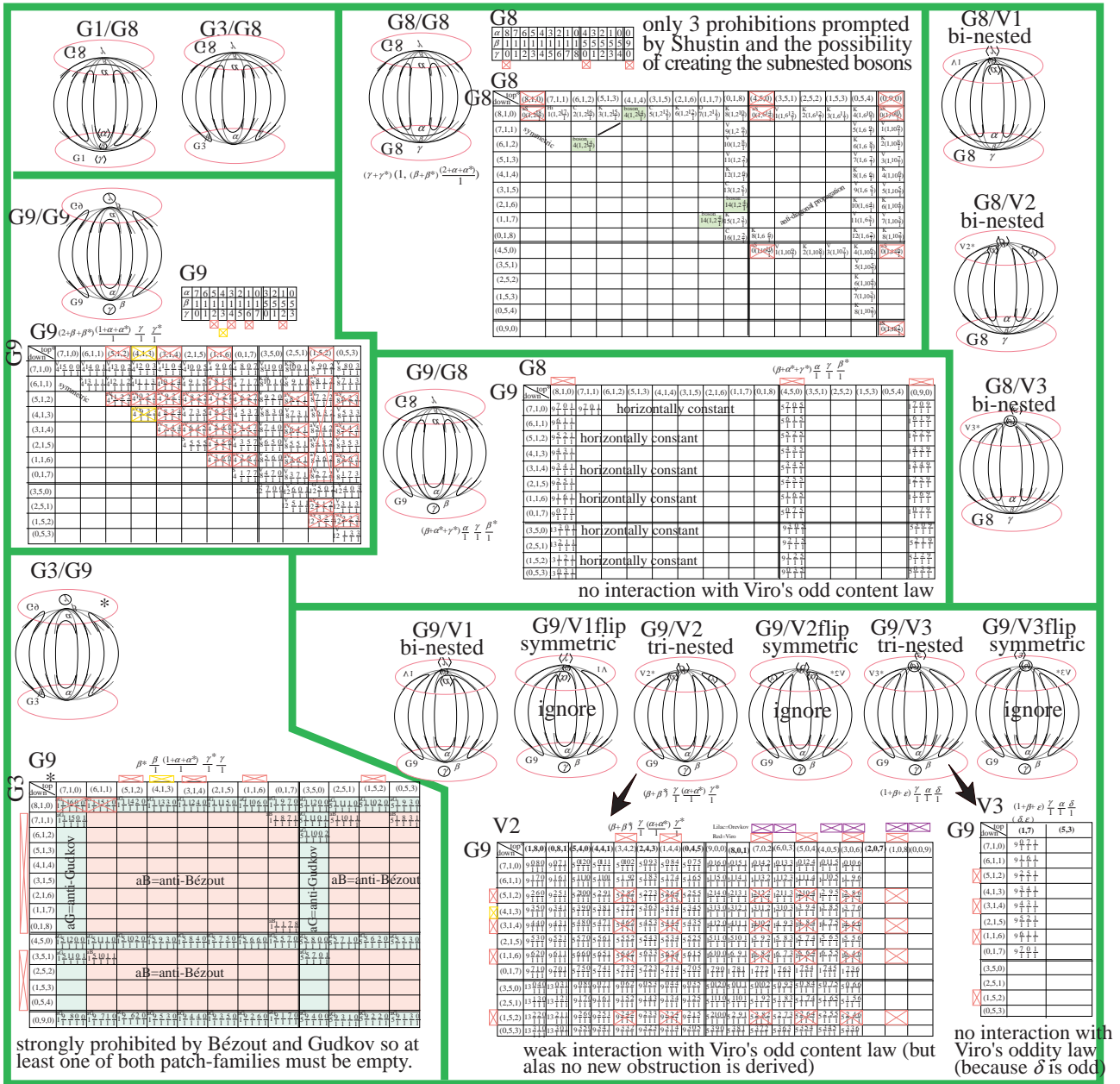

Figure 41: Patchworking exotic patches (continued)

By Gudkov periodicity the parameter β can be chosen as $\beta = 1$ plus its companions mod 4, i.e. 5, and 9. It may be observed that the general formula of the Gudkov symbol differs only slightly from that arising via G1/G1, yet as we choose the parameters differently it seems that we must restart anew the whole calculation. As the evolution rule is so simple it is a simple matter to cut-and-paste the symbols while adjusting a bit the geometry. Once the table dressed, we see that G8/G8 sweeps out slightly less schemes than G1/G1, but again as Shustin's prohibition concerns only the top of the 3rd pyramid only 3 direct obstructions are gained, namely (8, 1, 0), (4, 5, 0) and (0, 9, 0). Again it is not clear how Viro can prohibit the majority of those surviving patches. In case of a realization of them, the net bonus would be the creation of new bosons,

as well as trivialization of many schemes due to Viro (ad-hoc's construction with horses and beavers), Korchagin, Chevallier, and Orevkov. The philosophy would be that the simplest animal (namely the protozoan of the quadri-ellipse), incarnating something like a primitive biological shape is sufficient to access most curves of the world. Hence, the embryology of the most complex real octic could be readily traced back to its most primitive ancestor by a direct morphogenesis (dissipation).

Next, we can glue G1/G8 or G3/G8, yet the slight defect of this scheme is that it is only doubly-nested. So we imagined a variant of G3 called G9 where we introduced β subsequently as to make possible Gudkov periodicity upon choosing $\beta = 1$ and its companion mod 4. While filling this table we wondered if did not made basic mistakes in the earlier tables??? Further a simple trick is to discover the evolution rule along the diagonal without having to fill the full table. At any rate, by the usual method we can kill via Viro's law 4 patches, and one more is killed by Viro's sporadic obstruction.

For instance we decided to check the table of G2/G2, or maybe even V2/V2. This is a boring task and we reserve it for later as we need an optical pause.

[12.08.13] Next, it remains to compose G3 with G9 which leads to an M -curve since both patches have the same underlying graphics. The resulting patchwork G3/G9 looks quadrinested so there should be severe obstructions. More precisely, the gluing G3/G9 is quadri-nested as soon as β, γ, γ^* are positive. On working out the table we remark that all schemes which are not frankly anti-Bézout are anti-Gudkov in the fine form of the latter not covered by Arnold's weaker version thereof. Therefore it must be recognized that all schemes of the G3/G9-table are nonexistent, and therefore that at least one of dissipation mode G3 or G9 is empty (i.e. contains not a single patch). Okay but can we really conclude that both types G3 and G9 are empty as Viro seems to claim?

From the table G3/G3 (which is the same as that of G2/G2 on Fig. 13) we know that only 3 patches at most can survive to the Fiedler-Viro oddity law, namely $(8, 1, 0)$, $(4, 5, 0)$, and $(0, 9, 0)$. Granting moreover Orevkov's obstruction(=desintegration) of the (pseudo)-boson $1\frac{6}{1}\frac{13}{1}$ we see that that both first patch cannot coexist simultaneously. Which one is not clear a priori albeit the patch $(8, 1, 0)$ looks more down-to-earth as its self-gluing yields a simplest Viro's scheme, namely $1\frac{2}{1}\frac{17}{1}$. So accepting Orevkov as true, three scenarios are possible, according to the exhaustive list of G3-patches:

- (1) G3 contains $(8, 1, 0)$ and $(0, 9, 0)$ (and nothing more); [in this case the bosons b_1 and b_9 are materialized]
- (2) G3 contains $(4, 5, 0)$ and $(0, 9, 0)$ (and nothing else); [in this case the same bosons b_1 and b_9 are materialized]
- (3) G3 contains only $(8, 1, 0)$; [in this case no boson is materialized]
- (4) G3 contains only $(4, 5, 0)$; [in this case the bosons b_9 is materialized]
- (5) G3 contains only $(0, 9, 0)$; [in which case the bosons b_1 is materialized]
- (6) G3 is the empty set [no new boson is materialized].

This looks really meagre and sloppy piece of knowledge, and one would like to know more! A priori we could hope to draw sharper information by the interaction G3/G9. For instance if we knew that the G9-family of patches is nonempty, we could deduce that G3 is empty, and we would be in the arid scenario (6). Alas, it is not clear which of G3 and G9 is more likely to be empty. From a naive probabilistic perspective, the diagonal of G9/G9 contains fairly many realized schemes due to Gudkov (once), Viro (thrice), Shustin (thrice). In contrast the G3/G3-table hits more systematically against the Fiedler-Viro obstruction so that one could suspect that emptiness of G3 is more likely. Further, G3/G3 can create bosons whilst G9/G9 only creates standard schemes (at least when not violating Viro's highly sporadic obstruction). Accordingly, it could be that emptiness of G3 is more likely than that of G3, of course not impeding an extinction of both species (as seems implicit in Viro), yet we know no theoretical justification for this collapse.

However remind from the table G3/G3flip that it suffices to believe in Viro's sporadic obstructions to kill the patches $(4, 5, 0)$ and $(0, 9, 0)$, so that in principle

only scenarios (3) and (6) are logically possible. Alas, we do not know how to produce more information, as one of the pity is that since G9 is symmetric we cannot infer more information by composing the patch with itself flipped.

Of course the general feature to be remembered from our experiments with V2/V3 and G3/G9 is that both patches are coupled with one differing from the other merely by the addition of an outer island (and slight restriction in the parameters). Each pair of such partner patches will create an additional table of M -schemes from which one may infer additional patching-prohibitions. Alas, one does not receive complete information by this method, at least not as complete as tacitly claimed by Viro.

One of the other problem is that as yet we could not exploit the Viro's prohibitions on $(M - 2)$ -schemes of RKM-type in the trinested realm. Those will perhaps enter into action when composing G9/G8, which by construction will land in the 3ply-nested zone. From the scratch, i.e. by filling the first entry of the table and comparing with the main pyramid (Fig. 155) we see that we land in the RKM-domain where $\chi \equiv k^2 + 4 \pmod{8}$, so there is a good chance to meet Viro's $(M - 2)$ -obstruction. Yet on the same moment since the table G9/G8 is not a self correspondence it will only results hypothetical patches-obstruction unless we know a specific construction in one of both patch family. So it is not clear that the device will lead to any tangible piece of information. Yet having no better idea in the pockets let us peacefully fill the complete G9/G8-table. It is quickly observed that the table is horizontally constant, and during the tabulation we see that the vertical rows do the usual palindromic motions in the pyramid yet *without* interacting with Viro's $(M - 2)$ -obstruction.

Now what about composing G9 with V1, or V2, etc. Of course G9/V1 does *not* lead to the 3-ply nested realm, but so does G9/V2 and G9/V3. On tabulating the patch-works, we expect so to infer valuable information from G9/V2 and G9/V3. On filling G9/V2 the very first item is actually the scheme $11 \frac{8}{1}$ which is RKM. Then we propagate the table, e.g. first along the vertical row, where we observe the usual palindromic path. Then we copy and adapt each raw along the evolution rule. A Viro obstruction appears first in the 5th vertical row, but alas as the vertical V2-entry $(3, 4, 2)$ is not existing we cannot infer damages on the corresponding G9-entries. We hope that things will improve in the next row, but alas there we meet no Viro obstruction. On the next row $(0, 4, 5)$, we have the 3rd numerator equal to 5 so there is no Viro obstruction, as the latter amounts to forbid all three numerators being even integers. Of course, prior to filling the whole it is already evident that we will gain no (new) obstruction along the way, because the schematic obstruction of Viro always fails to land in bold-faced rows corresponding to materialized patches. As a result we see

Scholium 4.16 *Viro's oddity law for $(M - 2)$ -schemes of type RKM does not implies more patches obstructions than those already gathered from the oddity law for M -schemes.*

It remains to hope that the situation is changed when using G3/V3 which despite naive expectation is only triply- (and not quadruply) nested. As V3 is inherently restricted to two patches by Bézout the tabulation-efforts are more user friendly. The first entry of the table is reassuring (yielding an RKM-scheme). However as δ is odd (even $1 \pmod{4}$) it is clear that the schemes so created never interact with Viro's obstruction and no additional information on G9 is gained.

At this stage the methodology is fairly clear, nearly algorithmizable as follows:

Step 1: Imagine all the patches that you want by tracing them as if you where an artist like Saint-Exupéry's Petit Prince,

Step 2: combine all the patches between themselves (especially with the V-family of Viro which is known to contain explicit dissipations), and report the elementary obstruction of Bézout and Gudkov, and optionally the highbrow obstruction of Fiedler, Viro, Shustin, Orevkov. Keep also in mind the option

of looking at non-maximal (hybrid) smoothing which could potentially interact with Viro's 2nd oddity law (not all 3 numerators of a trinested RKM-scheme can be even). Further the important trick is to combine a patch with its partner which has the same look plus an extra island, so that it is a fake hybrid, leading thus to the M -realm, where perhaps the most stringent obstruction are known.

Step 3: Self-criticism keep in mind the option that some of those Russian obstructions are potentially erroneous, and that the actual state-of-the-art on $H(8)$ (=Hilbert in degree 8) is over rigidified by too many prohibitions. Keep in minds that Russian citizens prefer life with not excessive prohibitions, especially when it comes to distilled vegetables.

Step 4: Notice, that apart from being a combinatorial looser, a certain discrepancy between the obstruction so generated and those claimed (semi-tacitely) by Viro 89 is quite big, leaving the topic in an unsatisfactory state of affair.

To be concrete again it seems that we missed as yet to compose G8 with V1, etc. However it seems (see Fig. 41) that all those schemes G8/V1, G8/V2 and G8/V3 are never trinested and so we can interact with Viro's $(M - 2)$ -prohibition. Of course flipping the top patch does not help as the bottom one i.e. G8 is symmetrical.

5 Viro's construction of the patches for X_{21} (=quadruple rainbow)

5.1 The method employing hyperbolisms (Huyghens, Newton, . . . , Viro)

[13.08.13] After the energy spent in prohibiting patches it seems advisable (and even logically requested in the prohibitive aspect) to construct patches. We follow the geometric approach in Viro 1989/90 [1535], along a methodology using Gudkov, Polotovskii, etc, and hyperbolism à la Huyghens, Newton.

[30.08.13] Quite strangely Viro's exposition is fairly geometric and not brute-force combinatorial patchwork. Also puzzling from the entrance is the issue that the patch is something local but constructed by excision out of a global object.

[01.09.13] Now we give the details. Viro starts with affine quintics due to Harnack, Gudkov and Polotovskii and deduce some quintics with special position w.r.t. the 3 coordinate axes. The patch will be deduced via a hyperbolism (Huygens-Newton-Cremona).

It may be noted that Polotovskii's affine quintics yields when smoothed (along with the line "at infinity") the RKM-schemes of degree 6 studied by Rohlin and Le Touzé ($2\frac{6}{1}$ and $6\frac{2}{1}$). Also pleasant is the issue of interpreting affine curves as waves profiles, and then Polotovskii species correspond to giant waves forming a rouleau, while the additional oval of the quintic may be imagined as droplets of water resp. bubbles of air injected in the sea profile. This metaphor loses of its pertinence once it is remembered that the pseudoline fails to divide the plane $\mathbb{R}P^2$. Hence, there is no distinguishable mediums of water and air.

From all those 4 fundamental species of affine quintics, it is argued that by dragging the line at ∞ to a tangent we get six types of projective quintics behaving as depicted w.r.t. the fundamental triangle allied to projective coordinates. At this step, one may wonder if there is not also a configuration as shown below Polotovskii's where the 6 air bubbles are converted to droplet surfing below the rouleau of the wave front. (One should perhaps keep this or other possibility as an attempt to expand Viro's list of patches, with the possible net bonus of getting the boson of M -octics not yet known to be realized, at least some of them.) Of course the classification of affine M -quintics is in principle a closed chapter of geometry certainly going back to Polotovskii himself. For simplicity, let us leave aside this difficulty for the moment to continue Viro's argument.

The next step involves applying a hyperbolism to all those six quintics. This is nothing else than a Cremona transformation involving the net/web of all conics through the 3 fundamental points of the triangle.

[02.09.13] The resulting curve resembles a Bugs-Bunny (rabbit with two big ears), and can be recognized as a margarita with 3 petals. Actually, we fail to understand exactly why the resulting curve has degree 8 as perhaps a hyperbolism is slightly different from the standard Cremona transformation. When applied to Polotovskii's curve we get a variant with both ears invaginated into the head of the rabbit. Of course one may wonder if there is not a variant where one ear is invaginated while the other lies outside (and this naturally comes up when tracing the curve on an electronic tracer like Illustrator, see Fig. a). It is also puzzling that both Harnack's and Gudkov's curve creates two projective curves while those of Polotovskii just a single one. So it is a hard duty to get convinced that Viro's exposition is exhaustive. For instance we could wonder of what happens if the tangency is arranged along the extremity of the wave in Polotovskii's curve (Fig. b).

The next step involves dissipating the triple point while creating a new little oval (as is evident from the theory of cubics) and this in a somewhat eretical way so that one of the connecting branch of the patch performs a meander of 3 crossings along one of the fundamental lines. This step we call a vibratory dissipation and in substance goes back to Harnack himself, yet in the present twist this seems to be due to the Russian scholars (Gudkov, Polotovskii, Viro, etc.) Remember that a similar trick was used in Gudkov's 2nd construction of his novel sextic $5\frac{5}{1}$. Actually as the curve is of degree 8 one could try achieving more oscillation than four, yet it should probably be kept in mind that there is dormant a supermassive black-hole of an X_{21} -singularity with invisible/imaginary branches located at the upper vertex of the fundamental triangle and this absorbs 4 intersections with the oscillated-about line.

The last step involves another hyperbolism, but alas here Viro's paper lacks any depiction and becomes fairly incomprehensible. We were thus blocked for a while at this place. Our heuristic idea is that the hyperbolism might be interpretable as a smashing followed by an inversion, and then indeed we recognize the patch C2(1,8,0) in the notation of Fig. 18. Again the trick of the inversion gives us a "Wiedergeburt und a Neuaufstehung" in Jakob Steiner's picturesque language. Of course, this inversion is a naive vision-de-l'esprit and can be directly interpreted as an isotopy akin to a mitosis in cell-biology, or better, as the growth of a carnivore plant with several tentacles merging at the opposite pole. The other cases are then self-explanatory and we get successively the patches C3(1,7), C2(5,4,0), C3(5,3). Then the first Polotovskii specimen yields the patch C1(2,0,7) not readily listed by Viro, and which may thus be considered as relatively-new. Remind that when combined with the hypothetical patch C2(9,0,0), this yields the boson $b7 = 1\frac{7}{1}\frac{12}{1}$.

This divergence from Viro is a bit puzzling and may suggest that our interpretation of the hyperbolism is not entirely adequate. Alternatively, it could be that our patches are correct, but those of Viro are *not* since everything depends just upon the location of the letter γ on his picture, and one can easily imagine this can be misprinted. This hypothesis, although poorly founded, has to be envisaged with non-zero probability in view of the density of misprints detected in Viro's paper. Of course it can also be that both collection of patches (C1 and C2) both exist, so that both Viro and "Gabard" are right without excluding themselves.

Note incidentally that our earlier incertitude about the exact location of the micro-oval arising from the triple point dissipation (as being either above or below the oblique line) seems anyway irrelevant in view of the merely isotopic nature of the problem.

So at this stage we have the important:

Scholium 5.1 *Looking at the entraille of Viro's method we see that his list of patches is possibly not exhaustive. Maybe Viro can be excused because the new patches are producing isotopic schemes than those generated by the old list, or because a slight misprint infested his picture. Alternatively, it can be that our visual interpretation of the hyperbolism is foiled, and then Viro is correct.*

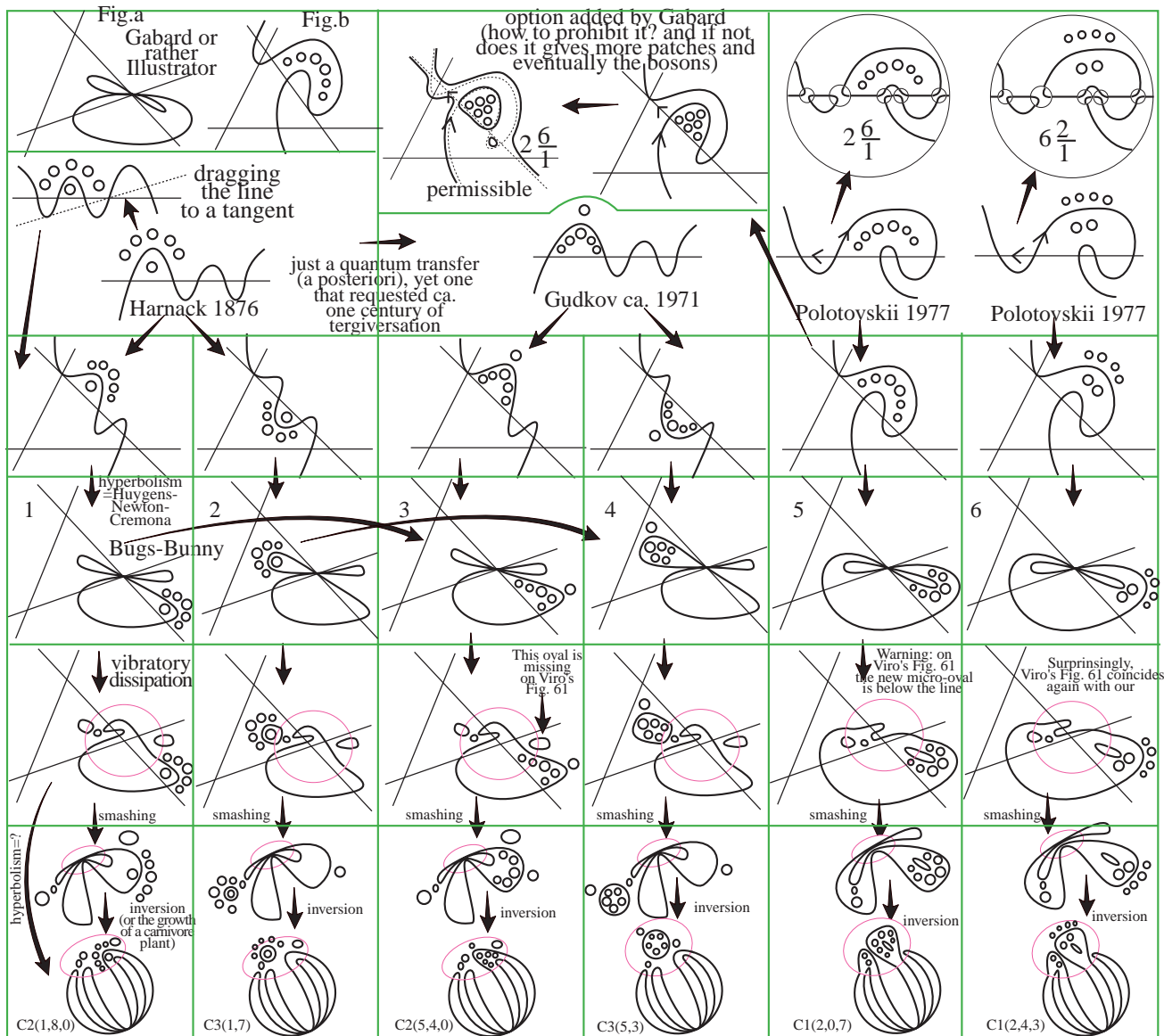

Figure 42: Viro's construction of the patches (via hyperbolisms): nearly complete modulo the mirrors to be found on the next plate

Now, Viro's argument has still not yet been exploited in full, because he also proposes working with symmetrized replicas of the ground otics numbered 1,3,5,6 (on Fig. 42); compare our Fig. 43 especially the "mirror" curves M1, M3, M5, M6 near the bottom of that plate. Those produce the patches C1(0,8,1), C1(0,4,5), C1(8,0,1), C1(4,4,1). It is slightly puzzling that those are initially the palindrome of the original patches (prior to the mirroring), but this palindromic law is not always respected.

At this stage, we really exhausted Viro's discourse, yet getting rather the C1-patches instead of the C2-versions. Further one can wonder if there is the smoothing M52 where the micro-oval born out of the triple point is located more on the right. This would give the patch C1(7,0,2), which is however ruled out by Viro's oddity law or by Orevkov's disintegration of the boson b3. Hence it seems that the dissipation M52 has to be excluded.

Besides going back to the very first construction (curve 1), we may also a priori imagine a dual dissipating vibration (shown as D1), but this yields again the patch C1(0,8,1) already obtained via M1. Of course we could imagine that the micro-oval as on Fig. D1b by being roughly speaking inside of the meander, yet the resulting patch just violates Bézout.

Of course whenever $\gamma = 0$, then $C1=C2$, and so all the patches constructed

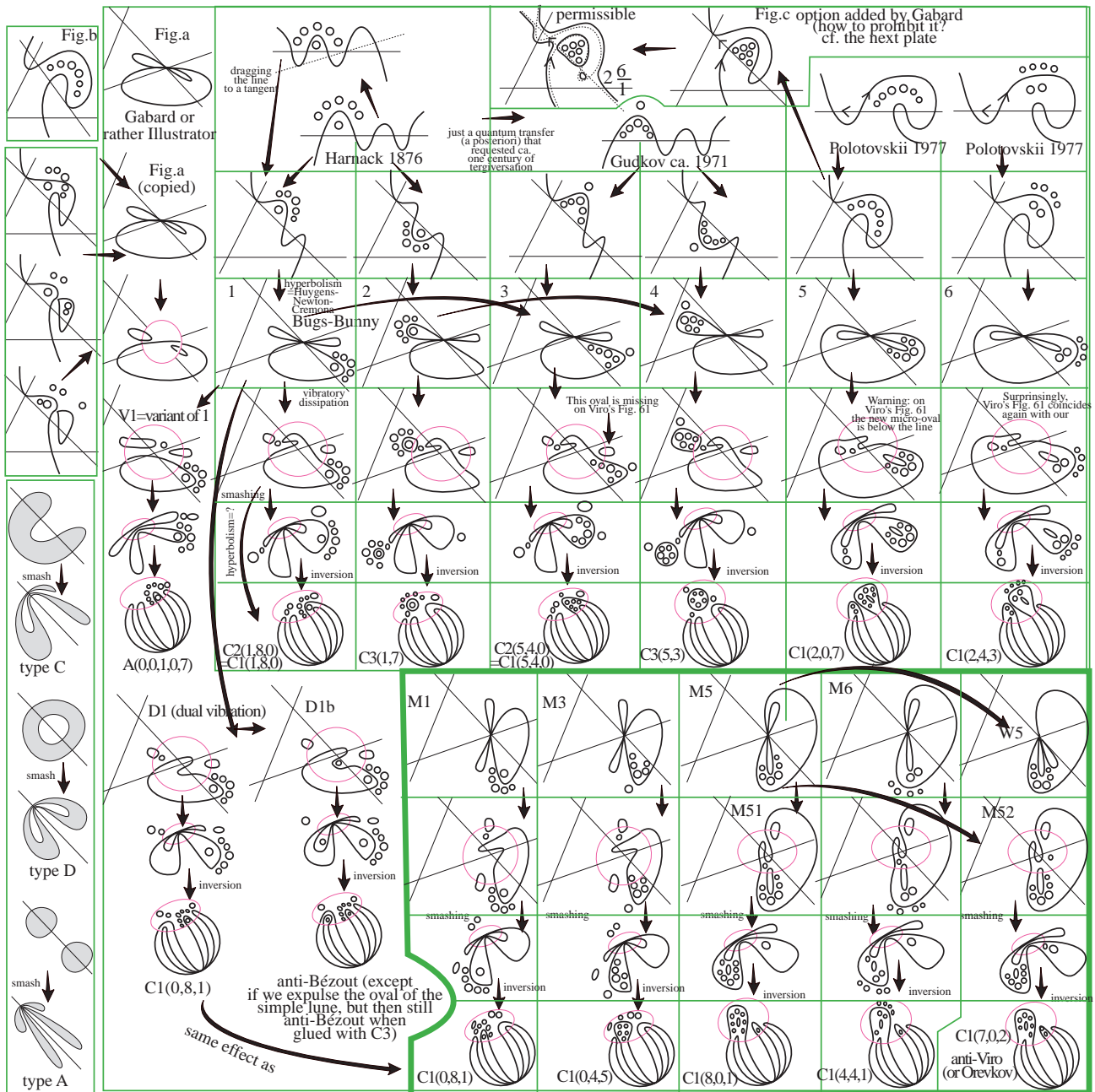

Figure 43: Viro's construction of the patches (continued, i.e. the mirrors)

can be interpreted as belonging to class C1. Hence in our interpretation all the patches constructed belong to C1 and not C2 as asserted by Viro's Fig. 55 (p. 1118 of Viro 89/90 [1535]). Of course it could be that there is another construction yielding the class C2, or if not it could be that Viro's Figure contains a perfidious misplacement of the symbol γ in the outer lune instead of the inner lune.

Incidentally all those constructions are based on the tricky issue of the possibility of a vibratory dissipation and so it could be that all constructions are actually foiled in case this crucial step is fallacious.

At any rate we see that much variants have to be explored (for instance our Fig. a and our Fig. c). More philosophically we see that Viro's method is very much in continuity with Gudkov's technique.

We may note that our Fig. c leads to a path violating Bézout (when it is doubled). Still, we may hope that the method can be more varied to produce new patches (so perhaps new *M*-schemes), especially if we use also the rabbit with one ear invaginated (Fig. a).

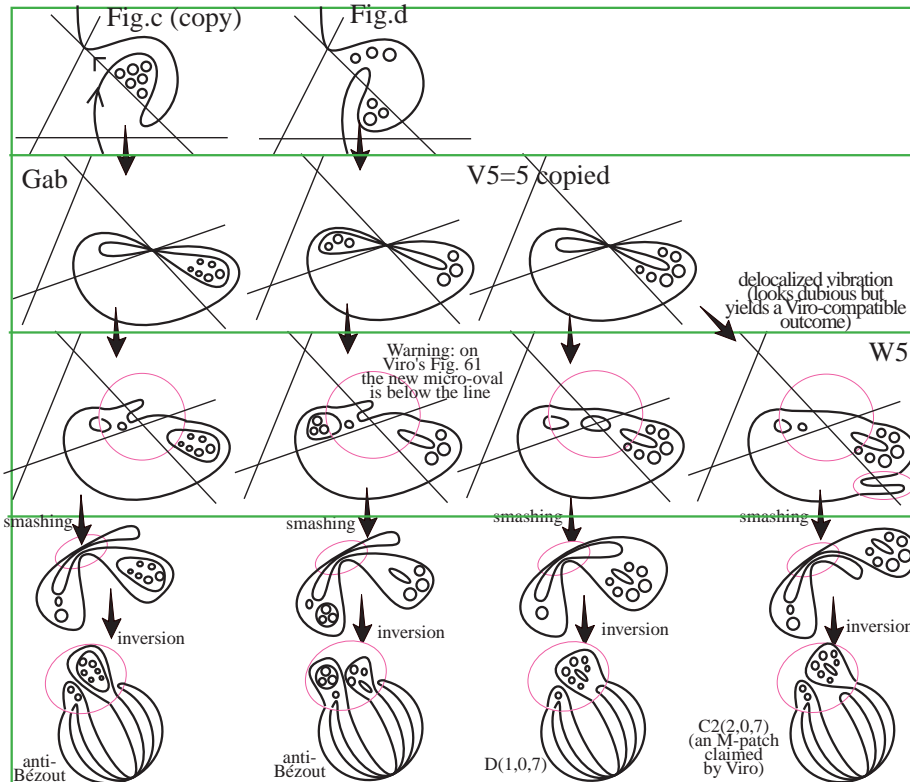

Figure 44: Prohibiting Fig. c and other variants of Viro's hyperbolic method

[02.09.13, 23h39] Disinhibited by some alcohol (cf. Ahlfors or the Greco-Roman tradition in "Vino veritas"), and according to our previous dubitative-ness (especially that based on Rohlin's maximality principle corrupted by—despite its intrinsic beauty—Viro, Gudkov, and even Hilbert, cf. one of the previous sections), we must confess that most of those Viro's constructions of patches seems to lack (severely?) in rigourousness to be algebraically christianizable. Of course, by social-ethnic affinity with Viro (Leningrad, Kronstad[t]) the writer wishes Viro all the best, i.e., all his constructions being correct (and perhaps more importantly exhaustive). It seems that whatever happens (i.e. Viro's death vs. Viro's triumph) there is—in the present state-of-affairs, at least—a serious lack of didactic value in the presentation, admittedly imputable to the intrinsic difficulty of the subject. Actually, the subject itself looks not so much intrinsically difficult, yet sufficiently boring in requesting high-memory faculty from the worker that the task turns quickly to an existential stress.

In comparison, some natural philosophers (like Markus Schneider, oder aber, his young brother Traugott Schneider (=two of the uncles of the writer on the maternal side of the genetical tree) who are epistemologically satisfied with phenomenologically more trivial apparitions of lesser logical structuring (like Buddhas appearing in the clouds), yet still apparently able to enjoy life at some more primitive level of an irrational Weltanschauung. This is ungefähr wie bei dem Otto Walkes (aus Ostfriesland), der den Markus so gut immitieren kann.

[03.09.13] An obvious challenge would be to realize the wonder-patch $C1(9,0,0)$ in which case we could progress the Hilbert-Viro 16th problem by constructing two new bosons namely $b1 = 1\frac{1}{1}\frac{18}{1}$ and $b7 = 1\frac{7}{1}\frac{12}{1}$. As yet the closest patch is $C1(8,0,1)$ obtained via $M5$ and we could try to contort this construction as to get the wonder-patch. Basically, this would involve turning the upper loop of $M5$ upsidedown like on Fig. $W5$ for wonder. Alas it is clear that such a contortion cannot be effected, just because then the number of semi-branches emanating from the singularity would be split w.r.t. the line smashed under the hyperbolism as $1 + 5$ instead of $3 + 3$ which is the sole reasonable splitting. So it seems that the wonder patch—if it exists at all—requests a principally new mode of construction.

We remind that Viro's construction as not yet been exposed in full since it remains to construct the 4 patches of the family $E=V1$ (i.e., those with a

trimested lune). Those are obtained by another device of Viro (exposed in the next section), which is actually somewhat more elementary in circumventing the use of hyperbolisms.

On the other hand we could suspect an affine quintic like our Fig. d which differs from Polotovskii's just by dragging a certain number of ovals in the wave extremity. However the resulting patch is clearly anti-Bézout because by gluing with a symmetric copy we get 2 subnests.

Our next random idea is to wonder about the case where the fundamental oval of the pre-smashed octic vibrates rather like a horse-shoe. Yet, on more mature thinking we realize that the example considered by Viro are already horse-shoes. Actually it seems that the horse shoe is the only admissible shape for a cell to intercept four-times a line. Another option is to have a ring (annulus) where of course the cell-shape is changed. This suggests looking at a variant of Fig. 5, our Fig. V5 which gives the patch $D(1,0,7)$ referring to the notation of Fig. 18. Of course this is not an M -patch, yet maybe still a valuable instrument to study $(M - 1)$ -curves when patched with Viro's patches. When glued with itself it gives the $(M - 2)$ -scheme $\frac{2}{1}\frac{15}{1}$ which is fairly familiar (below Orevkov's obstruction and accessible via a twisted gluing of Viro's M -patches).

Our next crazy idea is materialized by Fig. W5. Here we assume that dissipating the triple point the oscillation does not take place in the vicinity of the smoothed point but faraway like in a non-local phenomenon of quantum chromodynamics. The net effect of this crazy modification is just that the ovals are transferred in the outer lune and so we get the patch $C2(2,0,7)$, referring as usual to the notation of our Fig. 18. It is evident at this moment, that we can (assuming that this delocalized quantum vibration is always possible) reach all the patches of the C2 family as claimed in Viro 89/90 (granting that there is no misprint on his fundamental figure, i.e. no misplacement of the γ parameter).

Added [15.09.13].—Let us check this assertion more pedestrianly. So we copy the Viro table, and rationalize a bit our depiction of it by killing the “carnivore-plant stage” which is quite unnecessary by the way. Then, for each of Viro's constructions, we consider the avatar with a vibration acting at long distance (see Fig. 45). Although counter-intuitive this is still Bézout compatible so that there is perhaps an algebraization of such pictures. By this recipe we get indeed patches claimed by Viro starting with $C2(0,8,1)$. We report the patches so realized in the catalogue (Fig. 18) by yellow-green rectangles to emphasize the issue that those patches are more dubious than the evergreen patches gained by a localized vibration. Next, we get successively the patches $C3(1,7)$ (as above), $C2(0,4,5)$ (relatively new and the palindrome of the above), $C3(5,3)$ (the same as above), $C2(2,0,7)$ (new and the C2-avatar of the above), $C2(2,4,3)$ (new and the C2-avatar of the above).

At this moment, a look on the patch-catalogue (Fig. 18) shows that we still miss two patches claimed by Viro, namely $C2(4,4,1)$ and $C2(8,0,1)$.

Another idea is to invert the sense of the meander as shown on series C. Here we get first a monotonic repetition of the first four patches of the original Viro's series (A), but when it comes to 5, we find the patch $C2(7,0,2)$ violating Viro's oddity law as well as Orevkov's (link-theoretic) prohibition of b3. Likewise the sixth configuration, yields the patch $C2(3,4,2)$ corrupting Viro's law of oddity.

Alas we still do not have obtained all patches claimed by Viro, and still miss the two mentioned ones in the C2-class.

At this moment we had the idea (especially when looking at the entry C-5 of the previous table) that we may get something different (hence new) when smashing instead of up as we did till now. The next figure gives a systematic tabulation of those smashing down by giving them in the little right window of each configuration of the previous table. It is observed that the down smashing is isotopic to to up version for the first four entries 1,2,3,4, but leads to a different patch for fifth entry, namely we get $C2(2,0,7)$ at entry A5-down, instead of $C1(2,0,7)$ at A5-up. As far as our presentation is concerned this corroborates (with delocalization) Viro's claim of existence of this patch. Likewise along the sixth entry 6, we get the C2-version or the earlier C1-patch. All this concerns

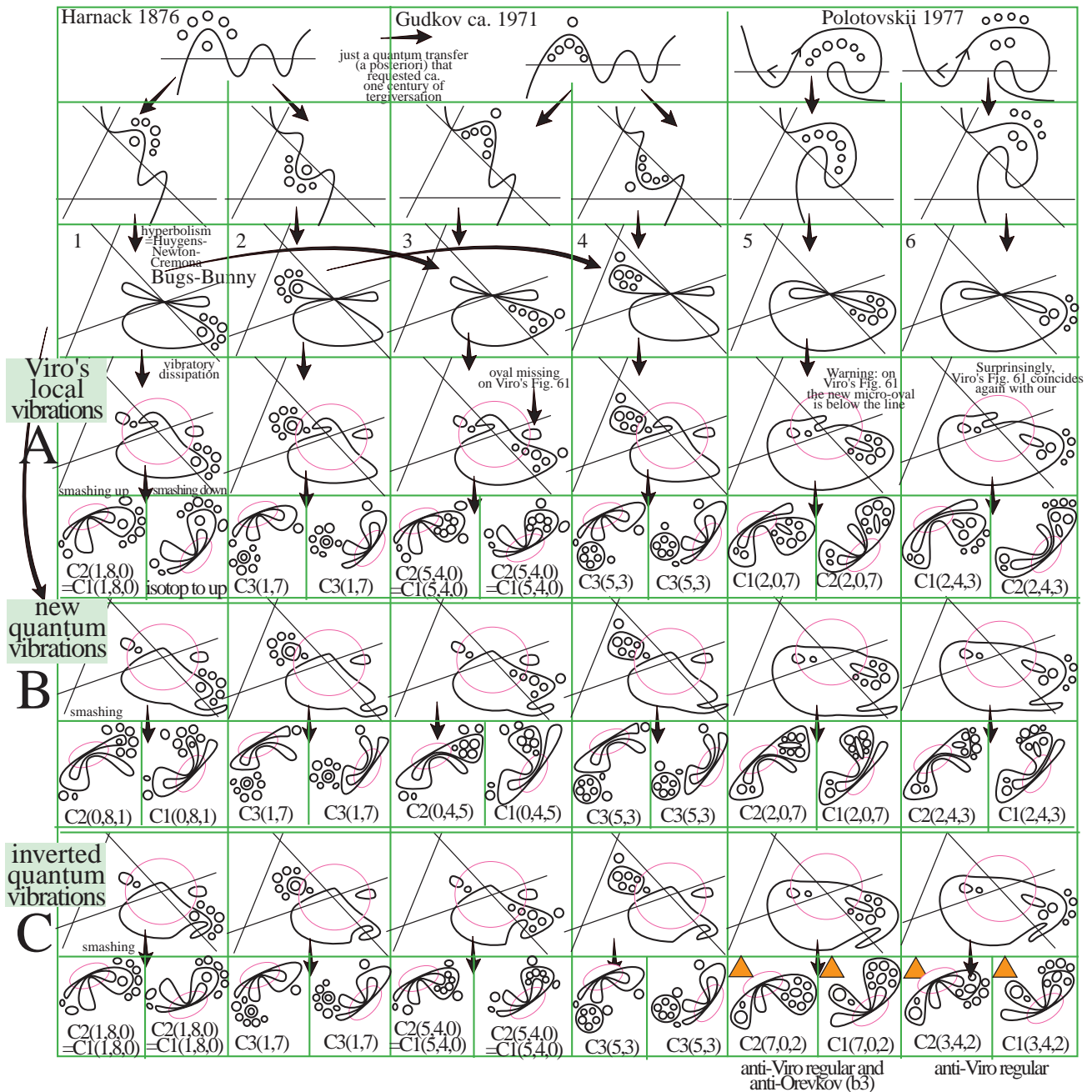

Figure 46: Smashing down

believe that our C1-patches also exist albeit this is not explicitly mentioned in Viro 89/90.

5.2 On a bending principle for patches

[16.09.13] It seems that one could supply a formal definition of a patch as being the trace of a real algebraic curve on the unit ball $B^4 \subset \mathbb{C}^2$ and bounding the link of the singularity X_{21} , which has 4 components (in general as many as the singularity has branches). Now it seems that given a patch one can bend its content by changing the curvature of all its branches simultaneously. Referring to our patch catalogue, we see then that C1 turns to C2 and viceversa. The class A is self-dual. The class B transmutes to the class I. Class C is self-dual, with its subspecies C1 and C2 permuted, while C3 stays invariant under bending. The class D is also invariant under bending.

The class E is likewise invariant under bending. So at least at the topological level, but it seems interesting to speculate about a higher form of algebraic

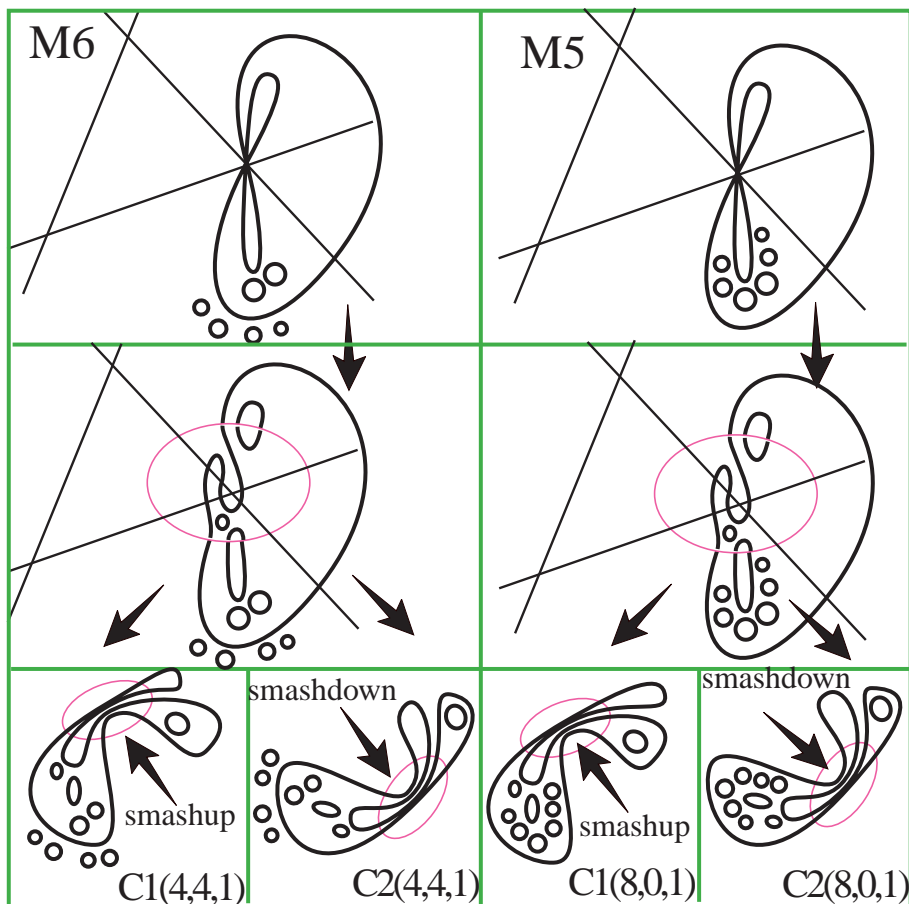

Figure 47: Getting the last two patches claimed by Viro

invariance, that is of algebraic patches. As noted yesterday, this is in part motivated by the issue that smashing-up or -down hyperbolisms gave within the C-class the dual patch. Alas the E-patches are not as yet realized via hyperbolisms, and some heuristic thinking about the shape of embryos under smashing inclines one to believe in the impossibility of a such a realization.

On the other hand, the bending duality transforms the patch $E(\alpha, \beta, \gamma)$ into $E(\gamma, \beta, \alpha)$ (compare the catalogue=Fig. 18). As we shall see in the next section Viro's construction produces four patches in the E-class, which are in stable equilibrium under the bending symmetry. Hence the hypothesis of invariance under bending appears as experimentally verified, but it would be nice to find a theoretical justification (if any). One can imagine that a simple hyperbolism (Cremona transformation) transmutes a patch into its bending, and if this exists it must easy to write down. So:

Scholium 5.2 *The whole theory of Viro's patches is probably invariant under the bending involution transforming an X_{21} -patch to its companion with branches of inverted curvatures.*

Albeit only heuristic, this principle suggests new results or at least novel predictions as side effects. For instance in the I-class we have 3 restrictions caused by Shustin (hoping this to be true). But as the patch $I(\alpha, \beta, \gamma)$ bends to $B2(\gamma, \beta, \alpha)$, it would result three new obstructions in the B2-patches as reported by red rhombic crosses on the catalogue (Fig. 18).

Next the patch F bends to the patch H, compatibly with the fact that both families are empty as inferred from Arnold's weak version of Gudkov periodicity.

The patch G is in contrast self-dual under bending, and again bending acts palindromically over the symbols α, β, γ . So at least for the class G1 where bending $G1(\alpha, \beta, \gamma)$ yields $G1(\gamma, \beta, \alpha)$. Thus again by the posited principle of invariance one can reflect three of Shustin's prohibitions to get three new (but

hypothetical) restrictions marked by rhombic crosses in the catalogue. Bending is somehow akin to an inversion of the magnetic poles of planet Earth. In particular it causes serious damages on the patch family G2. This bends indeed to a configuration which is anti-Bézout [at least if $\gamma > 0$]. As a novel consequence bending would permit to rule out the three remaining patches of the G2-family as to make it completely empty. [Warning: in fact in view of the proviso in bracket, I am not completely sure about this conclusion.] In fact bending G2(0,8,0) gives G1(9,0,0), which is prohibited by Shustin, hence so is G2(0,8,0). For G2(4,4,0) the bending is G1(5,4,0) (because in general G2($\alpha, \beta, 0$) bends to G1($\beta + 1, \alpha, 0$)). However the latter is prohibited by Shustin. Finally the last standing man G2(8,0,0) bends to G1(1,8,0) also prohibited by Shustin. Thus:

Lemma 5.3 *Shustin's obstruction diffuses from the G1-family into the G2-family via bending and par-achieves killing completely this family, whose generic member G2($\alpha, \beta, \gamma > 0$) was already killed by Bézout via the gluing E/G2, or via bending of G2 to a scheme enlarging the nest of depth 4.*

Then our discussion is essentially complete since H is in duality with F, I with B, and J is self-dual (and trivially understood via Bézout).

The moral of all this is that invariance bending looks an extremely versatile tool. On the one hand it is like a hidden symmetry explaining why the M -patches C and E are the most populated (even the sole populated by algebraic representatives according to the present state of knowledge), and this despite lacking symmetry along the vertical axis.

Further it seems that bending affords a powerful method of prohibition. For instance, bending the patch B3 corrupts Bézout for line provided $\beta > 0$. Thus we can conclude that the family B3 is nearly empty. Actually, it may be considered as empty since if $\beta = 0$ the family B3 degenerates inside B2. Similarly bending B4 is anti-Bézout when $\gamma > 0$, and if not then B4 collapses to B2. Finally, on bending B5 we get a configuration anti-Bézout as soon as either β or γ is positive (glue with the flip). Hence strikingly, this re-explains all the first series of red-crosses (prohibitions derived from Viro's oddity law) in a much more elementary fashion. Even more, even the remaining three B5-patches with $\gamma = 0$ are killed, e.g. B5(8,1,0), since—as noted—gluing with the flip corrupts Bézout. Hence it would follow (from bending invariance) that the family B5 is completely extinct.

Looking closer to the remaining B4-patches with $\gamma = 0$ we identify them as B4($\alpha, \beta, 0$)=B2(0, $\alpha, \beta + 1$), and so the specific element B4(7, 1, 0) is B2(0, 7, 2) which is not even present in the list as a consequence of the periodicity modulo four imposed on β . Yet, doubling B2(0, 7, 2) gives the scheme $6\frac{15}{1}$ which respects Gudkov and even exists since Viro. Thus we are never entirely sure that we did not from the scratch overrestricted the parameters. Actually, in the B2-class β was pre-calibrated as 1 (mod 4), but it could be just odd. The crucial point is just that when doubled B2 yields a subnested M -scheme with 2β big eggs (=ovals at depth 1). But this quantity has to be 2 (mod 4) by Gudkov periodicity (compare the periodic table of elements), and thus β has to be odd. The point however is that the case $\beta \equiv 1 \pmod{4}$ and $\beta^* \equiv 3 \pmod{4}$ cannot cohabit because the gluing of both patches would have $\beta + \beta^* \equiv 0 \pmod{4}$ big eggs, violating Gudkov periodicity. So we have, alas, to enrich the catalogue by the family B2* where β is 3 (mod 4), and we lack unfortunately a recipe to prohibit them. Of course all of B2* would be killed in one stroke if there were any element in B2, yet Viro's theory seems rather to tell that B2 too is empty.

[17.09.13] In contrast, one can entertain the dream that the B2 family is non-void. As we saw, the patch B is not readily seen as the product of a smashing hyperbolism acting upon a ground shape (topological cell, binion=annulus, or 2 disks). Fig. 49 shows indeed that under a topological smashing only patches of type C, D and A do occur, from respectively a cell of the horseshoe type, a ring or a double cell. This basic experiment adumbrates also why only type-C patches achieve Harnack-maximality of 9 micro-ovals, since in the other two cases (ring

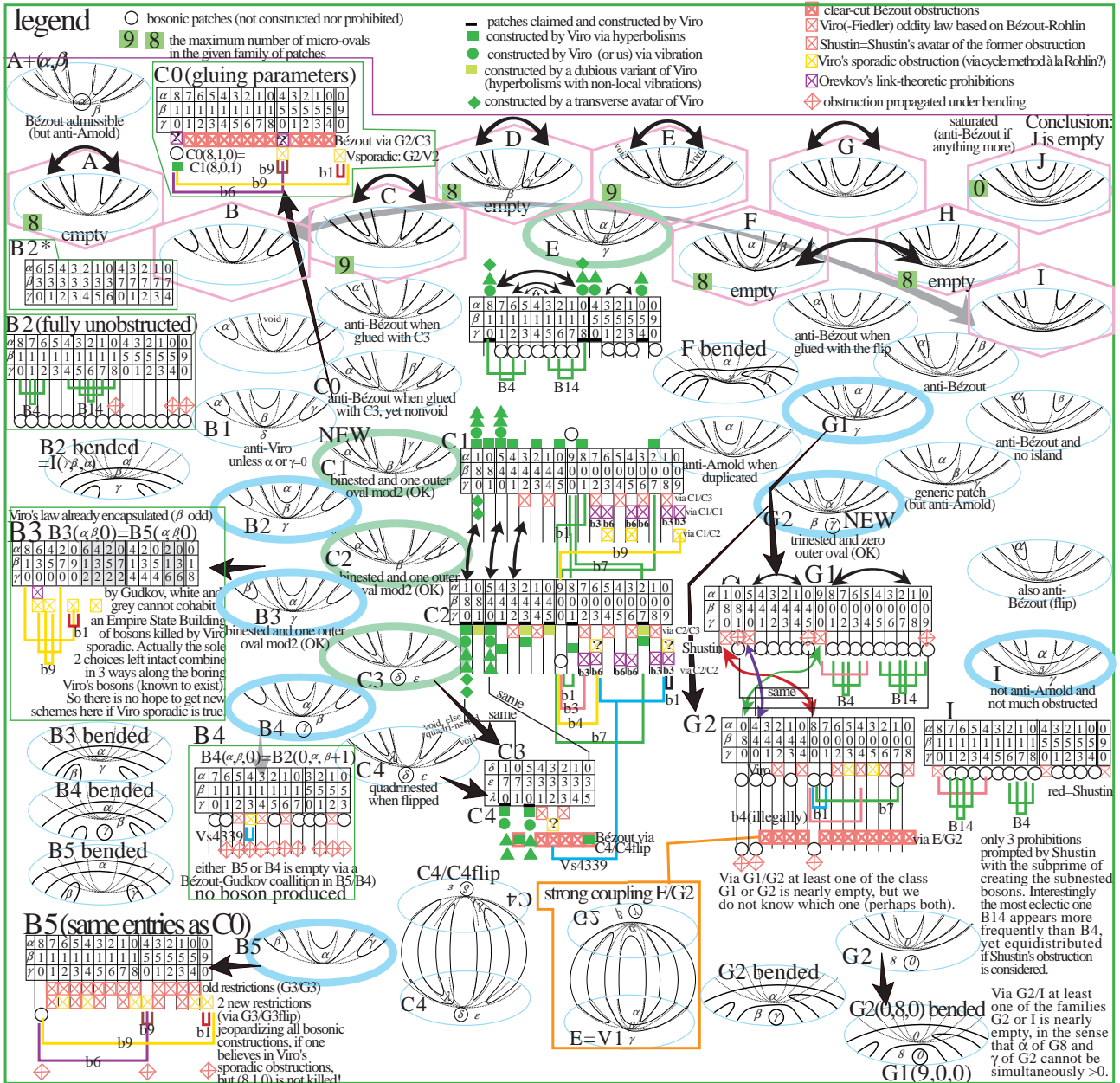

Figure 48: Catalogue of all patches under bending duality

or bi-disc) one oval is already wasted as contour of the ground shape. Albeit heuristic, this justification stands in perfect accordance with Viro's theory.

It is evident that the embryology of Fig. 49 is exhaustive, and so we get:

Lemma 5.4 *Viro's method of the hyperbolism is only capable producing M -patches of type C, and eventually $(M - 1)$ -patches of type D and A. In particular there is no chance to get new M -patches of type B via the hyperbolism method.*

Actually, we can obtain the B-type through smashing a ground shape involving 3 contours. As a slight surprise we can also access the E-type through smashing a snail (with only one contour). So this raises some hope that the method of hyperbolism could as well produce patches of type E, and eventually new ones, as it must be confessed that Viro's knowledge of the E-class remains fairly lacunary (compare the catalogue).

Our snail-model leading to type E involves the smashing of a line somehow trapped inside the bag of the snail. So by Jordan separation applied to the Bendixson-style bag formed by the spiral arc closed by the transverse segment (cf. red contour on the figure), we get a trapping of the one-end of the line.

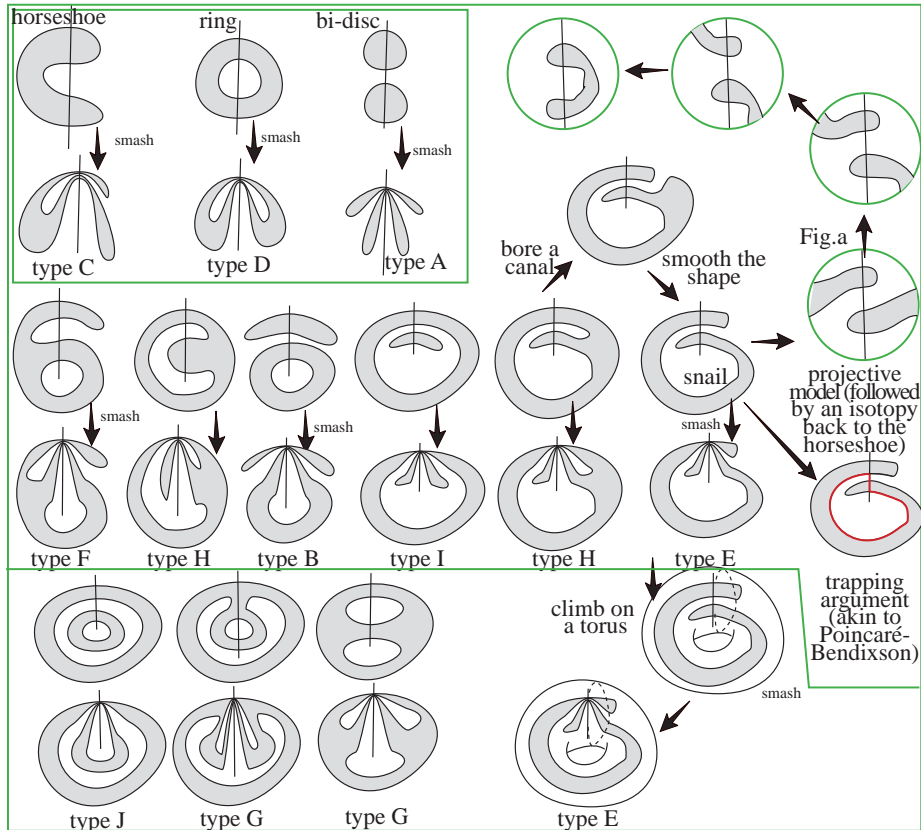

Figure 49: Morphogenesis of patches under smashing hyperbolisms

Hence the line should actually have more than the four visible intersections with the snail, but after smashing this yields a singularity with more than four branches (hence not a dissipation of X_{21}).

One can try to find a refuge by imagining a model of the snail in the projective plane, but ours (Fig. a) seems isotopic to the horseshoe. So it seems that the Poincaré-Bendixson-style trapping argument prevails, preventing thereby the creationism of E-patches via hyperbolisms (in accordance with Viro's praxis, yet disappointing from an avantgardist viewpoint). More generally all other configurations outside of the sub-frame of Fig. 49 involve a trapping and therefore inadmissible for creating the corresponding patches (all types safe C,D,A) by the method of hyperbolisms.

Despite the trapping obstruction, it is amazing that from this naive embryological viewpoint only the types C and E arise by smashing a single simple cell, those being precisely the patch-families populated by algebraic representatives according to Viro's theory. This is a striking coincidence, but alas (apparently) not vivid enough to bring the E-class within the range of hyperbolisms.

One way to get around the trapping obstruction would be to replace the plane by a torus, and imagine the figure of E-type traced on a such (materialized as usual by a quadric in 3-space abstractly isomorphic to $\mathbb{P}^1 \times \mathbb{P}^1$). Then we can smash along a meridian of the torus without encountering a trapping obstruction. It maybe speculated that the whole construction projects down to the plane, as to get patches of type-E, hopefully of a new sort not yet listed by Viro. Of course, all this looks fairly tricky and hard-to-implement geometrically, yet perhaps there is some chance to concretize this idea.

Of course, it would be overall simplifying if all patches of the E-class existed. In this scenario the two subnested bosons would be created and most of Korchagin, and Chevallier's octic schemes trivialized to Viro's simplest method (as shown by the relevant composition-table, i.e., V1/V1 on Fig. 8). Alas, for the moment it is extremely hard to decide which scenario corresponds to reality.

[16.09.13] The overall philosophy is that under bending invariance we can rule

out huge family of patches just by basic reliance upon Bézout, hence trivializing most of the highbrow Viro-style obstructions.

Another consequence of the bending hypothesis is that upon looking at the E-patches the obvious creationism of the boson B4 (via the patch $E(5,1,3)$) would automatically create the palindromic patch $E(3,1,5)$, and consequently materializes the “dual” boson B14. Unfortunately, since Viro’s method is just a method, and not an intrinsic feature of the universe, one cannot deduce the existence of one boson being coupled to that of its dual, i.e., B4 exists iff B14 does exist. However this becomes true as soon as one of the boson is realized as perturbation of the quadri-ellipse, provided our bending principle holds true.

Stupid remark.—Of course, bending translates to palindromic symmetry in the E-class but not in the C-class. Otherwise, applying palindromic symmetry in the C1-class leads to serious contradictions in mathematics, like Viro’s construction of $C1(4,4,1)$ conflicting with Viro’s prohibition of the palindrome $C1(1,4,4)$. This is just mentioned in order to avoid the reader doing the same basic mistake as the tired writer.

Also, note that the class C3 is self-dual under bending, and actually point-wise invariant. Hence we cannot infer any new information, but the census in this family was complete just under basic Bézout obstructions and Viro’s constructions (either in the hyperbolism setting or via the more elementary vibratory method, as we shall see later).

Let us summarize the situation as follows:

Lemma 5.5 *If the bending principle is true, then most families of our catalogue of exotic patches are empty by virtue of a trivial reduction to Bézout. More precisely the M-patches families B3, B4, B5 are empty, and so is G2. However the dual pair B2 and I, and also self-dual class G1 are potentially non-empty, as to contain algebraic patches favoring the creation of the bosons B4 and B14. Alas, presently nobody ever succeeded constructing any such patch. Besides, the classes C and E are self-dual yet not completely elucidated, when looking very deeply into the glass (all white-circles in the catalogue are not yet known). As a last remark, the method of hyperbolism amounting to a smash, seems only able to create the C-patches (when smashing a horse-shoe), or D-patches (when smashing a ring), or finally A-patches when smashing a pair of discs. Accordingly, it should be no surprise that the E-patches are not accessed by hyperbolisms, which in the realm of maximality produce only C-patches.*

In sum this means that under bending we are fairly close to getting a complete census of all patches modulo the ambiguity left in the B2/I-classes, the G1-class, the completion of the C1/C2 pair which is nearly settled if Viro-Orevkov are true (sole exception $C1(9,0,0)=C2(9,0,0)$, and the E-class which is still elusive (no known prohibitions).

Of course to substantiate all this bending hypothesis one should take the pain to write down a simple (algebraic) transformation doing the requested deformation of bending. We imagine this must be a trivial task. Besides, bending invariance seems to fit with all factual data available up to now.

As we saw the idea of bending trivializes at the basic Bézout level several obstructions first derived via Viro’s oddity law. This reduction truly concerns patches, yet it would be of interest to wonder about a global avatar of bending acting on projective curves and reducing the Viro obstruction to Bézout.

As a last philosophical touch, we always found Viro’s census of patches shocking, as it seems to corrupt the “Didon principle” of extremality: *most solutions to extremal problems are inhabited by deep character of symmetry*, like in the isoperimetric problem, the Bloch constant, etc.) However, in Viro census the vertically-symmetric patches (typically classes B or I) lack apparently any representative, while the asymmetric families C and D extremalize the number of ovals. As already noted, this violation of the Didon principle is relaxed if we imagine bending as a hidden symmetry of the problem.

5.3 Speculating about a global bending: alias the NAS= Neuaufstehung

[17.09.13] If we look the table of M -symbols (Fig. 130), and in it on the 3rd pyramid of subnested schemes one is struck by a certain symmetry of the symbols putting in duality the symbol $x(1, n \frac{y}{z})$ with $y(1, n \frac{x}{z})$. Geometrically, this is merely a reflection of each vertical rows about its midpoint. Strikingly, this duality almost everywhere respects the constructor of the scheme. The sole exceptions are:

- in the 1st row, the pair $7(1, 2 \frac{11}{1})$ (O=Orevkov) and $11(1, 2 \frac{7}{1})$ (V=Viro);
- in the 2nd row, the pair $3(1, 6 \frac{11}{1})$ (K=Korchagin) and $11(1, 6 \frac{3}{1})$ (V=Viro);
- in the 3rd, 4th and 5th rows, there is no exception to the symmetry of the constructors.

It seems natural to speculate about a global duality of a geometric nature explaining directly this symmetry. Of course one way would be the symmetry on patches, but this would really work if knew how to construct all E-patches.

The sole objection against this duality comes from Shustin's obstruction of subnested schemes without outer ovals. Indeed under our duality, those schemes correspond to the relevant simply-nested schemes, all of which exist since Harnack, Gudkov and Viro. Thus, there is a violent break of symmetry, only remediable by rejecting Shustin's obstruction. More politically correct, is to imagine that our duality reigns only over a restricted range not going as far as Shustin's series.

Is there a direct geometric interpretation of this hypothetical duality? At the (soft) topological level via Fig. 50 below, we may just interpret the duality as being merely a human face with an indigestion of smarties (chocolates) in the mouth, and exchanging this out and in. So we can call this the digestive python-duality, or the smarties-duality. Of course, this move or rather exchange can be imagined as the combination of two Morse surgeries: first the mouth content is liberated by a fission of the buccal cavity, and in turn new labial expansions phagocytose the outside. Of course this digestion process looks magic and delicate to ape in the algebraic category. Besides, the whole process transits through a single intermediate uni-nested $(M - 1)$ -curve.

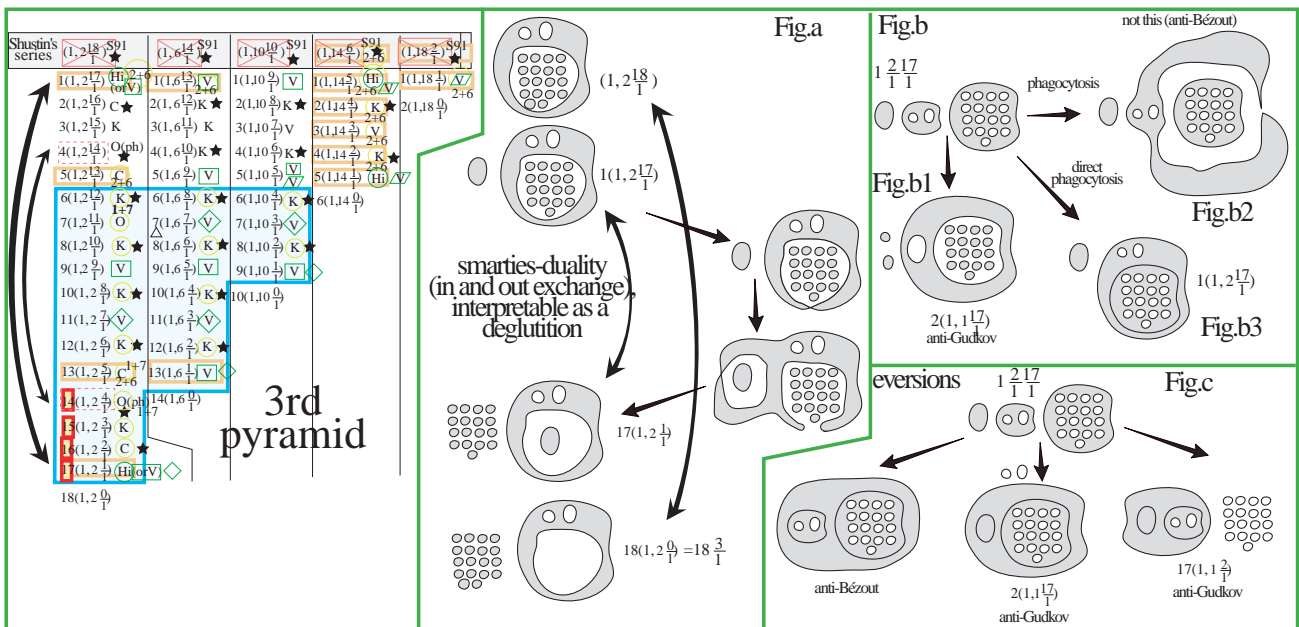

Figure 50: Subnested Duality

Imaginatively, and without referring to a rigid isotopy, this duality could be realized instantly like an inversion with respect to the ring formed by the nonempty oval at depth 0 and the subnest (i.e. nonempty oval at depth 1). In case of Shustin's series the duality appears as broken since there is no canon-

ical way distinguishing the mouth from the eyes in the figure for $18\frac{3}{1}$. One may dream about a God-given Cremona transformation effecting such an inversion directly. By any reasonable Nullstellensatz (algebraic rigidity), we cannot expect the transformation to fix (pointwise) the ring, nor any of its contour. In parallelism, one could search a synthetic rule doing the inversion like via a transformation of reciprocal radii. À la Zeuthen, we would like to infer some convexity properties of the deepest oval, and exploit this for a synthetical inversion keeping algebraicity and the degree constant to 8. If implementable both bosons B4 and B14 would be coupled in strong-duality, with joint destiny of life or death, like inseparable, fusional partners.

5.4 Trying (but failing) to extend duality outside the sub-nested realm

[18.09.13] It seems of even greater importance and predictive power to extend the duality to the other pyramids (binested and trinested case), since in those cases the available theory looks more lacunary and of lesser symmetry than in the 3rd pyramid where everything just depends on the existence of the two bosons. As above we may first like to guess the symmetry at the combinatorial level of symbols, as some intrinsic symmetry of the table of periodic elements.

From the very beginning, one feels subconsciously the duality linking say both of Orevkov's schemes $1\frac{3}{1}\frac{16}{1}$ and $1\frac{6}{1}\frac{13}{1}$ (both prohibited by link theory). More generally this involves the involutory symmetry $k\frac{x}{1}\frac{y}{1} \mapsto k\frac{x+10}{1}\frac{y-10}{1}$, where a packet of 10 is traded between both nests. A priori this looks special astrological numerology involving the number 10 (of our fingers), and there is of course many variants involving other integers. So let us abort this viewpoint in the hope to find some more intrinsic symmetry based on the idea of a topological inversion.

For instance starting from Viro's binested scheme $1\frac{2}{1}\frac{17}{1}$, one may imagine to invert with respect to the non-empty oval containing the least number of ovals (Fig. b1). It results the scheme $2(1, 1\frac{17}{1})$ which does not even respect Gudkov periodicity (as the number of big eggs must be $2 \pmod{4}$). Of course the same aberration occurs when inverting w.r.t. the nonempty oval of greatest content. The problem is that the outer ovals of a bi-nest (congruent to $1 \pmod{4}$) becomes under inversion the number of big eggs of the subnest, but the latter has to be $2 \pmod{4}$. Maybe, an ad hoc correcting intervention can repair this, but looks unnatural.

Another piste of longstanding is some natural symbolic duality between symbols like $1\frac{2}{1}\frac{17}{1}$ (V=Viro) and $1(1, 2\frac{17}{1})$ (Hi=Hilbert), etc, given generally by the formula $k\frac{x}{1}\frac{y}{1} \mapsto k(1, x\frac{y}{1})$. For Orevkov's $1\frac{3}{1}\frac{16}{1}$, this leads to $1(1, 3\frac{16}{1})$ which is outside of Gudkov's range. Viro's existing scheme $1\frac{5}{1}\frac{14}{1}$ is carried to an anti-Gudkov scheme, hence foiling the invariant character of the postulated symmetry. Next Orevkov's anti-scheme $1\frac{6}{1}\frac{13}{1}$ dualizes to $1(1, 6\frac{13}{1})$ which exists by Viro's basic theory of the quadri-ellipse. Hence our symbolic duality does not seem to respect the intrinsic nature of algebraic-geometry. Notwithstanding we may seek a direct geometric interpretation of it. Alas several phagocytosis attempts failed miserably. A first such, is a cannibalistic attempt of the small nest to annex (eat) the large one, as shown on Fig. b2. Unfortunately, the resulting curve violates Bézout (extension of the deep quadri-nest). So the desired phagocytosis involves a direct absorption of the big nest without forming a buccal cavity so-to-speak (Fig. b3). Alas it seems that there is no Morse theoretical historiography for such a move. Further, in contrast to the earlier smarties-duality, the present one seems chromatically anomalous w.r.t. to the natural black-and-white coloration of the Ragsdale membrane.

In conclusion, both experimental and theoretical evidence seem to fight against the symbolic duality $k\frac{x}{1}\frac{y}{1} \mapsto k(1, x\frac{y}{1})$, where it is assumed $x \leq y$.

Besides, there are several eversions shown on Fig. c. Yet, as we already knew, those fails dramatically to respect Gudkov periodicity, and therefore are prohibited despite the lack of evident topological obstructions.

At this stage our quest of hidden symmetries in the periodic table elements seems already exhausted, and to be in “panne”.

In conclusion, the smarties-duality (or *deglutition*) seems to be the sole global tangible symmetry we could detect in the periodic table of elements.

In fact, we can also speculate more about the dubious symmetry by 10. In the binested realm, especially in the bosonic strip, this symmetry takes the boson $1\frac{1}{1}\frac{18}{1} =: b1$ to $1\frac{11}{1}\frac{8}{1}$ (constructed by Viro), so giving some evidence for the materialization of the boson $b1$. Next Viro’s scheme $1\frac{2}{1}\frac{17}{1} =: b2$ dualizes to the boson $1\frac{7}{1}\frac{12}{1} =: b7$, which get so some existential probability. Next we have Orevkov’s pair, both prohibited, so that our postulated symmetry by ten-trading is still plausible. Finally the boson $1\frac{4}{1}\frac{15}{1} =: b4$ is allied to Viro’s scheme and therefore likely to materialize.

Next we may also try to extrapolate the ten-trading symmetry in the realm of trinested schemes. Looking in the 4th row of the 2nd pyramid, we see first $4\frac{1}{1}\frac{1}{1}\frac{13}{1}$ (S=Shustin) in duality with $4\frac{1}{1}\frac{11}{1}\frac{3}{1}$, also due to Shustin. Next we have $4\frac{1}{1}\frac{2}{1}\frac{12}{1}$ which is self-dual, or dualizes to $4\frac{1}{1}\frac{2}{1}\frac{2}{1}$, all being anti-Viro regular. Next $4\frac{1}{1}\frac{3}{1}\frac{11}{1}$ is also in duality (rather trinity) with $4\frac{11}{1}\frac{3}{1}\frac{1}{1}$, that is itself, so that everything is right. However when it comes to the next scheme $4\frac{1}{1}\frac{4}{1}\frac{10}{1}$, the trading-by-ten brings it to $4\frac{1}{1}\frac{14}{1}\frac{0}{1} = 5\frac{1}{1}\frac{14}{1}$ (due to Viro). So we get an existential conflict w.r.t. to our dubious symmetry. Of course the scheme in question dualizes also to $4\frac{11}{1}\frac{4}{1}\frac{0}{1} = 5\frac{4}{1}\frac{11}{1}$ (also constructed by Viro).

In conclusion, it seems that our naive trading by 10 is not compatible with actual knowledge, and of course looks very dubious numerology, without strong geometric support.

[19.09.13] As a last attempt it can be imagined that one of the bi-nest is directly glued inside one of the oval of the other nest, while another oval is created outside to compensate the loss. But basically this gluing yields again either Fig. b1 or Fig. b3 depending on how “outside” is interpreted. The first option is anti-Gudkov, while the second interpretation amounts to a direct phagocytosis of Fig. b3. As we showed this runs against troubles when it comes to Viro’s scheme $1\frac{5}{1}\frac{14}{1}$ whose dual $1(1, 5\frac{14}{1})$ violates Gudkov periodicity (even in the weak sense of Arnold). Likewise our duality is disrupted for Orevkov’s anti-scheme $1\frac{6}{1}\frac{13}{1}$ whose dual $1(1, 6\frac{13}{1})$ exists by Viro’s simplest method (quadri-ellipse).

5.5 Overview

[19.09.13] Most of the mathematicians are not discovering new fruits but just distilling old ones, to high-condensed beverages, that nobody is virtually able to drink, without serious intoxication (brain damages). Viro’s theory is no exception to the rule. Somehow, we need to present its “*deploiement universel*”, at the level of the primitive fruits so that everybody can understand (and check) the whole distillation process. In particular the theory of patches looks to us still unachieved, and so is the global Hilbert’s 16th problem in degree 8. It seems that what remains left are just peanuts (a negligible proportion of 6 bosons over the 104 logically possible cases), yet this can safely occupy several generation of workers unless one finds the correct ideas, perhaps possible revisions, and rationalizations of the existing theory.

Roughly, it seems that several strategies could intermingle to complete our understanding of degree 8.

1. Construction of new patches for X_{21} via an adaptation or renovation of Viro’s methods. Note the plural since the epicenter of Viro’s method splits apart into hyperbolisms and a basic vibrational method with tangency (a sort of non-transverse avatar of Harnack-Hilbert-Brusotti).

2. Prohibition either via the method of total reality (Riemann et ali) or just via tracing a curve interpolating the deepest nests. This is what we call the *method of deepest penetration*, which we are quite incapable to implement seriously. Basically, one should imagine that several regions of the periodic table of M -elements (Fig. 130) are frozen because they are over-nested. Algebraic curves like nesting, but they cannot be too nested as evidenced by Bézout for

lines. Higher order curves than lines or conics should prompt novel (or semi-novel) obstructions of the Rohlin-Fiedler-Viro era, with recent ramification in Orevkov's link theory.

One can employ the usual metaphor about phase-changes between solid, liquid and gaseous states, with the bosons unambiguously identified to the intermediate liquid-state with ultimate destiny yet undecided. What freezes a scheme to the algebraic crystal or in contrast evaporate it as a nebulous gas unobservable with naked eyes is the mystery of those bosons.

3. The method of hidden symmetry in order to detect symmetry patterns in the table of elements (especially M -elements), while guessing the underlying geometrical motives. Alas, presently we failed to disclose any such symmetry beyond the deglutition-symmetry of subnested schemes exchanging the inside of the subnest with the outside of the primary nest (see Fig. 50a). Alas, this hypothetical duality does not readily afford new concrete information on Hilbert's 16th, safe for a coupling of the existential destiny of both subnested bosons.

4. This method of duality admits apparently a semi-local avatar at the level of patches, where it seems experimentally sound to expect a duality of bending prompting a global symmetry over all patches for X_{21} . This could be an important tool to complete the classification of patches.

5. Finally, the whole philosophy of the method of small perturbation up to its ultimate era of glory reached in Viro's method seems to use a infinitesimal gluing principle of patches inside algebraic objects much akin to surgeries feasible usually in the smooth category. That the surgeries works algebraically while keeping the degree controlled is much miraculous, and in the case of the simplest nodal singularity already amounts to the Severi-Brusotti transcription of Riemann-Roch. The general case of independence of smoothing is the credit of Gudkov-Viro-Shustin under varied decorations. Of course course conceptually it seems that the principle of gluing as local surgeries encompass the principle of independence of smoothing: just patch locally and contemplate globally.

6. In principle, it is expected that Hilbert's problem at least in degree 8 is reducible to this method (Viro's patchwork), either from the sole quadri-ellipse or via more elaborate ground curves, themselves generated by ad hoc recipes (hyperbolisms, Cremona, etc.). Remind here the biotope of curves imagined by Russian scholars: Viro's beaver, horse, Shustin's medusa, etc (see our Fig. 95). It is here that patchworking degenerates, or rather ramifies, to an artwork difficult to implement systematically, yet offering highly arborescent possibility for the artistically inclined worker.

7. If Viro's method fails to construct all curves, this means there are smooth curves in remote mysterious chambers past the discriminant. This is somehow akin to dark energy/matter hard to interact with (within the standard model). Yet, in down-to-Earth reality each smooth curve can degenerate toward the discriminant, and a priori along several faces of it, so that we get a highly singular curve with controlled singularities, and to which Viro's method applies. Admittedly, all this is somewhat ill-posed, but perhaps there is a reasonable way to claim-and-prove that Viro's method is omnipotent, i.e. able to construct all smooth curves as perturbation of a suitable curve with controlled singularities (the *protozoan* so-to-speak). The latter has not to be same throughout the hyperspace of all curves, and rather one expects the presence of several gurus (=prototypical curves) required to explore the full universe. The situation is somewhat akin to a universe with several big-bangs with overlapping zone of influences.

At least, the following quantitative problem seems sensible:

Problem 5.6 *For a fixed degree m , what is the least number $\pi(m)$ of protozoans (i.e., points of the discriminant) requested, so that arbitrarily small neighborhoods of those overlap all chambers past the discriminant (or at least all isotopy type of curves). In particular, each smooth curve is rigid-isotopic to a small perturbation of one of the protozoan.*

This magnitude $\pi(m)$ admits alas several variants depending on whether we

restrict attention to M -curves, or admit all curves in the competition. In the M -context we denote it $\Pi(m)$. For instance by Viro's revisiting of the Harnack-Hilbert-Rohn-Gudkov theory we have $\Pi(6) = 1$, since all M -sextics arise as small perturbation of the tri-ellipse. We guess (cf. also one of Viro's text) that all sextics are small perturbation of the tri-ellipse save the empty sextic (this must follow rather easily from Nikulin's theory). In that case $\pi(6) = 2$, using as other protozoan the curve $x^6 + y^6 = 0$ with an isolated real point, but six linear branches over \mathbb{C} .

Intuitively one could expect that the geometry past the discriminant is so intermingled, or that Viro's method is so versatile, that those (protozoan) numbers grow quite slowly in function of m , and constitute so to speak black-holes governing a whole galactic ama. Maybe $\pi(m)$ and $\Pi(m)$ even grows only linearly in m . At the opposite extreme, one may speculate that Hilbert's problem is so messy that even under this condensed viewpoint there is an exponential growth of protozoans when the degree m increases.

All this is interesting yet one would like in a more narrow-minded and stubborn fashion first fix the case of Hilbert's 16th in degree 8. The work for this is still immense, and decomposable in the following great lines:

1. Ensure (or perhaps refute?) that Viro's dissipation of X_{21} is complete so as to rule out the option of creating new bosons by the most rudimentary protozoan (namely the quadri-ellipse).

2. Prove that the Fiedler-Viro oddity obstruction is right, and then prove (or disprove) Viro's sporadic obstructions as well as Shustin's obstruction of subnested M -schemes with outer ovals.

3. Understand the link theory of Orevkov and the two resulting obstructions.

4. Hope to use total reality or the method of the deepest penetration as a way to unify and ideally to discover new prohibitions.

5. Try to implement the deglutition-duality in order to link the destiny of both subnested bosons.

6. If there is still some hope to construct new M -schemes and if Viro's simplest method seems to have reached its limits, then try à la Viro-Shustin to flexibilize the whole method by free-hand tracing some protozoans creating new curves. Here there are several ramifications: either via decomposing curves of all possible orders splitting 8 ($4+4$, $3+5$, $2+6$, $1+7$), or via prescribed singularities of multiplicity splitting 8 too, like $4+4$ (Viro's quadri-ellipse, Shustin's medusa), $3+5$ (Viro's beaver and horse), $2+6$, etc. As we already saw, it is usually an easy matter to discover qualitative configurations leading to certain bosons, yet it is another "paire de manche" to ensure algebraicity of the construction.

5.6 Some new artwork hybridizing Viro and Shustin (gorillas, yetis, etc)

[19.09.13] It is evident that the number of ideas susceptible to make progress the problem is fairly enormous, and one needs some clairvoyance to find the right path to the goal. Fortunately, bad geometers like to waste their time in this mess. For instance we may wonder if there is any curve hybridizing Viro's mandarine with Shustin's medusa, or to speak more concretely with one singularity X_{21} (quadri-contact) and one of type Z_{15} (tri-contact plus one crossing, alias the candelabrum). We cannot remember to have tried this idea already, so we explore it anew. Of course a reasonable attitude to have in this Hilbert problem, is to not fear to repeat oneself since one can easily make mistakes leading to erroneous conclusions or miss a combinatorial possibility in the arborescences of the method.

After some trials on how to combine X_{21} with J_{15} (under the obvious constraint that nothing more must traverse the line joining both singularities), we arrive at the gorilla curve depicted below. This results from a search guided by the desideratum of landing in the bosonic strip (one outer oval), hence also preferring the X_{21} -dissipation of type E, as those leave precisely hanging out one lune only (instead of the two involved in type C smoothings). For a suit-

able quantization of the gorilla (i.e. materialization of the 2 quantum ovals), we nearly get the boson $1 \frac{1}{1} \frac{18}{1}$ provided we could employ the patch $E(0,9,0)$. This is alas not available in Viro's theory (but as far as we know not prohibited too). Another smoothing (said to be *external*, as the trunk of the candelabrum connects with the extern branch) of our quantized gorilla leads to a curve corrupting Bézout (saturation of the deep nest). In conclusion, the quantum oval cannot bubble out in the inner loop as we did. In contrast it looks permissible to let it grow in the outer loop, but even this violates Bézout as shown by the suitable (external) smoothing with both a nest of depth 3 and one of depth 2.

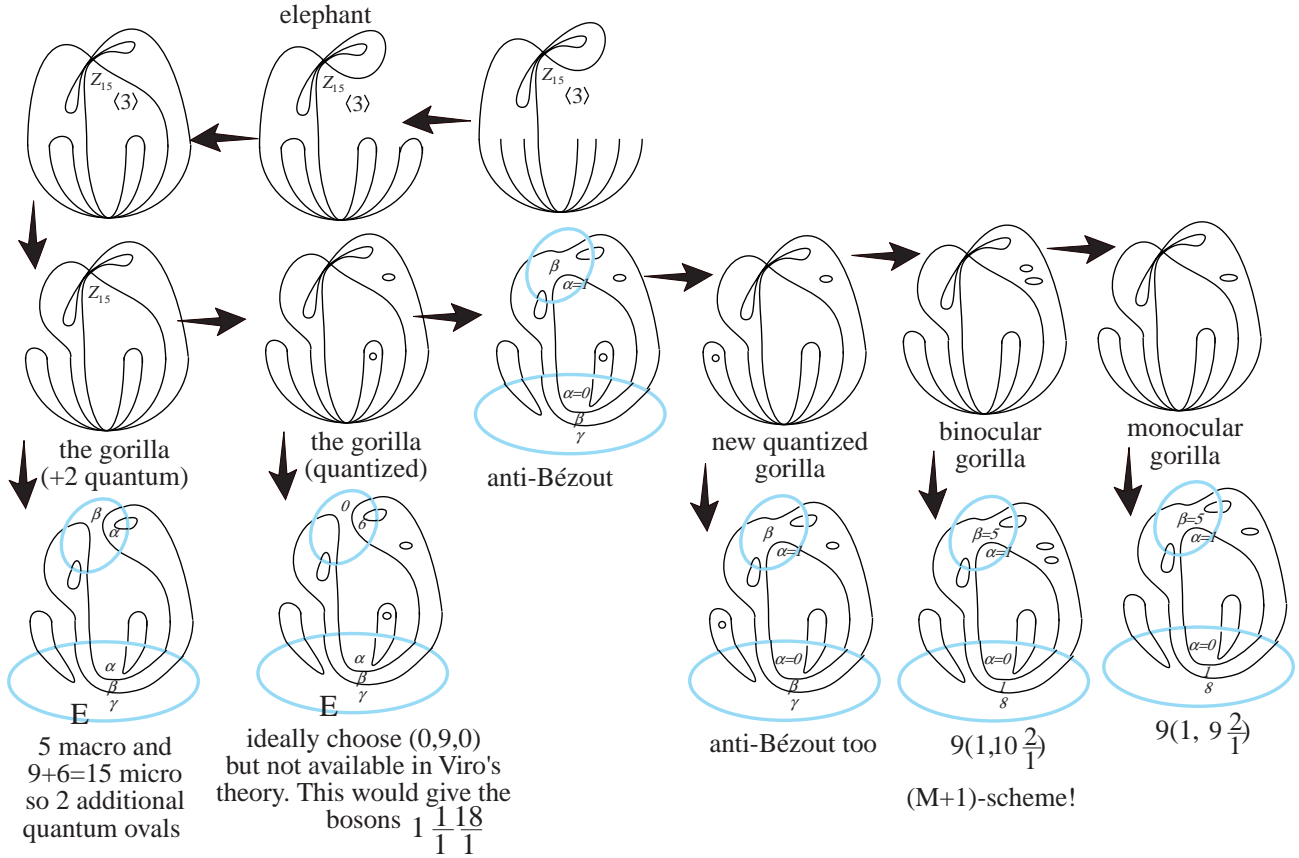

Figure 51: Hybrid of Viro-Shustin

So we finally opt for the *binocular gorilla*. Its depicted smoothing is an $(M + 1)$ -curve violating Harnack! So in reality the gorilla can accept only one eye (*monocular gorilla*), and we made a mistake at the beginning when evaluating the number of quanta by using a suboptimal smoothing. Alas, the resulting (monocular) smoothing yields the symbol $9(1, 9 \frac{2}{1})$, which corrupts Gudkov periodicity (forcing the number of big eggs to be $2 \pmod{4}$). It is clear that wherever the quantum oval is localized the number of big eggs will always be 9 or eventually 8 if the quantum oval is ejected outside or injected inside, but never $2 \pmod{4}$. It follows the:

Lemma 5.7 *Gudkov periodicity forbids any singular octic to be modelled over the ground shape of the gorilla curve. Roughly put, the gorilla is not sufficiently civilized to be algebraizable.*

In fact the gorilla curve may also be imagined as a carnivore-plant two of which protuberances are French-kissing in the crepuscule. If preferring ornithology, you can also imagine a mother bird feeding its progeniture by direct transfer in the gullet (throat). With this view it is simple to imagine variant of the gorilla. First we got the external kiss, but this seems involving as optimal smoothing of the bottom X_{21} -singularity the A-patch, which fails being an M -patch (essentially by Arnold). Hence we considered rather the curve we call the

yeti (a nordic avatar of the gorilla). Considering the dissipation depicted below it we see that there is place for one quantum oval. This can be materialized either on the right or on the left getting so the right- and left-yeti. From the right versions we get two bosons while the left avatar yields schemes due to Viro. Hence yeti-right is a good candidate to create bosons, but before getting too excited we shall impose it some harder resistance tests by evaluating on this architecture all possible dissipation known in the Viro/Korchagin catalogues. Besides, it may be of interest to test also our (Gabard's) dissipation of type-C1, not mentioned by Viro. However using those Gabard's patches yields corruption of Fiedler and Viro-regular. More frankly, using Viro's class C3 we get likewise corruptions of Viro's oddity law. So if the Fiedler-Viro theorem is right, our right-yeti is jeopardized and so is the corresponding stratagem to get the new bosons b_4 and b_9 .

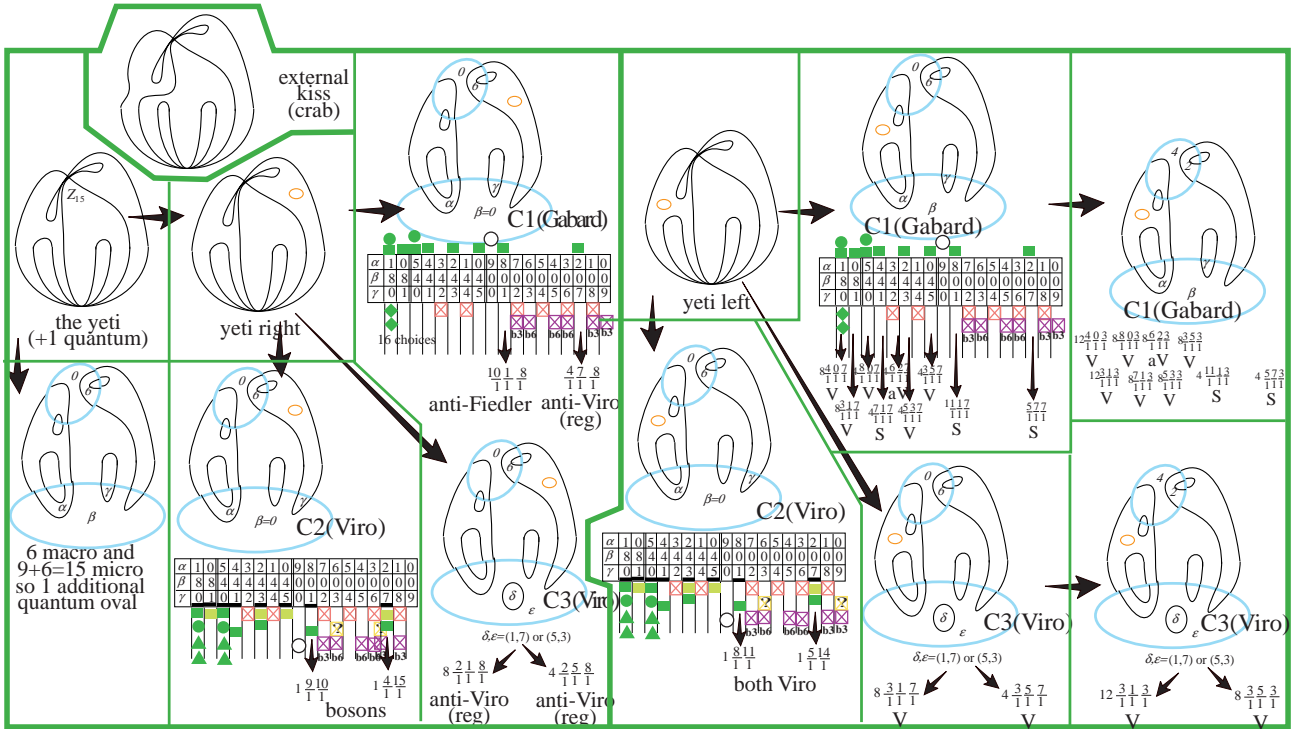

Figure 52: The yeti: another hybrid of Viro-Shustin

It remains now to investigate whether the left-yeti is a more respectable species supporting the patchworking test-de-resistance.

(Skip this messy paragraph of dubious philosophy.)—[19.09.13, 23h51] Principles of relativity (à la Einstein) are only required in physics where the basic concepts (forces, mass, acceleration, speed, matter, energy, time, physical space) are ill-defined, perhaps because the are Gods creation instead of our owns. More dramatically, since teaged, we believe that reality is only an appearance, without sound conceptual foundation except the divinity. In contradistinction, the mathematical world (be it human or divine Schöpfung) is perfectly well-defined and therefore absolutist. No relativism is required to arrange the intrinsic misconceptions. Each well-formulated problem reduces to a yes or no answer⁵, apart maybe the so-called undecidable problem à la Gödel, hopefully reducible to a matter of semantical misconception. In the real geometrical world (like Hilbert's 16 th, etc.) it is evident that any reasonable question receives a reasonable answer in finite time. Hilbert' 16th itself, after a small combinatorial cleaning, receives itself a yes or no binary treatment, since there are only finitely many possible schemes by virtue of Harnack's bound, and evident combinatorics. The puzzling issue, however, is that the shortness of the question involves usually a very alembicated answer. However there is then in principle algorithms of rationalization allowing one to trivialize his long quest to a short explanation, yet of a violent nature since it ignores the whole random exploration process requested to find the solution by lucky stroke, or by natural selection which is nearly synonym as inefficient as it is. Otherwise we would since the Jurassic era already be immortal!

[20.09.13] Indeed when plugging in the left-yeti the C1-patches of Gabard, or the C3-patches of Viro we get throughout respectable schemes due either to Viro or Shustin. Hence the left-yeti seems to pass the exam-test of resistance under patching. Of course, this does not alone imply algebraicity of the left-yeti, but may give supporting evidence for this. Unfortunately, the left-yeti is conservative in the sense that it does not produce *new* schemes.

Maybe there is still other variants of gorillas, yetis, etc. Further there exist maybe also variants of Shustin's medusa, as say the curve depicted below where both arms of the medusa are merged together. Call it the *octopus*. This curve

⁵Compare optionally Steve Smale's list of problem as a palish avatar of Hilbert's own, modulo the Gottschalk conjecture ca. 1958.

is composed of 2 circuits and we believed a long time ago this being an obstacle toward Harnack-maximality. Let us abort this prejudice and explore the setting more liberally. So we smooth the configuration in the optimal way and count the number of extra quantum ovals required to reach Harnack-maximality. Here we find 4 quantum ovals. By Bézout those cannot emerge inside of the 4 loops emanating from both singularities. Using the smoothings along the exterior branches, we see that Shustin's obstruction forces at least one quantum oval to be outside. Also the interior smoothing and Gudkov periodicity shows that exactly one quantum oval must be outside. Then looking again at the interior smoothing we see that the quantum ovals cannot be in the ventricle of the octopus, and so have to be essentially as on our picture (binocular octopus). When smoothed (interiorly) this produce the boson $1 \frac{4}{1} \frac{15}{1}$. When smoothed exteriorly we get 17 big eggs, violating thereby Gudkov periodicity. Hence we are faced a serious dilemma as we like to arrange Gudkov periodicity on both panels of interior and exterior smoothing yielding respectively binested schemes (forced to have one outer oval mod 4) and subnested schemes (forced to have 2 big eggs mod 4). It seems that there is no solution of compromise arranging both relations in one stroke. In fact even without appealing to Shustin's obstructions, it seems that there is no positioning of the quantum ovals on the octopus so that both the interior and exterior smoothings verify Gudkov periodicity. For instance we may drag the outer quantum inside the ventricle of the octopus. When smoothing interiorly then the situation is unchanged, but under the exterior smoothing the situation has not been improved.

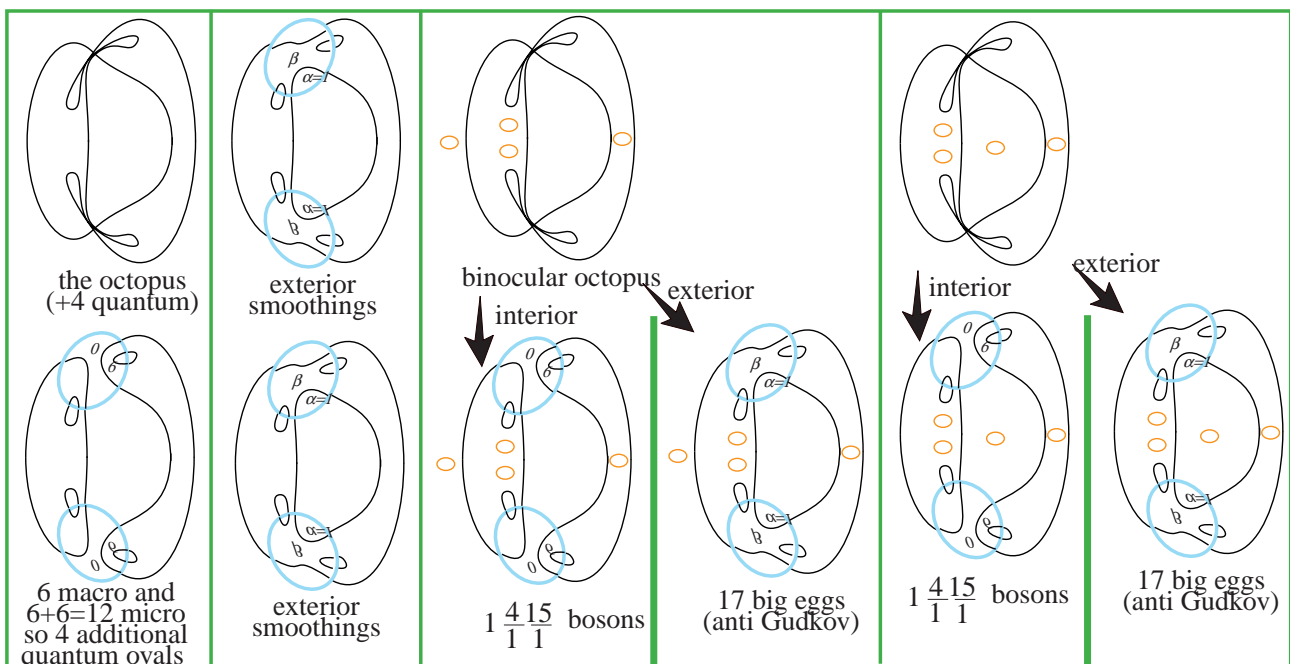

Figure 53: Octopus as a variant of Shustin's medusa: one boson is created, with anti-Gudkov dual particles

Hence we hope to have proven:

Lemma 5.8 *There is no algebraic curve whose topology is that of the octopus plus 4 quantum ovals whatever their location.*

Next at the very beginning of our idea to recombine Viro's mandarine (quadri-ellipse) with Shustin's medusa we traced a curve (the *elephant*) which we neglected to consider more seriously as it seemed to have two outer ovals driving us outside the bosonic strip (=binested with one outer oval). This could be remedied by injecting a quantum oval into the loop, yet there are 2 objections against this. First, our curve would be trinested. Second, applying Viro's C3-dissipation gives a quadri-nested curve violating the saturation principle of

the quadri-bifolium $\frac{1}{1}\frac{1}{1}\frac{1}{1}\frac{1}{1}$. Next we find a variant of the yeti, which we call the cobra. Probably its status is essentially the same as the yeti. Next we can trace the full zoo of animals encountered in a safari-tour: rhinoceros, hippopotamus, scorpion, crab, scorpion, crab.

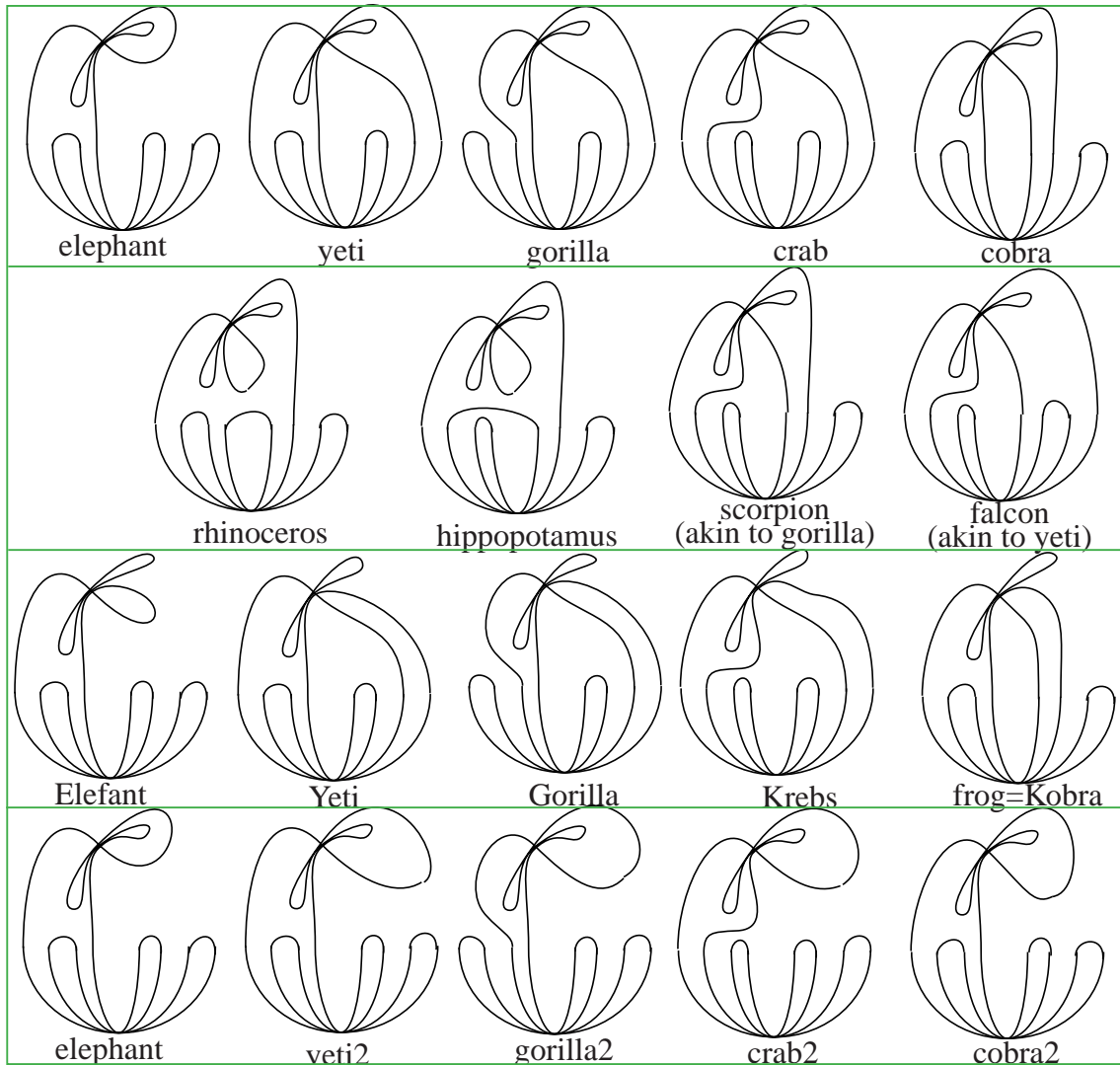

Figure 54: A zoo of animalistic curves

[21.09.13] From all those animals which one is best suited to revolutionize Hilbert's 16th problem in degree $m = 8$? As we saw the yeti was a good candidate but alas its most interesting decoration creating new bosons turned out to conflict with Fiedler-Viro's oddity law. Of course we could reject the latter, but this looks a bit cavalier. Still, we must confess that as yet our brain never had the patience to study carefully the Fiedler-Viro theorem. As to the cobra it is when smoothed essentially isotopic to the yeti, especially if the collection of patches C1 and C2 are symmetric as we could infer from our interpretation of Viro's method. This would be more conceptually explainable via the hypothesis of invariance under bending.

Let us be more systematic. First we see the elephant, but its natural smoothing with a C-patch at the bottom create 2 outer ovals so that we miss the bosonic strip. The natural parade is to inject a micro (quantum) oval in one of the loop emanating from X_{21} , but then either by using the appropriate dual patch C1 or C2 as to fill the other loop, or just by taking C3, we arrive at a quadri-nested scheme violating Bézout. Hence:

Lemma 5.9 *There no chance for the elephant, even if it exists algebraically, to*

realize the four binested bosons.

The destiny of the yeti was already discussed and there is no chance for him to create boson unless the Fiedler-Viro obstruction is wrong.

The case of the gorilla was already analyzed and conflicts with Gudkov periodicity.

The case of the crab seems ruled out from entrance, because the optimal smoothing is the A-type where only 8 micro-ovals can appear. Despite this defect, one could hope still reaching Harnack-maximality provided there are sufficiently many quantum ovals (probably 2). But even if possible, one can argue that there will be 2 outer ovals (at least), so failing to land in the bosonic strip. It can then be counter-argued that one of the quantum oval could appear in one of the loop.

So a more thorough analysis of the crab seems necessary. First, as we said a smoothing of type A shows that to reach an M -curve with 22 ovals the crab must be capable of receiving 2 additional quantum ovals. (As usual quantum ovals are just ovals whose exact location is not yet determined.) Next to drive the crab in the bosonic region we force it to accept a quantum oval in one of the loop. Now choosing on the top the external branch dissipation of the candelabrum, and one the bottom a type I smoothing (granting its existence) we get would get a configuration violating Bézout. Hence we suspect that the crab cannot be quantized as to reach the bosonic strip, and therefore even if it existed it would be useless to Hilbert's problem, except maybe in the subnested case.

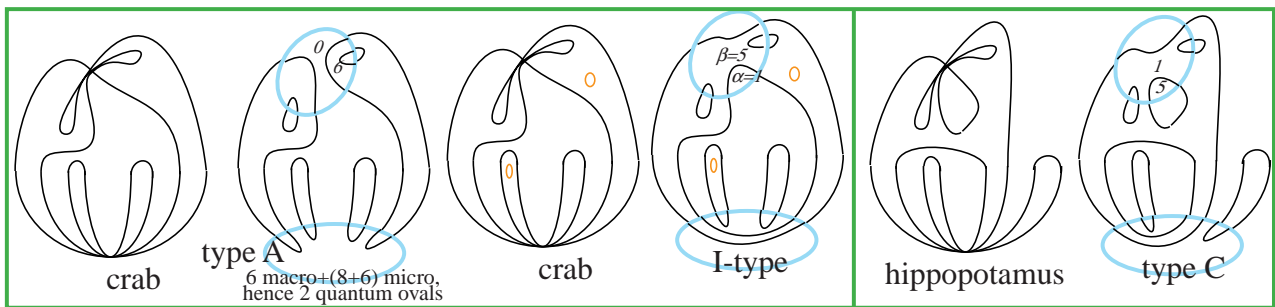

Figure 55: The crab attempting to reach Harnack-maximality despite bad pre-dispositions (followed by the hippopotamus, who frankly corrupts Bézout)

After the crab we have the cobra, but the latter is much akin to the yeti, and by virtue of the structural symmetry between C1- and C2 patches (Gabard's belief, but check once by e-mail if Viro agrees), both curves produce isotopic schemes. Hence nothing new can be expected from the cobra, that the yeti not already revealed. To remind the latter only produced boring schemes of Viro-Shustin, when not conflicting with the Fiedler-Viro law.

Next it comes to the rhinoceros: this may be ruled out from the scratch as the requested patch is of type F and only capable of 8 micro-ovals (spermatozoid droplets).

The hippopotamus deserves more respect as there is M -patches to smooth the bottom singularity, namely those of type E. As to the candelabrum it can be smoothed in the optimal way (compare Viro's Fig. 39, p. 1112 in Viro 89/90 [1535]), but the end-result involves two subnest and so foils Bézout. Hence:

Lemma 5.10 *There is no octic whose morphology is that of the hippopotamus. In particular the latter will not aid us to advance Hilbert's 16th problem on the qualitative theory of algebraic curves.*

Our story continues with the scorpion, which is symmetric to the gorilla, hence of no use; and idem for the falcon which is symmetric to the yeti.

One question arises: was our safari tour in the zoo exhaustive, or did we missed a species of special noteworthy-ness? Besides, some principle of graphical elegance of algebraic curves often allied to a principle of minimization (least

effort law) seems to corroborate the fact that the hippopotamus is ruled out. One may first classify species along the number of connection linking both singularities. For instance the yeti has 4 such connections, while the hippopotamus only two. At this stage only our brain noted that our picture of the hippopotamus is ruled out from entrance by tracing the line through both quadruple points.

Trying to answer the above question one can create new animals by surgery. For instance starting from the cobra and reconnecting some braids we get the frog. Of course this alteration can be operated on all animals listed, and so we get the 3rd row of animals whose name is just translated in German (often just amounting to a capitalization of the word). In particular we rebaptize the frog as Kobra. As a first remark in those germanic version of the animals there is always a smashed loop at the candelabrum, so that the curve contains (at least) two circuits. From earlier experience, we think this being a defect as somehow Harnack's bound cannot then be optimized, but maybe we were a bit prejudiced by a misconception. So let us start a naive browse through the German bestiary.

Before doing this we see that the primary bestiary can undergo another surgery amounting to cut the right arm of the animal viewed as a carnivore plant, and this gives the series 2: involving yeti2, gorilla2, etc. It may be observed that yeti2 and cobra2 are nothing but the elephant. The other species looks suboptimal as their best smoothing does not involve an M -patch. As this stage it seems important to investigate more thoroughly the elephant without prejudice about the two outer ovals.

Starting from the elephant and doing the optimal smoothing depicted, involving the type C patch plus an internal bifurcation on the candelabrum, we get a curve with 7 macro ovals, and 6+9 micro ovals so that Harnack's bound is already attained with having to introduce quantum ovals. In other word the elephant configuration is already saturated (i.e. peasant enough that nothing more can appear in the horizon). Somehow this is a bad new as we hoped to use a quantum to kill one outer oval by injecting stuff inside of it. (Keep in mind our intention to reach the bosonic strip.) Though a lesser hot-spot, it seems still of interest to investigate what schemes arise as progeniture of the elephant. (One of our hope would be to get Shustin's last scheme that we as yet never succeeded to construct.) On patchworking "Gabard's" series of patches C1 we get schemes violating Gudkov periodicity. Of course the same outcome would result from using Viro's more respectable patches of type C2. Hence:

Lemma 5.11 *Gudkov periodicity (and probably nothing more elementary) impedes any (singular) octic to acquire the morphology of an elephant.*

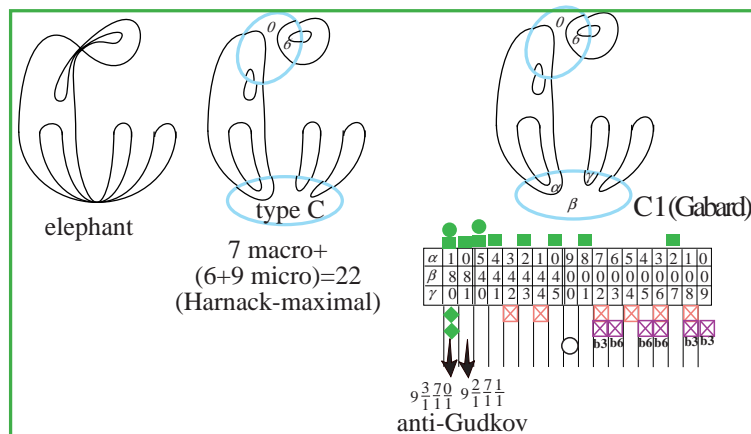

Figure 56: Elephant trying to reach the bosonic strip despite bad predispositions

[22.09.13] *Optional digression.*—As a side remark to clean at the occasion, one can start with any M -octic and a line cutting it four times, and perform a karate move (smashing) generated by a hyperbolism. This just amounts picturesquely to hang on the curve like a dead medusa over a nail. Then a X_{21} -

singularity is created and one can dissipate it along the usual Viro patches. It seems evident then, especially in case when the line hits only one oval like a horseshoe pattern, that the new curve will have 9 additional micro oval coming from the patch, while the smashing deteriorating at most one oval. Hence it seems clear that the new curve will have circa $22 + 9 = 31$ ovals, overwhelming seriously Harnack. Presumably this paradox is explained by the issue that the hyperbolism does not conserve the degree to 8, but might increase it. Sorry for this loose idea, but we just wrote it to not forget it, and in the hope to clarify it at the occasion.

Spruch der gut klingelt.—Si on commence à s'enliser dans les détails arithmétiques, on ne comprend plus la structure géométrique du cosmos.

Next, we were sidetracked by the following idea. All animals depicted as yet (models of qualitative ootics) have the special feature of not intersecting the line at infinity over the reals. We may thus imagine more general (projective) curves drawn in the projective plane (disc with boundary antipodically identified). Perhaps we get then new animals susceptible of producing the new bosons. The unfinished picture below tries to explore this idea, and must be completed at the occasion.

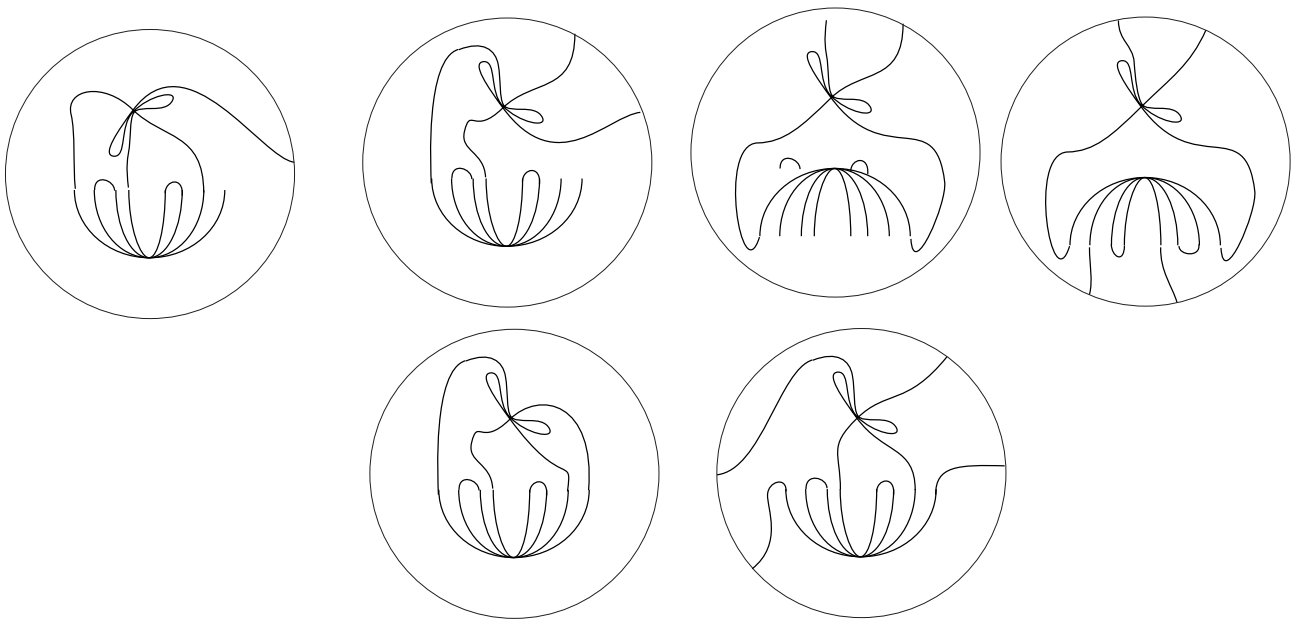

Figure 57: Projective connections: a new menagerie of animals

Besides, now that we have understood the epicenter of Viro's patch method (in its two decorations hyperbolism versus vibrational) it seems also realist to adventure into new singularities type like a quintuple flat point plus a triple point. By a k -tuple flat point F_k we mean k branches with 2nd order tangency; so for instance $X_{21} = F_4$.

The work then decomposes in two steps.

1. First, exploration of the dissipation theory of F_5 by an extension of Viro's two methods. In one decoration this merely involves looking at one more step in Viro's vibrational process.

2. Second, enumeration of singular ootics with a $F_5 + F_3$ pair of singularities.

Unfortunately, one sees quickly that the singularities F_5 seems to involve 10 intersections with a perturbed tangent to the "south" pole. Hence the singularity F_5 seems ruled out for ootics. Things could be salvaged if the outer branch had inverted curvature, but in reality on taking the tangent to the south pole (F_5) we get again a multiplicity intersection of at least 10, violating Bézout. Hence:

Lemma 5.12 *In the construction of ootics (more generally curve of order $m = 2\ell$), flat singularities F_k can have at most multiplicity $k = 4$ (resp. $k = \ell$).*

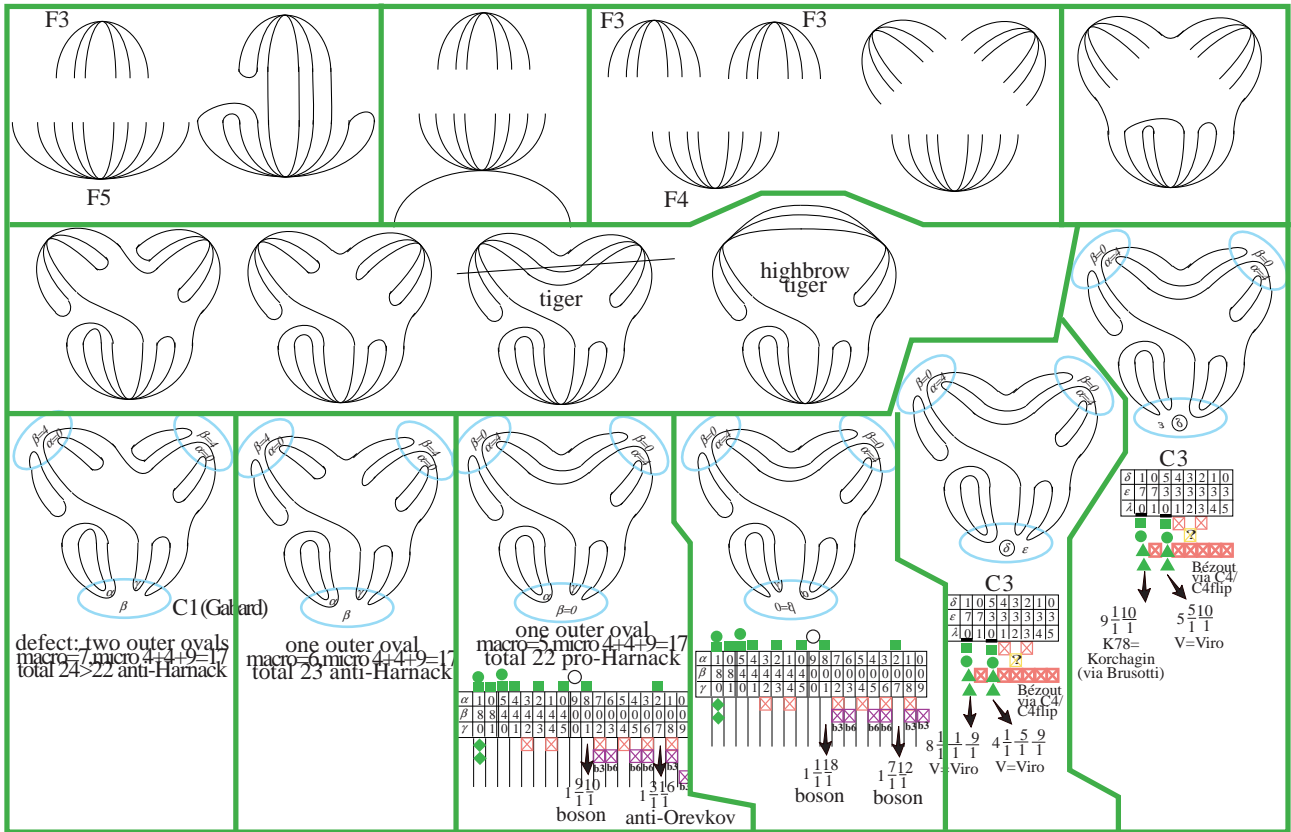

Figure 58: Singularities F3+F5, F3+F3+F4 including the tiger, as a powerful detergent of bosons, yet anti-Bézout after more mature thinking

Maybe one can investigate F4+F3+F3, i.e. curves with one flat quadruple point and two triple points. After few attempts we found a curve called the *tiger*, which respects Harnack's bound. When smoothed in the clever way as to land in the bosonic strip this yields the boson $1\frac{9}{1}\frac{10}{1}$, plus the anti-Orevkov scheme $1\frac{3}{1}\frac{16}{1}$. Hence:

Lemma 5.13 *Orevkov's link theoretic obstruction (if true at all⁶) kills the tiger, and so our plan to get a new boson.*

Besides, if we still believe in the tiger (price-to-pay=mistrust Orevkov), then opting for the vertically symmetrized patch we get two other bosons. Hence the tiger looks very puissant at the bosonic level, i.e. a good particles detector in CERN's jargon. Further, gluing Viro's C3-patches yields no obstruction but recovering standard schemes due to Viro's quadri-ellipse method. In summary:

Scholium 5.14 *The tiger offers a real opportunity to win three new bosons in the binested realm (all safe $1\frac{4}{1}\frac{15}{1}$), provided Orevkov's obstruction of $b_3 = 1\frac{3}{1}\frac{16}{1}$ is wrong. However as we shall see, there is a basic Bézout obstruction working against the tiger.*

Note.—The reader may have noticed sooner than us, that the tiger as it stands is intercepted ten times by the depicted line. This is a violation against Bézout, yet a soft one since by inflating the tiger's brain we may get the *highbrow tiger* were this defect is remedied upon.

Further, flipping C3 along vertical-axis symmetry yields common schemes due to K78=Korchagin 1978 (via Brusotti), and one scheme due to Viro (quadri-ellipse).

The tiger seems to respect Bézout for lines, but what about conics? The test involves passing a conic through the singularities. From the five points through

⁶We have no specific objection against Stepan, but only confess to have not yet found the energy to check his proof.

which one may pass a conic we may amalgamate 2 pairs in the infinitely small so as to offer tangency conditions. Imposing tangency at X_{21} (the quadruple point), and one more tangency at the triple point, plus a simple passage through the remaining triple point, we get a multiplicity intersection of $8+6+3 = 14+3 = 17 > 16 = 2.8$, overwhelming Bézout. This seems to kill the tiger and comforts thereby Orevkov’s obstruction.

Of course the tiger is probably not an isolate species in the class $F3+F3+F4$, and probably there is another curve leading to the fourth (binested) boson. Yet this hypothetical curve will be subsumed of course to the same Bézout obstruction just sketched.

In fact to lower this “singular multiplicity” one could replace one triple point by a double one, or alternatively, trade the quadruple point X_{21} for a candelabrum (where one of the four branches is transverse). Then the multiplicity intersection of the conic interpolating the singularities is only $7 + 6 + 3 = 16$ and Bézout is respected. This brings us to our next picture (Fig. 59).

5.7 C4+F3+F3: one candelabrum and two flat triple points

[23.09.13] Usually, mathematicians exposes their results, but not the methods. Presumably, the reverse-engineering would be at least as useful. A typical example is Viro’s sporadic obstruction.

Side-remark.—Actually, Ahlfors extremal problem, is probably more a Mittel zum Zweck (biased by the Koebe-Carathéodory tradition) than an intrinsic feature of the problem.

[23.09.13] On this picture (Fig. 59) we get several animals and corresponding curves. Alas, apart from recovering Shustin’s last scheme $4\frac{5}{1}\frac{5}{1}\frac{5}{1}$, we were not able (after a boring tedious search) to reach the bosonic strip. We do not know if this is caused by our incompetence, or an intrinsic feature of this distribution of singularities.

Specifically, we found first the *lion* producing Shustin’s last scheme. Then we have several curves with anti-Gudkov smoothings, hence not worth paying attention at (those include the *panther*, *pig*, *cingallo*, etc.). Several others do not attain Harnack-maximality (at least without injecting extra “quantum” ovals); so for instance the *guépard* (=cheetah), *pork*, *cow*, etc. Browsing through the whole figure there is—apart from the lion—only the *cat* which is Gudkov compatible, hence susceptible to admit an algebraic model. Alas, it does not produce any new boson but still Shustin’s last scheme. We do not know alas if there is an octic isotopic to the lion or the cat. But even if, this does not impact tremendously upon Hilbert’s 16th (except if it may help to clarify Shustin’s construction that we were as yet unable to digest). So it seems reasonable to leave the question asides for the moment.

And we continued our search, on a 2nd figure (Fig. 60) yet not finding any species worth of commentary. So our boring pictures are given without any comments. So far so good but alas TeX is not happy with little comments because then the overflow of pictures overwhelms its page-making aptitudes. So let us comment against our will. First we have a *chèvre* (=coat), which produces 9 macro-ovals, but this stays okay because the suited patch permits only 5 micro-ovals (compare the Viro-Korchagin catalogue reproduced on our previous figure). But then there are apparently no restriction on α, β , and thus we frequently collide against Gudkov periodicity. In conclusion there should be no octic taking the form of the goat.

Next we have the *sheep*, but this looses one oval over the goat, and thus should not be able to reach Harnack-maximality. Next, we imagined a *zebra*, which is however anti-Bézout as it contains two nests of depth 3 and 2 respectively. The *borsuk* (=blaireau=badger?) is for the same reason anti-Bézout. The *dolphin* has only 5 macro-oval, and so its smoothing severely fails to be an M -curve, except if we would add quantum ovals. Next we have a *shark* with 7 macro-ovals, but this is still not enough. One can increase by going to the *orc* (=orque in French=grampus?), but its progeniture under smoothing is alas anti-Gudkov (even in the simple form of Arnold). Next we have the *wale* whose smoothing produces only 7 macro-ovals. This can improved by choosing a better patch splitting apart the “huge” contorted oval, and we get so an M -scheme, alas anti Gudkov periodicity. (The latter forces in the binested case the number

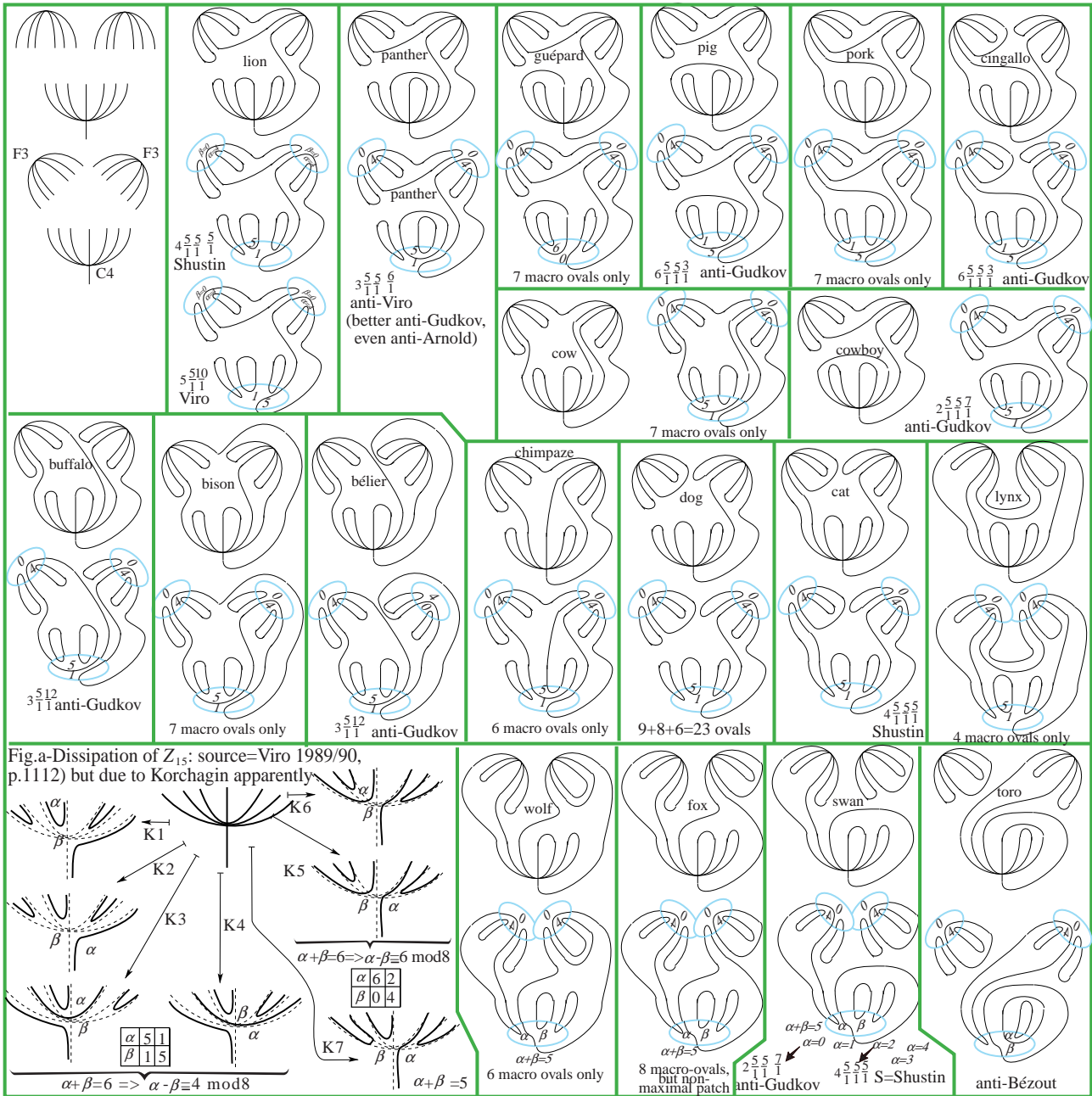

Figure 59: Singularities F3+F3+C4 (candelabrum) including the lion, etc.

of outer oval being 1 (mod 4).) From the wale there is an obvious morphogenesis to the *Stier* (=German for bull), but its smoothing is anti-Gudkov. By the way the more suited split-smoothing would violate Harnack's bound.

Next being à cours de vocabulaire, we decided to opt for names of famous geometers instead of animals. The basic idea is to consider a curve like *Bessel-Hagen* which is more "claustrophobic" or squat (trappu in French) with a branch winding around the whole configuration before closing back to the singularity. However its production is anti-Gudkov, and of course there is also a line cutting the curve along 10 points. We explored so a long list of curves termed after Kerekjarto, Whitney, Kaplan, Reeb, etc. The sole interesting species is that called Ronga, which produces Shustin's last scheme $4 \frac{5}{1} \frac{5}{1} \frac{5}{1}$. Of course our model of Ronga is still intersectable in 10 points by a line. Further on choosing another best suited smoothing (depicted in the margin) we can gain one more oval, and this brings Ronga's curve outside the realm of Harnack-maximality. Next we have Grivel's curve to which the same token applies mutatis mutandis.

[24.09.13] Of course the canonical idea to work more systematically is to start

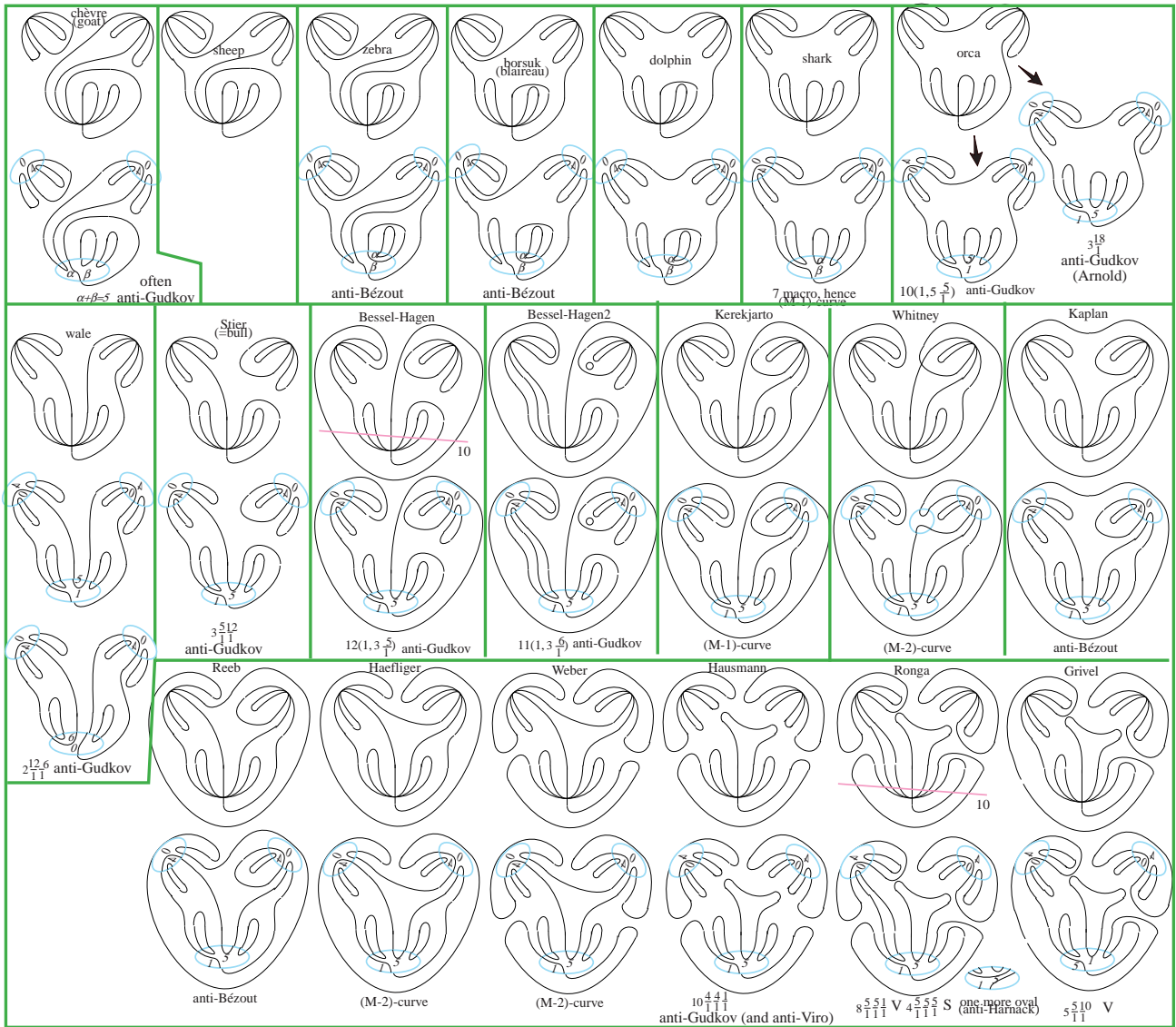

Figure 60: Singularities $F3+F3+C4$ (candelabrum): from the goat to Grivel

from the M -smoothing of the candelabrum, and then connect the branch so as to reach maximality. Hence, one may start from the Viro-Korchagin catalogue of dissipations and then complete the curve. Doing so while connecting the trunk of the candelabrum to the other side, we found first a curve (called *Garfield*) violating two of Shustin's prohibitions $((1, 14\frac{6}{1}), (1, 18\frac{2}{1}))$. So:

Lemma 5.15 *Either two of Shustin's prohibitions are wrong or there is no octic curve isotopic to the Garfield. However it seems to us that the singular version of Harnack's bound (due to either Harnack, Klein or Hurwitz, who else?) easily expels the Garfield outside the algebraic realm. Hence, Shustin is probably safe.*

[Added 27.09.13.—One may also wonder about avatars of the Garfield attacking the other three Shustin's obstructions. Besides, one may also imagine another Garfield with ovals quantized elsewhere as to get the boson $1\frac{1}{1}18\frac{1}{1}$. Of course there is still the critique of the singular Harnack bound, yet it seems still worth tracing that curve, as *goret* on Fig. 61. Of course its smoothing turns to be anti-Bézout. So sorry for that stupid example.]

Another smoothing of the Garfield yields a more respectable Hilbert's M -curve. Yet, this is certainly not enough evidence to fight against Shustin. We shall soon give an argument based on the Harnack-Klein bound preventing the Garfield's existence.

[Added 27.09.13.—Actually, if we pass a conic tangent to both fat branches of the Garfield at the point $C4$ and $F3$ while passing simply through the other $F3$, we get $3.2 + 1 + 3.2 + 3 =$

16 = 8.2, and Bézout is still happy. Sorry, this is a stupid remark, since by construction we know that this distribution of singularity is Bézout permissible.]

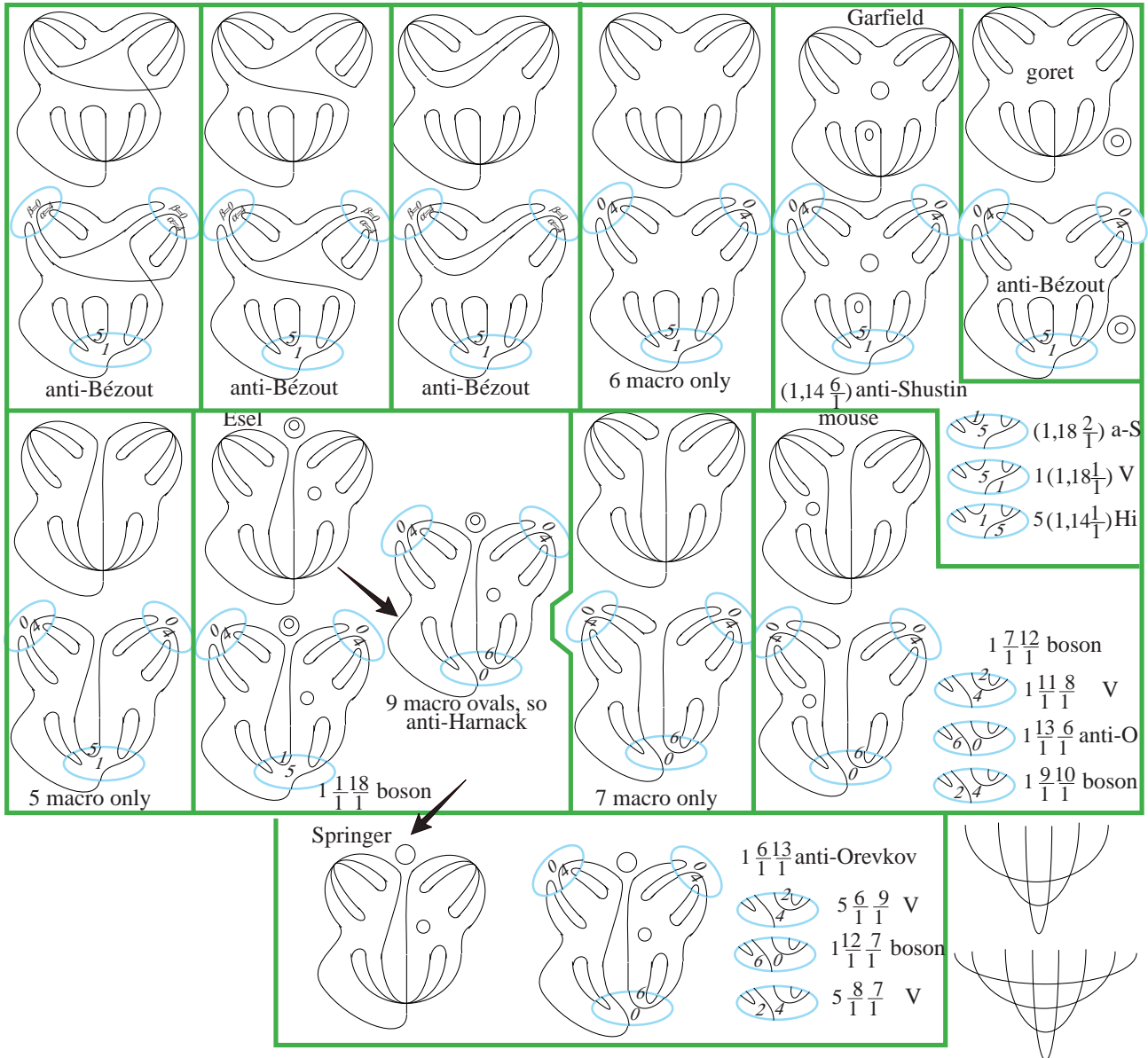

Figure 61: Singularities F3+F3+C4 (candelabrum): Garfield, Esel, etc.

Next, stubborn as a mule, we found a curve called the *Esel* (=âne=ass, or donkey) which produces the boson $b1 = 1 \frac{1}{1} 18$. However smoothing it differently violates Harnack's bound. Of course we can just kill one quantum oval, to get the *Springer*. Its most virulent smoothing produces the scheme $1 \frac{6}{1} 13$ violating Orevkov. Other patches give two Viro schemes, plus the boson $1 \frac{7}{1} 12$. In conclusion the Springer is only executed (killed) by Orevkov, but we think that the singular Harnack bound also prohibits the Springer.

Further, the *mouse* creates two (new) bosons ($b7$ and $b9$) but conflicts once more with Orevkov's $b6$. Hence:

Lemma 5.16 *Orevkov is either false, or prohibits the mouse.*

Of course our mouse is just found by successive trials, especially introduction of additional (quantum) ovals as to force Harnack-maximality. Perhaps the mouse is readily ruled out by Harnack's bound in the singular realm.

5.8 The singular Harnack bound argument

For this one must predict the (salaries) dumping effected on the genus by singularities F3 and C4 (so-called *Mindestlohn* in Germany). We would have preferred to skip this issue for the moment, but let us improvise despite our unculture, since the method seems a powerful tool of censorship against our pseudo-counterexamples to Shustin, Orevkov.

If we imagine a sextic C_6 with two F3-points it will split toward a tri-ellipse of genus -2 (imagine spherical modifications, each lowering the genus by one). As a smooth sextic has genus 10, each F3 must drop the genus by 6.

[Added 27.09.13].—Another method consists in perturbing the singularity into an arrangement with normal crossings while counting the number of double-points so created. For F3 we get 3 elliptical branches with a total of $2+4=6$ nodes (cf. Fig. 61). The same method for $F4=X_{21}$ gives $2+4+6=12$ nodes in accordance with the result that one may derive by the first “genus” method.

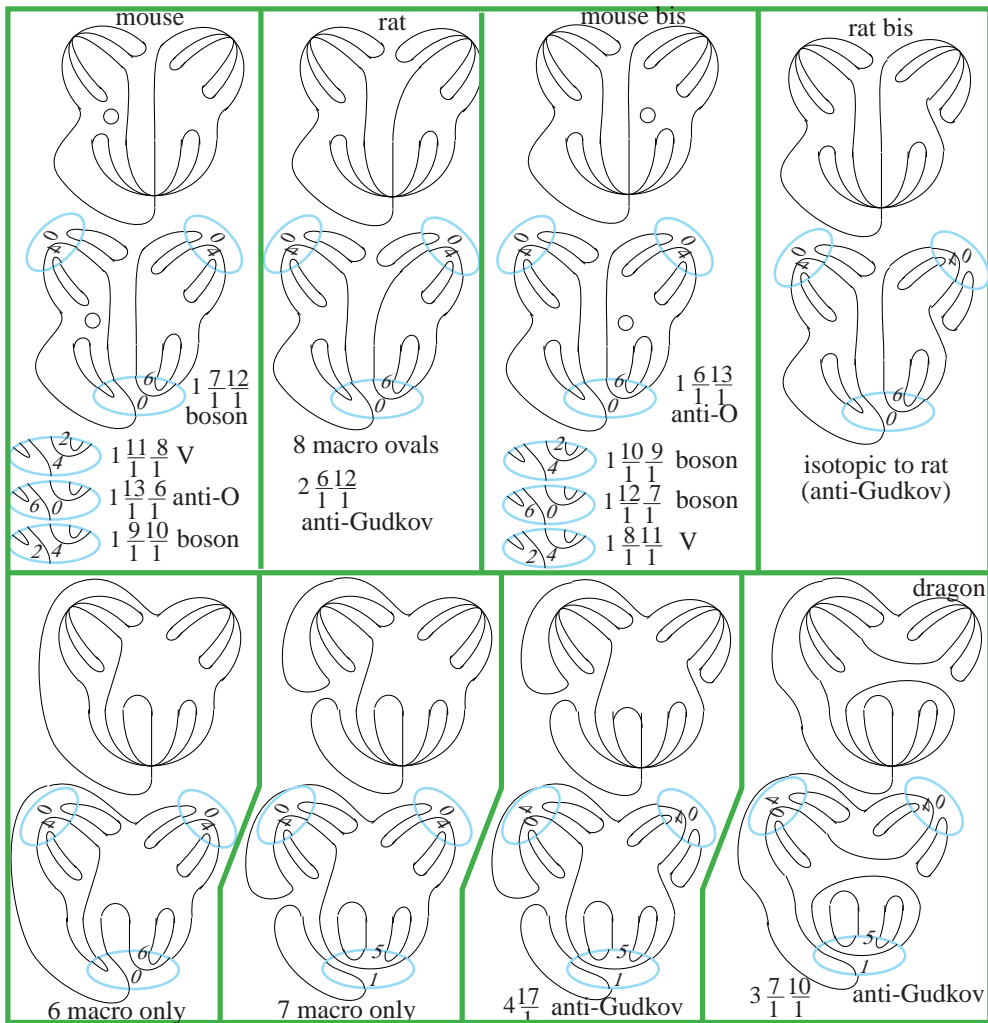

Figure 62: Singularities F3+F3+C4 (candelabrum): rat, etc.

As to the candelabrum C4, it may be conceived as F3 plus a transverse branch. Hence we have 3 additional crossings, each eating one unity to the genus. So C4 decreases the genus by $6+3=9$. This count is compatible with Shustin’s medusa (Fig. 95) which has two candelabrams C4, hence genus $21 - 18 = 3$, while totalizing precisely 4 circuits in accordance with Harnack’s bound. In sum, our distribution of singularities $2.F3+C4$ drops the genus of a smooth octic ($g = 21$) to $21 - 12 - 9 = 0$. Thus our mouse has too many circuits. Using curvature conventions along branches, the mouse consists actually of 3 circuits; yet, already without them Harnack’s bound is violated.

The same argument applies *a fortiori* to the Garfield (2 quantum ovals), which by curvature conventions even raises to 5 circuits. It applies also to the Springer (2 quantum ovals).

Then we transform the mouse to a *rat* producing more ovals when smoothed. Alas the resulting M -scheme violates Gudkov periodicity even in the simple version of Arnold. Note en passant that the quantum oval of the mouse could as well have appeared in the other half of the curve (cf. mouse bis). This produces exactly the same collection of four M -schemes modulo a shuffle. If our above genus dropping count is correct, we are not allowed to add quantum ovals, and the game becomes fairly rigid, in the sense that it becomes hard to land in the bosonic strip.

So the problem seems to be: is it possible to interconnect the branches of two singularities of type F3 plus one of type C4 as to get a single circuit (Harnack's bound for the singular curve) while simultaneously arranging an M -scheme in the bosonic strip, i.e. binstested with one outer oval. This is tantamount the Gudkov symbol being $1 \frac{x}{1} \frac{y}{1}$ with $x + y = 19$ (w.l.o.g. $x \leq y$).

5.9 Sidetracked to C4+C4: two candelabrum

[24.09.13] Albeit our search on 2.F3+C4 was far from systematic, there is maybe more freedom when composing two candelabrum (C4+C4) like in Shustin's medusa. This gives us the following picture (Fig. 63).

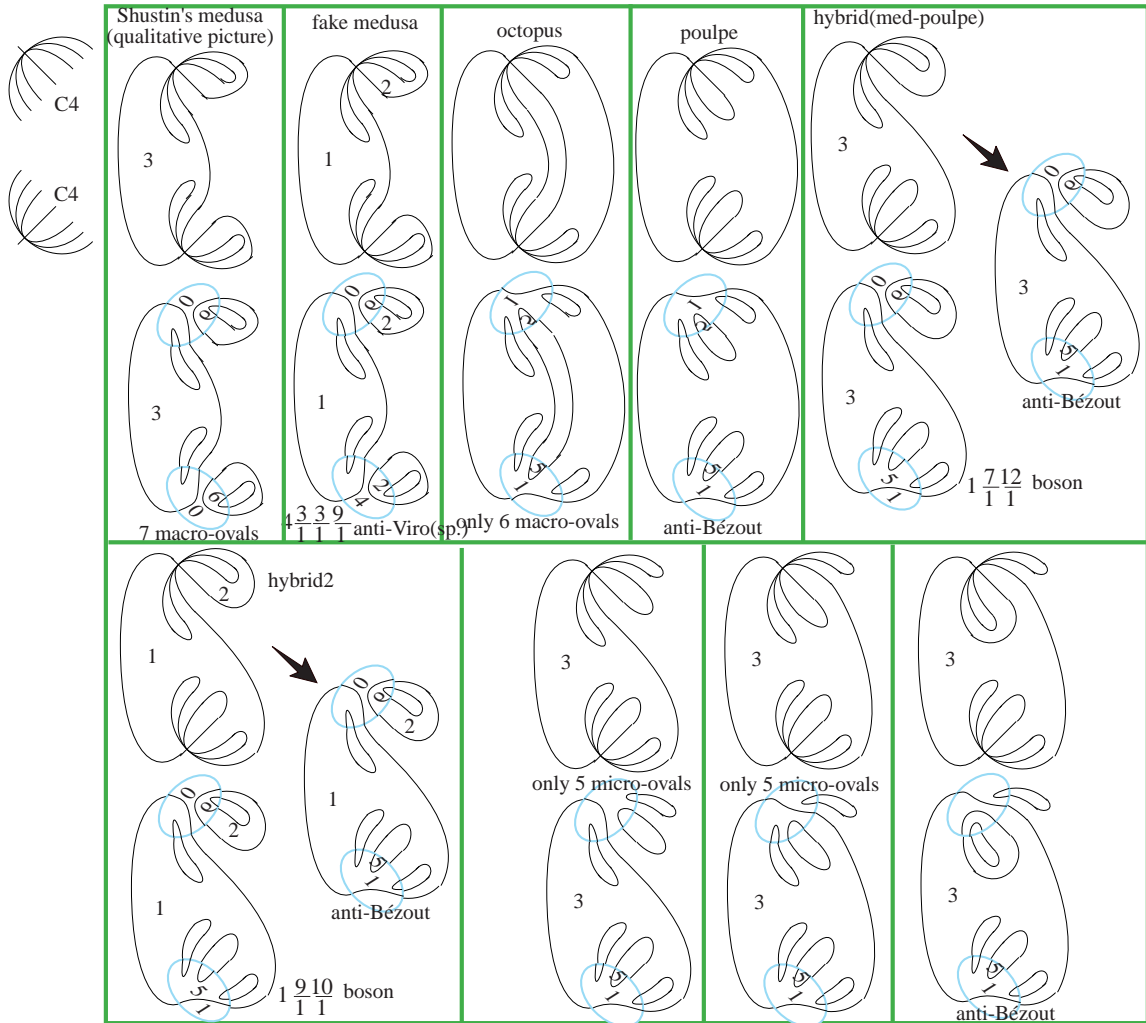

Figure 63: C4+C4 (two candelabrum): bosons created but anti-Bézout cousins

Here we start with a distribution of two candelabrum with four branches (notation C4). A first natural way to connect them is like in Shustin's medusa, whose natural smoothing has 7 macro-ovals. As $6 + 6 = 12$ micro-ovals are

given by dissipation theory, we can add 3 quantum ovals. One adds them traditionally in the *core* like on the medusa picture (i.e., the region limitrophe to both candelabrum). As a variant one may imagine a *fake-medusa* where only one quantum oval is centrally placed, but two delocalized in the double-loop (see the *fake-medusa* picture). Then it is a simple matter to arrange the gluing patches as to offend Viro's most cavalier sporadic obstruction, namely $4\frac{3}{1}\frac{3}{1}\frac{9}{1}$. Hence:

Lemma 5.17 *Either Viro's sporadic obstruction ($4\frac{3}{1}\frac{3}{1}\frac{9}{1}$) is false or it kills the fake-medusa (of Fig. 63). As we shall see later a simple trapping argument à la Poincaré-Bendixson combined with Bézout rather corroborates this 2nd alternative (alas without proving Viro's obstruction).*

It seems of interest to inspect the full dépliant of this fake-medusa as it seems to corrupt other Viro sporadic obstructions. This deserves a separate plate (Fig. 64).

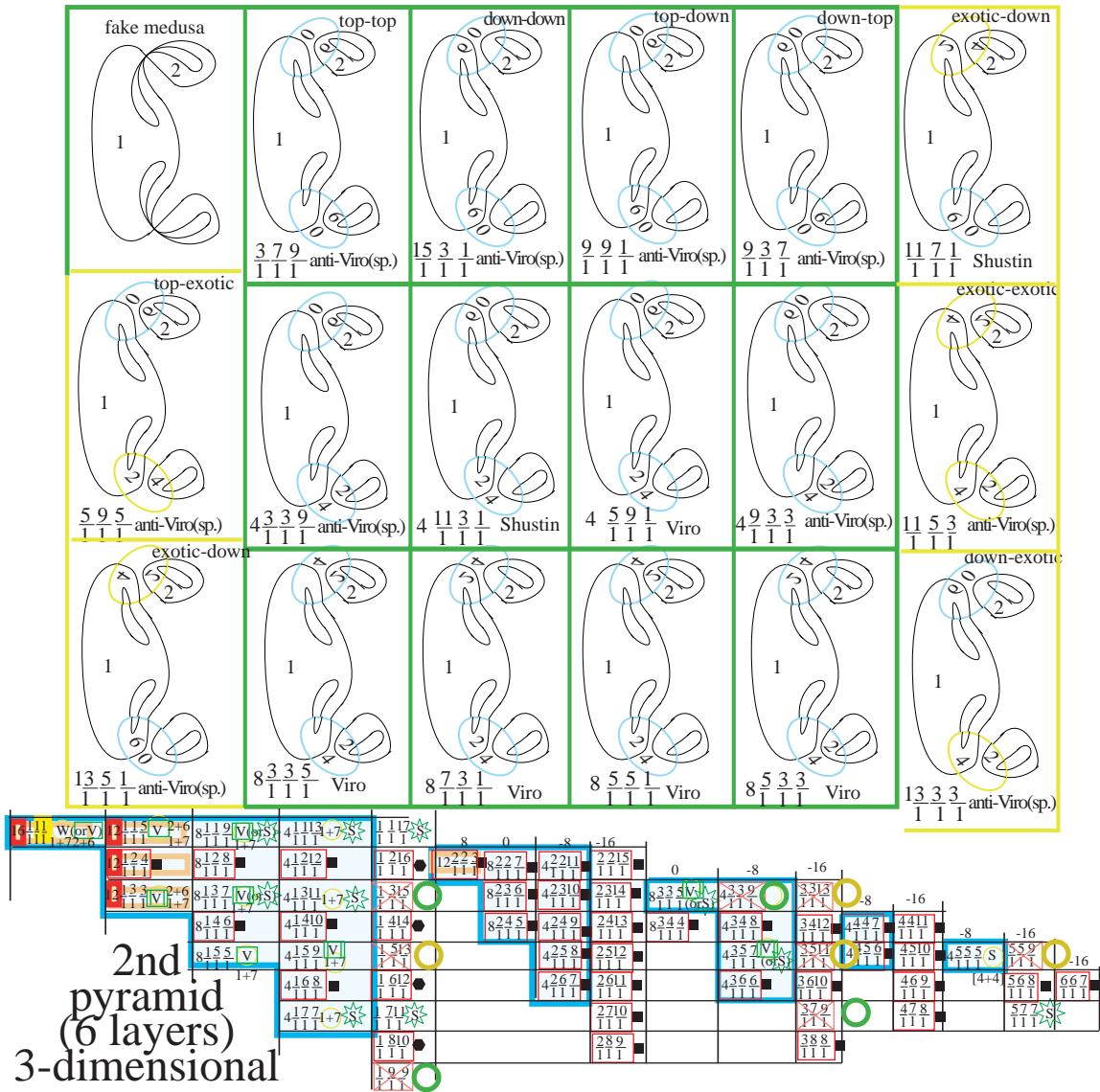

Figure 64: Fake medusa and its full dépliant: killing half of Viro sporadic

After the fake-medusa we have the *octopus*, arising by conjunction of the tentacles of the medusa, and so look structurally incapable to reach Harnack-maximality. The sole deliverance could come from more spontaneous quantum ovals, but as discussed earlier (Fig. 53) it seems impossible to produce bosons without conflicting (radioactively) with Gudkov periodicity. Next we have a

poulpe (=French for Devil-fish), but this mutates anti-Bézout on gluing the appropriate patch (two subnests). Next, we imagined a hybrid of the medusa and the poulpe (called *med-poulpe*). This even produces an exciting boson, but alas runs against Bézout when smoothed differently. Then we can imagine *hybrid2* which produces another boson, but again along an illegal way foiling Bézout. The next two curves involves the non-maximal patch (K7), and so Harnack-maximality seems out of reach, except if more quantum ovals (viz. four) are created.

5.10 On the fake-medusa

[25.09.13] Now we turn back to the project of enumerating all smoothings of the fake-medusa. Fig.64 shows that we can attack several of Viro’s sporadic obstructions from this single position. Precisely:

Lemma 5.18 *If there is a fake-medusa, then all the following four sporadic Viro obstructions are wrong: $\frac{3}{1} \frac{7}{1} \frac{9}{1}$, $4 \frac{3}{1} \frac{3}{1} \frac{9}{1}$, $\frac{1}{1} \frac{9}{1} \frac{9}{1}$, $\frac{1}{1} \frac{3}{1} \frac{15}{1}$. Conversely, it suffices one of those obstructions being true to rule out the fake-medusa.*

Further, on using dubious (yellow-colored) patches we can also construct the four remaining Viro obstructions. Hence supposing that the dissipation of the candelabrum was not fully explored (by Korchagin-Viro), it could be that all the eight sporadic Viro obstructions in Hilbert’s 16th for $m = 8$ are wrong.

So the point is twofold. First we see a splitting of Viro’s sporadic obstructions in two classes of four, one more suspect than the other. Besides, it is pretty remarkable that the fake-medusa seems refuted only by sporadic obstructions and nothing more tangible, like Bézout, Gudkov, Viro’s law of oddity, etc.

One naive idea to get a contradiction is to opt for the interior smoothing without nesting (see Viro’s Fig. 39, p.1112 or equivalently our K7 on Fig. 59). Apparently here Viro claims that for $\alpha + \beta = 5$ each values $\alpha = 0, 1, 2, 3, 4, 5$ can be realized. One could imagine this falsifying GKK-periodicity (GKK=Gudkov-Krakhnov-Kharlamov). In reality, when gluing K7, we loose both a macro-oval and one micro-oval and so land with an $(M - 2)$ -scheme only, where periodicity is abolished. Using instead the patch K1 we may get an $(M - 1)$ -scheme but GKK-periodicity seems respected. Maybe there is a theological reason explaining that as the M -production of the curve respects Gudkov, so must its $(M - 1)$ -descendance respects GKK-periodicity. More experimentally, a quick browse—hopefully exhaustive—through all patches listed by Viro(-Korchagin) does not conflicted with GKK when glued inside the fake-medusa (compare Fig. 65).

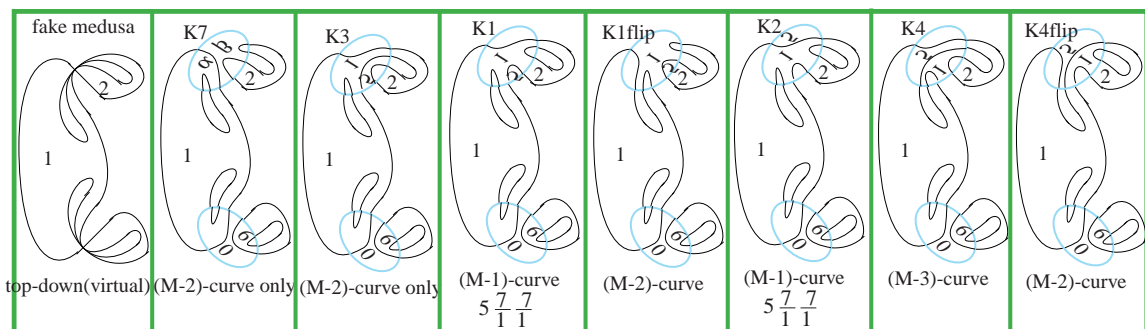

Figure 65: Fake medusa versus GKK

Of course, it is a serious challenge to construct algebro-geometrically the fake-medusa. A loose essay would be to ape Shustin’s construction of the original medusa, while trying to deviate from it as soon as the occasion presents itself. This is of course pure opportunism without tangible knowledge of the terrain.

Another idea would be to search a direct Bézout obstruction on the singular model prior to smoothing. The method, by-now-standard, is to pass a conic through the singularities. First impose 2 tangencies along the fat branches of both candelabrams. Besides, impose another anchor-point, typically inside one

of the quantum oval. Counting intersection we find $2.7 + 2 = 16 = 2.8$ so that Bézout's bound is already attained, forbidding any further unassigned intersections. Applying this recipe to Shustin's medusa, it seems plausible that the interpolating conic through one of the 3 quantum ovals will not intercept anymore the singular octic C_8 apart in the assigned loci (cf. Fig. 66 left). In contrast, applying it to the fake-medusa (with one central oval and two peripheral ones), while asking the conic to visit a point situated on one of the two peripheral ovals then the loop defines a trap à la Jordan-Poincaré-Bendixson where the conic stays confined without possible issue (Fluchtweg). So the conic-circuit is actually forced to revisit the singular point of the C_8 , but this is intolerable (either for a conic to become a figure eight or the intersection $C_2 \cap C_8$ would then exceed Bézout). At any rate it seems evident that:

Lemma 5.19 *A Poincaré-Bendixson trapping argument combined with Bézout excludes the fake-medusa from the temple of algebraic-geometry.*

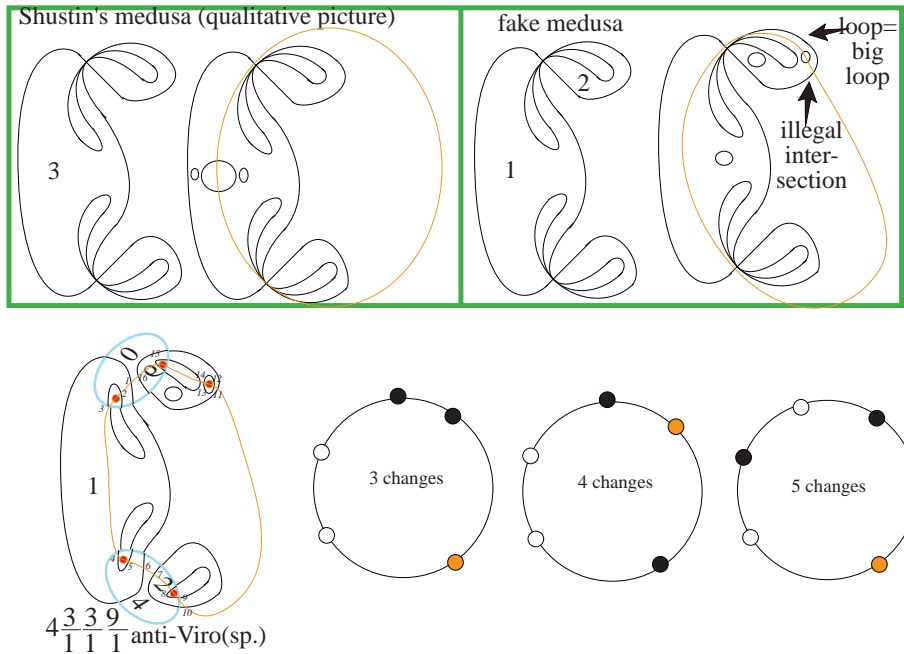

Figure 66: Trapping argument on the singular curve: genuine vs. fake medusas

This is a fatal jeopardy of our essay to corrupt Viro's sporadic laws. If the latter are true, one may wonder if an elaboration of this Poincaré-style argument could assess those Viro obstructions. One method could be to smash the smooth curve to a fake medusa by a suitable "hyperbolism", broadly interpreted as a geometrical recipe preserving degree and contracting certain lines. Yet this would probably involve deep enumerative properties valid in some universal sense. This looks of course completely out of reach.

[Added 27.09.13.—Further it is clear that the above lemma (5.19) applies as well to two other types of fake-medusas where the three quantum ovals are distributed either

(FM2) as one in the core (=central region limitrophe to both singularities), and one in each legs (periphery) of the medusa;

(FM3) as two in the core, and one in one of both legs.

Of course, existence of such medusas is also ruled out by Viro's oddity law.]

5.11 Falling back to the method of deep penetration with salesman travelling

[26.09.13] Alternatively to the method of hyperbolizing to a fake-medusa, one may try to ape the infinitesimal tangency conditions imposed on the osculating

conic at the more global level of the smooth curve. For concreteness, starting with Viro's anti-scheme $4\frac{3}{1}\frac{3}{1}\frac{9}{1}$, we may impose 5 basepoints (red-points on Fig. 66, which are located in the deepest lunes akin to fossil residues of the candelabrum dissipation. Of course, our picture holds only in the vicinity of the dissipated curve, yet we expect afterwards extending the argument to a general curve in the fixed isotopy class $(4\frac{3}{1}\frac{3}{1}\frac{9}{1})$. The corresponding conic will cut the C_8 in at least 16 points, still in accordance with Bézout. Can we be more clever?

In summary, for any trinested octic holds already a phenomenon of Bézout saturation when passing a conic through five deep ovals provided those are dispatched in all three nests. To contradict Bézout it suffices to arrange a salesman travelling, i.e. one more color change than the three granted ones. Each color change forces 2 intersections (out from the old nest to get in the new one). Thus a conic with 4 color-changes intercepts the C_8 along $5.2 + 4.2 = 10 + 8 = 18 > 16$ points, violating Bézout.

Hence the whole game of prohibiting curves reduces to that of ensuring dichromatism, as opposed to the monochromatism of an uniform color distribution with only 3 changes. First, it is advisable to impose the 5 basepoints on the ovals themselves instead of their insides. (This avoids a minor technical worry.) Next we may let vary the location of the five basepoints, inside a five-dimensional tori, where each element is assigned the interpolating conic (generically unique), and in turn a color distribution. On varying the position this color distribution stays constant by continuity unless a catastrophe happens. What are the catastrophes of the problem? One is certainly the degeneration of the conic to a pair of lines. If this happens—by the pigeonhole principle—at least three of the five points land in the same line, and we get a three-in-line condition which violates Bézout. Indeed, recall that we have two white and two black points plus a red one (coloring being by appurtenance to a given nest). Hence our line with 3 points intercepts the C_8 in $3.2 + 2.2 = 10 > 8$ points, since it involves 2 color changes.

From hereon, it seems possible to infer that the conic is always uniquely defined. Otherwise, there would be a pencil of such conics (interpolating the five points=pentagon), but then there would be also a singular member in this pencil (e.g. by a crude dimension count of the discriminant=hypersurface), yet this violates Bézout for lines as just observed.

Lemma 5.20 *Given any trinested octic, C_8 , plus a trichromatic pentagon (injectively) inscribed in the deep ovals of the C_8 such that each color appears at most twice. (As usual, the three colors are assigned in reference to the three nests.) Then, there is a unique conic interpolating the pentagon, and it is smooth. Hence we have a canonical mapping from a five-torus to the hyperspace of conics \mathbb{P}^5 (which avoids the discriminant). The number of chromatic changes in the pentagon coursed along the conic is thus constant through continuous variation of the pentad, and is at least 3 (unicolor), in which case the conic cut the C_8 already in $5.2 + 3.2 = 16$ points. If multicolor (i.e. at least 4 changes), Bézout is violated and the octic prohibited.*

So far so good, but can one implement this basic method on any concrete octic curve prohibited by Fiedler, Viro, Shustin, Orevkov, or maybe even in the more select realm of bosons not yet prohibited? (Of course this involves primarily the four binested bosons, and so the discourse has to be slightly adapted; i.e. only two colors instead of three.) One capable doing this, gets probably his name gravated on the obelisk of Hilbert's problems solvers (Dehn, Bieberbach, Arnold, Gudkov ($m = 6$), Viro ($m = 7$), etc.)

Let us formulate a (loose) avatar for *binested* octics:

Lemma 5.21 *Given any binested octic, C_8 , plus a dichromatic pentagon inscribed in the deepest ovals of the C_8 such that each color appears at least twice. If a color appears only once, then we cannot expect more than two color changes, and Bézout is respected ($5.2 + 2.2 = 14 < 16$). Then there is a unique conic interpolating the pentagon, and it is smooth. (Maybe not true because it may split*

off in two lines each monochromatic, hence respecting Bézout). Hence we have a canonical mapping from a five torus to the hyperspace of conics \mathbb{P}^5 which avoids the discriminant. The number of chromatic changes in the pentagon coursed along the conic is thus constant through continuous variation of the pentad, and can be at most equal to 3 (discolored). If more colorful, then Bézout is violated and the octic curve prohibited.

So a direct avatar looks dubious yet we may perhaps impose a 3rd color by looking at the outer oval (existence granted by Gudkov periodicity). This we declare as defining the red color. A shift through it forces only one (bonus) intersection (instead of the two gained by changing of nest). So we distinguish strong (black-to-white) color-changes from weak ones (black-to-red or white-to-red).

Assume given a binested M -octic, and suppose it to have one outer oval. Choose a pentagon with say 2 pairs of vertices in each nest and one vertex on the outer oval. The conic interpolating this pentad has $2.5 + 2 + 2.1 = 14$ real intersections granted in case of the worst possible colorimetry. This is not enough to foil Bézout, but the distribution with 5 color-changes is enough to attack Bézout. By the way, the interpolating conic could still split off a line without violating Bézout.

Hence the binested case looks intrinsically harder, yet perhaps subsumable to the same basic method. This is in accordance with the factual knowledge assembled by Russian scholars, especially Fiedler, Viro, Orevkov. So it seems wise modesty to first understand the trinested case (while recovering only old truths), hoping that no revisionism of Viro sporadic is necessary.

Of course in the trinested case certain curves do exist while other do not apparently. It is a very subtle matter of deciding under which circumstance a multicolor pentad can be arranged, and thus the corresponding scheme prohibited. A first condition for our method to apply is the presence of at least two nests containing at least two ovals. Diagrammatically, this merely amounts to rule out the first line in the 1st layer of the trinested pyramid. This represents no loss of generality as all those (five) schemes (containing $\frac{1}{1}\frac{1}{1}$ as sub-symbol) are resp. constructed by Wiman, Viro, and Shustin.

This being said, we can fix a pentad in our trinested scheme which is tricolored in such a way that each color is represented at most twice. Under this condition we can grant no degeneration of the conic interpolating the pentad, and therefore its uniqueness too.

To each pentad inscribed inside the deep ovals, we may assign a coloration according to the nest of appurtenance, and count the number C of color-changes when circulating along the interpolating conic (which is unambiguously defined). Of course $3 \leq C \leq 5$, and it suffices to have $C \geq 4$ in order to corrupt Bézout, since each color-change forces 2 intersections with C_8 . We say then that the pentad is *multicolor*, and one needs a trick ensuring a multicolor pentad on certain hypothetical curves as a weapon for their prohibitions.

Alas, it is here that things start becoming difficult. We would like to show that certain curves prohibited by Viro always contain a multicolor pentad.

To fix the idea we would like to solve this problem along three levels of successive difficulties:

- (1) the Fiedler oddity law for trinested M -schemes without outer ovals.
- (2) Viro's oddity law extending Fiedler's to an arbitrary number of outer ovals.
- (3) Viro's sporadic obstructions (mostly concerned with the case of naught outer ovals safe one exception).

So let us consider Fiedler's setting first in the hope that history was right in finding it first. We have then basically $22-3=19$ ovals ranged in 3 nests.

We must first distinguish between two tricolor spectra:

- (C1) two black, two white and one red ($5=2+2+1$); or
- (C2) three black, one white and one red ($5=3+1+1$).

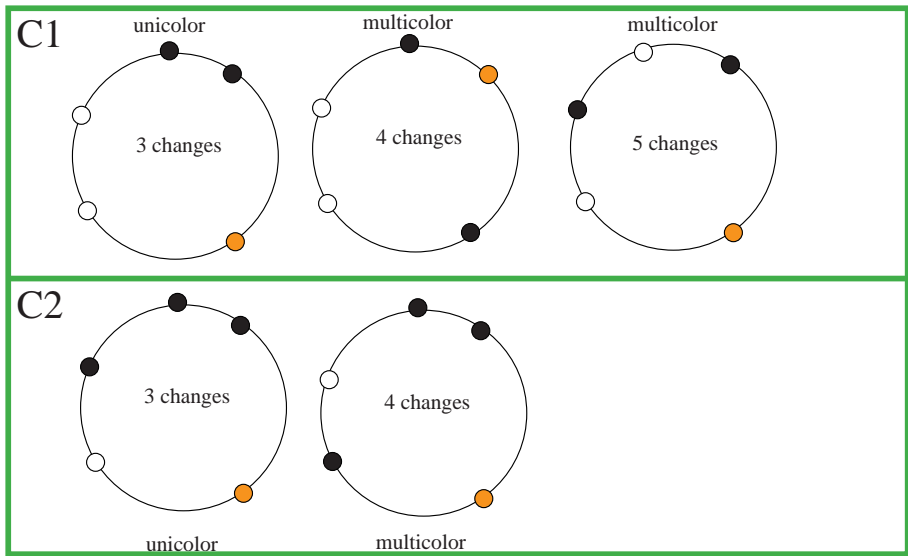

Figure 67: Trapping argument on the singular curve: genuine vs. fake medusas

Perhaps one can do all the work solely with the color spectrum C1, as the 2nd one really pertains to the 1st line of the 1st layer which is already completely elucidated by the constructions of Wiman, Viro and Shustin.

Further, as we said it seems that the color-palette (C1) has the definitive advantage that the interpolating conic cannot split off a line, because then the five points migrate apart in the two lines, one of which containing three of them (pigeonhole), and in the colorimetry C1 this forces a dichromatism, hence $3 \cdot 2 + 2 \cdot 2 = 10 > 8$ intersections with a line (against Bézout).

So in the color (C1), it is ensured that the interpolating conic is smooth and therefore unique.

To fix better ideas, we examine Fiedler's scheme $\frac{1}{1} \frac{2}{1} \frac{16}{1}$. Here we distribute the 5 basepoints on the deep ovals along the coloration C1. So we choose a pentad with one point on $\frac{1}{1}$, two points on the deep ovals of $\frac{2}{1}$, and 2 points on the 16 ovals of $\frac{16}{1}$. Here there is $\binom{16}{2} = 8 \cdot 15 = 120$ ways to proceed up to continuous deformation.

Again by continuous variation of the pentad, the conic varies continuously, and as it stays smooth (C1 hypothesis) the distribution of colors stays constant during the deformation. Accordingly, each distribution of 5 points on the deep ovals of colorimetry C1 defines unambiguously the number of color-changes which is either 3 (unicolor), or 4, 5 (multicolor). So from a brute statistic viewpoint, among the 120 possible distributions (in case of Fiedler's curve), it would be pure miracle if all 120 chromatic numbers would be 3. The probability for this event would be ca. $(\frac{1}{3})^{120}$.

From this perspective, it looks very miraculous that trinedsted M -schemes exist at all, e.g. Shustin's scheme $4 \frac{1}{1} \frac{3}{1} \frac{11}{1}$ where in technicolor C1, there is $3 \cdot \binom{11}{2} = 3 \cdot 55 = 165$ possible distributions of pentads. All of them have to be unicolor, and this is a probabilistic miracle, yet made real by geometry.

So the big problem is to find a *technique d'existence* of a multicolor pentad on a Fiedler curve of type $\frac{1}{1} \frac{2}{1} \frac{16}{1}$ (more generally on any curve declared prohibited by Fiedler, and especially Viro)

[25.09.13] Besides, the whole theory of the dissipation of the candelabrum can obviously be correlated (via a tri-ellipse plus a line) to Viro's census of septics (especially M -septics). In particular one of Viro's global obstruction should prohibit certain candelabrum patches. It must be of primary interest to work this out in full detail at the occasion.

5.12 F4+F4

[28.09.13] To construct curves one natural method is that of dissipation theory, small perturbation of common objects. The point is that singular (in particular decomposed curves) are better known and anchor-bases toward the exploration of new continents. This is the philosophical substance of Viro or older methods. Alas even in degree 8 the method seems in panne toward solving the isotopy classification (Hilbert's problem) unless one is able to prohibit what has not yet been constructed.

One basic idea would be to smooth two $F4=X_{21}$, yet not incarnated as a quadri-ellipse, but as a more complicated curve interconnecting those germs.

However we had already this idea a long time ago, and actually any octic with this prescribed configuration is a quadri-ellipse. Indeed the osculating conics with prescribed contacts of tangency along the 2 singular points form a pencil. Imposing to visit any additional point of the C_8 gives $2.8 + 1 = 17 > 16$ intersections so that the octic has to split off the conic of the pencil through that point.

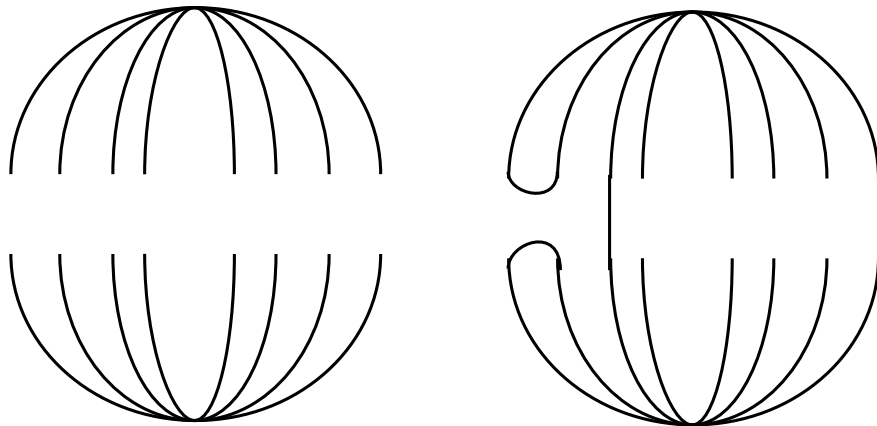

Figure 68: F4+F4: two rainbows

5.13 Some general ideas: Stonehenge alinement of all Gudkov pyramids

[27.09.13] (Written down but based on a older idea ca. April 2013, when publishing v2 of this text).

As we wrote in the introduction (of v.2) it seems that there is phenomenon of stability under satellites that was anticipated by Wiman 1923, and Rohlin 1978. Here it is understood that if a scheme of a certain degree is saturated (usually via Bézout) then all its satellites are likewise saturated.

The special corollary is that the Gudkov pyramids in degrees an integer which has a rich decomposition into primes will be more lacunary than those in degree a prime where no censorship is induced by satellites. So Gudkov pyramids in primes degree will appear as dense crystal with a minimal number of prohibitions, while those of compound degrees will have a much more lacunary architecture, with several flaps and wings of the edifice completely missing.

Of course the drama is that censorship under satellites (even combined with all versions of Gudkov periodicity) does not explain all prohibitions as best exemplified by degree $m = 8$. This constat follows from the Fiedler, Viro, etc. prohibitions, at least granting them as being correct.

So the general Hilbert's 16th problem splits into two parts:

- (1) the regular prohibitions explainable by periodicity, and satellites censorship,
- (2) the irregular part formed by several sorts of prohibitions, whose raison d'être is poorly understood (at least by the writer). Of course it could be

that all those Fiedler-Viro-Orevkov style prohibitions are subsumed to a basic Bézout-Möbius style of prohibitions; or to the method of total reality.

Another way to emphasize our ignorance is along the following quantitative idea. As we know, of the about 144 logically possible M -schemes in degree $m = 8$ satisfying Gudkov periodicity only about 83 are constructed at most 89 of them are constructible (if the present state-of-knowledge is reliable). Hence, for each integer m we may list all logically possible schemes (under Gudkov periodicity when m is even) and denote their numbers by $G(m)$. Of course we also take into account the basic Bézout-Hilbert style prohibitions prompted by intersection with lines and conics, etc. Here already it becomes a bit messy to dissociate trivial from nontrivial obstructions. Yet let us assume that there is a well-defined $G(m)$ taking into account all trivial obstructions plus Gudkov periodicity. In contrast one defines $R(m)$ the number of schemes which are effectively realized. For instance $R(6) = G(6) = 3$. Then $83 \leq R(8) \leq 89 \leq G(8) = 144$. The ratio $R(m)/G(m)$ measures essentially the existential probability for an M -scheme to be algebraic. Naively, see especially the note by Kharlamov-Orevkov 2003 [1133], it seems clear that even $R(m)$ grows exponentially with m . However algebraic curves may become a rarity as m increases and we could imagine that $R(m)/G(m)$ tends quickly to 0 as $m \rightarrow \infty$.

Of course here Gudkov periodicity only intervenes for a censorship factor of four and so can be actually ignored without altering the qualitative behavior of the asymptotic ratio. As we said above we expect that when $m = p$ is prime the score $R(m)$ of algebraic schemes is high and viceversa it is low when m is much compounded. Thus perhaps $R(p)$ is sufficiently high that the ratio starts an oscillating behavior without tending to a definite limit. Of course all this a very naive speculations and just supply a vertiginous feeling of imagining which sorts of combinatorial tour-de-force is requested to get some intuition of how high order algebraic curves looks alike.

5.14 Dissipation of the candelabrum via the theory of septics

[25.09.13] [not yet written, but a straightforward adaptation of what we did in degree 8, with Viro's X_{21}]. The basic idea here is to attempt to get as many curves as possible from a tri-ellipse plus a transverse line. As a reasonable competitor, one can consider a basic septic consisting of a tri-ellipse plus the line tangent to the triple branch. Then we have again an X_{21} -singularity (F4 in our more naive notation), and perhaps the theory of septics affords prohibition on the X_{21} -patches.

It is clear that the whole topic is so much ramified that the researcher quickly loses his strength and moral along the menagerie of pathes to be explored.

5.15 Dissipation of X_{21} via septics

[25.09.13] In this section we focus on the *sunset* septic depicted below, consisting of a tri-ellipse plus the line tangent to one of the singularity. Then one may apply the usual patchwork method, while hoping to infer “relatively new” (i.e. new for our own personal understanding of the topic) obstructions on patches. By the way, the universal (absolute=Russian) knowledge is not complete in our opinion.

First, we tabulate the table induced by Gabard's patch C1 for $X_{21} = F4$. Here the scheme depends only upon the value of γ and we get effective constructions of five M -septics (marked by little green squares on the table below). Using Viro's patches C2 we get very monotonically the sole and same scheme 15 (unnest) due to Harnack first. Using the patch C3 (where $\alpha = 1, 5$) gives two schemes already obtained via C1. Finally, employing the patch E, we get four M -schemes marked by green circles, two of which being “new”. However our expectation to deduce new prohibitions is *not* borne out because the (sole) prohibited M -septic is never encountered.

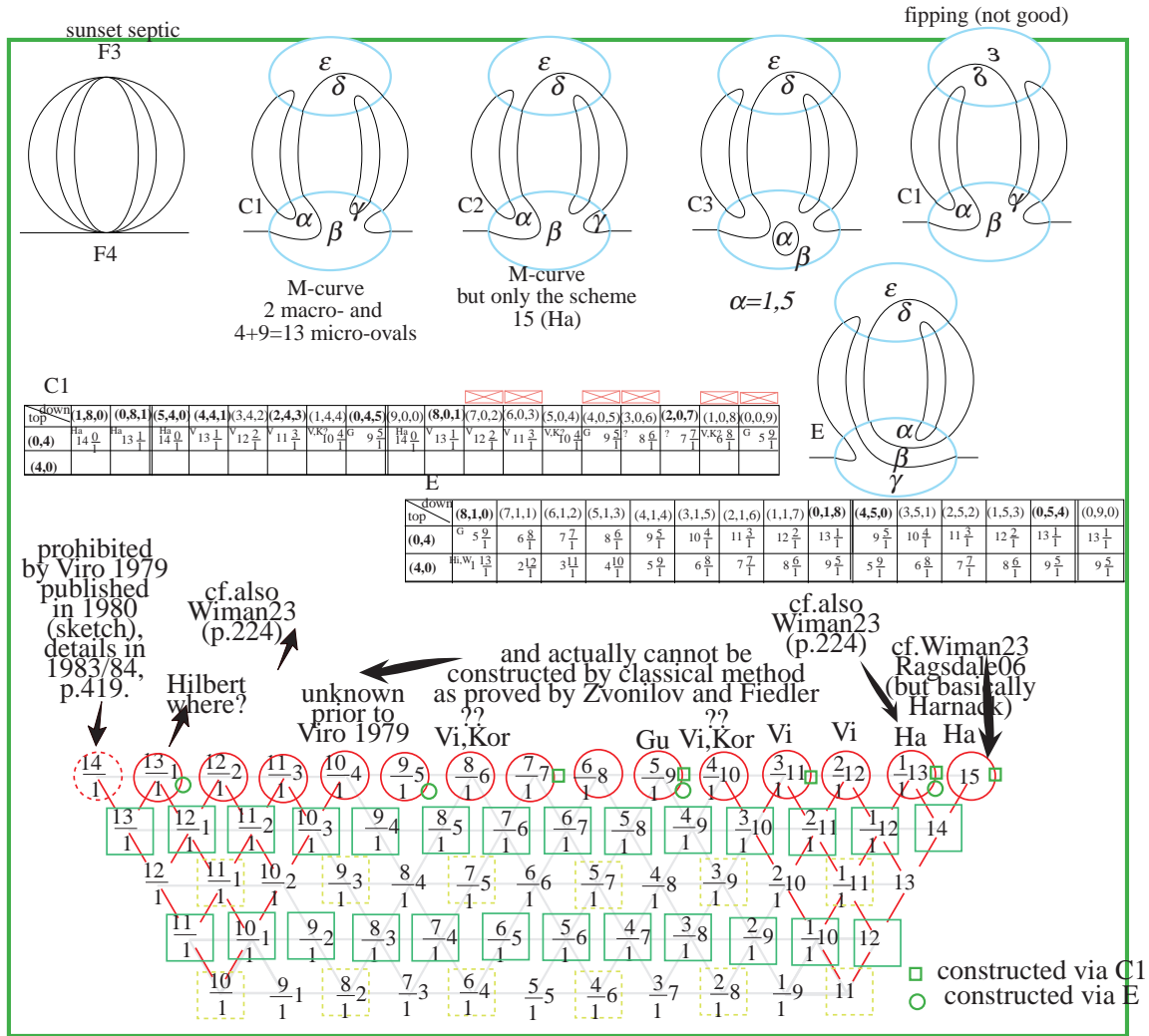

Figure 69: Septics and X_{21}

Further one must also analyze the other types of patches (A, B, D, F, G, H, I, J) according to our catalogue (Fig. 18). Working this out, we note that first the G-patch gives interesting M -curves, yet with one outer oval visible as macro-oval hence there is no chance to draw a prohibition via Viro's obstruction of $\frac{14}{1}$ (maximally nested scheme). Then, interestingly, the patch H creates 3 macro-ovals, and so we get an M -scheme despite non-maximality of the patch employed. It would be interesting to work out exactly which M -schemes are so obtained, but the presence of one outer lune will not produce any prohibition. Then we may flip the H-patch, but this forms a snakelike oval wasting much of the energy in meanders. Finally, the patch I looks the most promising as there is no outer ovals. Indeed, the patch I(9,0,0) would create the M -septic prohibited by Viro, but the former (patch) was already prohibited by Gudkov periodicity applied to the doubled patch (with 0 big eggs, hence not $2 \pmod 4$). So:

Scholium 5.22 *Quite disappointingly the theory of septics does not prompt any prohibition upon the patch for $X_{21} = F4$ the flat point of multiplicity four.*

Of course when less tired one can do the same game for the candelabrum using the septics consisting of a tri-ellipse, plus the line through both singularities.

As a guess, it seems that—since the theory of M -septics is so little obstructed—we may not be able to draw any serious prohibitions on patches by this method. So, one may wonder what is the avatar in degree 8 of the quadri-ellipse allied

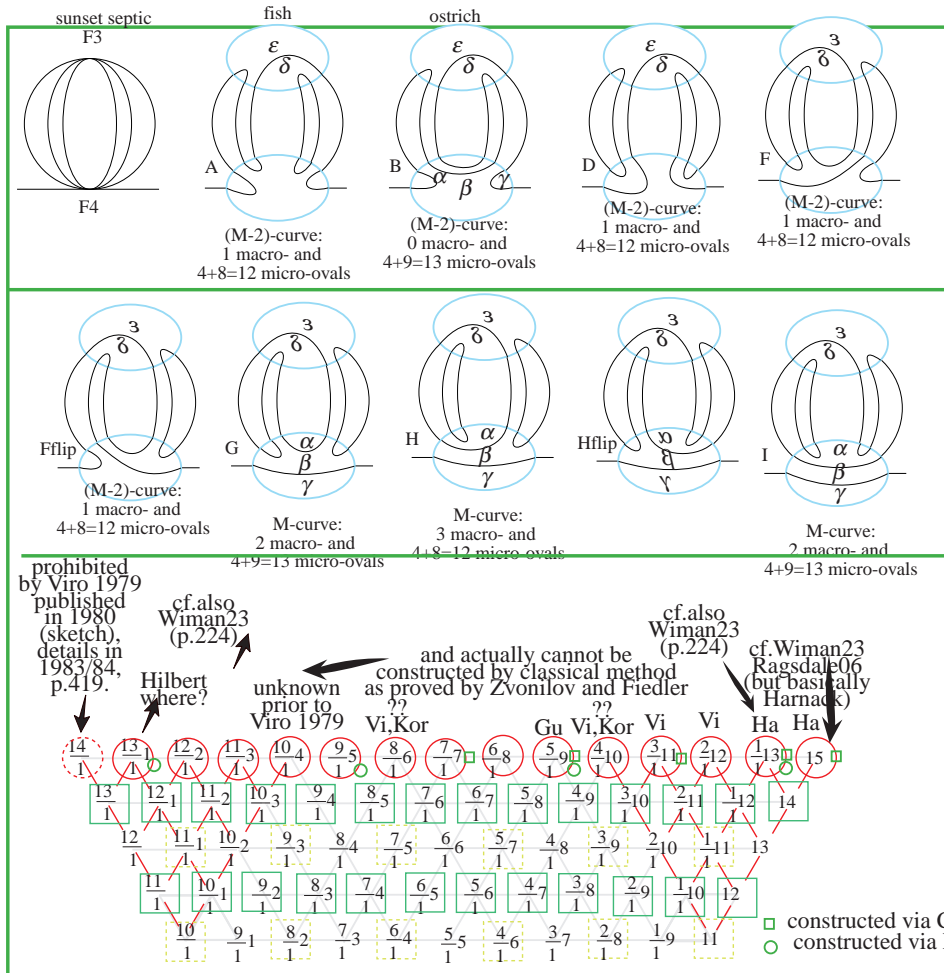

Figure 70: Septics and X_{21} (continued)

to $X_{21} = F4$, when it comes to the candelabrum C4. Perhaps the natural candidate is Shustin's medusa.

5.16 Sequel of old text

Sequel of the old text.—Now at some more fundamental level the ubiquity of the horse-shoe—as a fundamental shape crossing four times a line—becomes when smashed Viro's pattern of dissipation of type C (i.e. lateral double-lune plus two simple lunes). Actually as shown by Fig.e it seems that the method only yields the types C, D, and A. Of course the operation of smashing is akin to chocolate and cream decoration in French gastronomy, namely the experience of taking a knife and dragging through black chocolate and white-colored cream so as to created the depicted patterns.

As we note yesterday already it seems that Viro does not exploit the rabbit with one invaginated ear (as depicted on our Fig. a), and this can be interpreted as a so-called "angst-Haase", i.e. an *anxious rabbit*. Of course, it is hard to imagine which affine quintic could be the antecedent (primitive) of this angst-rabbit, since Polotovskii's curves seems to be the only possible alternative to standard undulations. Let us yet, cavalier, inspect which sort of patch could result from such a possibility. In fact, noting that the angst-Haase has in fact two circuits we can better imagine which sort of quintics is the primitive of the configuration. This amounts just to breakdown of the wave from Polotovskii's model, and this by Bézout can only occur if the separating mass of water contains no bubbles of oxygen (otherwise Bézout for quintic is violated unless the configuration reduces to the deep nest $\frac{1}{1}J$), which has however a too ridiculous number of oval to merit our attention. Notwithstanding if the breaking mass

of water is empty (of oxygenation) then the configuration is permissible, but of course we lose one micro-oval having only five of them on the quintic (since one is consumed by the breaking mass of water). Hence before doing any specific depiction we look wrong engaged to reach any M -patch from the angst-Haase.

Now, albeit this fails miserably, we get the idea that starting say from Fig. 1 we can do the dissipation in such a way that the ear intercept the smashed line, and so we get the variant V1. This produces the patch $A(0,0,1,0,7)$ using more-or-less self-explanatory notation. Of course, this only an $(M-1)$ -patch because to get the type A, we essentially wasted one oval just to create the singularity X_{21} , and thus we cannot expect an M -patch. Our patch when doubled gives the scheme $17\frac{2}{1}$, which is well-known (i.e. accessible to Viro's purest method via the quadri-ellipse).

Now we confess being a bit a "cours-d'imagination", yet we can still explore the result of opting always for the dual vibration. It seems that this trick essentially amounts to the symmetrization device used by Viro as shown by our Figs. D1 and M1. Still a systematic search looks desirable. To explore this properly we need a new figure (Fig. 71). For the next dualization D2 we get the same patch $C3(1,7)$ due to an evident symmetry. Working out D3, we get as expectable from D1 just the symmetrized patch $C1(0,4,5)$ where over the original construction O3 the lateral symbols are just switched. Alas this patch is not new as it was already cooked by Viro's M3 (on the former plate=Fig. 43). At this stage it seems that the work is automatic, i.e. the dual vibration should just produce the patch with palindromic parameters, i.e. (α, β, γ) changes to (γ, β, α) . Yet some surprise (cf. the mirrors of the earlier plate) still encourage us to tabulate naively the dualized patches. (Philosophy: Nothing is more concrete than mathematics, especially geometry.)

Then we arrive at D4 and this is certainly not even worth depicting by same symmetry as that encountered by D2. Next we arrive at D5(dual), but then it seems necessary to distinguish two cases depending on the location of the newly formed micro-oval arising through dissipation of the triple-point. In the first version $D5=D5A$, the new oval is on the left, while in the 2nd version $D5B$, it sits on the right of the line smashed under the hyperbolism. The 1st cast yields the patch $C1(7,0,2)$, heavily prohibited by Viro's oddity law or by Orevkov's dematerialization of the boson $b3$. At this stage the philosophy is two-fold: first Viro's method (liberally interpreted) seems nearly to violate Viro and Orevkov's obstructions as we saw via $D5=D5A$. However dissipation $D5B$ leads to an admissible patch, and is by the way kinematically more likely, since the new micro-oval is located in the prolongation of the branch performing the vibration. Still, one could counter-argue that even on Fig. D5 we could arrange this property by increasing the curvature so as to form an isthmus nearly connecting the branch to the micro-oval (cf. detail D5D). Perhaps one can counter-counter-argue that the infinitesimal cubical patch then seems to violate Bézout by tracing the orange-line which seems to intercept five times the cubic. So we gain perhaps here some insight of why it is not so easy to corrupt Viro's oddity law nor Orevkov's obstruction.

Then we have D6 (dual) with again a surrealist micro-oval formed on the left and the resulting patch again violates Viro's oddity law. However, the more realist version $D6B$ produces the patch $C1(4,4,1)$ already found by Viro (at least provided that there is a misplacement of the symbol γ on his Fig. 55). Of course it is also more likely that our visualization of the hyperbolism is slightly incorrect leading to a twist of all the results. In any event this is merely a psychological difficulty that should be easy to fix once more time is available.

Another point is to wonder if there is also a bifurcation of the dual dissipation in the earlier cases 1,2, 3, 4 depending on the location of the micro-oval. Of course we can drag on D1 the micro-oval on the right of the smashed line, yet this will not affect the isotopy type unless we drag this oval to its ultimate confinement, namely inside the meander, back again to the left side of the smashed-line. However the resulting patch will frankly corrupt Bézout (for lines) as the duplicated patch will exhibit a nest of depth 3 plus an outer nest

of depth 2, forcing 10 intersections with a line through their centers.

At this stage we must (rather disappointingly) confess that Viro's search looks exhaustive unless one can imagine a really new twist of the construction.

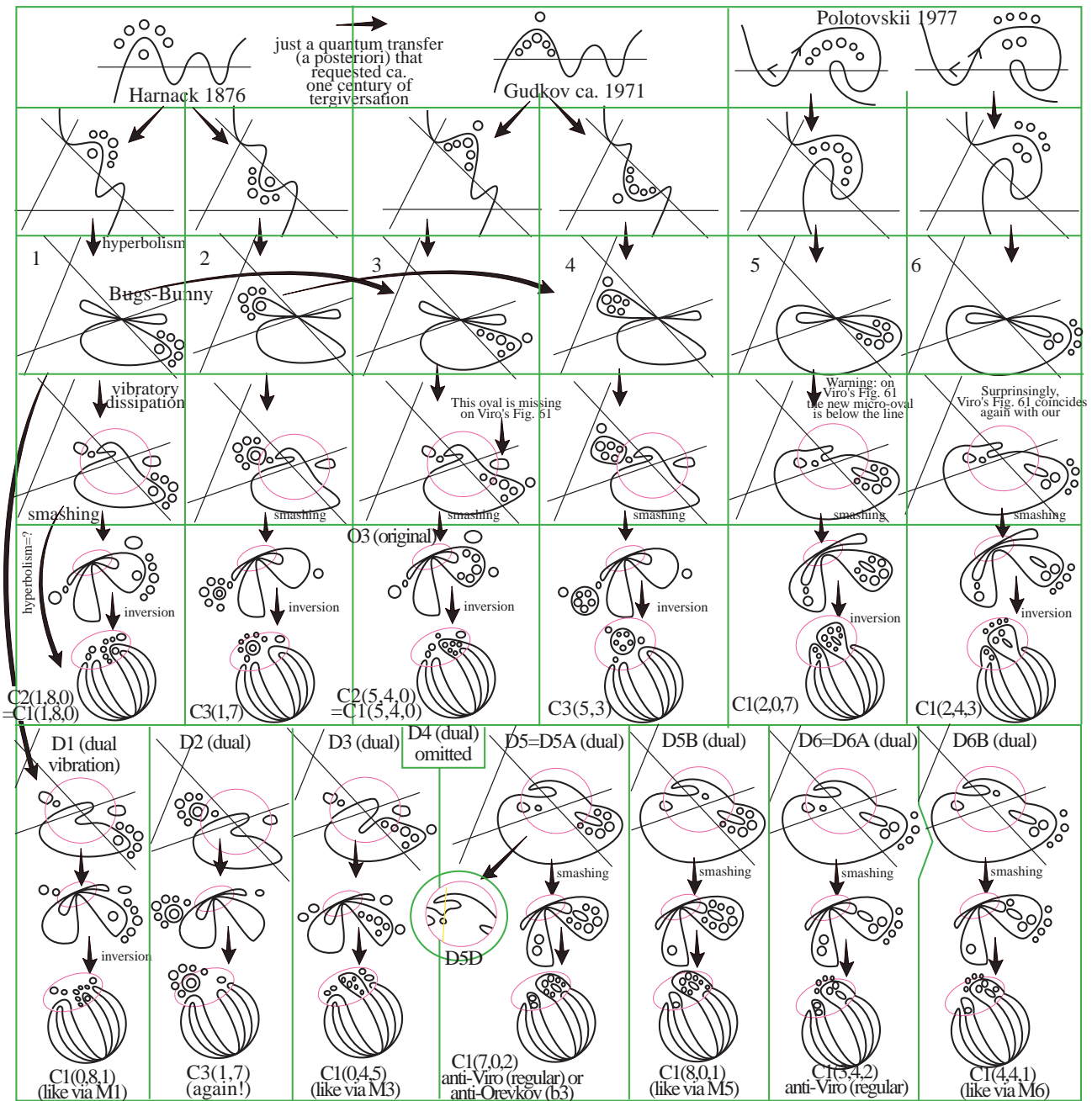

Figure 71: Dual vibrations as those of Viro

So far so good, and we have modulo the C1-versus-C2 ambiguity a complete understanding of Viro's theorem regarding patches of type C. It remains now to understand those of type E (trinedsted lune), which are explained in Viro, p. 1119 (especially Fig. 56). Alas, this figure is awkwardly depicted in the Bible (Viro 89/90), but seems to involve another genius stroke of Oleg Yanovich's imagination.

6 Viro's vibratory method

This section explains another fundamental construction by Viro, in some sense even more elementary than the one involving hyperbolism presented earlier.

6.1 Viro's trick for patches of type E (trimested lune)

[03.09.13] Viro starts with a pair of conics tangent at one point and transverse at the remaining two points (cf. Fig. 72). A suitable perturbation of their union offers a quartic C_4 oscillating as depicted across C_2 . Note that the intersection $C_2 \cap C_4$ is totally real involving 4 transverse and two 2nd order contacts at the "north pole". Actually, as the sequel of Viro's Figure 56 involves an A_3^- -singularity we wondered if the perturbation C_4 is not rather involving a tangency. Recall that A_k^- is the germ of $y^2 - x^{k+1} = 0$. Then we managed finally understanding Viro's picture despite being really poorly traced (at least on my small sized Xerox copy of the article). Notwithstanding Viro's construction is genial, and the crucial step is to count properly the contacts to get the right perturbation (Fig. a). At the A_3^- -point we have two contacts of order two between C_2 and C_6 , while at the J_{10} -point we have 3 contacts of order 2. Hence the intersection $C_2 \cap C_6$ consists already of $2 \cdot 2 + 3 \cdot 2 = 4 + 6 = 10$ intersections (counted by multiplicity), whence the possibility to impose two additional intersections as shown by the bump on Fig. a. The sequel of the construction should be self-explanatory from the figure. It is perhaps still puzzling that at some stage of the argument we thought that the line through both singularities of the C_6 would corrupt Bézout, but apparently not so. Another slightly puzzling aspect is that on Fig. b the curvature of the branches of the tripod-singularity J_{10} does not seem respected: maybe there is a topologico-metrical parade identifying this as mere optical illusion).

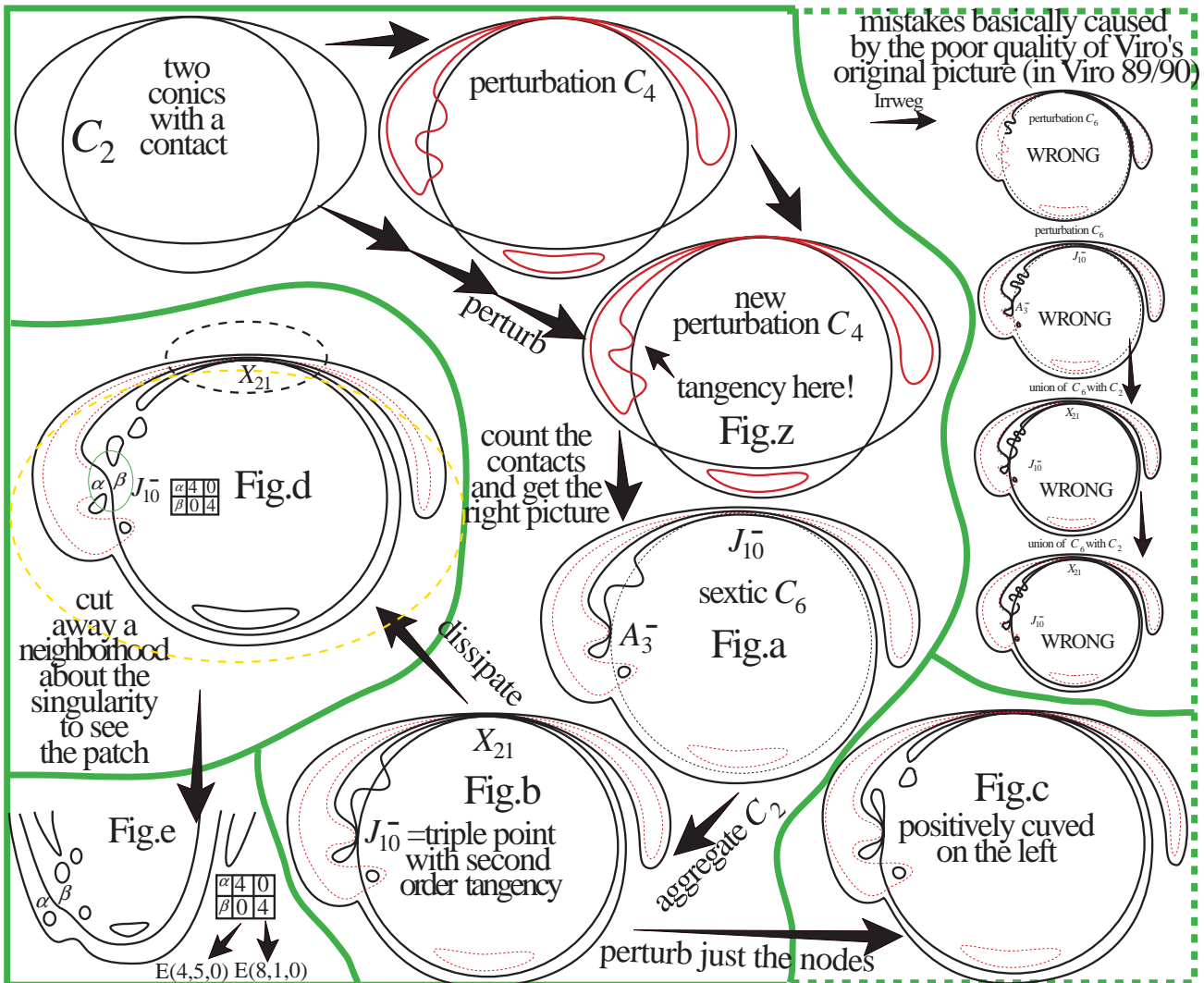

Figure 72: Viro's vibrational method leading to the E-class (trimested lune)

Added [14.09.13].—Actually there is at last two parades. A first involves Fig. c consisting in first dissipating the nodes of the C_8 (Fig. b) and one may expect the resulting curve C_8 having three branches positively curved inside the same half-plane. Then we are in a position to apply the usual dissipation theory of this triple point (J_{10}). The other parade is that our Fig. b is actually much distorted. In reality, the two branches at J_{10} which looks curved to the left are in reality much closer to the circle C_2 to such a point that those branches are in fact curved to the right. Concomitant to this, remark that on our picture of the quartic (Fig. z), the line tangent $T_p C_4$ to the bicontact of $C_4 \cap C_2$ seems to intersect 6 times the quartic. This aberration is dissolved if the curve C_4 is imagined much closer to the circle. Getting a metrically accurate vision is a challenging task, compare optionally our free-hand Fig. 73.

Next, dissipate the triple-point J_{10} to get Fig. 72d. Finally, cut away a neighborhood of the X_{21} -singularity to find with the complement a patch for the same singularity X_{21} . This is a trivial, yet somewhat miraculous step, reminiscent of Steiner's Wiedergeburt und Neuaufstehung (when it came to philosophize about inversions). From Fig. e we easily recognize the patches $E(4,5,0)$ and $E(8,1,0)$, in the notation of our catalogue (=Fig. 18). Keep maybe in mind the following slight objection: the excised object is an $\mathbb{R}P^2$ less a disc so a Möbius band, hence not so much a topological disc, as one imagine the patch substratum. This defect can be resolved by choosing instead the yellow-colored ellipse and by keeping its inside instead (see again Fig. d).

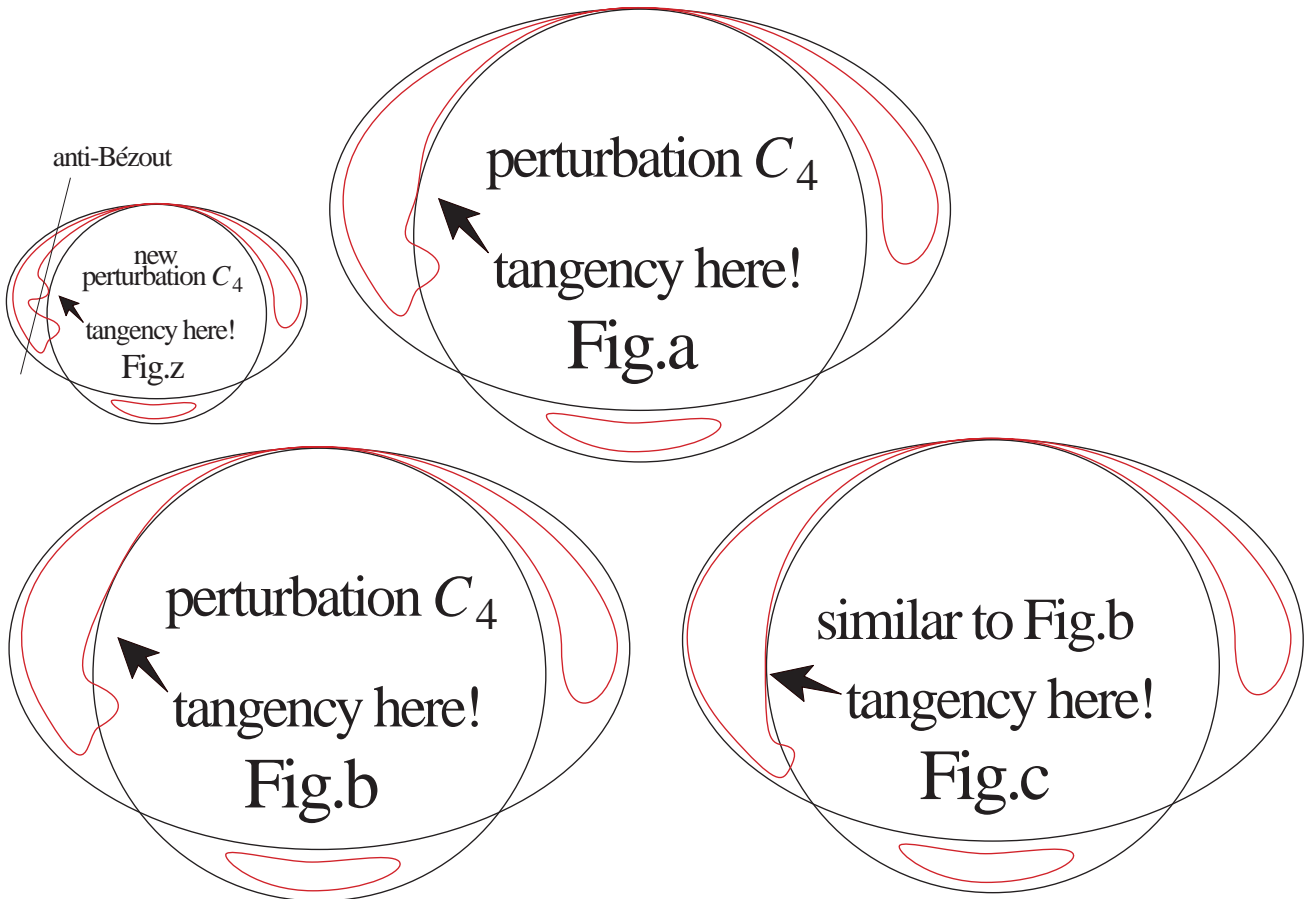

Figure 73: Viro's E-class (trimested lune)

Note: If we could choose other values of (α, β) , e.g. $(2, 2)$, we could get more patches, but unfortunately $(2, 2)$ though realistic as being involved in subdivision of Gudkov's sextic $5\frac{2}{7}$ —imagined as a patchwork of J_{10} -singularities—are not realized since when glued with Viro's patches $(4,0)/(0,4)$ yields sextics corrupting Gudkov periodicity.

Comparing with Viro's catalogue, we still miss two of his patches. In his article (Viro 89/90) he proposes a conceptual argument we were not able to

follow. Surely, there is alternatively a variant of the construction in view of the palindromic reversion of the missing parameters. (The sequel will indeed supply an alternative of Viro's construction doing this job.)

More importantly, the class E is presently not much obstructed and one is naively expecting that a variant of Viro's trick should be capable producing more patches, especially those materializing the two remaining subnested bosons B4 and B14.

One naive idea is what happens in the above construction if the oscillation (bump) of Fig. a is effected on the other side of the circle, or eventually below the tacnode singularity (A_3^-).

A more elaborate idea that we had later on that day (22h31), is wonder about the case where two tangencies are arranged. However it seems then that we get already $(2 + 2 + 3) = 7$ second order contacts between the C_6 and C_2 (even prior to introducing any bump). This yields a multiplicity intersection of $7 \cdot 2 = 14$ corrupting severely Bézout. So it seems that we cannot arrange such a double bicontact (as on Fig. A). Perhaps it would still be of interest to see which sort of patches results from transgressing this Bézout obstruction (probably one which overwhelms violently Harnack's bound). To our little surprise Harnack is respected (9 micro-ovals) despite the double production of ovals allied with the pair of triple points, but the patches so obtained $E(1,8,0)$, $E(9,0,0)$ and $E(5,4,0)$, when doubled certainly violates Gudkov periodicity (e.g. $2 \cdot E(1,8,0) =$). For instance, $E(9,0,0)$ doubles to the scheme $1(1,0 \frac{19}{1})$, which is not to be found on the periodic table of elements.

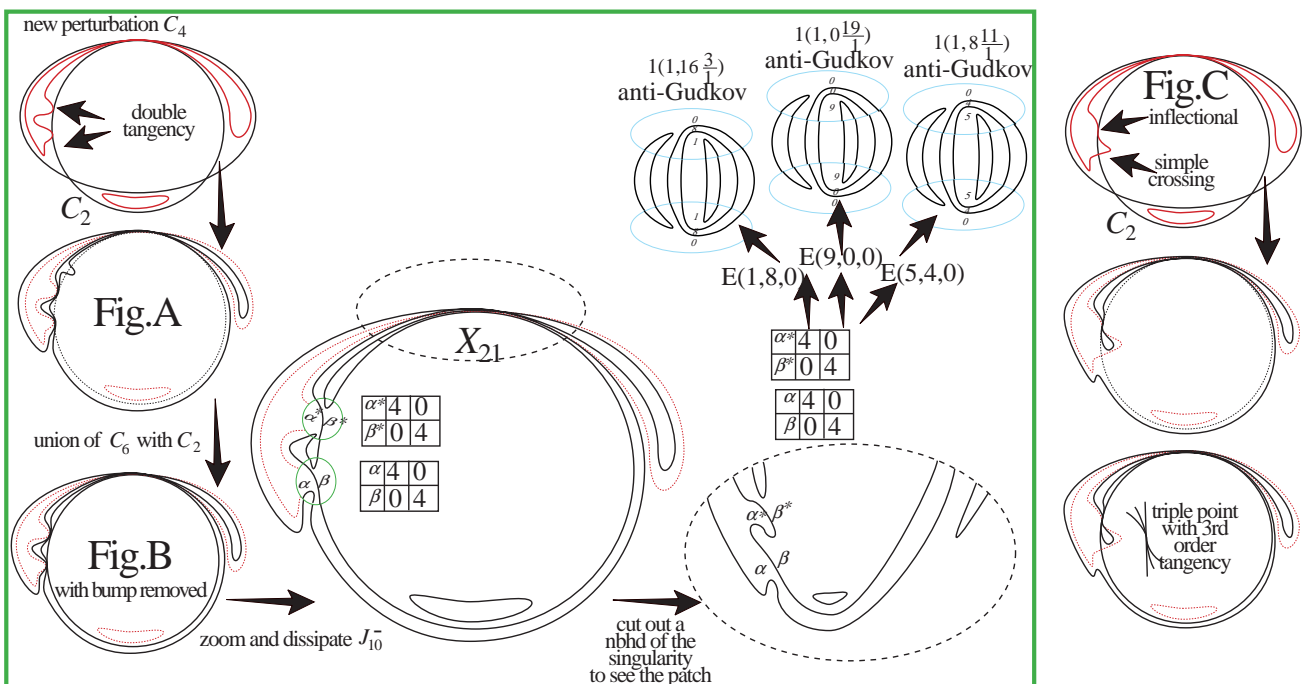

Figure 74: Double bicontact (fails miserably against Bézout and then Gudkov)

Despite failing miserably, our attempt may adumbrate other combinations of singularities and contacts permissible for Bézout procuring more patches (potentially leading to new breakthroughs of more flexibility in Hilbert's 16th).

[05.09.13] More modestly, we may wonder if this elementary vibrational method of Viro (yielding the E-patches) modifies as to offer as well the C-patches constructed by the somewhat different technology of hyperbolisms. (We shall find a positive answer at least upon admitting some common elasticity of algebraic geometry.)

Turning again to our last miserable construction (double bicontact), one can wonder if the topos is improved if we amend on the outer side of the ellipse (Fig. X). Of course, this will change nothing to the numerology of bicontacts, and Bézout is still jeopardized.

One another possibility is to have a triple contact followed by a transverse crossing (as shown on Fig. C). It remains then to improvise the dissipation theory of triple point with 3rd order tangency.

Another option is that of introducing a finger-move on the quartic like on Fig. D., on the variant of Fig. E. Of course Bézout looks foiled when tracing a suitable line centered through the Hohlraum (=trap) formed by the finger-move. Still, on resorbing progressively the “Falaise-pocket” through the isotopy suggested by Figs. E,F,G we may rehabilitate Bézout, and so perhaps there is some quartic perturbation realizing the qualitative picture of Fig. G. Alas, the latter as another Bézout defect with respect to the dashed line, but this can be remedied by deflating the inner bump below the “horizon” as shown on Fig. H. As a conundrum, it seems that in the sinuous S -shaped tube there will be a bitangent line which when escaping from the circuit has to create at least 6 intersections with the C_4 .

Despite all those defects, let us apply Viro’s algorithm to Fig. G (as being a respectable isotopic model). On perturbing $C_2 \cup C_4$ we get Fig. g0 with an flex on the left of C_2 , which we perturbed transversally on Fig. g1 so as to avoid referring to an obscure dissipation theory. On the latter figure, we count in the intersection $C_2 \cap C_6$ as many points as $2.2+3.1+3.2 = 4+3+6 = 13 > 2.6 = 12$, overwhelming Bézout. Of course a stupid parade is to lower this mischance-number 13 to 11, by dissipating the undulation yet there is an anomaly with Bézout-Galois (i.e. the Bézout count modulo two over the reals). Another option, would be that during the perturbation we do not have anymore 3 bi-contacts at the north pole of the circle C_2 . Actually, this is the forced scenario as soon as we take notice that the most in-curved branches through the north pole actually crosses the fundamental circle. Hence the true multiplicity count for $C_2 \cap C_6$ as materialized on Fig. g1 is $2.2 + 3 + 5 = 12$ and Bézout is intact. Working out the resulting patch gives C1(3,5,0) and C1(7,1,0). Alas, those have only 8 (micro) ovals, so not M -patches. Still, it seems of interest to stress that so Viro’s vibratory method reaches the C-class of patches, though it looks apparently difficult to gain maximal patches. (We shall soon see that we can arrange maximality in the C-class as well!)

Of course it could be that we misplaced the bump, imagined as cached in the oscillation. So there is perhaps more clever bumps leading to M -patches. So, considering Fig. g2, yields indeed—somewhat miraculously— M -patches, und zwar (=and actually, in German) those with symbols C3(1,7) and C3(5,3). Of course, those are *not* new, but now obtained via a perhaps more elementary method avoiding hyperbolisms. Of course, one challenge could be to obtain all of Viro’s patches (and more if divinity agrees) by this uniform method (due to Viro, but perhaps twistable).

Evidently, we may the alter the finger-move trick by oscillating instead across the eccentric ellipse. This idea materializes to Fig. I.

Scholium 6.1 *Generally speaking, especially in the fingers of Gudkov, Polotovskii, Orevkov, this suggests that most of the constructional aspect of Hilbert’s 16th must reduce to a catalogue of erotical position (kamasutra like) adopted upon by algebraic curves (especially those of decomposing type where both components can interlace along fairly complicated patterns).*

Back to Fig. I, we derived only $(M - 1)$ -patches via Fig. i1, but perhaps we missed a more strategic option. Indeed, adhering to the more clever smoothing of Fig. i2 we arrive at M -patches, but alas the same as those already obtained (via Fig. g2). Did we exploited all possibilities? As usual it is here that the brain starts blocking, as the problem requires both memory and combinatorial skills (creativity), which are somehow incompatible hemispheres of the brain (like the dead and vive memory in computing machines).

A naive idea is to vary the bump location. So from Fig. g2 we manufacture Fig. g3 (with a bump on the left-fringe of Viro’s hairs which in reality are short-cut). The resulting octic patch has 8 ovals only (and belongs to type A).

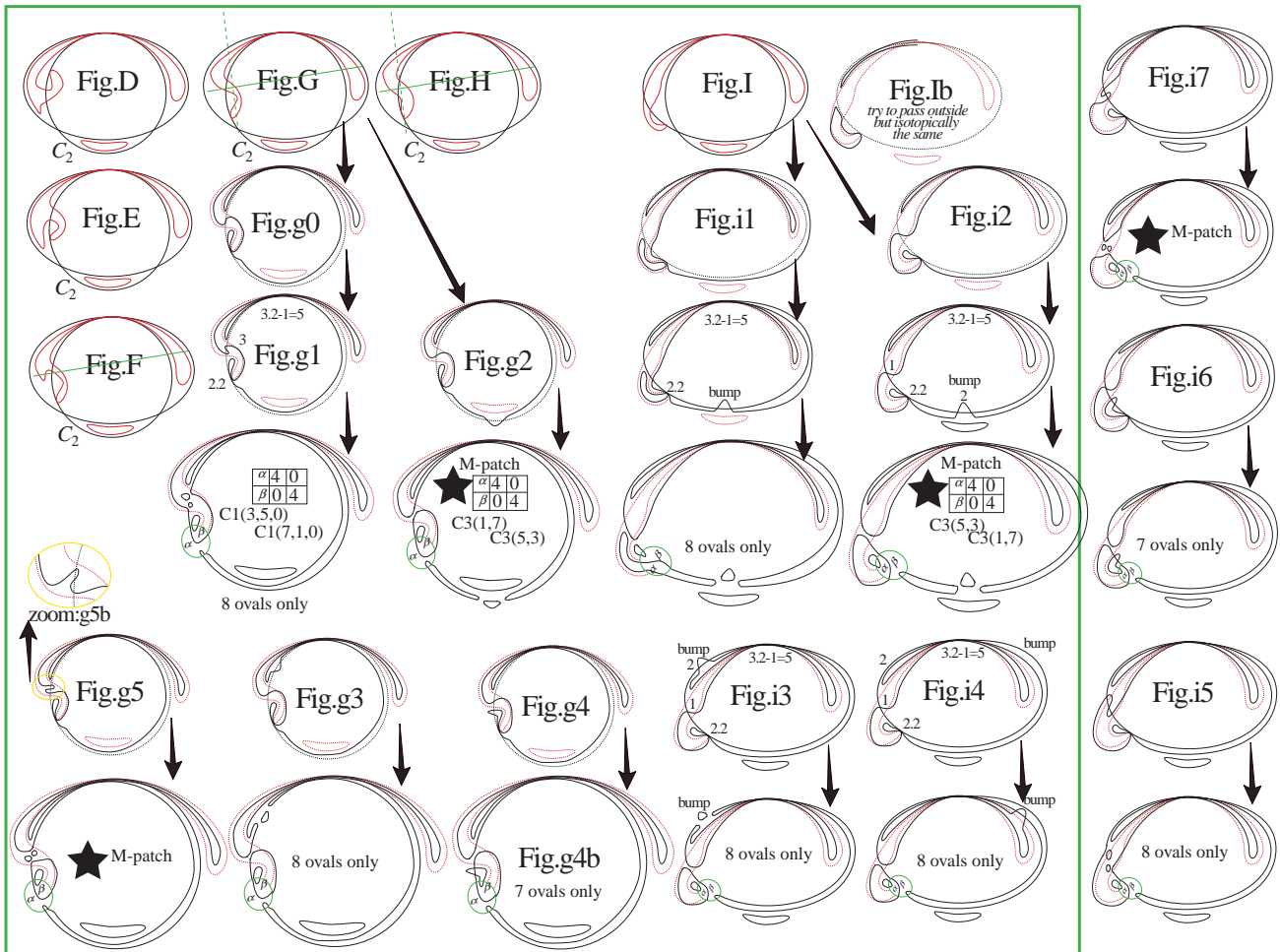

Figure 75: Finger moves: elementary construction of the C3-patches

Next Fig. g4 shows the case where the bump is placed inside of the ventricle. This variant looks quite erotic, yet hopefully still algebro-geometrizable. We get so Fig. g4b where there is two maximizing options of smoothing (nested or not), but alas there is only 7 ovals created (either way).

Of course it remains now to work this out more systematically (i.e. all bump locations also the case of Fig. I), but we wanted prior to this to investigate the fairly contorted case, akin to Fig. g1, yet where the undulation sense is “reversed”. By this we mean Fig. g5, which admittedly does not look very natural, but it looks wise exploring all the options as to get a better grasp of the phenomenology. On the zoom:g5b we try to show how the real oscillation looks alike, but it is quite puzzling to know if this works algebraically. Working out the next perturbation, gives us indeed M -patches, but unfortunately the same ones as those cooked by Fig. g2.

[06.09.13] Next we tried Fig. i3 where the bump is placed on the left fringe, but it results only an $(M - 1)$ -patch with 8 ovals. This suggested also placing the bump on the right fringe (Fig. i4), which creates only 8 ovals. Further there is 2 options for smoothing the bumpy part, and one yielding a patch of type D, which as far as we can remember was not yet realized.

Then Figs. i5, i6, i7 are obvious variants, the latter of which giving M -patches, but alas still the same two of type C3.

Next deforming Fig. I we get Fig. J, yet with oscillatory pattern across the ground ellipse isotopic to that of the previous configuration, so that there is no chance to get something new. Fig. K shows a more contorted position for the C_4 , yet one violating Bézout (intersect with the circle), except if one branch is actually transverse to the north pole (the most incurved branch actually traverse the circle, so the contact must be odd and it would arrange us being just one). The result is an M -patch of type A, which for $\alpha > 0 (= 4)$ violates Bézout when

glued with its flip. (Then we get an extension of the biquadrifolium $\frac{1}{1}\frac{1}{1}\frac{1}{1}$, which is saturated in degree 8).

As a moral too much erotical contortion foils Bézout and kills any viable progeniture. Moreover Fig.k2 yields a patch with supernumerary 10 ovals (so violating Harnack, aber Hallo!). Hence Fig.K looks definitively too violent.

Then we have of course Fig.L with an upward finger-move, but by a trapping argument (based on Jordan separation like in Poincaré-Bendixson), it seems impossible that this will ever satisfy Bézout. Despite, it is perhaps still informative to inspect which sort of patches results from this unlikely specie. The perturbation of Fig.l1 yields only a patch with 8 ovals, while that of Fig.l2 seems to corrupt Bézout if we keep the bump. Transgressing this, the resulting patch has nine ovals and is of type A, but of the sort violating Arnold's weak version of Gudkov-Rohlin periodicity. The version of Fig.l2 without bump (at the south pole of the ellipse) probably exists, and yields A-patches with 7 ovals, namely $A_+(5,1)$ and $A_+(1,5)$. When doubled those produce the $(M-4)$ -schemes $6\frac{2}{1}\frac{2}{1}$ and $14\frac{1}{1}\frac{1}{1}$ (whose geography can be checked on Fig. 38).

Next, the earlier Fig.G suggests that the left-fringe of the C_4 may travel as far as to touch the ellipse, and it remains then the option to get a bump as on Fig.M. This gives two M -patches each interpretable as belonging to either class-C1 or C2. Although those patches are structurally new, it is a quite spectacular methodological success because Viro accessed to these patches via the somewhat more elaborate technique involving hyperbolism. Further, this is the first intrusion of Viro's elementary method in the realm of C1- and C2-patches.

Then, we realized that Fig.M may be changed to Fig.N, which may look more natural (hence algebraizable), yet still leading to the same patches as before, since the construction is independent of the circular ellipse.

The next natural variant is Fig.O, but that was already analyzed via Fig. 88z (perhaps later in this text but earlier in our historiography).

At this moment, we see that we can let oscillate the left-fringe (w.l.o.g.) either first tangentially and then transversally (abridged tantra like on Fig.O) or vice-versa first transversally and then tangentially (tratan as on Fig.N). Additionally we can tell the same story by vibrating across the circular ellipse (so-call internal vibration). In principle, we have already followed all those options. However, on comparing Fig.N with Fig.I we see that it is not enough specifying first transverse and then tangent, but there is two options depending on whether the appendicitis makes it contact from inside or outside (again compare Fig.N with Fig.I).

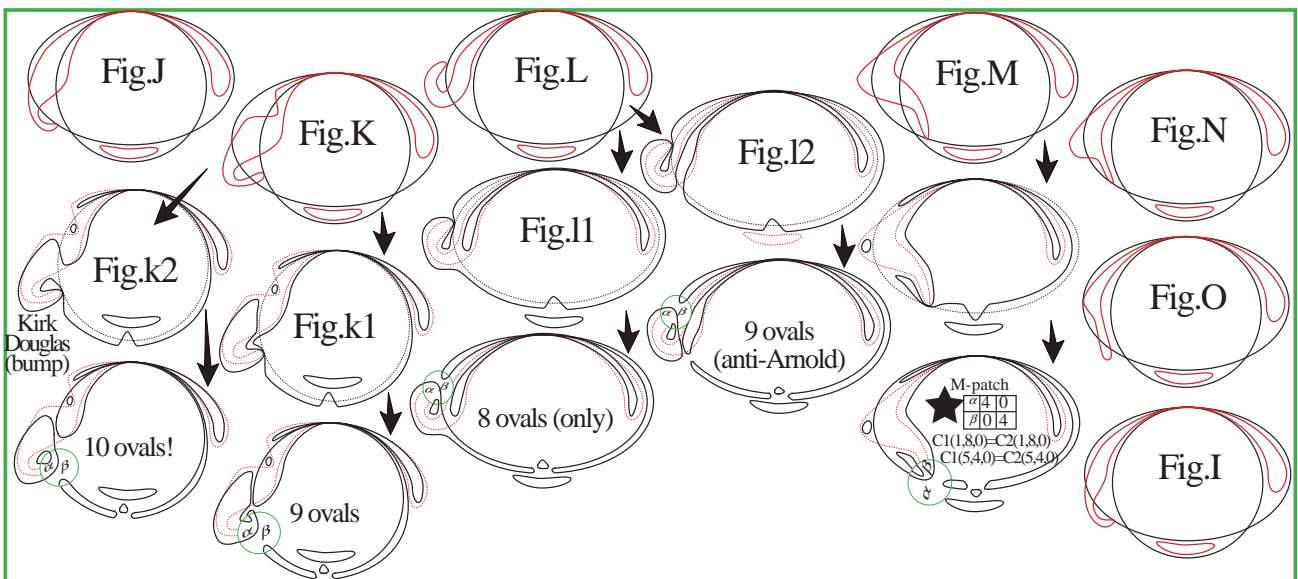

Figure 76: Finger moves: elementary construction of the C3-patches
So at this stage it seems that we can work more systematically with Fig. 77

that should be self-explanatory. Note yet from the eight possibilities two are isotopic for tautological reasons. Next we apply Viro's algorithm (of perturbation with bump) to all possibilities and mark by green triangles the resulting patches on the main-catalogue (=Fig. 18). As we already experimented it seems that to get an M -patch we are forced to bump between the north pole (X_{21}) and the point of tangency of $C_4 \cap C_2$ (which becomes a J_{10} -singularity). After completing this genealogical tree (where it is not necessary to work out the last specimen of each series of four), we recover with triangles all the patches gained erratically by circles via the same method. However we do not get all the C_1 - and C_2 -patches gained by the hyperbolisms method. Unfortunately, it seems that we have exhausted the power of the method, but we may still hope that suitable twist of this basic method will give more patches.

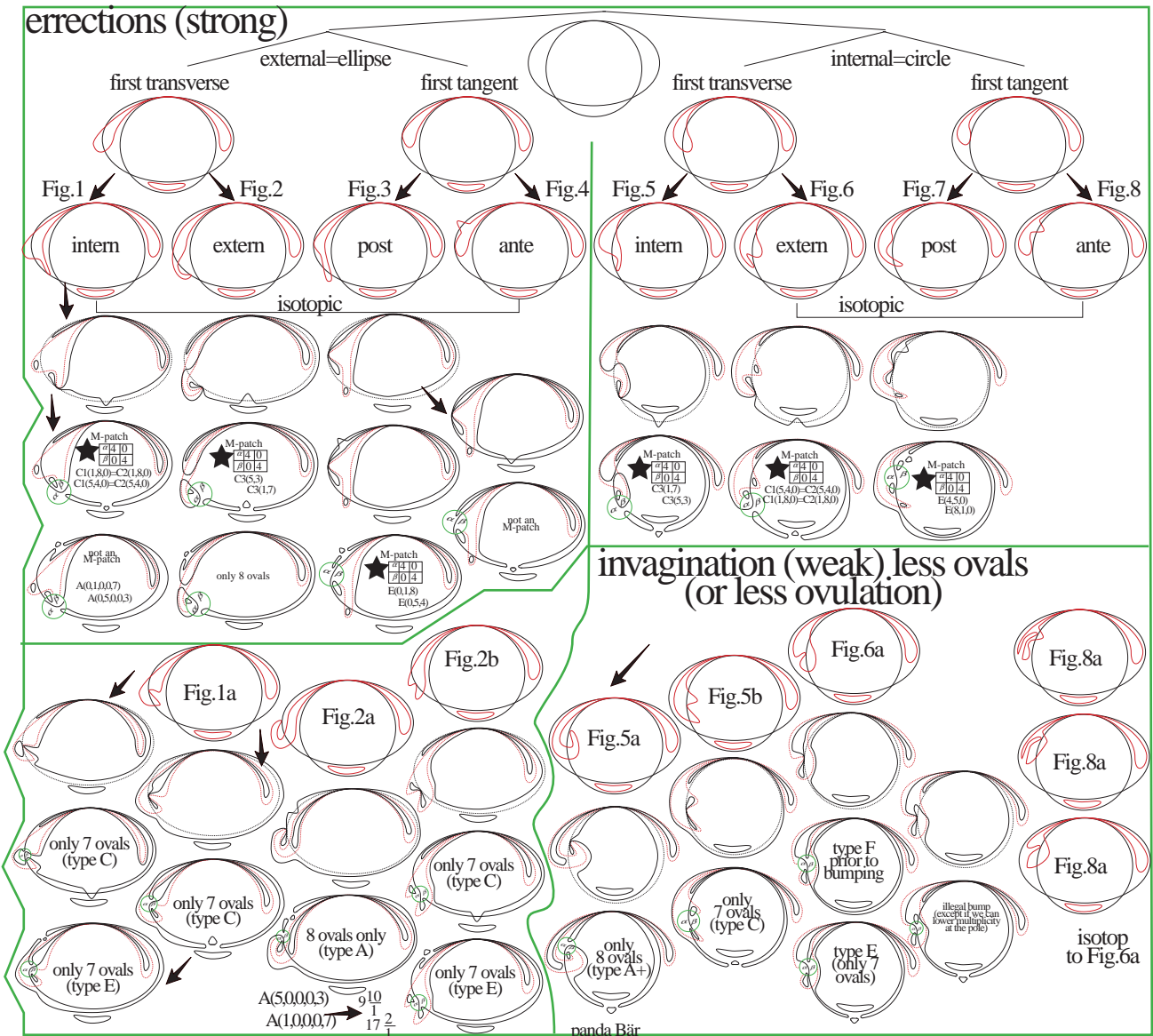

Figure 77: Finger moves: systemic construction of the patches via erections (which turn out to be more energetic than the dual invaginations)

A perhaps promising route is to explore situations where the 2nd cytoplasmic expansion involves a curly protuberance (like on Fig. 5a), but alas often those versions enter in conflict with Bézout. Moreover the first C_4 in the first census of eight admit an invaginated version depicted below (as Fig. 1a). Although sembling erotical, we reached only 7 ovals so that some vibratory energy is lost due to the invagination.

Then we may look at the dual erection of the 2nd C_4 , getting so Fig. 2a,

which probably leads nowhere due to a basic Bézout corruption. Somewhat more exciting looks Fig. 2b, but alas we could only press 7 ovals out of it (one of the reason being that the triple-point lacks a maximal dissipation with the external branch as leaf). This is essentially a corollary of Rohn’s prohibition of the M -sextic $\frac{10}{1}$.

[07.09.13] Then along the idea of the invaginated protuberance we have also (dually) Fig. 5b, but here again the maximal J_{10} -patches are not ideally suited to perturb the corresponding C_6 .

(*Natur-sozial parenthesis.*—Everybody must know precisely why his work is useful, and not be the slave of a capitalism. The goal of all work—since Neanderthal and earlier—is to reach free immortality of the individuuum, and this must be conscious in every mind as the true motor of life. No money is required in such a system, and its usage even impedes the system being perfectly rentable.)

Of course, one of the little difficulty of Hilbert’s 16th is its Warenhaus catalogue nature (compare optionally a commentary upon Edmund Landau). Besides, the position adopted by algebraic curves as rigid configuration yet able doing the most erotical/acrobatical position provided Bézout restriction are respected emphasize a sort of elasticity of the algebro-geometric crystal, which for some deep reason is both allied to gravitation (ellipses by Kepler-Newton), and the role of higher order curve in optics by Newton (etc.) By Gabard 2012 (v1 of this text), it was also clear that there is some connection with dynamics of the electrons around any massive nucleus, at least so can one interpret the fantastic dance of points allied to a totally real map à la Ahlfors.

Alas, as to our concrete problem it seems (being in a bad day) that our above organigram (Fig. 77) have exhausted all the swing of this Viro (vibratory) method.

Of course we can still imagine a replica of the catalogue with all other positioning of the bump of the C_6 , although we think to have always exploited the maximizing option. Then it remains also to investigate all the variants where there is a bicontact (i.e. two points of tangency between C_4 and C_2). After that it remains also to study the configuration $C_4 \cup C_2$ with two pairs of transverse points.

At any rate, the core of Viro’s method is much akin to the vibratory methods of Harnack-Hilbert (ovals=ovules, etc.). In the case of bi-contacts (as we already once experimented), but re-experiment again (Fig. 78) we can even reach a patch with 10 ovals thereby corrupting Harnack’s bound. Of course, our intersection $C_6 \cap C_2$ involves $4.2+3.2 = 7.2 = 14 > 12$ supernumerary intersection, yet we can imagine that multiplicities at the north pole can be lowered (from 6 to 4) by transverse behavior. Notwithstanding there is some psychological frustration that the involved lovely picture (reminiscent of a galvanic current) does not produce a reasonable patch.

As a loose idea, we have not yet the energy to follow, one could imagine that the fringe of the C_4 has contact with both the ellipse and the circle and that during the vibratory process always accompanied by the aggregation of the conics, one alters between the circle and the ellipse. This would be a sort of alternating Viro method, but probably this idea leads to no serious result.

Now we adapt the table to transverse behaviorism (Fig. 79). It seems evident that transversality will *not* aid attaining M -patches. However the little surprise is that the first Fig. 1 yields the patch $V(0,4)$ for J_{10} , i.e. three branches with 2nd order tangency (i.e. what is fundamental to degree 6, and so Gudkov’s solution to Hilbert’s problem can be derived along Viro’s method, compare his letter in v.2 of Gabard 2013). On the next step of the iteration we recover the M -patch $C1(1,8,0)$ (for X_{21}), and also $E(0,1,8)$ if vibrating the left fringe. Albeit, not novel this is a slight methodological breakthrough, since it trivializes Viro’s method at the Harnack-Hilbert-Brusotti level involving only dissipation of ordinary double points. Dually, via the internal vibration (e.g. the model of Fig. 7) we get first the M -patch of degree six $V(4,0)$ (4 ovals in the bi-lune), and at the next step of the iteration the patches $C1(1,8,0)$ and $E(8,1,0)$ depending on the location of the vibration (in the beard or in the hairs). The corresponding patches are catalogued by green-rhombs on Fig. 18. Alas this transverse case leads only to a minim proportion of all Viro’s patches and therefore the force of Viro’s seems to reside in its inherent tangential-ness (complicated singularities) as a more versatile angle of attack upon the optical phenomena allied to Newton-

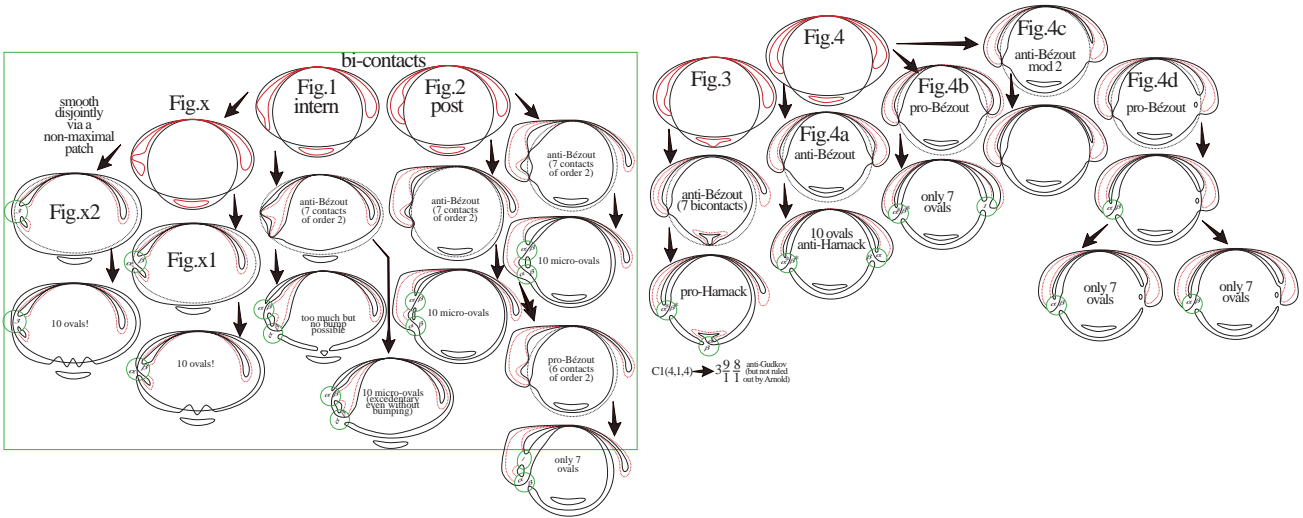

Figure 78: Bicontacts

Hilbert et cie. Hence the power of Viro's method is unantastbar, contrary to the loose opinion expressed some few line above.

[08.09.13] Those patches are so-to-speak the most elementary one, and when doubled produce the schemes $2.C_1(1, 8, 0) = 18\frac{3}{4}$ (Harnack), $2.E(0, 1, 8) = 17(1, 2\frac{1}{4})$ (Hilbert), and $2.E(8, 1, 0) = 1(1, 2\frac{1}{4})$ (Hilbert).

Further from Fig. 1 we can make vibrate one of the oval to get the patch $H(0,6,2)$ with alas only 8 ovals. If instead the inner oval is vibrated we get the $(M - 1)$ -patch $H(0,0,8)$. Doubling those gives $2.H(0, 6, 2) = 4(1, 13\frac{1}{4})$, which is below a Korchagin scheme, and $2.H(0, 0, 8) = 16(1, 1\frac{1}{4})$, which is below a Chevallier M -scheme.

In the overall we see that transversality (code $1 + 1 + 1 + 1$) amounts to only few patches, while Viro's tangentiality $1 + 1 + 2$ leads to more patches. Hence it seems that the more tangentiality is reigning, the more flexible is the method (of small perturbation). In this optic, we have then to analyze the case $1 + 3$ (one contact of order three) and $4 = 4$ (one contact of order four). Besides we have the case of $2 + 2$ (double bi-contact), which as we saw seems to violate Harnack.

Perhaps one can even imagine the situation where both bi-contacts are located at the same place, the so-called *place-to-be* (compare Fig. 78x). Of course, this looks bizarre as Fig. x does not look a small perturbation of both ellipses, since the red-circuit close to the circle deviates violently to reach the ellipse. Looking at the corresponding patch (Fig. x1 and below) we get one violating Harnack's bound with 10 micro-ovals. The variant Fig. x2 may look more clever as it employs a patch disjoint from the ellipse so that more vibrations can be forced on the C_6 . Alas, the ultimate result also involves too many micro-ovals.

Then we were struck by the idea of using a bitangent initial configuration of ellipses. According to the Viro-style philosophy that more tangentiality leads to stronger patches, this idea should not be completely stupid, but alas led us nowhere.

[22h36, vor dem Einschlafen]: Sozial-Philosophischer Spruch auf Französzich: La quête de l'immortalité est un motif suffisant pour que chacun travaille librement, sans être exploité ni esclavagisé, au projet d'une vie meilleure, infinie, et affranchie du joug du capitalisme.

[09.09.13] A lost day due to capitalistic duties. (Christa's Konto nicht für Ruthli zuständig geleistet, Sozialschmarotzern bei der Bank, usw.)

[10.09.13] Next, we noted that the pseudo-quartic C_4 of Fig. 80b probably violates Bézout due to the bitangent along both fringes (cf. the dashed line).

Next our brain came back again to Fig. 78 where there are too much (seven) contacts of order two in $C_6 \cap C_2$. It seems puzzling that Figs. 1 or 2 of that plate must exist but they do not lead to reasonable perturbation in degree 6. Of course the algebraic realm is flexible in the sense that any (reducible) curve can be deformed just by perturbing the coefficients. It is puzzling therefore that we lack as yet any realist perturbation for say Fig. 2. Eventually, we discovered

transverse stuff (not all updated)

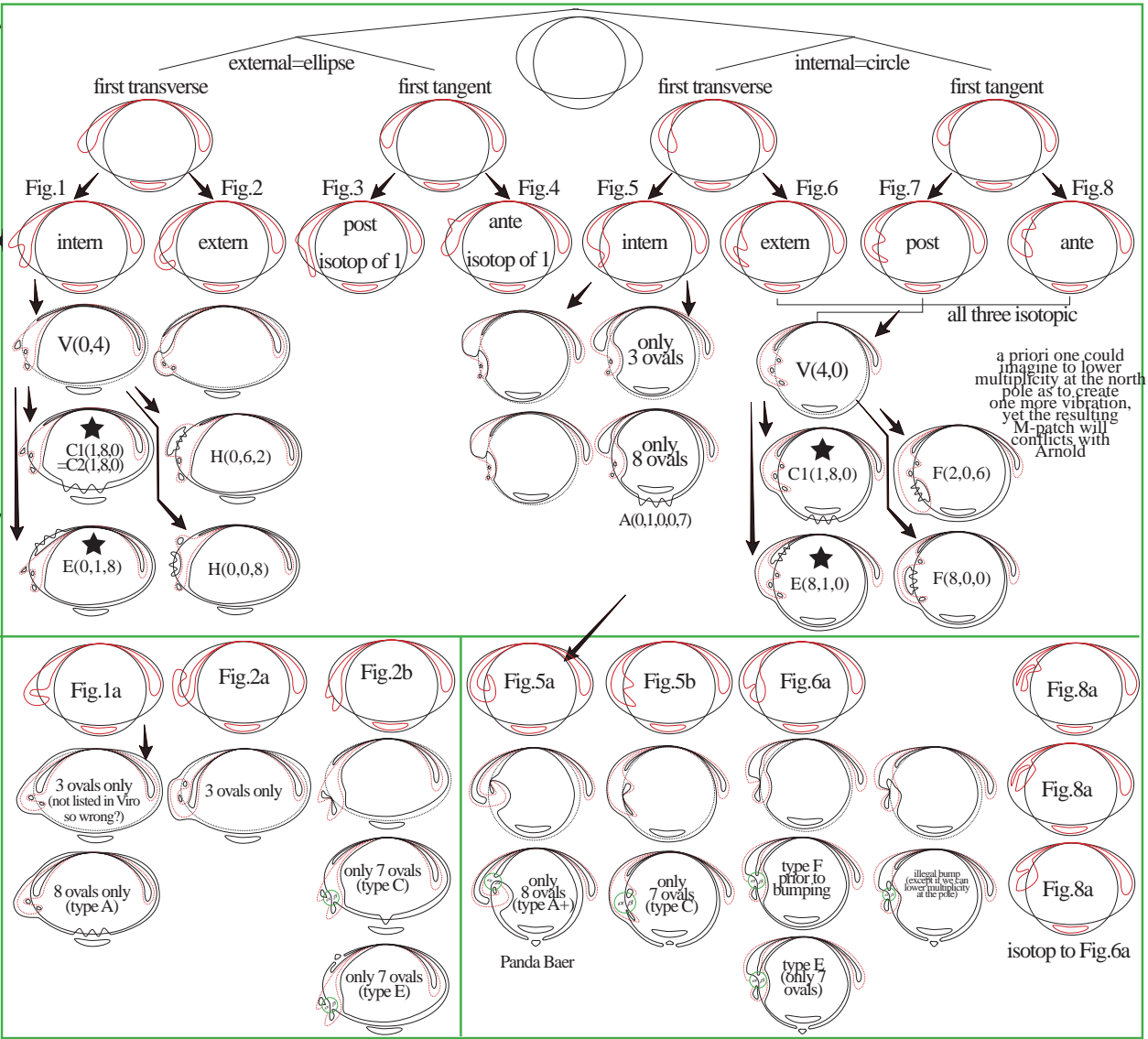

Figure 79: Transverse behaviorism

Fig. 2d where the correct number of 12 contacts is totalized. Here we meet candelabrum-type singularity with 3 branches. Hence it suffices to know the dissipation theory of the former to get a patch. A priori, when there is 3 branches there should be 4 micro-ovals (compare the patches for J_{10} =three tangential branches). But on comparing with the higher candelabrum with 4 branches (Fig. 39 in Viro 89/90, p. 1112), we note that the former accepts at most $\alpha + \beta = 6$ micro-ovals, and not nine like for X_{21} which is also four branched. By analogy, it seems that the three-branch candelabrum lacks a smoothing with 4 ovals, as this maximum is preferably achieved in the purely tangential setting. For a more intrinsic reason if the 3-candelabrum had a smoothing with 4 micro-ovals, then (whatever their location) applying this patch on a quintic union of two ellipses plus a transverse line would create a quintic with $3 + 4 + 4 = 11$ circuits (cf. Fig. 83 if necessary), violating frankly Harnack's bound.

So again we have a Viro's style philosophy: tangentiality is the motor of Harnack-maximality. The contrary would more readily serves our purpose, as then Fig. 2d could perturb to an M -patch.

So we need to understand the dissipation of the tri-branched candelabrum. An imperfect attempt is done below (Fig. 83), but we still find the patch of Fig. xx, which is a plausible model in view of the knowledge a-priori of M -quintics. Alas, when glued in our earlier Fig. 2d, yields only a patch with 6 ovals.

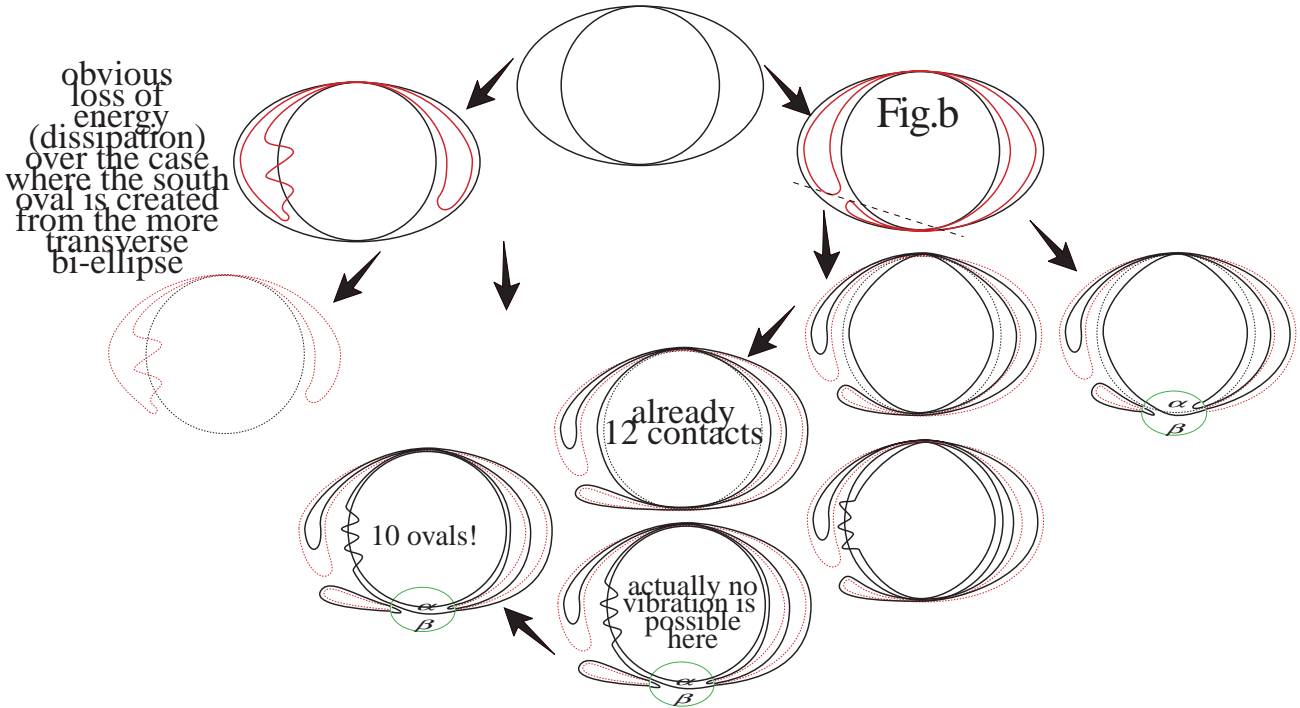

Figure 80: Transverse behaviorism

Fig. 2e exploits the idea of lowering the multiplicity of intersection by coining transversality at the north pole. Alas, this destroys the very basic desideratum of getting an X_{21} -patch. Accordingly, this seems to be a cul-de-sac.

Philosophy: The true core of any mathematical truth is a geometrical picture, hence so-to-speak a physical reality.

Next, we found Fig. 2h by concealing some transversality as to respect Bézout. So this is the first perturbation of a potentially algebraic character, but alas the resulting patches reach only 7 ovals.

Fig. 2i is an obvious variant, also procuring only 7 ovals.

At this stage we look blocked and it is somehow disappointing that we are unable from the C_4 -configuration with a bi-contact to produce M -patches for X_{21} .

[11.09.13] So our problem is still the same: can we produce more patches with Viro's elementary method of perturbation? In particular can we get all of Viro's patches including those obtained via the more tricky methodology of hyperbolism (Huyghens, Newton, Cremona, Gudkov, Viro).

If yes, which sort of initial geometric configuration for $C_4 \cap C_2$ has to be employed? Apparently the case of bicontact $4 = 2 + 2$ leads nowhere.

It is only at this moment, that we were flashed by the simple idea that if the bicontacts of Figs.78(1,2) are over-productive (10 micro-ovals) one can just consider the situation of Fig. 3 where some of the energy is lost by splitting the bicontacts over two different circuits. It results indeed then M -patches based on the geometry of a smiling-face. Precisely, we get when both α and α^* are 4 the patch $C1(4,1,4)$. This alas seems to violate Gudkov periodicity. Another objection is that the involved pair $C_6 \cap C_2$ does not respect Bézout, as we see 7 bicontacts between the sextic and the conic (circle). For $\alpha = 4$ and $\alpha^* = 0$ we find, etc... but by experience those will also certainly corrupt Gudkov.

Next, we have also Fig. 78(4) where both fringes have a bicontact (contact of order 2). Again our perturbation C_6 cannot be a genuine algebraic one, as the intersection with C_2 involves seven bicontacts violating Bézout. Hence in Fig. 4 exists in the algebraic category (and there is no Bézout obstruction to this), we infer that the a perturbation of $C_4 \cup C_2$ must have another look. For instance we have the perturbation of Fig. 4b which respects Bézout and involves a transverse behavior on the right fringe, but still a tangential one along the left fringe. Alas, making this concession, we get only a patch with 7 ovals instead

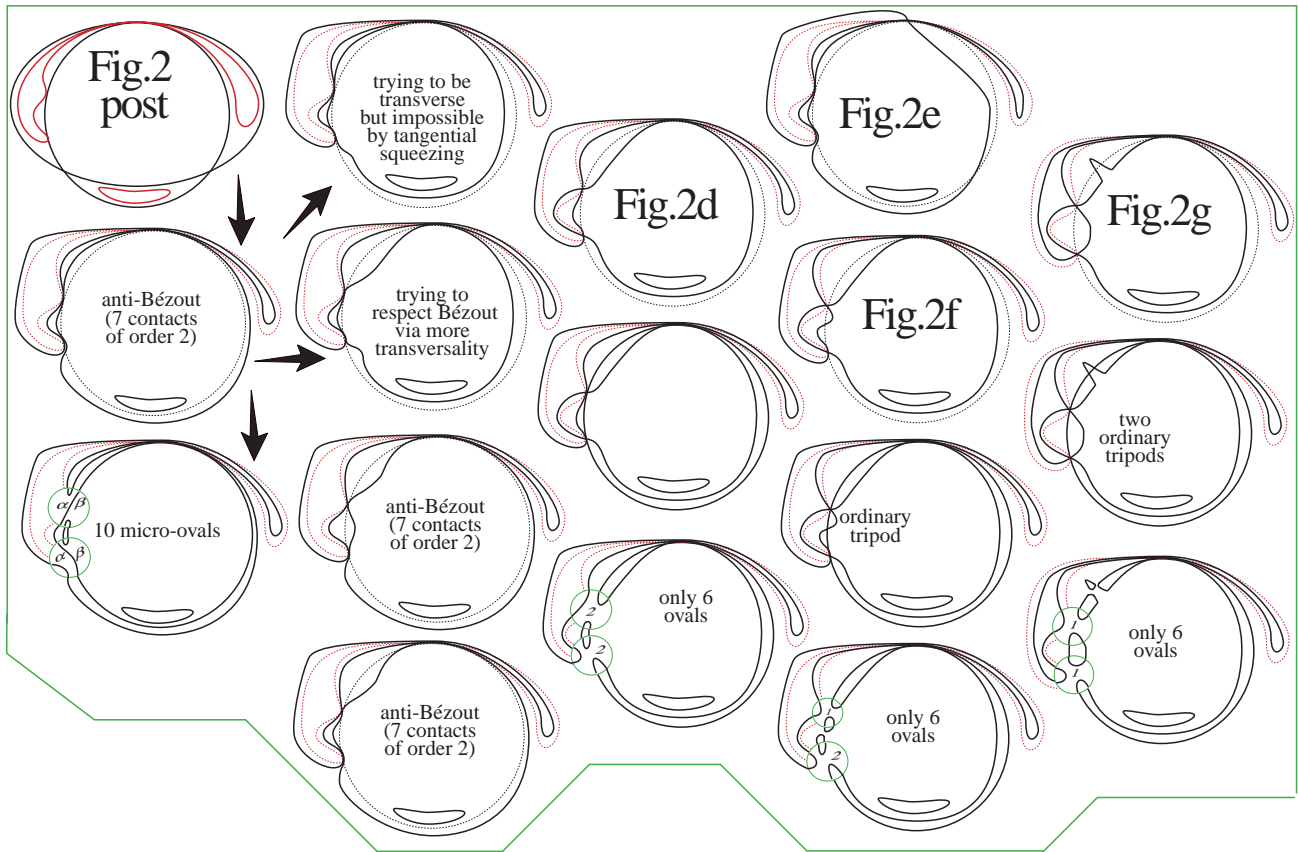

Figure 81: Transverse taming of the excedentary contacts

of the nine ones requested to reach Harnack-maximality.

Next, we can imagine the perturbation of Fig. 4c, but this appears to corrupt Bézout modulo 2. But this little defect may be corrected by Fig. 4d where we better into account the non-traversing issue about the branch of highest curvature through the north pole.

It seems clear at this moment that we have exhausted the power of the method, or to speak frankly, we missed any single M -patch from the bicontact trick. Alas we do not know if this is due to the incompetence of the writer (Gabard), or an intrinsic state-of-affairs.

6.2 Study of the contact $3 + 1$

[11.09.13] Let us now look at the case of a contact of type $3 + 1$ as shown on Fig. 84. Fig. 1 and Fig. 2 shows two ways of having a contact of order 3 between a quartic C_4 and a conic C_2 . By perturbing $C_4 \cup C_2$ we get the sextic of Fig. 1b. Then there is some conceptual difficulties of how to interpret the picture in terms of Puiseux (?) branches. We mean basically that either Fig. 1b1 or 1b2 could occur where the numbers 2,3 label a given branch, while its specific value measure the contact with the ground ellipse. Then there are other several conceptual obstacle but a rapid run through the lead us to the conclusion that the local singularity involved (say X_{31} improvising notation) should accept dissipations with 6 micro-ovals at most (as suggested by the count on Fig. x). Unfortunately, applying such a dissipation to Fig. 1b1 seems to create only 8 micro-ovals.

[12.09.13] Our next idea is materialized by Fig. 84(3), where like Viro we exploit the idea of keeping all singularities unsmoothed until the end in the hope that accumulated tension when ultimately liberated will act as a devastating flood offering a real breakthrough on Hilbert's 16th.

To be concrete we get first Fig. 3a, but the intersection $C_2 \cap C_6$ involves 5 bicontacts plus 4 crossings, hence a total of 14 points (counted by multiplicity), violating Bézout. Incidentally, the resulting patches corrupt Gudkov periodicity.

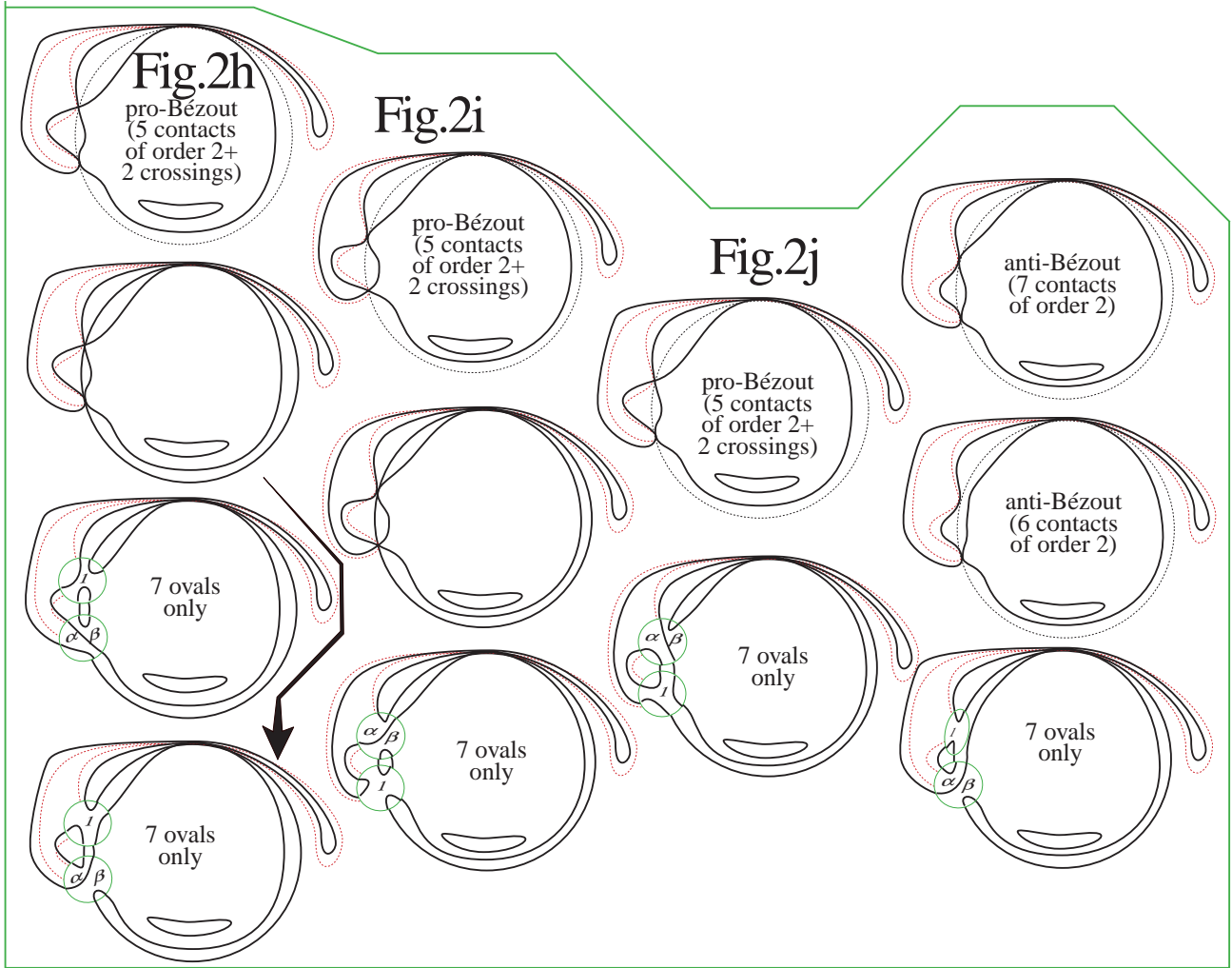

Figure 82: Transverse taming of the excedentary contacts (continued)

Fig. 3b shows a variant where Bézout is respected, but the resulting patch exhibit only 7 ovals, and so does not arise much interest. Next we tried Fig. 4, but again the intermediate product violates Bézout, and the final patch corrupt Gudkov (periodicity).

Our next idea is to consider an avatar of the previous systematic figure implementing Viro's vibrational method (acronym VVM) by passing the less curved branches outside instead of inside as in the original method. This gives us Fig. 85 where we were only able to reach 8 ovals in the erectile case, and only 7 in the invaginated case. So it seems evident that there is a loss of energy by using those inflated version of the earlier main-figure.

At this stage one is clearly lost in a sterile labyrinth, and some clairvoyance is requested to come out of it alive.

[21h42, 12.09.13] Vor dem Einschlafen, we were flashed by the following modest idea which we only report due to our deep level of depression. The idea is to consider a configuration of ellipses somewhat more transverse than Viro's namely that depicted below (Fig. 86). After more lucid experimental thinking it seems evident a priori to us that this lack of tangentiality will be incapable reaching Harnack-maximality. Nonetheless it would be nice to know the maximum number of ovals accessible by mean of a perturbation of such a configuration. A naive drawing suggests the answer being 16, because we see on the picture below 8 "macro" ovals and 8 micro-ovals coming from the α, β parameters. Needless to say our deception is great, but was somehow anticipated by our experimental knowledge. This is another typical illustration of the fact that too much transversality (between low degree objects) impedes Harnack-maximality.

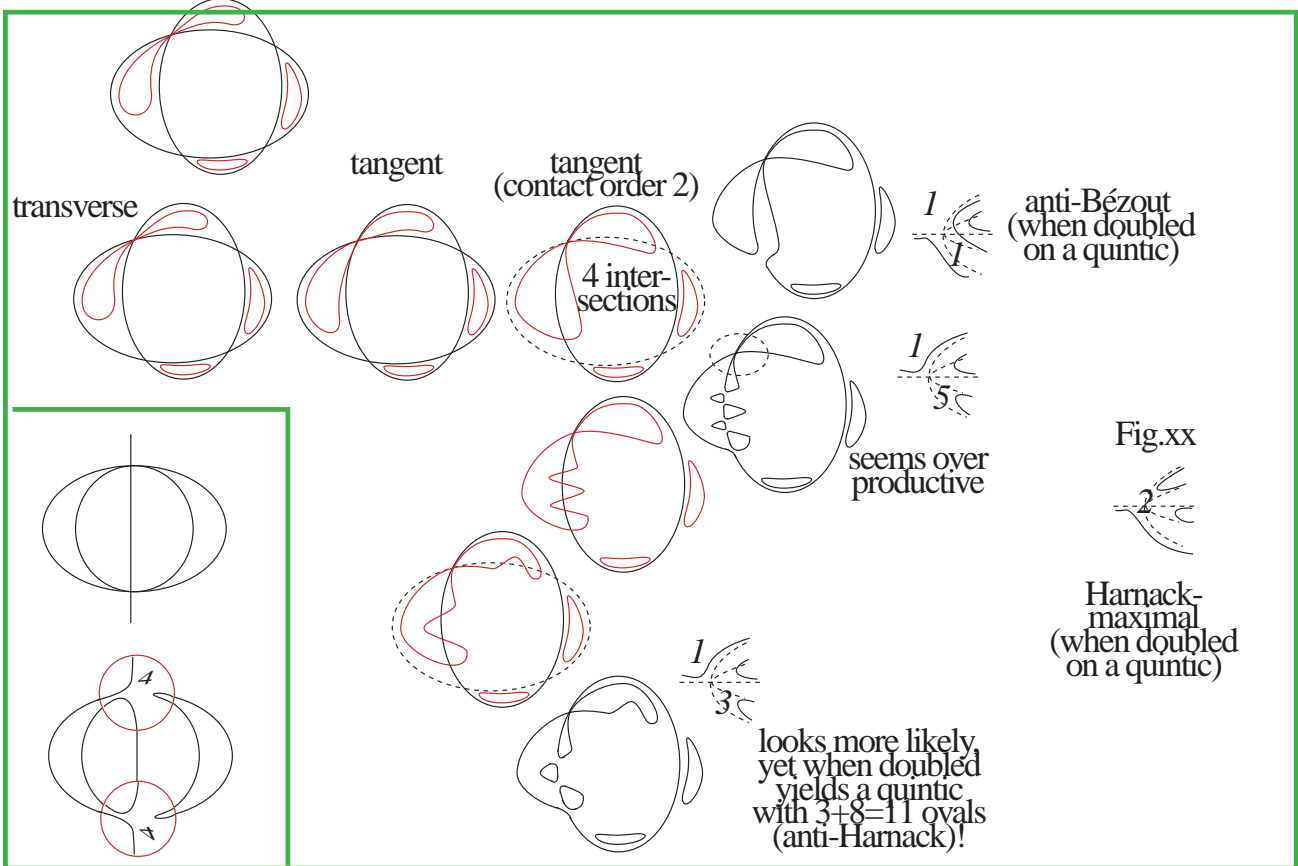

Figure 83: Transverse behaviorism

6.3 Falling in love with Oleg Yanovich

[04.09.13] Of course in the above construction of O. Ya. Viro it should be noted that it exploited the only two possible dissipations of J_{10}^- (which are precisely those involved in Hilbert's 16th in degree $m = 6$, and the only possible by virtue of the Hilbert-Rohn-Gudkov obstructions: compare the list of M -patches for J_{10}^-). Further, it is pleasant to contemplate the "gigogne" (telescopic) nature of the dissipation theories of all those singularities as a sort of big inductive process. (Hilbert would say a *Einschachtelung*: i.e. to understand the dissipation of the quadruple point with 2nd order tangency, we rest on same knowledge for the triple point.) Notwithstanding, Viro's method appears as split into the method for class C based split sextics of bidegree $1 + 5$ (so-called affine M -quintic) and now a method of tangential vibration (somewhat reminiscent of Hilbert's method), which furthermore avoids the usage of hyperbolism. Hence a basic task could be to find a more unified treatment of all Viro's patch by one and the same method.

Again we insist that on Fig. 72 there is no ore freedom in the dissipation of the triple-point with 2nd order tangency than those tabulated because otherwise we would get sextics violating the Hilbert-Rohn-Gudkov census (HRG).

Now let us explore some variant of Viro's (last) E-method, as we shall call it, since it produce patches of type E (i.e. with a triple lune).

One of our idea was one the previous Fig.a to move the location of the oscillation below the tacnodal singularity A_3^- . Another idea (simpler to depict) is just to permute the location of the oscillation and that of the tangency on the preliminary quartic C_4 , see Fig.x below. Disappointingly, the resulting patch has only 8 micro-oval (not an M -patch), yet still of the interesting class A which is thus non-empty outside of the maximal realm. (Note: one of this patch namely $A(1, 0, 0, 0, 7)$ is nearly equal to the one we speculated about yesterday).

Next one can imagine the same game yet oscillating against the other ellipse, cf. Fig. 87y. This gave us the patch $A(0, 1, 0, 0, 7)$ which is by virtue of

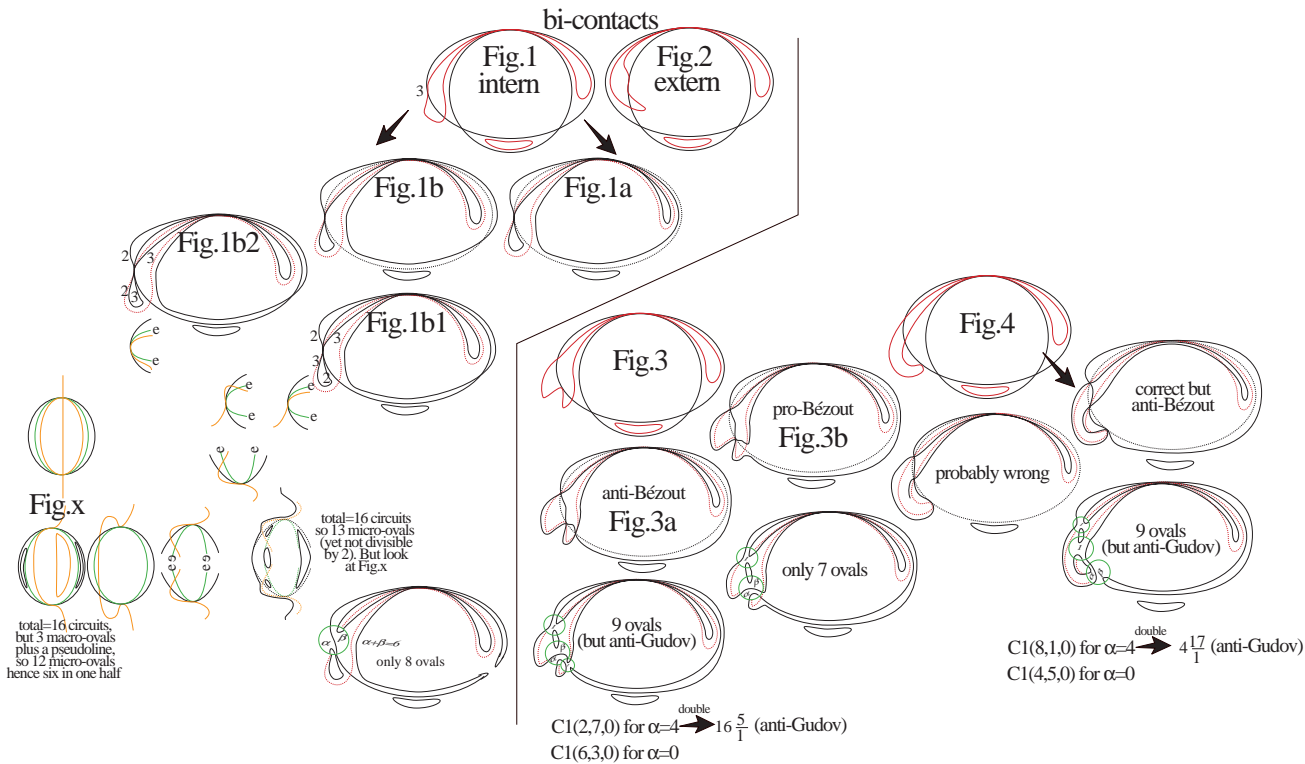

Figure 84: Contact 3 + 1

an obvious mirror-symmetry on the first 4 parameters $\alpha, \beta, \gamma, \delta$ equivalent to $A(0,0,1,0,7)$, which is exactly the patch on which we speculated yesterday. Of course the deception is that this is still not an M -patch, but there is certainly yet another variant where we get maximality. The vague experimental qualification (based on month of experimentation with the Harnack, Hilbert and Viro methods) prompts that usually damped dissipations comes from a division of the oscillating energy, and therefore a loss of newly created ovals (hence “dissipation of energy”). Put more concretely, this suggests looking at Fig. 88z where the tangency occurs more internally. Repeating Viro’s trick (algorithm adapted to this situation) we get the two M -patches $E(0, 1, 8)$, and $E(0, 5, 4)$ that were precisely the last two patches claimed by Viro that missed us as yet. Of course all this harmony and duality (Wechselbeziehung) is highly reminiscent of Hilbert’s method where depending upon an internal or external vibration we get either Harnack’s curves or Hilbert’s. In the present Viro context it seems that is a contiguity between the tacnode and the oscillation that permits to maximize the vibratory energy and therefore the number of springing ovals.

At this stage we have a complete knowledge of Viro’s theory (as far as X_{21} is concerned), yet there is still the hope that his assertions are not exhaustive that his method can be further varied as to give more patches. At least this the naive hope and we shall try to explore some additional possibilities (requesting poor level of imaginativeness).

One of the idea to explore is to vary the position of the “bubble” of Fig. z1, by placing it rather in the loop below the tacnode. Of course this is somewhat hard to depict, and so let us retrace Fig. z as Fig. w to get more free-room at the critical place. (We may so expect to find: a variant of Viro’s method leading to the materialization of some bosons in degree 8.) Alas the resulting patch is not maximal and belongs to type H (in the notation of Fig. 18). More specifically it realizes the patches $H(0,0,8)$ and $H(0,4,4)$ (where as usual we count the ovals’ number α, β, γ from inside to outside).

Another idea is to place the vibratory energy of the bottom oval of the quartic C_4 as shown on Fig. 89a. Alas the resulting patches though belonging to the interesting class I, have only 7 “micro-ovals” and so are $(M - 2)$ -patches (i.e. 2 units below the maximum possible). Remind beside, that the interest of

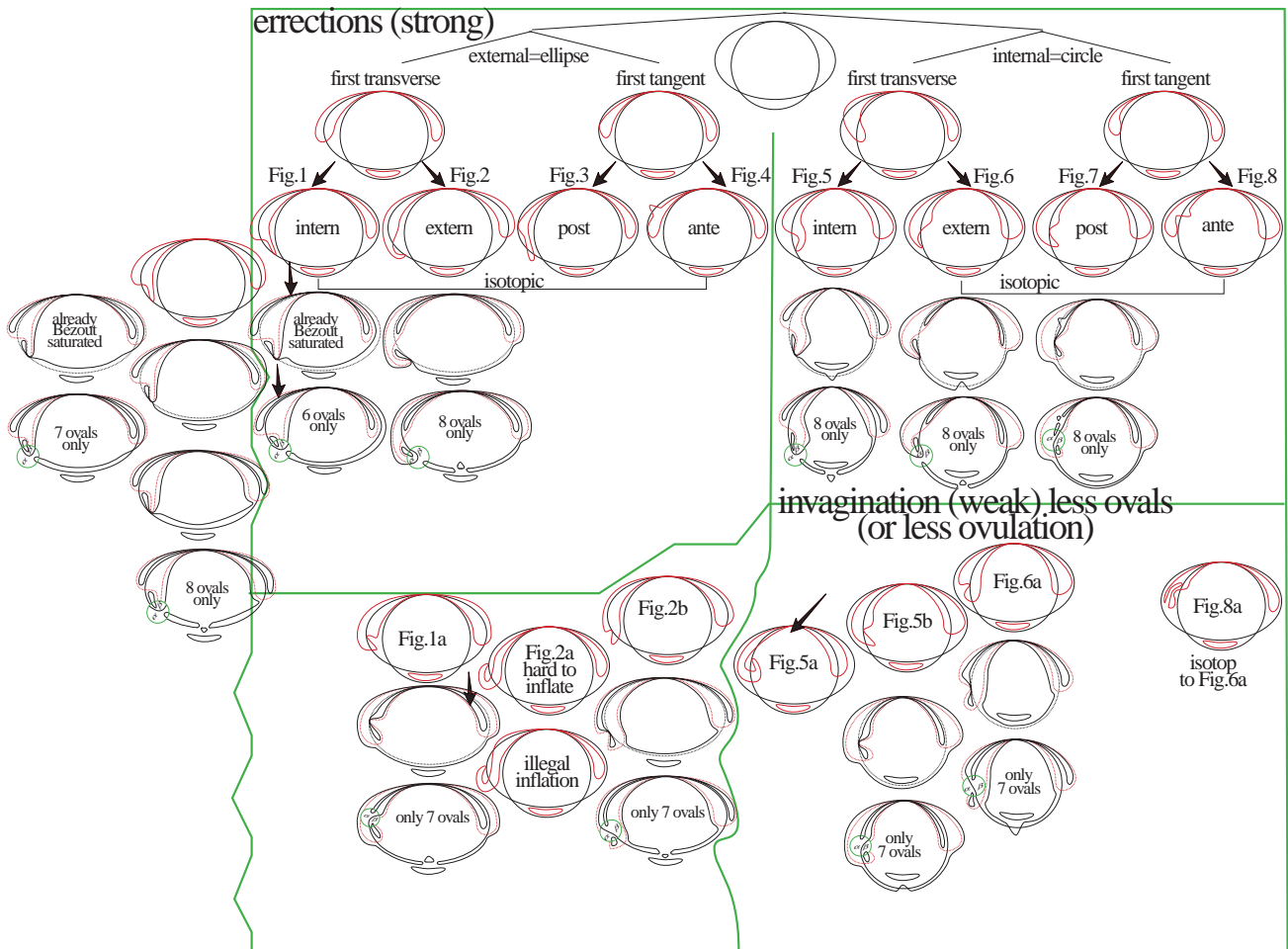

Figure 85: Inflated (or deflated) variants of the main-table, yet with a loss of one oval over the primordial construction

class I is that it is not much obstructed (a priori at least), and it could lead to the creation of bosons as summarized on Fig. 18. *Optional note:* If we double the patch I(7,0,0) we get the $(M - 4)$ -scheme $(1, \frac{16}{1})$ which 4 steps below Shustin's (anti)- M -scheme $(1, 2\frac{18}{1})$.

Perhaps for a more clever placement of the bump we may at least create an $(M - 1)$ -patch of type I. This suggests the variant Fig. b1 where the bump is placed on the left of the tacnode. First we trace Fig. b which is the same as Fig. a modulo leaving some more room at the place where intend to bump the curve. (General comment: as usual in those iterative methods à la Harnack, Hilbert, Gudkov, Viro just to name the Gods) we are permitted at each step the depiction to alter slightly the metrical proportions as to emphasize the topological properties of the curve under construction. This may be interpreted as an elasticity of the underlying ether.) For Fig. b we find then $(M - 1)$ -patches indeed, yet of type A, precisely $A(0,0,0,5,3)$ and $A(0,0,0,1,7)$. Doubling the first gives the $(M - 2)$ -scheme $9\frac{10}{1}$ (which is not extremely exciting).

Another option involves placing the bump on the very right of the scene, and this yields Fig. c, which creates ultimately the patches of type A with an island, hence denoted A+. Specifically, we get $A+(5,2)$ and $A+(1,6)$, but those are alas only $(M - 2)$ -patches.

Besides it remains thereafter the option of doing an outer vibration across the ellipse which is circle-like. This brings us to Fig. below. Of course all this series of pictures where the central bottom oval is vibrated never yield M -patches, in view of the fact that if left tranquil this oval contributed to one of the nine micro-ovals. Specifically Fig. d only gives an $(M - 2)$ -patch of type A (vut for which we have alas no canonical naming as yet).

Next we can as before continue the game by varying the location of the bump,

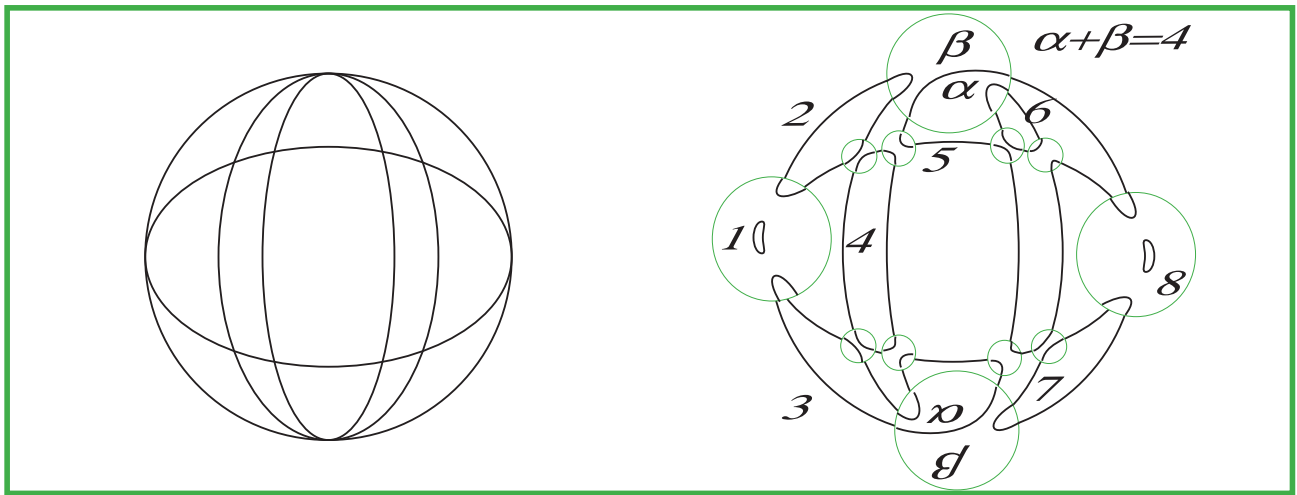

Figure 86: Another variant of Viro

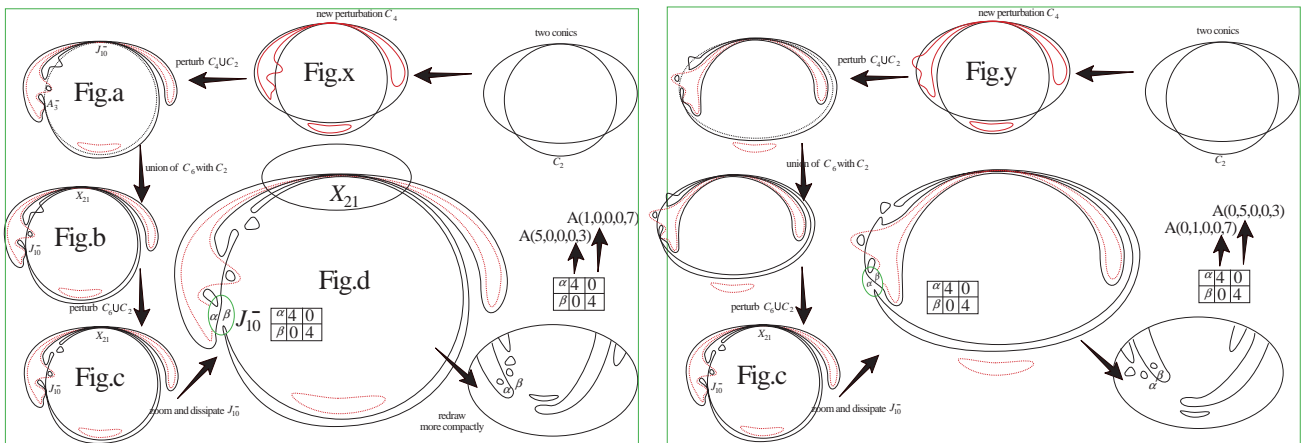

Figure 87: Viro's E-class (trinsted lune)

and this produces Fig. e and Fig. f. First, Fig. e gives only $(M - 2)$ -patches, yet of the not yet found type B2. Finally Fig. f, where the bump will be placed on the left. Again we only get $(M - 2)$ -patches, actually the same as those already derived via (the previous) Fig. c.

At this stage we are slightly disappointed, yet we should definitely study all the possibilities on a more charitable/peaceful day, as today some financial stress is apparent. As said Hassler Whitney let us do research naturally.

Then we can imagine variants of the very first constructions where the bump is placed on the other side of the circle, yet this will certainly leads to a loss of the vibratory energy.

Besides, after a sleep we were flashed by the dubious idea that perhaps we have not yet exploited the most general dissipation of the triple points with 2nd order tangencies (double contacts for short), alias J_{10}^- , in abstruse Arnold's notation. Our idea is just to imagine Gudkov's sextic curve $5\frac{5}{1}$ as split into two patches of the type depicted on Fig. 90g. A priori we knew no obstruction against the existence of such a patch, yet after some minute of thinking resurfaced in our memory Fiedler's enhancement by a factor 2 of Gudkov periodicity in the case of symmetric M -curves. This Fiedler's result ($\chi \equiv k^2 \pmod{16}$) obstructs the existence of the posited patch for $F3=J_{10}^-$ (flat singularity with 3 branches), and is as far as we know the sole obstruction against this patch. Still, it seems of interest to look at which sort of patches results for $F4=X_{21}$ assuming that this patch exist for $F3=J_{10}$ (we omit the minus from Viro-Arnold's notation as there is no ambiguity in principle). However some more basic thinking (that just escaped from our memory) shows that when gluing Viro's patch $V(0,4)$ with our patch $G(2,2)$, we get the M -scheme of degree 6 with symbol $7\frac{3}{1}$ corrupting Gudkov periodicity. So our patch cannot coexist with Viro's, and since the

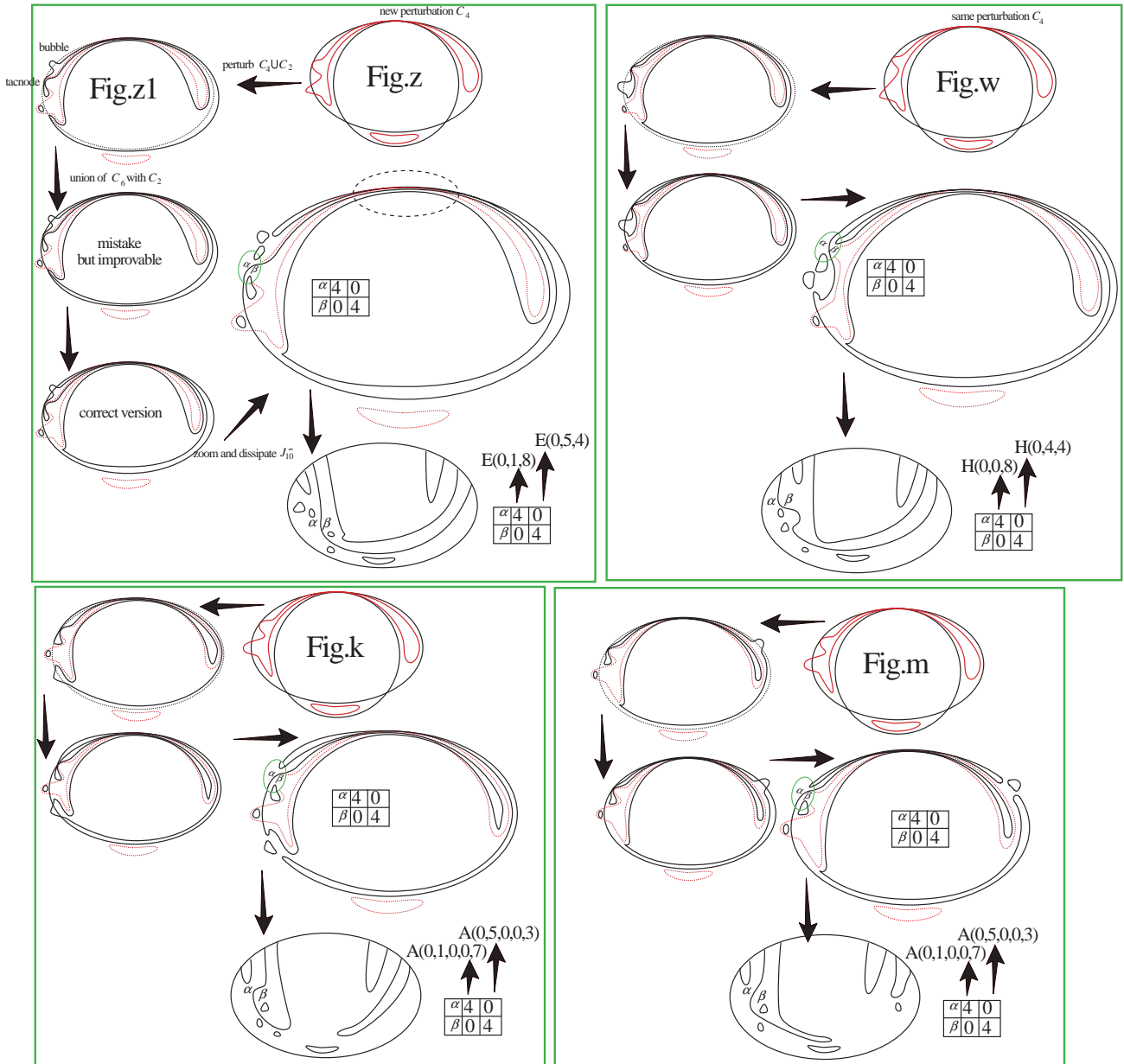

Figure 88: Viro's E-class (trimested lune)

latter exists, our does not. (Hence Fiedler's periodicity can be circumvented.)

Next coming back to the previous Fig. z, it seems that there is a 3rd option consisting in placing the bump on the bottom as shown on Fig. 88k, yet as expectable we get only an $(M - 1)$ -patch along this route. So it seems evident that to reach an M -patch the bump must really sit between the tacnode and the X_{21} -singularity (sorry for this vagueness).

For the sake of exhaustiveness, let us study the case of a bump placed on the right circuit of Fig. z1. This is shown on Fig. 88m, and gives actually the same patches as the just studied Fig. k, yet still no additional M -patches at the horizon.

Of course the study can be continued along any more systematic way, yet it seems also clear that we (or rather Viro) have extracted all the juice from his method.

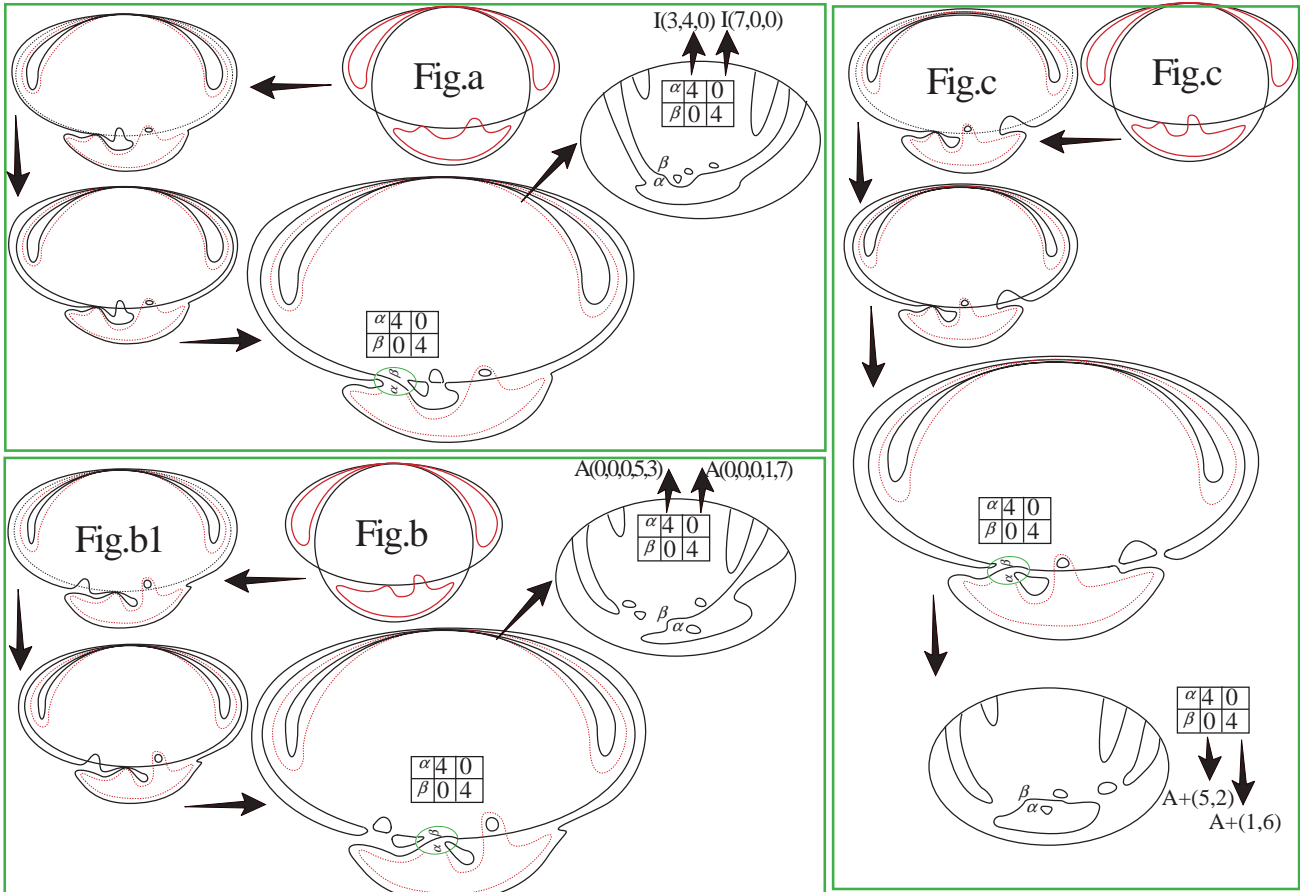

Figure 89: Viro's E-class (trinsted lune)

6.4 Toward a classification of all patches for X_{21} via knot theory

[14.09.13] Today only, we were flashed by the idea that potentially much obstruction on patches could come from knot theory alone. The idea is the simple trick of what is known as the Milnor fibre, or rather just the link of a singularity, a trick going back to Wirtinger and earlier. For X_{21} , if we intersect the singularity by a small 3D-sphere centered at the singularity we see four branches and thus a link with 4 components all unknotted, but maybe collectively linked.

Remind that the basic normal crossing $x.y = 0$ determines by this recipe Hopf's link, and likewise it would of interest to know which link of S^3 is determined by X_{21} . Evidently it must be like a catenary yet with all items interlaced.

Next the fascinating issue must be to interpret the complexified patch as a bordered Riemann surface filling smoothly this link inside of B^4 . So this bordered surface has 4 contours, and if we imagine the 4 ellipses as spheres creating 3 holes when pieced together, it remains a genus of $(21 - 3)/2 = 18/2 = 9$, i.e. nine, for the membrane of the patch.

Further the patch is invariant under complex conjugation and this shall give the number of ovals in case of an M -patch. All this context looks sufficiently fine and explicit that via some knowledge of topology the usual combinatorial tricks à la Poincaré, Rohlin, etc. should yields obstruction on the patches directly, without having to refer to global obstructions in $\mathbb{C}P^2$ coming from the Rohlin-Fiedler-Viro theory.

Naively (or abstractly) the symmetric patch may be visualized as a bordered surface with symmetry.

Apart from possible purely topological obstructions as we said in the realm of combinatorial topology that could reproduce those of Arnold, Gudkov that we already derived via doubling the patch, it could be that highbrow differential geometric obstruction arise when considering the patch as a minimal surface

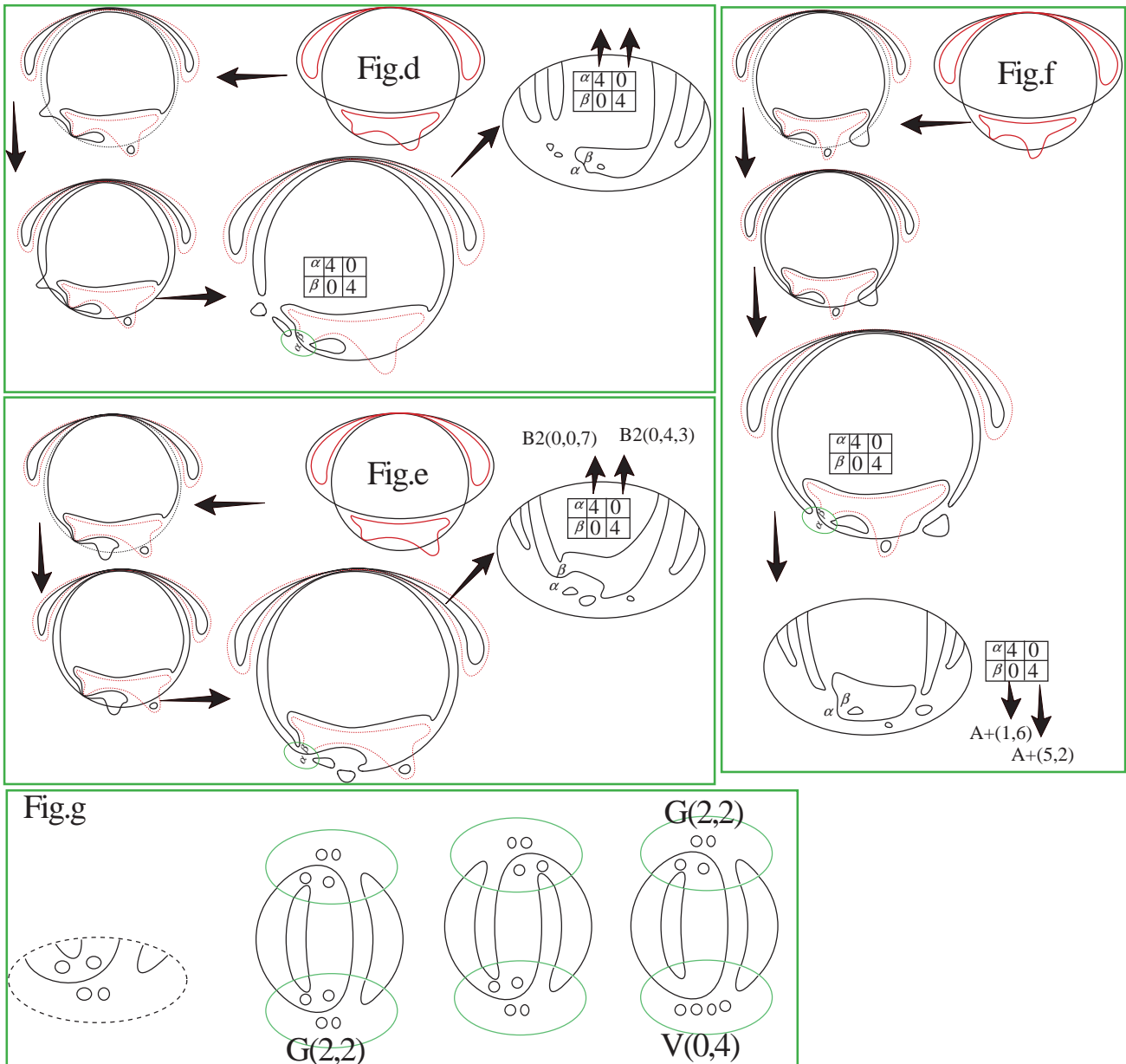

Figure 90: Viro's E-class (trinedsted lune)

filling the link.

So Viro's theory of the patches ought to be directly connected with soap film experiments in 4D-space, namely the ball B^4 .

The real challenge would be to prohibit all (or at least some) of the M -patches not constructed by Viro, and not already prohibited by classical or sporadic obstructions (compare for the present state-of-the-art our Fig. 18).

Of course even if we could prohibit a patch (by this or another method) then it would not directly result a prohibition of the corresponding scheme deduced by doubling, because it can be imagined that the scheme in question can be constructed by another method than via Viro's quadri-ellipse. Still, one may expect that at least if the curve is symmetric under a mirror involution then there is more global splitting of the curve into two patches. This reminds slightly Fiedler's ideas on symmetric curve, but we are too tired to make any direct connection.

Further more even if we could prohibit a patch then it could be that its double (which is an M -scheme) is realizable by another combination of patches, so that nothing could be inferred.

Still, we believe that obtaining a complete classification of all M -patches is

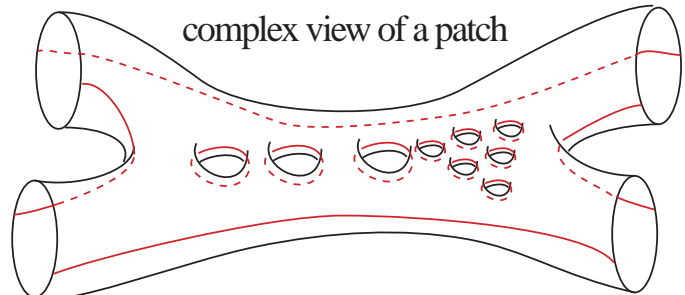
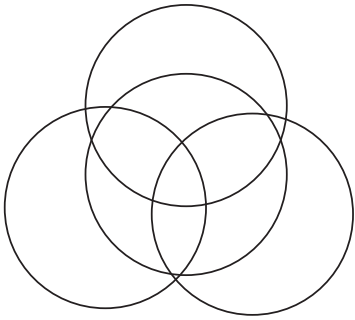

Figure 91: Link theoretical view of the patches

a problem of independent interest, certainly much intermingled with Hilbert's 16th (perhaps the key to its ultimate solution in degree 8) in case Viro's method has not yet been exploited to its full regime. Alternatively it can be the case omniscience of all patches is not even enough wisdom to fix Hilbert's 16th (for $m = 8$), in case Viro's method is not flexible enough to reach some of the bosons (assuming their existence). Put more intrinsically, it could be that bosonic curves (if they materialize) are far away from the quadri-ellipse. In this scenario of bosonic chambers far from the quadri-ellipse (let us speak of ghost curves) even a complete knowledge of all X_{21} -patches would not suffice to fix Hilbert's 16th.

By the way ghost chambers seem to exist as exemplified by Viro, Shustin, Korchagin, Chevallerier, Orevkov exotic construction not readily based on a perturbation of the quadri-ellipse. Accordingly ghost schemes may be a reality and impede solving Hilbert's problem purely in the vicinity of the quadri-ellipse.

In contrast, forcing a bit the passage, it is still conceivable in a more generous world of patches that all bosons are constructible via perturbation of the quadri-ellipse.

6.5 A naive idea for prohibitions via satellites

[13.08.13] In principle, if a plane curve is dividing then its satellite(s) should also be dividing, because it will be totally swept out by the same total pencil. In abstracto, this thesis is hard-to-defend because we may lack a concrete pencil realizing the total map whose existence is abstractly granted by Ahlfors' theory. Yet in the case of M -curves, total reality is trivially granted (compare Gabard 2013B [471]). So a naive method of obstruction could be to look at a curve and build its doubled satellite, which being dividing has to verify Rohlin's complex orientation formula. Additionally, all circuits which are doubled are circulated in the same sense due to a naive dextrogyration occurring within a real tubular neighborhood of the curve, and therefore form negative pairs of ovals in Rohlin's sense.

We can try to take any of the boson in degree 8, and satellites it to get a curve of degree 16 with $2 \cdot 22 = 44$ ovals and with complex orientations partially controlled by the above rule. On this sixteen-tics C_{16} we may hope to get sometimes trouble with Rohlin's formula. If the method does not readily apply to the boson themselves, it may at least perhaps re-explain some of Viro's obstructions (granting their correctness of course).

All this request some investigation, yet the methodology looks a bit overnaive

to lead somewhere. Imagine first the boson $1\frac{1}{1}\frac{18}{1}$. When doubled all ovals can be imagined as coupled in infinitesimal pairs, each of which is a negative pair in the sense of Rohlin, because it is swept out in the same sense by the total pencil of sextic (cf. again Gabard 2013B [471] for the fact that total reality of an M -curve of degree m is always flashed by a pencil of $(m-2)$ -tics).

Denote by C_{16} the curve of degree 16 doubling the octic C_8 . It is dividing, with $r = 44$ ovals and subsumed to Rohlin's formula $2(\pi - \eta) = r - k^2 = 44 - 8^2 = -20$. Further, Hilbert's tree of the doubled scheme is for the boson $1\frac{1}{1}\frac{18}{1}$ as depicted below (Fig. 92b), on which we may count the total number of pairs $\pi + \eta$ regardless of (complex) orientations. The count is effected by breaking along the 3 obvious components and according to the length ℓ of the pair, to get

$$\pi + \eta = \begin{cases} 1 & \text{of } \ell = 1 \\ 0 & \text{of } \ell = 2 \\ 0 & \text{of } \ell = 3 \end{cases} + \begin{cases} 3 & \text{of } \ell = 1 \\ 2 & \text{of } \ell = 2 \\ 1 & \text{of } \ell = 3 \end{cases} + \begin{cases} 1 + 2.18 & \text{of } \ell = 1 \\ 2.18 & \text{of } \ell = 2 \\ 18 & \text{of } \ell = 3 \end{cases} = 1 + 6 + 1 + 5.18 = 98.$$

Hence, $2\pi = 88$, whence $\pi = 44$.

On the other hand we may calculate π using Hilbert's tree with signed branches prescribed by complex orientations. For this purpose we use the evident signs-law to the effect that mixing the gene is good while consanguinity is bad. Further it is essential to know that during the doubling process Hilbert's tree grows but has a sort of trunk incarnating the original undoubled curve, and the latter complex orientations can be transplanted, while all other newly created branches of the doubled tree are just negatively charged by the dextrogyration argument (sketched right above).

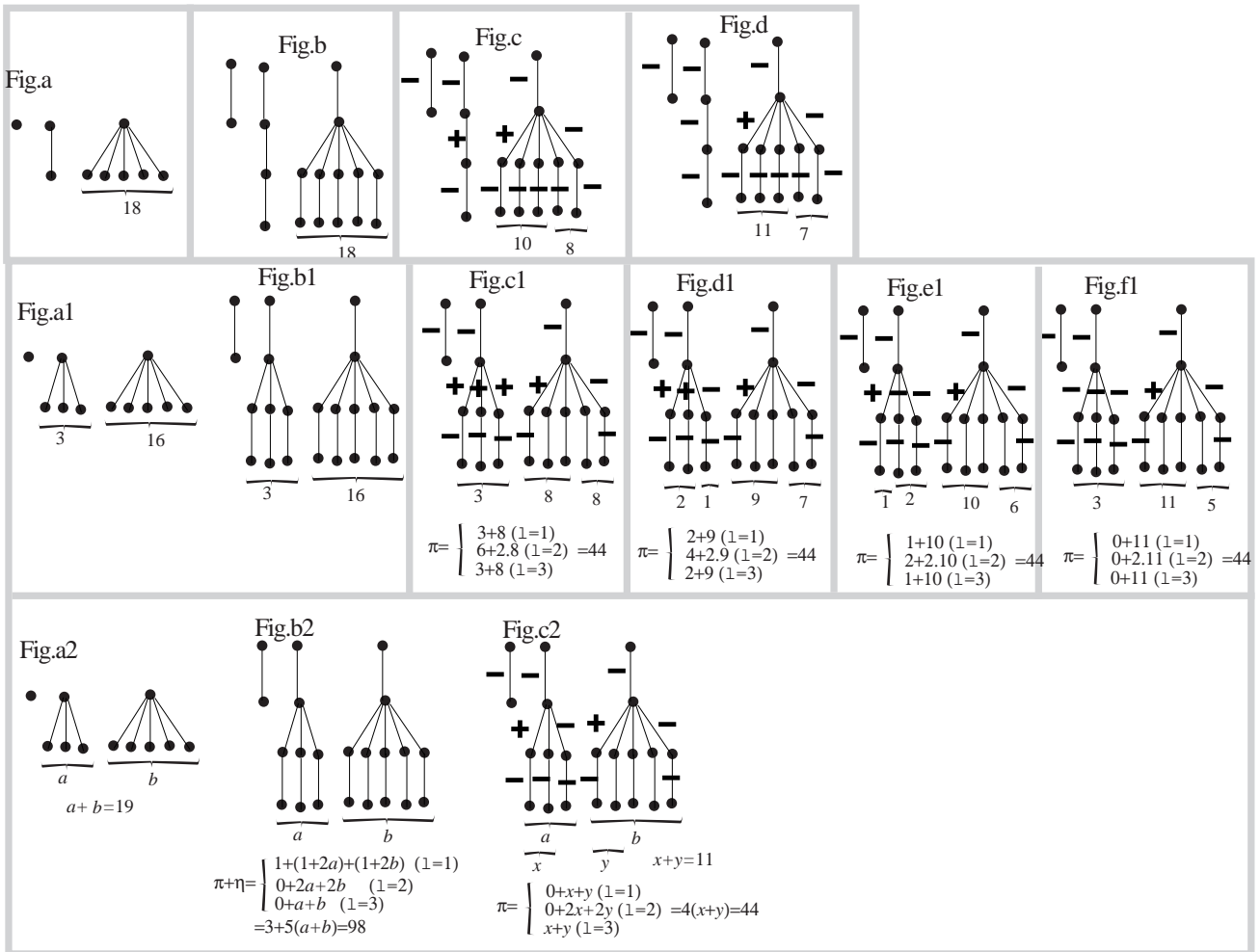

Figure 92: A Rohlin tree argument

Finally, applying Rohlin's formula to the original octic we have $2(\pi - \eta) = r - k^2 = 22 - 16 = 6$, whence $\pi - \eta = 3$ and $\pi + \eta = 19$ (looking at Fig. a), and therefore $2\pi = 22$, whence $\pi = 11$. We find then (assuming the distribution of charges as on Fig. c)

$$\pi = \begin{cases} 0 & \text{of } \ell = 1 \\ 0 & \text{of } \ell = 2 \\ 0 & \text{of } \ell = 3 \end{cases} + \begin{cases} 1 & \text{of } \ell = 1 \\ 2 & \text{of } \ell = 2 \\ 1 & \text{of } \ell = 3 \end{cases} + \begin{cases} 10 & \text{of } \ell = 1 \\ 10 & \text{of } \ell = 2 \\ 10 & \text{of } \ell = 3 \end{cases} = 0 + 4 + 4 \cdot 10 = 44,$$

somewhat miraculously in accordance with the earlier calculation. (It may be checked that for the other distribution of signs depicted on Fig. d we get still the same result of 44.)

Alas, we would rather have preferred a disagreement so as to gain an obstruction of this boson, but which perhaps exists. Of course one needs then to repeat the procedure for other schemes (especially the bosons or pseudo-bosons which are doubly-nested and with one outer oval) yet it turns out that our doubled inference of Rohlin's formula is always respected, and as a result, it seems that no obstruction stems from our simple device. Especially interesting, would be the case of Orevkov's anti-boson $1 \frac{3}{1} \frac{16}{1}$, yet repeating our method still yields twice $\pi = 44$, quite regardless of the changing isotopy type. Okay, but one has to check this for all logically possible original complex orientation, and this involves a menagerie of ca. four cases.

Let us do this more concretely. First Fig. a1 shows the nesting tree of the Orevkov's (anti)-scheme $1 \frac{3}{1} \frac{16}{1}$. Fig. b1 shows the tree of the doubled satellites of a (hypothetical) octic. Of course, for the C_8 we still have $\pi = 11$, as the total number $\pi + \eta$ of pairs is still 19, and the difference prescribed by Rohlin's formula $2(\pi - \eta) = r - k^2 = 22 - 16 = 6$.

Next we apply Rohlin's formula on the doubled curve of degree 16, obtaining as before $2(\pi - \eta) = r - k^2 = 44 - 8^2 = -20$, whence $\pi - \eta = -10$. Further looking at the tree (Fig. b1), we count the total number of pairs of nested ovals to find

$$\pi + \eta = \begin{cases} 1 & \text{of } \ell = 1 \\ 0 & \text{of } \ell = 2 \\ 0 & \text{of } \ell = 3 \end{cases} + \begin{cases} 7 & \text{of } \ell = 1 \\ 6 & \text{of } \ell = 2 \\ 3 & \text{of } \ell = 3 \end{cases} + \begin{cases} 1 + 2 \cdot 16 & \text{of } \ell = 1 \\ 2 \cdot 16 & \text{of } \ell = 2 \\ 16 & \text{of } \ell = 3 \end{cases} = 1 + 16 + 1 + 5 \cdot 16 = 98.$$

So $2\pi = 88$, and $\pi = 44$. Next we calculate this magnitude π by using the charged tree assuming the distribution of signs being that materialized by Fig. c1 (other charges being those of Figs. d1, e1, f1). A plain calculation (mimeographed right below the corresponding Fig. c1, etc.), using the signs law, shows that π is invariably equal to 44 regardless of the charges distribution. So we cannot expect deriving Orevkov's obstruction by our naive method, and more generally Figs. a2, b2, c2 and the allied calculation shows that π is always equal to 44 so that no violation of Rohlin's formula can be obtained. In particular no one of the 4 doubly-nested bosons can be prohibited by our pseudo-method.

6.6 The Hawaiian earring of Chevallier

[30.07.13] Another naive idea (yet suggested by the papers of Chevallier and Orevkov) is to consider an Hawaiian earring alone. But then we fails strong to approach an M -curve as we have only 9 micro ovals coming from the patch. Hence one must really appeal to another singularity than X_{21} , namely one where the contact between each branches is of order 4 and not just two.

It seems therefore that the singularity to be used has a rich dissipation theory, as it creates the 4 schemes of Chevallier and one due to Orevkov. Of course it produces 5 new schemes but probably overlap with many other older construction and this is actually what is really worth exploring. Indeed the point is really to decide if there is a best curve from where all other (or so many

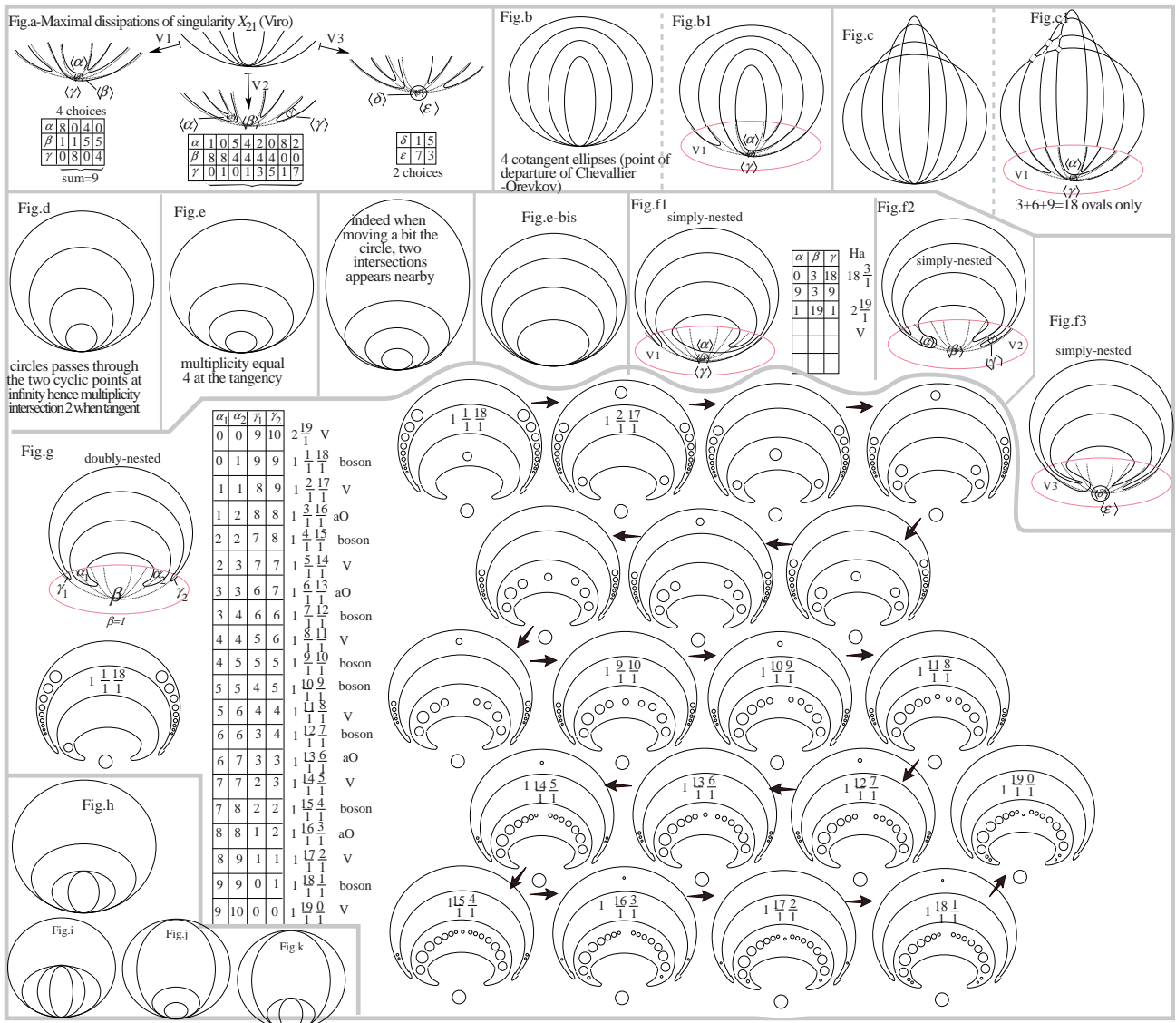

Figure 93: Viro's method in the Hawaiian context

as possible) derive. Alas we lack the technique to understand dissipations. A first improvisation is to posit that the dissipating pictures are the same as for X_{21} , safe of course, for the value of parameters α, β, γ . If so is the case then Hawaiian earring produces only simply nested schemes as shown by the three Figs. f (f1, f2, f3). Actually f1 resembles the fire-fox icon reminiscent of a snail, while f2, f3 involves a sort of snake. At any rate it seems clear that much contortion is involved (i.e. one oval is very long and contorted) and there is subconscious experimental principle telling us that we cannot thereby reach Harnack maximality under so much energy for creating a single oval. (Alas we do not know a formal phenomenon behind this but is the result of many accumulated evidence.) In contrast we can then dissipate as on Fig. g. To land in the bosonic strip we fix $\beta = 1$. To simplify we could hope to exploit symmetry as to choose $\alpha_1 = \alpha_2$ and $\gamma_1 = \gamma_2$. However then the content of both nonempty ovals would be even, contradicting a basic feature of the fundamental table of periodic elements (Fig. 130). Of course one could imagine an inflation of the deformation-zone (red ellipsoid) so that both α_i merges together to a single α . This could help finding symmetric models à la Fiedler.

The long table of Fig. g shows how all bosonic schemes can be swept out by a single procedure. Alas we are not able to prove existence of any such dissipation, so that we can only infer from Orevkov's octic obstructions the nonexistence of certain patches, notably $(\alpha_1, \alpha_2, \beta_1, \beta_2)$ equal to $(1, 2, 8, 8)$, $(3, 3, 6, 7)$, $(6, 7, 3, 3)$

and (8, 8, 1, 2). Of course those are only the mostly equilibrated patches, yet their shuffles are likewise prohibited, so for instance (1, 2, 8, 8) can be shuffled to (0, 3, 8, 8) which is likewise prohibited.

On the positive side this heuristic method does little in proving existence of any of the bosons, yet maybe there is free room for progresses along this line until someone claims to have fully exhausted the dissipation theory of this singularity (which we call the *Hawaiian contact* ≈ the French kiss of Chevallier).

Further it may be noted that there are other way to land in the bosonic strip (doubly nested with one outer oval), e.g. by injecting ovals in the little central island while letting the upper lune becomes empty. (More about this soon, see the next picture.)

Another idea is that for the curves of Fig. g it seems worth trying to sweep out the curve via a pencil of line based in the central island and so perhaps to infer some information on complex orientation via Fiedler's alternating rule. When combined with Rohlin's formula this can perhaps prohibit certain curve, and so the allied dissipation. Of course this would not prohibit the scheme itself but maybe only its realizability through our imposed procedure. Let us explore this method. Suppose the picture to be done more realistically as Fig. g1. Then sweeping from the island it could be that Fiedler's rule implies that the chain of ovals have alternating (complex) orientations. So among the 18 ovals inside the upper lune (croissant) there are as many positive pair than negative pair of ovals so that their contribution to Rohlin's formula $2(\pi - \eta) = r - k^2 = 22 - 16 = 6$ cancel out. So $\pi - \eta$ is equal to ± 1 depending on the orientation of the small lune and its inner oval. Yet in any event Rohlin's formula cannot be respected.

Examining the dissipation with injection of ovals in the central island gives the following table of schemes (Fig. 94a). Again this says little because our dissipation are fictional ones (not known by us to exist). Again all what can be inferred is the negative result prohibiting all patches converging to Orevkov's two schemes. Of course we cannot exclude the possibility that some patch leading to a boson do exist in which case we draw a new existence result. Alas we do not master the technology granting existence of a patch. Again there should be a geometric interpretation as a global (projective) object (probably in a toric manifold), but alas we do not understand properly the quintessence of Viro's method.

Finally there is still another possible mode of generation of the bosonic strip via the patch of Fig. 94b, where now both croissants are nested. Again no existence result can be inferred unless one has a deeper understanding, which apparently nobody has despite the related work by Chevallier and Orevkov (2002 [1130]) yet landing in another pyramid, i.e. the sub-nested realm.

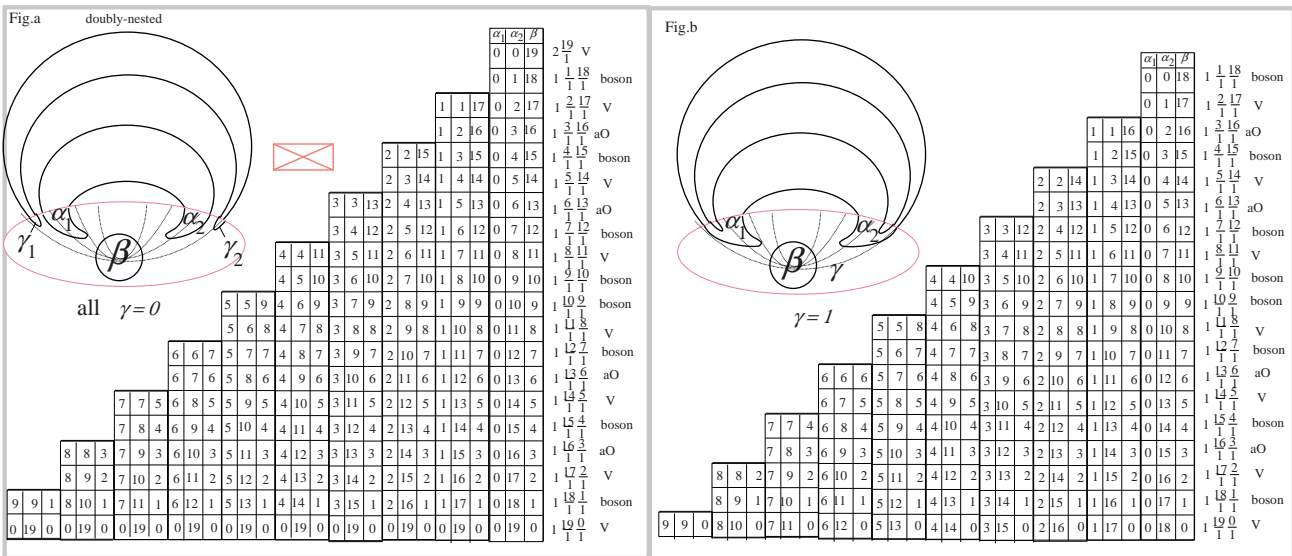

Figure 94: Viro's method in the Hawaiian context

As before one could expect that via a control of complex orientations one could prohibit such and such geometric realization of the abstract scheme via those more explicit model.

Alas it is clear that we technologically limited, and cannot advance further on the problem due basically to a lack of understanding of Viro's method.

Nonetheless, it would be of extreme importance to describe all patches for the Hawaiian singularity, so to know globally which schemes are adjacent to the Hawaiian configuration of 4 ellipses. As we said there is sub-nested schemes due to Chevallier and Orevkov that do the job, but what is demanded is a more exhaustive search (even when overlapping with older constructions by Viro). Of course the subconscious desideratum is that the Hawaiian curve has not yet delivered all its nectar (i.e., some new bosons could perhaps derive from it).

We could try at the occasion to understand Chevallier/Orevkov constructions in the hope that they do adapt to the doubly-nested bosonic region, yet this seems fairly difficult to implement as otherwise they could have done it themselves. With our poor understanding of Viro's method it seems that what is required is a little miracle of a convex triangulation of an arithmetic character (integral lattice points) yielding a sort of finitary crystallography in the Newton polygon. So what is needed is before our eyes, but nobody sees it merely because there is a myriad of such crystals (about one billion?), the patch being precisely constructed out of such a crystal.

6.7 Viro vs. le Chevallier du temple solaire, or monotheism vs. the necessity of several Gurus (Luc de Jouret et son charisme extraordinaire) as to account the full morphogenetic freedom of algebraic curves

[30.07.13, aber spät in der Nacht.] Actually the philosophical issue is about a sort of absence of monotheism and religion. More precisely, we have Viro's mandarine versus Chevallier's Hawaiian earring. What is more powerful? As we know it seems that Chevallier's earring was able to create 4+1 new schemes (when combined with Orevkov's variant thereof). Albeit modest those 5 schemes were previously inaccessible through the combined efforts of the eminent predecessors:

- Harnack 1876, Hilbert 1891, (and their Miss Ragsdale [1906] who perhaps made more explicit the output of the former's constructions),
- Wiman 1923 [1595] (who discovered a new scheme in degree 8 through a methodology that apparently both Hilbert and Ragsdale imagined as sterile and impossible),
- Gudkov ca. 1971 [576] (who after his successes in degree $m = 6$ made sporadic contribution in degree $m = 8$),
- Korchagin 78 (who using Brusotti, managed to construct one more scheme),
- Viro 80 (who suddenly learned us that M -curves are not so rare diamonds, but rather proliferating as fast as the *vermine du Pripet*),
- Shustin (who completed some of the efforts by creating a certain medusa (Fig. 121) of an interesting type basing himself on the dissipation theory of the candelabrum with 3 branches transverse to the trunk), plus, subsequently, a very clever construction using threefold symmetry to get the scheme $4\frac{5}{1}\frac{5}{1}\frac{5}{1}$. (Not yet assimilated by us at the time of writing.)
- Korchagin (who created a myriad of 19 new schemes by merely exploiting a complex dissipation theory and the Newton polygon).

So Chevallier's Hawaiian earring inspects another region of the spectrum, but we cannot exclude the crude option that it can phagocyte completely Viro's method via the mandarine (quadri-ellipse). Our belief (from pure intuition as we do not know the precise dissipation of Hawaii earrings) is that both Viro's mandarine and Chevallier earrings are complementary objects, perhaps even not sufficient to cover all octic distributions of ovals. Crudely put, it seems that in degree $m \geq 8$ (and higher a fortiori) there is no monotheism, but rather a pluralist world requesting several gurus (privileged curves) enabling one to access all rooms past the discriminant (or at least their isotopic incarnations).

Added [04.10.13].—Besides, it seems that one can imagine configuration of 4 ellipses hybridizing Viro’s contact of order 2 with Chevallier’s contact of order 4, see e.g. Fig. 93h, i, j, k.

Question 6.2 *Is there any chance that any one of those (hybrid) quadri-ellipses produce new bosons, as the Chevallier earring managed to produce new M -schemes not formerly accessed by Viro’s method(s).*

Despite this philosophical wisdom, it seems of interest to prove that no monotheism is possible and to measure the power of the varied gurus. By this we just mean, given a special singular octic, count the number of (M -)schemes, that can be gained by (infinitesimal) deformation (of the guru curve).

The list of gurus is as follows:

- Viro’s quadri-ellipses (coaxial) produces ca. 40 schemes. In principle Viro claims that the dissipation theory of the allied singularity X_{21} is fully understood (so that no new boson could emerge through that procedure). One may wonder where the proof of those assertions are supplied (source to compare Viro 89/90 [1535]).

- Chevallier’s (Hawaiian) earring produces at least $4 + 1 = 5$ schemes (according to literature, the last one being due to Orevkov) but probably creates much more (possibly even schemes not yet known to exist).

- perhaps the sequel of our text, or many lovely curves by Viro, Shustin, etc, depicted in the sequel of this text shows that there is plenty of other gurus-curve allowing potentially to construct new scheme not yet known to exist.

So questions worth elucidating are (focusing on $m = 8$ just for the sake of concreteness):

(1) What is the best guru, humanity can dream about? Jesus Christ? Mohammed? Herbert Grötzsch? Markus Schneider?

Natural candidates: Viro’s quadri-ellipse, but check if Chevallier’s earring is not stronger. Alas no complete data is available to us.

(2) Assuming that there is no monotheism, what is the minimal number of Gurus required to cover all schemes in degree 8? In general call this $G(m)$ the Guru constant in degree m . For instance $G(4) = 2$, as all schemes are deducible from two transverse ellipses save the empty scheme. Likewise $G(6) = 2$ as all non-empty schemes are deducible from Viro’s mandarine. This number has an intrinsic significance and it would be interesting to know if the despite the bewildering exponential rate of growth of all schemes as a function of m , if the number of Guru’s required can be kept into reasonable growth like a linear growth. Roughly put, mankind is stupid or “moutonesque” enough to tolerate very few Guru’s. Of course in an ideal world everyone should be his one guru (or at least take the responsibility thereof).

Of course we do not have any moral message to transmit, but just used this image to get red of the geometric insignificance of our search. Assuming that all 6 bosonic octic M -schemes are prohibited it seems that the Guru number $G(8)$ is circa one for Viro (plus two for its tricky variant), two for Shustin, one for Chevallier and Orevkov. So all M -schemes known up to date derives from only $3 + 2 + 1 = 6$ Gurus. Of course assuming taht all remaining 6 bosons exist we could let degenerate them by brute force on a wall of the discriminant and thereby get 6 new (ad hoc) gurus of poorly charismatic nature.

Hence it seems that actual knowledge (discussed in more detail in the sequel) implies the following:

Lemma 6.3 *The Guru constant in degree $m = 8$ is at most 12, $G(8) \leq 12$. Of course it can be much lower, say perhaps as low as $G(8) = 1$ in case the Chevallier (du temple solaire de Toulouse) is able to crack all M -schemes (the empty one being discarded incarnating the opposite spectrum of maximality).*

Of course there is (at least) two ways to define the Guru constant depending on whether we want to access all schemes or confine to the maximal ones. We denote $G(m)$ that for M -schemes, and by $g(m)$ that encompassing all schemes.

Evidently $G(M) \leq g(m)$. For instance $G(6) = 1$ via Viro's mandarine, while $g(6) = 2$ via Viro's mandarine plus Fermat's solitary curve $x^6 + y^6 = 0$.

Another way to define the Guru constant involves the rigid version of really spotting out all chambers past the discriminant and not crude isotopy type. This we call $\Gamma(m)$ the rigidified Guru constant. For $m = 6$ this is probably computable via the Rohlin-Nikulin-Kharlamov theory employing K3 surfaces. Probably $\Gamma(6) = 2$ once Viro's method is known.

Of course assuming that there is a linear complexity upon the number of Gurus then Hilbert's 16th could still be (sozusagen) tractable algorithmically, but probably energy resources to complete this work will be wasted by private Bankers and oriental oil merchant prior than humanity becomes conscious of its real mission. All the best and good luck for the sequel.

[31.07.13] Also, it would be nice to do a careful map of all the gurus and their zones of influence.

As we said we have as gurus the following curves:

(1) Viro's mandarine (Fig. 6). Its zone of influence is marked by green rectangles enclosing the letter "V" on Fig.95. This is very compact on the 1st pyramid, yet with severe lacunas on the bosonic strip. The mandarine zone attacks only 3 schemes in the trinested region (2nd pyramid).

(2) Viro's beaver (castor) which realizes 7 schemes (106).

(3) Viro's horse which realizes

(4) Shustin's medusa (cf. Fig.121)

(5) Shustin's flower with threefold symmetry (alas no depiction available for the moment)

(6) Korchagin but no understanding

(7) Chevallier's earrings

It seems further that a natural Guru is the following curve

(8) (Gabard's) margarita: a singular octic with an ordinary septuple point (alias the margarita flower), cf. Fig.140. The dissipation theory of this guru seems to reduce to that of affine M -septics with pseudo-line oscillating simply across the line at infinity. Hence the radiation influence of the margarita includes all M -schemes realized via affine M -septics. Albeit this zone is a priori equal to the blue region of Fig.95, but alas the dissipation of the septuple point or equivalently the theory of affine septic is not as yet sufficiently developed to make an exact description of the zone.

The next figure (Fig. 96) is an attempt to discover Shustin's flower yet we lost ourselves in random nonsense. In fact after a long search we came to the idea that if an octic has 3 candelabrum points then the conic through them and tangent to both both of them (think with 2 infinitely close points) will have an intersection of $3 \cdot 4 + 6 = 18 > 16 = 2 \cdot 8$, and Bézout is overwhelmed. So it seems that:

Lemma 6.4 *There is no singular octic with 3 candelabrams, except perhaps if it splits off a conic.*

[01.08.13] Further it is natural to wonder if there is any natural species (animal) between the horse and beaver that would permit the creation of new (or old) schemes. As we said in this game one must not strive toward extreme originality but rather try to get a global understanding through much overlap. Also one problem is to find the hottest curve permitting to create the greatest number of smooth curve.

For instance one can imagine a version of Viro's horse where all 4 inner ovals are transferred outside. Then the schemes are just changed by a fluctuation of 4 ovals so that probably just a left translation on the table (Fig. 95) is effected. Similarly one can imagine a version of the beaver with 4 outer ovals transplanted inside. Let us work out the scheme realized by those genetically modified birds. The little surprise is that we get so new schemes claimed by Viro (like $3(1, 14\frac{3}{4})$ or $3(1, 10\frac{7}{4})$) but which we were never able to construct as yet.

Of course one can then do even more radical genetic modification of beaver and horse, like transferring the beaver's eggs in its foot (Fig. c). The resulting

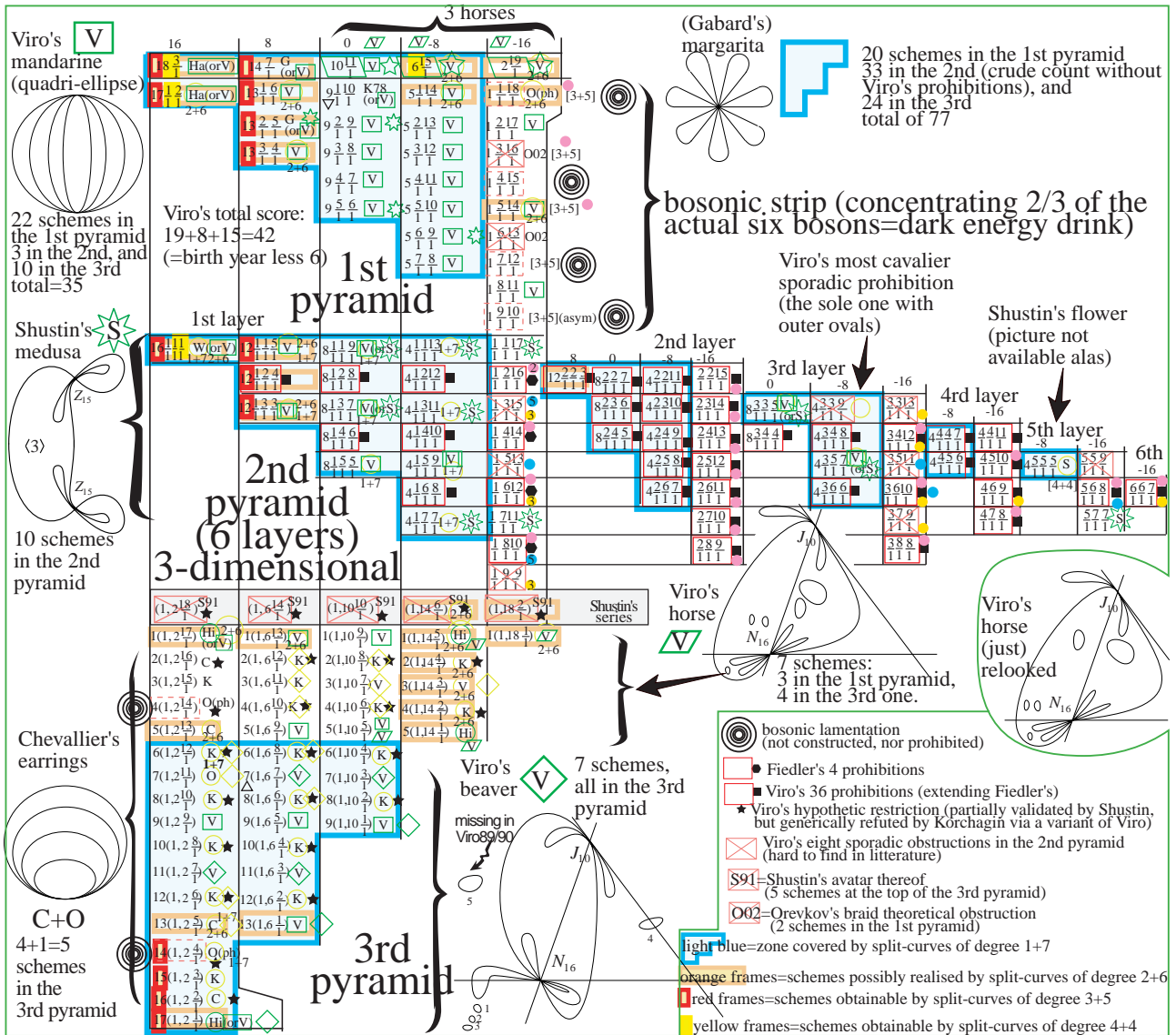

Figure 95: The Gurus and their zone of influence/radiation.

schemes are obtained just by shifting by 4 the 2 earlier tables. Then we get one scheme due to Korchagin but that we were never able to understand and which is thus relatively new, and also the scheme $7(1, 2\frac{11}{1})$ due to Orevkov. Likewise the 2nd table yields the interesting scheme of Chevallier $13(1, 2\frac{5}{1})$.

Scholium 6.5 *There is perhaps a fairly elementary construction of Orevkov's (unique) octic scheme by a variant of Viro's method using a genetically modified beaver (Fig. 97c).*

At this stage we were struck by the idea of using a quintuple flat point (i.e. with coincident tangent). This should have more power, or otherwise in the beaver we could trade the upper (flat) triple point for an ordinary one which admits a more elementary dissipation theory.

Fig. d transplants the outer egg in the pregnancy bag of the beaver, and then we get the same collection of schemes modulo a shift. Actually Fig. d is the extremal pregnancy level for the beaver and it creates then the schemes $2(1, 10\frac{8}{1})$ and $2(1, 6\frac{12}{1})$ plus all five schemes below them (on the table) amounting to eject the babies outside of the beaver's belly. From $6(1, 2\frac{12}{1})$ we can also run 5 schemes below on the table visiting in particular Orevkov's scheme. Once this is understood we have a clear view of the possibility (geographic aptitude) of the beaver. Roughly it is most interesting when pregnant, yet it still misses Chevallier's scheme $5(1, 2\frac{13}{1})$ and what is above.

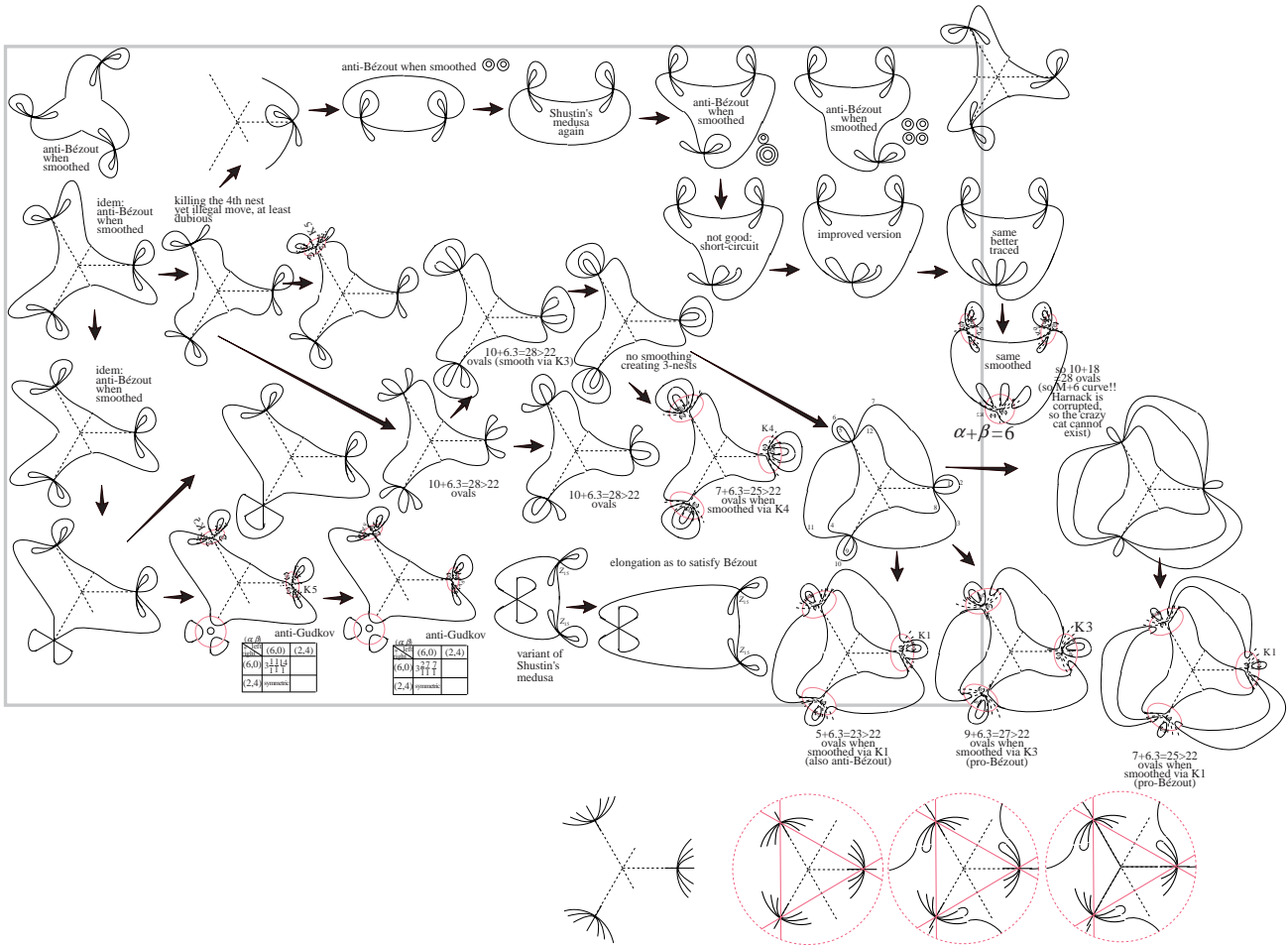

Figure 96: A la recherche of Shustin's curve

So it seems that we need a completely new animal to explore this zone, or perhaps the beaver's queue may be invaginated as on Fig. e. Alas on improving the picture it seems that there is a short-circuit then this represents usually a waste of energy leading us away from the realm of M -curve.

More formally, we know that a fivefold point eats 10 units to the genus, so as the beaver curve has 6 circuits (hence genus 5) we infer somewhat indirectly that the triple point eats 6 units to the genus ($21 - 10 - x = 5$, whence $x = 6$). At any rate the fact that Fig. e does not represent a perfect circuit diminish our aptitude to create ovals, and we are lost. It seems that we have completely exploited the capacity of the beaver.

As a last remark concerning the beaver, when Fig. produces Chevallier's scheme $13(1, 2\frac{3}{1})$, then we may additionally eject the deepest ovals outside of the belly and so we get the 4 schemes below it on the main-table, namely $14(1, 2\frac{4}{1})$ (boson), $15(1, 2\frac{3}{1})$ (K=Korchagin), $16(1, 2\frac{2}{1})$ (C=Chevallier), $17(1, 2\frac{1}{1})$ (Hi=Hilbert).

Actually one can represent the biotope of the beaver by black symbols on the table (see Fig.97) and one sees that actually permitting on Viro's original beaver quantum jump inside one can raise always one five positions so that from the fundamental parallelogram (green rhombs with signature "V=Viro") plus the 3 aligned same rhombs but shaded one can sweep out the full biotope of the beaver safe the right row. Then in a similar way it is as simple matter to delimit the biotope (habitat) of the horses and their genetic modification. Indeed one marks first the 4 fundamental schemes coming from Viro's horse (parallelogram of thickest circles), and then one can inject 4 median ovals in the subnest. Diagrammatically this implies a shift to the left (smaller circles), and once this is done one can progressively eject the deep ovals outside without changing the Euler-Ragsdale characteristic χ so that ejection one-by-one is permissible (without conflicting with Gudkov periodicity). Diagrammatically this has the

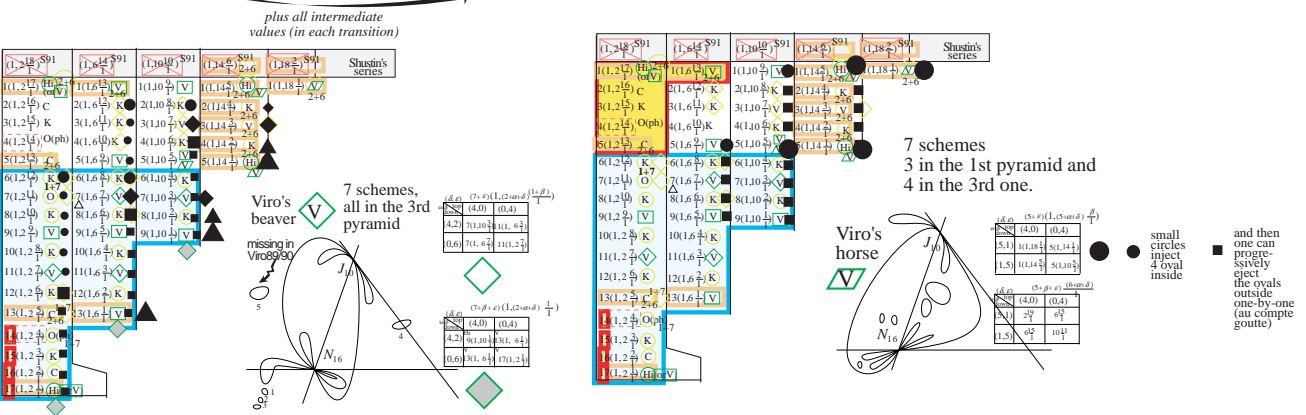
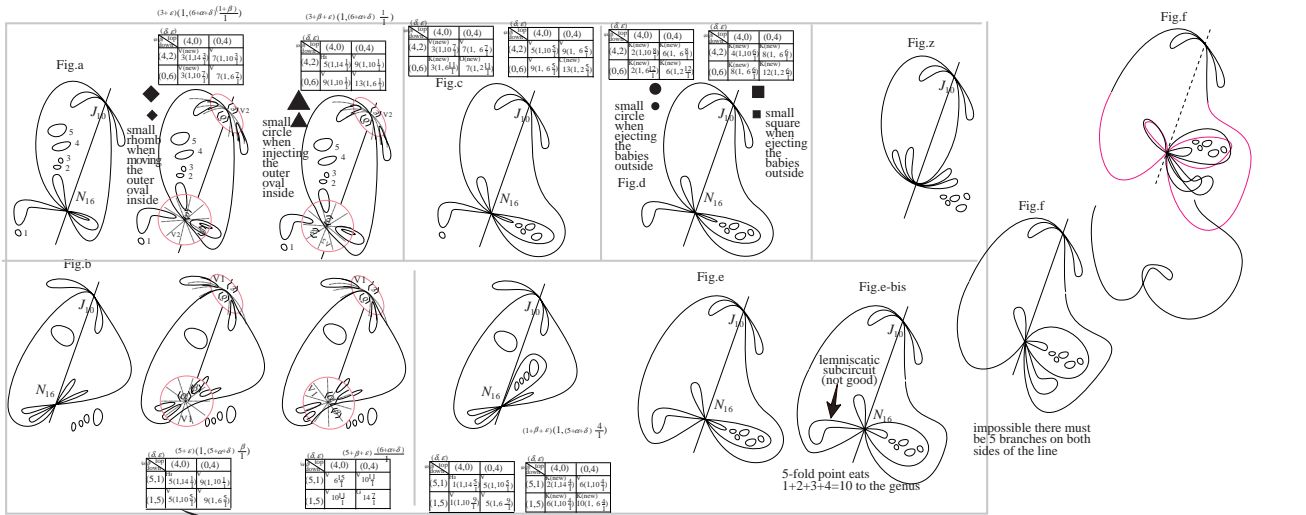

biotope of the beaver (black symbols) biotope of the horse (black symbols)

Figure 97: Beaver and horse genetically modified

effect of moving down along 4 positions, and so we get the black region.

It seems therefore that both the beaver and horse are never able to visit the polar (or desertic) region yellow-colored out our map. In particular it seems to us that the corresponding boson $(4(1, 2\frac{1}{4}))$ —which is in some sense protectionist with many ovals protected at depth 2—looks somewhat harder to detect than its open-minded/liberal companion $14(1, 2\frac{1}{4})$. Of course it can be as well as case that we did not as yet explored all type of animals by relying merely on Viro's beaver and horse.

So some artistic imagination power is required to draw new animals and here comes a sort of theory des dessins d'enfants into the game at least to make the task psychologically supportable. However it seems that there is some obstruction to modify the beaver in the requested geographical locus.

Hence, we may of course imagine more artistic tracing of curves representing principally new animals. Fig. z looks to be a serious candidate using a quintuple point with 5 tangent branches. Yet alas this requires a new dissipation theory that we are not familiar with. Of course one can improvise, yet we feel too tired today to explore this in any systematic fashion.

[02.08.13] Actually one can imagine such curves as coming from a Jordan domain (splashed disc) with tentacles growing (cytoplasmic expansion) and self-penetrating an invagination of the domain. So we get for instance the curve depicted once smashing the vertical point so to create higher singularities. For instance Fig. e looks promising because it has only one external teats hanging outside, and therefore the smoothed curve should land in the bosonic strip (where four M -schemes are in suspense/doubt). Fig. f is just a relooking with less Bézier points so that the curve looks better (a Kunstform der Natur). Actually the smoothing Fig. f1 leads potentially to Korchagin's (desertic) scheme

$3(1, 2\frac{15}{1})$, and when modified even the (protectionist) boson $4(1, 2\frac{14}{1})$.

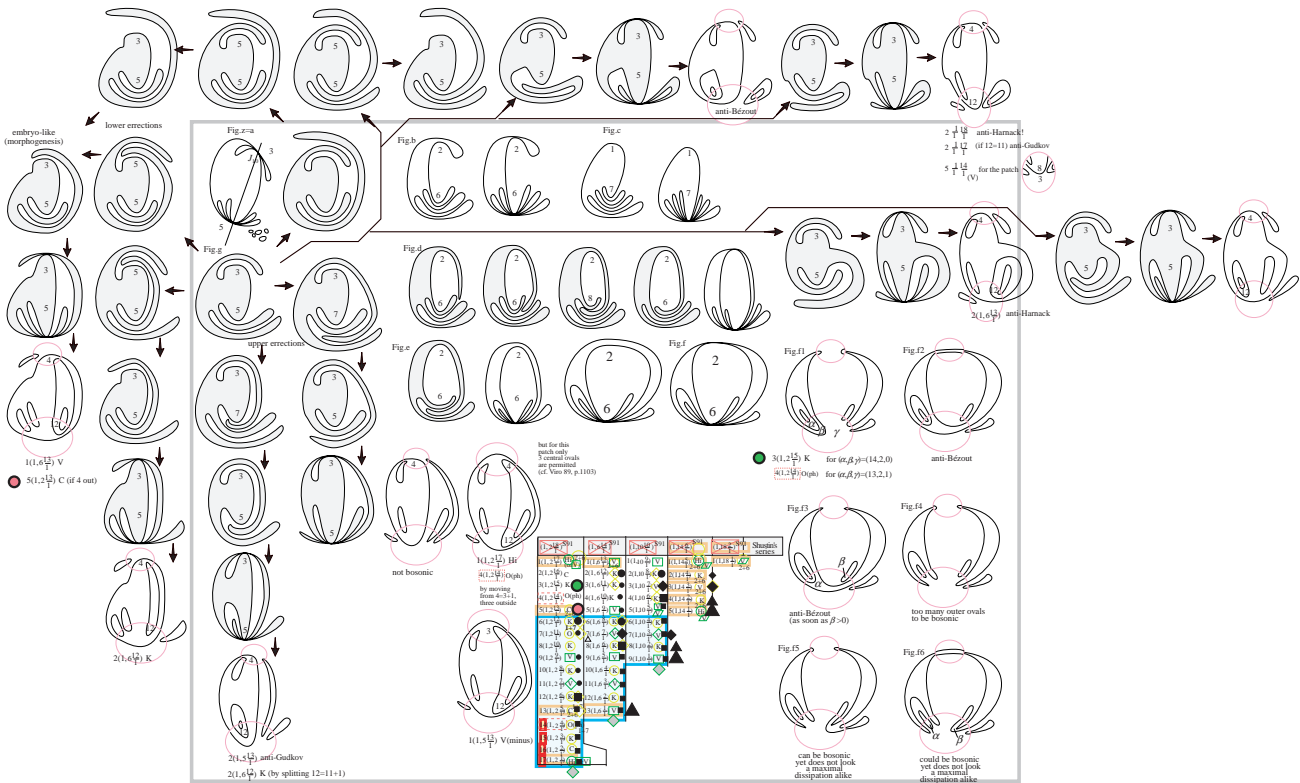

KILL ALL 3+5, because reported next FIGURE

Figure 98: More gurus

Then Fig.g shows a myriad of four fashions for this ground form to evolve through varied erections. The ground idea is to have a cell-like shape with cytoplasmic expansions interpenetrating themselves, and then smashing the cell we get two singularities of multiplicity 3 and 5 respectively. Eventually after a long search we realized that the snake of Fig.h or that of Fig.i incarnating the simplest forma for having one protuberance leads us potentially to the bosonic strip. Of course Fig.h1 may be an aggression for Bézout (look at the dashed line), hover it seems plain that a contortion of the queue could repair this misfortune. Of course in both cases (Figs.h or i) we just depicted the extremal value of the parameter, but transplanting one-by-one ovals through (hypothetical) patches yields in all cases all the bosons even in some palindromic repeated fashion. From Fig.h2 we get first for $(\alpha, \beta) = (12, 1)$ the boson $1\frac{1}{1}\frac{18}{1}$, and then run through all successors $1\frac{2}{1}\frac{17}{1}$, $1\frac{3}{1}\frac{16}{1}$ up to $1\frac{13}{1}\frac{6}{1}$. Of course if Örevkov's obstruction are correct, then we get a corresponding prohibition of the patch for $F5$ (flat quintuple point, in Gabard's notation not acquainted with Arnold's numerology). So again little can be gained but potentially all those 4 bosons are constructible if one had a understanding of the smoothing of $F5$, and of course if the curve of Fig.h1 (or better its contortion Fig.h3) exists algebraically. As to Fig.i it is noteworthy that despite the dissipation of $F3$ used is not maximal from the viewpoint of the only 3 quantum=small ovals created by the dissipation described in Viro 89/90 (p. 1103), globally the smoothed curve has 6 macro ovals (so one more that the former Fig.h2) and therefore we still obtain an M -curve.

Of course our method has to be explored much more systematically, yet it gives already a sort of algorithm to generate the singular circuit possibly realized by singular octics, via a pleasant embryology of the basic cell (disc).

Then of course beavers and horses corresponds to the combination $O5+F3$, where $O5$ in an ordinary quintuple point, while $F3$ is a flat triple point. One can imagine then to explore all possible combination like rather $F5+O3$, where we have a quintuple flat point and an ordinary triple points.

olates severely Harnack's bound. Indeed Viro's patches of X_{21} permits to create always 9 extra micro ovals whatever the type of dissipation used $V1, V2, V3$, so that the total number of ovals is equal to the apparent number plus $2 \cdot 9 = 18$. Eventually, we realized that for a deformed embryology Viro's original method can also be interpreted in terms of two cells degenerating to the topology of an annulus. We can imagine more (non-connected) embryos like the copyright symbol on the left of Viro's species. This, when smashed and smoothed, leads to $5 + 18 = 23 > 22$ ovals, violating again Harnack. So:

Lemma 6.6 *All the qualitative singular octics depicted on Fig. 100 below, do not exist algebraically simply because when dissipated à la Viro they produce curves violating Harnack's bound.*

Probably there is a theoretical justification a priori without invoking Viro's theory (dissipation of X_{21}), like arguing that if an octic has two $F4$ singularities ($F4 = X_{21}$ in Arnold's notation) then the conic through both points with the prescribed tangents has intersection number with the C_8 of at least $2 \cdot 4 = 8$ at each point, so a total of 16 intersections. This hold true for any conics of the pencil, yet when the curvature is made to coincide with one of the 4 branches then the contact exceeds 16, and so by Bézout the octic is forced to split off an ellipse (that ellipse). Hence:

Lemma 6.7 *Any singular octic with a distribution of two flat quadruple points is necessarily the union of 4 ellipses. (Disappointing corollary: there is no rich embryology as that just explored susceptible to produce new octic schemes, especially the six unsettled bosons not yet known to exist).*

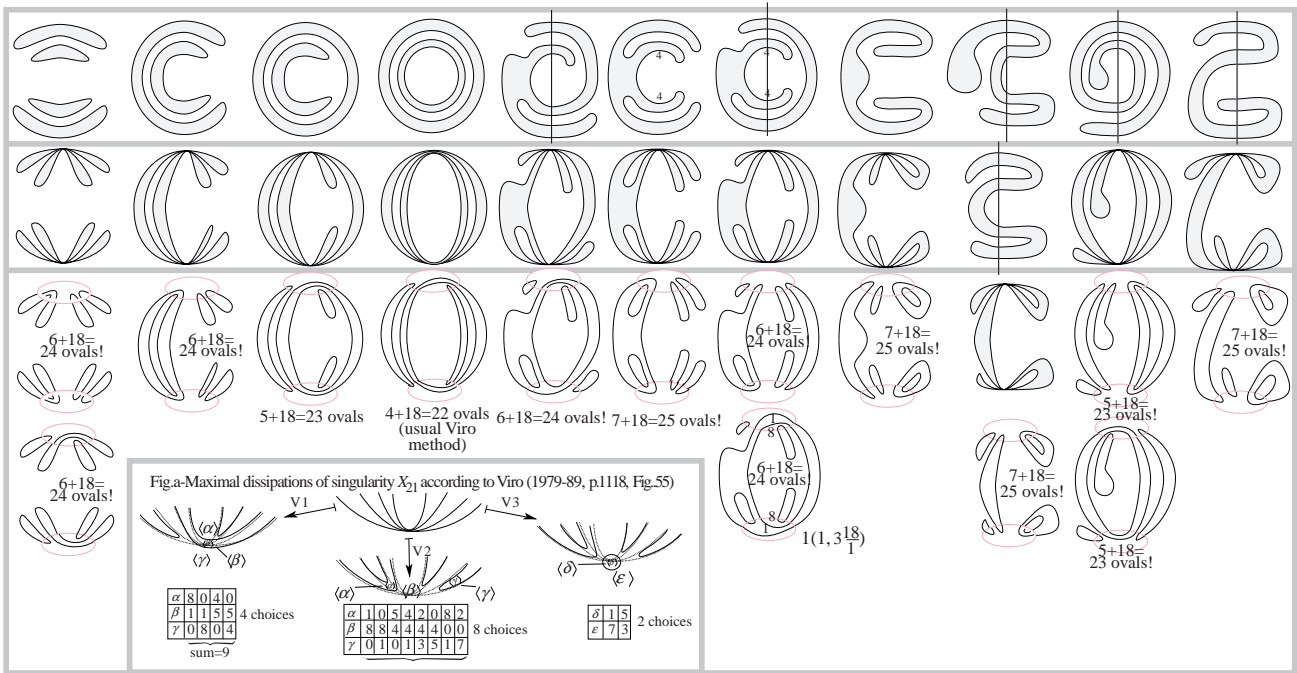

Figure 100: Embryology of gurus in degree $4 + 4$

So what next? Of course one could hope that embryology is still useful in other context like $8 = 3 + 5$ or $8 = 2 + 6$, or even $8 = 1 + 7$. Alas we run then again more obscure dissipation theory (not described in Viro's works to the best of our knowledge). One idea could be to use more complex pattern (embryos) involving other distribution of foldings than $F4+F4$, e.g. $F4$ plus several $F3$, or just several $F3$.

After some few trials we arrived at a somewhat ad hoc pseudo-octic (depicted as Fig. 101a) able to create the 2 bosons $1\frac{1}{1}\frac{18}{1}$ and $1\frac{7}{1}\frac{12}{1}$ via the usual dissipation theory for $F3=J_{10}$ and $F4=X_{21}$ in Arnold's nomenclature. So:

Scholium 6.8 *Possibly Viro’s standard dissipation theory has not yet been fully exploited if one dispose of a global curve tracer able to substantiate our embryology in the algebraic category.*

Of course our method is no mystery, as we started from a 3 + 4 configuration of Fig. a and then expanded to Fig. b by adding a 2nd triple point (of the flat type F3). Then smoothing the curve (downwards on the Fig.) we got a scheme with 25 many ovals. So we just have to kill 3 of them as this and this is achieved by our Fig. c. Of course another choice is to “bore the canal” like on Fig. d. Further our picture is intercepted 12 times by the red line (so Bézout is severely foiled). So the hard game is to get more respectable pictures of such pseudo-octic. An improvement along this way is given just by rotating the head of the animal to get Fig. e. Alas, there is still a line with 10 interceptions of our hypothetical octic C_8 . Of course one could hope that this is merely a defect of our model and that there is a diffeotopic model mimicking better the behavior of an algebraic octic.

[04.08.13] Next we had the idea of using a more symmetric embryo (Fig. f resembling a smiling face) and after slight morphogenetic adjustment (lowering the number of ovals within Harnack’s range while also arranging one outer oval) we find Fig. f1 producing both a schemes prohibited by Orevkov and one of the bosonic type (namely $1 \frac{7}{1} \frac{12}{1}$). Again our figure is not ideal as one can trace a line intercepting the C_8 along 10 points. Fig. f2 shows how to corrupt one Viro sporadic obstruction while also getting Shustin’s scheme $\frac{5}{1} \frac{7}{1} \frac{7}{1}$. Fig. f3 yields the same as Fig. f1, while Fig. f4 yields the same schemes as Fig. f2. Next we realized that appealing to Viro’s dissipation V3, all of our pseudo-octics (Figs. f2,f3,f4) produce other interesting schemes.

More precisely Fig. f0 produces under the smoothing V2 some basic Viro’s scheme, but under V3 schemes violating Viro’s oddness(oddity?) law. As a result either the latter is wrong (unlikely because published), or we deduce that there is no singular octic isotopic to our Fig. f0 (referring of course to its smashing depicted right below).

As to Fig. f1, it creates a scheme anti-Orevkov, one boson, and two classical schemes (a simple one of Viro plus the most tricky one of Shustin). Therefore either Orevkov’s sporadic obstruction is wrong or the latter implies that there is no singular octic like Fig. f1 (smashed as depicted right below).

When it comes to Fig. f2 (perhaps embryologically even nicer than the previous pictures), we see the creation one scheme violating a Viro sporadic obstruction, but besides 3 perfectly standard schemes of Viro and 2 of Shustin. Therefore, either Viro’s sporadic obstruction is wrong or it implies the non-existence of our singular octic Fig. f2. So, as a scholium, it perhaps quite probable that some of Viro’s sporadic obstructions are wrong

Likewise Fig. f3 violates one of Orevkov’s two prohibition while producing a boson plus two standard schemes due respectively to Viro and Shustin. It may be noted that Fig. f3 creates actually the same schemes as Fig. f1, yet perhaps afford perhaps a better aggression against Orevkov’s obstruction, as the picture of the singular octic is more symmetric. This seems remarkable enough to deserve a statement:

Lemma 6.9 *Either Orevkov’s obstruction of the octic M-scheme $1 \frac{6}{1} \frac{13}{1}$ is wrong, or if true then there is no singular octic isotopic to our Fig. f3.*

As to Fig. f4 it produces the same schemes as Fig. f2, yet through a more symmetric model, and thus represents perhaps a more severe offense against the relevant Viro’s sporadic obstruction. Precisely, we have the:

Lemma 6.10 *Either Viro’s obstruction of the octic M-scheme $\frac{1}{1} \frac{5}{1} \frac{13}{1}$ is wrong, or if true then there is no singular octic isotopic to our Fig. f4, nor to our Fig. f2. Crudely put there are two flexible singular octics fighting against the truth of the sporadic Viro obstruction, so that the latter is perhaps wrong. (Of course it would be of interest to realize the other Viro anti-scheme $\frac{1}{1} \frac{3}{1} \frac{15}{1}$ via our pseudo-method).*

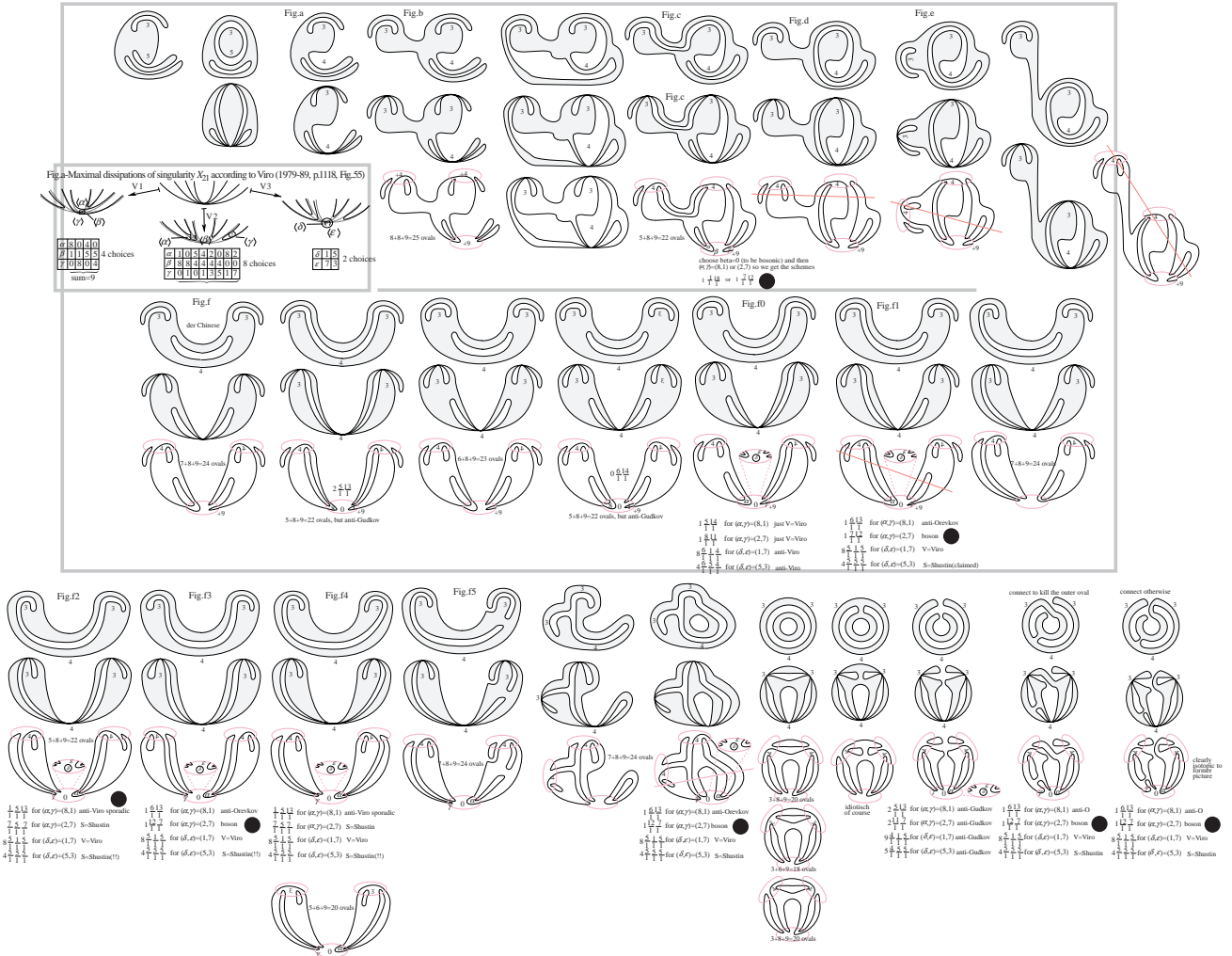

Figure 101: Embryology of gurus in degree 4 + 4

6.8 More bosonic embryology as applied to Hilbert's 16th

[05.08.13] Then there is more possibilities when quadruple point occurs through the interpenetration of 2 teats. After few trials leading to anti-Gudkov configurations we had the idea of taking an gemelar embryo like Fig. 102a. Albeit the latter leads again to an anti-Gudkov scheme, it is easy to imagine appropriate surgeries correcting the number of outer ovals (which in the doubly nested case has to be one mod 4, with special interest in the case when this is really one in the bosonic range), and so we get quickly Fig. 102b. The latter produces a pair of bosons, namely $1\frac{1}{1}\frac{18}{1}$ and $1\frac{7}{1}\frac{12}{1}$, plus two elementary schemes both accessible to Viro's simplest method (via the quadri-ellipse). So again this gives support that both bosons do have some chance to exist. Further this time there is no contradiction with Orevkov's obstruction when producing the boson $1\frac{7}{1}\frac{12}{1}$.

Is there other embryos leading to other bosons? Fig. c is another option for bringing the number of outer ovals to one, yet the resulting schemes are isotopic to those of Fig. b.

Fig. d shows another surgery leading to the trinedsted realm, yet outside Gudkov's range. Fig. e shows a simple correction to zero outer ovals as it should be in the trinedsted case. Alas, the resulting schemes are anti-Viro (imparity law), yet it is simple to correct by surgering at different places as to get Fig. f. Its smoothing gives the scheme $\frac{1}{1}\frac{9}{1}\frac{9}{1}$, which very shamefully is missing from our table say just at the combinatorial level. So we added it yet on Fig. 95 yet beware that other copies of that table may not be up-to-date.

More intrinsically we have the:

Scholium 6.11 (WRONG, cf. right-below) There is a potentially new boson

that we just overlooked at the combinatorial level. In particular, it seems to us that nobody (i.e. neither Viro nor Shustin or whoever else) never constructed nor prohibited this scheme which is therefore a potentially new boson in the trinested realm. In particular Shustin's assertion that Hilbert's 16th (isotopic classification) of M -curves is complete in that case is (slightly) erroneous. Compare e.g. Shustin 1990/ [1419] or some other work by this author.

Sorry very much, the problem was that this symbol disappeared during an electronic cut-and-paste procedure. So the real scholium is:

Scholium 6.12 Never thrust electronic computers (especially when cutting and pasting images in Adobe Illustrator, while forgetting to unlock stuff).

In reality the scheme in question is prohibited by a sporadic Viro obstruction (cf. Viro 86 [1534, p.67]). Let us now be more serious, Fig.f creates besides another anti-Viro scheme ($\frac{3}{1} \frac{7}{1} \frac{9}{1}$) plus two schemes constructed by Viro (albeit we were as yet not able to digest his construction, yet this is merely a matter of detail). Hence again we get:

Lemma 6.13 Either both of Viro's sporadic obstructions against $\frac{1}{1} \frac{9}{1} \frac{9}{1}$ and $\frac{3}{1} \frac{7}{1} \frac{9}{1}$ are false, or there is no singular octic like our Fig. 102f.

It is clear that the number of such statement can be multiplied and it is merely now a combinatorial quest to make an exhaustive list of such hypothetical statement. Though hypothetical we believe that they could offer new insights on the ultimate destiny of Hilbert's 16th in degree $m = 8$.

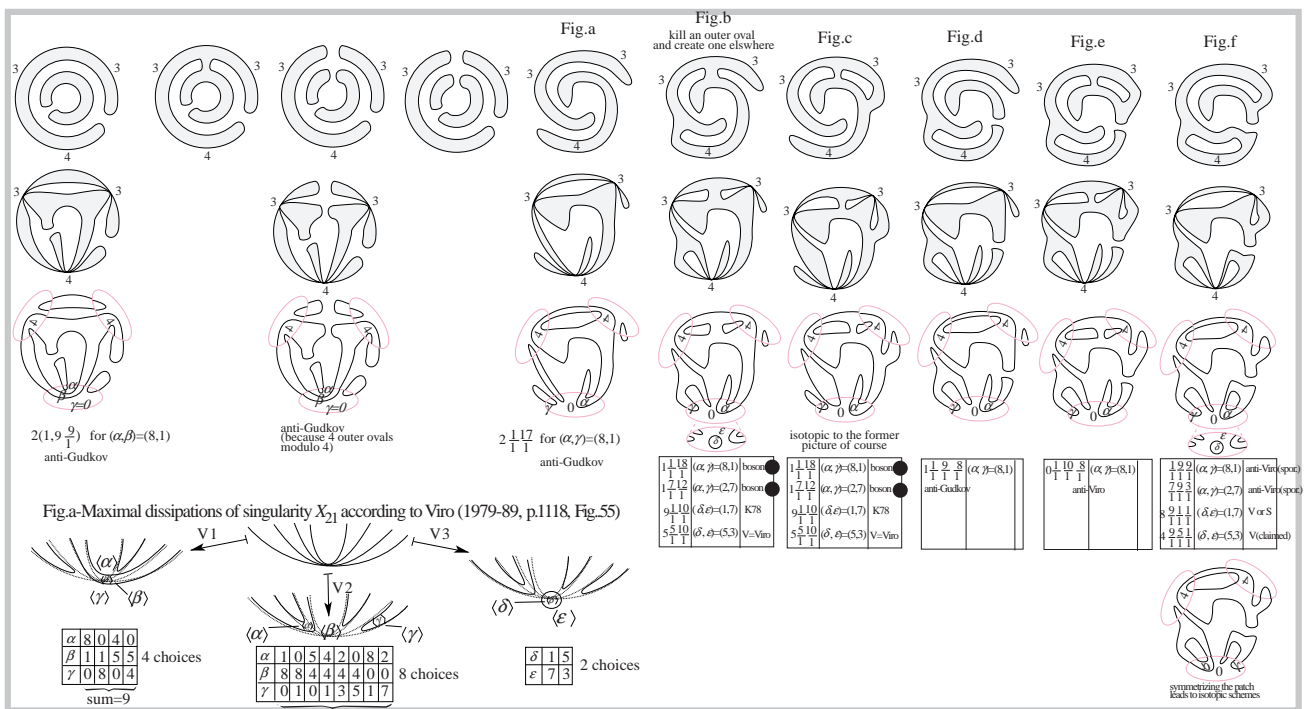

Figure 102: Gurus 4+3 BIS

Summary of the method.—It seems that what is missing is an organizational way to explore all embryos, i.e. a morphogenesis (e.g. in R.ené Thom's jargon). This is to say, that we could start from any ground shape and perform adequate smashing to get fundamental shapes of s -octic, where the prefix "s" refers to singular. Any s -octic generates then schemes via Viro's method of the patch(work), and this permits to explore either new schemes, or in contradistinction when the scheme is obstructed either by Harnack, Gudkov, Viro, Orevkov to deduce a corresponding obstruction on the s -octic. Possibly the method can be used to kill present day obstruction (say of Viro and Orevkov) which are possibly wrong. If not it is hoped at least that the embryology method

will aid us to detect s -octic producing new schemes among the six bosons not yet known to be realized or prohibited. As a typical example we believe that Fig. 102c could exist thereby producing in one stroke the two bosons $[1, 18]$ and $[7, 12]$ without conflicting with Viro nor with Orevkov's obstructions.

Let us implement our algorithm again. We start with a ring slightly distorted like a horse shoe (i.e. "U-shaped"). We select on it three series of anchor points (as they are called in the theory of Bézier curves). (French geometers include too many biseaux: Bézout, Bézier, who else?). Then to create our distribution of singularity $F4 + F3 + F3$ we smash respectively 4 or 3 of them to a single point. When we collapse 3 points in a tetrad there are two options amounting to coalesce either down or up. Then we merely have to tabulate all options as on Fig. 103.

Fig. a enters in conflict once with a sporadic Viro obstruction, but otherwise create respectable schemes due to Viro/Shustin. So either Viro's obstruction is false or there is no s -octic like Fig. a. Fig. b conflicts with Orevkov's obstruction and would produce one boson $(1, 7, 12)$. So either Orevkov's obstruction is false or there is no singular octic like our Fig. b. Fig. c is actually isotopic to Fig. b. Fig. d produces an interesting boson but conflicts with Orevkov's obstruction. Disappointingly, the next two figures (Figs. e, f) are isotopic to Fig. d. Finally Fig. g conflicts with Viro twice and more seriously with Bézout for conics. Hence we can safely claim the:

Lemma 6.14 *There is no singular octic with real locus isotopic to Fig. 103g.*

As yet the method seems confusing yet we have not exhausted all possibilities as we saw earlier that it is possible to find embryos creating bosons without conflicting with the Russian obstructions (which looks to us as random the Russian roulette game with the pistol used in transiberian cow-boys movies).

Then we continued our loose algorithm using as fundamental embryo a "S" digestive tube like Superman's logo. Fig. j gave one boson yet conflicting with Orevkov. Varying the position of the collapsing segment we arrived eventually at Fig. o where 2 bosons are created without conflicting with Russian obstructions. Curiously enough it seems that this curve permit only two M -smoothing (where as usual with Petrovskii M - abridges Harnack maximality). Then we arrived at Fig. p which seems to lack an M -smoothing.

Eventually we decided to change of embryo by tacking an "E"-letter shaped embryonic substratum for the morphogenesis. Let us remark from the intrinsic viewpoint that we did not as yet realized all bosons, so for instance we missed $1\frac{4}{1}\frac{15}{1}$ if my short-run memory is not failing. Using this letter we first found Fig. 103E1 realizing two bosons without that the other M -smoothing conflicts with Russian scholastic prohibitions (Viro/Orevkov). It should be remembered that Fig. 102 already showed this phenomenon of frictionless creationism while involving exactly the same two bosonic schemes. Therefore let us posit the following somewhat cavalier:

Scholium 6.15 *Among all remaining 6 bosons perhaps that $1\frac{1}{1}\frac{18}{1}$ and $1\frac{7}{1}\frac{12}{1}$ are the less mysterious one, i.e. they exist algebraically as it possible to create them out of a plastic curve (singular octic) without friction against the Russian prohibitions.*

Then we got Fig. E2 violating twice Fiedler and twice Viro's extension thereof (imparity law in the trinested case). So safe for a global mistake in Fiedler-Viro there is no curve like Fig. E2 for fairly deep reasons beyond immediate Bézout intuition. Fig. E4 shows again a phenomenon of non-maximality apparently allied to the issue that the chosen bridges (to be collapsed) do not exploit sufficiently the topological contortion of the ground shape. Intuitively, bridges have to be placed in an economical fashion so that all isthmus are properly visited. So for instance a system of efficient bridges is that generating Fig. E5, which alas produces schemes isotopic to those of Fig. E3. Fig. E6 shows the result of when the long bridge of length 4 is pushed inside the embryo. The

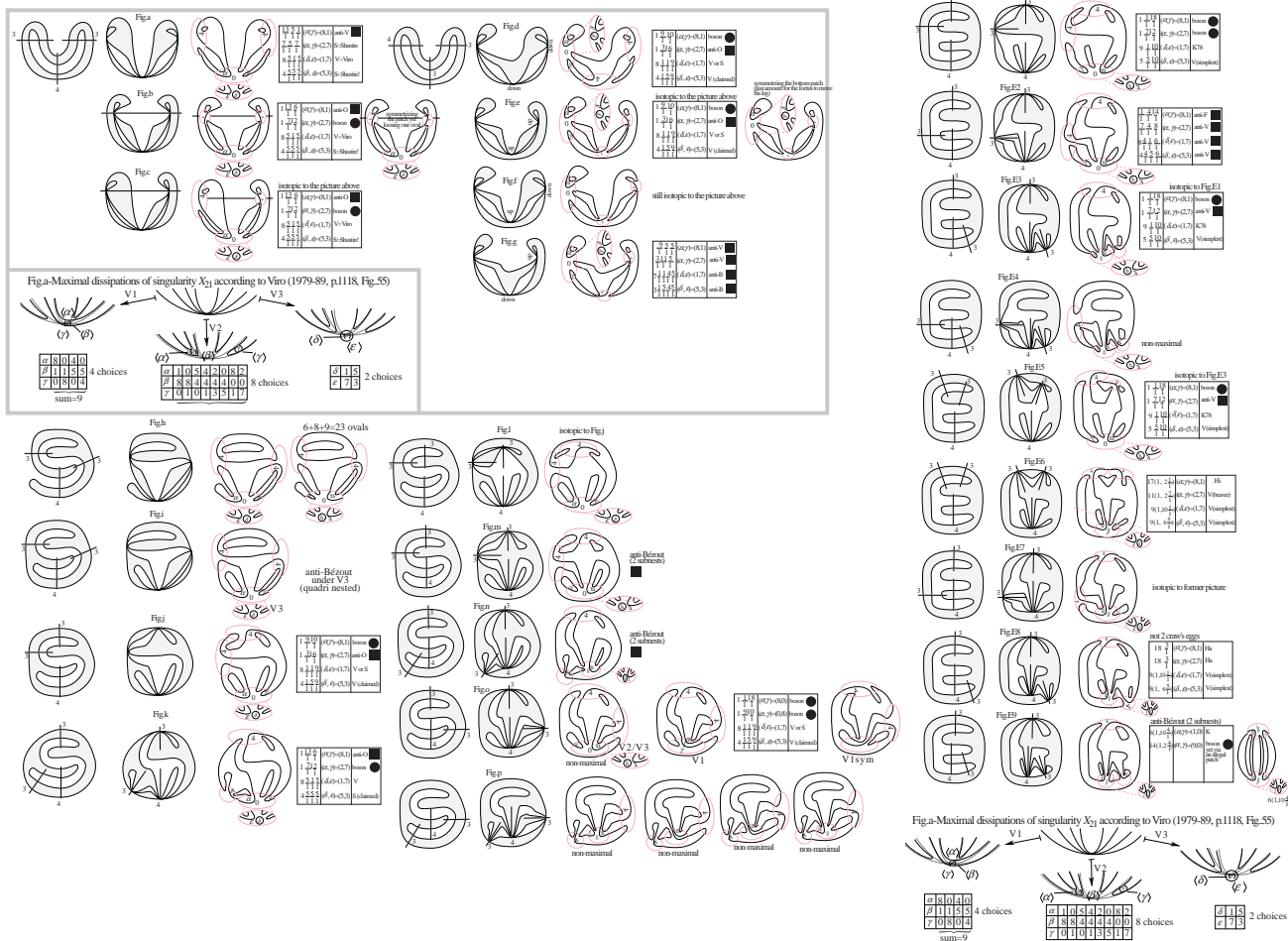

TO BE CONTINUED

Figure 103: Embryo

net results seems to be that we land in the subnested realm. Alas the schemes so obtained are super-classical (Hi, V/beaver or V simplest mandarine method with the quadri-ellipse). It should be remarked taht on E6 one can trace a line with 10 intersections, yet perhaps this is only a defect of our depiction and not an absolute property of the isotopy class of our singular octic.

[06.08.13] Let us call a nested oval an egg, as algebraic curves are like biotopes with several birds constructing the nests and placing their eggs in them with the possibility that small birds construct their nests inside one's larger bird nest. (Nid de moineau dans nid de corbeau.) In the subnested case (i.e. Gudkov symbol of the form $x(1, y \frac{z}{1})$) the bosonic strip involves schemes with the minimum number $y = 2$ of crawl eggs. A priori we would like to do construction of curves with controlled topology yet it seems that the piece of information missing are so large that it is not worth trying to be deterministic, preferring rather a random search as in each zone there is something to learn, or de-construct (i.e. mistrust Viro/Orevkov, etc.). So let us look at Fig. E7 which produces a configuration isotopic to the former one yet in a more acceptable way w.r.t. Bézout.

Fig. E8 shows how to access the boson $14(1, 2 \frac{4}{1})$, yet by using an illegal patch over a curve violating Bézout as soon as γ is positive. Yet naive question why is the (maximal) patch $(\alpha, \beta, \gamma) = (9, 0, 0)$ illegal? We hoped that gluing the patch with itself along the mandarine yields a contradiction, yet this produces the scheme $2 \frac{19}{1}$. Of course we studied already this question more systematically on Fig. 7, and their we noticed that the existence of the smoothing $V2(9, 0, 0)$ would only create the 2 bosons $1 \frac{1}{1} \frac{18}{1}$ and $1 \frac{7}{1} \frac{12}{1}$, which according to our Scholium 6.15 are the most plausible bosons. Should we therefore mistrust Viro when claiming

that his table of dissipation is complete?

Sorry, but it is at this stage only that we missed to combine the dissipation V2 and V3 which are perfectly compatible, i.e. married in strong Harnack maximality.

[NB 04.08.13: While doing all this picture requires some patience and skills with Adobe Illustrator. I would like to thanks a certain artist known as Cathia for giving us the requested encouragements to look always for the perfect curve. Compare her illustration for children. Alias I do not remember exactly her family name, yet googling Cathia, Geneva, illustration for children is perhaps enough to get something from the web.]

6.9 Irrational thinking and morphogenesis

Skip this subsection if you dislike rubbish.

[06.08.13, at 1:21, flashed by some dubious philosophy]. Why do we like curve? The primate (as says Gromov) is perhaps erotically attracted by curves. Especially aesthetical are the algebraic curves requesting only a finitary description and thereby incarnating a principle of least action that even nature adhered on, at least since the vision of Johannes Kepler, ca. 1603. Yet, why do we prise nowadays about those rigid objects often overwhelming our visualization power and seemingly very special and rigid for modern standards? The Answer is: in die Ruhe des Newton liegt die (Schwer)kraft! Yes, indeed it seems that it is fairly attractive to contemplate how an object like an algebraic curve [grooving in a moduli (better parameter) space of fairly big dimension $\binom{m+2}{2} - 1$], despite its intrinsic rigidness is nearly able to adopt highly contorted shapes and sees the singularity of any of its singular representant able to deviate along all possible dissipation of its singularities in an independent fashion (alias the Plücker-Klein-Harnack-Brusotti-Gudkov-Viro-Shustin principle incarnating the extreme graphical flexibility of algebraic objects.) Yet it seems that algebraic geometry is slightly (and probably violently) more rigid than combinatorics as exemplified by the case of octics, where we have some Russian obstruction that probably deserve to be more closely examined in view of our previous experiments. If not it seems valuable that those highbrow Russian obstructions (Fidler=Fiedler in RuSSian calligraphy, Viro, Shustin, Korchagin, Orevkov, nobody else!) receives better treatment in literature. If not, within the next few month, it is fairly probable that few of them, especially those given in random (only semi-published) fashion turns out to be fairly erroneous, inhibiting thereby the morphogenetic flexibility of algebraischen Gebilde. The latter to our greatest surprise turns out to be extremely flexible, and perhaps realize more schemes that Viro's original guess suspected. As an historical antecedent of this Viro "debandade", we need only to remind the 19 schemes constructed by Korchagin, to which may be safely added the 4 schemes by Chevallier (du temple solaire), plus that one exhibited by Orevkov. It seems now evident that several bosns as well as some few schemes now believed to be prohibited due to hasty exhaustivity in Viro's primitive methods (and a lack of imagination about contortion of algebraic shapes) is responsible of an actual probably biased state of affairs when it comes to list octic schemes.

Another idea striking the writer' understanding is the mediocre trend allied to Newton (cf. e.g. the anti-Riemann viewpoint expressed in Chevallier 1997 [281], that neither the déploiement universel nor the Riemann surface is requested since everything is readable from the Newton polygon). This looks to us severe mysticism or rather lack of poetical continuity method striving us to the claustrophobic realm of combinatorics or capitalism. However this suggested us a little flash, when thinking about Newton's method (the basic one=roots searcher in one variable) as compared to the Viro-Itenberg polyhedral method in two variable for tracing curves in the piecewise linear category. We realize only today that, by virtue of the principle of linearization in the small (alias calculus or analyse des infiniment petits) presumably the Viro-Itenberg method is nothing else than Newton's (parallelogram?) method amounting to detect

the zero loci of algebraic equations through linearization in the small.

6.10 More embryos

Not yet written, but easy to do-it-yourself.

6.11 Non-maximal dissipation of the mandarine

[22.06.13] We shall call the union of 4 coaxial ellipses either Viro’s 0th curve or the *mandarine*. It would be of interest to know as well which non-maximal dissipations arise through smoothings of singularity X_{21} . The remarks to be found in Viro 1989 (p. 1119) imbue to some vagueness: “We do not yet have a complete topological classification of the dissipations of X_{21} singularities. Shustik [32] proved [...]; however there is still a big gap between what is given by the constructions and the prohibitions. Curiously, the problem has been completely solved for dissipations that can occur in the construction of nonsingular M -curves.”

Despite this we can naively postulate (inspired by the Itenberg-Viro contraction principle of empty ovals) that all non-maximal dissipations derive from a maximal one via extinction (=contraction) of an empty (micro) oval. After more mature thinking this is certainly erroneous (imagine an RKM $(M - 2)$ -scheme lying in the depression of Gudkov’s sawtooth), but we really intended to say that that all contractions are realized algebro-geometrically so as to produce a smoothing. Then we can naively extend the dissipation pattern to the pre-maximal cases in order to tabulate the corresponding $(M - 1)$ - and $(M - 2)$ -curves. This requires some tedious tabulation (Fig. 104) with the evident drawback is that there is no absolute warranty about existence of such curves. Accordingly the corresponding schemes (distribution of ovals) will only be yellow-green colored on the main census plate (Fig. 155). As expectable, working out this tabulation (Fig. 104) essentially involves removing the empty ovals as to get the schemes below Viro’s schemes obtained via the 4 coaxial ellipses (tangent at 2 points). This needs little commentary apart from a long contemplation of this tabulation which looks really subsumed to the maximal dissipations. Perhaps one noteworthy detail is the obtention of the scheme $18\frac{1}{1}$ (cf. the red case on the 2nd table of Fig. 104), which resisted to the other methods (that will be exposed subsequently). Another little comment is that at some stage of the tabulation (cf. green-case) we get a scheme (namely $6\frac{14}{1}$) which is apparently not dominated by a Viro-style M -scheme, but which in reality is via the M -scheme $5\frac{1}{1}\frac{14}{1}$. Eventually, once the full triangle is filled, it remains a certain rectangle which combines M - with $(M - 2)$ -smoothings. Rosa-colored case depicts the first occurrence of a scheme (alas we did not did it systematically from the beginning so our tabulation is not perfect along this first occurrence option). Anyway, after completing the tabulation one sees that nearly all positions dominated by a Viro’s M -scheme are filled, apart some few schemes on the right-side of the 1st pyramid like $\frac{2}{1}\frac{17}{1}$, $\frac{5}{1}\frac{14}{1}$, $\frac{8}{1}\frac{11}{1}$, etc. It would be interesting to know if those schemes are realized.

6.12 An error to avoid

Insertion (of a misconception) [06.05.13].—The morning after having told Viro’s story to Misha Gabard (born in same year 1948), we wondered why the “braids” of Fig. 6a cannot be reconnected in a very symmetric fashion as to produce a curve C_8 with 2 nests of depth 2, i.e. like the left-half of the right-part of Fig. 6d extended by symmetry to give a fourth type of “mandarine” (with 4 lunes). So we can speculate about a fourth mode of dissipation in Fig. 6a which is like V3, modulo symmetric reproduction of its left-half. Alas, it seems that this smoothing was overlooked in Viro 89/90 [1535], and that the list of accessory parameters was not specified. But actually Viro 89/90 writes on p. 1119 (4.7.A.) “and also all of the [quasihomogeneous] dissipation obtained

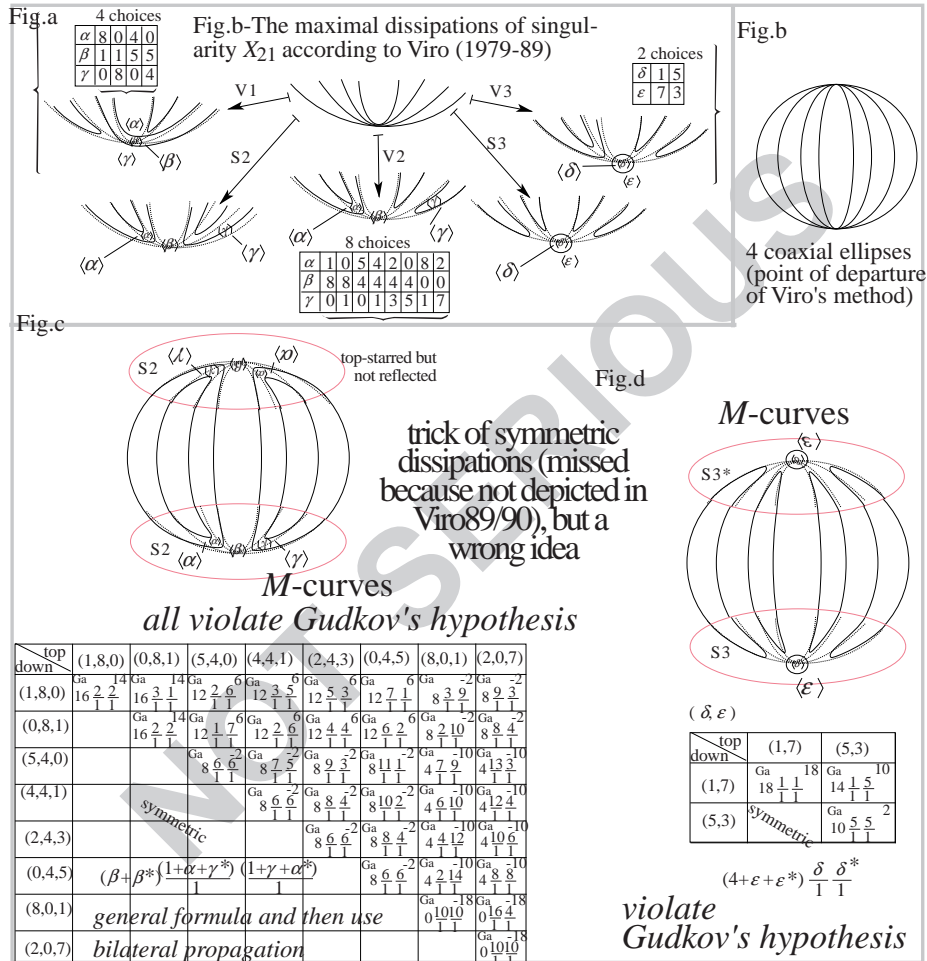

Figure 105: A misinterpretation of Viro 1980 contradicting Gudkov's hypothesis. Yet another Irrweg!

6.13 Discrepancy between Viro and our homemade patchwork (our mistake)

Comment on this subsection.—It was written before we realized that Viro's patches C2 and C3 can be glued in a maximal way. Hence, most of the sequel is based on a basic mistake of us, and so should be skipped by the reader.

So in reality, the Hawaiian=Leningradian dissipation of X_{21} via a quadruplet of coaxial ellipses creates $35 - 8 = 27$ new schemes. So this is less than the 42 revindicated by Viro 1980, and therefore the latter had another trick in his pocket.

At this stage we checked Viro's table of 1980, especially regarding the symbol $2X_{21}$ certifying that the scheme may be obtained by the above method of dissipation. Safe for our misunderstanding, Viro's table contains here another some few misprints, located by the symbol Δ on our Fig. 154. (Additionally, but less importantly, for the scheme $10\frac{11}{1}$, Viro's table omits its realizability via $2X_{21}$, i.e. the above construction.)

How can we explain this discrepancy between our patchwork and Viro's table? One possible explanation, is that (since we missed several schemes of the central row) Viro's list of values for (δ, ϵ) was not complete in the 1989 article.

Explaining the single missing scheme of the last row, namely $7(1, 6\frac{7}{1})$, is more tricky to guess a reason. We checked once more our first table (Fig. 6d, left) which looks perfectly correct.

Perhaps all these discrepancies may be ascribed to the typographer of Viro's article 1980, or we missed some detail. A next step is to understand Viro's other constructions (i.e. not via $2X_{21}$ =dissipation of a quadrirangent quadruplet of ellipses).

7 Artwork (Viro, Shustin)

7.1 Viro's twisted constructions (beaver)

We now explain other constructions due to Viro starting with a more complicated singular octic than the fundamental union of 4 coaxial ellipses. By these somewhat more complicated procedure some few other sporadic curves will be gained, yet alas not covering in full the Hilbert's 16th problem.

Again the key idea is explained in Viro 1989/90 [1535] (especially his Fig. 77), where 4 new schemes are obtained (see rhombic "V" on Fig. 154), by a clever construction we shall now attempt to summarize. Alas, Viro's original picture seems to contain minor bugs, and we hope our presentation being more reliable.

First, Viro constructs a singular octic with 2 singularities which are respectively an ordinary (nondegenerate) 5-tuple point (N_{15} in Arnold's census) and a triple branch each having 2nd order contact (J_{10} in Arnold's census), compare Fig. 106a. We shall detail this construction in the sequel, but first show its utility to Hilbert's 16th in degree $m = 8$. It is a good exercise to see how the complicated branch is unicursally travelled by a particle according to a simple law, namely whenever we cross J_{10} we stay on the branch having the same "curvature", while when crossing the ordinary 5-fold node N_{16} (locally like 5 concurrent lines) we always have to count 5 branches cyclically to find our way out of the singularity. This singular curve C_8 is constructed via a hyperbolicism à la Newton (essentially akin to Gudkov's clever use of Cremona transformation ca. 1972). Let us trace first the singular octic in question (Fig. 106a), and the game will be as before to dissipate the 2 singularities in all possible fashions while tabulating all resulting schemes (distribution of ovals).

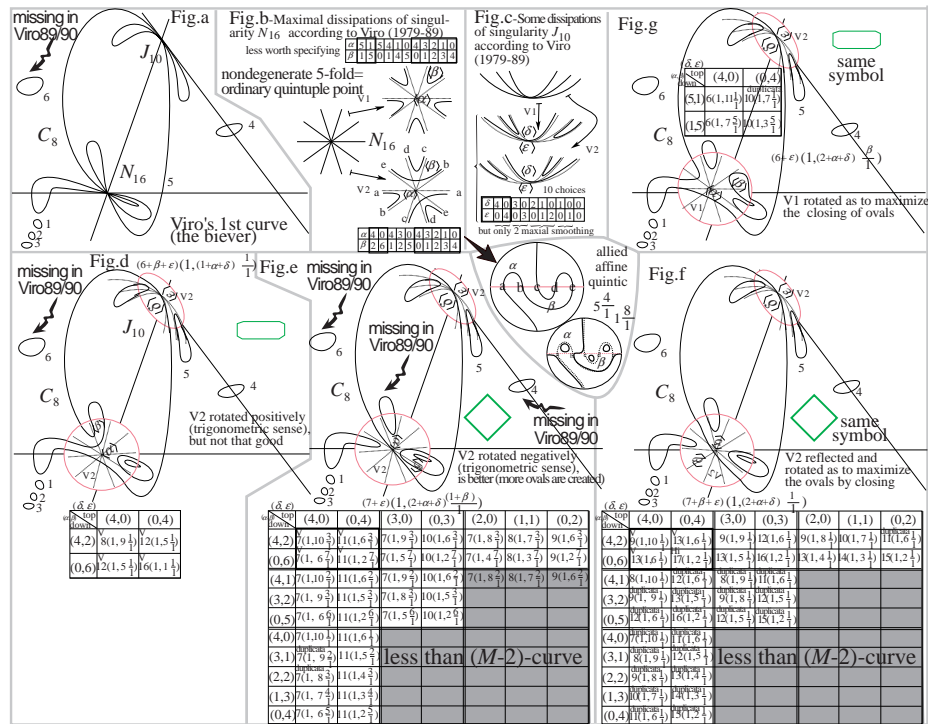

Figure 106: Detailing Viro 1980 via Viro89/90 (while correcting his picture).

The next step is to remember the dissipation of J_{10} (cf. Fig. c). Those were already used when exploring Viro's gluing in degree 6 hence no further ado is required, safe that (α, β) went relabelled (δ, ϵ) . For N_{16} the maximal dissipation are given on Fig. b following Viro89/90 [1535, p. 1109, Fig. 34]. There we read that when $\alpha + \beta = 6$ on V_2 , then $\alpha - \beta \equiv 2 \pmod{8}$ and this leaves only the 2 possibilities listed. The case of V_1 is not even needed as it does not create M -curves, but is of some interest if attention is paid to $(M - 2)$ -curves too.

We first traced Fig. 106d by gluing the V_2 dissipation of N_{16} (ordinary quintuple point) rotated so as to close the double petal to a nest of depth 2. Alas

doing so the upper petal is not closing, but rather connecting with the west petal (creating thereby a non-maximal smoothing). Albeit “less” interesting than M -curves, this still gives three $(M - 2)$ -schemes worth tabulating and reporting on Fig. 155.

On rotating clockwise the $V2$ -template at N_{16} , we get Fig. 106e, which leads to four M -curves, namely $7(1, 10\frac{3}{1})$, $11(1, 6\frac{3}{1})$, $7(1, 6\frac{1}{1})$ and $11(1, 2\frac{1}{1})$. Those 4 new schemes (due to Viro 1980) are reported on Fig. 154 via rhombic squares enclosing the letter “V”. It seems evident that no more M -schemes can be caught by this method, because the smoothing $V1$ of the quintuple point N_{16} fails creating the maximum number of ovals. (We warn the reader that some details of Viro’s picture in 1989/90 (esp. his Fig. 77) looks anomalous albeit his final (symbolical) results are in accordance with our own checking. The graphical omissions we detected are marked by squig-arrows on our figures.) For subsequent purposes, it is worth tabulating the non-maximal smoothings too of Fig. e. One can modulate further by examining also non-maximal smoothing of N_{16} , for which we must consult Viro 89/90. There on p. 1109, the structural constants of the dissipation are prescribed by a congruence (mod 8) which leads easily to the values tabulated above on Fig. b. Actually, for an $(M - 2)$ -smoothing it seems that there is no obstruction and the full range of pairs is realized from $(4, 0)$, $(3, 1)$, etc. up to $(0, 4)$. Interestingly, it may be observed that those smoothings are just interpretable as derived from the maximal smoothings through contraction of the empty micro-ovals. This explains how $(5, 1)$ creates $(5, 0)$ and $(4, 1)$, and so on. Subsequently, only $(2, 2)$ is of a new stock and not created by contraction. This is surely allied to Rohlin’s maximality conjecture for RKM-scheme. Further there are probably other smoothings leading to more schemes.

The $V1$ -smoothing leads (alas) only to $(M - 2)$ -curves depicted on Fig. 106g which were new (at the time we found them). Then we can progressively rotate the patch as shown on Fig. 107h,i,j,k,l,m,n,o,p,q,r,s, but nothing new is obtained.

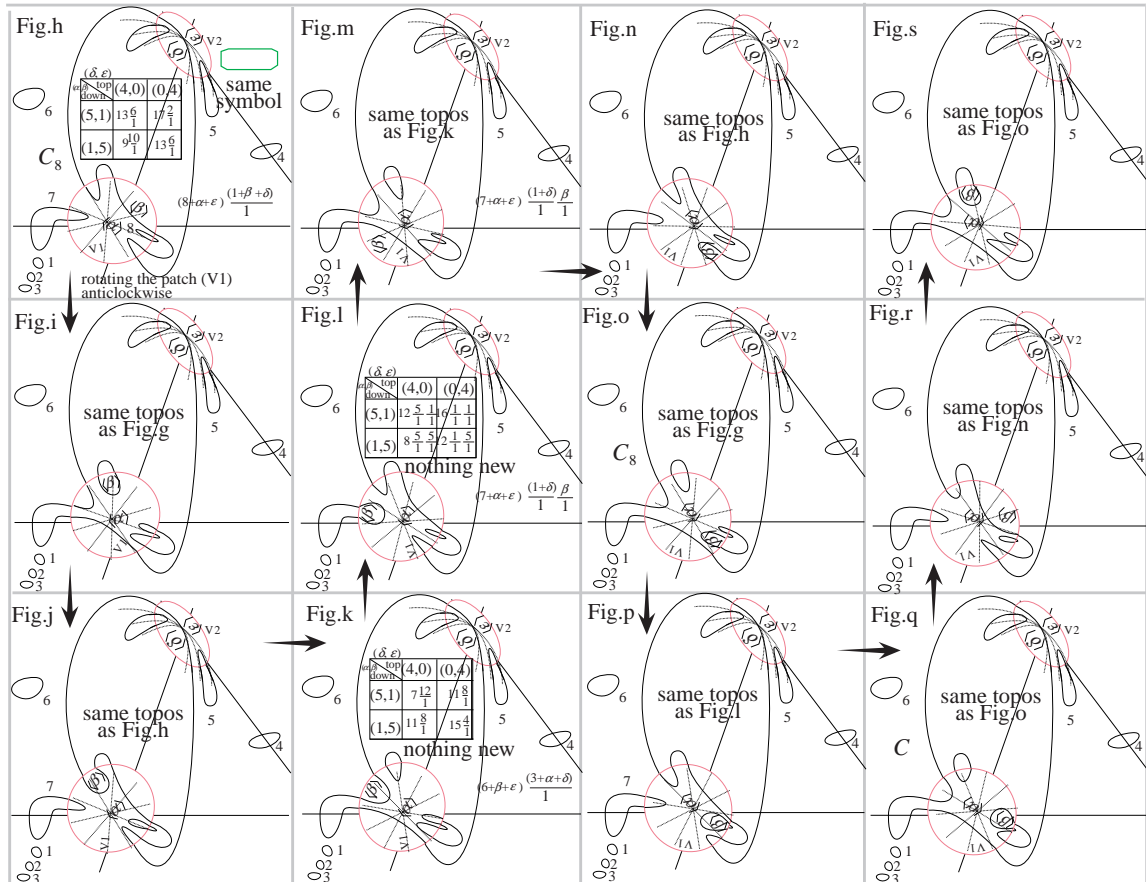

Figure 107: Little twists of Viro’s construction giving some $(M - 2)$ -curves.

Then it is also reasonable to reflect the patch and rotate it to get the curves

of Fig. 108. The series of curves so obtained is extremely boring producing not a single new curve. Actually, the symmetry of the patch V1 affords probably a metaphysical explanation a priori for this lack of newness.

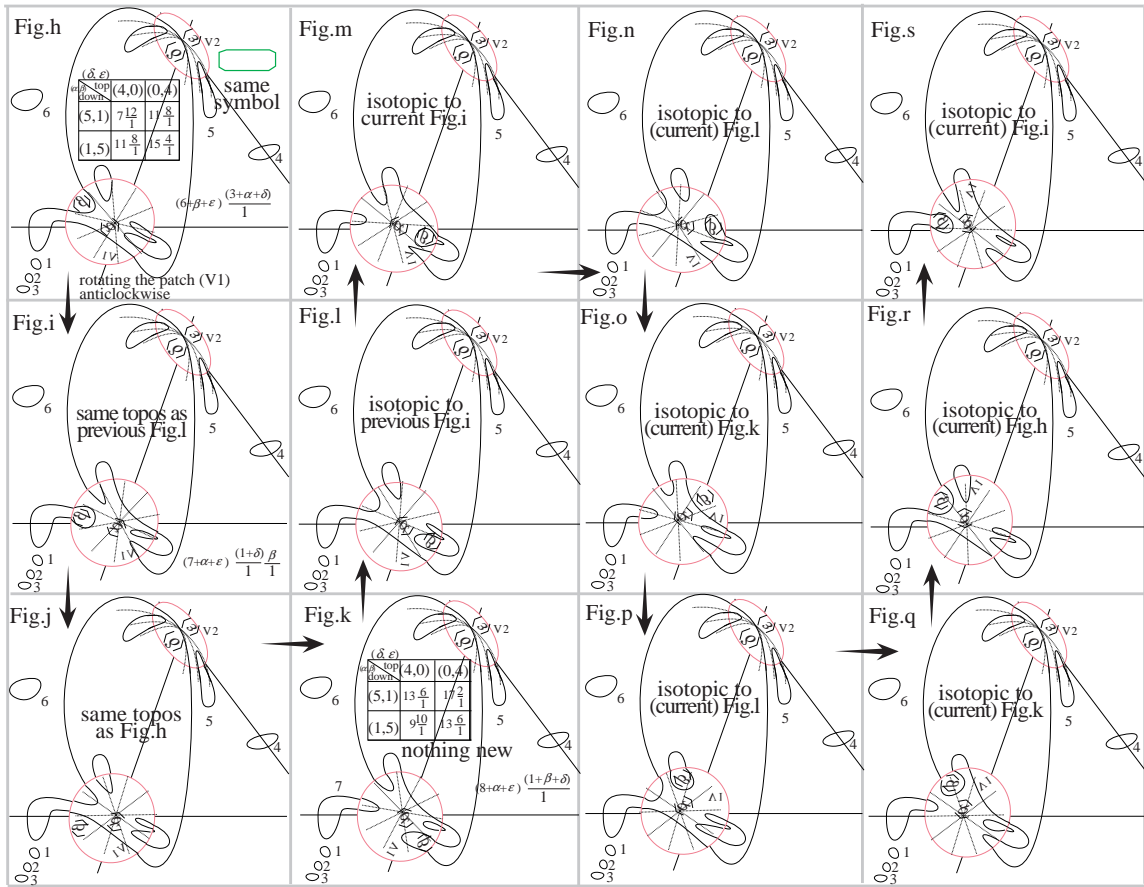

Figure 108: Reflecting the patch V1 at the bottom

So we get:

Lemma 7.1 *Considering Fig. 107k or Fig. 109f creates interesting RKM-schemes. (Those are also obtainable via a Shustin curve, see the subsequent Fig. 122.) Hence Viro's method applied to Viro's 1st curve (alias the beaver) realizes 3 simply-nested RKM-schemes, namely $15\frac{4}{1}$, $11\frac{8}{1}$, $7\frac{12}{1}$. Further any one of those (simply-nested) schemes suffices to refute Rohlin's maximality conjecture.*

Proof. Only the second clause deserves commenting upon. For instance we may consider the RKM-scheme $15\frac{4}{1}$. Aided optionally by the geography of Fig. 155 (or better its enlarged version Fig. 156), we have an $(M-1)$ -enlargement $13\frac{2}{1}\frac{4}{1}$, where so-to-speak two among the 15 free ovals went captured by a loop as to become "nested". In turn this scheme may be enlarged to the M -scheme $13\frac{2}{1}\frac{5}{1}$ which (though historically first constructed by Gudkov) may be constructed à la Viro via dissipation of the quadri-ellipse (cf. our previous Fig. 6). The proof is complete and Rohlin's conjecture refuted. ■

Philosophico-bibliographical comment.—It is fairly puzzling that this result holds true because as far as we could interpret the literature this problem was still open yet simpler to settle than the refutation of the reverse sense of Rohlin's maximality conjecture (abridged RMC henceforth). Recall that RMC posits that a scheme is of type I (purely orthosymmetric) iff it is maximal (in the hierarchy of all schemes in the prescribed degree). The reverse sense \Leftarrow was refuted by Shustin, while the other sense seemed to stay open. However in Viro's survey of 1986 [1534] the text is fairly confusing on this topic and it seems that there is an interversion of logical data when it comes to this topic, cf. p. ?? for the exact passage. As a vague guess, it may be argued that Viro

stayed confuse on this point because he did not wanted to attack frontally the conjecture of his beloved teacher (Rohlin). So either sentimentality or overmodesty contributed to add confusion to the topic. It is also possible that our above refutation is new, but since it is merely based on old techniques of Viro, what is new is not the geometric quintessence but merely the combinatorial skills allied to the contemplation of the architecture of higher Gudkov pyramids (notably Fig. 155).

Added [28.06.13].—At this stage it seems fairly plausible that the top-row RKM-schemes (i.e. the list of $(M - 2)$ -symbols $15\frac{4}{1}$, $11\frac{8}{1}$, $7\frac{12}{1}$, $3\frac{16}{1}$) should also be constructible via dissipation of the quadri-ellipse if we knew the (extended) accessory parameters of the smoothings. Indeed by analogy with the smoothings of N_{16} -singularity, those of singularity X_{21} must also have mutant species not derived by emptyfying (=contracting) the micro-ovals. As a consequence our previous tabulation of the X_{21} -smoothings (Fig. 104) cannot claim exhaustiveness, and it could be an interesting duty to make it complete. At this stage we could choose more or less random values of the parameters and experiment what global curve is resulting thereof. Since it is the V2-dissipation which leads to simply-nested curves, we consider the first listed $(M - 2)$ -dissipation, i.e. $(1, 6, 0)$ and alter it to the nearby value $(1, 5, 1)$. Then we get many new $(M - 2)$ -schemes of type RKM, that are tabulated on Fig. 104f. Similarly if we can twist the parameters to $(2, 5, 0)$, then we obtain the simply-nested RKM-schemes $15\frac{4}{1}$ and $11\frac{8}{1}$ that suffices to corrupt Rohlin’s maximality conjecture (RMC). So we have the following hypothetical lemma:

Lemma 7.2 *Viro’s most elementary method involving dissipation of the quadri-ellipse suffices to corrupt Rohlin’s maximality conjecture provided singularity- X_{21} admits the dissipation V2 of Fig. 104a with parameters $(\alpha, \beta, \gamma) = (2, 5, 0)$.*

Turning back to Viro’s 1st curve, we can also rotate the patch to obtain Figs. 109g,h,i,j,k,l,m, yet what is so obtained is not strikingly original.

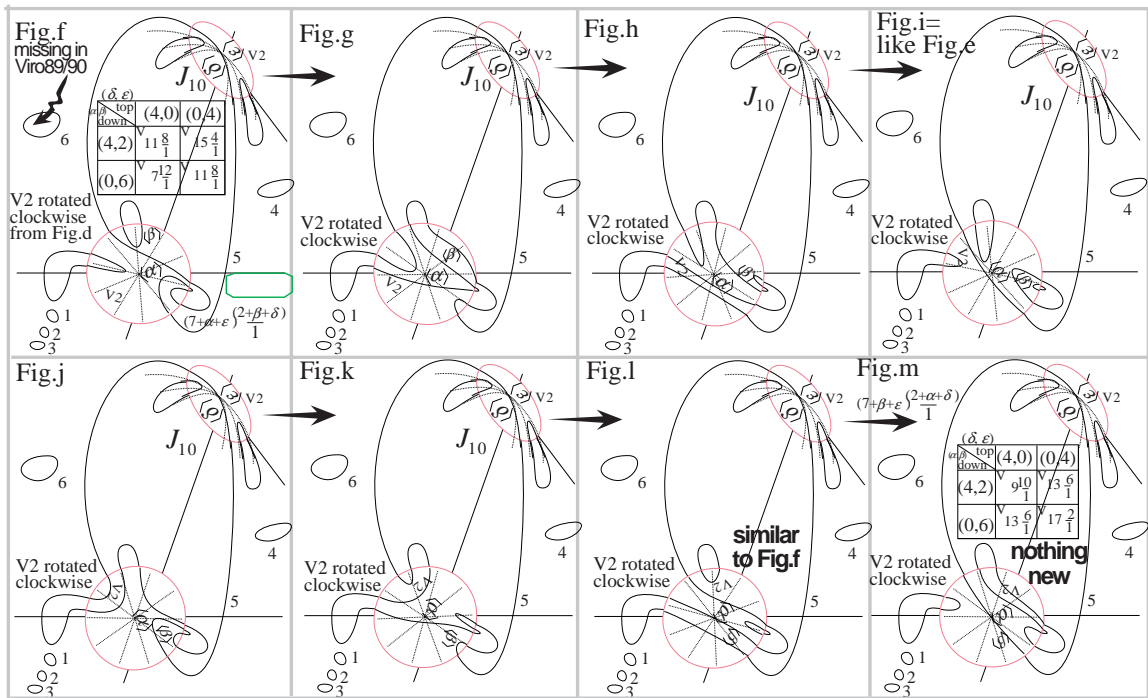

Figure 109: Counterexample to RMC via Viro, plus rotating the patch.

Finally we can also rotate the reflected patch V2 to get the following series of Fig. 110. Some few new species do occur denoted by “new”. Usually no more comment would be requested but again TeX is unhappy and is overflowed by the avalanche of pictures versus the little of text we have to say. Of course geometry is the art of staying silent in front of the beauty of the landscape to

be contemplated. So let us be silent and write some anodyne prose to get our text synchronized with the figures.

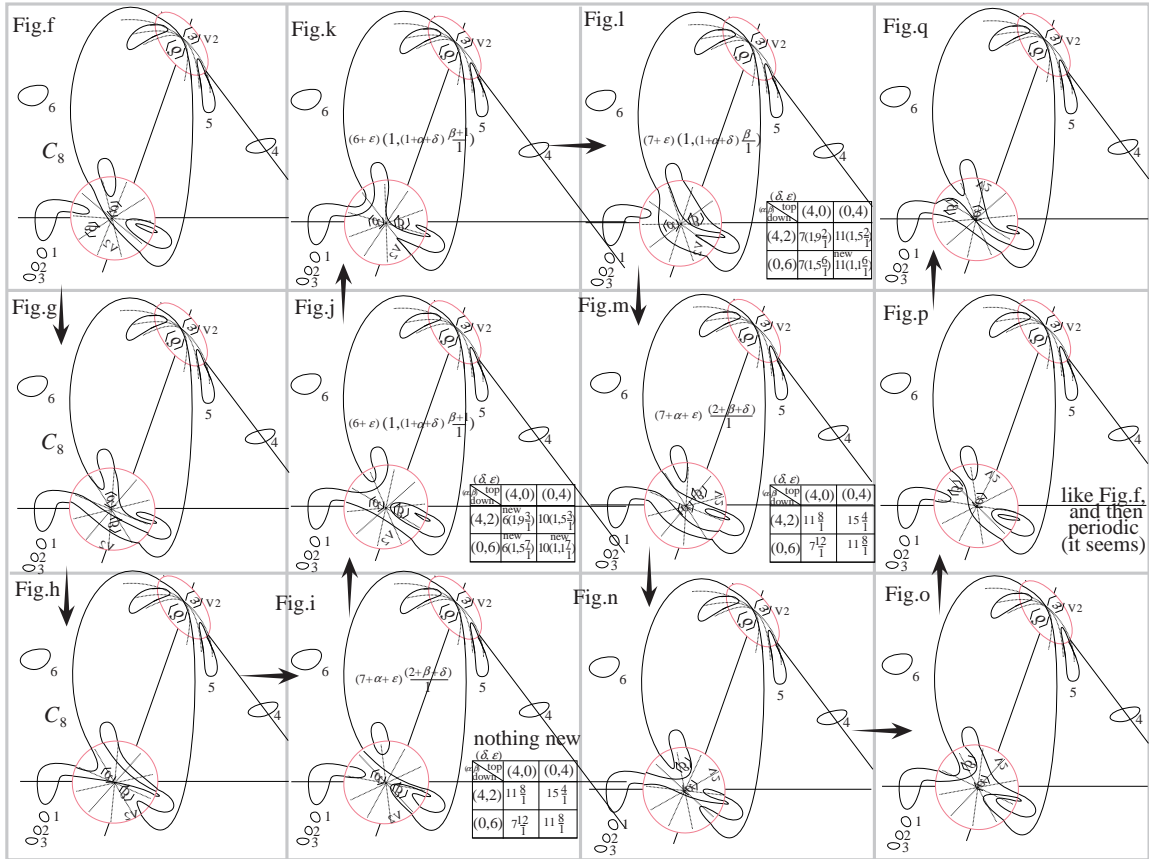

Figure 110: Rotating the reflected patch to get some new $(M - 2)$ -curves.

To construct the singular octic (of Fig.106a) Viro rests on the following picture (Fig. 111) in spirit akin to Gudkov's trick. The first step is a Harnack-style vibration creating a cubic C_3 oscillating 6 times across the conic C_2 . The 2nd step involves a (partial) smoothing of $C_3 \cup C_2$ to get a quintic C_5 with a unique ordinary double point. On Viro's figure (Fig. 76 of Viro 89/90) a branch of the 6th circuit is missing. The 3rd step involves a hyperbolism à la Newton (which reminisces Gudkov's use of Cremona transformation). The strict transform of the C_5 under this map is an octic because the pull-back of a line is a conic through the 3 basepoints of the fundamental triangle, which cuts the C_5 along 8 mobile points since 2 of them are statically located on the unique singularity of the C_5 . Our Fig.d shows one additional oval that was overlooked on Viro's picture (Fig. 73 of Viro 89/90). Beware that our location of the 6th oval might be exotic but it lies certainly outside of the singular circuit, at least on behalf of the sequel of Viro's text.

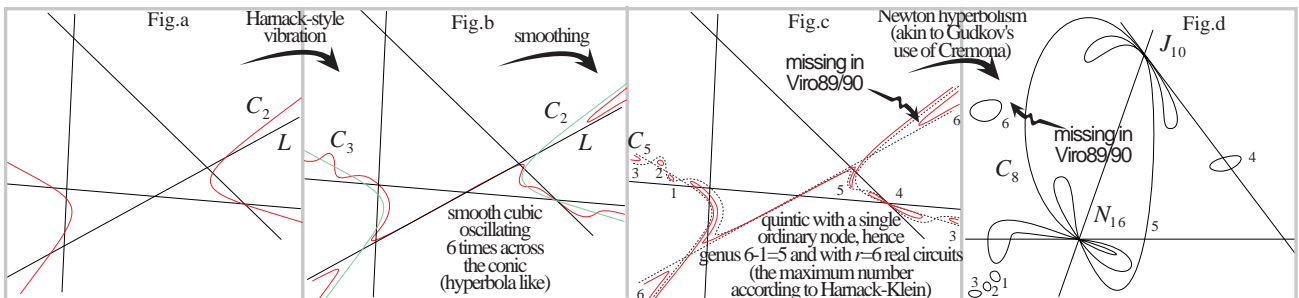

Figure 111: Creating Viro's 1st curve (from Viro 89/90 but corrected picture)

7.2 Viro's 2nd construction (horse)

[05.05.13] Finally, Viro proposes a 2nd fundamental curve C_8 (cf. our Fig. 112a based upon p. 1129–30 of Viro 89/90 [1535]) which leads to another series of M -octics. This curve resembles the profile face of a horse, hence refer to this curve as Viro's 2nd curve or the horse.

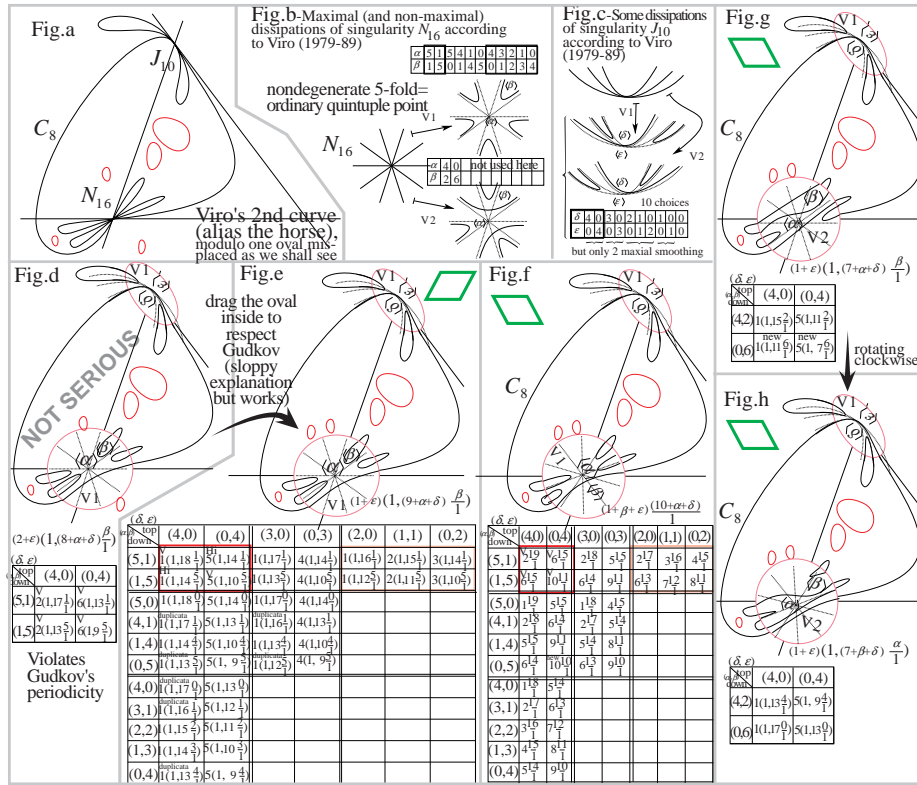

Figure 112: Following Viro 89/90 yet correcting his picture.

First, Viro constructs another singular octic (compare his Fig. 78 specialized to $k = 2$, or our Fig. 112a). We differ Viro's construction of this ground curve to later, to first work out the patchwork. On gluing the dissipation V1 of the quintuple point N_{16} where the allowed parameters (α, β) with $\alpha + \beta = 6$ have to satisfy the congruence $\alpha - \beta \equiv 4 \pmod{8}$ (hence restricted to take the values $(5, 1)$ or $(1, 5)$ as tabulated on Fig. b), we get Fig. d after choosing the appropriate V1 dissipation of the triple point J_{10} . Alas the curves so constructed do not fit on the tabulation (Fig. 154), the intrinsic reason being that those M -schemes violate Gudkov's hypothesis ($\chi \equiv_8 k^2$). A fairly simple explanation is that we wrongly located the oval of the fundamental curve on Fig. a. It suffices indeed to transfer the outer oval of C_8 inside of the singular circuit to get Fig. e, which create 4 new M -schemes, namely $1(1, 18\frac{1}{7})$, $5(1, 14\frac{1}{7})$, $1(1, 14\frac{5}{7})$, $5(1, 10\frac{5}{7})$. Actually, the 2nd and 3rd one were first realized by Hilbert's construction, yet the 1st and last one are pure creation of Viro 1980. As usual, we report the geography of those scheme on the main table (Fig. 154) by using this time a green-parallellogram enclosing the letter "V" honoring as usual Viro.

As before, we may rotate the patch, as much as we please, and do reflections. This is fairly tedious (space-consuming) to depict and it is not impossible that there is a more expediting way to construct those schemes maybe via Viro's most elementary 4-ellipses method if we knew the possible non-maximal smoothings. In particular upon rotating the bottom patch V2, we get the following series of curves (Fig. 113) extending the former Fig. g, yet yielding nothing tremendously revolutionary, since the obtained isotopy types seem subsumed to a law of repetition yielding a poor level of bio-diversity.

It remains then to symmetrize the bottom patch V2, and also to explore the rotations of the (symmetric) V1 patch (dispensing us to consider its reflection).

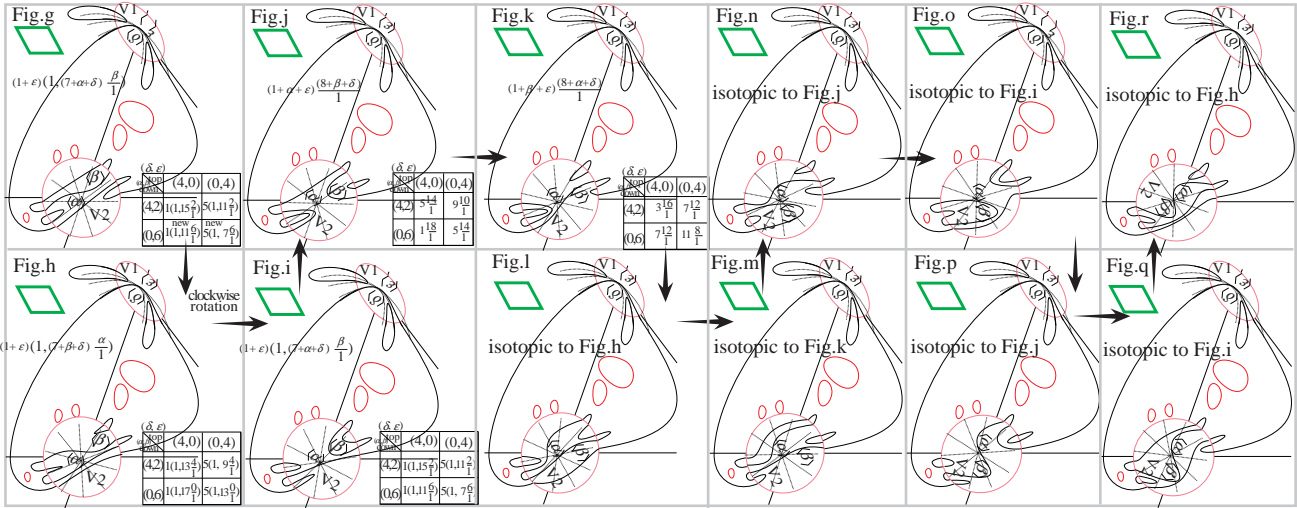

Figure 113: Rotating the bottom patch V1, while getting few new species.

Let us first rotate V1 (say in the clockwise sense), starting from Fig. e of the main former figure (Fig. 112), we get the following series of curves (Fig. 114). The first so obtained (Fig. f) is not even worth tabulating as there is zero (naught) ovals created nearby the bottom-patch, so that only $(M - 4)$ -curves are created. Continuing the rotating process we eventually arrive at Fig. k, which violates Gudkov's hypothesis (conclusion found the [21.06.13]), e.g. because it is not catalogued on our Table (Fig. 155). This is fairly puzzling and it is tricky to locate the plague of the reasoning. Maybe Viro's 2nd curve is a hallucination (so-called phatomorgana=mirage in German)? It should be remained that the fundamental curve of Fig. 112a had precisely a defect w.r.t. Gudkov periodicity that was remedied upon dragging one outer oval inside, yet this naive trick turns out to create another tension with Gudkov at the later level of rotation of the patch. Oh sorry, it seems rather that we made a fatal mistake when moving from Fig. i to Fig. j. Correcting this defect we get Fig. j-star (and so on), yet no tremendous gold-mine is discovered along this way giving only curves isotopic to Fig. e.

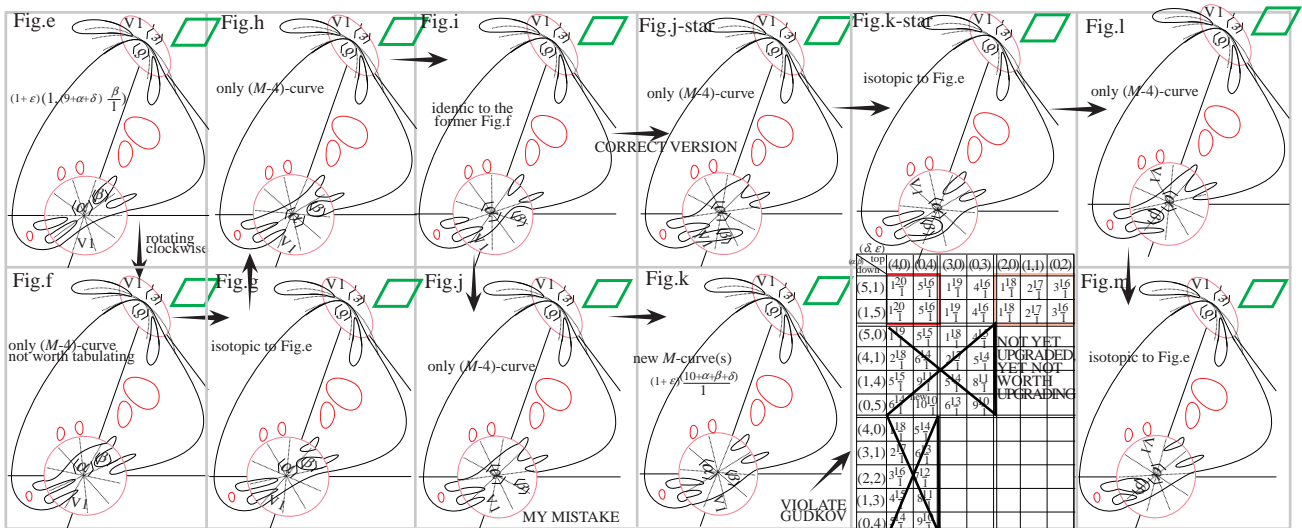

Figure 114: Rotating the bottom patch V2, while getting little new species.

We can then explore the symmetrized bottom patch V2, while performing a rotation initiating with Fig. 115g below (reflecting the original Fig. 112g). This gives the following series of curves (Fig. 115). Seen dynamically all this may be interpreted as the mastication of a herbivore, typically a horse whose resemblance with Viro's 2nd curve is self-explanatory. Again all this sentimental prose has to be introduced for otherwise there is a boring shift (d calage be-

tween pictures and text), due to TeX's rigidity. At any rate the conclusion is that reflecting the patch leads apparently always to configurations isotopic to those listed on the previous tabulation. Hence nothing original is created. After tracing Fig.l it is already evident that nothing tremendous will appear in the firmament, yet as we were fairly tired and bored by the game we decided to continue to be sure to miss nothing. Upon continuing up to Fig.r it seems clear that we explored everything albeit we did not closed completely the “loop”, or that some periodicity (in the sense of a boring repetition) start to predestine the story. Hence it is intuitively clear that no new schemes are created along this procedure.

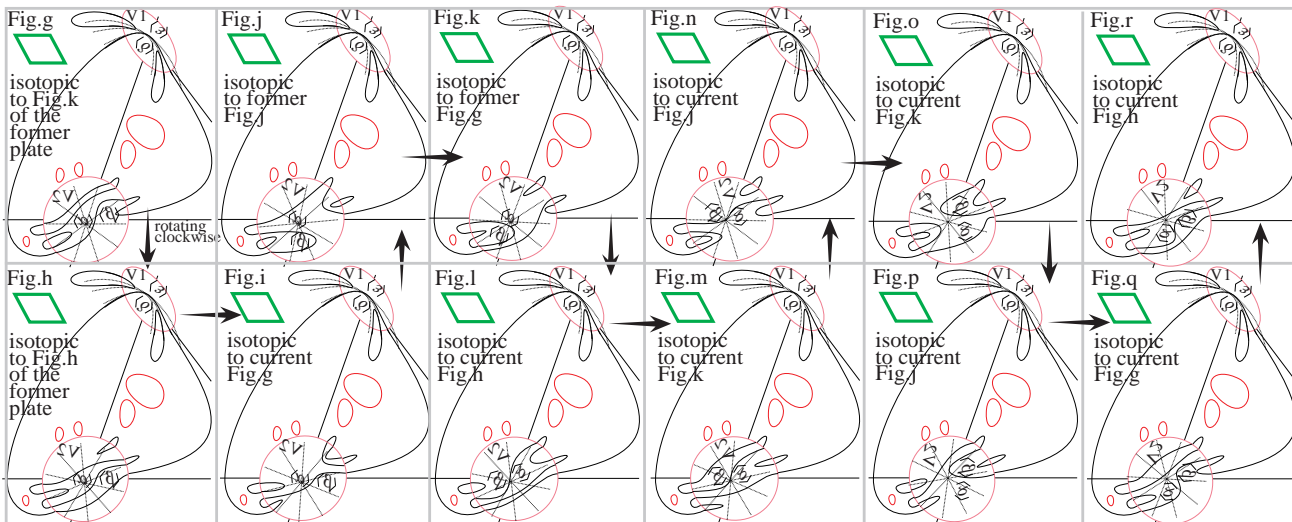

Figure 115: Reflecting the bottom patch, and then rotating it.

At this stage it seems that we have exploited all possible smoothings leading to $(M - 2)$ -curves (or better) of Viro's (3rd) “horse” curve.

It remains to explain Viro's construction of this auxiliary singular octic curve. Again the methodology is nearly the same and seems to owe some inspiration from both Brusotti and Gudkov. Again we follow Viro 89/90. We get started with a cubic C_3 oscillating across the axes L and L_1 (lines) as on Fig. 116a. Then $C_3 \cup L$ is smoothed to a C_4 of Fig. b. Here Viro's figure seems to miss an oval. Then $C_4 \cup L$ is vibro-smoothed à la Harnack to the quintic of Fig. c. Further it seems that Viro proposes to contract the oval 1 to a solitary node (isolated double point so as to ensure that the strict transform under the Newton-Cremona transformation will have degree 8 when one of the 3 basepoints of the pencil of conics is chosen on the isolated node). This gives therefore the octic C_8 of Fig. d. Here it is useful to introduce letters a,b,c,d,e,f in order to understand a bit the highbrow distortion of such a map. Warning: it seems that actually our picture created curves violating Gudkov, so that actually the oval 2 of Fig. d should be inside the complicated circuit of C_8 . At any rate, it seems that this construction of Viro is the most tricky as it uses as well a semi-regional (large) deformation principle. It is incidentally quite puzzling to wonder if this construction contributed to Viro's general formulation of the Itenberg-Viro contraction principle. Of course in degree 5 it could be that the latter conjecture is true essentially as in degree 6 (Itenberg 1994) and by virtue of Nikulin-Kharlamov's theory, but this is probably not really required.

[07.05.13] Along these 3 constructions we expected to obtain all the 42 (new) M -octics of Viro 1980. Yet it seems that this is not yet the case, because some few schemes assigned the letter “V” of Viro 1980's announcement are not yet constructed in our text based on Viro 89/90 (compare on our Fig. 154 the V-symbols not yet covered by squares, rhombs or parallelograms). Probably the other V-schemes are obtainable by variants of the 2 tricky methods just exposed. Maybe one can even drift to an art-form of freehand drawing of such singular octics with petals at two points. Notice that besides the petaliform circuit

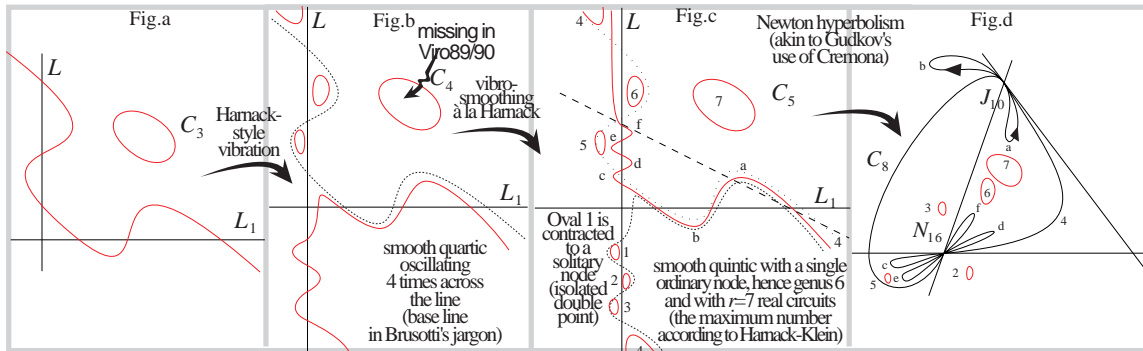

Figure 116: Viro's 2nd curve (from Viro89/90 plus our correction)

both singular C_8 used above have 5 extra ovals whose location can be derived a posteriori from Gudkov's congruence.

More precisely Fig. 117a,b recalls the 2 ground curves of Viro. One can drag a petal inside to get two bipetals as on Fig.c. However after smoothing we get Fig.d, violating Bézout (trace the line through the 2 nests of depth 2). Of course this is not a contradiction against Viro method, Bézout being already violated on our liberal singular octic of Fig. c. Let us instead drag the bi-petal of Fig.a outside to get Fig.e. Alas this produces only schemes that were already all obtained by the quadri-ellipse C_8 of Viro. Of course the construction of dragging can be much varied. For instance Figs.g,h produce the new scheme $6\frac{15}{1}$. Of course Fig.g is pure freehand drawing and so our patchwork is a bit sloppy.

At this stage the game is to reach the scheme $2\frac{19}{1}$ with only two outer ovals (compare the diagrammatic of Fig.154). Some few thinking brings us to Fig. 117i, which produces rigorously (without hand drawing) this and the former scheme $6\frac{15}{1}$. The corresponding schemes are marked by green-stars on the main-table (Fig. 154). Especially interesting is also the RKM-schemes $3\frac{16}{1}$ and $7\frac{12}{1}$ which affords another corruption of Rohlin's maximality conjecture.

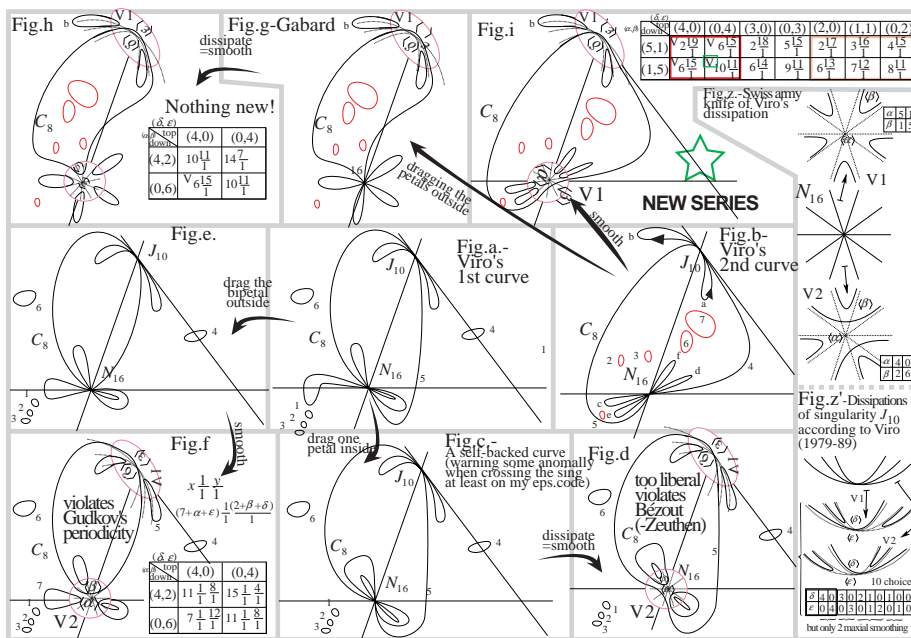

Figure 117: Freehand tracing of fundamental octics

At this moment we nearly have understood Viro's method that one can realize curves with preassigned topology, e.g. those Viro-types not yet realized on the table.

7.3 Some messy ideas of Gabard

The next idea that came to us is that since we just discovered another series allied to Viro's 2nd curve (cf. Fig. 117i) there must also be a 2nd series allied to Viro's 1st curve. However a priori it seems that the series so obtained will not be extremely exciting and will probably coincide with the boring curves of Fig. 77 of Viro 89/90 (p. 1129), that are already obtained by the more elementary device of the quadri-ellipses. Let us however trace them carefully to check our guess. As above the idea is to close the bi-petal by the pair of "paralleling" braids, yet this time in such a fashion that the resulting nest of depth 2 is not charged by extra ovals. This is possible after symmetrizing Viro's gluing pattern, and leads to Fig. 118b. This realizes 3 schemes marked by little rhombs on the main-table (Fig. 154), which (as expected) are the extremely boring specimens $9(1, 10\frac{1}{1})$, $13(1, 6\frac{1}{1})$, $17(1, 2\frac{1}{1})$ already obtained by the simpler device (of perturbation of 4 ellipses).

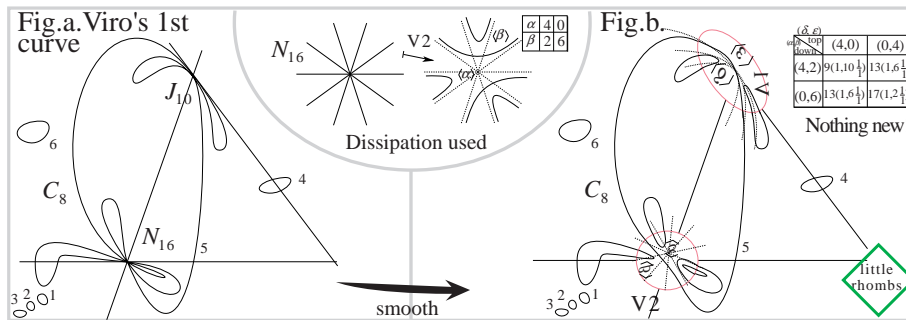

Figure 118: A variant from Viro's 1st curve

At this stage one is slightly puzzled and it is not clear if the obtention of the remaining Viro's M -schemes requires changing of fundamental curve or smoothing more cleverly the 2 singular curves of Viro.

The next idea of our somewhat random search is to consider Gabard's curve (so-called not because we are lacking in modesty but because it is just sloppily hand-drawn) depicted on Fig. 117g and reproduced as Fig. 119a) while changing the mode of smoothing to get Fig. b. Alas all those 4 schemes are already realized by Viro as smoothing of 4 ellipses. They are reported by a septagonal star on the main-table (Fig. 154). The most interesting scheme is perhaps $5\frac{6}{1}\frac{9}{1}$ as it flirts nearly with the $\chi = -16$ row (of the main-table) which is the most mysterious one containing 4 among the Hilbert-Viro bosons (not yet known to be realized nor to be prohibited). Those curves having only one outer ovals, one is inclined to look at a variant of Viro's 2nd curve where the loop b is dragged inside the singular circuit (Fig. d). Of course doing so the unicursality of the singular circuit is lost (at least under the postulate that branches of equal curvature are connected).

Then one produces the smoothing of Fig. e where the J_{10} -singularity is smoothed symmetrically so as to create the maximum number of ovals. However doing this and referring back to Viro's dissipation list (cf. Fig. 29, p. 1103 in Viro 89/90) we note that $\delta + \epsilon$ cannot be as large as 4 as in the asymmetric smoothing, but its maximum permissible value is only 3 realized by the pair $(\delta, \epsilon) = (3, 0)$. Let us however on the table of Fig. e also consider the value $(4, 0)$ to look what monster would result. Actually we obtain the M -scheme $1\frac{20}{1}$. Now recall Petrovskii's estimate $\chi \geq -\frac{3}{2}k(k-1) = -\frac{3}{2} \cdot 4 \cdot 3 + 1 = 18 = -18$, while our pseudo-curve has $\chi = 1 + (1 - 20)$ and so just respects it. However it is probably ruled out by the strengthened Petrovskii bound of Arnold 1972 or "more" elementarily by the Arnold congruence mod 4, which can be regarded as a formal consequence of Rohlin's formula. Of course Gudkov's hypothesis (mod 8) do as well the job, but is more tricky to prove (Rohlin 1972).

Now again with the idea to attack by surprise the last mysterious column with $\chi = -16$, let us trace freely a curve with 2 singular circuits by splitting of that of the 2nd Viro curve (cf. Figs. c,f). (After all nobody ever asserted

that real curves are connected and real geometers (say Plücker-Zeuthen-Klein-Harnack, etc.) nearly learned us the exact opposite.) Of course during the process it seems reasonable to destroy one red oval. However on smoothing the configuration as on Fig.g we will have at least 2 outer ovals and the case of 2 ovals is prohibited by Gudkov hypothesis (or just Arnold). Now the idea would be to split without loosing an oval while using the symmetrical dissipation of J_{10} . This idea leads to Fig.h, whose smoothing Fig.i creates the M -scheme $1 \frac{7}{1} \frac{12}{1}$ which was never constructed as yet. Of course since our method is pure free-hand drawing this does not prove existence of the curve. Yet it is interesting to vary the parameters to see which kinds of schemes arise, and actually there is only one maximal companion namely $5 \frac{7}{1} \frac{8}{1}$. Since the latter was first constructed by Viro's smoothing of coaxial ellipses, some "principe du raccord" (yet another patchwork if you like) gives some very weak evidence that the scheme $1 \frac{7}{1} \frac{12}{1}$ exists algebraically. Of course upon playing with the dissection of the singular circuit of Viro's 2nd curve, while keeping in mind that $\delta = 3$ we see that the upper (non empty) oval can contain either 5, 6, 7, 8, 9, 10 ovals. In fact it is convenient to denote by U the number of upper red ovals inside the J_{10} -circuit of Fig.h, i.e. after cellular subdivision of Viro's 2nd curve. This U can range from 0, 1, 2, 3, 4, 5 (a priori), and Fig.j tabulates the resulting schemes after smoothing. We obtain so for one outer ovals 2 schemes denoted by V, already constructed by Viro80 (via the most elementary method of 4 ellipses), and for $U = 2, 4$ two new schemes denoted by Ga (not yet known to exist), and one scheme prohibited by Orevkov 2002! Further by choosing instead the lower dissipation with $(\delta, \varepsilon) = (1, 5)$ we get schemes all realized by the elementary Viro method, so that the naive principle of propagation could imply that all the former schemes (1st row) also exists. Of course this would contradict Orevkov's theorem, and actually the latter can be interpreted as an obstruction to split Viro's 2nd curve (at least the variant with introverted the b-loop).

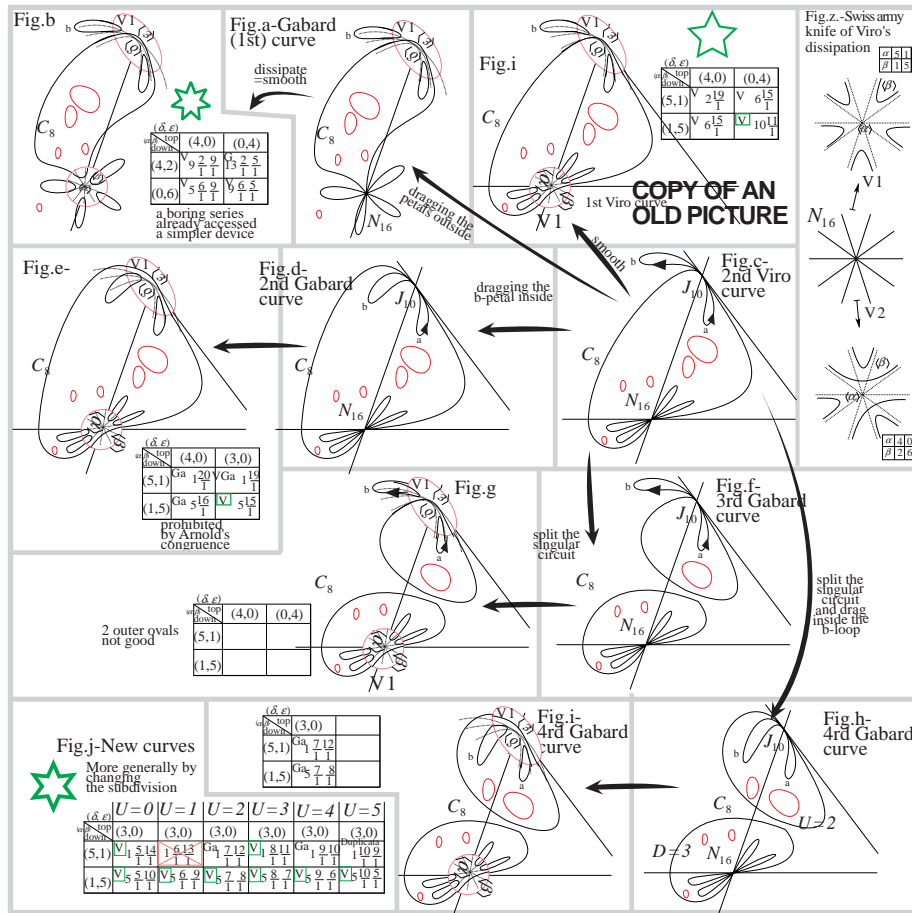

Figure 119: A variant from Viro's second curve

Of course all this is very speculative, and we need to return to a more pragmatical standpoint.

[05.06.13] On waking this morning (with short hairs), we were flashed by the idea of looking at the configuration of 3 coaxial ellipses plus a transverse one. Alas the curves so obtained are far from maximal and seem to reach at most $(M - 6)$ ovals. This is a big deception.

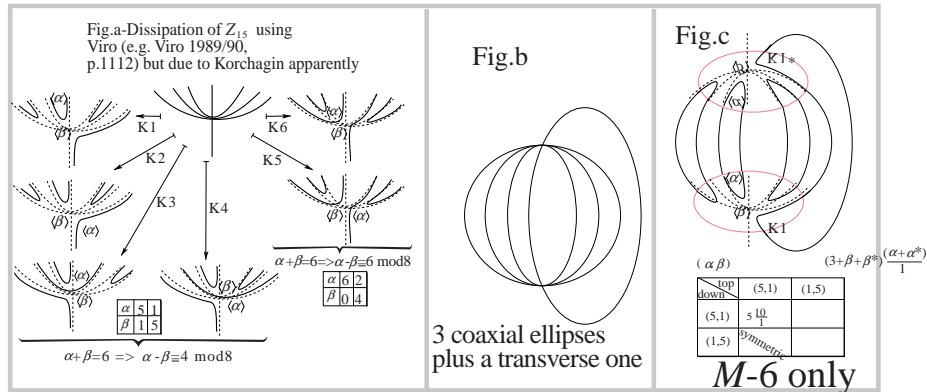

Figure 120: A variant of Viro's method due to Gabard (but fails blatantly)

Scholium 7.3 *In fact we realize now that Arnold's prose about the distribution of ovals (in his seminal 1971 paper) might have been inspired by the allied jargon concerning the distribution of primes in basic number theory. Probably, the analogy is far reaching in the sense that up to present knowledge the distributions realized appears as fairly random, without clear-cut rule governing the architecture of higher Gudkov pyramids parametrizing the periodic table of elements (schemes in Rohlin's terminology). Notwithstanding, it is only a matter of time to examine deeper the crystal as to uniformize all Viro, Shustin, and Orevkov prohibitions while subsuming to one and a sole paradigm, viz. total reality or perhaps the allied method of deepest penetration boiling down to Bézout for higher order curves.*

7.4 Shustin's constructions

- Shustin 1985 [1409] (announcement) and details in 1987–88 ([1415], [1414]) new constructions of $6 + 1 = 7$ schemes (probably via a variant of Gudkov or Viro) [of course Viro seems more likely]. In fact, it seems that Shustin's original proof was somewhat independent of Viro's method, compare p. 488 of Shustin 1988 [1415] where we read: "The existence of curves of degree 8 with schemes (1)[=the list of six] was announced by the author in [6](=Shustin 1985 [1409]), where it was deduced from results on investigation of smoothing of point of quadratic contact of four non-singular real branches⁷. Here we give another proof that was obtained by using Viro's method of gluing real algebraic curves [2](=Viro 1983 [1529]).". Slightly later, Shustin found the scheme $4\frac{5}{3} = 4\frac{5}{1}\frac{5}{1}\frac{5}{1}$. Fig. 154 below shows the exact list of 7 schemes realized by Shustin, denoted by the letter "S", where the last found is denoted "S=last". This is probably the construction alluded to Orevkov's letter (in v.2 of Gabard 2013), and the idea is probably to use octics with 3 singularities instead of the two used by Viro.

[08.05.13] Now we present the details following Shustin 1988 [1415]. Again it suffices to have singular octics while applying the dissipation method. This time Shustin considers curves with Z_{15} singularities (i.e. 3 branches with contact of order 2 and a fourth branch transverse to it). The dissipation of this singularity were apparently classified by Korchagin 1988 [859], the maximal ones being depicted on Fig. 121a. Actually we shall only employ the smoothings K5, K6. Next, Shustin traces 3 curves but actually the first one already leads to

⁷So this seems to be X_{21} , yet it looks hard to get all those schemes via dissipation of the quadri-ellipse.

the construction of the 6 schemes announced by Shustin namely those marked by the letter “S” and an octagonal star on the main-table (Fig.154). Additionally, Shustin’s construction recovers 4 cases claimed by Viro 1980 (namely those depicted by V? on Fig.121b), but which we were personally not able to construct (upon reading Viro’s text of 1989/90). Those mixed Viro-Shustin schemes are marked by the combined symbol “V (or S)” plus an octagonal star on the main-table. As a moral, Shustin’s method affords many new types that were inaccessible before. Interestingly, Shustin propose 2 other ground curves also doted of two Z_{15} singularities, whose smoothings may be worth exploring, yet it seems that they are not formally required as the first curve suffices to exhibit all (six) M -schemes claimed by Shustin.

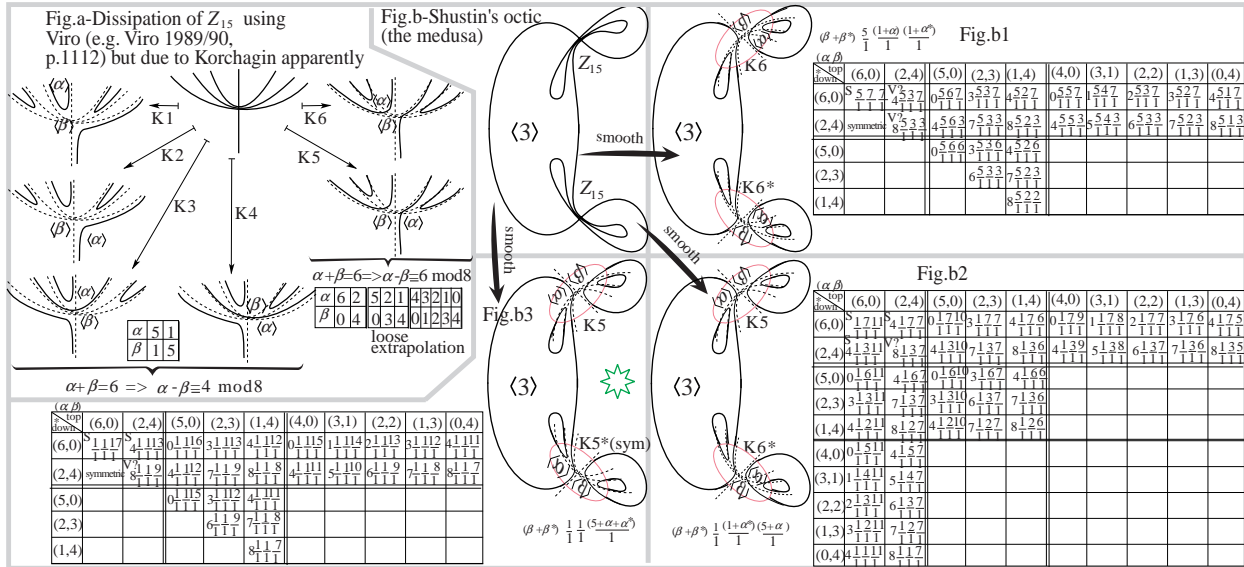

Figure 121: Shustin’s series of 6 new M -schemes via Z_{15} (twice) on the medusa

At this stage we see that Viro obtained first many M -octics by dissipating X_{21} (quadruple bicontact), then some few others by smoothing $N_{16} + J_{10}$ (quintuple point + triple bicontact), and finally Shustin added to the list several new schemes by dissipating Z_{15} (triple bicontact with a transverse branch, alias candelabrum). So philosophically, we see that Viro’s method enjoys two levels of freedom: the choice of the singularities and the global singular curve which is smoothed.

Further Shustin 1988 (p. 490–92 of *loc. cit.*) gives a detailed construction of the above singular C_8 along the method of hyperbolism à la Huyghens-Newton-Gudkov-Viro and himself. We shall detail this at the occasion.

It seems however more urgent to inspect what results from the 2nd (and 3rd) curve of Shustin. His second curve F2 (p. 489) looks an apple alike (Fig. 122b). As usual the algorithm is to self-connect the loops with themselves in order to maximize the number of ovals, selecting appropriately the dissipation. On the case at hand if we imagine the Z_{15} -singularity as a tree with a (vertical) trunk and 3 branches growing transversally from it, we choose the smoothing $K1^*$ (i.e. $K1$ symmetrized on the top). On the bottom it seems harder to find a closing-gluing and actually the one ideally suited achieves only $\alpha + \beta = 5$, cf. again Viro’s Fig. 39 in Viro 89/90 (p. 1112) or our Fig. a ($K7$). Hence tolerating a maximal smoothing ($\alpha + \beta = 6$) yet not closing perfectly all the loops gives Fig. c. So we choose for instance $K5^*$ where the star is the symmetrized dissipation of $K5$. Alternatively, we may choose a non-maximal dissipation which closes the loops, e.g. $K7^*$ at the bottom, but experimenting a bit (or reading better Shustin’s text especially p. 490) one sees that this 2nd curve leads only to $(M - 1)$ - or even $(M - 2)$ -curves. So it is not most exciting for our present purpose of cataloging M -curves.

Added [02.06.13].—However the $(M - 2)$ -scheme $7\frac{12}{1}$ (or its companions $11\frac{8}{1}$, $15\frac{4}{1}$ obtained on Fig. c) is of utmost interest in relation with Rohlin’s

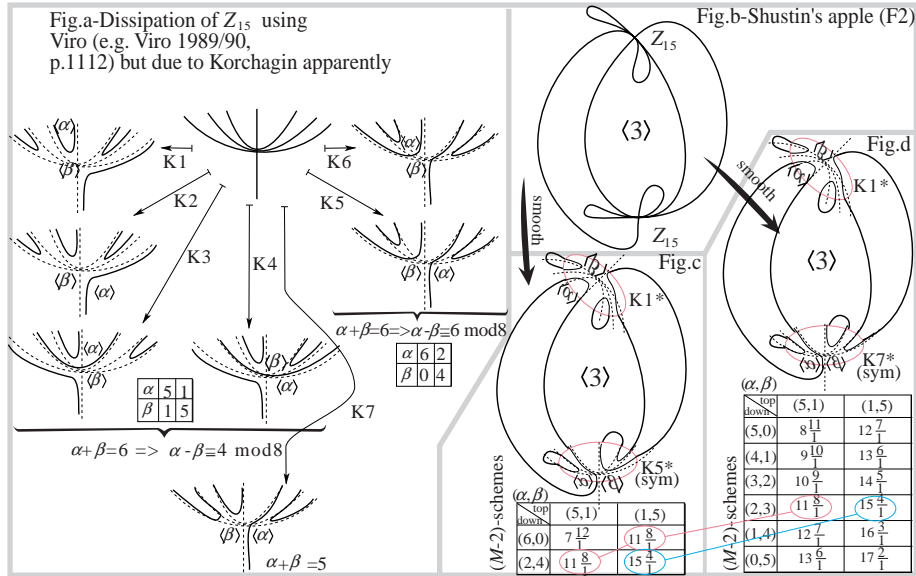

Figure 122: The 2nd Shustin's series

maximality conjecture. Indeed the scheme in question is RKM hence of type I, and so should kill all its enlargements. The geography of those extensions are depicted by 4-branched asters on Fig. 155, and includes for instance the $(M-1)$ -scheme $5\frac{2}{1}\frac{12}{1} =: S_{M-1}$. As the latter stands below Viro's M -scheme $5\frac{2}{1}\frac{13}{1}$ or even $5\frac{3}{1}\frac{12}{1}$, it may be inferred from Itenberg-Viro's contraction principle that the scheme S_{M-1} is very likely to exist. However this would conflict with Rohlin's maximality conjecture (RMC). Hence we reach a paradox, which can be solved either by a falsity of Shustin's construction, or of the contraction principle or finally a disruption of RMC. Actually, the contraction principle can even be left aside of the token, just by enlarging directly the $(M-2)$ -scheme to the M -scheme constructed by Viro.

Exactly the same comments apply to the scheme $11\frac{8}{1}$ or $15\frac{4}{1}$ which are also created by Shustin's construction. Additionally from Fig.122d, we may construct more schemes (namely all those of the form $(8+a)\frac{(11-a)}{1}$, with $0 \leq a \leq 9$), which are not necessarily RKM, yet we gain no more RKM schemes. To accentuate the paradox it would be nice to construct the $(M-1)$ -schemes extending the RKM-schemes by hand without reference to the (nebulous) Itenberg-Viro contraction principle. However even that is not an absolute prerequisite because it is actually sufficient to look directly at the M -schemes extending out RKM-schemes. So we get a direct conflict between RMC and Viro's method. For instance the RKM-scheme $15\frac{4}{1}$ enlarges to $13\frac{2}{1}\frac{4}{1}$ which in turn enlarges to the M -scheme $13\frac{2}{1}\frac{5}{1}$ constructed by Gudkov or Viro. So it seems at this stage that there is a clear-cut corruption of Rohlin's maximality conjecture. We resume the situation with the following result.

Theorem 7.4 *Shustin's apple construction (Fig.122c) refutes Rohlin's maximality conjecture that a scheme of type I is forced to maximality. More precisely any one of the three $(M-2)$ -schemes of degree eight $15\frac{4}{1}$, $11\frac{8}{1}$ or $7\frac{12}{1}$ satisfying the RKM-congruence $(\chi \equiv_8 k^2 + 4)$ are realized algebraically, yet enlargeable in the algebraic category via M -schemes constructible à la Viro by dissipating the quadri-ellipse (cf. Fig. 6d). Those are respectively for instance (compare Fig. 155), $13\frac{2}{1}\frac{5}{1}$ (constructed by $G=Gudkov$ or $V=Viro$), or $9\frac{2}{1}\frac{9}{1}$ (due to Viro), or finally $5\frac{2}{1}\frac{13}{1}$ (due to Viro).*

7.5 Shustin's last construction: $4\frac{5}{1}\frac{5}{1}\frac{5}{1}$

Another interesting task is to understand Shustin's last construction of the M -scheme $4\frac{5}{1}\frac{5}{1}\frac{5}{1}$, which was realized by Shustin's modification of Viro's method. This is published as Shustin 1987/87 [1414], but alas not enough pictures are

supplied there. We hope to remedy this at the occasion.

In fact inspired by Shustin's text we traced the following figure (Fig.123), which however corrupts violently Harnack's bound.

[09.05.13] At this stage we hoped to find a more geometric treatment of Shustin's last curve, in Polotovskii 1988 [1209] but alas not so.

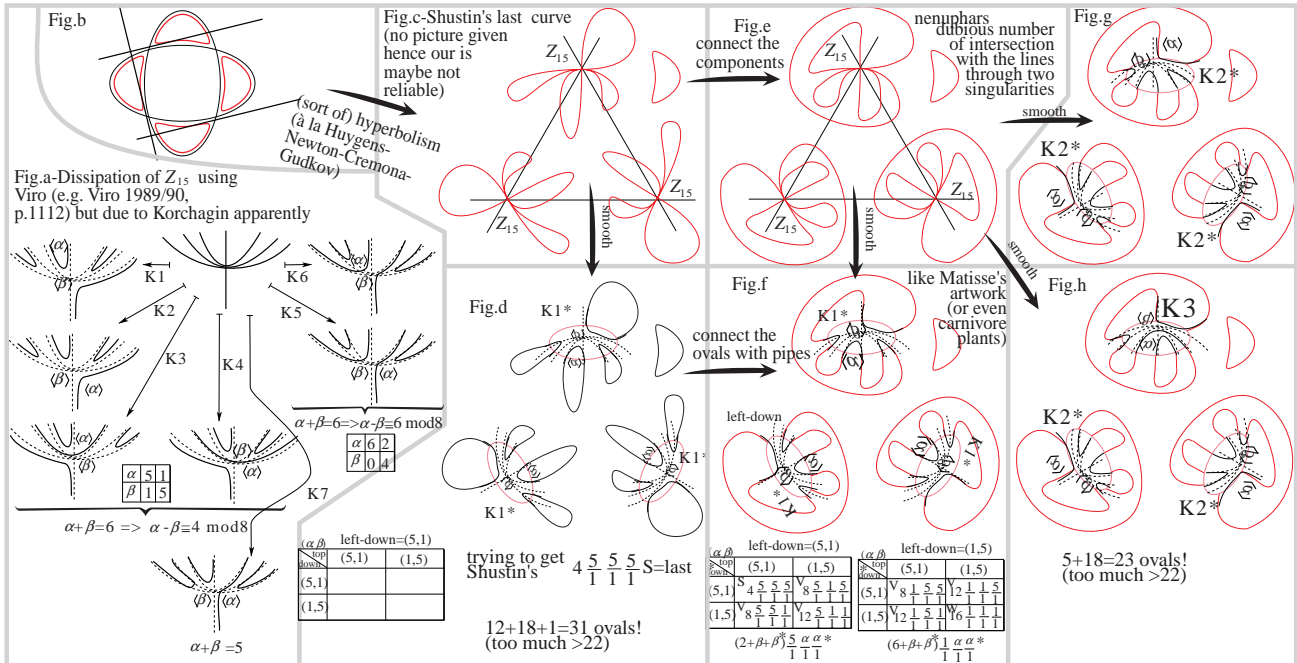

Figure 123: Trying to trace Shustin's last (seventh) curve $4 \frac{5}{1} \frac{5}{1} \frac{5}{1}$, but misdepicted by Gabard (ohne Gewähr and a lot of contradictions).

[02.07.13] Nearly 2 months later (with interruptions due mother's health problem) we had the idea that since the curve of Fig.d violates strongly Harnack's bound one should reduce the number of components by piping together its ovals. This idea suggested us to trace Fig.f, and also Fig.e by anticipating the piping at the level of the singular curve. Working out the dissipation we find indeed the curve asserted by Shustin $4 \frac{5}{1} \frac{5}{1} \frac{5}{1}$ as well as the curves $8 \frac{1}{1} \frac{5}{1} \frac{5}{1}$ and $12 \frac{1}{1} \frac{1}{1} \frac{5}{1}$ (both first constructed by Viro 1980), and finally recover $16 \frac{1}{1} \frac{1}{1} \frac{1}{1}$ (first constructed by Anders Wiman). All this is excellent (even if somewhat heuristic piping), if one had not remora with the issue that the line through any 2 of the 3 singularities of the octic C_8 of Fig.e seems to intersect the C_8 in more than 8 points. Indeed each singularity being a quadruple point with four branches meeting like the candelabrum, we see that each singular points contributes already for 4 intersections so that no extra intersection can occur (say as on our depiction). Hence the latter must be suitably correct in order to hope that our interpretation of Shustin's construction is a tangible one (the correct one).

Despite this little paradox we are presently not able to explain, we can somewhat cavalier explore the other smoothings of Shustin's curve (the nenuphar of Fig.e) using dissipation $K2$ (symmetrized). Yet on tracing Fig.g one sees (disappointingly) that the new curve so generated is isotopic to the former one (Fig.f), and since the structural constants α, β of the deformation are the same (Fig.a) we convince that no new curve will emerge from Shustin's nenuphar (nymphae). Of course we could also combine $K1^*$ with $K2^*$ dissipations (on different nenuphars of the curve), yet the same token should kill any hope to get something new along the way.

Of course one should still analyze other dissipations (like $K3, K4$, etc. of Fig.a) yet those will not be closing, and so certainly fail producing M -curves. However as already often illustrated those quasi-maximal curves are still of interest to appreciate the global architecture of the pyramid. Alas, we do not feel much motivated doing this work as we are not sure that our model of Shustin's curve is the correct one. However on doing it we get Fig.h, by choosing just

one K3 smoothing on the top singularity (although we could have prescribed thrice K3 on all three singularities by the independence principle à la Brusotti-Viro-Shustin). However to our little surprise the number of ovals increases then (due to an unexpected closing) and so passes beyond Harnack's bound. A contradiction in mathematics is obtained! Aber Hallo! Indeed, for the K3-dissipation $\alpha + \beta = 6$ too, so we have $3 \cdot 6 = 18$ micro-ovals, plus the $3 + 2$ traced on Fig. h yielding a total of $23 > 22$ ovals. So it seems that Shustin's nymphean curve (Fig. e) does not exist or that (Viro/Korchagin's) theory of dissipation of the candelabrum Z_{15} is foiled. Of course the most plausible explanation is that our drawing of Shustin's curve is not the correct one.

[03.07.13] But then what is the correct way to trace Shustin's singular octic? Of course there exists other ways to pipe together the ovals of Fig. d, and so we have for instance Fig. 124i and the allied Fig. j. The latter has however $18 + 6 + 1 = 25$ ovals (violating Harnack's bound by 3 units). Another piping of the ovals (or rather circuits) is given on Fig. k, yet its smoothing Fig. l also violates Harnack. So we need a more radical connection among the circuits suggesting, e.g., to trace Fig. m. Here it seems that the varied possible smoothings all respect Harnack's bound (as experimented by Figs. n,o,p,q,r). Alas the ground curve (Fig. m) corrupts Bézout for line (as the traced line shows 10 intersections with the presupposed C_8). So our our curve Fig. m is still not a *bona fide* model of Shustin's curve. Our Fig. s still respects Harnack (as $4 + 18 = 22$), yet choosing $(\alpha, \beta) = (6, 0)$ on all three singularities gives the scheme $\frac{21}{1}$ which is prohibited by Gudkov's hypothesis. (Alternatively it is prohibited by Petrovskii's inequality (??) we reads here as $-18 = -\frac{3}{2} \cdot 4(4 - 1) = -\frac{3}{2}k(k - 1) \leq \chi$.) So there is a structural obstruction to the existence of the curve of Fig. m.

Actually it is clear that our method is very lazy (i.e. purely topological without any algebro-geometric substance). For instance we may consider Fig. t which smoothed as Fig. u produces too many ovals, so we proceed to the Verschmelzung of Fig. v. Choosing $(\alpha, \beta) = (5, 1)$ gives the scheme $6\frac{15}{1}$, while taking $(\alpha, \beta) = (1, 5)$ produces $18\frac{3}{1}$. Changing one smoothing to K6 (starred=symmetrized) gives Fig. w where we choose the top α as 6 and the bottom α 's as 5 (and always $\alpha + \beta = 6$) we get the scheme $3\frac{1}{1}\frac{16}{1}$ which violates Gudkov periodicity (yet not killed by Arnold's weaker congruence mod 4). So the Fig. t with the conjunction of Fig. v is not a viable model of Shustin's curve. Since the above scheme falls fairly close to the mystery-scheme $1\frac{1}{1}\frac{18}{1}$ (not yet known to exist or not) it seems tempting to reiterate a nearby smoothing of Fig. y which gives the impossible scheme $\frac{21}{1}$ when $\alpha = 6$ throughout. Fig. z instead gives as corresponding scheme (for the depicted distributions of α 's) the following one $1\frac{1}{1}\frac{18}{1}$, which is precisely the one not yet known. So we have nearly proved something new but alas not so as our ground curve (Fig. u/v) is constructed by an irregular (purely topographical) device without control upon the algebraicity of the picture.

So it is evident that our method is purely heuristic and as yet not extremely successful. However we cannot exclude that clever twists of it (experiments) may lead to some new insights (at least by supplying a topological candidate for an algebraic singular octic that could produce new schemes by dissipation).

Below Fig. 125a is another failing attempt to surger the basic curve Fig. 123c. Of course during the process we noted that this basic curve itself violates Bézout (intersect with the fundamental lines). So we need first to fix this issue and this ay be arranged by rotating the petals as to avoid intersection with the 3 "coordinate-axes". This gives us Fig. b. Upon surgerying we get Fig. c whose smoothing (Fig. d) overwhelms Harnack. This brings us to the idea of connecting the 6 lunes in pair as to gain Fig. e, which looks promising. Indeed its smoothing Fig. f yields the desired scheme $4\frac{5}{1}\frac{5}{1}$ of Shustin, but alas another smoothing (Fig. g) violates Axel Harnack.

At this moment the situation looks a bit desperate. Of course, we can connect the 2 extra ovals of Fig. g yielding then Fig. h, whose smoothing as Fig. i creates again six macro-ovals (too much for Harnack). The desperation is now complete.

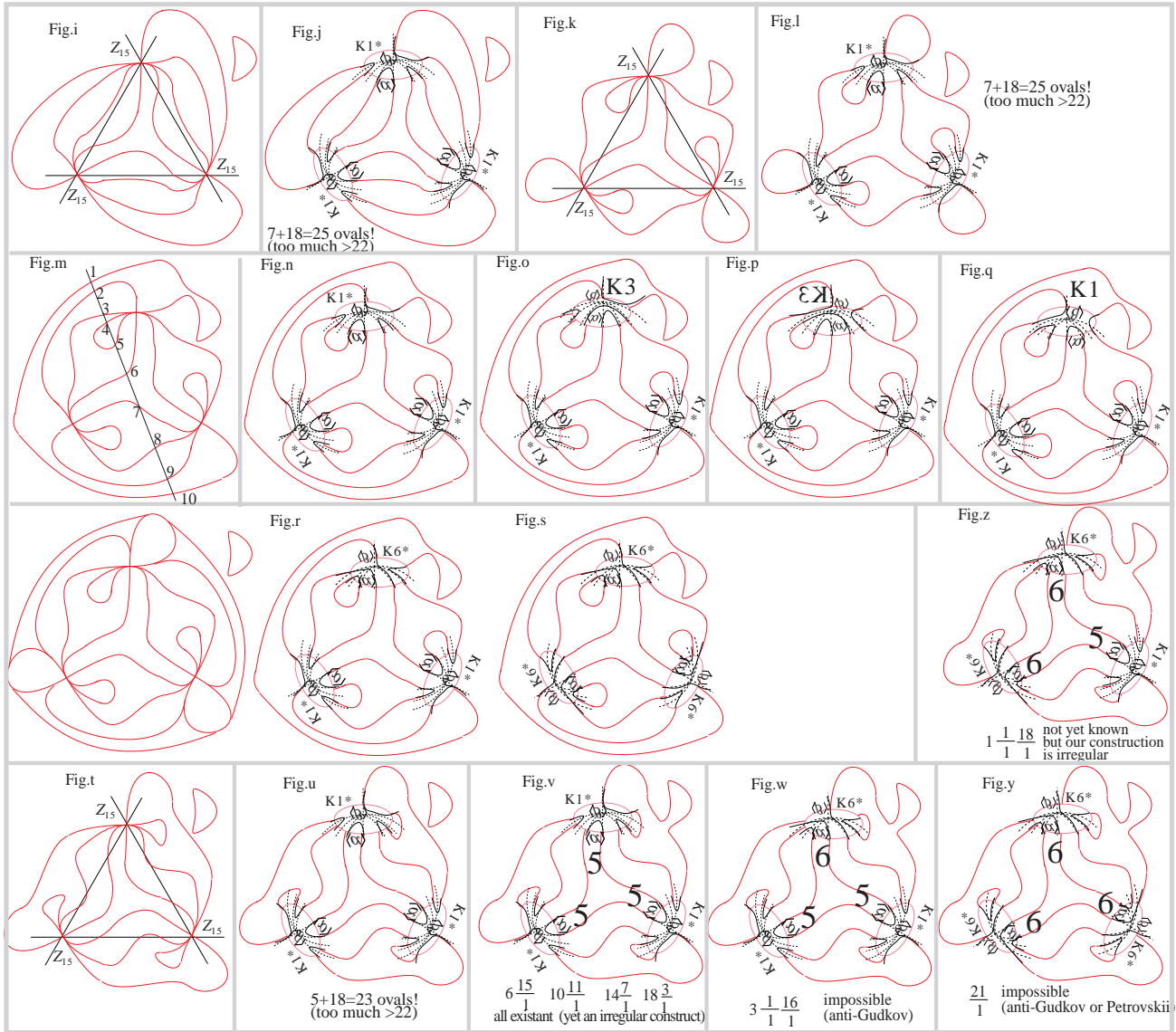

Figure 124: Further attempts to trace Shustin's last (seventh) curve $4\frac{5}{1}\frac{5}{1}\frac{5}{1}$, but still mis-depicted by Gabard (ohne Gewähr and a lot of contradictions).

Our question is still how to trace a singular octic whose dissipation leads to Shustin's scheme $4\frac{5}{1}\frac{5}{1}\frac{5}{1}$. It seems to us a pity that Shustin does not supply a picture of this curve and so we are relegated to a tedious guessing game. Of course the latter may be boring yet it could also offer new insights on the cases not yet settled. However we see that there is rather stringent obstruction to the manufacture of the divine C_8 of Shustin. In a state of quasi-somnolence (due to the high level of psychological complexes in front of Shustin's intelligence) we discovered Fig.j which albeit not intrinsically appealing (at least to my intuition) flashed our attention since we can remember that in Shustin's vague allusion is made to the union of 3 figures 8. Alas, the smoothing of Fig.k is over-productive yielding 7 macro-ovals (3 more than the four permissible by Axel Harnack).

7.6 Digressing on Orevkov's hypothetic curve

[05.07.13] Lacking imagination, we started a random reading of literature and found some inspiring idea in Orevkov 1999 [1121], p. 782, Fig. 4. There, Orevkov's Theorem 1.3 states that there is no curve of degree 8 as shown on Fig. 126a with $\alpha + \beta = 11$. Under such circumstance it seems of interest to look at the plethora of curves that would have resulted from dissipating singularities à la Viro. So for

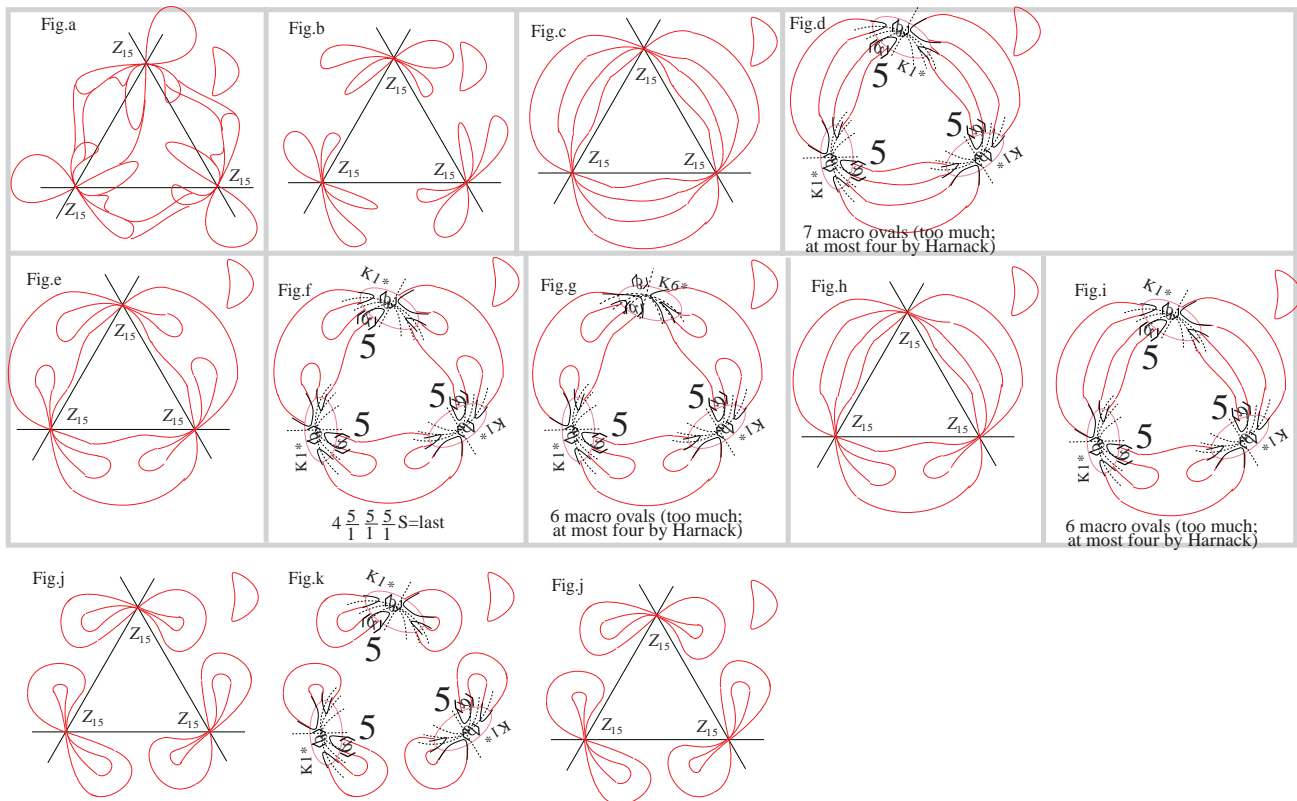

Figure 125: Further attempts to trace Shustin's last (seventh) curve $4\frac{5}{1}\frac{5}{1}\frac{5}{1}$, but still mis-depicted by Gabard (ohne Gewähr and a lot of contradictions).

instance we get Fig. c but as there is already 22 ovals coming from the brackets $\langle a \rangle$, $\langle b \rangle$ with $a + b = 11$ we get a contradiction in mathematics. (Note that we relabelled Orevkov's α, β as a, b as to avoid a confusion with Viro's parameters for micro-ovals α, β as on Fig. b.) So it seems completely obvious that Orevkov's curve (Fig. a) cannot exist and we do not really understand the interest of his statement (Theorem 1.3 on p. 782).

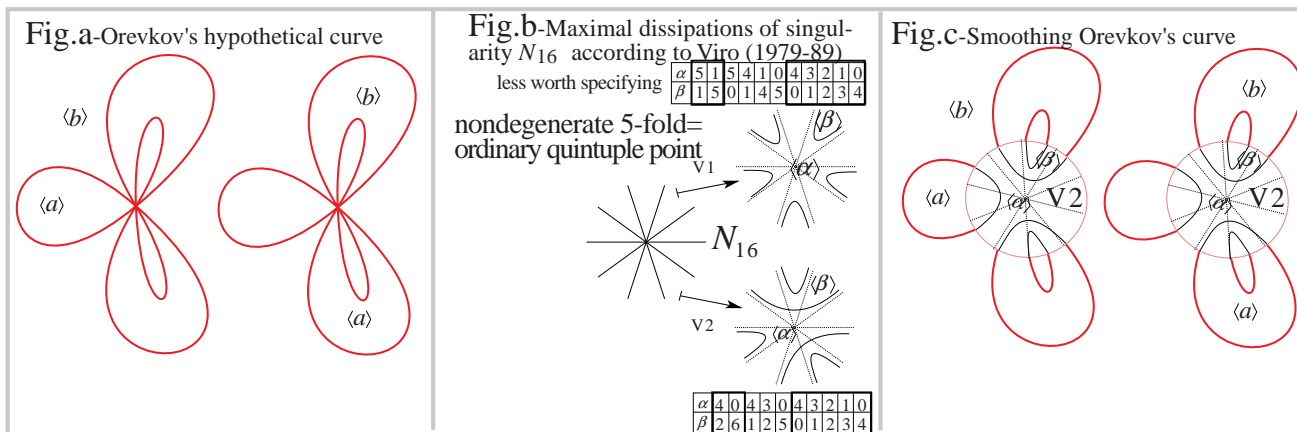

Figure 126: Further attempts to trace Shustin's last (seventh) curve $4\frac{5}{1}\frac{5}{1}\frac{5}{1}$, but still mis-depicted by Gabard (ohne Gewähr and a lot of contradictions).

8 Decomposing curves: loose constructions via freehand drawings

8.1 A messy idea à la Wiman and decomposing octics

[06.07.13] In view of the construction of Harnack, Hilbert, Wiman, etc. it seems that a realist method of construction consist to split the degree of interest in two and smooth a union of two curves realizing the given degree. This leads to an art-form well-known in Russia especially by Polotovskii, Shustin, Korchagin, Orevkov. For $m = 8$ we have the partition $1 + 7$, $2 + 6$, $3 + 5$ and $4 + 4$. For $8 = 4 + 4$ we have only one M -quartic and effecting a vibration gives a pair of quartics with one oval maximally intersecting the other along $4 \cdot 4 = 16$ points while the other 4 ovals are just disjoint replicas. On smoothing $C_4 \cup C_4$ à la Brusotti or otherwise (Wiman does not cite Brusotti) we get Wiman's M -octic with scheme $16\frac{1}{1}\frac{1}{1}$.

Similar games must be possible with the other partitions.

8.2 Degree 3+5

Let us examine $3+5$ first. Here we only one isotopy class of M -quintic (with $r = 7$) resp. M -cubic (with $r = 2$). Let us assume that a pair of ovals is maximally intersecting along $3 \cdot 5 = 15$ points. Warning this is a misconception since both pseudolines of the C_3 and C_5 have to intersect, hence their intersection $C_3 \cap C_5$ cannot be monopolized by an oval. So assume rather that both pseudolines are maximally intersecting along 15 points, but each pair of ovals chosen one from each curve is disjoint. Smoothing the union $C_3 \cup C_5$ gives a curve with $15 + 1 + 6 = 22$ ovals hence an M -octic. Of course knowing its exact scheme requires knowing more on how the unique oval of C_3 surrounds the 6 ovals of the M -quintic C_5 . However since the C_5 cannot be nested (unless it is the non-maximal deep nest) we can infer a priori that the resulting octic scheme will be simply nested, i.e. of the shape $x\frac{y}{1}$, hence not so interesting as all those schemes are already realized by Viro's method (look at the top row of Fig. 155, zoomed as Fig. 156).

8.3 Degree 2+6

Let us next examine the partition $8 = 2 + 6$. Here we imagine one ovals of the C_6 maximally intersecting the conic C_2 along 12 points. So one should try to analyze all types of such decomposing curves. This sort of problems is well-known to experts like Polotovskii and Orevkov and one sees some direct interconnection between the isotopic classification of decomposing curves (under the natural assumption of transversality) and the pure isotopic classification of a single curve of degree equal to the sum. To get started let us fix the C_6 as being of Harnack's type $9\frac{1}{1}$. A priori we can imagine that one oval oscillates across the ellipse C_2 as on Fig. 127? below. If the vibrating oval is an outer oval the resulting scheme is $(12 + 8)\frac{1}{1} = 20\frac{1}{1}$ which violates Gudkov periodicity mod 8. If the vibrating oval is the non-empty oval then we get the (unnested) scheme $9 + 12 + 1 = 22$, which cannot exist (e.g. by Petrovskii, or Rohlin's formula $(0 =)2(\pi - \eta) = r - k^2$). Finally if the vibrating oval is the unique empty nested oval we get the scheme $9\frac{12}{1}$ which is also anti-Gudkov (hence cannot exist).

Okay, but in reality we still have Hilbert's constructions yielding decomposing curve of "bidegree" $(6, 2)$ and producing the interesting (but classical) schemes $1(1, 2\frac{47}{1})$, etc. as depicted on Fig. 127. This is fairly exhaustive (i.e. mixing all possible internal versus external oscillation) yet this still misses the classical scheme $17\frac{4}{1}\frac{2}{1}$ so that Hilbert's method does not (in degree 8 as opposed to degree 6) encompass completely Harnack's one.

On doing a similar yet more liberal (i.e. artistic) drawing with a Gudkov-type sextic we get Fig. 127c whose first smoothing yields the scheme $5(1, 2\frac{13}{1})$ first constructed by Chevallier. Of course our construction is not a serious

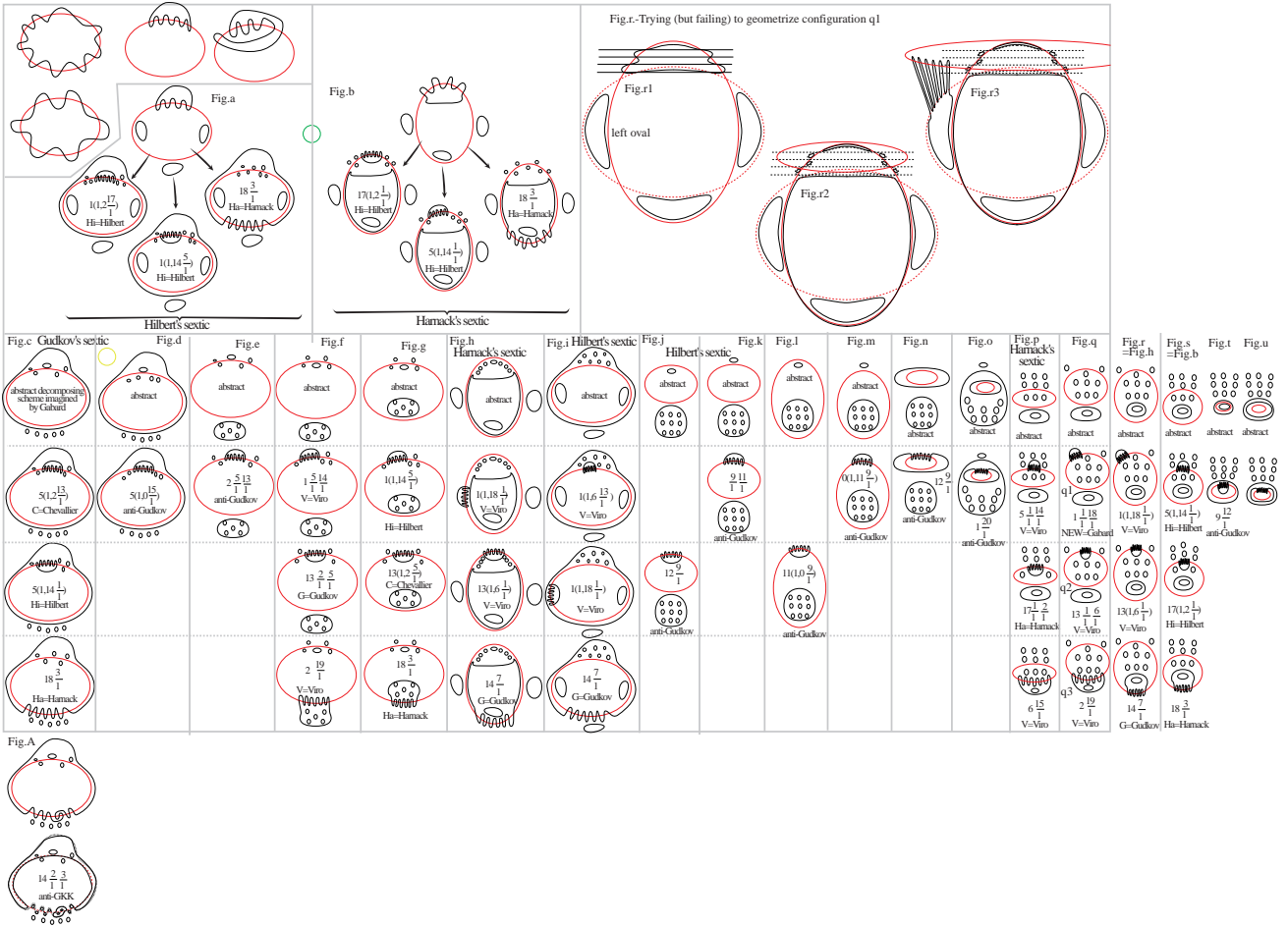

Figure 127: A flexible Harnack-Hilbert via floppy decomposing oetics 2 + 6 method yielding 3 schemes of Korchagin (green-colored), 2 schemes of Chevallier (blue) and one boson only pseudo-realized by Orevkov (black=Fig. b), plus finally one scheme prohibited by Shustin (red=Fig. a).

one but maybe can turned to serious. Continuing with this heuristic method we get Figs. d and e which cannot exist as they create smoothings which are anti-Gudkov (i.e. violates Gudkov's hypothesis corroborated by V. A. Rohlin). However the abstract qualitative picture Fig. f create 3 curves all known to exists (either first due Gudkov or to Viro) so there is some chance that Fig. f exist (where there is a sort of infinitesimal vicinity of certain ovals to the ground conic). This concept (of cytoplasmic curve) is somewhat ill-posed yet fruitful to create the derived decomposing curves with maximal oscillation. Fig. g is likewise interesting producing another Chevallier's scheme $13(1, 2\frac{5}{1})$, beside more standard birds due to Harnack and Hilbert respectively. Then it seems that we have exhausted all possibilities with Gudkov's curve so as to be compatible with Gudkov hypothesis (which permits only transfer of ovals by quanta of four-packs). This brought us to Fig. h which is Harnack's curve (of Fig. b, i.e. Harnack constructed à la Hilbert) with a transfer of 4 quanta inside. Likewise Fig. i shows Hilbert's sextic with a forced transfer of 4 ovals outside, so as to respect formally Gudkov hypothesis. Looking at the resulting smoothings we get curves due to Gudkov and Viro respectively. Thereafter we consider the series of Figs. j,k,l,m and get always anti-Gudkov curves, hence none of this abstract configuration exist algebraically. As those 4 options exhaust the distribution of Hilbert's 2 nests about the ellipse, we would infer that our discussion is systematic. It remains yet to examine Fig. o, whose outcome is also anti-Gudkov. So the ground ellipse must be inside the nest and then Figs. a,i together give an exhaustive census of the partition of the inner ovals compatible with the law of 4 quanta imposed by Gudkov periodicity.

Then we shall repeat this game with Harnack's curve $9\frac{1}{1}$. So we starts (randomly with Fig. p) whose production is pro-Gudkov, and actually includes one scheme of Harnack and 2 due to Viro. Next we proceed to a delocalization by a quanta of 4 to get Fig. q. Its first smoothing yields the boson $1\frac{1}{1}\frac{18}{1}$ not yet known to be realized algebraically (but known to be so pseudo-holomorphically by Orevkov 2002 [1129]). So we nearly made a progress on Hilbert's 16th, but alas not so due to the purely heuristic character of our method (which is truly just a flexible artistic avatar of Hilbert's method). Further as the two other schemes derived from Fig. q are classical birds of Viro, namely $13\frac{1}{1}\frac{6}{1}$ and $2\frac{19}{1}$, we may get some evidence for the existence of the (bosonic) scheme $1\frac{1}{1}\frac{18}{1}$. Here by bosonic we just mean hard to detect!

[[Added [14.07.13] Actually we can do the depiction slightly more rationally as on Fig. 129. At some stage we had also the idea to transfer (package of 4) ovals in the meander of the oscillation. Unfortunately this is not possible since this would create another nest but the sextic is already nested (Fig. a). Here we found a new Korchagin scheme after transferring 4 ovals in a meander namely $2(1, 14\frac{4}{1})$.

However from there we can via transfers entering once in the red ellipse and then sorting of it produce delocalization in the meanders creating first Hilbert's scheme $1(1, 14\frac{5}{1})$ and then the scheme $0(1, 14\frac{6}{1})$ prohibited by Shustin 90/91 [1419]. So provided the latter result is correct we have proven the lemma saying that it is impossible to have a decomposing curve of degree $6 + 2$ like that of Fig. a. Despite being of modest interest (if one is not an aficionado of decomposing curves), it is nonetheless a severe attack on our heuristic method since there is no hope that the bosonic scheme just obtained as Fig. b will really exist.

[15.07.13] After a lengthy search we arrived at the conclusion that we explored all decomposing octics of split-degree $2 + 6$ with a maximally intersecting oval which is undulating so as to produce an M -curve after perturbation of the nodes. Equivalently the undulating condition may be expressed by saying that the order of the 12 intersection points is the same along the ellipse as along the oval. So we would like to state:

Lemma 8.1 *A floppy decomposing curve of bidegree $2 + 6$ belongs to one of the isotopy type tabulated on Fig. 128 plus eventually some little variants like Figs. c and d. Despite some ambiguities we believe that the resulting list of octic M -schemes accessible via a bi-curve of bidegree $2 + 6$ is exhaustive, and labelled by orange colored frames on Fig. 130. Actually Fig. 128 has to be replaced by Fig. 129 where 2 additional schemes were discovered. Likewise we shall see (by virtue of Fig. 134) that all octic M -schemes in the light-blue regions of Fig. 130 are realized through a floppy split-curve of degree $1 + 7$ (sometimes referred to as affine septics, yet this concept is alas not universally defined, compare a well-known (amicable) controversy between Korchagin-Shustin and Orevkov, cf. optionally Orevkov 1998 [1118]).*

This was essentially safe that there is an even somewhat more rational way to present things via Fig. 129 where 2 additional (2+6)-split M -octic schemes are constructed. The underlying idea is that one starts with simply-nested schemes, e.g. Harnack's schemes $18\frac{3}{1}$ and then elevates by putting ovals in the fingers meanders. (Fig. a* just shows a useless quantum transfer to a Gudkov sextic yet producing the same triad as before.) Then one moves right by a quantum transfer of 4 ovals to get via Fig. b Gudkov's scheme $14\frac{7}{1}$ and mowing upwards by the finger moves yields a menagerie of 8 schemes moving fairly linearly on the geographical table. (Fig. b* shows an illegal transfer by the way violating Gudkov periodicity.) Next one considers the split curve of Fig. c yielding the scheme $6\frac{15}{1}$ and look at its versatile descendance under finger moves, which one the table correspond to a rectilinear motion with jump from the 0th pyramid to the 3rd one. Fig. d is deduced by a quantum transfer of 4 ovals. Fig. e is deduced by tranquilizing the vibrating oval and making vibrate the external one, while Fig. f and Fig. g should be self-explanatory. Of course albeit being better

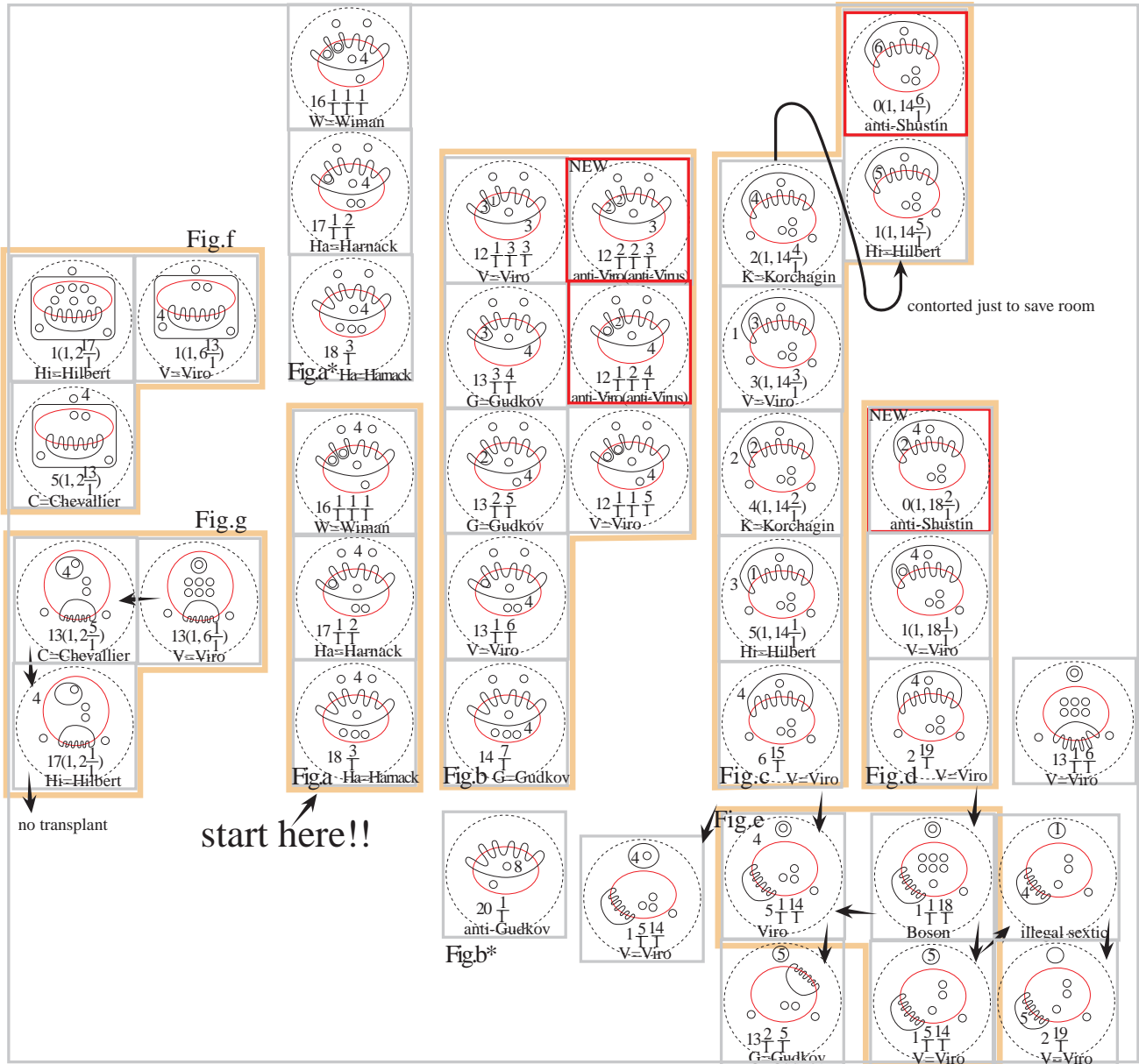

Figure 129: A more rational enumeration yielding 2 supplementary schemes

the blue regions since it would suggest existence of the bosonic scheme $14(1, 2\frac{4}{1})$.

Finally, albeit there is some overlap between the schemes covered by both procedures ($2 + 6$ vs. $1 + 7$) there is also some complementary nature of their domain of influences. Of course it remains to tabulate the geographical position of the split-curves $3 + 5$ and $4 + 4$. What is somewhat surprising is that for $1 + 7$ we could give a very regular enumeration whilst for $2 + 6$ we suffered under messiness and a chaotic somewhat random search. Perhaps this is due to the fact that we imposed a too prescription of the sextic schemes versus letting operate all quantum fluctuations of ovals compatible with Bézout and Gudkov periodicity (optionally Viro's imparity law). So at the occasion one should try to reorganize the $2 + 6$ table.

Finally it may also be observed that the axiom all floppy split curves does not enter in conflict with Fiedler's obstruction of four schemes (but as we already noted seriously damage or is damaged by Viro's imparity law for trinedsted schemes).

Let us now examine split curves of degree $3 + 5$. Reporting on the map the simple pictures of Fig.132 we get the (little) red framed schemes on Fig.130. The most interesting point is of course the realizability of the boson $14(1, 2\frac{4}{1})$

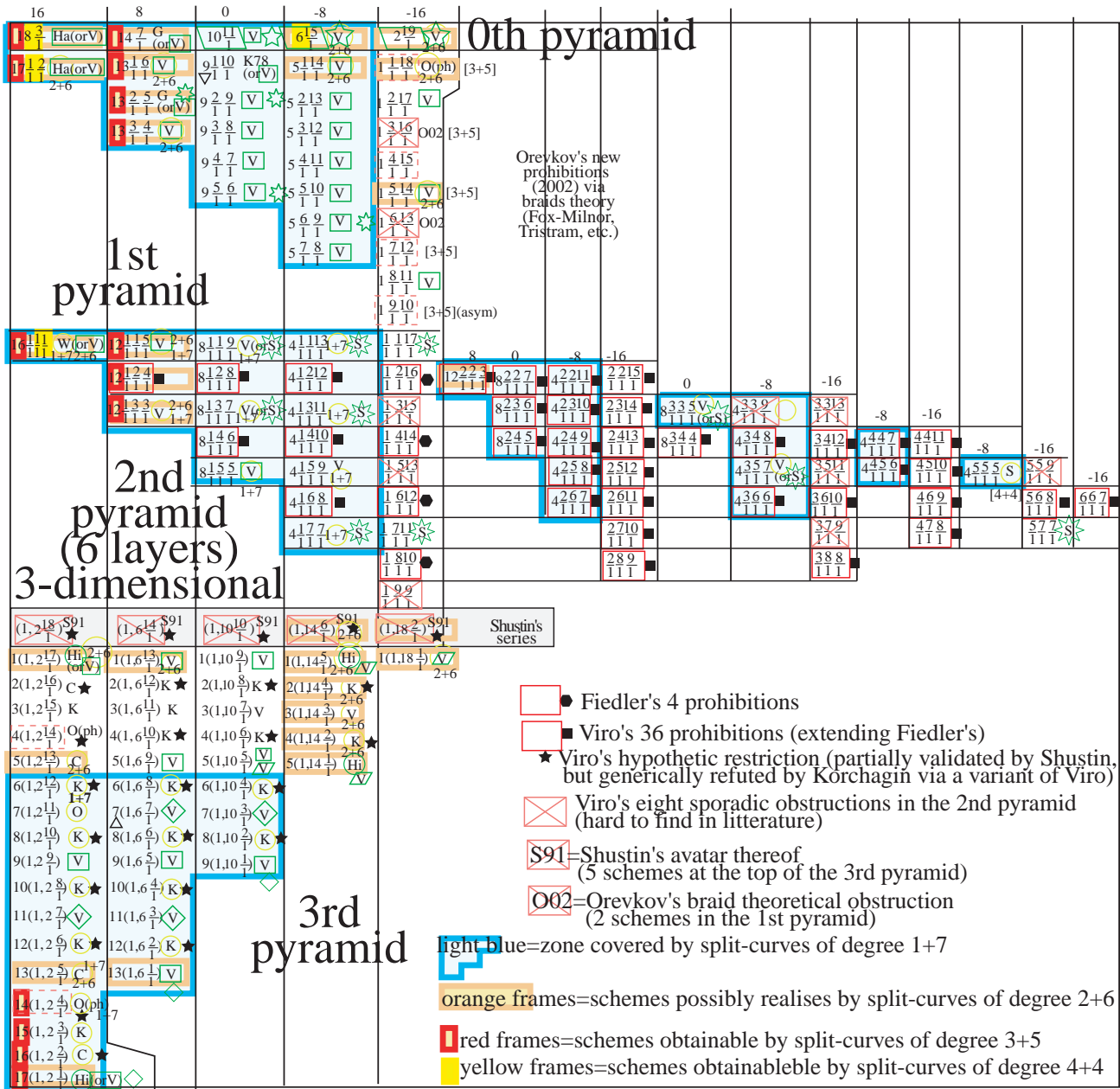

Figure 130: A flexible Harnack-Hilbert method yielding 2 schemes of Chevallier and one boson pseudo-realized by Orevkov

which is now realized twice (once in degree 1 + 7 and anew in degree 3 + 5). This should perhaps indicate that this boson is most likely to exist, but of course our viewpoint is so naively topological that there is no certitude yet. Nonetheless this may indicate that $14(1, 2, \frac{4}{1})$ is the less mysterious of all sic bosons. Actually I should confess that during the enumeration we first shamefully forgot the schemes below $14(1, 2, \frac{4}{1})$ and found them only after contemplating the architecture of the pyramid. So the lesson to keep in mind is always to geometrize the combinatorics in order to miss nobody.

Finally for bidegree 4 + 4, the corresponding schemes are explored on Fig. 131, and their geography reported by small yellow rectangles on the main-map (Fig. 130). The series of schemes so obtained is a nearly ridiculous collection of 4 schemes, yet contains Wiman's famous schemes $16\frac{1}{1}\frac{1}{1}$, which historically was first obtained through construction of the appropriate 4 + 4-slit curve in the algebro-geometric category (Wiman 1923 [1595]) thereby contorting some misconceptions of Hilbert/Ragsdale. Somewhat more interestingly we also encounter Viro's scheme $6\frac{15}{1}$ of which it would be nice to know if Wiman was techno-

logically able to construct it.

It is also interesting to observe that schemes of type $4 + 4$ form a subfamily of those of bidegree $2 + 6$, while those of type $3 + 5$ constitute a subfamily of those of type $1 + 7$. Apart from those observation the resulting architecture looks still a bit mysterious and our all endeavor shed only minimalist spot of lights on the overall global Hilbert's 16th problem.

[16h41] Of course one can wonder if our Walt-Disney/Gudkov flexible depiction can be rigidified in the realm of algebraic geometry so as to get an existence proof of the (bosonic) scheme $1\frac{1}{1}\frac{18}{1}$ at the algebraic level. Crudely speaking it seems to suffice to look at Fig. b (right) while tracing an ellipse enclosing the seven "upper" ovals (upperness being defined w.r.t. to the picture). The difficulty however is to ensure that 2 remaining outer oval are proximal enough to the ellipse as to effect the required schematic of Fig. q1 (where "q1" refers to the first row below Fig. q). If feasible then there is perhaps a perfectly elementary proof of existence of the bosonic scheme $1\frac{1}{1}\frac{18}{1}$, which is completely at the level of the Harnack-Hilbert technological level.

Let us state this as follows:

Lemma 8.2 *If there exist a decomposing octic of degree $8 = 6 + 2$ whose scheme is Fig. 127q1 then there exists a smooth octic with (bosonic) new scheme $1\frac{1}{1}\frac{18}{1}$, and one wins a Fields medal in chocolate for a spectacular advance on Hilbert's 16th.*

So configuration q1 is gold-worth (Goldwert für Hilbert/Viro/Orevkov) and trying to geometrize it on the larger Fig. r we meet some evident obstruction on the vibratory model of Hilbert. First the red ellipse trying to phagocyte all 7 "micro" ovals tends to collide with the nonempty oval. Of course this pity can be salvaged by imagining the ellipse of very large eccentricity (hence nearly osculating the bottommost horizontal line). It remains then to take the left (say) macro-oval and to make it oscillate across the ground ellipse (as heuristically depicted on Fig. r3). This looks structurally hard to do (without contorting algebraic respectableness) and we see why Orevkov's bosons $1\frac{1}{1}\frac{18}{1}$ is so hard to construct. Of course, it can be that there is an obstruction to this scheme.

Further one can of course mentally play with the geometric parameters of Fig. r1 by bringing the bottommost (horizontal) line closest possible to the crossing of the 2 primitive ellipses, and then hope that the left oval is close enough to the ground ellipse of Fig. r2 to vibrate across it. This looks a little puzzle with infinitesimals (we confess hard to believe in).

[07.07.13] What is fairly incredible is that our method (which is just a heuristic=flexible Harnack-Hilbert-Ragsdale-Brusotti-Wiman method) is very versatile realizing most of Viro's scheme by the dissipation of the simplest singularity A_1 (ordinary node with 2 real tangents). Hence supposing some intelligence able to implement at the rigorous level this would constitute a little attack upon the slogan that Viro's method is structurally stronger than the classical perturbation method. Albeit vague, our remark should be precise enough to open a little debate on the point after more work.

Next we examine Fig. r (where a ring is delocalized so that χ keeps unchanged), and then considered Fig. s. (Alas we did not realized first that those configurations were already analyzed as Fig. h and Fig. b respectively). It seems at this stage that we have analyzed all possibilities of an elliptical oval located w.r.t. one of the 3 possible M -sextic. Of course this does not mean that we do have catalogued all decomposing octic of bidegree $8 = 6 + 2$, because a priori the intersection may be not a vibration but a more complicated "meander" as depicted say on the top Fig. 127. So for instance Fig. A shows a meander, but it seems that this causes a loss of vibratory energy striving us outside the realm of M -curves (the smoothing below being only an $(M - 1)$ -scheme, actually forbidden by GKK (the $(M - 1)$ -avatar of Gudkov periodicity due to Gudkov-Krakhnov-Kharlamov).

Of course if meander fails to produce M -schemes it remains to investigate the other splitting of 8 as $4 + 4$, $3 + 5$, $1 + 7$.

8.4 Degree 4+4

Let us start for evenness psychological simplicity with the splitting $8 = 4 + 4$ (cf. Fig. 131). Here as well-known we recover Wiman's curve $16\frac{1}{1}\frac{1}{1}\frac{1}{1}$, plus schemes due to Harnack, and more interestingly Fig. f gives a schemes first cooked by Viro, namely $6\frac{15}{1}$. It would be of didactic interest to know if this scheme is (rigorously) constructible by an elementary method à la Wiman, thereby circumventing the intrusion of Viro.

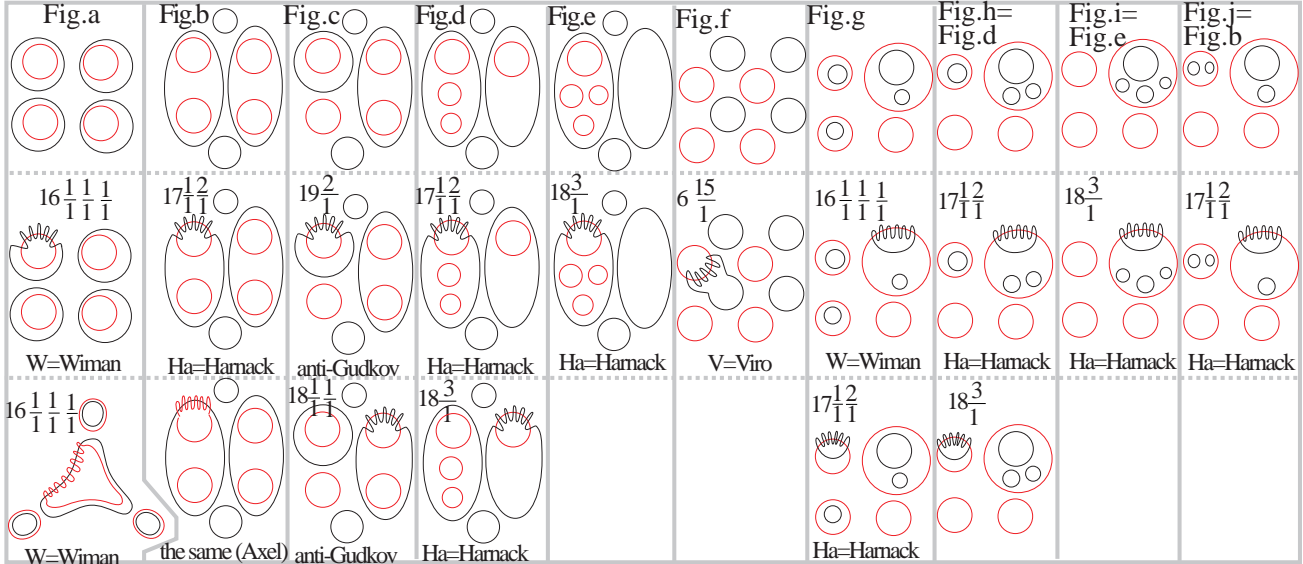

Figure 131: Smoothings of decomposable octics of bidegree 4 + 4

8.5 Degree 3+5 (revisited)

The next case to examine is $8 = 3 + 5$. Here we obtain Fig. 132. Fig. b,c,d illustrates the standard phenomenon that when splitting the oscillation into two circuit we loose vibratory energy failing so to reach the Harnack maximal case. On the sequel of the map should be self-explanatory, and it is noteworthy that we get again (added [14.07.13]) the bosonic scheme $14(1, 2\frac{4}{1})$, which we also realized via a curve of degree $1 + 7$ (cf. Fig. 134). However it could be that the present schematic view suggest a better technique to construct the curves as the individual curves involved in the splitting have lower degrees hence perhaps easier to control. One could perhaps try to attack the construction of such a split curve as an interpolation problem for a cubic given a fixed C_5 in the background landscape. One could try to start with a Harnack quintic (e.g. in the model constructed à la Hilbert) and then try to trace the appropriate cubic. Of course the problem looks violently over-determined and we can only tabulate on a very lucky stroke to get out. Of course conversely one could imagine as a reverse engineering telling that any curve $14(1, 2\frac{4}{1})$ could be through a dynamical procedure degenerate toward the split curve depicted (this being maybe reminiscent of a Hilbert-Rohn type method). Supposing further that one is able to prohibit our split curve (via say a theory à la Orevkov), then one would get an obstruction upon the bosonic scheme.

8.6 Degree 1+7

Thereafter we examine $8 = 1 + 7$. Here we base the analysis (situs) upon Viro's census of M -septics. This includes precisely the fourteen M -septics schemes 15 , $13\frac{1}{1}$, $12\frac{2}{1}$, $11\frac{3}{1}$, etc, $2\frac{12}{1}$, $1\frac{13}{1}$ (where the pseudoline J is omitted from the symbolism). On looking at the Fig. 133 (whose geometric essence is to say that a maximally dissipable decomposing curve occur when the pseudoline is undulating across the line) we see see a fairly disappointing issue that this method will

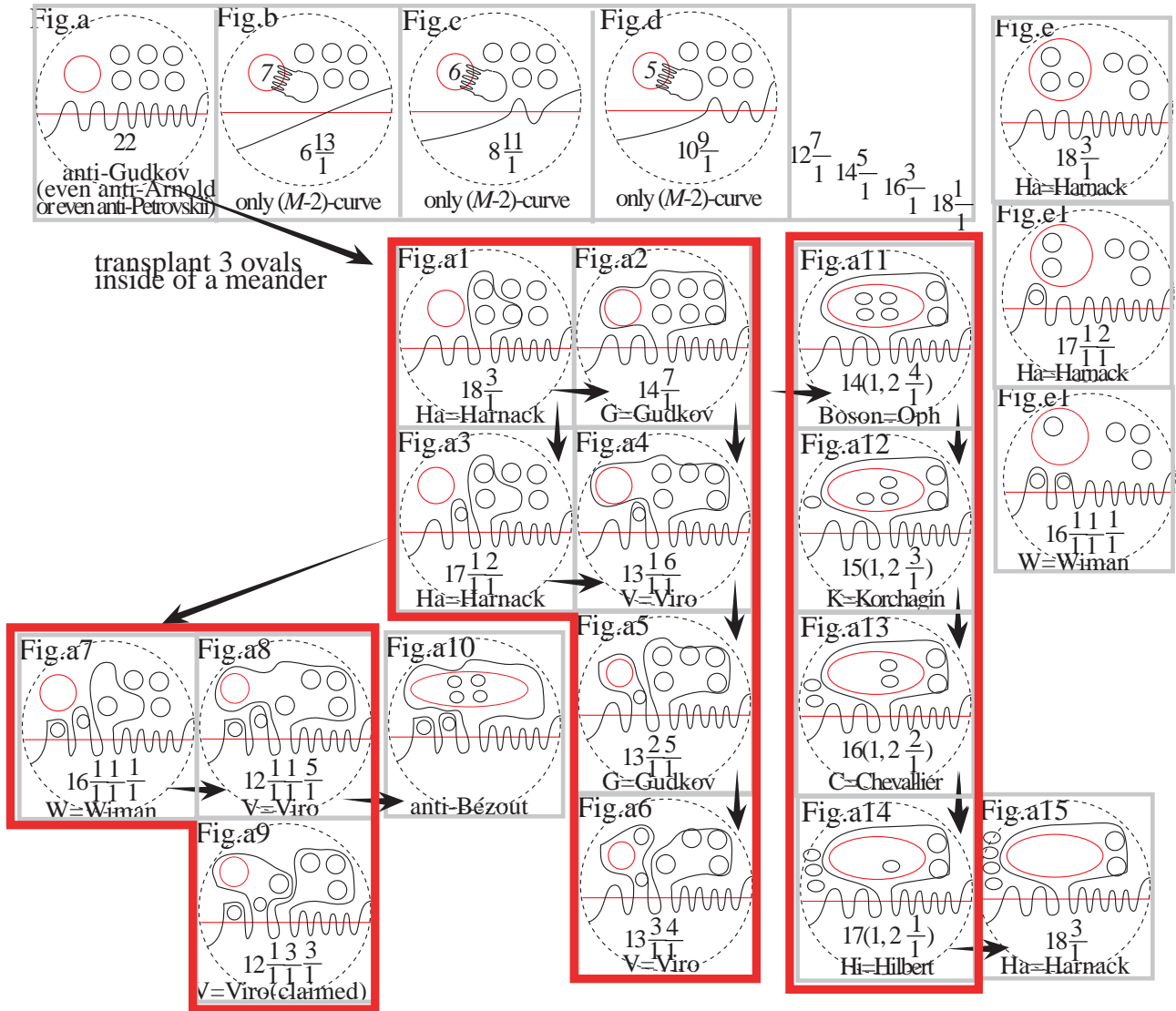

Figure 132: Smoothings of split octics of degree $3 + 5$ (at first view only one Harnack scheme, but then fairly original Korchagin and Chevallier schemes, plus even the pseudoholomorphic boson $14(1, 2 \frac{4}{1})$).

only created simply-nested schemes (whose theory is already completely elucidated through Viro's construction in degree 8). Actually on taking as septics those with scheme $3 \frac{11}{1}$ we get only $10 \frac{11}{1}$ and so this construction do not even realize the two schemes $6 \frac{15}{1}$ and $2 \frac{19}{1}$.

As a consequence it seems that the method of decomposable curves (combined with Brusotti's independence of smoothing for ordinary nodes) afford only a small list of M -schemes, yet some due to Viro, and 2 of Chevallier, as well as one boson $1 \frac{18}{1}$ not yet known to exist. Hence the method deserves be investigated more systematically to be sure that we missed nobody, and then needs to be geometrized in order to see if the above mentioned boson can be constructed, what nobody succeeded hitherto to do.

[11.07.13] Of course there is then much more configuration to analyze and the problem amounts to the classification of affine M -septics. It is notorious that already the case of M -sextics is extremely difficult (initiated by Korchagin/Shustin, Polotovskii and Orevkov and perhaps fairly close to completion now). The point is that ovals may be situated in the meanders of the pseudo-line oscillating across the line and this will produce additional M -schemes (or rather pseudo M -schemes as we are not ensured a priori that the configuration exists). However one can start a qualitative exploration by transferring packages (quanta) of 4 ovals. So starting from the above Fig. d, and transferring one

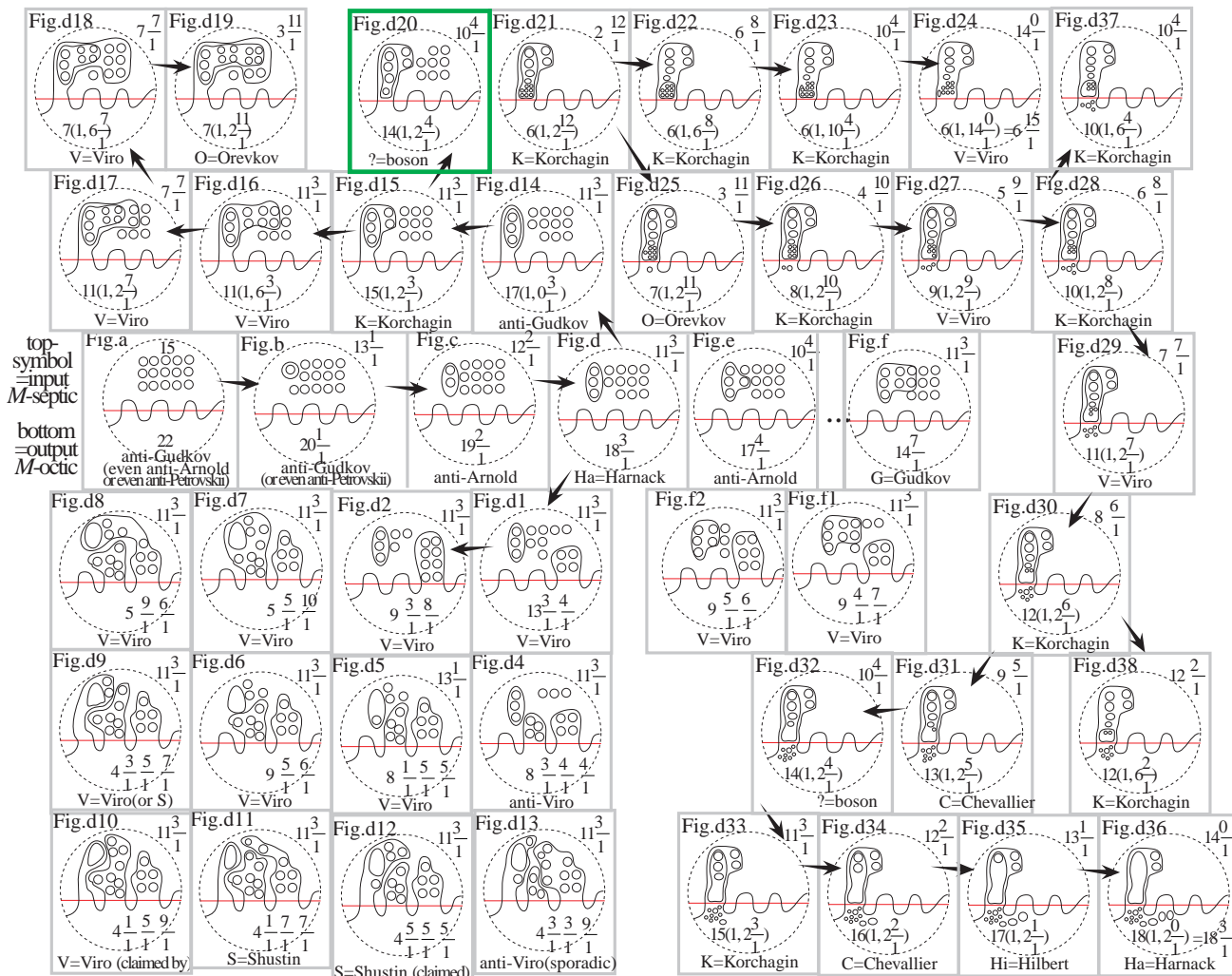

Figure 133: Smoothings of decomposable octics of bidegree $1 + 7$ (cf. next Fig. for a cleaner way)

quanta of 4 outer oval in the meander while smoothing the resulting $C_7 \cup L$ produces the scheme $13 \frac{3}{1} \frac{4}{1}$ which is known to exist by Viro. Of course continuing in this fashion, we get the $9 \frac{3}{1} \frac{8}{1}$ (also due to Viro), and then $5 \frac{3}{1} \frac{12}{1}$ (also Virotian), and finally $1 \frac{3}{1} \frac{16}{1}$. The latter is actually prohibited by Orevkov's braid theory (cf. Orevkov 2002 [1129]). So our method is completely hopeless, yet heuristic. Alas it seems that the originality of our method resides in the fact that we are not readily considering classical deterministic curve like the famous Russian decomposing curves. (For a bribe of decomposing curve in primitive Germany, cf. Mohrmann's 1912 [1029] lovely introduction.) In fact we considered on the earlier pictures in degree $6 + 2$ and $4 + 4$ (Figs. 127 and 131 respectively), what could be called a *quantum fluctuating curve*. This is like a decomposing curve save that both constituents are disjoint yet with each oval susceptible to oscillates across each of his neighbors. The power of the method was that we got so series (triads in general) of classical decomposing curve, which produce by Brusotti's smoothing some (potentially new) M -curves. The heuristic idea was then that if two of the three smoothing exists then there is some hope that the 3rd product is also modelling a real algebraic curve. Alas when working in odd+odd bidegree both pseudolines are forced to intersect and so the intersection has to be monopolized on the pseudolines and we loose the quantum plurality of matter (where an object admits a nebulousness of things around it like its descendance). This being said our method seems to loose its multivalued-ness which was the source of a little principle of rigidity aping very vaguely the algebraic rigidity of the real world we are interested in.

However on working more carefully the (quantum) transfers as Fig. d1. and d2 we see that we met an obstruction not allowing one to reach Viro's scheme $5\frac{3}{1}\frac{12}{1}$, whence a fortiori not Orevkov's scheme $1\frac{3}{1}\frac{16}{1}$. However on propagating the quantum fluctuations (suitable transfers of ovals) we see that we may obtain some schemes due to Shustin (hence lying somewhat deeper than the first generation of Viro), like $4\frac{1}{1}\frac{7}{1}\frac{7}{1}$ (Fig. d12) or $4\frac{5}{1}\frac{5}{1}\frac{5}{1}$. All this is pleasant depiction (morphogenesis or waves with oxygenating bubbles) yet it seems that there are obstruction to reach by the method more Orevkov(ian) schemes on the first pyramid (of doubly nested schemes) and with $\chi = -16$ (i.e. extreme-right portion of the diagram). Of course even Viro's schemes on this strip look inaccessible via decomposing curve of degree $7 + 1$. This deserves to be better understood at the occasion yet it seems that there is a fairly simple explanation due to the oscillating character of the pseudoline and the aptitude for at most three meanders to tolerate ovals. (Otherwise the smoothed octic violates Bézout for conics, or equivalently the doubled quadrifolium $\frac{1}{1}\frac{1}{1}\frac{1}{1}\frac{1}{1}$ is saturated.)

[13.07.13] Ultimately we noticed that from Fig. d5, we changed the isotopy class of the septics to $13\frac{1}{1}$, and later on to even 15 a configuration first constructed by Ragsdale 1906 [1238] and later rediscovered by Wiman 1923 [1595].

Eventually we had the idea that in order to have a super-nest (i.e. a subnest in a nest so as to land in the 3rd pyramid), we only have to put the nest of the septic into the meander as on Fig. d14. This has wrong characteristic but it is a simple matter to correct this with Fig. d15 realizing the scheme $15(1, 2\frac{3}{1})$ first constructed by Korchagin. Then one can do quantic jumps with packets of 4 ovals up to reach Fig. d19 which is a truly remarkable scheme $7(1, 2\frac{11}{1})$ due to Orevkov (essentially the last one constructed up-to-date). Even more cleverly, turning back again to Fig. d15 (which is fairly close to the boson $14(1, 2\frac{4}{1})$) we realize that it is enough to drag an outer oval of C_7 in the meander and let it be phagocytized by the nonempty oval to get the bosonic scheme $14(1, 2\frac{4}{1})$ resisting to present knowledge. We have proved the modest:

Lemma 8.3 *There is no (naive) topological obstruction to the realizability of the bosonic M -scheme $14(1, 2\frac{4}{1})$ by a Brusotti perturbation of a decomposing curve of degree $7 + 1$ where the septics has (reduced) scheme $10\frac{4}{1}$ (pseudoline omitted) while the line intercepts it maximally as depicted on Fig. 133d20.*

Dragging the 8 remaining outer ovals into the meander create $6(1, 2\frac{12}{1})$ due to Korchagin. Alas it seems evident that we will never reach the other boson with a subnest, i.e. $4(1, 2\frac{14}{1})$ because too many outer ovals are created by the meanders of the oscillation.

Then, starting from Fig. d21 (realizing Korchagin's scheme $6(1, 2\frac{12}{1})$), one can imagine a progressive transfer of the ovals at depth 2 to oval at depth 0 (hence no quanta rule of 4 has to be respected) and we get so Fig. d25 which is again Orevkov's (unique) scheme $7(1, 2\frac{11}{1})$. Continuing, this process sweeps out all schemes of the fundamental table (Fig. 130) yielding successively the schemes $8(1, 2\frac{10}{1})$ (K), $9(1, 2\frac{9}{1})$ (V), $10(1, 2\frac{8}{1})$ (K), $11(1, 2\frac{7}{1})$ (V), $12(1, 2\frac{6}{1})$ (K), $13(1, 2\frac{5}{1})$ (C), $14(1, 2\frac{4}{1})$ (Oph=boson), $15(1, 2\frac{3}{1})$ (K), $16(1, 2\frac{2}{1})$ (C), $17(1, 2\frac{1}{1})$ (Hi), $18(1, 2\frac{0}{1}) = 18\frac{3}{1}$ (Ha). As usual, we use the following abbreviations: Ha=Harnack, Hi=Hilbert, V=Viro, K=Korchagin, C=Chevallier, O=Orevkov, Oph=Orevkov but only pseudo-holomorphically. Of course in view of our earlier twist (Fig. d21 up to d24) it is clear that on the main-table we can move horizontally to the right as well so as to sweep out the whole portion of the pyramid below Korchagin's $6(1, 2\frac{12}{1})$. So for instance Fig. d37 gives Korchagin's scheme $10(1, 6\frac{4}{1})$, and likewise Fig. d38 gives Korchagin's scheme $12(1, 6\frac{2}{1})$. Applying the same lateral dynamics to Chevallier's scheme $13(1, 2\frac{5}{1})$ yields merely Viro's scheme $13(1, 6\frac{1}{1})$, yet this might give confidence in the method. Applying the lateral shift to "Orevkov's" boson $14(1, 2\frac{4}{1})$ produces the scheme $14(1, 6\frac{0}{1}) = 14\frac{7}{1}$ due to Gudkov. Hence this may give some evidence that the boson in question exists (algebraically).

At this stage, it seems that we were fairly exhaustive and we would like a statement about the combinatorial confinement of M -schemes obtained by small

perturbation of a decomposing octic splitting of a line plus a septic.

Before let us make some more basic experiment. Let us start with Fig. 134g (which is actually a perfect replica of the former Fig. a). Then as we are interested mostly in doubly-nested schemes (enclosing 4 mysterious bosons) we transfer ovals in the meanders, e.g. just one in each meanders to get Fig. g1 which gives the scheme $18\frac{1}{1}\frac{1}{1}$ which is anti-Gudkov. Looking at the map (Fig. 130) we see that the closest scheme is $17\frac{1}{1}\frac{2}{1}$ (Ha) and so we correct to Fig. g2 (successive approximation). After that we do quantic jumps of 4 ovals to derive laterally on the right through Figs. g3, g4, g5 but alas cannot so reach the boson $1\frac{1}{1}\frac{18}{1}$ (which we could however find via a $6+2$ splitting, cf. Fig. 127). Then looking at the pyramid again (Fig. 130) it is clear how to move down to get $13\frac{2}{1}\frac{5}{1}$ (Fig. g6), which is due to Gudkov. (Probably Gudkov's original construction really involves this stronger decomposing scheme). This can in turn derives to the right, yet cannot reach the scheme $1\frac{2}{1}\frac{17}{1}$ (due to Viro however). Continuing in the obvious way gives all pictures in the first triangle of Fig. 134 proving thereby the:

Lemma 8.4 *Among all M -schemes of the 1st pyramid of Fig. 130 (consisting of so-called doubly nested schemes plus those which are simply-nested) only those located in the sub-triangle where the right edge is deleted are (potentially) realizable through perturbation of a decomposing curve of degree $7+1$. In particular it seems that there is no chance to construct via the splitting $7+1=8$ the four doubly-nested bosons, namely $1\frac{1}{1}\frac{18}{1}$, $1\frac{4}{1}\frac{15}{1}$, $1\frac{7}{1}\frac{12}{1}$, $1\frac{10}{1}\frac{9}{1}$. Actually the first such boson is constructible via a "flexible" sexti-conic of degree $6+2$.*

Actually it is evident that our messy random table (Fig. 133) can be improved into the following one (Fig. 134) whose architecture is directly adapted to that of the main-pyramid (Fig. 130).

As a moral, Fig. 133 shows that potentially Brusotti's classical method is susceptible of recovering many schemes (in particular many of those of Korchagin that Viro himself conjectured not to exist). Hence potentially Brusotti's method could be nearly as puissant as Viro's method, yet alas apparently nobody ever succeeded to trace those splitting curves in the algebraic category. Even more importantly, we remark that the classical Harnack-Brusotti method (with a ground line) is susceptible of yielding one bosonic scheme (namely $14(1, 2\frac{4}{1})$).

9 More artwork via other distributions of singularities

9.1 Switching to affine sextics

Added [17.07.13].—There is a fairly interesting Master thesis by Daniel Eric Smith 20XX [1442] (one of Korchagin's student) who exhibits some algebraic models of $(1+7)$ -split octics. Alas the specimens so obtained looks rather ridiculous and a classification looks fairly out of reach for the moment. Of course for our purpose of constructing M -octics one does not need to go through a complete census of maximally interesting oval (in one case of which Smith's work affords no data) but which is conjectured to be empty by analogy with Shustin's result that the camel is left unrealized in degree one less (i.e., $1+6$ corresponding to so-called *affine sextics* when the line is interpreted as that lying at infinity). One finds there (Smith 2005 *loc. cit.*) also a lovely table of affine M -sextics known yet to exist. It would be extremely interesting to adapt this table to degree $1+7$ even after restricting focus to the comb case. Let us briefly explain the classification of affine sextics with a maximally intersecting oval cutting the line transversally across 6 points. First one can as on Fig. 135a distinguish the following configurations termed (by Arnold, Korchagin, ?) the *comb*, *snake*, *snail*, and *camel* respectively. This shows all possible isotopic placement of such an oval w.r.t. a line in $\mathbb{R}P^2$. Then Fig. 135b represents the more global algebraic problem of configuration actually known to exist. Albeit the problem of classifying

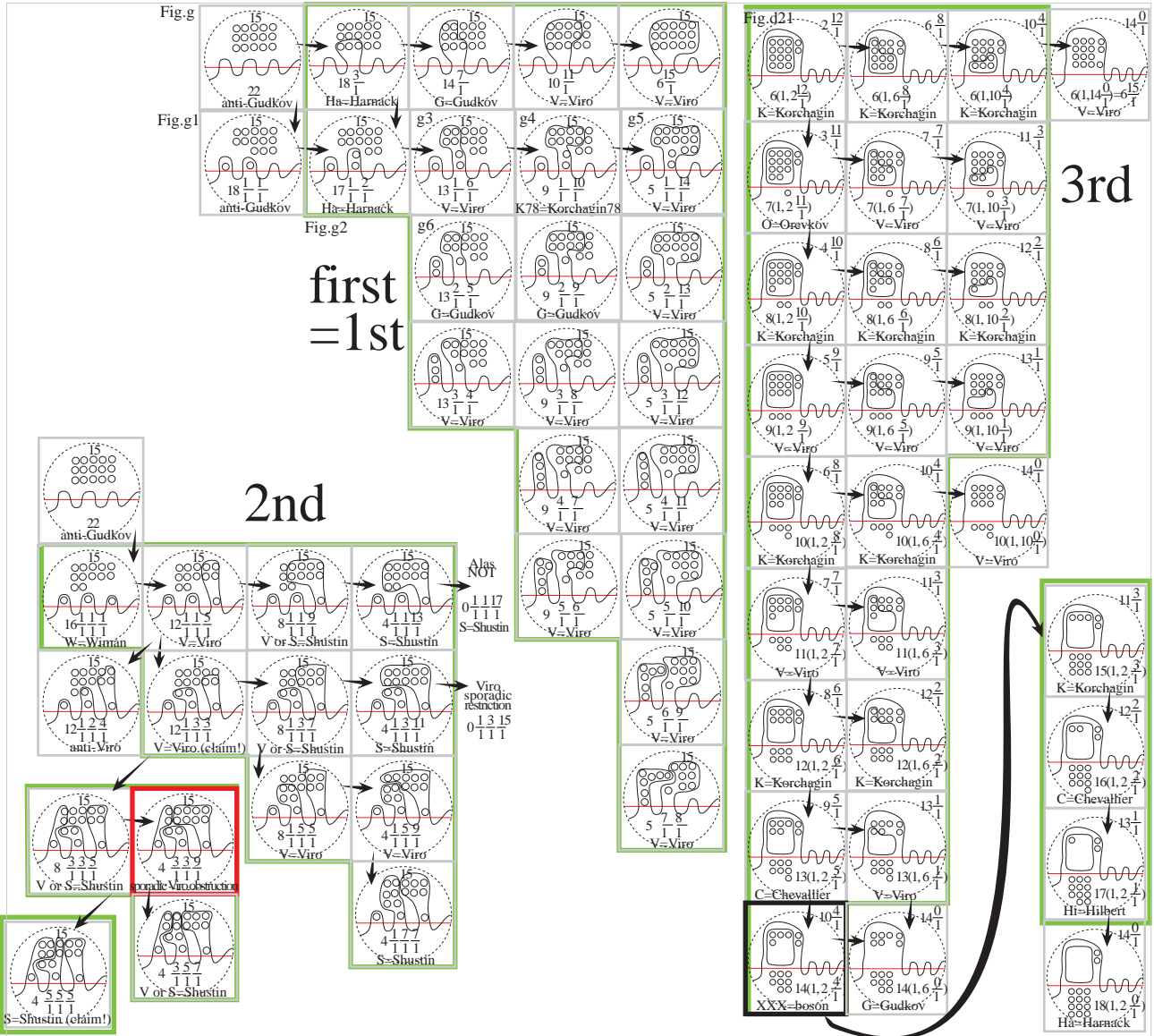

Figure 134: Smoothings of decomposable octics of bidegree $1 + 7$: one recovers many classical schemes, and also one new one yet also enters in conflict with one Viro sporadic obstruction (of course we suited to the Fiedler-Viro oddity law for trinested schemes already.)

such affine sextics was really started by Korchagin/Shustin (first independently and then jointly) earlier workers made implicit contribution starting with the 2 (split)-schemes of Harnack, Gudkov for 2 schemes, Viro for 9 schemes, Korchagin for 16 new species, Shustin 4 species, and Orevkov 1998 [1118], [1118] to two species (the second of which having been erroneously declared prohibited in Shustin 1988 [1416]). Fig. b* is an attempt to mix the 2nd species of Gudkov (G2) with V2 the 2nd species of Viro in order to build an interesting curve of degree 8 (alas it fails seriously to be maximal for evident reasons). Fig. c shows some configurations not constructed which are either prohibited or perhaps some few which are not yet known to exist. Especially noteworthy is the deep collaborative obstruction of Le Touzé-Orevkov 2002 [425] where the black framed species of Fig. d is prohibited. Despite of our poor understanding of this problem, it seems that experts are fairly close to a complete census of all affine sextics. On the table above $Ha + G + V + K + S + O = 2 + 2 + 9 + 16 + 4 + 2 = 35$ species are constructed. Actually, prior to Orevkov's constructions we had 33 species constructed in Korchagin-Shustin 1988 [861] and other (according to Orevkov 1998 I [1118] more detailed) constructions of these 33 (affine) curves

were given in Korchagin 1996 [863]. Further good explanations are to be found in Orevkov 1998I [1118] where it is explained that Korchagin-Shustin made some mistake at the prohibitive level, and that actually Orevkov managed to prohibit all species except the 33 constructed by Korchagin-Shustin (and their forerunners like Harnack, Gudkov, Viro) and five species corresponding to the symbols

$$A_3(0, 5, 5), A_4(1, 4, 5), B_2(1, 8, 1), B_2(1, 4, 5), C_2(1, 3, 6).$$

Orevkov's 1st note on affine M -sextic is devoted to proving existence of $B_2(1, 8, 1)$ (which clearly corresponds to Fig. 135b1). So it seems that B (or B_2) refers to the snake and the sequence $(1, 8, 1)$ to the number of inner ovals when travelled along the cell along the natural sense. Orevkov's 2nd note is devoted to the construction of $A_3(0, 5, 5)$ which corresponds to our Fig. b2. So it seems that the coding of Korchagin-Shustin means that A is the comb, B is the snake, while the first two entries are the number of inner ovals ordered by a natural convention of contiguity between subregion of the cell (as split by the line) while the last parameter describes the number of outer ovals (which in principle is predestined so that the total sum is 10). The index is somewhat mysterious, but there is surely an explanation. At any rate the next development is Le Touzé-Orevkov 2002, where the species of Fig. d is prohibited. This should correspond to the symbol, $B_?(1, 4, 5)$ with $? = 2$ the only choice possible from the above displayed list of five. So if we decode correctly the symbolism, $A_4(1, 4, 5)$ corresponds to Fig. d1 (hopefully) while $C_3(1, 3, 6)$ could be something like our Fig. d2 (as C is probably standing for the snail). In conclusion there is (in principle) 35 types constructed and only two remains in doubt. As far as we know the problem did not progressed anymore since Le Touzé-Orevkov 2002 [425] and so the situation is quite reminiscent of Hilbert's 16th in degree $m = 8$.

Further it seems (cf. e.g. an article by Polotovskii, maybe the end notes of Polotovskii 2000 [1214]) that decomposing curve do have direct application to Hilbert's original problem. So it is not impossible (browse also through Orevkov's texts) that a resolution of the problem of the $35 + 2$ affine sextics has some direct impact upon Hilbert in degree $m = 8$, abridged $H(8)$ (for say M -curves to simplify a bit).

If so, it would be interesting to know which realizabilty implies automatically which schemes. So let us assume that one of the 2 bosonic affine M -sextic exist. Does this implies existence of a new M -octics?

[18.07.13] Apparently to answer this question, one may look at Korchagin 1996 [863] article where affine M -sextic are used as patches to be glued in 6-fold ordinary singularity. For this to be properly understood it is most convenient to represent an affine sextic in the fundamental circle, yet instead as above rather in the fashion that the red lines at infinity corresponds to the fundamental circle with the usual antipodal identification. Once this is done we directly get the required patches and so Korchagin 1996 (*loc. cit.*) is able to construct new M -nonics starting from certain Viro's quintics while applying to them quadratic transformation to get a highly singular nonic to which the gluing method à la Viro is applied.

Yet our goal is not getting sidetracked to the more ambitious case of nonics before completing the chapter of M -octics. Hence in order for affine M -sextics to be useful in the construction of M -octics it seems that one should have a (global) singular octic with a 6-fold point. Additionally as we impose $m = 8$ there is room for a 2-fold point (alias double point). So basically 8 is split as $2 + 6$ (instead of $4 + 4$ like in the quadri-ellipse basic Viro method, or as $5 + 3$ in Viro's more sophisticated avatar involving the 5-fold singularity N_{16} combined with the triple point J_{10} , see also Shustin's variant involving two quadruple points). At any rate from our present perspective we could try to use an affine M -sextic as patch for dissipating the 6-fold point M_{25} and use additionally an ordinary double point A_1 . To get started we need only a global singular octic with this prescribed M_{25}, A_1 singular datum. As we do not feel comfortable with Huyghens/Newton/Cremona's transformation/hyperbolism we shall direct

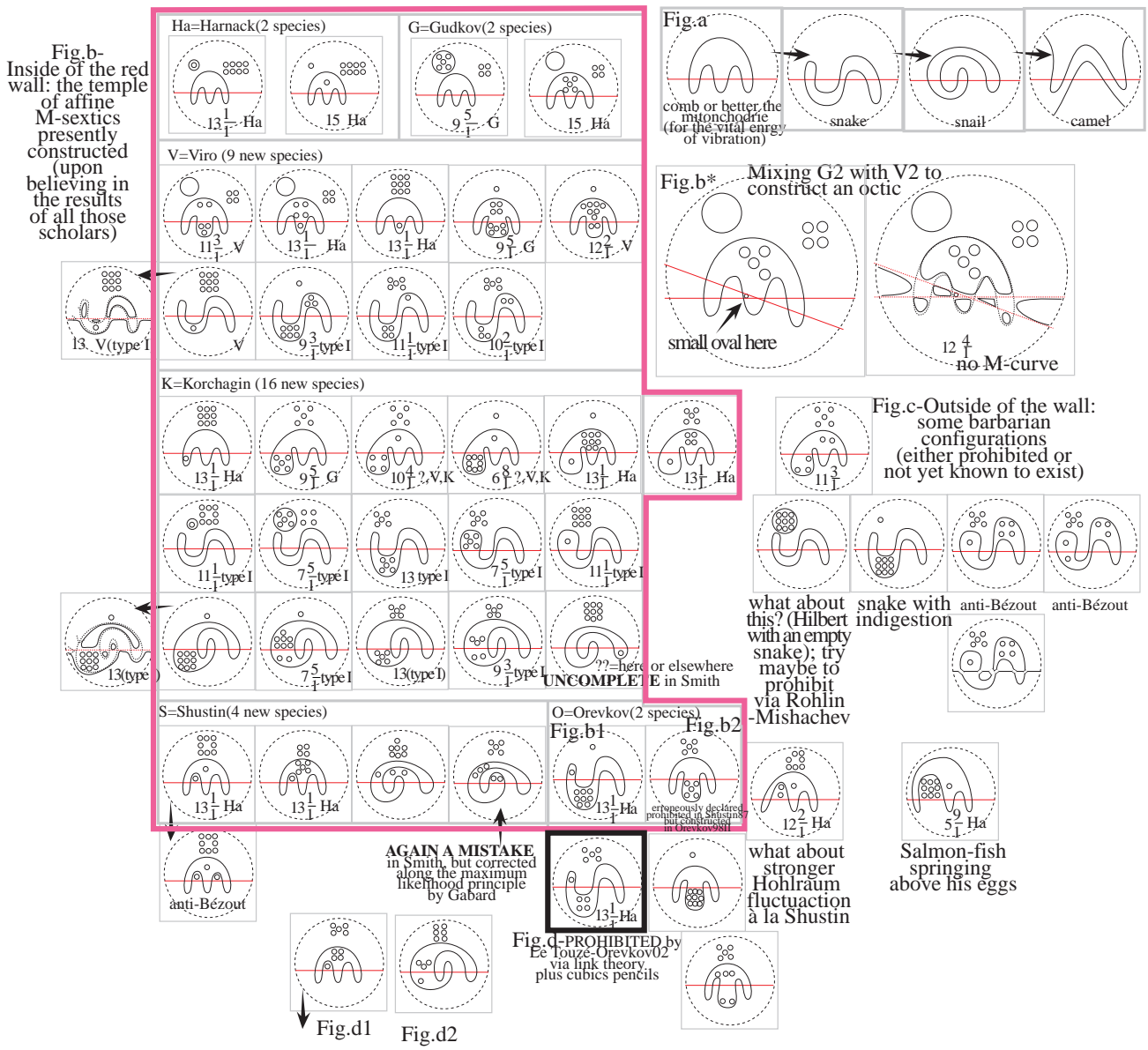

Figure 135: Picture of the fundamental sextic contortions and the (actual, not definitive?) census of all affine sextics (Harnack, Gudkov, Korchagin, Shustin, Orevkov). Shustin showed (indirect source via Smith) that the camel is not realized algebraically (by sextics).

appeal to artistic creativity (i.e. free hand drawing) in the hope that algebra is flexible enough to follow our freewill.

Recall a priori that we know with the last progresses by Orevkov 98/98II [1119] 35 types of dissipation of M_{25} so we can expect the method to be quite versatile, and supplying new progresses in $H(8)$, i.e. Hilbert's 16th in degree $m = 8$.

So let us start with the following curve (Fig. 136) obtained by a fairly random connection between a double and sextuple point which we postulate as existent as an octic. As we know an ordinary double point diminish the genus by one, a triple point counts—when perturbed—like 3 ordinary points, while a quadruple point generate $1 + 2 + 3 = 6$ ordinary points. Hence a sextuple points eats $1+2+3+4+5 = 15$ units to the genus so our curve has genus $g = (21 - 15 - 1) = 5$ hence at most 6 real circuits by Klein's version of Harnack. Alas it seems that our Fig. a was not optimally chosen because we already consumed 4 circuit for the singular locus. After some trial we eventually arrive at Fig. d with a single circuit. Alas this curve violates Bézout for line yet maybe this is just a topological model of an isotopy type admitting also a model satisfying Bézout.

If not one should try further maybe by rotating the petals as to be obturating the vision between both singular points (compare e.g. Fig.25 of Korchagin 1996 [863] and then our idea should be meaningful). This inspired us Fig.e which looks more Bézout compatible. Of course as the genus is $g = 5$ we have 6 circuits so one can add 5 additional ovals. Presently we do not know were yet we shall try random locations while trying to fit to the experimental data already available.

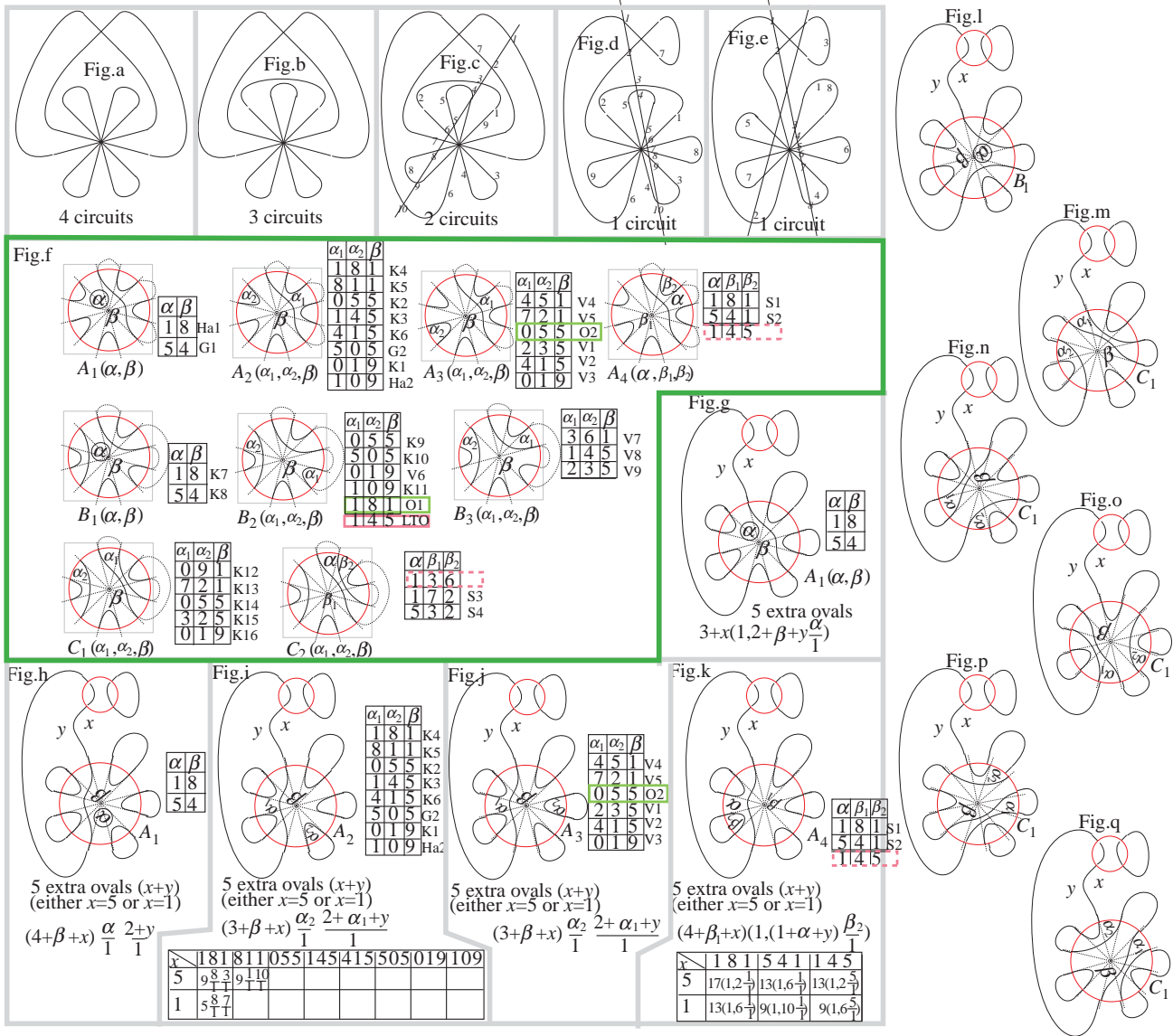

Figure 136: A freehand singular octic and Korchagin's list of affine M -sextics (in absolute "circular" representation)

9.2 Smoothing M_{25} ($=O_6$ =ordinary sextuple point): after Korchagin, Orevkov, Le Touzé

In order to dissipate the singularity M_{25} (sextuple point) of Fig.d we merely need to repeat the quasi-census of singularity M_{25} as presented say in Korchagin 1996 [863]. This is the same as the one depicted above except that the line is represented as the absolute circle at infinity. So we merely have to copy Korchagin's series of Figs.3 given on p. 143–144 of *loc. cit.* to get our Fig.f. Maybe we just take the initiative for gluing convenience to kill the square depiction of Korchagin which looks anyway anecdotic. Korchagin's table turns out to be apparently perfectly correct (no misprints and permit thereby to correct the 2 obvious errors that were evident in Smith's table). Of course we just added to

Korchagin's list both M -sextics of Orevkov (cf. the green framed one, namely $B_2(1, 8, 1)$ and $A_3(0, 5, 5)$). Finally we added also the species $B_2(1, 4, 5)$, albeit prohibited in Le Touzé-Orevkov 2002 [425] since it is fairly probable that there proof is too involved to be solid. At least it is always interesting to keep track of such a strange bird to see what result from it in degree $m = 8$. Finally we added also to Korchagin's list the 2 bosons $A_4(1, 4, 5)$ and $C_2(1, 3, 6)$ (as red dotted frames), again the motivation being to contemplate what is generated from them in the realm of octics.

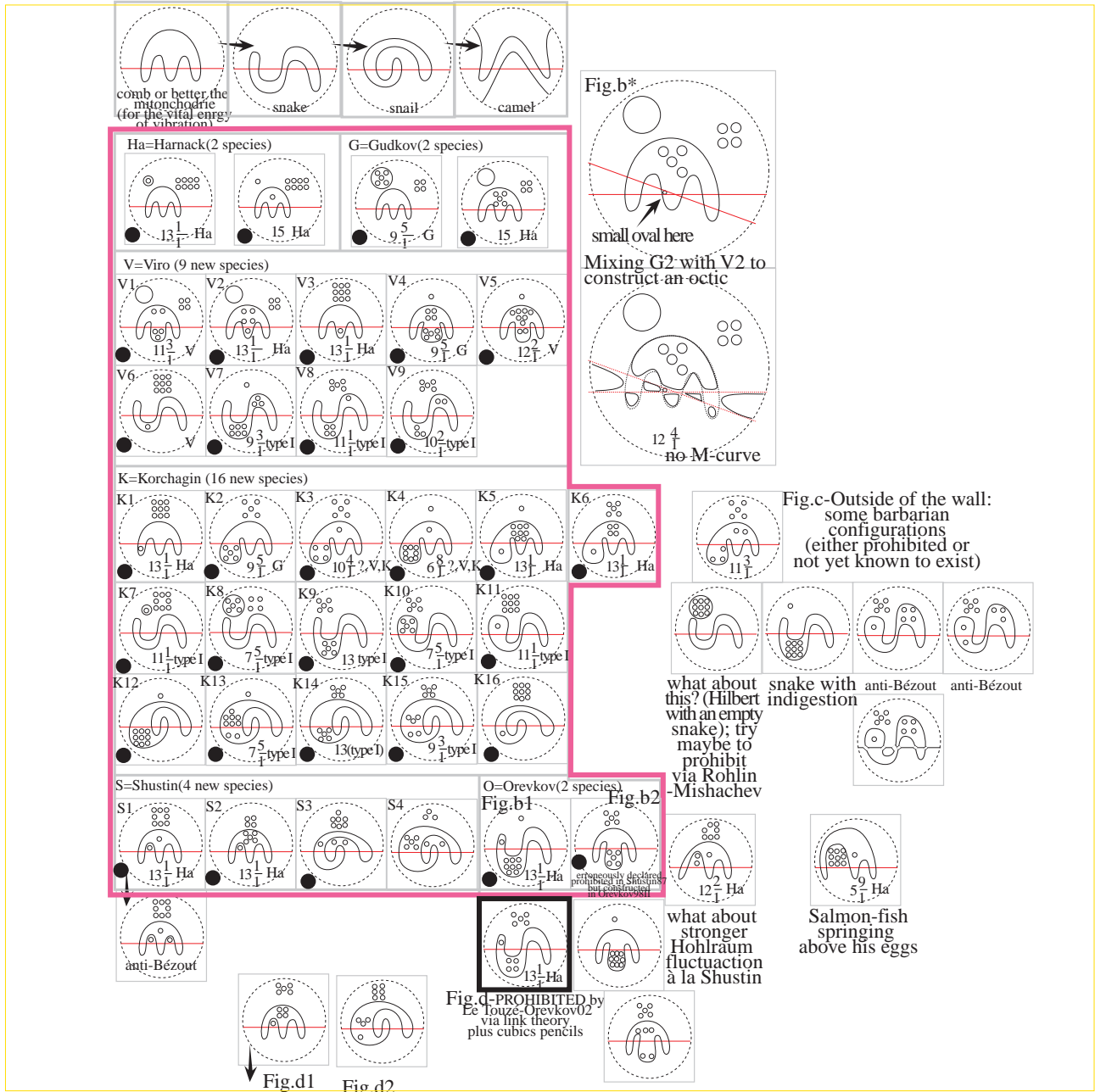

Figure 137: Korchagin's list of affine M -sextics in "linear" representation

This being said we are now pared to glue the 35 (known) dissipations in our floppy singular octic. By choosing the A_1 dissipation we get (Fig. g) with scheme $3 + x(1, 2 + \beta + y \frac{\alpha}{1})$. Here $x + y = 5$ represent the 5 extra ovals which according to Bézout can only be located as indicated. So the total number of oval is $7 + 9 + 5 = 21$ only. This is because we did not choose the optimal dissipation. It suffices however to rotate the patch to get a maximal formation of ovals (Fig. h). The corresponding scheme has Gudkov symbol $(4 + \beta + x) \frac{\alpha}{1} \frac{2+y}{1}$. For the first listed smoothing $(\alpha, \beta) = (1, 8)$, this specializes to $12 + x \frac{1}{1} \frac{2+y}{1}$.

Looking at the table of M -octic (Fig. 130) we see that Gudkov periodicity forces choosing either $x = 5$ or $x = 1$, but the resulting schemes are all well known (i.e. the first 2 colons of the table). However now the parameter x is nearly fixed and we may explore other smoothings. For A_2 we get Fig.i but alas the first coefficient $3 + \beta + x$ is at least 5 when $x = 1$ and β takes its lowest value 1. The smoothing A_3 leads to Fig.j, with the same Gudkov symbol, hence the same defect of having the 1st coefficient ≥ 5 , as opposed to having it equal to 1 as to land in the bosonic zone where little is known (apart 4 construction by Viro and 2 prohibitions by Orevkov, cf. Fig. 130). Finally the smoothing A_4 leads to Fig.k and even appealing to the exotic dissipation $(1, 4, 5)$ merely produces Chevallier's scheme $13(1, 2\frac{2}{1})$ when $x = 5$, and when $x = 1$ we merely get schemes well-known since Viro's most basic method involving the quadri-ellipses.

So the game is a bit disappointing but it remains of course to exploit the other dissipation not of comb-type (i.e. class B and C being respectively the snake and the snail). A priori our intuition is that those guys will not produce M -curves, and this seems corroborated by Fig. l,m,n,o,p,q.

So it seems that we need more artistic imagination when tracing the ground singular octic. So reminding our former Fig.e as Fig.138a, we had first the idea (in order to kill outer ovals) of looking at Fig. b. This seems alas to have 2 defects. First the curve in question has already 2 circuits and further the red line exposes the octic to 10 intersections. Next the morphogenetic brain thinks about Fig. c but this does not satisfy the desideratum of only one outer oval under a maximally closing dissipation. So it seems that the idea is that the large circuit has to enclose as many petal possible. Further still under the desideratum of minimizing the number of outer oval it is evident that it is more clever if the loop self-connecting the node is traced introverted as on Fig. d, but the latter has unfortunately 2 circuits. This suggested next Fig. e, alas also with 2 circuits. Then Fig. f is lovely for having only 1 circuit but its maximal closing will have at least 2 outer ovals coming from the external petals. So the more radical choice is to go to Fig. g but the price to pay is the presence of 2 circuits (impeding us to add the maximum number of five extra ovals). Finally after numerous trials we arrived at Fig. z. On applying the dissipation A_1 we get an octic violating Bézout as it has 2 subnests (Fig. z1). Of course we could choose another dissipation like A_2 , yet the paradigm of the independence of smoothing leads rather one to seek an universal object viable under all possible dissipations. At any rate also using A_2 leads to 2 subnests (Fig. z2), while rotating more the patch like on Fig. z3, we loose one oval.

[19.07.13] Then we transformed Fig. a to Fig. a1, and studying variants arrived at Fig. a5 and considered its smoothings. A first little surprise is that if such a curve exist (parameters x, y of additional ovals went adjusted as to respect Gudkov periodicity) then using the A_3 -smoothing $(7, 2, 1)$ due to Viro one gets already the Korchagin's scheme $12(1, 6\frac{2}{1})$. In contrast using the (semi?) high-brow (sextic) patch $A_3(0, 5, 5)$ of Orevkov one only recover the basic (quadri-ellipse type) Viro curve $5(1, 10\frac{5}{1})$. Using the smoothing A_4 should have conducted to the most spectacular result especially when using the hypothetical dissipation $A_4(1, 4, 5)$, but alas the latter only produce a basic (quadri-elliptic) Viro scheme, namely $5\frac{5}{1}10\frac{10}{1}$. Of course the other smoothings (snake and snail like) will not produce M -curves (because the corresponding patches do not have 3 consecutive bumps).

So we need a new curve and we designed Fig. b5 after the evolution law given by the arrow starting for Fig. a5. Now the maximal smoothing does not come from the comb (type A) but from the snake family B . Alas the curve so obtained under the B_1 -smoothing (symmetrized) violates Bézout.

Another idea is to replace the (ordinary) double point by a solitary double points. And so we consider Fig. f1 where the black dot is the solitary node (the trick being that we placed it inside of a petal in order to kill an outer oval) so as to land in the critical bosonic strip where very little is known. As before the genus of this singular octic is $21 - (1 + 2 + 3 + 4 + 5) - 1 = 5$ so

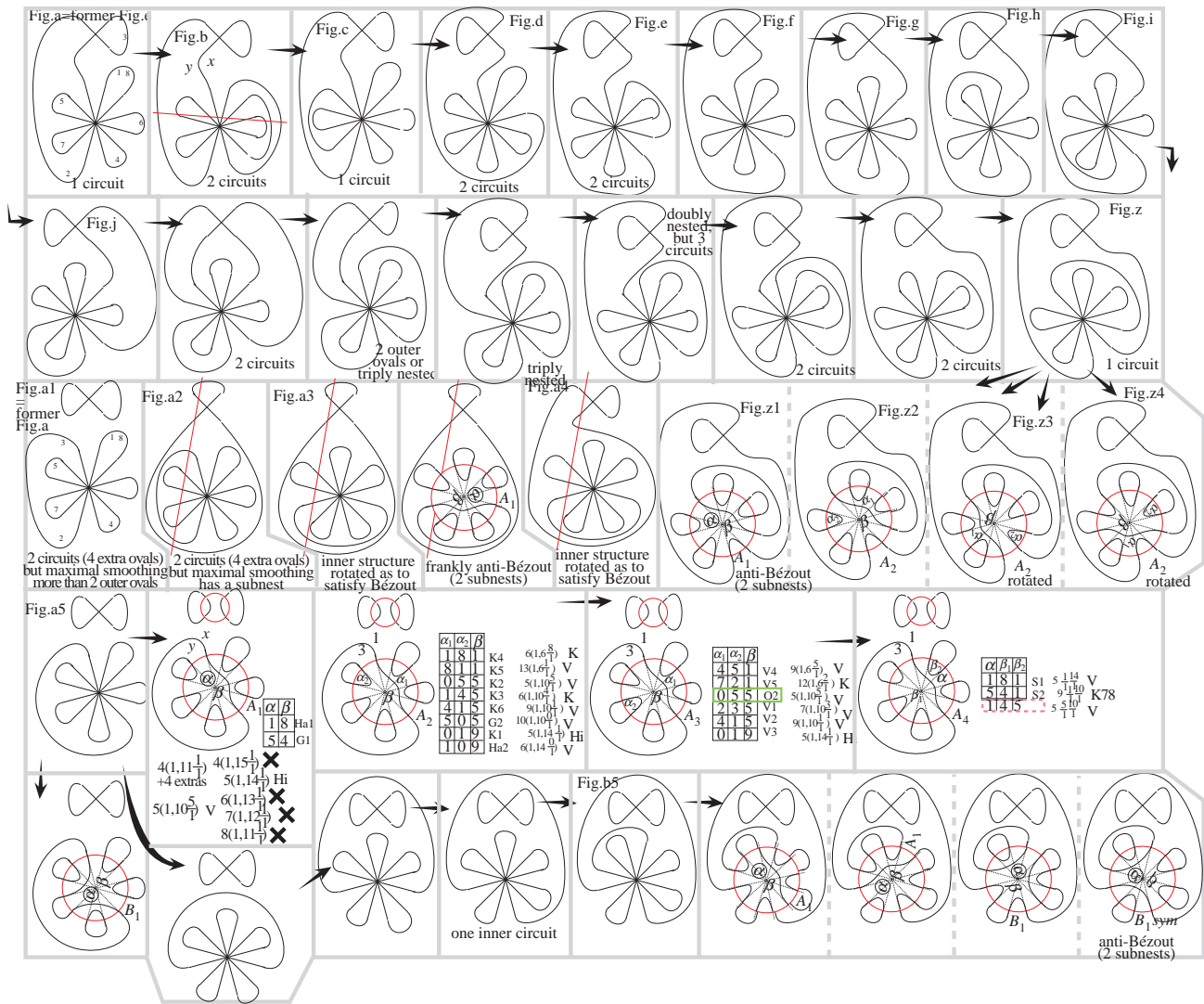

Figure 138: A new freehand browsing through singular octics with smoothings

that 6 real circuit are permissible (and 5 of them are not yet traced). Further in view of the global pattern of the curve it is clear that the A -type (comb) smoothing produces the maximal M -smoothings. Of course according to the independency of smoothing we choose the solitary node to deform to a little oval, yet Fig. f1A1 shows a scheme with a subnest and an outer nest so that Bézout is contradicted. Hence the configuration Fig. f1 cannot exist. (Incidentally one can wonder how difficult it would be to draw this conclusion if Viro's theory was not available!) So this is a deception, yet let us surf however the principle of independency (albeit it might have been proven in this context by Shustin, cf. e.g. Shustin 1987 [1413] (versal deformation paper)) to look at the more interesting smoothing A_2 . This gives Fig. f1A2, where again Bézout is generically foiled except when $\alpha_2 = 0$, but then alas α_1 is not zero so that we get ≥ 2 outer ovals (and not just one as desired). After a long sequence of trials we arrived at Fig. q1, whose smoothings along A_2 and A_3 includes schemes violating Viro's imparity law. Further, as evident from the scratch, the smoothing A_4 violates Bézout.

Another idea is to construct the global curve around some fixed smoothing. So we get from B_1 (reproduced as Fig. t1) the Fig. u1 where the solitary node is placed so that the line joining it to the heavy singularity never meet the curve anymore. Smoothing along B_1 gives Fig. u1B1 which leads primarily to the symbol $\frac{1}{1} \frac{1}{1} \frac{1}{1}$, which among M -schemes can only be completed as Wiman's scheme $16 \frac{1}{1} \frac{1}{1} \frac{1}{1}$ so that we can adjust the number of outer ovals as being 5. So Fig. u1 must be mentally refreshed with 5 outer ovals, and then we can

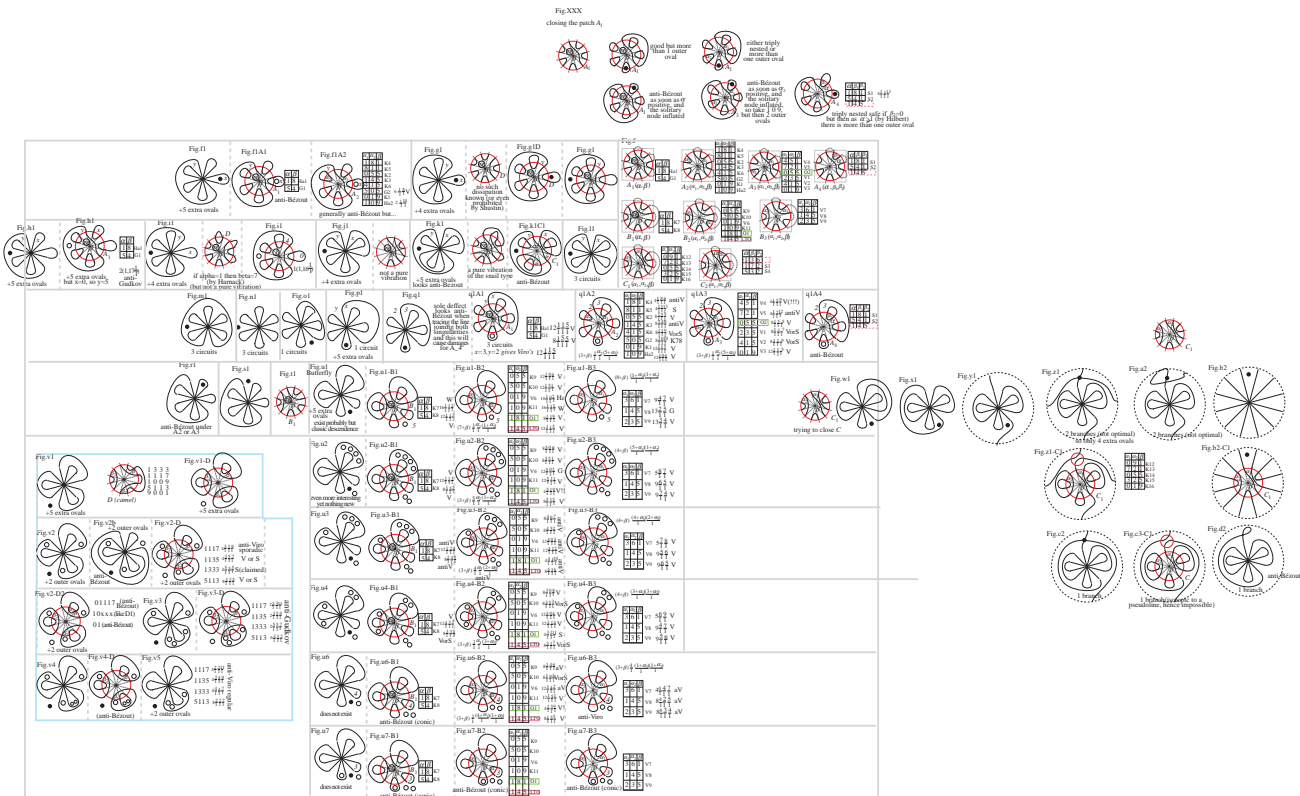

Figure 139: Browsing more through singular octic with a solitary node

explore the full kaleidoscope of all possible smoothings of this (hypothetical) singular octic. On Fig. u1-B2 one sees that Orevkov's fairly recent smoothing only produce a (fairly) well-known Viro's scheme (which I could only understand by Shustin), whilst the smoothing in principle forbidden by Le Touzé-Orevkov produces only the ultra-classical Viro scheme $12\frac{1}{1}\frac{1}{1}\frac{5}{1}$. (So maybe the Le Touzé-Orevkov affine-sextic obstruction is wrong!?) Finally Fig. u1-B3 produces only super classical schemes (of G =Gudkov and V =Viro).

Added [21.07.13] We first missed to consider as well singular octic deduced by quantum transfer of 4 ovals. This produces e.g. Fig. u2 where the number of outer ovals is just diminished by 4. Then there is also Fig. u3 which alas runs into trouble with Viro's imparity law. So if the latter is true an octic like Fig. 3 is excluded. Alternatively it is strange that Fig. u3-B3 leads only to viable schemes (first constructed by Viro) and this phenomenology could imply (if our singular C_8 really existed) that there is no independency in the smoothings (so violating a principle/theorem of Viro/Shustin). Then we can move to Fig. u4, where interestingly Orevkov's smoothing $B_2(1, 8, 1)$ yields Shustin's (fairly original) scheme $4\frac{3}{1}\frac{11}{1}$. Further Le Touzé-Orevkov presupposed anti-smoothing $B_2(1, 4, 5)$ realizes a even more standard scheme of Viro (or Shustin). So no obstruction à la Le Touzé-Orevkov is detected by patchworking on this curve (Fig. u4). Since the patch is symmetric about a line angled 120 degrees there is no need to examine the next configuration u5, where 1 oval lye in the first petal and 3 in the 2nd petal. Finally we could transfer ovals in the simple petals (e.g., like on Fig. u6) but then the smoothing B_1 violates Bézout for conics (equivalently the maximality of the doubled quadrifolium). However it is still interesting to look at the other smoothing which are less blatantly foiled (contradicting only with Viro's imparity law). This little corruption of Viro can be tamed by transferring one oval in the other petal like on Fig. u7, but then each dissipation foils Bézout for conics (due to the presence of 4 nests). It seems evident at this stage that we have exhausted the possibilities allied to the butterfly type.

So we see that one more efficient method consist to start from the dissipation and find a global closing of it. Hence of starting of the curve we suit the curve to the smoothing. So starting from the A-smoothing we get Fig. XXX but alas

we fail so to reach the doubly-nested case with one outer oval.

Of course for reason of symmetry Fig. v1 suggests by itself, yet alas it is not calibrated on a smoothing. Hence starting from the C smoothing (in any of its incarnation C_1 or C_2 which have the same ground skeleton) we may construct the most natural closing as Fig. w1 but it is evident that the latter curve corrupt Bézout (as is especially visible after the smoothing as we have two nests of respective depths 3 and 2 so forcing 10 intersections with a suitable line chosen to pass through the deepest ovals). Is there a more clever way to globalize this infinitesimal smoothing? Of course there is the variant shown as Fig. x1, yet this is subjected to the same objection. Of course it could as well globalize as Fig. y1, yet this looks an illegal art-form as it involves a pseudoline (alias branch of odd degree) not so realizable by an octic curve. The issue seems to be to look at Fig. z1 by introducing again a non-isolated ordinary node so that another odd branch restore the parity of the degree (homology class). Alas we found nothing extremely convincing along closing the snail by a global octic.

[20.07.13] Then coming back to Fig. v1 whose maximal dissipation is depicted right below and clearly identified to the camel type (which in principle is obstructed by Shustin as we learned in Smith 200X [1442], see also Korchagin 1996 [863]). Improvising a short list of dissipation especially the type $D_1(1, 3, 3, 3)$ which corresponds to a sextic of Harnack type $9\frac{1}{1}$ would produce the M -octic $7\frac{4}{1}\frac{4}{1}\frac{4}{1}$ which obviously violates Viro's imparity law, and even more radically Gudkov periodicity (even in the simplest Arnold version mod 4). So what to conclude? Either the smoothing $D(1, 3, 3, 3)$ does not exist (as asserted e.g. in Korchagin 1996) or maybe even the global curve of Fig. v1 does not exist. What about trying another smoothing like $D(1, 0, 0, 9)$. Patching this into Fig. v1 gives the scheme $7\frac{1}{1}\frac{1}{1}\frac{10}{1}$. Again Gudkov periodicity is foiled as the first outer coefficient of the symbol as to be a multiple of four (compare Fig. 130).

However tacit in our depiction of Fig. v1 was the assumption that the 5 extra ovals are outer and we merely need to delocalize 3 inside the singular circuit to get the first (outer) coefficient reduced from 7 to 4. This suggests Fig. v2 which smooth under $D(1, 3, 3, 3)$ to $4\frac{5}{1}\frac{5}{1}\frac{5}{1}$ a well-known scheme due to Shustin. So let us pose as an Ansatz that the curve depicted as v2 exists and that the dissipation $D(1, 3, 3, 3)$ exists too (albeit this seems to violate a result of Shustin). We would like to speculate about further smoothing of the camel type yet it suffice less imaginatively to explore the other more classical smoothing (but those are most best suited so fail to produce M -schemes). So we are condemned to adventure in the (in principle) deserted type of the camel (which according to Smith's interpretation of a Shustin work does not exist at all). So the question is: is the Sahara so deserted as to support no camel?

Let us again improvise a list of dissipation right below Fig. v1 involving the parameters $(1, 3, 3, 3)$, $(1, 1, 1, 7)$, $(1, 1, 3, 5)$, etc. The sole condition is that the β_i have to be odd as to respect Viro's imparity law and we restrict first attention to the case of a Harnack curve with one inner oval so $\alpha = 1$. The complete enumeration of such smoothing is therefore in lexicographical order $(1, 1, 1, 7)$, $(1, 1, 3, 5)$, $(1, 3, 3, 3)$, and nothing more. If we move to Gudkov's type of an affine sextic we get additionally $(5, 1, 1, 3)$, and the Hilbert's sextic leads to $(9, ?, ?, ?)$ nothing compatible with Viro as the question marks are odd hence ≥ 1 . Supposing that all these 4 smoothings exists their injection as gluing into the hypothetical curve v2 (which looks fairly reasonable and especially esthetic) produces the schemes listed on Fig. v2-D which are all either due to Viro or Shustin, safe the scheme $4\frac{3}{1}\frac{3}{1}\frac{9}{1}$ which is declared prohibited by Viro's sporadic obstruction.

Of course it remains then also to explore other smoothing of the camel type with the same ground picture yet with different locations for the micro-ovals. So have a second type of smoothing D_2 tabulated on Fig. v2-D2, but it seems that all of them will just violate Bézout (at least granting existence of our ground curve Fig. v2). So it seems that there is only one class of dissipation of the camel type (namely D_1 abridged as D). Then one can speculate about a curve like Fig. v3 yet its smoothing are anti-Gudkov (see Fig. v3-D). However another

trading keeping χ constant, is to drag the two outer ovals in the one same nest so as to get Fig. v4, but the Bézout explodes as seen on Fig. v4-D (if not already apparent on Fig. v4 already). Of course we can also imagine Fig. v5, but the resulting scheme are anti-Viro (imparity law).

Looking back to Fig. v1-D one's desideratum could be to get Wiman's curve $16\frac{1}{1}\frac{1}{1}\frac{1}{1}$ which is more in the bottom levels of the 2nd pyramid. Of course this would be possible if we could set all three $\beta_i = 0$ and $\alpha = 10$. Looking however at the camel patch it is clear that the tripodal amoebic region occupied by α extend through infinity by small semi-disk, so that this expansion is a cell and therefore the interior of the traced oval consisting of the 6 branches all connected together through infinity. Therefore the choice $\alpha = 10$ corresponds to the sextic $\frac{10}{1}$ prohibited by Rohn (or just via Arnold-Rohlin). Instead a smoothing with parameters $(\alpha, \beta_1, \beta_2, \beta_3) = (9, 0, 0, 1)$ is permissible (a Hilbert's sextic), yet when glued in Fig. v1-D would violate Viro's parity law, yielding the scheme $15\frac{1}{1}\frac{1}{1}\frac{2}{1}$ which actually violates Gudkov periodicity (even in the simple version of Arnold modulo 4). Of course we could repair it by moving outer ovals inside, but as the patch is rotationally mobile, this forces one transfer into each three ovals and so we get again Fig. v2 which under smoothing $D(9, 0, 0, 1)$ gives $12\frac{2}{1}\frac{2}{1}\frac{3}{1}$, which respects Gudkov but violates Viro (imparity law).

Albeit fairly complicate to get through all this, we see that there is an intricate interaction between affine sextics (and the allied infinitesimal dissipation), global singular octics with 2 singularities of type A_1 (double point), M_{25} (sextuple point) and global smooth M -octics. Of course for this interaction to take place it is vital to have a result of independency of smoothing singularities (that is in principle by an extension of the usual Riemann-Roch-Severi-Brusotti argument) to higher singularities (work of Gudkov-Viro-Shustin). As a concrete example let us state the following:

Lemma 9.1 *Assume that the singular octic of Fig. v2 to exist and that the dissipation $D(1, 1, 1, 7)$ exist as well. Then there is an M -octic with scheme $4\frac{3}{1}\frac{3}{1}\frac{9}{1}$. However the latter is forbidden by a Viro sporadic obstruction (alas not extremely well published). Hence either the latter Viro's result is false, or at least one of our two hypotheses is erroneous.*

Of course one can try to attack directly the Fig. v2 by arguing that the line through both singularities has exceeding intersection, since this line has already $2 + 6 = 8$ multiplicity of intersection and there seems no possible location for the node from where the fundamental line (through both singularities) could avoid the rest of the curve.

All this is fairly pleasant yet it seems to sidetrack us in the realm of trinedsted M -curves (which in principle in totally settled by the sporadic obstructions of Viro and constructions of Shustin). In contrast the real golden El Dorado involves doubly nested and sub-nested schemes where there is respectively 4 and 2 bosons still awaiting for some realization (resp. prohibitions). As yet it seems fairly difficult to get to doubly nested schemes with only 1 outer ovals with our method involving a double and sextuple point. Likewise we could not find much boson in the subnested family.

Another idea is to use $8 = 3+3+2$ and so to construct an octic by dissipating 2 triple point and one double point. Of course one can also exploit $4 + 2 + 2$ and look what happens there.

9.3 $8=1+7$

Finally via $8 = 7 + 1$ has to be interpreted as smoothing a septuple point plus a simple (smooth) point. Alas this seems to require a good understanding of affine M -septics (a complete understanding looks a bit out of reach for the present days, as we do not have even settled the degree 6 case). Yet we can still try to explore the possibility in a floppy (and sloppy) way so as to look if there is there some maneuvering room to realize the bosonic schemes.

Let us be more concrete. Start with a septuple point (Fig. 140a). Imagine a certain M -smoothing (like Fig. 1) and imagine a global singular octic with a unique septuple point (Fig. c). It may be noted that the curve is therefore rational (pencil of lines through the singularity). Alternatively one can use the genus, and note that a septuple point diminish the genus by $1+2+3+4+5+6=21$ (imagine a perturbation of Fig. a into a generic arrangement of lines and count the resulting ordinary nodes). So Fig. c is complete, i.e. there is no additional circuits. Gluing the smoothing Fig. 1 into Fig. c produces Fig. c1 which is M -curve, yet one violating Gudkov periodicity even mod 4 version à la Arnold. However if we consider the smoothing of Fig. 2, we get Fig. c2, i.e. the bosonic scheme $1\frac{1}{1}\frac{18}{1}$ not yet known to exist. Of course this proves little but shows at least that the $1+7$ method looks better suited (than its $2+6$ companion) to reach the bosonic strip of doubly-nested schemes with one outer oval. Of course one defect of our argument is that our nenuphar like curve (Fig. c) does not look a bona fide octics for most lines through the singularity cut it in nine points. This can be arranged by looking at Fig. d. Before doing this let us note that the affine septics depicted (as Fig. 2') when smoothed yields the scheme $18(1, 1\frac{1}{1})$ which violates Gudkov periodicity.

One is next faced to the ingrate duty of listing all dissipations of a septuple point (at least those of the class A having a prescribed oscillating pseudoline). This task is difficult and long yet still manageable at least in qualitative substance. Bypassing the exact details for the moment it seems that it can already be inferred (from abstract thinking) that the resulting scheme (after gluing) will always possess at least 4 outer ovals for we can only fill 3 ovals (with ovals) without contradicting Bézout for conics. So we will certainly not reach the bosonic strip by such a construction. However there is perhaps some chance getting new existence results (constructions) for the 2 subnested bosons. As one of these bosons is $14(1, 2\frac{1}{1})$ it suffices to consider the dissipation of Fig. 3 and to glue in Fig. d to get Fig. d3 which is the required bosonic scheme. Of course we notice that we could have directly smoothed out the affine septic model to get via Brusotti the same scheme. Extracting the exact philosophy behind this phenomenology, it seems that the dissipation of the margarita flower (Fig. d) are in bijection with decomposing curves of degree $1+7$ with a simple slaloming pseudoline, compare our former Fig. 134.) Now the game could be to reach the other subnested boson $4(1, 2\frac{1}{1})$ and this suggests killing some petals of the flower like on Fig. e. Alas then there is 3 circuits (too much for a rational (unicursal) curve). Further a line through an inner petal has 3 intersection outside the septuple point leading hence to a total of 10 intersections (anti-Bézout for line alias Euclid? since it the Euclidean algorithm for polynomials that bound the number of roots via the degree).

[22.07.13] Next we can at look at Fig. f which has the same defect. Notwithstanding we still consider a suitable smoothing (Fig. f5) which is Wiman's scheme $16\frac{1}{1}\frac{1}{1}\frac{1}{1}$. The corresponding affine septics is Fig. f6, whose direct smoothing (Fig. f7) is only an $(M-1)$ -curve (actually one lying right below Harnack's scheme $17\frac{1}{1}\frac{2}{1}$). Then Fig. h looks ideally suited to bring us in the bosonic strip of doubly-nested schemes. As shown by Figs. h6–h10 it is clear that we could sweep out all the bosonic strip (safe for omitting its first item $1\frac{1}{1}\frac{18}{1}$). This would be a spectacular advance nearly closing the completion of Hilbert's 16th for $m=8$. Alas the sole problem seems to be that there is no algebraic model for Fig. h as the latter corrupts Bézout upon tracing the singular line through an inner petal. Via Fig. i we can also get the boson $1\frac{1}{1}\frac{18}{1}$ as shown by Fig. i11, but of course our singular octic is still defective w.r.t. Bézout.

All this Fig. 140 is fairly *avant-gardiste* as it produces all the 6 bosons and even the 2 schemes prohibited by Orevkov, yet it must be confessed that our method is highly irregular primarily because the ground singular octics of Figs. c,e,h corrupt Bézout for lines. However Fig. d is Bézout-regular and still contains a gluing which is bosonic. Of course it seems however that the margarita curve (Fig. d) really amounts to think directly about the corresponding affine septic. Hence no real bonus is gained through the power-flower method.

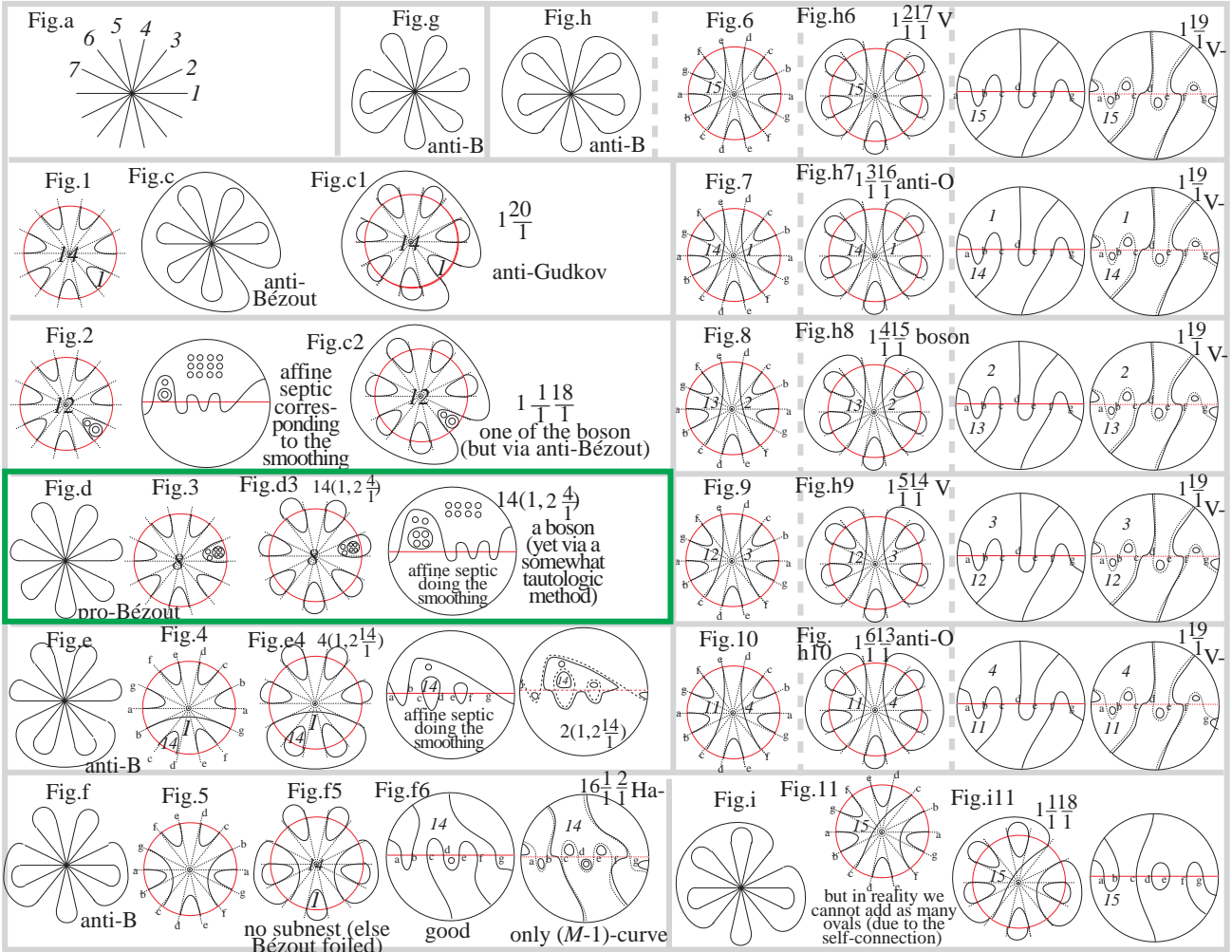

Figure 140: Singular octics with a septuple point with irregular constructions of all the bosons (and more like schemes prohibited by academician Orevkov)

To paraphrase a bit, it seems clear that we have the following principle:

Scholium 9.2 *The class of M -octics occurring through small perturbation of the margarite curve (Fig. d) via Viro's gluing method coincides exactly with those of decomposing curves of degree $1 + 7$ via the Harnack-Brusotti method of dissipation of ordinary nodes. Those schemes (albeit not being exactly known) have a range contained in the blue zone of Fig. 130. In particular this region contains the boson $14(1, 2 \frac{4}{1})$, but not much more.*

9.4 $8=2+2+2+2$, $8=3+5$

Now we could as well inspect a pair of quadruple ordinary nodes, and then likewise consider a quintuple plus a triple point. Let us first look at Fig. d as a combination of the quintuple and triple point. On gluing with maximally closing dissipation like Fig. d1 we get Fig. d2. The idea is then of course to kill one outer ovals by injecting micro-ovals inside of it. Alas doing this as on Fig. d3 leads to an affine quintic violating Bézout. So it seems that our sole chance is that the killing of the outer oval is produced by a global oval of Fig. d. Let us calculate the genus of the curve C_8 of Fig. d. A quintuple point is tantamount to $1 + 2 + 3 + 4 = 10$ ordinary nodes while the triple point contributes to 3 such nodes. Accordingly, the genus of C_8 is $21 - 10 - 3 = 8$ so that (by Harnack's bound $r \leq g + 1$) there is 8 extra ovals possible on Fig. d. Then we consider the smoothing maximally closing the ovals of Fig. d5, yet since the main circuit of the patch has already 3 components we can (for a

quintic) only add 4 ovals, and we ascertain with deception that the resulting gluing (Fig.d6) is not maximal. Then we had the idea to look at Fig.e (but the line through the singularities has excess intersection). This may be settled by Fig.e, but then there are too many free petals inducing many outer ovals impeding a safe landing in the bosonic strip where there is only one outer oval. Fig.f looks better yet 2 circuits. Fig.h is deduced by creating more petals and looks perfect for having both one circuit and for respecting Bézout. Alas the fairly standard dissipation of Fig.h2 (involving basically an affine quintic of Harnack type, cf. Fig.h3 for the resulting M -sextic of Harnack type) leads after patchworking to an octic violating seriously Gudkov periodicity (even in the weaker Arnold version mod 4). Our next idea was to create the second nest from the 8 extra ovals available suggesting thereby Fig.i which smooth indeed to Fig.i3 realizing the boson $1\frac{1}{1}\frac{18}{1}$. At this stage we could be very happy, if had not realized that the line through the outer nest just created plus the quintuple point had at least 9 intersection with our hypothetical octic. Hence the next idea was to look at Fig.j where the outer nest is created from the petals (and not from the 8 extra oval). The little defect of this curve is that it has 2 circuits already and therefore the fundamental part of the patch (i.e. without the micro quantum ovals) already consume two circuits, so that only 5 are left and we distributed as on Fig.j1 the resulting gluing is only an $(M - 1)$ -octic with only 17 inner ovals instead of the 18 desired ones. To palliate this defect we change a bit the connections to get Fig.k where we have just one circuit and smoothing appropriately (Fig.k1) yields the bosonic scheme $1\frac{1}{1}\frac{18}{1}$ via Fig.k2. Finally, Fig.k3 shows as series of quantum fluctuation of the 8 indeterminate ovals creating all schemes of the bosonic strip (of course making so a big razzia (a clean sweep) on Hilbert's 16th, of course sometimes entering in conflict with Orevkov). But of course there is no direct confrontation of our method with Orevkov's conclusion since the big job is to construct the singular octic in the algebraic category, yet we know at least a possible place for where to look for new constructions. Summarizing:

Scholium 9.3 *All of the bosonic M -octic are potentially realized by curves with a quintuple plus a triple point with branches interconnected as depicted on Fig. 141k. So potentially there is no more obstruction on Hilbert's 16th than those (15 many) presently known.*

*Added [05.10.13].—*One can try exasperating Bézout by passing a conic through the octic singularities along the most osculating way. For instance we may impose two 'horizontal' tangents at the singularities, plus visiting one simple oval. Then the multiplicity intersection is $6+4+2=12$, still in Bézout's range ($2.8=16$). Maybe fixing the upper tangent slightly inclined (angle ca. -10 degrees), then it penetrates inside the double loop, and to escape it forces 2 intersections. Moreover one more intersection seems granted by crossing the path joining both singularities. All this gives $5+2+1+2+4=14$ still below Bézout. So it seems that our freehand curve resists the Bézout test.

Of course it remains to find algebraic constructions. It remains also to investigate the composition of two quadruple points. Philosophically we see that our game (Viro method basically, sometimes in variants à la Shustin, Korcha-gin, etc.) is basically a matter of exploring the complement of the discriminant (smooth curve) by entering through such chambers via the walls of the discriminant separating the big castle of all curves into varied chambers. Of course there is no theological reason a priori that using even higher strata conditioned by the presence of several singularities (recall that the smooth locus of the discriminant is swept out by uninodal curves) we should be able to access all the chambers. So perhaps Viro's method can fail to detect all schemes, but what is certain is that if it works then it works. This sounds a tautologically but we hope that you know what we mean.

Let us now work out singularity $4 + 4$. Then one could also imagine 3 singularity or more. So there is a very exciting global game of constructing curves with prescribed singularities. The more the singularity is low the less it eats to

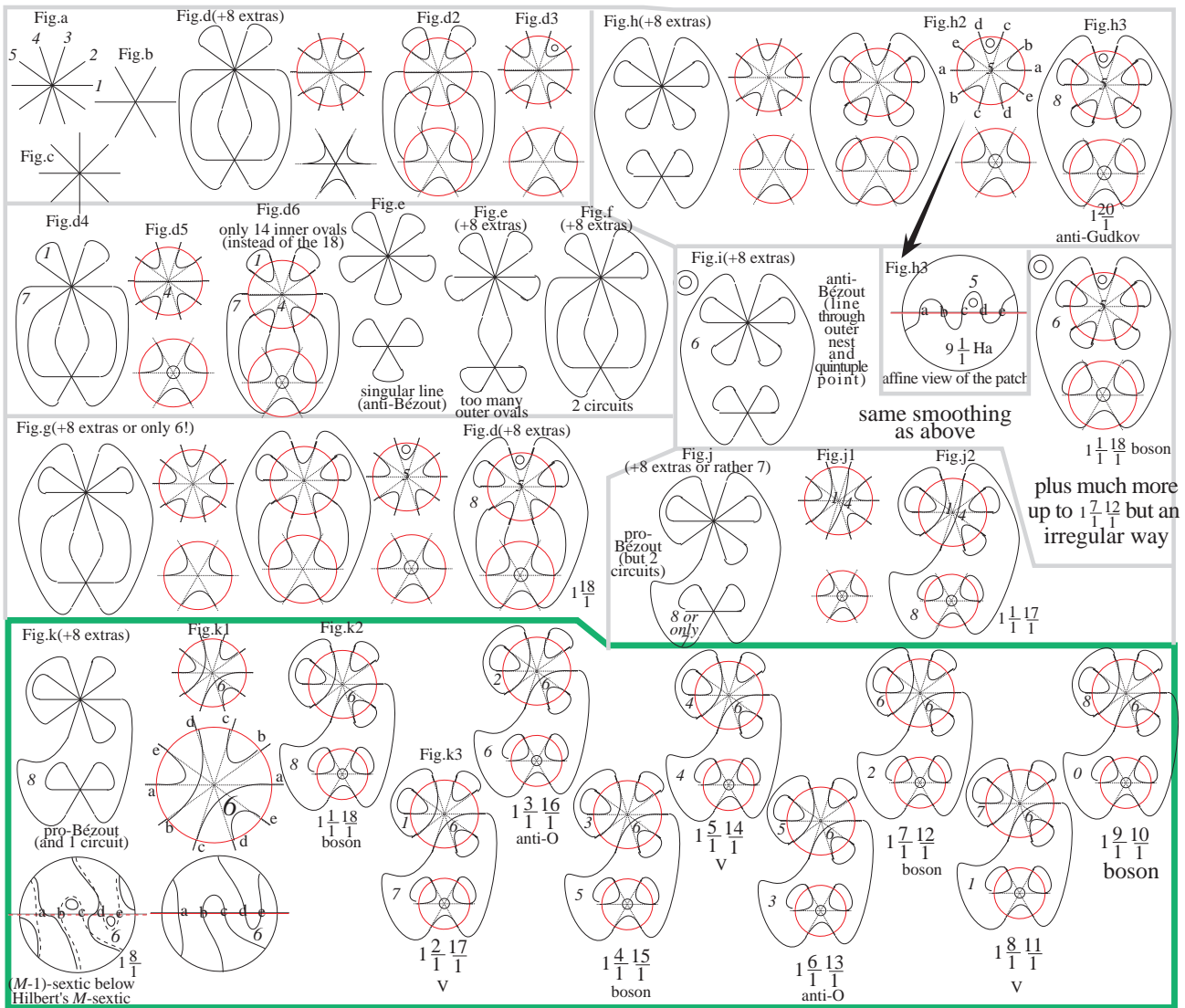

Figure 141: Singular octics with a quintuple and triple point while creating all bosons in a Bézout regular fashion (and of course potentially more like schemes prohibited by academician Stepan Orevkov)

the genus and so we can add several of them. Further it seems that low singularities have an easy dissipation theory, yet appeal to global curves of a more complicated nature (high genus). So it seems that one must proceed to a clever dissection of the problem by dividing in nearly equal part the difficulties allied to the local and global aspects of the questions, i.e. to have a relatively easy dissipation theory while having a fairly easy global singular curve to construct.

[23.07.13] Let us now come back to singular weight $4 + 4$. After a quick browse through qualitative pictures, we had the idea to consider configuration of ellipses like on Fig. 142. Alas we had some pain to reach M -curves. Fig. g2 is interesting as it seems to contradict the principle of independence of smoothing since the constructed curve appears to violate the maximality of the doubled quadrifolium, yet in reality the bug is of course that the dissipation used is tantamount to a Gürtelkurve (quartic with 2 nested ovals) and the latter do not support any extra infinitesimal ovals being already a saturated configuration. So Fig. g2 is only correct when one erases all “3” parameters and then one recovers the usual doubled quadrifolium. As to Fig. g1 we noticed after a better inspection that used is an illegal one for it would involve a quartic with 3 nested ovals (symbol $\frac{3}{1}$) which obviously violates the principle of saturation of the Gürtelkurve $\frac{1}{1}$ (Fig. g1a). For sure we can drag the 3 ovals at the center of the patch and then we get the scheme $16\frac{1}{1}\frac{1}{1}$. Fig. g3 shows how to get the

“unnest” 16, but this dissipation is far from maximal due to much consanguinity between the behavior of branches at infinity in the patch, allowing us only to introduce 2 extra ovals. At any rate it is fairly evident that the quadri-ellipse of Fig. g is not deformable to any M -curve. Next going back to freehand tracing we manufacture Fig. i, which is fairly interesting as it dissipations includes 3 schemes one of which agressing Orevkov’s link-theoretic prohibition of $1\frac{3}{1}\frac{16}{1}$ and the other one attacking Viro’s sporadic obstruction of $\frac{3}{1}\frac{3}{1}\frac{13}{1}$. Alas this is not a serious corruption of the results of those Russian scholars because our Fig. i is not extremely regular with respect to Bézout when it comes to trace the singular line. This invites to consider Fig. j where this Bézout trauma is palliated, but alas the price to pay is the formation of 2 circuits hence reducing the number of boni ovals. Fig. k has the sam defect. Fig. l is interesting for coming quite close to an M -scheme prohibited by Shustin (namely $(1, 18\frac{2}{1})$) yet only through an $(M - 1)$ -approximation (namely $(1, 18\frac{1}{1})$). Next Fig. m, though deviating from the desideratum of having one outer oval only to land in the bosonic strip, looks excellent otherwise as it respects Bézout and possess only one circuit so that the maximum number of extra oval permissible by Harnack is gained (namely 9). Let us place them inside the biggest circuit and get Fig. m1 realizing the Viro scheme $10\frac{11}{1}$. However on exploiting the other admissible smoothing of Fig. m2 we enter in conflict with Bézout since we get 2 subnest in the largest (banana-shaped) oval.

So we have proven the following paradox:

Lemma 9.4 *There is a structural incompatibility between existence of the curve Fig. m (for any quantum placement of the nine extra ovals) and the Plücker-Klein-Harnack-Brusotti-Gudkov-Viro-Shustin principle of independency of smoothing singularities.*

Yes, but our mistake is simple to detect, namely we used a dissipation which cannot exit, because the corresponding patch viewed as an affine quartic yields Fig. m4 whose smoothing (Fig. m5) violates Bézout (a quintic cannot be nested unless it is the deep nest $\frac{1}{1}J$). So everything is restored to normality and we can still expect for an algebraic model of Fig. m. Actually on doing all quantum transfer of ovals compatible with Gudkov periodicity (and optionally Viro’s imparity law) we get a collection of schemes all permissible (i.e. actually constructed) in particular two schemes of Korchagin namely $10(1, 6\frac{4}{1})$ and $10(1, 2\frac{8}{1})$. Accordingly it may seems reasonable to guess existence of a singular octic like Fig. m. Alas it seems that postulating its existence leads to no new result except for reproving some Korchagin’s scheme in a perhaps more elementary fashion (as we truly appeal to a trivial dissipation theory involving affine quartics). It remains of course then to construct Fig. m via the usual Gudkov-Viro trick of hyperbolism based on Huyghens-Newton-Cremona (but we are not not very strong in this game). Incidentally it may be observed that Fig. d is fairly close to Shustin’s medusa (depicted on Fig. 123).

Of course it is not clear that we exhausted all ways of connecting the branches of 2 quadruple points, yet it looks hard to reach the bosonic strip (doubly nested schemes with one outer oval). Of course we could try to look at what happens with 3 quadruple points.

Via Fig. c we see that we can realize most of Shustin’s schemes (safe those with zero outer ovals). To get to them it suffices however to start with Fig. d which looks even more like a mushroom and so even more anti-Bézout. The latter curve produces smoothing conflicting with Viro’s sporadic obstructions while sometimes regenerating schemes due to Shustin. From Fig. f on, we consider curve with threefold symmetry and so three quadruple points. Fig. g suitable smoothed (along the unique M -possibility) offers Viro’s (non-elementary) scheme $6\frac{15}{1}$ and quantum fluctuating the 3 outer ovals we may reach as well schemes of Hilbert, Korchagin and Viro. Fig. h is merely isotopic to the former (yet even dihedrally symmetric). Fig. i offers Harnack’s scheme $18\frac{3}{1}$ from which one can derive through quantum fluctuation to schemes by Hilbert, Chevallier and Korchagin (yet nothing truly new except that we did not as yet digested

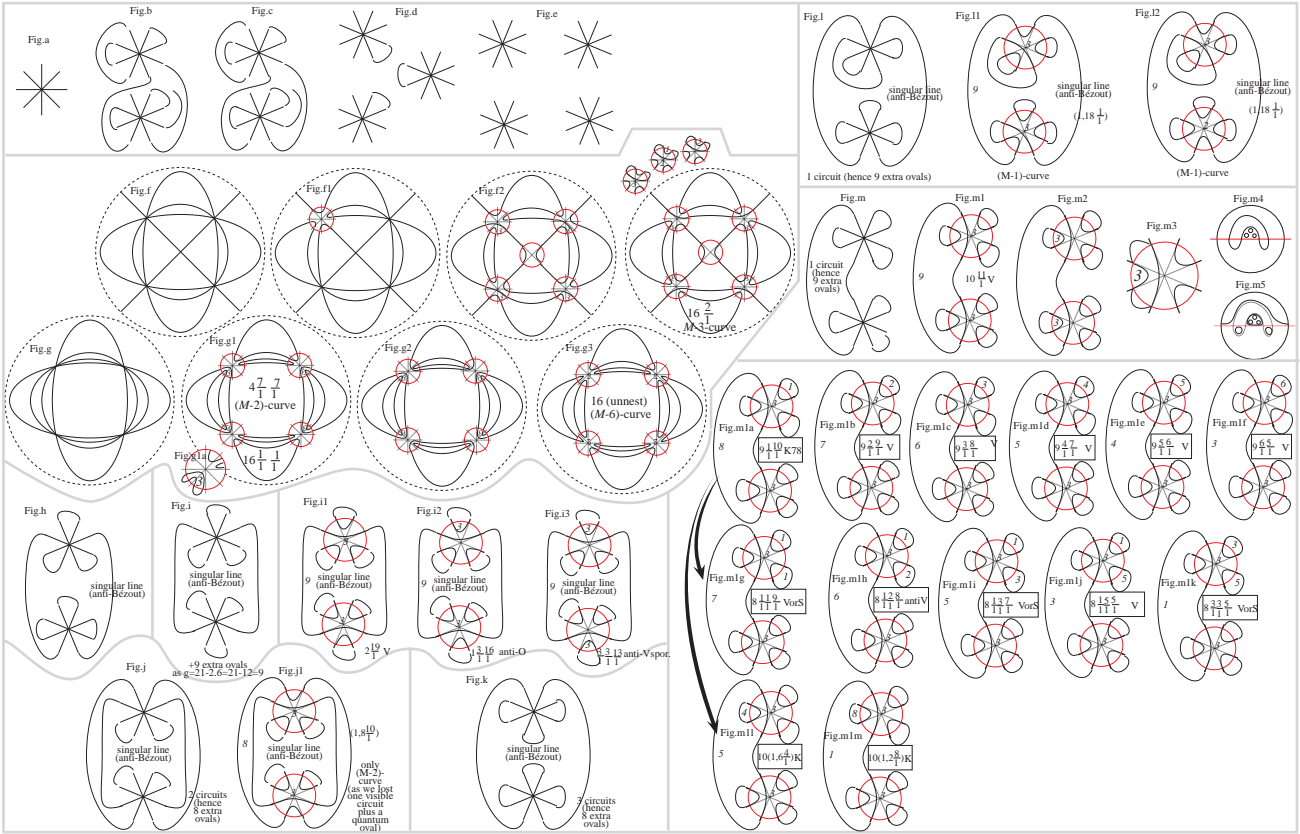

Figure 142: Singular octics from two (or more) quadruple points while creating 2 curves by Korchagin

the original construction of Korchagin and Chevallier as the tend to use the Newton polygon formalism with which we feel uncomfortable to say the least). Finally Fig. j produce the hard scheme of Shustin $4 \frac{5}{1} \frac{5}{1} \frac{5}{1}$, and in this case Bézout forbids any quantum fluctuation of the 3 outer ovals. So no more scheme can be derived. Again our construction is perhaps quite close to Shustin's original which we could not follow due to a lack of picturing. Phenomenologically, one could imagine that Fig. j appears through perturbation of a doubled tricuspidal quartic. To be frank and honest, it seems that our picture (Fig. j) violates Bézout when tracing the line joining 2 singularities, yet perhaps there is some distortion avoiding this aberration.

[24.07.13] Perhaps one should as well examine less symmetric junctures between the three quadruple points. Or one can also consider a configuration with 4 quadruple points.

[25.07.13] Coming back to Fig. d or even Fig. c both having rich descendance (sometimes conflicting with Viro's sporadic obstructions), yet being themselves optically anti-Bézout when it comes to trace the line through both singularities, we can try to remedy this defect via Fig. d-B. This is an attempt to stretch the curve as much as we can in order to respect Bézout and converging ultimately to Fig. d-C. During this process the quadruple point loose its ordinarieness (i.e. 4 distinct tangents) so that 2 of the branches acquires coincident tangents. This new singularity can be interpreted as an ordinary triple point with a two-fold (parabolic) branch tangent to one of the 3 linear branches. Alas it seems that the limiting Fig. d-C still corrupts Bézout because the line through the singularities has now a tangency along two branches and therefore the multiplicity intersection is about 6 at one singular point, and therefore at least 12.

Next we meditated more about how to place four quadruple points, with 3 of them forming an equilateral triangle and the fourth one lying in its center. Of course this configuration seems to lack structural symmetry and so suggested to us to look at the same with 4 quadruple points distributed on a square. Then there is 5 quadruple points and thus a conic through them cut $5 \cdot 4 = 20 >$

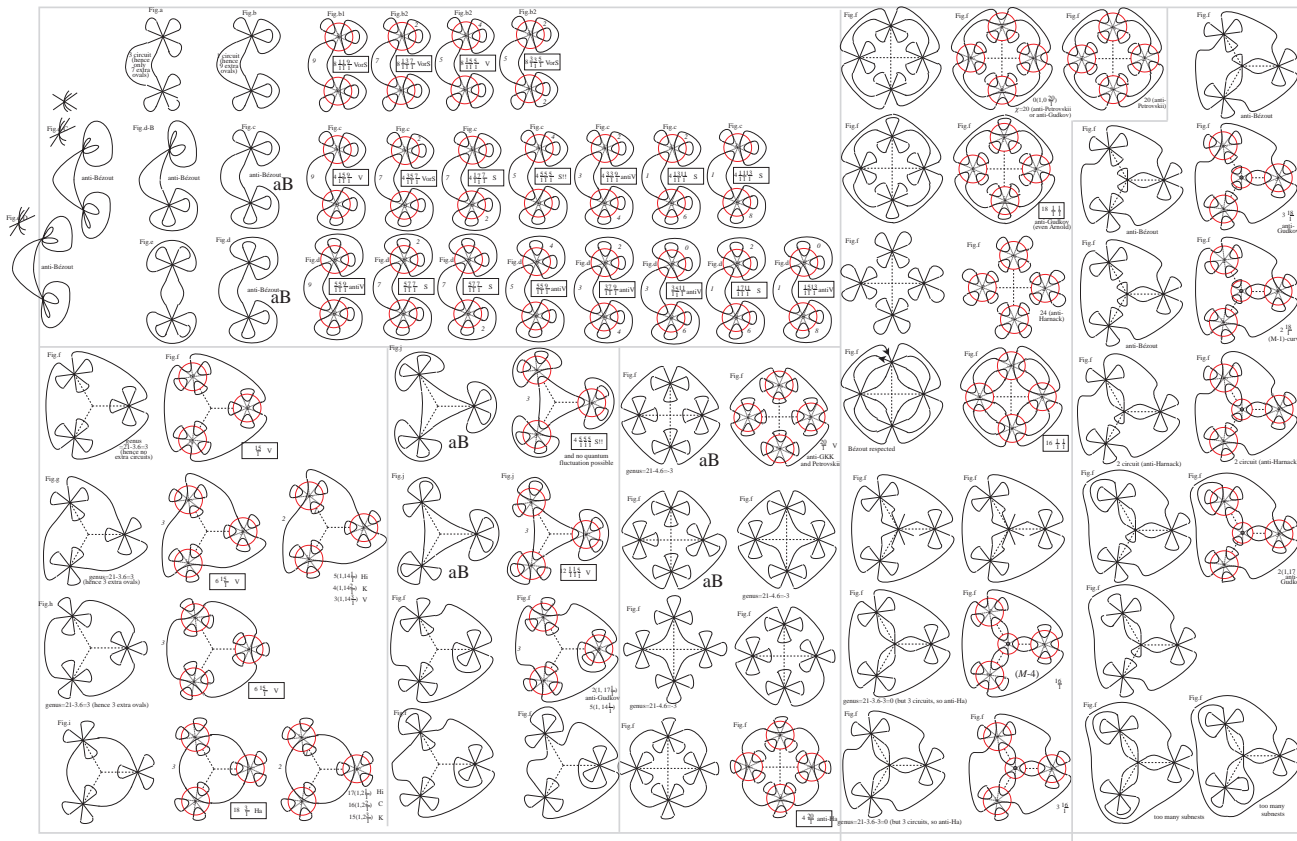

Figure 143: Singular octics from 2 or 3 quadruple points rotationally invariant

$2 \cdot 8 = 16$ so that Bézout is surpassed. In fact it seems that four quadruple points are already prohibited since considering the pencil of conics through the 4 singularities one can still pass a conic through any other point of the C_8 so that $4 \cdot 4 + 1 = 17 > 2 \cdot 8$ points are created violating once more Bézout. Of course there is however the little exception of when the octic split as 4 curves in a pencil of conics in which case the given distribution of singularity (four quadruple points) is realized.

Next we had the idea of a central quintuple point plus five triple points gravitating around. Alas the resulting curves violates Harnack's bound. And actually the initial singular curve foils Bézout when tracing the conic through the quintuple and 4 triple points which has intersection multiplicity at least $5+4 \cdot 3 = 17 > 2 \cdot 8$. So let us kill some triple points to get Fig. 144b. On smoothing the latter we get the M -scheme $20\frac{1}{2}$, which is anti-Gudkov (or even anti-Petrovskii). Hence we get as an interesting corollary of those Russian scholars (whose work is logically founded on either Rohlin 1952 or Euler-Jacobi-Kronecker interpolation) the following result not directly imputable to Bézout (as far as we can judge):

Lemma 9.5 *There is no singular octic whose real picture is like that of Fig. 144b albeit the latter seems perfectly Bézout compatible. Crudely put, there is rigidity of algebraic curves beyond the (naive) optical level.*

Fig. b was not adjusted to Gudkov periodicity and it is a simple matter to arrange this issue via Fig. c where the 2 loops are introverted. Of course the resulting schemes are not of the most exciting types, yet one can seek for more introversion yet usually this runs against Bézout's law.

Added [26.07.13] Then we had the idea to use only a quintuple point plus a constellation of double points so as to leave more maneuvering room for closing the petals without quickly entering in conflict with Bézout (see Fig. 145a). Its smoothing (Fig. a1) is alas only an $(M - 4)$ -curve with 18 ovals. Fig. b is a loose essay to introduce more nodes, the philosophy being that a rational curve is perhaps easiest to construct *ab ovo* and having only one circuit it is not sub-

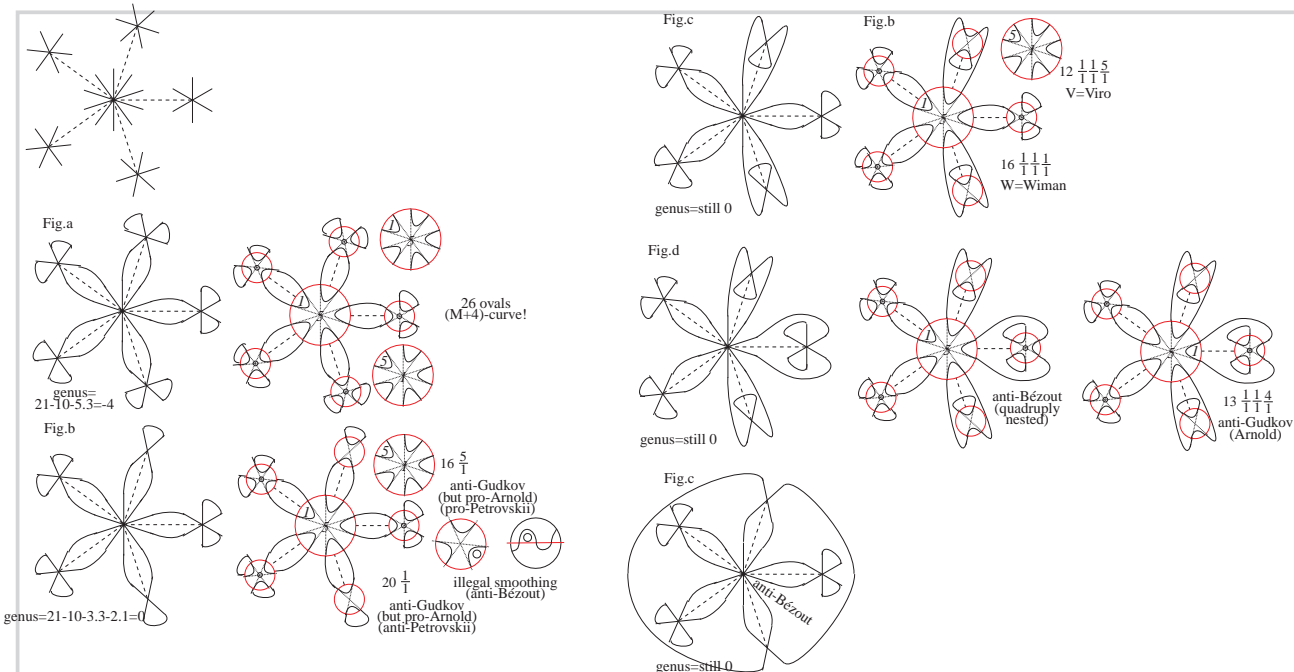

Figure 144: Singular octics from two or three quadruple points invariant under rotation by $2\pi/3$

jected to the extra quantum ovals. Its smoothing Fig. b1 has also only 18 ovals. Fig. c is another way to close the distribution of singularities specified. However if the 6 extra ovals are lying outside then the smoothing Fig. c1 contradicts Gudkov periodicity (proved by Rohlin). In contrast for other distribution of the outer quantum ovals fluctuating inside like Fig. c2, $c_3=c_4$, or $c_6=c_7$ we get respectable schemes originally due to Ha=Harnack, G=Gudkov or V=Viro. Yet the distribution Fig. c5 is forbidden if one believes in Viro's imparity law. Next one can look at Fig. d which has one extra oval (quantum as its location is not yet decided). As on Fig. d1 let x, y, z denote the marked position taken by the quantum oval. If at x then we get the scheme $20\frac{1}{1}$, which is anti-Gudkov. Otherwise we get 3 schemes with $\chi = 18$, hence violating the primitive version of Gudkov periodicity proved by Arnold (and a formal consequence of Rohlin's formula).

Hence albeit Fig. d is not extremely interesting from the viewpoints of constructing the 6 missing bosons, it is of some interest for showing that Viro's method (i.e. the possibility and independence of smoothing à la Plücker, Klein, Harnack, Hilbert, Brusotti, Viro, Shustin, etc.) acts actually when combined with Gudkov as a way of prohibiting schemes of singular curves. For instance, we have proven the following fact.

Lemma 9.6 *There is no singular octic of genus 1 whose singular circuit is isotopic to Fig. 145d, whatever the location of the one extra oval is.*

Fig. e shows another curve closing the given distribution of singularities, but its smoothing violates Bézout for conics as the configuration expands the doubled quadrifolium. Fig. g is permissible, yet its smoothings are not of the most exciting type having in the maximal case at least 3 outer ovals. Finally in view of the bound of the number of nest (at most three of them else the curve saturated at the doubled quadrifolium) we were rather inclined to tolerate at most threefold symmetry suggesting Fig. h, i, j were we successively increased the number of nodes. Alas Fig. j smoothed as Fig. j1 violated Gudkov's periodicity. Hence it follows again that Fig. j cannot exist algebraically which is not evident optically via say Bézout alone. In contrast a singular scheme like Fig. k yields the M -scheme $4\frac{5}{1}\frac{5}{1}\frac{5}{1}$ due to Shustin (albeit we did not understand his construction), and is therefore not prohibited.

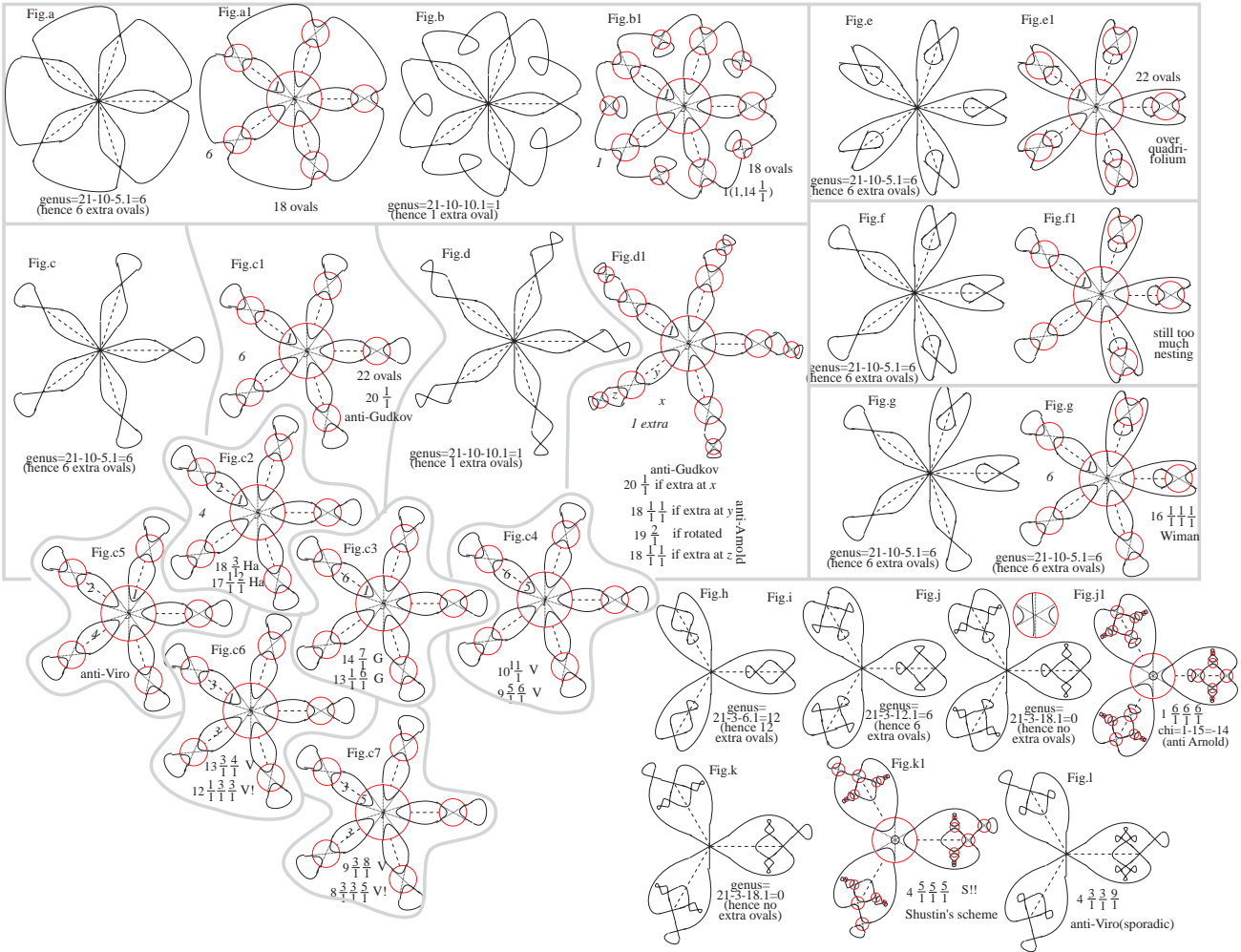

Figure 145: Singular octics with ...

In some contrast Fig. 145l deduced by transferring two nodes from 2 petals in the first petal, yields via the unique maximal smoothing the scheme $4 \frac{3}{1} \frac{3}{1} \frac{9}{1}$ in principle prohibited by Oleg Viro (sporadic obstruction not readily available from the pen of its discoverer). So granting this as correct we have:

Lemma 9.7 *Modulo the truth of Viro sporadic $4 \frac{3}{1} \frac{3}{1} \frac{9}{1}$, there is no rational singular octic whose real locus is isotopic to Fig. 145l, albeit the latter does not frankly seem to offend (Monsieur Étienne) Bézout.*

[27.07.13] Experimentation shows that our threefold symmetry tends to lead to the trined case, while the bosonic strip is primarily a matter of doubly nested schemes where 4 bosons are concentrated. This suggests to switch to a simple twofold symmetry like on Fig. 146a. Here we arrange to get 21 nodes as to drop the genus down to zero (rational curve) for which one can in principle write down an explicit parametrization. The Fig. b does the job yet create when smoothed the scheme $\frac{9}{1} \frac{11}{1}$ which is anti-Gudkov. However the closest Gudkovian approximation is the scheme $1 \frac{9}{1} \frac{10}{1}$ (highly bosonic, i.e nobody ever succeeded to realize it nor to prohibit it) which could be created out of the unicursal curve of Fig. c where we just traded an inner node of Fig. b for an outgoing node. Of course one can then successively transplant inner left nodes to the right generating so Fig. c1, c2, c3, ..., c9, c10 sweeping thereby all the 2 doubly nested bosons via unicursal curves. Hence:

Scholium 9.8 *Maybe there is a simple way to create some of the missing bosons via a rational curve with 21 nodes. Algorithmically, it is perhaps a reasonable game to trace by brute computer-force some random parametrization of degree 8 (yet both components of the parametrization may be of lower order) so that one of*

the above pattern appears on the screen (Hilbert's retina). Of course as we have now an explicit parametrization instead of a implicit (random) equation of degree 8, we hope that the present problem is somewhat more tractable electronically that the original setting of Hilbert's 16th involving highly irrational curves.

Of course in the above setting as our curve have only ordinary nodes they may be thought of as generic immersions of the circle (of an algebraic character) and thus more or less suited to a random search.

Fig. f shows some spires-like chain of nodes (that could also be imagined as a cactus like Fig. f2 or as the slalom variant of Fig. f3). Alas the resulting smoothed scheme $1 \frac{20}{1}$ is anti-Gudkov, but one can repair this defect by going to Fig. g realizing $2 \frac{19}{1}$ instead.

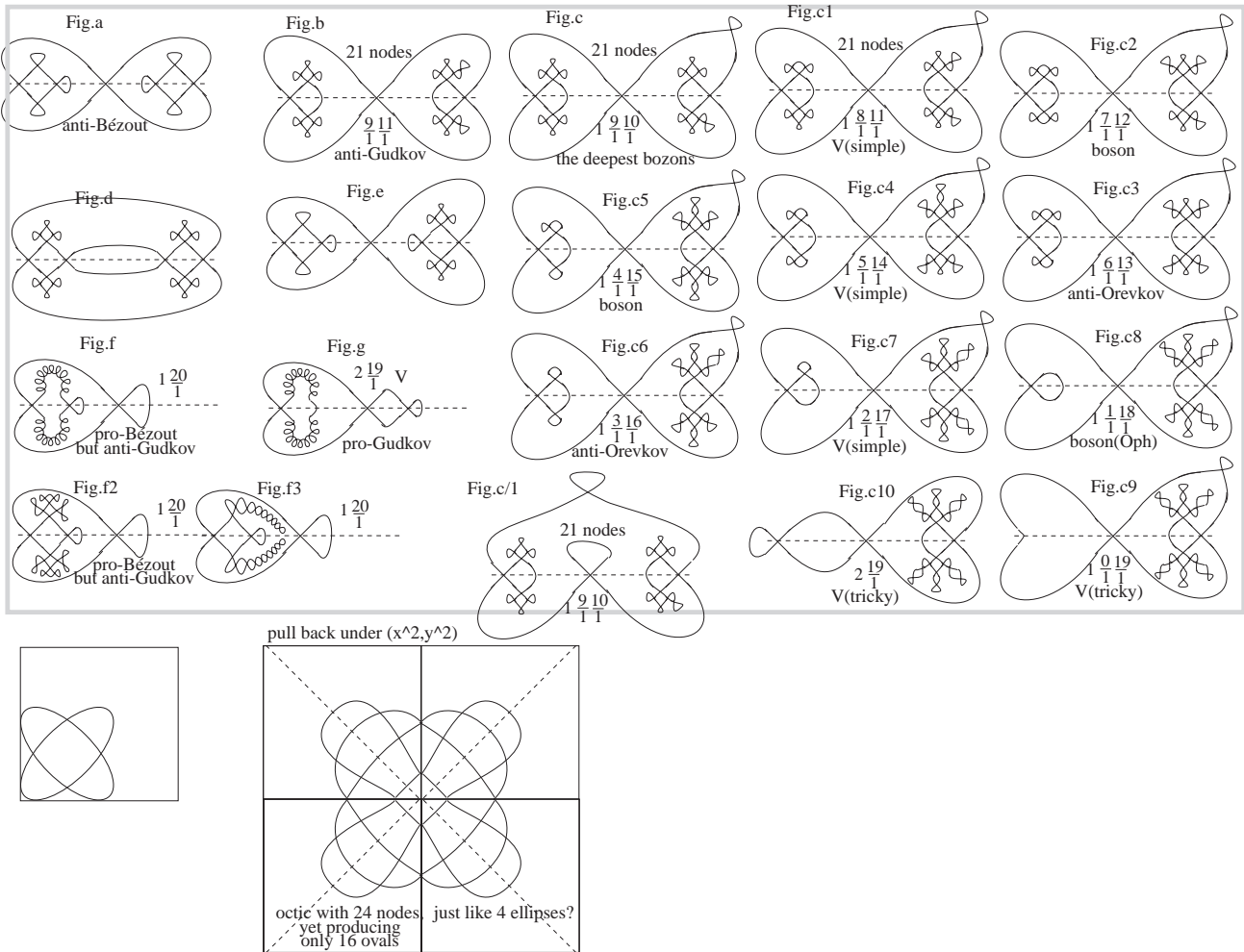

Figure 146: Singular octics with ...

Of course all this is merely a matter of free-hand tracing of very hypothetical unicursal curve of degree 8, yet this could be of some relevance to settling Hilbert's 16th in degree $m = 8$, which is the last one where the combinatorics is still at human size, but where we have to confess to be faced with serious geometric mysteries (bosons, sporadic Viro obstructions, Orevkov braid theoretic obstructions). Of course as a matter of construction it seems that the above pseudo-construction are not ideally suited as the use the simplest dissipation theory (for the ordinary node due to Severi-Brusotti and somehow anticipated by Germans like Klein, Harnack, etc.) yet with using a fairly complicated global curve whose range is purely hypothetical. In principle we can increase a bit the complexity of singularities involved while decreasing a bit the trickiness of the initial singular curve. We saw already a lot of such example where using merely ordinary multiple point we could generate schemes due to Viro yet without appealing to the dissipation of complex singularities like X_{21} (i.e. quadruple point

with 2nd order tangency between the branches). For a concrete example yet not perfectly justified see Fig. 143g or h.

Further let us observe again that among all of Viro's sporadic obstructions those impeding $4\frac{3}{1}\frac{3}{1}\frac{9}{1}$ looks to be the more risky one as the scheme is formally covered by an affine septic. So referring to a variant of the dissipation of the septuple point one can also easily corrupts this Viro octic obstruction, which if correct therefore implies an obstruction on one isotopy type of affine septics affine

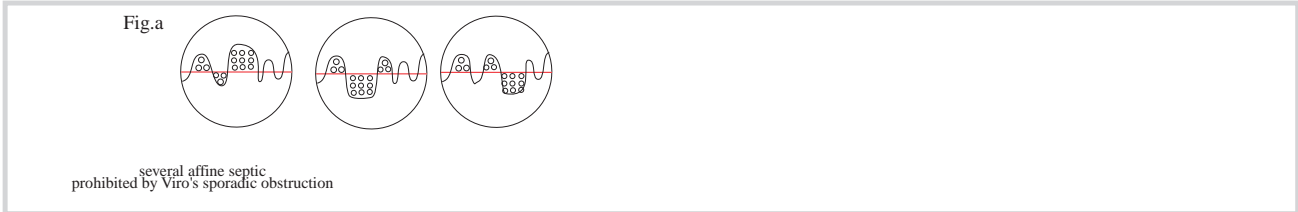
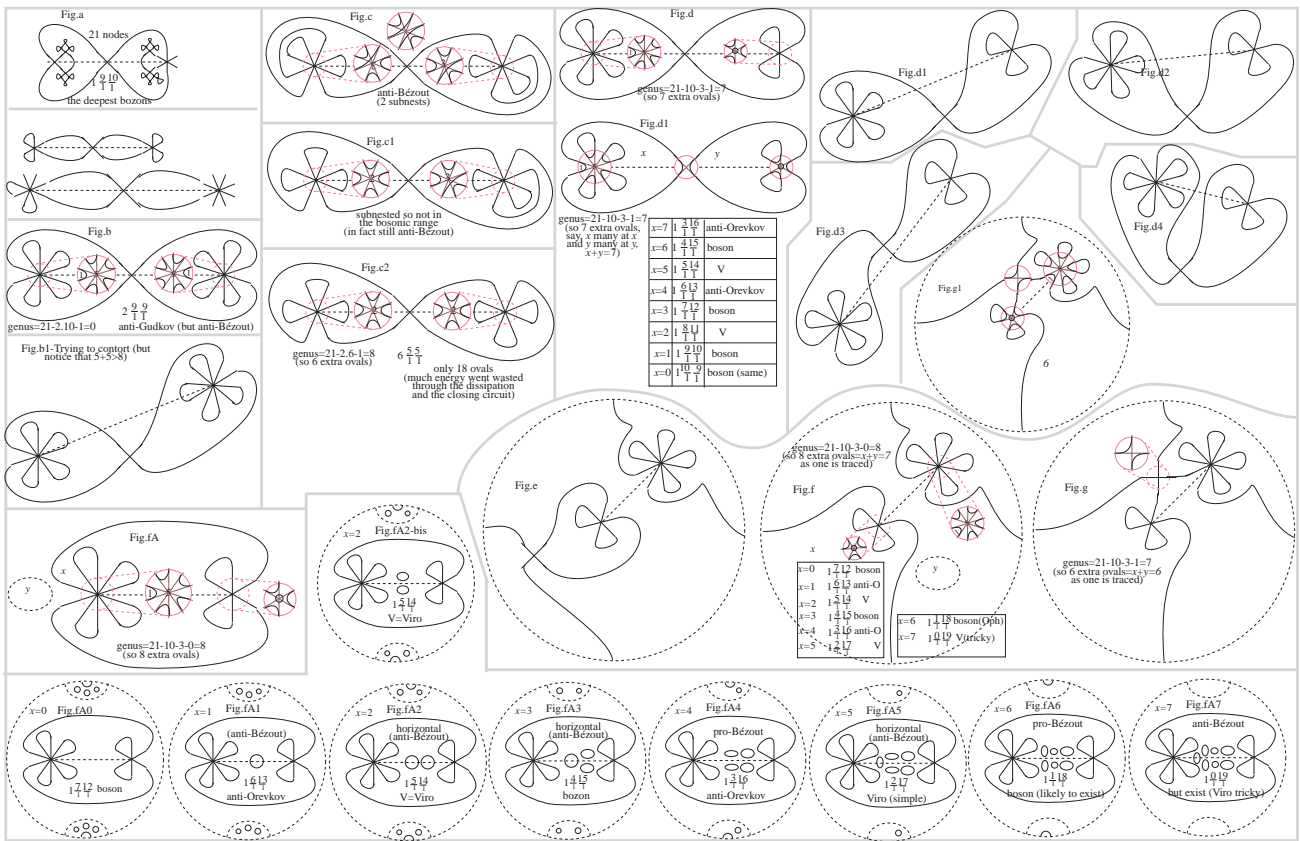

Figure 147: Several affine septics (indirectly) prohibited by Viro's most stinky sporadic prohibition of $4\frac{3}{1}\frac{3}{1}\frac{9}{1}$

[28.07.13] Maybe one can give more weight (geometric evidence) to the curve constructed by assigning a more massive singular points instead of the many nodes of Fig. 146. By increasing the mass of the singularity we quickly arrive at Fig. 148b where 2 quintuple points are introduced on both side of an ordinary node which should act as a splitter leading us in the doubly nested realm (where most bosons are concentrated). Why two quintuple points? Just because then we have a lucky stroke configuration as a 5-fold points drops 10 to the genus so that our curve has genus 0. Yet it should be noted that only concentrating on the genus we lost from sight the more basic constraint on the degree 8 which cannot tolerate an intersection of 10. So we consider the same configuration yet with only two *quadruple* points. Alas the resulting schemes Fig. c,c1,c2 turned to be either anti-Bézout, or not Harnack-maximal. In fact it seems that there is a better configuration when splitting 8 as $5 + 3$ yielding Fig. d whose smoothings manage to sweep out virtually all doubly-nested bosons safe the first species $1\frac{1}{1}\frac{18}{1}$. Of course the curve Fig. d as traced is not Bézout permissible yet maybe a suitable contortion of it can destroy the co-linearity of the 3 singularities. It is evident that each of our depicted flower has a trunk (stem/stalk/tige) which looks invaginated. It seems clear that invagination have to stay in front of each other as to respect Bézout for the line through both singularities. Fig. e supplies a projective depiction. Alas it seems that when the line penetrate in the hearth shaped region delimited by the two arcs connecting the triple to the double point that we get again in trouble with Bézout as the line as to escape of the Jordan cell. So it seems that there is a serious topological obstruction to existence of a singular octic with the prescribed distribution of singularities and controlled isotopic type. Of course our failing attempt to construct decently those bosons does not mean that the bosons does not exist, yet one could imagine à powered Hilbert-Rohn method stating that any smooth curve (say doubly nested and with one outer oval, i.e. in the bosonic range) degenerate toward such a singular curve (with singularities of masses 2,3,5) and then our argument would give a general obstruction. Fig. f seems to be a solution yet we lost the splitting double point. Fig. g is an attempt to reintroduce the lost node. Actually Fig. f with suitable quantum ovals (x and y) can produce nearly all bosons except the highest one $1\frac{9}{1}\frac{10}{1}$. Of course this picture can be affinized (i.e. be put at finite distance) as shown on Fig. fA, which seems a staphylococcus. It is tempting to posit a symmetric realization of the curve. (Incidentally as in the bosonic strip we have $\chi = -16$, this Ansatz is compatible with Fiedler's strengthened version modulo 16 of Gudkov's hypothesis $\chi \equiv k^2 \pmod{8}$.) Next we may examine the varied distribution of ovals. Fig. fA0 shows the case $x = 0$, hence with $y = 7$ in the outer oval depicted at infinity. Fig. fA1 shows the case $x = 1$ where there is one inner oval traced inside the singular circuit. By symmetry the latter is forced to be self-symmetric (invariant) but then we get troubles with Bézout

as the invariant line through both singularities exhibit already 8 intersections. By the way the smoothed scheme is prohibited by Orevkov and so we get some feeling of understanding his highbrow braid-theoretic obstruction. Fig. fA2 with $x = 2$ many inner ovals respects Bézout when both are distributed vertically as on Fig. fA2-bis, while the resulting scheme really exists through Viro's simplest construction. For $x = 3$ we get trouble with Bézout and the resulting scheme is a boson. So we feel fairly close to have a general law emerging. In particular we would say that the first boson $1\frac{7}{1}\frac{12}{1}$ exist, whilst $1\frac{4}{1}\frac{15}{1}$ would not. So far so good, but the sequel make our observational law quite stormy. Indeed as $x = 4$, our naive law would vote toward existence of the scheme, yet the scheme is prohibited by Orevkov. (Of course it could be that Orevkov's result are wrong but this is only weak superstition.) Next as $x = 5$, the odd number of inner ovals forces one to be invariant and so to possess a supernumerary point of intersection with the singular line is created, however the scheme is accessible through Viro's simplest method. So our law is severely foiled for a second time. When $x = 6$, we get the boson $1\frac{1}{1}\frac{18}{1}$ fairly likely to exist (remember also its realizability via decomposable curves of degree $2 + 6$). Finally as $x = 7$, Bézout is foiled but the scheme still exist via a (tricky) Viro method. This is a 3rd corruption of our law.



WARNING: all those curves violates Bézout (line through the 5-fold point and the outer nest)

Figure 148: Singular octics with ...

Of course our law splits in two parts (construction and prohibition):

(LAW1) If the number of inner ovals is odd then the scheme does not exist.

Of course this part of the law is fairly weak has it imposes a very peculiar mode of generation of the scheme. By the way it is contradicted twice by Viro's constructions.

(LAW2) When the number of inner ovals is even then the scheme does exist.

This sense looks logically stronger as it suffices to have one construction to have a construction. Ye this principle is foiled once by Orevkov (as $x = 4$). So either Orevkov's result is lase or more likely the octic of Fig. fA4 does not exist even though it looks Bézout respectable.

In conclusion very little can be extracted from our naive method, yet it cannot be excluded that some few new schemes could be constructed along this strategy.

Now it remains to examine Fig. g. One of the smoothing leads back to Fig. f (already analyzed). Actually the singular curve has two circuits so we do not have the maximum number of quantum ovals gained and so we certainly fails Harnack maximality. o the situation does not seem worth investigating any further (and Fig. g1 (Gibraltar's canal) shows that as expected we get only 20 ovals).

Let us summarize as follows our weak knowledge:

Lemma 9.9 *Among all schemes in the bosonic strip (doubly nested and one outer oval) all are realized via a singularity of masses $3 + 5$ safe $1\frac{9}{1}\frac{10}{1}$. This gives weak evidence that the schemes $1\frac{7}{1}\frac{12}{1}$, $1\frac{3}{1}\frac{16}{1}$, $1\frac{1}{1}\frac{18}{1}$ do exist algebraically but the middle term is actually ruled out according to Orevkov's theory. Further the last boson $1\frac{9}{1}\frac{10}{1}$ albeit not accessible via the $[3 + 5]$ -method, it is via the $[2+3+5]$ -method (see Fig. 148d1), where however the picture is plagued by robust anti-Bézoutism. So our rating agency can give only low existential evidence for this species to be observed in nature.*

[ca. 26.07.13] Maybe (somewhat inspired by a certain Yves (tailleur de pierre) who learned me yesterday that natural crystals never stabilizes to fivefold symmetry) we can do the same game for a sextuple point with a halo of double points (see Fig. 149). Suddenly one sees that arithmetics works then smoother as $21 - 15 - 6 \cdot 1 = 0$, so that more symmetry is gained (while keeping the genus ≥ 0). We do not know if there is a direct relation between crystals and algebraic curves (apart of course in the prose of Alexander Grothendieck). On tracing Fig. c we realized that our configuration of singularities overwhelms Bézout, since the sextuple and two double points are aligned. After a very erratic search the sole interesting thing is Fig. g5A4 where we recover a Chevallier scheme using the hypothetical curve of Fig. g5.

On the next figure we try to develop an introverted version of Fig. g5. Philosophically speaking, we thought initially that symmetry is likely to be favorable for Harnack maximality yet in reality it seems rather to be an extra constraint removing some freedom.

9.5 Reflex de Pavlov vs. complex de Gromov

[26.07.13] Among the big scientists of the world, we have two scientists like Pavlov and Gromov. The latter is a well-known student of Rohlin () one of our main hero, well known for semi-deep contributions on Riemannian geometry. Especially important is Gromov's assertion that mathematics are so trivial that once after a long effort we have understood the fully story we do not take the pain to write down the details feeling almost shameful of the triviality of the truth. This phenomenon we call the complex de Gromov. Needless to say we feel not affected by the latter. Needless to say, we feel quite besoffen but it is at such time (as would say Ahlfors that the mathematical Empire appears in its full great). It is only then that anodyne details swamp out so that the true architecture become visible. Actually, our main philosophical purpose is to give some text to TeX so as to picture more tomorrow along the action painting à la Jackson Pollock tomorrow. As we said often in this text it is a pity that TeX is so painful when it comes to integrates Figures. We, geometers are not linguists willing to speak a lot, but we are rather pure observers trying to put so much pressure on the optical Universe as to force the latter to deliver its archaic secret about Space, Time, Matter and Immortality. This sounds pathetic, we confess, but what more pathetic than masking the true expectation of our endeavor while dilapidating social funds while bronzing along the coast of the Aegean sea like Steve Small (annoying Jack Milnor). Science needs workers and not capitalists. Sorry for all this boring Naturphilosophie aus the best Bavarian Stock, but it is to remedy TeX Page-Making (un)skills. Hätten wir was besseres verdient wenn

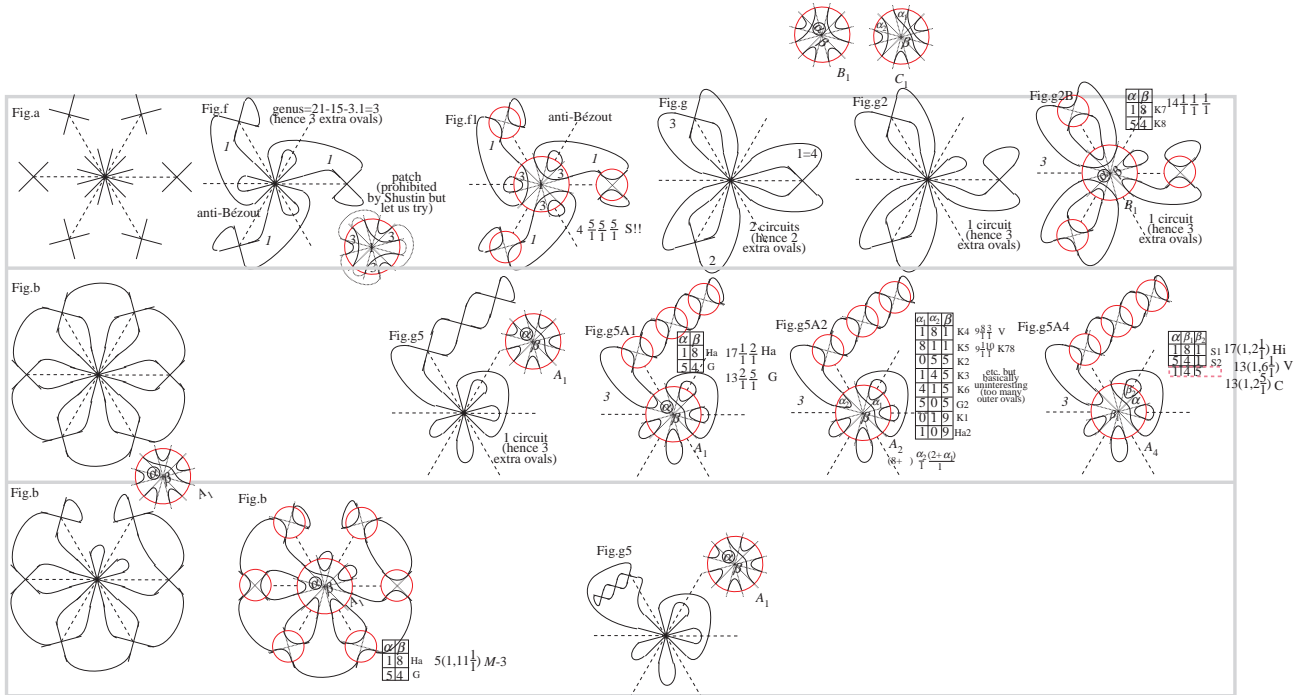

Figure 150: Introverting

contributors (Shustin, Korchagin, Chevallier, Orevkov) which is rigorous yet fairly intricate artwork.

[14.07.13] It seems also worth noticing that the M -octic schemes obtained via our “floppy” decomposing curve (our picture are not algebro-geometric a priori) includes 2 of the 3 schemes pseudo-holomorphically realized by Orevkov. Maybe this gives some support that those 2 pseudoholomorphic models can be rigidified (crystallized) in the algebraic category.

9.6 Interlude: impact upon the Wiman-Rohlin-Gabard dream of satellites (le théorème de Riemann rendu synthétique)

[02.07.13] All the little counterexamples to RMC described previously in this text seems to affect/jeopardize the grand programme we drafted in the Introduction of this essay (v.2). Our thesis was essentially that the phenomenon of total reality should explain all prohibitions of Hilbert’s 16th problem, emphasizing a great domination of Riemann-Schottky-Klein upon Hilbert. In particular we expected a phenomenon of stability under satellites, say of being of type I or of being maximal. Actually stronger than all these conditions is the total reality of a scheme and this should be the right condition forcing maximality of the scheme, hence a series of “criminal” prohibitions (by killing all enlargements). So even though Rohlin’s maximality conjecture looks foiled (essentially by Viro), another maximality principle allied to total reality can still regulate the isotopic classification of curves (Hilbert’s 16th).

9.7 Temptation of free-hand drawing

[02.07.13] In view of the failure of Shustin’s apple to reach Harnack-maximality it seems tempting to create more ovals by splicing the apple in two halves. However most curves so obtained violates Gudkov’s hypothesis validated by Rohlin (et cie), whence a violent obstruction to dissecting Shustin’s apple in two pieces.

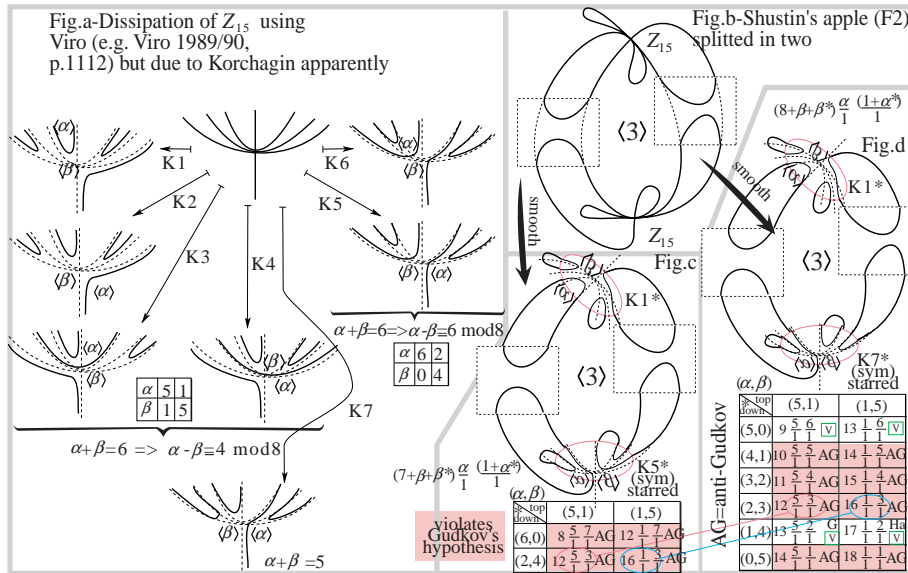

Figure 151: A free split of Shustin's apple, yet violating Gudkov

10 Post-Viro neoconstructivism: the latest tricks by Korchagin, Chevallier, Orevkov

10.1 Korchagin's tsunami of 19 new M -schemes

Without getting too excited by this last scheme of Shustin let us rather look at the next contribution namely that of Korchagin which covers some 19 new schemes.

- Korchagin 1988 [858](=announcement in the Summary of Candidate's dissertation, Leningrad) and published in 1989 [860] (constructions of 19 new schemes, raising Korchagin's score to 20) probably via a variant of Viro. Yes, but one variant of his own stock and alas also difficult to follow as there is no projective picture given, but just the "Newton-Viro charts" which we are not yet acquainted with. Is it possible to make "projective" pictures of Korchagin's curve, probably but it requires some working aptitude. TO BE CONTINUED.

10.2 Shustin's 5 new prohibitions of M -schemes

- Shustin 1990/91 [1419] new prohibitions (of five M -schemes of the form $(1, a \frac{20-a}{1})$ with a adjusted as to verify Gudkov's hypothesis, cf. Fig. 154 for the exact values $a = 2, 6, 10, 14, 18$). This result probably involves a variant of Hilbert-Rohn [Shustin being a direct student of Gudkov and arguably among the living best-expert of this method]; but NO it is rather by a topological method initiated by Viro 1984, whose first variant seems even to go back to Rohlin, cf. p. 424 of *loc. cit.*); in fact Shustin claims only to prohibit 5 schemes [and conjectures that the method employed also prohibit 2 additional schemes (cf. Remark 6, p. 443)]. (Omit please, this bracketed text as this pertains only to $(M - 1)$ -curves.)

10.3 21st century heroes: Chevallier and Orevkov

- Chevallier 2002 [282] (new constructions of 4 schemes) probably via a variant of Viro's method (yes but one requiring a very clever twist); Chevallier's schemes are $a(1, 2 \frac{18-a}{1})$ for $a = 2, 5, 13, 16$, compare Fig. 154 for a visualization.
 - Orevkov 2002 [1129] prohibition of 2 schemes (namely $1 \frac{3}{1} \frac{16}{1}$ and $1 \frac{6}{1} \frac{13}{1}$) by his revolutionary techniques involving braids (Fox-Milnor, Lee Rudolph, quasipositivity), pseudoholomorphic curves, etc.
 - Orevkov 2002 [1130] construction of one scheme (namely $7(1, 2 \frac{11}{1})$), by using apparently Grothendieck's dessins d'enfants.

At this stage (and the situation does not changed since) there remains precisely 6 schemes (depicted on Fig. 152) which are not yet known to be realized. For their exact geography in the universe of all 104 schemes, cf. again Fig. 154. At this stage the proof of the (fragmentary) theorem 2.2 is completed. ■

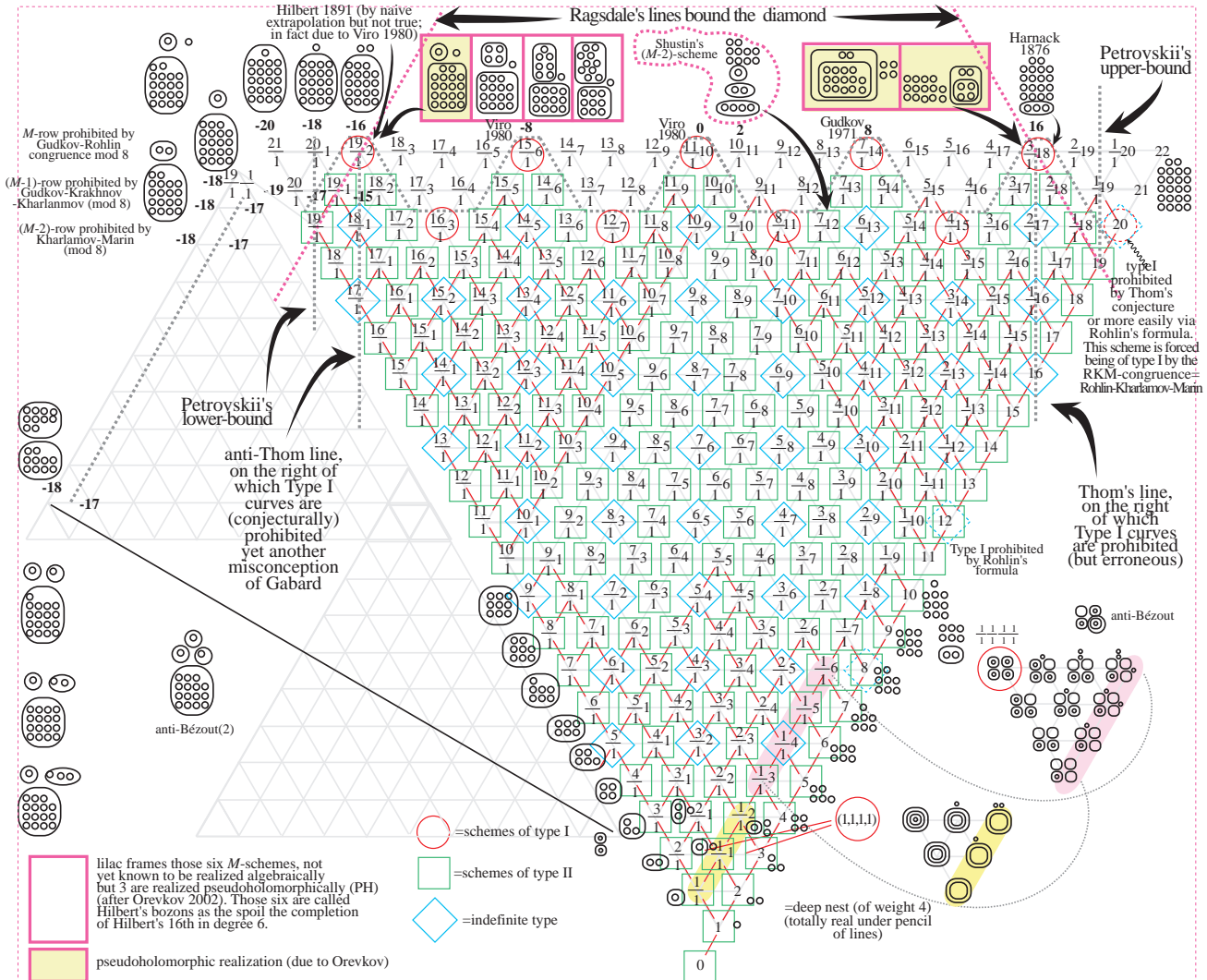

Figure 152: Naive pyramid and the six bosons

[30.04.13] We summarize this intricate system of contribution by a table (Fig. 153):

Alas this does not clarify much the situation and we must of course do our own exhaustive table of schemes to understand better what happens. We were guided by the table in Orevkov 2002 [1129], but working out our own map was still necessary to understand better the architecture.

[01.05.13] To gain a better understanding let us make a table of all M -schemes in degree 8 (such tables are designed in Viro 1980 [1527], Viro 1984/84 [1532], Viro 1986 [1534, p. 78], and Orevkov 2002 [1129]), and we try to stay close to their mode of depiction. Just a little warning the values of χ are inverted in comparison to our convention used on pyramids (e.g. Fig. 152). Especially useful is Orevkov's trick to inform the reader of the original builder of the curve [this trick was already used in Viro 1980 [1527], but in a less efficient fashion, e.g. why calling Hilbert=(12), and Harnack=(11)?]. Yet, at some place it seemed to us desirable (especially in the case of Korchagin) to precise further the date of fabrication. So for instance K78 means Korchagin 1978 [850], where only one scheme was constructed (by a variant of Brusotti), while in contrast K alone correspond to the 19 schemes constructed later by Korchagin in 1989 [860]. Further Orevkov's table is more complete than Viro's, yet contains at

	constructed		prohibited	logically possible	questionable not yet realized
	new	total			
Bézout 1779					
Harnack 1876	2	2	infinity		
Hilbert 1891	4	6	like Bézout		
Wiman 1923	1	7			
Gudkov 1971	2	9			
Gudkov-Rohlin72			one quarter (congruence mod 8)		
Korchagin78	1	10	at this stage M -curves seemed rare birds		
Fiedler-Viro80			many (4+36)		94
Viro 1980	42	52			52
Viro84/86			8		44
Shustin85/87/88	6+1	59		104	37
Korchagin88/89	19	78	hence a total of 40 as asserted in Viro80		18
Shustin91			5 - or Viro83/84		13
Chevallier02	4	82			9
Orevkov02	1	83	2		6

Figure 153: Histogram of Hilbert’s 16th for M -octics

some places misprints. We hope that our version combines the advantages of both tabulation, while pointing the mistake to be found in Orevkov’s.

Further at the bottom of the first column, it seems that Orevkov 2002 erroneously ascribes to Viro a scheme (namely $17(1, 2\frac{1}{2})$) constructible via Hilbert’s method (compare the appropriate Fig. in v.2 of Ahlfors). By the way, this mistake seems compatible with the fact that on Orevkov’s table Hilbert scores only 3 schemes, while even in Viro 1980 [1527, p. 568, Table 1], Hilbert scored 4 schemes, and incidentally the scheme in question is correctly ascribed to Hilbert 1891 (cf. 7th line of the first column, in Viro 1980 *loc. cit.*).

Further our map is slightly more practical than Orevkov’s as it also shows the prohibitions. As 83 schemes are constructed and $8+5+2 = 15$ are prohibited by V,S and O respectively, yielding a total of $83 + 15 = 98$ so in comparison to the 104 of the Fiedler-Viro universe, 6 schemes are left undecided.

By the way it should be noted that Viro’s table (in Viro 1980 [1527]) contains some anomalies, for instance certain schemes are misplaced depending on the value of $\chi = p - n$ (e.g. all the last 8 schemes of the series $(p, n) = (19, 3)$ should be moved to $(p, n) = (11, 11)$). In this respect Orevkov’s table (2002) is much more reliable. (At any rate we believe that our table is the most accurate one.) Upon comparing Viro’s 1980 table with ours (or Orevkov’s 2002) it seems that these 8 schemes is the sole inaccuracy in Viro80’s table (and probably this can be ascribed to the typographer who otherwise would have been much annoyed to split the table in two rows of equal heights).

Having checked this properly, we see that Viro 1980 (compare his table) constructs for $\chi = 16, 8, 0, -8, -16$ respectively $2 + 10 + 14 + 11 + 5$, hence a total of 42 schemes (exactly as he asserts).

At several occasions (during the 1980’s) Viro advanced the following conjecture (1980, 1983 [1532, p. 416, 2.3.B], and even 1986 [1534]):

Conjecture 10.1 (Viro’s conjecture, disproved by Korchagin, but partially verified on 5 cases by Shustin).—*If $\alpha(1, \beta\frac{2}{3})$ is the real scheme of an M -curve of degree 8 with $\gamma \neq 0$, then α and γ are odd integers.*

This conjecture (wrote Viro 1983/84 [1532, p. 416/17]) “arose as a consequence of unsuccessful attempts to realize the schemes which are ruled out by it. Despite considerable efforts, no counterexample to this conjecture has yet been constructed.” Viro’s conjecture would have ruled out all the 25(=9+7+5+3+1) schemes marked by stars “★” on Fig. 153. Viro’s conjecture turned out to be generically false, with many counterexamples due to Korchagin ($4+6+4+2 = 16$ many, the magic number of this theory and the number chosen by Hilbert, and Rohlin) and 2 counterexamples due to Chevallier (2002), yet 5 corroborations of Viro’s intuition by Shustin 1990/91 [1419], and 2 cases which are still open nowadays. So Viro’s conjecture is true with feeble probability $\geq 5/25 = 1/5 = 0.2$ but at most with probability $7/25 = 0.28$ [reminding Plücker’s count of the bitangents to a quartic, or Milnor-Kervaire count of smoothness structures on S^7]

χ	16	8	0	-8	-16	
1 non-empty oval	$18 \frac{3}{1}$ Ha(orV)	$14 \frac{7}{1}$ G(orV)	$\nabla 10 \frac{11}{1}$ V	$6 \frac{15}{1}$ S	$2 \frac{19}{1}$ S	
2 non-empty oval	$17 \frac{1}{1} \frac{2}{1}$ Ha(orV) $17(1,2 \frac{1}{1})$ misprint in Viro85-Orevkov02? probably not rather a mistake of Gabard, yet caused by an annoying mistake in Orevkov's table, cf. the bottom of this row, ignore this frame	$13 \frac{1}{1} \frac{6}{1}$ V $13 \frac{2}{1} \frac{5}{1}$ G(orV) $13 \frac{3}{1} \frac{4}{1}$ V misprint in Viro80, in omitting $2X_2$	$9 \frac{1}{1} \frac{10}{1}$ K78(orV) $9 \frac{2}{1} \frac{9}{1}$ V $9 \frac{3}{1} \frac{8}{1}$ V $9 \frac{4}{1} \frac{7}{1}$ V $9 \frac{5}{1} \frac{6}{1}$ V	$5 \frac{1}{1} \frac{14}{1}$ V $5 \frac{2}{1} \frac{13}{1}$ V $5 \frac{3}{1} \frac{12}{1}$ V $5 \frac{4}{1} \frac{11}{1}$ V $5 \frac{5}{1} \frac{10}{1}$ V $5 \frac{6}{1} \frac{9}{1}$ V $5 \frac{7}{1} \frac{8}{1}$ V	$1 \frac{1}{1} \frac{18}{1}$ O(ph) $1 \frac{2}{1} \frac{17}{1}$ V $1 \frac{3}{1} \frac{16}{1}$ O02 $1 \frac{4}{1} \frac{15}{1}$ V $1 \frac{5}{1} \frac{14}{1}$ V $1 \frac{6}{1} \frac{13}{1}$ O0b $1 \frac{7}{1} \frac{12}{1}$ V $1 \frac{8}{1} \frac{11}{1}$ V $1 \frac{9}{1} \frac{10}{1}$ V	
3 non-empty oval	$16 \frac{1}{1} \frac{1}{1} \frac{1}{1}$ W=Wiman(orV) misprint in Orevkov02, but correct in Viro86 expanded code	$12 \frac{1}{1} \frac{5}{1}$ V $12 \frac{2}{1} \frac{4}{1}$ V misprint in Viro80, in asserting $2X_2$ here Viro's condensed notation breaks the regularity (compare Viro86 with Orevkov02) expanded code	$8 \frac{1}{1} \frac{9}{1}$ V(orS) $8 \frac{2}{1} \frac{8}{1}$ V(orS) $8 \frac{3}{1} \frac{7}{1}$ V $8 \frac{4}{1} \frac{6}{1}$ V $8 \frac{5}{1} \frac{5}{1}$ V(orS) $8 \frac{6}{1} \frac{4}{1}$ V Viro's chasse gardée	$4 \frac{1}{1} \frac{13}{1}$ S $4 \frac{2}{1} \frac{12}{1}$ S $4 \frac{3}{1} \frac{11}{1}$ V $4 \frac{4}{1} \frac{10}{1}$ V $4 \frac{5}{1} \frac{9}{1}$ V $4 \frac{6}{1} \frac{8}{1}$ V $4 \frac{7}{1} \frac{7}{1}$ S $4 \frac{8}{1} \frac{6}{1}$ V $4 \frac{9}{1} \frac{5}{1}$ V(orS) $4 \frac{10}{1} \frac{4}{1}$ S=last	$0 \frac{1}{1} \frac{17}{1}$ S $0 \frac{2}{1} \frac{16}{1}$ V84/86 $0 \frac{3}{1} \frac{15}{1}$ V84/85 $0 \frac{4}{1} \frac{14}{1}$ S $0 \frac{5}{1} \frac{13}{1}$ V84/86 $0 \frac{6}{1} \frac{12}{1}$ S $0 \frac{7}{1} \frac{11}{1}$ S $0 \frac{8}{1} \frac{10}{1}$ V84/86 $0 \frac{9}{1} \frac{9}{1}$ V84/86 $0 \frac{10}{1} \frac{8}{1}$ V84/86 $0 \frac{11}{1} \frac{7}{1}$ V84/86 $0 \frac{12}{1} \frac{6}{1}$ V84/86 $0 \frac{13}{1} \frac{5}{1}$ V84/86 $0 \frac{14}{1} \frac{4}{1}$ V84/86 $0 \frac{15}{1} \frac{3}{1}$ V84/86 $0 \frac{16}{1} \frac{2}{1}$ V84/86 $0 \frac{17}{1} \frac{1}{1}$ S modulo a misprint prohibited in Viro86 [p.67, Art.(4.12)], but correct in Shustin88, p.488 or Polotovskii88, p.458 (LNM 1346) those 3 Shustin's constructions are already announced in Viro86(p.67)	
all this row is subsumed to the Fiedler-Viro prohibition whence the odd content of all non-empty ovals	$16 \frac{1}{1} \frac{1}{1} \frac{1}{1}$ W another proof of this Shustin's prohibition in Gilmer1997 expanded code	$12 \frac{1}{1} \frac{5}{1}$ V $12 \frac{2}{1} \frac{4}{1}$ V	$8 \frac{1}{1} \frac{9}{1}$ V(orS) $8 \frac{2}{1} \frac{8}{1}$ V(orS) $8 \frac{3}{1} \frac{7}{1}$ V $8 \frac{4}{1} \frac{6}{1}$ V $8 \frac{5}{1} \frac{5}{1}$ V(orS) $8 \frac{6}{1} \frac{4}{1}$ V Viro's chasse gardée	$4 \frac{1}{1} \frac{13}{1}$ S $4 \frac{2}{1} \frac{12}{1}$ S $4 \frac{3}{1} \frac{11}{1}$ V $4 \frac{4}{1} \frac{10}{1}$ V $4 \frac{5}{1} \frac{9}{1}$ V $4 \frac{6}{1} \frac{8}{1}$ V $4 \frac{7}{1} \frac{7}{1}$ S $4 \frac{8}{1} \frac{6}{1}$ V $4 \frac{9}{1} \frac{5}{1}$ V(orS) $4 \frac{10}{1} \frac{4}{1}$ S=last	$0 \frac{1}{1} \frac{17}{1}$ S $0 \frac{2}{1} \frac{16}{1}$ V84/86 $0 \frac{3}{1} \frac{15}{1}$ V84/85 $0 \frac{4}{1} \frac{14}{1}$ S $0 \frac{5}{1} \frac{13}{1}$ V84/86 $0 \frac{6}{1} \frac{12}{1}$ S $0 \frac{7}{1} \frac{11}{1}$ S $0 \frac{8}{1} \frac{10}{1}$ V84/86 $0 \frac{9}{1} \frac{9}{1}$ V84/86 $0 \frac{10}{1} \frac{8}{1}$ V84/86 $0 \frac{11}{1} \frac{7}{1}$ V84/86 $0 \frac{12}{1} \frac{6}{1}$ V84/86 $0 \frac{13}{1} \frac{5}{1}$ V84/86 $0 \frac{14}{1} \frac{4}{1}$ V84/86 $0 \frac{15}{1} \frac{3}{1}$ V84/86 $0 \frac{16}{1} \frac{2}{1}$ V84/86 $0 \frac{17}{1} \frac{1}{1}$ S those 3 Shustin's constructions are already announced in Viro86(p.67)	
Shustin's series	$(1, 2 \frac{18}{1})$ S91	$(1, 6 \frac{14}{1})$ S91	$(1, 10 \frac{10}{1})$ S91	$(1, 14 \frac{6}{1})$ S91	$(1, 18 \frac{2}{1})$ S91	
	$1(1, 2 \frac{17}{1})$ Hi(orV) $2(1, 2 \frac{16}{1})$ C $3(1, 2 \frac{15}{1})$ K $4(1, 2 \frac{14}{1})$ O(ph) $5(1, 2 \frac{13}{1})$ C $6(1, 2 \frac{12}{1})$ K $7(1, 2 \frac{11}{1})$ O $8(1, 2 \frac{10}{1})$ K $9(1, 2 \frac{9}{1})$ V $10(1, 2 \frac{8}{1})$ K $11(1, 2 \frac{7}{1})$ V $12(1, 2 \frac{6}{1})$ K $13(1, 2 \frac{5}{1})$ C $14(1, 2 \frac{4}{1})$ O(ph) $15(1, 2 \frac{3}{1})$ K $16(1, 2 \frac{2}{1})$ C $17(1, 2 \frac{1}{1})$ Hi(orV)	$1(1, 6 \frac{13}{1})$ V $2(1, 6 \frac{12}{1})$ K $3(1, 6 \frac{11}{1})$ K $4(1, 6 \frac{10}{1})$ K $5(1, 6 \frac{9}{1})$ V $6(1, 6 \frac{8}{1})$ K $7(1, 6 \frac{7}{1})$ V $8(1, 6 \frac{6}{1})$ K $9(1, 6 \frac{5}{1})$ V $10(1, 6 \frac{4}{1})$ K $11(1, 6 \frac{3}{1})$ V $12(1, 6 \frac{2}{1})$ K $13(1, 6 \frac{1}{1})$ V nearly perfect Viro-Korchagin alternance misprint in Orevkov02, as this can be constructed by Hilbert, but correct in Viro 80	$1(1, 10 \frac{9}{1})$ V $2(1, 10 \frac{8}{1})$ K $3(1, 10 \frac{7}{1})$ V $4(1, 10 \frac{6}{1})$ K $5(1, 10 \frac{5}{1})$ V $6(1, 10 \frac{4}{1})$ K $7(1, 10 \frac{3}{1})$ V $8(1, 10 \frac{2}{1})$ K $9(1, 10 \frac{1}{1})$ V perfect Viro-Korchagin alternance	$1(1, 14 \frac{5}{1})$ Hi $2(1, 14 \frac{4}{1})$ K $3(1, 14 \frac{3}{1})$ V $4(1, 14 \frac{2}{1})$ K $5(1, 14 \frac{1}{1})$ Hi perfect Viro-Korchagin alternance (modulo Hilbert's patenting)	$1(1, 18 \frac{1}{1})$ V Optional comments the 6 schemes not yet understood (algebraically) prohibition misprint in Orevkov's table or in Viro1980-86-89's texts 4 schemes ruled out by Fiedler ca.79 36 new schemes ruled out by Viro 80/83 25 schemes ruled out by Viro's conj.	
				Constructors	Scores vs. total	
				Ha=Harnack1876	2	
				Hi=Hilbert1891	6	
				W=Wiman1923	7	
				G=Gudkov1972	9	
				K78=Korchagin78/89	1(+19)=20	
				V=Viro80	42	
				S=Shustin87/88	3+4	
				K=Korchagin89	19	
				C=Chevallier02	4	
				O=Orevkov02	1	
				O(ph)=pseudo-holomorphic model (Orevkov)	(3)	
					V84/86-Viro84/86	
					8	
					S91=Shustin90/91	
					5	
					O02=Orevkov02	
					2	
Total constructed	Ha=2, Hi=2, W=1, K=6, V=2, C=4, O=1	G=2, V=10, K=7	V=14, K=5	Hi=2, V=11, K=2, S=4	V=5, S=3	Exactly as stated in Viro80 or 83
Total	21	20	20	21	22	Total=104

Figure 154: The Viro-Orevkov table of M -octics: all the 104 Dalmatians forming the universe of logically possible schemes after the Fiedler-Viro obstruction (announced in Viro 1980 [1527] and detailed in Viro 1983/84 [1532]).

in case both bosons are prohibited. Of course Korchagin (and Chevallier) merely employ a (clever) variant of Viro's method. It is therefore not clear presently if the 6 bosons will succumb under another clever twists of Viro's method, or if they are new obstructions.

[02.05.13] It is hard to decipher any regularity in the Viro-Shustin-Korchagin-Orevkov table (Fig. 154). The combinatorics of this table is best appreciated by considering it as constituted of 3 pyramids (triangles), two of them having an edge "doubled". The first pyramid (schemes with 2 nonempty ovals) contains 4 mysterious bosons, namely $1 \frac{a}{1} \frac{19-a}{1}$ for $a = 1, 4, 7, 9$. Assuming that all these curves are not realized there would be some symmetry in the first pyramid. Conversely if the latter is symmetric, then at least the central schemes with $a = 4, 7$ would be prohibited by extending Orevkov's prohibition symmetrically. However in the second pyramid where the classification is complete, by virtue of the Viro obstruction (exposed by Korchagin-Shustin) there is a severe lack of symmetry, and apparent chaos is reigning. Of course "Gott würfelt nicht" (prose of A. Einstein, courtesy of Pharouk Garidi) and so some hidden symmetry can prevail. One should not exclude the possibility that the Viro-Shustin consensus on this second pyramid contains mistakes (this occurred to the best

workers, remember Gudkov's saga 1954/69/72). Finally the 3rd pyramid involving schemes of the form $a(1, b\frac{c}{1})$ with $a + b + c = 20$ is nearly settled, modulo 2 bosons which looks symmetrical. Like in degree 6, what could cause symmetry is the phenomenon of eversions. So maybe the Viro-Shustin asymmetry at the "top" of the 2nd pyramid could represent an obstruction to eversions, or vice-versa eversions could detect an anomaly in the present census. (As we learned from Kharlamov (letter in v.2 of Ahlfors) and Viro it seems that Gudkov's referee Morosov suggested so a possible mistake in Hilbert's immature census.) On more mature thinking the lack of symmetry is more a defect of our table than an intrinsic feature of the problem. So it can be an interesting problem to find a better diagrammatic than our table respecting some symmetry, and giving full swing to the Viro's eight (sporadic) prohibitions.

Another crucial philosophical aspect concerns the constructions. Viro's original method constructed 42 types of M -schemes. Admittedly all what came next to Viro's breakthrough, i.e. Shustin's 7 schemes, Korchagin 19 (new) schemes, and Chevallier's 4 schemes, are merely variants of Viro's method (yet along very clever twists). An exception is perhaps Orevkov's construction (2002) of the scheme $7(1, 2\frac{11}{1})$ by a method probably fairly distant from Viro's. So the ubiquity of Viro's method seems very slightly attacked, although it is of course not clear if Orevkov's scheme cannot be cooked à la Viro. *Added* [05.10.13].— This comment looks immature, as looking at Orevkov's paper one sees that is much akin to Chevallier's, which is pure Viro theory, yet for another singularity than X_{21} .

In recent literature, we often read that nearly all objects may be constructed along Viro's method (cf. e.g. Shustin 2005 [1425] where we read (p.3): "In 1979-80, O. Viro [29,30,31,32] invented a patchworking construction for real non-singular algebraic hypersurfaces. We would like to mention that almost all known topological types of real non-singular algebraic curves are realized in this way.") Cf. also Itenberg 2002 [707] (p.3) where we read: "Almost all the constructions in topology of real algebraic varieties since 1979 use the Viro method."

10.4 Naive questions on T -curves

For instance via the T -construction of Itenberg-Viro(-Orevkov) is it possible to gain Orevkov's scheme? Maybe experimentally nobody ever succeeded, but is there a proof that it cannot be obtained by this recipe? Recall that Haas's result (1997 [597]) implies that maximal T -curves respect Ragsdale $|\chi| \leq k^2$, but this does not answer our question. Maybe in degree 8, the T -construction can be programmed by a machine exploring all distribution of signs (and triangulations!) so as to assert that nothing more can be obtained by this device that what is already tabulated on Fig.154. In contradistinction, it could be just a matter of time until some machine traces a T -curve realizing a new M -octic. It would be actually interesting to know which schemes are realized by T -curves. Usually Itenberg's T -construction (which in Itenberg 1994 [698] is in part ascribed to Orevkov) is generally presented as a special case of Viro's method, yet probably is also somewhat stronger (or rather more flexible) remind for instance Itenberg's breakthrough on Ragsdale's problem (at the $(M - 2)$ -level). So it is fairly probable that the T -construction affords more than the 42 schemes derived by Viro's original method (within the limited set of dissipation envisaged in the 1980 paper).

Question 10.2 *Which M -schemes of degree 8 are realized via the T -construction? How many triangulations and distribution of signs exist in degree 8? Were they all listed and analyzed?*

Insertion [03.04.13] A paper contributing to this question is De Loera-Wicklin 1998 [353]. There some nice tables of schemes realizable via the T -construction are presented with focus on the critical degree $m = 8$ (the present frontier of

knowledge). However the quantity of M -schemes created by a random computer search browsing apparently a million of T -curves in degree 8 (cf. p.213 of *loc. cit.*) created only 2 types of M -curves namely $18\frac{3}{1}$ (cf. box on their Fig. 8) and $17\frac{2}{1}$ (cf. box on their Fig.9). Comparing with our Viro-Orevkov table (Fig. 154), those schemes are merely the first ever constructed namely by Harnack 1876. Hence, the De Loera-Wicklin computer search seems extremely disappointing. As they wrote on p.207: “The obtainable schemes of degree 8 are not yet classified, and no one knows which schemes are obtainable as T -curves.” The article contains a basic trick to keep track of all schemes on only 3 tables which are of course not enough as we have at least the 4 classes of pyramids depicted on the Viro-Orevkov table. [Added in proof: I am not sure to understand myself here.] So it is a good problem to know the number of sheets of paper required to depict all schemes of degree 8. As a last remark on their paper, it seems that the authors omit to use the RKM-congruence as to infer that their scheme on Fig. 8, with $(\alpha, \beta) = (15, 4)$ is of type I. Finally on p.211, we read a comment that we had some pain to interpret properly: “The data for regular triangulations indicates that Rohlin’s comment 20 years ago [18] continues to hold in view of this new data: nothing so far contradicts the conjecture that all real schemes not prohibited by known theorems are of indefinite type.” This is probably a complex way to reformulate Rohlin’s maximality conjecture that a scheme of type I kills all its enlargement. Of course their tables invite one to play the same game as we did in degree 6, namely smoothing the union of 4 ellipses to see what can be gained by this more elementary method. Probably their table is also much weaker than those compiled by Polotovskii 1988 [1209].

10.5 Riemann’s gyroscopic total reality

In sharp contrast it could be that all the 6 last M -schemes (or at least a good portion thereof) are prohibited say by Riemann’s method of total reality (cf. Gabard 2013B [471]) involving pencil of sextics with $B = M + (m - 4) = 22 + 4 = 26$ basepoints oddly distributed on each oval (so as to grant one bonus-intersection on each oval to reach total reality at $26 + 22 = 48 = 6 \cdot 8$). Alas, as yet we were not even able to recover the two Hilbert/Rohn prohibitions in degree $m = 6$ by this method (of the schemes 11 and $\frac{10}{1}$ respectively). However it may be argued that Hilbert’s and Rohn’s obstructions derive very simply from Rohlin’s formula. In degree $m = 6$, Rohlin’s formula affords less obstructions than Gudkov’s hypothesis but is it a general feature? In degree 8, is there any scheme of our table prohibited by Rohlin’s formula? We presume not but this requires a little exercise. Try for instance cavalier the (still open) scheme $1\frac{18}{1}$. Then $2(\pi - \eta) = r - k^2 = 22 - 16 = 6$ so that $\pi - \eta = 3$ and as $\pi + \eta = 19$ (the number of edges in Hilbert’s tree) the equation is (uniquely) soluble as $\pi = 11$ and $\eta = 8$. Further the signs-law affords no constraint (since there no deep edges available for concatenation). The dream could be that the dynamics of the electron(s) allied to the totally real pencil puts some restriction upon complex orientations (via the dextrogyration principle). Indeed any dividing (so in particular M -) curve appears as a *gyroscope*⁸ under a holomorphic map of Ahlfors or Riemann-Schottky-Bieberbach-Grunsky respectively. More specifically we have the phenomenon of total reality described in Gabard 2013B [471] (as recalled just above), and under such a sweeping one could try to infer the structure of complex orientations (as one is able to do in the trivial case of the deep nest via gyration along the pencil of lines). From this knowledge one may expect a contradiction with Rohlin’s formula. To be very specific we can prescribe the 4 extra basepoints either as a tower of 4 points concentrated on one oval or split them apart in two groups of mass 2. Deciding which distribution of basepoints is most instructive from the viewpoint of complex orientation is a puzzle even for the writer.

So meta-principle:

⁸Coinage of Emmanuel Boulé (ca. April 2013), the cousin of the writer.

Scholium 10.3 (*Riemann’s gyroscopic principle*).—*New (and probably even old) obstructions in Hilbert’s 16th (especially for M -curves) may be derived by a conjunction of Riemann’s gyroscopic principle of total reality combined with Rohlin’s complex orientation formula.*

The philosophy is that Rohlin’s formula alone explains the prohibition of Hilbert and Rohn in degree $m = 6$, but becomes quite impuissant in degree 8 (at least if Gudkov’s hypothesis is already imposed as on the Viro-Orevkov table, Fig. 154). Yet, perhaps when assisted by Riemann’s gyroscopic principle (1857) then Rohlin’s formula gain more swing and could rule out one of the 6 bosons not yet detected (compare with the metaphor by C. Taubes in Bull. AMS ca. 1994/96 on “particles” hard-to-detect, like Higgs’ bosons, when it comes to worry about possible exotic smoothness structure on the 4-sphere S^4).

To ensure total reality of an M -octic we have to distribute the $B = M + (m - 4) = 22 + 4 = 26$ basepoints on the 22 ovals plus the remaining 4 as either a tower (skyscraper) of height 4, or 2 mini-towers (twin-towers) of height 2. So we have up to continuous deformation as many total pencil as 22 (location of the skyscraper) or the binomial coefficient $\binom{22}{2} = \frac{22 \cdot 21}{2} = 11 \cdot 21 = 231$ many possible choices of total pencils. Which one (among those $22 + 231 = 253$ many) is the most clever choice in order to settle the question of the 6 bosons (e.g. $1\frac{1}{1}\frac{18}{1}$) via Riemann’s gyroscopic effect is hard to predict. One should first be capable visualizing pencil of sextics as to infer valuable information upon complex orientations. Of course it should also be noted that a priori the real scheme does not predestine (uniquely) the complex orientations (alias complex scheme), remember Marin’s example in degree $m = 7$ (cf. appropriate Fig. in v.2 of Ahlfors). It seems evident that Marin’s phenomenon prevails a fortiori in degree 8, and we cannot expect unique determination of the complex orientations from the real scheme.

Another remark is in order. We know that some schemes are realized pseudo-holomorphically (Orevkov 2002), and that Viro’s method without convexity assumption [so called C -curves] leads to pseudo-holomorphic curves (Itenberg-Shustin 2002 [706] and/or 2003 [708]). In the same source, it is also proved that C -curves are flexible curves in the sense of Viro 1986, hence subsumed to all classical obstructions of topological origins, in particular Rohlin’s formula (and even the Gudkov-Rohlin congruence). Hence there is no chance that Rohlin’s formula alone fixes Hilbert’s 16th in degree 8, and the full swing should come by the adjunction of the totally real pencil materializing a sort of transverse structure (à la Haefliger, etc.). So Riemann’s gyroscopic effect should play a tremendous role in the final elucidation of Hilbert’s 16th problem.

10.6 The extended Polotovskii tables of octics (deposited in VINITI? ca. 1985)

[10.05.13] To understand better Rohlin’s maximality conjecture (RMC) in degree 8 (where it is still open I think) it would be valuable to trace an extended table showing also the $(M - 1)$ - and $(M - 2)$ -schemes. [★ *Update*.—Meanwhile we think to have refuted Rohlin’s conjecture, cf. Lemma 7.1.] All this must be represented on the same plate in 3D so-to-speak. This is a fairly good avatar of the degree 6 Gudkov pyramid to degree 8, yet showing only the 3 top levels with resp. ca. 100, 200 and 400 schemes (recall the trinity of congruences allied to Gudkov *et cie.*). In fact our multi-pyramid (Fig. 155) was constructed by taking the Viro-Orevkov table of M -schemes (Fig. 154) while extending downwards to their servitude of $(M - 1)$ - and $(M - 2)$ -schemes. The plate so obtained is fairly massive and it took us circa one day just to dress its basic architecture (combinatorial structure) with the help of Adobe Illustrator. Alas this plate can globally only be consulted on a computer with moving resolution, so do not worry if you see nothing on the paper. Understanding the full architecture of this pyramid is tantamount settling Hilbert’s 16th in degree 8. Especially exciting is whether Rohlin’s maximality conjecture for schemes of type I holds

true in degree 8. [Same update as before, i.e. cf. ★ above.] Of course once this global plate will be updated (as to know exactly which schemes are realized we shall print all individual pyramids separately as to appreciate on paper-scale those great achievement of the Russian scholars (on both sides of Ural, i.e., Leningrad (Viro) and Gorki (Polotovskii, Shustin, Korchagin), plus the more recent contributors like Chevallier and Orevkov.

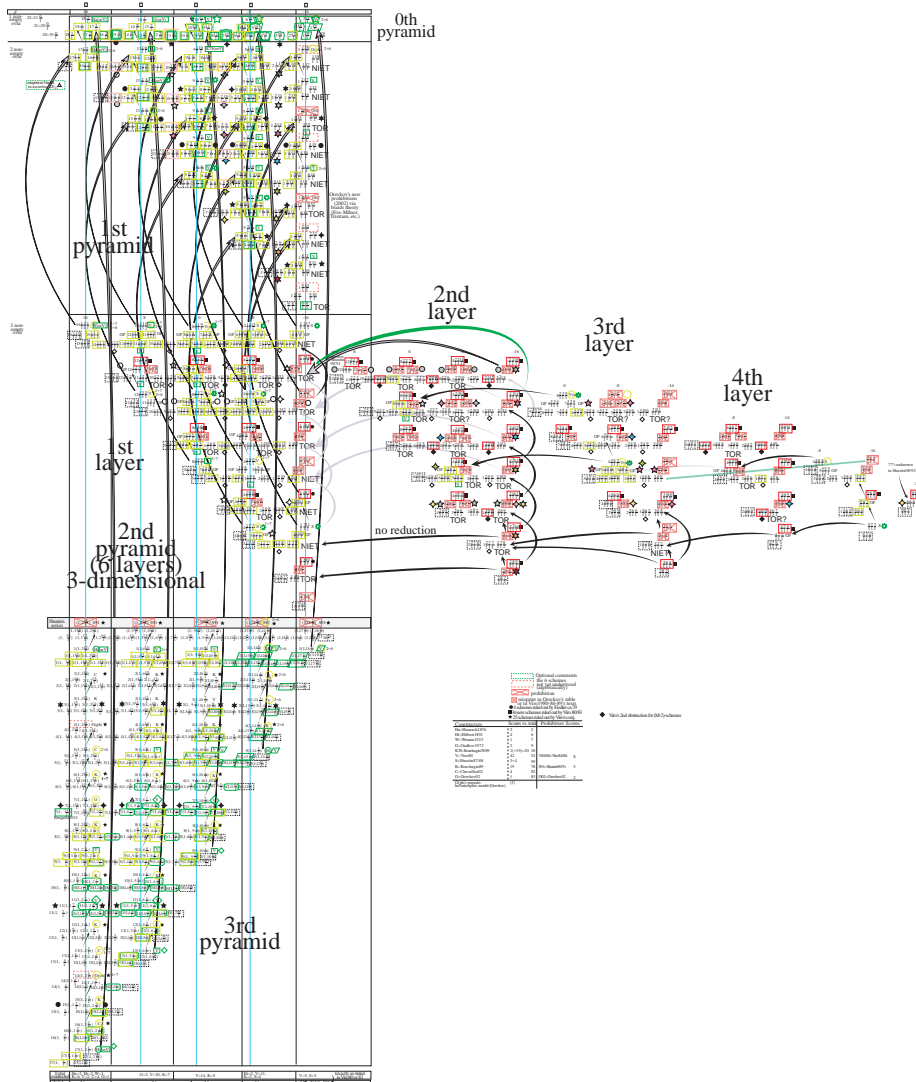

Figure 155: Viro-Polotovskii table for $m = 8$ (Viro 1980, Polotovskii 1983 published in VINITI): hard-to-read but enlargements on three sub-plates to be found subsequently (Figs. 156,157,158)

It is also a good exercise to appreciate Shustin's disproof of the other sense of Rohlin's maximality conjecture on the basis of this table (Fig. 155). Indeed the first Shustin scheme is $10\frac{1}{1}\frac{2}{1}\frac{4}{1}$ which is of type II by Arnold's congruence, but from the diagrammatic it is fairly clear that this scheme is maximal since by Viro's obstruction there is nothing above it. Actually, right above Shustin's scheme under examination (i.e. $10\frac{1}{1}\frac{2}{1}\frac{4}{1}$) we find $11\frac{1}{1}\frac{2}{1}\frac{4}{1}$ which is actually prohibited by a deep result of Shustin (cf. Shustin 1990/91 [1419, Thm 2]), which can be summarized as follows:

Theorem 10.4 (Shustin 1990/91).—All trined (M - 1)-schemes barred on Fig. 155 by a red-cross rectangle are prohibited. This involves a collection of exactly fifty (M - 1)-schemes (prohibited by Shustin). Basically, this Shustin obstruction can be summarized as follows. An (M - 1)-scheme is prohibited whenever it is immediately dominated (on Fig. 155) by an M-scheme prohibited by Viro's 1st law (imparity law for trined M-schemes), excepted when

it derives from another constructible M -scheme (constructed as a rule either by Viro or Shustin) as depicted on Fig. 155 via arrows. This system of degenerations (each interpretable as a contraction of an empty oval) explains all fifty obstructions of Shustin, but leaves open 2 cases namely the $(M-1)$ -schemes $\frac{6}{1}\frac{6}{1}\frac{6}{1}$ and $12\frac{2}{1}\frac{2}{1}\frac{2}{1}$ which though being immediately dominated by a Viro-prohibited M -scheme, yet non-dominated by a constructible scheme (for architectonic reasons, i.e. cf. Fig. 155) are not known to be prohibited. So those two case are 2 exceptions toward the synthesizing Shustin's 50 prohibitions (to an uniform prohibition of 52, like the Boeing B-52). (I am going like a Boeing.-Joke of Cornelius de Boeck.)

Actually, it must be remembered that this deep result of Shustin is not even logically required to refute RMC, because even if the scheme $11\frac{1}{1}\frac{2}{1}\frac{4}{1}$ existed (algebraically) then it would constitute itself a counterexample to RMC, by virtue of Klein's congruence and the maximality of the scheme granted by Viro's imparity law (VIL). Indeed, it must be noted that this $(M-1)$ -scheme cannot be enlarged into a quadruply nested one (without violating Bézout or total reality, i.e. maximality of the 2nd satellite of the quadrifolium). So it seems that the sole enlargement possible involves adding nested ovals, yet those operations (diminishing χ by 1) push the scheme outside of the GKK-range (Gudkov-Krakhnov-Kharlamov) as may be visualized on the main-Table (Fig. 155).

So we see that Shustin's example can be replicated at several places whenever we look at an $(M-2)$ -scheme where the Gudkov sawtooth is a broken-line and under the M -schemes prohibited by Viro. So once the geography is fixed it becomes nearly trivial to get a birdseye view upon all schemes coherently organized into a pyramid. In particular we can look at a "broken" $(M-2)$ -scheme below a Fiedler prohibited scheme, for instance $\frac{1}{1}\frac{2}{1}\frac{14}{1}$ and Shustin's argument probably applies as well here (after constructing the scheme via Viro's method or a suitable variant thereof). If this can be done we see that from the Germanic angle of view:

Scholium 10.5 *Fiedler's special case of Viro's imparity law certainly suffices to disprove Rohlin's maximality conjecture and so Klein vache as a byproduct.*

It is also interesting to wonder about Rohlin's maximality conjecture, i.e. a type I scheme is maximal. At first sight the conjecture looks trivially true for geographical reasons. More precisely in the above pyramid (Fig. 155) we see always Gudkov's sawtooth undulating piecewise linearly between maxima at M -schemes and minima at $(M-2)$ -schemes satisfying the RKM-congruence $\chi \equiv_8 k^2 + 4$ (forcing type I). Hence all those RKM-schemes (in the depression of the sawtooth) are of type I and (at first sight) maximal by virtue of the Gudkov-Rohlin and GKK congruences (which diagrammatically forbid direct enlargements of those schemes). However as we shall see there may be indirect enlargement somewhat more perfidious to visualize on the planar model of our pyramid. Actually upon looking carefully at the architecture of this main-table we see that the (unnested) $(M-2)$ -scheme 20 is RKK and so of type I (if it existed) and so would kill the 2 enlargements 21 and 22, thereby reproving nearly Petrovskii's bound $\chi \leq 19$ via Rohlin's maximality principle (RMC). Note yet two objections: first the scheme 20 does not exist as may be inferred either from Petrovskii's bound or from Rohlin's formula $2(\pi - \eta) = r - k^2$, hence as the left side vanishes we have $r = k^2 = 16$ many ovals and not twenty. Further the scheme 20 would kill as well a myriad of other $(M-1)$ -schemes on the row right above it (like $18\frac{2}{1}$, etc.) as well as larger M -schemes which are known to exist by classical (e.g. Harnack) or neoclassical methods (i.e. Viro).

10.7 Enlarged plates I, II and III

In this subsection we just reproduce the Hauptfigur (Fig. 155) on several sub-plates viewable at the normal printed size.

Our first plate is the first pyramid.

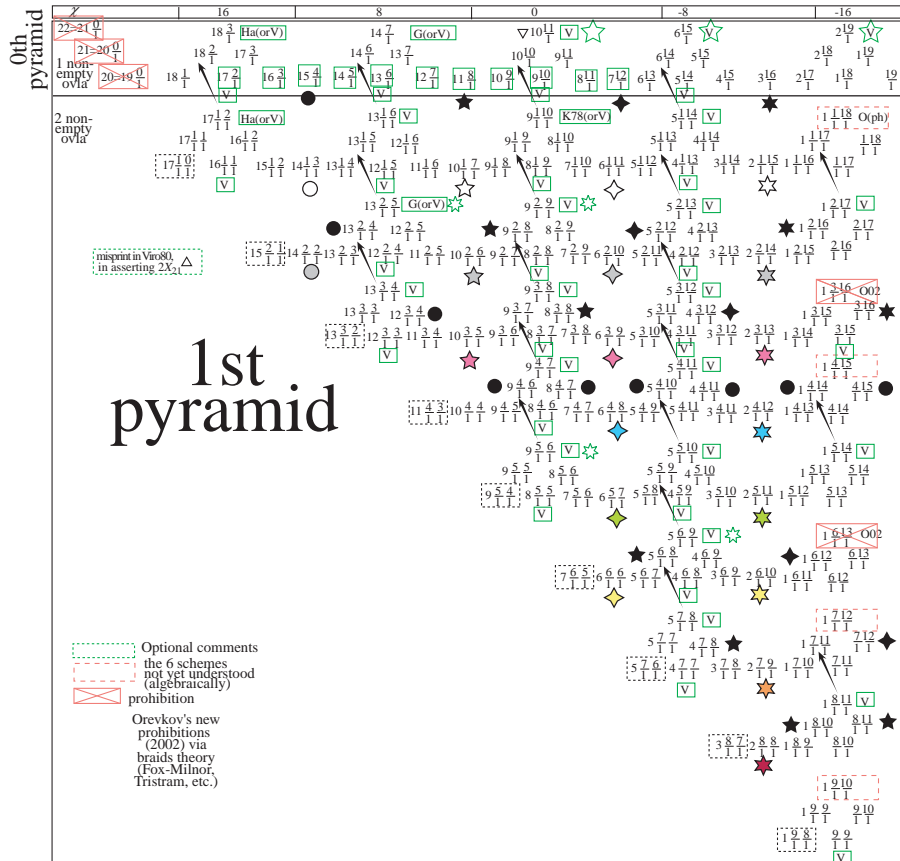

Figure 156: Zooming the 1st pyramid

Next, the second plate is the 2nd pyramid. To depict it at an acceptable scale, we had to break it like a snake.

Finally the 3rd plate is the 3rd pyramid.

Propagating the above reasoning, consider a geographical avatar of the scheme 20, namely two rows below the $(M - 2)$ -scheme $14 \frac{2}{1} \frac{2}{1}$ which is RKM. Granting RMC this should kill all its enlargements, it particular those where the additional oval separates the 14 outer ovals in two groups. Hence all schemes of the form $\alpha \frac{\beta}{1} \frac{2}{1} \frac{2}{1}$ where $\alpha + \beta = 14$ (or even 15) are killed. Those schemes are located in the second multi-pyramid (i.e. the 2nd row of the large table). This conclusion inferred from RMC is in agreement with Viro-Fiedler's prohibition via complex orientations. Actually, the scheme $12 \frac{2}{1} \frac{2}{1} \frac{2}{1}$ should likewise be prohibited, yet this is still unknown as we know since Shustin 90/91 (10.4).

On applying the same method to the RKM-scheme $10 \frac{3}{1} \frac{5}{1}$ we get enlargements by looking where the sub-symbol $\frac{3}{1} \frac{5}{1}$ appears in an $(M - 1)$ -scheme. Aided by our map, we locate so the schemes $7 \frac{3}{1} \frac{3}{1} \frac{5}{1}$, $4 \frac{3}{1} \frac{5}{1} \frac{6}{1}$, $3 \frac{3}{1} \frac{5}{1} \frac{7}{1}$. However on behalf of Shustin 90/91, it seems that all those 3 schemes were constructed in Goryacheva-Polotovskii 1985 [535] (abridged GP in the sequel). Hence existence of this RKM-scheme (with principal symbol $(3, 5)$) would corrupt Rohlin's maximality conjecture. So it may be reasonable to expect that our RKM-scheme does not exist algebraically. (*Update* [30.06.13].—With some more maturity, it seems rather more plausible that RMC is foiled, as we found even simpler counterexample to it, cf. e.g. Lemma 7.1.)

The game can be continued straightforwardly, cf. our map where sometimes we encounter no obstruction. However sometimes we get conflicts between RMC and construction claimed by Polotovskii (and cie.). So for the scheme $6 \frac{5}{1} \frac{7}{1}$ we look for the principal symbol $(5, 7)$ and discover on the table the scheme $4 \frac{2}{1} \frac{5}{1} \frac{7}{1}$, and also $3 \frac{3}{1} \frac{5}{1} \frac{7}{1}$. Both those $(M - 1)$ -schemes are constructed by GP, hence we get either a conflict with RMC or a prohibition of the initial RKM-scheme.

Along the same mode-of-thinking the RKM-scheme $6 \frac{6}{1} \frac{6}{1}$ offers an interesting twist. Looking at $(M - 1)$ -enlargement of its principal symbol $(6, 6)$, we find

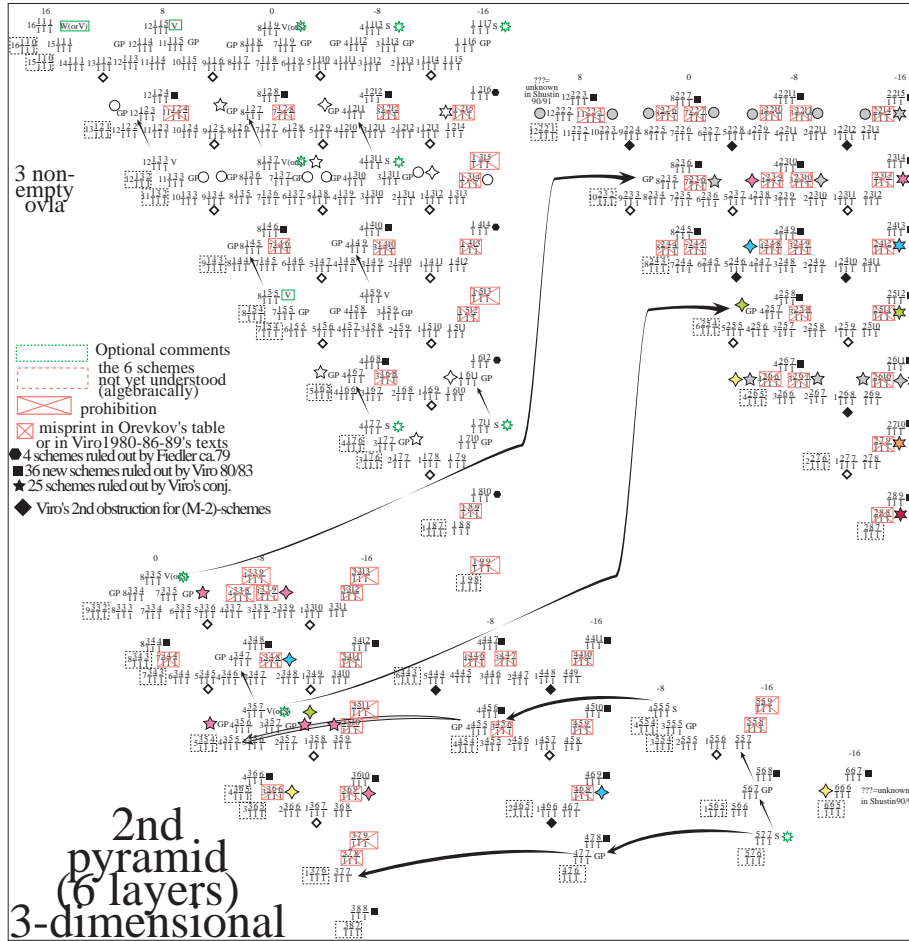

Figure 157: Zooming the 2nd pyramid

the schemes $4\frac{2}{1}\frac{6}{1}\frac{6}{1}$, $3\frac{3}{1}\frac{6}{1}\frac{6}{1}$, and finally $\frac{6}{1}\frac{6}{1}\frac{6}{1}$. Interestingly the first 2 schemes are prohibited by Shustin 90/91 [1419], while the third is not known to be realized. Hence there is some evidence that the original RKM-scheme exists.

Applying the same (heuristic) method to the RKM-scheme $S := 14\frac{1}{1}\frac{3}{1}$ gives enlargements of the shape $\alpha\frac{\beta}{1}\frac{1}{1}\frac{3}{1}$ with $\alpha + \beta = 14$ (or even 15). Those schemes are located on the first layer of the 2nd (3-dimensional) pyramid (specifically in its 2nd and 3rd rows). However some of those schemes (or their direct M -enlargements) are constructed by either Viro (or Shustin's method), for instance $12\frac{1}{1}\frac{3}{1}\frac{3}{1}$ (is claimed by Viro though we were incompetent enough to miss this as yet) or $8\frac{1}{1}\frac{3}{1}\frac{7}{1}$ (claimed by Viro, and which we were able to manufacture following Shustin). We arrive at an interesting psychological tension. Several logical issues are possible.

- First, it could be that the scheme in question (i.e. $14\frac{1}{1}\frac{3}{1}$) does not exist. (Added [30.06.13]: for a weak heuristic construction à la Viro, cf. our Fig. 104f.) This nonexistence looks a priori quite improbable as this scheme has nearby two (companion) M -schemes coming either from Harnack's $17\frac{1}{1}\frac{2}{1}$ or Viro's $13\frac{1}{1}\frac{6}{1}$ (cf. the Ha and V certificates/patents of construction on the table) which were both constructed earlier in this text by Viro's dissipation method (Fig. 6) in its most elementary incarnation (dissipation of 4 coaxial ellipses).

- Second it could be that Shustin's construction is erroneous. (Remind that as yet we were not able to realize $12\frac{1}{1}\frac{3}{1}\frac{3}{1}$ by Viro's method as asserted in Viro 1980.)

- Third it could be that we located a counterexample to RMC (Rohlin's maximality conjecture).

So see clearer it would be nice to construct the above scheme S (i.e. $14\frac{1}{1}\frac{3}{1}$). We think that this should be an easy matter, but let us look at related scheme probably even easier to construct.

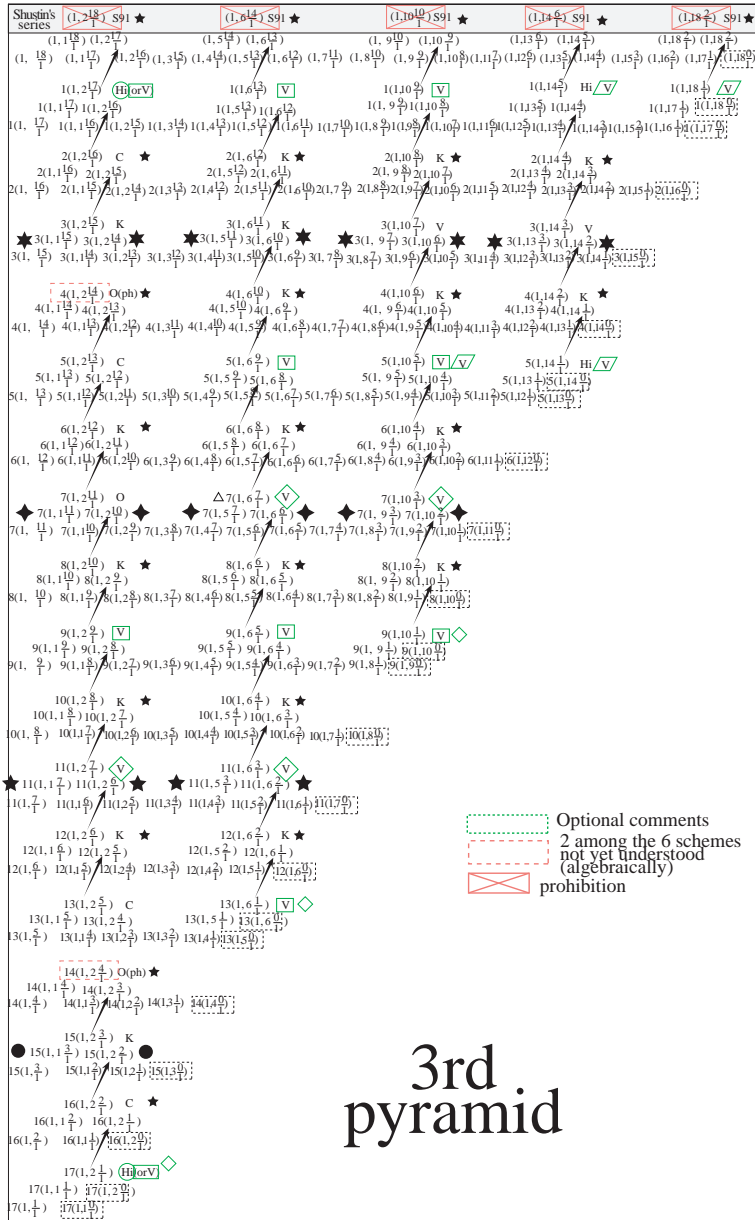

Figure 158: Zooming the 3rd pyramid

Let us repeat the same method to the RKM-scheme $S_0 := 15\frac{4}{1}$. Its enlargements have the shape $\alpha\frac{\beta}{1}\frac{4}{1}$ with $\alpha + \beta = 15$ (or even 16). Those are encountered in the 1st pyramid especially in its fourth row (while being depicted by black circular bullets). So the same conflict with Viro's method is obtained. Hence, either Viro's method is wrong (unlikely but personally we confess to have not yet understood its mechanism in all details), or Rohlin's maximality conjecture is false, or finally, the scheme $S_0 = 15\frac{4}{1}$ does not exist (algebraically). However since S_0 lies in the depression of the sawtooth between two M -schemes due to Ha=Harnack and G=Gudkov resp., yet most easily constructed via Viro (namely Ha= $18\frac{3}{1}$ and G= $14\frac{7}{1}$), it is likely that the scheme in question exists (albeit not readily obtained by the contraction principle for empty ovals). [Update [30.06.13].—For one construction of this scheme cf. Fig. 107k.]

Let us now try to check more pragmatically this point (realizability of S_0 defined above) to accentuate the paradox. So we look again at our earlier Fig. 6 of the elementary Viro method with 4 ellipses. A priori there is 2 options to create $(M - 2)$ -curves. Either employ a non-maximal dissipation of Fig. 6d where V_i is glued with its symmetric V_i^* , or use a maximal dissipation of an asymmetrical gluing like on Fig. 6c. Let us first explore this 2nd idea. First, look

at the left part of Fig. 6c (reproduced below as Fig. 159 for optical convenience) where we actually already tabulated the possible schemes in the tablet right-below that figure. Clearly as β is ≥ 1 we have (at least) two nonempty ovals and so our scheme S_0 is not realized. Next look at the middle part of the same Fig. c. Then we have a contorted oval (union of essentially 3 lunes). For the bottom β we can only choose 1 or 5. The latter being too much for S_0 (where 4 ovals are nested) we choose $\beta = 1$. But then the top α should be 3, which is however not a permissible value (cf. Fig. a). Let us now examine the 3rd configuration of Fig. c. Again for the bottom β we are forced to take $\beta = 1$. So our desideratum is to choose $\alpha + \gamma = 3$ on the top dissipation $V2^*$. However a glance at Fig. a shows that $\alpha + \gamma$ can only be 1, 5, 9, and so we fail constructing the desired curve.

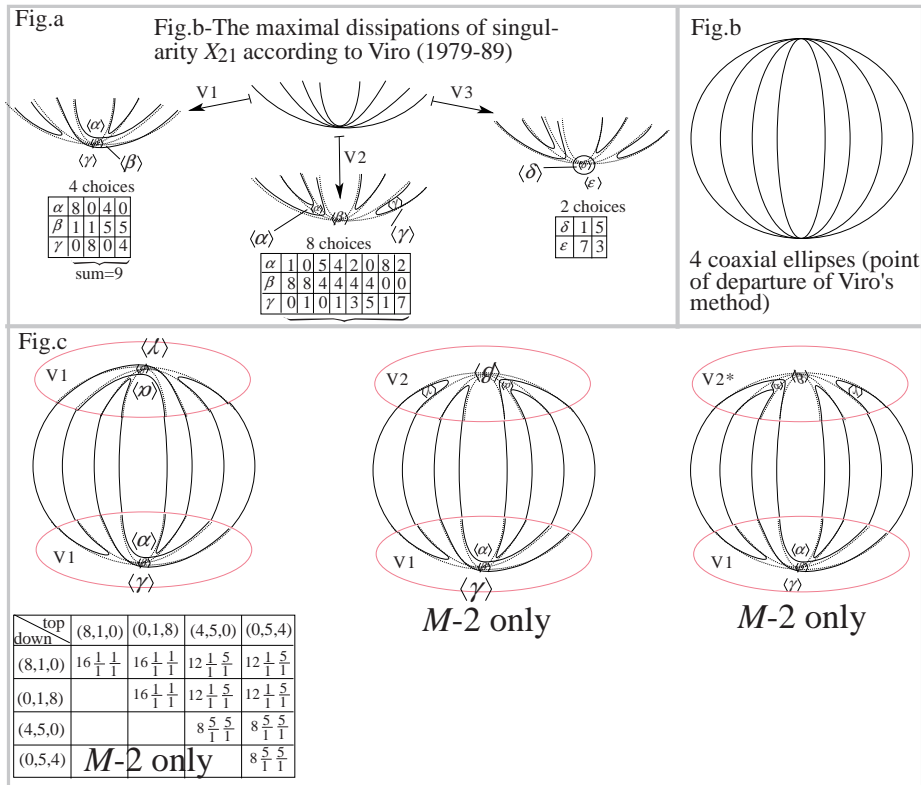

Figure 159: Viro's method for $(M - 2)$ -schemes

Of course all our game looks ancient Russian games à la Viro-Polotovskii of the early 80's. In literature, it is often asserted that Rohlin's maximality conjecture resisted all assaults of Viro's 1980 Red October revolution (cf. e.g. Polotovskii 1992 [1210]). So it seems that the scheme $S_0 = 15 \frac{4}{1}$ should not exist.

Recall at this stage that Viro has another obstruction for $(M - 2)$ -curves stating that if the content of a scheme with 3 nonempty ovals is divisible by 4 then two of the nested numbers are odd and one is even. This does not (alas) apply to the case at hand where there is only one nonempty oval. Yet it is worth reporting this obstruction via black rhombs on the main-table (Fig. 155). The resulting pattern is especially delightful of regularity and once more Viro's genius is baffling our spirit and requires highest admiration. What a pity just that nobody ever published this table (except perhaps in Viniti's preprint-series of Gorki not accessible in the west). It should be noted (from the geography of the main-table=Fig. 155) that Viro's hypothesis of divisibility by 4 of the content seems fulfilled precisely in the depressions (of Gudkov's sawtooth) corresponding to RKM-schemes. As the latter are of type I, it is very likely that this Viro obstruction involves again (like the imparity law) a matter of complex orientations.

This is very interesting but alas does not answer our query on the scheme $S_0 = 15 \frac{4}{1}$. So lacking a better idea let us turn to our first method of construc-

tion by using non-maximal dissipation of $2X_{21}$ (i.e. the coaxial quadruplet of ellipses). Alas on consulting again Fig. 55 on p. 1118 of Viro 89/90 [1535], we realize that only maximal dissipation are listed there. So what about the other permissible dissipation? [*Update* [01.07.13].—For some improvised tabulation of those non-maximal dissipations, see our Fig. 104, where we nearly got the curve in question $S_0 = 15\frac{4}{1}$ through Viro’s quadri-ellipse dissipation.]

10.8 Shustin’s fifty $(M - 2)$ -obstructions

[12.05.13] Another valuable piece of information is the table of Shustin 1990/91 [1419] of $(M - 1)$ -schemes with 3 nonempty ovals. This reports new obstruction due to Shustin and constructions made by Goryacheva-Polotovskii 1985 [535] (abridged GP on the table or below). Alas it seems that the 6th and 7th line of the first row contains a misprint. Perhaps one should read $(1, 6, 11)$ instead of $(1, 7, 11)$. So it seems that there was just a typographical permutation there.

At first sight Shustin’s table looks a bit chaotic since an $(M - 1)$ -scheme below the Fiedler-Viro M -prohibition is generically prohibited, but there are exceptions to the rule. For instance the scheme $\frac{1}{1}\frac{6}{1}\frac{11}{1}$ is constructed by GP, and this may be explained as a degeneration (better contraction) of Shustin’s M -scheme $\frac{1}{1}\frac{7}{1}\frac{11}{1}$. Same remark for $\frac{4}{1}\frac{7}{1}\frac{7}{1}$ which can be regarded as a contraction of Shustin’s M -scheme $\frac{5}{1}\frac{7}{1}\frac{7}{1}$. Likewise the $(M - 1)$ -scheme $\frac{5}{1}\frac{6}{1}\frac{7}{1}$ can be viewed as contraction of the same Shustin M -scheme. Next $4\frac{1}{1}\frac{2}{1}\frac{11}{1}$ also looks irregular but occur as degeneration of Shustin’s scheme $4\frac{1}{1}\frac{3}{1}\frac{11}{1}$. Hence Shustin’s list of scheme is therefore quite concomitant with the Itenberg-Viro contraction principle (see v.2), and the latter could be used to explain regularity of the sequence (through understanding the architecture of the pyramid). Precisely, whenever an $(M - 1)$ -scheme appears as degeneration of a constructed M -scheme then it appears in the GP-list of Goryacheva-Polotovskii. So for instance it is quite nice to visualize the 4 possible degenerations of (Viro-Shustin’s) scheme $4\frac{3}{1}\frac{5}{1}\frac{7}{1}$ (diminishing à tour de rôle any of the structural constants, i.e either $3\frac{3}{1}\frac{5}{1}\frac{7}{1}$, $4\frac{2}{1}\frac{5}{1}\frac{7}{1}$, $4\frac{3}{1}\frac{4}{1}\frac{7}{1}$, $4\frac{3}{1}\frac{5}{1}\frac{6}{1}$). In comparison Viro’s scheme $8\frac{3}{1}\frac{3}{1}\frac{5}{1}$ admits only 3 possible contractions. All this and more is best explained by the geometric view of this 3D-pyramid, when all 6 layers are imagined superimposed.

Further the 1st level of the 2nd pyramid can degenerate upon the 1st pyramid. For instance Viro’s M -scheme $8\frac{1}{1}\frac{3}{1}\frac{7}{1}$ can degenerate by contraction of an empty oval to $8\frac{0}{1}\frac{3}{1}\frac{7}{1} = 9\frac{3}{1}\frac{7}{1}$, which belongs to the 1st pyramid. Albeit we do not took the pain as yet to construct this very specific scheme (yet cf. Fig. 104 for a heuristic construct), its existence looks nearly evident for it may appear as contraction of many (at least two) other M -schemes, namely $9\frac{3}{1}\frac{8}{1}$ and $9\frac{4}{1}\frac{7}{1}$ (both obtained via Viro’s simplest method with a quadruplet of ellipses).

In conclusion, the principle of contraction makes all constructions mentioned in Shustin’s table (and implemented by Polotovskii et al.) look nearly evident. Shustin (or his typographer?) seems only to miss the $(M - 1)$ -scheme (immediately) below Wiman’s, i.e. $15\frac{1}{1}\frac{1}{1}\frac{1}{1}$. Further (as remarked by Shustin, *loc. cit.*) there are 2 interesting exceptions where the domination principle via contraction of an empty oval of an M -curve does not tell anything. First there is the $(M - 1)$ -symbol $S_{top} := \frac{6}{1}\frac{6}{1}\frac{6}{1}$ near the summit of the pyramid materialized by $\frac{6}{1}\frac{6}{1}\frac{7}{1}$ (yet ruled out by Viro’s parity law proved via complex orientations). So the status of $\frac{6}{1}\frac{6}{1}\frac{6}{1}$ is extremely puzzling, and perhaps still open today (a priori unaffected by the recent efforts of Chevallier, Orevkov ca. 2002 remodelling other portions of the pyramid). So if this scheme exists then it is quite likely to be maximal, yet not of type I. (For instance the enlargement obtained by adding one outer oval is not permissible via Gudkov’s hypothesis.) This would be another counterexample to the (reverse) sense of Rohlin’s maximality conjecture. On the other hand, if the scheme $\frac{6}{1}\frac{6}{1}\frac{6}{1}$ existed, we would by the contraction principle get the scheme $\frac{5}{1}\frac{6}{1}\frac{6}{1}$ which looks constructible being dominated by Shustin’s M -scheme $\frac{5}{1}\frac{7}{1}\frac{7}{1}$ (after 2 contractions).

Further another case left open by Shustin is the $(M - 1)$ -scheme $12\frac{2}{1}\frac{2}{1}\frac{2}{1}$. It is somewhat more surprising that this scheme does not fall under Shustin’s

prohibition (at least from an architectural viewpoint of a pyramid builder). Of course if the scheme existed it could degenerate to $12\frac{1}{1}\frac{2}{1}\frac{2}{1}$, which is likely to exist being dominated by $12\frac{1}{1}\frac{2}{1}\frac{3}{1}$ itself dominated by Viro's M -scheme $12\frac{1}{1}\frac{3}{1}\frac{3}{1}$ (which alas we were presently/personally not able to construct despite Viro's revendication of this territory).

Of course the philosophy of all this is the superiority of geometry upon arithmetics and symbolism (e.g. Shustin's linear table). After all, the abstract concept of integer just arose by visualizing sheep[s] ca. 50'000 BC (evidence of counting according to Boyer-Merzbach [183]).

All this does not, alas, answers our basic query about $S_0 := 15\frac{4}{1}$ (UPDATE: this is almost surely realized, cf. either Fig. 122 for a construction via Shustin's curve or Fig. 107k for one via Viro's 1st curve, or even Fig. 104f for a derivation from the quadri-ellipse yet with self-guessed accessory parameters (α, β, γ) .) On the table we reported its $(M-1)$ -enlargements by black circles. Those schemes are those of the 1st pyramid with the symbol $\frac{4}{1}$ occurring as substring. Further if the additional oval is traced inside the nonempty one then we get two schemes near the bottom of the 3rd pyramid, namely $15(1, 1\frac{3}{1})$ and $15(1, 2\frac{2}{1})$. But those being dominated by a Korchagin scheme (namely $15(1, 2\frac{3}{1})$) we get again a corruption of Rohlin's maximality principle (at least when combined with the contraction principle of Itenberg-Viro, but that is not needed actually).

Likewise we can trace all enlargements of the other RKM-schemes with one nonempty oval by using other symbols. For instance for $11\frac{8}{1}$ we get a trajectory of 5-branched stars on the main-table involving schemes running below Viro's M -schemes. So again a corruption of RMC is derived. The same remark applies to the schemes $7\frac{12}{1}$ and $3\frac{16}{1}$. So we arrive at the:

Lemma 10.6 *Either the four RKM-schemes with one nonempty oval are prohibited or Rohlin's maximality conjecture (RMC) is false. (Of course another dramatic issue would be that RMC is true but Viro's method is false!)*

Then we can apply the same method to the RKM-scheme $14\frac{1}{1}\frac{3}{1}$ and get a series of enlargements in the 2nd pyramid running below M -schemes constructed by either Viro (not understood by us as yet) or Shustin (clearly understood and depicted earlier in our text, cf. Fig. 121).

So again this RKM-scheme looks prohibited. One can continue the same game with the RKM-scheme $10\frac{1}{1}\frac{7}{1}$ and again we find in the 2nd pyramid symbols running below schemes constructed by Shustin. Idem for $6\frac{1}{1}\frac{11}{1}$.

Then we arrive at the RKM-scheme $2\frac{1}{1}\frac{15}{1}$. It admits one $(M-1)$ -enlargement in the 2nd pyramid (which is prohibited by Shustin's obstruction), and by Bézout it cannot be enlarged in the 3rd pyramid. So it seems that the scheme in question should exist. One can try to realize it via Viro's method but we failed after a quick try. To proceed more systematically let us tabulate what is gained by Viro's method for $(M-2)$ -schemes. Compare Fig. 160. The schemes so obtained always satisfy the Gudkov congruence mod 8 (i.e. lies 2 stages below certain M -curves). This is surprising but probably related to the fact that we use only the maximal dissipation. In fact, it seems that one can confine to the greatest table which is by far the most prolific in creating schemes. As for M -curves the sequence into which Viro's method creates schemes looks a bit random (for a modest intelligence like the writer but there is surely some hidden rule regulating this).

Of course it is fairly evident how to vary the construction to gain more schemes by using other curves or singularity. The difficulty is just to proceed as systematically as possible despite the varied choice. Some feeling for arts it a bit required, or at least patience. As yet the method is a bit disappointing as it did not generated any RKM-scheme (lying in the depression of sawtooth). Those are however the most interesting guys for testing Rohlin's maximality conjecture. In particular we expect that all RKM-schemes marked by large symbols (circles, stars with 5,4,6 branches either black or white colored) are not realized algebraically, safe for the scheme starred in white by 6 branches (i.e. $2\frac{1}{1}\frac{15}{1}$). However as yet we could not realize it.

of 122 schemes. (Maybe there is a little mistake in Viro at this place, which we actually cite via Brugallé 2005 [197], so that maybe the mistake is perhaps due to Brugallé). No in fact the explanation is that the scheme $\frac{14}{1}$ is not realized, since we cannot take $\beta = 14$ in (10.7).

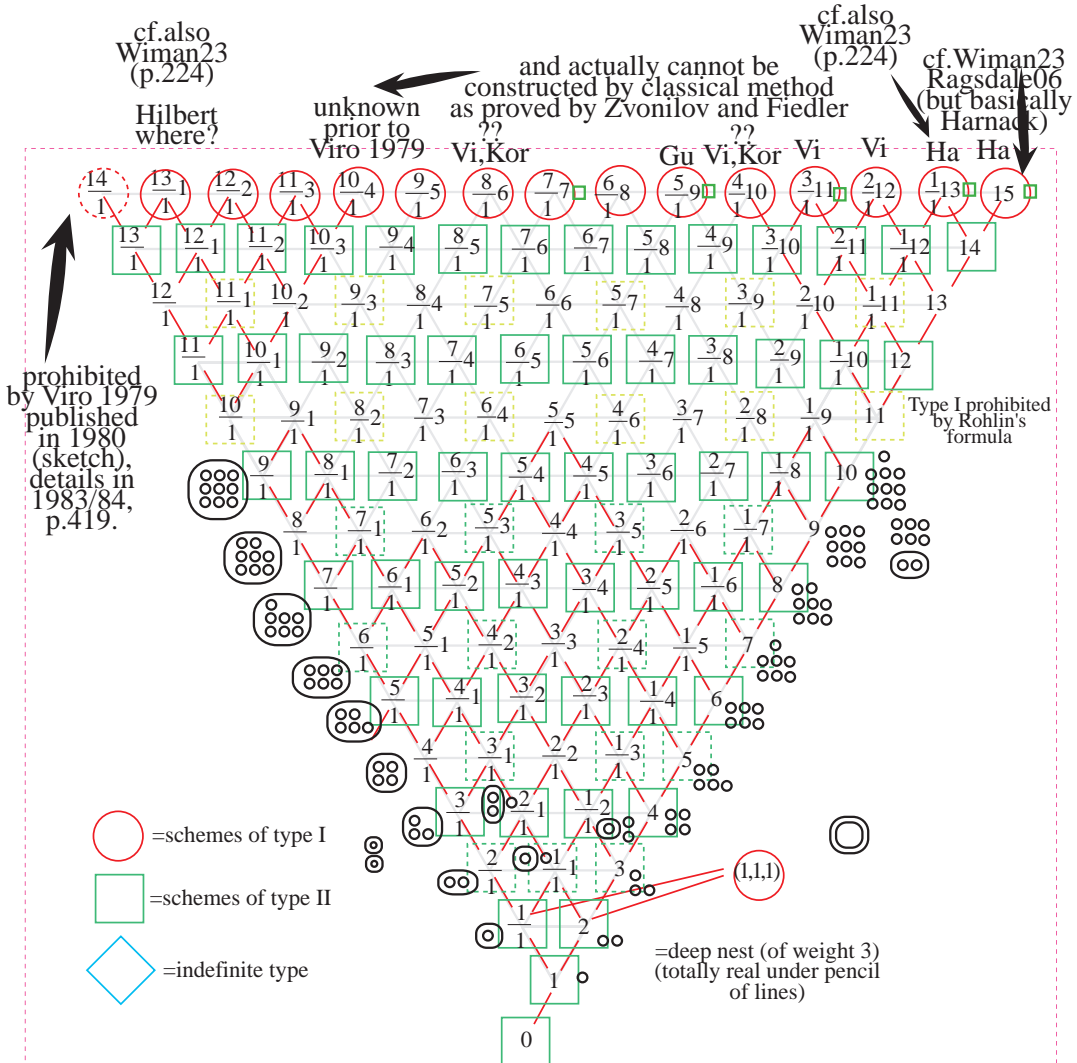

Figure 161: The Gudkov table in degree 7 due to Viro 1979 (details published slightly later, notably in Viro 1986 [1534])

Of course it would be also useful to enhance this Viro classification by the types I/II/indefinite in the sense of Klein 1876 (and Rohlin 1978). The first basic point is that with periodicity 2 all horizontal rows are of type II by Klein's congruence $r \equiv_2 g + 1$. Also by total reality the deep nest $(1, 1, 1)$ is of type I and so are all M -schemes by Klein 1876. Probably this affords the complete list of all type I schemes. Also by the Rohlin-Mishachev a dividing curve has at least $r \leq m/2 = 3.5$ components so we may infer that the scheme 1 is of type II (although this information is not covered by Klein's congruence). Further according to our "toutou" conjecture (in v.2 of Ahlfors) a scheme of type II remains of type II after addition of a pseudoline (while augmenting its degree by one unit). First when comparing with the Gudkov table in degree 6 we see that this principle recover a good portion of the type II inferences drawn automatically from Klein's congruence. But doing transfers at other levels (non predestined by Klein's congruence) yields a new collection of schemes of type I marked by dashed-green squares on Fig. 161. If this is true we suspect that this and more information (propagate the 2-by-2 lattice of dashed squares upwards, cf. yellow-green dashed squares) may be derived from Mishachev's formula (1975/76 [1019]), i.e. the odd-degree avatar of Rohlin's formula. Once this

extension is effected it is perhaps the case that all remaining schemes are of indefinite type. All this remains of course to be verified more seriously but is surely already well-known to Viro, Fiedler, etc (and perhaps even Rohlin).

Let us now do some constructions. Let us start with the sextic C_6 of scheme $\frac{2}{1}2$ and of type II depicted below while adding a line and smoothing consistently à la Fiedler so as to ensure type I. The resulting C_7 is of type I and realize the scheme $\frac{1}{1}3$. This spoils our toutou conjecture. For cross-reference let us state:

Proposition 10.8 *The toutou (= the doggy way) conjecture is false, i.e. a scheme of type II needs not staying of type II after aggregating a pseudoline.*

Proof. In fact our conjecture was motivated by the case of quintic where the conjecture toutou is true. However in degree 7 it is false as the sextic scheme $\frac{1}{1}3$ is of type II (cf. Rohlin's table (in v.2 of Ahlfors) as follows from either Arnold's congruence or Rohlin's formula), yet the same scheme augmented by a pseudoline is not of type II since it contains the dividing representative depicted on Fig. 162a. ■

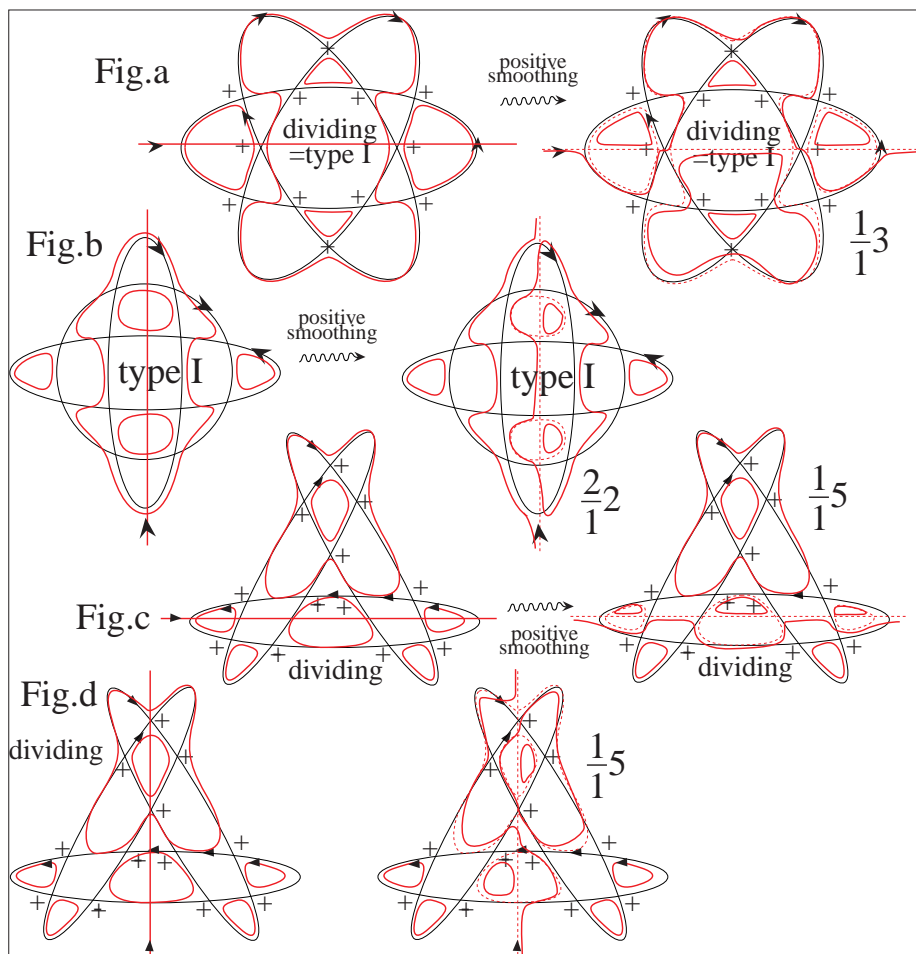

Figure 162: Corrupting the toutou conjecture

So in fact we would like to know exactly the distribution into the 3 possible types as Rohlin 1978 was able to do for sextics. The correct (and complete?) answer seems to be given by Brugallé 2005 [197, p.4] upon assembling the following 3 prohibitive results:

- elementary Bézout prohibitions;
- Fiedler's orientation alternating rule (cf. Viro 1986/86 [1534]);
- the Rohlin-Mishachev formula;

while combining at the constructive level with the articles by Soum 2001 [1448] and Le Touzé 1997 [422].

So taking for granted the two lemmas (1.2 and 1.3) stated by Brugallé 2005 [197], we arrive at the following corrected map. Hopefully this information is correct as we had not the patience to check all the details carefully. Crudely put we see that everything is governed by Klein's congruence safe the lower rows of blue rhombs which (at lower altitudes $r = 10, 8, 6, 4$) have lacunae probably explained by Mishachev's formula, while tending to contains an increasing number of schemes of type II as r decreases (thermodynamical interpretation?).

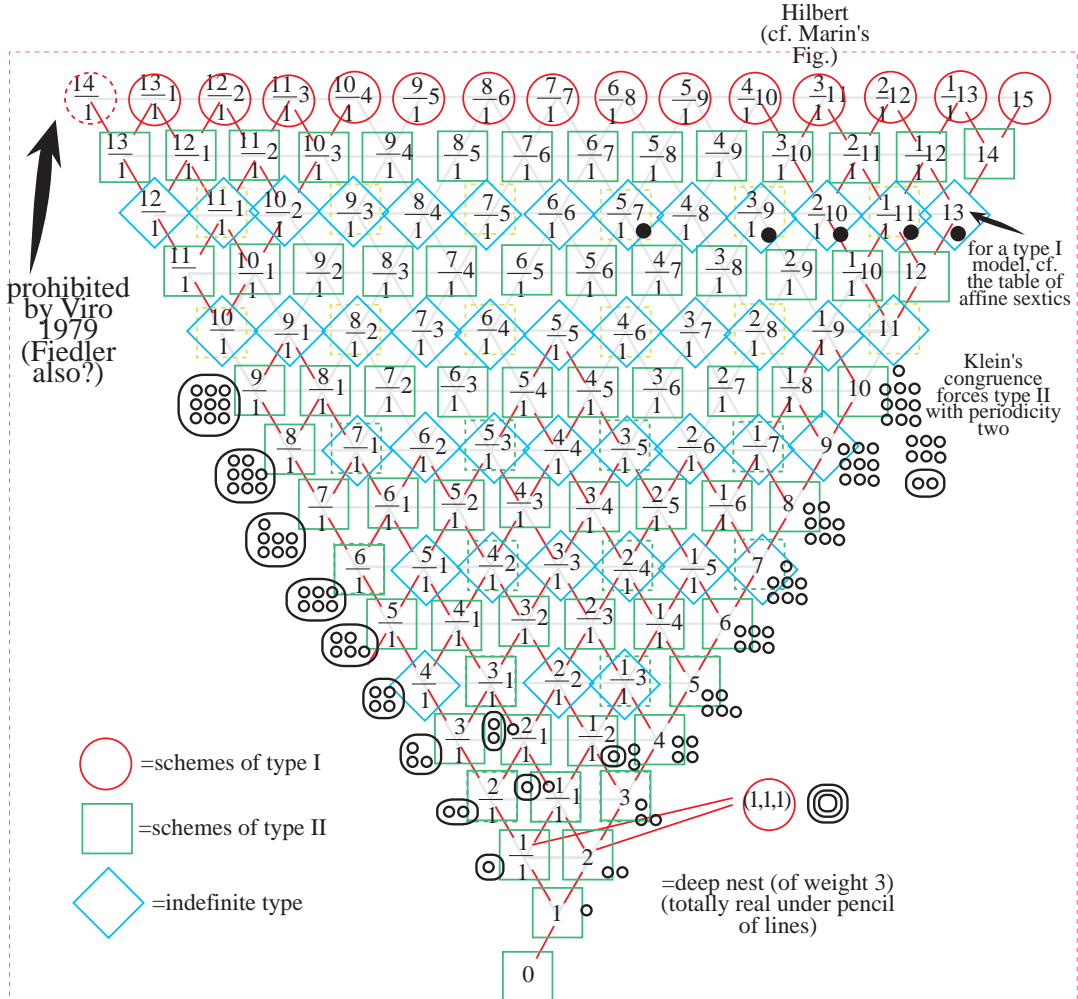

Figure 163: The Gudkov table in degree 7 due to Viro 1979 but decorated à la Klein-Rohlin with types (courtesy of Le Touzé 1997, Soum 2001, Brugallé 2005).

[03.05.13] An incomplete version of this Brugallé table was also published as Fig. 7 of De Loera-Wicklin 1998 [353, p. 204]. But this contains very sparse information on degree 7, in sharp contrast with the complete solution of Brugallé.

Of course by virtue of Marin's example (cf. v2 of Ahlfors) we cannot like in degree 6 expect the schemes plus the type data to form a unique rigid isotopy class. Yet Brugallé's result combined with Marin's "duplication" of chambers should produce a lower bound on the number of components past the discriminant of septic. Probably non body in the world has the slightest idea of the value of this number δ_7 . By using Brugallé only we get a lower bound of ca. the 121 schemes of Viro, plus some duplication on $13 + 11 + 8 + 6 + 3 = 39$ so that we get 160 components past the discriminant. By using Marin's argument this can be raised to 161. This is certainly far from sharp and we speculate that δ_7 could be as high as 500? Probably no technology like K3 surfaces and their periods tackling the case $m = 6$ is presently available. But can we get an upper bound on δ_7 ?

As another little remark it may be observed that Rohlin’s maximality conjecture holds true in degree 7 (as a consequence of Brugallé’s table), and even in the strong sense that a scheme is of type I iff it is maximal.

10.10 Acknowledgements

The author wishes to thank the following long list of geometers (in chronological order of their interaction with the writer in connection to the present text)

- Felice Ronga (ca. 1997/98 for his explanation of Brusotti’s theorem),
- Claude Weber, Michel Kervaire (for their explanations on how to classify Klein’s symmetric surfaces via the quotient bordered surface),
- Daniel Coray for the geometric Galois action and all his logistical support throughout the years (up to present days),
- Frédéric Bihan for pleasant freshman calculus discussions about real algebraic geometry,
- Lee Rudolph (ca. 1999 for explaining to us [Claude and me] what is the natural topological model for a real elliptic curve with only one “oval”, namely just a torus $S^1 \times S^1$ acted upon by factor permutation $(x, y) \mapsto (y, x)$ fixing thereby the diagonal circle),
- Alexis Marin, Viatcheslav Kharlamov, Oleg Viro, Jean-Jacques Risler, Thierry Vust, Michel Kervaire, Pierre de la Harpe, John Steinig (for their comments and corrections improving the shape of the article Gabard 2000 [461])
- Ragahavan Narasimhan, Jacek Bochnack (ca. 1999 for *not* having been in touch with Ahlfors’ result of 1950 [19] enabling me some free gestation about thinking on the problem)
- Manfred Knebusch for his kind interest in the modest work Gabard 2000 [461],
- Johannes Huisman for his constant interest (2001–04–06), and his care about correcting bugs in both my Thesis and the article Gabard 2006 [463],
- Sergei Finashin for an exciting discussion in Rennes 2001,
- Jean-Claude Hausmann (ca. 2000/01) for telling me about the standard surjectivity criterion via the Brouwer degree, which was decisive to complete Gabard 2006 [463],
- Antonio Costa, for his fascinating talks in Geneva,
- Bujalance for his surely over-enthusiastic Zentralblatt review of my article (Gabard 2006 [463]),
- Fraser-Schoen, whose brilliant work revived my interest in the theory of the Ahlfors’ mapping (ca. the 13 March 2011) at a stage were I was mostly sidetracked by “non-metric manifolds” due to the infectious fascination of Mathieu Baillif and David Gauld.
- Mathieu Baillif (the world leader de la Wissenschaft de gauche, especially, when it comes to the Dekrummante) is much acknowledged for all his wisdoms, partnership advices, and overall pleasant approach to life, science and arts. (Especially noteworthy is the obvious analogy between some of his minimalist picturing and those by Polotovskii in the qualitative theory of decomposing curve, see also the Petit Prince catalogue by Orevkov.)
- Elias Boulé, Tarik Garidi, Marie Pittet for frequent electronic support, and their patience about earring scenes of the adventure,
- Stepan Orevkov, Oleg Viro (2011) for their talks and pleasant discussions,
- Marc Coppens (2011–12) for e-mails, and his work on the separating gonality (2011 [322]) adumbrating sharper insights on the degree of the Ahlfors function (or rather the more general allied circle maps). His turning-point result appeals to a better conciliation of the analytic theory of Ahlfors with the algebro-geometric viewpoint.
- (2011/12) Hugo Parlier, Peter Buser, Alexandre Girouard, Gerhard Wanner und Martin Gander are acknowledged for their recent e-mail exchanges.
- (Oct. 2012) Daniel Coray for enlarging the capacity of my TeX-compiler, and for his lovely (Cambridge-style) teaching about the geometric Galois action in ca. 1999.

- (16 Nov. 2012) Franc Forstnerič for pointing out his text with Wold (2012 [453]) showing the state of the art on the proper holomorphic embedding problem.
- (09 Jan. 2013) Oleg Viro for his excellent answers on some naive questions on Rohlin’s paper (cf. v2 of Ahlfors);
- (10 Jan. 2013) Alexis Marin for his invaluable insights on Klein’s intuitions and more (cf. v2 of Ahlfors);
- (January-February-March 2013) Viatcheslav Kharlamov, Stepa Orevkov, Eugenii Shustin, Séverine Le Touzé, Thomas Fiedler for all their letters reproduced in (v2 of Ahlfors);
- (ca. 14/16 April 2013) Grisha Mikhalkin for pointing out that my idea of stability with satellites bears some resemblance with Wiman 1923 [1595] an intuition which turned to to be perfectly correct when I took the pain to read Wiman’s text in more details about one month later (the 09.05.13). Hence Wiman’s role as a sort of forerunner of Rohlin might be more emphasized (of course both admit some inspiration from Klein). Wiman’s idea of satellites is very acute relegate all of our priority in conjecturing a stability under satellites. To pinpoint a bit, Wiman only stresses maximality for satellites of his series of M -schemes (cf. Fig.4) whereas we conjecture it for any scheme of type I (so for instance for the double of Rohlin’s schemes in degree 6 satisfying the RKM-congruence).

11 Bibliographic comments

The writer does not pretend that the following bibliography is complete (nor that he absorbed all those fantastic contributions in full details). More extensive bibliographies (overlapping ours), but covering more material include those of:

- Ahlfors-Sario 1960 [26] (ca. 40 pages times 25 items per pages=1000 entries covering such topics as the Dirichlet problem, extremal problems, the type problem, the allied classification theory, etc.);
- Grunsky 1978 [568] (=562 refs, including 48 Books).

Most entries of our bibliography are followed by some comment explaining briefly the connection to our primary topic of the Ahlfors map. The following symbolism is used:

♣ serves to point out a special connection to Ahlfors 1950 (especially alternative proofs).

♠ gives other comments (attempting to summarize the paper contents or to explicit the connection in which we cite it).

★ marks sources, I could not as yet procure a copy.

• the stickers/sigles **A560**, **G78** are assigned when the source has already been cited in Ahlfors-Sario 1960 [26] resp. Grunsky 1978 [568].

• **A50** designates those references citing the paper Ahlfors 1950 [19] (there represents circa 106 articles on “Google”), and occasionally **A47** those quoting Ahlfors 1947 [18].

♡**n** is something like the indicator of the US rating agency (to be read “liked by n ”). It indicates the cardinal number **n** of citations of the paper as measured by “Google Scholar”. The latter machine often misses cross-citations, especially those in old books, or old articles with references given in footnotes format. Many sources cited in Grunsky’s book (1978 [568]) are never cited electronically. Accordingly, those rating numbers only supply a statistical idea of the literature ramifications lying beyond a given entry. Also low-citation articles are sometimes the most polished product ripe for museum entrance. Forelli 1979 [449] is typical: self-contained, elegant and polished proof of Ahlfors result, yet only rated by 3.

Our bibliography is somewhat conservative with comparatively few modern references. Our excuse is two-fold: modern expressionism is sometimes harder to grasp, and recent references are usually well detected through computer search.

(Papers are listed in alphabetical, and then chronological order, regardless of shared co-authorship.)

The primary focus is on the Ahlfors map and the weaker (but more general) circle maps. As a such the topic overflow slightly over the territory of real algebraic geometry. Ahlfors-Sario's book AS60 address Riemann surfaces, whereas Grunsky's book G78 focuses to the case of planar domains. Hence both bibliographies AS60, G78 are quite complementary, and ours is essentially a fusion of both, but we gradually included more and more recent contribution. Still additional references are welcome.

For conformal maps, it is helpful when browsing the vast literature to keep in mind the basic question: *what result through which method?*

Results. Objects traditionally range along increasing order of generality through: simply-connected regions, multiply-connected ones and finally Riemann surfaces. We often add a humble compactness proviso, as the passage to open objects is traditionally achieved through the exhaustion trick (going back at least to Poincaré 1883 [1189], and see also Koebe 1907 [823]), and active in recent time (e.g. Garabedian-Schiffer 1950 [498].)

As to the mappings, they may all be interpreted in some way or another as ramification of RMT (Riemann's mapping to a circle=disc). We distinguish primarily:

- CM=circle maps (usually not univalent, but multi-sheeted disc with branch, or winding points=Windungspunkte)
- KNP=Kreisnormierung(sprinzip) (univalent map to a circular domain)
- SM=slit mappings for various types of them (parallel, circular, radial, logarithmic spiral, etc.). Those are all allied to certain natural foliation of the sphere, and some extreme generality in this respect is achieved in Schramm's Thesis where any foliation is permitted as support for the slits.

Methods. They may be classified in two broad classes quantitative vs. qualitative (each having some branchings):

★ (Quantitative) variational methods, including:

- DP=Dirichlet principle (or more broadly speaking, potential theory=PT, centering around such concepts as the Green's function, harmonic measures (i.e. harmonic function with special null/one boundary prescription of the various contour), etc. Of course, there is a standard yoga between Dirichlet and Green, so all this is essentially one and the same method.

- IM=Iterative methods (originators: Koebe and Carathéodory), and by extension this may proliferate up to including the circle packings.

- EP=extremal problems (e.g. the one of maximizing the derivative amongst the class of function bounded-by-one) and leads to the Ahlfors map.

- BK=Bergman kernel (or Szegő kernel), here the fundamental ideas rest upon Hilbert's space methods, and the idea of orthogonal system. Initially, the method is also inspired by Ritz, and Bieberbach extremal problem (1914 [142]) for the area swept out by the function. Since the middle 1940's, there were found several conformal identities among so-called domain functions (Green's, Neumann's, etc.) and the kernel functions so that virtually this is now highly connected to DP≈PT. Also the Ahlfors map is expressible in term of the Bergman kernel (cf. e.g., Nehari 1950 [1078]) so that this heading is strongly connected to EP.

- PP=Plateau problem style methods (for RMT, this starts with the observation of Douglas 1931 [371]). This strongly allied to DP, albeit some distinction is useful to keep in mind just for cataloguing purposes.

★ (Qualitative) topological methods:

- the *continuity method*, as old as Schläfli, (as Koebe notices somewhere) is involved in the accessory parameters of Schwarz-Christoffel, in Klein-Poincaré's uniformization through automorphic functions, Brouwer (invariance of the domain), Koebe, etc., e.g. Golusin 1952/57 [534])

- Brouwer topological degree and the allied surjectivity criterion (cf. e.g., Mizumoto 1960 [1025], Gabard 2006 [463]). Here the idea is that there is some topological stability of the embedding of a curve into its Jacobian via the Abel

mapping in the sense that its homological features are insensitive to variation of the complex (analytic) structure (moduli), and this enables one to draw universal statements by purely topological considerations.

Finally we have attempted to manufacture a genealogy map showing the affiliation between the authors. The picture turned out to be so large that TeX prefers to reject it at the very end of the file.

[15.10.12] When I reached 884 references, I unfortunately met the so-called “TeX capacity exceeded, sorry.” obstruction (cf. Knuth’s “The TeX Book”, p. 300 for more details). Thus I had to deactivate some references which are not used for cross-citation, albeit they clearly belong to our topic. [16.10.12] This problem was ultimately solved by my advisor Daniel Coray, to whom I express my deepest gratitude for enlarging the TeX capacity of my compiler.

References

- [1] H. Abe, *On some analytic functions in an annulus*, Kodai Math. Sem. Rep. 10 (1958), 38–45. [♠ quoted in Minda 1979 [1013] in connection with the theta function expression of the Ahlfors function of an annulus] ♡??
 ★★★ Niels Henrik Abel (Finnøy 1802–Arendal 1829), Norwegian mathematician, contributing to the theory of elliptic integrals (and much more), among the first to prove the impossibility of solving the general equation of the fifth degree by radicals.
- [2] N. H. Abel, *Mémoire sur une propriété générale d’une classe très étendue de fonctions transcendentes*, présenté à l’Académie des Sciences à Paris le 30 octobre 1826; published (only) in: *Mémoires présentés par divers savants*, t. VII, Paris, 1841. Also in Œuvres, t. I, 145–211. [♠ first occurrence of Abel’s theorem, which in Gabard 2004/06 [463] is used as the main weapon toward proving existence of Ahlfors circle maps] ♡??
- [3] N. H. Abel, *Remarques sur quelques propriétés générales d’une certaine sorte de fonctions transcendentes*, Crelle J. Reine Angew. Math. 3 (1828). [♠] ♡??
- [4] N. H. Abel, *Démonstration d’une propriété générale d’une certaine classe de fonctions transcendentes*, Crelle J. Reine Angew. Math. 4 (1829), 201–202. [♠] ♡??
- [5] W. Abikoff, *The Real Analytic Theory of Teichmüller spaces*, Lecture Notes in Math. 820, Springer, 1980. [♠] ♡??
- [6] M. B. Abrahamse, *Toeplitz operators in multiply connected domains*, Amer. J. Math. 96 (1974), 261–297. [♠ extend to finite Riemann surfaces? try Alpay-Vinnikov 2000 [48]] ♡41
- [7] M. B. Abrahamse, R. G. Douglas, *A class of subnormal operators related to multiply connected domains*, Adv. Math. 19 (1976), 106–148. [♠ for extension to finite Riemann surfaces? try Alpay-Vinnikov 2000 [48], Yakubovich 2006 [1608]] ♡??
- [8] M. B. Abrahamse, J. J. Bastian, *Bundle shifts and Ahlfors functions*, Proc. Amer. Math. Soc. 72 (1978), 95–96. A47 [♠ the Ahlfors function of a domain R with n contours is applied to the calculation of a bundle shift (that is, a pure subnormal operator with spectrum contained in the closure of R and normal spectrum contained in the boundary of R)] ♡2
- [9] M. B. Abrahamse, *The Pick interpolation theorem for finitely connected domains*, Michigan J. Math. 26 (1979), 195–203. [♠ extend to finite Riemann surfaces? try Heins 1975 [637], Jenkins-Suita 1979 [719], both works subsuming in principle Ahlfors 1950 [19]] ♡??
- [10] N. A’Campo, *Sur la première partie du seizième problème de Hilbert*, Sém. Bourbaki 537 (1979). [♠ contains a nice picture of Hilbert’s method in degree 6 ♠ an exposition of Gudkov’s construction of the M -scheme $\frac{5}{1}$ omitted by Hilbert] ♡??
- [11] R. Accola, *The bilinear relation on open Riemann surfaces*, Trans. Amer. Math. Soc. ?? (1960), ??–??. A50 [♠] ♡31
- [12] J. Agler, J. Harland, B. J. Raphael, *Classical function theory, operator dilation theory, and machine computation on multiply-connected domains*, Mem. Amer. Math. Soc. 191 (2008), 159 pp. G78 [♠ cite Grunsky 1978 [568] and gives via the Grunsky-(Ahlfors) extremal function an interpretation of the Herglotz integral representation via the Kreĭn-Milman theorem ♠ [06.10.12] contains also a nice

- description of circle maps (in the form of half-plane maps, which seems to be directly inspired from Heins' treatment (1985 [639]) who probably offers an alternative derivation of Ahlfors' bound $r + 2p$) ♠ "In three chapters the authors first cover generalizations of the Herglotz representation theorem, von Neumann's inequality and the Sz.-Nagy dilation theorem to multiply connected domains. They describe the fist through third Herglotz representation and provide an ...]" ♥9
- [13] D. Aharonov, H. S. Shapiro, *Domains on which analytic functions satisfy quadrature identities*, J. Anal. Math. 30 (1976), 39–73. G78 [♠ includes the result that the Ahlfors map of a quadrature domain is algebraic, see also papers by Gustafsson, Bell, etc.] ♥126
- [14] P. R. Ahern, D. Sarason, *On some hypo-Dirichlet algebras of analytic functions*, Amer. J. Math. 89 (1967), 932–941. [♠] ♥??
- [15] P. R. Ahern, D. Sarason, *The H^p spaces of a class of function algebras*, Acta Math. 117 (1967), 123–163. [♠ "This paper is a study of a class of uniform algebras and of the associated Hardy spaces of generalized analytic functions. It is a natural continuation of a number of similar studies which have appeared in recent years; see Bochner [7], Helson and Lowdenslager [15], ...]" ♥53
- [16] P. R. Ahern, *On the geometry of the unit ball in the space of real annihilating measures*, Pacific J. Math. 28 (1969), 1–7. A50 [♠ Ahlfors 1950 [19] is cited on p.4, yet not exactly for the result we have in mind, but see also the related paper Nash 1974 [1058] where the fascinating study of the geometry of the convex body of representing measures is continued ♠ [13.10.12] it could be fascinating to penetrate the geometry of this body in relation to the "link" (collection of circles in the "same" Euclidean space \mathbb{R}^g , where g is the genus of the double), as it occurs in Ahlfors original proof 1950 [19]). Understanding this is probably the key to a sharper understanding of circle maps, in particular of their lowest possible degrees] ♥5
- [17] L. V. Ahlfors, H. Grunsky, *Über die Blochsche Konstante*, Math. Z. 42 (1937), 671–673. [♠ not directly relevant to this text, except for the hardness of some extremal problems. Compare the front cover of Grunsky's Coll. Papers for a depiction of the hyperbolic tessellation allied to the conjectured extremal function. Basically one consider in the Euclidean plane \mathbb{C} the triangulation by equilateral triangles and above it in the hyperbolic disc one manufactures a equilateral triangle of angle the half value namely $\pi/6$. Mapping conformally (via Schwarz-Christoffel) this hyperbolic triangle to the fatter Euclidean triangle, while reproducing this map by the (Riemann)-Schwarz principle of reflection yields a function conjectured to have extremal Bloch constant. The latter amounts to have the largest schlicht disc avoiding the ramification. In our case the densest packing (à la Kepler) is clearly the equilateral triangulation of \mathbb{C} , so the above Ahlfors-Grunsky function is the natural candidate for having the maximum Bloch radius, alas nobody ever succeeded to show this. Similar problems make sense for other geometries, e.g. planar to spherical, in which case the Bloch constant was estimated in the breakthrough of Bonk-Eremenko, ca. 2002] ♥47?
- [18] L. V. Ahlfors, *Bounded analytic functions*, Duke Math. J. 14 (1947), 1–11. AS60, G78 [♣ the planar case of Ahlfors 1950 [19], cite Grunsky 1940–42 [563, 564] as an independent forerunner ♠ albeit less general than the next item (Ahlfors 1950 [19], which includes the case of positive genus) this article is more quoted that its successor essentially due to the intense activity centering around analytic capacity and the Painlevé null-sets implying a super vertical series of workers like Vitushkin, Melnikov, Garnett, Calderón 1977 [222], David, etc. culminating to Tolsa's 2002/03 [1496] resolution of the Painlevé problem ♠ as a detail matter, it may be recalled that the present article contains a minor logical gap fixed in Ahlfors 1950 [19] (cf. the later source, especially footnote p.123) and also the "Commentary" in the Collected papers Ahlfors 1982 [30, p. 438]: "When writing the paper I overlooked a minor difficulty in the proof. This was corrected in [36](=Ahlfors 1950 [19])." ♠ compare also the comment in the German edition of Golusin 1952/57 [534, p.415, footnote 2]: "Der bisherige Beweisgang erlaubt es nicht, zu schließen, daß keine der $n - 1$ Nullstellen eine mehrfache ist. Diese Lücke des AHLFORSschen Beweises wurde von P. R. Garabedian in seiner Dissertation (=1949 [495]), beseitigt., Anm. d. Red. d.deutschen Ausgabe." ♥180
- [19] L. V. Ahlfors, *Open Riemann surfaces and extremal problems on compact subregions*, Comment. Math. Helv. 24 (1950), 100–134. AS60, G78 [♣ the central reference of the present article ♣ contains the first existence-proof of a circle map on a

- general compact bordered Riemann surface ♣ in fact both a qualitative existence result as well as a quantitative extremal problem are presented] AS60, G78 ♡106
- [20] L. V. Ahlfors, A. Beurling, *Conformal invariants and function-theoretic null sets*, Acta Math. 83 (1950), 101–129. AS60, G78 ♡high 300?
- [21] L. V. Ahlfors, *Development of the theory of conformal mapping and Riemann surfaces through a century*. In: *Contributions to the Theory of Riemann Surfaces. Centennial Celebration of Riemann's Dissertation*, Annals of Math. Studies 30, 3–13, Princeton 1953; or *Collected Papers*, Vol. 1, 1929–1955, Birkhäuser, 1982. [♠ a colorful historical survey of Riemann, Schwarz, Poincaré, Koebe, Nevanlinna, Grötzsch, Grunsky and Teichmüller] ♡??
- [22] L. V. Ahlfors, *Variational methods in function theory*. Lectures at Harvard University, 1953 transcribed by E. C. Schlesinger. [♠ cited in Read 1958 [1243]. Does this contain another (more pedestrian) treatment of Ahlfors 1950 [19]?]★★ ♡??
- [23] L. V. Ahlfors, *On quasiconformal mappings*, J. Anal. Math. (Jerusalem) 3 (1953–54), 1–58. (+Erratum) [♠] ♡??
- [24] L. V. Ahlfors, *Extremalprobleme in der Funktionentheorie*, Ann. Acad. Sci. Fenn., A.I., 249/1 (1958), 9 pp. [♠ survey like, but pleasant philosophy] ♡3?
- [25] L. V. Ahlfors, *The complex analytic structure of the space of closed Riemann surfaces*, In: *Analytic functions*, Princeton Univ. Press, 1960, 45–60. [♠] ♡??
- [26] L. V. Ahlfors, L. Sario, *Riemann Surfaces*, Princeton Univ. Press, 1960. ♡946
- [27] L. V. Ahlfors, *Classical and contemporary analysis*, SIAM Review 3 (1961), 1–9. ♡??
- [28] L. V. Ahlfors, *Complex Analysis*, McGraw-Hill Book Co. (2nd ed.), 1966. [♠ p. 243–253 proof of the PSM (and other radial/circular avatars) via the Dirichlet principle] ♡2500?
- [29] L. V. Ahlfors, *Lectures on Quasiconformal mappings*, Van Nostrand, Princeton, NJ, 1966, 146 pp. [♠] ♡??
- [30] L. V. Ahlfors, *Collected Papers, Vol. 1, 1929–1955*, Birkhäuser, 1982. [♠ p. 438 is worth quoting in extenso: “The point of departure in [30](=Ahlfors 1947 [18]) is Painlevé’s problem: Given a compact set $E \subset \mathbb{C}$, when does there exist a nonconstant bounded analytic function $f(z)$ on $\mathbb{C} \setminus E$? I was really interested in the function with the smallest upper bound of $|f(z)|$ when normalized so that $f(z) \sim 1/z$ at ∞ . This smallest maximum is now called the *analytic capacity*⁹ of E , and the Russians¹⁰ used to refer to the extremal function, if it exists¹¹, as the “Ahlfors function”, an unexpected and probably unearned distinction. In this form Painlevé’s problem is closely related to the precise form of Schwarz’s lemma¹² for an arbitrary region, and that is what the paper is actually about. To be specific: if $\Omega \subset \mathbb{C}$ is a region and if $|f(z)| \leq 1$ in Ω while $f(z_0) = 0$ for a given $z_0 \in \Omega$, exactly how large can $|f'(z_0)|$ be?—The difficulty lies in the fact that while $u = \log |f(z)|$ is a harmonic function with a logarithmic pole at z_0 , the single-valuedness of f translates into diophantine conditions on the conjugate harmonic function v . Quite obviously this makes the problem much harder than if only the absolute value $|f(z)|$ were required to be single-valued.—In my paper I restrict myself to a region Ω of finite connectivity n , and my aim is to describe the extremal function $f(z)$. I show that $|f(z)| = 1$ on the boundary and that f has exactly $n - 1$ zeros¹³. In other words, f maps Ω on an $n - 1$ times covered disk¹⁴. In

⁹According to Havinson 2003/04 [623], this terminology is due to Erokhin 1958: “In accordance with V. D. Erokhin’s proposal (1958), the quantity $\gamma(F)$ has been called the *analytic capacity* or the *Ahlfors capacity* since that time.”

¹⁰Who exactly? candidates: Golusin, Havinson, Havin, Vitushkin, etc., but see also Nehari (alias Willi Weisbach) as early as 1950. Indeed, “Ahlfors’ extremal function” occurs already in Nehari’s survey 1950 [1079, p. 357], and “Ahlfors mapping” alone occurs in Nehari 1950 [1078, p. 267]. This probably beats any Russian contribution, for one of the first texts is Golusin 1952/57 [534], where actually the term “Ahlfors function” is not employed. However Havinson torrential list of publication on the topic starts as early as 1949 [617].

¹¹Existence is ensured under the mild condition that the domain supports nonconstant bounded analytic functions.

¹²A coinage of Carathéodory, cf. Carathéodory 1912 [230].

¹³This seems to be a misprint, and should be “ n zeros” ([27.09.12]). Further it is tacitly assumed that the domain is bounded by Jordan curve, for pointlike punctures are removable singularities hence do not affect the Ahlfors function. To be concrete making $(n - 1)$ punctures in the unit disc the domain reaches connectivity n but its Ahlfors function is still the identity as if there were no punctures.

¹⁴Again “ n times covered disk” sounds more correct.

addition there are conditions on the location of the zeros¹⁵. When writing the paper I overlooked a minor difficulty in the proof. This was corrected in [36](=Ahlfors 1950 [19]).—The purpose of [36](=Ahlfors 1950 [19]) was to study open Riemann surfaces by solving extremal problems on compact subregions and passing to the limit as the subregions expand. The paper emphasizes the use of harmonic and analytic differentials in the language of differential forms. It is closely related to [35](=Ahlfors-Beurling 1950 [20]), but differs in two respects: (1) It deals with Riemann surfaces rather than plane regions and (2) the differentials play a greater role than the functions.—I regard [36] as one of my major papers. It was partly inspired by R. Nevanlinna, who together with P. J. Myrberg (1954¹⁶) had initiated the classification theory of open Riemann surfaces, and partly by M. Schiffer (1943 [1346]) and S. Bergman (1950 [123]), with whose work I had become acquainted shortly after the war. The paper also paved the way for my book on Riemann surfaces with L. Sario (1960 [26]), but it is probably more readable because of its more restricted contents.—I would also like to acknowledge that when writing this paper I made important use of an observation of P. Garabedian to the effect that the relevant extremal problems occur in pairs connected by a sort of duality. This is of course a classical phenomenon¹⁷, but in the present connections it was sometimes not obvious how to formulate the dual problem.”] ♡??

- [31] L. V. Ahlfors, *The Joy of function theory*, ca. 1984. [♠ p.443: “It has been customary to write about the joy of everything, from the joy of cooking to the joy of sex, so why not the joy of function theory?” ♠ p.444: “I remember vividly how he [=Lindelöf] encouraged me to read the collected papers of Schwarz and also of Cantor, but he warned me not to become a logician, for which I am still grateful. Riemann was considered too difficult, and Lindelöf never quite approved of the Lebesgue integral.” ♠ p.445: “It is impossible to change an analytic function at or near a single point without changing it everywhere. This crystallized structure is a thing of great beauty, and it plays a great role in much of nineteenth-century mathematics, such as elliptic functions, modular functions, etc. On the other hand, it was also an obstacle, perhaps most strongly felt in what somewhat contemptuously was known as “Abschätzungsmathematik”. Consciously or subconsciously there was a need to embed function theory in a more flexible medium. For instance, Perron used the larger class of subharmonic functions to study harmonic functions, and it had also been recognized, especially by Nevanlinna and Carleman, that harmonic functions are more malleable than analytic functions, and therefore a more useful tool.”] ♡??
- [32] V. B. Alekseev, *Abel’s Theorem in Problems and Solutions*, Nauka, Moscow, 1976. (Russian).★ ♡??
- [33] Ju. E. Alenicyn, *On some estimates for functions regular in a region of finite connectivity*, (Russ.) Mat. Sb. N. S. 49 (1959), 181–190. G78 ★ ♡??
- [34] Ju. E. Alenicyn, *An extension of the principle of subordination to multiply connected regions*, (Russ.) Trudy Mat. Inst. Steklov 60 (1961), 5–21; Amer. Math. Soc. Transl. (2) 43, 281–297. G78 ★ ♡??
- [35] Ju. E. Alenicyn, *Conformal mappings of a multiply connected domain onto many-sheeted canonical surfaces*, (Russ.) Izv. Akad. Nauk SSSR, Ser. Mat. 28 (1964), 607–644. G78 ♡??
- [36] Ju. E. Alenicyn, *An estimate of the derivative in certain classes of function, analytic in a multiply connected domain*, Zap. Nauch. Sem. Leningrad Otdel. Mat. Inst. Steklov 24 (1972), 6–15; English transl. (1974), 565–571. G78 [♠ Ahlfors extremal problem is recalled and extended to a more general setting, where instead of considering functions bounded-by-one in modulus, there is some continuous positive function $\lambda(z)$ defined on the contour which acts as the upper-bound over the permissible modulus via $\limsup_{z \rightarrow z_0 \in \partial D} |f(z)| \leq \lambda(z_0)$] ♡??
- [37] Ju. E. Alenicyn, *Inequalities for generalized areas for multivalent conformal mappings of domains with circular cuts*, Translated from Matematicheskie Zametki 29 (1981) 387–395; [♠ extension of the result of Vo Dang Thao 1976 [1545] and Gaier

¹⁵This is indeed one of the fascinating difficulty also discussed in A. Mori 1951 [1040] and Fedorov 1991 [410], who coins the lovely prose of a “rather opaque condition must be satisfied”.

¹⁶Here there is maybe a wrong cross-reference and Myrberg 1933 [1051] was rather understood?

¹⁷Can one be more explicit? Hahn-Banach like in Read 1958 [1243] or Royden 1962 [1305] or just something more in the realm of classical analysis.

- 1977 [474] (which the latter ascribes to Grötzsch 1931 [559]) ♠ this is close to (but not exactly) the desideratum that Bieberbach’s minimum problem (1914 [142]) yields another interpretation of the Ahlfors circle map when extended to multiply-connected domains ♠ p.202 a cross-reference to Nehari 1952 [1081] is given, but this does not really answer our question whether the minimal map (of least area) is a circle map (it is just observed that in higher-connectivity it is *not* schlicht) ♡??
- [38] Ju. E. Alenicyan, *Least area of the image of a multiconnected domain of p -sheeted conformal mappings*, Translated from *Matematicheskie Zametki* 30 (1981) 807–812; [♠ extension of the result of Vo Dang Thao 1976 [1545] and Gaier 1977 [474] (which Gaier 1978 [475] ascribes to Grötzsch 1931) ♠ this is close to (but not exactly) the desideratum that Bieberbach’s minimum problem (1914 [142]) yields another interpretation of the Ahlfors circle map when extended to multiply-connected domains] ♡??
- [39] J. W. Alexander, *Functions which map the interior of the unit circle upon simple regions*, *Ann. of Math. (2)* 17 (1915), 12–22. [♣] ♡??
- [40] N. L. Alling, *A proof of the corona conjecture for finite open Riemann surfaces*, *Bull. Amer. Math. Soc.* 70 (1964), 110–112. [♣ applies Ahlfors 1950 [19] to the corona as a lifting procedure of the disc-case established in Carleson 1962 [247] ♠ for an alternative proof of the same result avoiding the Ahlfors map but using uniformization instead, cf. Forelli 1966 [447]] ♡18
- [41] N. L. Alling, *Extensions of meromorphic function rings over non-compact Riemann surfaces. I*, *Math. Z.* 89 (1965), 273–299. [♣ idem as Alling 1964 [40] with full details] ♡17
- [42] N. L. Alling, *Extensions of meromorphic function rings over non-compact Riemann surfaces. II*, *Math. Z.* 93 (1966), 345–394. A50 [♣ p.346: “Finally, I am indebted to Professor Royden for his excellent paper, *The boundary values of analytic and harmonic functions*, [24](=Royden 1962 [1305]), which not only gave a new proof of the existence of the Ahlfors’ map, but also gave generalizations of the classical boundary value theorems over the disc. . . .” ♠ p. 345: “As in Alling 1965, theorems are frequently proved for \overline{X} [=a finite open Riemann surface] by lifting the corresponding classical result for the disc, using the Ahlfors map in conjunction with various algebraic facts. For example, Fatou’s theorem and Nevanlinna’s theorem (about functions of bounded characteristics) are easily proved in this way.”] ♡7
- [43] N. L. Alling, in *MathReviews*, Review of Stout 1965, Bounded holomorphic functions on finite Riemann surfaces. [♣ quoting an extract of the text: “It is now clear that a great many of the results for the disc U , which can be found, for example in K. Hoffman’s book (=1962 [678]), also hold for R [=the interior of a compact bordered surface]. The choice of technique to extend such results depends then on the ease of proof, the intuition generated by the setting, and the predisposition of the investigator. Uniformization and the algebraic approach [based upon Royden’s idea (1958=[1304]) of a lifting procedure along an Ahlfors map] seem to have an advantage over annular analysis in that they treat the whole space and the whole ring simultaneously. Still, special advantages in using uniformization and in using the algebraic approach persist. For example, the theory of the closed ideals in the standard algebra on R , $\mathcal{A}(R)$, and the theory of invariant subspaces have been worked out by M. Voichick (=1964 [1546]), using uniformization, but has not been achieved yet using the algebraic approach. (See also Voichick 1966 [1548], and a paper by Hasumi now in preprint [=Hasumi 1966 [614]], all of which deal with the invariant subspace problem.)” ♠ [13.10.12] for an upgrade giving full answer to Alling’s desideratum of an Ahlfors-map proof of the closed ideals, see Stanton 1971 [1451] ♠ the review is concluded with the following: “Finally, concerning the corona problem, as far as the reviewer knows, no one has given a new proof of Carleson’s theorem or re-proved it on R ; everyone, to generalize it to R , has merely lifted the result to R [Or “descended” in the case of the uniformizing approach.]. A substantially simpler and more lucid proof of Carleson’s theorem still remains the most challenging question in this subject.” ♠ possible upgrades the new proofs à la Hörmander/Wolff (cf. e.g. Gamelin 1980 [491]), and also the localization of the corona done by Gamelin 1970 [483] should be satisfactory answers. Yet our impression is that eventually any sharper understanding of the geometry of Ahlfors map (e.g. Gabard’s improved bound (2006 [463]) on the degree of the Ahlfors circle maps) could implies modest quantitative refinements in the corona with bounds (cf. Hara-Nakai 1985 [606] and Oh 2008 [1113])) ♡??

- [44] N. L. Alling, N. Greenleaf, *Klein surfaces and real algebraic function fields*, Bull. Amer. Math. Soc. 75 (1969), 869–872. [♣ the first paper (to the best of my knowledge) which makes explicit the link between Ahlfors 1950 [19] and the much older Kleinian theory (1876–82) of orthosymmetric (=dividing) real algebraic curves, see Klein 1876 [795] and Klein 1882 [797]] ♡14
- [45] N. L. Alling, N. Greenleaf, *Foundations of the Theory of Klein Surfaces*, Lecture Notes in Math. 219, Springer-Verlag, Berlin, 1971. [♣ repeat the same Klein-Ahlfors connection (cf. comments to the previous entry Alling-Greenleaf 1969 [44]), and develop a systematic theory of Klein surfaces, a new jargon derived from Berzolari 1906 [132] ♣ Ahlfors’ theorem (compare p. 16, Theorem 1.3.6) is stated as follows: “Theorem 1.3.6 (Ahlfors [A₁]). Let \mathfrak{X} be [a] compact, connected, orientable Klein surface with non-void boundary. There exists $\underline{f} \in E(\mathfrak{X})$ such that $\partial X = \Gamma_{\underline{f}}$. ♠ if I do not mistake Ahlfors’ result is only stated but not reproved in the text (perhaps quite contrary to the hope borne out by the cross-citation in Alpay-Vinnikov 2000 [48]) ♠ personal reminiscence [03.09.12]: I can remind clearly that I knew this famous Alling-Greenleaf text quite early (ca. Spring 1999), but did not appreciate directly the significance of Ahlfors result, and had to rediscover it later (ca. 2001) after some intense own work (ca. 2 years of efforts) ♠ this is a bit ironical for showing how one can severely miss a crucial information through quick reading, but permitted me to develop an independent approach which ultimately turned out to give a sharper result than Ahlfors’ ♠ so this is probably a perfect illustration of how a poor knowledge of the literature is sometimes beneficial for the creativity in “young men games” (if we can borrow Hardy’s bitter joke)] ♡200
- [46] N. L. Alling, B. V. Limaye, *Ideal theory on non-orientable Klein Surfaces*, Ark. Mat. ?? (1972), 277–292. [♣ extension of the Beurling-Rudin result for the disc to non-orientable bordered surfaces, hence cannot employ the Ahlfors map (whose existence is confined to the orientable case), for which case see Stanton 1972 [1451] who uses the Ahlfors map for the same purpose (extension of Beurling-Rudin)] ♡4
- [47] N. L. Alling, *Analytic geometry on real algebraic curves*, Math. Ann. 207 (1974), 23–46. [♠] ♡??
- [48] D. Alpay, V. Vinnikov, *Indefinite Hardy spaces on finite bordered Riemann surfaces*, J. Funct. Anal. 172 (2000), 221–248. A50 [♣ p. 240 Ahlfors 1950 [19] is cited and other references are given namely Alling-Greenleaf 1971 [45] (where however no existence-proof is given), Fay 1973 [409] (where perhaps only the schlicht case is treated?), and finally Fedorov 1991 [410] (where probably only the planar case is treated) ♠ still on p. 240 it is asserted that $g + 1$ is the minimal possible degree for expressing a compact bordered Riemann surface as ramified covering of the unit-disc (g being as usual the genus of the double, cf. p. 230) ♠ if correct this assertion would (blatantly) corrupt the main result of Gabard 2006 [463] (which by virtue of the incertitude principle could be false) ♠ however the sharpness of $g + 1$ in general is easily corrupted on the basis of simple concrete example of Klein’s Gürtelkurve (real quartic with two nested ovals) projected from a real point situated in the inner oval (cf. Figure 6 in Gabard 2006 [463, p. 955]), and therefore Alpay-Vinnikov’s assertion looks slightly erroneous. NB: this little misconception about the sharpness of Ahlfors bound seems to originate in Fay’s book, cf. Fay 1973 [409] ♠ of course this sloppy detail does not entail at all the intrinsic beauty of this paper namely the study of Hardy spaces on finite bordered Riemann surface: “Furthermore, each holomorphic mapping of the finite bordered Riemann surface onto the unit disk (which maps boundary to boundary) determines an explicit isometric isomorphism between this space [a certain Krein space] and a usual vector-valued Hardy space on the unit disk with an indefinite inner product defined by an appropriate Hermitian matrix.”] ♡11
- [49] E. van Anel, *Extending Riemann mapping capabilities for the sage mathematics package*, Calvin College, 2011. [♠ p. 1: “computation and visualization tools for the Riemann mapping”, “Ahlfors spiderweb”; p. 3: “the Ahlfors map conformally maps multiply-connected regions to the unit circle. [Of course in this case it is more traditional (at least correct) to speak of the Bieberbach-Grunsky map.] This map is such that for a region with n holes, $n + 1$ points in the original region will map to 1 point in the unit circle.”] ♡??
- [50] C. Andreian Cazacu, *On the morphisms of Klein surfaces*, Rev. Roumaine Math. Pures Appl. 31 (1986), 461–470. [♣ inspired by Alling-Greenleaf 1971 [45] and Stilow 1938 [1455] ♠ [17.10.12] for another (more elementary) proof of this result, cf. a paper by Cirre 1997] ♡??

- [51] C. Andreian Cazacu, *Interior transformations between Klein surfaces*, Rev. Roumaine Math. Pures Appl. 33 (1988), 21–26. [♣ from the Introd.: “The interior transformations were introduced by Simion Stoilow in order to solve Brouwer’s problem: the topological characterization of analytic functions. By means of these transformations he founded a vast topological theory of analytic functions with essential implications in the study of Riemann surfaces [8](=Stoilow 1938 [1455]). In this paper we show that interior transformations are a powerful tool in Klein surfaces theory [2](=Alling-Greenleaf 1971 [45]) too. [...]”] ♡??
- [52] C. Andreian Cazacu, *Complete Klein coverings*, Bull. Soc. Sci. Lett. Lódz Sér. Rech. Déform. 37 (2002), 7–14. [♣ the notion of the title is introduced as a generalization of the Ahlfors-Sario notion of complete Riemann coverings (1960 [26, p.42, §21A]), i.e. any point in the range has a neighborhood whose inverse image consists only of compact components. For the case of coverings with a finite number of sheets, it is shown that a Klein covering is complete iff it is total, in the sense of Stoilow (1938 [1455]), that is any sequence tending to the boundary has an image tending to the boundary. ♠ [13.10.12] such purely topological conceptions are mentioned for they subsume the topological behaviour of Ahlfors circle maps (i.e. full covering of the circle, alias disc)] ♡??
- [53] A. Andreotti, *Un’applicazione di un teorema di Cecioni ad un problema di rappresentazione conforme*, Ann. Sc. Norm. Super. Pisa (3) (1950), 99–103. AS60, but not in G78 [♣ seems to extend the result of Matildi 1948 [982] to the case of several contours, hence could be an (independent) proof of the existence of a circle map (than that of Ahlfors 1950 [19]) ♣ in fact the writer (Gabard) was not able to follow all the details of Andreotti’s proof but I have no specific objection to make (it would be a good challenge if somebody is convinced by the argument to translate it in English to make the argument more generally accessible, ask maybe Coppens or Huisman) ♣ it would be interesting to see which degree is obtained by this method (presumably the genus of the double plus one, i.e. $p + 1$ cf. p.101, where $k > p$ [by Riemann-Roch]) ♣ maybe a last comment is that in Andreotti’s result it is not perfectly clear if the circumference can be arranged to coincide, so has to get an Ahlfors circle map] ♡??
- [54] P. Appell, E. Goursat, *Théorie des fonctions algébriques*, Paris, 1895. [♠] ♡??
- [55] P. Appell, E. Goursat, *Théorie des fonctions algébriques d’une variable et des transcendentes qui s’y rattachent*, Deuxième édition revue et augmentée, Tome II, Fonction automorphes, par Pierre Fatou, Paris, Gauthier-Villars, 1930. AS60 [♠ discusses Klein’s orthosymmetry] ♡??
- [56] E. Arbarello, M. Cornalba, *Footnotes to a paper of Beniamino Segre. The number of g_1^1 ’s on a general d -gonal curve, and the unirationality of the Hurwitz spaces of 4-gonal and 5-gonal curves*, Math. Ann. 256 (1981), 341–362. ♡??
- [57] E. Arbarello, M. Cornalba, P. A. Griffiths, J. Harris, *Geometry of algebraic curves, Volume I*, Grundlehren der math. Wiss. 267, Springer-Verlag, 1985. [♠ p. 217: “The existence theorem for g_1^d ’s was first proved by Meis [1](=Meis 1960 [993]). Later, at a time when the techniques of enumerative geometry were better understood, the first fundamental theorem of the theory was established with a completely modern approach. In fact (partly under the influence of unpublished work of Mumford) simultaneously Kempf and Kleiman–Laksov gave the first rigorous proof of the Existence Theorem, and of Theorem (1.3). (See Kempf [1](=1971/72 [757]), Kleiman–Laksov [1,2](=1972 [788], 1974 [789]))” ♠ [09.10.12] again one may wonder if this enumerative geometry technology is susceptible to adapt to the context of the Ahlfors map, which amounts to real curves of the orthosymmetric(=dividing) type (ideally the goal would be to adapt the Kempf/Kleiman–Laksov proof to recover the bound of Gabard 2006 [463] interpreted as a bordered avatar of Meis 1960 [993]) ♠ another reason for quoting this book in connection with the Ahlfors map is the issue about generalized Ahlfors maps taking values not in the disc but in another finite bordered Riemann surface. Then there is a certain evidence that such Ahlfors maps generally fail to be full covering surface, for the doubled map relates two closed Riemann surfaces. But the latter are severely restricted and generally not existing. This can be either argued via a moduli count as in Griffiths-Harris 1980 [545] or via Exercise C-6. given on p.367 (of the book under review): “From the preceding exercise and the theorem on global monodromy proved in Chapter X conclude that a general curve of genus $g \geq 2$ does not admit a nonconstant map to a curve of positive genus.” ♠ of course the statement is a bit sloppy for there is always the identity map as a trivial counterexample, but probably maps of

non-unity degree are excluded tacitly. The proof given seems to use the fact that given a branched covering of curves the fundamental class of the inverse image of the Jacobian variety of the image curve is not a rational multiple of θ^{g-h} , where θ is the theta divisor and g, h are the resp. genera of the curves] ♡??

- [58] R. Arens, *The closed maximal ideals of algebras of functions holomorphic on a Riemann surface*, Rend. Circ. Mat. Palermo 7 (1958), 245–260. [♠] ♡14
 ★ V. I. Arnold, student of Kolmogorov, the middle of KAM-theory (the M being Moser), quite famous for his Gudkov-inspired achievement in the topology of real plane curves via 4D-topology and the renewal of the complexification adumbrating the revolution of Rohlin’s era and all the disciple (Kharlamov, Viro, Fiedler, Finashin, Shustin, Korchagin, etc.). Of course, Thom’s influence on Arnold (ca. 1965 especially on singularities) is also of some pivotal importance for the sequel (Viro, etc.)
- [59] V. I. Arnold, *Distribution of ovals of the real plane algebraic curves, the involutions of four-dimensional smooth manifolds, and the arithmetic of integral quadratic forms*, Funkt. Anal. Priložen 5 (1971), 1–9; English transl., Funct. Anal. Appl. 5 (1972), 169–175. [♠ some revolutionary ideas preparing the terrain for Rohlin’s breakthrough] ♡54
- [60] V. I. Arnold, *The topology of real algebraic curves (the works of Petrovskii and their development)*, Uspekhi Mat. Nauk 28 (1973), 260–262. [♠ cited in Gudkov 1974 [579]] ♡??
- [61] V. I. Arnold, ??, Uspekhi Mat. Nauk 30 (1975), 185; English transl., Russian Math. Surveys 30 (1975), ?. [♠ this text of Arnold includes a symbolical enumeration of singularities often employed by Viro (starting with Viro 1980 [1527]) in his method of perturbing curve with complicated singularities, which becomes especially crucial when it comes to Hilbert’s 16th in degree 8 (in degree 6, Gudkov’s method of construction can be considered as versatile enough) ♠ compare also the book Arnold–Varchenko–Gusein-Zade 1982/85 [64] cited by all patchworkers (Viro, Shustin, Polotovskii, Korchagin, etc.)] ♡??
- [62] V. I. Arnold, *Index of a singular point of a vector field, the Petrovskii–Oleinik inequalities, and mixed Hodge structures*, Funkt. Anal. Priložen 12 (1978), 1–14; English transl., Funct. Anal. Appl. 12 (1978), 1–12. [♠] ♡??
- [63] V. I. Arnold, O. A. Oleinik, *The topology of real algebraic varieties*, Vestnik Moscov. Gos. Univ. Ser. 1 (1979), 7–17; English transl., Moscow Univ. Math. Bull. 34 (1979), 5–17. [♠ a survey oft cited, e.g. in Viro 1986/86 [1534], Viro 1989/90 [1535], Risler 1992 [1265], Itenberg 2002 [707] or in Kharlamov 1986/96 [781].] ♡??
- [64] V. I. Arnold, A. N. Varchenko, S. M. Gusein-Zade *Singularities of Differentiable maps, I*, Nauka, Moscow, 1982, 304 pp.; English transl., Birkhäuser, 1985. [♠ where Arnold’s classification of singularities is presented (compare also the original article Arnold 1975 [61]), a whole series thereof being systematically dissipated in Viro 1989/90 [1535]. The impact on Hilbert’s 16th is eloquent, especially when it comes to degree 8, compare e.g. our Table (Fig. 154) which shows the state-of-the-art after Orevkov 2002 intervention (less some minor misprint in his table). For the geometric construction of Viro’s oetics, cf. our Fig. 6. ♠ this book is cited by all patchworkers (Viro, Shustin, Polotovskii, Korchagin, etc.)] ♡??
- [65] V. I. Arnold, *The branched covering $\mathbb{C}P^2 \rightarrow S^4$, hyperbolicity and projective topology*, Sibirsk. Mat. Zh. 29 (1988), 36–47; English transl., Sib. Math. J. 29 (1989), 717–726. [♠ compare also Anosov’s “obituary of Pontrjagin” where this famous homeomorphism $\mathbb{C}P^2/\text{conj} \approx S^4$ (Kuiper–Massey–Marin) is ascribed back to Pontrjagin ♠ Rohlin expressed (orally) the same opinion, cf. e.g. Finashin 1995/98 [432] ♠ yet according to Arnold this result can be traced back to Maxwell] ♡??
- [66] V. I. Arnold, *Topological content of the Maxwell theorem on multipole representation of spherical functions*, Topol. Methods Nonlinear Anal. 7 (1996), 205–217. [♠ cited in Degtyarev–Kharlamov 2000 [355, p.757]: “as explained in [5](=Arnold 1996=this entry [66]), this beautiful explicit proof was essentially known to Maxwell; [...]”] ♡??
- [67] V. I. Arnold, *Symplectization, complexification and mathematical trinitities*, Fields Inst. Communications ?? (20??), ?–?. [♠ p. 7: “Near 1970 Petrovsky asked me to help in evaluating a thesis of a mathematician Gudkov from Nizhni Novgorod (it was Gorky at that time). He was studying the Hilbert problem 16, the question on the plane algebraic curves of degree 6: what are the possible shapes of the set

$f(x, y) = 0$, if $\deg f = 6$?—The classical answers for degree 2 were extended to degrees 3 and 4 by Newton and Descartes. But then the difficulties starts. Hilbert was unable to solve the case of degree 6, and this problem was explicitly formulated in his list. One may also consider the affine version but it is more complicated and instead we may consider the projective one, dealing with [the] curves in $\mathbb{R}P^2$. Even to this, easier question no answer was known at Hilbert’s time.—The only known thing was the celebrated theorem of Harnack [...] Gudkov claimed to obtain the complete possible configurations list of ovals of degree 6 curves but Petrovsky was doubtful of his result. Let us describe it. The list contains three M -curves. [...] And this relation $\chi \equiv k^2 \pmod{8}$ was observable in all examples of M -curves of degree $2k$ which Gudkov was able to construct for higher degrees. But there were no explanations for this behavior.—I was aware that congruences modulo 8 were standard in 4-dimensional topology. So my idea was that there existed somewhere a 4-dimensional manifold which governed the topology of the real plane curve. But how to construct it? This was the place where the complexification came into the game and became very helpful. [...] p. 14 **Question.** Did Gudkov get the recommendation for his thesis?—**Answer** The thesis was of course defended even though I was never able to read it. But as a result I invented all the matter I have explained to you: I was working hard for a month and after this I proved his conjecture modulo 4. The most difficult thing was some lemma which I was able to guess but not to prove. I always had very good undergraduate students and at that time I asked Varchenko to help me. [...] Unfortunately Varchenko had declined to sign the final paper as a coauthor.—D. A. Gudkov became the leader of a strong team in real algebraic geometry at Nizhni Novgorod (Utkin, Polotovskii, Shustin, ...). Some of the results of Gudkov and his student were recently rediscovered by C. T. C. Wall. [...]” ♡10

[68] V. I. Arnold, *I. G. Petrovskii, Hilbert’s topological problems and modern mathematics*, Uspekhi Math. Nauk 57 (2002), 197–207; English transl., Russian Math. Surveys 57 (2002), 833–845. [♠ p. 197: “The content of Hilbert’s problem is to give a topological classification of real algebraic curves and manifolds (of fixed degree). It is one of the principal and eternal problem of mathematics which is also important for many of its application (where these curves and manifolds describe laws of nature). *What algebraic curves look like*; even today this is unnown, even for plane curves of degree 8 consisting of 22 connected ovals [...]” ♠ p. 834: “There are 1812 topologically possible arrangements of 11 ovals in the plane. Hilbert’s result stated that of all these arrangement only two are realised by algebraic curves of degree 6.—This result of Hilbert is wrong, as was shown 70 years later by D. A. Gudkov, who was a student of both Petrovskii and the physicist A. A. Andronov. Gudkov showed that there are three, not two, realizable arrangements.”] ♡6

[69] V. I. Arnold, *From Hilbert’s superposition problem to dynamical systems*, Amer. Math. Monthly 111 (2004), 608–624. [♠ p. 608: “Some people, even though they study, do so without enough zeal, and therefore live long.”—Archbishop Genady of Novgorod, ca. 1500. ♠ p. 608: philosophy of the mushroom ♠ p. 622: “**Question** (J. Milnor) You often told us about important mathematical work in Russia that we did not know about and you gave another example today. I wonder if you can explain to us how to locate something interesting in the literature starting with zero information.”—**Answer.** [...] I usually start with the German *Encyclopædia* ... In Klein’s *Vorlesungen über die Entwicklung der Math. im 19. Jahrhundert* there is a lot of information on whatever happened in the nineteenth century and before. [...]”] ♡4

[70] (On) V. I. Arnold, by A. A. Davydov, S. M Gusein-Zade, Yu. S. Ilyashenko, M. E. Kazaryan, A. G. Khovanskii, A. G. Kushnirenko, S. K. Lando, A. N. Varchenko, V. A. Vassiliev, and V. M. Zakayukin, *Vladimir Igorevich Arnold in the eyes of his students*, Proc. Steklov Inst. Math. 259 (2007), 1–5. [♠ p. 3: “Arnold’s seminar covered everything, for example real algebraic geometry. Hilbert spent a lot of effort constructing real plane algebraic curves of a given degree that have the maximum possible number of ovals. Unsuccessful attempts to construct such curves with an a priori possible topology of arrangement on the projective plane convinced him that not all possibilities are feasible. Hilbert collected open problems of real algebraic geometry in his 16th problem. D. A. Gudkov solved one of these problems for curves of degree 6; however, the general picture remained unclear. Arnold general surprisingly fine topological obstacles showing that many a priori possible arrangements of curves with the maximal number of ovals cannot be realized. Arnold’s

- studies were picked up by V. A. Rokhlin, D. A. Gudkov, and their students. As a result real algebraic geometry has reached a completely new modern level.”] ♡0
- [71] V. I. Arnold, *Topological properties of eigenoscillations in mathematical physics*, Proc. Steklov Inst. Math. 273 (2011), 25–34. [♠ discussion of Courant’s theorem on the number of residual component of the nodal hypersurface of an oscillating manifold (vibrating membrane) and its relationship with Hilbert’s 16th problem ♠ precisely, Abstract: “Courant proved that the zeros of the n th eigenfunction of the Laplace operator on a compact manifold M divide this manifold into at most n parts. He conjectured that a similar statement is also valid for any linear combination of the first n eigenfunctions. However, later it was found out that some corollaries to this generalized statement contradict the results of quantum field theory. Later explicit counterexamples were constructed by O. Viro. [...]”] ♡0
- [72] D. S. Arnon, S. McCallum, *A polynomial time algorithm for the topological type of a real algebraic curve*, J. Symb. Comput. 5 (1988), 213–236. [♠ cited in Kalla-Klein 2012 [746]] ♡??
- [73] N. Aronszajn, *Theory of reproducing kernels*, Trans. Amer. Math. Soc. 68 (1950), 337–404. [♠ abstract unified view on the theory of the reproducing kernel containing the special cases of Bergman and Szegő, etc.] ♡??
- [74] C. Arzelà, *Sul Principio di Dirichlet*, Nota letta alla R. Accademia delle Scienze dell’Istituto di Bologna nell’Adunza del 24 Gennaio 1897. [♠ cited in Zaremba 1910 [1623] as a precursor of Hilbert’s resurrection of the Dirichlet principle]★★★ ♡??
- [75] M. F. Atiyah, I. M. Singer, *The index of elliptic operators, III*, Ann. of Math. (2) 87 (1968), 546–604. [♠ used in Kharlamov’s solution (1972/73 [764]) to the Rohn-Hilbert 16th problem of sharp estimation of the number of component of a quartic surface in 3-space (Kharlamov’s answer 10, instead of the 12 that Rohn 1886 [1293] established) ♠ also cited in Gudkov 1974 [579] and probably first used by Rohlin as a weapon against Gudkov hypothesis (although his first proof) was even more geometrical despite slight Rohlinian inaccuracies fixed by Marin. ♠ of course in substance Hirzebruch’s signature formula (which in the special 4D-case is a Pontrjagin story?) must be enough to settle Gudkov’s quiz? Need to review the foundation of differential topology.] ♡??
- [76] M. F. Atiyah, *Riemann surfaces and spin structures*, Ann. Sci. École Norm. Sup. (4) 4 (1971), 47–62. ♡??
- [77] M. F. Atiyah, *Convexity and commuting Hamiltonians*, Bull. London Math. Soc. 14 (1982), 1–15 [♠ often cited in the context of Viro’s method, e.g. in Risler 1992 [1264]]. ♡??
- [78] G. Aumann, C. Carathéodory, *Ein Satz über die konforme Abbildung mehrfach zusammenhängender ebener Gebiete*, Math. Ann. 109 (1934), 756–763. G78, but not in AS60 ♡??
- [79] H. F. Baker, *Abel’s theorem and the allied theory including the theory of the theta function*, Cambridge Univ. Press, Cambridge, 1897. [♠] ♡??
- [80] W. W. Rouse Ball, *On Newton’s classification of cubic curves*, Proc. London Math. Soc. 50 (1891), 104–143. [♠ cited through Korchagin-Weinberg 2005 [867]] ♡??
- [81] J. A. Ball, *Operators of class C_{00} over multiply-connected domains*, Michigan Math. J. 25 (1978), 183–196. A47 [♠ p.187, Ahlfors 1947 [18] is cited for the following result (in fact due to Bieberbach 1925 [147] in this formulation): “If R is a domain in the complex-plane bounded by $n + 1$ nonintersecting analytic Jordan curves, there exists a complex-valued inner function on R , which is analytic on a neighborhood of \bar{R} , has precisely $n + 1$ zeros in R , and wraps each component of the boundary of R once around the unit disk [sic, but “disk” should rather be “circle”] ♠ this theorem (of Bieberbach-Grunsky-Ahlfors) is then applied to a problem in operator theory] ♡??
- [82] J. A. Ball, *A lifting theorem for operator models of finite rank on multiply-connected domains*, J. Operator Theory 1 (1979), 3–25. A47 [♠ Ahlfors 1947 [18] is cited on p. 11 (in a context where perhaps Bieberbach 1925 [147] would have been logically sufficient) ♠ again the philosophy of the paper seems to transplant via the Ahlfors function a certain lifting theorem for operator models on the disc (due to Sz.-Nagy-Foias) to the more general case of a multi-connected domain ♠ one can of course wonder about extension on bordered Riemann surfaces, probably established meanwhile (?)] ♡??

- [83] J. A. Ball, K. Clancey, *Reproducing kernels for Hardy classes on multiply-connected domains*, Integral Equations Operator Theory 25 (1996), 35–57. [♠ extension to finite bordered Riemann surface, try Alpay-Vinnikov 2000 [48]] ♡??
- [84] E. Ballico, *Real algebraic curves and real spanned bundles*, Ricerche di Matematica 50 (2001), 223–241. [♠] ♡??
- [85] E. Ballico, G. Martens, *Real line bundles on k -gonal real curves*, Abh. Math. Sem. Univ. Hamburg 71 (2001), 251–255. [♠ real curves, “symmetric” Riemann surfaces, diasymmetric/orthosmmetric, p.251: “One cannot expect irreducible moduli for real curves of genus g . But as already indicated by Klein (in permitting shrinkage of components of $X(\mathbb{R})$ to isolated double points, [9]=(Klein 1892 [801])), the set of (real or complex, whatsoever) isomorphism classes of real stable curves of arithmetic genus $g \geq 1$ can be equipped with a topology making it a connected space ([14]=Seppälä 1991 [1387]). ♠ p.252: “In particular the classical bound $k_{\mathbb{C}} \leq (g+3)/2$ may be false for the real gonality k ([5](=Chaudary 1995 [270]), [10](=Martens 1978 [969])). If $n(X) > 0$ one knows ([3]=Ballico 2003 [87]) that $k \leq (g+3)/2 + 3$; it seems not known if this is sharp for some g .”] ♡??
- [86] E. Ballico, *Gonality and Clifford index for real algebraic curves*, Collectanea Math. 53 (2002). [♠] ♡??
- [87] E. Ballico, *Codimension 1 subvarieties of \mathcal{M}_g and real gonality of real curves*, Czechoslovak Math. J. 53 (2003), 917–924. [♠ some results seem to be reanalyzed in Coppens-Huisman 2010...] ♡3
- [88] E. Ballico, *Real curves with fixed gonality and empty real locus*, Le Matematiche 60 (2005), 129–131. [♠] ♡??
- [89] E. Ballico, *Real ramifications points and real Weierstrass points of real projective curves*, Glasnik Mat. 41 (2006), 233–238. [♠] ♡??
- [90] S. Banach, *Théorie des opérations linéaires*, Warsaw, 1932. [♠ cited in Read 1958 [1243], where the Hahn-Banach theorem is put in connection to the Ahlfors map] ♡??
- [91] C. Bandle, M. Flucher, *Harmonic radius and concentration of energy; hyperbolic radius and Liouville’s equations $\Delta U = e^U$ and $\Delta U = U^{\frac{n+2}{n-2}}$* , SIAM Review 38 (1996), 191–238. A47 [♠ Ahlfors 1947 [18] is cited on p.200 as follows: “Corollary 4 extends Liouville’s formula to multiply connected planar domains and so does the following formula from Mityuk’s monograph [79](=1985). Denote by $f: \Omega \rightarrow B$ an Ahlfors map of Ω (cf. Ahlfors [1](=Ahlfors 1947 [18]), obtained as a solution of the same extremal problem that we used for the definition of the Riemann map (§1). Then the inner radius of Ω is given by $r(x) = \frac{1-|f(x)|^2}{|f'(x)|} \exp(-2\pi \sum_{\{y \neq x: f(y)=x\}} G_x(y))$, provided $f'(x) \neq 0$. Note that on a k -connected domain the Ahlfors map is a k -sheeted branched covering. A modified formula involving higher derivative of f holds at the branch points. The proof is similar to that of Corollary 4.” ♠ perhaps instead of the mentioned monograph, the original articles of Mitjuk already contain this (multi-connected) extended formula, cf. Mitjuk 1965 [1021] (and also Mitjuk 1968 [1022] for the statement (in English), yet without the proof)] ♡??
- [92] V. Bangert, C. Croke, S. Ivanov, M. Katz *Filling area conjecture and ovalless real hyperelliptic surfaces*, Geom. Funct. Anal. ?? (2005), ?-?. [♠ solve the hyperelliptic case of the filling area conjecture due to Gromov, hence in particular the genus-one case $p = 1$ ♠ the hearth of the argument seems to be an old result of Hersch] ♡26
- [93] W.H. Barker II, *Kernel functions on domains with hyperelliptic double*, Trans. Amer. Math. Soc. 231 (1977), 339–347. (Diss. under M. M. Schiffer) [♠ p.345, the Ahlfors (extremal) function of a domain is discussed by referring to Bergman 1950 [123], Heins 1950 [634], and also the original treatment due to Ahlfors 1947 [18] and that of Garabedian 1949 [495]] ♡5
- [94] E. Bedford, *Proper holomorphic mappings*, Bull. Amer. Math. Soc. (N.S.) 10 (1984), 157–19?. A50 [♠ p.159, Ahlfors 1950 is quoted as follows: “The existence of many proper mappings is given by a result of Grunsky [55](=[561]) and Ahlfors [1](=1950 [19]). THEOREM. If M is a finite Riemann surface with nondegenerate boundary components, then there exists a proper mapping $f: M \rightarrow \Delta$. In general, however, given two Riemann surfaces M and N , it does not seem easy to say whether there exists a proper mapping $f: M \rightarrow N$.”] ♡43

- [95] H. Behnke, H. Zumbusch, *Konforme Abbildung von Bereichen auf in ihnen liegenden Bereiche*, Semester-Ber. math. Sem. Münster 8 (1936), 100–121. [♠ quoted in Grunsky 1940 [563, p. 233], in connection with the definition of the Carathéodory metric (first appearance in Carathéodory 1926 [234]) for multi-connected domains] ♡??
- [96] H. Behnke, K. Stein, *Entwicklungen analytischer Funktionen auf Riemannschen Flächen*, Math. Ann. 120 (1947/49), 430–461. [♠ proves that any open Riemann surface carries a nonconstant analytic function ♠ in the case where the Riemann surface is the interior of a compact Riemann surface this also follows from Ahlfors 1950 [19] in the much sharper form of a branched covering of the disc ♠ naive question [01.10.12]: by using an exhaustion of the open Riemann surface by finite bordered ones what sort of functions can be constructed on the whole surface? Is it in particular possible to subsume the Behnke-Stein theorem to that of Ahlfors? (looks a bit naive I confess)] ♡??
- [97] H. Behnke, F. Sommer, *Theorie der analytischen Funktionen einer komplexen Veränderlichen*, Die Grundlehren der math. Wiss. in Einzeldarstellungen, Bd. 77, Springer-Verlag, Berlin, 1955; Third Edition, Springer-Verlag, New York, 1965. [♠ pp. 581–2 is quoted in Černe-Forstnerič 2002 [267] for the “(Schottky) double” ♠ other sources for this purposes are Klein 1882 [797] (in romantic pre-axiomatic style), else Koebe 1928 [842], or Teichmüller 1939 [1484] and of course also Springer’s book 1957 [1450] or Schiffer-Spencer 1954 [1352]] ♡262
- [98] S. R. Bell, *Numerical computation of the Ahlfors map of a multiply connected planar domain*, J. Math. Anal. Appl. 120 (1986), 211–217. [♠ from the Introd.: “N. Kerzman and E. M. Stein discovered in [6](=1978 [762]) a method for computing the Szegő kernel of a bounded domain D in the complex plane with C^∞ smooth boundary. In case D is also simply-connected, the Kerzman-Stein method yields a powerful technique for computing the Riemann mapping function associated to a point $a \in D$ (see [6](=Kerzman-Stein 1978 [762]), [7](=Kerzman-Trummer 1984)). In this note, we show how the Kerzman-Stein method can be generalized to yield a method for computing the Ahlfors map associated to a point in a finitely connected, bounded domain in the plane with C^2 smooth boundary. The Ahlfors map is a proper holomorphic mapping of D onto the unit disc which maps each boundary component of D one-to-one onto the boundary of the unit disc.—The Ahlfors map might prove to be useful in certain problems arising in fluid mechanics. For example, in the problem of computing the transonic flow past an obstacle in the plane, a conformal map of the outside of the obstacle onto the unit disc is used to set up a grid which is most convenient for making numerical computations (see [5](=Jameson 1974, “Iterative solution of transonic flows over airfoils and wings, including flows at Mach 1”). The Ahlfors map could be used in a similar way in problems of this sort in which more than one obstacle is involved. [...]”] ♡8
- [99] S. R. Bell, *The Szegő projection and the classical objects of potential theory in the plane*, Duke Math. J. 64 (1991), ?–?. [♠ quoted in McCullough 1996 [988] for the result that the Ahlfors function acquires distinct (simple) zeros when the center a (the place where the derivative is maximized) is chosen near enough to the boundary of the domain ♠ a probably related result is to be found in Ovchintsev 1996/96 [1152] ♠ question [20.09.12]: does this result extend to bordered surfaces] ♡??
- [100] S. R. Bell, *The Cauchy transform, potential theory, and conformal mapping*, CRC Press, Boca Raton, Florida, 1992. A50 [♠]★ ♡147
- [101] S. R. Bell, *Complexity of the classical kernel functions of potential theory*, Indiana Univ. Math. J. 44 (1995), 1337–1369. [♠] ♡??
- [102] S. R. Bell, *Ahlfors maps, the double of a domain, and complexity in potential theory and conformal mapping*, J. d’Anal. Math. 78 (1999), 329–344. [♠ proof that generically two Ahlfors maps suffice to generate the field of meromorphic function of the double of the domain (so-called primitive pairs)] ♡13
- [103] S. R. Bell, *Complexity in complex analysis*, Adv. Math. 172 (2002), 15–52. A50 ♡??
- [104] S. R. Bell, *Möbius transformations, the Carathéodory metric, and the objects of complex analysis and potential theory in multiply connected domains*, Michigan Math. J. 51 (2003), 352–361. [♠ p. 361: “It is also a safe bet that many of the results in this paper extend to the case of Riemann surfaces. I leave these investigations for the future.”] ♡5

- [105] S.R. Bell, *Quadrature domains and kernel function zipping*, Ark. Math. 43 (2005), 271–287. [♠ p.271 (Abstract): “It is proved that quadrature domains are ubiquitous in a very strong sense in the realm of smoothly bounded multiply connected domains in the plane. In fact they are so dense that one might as well assume that any given smooth domain one is dealing with is a quadrature domain, and this allows access to a host of strong conditions on the classical kernel functions associated to the domain.”] ♡5
- [106] S.R. Bell, *The Green’s function and the Ahlfors map*, Indiana Univ. Math. J. 57 (2008), 3049–3063. [♠ yet another fascinating paper among the myriad produced by the author, where now a striking expression is given for the Green’s function of a finitely connected domain in the plane in terms of a single Ahlfors mapping answering thereby (see third page of the introd.) a subconscious desideratum of Garabedian-Schiffer 1949 [494]] ♡??
- [107] S.R. Bell, *The structure of the semigroup of proper holomorphic mappings of a planar domain to the unit disc*, Complex Methods Function Theory 8 (2008), 225–242. [♠ a description of all circle maps is given by returning to the original papers of Bieberbach and Grunsky] ♡2
- [108] S.R. Bell, *The Szegő kernel and proper holomorphic mappings to a half plane*, Comput. Methods Funct. Theory 11 (2011), 179–191. A50 [♠ construction (for domains) of proper holomorphic maps of arbitrary mapping degree, reminiscent of Heins’ argument 1950 [634] about positive harmonic functions] ★★ ♡0
- [109] E. Beltrami, *Saggio di interpretazione della geometria non-euclidea*, Giornale di Matematiche 6 (1868), 262–280. [♠] ♡??
- [110] E. Beltrami, *Teoria fondamentale degli spazii di curvatura costante*, Annali di Matematica (2) 2 (1868), 232–255. [♠] ♡??
- [111] R. Benedetti, J.-J. Risler, *Real Algebraic and Semi-algebraic Sets*, Hermann, Paris, 1990. [♠ contains much material (and where from I initially learned the Brusotti theorem in “un lavoro di Diploma” under the guidance of Felice Ronga) ♠ p. 260: elementary properties of separating curves ♠ exposition (not always with complete proofs) of some results of the Germano-Russian school: Harnack, Hilbert, Gudkov, Arnold, Rohlin, etc. ♠ p. 288: “. . . it can easily be [=be] (sic!) proved that any configuration under the broken line of figure 5.24, can be realized by a smooth curve of degree 6.” This is a bit sloppy, for Gudkov’s skill is required!] ♡??
- [112] M. Berger, *Riemannian geometry during the second half of the twentieth century*, Jber. d. Dt. Math.-Verein. 100 (1998), 45–208. [♠ p.147: “The simplest filling volume, namely that for the circle S^1 , was only obtained in ([N.] Katz, 1998).”, where the reference is (cf. p. 196) “Katz, N. (1998). Filling volume of the circle.” ♠ This work, presaging a complete solution to Gromov’s filling conjecture, has apparently never been published and probably turned out to contain a gap.] ♡??
- [113] M. Berger, *A Panoramic View of Riemannian geometry*, Springer, 2002. [♠] ♡??
★★★ Stefan Bergman (18XX–19XX), one of the architect of modern conformal mapping theory (deep influence upon Schiffer, Garabedian, and perhaps more anecdotically upon Ahlfors). In substance his theory is rooted on Hilbert-Schmidt on the one hand and Ritz-Bieberbach (cf. Bieberbach 1914 [142]) on the other. Actually both Hilbert and Ritz are in substance syllogistic paraphrase of each other, the second being only more algorithmic than the former. Should we recall Riemann motto, “Jacobi war ihm zu algorithmisch” as opposed to Dirichlet’s pure existence proof. Compare Klein 1926 (posthumous historiography) [808] for more accurate citations.
- [114] S. Bergman[n], *Über die Entwicklung der harmonischen Funktionen der Ebene und des Raumes nach Orthogonalfunktionen*, Math. Ann. 86 (1922), 238–271. (Thesis, Berlin, 1921.) [♠ formulates—like Bieberbach 1914 [142]—the desideratum that the function minimizing the area integral $\int \int |f'(z)|^2 d\omega$ is the Kreisabbildung (alias Riemann mapping) ♣ this desideratum will be only accomplished in the late 1940’s, i.e. Garabedian/Lehto’s era] ♡60
- [115] S. Bergman[n], *Über eine Darstellung der Abbildungsfunktion eines Sternbereiches*, Math. Z. 29 (1929), 481–486. [♠ Minimalbereich in a special case] ♡??
- [116] S. Bergman[n], *Über unendliche Hermitesche Formen, die zu einem Bereiche gehören, nebst Anwendungen auf Fragen der Abbildung durch Funktionen von zwei komplexen veränderlichen*, Math. Z. 29 (1929), 641–677. [♠ p.641 formulates—inspired by Bieberbach 1914 [142]—the concept of a Minimalbereich, by referring to 3 of his previous work (alas no precise cross-references)] ♡??

- [117] S. Bergman[n], *Eine Bemerkung über schlichte Minimalabbildungen*, Sitzsber. Berliner Math. Ges. 30 (1932) [♠ quoted in Lehto 1949 [920] for yet another formulation—like Bieberbach 1914 [142]—of the desideratum that the function minimizing the area integral $\int \int |f'(z)|^2 d\omega$ is the Kreisabbildung (alias Riemann mapping) ♣ this desideratum will be only accomplished in the late 1940's, i.e. Garabedian/Lehto's era, cf. Lehto 1949 [920, p. 46]] ♡60
- [118] S. Bergman[n], *Über die Kernfunktion eines Bereiches und ihr Verhalten am Rande*, J. Reine Angew. Math. 169 (1933), 1–42; and 172 (1934), 89–128. [♠ p. 3 footnote 2 contains some brief indication on the case of multi-connected domains (in one complex variable) and a cross-ref. to Zarankiewicz 1934 [1621]] ♡60
- [119] S. Bergman, *Partial differential equations, Advanced topics* (Conformal mapping of multiply connected domains), Publ. of Brown Univ., Providence, R. I., 1941. [♠ probably completely incorporated in Bergman 1950 [123]] ★★★ ♡60
- [120] S. Bergman, *A remark on the mapping of multiply-connected domains*, Amer. J. Math. 68 (1946), 20–28. [♠ uniformize via the Bergman kernel domains of finite connectivity, and via Koebe (1914/15) can be used for the Kreisnormierung.] G78 ♡??
- [121] S. Bergman[n], *Sur les fonctions orthogonales de plusieurs variables complexes avec les applications à la théorie des fonctions analytiques*, Mémorial des Sci. Math. 106 (1947), 1–63. [♠ p. 32 points out that the old desideratum of Bieberbach-Bergman 1922 [114] of reproving RMT via the problem of least area was still not achieved until this date of 1947, except for the special case of starlike domains (Bergman 1932 [117] and Schiffer 1938 [1343]). The breakthrough may have occurred only by Garabedian and Lehto's Thesis, cf. e.g. [920]] ♡??
- [122] S. Bergman[n], *Sur la fonction-noyau d'un domaine et ses applications dans la théorie des transformations pseudo-conforme*, Mémorial des Sci. Math. 108 (1948). [♠ quoted in Maschler 1956 [975] for the theory of minimal domains ♠ p. 41, Kufarev [891] is credited for the issue that for a doubly-connected domain the least area map is not univalent(=schlicht) ♠ of course it looks evident that univalence fails as well in higher connectivity, cf. e.g. Garabedian-Schiffer 1949 [494] ♠ yet nobody seems to claim that the range is a circle] ♡??
- [123] S. Bergman, *The kernel function and conformal mapping*, Mathematical Surveys 5, Amer. Math. Soc., New York, 1950. A50, AS60, G78 [♠ p. 87 existence of a circle map for domains via an explicit formula (p. 86) as a ratio of two kernel functions ♠ a second revised edition was published in 1970] ♡664
- [124] S. Bergman, M. Schiffer *Kernel functions and conformal mapping*, Compositio Math. 8 (1951), 205–249. AS60, G78 ♡??
- [125] A. Bernard, J. B. Garnett, D. E. Marshall, *Algebras generated by inner functions*, J. Funct. Anal. 25 (1977), 275–285. [♠ p. 282, the Ahlfors function is briefly mentioned as follows: “To show the inner functions separates the points of X we modify the well-known construction of the Ahlfors function for a Denjoy domain.” ♠ the bulk of the paper is devoted to the question of knowing when the unit ball of an uniform algebra (typically $H^\infty(\Omega)$ for Ω a finitely connected domain) is the closed convex hull of the inner functions ♠ Corollary 5.2 (p. 285) gives this conclusion provided the inner functions separate the points of the Shilov boundary, but the authors seem to confess that they do not know whether this proviso is automatically fulfilled (note: of course the simple argument of Stout 1966 [1459, p. 375] saying that inner functions separates points on the Riemann surface (just because the Ahlfors function based at the two given points do separate them) does not apply here, as we are truly looking at mystical points of the Shilov boundary) ♠ p. 276, one reads: “Minor modifications of the proof for this case [i.e. finitely connected plane domain] will give the result when Ω is a finite open Riemann surface, but we leave those details to the interested reader.” ♠ conclusion: since the whole paper actually seeks for an extension of a disc result of Marshall (asserting precisely that the unit ball of the disc algebra $H^\infty(\Delta)$ is the closed convex hull of the inner functions), one could wonder if there is not a more naive strategy exploiting more systematically the Ahlfors function] ♡??
★★ Lipman Bers (Ph.D. in 1938), a well-known student of Löwner, well-known for several investigations on PDE, quasi-conformal-maps. In the overall his works looks strongly intermingled with those of Teichmüller, and Ahlfors (or vice-versa depending upon history vs. originality).

- [126] L. Bers, *Quasiconformal mappings and Teichmüller's theorem*, in: Analytic functions, Princeton Univ. Press, 1960, 89–119. [♠ modernized account of Teichmüller theory] ♡??
- [127] L. Bers, *Uniformization by Beltrami equation*, Comm. Pure Appl. Math. 14 (1961), 215–228. [♠ contain striking results on the Kreisnormierung] ♡??
- [128] L. Bers, *Automorphic forms for Schottky groups*, Adv. Math. 16 (1975), 332–371. [♠ modernized proof via quasiconformal deformation of the retrosection theorem (alias Rückkehrschnitttheorem=RST) going back to Klein 1882 [798] and first seriously proved in Koebe 1910 UAK2 [831] ♠ a question of some interest is whether the bordered avatar of this RST implies the Ahlfors circle mapping]★ ♡??
- [129] E. Bertini, *Sui sistemi lineari*, Rend. del R. Istit. Lomb. 15 (1882), 24–28. [♠ often cited by Brusotti]★ ♡??
- [130] E. Bertini, *La geometria delle serie lineari sopra una curva piana secondo il metodo algebrico*, Ann. Mat. Pura Appl. (Milano) (2) 22 (1894), 1–40. [♠ cited in Gudkov 1974 [579]] ♡??
- [131] E. Bertini, *Introduzione alla geometria proiettiva degli iperspazi*, 1912, 2nd ed., Messina, 1923. [♠]★ ♡??
- [132] L. Berzolari, *Allgemeine Theorie der höheren ebenen algebraischen Kurven*, in: Enzyklopädie der math. Wissenschaften, Bd. III, 2, 1, 313–455, Leipzig, 1906. [♠ a short survey of Klein's theory of symmetric surfaces while coining first the designation “Klein's surfaces” made popular much later by Alling-Greenleaf 1971 [45].] ♡??
- [133] L. Berzolari, *Algebraische Transformationen und Korrespondenzen*, in: Enzyklopädie der math. Wissenschaften, Bd. III, C, 1, 1, 1781–2218, Leipzig, 1933. [♠] ♡??
 ★ Enrico Betti (not to be confused with Enrico Poincaré, nor with Brioschi as erroneously did Poincaré in 1895 [1192]). At this stage one starts to believe in Klein's prose “die Franzosen unhistorisch wie Sie sind”. More seriously, Enrico was a good friend of Riemann and assimilating both the latter's conception on Analysis Situs (connectivity number, and balbutiant Poincaré's duality, which Poincaré 1895 considers as well-known without offering his source, Riemann?, Betti=Brioschi?, Maxwell?), and the problems of potential theory contributed seriously to several epoch making details that went actively discussed at that period.
- [134] E. Betti, *Sopra l'equazioni algebriche con più incognite*, Annali di Matematica (2) 1 (18XX), 1–8. [♠ cited (but slightly criticized) in Kronecker 1865/95 [885]] ♡??
- [135] E. Betti, *Sopra gli spazi di un numero qualunque di dimensioni*, Annali di Matematica (2) 4 (1871), 140–158. [♠ inspired from Riemann 1852/53 Fragment aus der Analysis situs [1255], and will in turn inspire (modulo being misspelled as Brioschi) Poincaré 1895 [1192] ♠ this well-known line of thoughts leads to “homology theory” and is inasmuch relevant to the present article for the issue that several peoples (starting with Riemann, Klein, Poincaré, Brouwer, etc.) used topological methods in function theory, and in the specialized context of Ahlfors circle maps (similar inferences were used by Garabedian 1949 [495], Mizumoto 1960 [1025], and Gabard 2004/06 [463])] ♡??
 ★ Arne Beurling, the best friend of Ahlfors, and the student of Anders Wiman, one of the fore runner of our philosophy of stability under satellites. Compare Wiman 1923 [1595] for more comments.
- [136] A. Beurling, *Sur un problème de majoration*, Thèse, Upsala, 1935, 109 pp. ♡??
- [137] A. Beurling, *On two problems concerning linear transformation in Hilbert space*, Acta Math. 81 (1949), 239–255. [♠ the so-called Beurling's invariant subspaces theorem ♠ for an extension to finite bordered Riemann surface see M. Hasumi 1966 [614] (and also related work by Voichick 1964 [1546]), yet without using the Ahlfors map, but cite Royden 1962 [1305] which is closely allied ♠ [03.10.12] one can wonder if like for the corona problem/theorem there is a direct inference of the Ahlfors map upon Beurling's invariant subspaces (as Alling 1964 [40] managed to do for the corona)] ♡??
- [138] G. V. Beylĭ, *On Galois extensions of the maximal cyclotomic field*, Izv. Akad. Nauk SSSR Ser. Mat. 43 (1979), 269–276; English transl., Math. USSR Izv. 14 (1980), 247–256. [♠ proof that a closed surface is defined over $\overline{\mathbb{Q}}$ iff it ramifies only above 3 points of the sphere ♣ can this be extended to bordered surfaces in the context of Ahlfors maps?] ♡??

- [139] G. V. Beyli, *A new proof of the three points theorem*, Sb. Math. 193 (2002), 329–332. [♠] ♥??
- ★★ Étienne Bézout, well known for his work upon elimination and the resulting intersection theory between curves in the plane (or more general situation easy to guess when it comes to varieties of complementary dimensions). This (albeit trivial) is quite pivotal both for Hilbert’s 16th or for the phenomenon of total reality, cf. e.g Gabard 2013B [471].
- [140] Etienne Bézout, *Text on elimination*, 1779. [♠ prhaps where Bézout’s theorem is first stated and proved] ♥??
- ★★ Ludwig Bieberbach, a sort of joint student of Klein and Hilbert, quite infamous for his political incorrectness during the dark period of German history (1933–45), but quite important for his 1925 paper ([147]) establishing the total reality of M -curves, along lines sketched by Riemann 1857 [1258] and Schottky 1875–77 [1366], and further elaborated (yet without gaining nothing in qualitative sharpness) by Grunsky 1937, Ahlfors 1947, and a myriad of subsequent workers in Russia (Golusin 1952/57 [534], Japan esp. A. Mori 1951 [1040], etc.)
- [141] L. Bieberbach, *Über ein Satz des Herrn Carathéodorys*, Gött. Nachr. (1913), 552–560. ♥??
- [142] L. Bieberbach, *Zur Theorie und Praxis der konformen Abbildung*, Rend. del Circolo mat. di Palermo 38 (1914), 98–112. [♠ this had some influence over Bergman’s Thesis 1921/22 [114], and is in turn inspired by W. Ritz ca. 1908–09 ♠ p.100, first formulation of the principle that the function minimizing the area integral $\int \int |f'(z)|^2 d\omega$ is the Kreisabbildung (alias Riemann mapping), and the hope is expressed of getting an independent proof of its existence through this least area problem ♣ this desideratum (vividly sustained in Bergman’s Thesis 1921/22 [114] and Bochner’s 1922 [175]) will be only achieved in the late 1940’s, i.e. Garabedian/Lehto’s era (see Lehto 1949 [920]) ♣ another desideratum (Gabard 16- ε June 2012, but perhaps already known) would be that such an extremal problem (closely allied to the theory of the Bergman kernel) yields an alternative proof of the Ahlfors mapping ♣ even more since it is eminently geometric can we crack—via this Bieberbach-Bergman philosophy—the Gromov filling area conjecture? (Recompense 50 Euros)] ♥??
- [143] L. Bieberbach, *Einführung in die konforme Abbildung*, Sammlung Göschel, Berlin, 1915. [♠ pp.94–108 deal specifically with Bieberbach’s minimizing principle (cf. Bieberbach 1914 [142])] ♥??
- [144] L. Bieberbach, $\Delta u = e^u$ und die automorphen Funktionen, Math. Ann. 77 (1916), 173–212. [♣ p.175 speaks of (Klein’s) orthosymmetry, and write a sentence (which when read outside of its context) bears strange resemblance with the Ahlfors circle map: “Wir nehmen die Fläche orthosymmetrisch an, d. h. sie möge durch diese Symmetrielinien in zwei symmetrische Hälften zerlegt werden, so daß es sich also im Hauptkreisfalle um die konforme Abbildung eines berandeten Flächenstückes—der einen Flächenhälfte—auf das Innere des Einheitskreises handelt.” ♠ the real issue in this paper is to implement Schwarz’s desideratum (Göttinger Preisaufgabe 1889) (primarily followed by Picard and Poincaré) of uniformizing (compact) Riemann surfaces via the Liouville equation whose geometric interpretation amounts searching a conformal metric of constant Gaussian curvature ♠ [03.10.12] probably the above should not be interpreted as an Ahlfors map but rather as the fact that the interior of any compact bordered Riemann surface is uniformized by the unit disc (i.e. the universal covering of the interior is the unit disc)] ♥??
- [145] L. Bieberbach, *Über einige Extremalprobleme im Gebiete der konformen Abbildung*, Math. Ann. 77 (1916), 153–172. [♠ includes (among other nice geometrical things) the first proof of Koebe’s Viertelsatz with the sharp constant $1/4$ upon the radius of a disc contained in the range of a schlicht map of the unit disc normed by $|f'(0)| = 1$] ♥??
- [146] L. Bieberbach, *Über die Koeffizienten derjenigen Potenzreihen, welche eine schlichte Abbildung des Einheitskreises vermitteln*, S.-B. Preuss. Akad. Wiss. Berlin (1916), 940–955. [♠ where the Bieberbach/coefficient conjecture is first formulated. Solution: de Branges 1984/85.] ♥??
- [147] L. Bieberbach, *Über einen Riemannschen Satz aus der Lehre von der konformen Abbildung*, Sitz.-Ber. Berliner Math. Ges. 24 (1925), 6–9. AS60, G78 (also cited in Courant 1939 [334]) [♣ the schlicht(artig) case of Ahlfors 1950 [19] is proved,

- and earlier work by Riemann 1857/58 [1258] and Schottky 1877 [1366] is put in perspective] ♡??
- [148] L. Bieberbach, *Adresse an Herrn F. Schottky zum fünfzigjährigen Doktorjubiläum*, Sitz.-Ber. Preuß. Akad. d. Wiss. (1925), 327–328. [♠ discuss perhaps (once more) the Riemann-Schottky-Bieberbach theorem.] ♡??
- [149] L. Bieberbach, *Über die reellen Züge der algebraischen Gebilde*, Math. Zeit. 31 (1929), 161–175. [♠ finiteness result (Endlichkeitssatz) on the number of components of a real algebraic variety through an inductive process on the dimension of the ambient space, yet without explicit bound. ♠ It seems that ten years later (in 1939) Bieberbach published another article with exactly the same title in *Deutsche Mathematik*, which article is cited in Gudkov 1974.] ♡??
- [150] L. Bieberbach, *Gedächtnisrede auf Herrn F. Schottky*, Sitz.-Ber. Preuß. Akad. d. Wiss. (1936), CV–CVI. [♠ discuss perhaps (once more) the Riemann-Schottky-Bieberbach theorem.] ♡??
- [151] L. Bieberbach, *Über die reellen Züge der algebraischen Gebilde*, Dt. Math. 4 (1939), 348–360. [♠ probably an improved version of the former article Bieberbach 1929 [149].] ♡??
- [152] L. Bieberbach, *Lehrbuch der Funktionentheorie*, vols. 1 and 2, Berlin, New York, 1945. (Photographic reprint of the 4th edition of Band I (1934) and the 2nd edition of Band II (1931)) [♠ cited by Bergman 1950 [123, p.24] for the proof that the minimum function for the problem $\int \int_B |f'(z)|^2 d\omega$ has circle range; of course the original source is Bieberbach 1914 [142]] ★★★ ♡??
- [153] L. Bieberbach, *Conformal mapping*, Chelsea, New York, 1953. [♠]★ ♡??
- [154] L. Bieberbach, *Eine Bemerkung zur konformen Abbildung zweifach zusammenhängender Gebiete*, Math. Z. 67 (1957), 99–102. G78 ♡??
- [155] L. Bieberbach, *Einführung in die konforme Abbildung*, Sammlung Götschen Bd. 768/768a, Walter de Gruyter and Co. (6th ed., 1967). G78 [♠ includes a proof of the Hilbert-Koebe PSM (in infinite connectivity) ♠ presumably an earlier edition (as the one cited in Burckel 1979 [217]) do the job as well] ♡??
- [156] L. Bieberbach, *Das Werk Paul Koebes*, Jahresber. Deutsche Math.-Verein. 70 (1968), 148–158. G78 [♠ contains a complete tabulation of Koebe's work] ♡??
★ Giuseppina Masotti Biggiogero (a student of Brusotti).
- [157] G. Biggiogero, *Sulle curve piane, algebriche reali che presendono massimi d'inclusione*, Ist. Lombardo Sci. Lett. Cl. Sci. Mat. Nat. Rend. (2) 55 (1922), 499–510. [♠ cited in Gudkov 1974 [579]] ♡??
- [158] G. Biggiogero, *Gruppi di massimi d'inclusione per curve piane, algebriche, reali d'ordine n*, Ist. Lombardo Sci. Lett. Cl. Sci. Mat. Nat. Rend. (2) 56 (1923), 841–849. [♠ (also) cited in Gudkov 1974 [579]] ♡??
- [159] B.[runetta] Bigi, *La "piccola variazione" di una curva algebrica reale connessa, con speciale riguardo al caso di Harnack*, Rend. Acc. Naz. Lincei (8) 2 (1947), 27–30, 126–129. [♠ cited in Brusotti 1952 [206]] ♡??
♠ Frédéric Bihan, a student of Itenberg (in Rennes), in turn a student of Viro, and so of Rohlin; so Rohlin number=3.
- [160] F. Bihan, *Construction combinatoires de surfaces algébriques réelles*, Ph. D. Thesis, Rennes, 1998 (advisor Itenberg). [♠ contains many record value results upon the critical case of quintics, where Hilbert's 16th is still wide open, notably the construction of a "numerical" quintic (i.e. embeddable only after deformation of the complex-structure) with $b_0 = 23$ the best known result, as well as asymptotic results ♠ for a better summary of the importance of Bihan's achievements, compare Itenberg 2002 [707]] ♡??
- [161] F. Bihan, *Une quintique numérique réelle dont le premier nombre de Betti est maximal*, C.R. Acad. Sci. Paris Sér. I Math. 329 (1999), 135–140. [♠ contains the construction a real quintic surface has 23 real components (at least after deformation of the complex-analytic structure), which is two unit less than 25 the maximum permissible ♠ for a slightly sharper result relaxing the parenthetical proviso, cf. Orevkov 20XX [1127] ♠ the question of deciding if a quintic can have 24 or even 25 components is still open and his the direct avatar of Hilbert's question for quartics settled as $b_0(max) = 10$ in Kharlamov 1972 [764]] ♡??

- [162] F. Bihan, *Betti numbers of real numerical quintic surfaces*, in: *Topology ergod. th., real algebraic geom*, Amer. Math. Soc. Transl. Ser. 2 202, Amer. Math. Soc., Providence, RI, 2001, 31–38. [♠] ♥??
- [163] F. Bihan, *Une sextique de l'espace projectif réel avec un grand nombre d'anses*, *Rev. Mat. Complut.* 14 (2001), 439–461. [♠] ♥??
- [164] E. Bishop, *Subalgebras of functions on a Riemann surface*, *Pacific J. Math.* 9 (1959), 629–642. [♠] ♥??
- [165] E. Bishop, *Abstract dual extremal problems*, *Notices Amer. Math. Soc.* 12 No. 1 (1965), 123. [♠ cited in O'Neill-Wermer 1968 [1117] for an abstract version of Ahlfors' extremal problem pertaining to a function algebra over a compact space X] ♥??
- [166] E. Biswas, *On line bundles over real algebraic curves*, *Bull. Sci. Math.* 134 (2010), 447–449. [♠] ♥??
- [167] A. Bloch, *La conception actuelle de la théorie des fonctions entières et méromorphes*, *L'Enseign. Math.* 25 (1926), 83–103. [♠ great French prose and finitistic philosophy à la Kronecker, culminating to the slogan “Nihil est infinito...”] ♥??
- [168] A. Bloch, *Les fonctions holomorphes et méromorphes dans le cercle-unité*, *Mémorial des Sci. Math.* 20 (1926), 1–61. ♥??
- [169] A. I. Bobenko, *Schottky uniformization and finite-gap integration*, *Dokl. Akad. Nauk SSSR* 295 (1987), 268–272; English transl., *Soviet Math. Dokl.* 36 (1988), 38–42. [♠] ♥??
- [170] M. Bôcher, Some propositions concerning the geometric representation of imaginaries. *Ann. of Math.* 7 (1892/93), 70–76. [♠] ♥??
- [171] J. Bochnack, M. Coste, M.-F. Roy, *Géométrie algébrique réelle*, *Ergebnisse Springer-Verlag*, 1986. [♠ cf. also the (augmented) English Edition dated 1998] ♥??
- [172] J. Bochnack, W. Kucharz, *A characterization of dividing real algebraic curves*, *Topology* (1996), 451–455. [♠ definition of dividing curves à la Klein ♠ albeit the title could be perfectly adequate to reflect the Ahlfors circle map existence theorem, the paper treat another characterization of dividing curves in terms of “regular mapping” (in the sense of real algebraic geometry) and their Brouwer's topological degree, plus the Hopf's theorem (classification of sphere valued mappings up to homotopy by the Brouwer degree)] ♥??
- [173] J. Bochnack, W. Kucharz, R. Silhol, *Morphisms, line bundles and moduli spaces in real algebraic geometry*, *Publ. Math. IHES* (1997 ca.), 5–65. [♠ p. 12: “dividing curves” appear, and occur in some problems about approximation of the smooth category by the algebro-geometric one] ♥17
- [174] J. Bochnack, M. Coste, M.-F. Roy, *Real Algebraic Geometry*, *Ergebnisse* 36 Springer-Verlag, 1998. [♠ augmented version of the French original ♠ p. 285–290 contains some few page devoted to Hilbert's 16th, culminating to the Gudkov-Rohlin congruence (with a “loose” cross-reference to Wilson 1978, where to the best of my knowledge no proof of the congruence in question is given)] ♥??
- [175] S. Bochner, *Über orthogonale Systeme analytischer Funktionen*, *Math. Z.* 14 (1922), 180–207. (Thesis, Berlin, 1921.) [♠ p. 184: like Bieberbach 1914 [142] and Bergman 1922 [114] the author confesses to be not able to reprove the RMT via Bieberbach's minimum problem (least area map) ♠ this problem will be cracked (independently) in Garabedian and Lehto's Thesis (cf. Garabedian 1949 [495] and Lehto 1949 [920])] ♥??
- [176] S. Bochner, *Fortsetzung Riemannscher Flächen*, *Math. Ann.* 98 (1927), 406–421. [♠ any Riemann surface of finite genus embeds conformally into a closed Riemann surface of the same genus ♠ any Riemann surface embeds into a non-prolongeable Riemann surface] ♥??
- [177] C. F. Bödigheimer, *Configuration models for moduli spaces of Riemann surfaces with boundary*, *Abh. Math. Seminar Hamburg* (2006). [♠] ♥14
- [178] M. D. Bolt, S. Snoeyink, E. van Andel, *Visual representation of the Riemann and Ahlfors maps via the Kerzman-Stein equation*, *Involvement* 3 (2010), 405–420. [♠ from MR: “The paper provides an elementary description of the Riemann and Ahlfors maps using the Szegő kernel. It further describes a numerical implementation of the maps.”]★★♥??

- [179] J. Bolyai, *Absolute Science of Space*, 1832. [♠ discovery of non-Euclidean geometry, with parallel works by Gauss and Lobatchevskii] ♥??
- [180] G. Boole, *Laws of Thought*, 1854. [♠ Lindelöf said once to Ahlfors: “read a bit Cantor, but do not become a logician”] ♥??
- [181] E. Borel, *Leçons sur la théorie des fonctions*, Gauthier-Villars, Paris, 1898. [♠ complex function theory, but also the starting point of modern measure theory (influence over Lebesgue)] ♥??
- [182] J. B. Bost, *Introduction to compact Riemann surfaces, Jacobians and Abelian varieties*, in: *From Number Theory to Physics*, Springer-Verlag, 1992, Second Corrected Printing 1995. [♠ p.99–104 contains an account of the Belyi-Grothendieck theorem as well as its geometric traduction in terms of equilateral triangulations] ♥??
- [183] C. B. Boyer, U. C. Merzbach, *A History of Mathematics*, 2nd Edition, 1989 (1st Edition 1968). [♠ a second hand source which contains a pleasant chronological table, that we used to compile some early dates in our Table Fig. 164] ♥??
- [184] M. Brandt, *Ein Abbildungssatz für endlich-vielfach zusammenhängende Gebiete*, Bull. de la Soc. des Sciences et des Lettres de Łódź XXX, 3 (1980). [♠ extension of Koebe’s KNP to shapes with arbitrary contours; similar result in Harrington 1982 [611] ♠ variant of proof in Schramm 1996 [1370]] ★★★ ♥??
- [185] G. E. Bredon, *Cohomological aspects of transformation groups*, in: Proc. of the Conf. on Transformations Groups, New Orleans, 1967, Springer-Verlag, 1968, 245–280. [♠ cited in Kharlamov 1972/73 [764] for a lemma of Smith’s theory used in the resolution of the Rohn-Hilbert 16th problem of estimating sharply the number (10) of components of a quartic surface in 3-space, and also cited in Rohlin 1972/73 [1287]] ♥??
- [186] M. Brelot, G. Choquet, *Espaces et lignes de Green*, Ann. Inst. Fourier 3 (1951), 199–263. AS60 [♠ the paper is started with a result of Evans (1927) that the streamlines of the Green’s function $G(z, t)$ [with pole at t] in a simply-connected plane domain have almost all (in the angular sense about t) finite length and therefore converge to a frontier-point ♠ this is adapted to domains of arbitrary connectivity (as well as to “superior spaces”) ♠ presumably as well as to bordered surfaces: [11.08.12] incidentally one could dream of a proof of Gromov’s FAC just via the Green’s function, while using the corresponding isothermic coordinates to calculate the area] ♥??
- [187] M. Brelot, *La théorie moderne du potentiel*, Ann. Inst. Fourier 4 (1952), 113–140. [♠ p.114 “Mais si l’on peut dire que tout est dans l’œuvre de Gauss, il apparut bientôt que la rigueur était insuffisante” ♠ a historical survey starting from Poisson, then Gauss 1840 (who considers as evident that the minimum energy is attained, electrostatic influence, problème du balayage), and the culmination of Frostman’s Thesis (1935); meanwhile Dirichlet, Riemann and Hilbert; and also Neumann, Schwarz, Harnack and Poincaré’s balayage; next Fredholm’s theory (1900) and its application to Dirichlet and Neumann; Zaremba’s works; Lebesgue’s integral found an application in Fatou’s study of the Poisson integral and Evans introduced the Radon integral in potential theory; Perron and Wiener renewed the Dirichlet problem; F. Riesz introduced subharmonic functions (precursors like Poincaré and Hartogs are signaled on p.134); ca. 1930 de la Vallée Poussin took up again the méthode du balayage to study “les masses balayées”, etc.] ♥??
- [188] E. Brettler, *Absolute Galois groups of real function fields in one variable*, Diss. McGill, Univ. Montréal 1972. [♠ quoted in Geyer-Martens 1977 [520]] ♥??
- [189] E. Brieskorn, H. Knörrer, *Ebene algebraische Kurven*, Birkhäuser Boston, 1981; English translation: *Plane Algebraic Curves*, Trans. from the German by John Stillwell, Birkhäuser Basel, 1986. [♠ p. ii: “Es ist die Freude an der Gestalt in einem höheren Sinne, die den Geometer ausmacht. (Clebsch, in memory of Julius Plücker, Gött. Abh. Bd. 15).”] ♥??
- [190] A. Brill, M. Noether, *Ueber die algebraischen Functionen und ihre Anwendung in der Geometrie*, Math. Ann. 7 (1874), 269–310. [♠] ♥??
- [191] A. Brill, M. Noether, *Bericht über die Entwicklung der Theorie der algebraischen Functionen in älterer und neuerer Zeit*, Jahresber. Deutsche Math.-Verein. 3 (1894), 107–566. [♠ a monumental historiography spreading over more than 400 pages, from Descartes to Riemann and much more] ♥??

- [192] A. Brill, *Über den Weierstraßschen Vorbereitungssatz*, Math. Ann. 64 (1910), 538–549. [♠] ♥??
- [193] L. E. J. Brouwer, *Über die topologischen Schwierigkeiten des Kontinuitätsbeweises der Existenztheoreme eindeutig umkehrbarer polymorpher Funktionen auf Riemannschen Flächen*, Gött. Nachr. (1912), 603–606. AS60 [♠ topological methods as applied to uniformization] ♥??
- [194] L. E. J. Brouwer, *Über die Singularitätenfreiheit der Modulmannigfaltigkeit*, Gött. Nachr. (1912), 803–806. AS60 [♠ idem] ♥??
- [195] L. E. J. Brouwer, *Ueber eineindeutige, stetige Transformationen von Flächen in sich (6. Mitt.)*, KNAW Proceedings 21 (1919), 707–710. [♠ Brouwer seems to vindicate his priority over Koebe for a topological proof of uniformization via the continuity method] ♥??
- [196] J. W. J. Bruce, P. J. Giblin, *A stratification of the space of plane quartic curves*, Proc. London Math. Soc. 42 (1981), 270–289. [♠ intrusion into what seems to be a Russian territory (Gudkov); work cited in Korchagin-Weiber 2005 [867]] ♥??
 ★ Erwan Brugallé, student of Itenberg ca. 2004 (Rennes), a well-known expert in history of mathematics tracing everything back to Cro-Magon.
- [197] E. Brugallé, *Symmetric plane curves of degree 7: pseudoholomorphic and algebraic classifications*, arXiv ca. 2005; or J. reine angew. Math. 612 (2007), 129–171. [♠ highly recommended by Th. Fiedler, compare his letter in v.2 dated ca. [16.04.13].] ♥4
- [198] E. Brugallé, *Real plane algebraic curves with asymptotically maximal number of even ovals*, Duke Math. J. 131 (2006), 575–587. [♠ asymptotical sharpness of the combined Harnack-Petrovskii estimates on p, n via an hexagonal variant of the Viro-Itenberg (triangular) T -construction. It seems that this clever variant still leaves intact the M -Ragsdale conjecture $|\chi| \leq k^2$ (cf. p. 576 of the article)] ♥??
- [199] E. Brugallé, *Construction of $7 \sqcup 1\langle 1\langle 11 \rangle \rangle (= 7(1, \frac{11}{1}))$ in degree 8*, Preprint available on the web page of the author (2011), 3 pages. [♠ construction of the $(M - 2)$ -scheme announced in the title which is below Orevkov's scheme $7(1, 2\frac{11}{1})$ answering thereby a question of the latter (Stepan Orevkov). To appreciate how much this is an electrified droplet in the ocean of our ignorance, cf. the combinatorics of Fig. 155. Of course heuristically this Brugallé result looks fairly standard *pain quotidien* as long as it is conjectured (Itenberg-Viro, cf. v2) that every empty oval of a real plane curve can be contracted to a solitary node to subsequently disappear in the blue sky (so-called *blue-sky catastrophe*).] ♥??
 ★ Luigi Brusotti (1877–1959), student of Bertini, Bianchi, Dini Berzolari, etc., and one of the heroes (beside Thom, and Haefliger) of Felice Ronga who introduced the writer (Gabard) to the whole topic of real geometry. More precisely Brusotti seems to have been the first writer to explain the independence of smoothing of the simplest singularities (ordinary nodes) on the basis of Riemann-Roch. Thus he put on some more conceptual ground the ad hoc perturbation used massively by Klein, Harnack, Hilbert, etc. The work of Brusotti is massive and should definitively be best assimilated (at least by the writer). Important ramification of it occurs in the work by Mikhalkin (e.g., the bases and simple Harnack curves). Also promising is the dynamical twist that Brusotti gave in some of his latest papers (*fasci di curve*) that are strongly reminiscent of our project of total reality à la Riemann seen as a tool to attack Hilbert-Rohn style prohibition.
- [200] L. Brusotti, *Sulla generazione delle curve piane di genera “p” dotate di “p + 1 circuiti”*, Ist. Lombardo Sci. Lett. Cl. Sci. Mat. Nat. Rend. (2) 43 (1910), 143–156. [♠ probably the first publication of Brusotti (at least the first listed in Gudkov 1974 [579])] ♥??
- [201] L. Brusotti, *Sulla generazione di curve piane algebriche reali mediante “piccola variazione” di una curva spezzata*, Annali di Mat. (3) 22 (1913), 117–169. [♠ systematic small perturbation method for the independent smoothings of nodal plane curves (based upon an extrinsic version of Riemann-Roch (??), worked out over \mathbb{C} by Severi ♠ forerunners Plücker 1839 [1187], Klein 1873 [791], Harnack 1876 [607], etc ♠ this is besides Plücker, Harnack 1876, Klein 1876, Hilbert 1891, the pivotal work regarding the method of small perturbation, which incarnates the mature era of the old method (prior to Viro's revolution ca. 1980), and the little Cremona-twist in Gudkov 1969/72 permitting to crack Hilbert's 16th in degree $m = 6$ ♠ this work of Brusotti is often cited by the experts for illustrating the Golden age of the classical method (e.g. in Itenberg 2002 [707])] ♥??

- [202] L. Brusotti, *Nuovi metodi costruttive di curve piane d'ordine assegnato, dotate del massimo numero di circuiti*, I–VI, Rend. Ist. Lombardo Sci. Lett., Serie IIa 47 (1914), 489–504, 797–811; 48 (1915), 182–196; 49 (1916), 495–510, 577–588, 905–919. [♠ pp. 577–588 (so part V=cinque), cited by Viro 1980 [1527] for being the first paper proposing a symbolical way to encode a distribution of ovals, and cited again for the same purpose in Viro 1983/84 [1532, p. 410] ♠ for the same purpose cited more extensively (all six parts) in Polotovskii 1988 [1209]] ♡??
- [203] L. Brusotti, *Curve generatrici e curve aggregate nella costruzione di curve piane d'ordine assegnato dotate del massimo numero di circuiti*, Rend. Circ. Mat. Palermo 42 (1917), 138–144. [♠ cited in Mikhalkin 2000 [1008]] ♡??
- [204] L. Brusotti, *Sulla “piccola variazione” di una curva piana algebrica reale*, Rend. Rom. Acc. Lincei (5) 30 (1921), 375–379. [♠ systematic small perturbation method for the independent smoothings of nodal plane curves (based upon an extrinsic version of Riemann-Roch, worked out over \mathbb{C} by Severi ♠ forerunners Plücker 1839 [1187], Klein 1873 [791], Harnack 1876 [607], etc. ♠ immediate follower Gudkov 1962 [571] (extension to cusps), Gudkov 1980/80 [581] (extension to other surfaces), etc.)] ♡??
- [205] L. Brusotti, *Fasci reali di curve algebriche*, Semin. Mat. e Fis. 33 (195X), 21–35. [♠ quite useful for supplying the precise links to the early German literature] ♡??
- [206] L. Brusotti, *La “piccola variazione” nei suoi aspetti e nel suo ufficio*, Boll. dell'Unione Mat. Italiana (3) 7 (1952), 430–444. [♠ quite useful for supplying the precise links to the early German literature] ♡??
- [207] L. Brusotti, V.E. Galafassi, *Topologia degli enti algebrici reali*, in: Atti del Quinto Congresso dell'Unione Matematica Italiana tenuto a Pavia, Torino 1955. Roma Edizione Cremonese, 1956, 57–84. [♠ a general overview cited in Kharlamov 86/96 [781].] ♡??
- [208] L. Brusotti, *Su talune questioni di realità, nei loro metodi, risultati e problemi*, in: Colloque sur les questions de réalité en géométrie, (Liège 1955), Georges Johné, Liège, et Masson, Paris, 1956, 105–129. [♠ briefly discussed in Viro's survey 1989/90 [1535] and also cited in Viro 1986/86 [1534] as well as in Kharlamov 1986/96 [781].] ♡??
- [209] E. Bujalance, J. J. Etayo, J. M. Gamboa, G. Gromadzki, *Automorphisms groups of compact bordered Klein surfaces*, Lecture Notes in Math. 1439, Springer-Verlag, Berlin, 1990. [♠] ♡??
- [210] E. Bujalance, A. Costa, S. Natanzon, D. Singerman, *Involutions of compact Klein surfaces*, Math. Z. 211 (1992), 461–478. [♠] ♡??
- [211] E. Bujalance, G. Gromadzki, D. Singerman, *On the number of real curves associated to a complex curve*, Proc. Amer. Math. Soc. 120 (1994), 507–513. [♠] ♡??
- [212] J. Burbea, *The Carathéodory metric in plane domains*, Kodai. Math. Sem. Rep. 29 (1977), 159–166. [♠ application of the Ahlfors function to a curvature estimate of the Carathéodory metric (defined via the analytic capacity) along the line of Suita's works ♠ Abstract: “Let $D \notin O_{AB}$ be a plane domain [i.e., supporting non-constant bounded analytic functions] and let $C_D(z)$ be its analytic capacity at $z \in D$ [that is the maximum distortion of a circle-map centered at z]. Let $\mathcal{K}_D(z)$ be the curvature of the Carathéodory metric $C_D(z)|dz|$. We show that $\mathcal{K}_D(z) < -4$ if the Ahlfors function of D w.r.t. z has a zero other than z . For finite [domains] D , $\mathcal{K}_D(z) \leq -4$ and equality holds iff D is simply-connected. As a corollary we obtain a result proved first by Suita, namely, that $\mathcal{K}_D(z) \leq -4$ if $D \notin O_{AB}$. Several other properties related to the Carathéodory metric are proven.” ♠ a little anachronism is noteworthy, here logically the Ahlfors function and the allied analytic capacity (1947 [18]) precedes the Carathéodory metric (1926 [234] and 1927 [235]), but of course in view of the real history, especially Carathéodory 1928 [236] the definitional aspect is essentially compatible with the historical flow] ♡??
- [213] J. Burbea, *The curvatures of the analytic capacity*, J. Math. Soc. Japan 29 (1977), 755–761. [♠ p. 755: Ahlfors function à la Havinson 1961/64 [621], i.e. for domains $D \notin O_{AB}$, analytic capacity, method of the minimum integral w.r.t. the Szegő kernel] ♡??
- [214] J. Burbea, *Capacities and spans on Riemann surfaces*, Proc. Amer. Math. Soc. 72 (1978), 327–332. [♠ p. 329: “Ahlfors function” is mentioned (in connection with the analytic capacity, yet it is not clear to me [03.10.12] if this definition is meaningful not for a domain but also on a finite Riemann surface)] ♡??

- [215] J. Burbea, *The Schwarzian derivative and the Poincaré metric*, Pacific J. Math. 85 (1979), 345–354. [♠] ♥??
- [216] J. Burbea, *The Cauchy and the Szegő kernels on multiply connected regions*, Rend. Circ. Mat. Palermo (2) 31 (1982), 105–118. [♠ Ahlfors function mentioned on p.106 and p.116] ♥9
- [217] R. B. Burckel, *An Introduction to Classical Complex Analysis*, Vol.1, Mathematische Reihe 64, Birkhäuser, 1979. [♠ p.357 some nice comments upon the literature about PSM] ♥??
- [218] D. Burns, M. Rappoport, *On the Torelli problem for kählerian K3 surfaces*, Ann. Scient. Ec. Norm. Sup. (4) 8 (1975), 235–273. [♠ adaptation to the Kählerian context of Pyatetsky-Shapiro-Shafarevich 1971 [1229] which is cited in Finashin-Kharlamov 2013 [435].] ♥??
- [219] W. Burnside, *On functions determined from their discontinuities, and a certain form of boundary condition*, Proc. London Math. Soc. 22 (1891), 346–358. [♠ detected [30.07.12] via W. Seidel’s bibliogr. (1950/52), who summarize the paper as: a method is given for mapping a region bounded by m simple closed curves C_i on an n -sheeted Riemann surface over the w -plane, where the curves C_i correspond to rectilinear slits ♠ surprisingly this paper is not quoted in Ahlfors-Sario 1960 [26] nor in Grunsky 1978 [568] ♠ the topic addressed bears some vague resemblance with the Bieberbach-Grunsky-Ahlfors paradigm of the circle map] ♥??
- [220] W. Burnside, *On a class of automorphic functions*, Proc. London Math. Soc. (3) 23 (1892), 49–88. [♠] ♥??
- [221] P. Buser, M. Seppälä, R. Silhol, *Triangulations and moduli spaces of Riemann surfaces with group actions*, Manuscr. Math. 88 (1995), 209–224. [♠ connectedness of the moduli space of real curves when projected down in the complex moduli] ♥??
- [222] A. P. Calderón, *Cauchy integrals on Lipschitz curves and related operators*, Proc. Nat. Acad. Sci. U.S.A. 74 (1977), 1324–1327. [♠ implies a resolution of the so-called Denjoy conjecture, according to which a subset of a rectifiable curve is removable for the class of bounded analytic functions (alias Painlevé null-sets) iff it has zero length ♠ the explicit link from Calderón-to-Denjoy is made explicit in Marshall [966], upon combining a long string of previous works (Garabedian, Havinson, Davie 1972 [346])] ♥318
- [223] A. P. Calderón, *Commutators, singular integrals on Lipschitz curves and applications*, ICM Helsinki 1978, 85–96. [♠ the Denjoy’s conjecture is mentioned as an application of Calderón 1977 [222], as follows (p.90): “Now let us turn to applications. Let Γ be a simple rectifiable arc in the complex plane. Then the function $G(z) = \frac{1}{2\pi i} \int_{\Gamma} \frac{f(w)}{w-z} dw$, where $f(w)$ is a function on Γ which is integrable w.r.t. arc length, has a limit almost everywhere in Γ as z approaches nontangentially a point of Γ . [...] Another application is the following result due to D. E. Marshall (personal communication) which confirms an old conjecture of A. Denjoy (1909 [360]): the analytic capacity $\gamma(E)$ of a compact subset E of a rectifiable arc in the complex plane is zero if and only if its one-dimensional Hausdorff measure vanishes.” ♠ for the detailed proof see Marshall [966] (and maybe also Melnikov 1995 [996])] ♥56
- [224] A. P. Calderón, *Acceptance speech for the Bôcher Prize*, Notices A.M.S. 26 (1979), 97–99. [♠ the solution to the Denjoy’s conjecture is mentioned as one of the most significant application of the article Calderón 1977 [222]]★★ ♥4
- [225] A. Candel, *Uniformization of surface laminations*, Ann. Sci. Ecole Norm. Sup. (1993). [♠ ... To have the same relation between Riemann surface laminations and oriented surface laminations with riemannian metric we then need a regularity theorem for the Beltrami equation depending on parameters. This is precisely what Ahlfors and Bers proved in their classical ...] ♥110
- [226] C. Carathéodory, *Sur quelques applications du théorème de Landau-Picard*, C. R. Acad. Sci. Paris 144 (1907), 1203–1204; also in: Ges. Math. Schriften, Band 3, 6–9. [♠ first modern proof of the Schwarz lemma, acknowledging E. Schmidt, compare footnote 2: “Je dois cette démonstration si élégante d’un théorème connu de M. Schwarz (Ges. Abh., t.2, p.108) à une communication orale de M. E. Schmidt.”] ♥??
- [227] C. Carathéodory, *Über die Variabilitätsbereich der Koeffizienten von Potenzreihen die gegebene Werte nicht annehmen*, Math. Ann. 64 (1907), 95–115. [♠ this

- and the next entry where the first work bringing together Minkowski's theory of convex sets with complex function theory ♠ for an extension of this Carathéodory theory to finite Riemann surface, cf. Heins 1976 [638]] ♥220
- [228] C. Carathéodory, *Über die Variabilitätsbereich der der Fourierschenkonstanten von positiven harmonischen Funktionen*, Rend. Circ. Mat. Palermo 32 (1911), 193–217. [♠] ♥220?
- [229] C. Carathéodory, L. Fejér, *Über den Zusammenhang der Extremen von harmonischen Funktionen mit ihren Koeffizienten und über den Picard-Landauschen Satz*, Rend. Circ. Mat. Palermo 32 (1911), 218–239. [♠ for a (vague?) interconnection of this article with the Ahlfors map, cf. Jenkins-Suita 1979 [719]] ♥??
- [230] C. Carathéodory, *Untersuchungen über die konformen Abbildungen von festen und veränderlichen Gebieten*, Math. Ann. 72 (1912), 107–144. G78 ♥??
- [231] C. Carathéodory, *Über die gegenseitige Beziehung der Ränder bei der konformen Abbildung des Inneren einer Jordanschen Kurve auf einen Kreis*, Math. Ann. 73 (1913), 305–320. ♥??
- [232] C. Carathéodory, *Über die Begrenzung einfach zusammenhängender Bereiche*, Math. Ann. 73 (1913), 323–370. ♥??
- [233] C. Carathéodory, *Elementarer Beweis für den Fundamentalsatz der konformen Abbildung*. In: *Mathematische Abhandlungen*, Hermann Amandus Schwarz zu seinem fünfzigjährigen Doktorjubiläum am 6. August 1914 gewidmet von seinen Freunden und Schülern, 19–41; also in: *Ges. Math. Schriften*, Band 3, 273–299. [♠ p. 294 perhaps the first usage of the jargon “*quasikonform*”, compare Ahlfors' memory failure reported in Kühnau 1997 [894] ♠ more importantly the classical square-root procedure is developed in detail] ♥??
- [234] C. Carathéodory, *Über das Schwarzsche Lemma bei analytischen Funktionen von zwei komplexen Veränderlichen*, Math. Ann. 97 (1926), 76–98. [♠ quoted in Grunsky 1940 [563, p. 233], who discusses the connection between the Carathéodory metric and the “Ahlfors” function (which in the present connection should be definitively better called the “Grunsky-Ahlfors function”)] ♥??
- [235] C. Carathéodory, *Über eine spezielle Metrik, die in der Theorie der analytischen Funktionen auftritt*, Atti Pontifica Acad. Sc., Nuovi Lincei 80 (1927), 135–141. [♠ where the so-called Carathéodory metric is first defined (but see also the previous entry Carathéodory 1926 [234]), which in turn turned out to be closely related to the Ahlfors function, cf. e.g. Grunsky 1940 [563], Simha 1975 [1437], Burbea 1977 [212], Krantz 2008 [874]] ♥??
- [236] C. Carathéodory, *Bemerkungen zu den Existenztheoremen der konformen Abbildung*, Bull. Calcutta Math. Soc. 20 (1928), 125–134; also in: *Ges. Math. Schriften*, Band 3, 300–310. AS60 [♣ along lines initiated by Fejér-Riesz (published by Radó 1922/23 [1231]) a new proof of RMT is given via an extremal problem, which is a simply-connected prelude to Ahlfors 1950 [19] ♣ as pointed out by Remmert 1991 [1246] Carathéodory's elegant proof appears rarely in book form (exception Narasimhan's book), and is somewhat less popular than the variant of Fejér-Riesz-Bieberbach-Ostrowski ♠ the article involves (cf. p. 303) the extremal problem $\max |f(z_1)|$ of maximizing the modulus of the function at an auxiliary point z_1 , whereas the other method (Fejér-Riesz, etc.) maximizes the derivative at the basepoint z_0 ♠ it is precisely Carathéodory's version which is extended in Ahlfors 1950 [19], but of course the other formulation lead likewise to a circle map] ♥??
- [237] C. Carathéodory, *Conformal representation*, Cambridge Tracts in Math. and Math. Physics 28, London 1932. (2nd edition 1958) AS60, G78 [♠ an introduction to problem of conformal mapping] ♥??
- [238] C. Carathéodory, *On Dirichlet's problem*, Amer. J. Math. 59 (1937), 709–731. [♠ surprisingly this item is not quoted in Ahlfors-Sario 1960 [26] ♠ p. 710: “In the foregoing chapter, I have tried to give a very elementary treatment of the principal properties of harmonic functions culminating in the existence proof for Dirichlet's problem devised by O. Perron [=1923 [1165]] and very much simplified by T. Radó and F. Riesz [=1925 [1236]]. I have done this in order to show how the whole theory can be condensed if one puts systematically from the outset Poisson's Integral in the limelight.”] ♥??
- [239] C. Carathéodory, *A proof of the first principal theorem on conformal representation*, Studies and Essays presented to R. Courant on his 60th birthday, Jan. 8, 1948,

- Interscience Publ., 1948, 75–83; also in: Ges. Math. Schriften, Band 3, 354–361. AS60, G78 [♠ another proof of RMT through an iterative method, using square-roots operations, Schwarz’s lemma and Montel ♠ naive question, although this might be more in line with the earlier approach ca. 1910 of Koebe-Carathéodory, this approach looks more involved than the extremum problem in the previous item [236], and perhaps less susceptible of extension to Riemann surfaces] ♡??
- [240] C. Carathéodory, *Funktionentheorie, I, II*, Birkhäuser, Basel, 1950. AS60, G78 ♡??
- [241] C. Carathéodory, *Bemerkung über die Definition der Riemannschen Flächen*, Math. Z. 52 (1950), 703–708. AS60 [♠ purist approach to uniformization via extremal problems, similar ideas in several papers by Grunsky not listed here, cf. his Coll. Papers ♠ the (Grenzkreis) uniformization appears also in Carathéodory 1928 [236]] ♡??
- [242] A. L. Carey, K. C. Hannabuss, *Infinite dimensional groups and Riemann surfaces field theories*, Comm. Math. Phys. 176 (1996), 321–351. [♠] ♡??
- [243] T. Carleman, *Über ein minimal Problem der mathematischen Physik*, Math. Z. 1 (1918), 208–212. G78 [♠ used in Gaier 1978 [475] and Alenycin 1981/82 [38] in connection with an extension of the (Bieberbach 1914) minimum area problem to multiply-connected regions] ♡??
- [244] T. Carleman, *Sur la représentation conforme des domaines multiplement connexes*, C.R. Acad. Sci. Paris 168 (1919), 843–845. G78 [♠ another proof of KNP=Kreismormierungsprinzip, originally due to Koebe 1907/1920, if not (implicit in) Schottky 1877 [1366]] ♡??
- [245] T. Carleman, *Über die Approximation analytischer Funktionen durch linear Aggregate von vorgegebenen Potenzen*, Arkiv för mat., astron. o. fys. 17 (1922). [♠ credited in Lehto 1949 [920, p.8] for some work (independent of Bergman 1922 [114] and Bochner’s 1922 [175]) inaugurating the usage of orthogonal systems in the theory of conformal mappings] ♡??
- [246] L. Carleson, *On bounded analytic functions and closure problems*, Ark. Mat. 2 (1952), 283–291. [♠]★★ ♡??
- [247] L. Carleson, *Interpolations by bounded analytic functions and the Corona problem*, Ann. of Math. (2) 76 (1962), 547–559. [♠ one of the super-famous problem solved by Carleson, and which received (thanks Alling 1964 [40] and others) an extension from the disc to any compact bordered Riemann surface via the Ahlfors circle map] ♡560
- [248] L. Carleson, *Selected problems on exceptional sets*, Van Nostrand, Princeton, 1967. [♠ p.73–82 uniqueness of the Ahlfors extremal function [the one maximizing the derivative at a fixed point amongst functions bounded-by-one] for domains of infinite connectivity; similar work in Havinson 1961/64 [621] and simplifications in Fisher 1969 [439]] ♡??
- [249] L. Carleson, *Lars Ahlfors and the Painlevé problem*. In: *In the tradition of Ahlfors and Bers* (Stony Brook, NY, 1998), 5–10. Contemp. Math. 256, Amer. Math. Soc., Providence, RI, 2000. Nostrand, Princeton, 1967. [♠ survey of the theory of removable sets for bounded analytic functions (a.k.a. Painlevé null-sets) from Painlevé, Denjoy to G. David, via Ahlfors (analytic capacity), Garabedian and Melnikov (Menger curvature). Future research is suggested along the 3 axes: (i) develop a theory of periods for the conjugate of positive harmonic functions (ii) sharper study of the extremal function (and induced measure) that appear in Garabedian 1949 [495] (iii) to continue the study of the Cauchy integrals in relation with Menger curvature and rectifiability] ♡??
- [250] F. Carlson, *Sur le module maximum d’une fonction analytique uniforme. I*, Ark. Mat. Astron. Fys. 26 (1938), 13 pp. G78 [♠ quoted (joint with Teichmüller 1939 [1484] and Heins 1940 [632]) in Grunsky 1940 [563] as one of the precursors of the extremal problem for bounded analytic functions] ★★★ ♡??
- [251] ?. Carnot, *La métaphysique du calcul*, 1797. [♠ an attractive title for Laurent Bartholdi or Michel Kervaire (people liking calculation, but do it rather à la Dirichlet-Riemann, i.e. minimizes blind computation (cf. also Dehn when criticizing his student of which I forgot the name although super-famous))] ♡??
- [252] ?. Carnot, *Géométrie de position*, 1803. [♠ often quoted by Gauss as being one of the first topological text, after Descartes, Leibniz and Euler] ♡??

- [253] H. Cartan, *Théorie élémentaire des fonctions analytiques d'une ou plusieurs variables complexes*, Hermann, Paris, 1961. [♠] ♥??
- [254] E. Casas-Alvero, Roots of complex polynomials and foci of real algebraic curves, *L'Enseign. Math.* 2013. [♠] ♥??
- [255] A. L. Cauchy, *Mémoire sur la théorie des intégrales définies*, communicated to the Paris Academy in 1814, and first published in 1827. [♠ first occurrence of the Cauchy-Riemann equations, as criterion for the analyticity (holomorphy) of functions of a complex variable, modulo earlier occurrences in the work of Euler on hydrodynamics, and even earlier in the work of Jean le Rond d'Alembert (1717–1783) (on behalf of p. 12 of Monastyrsky 1987/99 [1030], who do not give the exact sources)] ♥??
- [256] A. L. Cauchy, *Mémoire sur les intégrales définies prises entre des limites imaginaires*, De Bure Frères, Paris, 1825, posthumous papers not published until 1874, in: *Œuvres de Cauchy*, 1876, Série II, tome XV, 41–89. [♠ definition of the integral of a function in the complex domain, including the case of singularity in which case the integral may depend on the path ♠ first appearance of the notion of residue] ♥??
- [257] A. L. Cauchy, ???, work completed in 1831, published in 1836. [♠ power series expansion of an analytic function and the integral representation of $f(z)$ inside a circle (Cauchy formula)] ♥??
- [258] A. L. Cauchy, *Considérations nouvelles sur les intégrales définies qui s'étendent à tous les points d'une courbe fermée, et sur celles qui sont prises entre des limites imaginaires*, *C. R. Acad. Sci. Paris* 23 (1846), 689. [♠ Cauchy's residue theorem] ♥??
- [259] A. Cayley, *On quartic curves*, *Phil. Mag.* 29 (1865), ??. [♠ often cited by Scott 1902 [1378], Brusotti 1914, etc.] ♥??
 ♠ Francesco Cecioni is a well-known conformal mapper in Italy famous for having first established (1908) rigorous proofs of the Parallelschlitzbereich mapping theorem first enunciated in Schottky 1877.
- [260] F. Cecioni, *Sulla rappresentazione conforme delle aree piane pluriconnesse su un piano in cui siano eseguiti dei tagli paralleli*, *Rend. Circ. Mat. Palermo* 25 (1908), 1–19. G78 [♠ another derivation of the parallel-slit map of Schottky 1877 [1366], via several citation to Picard's book for the foundational aspects ♠ as Schottky's proof depends on a heuristic moduli count, this paper of Cecioni may well be regarded as the first rigorous existence proof of PSM (cf., e.g., Grunsky 1978 [568, p. 185])] ♥??
- [261] F. Cecioni, *Sulla rappresentazione conforme delle aree pluriconnesse appartenenti a superficie di Riemann*, *Annali delle Università Toscane* 12, nuova serie (1928), 27–88. [♠ cited via Matildi 1948 [982]; WARNING: this entry looks much like the next item, yet differs in the pagination] ★★ ♥??
- [262] F. Cecioni, *Sulla rappresentazione conforme delle aree pluri-connesse appartenenti a superficie di Riemann*, *Rend. Accad. d. L. Roma* (6) 9 (1929), 149–153. AS60 [♠ cited via Ahlfors-Sario 1960 [26]] ★★ ♥??
- [263] F. Cecioni, *Osservazioni sopra alcuni tipi aree e sulle loro curve caratteristiche nella teoria della rappresentazione conforme*, *Rend. Palermo* 57 (1933), 101–122. [♠ la parole “curve catteristiche” means the Schottky(-Klein) double ♠ contains several nice remarks about the Klein correspondence when particularized to orthosymmetric curve tolerating a direct-conformal involution which is sense reversing on the ovals] ♥??
- [264] F. Cecioni, *Un teorema su alcune funzioni analitiche, relative ai campi piani pluriconnessi, usate nella teoria della rappresentazione conforme*, *Ann. Pisa* (2) 4 (1935), 1–14. G78 ♥??
- [265] F. Cecioni, *Alcune disegualinze fra una sistem di moduli trascendenti delle curve algebriche presentati il caso di Harnack*, *Scritti matematici offerti a L. Berzolari*, Pisa 1936 487–509. [♠ cited in Gudkov 1974 [579].] ♥??
- [266] M. Černe, J. Globevnik, *On holomorphic embedding of planar domains into \mathbb{C}^2* , *J. Anal. Math.* 81 (2000), 269–282. A50 [♠ Koebe's Kreisnormierungsprinzip is combined with the Ahlfors function to show that every bounded, finitely connected domain of \mathbb{C} without isolated boundary points embeds properly holomorphically into \mathbb{C}^2 ♠ of course, those are not the sole ingredients for otherwise the method

- would probably extend to positive genus surfaces in view of Ahlfors 1950 [19], and positive genus extensions of KNP due to Haas 1984 [595]/Maskit 1989 [980]] ♡4?
- [267] M. Černe, F. Forstnerič, *Embedding some bordered Riemann surfaces in the affine plane*, Math. Research Lett. 9 (2002), 683–696. A50 [♠ Ahlfors 1950 is cited at several places ♠ p. 684: “On each smoothly bounded domain $\Omega \Subset \mathbb{C}$ with m boundary components there exists an inner function f with $\deg(f) = m$ [Ahl](=Ahlfors 1950 [19])¹⁸. The map $F(x) = (f(x), x) \in \mathbb{C}^2$ for $x \in \overline{\Omega}$ satisfies the hypothesis of Theorem 1.2 and hence Ω embeds in \mathbb{C}^2 . This is the theorem of Globevnik and Stensønes [GS](=1995).” ♠ p. 684: “We shall call a bordered Riemann surface \mathcal{R} hyperelliptic if its double is hyperelliptic. Such [an] \mathcal{R} has either one or two boundary components¹⁹ and it admits a pair of inner functions (f, g) which embed $\text{int}\mathcal{R}$ in the polydisc U^2 such that $b\mathcal{R}$ is mapped to the torus $(bU)^2$; moreover, one of the two functions has degree $2g_{\mathcal{R}} + m$ and the other one has degree 2 (see [Ru1](=Rudin 1969 [1312]) and sect. 2 in [Gou](=Gouma 1998 [536])). Thus \mathcal{R} is of class \mathcal{F} and we get:—**Corollary 1.3** *If \mathcal{R} is a hyperelliptic bordered Riemann surface then $\text{int}\mathcal{R}$ admits a proper holomorphic embedding in \mathbb{C}^2 . In particular, each torus with one hole embeds properly holomorphically into \mathbb{C}^2 .* ♠ p. 686: “**Comments regarding class \mathcal{F} .** It is proved in [Ahl, pp. 124–126](=Ahlfors 1950 [19]) that on every bordered Riemann surface \mathcal{R} of genus $g_{\mathcal{R}}$ with m boundary components there is an inner function f with multiplicity $2g_{\mathcal{R}} + m$ (although the so-called Ahlfors functions may have smaller multiplicity). A generic choice of $g \in A^1(\mathcal{R})$ gives an immersion $F = (f, g): \mathcal{R} \rightarrow \overline{U} \times \mathbb{C}$ with at most finitely many double points (normal crossings). The main difficulty is to find g such that $F = (f, g)$ is injective on \mathcal{R} . We do not know whether such g always exists as Oka’s principle does not apply in this situation (Proposition 2.2).” ♠ Ahlfors 1950 is cited once more on p. 687 during the proof of Theorem 1.1 stating that there is no topological obstruction to holomorphic embeddability in \mathbb{C}^2 , in the following sense (p. 683) “**Theorem 1.1** *On each bordered surface \mathcal{R} there exists a complex structure such that the interior $\text{int}\mathcal{R} = \mathcal{R} \setminus \partial\mathcal{R}$ admits a proper holomorphic embedding in \mathbb{C}^2 .* ♠ p. 693: “**Remark.** As already mentioned, Ahlfors [Ahl](=1950) constructed inner functions of multiplicity $2g_{\mathcal{R}} + m$ on any bordered Riemann surface. Proposition 4.1 shows that such functions are stable under small perturbations of the complex structure. On the other hand this need not be true for the Ahlfors function f_p which maximizes the derivative at a given point $p \in \mathcal{R}$ since the degree of f_p may depend on p .”
◇ [28.09.12] maybe there is a somewhat more elementary approach to the main result (no topological obstruction) by looking at some real algebraic models in \mathbb{P}^2 or $\mathbb{P}^1 \times \mathbb{P}^1$, for instance taking a saturated pencil on the Gürtelkurve (cf. Gabard 2006 [463]) and removing an imaginary line of this pencil one gets an embedding of the bordered surface (half of the real quartic C_4) into \mathbb{C}^2] ♡13
- [268] M. Černe, *Nonlinear Riemann-Hilbert problem for bordered Riemann surfaces*, Amer. J. Math. 126 (2004), 65–87. A50 [♠] ♡??
- [269] M. Černe, M. Flores, *Generalized Ahlfors functions*, Trans. Amer. Math. Soc. 359 (2007), 671–686. [♠ a promising generalization of the Ahlfors function is given where the (static) unit-circle is replaced by a dynamical family $\{\gamma_z\}_{z \in \partial F}$ of Jordan curves enclosing the origin parametrized by the boundary of the bordered surface F] ♡5
- [270] S. Chaudary, *The Brill-Noether theorem for real algebraic curve*, Ph. D. Thesis. Duke University, 1995. [♠]★ ♡??
- [271] Chasles, *Traité de géométrie supérieure*, 1852. [♠] ♡??
- [272] ?. Chebotarev, ?, ? , 1948. [♠ a textbook on analytic functions and Riemann surfaces cited in Gudkov 1974/74 [579] for the intrinsic proof of Harnack’s inequality ♠ this entry is possibly the source of some historical confusion crediting Hurwitz instead of Klein for this result (compare comments after Gudkov 1974/74 *loc. cit.*) ♠ Hurwitz extended to the case of singular curves, but modulo the normalization (desingularization) everything reduces to the smooth case] ♡??
- [273] A. L. Cheponkus, *On nests of real plane algebraic curves*, Litovsk. Mat. Sb. 16 (1976), 239–243, 257; English transl., Lithuanian Math. J. 16 (1976), 634–637. [♠ cited in Rohlin 1978 [1290], cf. also a paper by Marin 1988 [964] for another proof ♠ in fact Cheponkus’ proof turned out to be incorrect (cf. e.g. Viro 1986/86 [1534, p. 68] and especially Marin 1988 [964] for a specific objection)] ♡??

¹⁸Of course for this purpose it would have been enough to cite Bieberbach 1925 [147].

¹⁹This is true modulo the possibility of the planar case (i.e. Harnack-maximal Schottky double).

- [274] I. V. Cherednik, *Reality condition in "finite-zone integration"*, Dokl. Akad. Nauk SSSR 252 (1980), 1104–1108; English transl., Soviet Phys. Dokl. 25 (1980), 450–452. [♠ cited in Dubrovin 1983/85 [381]] ♡??
- [275] S. S. Chern, P. Hartman, A. Wintner, *On isothermic coordinates*, Comment. Math. Helv. 28 (1954), 301–309. [♠] ♡??
- [276] S. S. Chern, *Complex Manifolds without Potential Theory*, Second Edition. Springer-Verlag, Berlin, 1979. [♠] ♡??
- [277] C. Chevalley, *Introduction to the Theory of Algebraic Functions of One Variable*, Math. Surveys 6, Amer. Math. Soc., New York, 1951, 188 pp. [♠] ♡??
 ★ Benoît Chevallier, (student of ?), well-known since the mid 1980's and contributed recently (2002) to adding 4 new M -schemes in degree 8 by flexibilizing the Viro method, actually by smoothing a Hawaiian earring constituted by 4 ellipses with fourfold contact.
- [278] B. Chevallier, *Sur les courbes maximales de Harnack*, C. R. Acad. Sci. Paris, Sér. I, Math. 300 (1985), 109–114. [♠] ♡??
- [279] B. Chevallier, *À propos des courbes de degrés 6*, C. R. Acad. Sci. Paris, Sér. I, Math. 302 (1986), 33–38. [♠] ♡??
- [280] B. Chevallier, *Problèmes de désingularisations maximales de courbes analytiques réelles planes*, Preprint, Univ. Toulouse, 1992. [♠ cited in Risler 1992 [1265]] ♡??
- [281] B. Chevallier, *Secteurs et déformations locales de courbes réelles*, Math. Ann. 307 (1997), 1–28. [♠ variant of the Viro method via deformation of degenerate singularities, with the background idea to application to Hilbert's 16th, with reward of the approach in the next entry Chevallier 2002 [282] reducing to 9 the questionable M -schemes of Hilbert's 16th in degree $m = 8$ ♠ p. 4: "Il est généralement admis que la connaissance des types topologiques des variétés algébriques maximales, ou M -variété[s], affines ou projectives, définies par une dimension d'homologie totale la plus grande possible pour une dimension et un degré donnés, permet de déduire une grande partie des types topologiques des variétés non maximales." ♠ p. 6: "Les différents contextes sous-jacents (déploiements universels, surfaces de Riemann, ...) ne sont pas utilisés ici. Tout est obtenu à partir du polygone de Newton. [...]"] ♡??
- [282] B. Chevallier, *Four M -curves of degree 8*, Funkts. Analiz Prilozhen. 36 (2002), 90–93; English transl., Funct. Anal. Appl. 36 (2002), 76–78. [♠ four schemes are constructed yielding one of the most recent contribution to Hilbert's 16th in degree $m = 8$; at this stage of the story it remained after 2 decades of efforts since the post-Rohlin era of Fiedler-Viro (1980) only 9 schemes left unrealized among the 104 logically possible (after Fiedler-Viro 1980) ♠ the next step of the story is Orevkov 2002 [1129], where the 9 Higgs bosons are reduced to a list of 6 (by prohibiting 2 of them, even pseudo-holomorphically) and constructing one of them (via Grothendieck's dessins d'enfants?)] ♡??
 ★ Chislenko, student of ?, known in particular for contributions on the degree 10 case of Hilbert's 16th for M -curves.
- [283] Yu. S. Chislenko, *Pencils of real algebraic curves*, Leningrad Topology Conference, 1982, 28. [♠ correct proof of a special case of Cheponkus' theorem, namely through 13 points in general position in the real projective plane passes a connected quartic ♠ for a generalization based upon Klein's remark (1876), cf. Marin 1988 [964]] ♡??
- [284] Yu. S. Chislenko, *M -curves of degree 10*, Zap. Nauchn. Sem. Leningrad. Otdel. Mat. Inst. Steklov. (LOMI) 122 (1982), 142–161; English transl., J. Soviet Math. 26 (1984), 1689–1699. [♠ as reported in Viro 1986/86 [1534] this article exhibits about 500 M -schemes in degree 10 (along the methodology proposed by Viro), while the classical old methods (Harnack, Hilbert, Brusotti, Wiman, Gudkov) exhibited only 38 schemes, so that in degree 10 Viro is ≈ 13 times stronger than the conjunction of all his predecessors. In degree 8, we know since Viro 1980 [1527] that the new (Viro) method produces 42 new M -schemes while prior to Viro only 10 were known to be realized (namely Harnack=2, Hilbert=4, Wiman=1, Gudkov=2, Korchagin=1 via a variant of Brusotti) and so here for $m = 8$ Viro is $42/10 = 4.2$ times stronger than the conjunction of all predecessors ♠ this article is also cited in Risler 1992 [1265] with the wrong(?) date 1989] ♡10
- [285] M. Christ, *A $T(b)$ theorem with remarks on analytic capacity and the Cauchy integral*, Colloq. Math 60/61 (1990), 1367–1381. [♠] ♡??

- [286] E. Christoffel, *Ueber die Abbildung einer n -blättrigen einfach zusammenhängender ebenen Fläche auf einen Kreise*, Gött. Nachr. (1870), 359–369. [♠ the so-called Schwarz-Christoffel formula effecting the (one-to-one) conformal representation of a polygon upon the disc ♠ more precisely Schwarz 1869 [1372] stated that the formula is easily generalized to the case of a multi-sheeted domain bounded by straight lines and containing branch points, and Christoffel considers here this generalization in some detail ♠ [07.10.12] can we connect the Schwarz-Christoffel theory with that of the Ahlfors map? try perhaps Kühnau 1967 [892]] ♡??
- [287] Y.-B. Chung, *The Ahlfors mapping function and an extremal problem in the plane*, Houston J. Math. 263 (1993), 263–273. [♠]★ ♡??
- [288] Y.-B. Chung, *The Bergman kernel function and the Ahlfors mapping in the plane*, Indiana Univ. Math. J. 42 (1993), 1339–1348. [♠ Ahlfors mapping, Bergman kernel, etc.] ♡??
- [289] Y.-B. Chung, *Higher order extremal problem and proper holomorphic mapping*, Houston Math. J. 27 (2001), 707–718. A50 [♠ Ahlfors extremal problem (in the domain-case) with multiplicity (i.e. some first derivatives are imposed to be 0 at some base-point a)]★★★[MR-OK] ♡??
- [290] Y.-B. Chung, *The Bergman kernel function and the Szegő kernel function*, J. Korean Math. Soc. 43 (2006), 199–213. [♠ the “Ahlfors map” of a smoothly bounded domain in the plane occurs several times through the paper] ♡0
- [291] C. Ciliberto, C. Pedrini, *Annibale Comessatti and real algebraic geometry*, Rend. Cont. Circ. Mat. Palermo (2) Suppl. 36 (1994), 71–102. [♠] ♡??
- [292] C. Ciliberto, C. Pedrini, *Real abelian varieties and real algebraic curves*. In: Lectures in Real Geometry, F. Broglia (ed.), de Gruyter Exp. in Math. 23 (1996), 167–256. [♠ a modernized (neoclassical) account of the theories of Klein, Weichold and Comessatti] ♡??
- [293] K. Clancey, *Representing measures on multiply connected planar domains*, Illinois J. Math. 35 (1991), 286–311. [♠ what about Riemann surface? try Alpay-Vinnikov 200 [48], and also Nash 1974 [1058]] ♡??
★ Alfred Clebsch joint teacher with Plücker of Felix Klein. Prematurely deceased when editing Riemann’s work and so the legacy went to Klein to pursue the tradition of synthetic geometry. He succeeded better than any expectation (to say the least), yet we can still regret that Clebsch passed away too quickly.
- [294] A. Clebsch, *Ueber die Anwendung der Abelschen Functionen in der Geometrie*, J. Reine Angew. Math. 63 (1863), 189–243. [♠] ♡??
- [295] A. Clebsch, *Ueber diejenigen ebenen Curven, deren Coordinaten rationale Functionen eines Parameters sind*, J. Reine Angew. Math. 64 (1865), 43–65. [♠ coins the nomenclature genus, conceptually put in the limelight by Riemann (plus maybe Abel in some algebraic disguise)] ♡??
- [296] A. Clebsch, P. Gordan, *Theorie der Abelschen Functionen*, Teubner, Leipzig, 1866. [♠] ♡??
- [297] A. Clebsch, ??, J. Reine Angew. Math. 65 (1866), 359. [♠ cited in Wright 1907 [1606].] ♡??
- [298] A. Clebsch, *Zur Theorie der Riemann’schen Flächen*, Math. Ann. 6 (1872), 216–230. AS60 [CHECK date for Ahlfors-Sario 1960, it is 1873?] ♡??
- [299] C. H. Clemens, *A Scrapbook of Complex Curve Theory*, Plenum Press, New York, 1980, 186 pp. [♠] ♡??
★ Clifford (1845–1879, aged 34) well-known British scientist sometimes regarded as forerunner of Einstein when the space-time substratum starts bubbling under the presence of materia and gravitational clumping.
- [300] W. K. Clifford, *On the space-theory of matter*, Cambridge Philos. Society’s Proc. 2 (1876), 157–158. [♠] ♡??
- [301] W. K. Clifford, *On the canonical form and dissection of a Riemann’s surface*, Proc. London Math. Soc. 8 (1877), 292–304. [♠ not cited in Ahlfors-Sario 1960!] ♡??
- [302] W. K. Clifford, *Il senso comune nelle scienze esatte*, Milano, 1886. [♠ cited in Brusotti 1952 [206], with the following explanations (traduzione Italian dovuta a G. A. Maggi).] ♡??

- [303] R. Coifman, G. Weiss, *A kernel associated with certain multiply connected domains and its application to factorization theorems*, *Studia Math.* 28 (1966), 31–68. G78 [♠ p.31: “Our main result is a generalization of the classical factorization theorem for function in the Nevanlinna class of the unit disc.”] ♡??
- [304] R.R. Coifman, A. McIntosh, Y. Meyer, *L’opérateur de Cauch définit un opérateur borné sur L^2 pour les courbes lipschitziennes*, *Ann. of Math. (2)* 116 (1982), 361–387. [♠] ♡??
- [305] Y. Colin de Verdière, A. Marin, *Triangulations presque équilatérales des surfaces*, *J. Differential Geom.* 32 (1990), 199–207. [♠] ♡??
 ★ Annibale Comessatti, a real geometer (student of ?) much influenced (and in admiration) for the genial works of Felix Klein (compare Comessatti 1931 [313]) and the Italian school of complex geometry (especially Severi), somewhat much in advance upon his era, and apparently prematurely deceased (troppo presto mancato alla scienza, according to Brusotti 1952 [206, p. 431]).
- [306] H. Comessatti, *Fondamenti per la geometria sopra le superficie razionali dal punto di vista reale*, *Math. Ann.* 43 (1912), 1–72. [♠ p.2: “Si aggiunga che all’infuori del concetto di superficie di Riemann immetriche introdotto e largamente usato dal Klein si può dire che nessun altro concetto veramente generale governi le ricerche che si son fatte in tale argomento, con profondità d’indagine, ma con indirizzi e metodi disparati, e senza vedute largamente sistematiche.”] ♡??
- [307] H. Comessatti, *Sulla connessione delle superficie razionali reale*, *Ann. di Mat. (3)* 23 (1914/15), 215–283. [♠ topological classification of the real part of a rational surface, compare with work by Huisman, etc. as well as that of Enriques 1911–12 [395] ♠ the precise statement is that any orientable rational surface has a real part homeomorphic to either the sphere S^2 or the torus $S^1 \times S^1$ (and so cannot be of genus $g \geq 2$).] ♡??
- [308] A. Comessatti, *Sulle varietà abeliane reali, I, II*, *Ann. Mat. Pura Appl. (4)* 2 (1924–25), 67–106. ♡??
- [309] A. Comessatti, *Sulle varietà abeliane reali, II*, *Ann. Mat. Pura Appl. (4)* 4 (1925–26), 27–71. ♡??
- [310] A. Comessatti, *Sulla connessione delle superficie algebriche reali*, *Ann. Mat. Pura Appl. (4)* 5 (1928), 299–317. [♠ Zeuthen-Segre invariant (alias Euler characteristic), base number (à la Severi), total connectivity number (connessione totale) ♠ based on works by Picard, Severi, Lefschetz.] ♡??
- [311] A. Comessatti, *Sulla connessione delle superficie algebriche reali*, *Verhandl. Internat. Math. Kongress Zürich*, vol. 2, 1932, p. 129. [♠ contains already the so-called Comessatti inequality pivotal to address the 2nd quarter of Hilbert’s 16th, e.g. the estimation of the number of components of surface of degree 4,5, compare e.g. Itenberg 2002 [707]] ♡??
- [312] A. Comessatti, *Sulla connessione e sui numeri base delle superficie algebriche reali*, *Rend. Semin. Mat. Univ. Padova* 3 (1932), 141–162. [♠ seems to contain the first proof of what in modern language can be stated has $\chi(S(\mathbb{R})) \leq h^{1,1}$, which was rediscovered by Petrovskii-Oleinik 1949 [1170] and which plays a pivotal in Kharlamov’s 1972 [764] solution to the 2nd quarter of Hilbert’s 16th, namely the maximum number (10) of components that a quartic surface in 3-space can have] ♡??
- [313] A. Comessatti, *Reelle Fragen in der algebraischen Geometrie*, *Jahresb. d. Deutsch. Math. Verein.* 41 (1932), 107–134. [♠] ♡??
- [314] A. Comessatti, *Sui circuiti dispari delle curve algebriche reali trcciate sopra superficie razionali*, *Boll. Unione Mat. Ital.* 12 (1933), 289–294. [♠] ♡??
- [315] A. Comessatti, *Problemi di realtà per le superficie e varietà algebriche*, *Reale Accademia d’Italia (Fondazione Alessandro Volta), Atti dei Convegni*, vol. 9 (1939), Roma 1943, 15–41. [♠ apparently one of Comessatti’s last work: cited in Gudkov 1974 [579] Nikulin 1983/84 [1108] and in Kharlamov 1986/96 [781].] ♡??
- [316] J.L. Coolidge, *A Treatise on Algebraic Plane Curves*. Oxford University Press, London, 1931. [♠ cited in Gudkov 1974 [579]] ♡??
- [317] M. Coppens, *One-dimensional linear systems of type II on smooth curves*, Ph.D. Thesis, Utrecht, 1983. [♠] ♡??
- [318] M. Coppens, G. Martens, *Linear series on general k-gonal curves*, *Abh. Math. Sem. Univ. Hamburg* 69 (1999), 347–371. [♠] ♡??

- [319] M. Coppens, *Totally non-real divisors in linear systems on smooth real curves*, Adv. Geometry 8 (2008), 551–555. [♠] ♥??
- [320] M. Coppens, G. Martens, *Linear pencils on real algebraic curves*, J. Pure Appl. Algebra 214 (2010), 841–849. A50 [♣ Ahlfors 1950 [19] is cited in the following fashion (p.843): “Let X be a real curve of genus g with $s \geq 1$ real components and g_d^1 be a basepoint free pencil on X . Since $X(\mathbb{R}) \neq \emptyset$ the image curve X' of the morphism φ induced by the pencil is the rational real curve $\mathbb{P}_{\mathbb{R}}^1$. Assume that the fibre of φ at every real point of X' consists entirely of real points of X (or, what is the same, that φ separates conjugate points of $X_{\mathbb{C}}$: $\varphi(\sigma P) \neq \varphi(P)$ for any non-real point $P \in X_{\mathbb{C}}$); we call such a g_d^1 *totally real*. Then φ is a ramified covering of bordered real surfaces (in the topological sense, cf. [7, part 3](=Geyer-Martens 1977 [520])), and the induced covering $X(\mathbb{R}) \rightarrow X'(\mathbb{R}) \cong S^1$ is unramified. In particular, $s \leq d$. Since $X' = (\mathbb{P}_{\mathbb{C}}^1 \text{ mod conjugation})$, a half-sphere with boundary, is an orientable real surface it follows that also the Klein surface [of]²⁰ X must be orientable which implies $s \not\equiv g \pmod{2}$ (cf. [7, part. 2](=Geyer-Martens 1977 [520]))²¹. Hence the assumed property that every divisor of X in the g_d^1 is entirely made up by real points puts severe restrictions on X . So we cannot expect to find such a pencil on every real curve. More precisely, by a result of Ahlfors [10](=1950 [19]) there is a totally real pencil of degree $g + 1$ on X iff the Klein surface X is orientable thus giving an interesting algebraic characterization of a topological property.”] ♥3
- [321] M. Coppens, J. Huisman, *Pencils on real curves*, arXiv (2011). [♣] ♥??
- [322] M. Coppens, *The separating gonality of a separating real curve*, arXiv (2011); or Monatsh. Math. 2012. [♣ the spectacular result is proven that all intermediate gonality compatible with Gabard’s bound ($\leq r + p$) are realized by some compact bordered Riemann surface ♠ the work is written in the language of real algebraic geometry, especially dividing (or separating) curve and is a tour de force involving several techniques: Kodaira-Spencer deformation theory, Meis’ bound and its phagocytose into modernized Brill-Noether theory, stable curves à la Deligne-Mumford (1969), geometric Riemann-Roch, Hilbert scheme, etc.] ♥0
- [323] M. Coppens, *Pencils on separating $(M - 2)$ -curves*, arXiv (2012). [♣] ♥0
- [324] A. F. Costa, *On anticonformal automorphisms of Riemann surfaces with nonembeddable square*, Proc. Amer. Math. Soc. 124 (1996), 601–605. [♠] ♥3
- [325] A. F. Costa, *Embeddable anticonformal automorphisms of Riemann surfaces*, Comment. Math. Helv. 72 (1997), 203–215. [♠ outgrowth of the work by Garcia/Rüedy on conformal embeddings, in particular Prop.1.1. *Let f be an anticonformal involution of a Riemann surface S then f is embeddable iff either S/f is orientable or S/f is non-orientable without boundary.* ♠ Since the problem of conformal embeddings of Riemann surface as classical surface was first posed by Klein, it is easy to imagine how this result is a double Kleinian synthesis, which would have much pleased the “magister ludis”] ♥2
- [326] A. F. Costa, M. Izquierdo, *On the connectedness of the locus of real Riemann surfaces*, Ann. Acad. Sci. Fenn. Math. 27 (2002), 341–356. [♠ a new proof is offered of a result due Buser-Seppälä-Silhol 1995 [221], stating the connectedness of the projection of the real moduli down to the complex one (upon forgetting the antiholomorphic involution) ♠ intuitively this means that any symmetric Riemann surface can be deformed so as to create a new symmetry and one can explore the full real moduli space (doing some jump when one switch the symmetry)] ♥??
- [327] A. F. Costa, M. Izquierdo, *On real trigonal Riemann surfaces*, Math. Scand. (2006). [♠ A closed Riemann surface X which can be realized as a 3-sheeted covering of the Riemann sphere is called trigonal, and such a covering will be called a trigonal morphism. A trigonal Riemann surface X is called real trigonal if there is an anticonformal involution (symmetry) ...] ♥15
- [328] R. Courant, *Über die Anwendung des Dirichletschen Prinzipes auf die Probleme der konformen Abbildung*, Math. Ann. 71 (1912), 141–183. G78 [♠ Diese Arbeit ist bis auf einige redaktionelle Änderungen ein Abdruck meiner Inauguraldissertation, Göttingen 1910.] ♥??

²⁰Addition of Gabard, otherwise seems an abuse of notation.

²¹This argument looks all right, yet it seems to the writer than one can easily dispense of the concept of orientability, by just using the separation effected by the existence of the map induced on imaginary loci, i.e. $X(\mathbb{C}) - X(\mathbb{R}) \rightarrow \mathbb{P}^1(\mathbb{C}) - \mathbb{P}^1(\mathbb{R})$.

- [329] R. Courant, *Über eine Eigenschaft der Abbildungsfunktion[en] [sic!?] bei konformer Abbildung*, Gött. Nachr. (1914), 101–109. G78 [♠ this work is regarded by Gaier 1978 [475, p.43] (and probably many others) as the first apparition of the length-area principle, which will be largely exploited by Grötzsch (Flächenstreifenmethode) and Ahlfors-Beurling (extremal length), etc., and which in the long run should obviously constitutes one of the key to the resolution of the Gromov filling conjecture ♠ uses also the area integral $\int \int |f'(z)|^2 dx dy$ like Bieberbach 1914 [142]] ♡??
- [330] R. Courant, *Über konforme Abbildung von Bereichen, welche nicht durch alle Rückkehrschnitte zerstückelt werden, auf schlichte Normalbereiche*, Math. Z. 3 (1919), 114–122. AS60 ♡??
- [331] R. Courant, D. Hilbert, *Methoden der mathematischen Physik. I*, Springer-Verlag, Berlin, 1931. (Reedited 1968) [♠ cited e.g. in Simha 1975 [1437] for an explicit formula for Jacobi theta function, the latter being involved in an explicit description of the Ahlfors map and the Carathéodory metric or in Gudkov 1974 [579], etc.] ♡??
- [332] R. Courant, *Plateau's problem and Dirichlet's principle*, Ann. of Math. 38 (1937), 679–725. ♡??
- [333] R. Courant, *Remarks on Plateau's and Douglas' problem*, Proc. Nat. Acad. Sci. U.S.A. 24 (1938), 519–522. [♣ this is first place where the theorem of Bieberbach-Grunsky is reproved via Plateau, yet without citing them ♠ a more detailed proof is given in the next entry (Courant 1939 [334])] ♡??
- [334] R. Courant, *Conformal mapping of multiply-connected domains*, Duke Math. J. 5 (1939), 814–823. AS60, G78 [♣ the Bieberbach-Grunsky theorem is re-proved à la Plateau; now Bieberbach 1925 [147] and Grunsky 1937 [561] are cited as well as Riemann (as an oral tradition)] ♡??
- [335] R. Courant, *The existence of minimal surfaces of given topological structure under prescribed boundary condition*, Acta Math. 72 (1940), 51–98. [♠ specializing to the case of ambient dimension 2 might perhaps reprove a theorem like the Ahlfors circle map ♠ recall however that Tromba 1983 [1502] seems to express doubts about the validity of Courant's proof, compare also Jost 1985 [731]] ♡??
- [336] R. Courant, M. Manel, M. Shiffman, *A general theorem on conformal mapping of multiply connected domains*, Proc. Nat. Acad. Sci. U.S.A. 26 (1940), 503–507. G78 [¶Result generalized in Schramm's Thesis ca. 1990, cf. arXiv] ♡??
- [337] R. Courant, *The conformal mapping of Riemann surfaces not of genus zero*, Univ. Nac. Tucumán Revista A. 2 (1941), 141–149. AS60 [♠ detected only the 13.06.2012, via Ahlfors-Sario 1960 [26] ♠ alas Gabard could not find a copy of this article, and it seems unlikely that the article contains material not overlapping with previous and subsequent work by Courant, especially it is unlikely that the paper contains an existence of circle maps à la Ahlfors] ★ ♡??
- [338] R. Courant, *Dirichlet's principle, Conformal Mapping, and Minimal Surfaces*, with an appendix by M. Schiffer. Pure and appl. math. 3, New York, Interscience Publishers, 1950. AS60, G78 [♣ overlap much with the previous ref., but somehow hard to read due to its large content and mutatis mutandis type proof, in particular it is not clear if p. 183 contains another proof of the circle map of Ahlfors ♠ p. 169 contains a proof of the Kreisnormierung in finite connectivity] ♡??
- [339] R. Courant, *Flow patterns and conformal mapping of domains of higher topological structure*. In: *Construction and Applications of Conformal Maps*, Proc. of a Sympos. held on June 22–25 1949, Applied Math. Series 18, 1952, 7–14. ♡??
- [340] L. Cremona, *Sopra alcune questioni nella teoria delle curve piane*, Ann. di Mat. (1) 6 (1864), 153–168. [♠] ♡??
- [341] D. Crowdy, J. Marshall, *Green's functions for Laplace's equation in multiply connected domains*, IMA J. Appl. Math. (2007), 1–24. [♠ p. 13–14, contains beautiful pictures of the levels of the Green's function on some circular domains] ♡??
- [342] D. Crowdy, *Conformal mappings from annuli to canonical doubly connected Bell representations*, J. Math. Anal. Appl. 340 (2008), 669–674. [♠ p. 670, the Ahlfors map is briefly mentioned in connection with the work of Jeong-Oh-Taniguchi 2007 [724] on deciding when Bell's doubly-connected domain $A(r) = \{z \in \mathbb{C} : |z+z^{-1}| < r\}$ is conformally equivalent to the Kreisring $\Omega(\rho^2) = \{\zeta \in \mathbb{C} : \rho^2 < |\zeta| < 1\}$] ♡4

- [343] V. I. Danilov, *The geometry of toric manifolds*, Uspehki Math. Nauk. 33 (1978), 85–134. [♠ often cited by Viro, e.g. in Viro 89/90 [1535], yet we presume can be logically dispensed to crack the next case $m = 8$ of Hilbert’s 16th; compare the dissipation technique of Viro via geometric constructions.] ♡??
- [344] G. David, *Unrectifiable 1-sets have vanishing analytic capacity*, Rev. Mat. Iberoam. 14 (1998), 369–479. A47 [♠ p.369: “**Abstract.** We complete the proof of a conjecture of Vitushkin that says that if E is a compact set in the plane with finite 1-dimensional Hausdorff measure, then E has vanishing analytic capacity iff E is purely unrectifiable (i.e., the intersection of E with any curve of finite length has zero 1-dimensional Hausdorff measure). [...]” ♠ [29.09.12] this is quite close to a solution of Painlevé’s problem, but just not so due to the proviso $H^1(E) < \infty$, which cannot be relaxed for p.370: “Actually Vitushkin’s conjecture also said something about the case when $H^1(K) = +\infty$ ²², but this part turned out to be false ([Ma1]=(Mattila 1986 [985]))”] ♡??
- [345] G. David, *Analytic capacity, Calderón-Zygmund operators, and rectifiability*, Publ. Mat. 43 (1999), 3–25. A47 [♠] ♡??
- [346] A. M. Davie, *Analytic capacity and approximation problems*, Trans. Amer. Math. Soc. 171 (1972), 409–414. [♠ a reduction is effected of the Denjoy conjecture (on removable sets lying on rectifiable curves) to the case where the supporting curve is C^1 , giving one of the ingredient toward the ultimate solution of Denjoy’s conjecture (compare Marshall [966]), where the last piece of the puzzle is the contribution of Calderón 1977 [222]] ♡??
- [347] A. M. Davie, B. Øksendal, *Analytic capacity and differentiability properties of finely harmonic functions*, Acta Math. 140 (1982), 127–152. [♠] ♡??
- [348] P. Davis, H. Pollak, *A theorem for kernel functions*, Proc. Amer. Math. Soc. 2 (1951), 686–690. [♠ parallel-slit mapping via Bergman kernel] G78 ♡??
- [349] B. Deconinck, M. van Hoeij, *Computing Riemann matrices of algebraic curves*, Physica D 152/153 (2001), 28–46. [♠]★ ♡??
- [350] R. Dedekind, ??, *Abhandlungen der Königl. Gesellschaft der Wiss. zu Göttingen* 13 (1868). [♠ first published report of Riemann’s Habilitationsvortrag (1854 [1254]) analyzing primarily the mathematical side of Riemannian geometry ♠ in particular the so-called Laplace-Beltrami operator ought to be discussed here; there is somewhere a commented version in French] ♡??
- [351] R. Dedekind, *Stetigkeit und irrationale Zahlen*, 1872. [♠ first serious construction of the real numbers, upon neglecting the ideas of Bolzano (and Cauchy)] ♡??
- [352] R. Dedekind, H. Weber, *Theorie der algebraischen Funktionen einer Veränderlichen*, Crelles J. 92 (1879). [♠ “arithmetized” account of algebraic function and the allied Riemann surfaces, cf. also in the same spirit Hensel-Landsberg 1902 [649] and H. Weber 1908 [1569]] ♡??
- [353] J. A. De Loera, F. J. Wicklin, *On the need of the convexity in patchworking*, Adv. in Appl. Math. 20 (1998), 188–219. [♠ article often cited by patch-workers, e.g. Itenberg-Shustin 2003 [708], Parenti 2003 [1159], etc.]★ ♡??
★ Alexander Degtyarev, student of ? ca. 1985, a well-known expert both of real and complex geometry (especially Zariski’s pairs, singular plane curve, fundamental group of the complement à la van Kampen-Zariski-Deligne).
- [354] A. Degtyarev, V. Kharlamov, *Around real Enriques surfaces*, Revista Mat. Univ. Complut. Madrid 10 (1997) 93–109. [♠ p.95: cite Comessatti’s bound (traded in modern language) $\chi(S(\mathbb{R})) \leq h^{1,1}$ for a real algebraic surface, which appears to be a forerunner of the Petrovskii-Oleinik bound of 1949] ♡??
- [355] A. Degtyarev, V. Kharlamov, *Topological properties of real algebraic varieties: Rokhlin’s way*, Uspekhi Mat. Nauk 55 (2000) 129–212; English transl., Russian Math. Surveys 55 (2000), 735–814. [♠ p.736: “Another fundamental result difficult to overestimate is Rokhlin’s formula for complex orientations. The notion of complex orientation of a dividing real curve (see below), as well as Rokhlin’s formula and its proof, seem incredibly transparent at first sight. The formula settles, for example, two of Hilbert’s conjectures on 11 ovals of plane sextics, which Hilbert himself tried to prove in a very sophisticated way and then included in his famous problem list (as the sixteenth problem).” ♠ p.739: “Note that the topological properties of abstract, not embedded, real curves are simple and have been understood

²²This is maybe a misprint and the “ K ” should be an E ?

- completely since Klein’s time; see for example, [87](=Natanzon 1990 [1069]) and [99](=Rohlin 1978 [1290]).” ♠ p. 757: “According to Arnol’d, the following result is due to Maxwell.—**3.2.1 Theorem.** The orbit space \mathbb{P}^2/conj is diffeomorphic to S^4 .” ♠ p. 785: “**4.6.8. Klein’s statement.** If a real curve of type I undergoes a Morse surgery through a non-degenerate double point, then the number of connected components of this curve cannot increase. [...]” (For related literature see Klein 1876 [795]), Rohlin 1978 [1290], and Marin?, etc. ♠ p. 788: “**Digression: real rational curves.** As far as we know, the following problem is still open: is it possible to draw an irreducible real rational curve (or more precisely a connected component of it) of degree q through any set of $3q - 1$ real points in general position? In [99](=Rohlin 1978 [1290]) the question is answered in the affirmative; however, the proof has never been published; possibly it contained a gap. [...] The first non-trivial case (and the only case in which the complete answer is known) is $q = 3$, namely through 8 generic points one can draw 12 rational cubics; depending on the arrangement of the points, the number of real cubics among them can be 8, 10 or 12. (All three values occur; the 12 rational cubics in a pencil are real iff the pencil contains 2 cubics with a solitary real double point.)” ♡75
- [356] A. Degtyarev, I. Itenberg, V. Kharlamov, *Real Enriques Surface*, Lect. Notes in Math. 1746, Springer, Berlin, 2000. [♠ a complete classification of real Enriques surfaces paralleling that of K3 surfaces obtained in Nikulin 1979 and the related works of Kharlamov] ♡??
- [357] K. de Leeuw, W. Rudin, *Extreme points and extremum problems in H_1* , Pacific J. Math. 8 (1958), 467–485. [♠ gives a characterization of the extreme points of the unit ball of the disc-algebra $H^1(\Delta)$, an analogue of which for the same algebra attached to a finite bordered Riemann surface will be given in Gamelin-Voichick 1968 [480] upon making use of the Ahlfors map or at least techniques closely allied to its existence-proof (as given by Ahlfors 1950 [19])] ♡??
- [358] P. Deligne, D. Mumford, *Irreducibility of the space of curves of given genus*, Publ. Math. Inst. Hautes. Études Sci. 36 (1969), 75–109. [♠] ♡??
- [359] A. Denjoy, ???, C.R. Acad. Sci. Paris 14? (1907), 258–260. AS60 [♠ yet another Denjoy conjecture (not to be confounded with that of the next entry) on the number of asymptotic values of entire functions of finite order ♠ formulated by Denjoy at age 21, it was solved by Ahlfors in 1928 (at age 21), 21 years after its formulation (arithmetical curiosity noticed by Denjoy)]★ ♡??
- [360] A. Denjoy, *Sur les fonctions analytiques uniformes à singularités discontinues*, C.R. Acad. Sci. Paris 149 (1909), 258–260. AS60 [♠ the following theorem is proved (or rather asserted since a gap was later located in proof) but Denjoy’s assertion turned out to be ultimately correct via Calderón 1977 [222] and Marshall [966]: “a closed set of positive length lying on a rectifiable arc is unremovable in the class of bounded analytic functions” ♠ this became the famous “Denjoy conjecture” ♠ partial positive results on it were obtained by Ahlfors-Beurling 1950 [20] in the case where the supporting arc is a segment (for this case they credit Denjoy himself) and then they extend the result to an analytic curve via conformal mapping ♠ Ivanov treated the case of curves slightly smoother than C^1 ♠ Davie 1972 [346] proved that it sufficed to assume the curve C^1 (i.e. the rectifiable case of Denjoy can be reduced to the C^1 case) ♠ then, Caderón 1977 [222] proved that the Cauchy integral operator, for C^1 curves, is bounded on L^p , $1 < p < \infty$ ♠ at this stage, Marshall [966] put the “touche finale” by writing a note explaining how Calderón implies Denjoy via classical results of Garabedian, Havinson and finishing the proof with Davie’s reduction to the C^1 -case, validating thereby Denjoy’s assertion announced ca. 7 decades earlier ♠ Calderón himself was first not aware of the relevance of his work to Denjoy’s (as one learns e.g. from Verdera 2004 [1517, p. 29]), but in the acceptance speech for the Bôcher price (see Calderón 1979 [224]), Calderón mentions the solution to the Denjoy conjecture as one of the most significant application of his article (see also Calderón 1978 [223], ICM lecture)]★ ♡??
- [361] H. Denneberg, *Konforme Abbildung einer Klasse unendlich-vielfach zusammenhängender schlichter Bereiche auf Kreisbereiche*, Ber. Verhd. Sächs. Akad. Wiss. Leipzig 84 (1932), 331–352. AS60, G78 [♠ a contribution to KNP]★ ♡??
- [362] S. Diaz, *Irreducibility of equiclassical stratum*, J. Diff. Geometry 29 (1989), 489–498. [♠ cited in Shustin 90/91 [1418].] ♡??

- [363] S. Diaz, J. Harris, *Ideals associated to deformations of singular plane curves*, Trans. Amer. Math. Soc. 309 (1988), 443–468. [♠ cited in Shustin 90/91 [1418].] ♡??
- [364] J. Dieudonné, *Cours de géométrie algébrique*, Presses universitaires de France, Paris, 1974. [♠ as mixture of Bourbakist pesanteur mixed with the usual charming touch of the gifted “God-given” writer] ♡??
- [365] J. Diller, *Green’s functions, electric networks, and the geometry of hyperbolic Riemann surfaces*, Illinois J. Math. 45 (2001), 453–485. [♠ p.456, Swiss cheese description of Hardt-Sullivan’s work (1989 [609]) on the Green’s function for a bordered Riemann surface given as a branched cover of the unit-disc ♠ so this Hardt-Sullivan work may possibly interact with the Ahlfors function] ♡1
- [366] P.G. Lejeune Dirichlet, ??, Crelle’s Journal 1829. [♠ first convergence proof of the Fourier series toward the given (continuous) function] ♡??
- [367] P.G. Le Jeune Dirichlet, *Vorlesungen über die im umgekehrten Verhältniss des Quadrats der Entfernung wirkenden Kräfte*, herausgegeben von Dr. F. Grube, Leipzig, 1876. [♠ first version of DP available in print under (essentially) Dirichlet’s own pen, as Grube reproduced a Dirichlet Göttingen lecture (ca. 1856) ♠ alas Dirichlet’s formulation was a bit ill-posed, as came very apparent through the example of Prym 1871 [1226] (compare also Elstrodt-Ullrich 1999 [392])]★ ♡??
- [368] J. H. Mc Donald, *The ovals of the plane sextic curve*, Amer. J. Math. 49 (1927), 523–526. [♠ cited and criticized in Gudkov 1974 [579] or better in Hilton 1936 [673].] ♡??
- [369] S. Donaldson, *Yang-Mills invariants of smooth four-manifolds*, in: Geometry of low-dimensional manifolds, vol. 1, Cambridge Univ. Press, 1990, 5–40. [♠ contains some trick to transmute to holomorphic the antiholomorphic involution induce by Galois on a real quartic surface (or more general K3 surfaces=Kummer-Kähler-Kodaira in Weil’s designation)] ♡??
- [370] S. Donaldson, *Complex curves and surgery*, Publ. Math. Inst. Hautes Ét. Sci. 1989, 91–97. [♠ a discussion of Thom’s conjecture, p. 91: “An entrancing problem in Geometric Topology, usually ascribed to R. Thom, asks whether C minimises the genus among all C^∞ representatives for the homology class.” p.92 Lee Rudolph (1984 [1315]) counterexamples for “topologically locally flat” surfaces are mentioned ♠ Kirby’s 1970 list [785] of problems already contains (conjecturally) an extension of Thom to any complex projective surface] ♡??
- [371] J. Douglas, *Solution of the problem of Plateau*, Trans. Amer. Math. Soc. 33 (1931), 263–321. [♠ a new proof of RMT is given via Plateau, including the Osgood-Carathéodory refinement about the boundary behaviour of the Riemann map ♠ reduces the mapping problem to that of minimizing a functional (named after Douglas by now)] ♡??
- [372] J. Douglas, *Some new results in the problem of Plateau*, Amer. J. Math. 61 (1939), 590–608. ♡??
- [373] J. Douglas, *Minimal surfaces of higher topological structure*, Ann. of Math. (2) 40 (1939), 205–298. G78 ♡??
- [374] J. Douglas, *The most general form of the problem of Plateau*, Amer. J. Math. 61 (1939), 590–608. AS60 ♡??
- [375] R. G. Douglas, W. Rudin, *Approximation by inner functions*, Pacific J. Math. 31 (1969), 313–320. [p.314 the Ahlfors function (in the very trivial case of an annulus $D = \{z: r_1 < |z| < r_2\}$) is involved in the proof of the following theorem: the set of all quotients of inner functions is norm-dense in the set of unimodular functions] ♡??
- [376] B. Drinovec Drnovšek, *Proper discs in Stein manifolds avoiding complete pluripolar sets*, Math. Res. Lett. 11 (2004), 575–581. A50 [♠ Ahlfors 1950 [19] is cited] ♡??
- [377] B. Drinovec Drnovšek, F. Forstnerič, *Holomorphic curves in complex spaces*, Duke Math. J. 139 (2007), 203–252. [♠ Ahlfors 1950 [19] is cited in the bibliography, but apparently not within the text ♠ yet the connection with Ahlfors is evident in view of the following extract of the review of the paper: “Since the early 1990’s a series of papers, motivated mainly by works J. Globevnik and of Forstnerič, has been devoted to constructing holomorphic discs $f: \Delta \rightarrow M$ in complex manifolds that are proper. The article under review offers a culmination of the subject, lowering as much as possible the convexity assumptions, working

- on complex spaces with singularities, and “properizing” not only discs, but general open Riemann surfaces whose boundary consists of a finite number of closed Jordan curve. [...]” ♡??
- [378] V. N. Dubinin, S. I. Kalmykov, *A majoration principle for meromorphic functions*, Sbornik Math. 198 (2007), 1737–1745. [p. 1740 a majoration principle is specialized to the Ahlfors function upon using the formula expressing the logarithm of the modulus of the Ahlfors function as a superposition of Green’s functions with poles at the zeros of the Ahlfors function] ♡??
- [379] B. A. Dubrovin, I. M. Krichever, S. P. Novikov, *The Schrödinger equation in a periodic field and Riemann surfaces*, Dokl. Akad. Nauk SSSR 229 (1976), 15–18; English transl., ?? ? (197?), ?–?. [♠ cited in Dubrovin 1983/85 where some connection with Klein’s orthosymmetry/separating type I is given] ♡??
- [380] B. A. Dubrovin, S. M. Natanzon, *Real two-zone solutions of the sine-Gordon equation*, Funkt. Anal. Prilozhen. 16 (1982), 27–43; English transl., Funct. Anal. Appl. 16 (1982), 21–33. [cited in Vinnikov 1993 [1521] who claims a simplified proof] ♡84
- [381] B. A. Dubrovin, *Matrix finite-zone operators*, (Itogi Nauki i Tekhniki) 23 (1983), 33–78; English transl., Contemporary problems in math. ? (1985), 20–50. [♠ cited in Vinnikov 1993 [1521, p. 478] for a proof of the rigid-isotopy of any two smooth plane real curves having a deep nest (a result first established by Nuij 1968 [1112]) ♠ p. 48: “We shall now list the most important properties of real Riemann surfaces. A Riemann surface is called real if on it there is given an antiholomorphic involution [...] There are two possible cases: I) the union of real ovals decomposes Γ into two components [...]; or II) the union of ovals does not decompose Γ . Surfaces of type I we call surfaces of separating type, while those of type II we call surfaces of nonseparating type.” ♠ p. 43: “The Riemann surface Γ with antiinvolution τ belongs to [the] separating type. (the proof given on p. 43–44 seems to use a sort of total reality?) ♠ p. 41: “separating type” ♠ p. 42: Fay 1973 [409] is cited, yet not clear to Gabard [12.01.13] if Dubrovin’s paper has any dep connection with Ahlfors 1950 [19] ♠ p. 43: Rohlin 1978 [1290] is cited for the simple fact that a plane curve with a deep nest is separating] ♡43
- [382] B. A. Dubrovin, *Theory of operators and real algebraic geometry*, in: Global Analysis and Math. Physics, III, Voronezh State Univ., 1987; English transl., Lecture Notes in Math. 1334, 1988, 42–59. [♠]★ ♡??
- [383] B. A. Dubrovin, S. M. Natanzon, *Real theta-function solutions of the Kadomtsev-Petviashvili equation*, Izv. Akad. Nauk SSSR Ser. Mat. 52 (1988), 267–286; English transl., Math. USSR Izv. 32 (1989), 269–288. [♠]★ ♡??
- [384] B. A. Dubrovin, S. P. Novikov, A. T. Fomenko, *Modern Geometry: Methods and Applications*, 3rd ed., Nauka, Moscow, 1986; English transl., Part I, II, III, Springer, 1984, 1985, 1990. [♠]★ ♡??
- [385] C. J. Earle, A. Marden, *On Poincaré series with application to H^p spaces on bordered Riemann surfaces*, Illinois J. Math. 13 (1969), 202–219. [♠ cited in Forelli 1979 [449], where the automorphic uniformization is employed to construct the Poisson kernel of a finite bordered Riemann surface, which in turn is involved in a new derivation of Ahlfors circle maps of controlled degree $\leq r + 2p$] ♡36
- [386] C. J. Earle, A. Schatz, *Teichmüller theory for surfaces with boundary*, J. Differential Geom. 4 (1970), 169–185. [♠] ♡??
- [387] C. J. Earle, *On the moduli of closed Riemann surfaces with symmetries*, In: Advances in the Theory of Riemann Surfaces, Annals of Math. Studies 66, Princeton Univ. Press and Univ. of Tokyo Press, Princeton, N. J., 1971, 119–130. [♠ modernized account of Klein 1882 [797] and Teichmüller 1939 [1484], cf. also related works by Natanzon and Seppälä 1978 [1383] ♠ *Warning*. According to Natanzon 1999 [1072, p. 1101], Earle’s description of the topological structure of the components of the moduli space of real algebraic curves (as being each diffeomorphic to $\mathbb{R}^{3g-3}/\text{Mod}_{g,r,\varepsilon}$ for a suitable discrete modular group) while being correct, its proof (using the theory of quasiconformal maps) is not, since it relies on a Kravetz (1959 [881]) theorem “which turned out latter to be wrong”. Still according to Natanzon (*loc. cit.*) “A correct proof based on the theory of quasiconformal maps was obtained in Seppälä 1978 [1383].”] ♡??
- [388] A. Einstein, *Über die Elektrodynamik bewegter Körper*, Annalen der Physik, 1905. [♠ special relativity] ♡??

- [389] A. Einstein, *Die Grundlage der allgemeinen Relativitätstheorie*, Annalen der Physik, Leipzig, 1916. [♠] ♥??
- [390] T. Ekedahl, S. Lando, M. Shapiro, A. Vainshtein, *Hurwitz numbers and intersections on moduli spaces*, Invent. Math. 146 (2001), 297–327. [♠ a new derivation of Hurwitz’s count of the number of branched coverings of the sphere having prescribed ramification] ♥??
- [391] A. El Soufi, S. Ilias, *Le volume conforme et ses applications d’après Li et Yau*, Sémin. Théo. Spectrale Géom. (1983/84), 15pp. [♠ exploits the optimum $[\frac{g+3}{2}]$ gonality (Riemann-Brill-Noether-Meis) in the realm of spectral theory] ♥??
- [392] J. Elstrodt, P. Ullrich, *A real sheet of complex Riemannian function theory: a recently discovered sketch in Riemann’s own hand*, Historia Math. 26 (1999), 268–288. ♥??
- [393] *Encyclopedic Dictionary of Mathematics*, edited by Kiyosi Itô, Vol. II, Second Edition, English transl. (1987) of the third (Japanese) edition (1968) [sic!]. A50 [♠ on p. 1367 the result of Ahlfors 1950 [19] is quoted as follows (with exact source omitted but given on the next page p. 1368): “L. Ahlfors proved that a Riemann surface of genus g bounded by m contours can be mapped conformally to an at most $(2g + m)$ -sheeted unbounded covering surface of the unit disk.”] ♥??
 ★ Federigo Enriques, one of the architect of Italian (algebraic) geometry, most famous for his classification of algebraic surfaces (joint with Castelnuovo) and relevant to our present topic for having first explained the phenomenon of total reality on M -curves via a simple application of Riemann-Roch. Compare Enriques-Chisini 1915 [396], and our Theorem in v2. In the opinion of Arnold, Enriques stands almost as high as Newton and Riemann in the hierarchy of all philosophers (exercise recover the exact source).
- [394] F. Enriques, *Sul gruppo di monodromia delle funzioni algebriche, appartenenti ad una data superficie di Riemann*, Rom. Acc. L. Rend. 13 (1904), 382–384. A560 [♠ just quoted to ponder a bit the severe diagnostic to be found in the next entry (i.e. Ahlfors was of course by no mean ignorant about the Italian algebro-geometric community)] ♥??
- [395] F. Enriques, *Alcune osservazioni sulle superficie razionali reali*, Acc. Scienze Ist. Bologna (2) 16 (1911–12), 70–73. [♠ related to the subsequent work by Comessatti 1914 [307]] ♥??
- [396] F. Enriques, O. Chisini, *Lezioni sulla Teoria Geometrica delle Equazioni e delle Funzioni Algebriche*, Zanichelli, Bologna, 1915–1918–1924. [♠ appears to the writer as a clear-cut forerunner of both Bieberbach 1925 [143] and Wirtinger 1942 [1601], as argued in Gabard 2006 [463, p. 949] (cf. also Huisman 2001 [683] for a similar proof) ♠ actually Enriques-Chisini give another derivation of Harnack’s bound (on the number of components of a real curve) via Riemann-Roch, but their argument supplies an immediate proof of the so-called *Bieberbach-Grunsky theorem* (cf. Bieberbach 1925 [147], Grunsky 1937 [561] and for instance A. Mori 1951 [1040]), that is, the planar version of the Ahlfors map ♠ as far as I know this little anticipation of Enriques-Chisini over Bieberbach-Grunsky has never been noticed (or admitted?) by the function-theory community (say Bieberbach, Grunsky, Wirtinger, Ahlfors, A. Mori, Tsuji, . . .) showing an obvious instance of lack of communication between the analytic and geometric communities] ♥??
- [397] F. Enriques, *Sulle curve canoniche di genere p dello spazio a $p - 1$ dimensioni*, Rend. Accad. Sci. Ist. Bologna 23 (1919), 80–82. [♠ so-called canonical curve termed “Normalkurve der φ ” in Klein 1892 [801] and also studied by M. Noether] ♥??
- [398] B. Epstein, *Some inequalities relating to conformal mapping upon canonical slit-domains*, Bull. Amer. Math. Soc. ?? (1947), ??–??. [♠] ♥5
- [399] B. Epstein, *The kernel function and conformal invariants*, J. Math. Mech. 7 (1958). [♠ quoted in Gustafsson 2008] ♥?? ★★★
- [400] A. Eremenko, A. Gabrielov, *Rational functions with real critical points and B. and M. Shapiro conjecture in real enumerative geometry*, Ann. of Math. (2) 155 (2002), 105–229. [♠ quoted in Sottile 2002 [1447]] ♥??
- [401] L. Euler, *Introductio anlysis infinitorum*, tom 2, Lausanae, 1750. [♠ cited in Gudkov 1988 [584]] ♥??

- [402] L. Euler, *Instit. Calc. Integr. Petrop.*, 1768–70, 2, 1169. [♠ cited in Petrowsky 1938 [1168] as one of the tool used in the proof of the Petrovskii’s inequalities via the so-called Euler-Jacobi interpolation formula (Kronecker also involved) concerning solutions of systems of algebraic equations and yielding a highbrow extensions to curves of higher orders of the results of Hilbert-Rohn for sextics] ♡??
- [403] G. Faber, *Neuer Beweis eines Koebe-Bieberbachschen Satzes über konforme Abbildung*, Sitz.-Ber. math.-phys. Kl. Bayer. Akad. Wiss. (1916), 39–42. [♠ related to the so-called area principle of Gronwall 1914/15 [550], Bieberbach 1916 [145]] ♡??
★★★
- [404] G. Faber, *Über den Hauptsatz aus der Theorie der konformen Abbildung*, Sitz.-Ber. math.-phys. Kl. Bayer. Akad. Wiss. (1922), 91–100. G78 [♠ must be another proof of RMT ♠ regarded in Schiffer 1950 [1350, p. 313] as one of the originator of the method of *extremal length* (jointly with Grötzsch (1928) and Rengel 1932/33 [1248]), cf. also the introductory remarks of Bieberbach 1957 [154] ♠ maybe another origin is Courant 1914 [329] (at least for the length-area principle), cf. e.g. Gaier 1978 [475]] ★★★ ♡??
- [405] G. Faltings, *Endlichkeitssätze für abel’sche Varietäten über Zahlkörpern*, Invent. Math. 73 (1983), 349–366. [♠ proof of the so-called Mordell conjecture that a curve defined over \mathbb{Q} (or a more general number field, i.e. a finite extension of \mathbb{Q}) has only finitely many rational points provided the genus g of the underlying complex curve has genus $g \geq 2$ ♠ it would be interesting to detect if the finer Kleinian invariants allied to real curves also have some similar arithmetical repercussion (to my knowledge nothing is known along this way, even at the conjectural level)] ♡??
- [406] G. Faltings, *Real projective structures on Riemann surfaces*, Compos. Math. 48 (1983), 223–269. [♠ p. 231: “Any Riemann surface may be considered as an algebraic curve defined over \mathbb{C} . Sometimes this algebraic variety is already definable over the real numbers. This happens precisely if there exist an antiholomorphic involution on the surface, and these involutions correspond bijectively to the different real models of the curve.—The basic example here is the double of a Riemann surface with boundary, which has a canonical real structure. The real points of this real curve are the fixed-points of the involution, hence the points in the boundary of our original Riemann surface.—Not every real curve is of this form, since for example there exist curves X over \mathbb{R} for which $X(\mathbb{C}) - X(\mathbb{R})$ is connected. ($X(\mathbb{C})$, $X(\mathbb{R})$ denote the \mathbb{C} -respectively \mathbb{R} -valued points of a real algebraic curve X .) We shall see that all counterexample are of this form.” (Okay but all this is of course trivial since Felix Klein.) ♠ [20.12.12] an evident “Jugendtraum” of mine (and probably of many others, Gross, Faltings, etc.?) since ca. 1999/2000 is whether the finer topological invariants of Klein of a real curve (as opposed to the sole Riemannian genus fixing the topology of the underlying complex curve) have any arithmetical repercussion, à la Mordell-Faltings, namely finiteness of the rational points $C(\mathbb{Q})$ whenever the genus $g \geq 2$. To my knowledge not a single result of the sort is known and it is quite hard to speculate about any such topologico-arithmetical connection. Crudely speaking the implication could be of the format if the curve is dividing then the cardinality of $C(\mathbb{Q})$ is even, but this is surely wrong] ♡ca.45
- [407] H. M. Farkas, I. Kra, *Riemann surfaces*, Second Edition, Grad. Texts in Math. 71, Springer, 1992. (1st edition published in 1980) ♡??
- [408] P. Fatou, *Séries trigonométriques et séries de Taylor*, Acta Math. 30 (1906), 335–400. [♠ influenced by Lebesgue, and will in turn influence F. Riesz (so called Fischer-Riesz theorem)] ♡??
- [409] J. Fay, *Theta functions on Riemann surfaces*, Lecture Notes in Math. 352, Springer, 1973. A47, A50 [♠ cite Ahlfors 1950 [19] and write down explicit formulas for the Ahlfors function (at least in the planar case) in terms of theta-functions ♠ gives perhaps another proof of Ahlfors 1950 (cf. Alpay-Vinnikov 2000 [48]) but this hope is probably not borne out (Fay probably only recovers the Ahlfors circle map in the planar case) ♠ Ahlfors 1950 [19] is cited thrice in this booklet ♠ on p. 108 (just for the double) ♠ on p. 116: “It has been proved in [3, p. 126](=Ahlfors 1950 [19]) that there are always unitary functions with exactly $g + 1$ zeroes *all* in R ; and when R is a planar domain, it is shown in Prop. 6.16 that $S_{0,\dots,0} \cap \Sigma_a$ is empty for $a \in R$ and that the unitary functions holomorphic on R with $g + 1$ zeroes are parametrized by the torus S_0 .” [Added by Gabard [10.09.12]: of course one can wonder how much of this is anticipated in Bieberbach 1925 [147]] ♠ p. 129: “Using

this result, a solution can be given to an extremal problem for bounded analytic functions as formulated in [3, p. 123](=Ahlfors 1950):” where the Ahlfors function is expressed in terms of the theta function and the prime form, yet it should be noted that unfortunately at some stage Fay’s exposition is confined to the case of planar domains ♠ somewhat earlier in the text (in a portion not yet confined to the planar case) we read on p.114: “The spaces S_μ parametrize the generic unitary functions on C with the minimal $(g + 1)$ number of zeroes:”, maybe this claim of minimality is erroneous as it could be incompatible with Gabard 2006 [463], and even if the latter is incorrect there is basic experimental evidence violating this minimality claim on the bound $g + 1$, compare our remarks after Alpay-Vinnikov 2000 [48]] ♠853

[410] S. I. Fedorov, *Harmonic analysis in a multiply connected domain, I*, Math. USSR Sb. 70 (1991), 263–296. [♠ credited by Alpay-Vinnikov 2000 [48, p. 240] (and also Yakubovich 2006 [1608]) for another existence-proof of the Ahlfors map (at least for planar domains), cf. p.271–275 ♠ on p.272 it is remarked that one cannot prescribe arbitrarily the n zeroes of a circle-map on an n -connected domain of minimum degree n as follows: “Unfortunately we cannot prescribe n points on Ω_+ arbitrarily in such a way that their union will be the set of zeros of an n -sheeted inner function θ of the form (3), since the zeros of an n -sheeted function θ must satisfy the rather opaque condition $\sum_{k=1}^n \omega_s(z_k)$, $s = 1, \dots, n - 1$, where ω_s is the harmonic measure of the boundary component Γ_s .” ♠ [26.09.12] it seems to the writer (Gabard) that this condition already occurs (at least) in A. Mori 1951 [1040] ♣ it would be interesting to analyze carefully Fedorov’s argument (or Mori’s) to see if it can be extended to the positive genus case (this is perhaps already done in Mizumoto 1960 [1025]) ♠ p.272 desideratum of a constructive procedure for building all n -sheeted inner functions on an n -connected domain, which is answered on p.274 via “Theorem 1. Let z_1, \dots, z_n be arbitrary points with $z_k \in \Gamma_k$, $k = 1, \dots, n$. Then there exist positive numbers $\lambda_1, \dots, \lambda_n$ such that the function $w = \int_{z_\Gamma} \sum_{j=1}^n \lambda_j \nu_{z_j}$, $z_\Gamma \in \Gamma$, $z_\Gamma \neq z_j$, $j = 1, \dots, n$, is a single-valued n -sheeted function on $\hat{\Omega}$, real-valued on Γ , with positive imaginary part on Ω_+ . The function $\theta = \frac{w-i}{w+i}$ is an n -sheeted inner function.” ♠ of course in substance (or essence) this is nothing but what Japanese calls the Bieberbach-Grunsky theorem (cf. Mori 1951 [1040] or Tsuji 1956 [1505])] ♠???

[411] J. L. Fernandez, *On the existence of Green’s function in Riemannian manifolds*, Proc. Amer. Math. Soc. 96 (1986), 284–286. [♠] ♠???

★ Thomas Fiedler, student of V. A. Rohlin, ca. 1978, well-known for advanced Bézout-style prohibitions (sharpened in Viro 1983/84 [1532]) and affording a crucial ingredient toward the settlement of Hilbert’s 16th in degree 8 (which involves still six undecided M -schemes after Orevkov 2002 [1129]), compare our table (Fig. 154). Albeit, Fiedler’s obstruction involves only 4 schemes in degree 8 inside a universe of $104 + 4 + 36 = 144$ logically possible M -schemes respecting Gudkov periodicity (compare e.g. our Fig. 155), it seems to be the basis of the more virulent Viro’s obstruction of 36 schemes, and also very versatile in Le Touzé’s extension to nonics (degree $m = 9$, cf. Le Touzé 2002 [424]) as well as playing a major role in several of Orevkov’s works. So it is undeniably a major weapon in Hilbert’s 16th but which alas does not kill completely the problem since it leaves a good portion of schemes intact (apparently increasing in proportion as the degree augments from 8 to 9). So it seems that a more systematic method of prohibition still remains to be discovered and we tabulate on the usage of the Riemann map (and the allied property of dextrogyration) as sketched in Gabard 2013B [471]. Of course there is also Orevkov’s methodology of braids, yet the limitation it produces looks like rare diamonds in comparison to the homological methods of Fiedler-Viro (e.g. for $m = 8$, Fiedler+Viro prohibits $4 + 36 = 40$ schemes, whilst Orevkov only kills 2 of them). In degree 9, Fiedler-Viro (implemented as in Le Touzé 2002 [424]) kills 223 schemes, whilst Orevkov’s braid theory kills 16 schemes. Crudely put, we see that Fiedler-Viro-Le Touzé is always ca. 20 times stronger than Orevkov at least at the crude quantitative level, albeit it might be that in reality Orevkov’s method is a stronger detergent for cleaning more remote portion of the cavern!

[412] T. Fiedler, ???, Wiss. Beitr. Martin-LutherUniv. Halle-Wittenberg, in press (198?). [♠ cited in Viro 1980 [1527] for a proof of the fact that the M -scheme of degree seven $\frac{10}{1}4$ cannot be realized by any classical method as perturbation of 2 transverse curves, assessing thereby the power of Viro’s method] ♠???

- [413] T. Fiedler, *Eine Beschränkung für die Lage von reellen ebenen algebraischen Kurven*, Beiträge Algebra Geom. 11 (1981), 7–19. [♠ the eminent DDR student of Rohlin, who seems to have been the first to notice the simple fact that orientation-preserving smoothings conserve the dividing character of curves, compare also Rohlin 1978 [1290] where the contribution of Fiedler is already mentioned] ♡??
- [414] T. Fiedler, *Geraden Büschel und die Topologie der reellen algebraischen Kurven*, Dissertation, 1981. [♠ (in part) reproduced in the next entry Fiedler 1982/83 [415]] ♡??
- [415] T. Fiedler, *Pencils of lines and the topology of real algebraic curves*, Izv. Akad. Nauk SSSR Ser. Mat. 46 (1982), 853–863; English transl., Math. USSR Izv. 21 (1983), 161–170. [♠ p. 161 (Abstract): “[...] a new invariant of the strict isotopy type of the curve is given, which in particular distinguishes some seventh degree M -curves with the same complex scheme.” ♠ contains also Fiedler’s original proof of the obstruction of 4 types of M -octics; for another proof and a more general result cf. Viro 1983/84 [1532]. For the geography of those prohibitions contributing to rule out $4+36$ (=forty) M -schemes in degree 8, among the 144 logically possible, cf. our Fig. 5 and Fig. 154] ♡??
- [416] T. Fiedler, *New congruences in the topology of real plane algebraic curves*, Dokl. Akad. Nauk SSSR 270 (1983), 56–58; English transl., Sov. Math. Dokl. 27 (1983), 566–568. [♠] ♡??
- [417] T. Fiedler, *New congruences in the topology of singular real plane algebraic curves*, Dokl. Akad. Nauk SSSR 286 (1986), 1075–1079; English transl., Sov. Math. Dokl. 33 (1986), 262–266. ★★★[♠ cited in Gilmer 2005 [526]] ♡??
- [418] T. Fiedler, *Additional inequalities in the topology of real plane algebraic curves*, Izv. Akad. Nauk SSSR Ser. Mat. 49 (1985), 874–883; English transl., Math. USSR Izv. 27 (1986), 183–191. [♠] ♡??
- [419] T. Fiedler, *Real points on complex plane curves*, Math. Ann. 284 (1989), 267–284. [♠] ♡??
- [420] T. Fiedler, *Topologie des courbes algébriques réelles symétriques*, Preprint, Lab. Emile Picard, Toulouse, 1994. [♠ cited in Trilles 2003 [1501], and seems to contain the same result as the next entry Fiedler 1995 [421]] ♡??
- [421] T. Fiedler, *Congruence mod 16 for symmetric M -curves*, hand-written paper, estimated date 1995 (Mid 1990’s according to Fiedler). [♠ I was made aware of the existence of this work in a letter by Fiedler (dated [14.04.13] cf. v.2) ♠ this work is cited in articles by Trilles, Brugallé and Orevkov 2007/08 [1138] ♠ in view of this popularity it would perhaps advisable to dactylography on the arXiv a version of this manuscript (I would be very pleased to do the job, if someone send me a copy of the original at the address: Alexandre Gabard, 4 rue des Bossons, 1213 Onex, (near Geneva), Switzerland)] ♡??
 ★★ Séverine Fiedler-Le Touzé, presumably a Student[in] of Th. Fiedler, 1997 (DEA), 2000 (Thèse), is well-known for several key prohibitions on Hilbert’s 16th especially in degree 9 (via cubics as an ancillary tool), and more recently for her (partial) validation of Rohlin’s total reality claim about pencils of cubics on the two $(M - 2)$ -sextics satisfying the RKM-congruence, i.e. $\frac{6}{1}2$ and $\frac{2}{1}6$. Methodologically, her work builds over that of her husband Thomas Fiedler yielding tricks to control Rohlin’s complex orientations. It would be of interest to know if Riemann’s theorem (aka the Bieberbach-Grunsky theorem, e.g. in the more synthetic formulation given in Gabard 2013B [471]) cannot be used as a weapon toward describing complex orientation by the principle of dextrogyration inherent to the complex-analytic nature of the Riemann-Ahlfors map. If so, then we may expect to get new limitations on complex orientations and as a byproduct new restrictions in Hilbert’s 16th (for M -curves) to which Riemann’s theorem readily applies. Ahlfors’ more general theorem could likewise produces prohibitions for dividing curves non necessarily maximal, but this can be regarded as of secondary importance unless Hilbert’s 16th is not settled for M -octics.
- [422] S. Fiedler-Le Touzé, *Orientations complexes des courbes algébriques réelles*, Mémoire de DEA, 1997. [♠ cited in Brugallé 2005/07 [197] for an avatar of Viro’s census with controlled types in the sense of Klein ♠ the next entry (Thesis) with the same title is probably an extension of the DEA work (DEA=diplome d’étude avancées≈Master (of the world), joke due to Christian Wüt[h]rich)] ♡??
- [423] S. Fiedler-Le Touzé, *Orientations complexes des courbes algébriques réelles*, Thèse doctorale, 2000. [♠ cited in the entry Le Touzé 2013 [429]] ♡??

- [424] S. Fiedler-Le Touzé, *Cubics as tools to study the topology of M -curves of degree 9 in $\mathbb{R}P^2$* , J. London Math. Soc. (2) 66 (2002), 86–100. [♠ p. dividing curves ♠ according to Shustin’s review: “The main theorem claims that curves of degree 9 with 28 ovals (the maximal possible number of ovals for degree 9) cannot realize 223 oval arrangements among 745^{23} arrangements which have been in question before. The proof [...] combines the complex orientation theory of real curves relative to a pencil of lines and conics, and the Bézout theorem for intersection of the hypothetical curves with specially chosen real cubic curves.” ♠ p. 89: “This paper deals with M -curves of degree 9, for which the classification is still wide open. In his survey [9](=1997 [864]), Korchagin gives a list of 1227 a priori possible schemes for these curves. This list was established in the early 1990s by a systematic use of the classical method[s] of restriction, which combines Bézout’s theorem with auxiliary lines and conics, Fiedler’s theorem, and the Rokhlin-Mishachev formula [1,5,9](=Fiedler 83 [415], Korchagin 86 [853], 97 [864]). At the same time, curves realizing 404 of these schemes were constructed, with the help of Viro’s method ([6–9]= Korchagin 89 [860], 92 [862], 96 [863] [Added by Gabard: 8 new schemes and at this stage the total constructed is already 404]), 97 [864]). More recently Orevkov [10,11](=99 [1121], 00 [1124]) eliminated 16 supplementary cases with the help of his new restriction method involving braid theory. He also proved realizability of 62 schemes [12](=99/03 [1134]). In our thesis [2](=00 [423]), we excluded a further 223 cases from the list. The aim of this paper is to expose these prohibitions; the method used here is inspired by the classical one, but it involves auxiliary nodal cubics that are supplementary to the lines and conics. Recently, Orevkov and Viro [13](=01 [1128]= [1538]) prohibited 35 other cases, using a congruence of Viro and Kharlamov for singular curves.” ♠ So in résumé, in Korchagin’s universe of 1227 there are $404 + 62 = 466$ constructions and $16 + 223 + 35 = 274$ prohibitions, so Hilbert’s M -problem is only solved with probability $(466 + 274)/1227 \approx 0.603$. Recent advances on the problem are given in Orevkov 2005 [1137] (where 2 more M -schemes are excluded), Le Touzé 2009 [426] where 10 more M -schemes are prohibited, and in Orevkov 2012 [1141] where 10 new M -schemes are constructed by a clever twist of Viro’s method. Then the probability becomes $(476 + 286)/1227 \approx 0.621$, a fairly slow rate of progression. It seems evident that new ideas seems requested to attack more frontally the problem (by the flank)! We suggest ([09.07.13]) the method of total reality (i.e le théorème de Riemann rendu synthétique) via pencils of curves of degree $(m - 2)$, here pencil of septics. Cf. e.g. Gabard 2013B [471] for the very first step of this programme.] ♡3
- [425] S. Fiedler-Le Touzé, S. Orevkov, *A flexible M -sextic which is algebraically unrealizable*, J. Algebraic Geom. 11 (2002), 293–310. [♠ this continues the work initiated by Korchagin/Shustin (independently and then in collaboration, cf. Korchagin-Shustin 1988/90 [861]), and then continued in Orevkov 98/98 [1118], [1119] where it remained only ca. 3 configurations in doubt. As is well-known this problem has direct impact upon smoothings and so contributes directly to construction of M -schemes via Viro’s method. More precisely affine M -sextics are involved in the dissipation of which singularity [?] and therefore contributes to Hilbert’s 16th in degree 8 or 9 [??]. Sorry but we do not know the exact answer!] ♡3
- [426] S. Fiedler-Le Touzé, *M -curves of degree 9 with deep nests*, J. London Math. Soc. (2) 79 (2009), 649–662. [♠ 10 new M -prohibitions in degree $m = 9$ via the classical restriction method (à la Fiedler-Viro?) supplemented by more recent gadgets (pencils of rational cubics, Orevkov’s (1999 [1121]) complex orientation formulas for an M -curve with deep nest). ♠ p. 649: “The classification of the real schemes that are realizable by M -curves of a given degree in $\mathbb{R}P^2$ is part of Hilbert’s sixteenth problem, see for example [15–18](=Rohlin 78, Viro 86, Viro 89/90, Wilson 78). This classification is complete up to degree 7 and almost complete in degree 8 [yet in complete stagnation since Orevkov 2002, with 6 casus irreducibilis resisting all attempts]. A systematic study of the case $m = 9$ has been done, the main contribution being that of Korchagin. See for example, [7–10,12](=Korchagin 89 [860], Korchagin 91/92 [862], Korchagin 96 [863], Orevkov 03 [1134]) for constructions and [1,3,6,10,13,14](=Fiedler 83 [415], Le Touzé 02 [424], Korchagin 86 [853], Korchagin 97 [864] (survey), Orevkov 05 [1137], Viro-Orevkov 2001 [1538]) for restrictions.] ♡??

²³I presume this can be considered as an analog of the 104 octic schemes logically possible (post Fiedler-Viro).

- [427] S. Fiedler-Le Touzé, *M-curves of degree 9 with three nests*, arXiv 2010 (v.2, 15 September), 37 pages. [NB.—It seems that v.1 is as old as 2008, being cited so in Le Touzé 2009 [426].] [♠ 41 new M -prohibitions in degree $m = 9$ via Fiedler, Cremona, and Orevkov’s complex orientation formulas. ♠ p. 2: “A systematic study of the case $m = 9$ has been done, the main contribution being due to A. Korchaĭin. See e.g. [10](=K97), [7](=K92), [8](=K89), [9](=K96), [13](=O03), [17](=O12 [1141]) for the constructions, and [5](=K85), [6](=K86), [10](=K97), [1](=F83), [2](=LT00), [3](=LT02), [4](=LT09), [12](=O00), [14](=O05), [15](=VO01), [17](=O12) for the restrictions.”] ♡??
- [428] S. Fiedler-Le Touzé, *Pencils of cubics with eight base points lying in convex position in $\mathbb{R}P^2$* , arXiv, v2, 53 pages, Sept. 2012. [♠ contains foundations required in the next entry Le Touzé 2013 [429]] ♡??
- [429] S. Fiedler-Le Touzé, *Totally real pencils of cubics with respect to sextics*, a marvellous preprint received the 1 March 2013 (v.1), and a second version (v.2) the 3 March 2013 (where the basepoints are assigned on the ovals instead of in their insides like in v.1). Final version on arXiv 18–19 March 2013. [♠ a seminal work containing proofs of Rohlin’s 1978 (unproven) total reality assertion for certain $(M - 2)$ -sextics totally swept out by suitable pencil of cubics ♠ this is the first non-trivial (i.e. not involving pencil of lines or conics) extrinsic manifestation of Ahlfors theorem ♠ another but much more modest phenomenon of total reality occurs for M -curves (as slowly discovered by Gabard, cf. Theorem (in v.2) but this is merely at the level of the Bieberbach-Grunsky theorem, i.e. the genus zero case of Ahlfors theorem ♠ [20.03.13] as brilliantly explained in the paper in question (p. 3), Le Touzé proves actually a slightly weaker statement that Rohlin’s original claim, namely the dividing character is not deduced a priori from total reality (as Rohlin claimed being able to do), but rather the dividing character is taken as granted via the Rohlin-Kharlamov-Marin congruence while total reality of the pencil of cubics is built upon this preliminary knowledge. Hence it could still be of some interest to reconstruct a proof *purely a priori* assuming of course that there is a such. This looks quite likely, yet apparently quite elusive to implement.] ♡??
- [430] ?. Field, *On the circuit of a plane curve*, Math. Ann. 62 (190X), 218–??. [♠] ♡??
 ★ Sergei Finashin, probably still one of the notorious student of V. A. Rohlin, well know for his studies on the interplay between real geometry and 4D-smooth topology via the quotient 4-manifold under complex-conjugation.
- [431] S. M. Finashin, *The topology of the complement of a real algebraic curve in $\mathbb{C}P^2$* , Zap. Nauch. Sem. LOMI 122 (1982), 137–145; English transl., J. Soviet Math. 26 (1984), 1684–1689. [♠ briefly discussed in Viro 1986/86 [1534]] ♡??
- [432] S. M. Finashin, *Differential topology of quotients of complex surfaces by complex conjugation*, Zap. Nauch. Sem 231 (1995), 215–221; English transl., J. Math. Sciences 91 (1998), 3472–3475. [♠ p. 3472: “A well-known example is $X = \mathbb{C}P^2$, for which [the quotient by conj is] $Y \cong S^4$. According to V. A. Rohlin, the last equality was quite widely known in the mathematical folklore, in any case to those who reflected on the four-dimensional Poincaré conjecture, for example, to Pontryagin. However, the author knows no mention of this account before Arnold’s paper [2](=1971 [59]) and no published proofs before the papers of Kuiper [9](=1974) and Massey [10](=1973).” ♠ according to some subsequent publication by Arnold, the result goes back to Maxwell!] ♡0
- [433] S. M. Finashin, *Rokhlin conjecture and quotients of complex surfaces by complex conjugation*, J. reine angew. Math. 481 (1996), 55–71. [♠ p. 68: some remarks on sextics, e.g. Fig. 10 gives the $(M - 1)$ -scheme 10 via a perturbation of a line arrangement ♠ p. 68: “It is well known and not difficult to see directly from the Hilbert and Gudkov constructions of nonsingular real sextics (cf. [V](=Viro 1986/86 [1534])), that the ones with schemes $\langle \alpha \sqcup 1 \langle \beta \rangle$ can be deformed to the both schemes [having resp. one less outer oval or inner oval] by passing through a cross-like real node which connects the ambient oval with an exterior oval resp. with an interior one. The only exceptio is the scheme $\langle 9 \sqcup 1 \langle 1 \rangle$ [of Harnack] which can be reduced to $\langle 10 \rangle$ only by contracting the inner oval.”] ♡??
- [434] S. M. Finashin, *On the topology of real plane algebraic curves with nondegenerate quadratic singularities*, Algebra i Analiz 8 (1996), 186–204; English transl., St. Petersburg Math. J. 8 (1997), 1039–1051. [♠] ♡??
- [435] S. M. Finashin, V. Kharlamov, *Apparent contours of nonsingular real cubic surfaces*, arXiv 9 June 2013 [also after myself coined the term “eversion” ca. Jan.

- 2013 (cf. e-mail Sec. in v2], 63 pages. [♠ a very impressive work philosophically akin to Rohlin-Nikulin-Kharlamov’s rigid isotopy classification of smooth sextic, yet adapted to the singular context of “Zariski’s cuspidal sextics” occurring as (generic) apparent contours of cubic surfaces projected out from a point outside of it. The resulting theory affords a refinement of earlier work by Mikhalkin 1995. ♠ the article uses the notion of partner/reversion that it somewhat related to what we called eversion, and more importantly contains (p.62) pleasant historical details of the rôle of Morosov into shaping the ultimate destiny of Hilbert’s 16th in degree $m = 6$.] ♡??
- [436] A. E. Fischer, A. J. Tromba, *On a purely “Riemannian” proof of the structure and dimension of the unramified moduli space of a compact Riemann surface*, Math. Ann. (1983). [♠ ... Ahlfors [2]. The space of extremal quasi-conformal maps between two Riemann surfaces (the so-called Teichmüller space) is in fact a ramified covering of the space of conformal classes of Riemann surfaces of prescribed genus (the real moduli space). In [4] Ahlfors shows that ...] ♡73
- [437] S. D. Fisher, *Exposed points in spaces of bounded analytic functions*, Duke Math. J. 36 (1969), 479–484. A50 [♠ cite Ahlfors 1950 [19] and the following result is obtained: the exposed points of the algebras $A(\overline{R})$ (resp. $H^\infty(R)$) are uniformly dense in the unit sphere of the respective space]★★★ ♡8
- [438] S. D. Fisher, *Another theorem on convex combination of unimodular functions*, Bull. Amer. Math. Soc. ?? (1969), 1037–1039. [♠ finite Riemann surfaces, inner functions and it is proved that the closed convex-hull of the inner functions is the unit ball (for the sup norm) of the algebra $A(R)$ of analytic functions continuous up to the border ♠ this is proved via an interpolation lemma due to Heins 1950 [634], which is closely allied to the Ahlfors function (plus maybe some Garabedian) ♠ this is stated as: “Lemma 1: Let z_1, \dots, z_N be distinct points of R (=a finite Riemann surface) and let h be an analytic function on R bounded by 1. Then there is an inner function f (i.e. of modulus one on the boundary ∂R) in $A(R)$ with $f(z_j) = h(z_j)$, $j = 1, \dots, N$.” ♠ one can take $h \equiv 1$ then f looks strange for it maps inner points to the boundary point 1, yet still $f = 1$ works ♠ the question is of course whether this reproves Ahlfors 1950, but this looks unlikely especially as no control is supplied on the degree, but see Heins 1950 [634], which suitably modified should recover Ahlfors result by controlling appropriately the bound involved] ♡??
- [439] S. D. Fisher, *On Schwarz’s lemma and inner functions*, Trans. Amer. Math. Soc. 138 (1969), 229–240. A47, G78 [♠ after Havinson 1961/64 [621] and Carleson 1967 [248], study the Ahlfors map for domains of infinite connectivity ♠ subsequent ramifications in Rödning 1977 [1280], Minda 1981 [1015], Yamada 1983–92 [1610, 1611]] ♡24
- [440] S. D. Fisher, *The moduli of extremal functions*, Michigan Math. J. 19 (1972), 179–183. A47 [♠ the Ahlfors function of a domain (supporting nonconstant bounded analytic functions) is shown to be of unit modulus on the Šilov boundary of H^∞] ♡10
- [441] S. D. Fisher, *Non-linear extremal problems in H^∞* , Indiana Univ. Math. J. 22 (1973), 1183–1190. A50 [♠ p. 1183/7 speaks of the “Ahlfors-Royden extremal problem” ♠ the author explains that in Ahlfors extremal problem the class of competing functions is convex, explaining uniqueness of the solution and studies a variant of the problem with a side-condition amounting to require “no other zeros” which leads to a non-convex problem lacking uniqueness ♠ p. 1187/88, grasp of the geometric quintessence of Ahlfors’ argument: “By a theorem of Ahlfors [A1; §4.2] there is a set of $r + 1$ points p_j in Γ such that if v_i is the period vector of a unit mass at p_j , then v_0, \dots, v_r form the vertices of a simplex in \mathbb{R}^r which contains the origin as an interior point.”] ♡??
- [442] S. D. Fisher, *Function theory on planar domains*. A second course in complex analysis. Pure and Applied Mathematics (New York). A Wiley-Interscience Publication. John Wiley & Sons, Inc., New York, 1983. ♡179
- [443] S. D. Fisher, D. Khavinson, *Extreme Pick-Nevalinna interpolants*, Canad. J. Math. 51 (1999), 977–995. [♠ Ahlfors function (in the domain case only), its connection with Blaschke products and the Green’s functions, Pick bodies (jargon of Cole, Lewis, Wermer) and interpolation] ♡??
- [444] H. Florack, *Reguläre und meromorphe Funktionen auf nicht geschlossenen Riemannschen Flächen*, Schr. Math. Inst. Univ. Münster no. 1 (1948), 34 pp. AS60 [♠

cited also in Royden 1962 [1305] (yet not within the text?) and briefly summarized in a ICM talk ca. 1954 of Behnke]★★★ ♡??

- [445] V. Florens, *Murasugi-Tristram inequality for generalized signatures and application for real algebraic curves*, Preprint (2001); or ???. [♠ cited in Orevkov 2001 [1126]] ♡??
- [446] V. Florens, *Signatures of colored links with applications to real algebraic curves*, J. Knot Th. Ramif. (2005), 883–918. [♠ a fairly fundamental contribution at the interface of knot theory and real curves along Orevkov’s strategy as applied to the problem of completing the possible complex orientations of M -curves in degree $m = 7$.] ♡??
- [447] F. Forelli, *Bounded holomorphic functions and projections*, Illinois J. Math. 10 (1966), 367–380. [♠ the universal covering method is employed to derive another proof of the corona theorem for interiors of compact bordered Riemann surfaces, relativizing thereby the ubiquitousness of the Ahlfors function given in Alling 1964 [40] ♠ Forelli’s proof uses the following tools: • (p.368) “measure and Hilbert space theory, and the harmonic analysis that goes with the Hilbert space H^2 ” • (p.373, 374) existence of analytic differentials with prescribed periods on the Schottky double (via Pfluger 1957 [1174]) • Beurling’s invariant subspace theorem (p.366), but this can be dispensed in the compact bordered case by appealing to a holomorphic function continuous up to the border “whose zeros are the critical point of the Green’s function with pole at $t(0)$ ” (p.377)] ♡45
- [448] F. Forelli, *Extreme points in $H^1(R)$* , Canad. J. Math. 19 (1967), 312–320. [♠]★★ ♡??
- [449] F. Forelli, *The extreme points of some classes of holomorphic functions*, Duke Math. J. 46 (1979), 763–772. [♠ study of the extreme points of the family of analytic functions with positive real part on a given finite Riemann surface normalized to take the value 1 at a given point ♠ the paper Heins 1985 [639] supplements the results of Forelli by precise characterizing results for the case where the genus of S is positive ♣ [11.10.12] in fact this Forelli paper is a jewel (that I was only able to read today=[11.10.12], shame on me!) ♣ despite presenting itself too humbly as a modest appendix to Heins 1950 [634], its main result (Theorem 3.2, p.766) gives the chain of inclusions $N_q(W, \zeta) \subset \partial N(W, \zeta) \subset \bigcup_q^{2p+q} N_k(W, \zeta)$, which readily implies a new proof of circle maps of degree $\leq 2p + q$ (like Ahlfors 1950 [19]). To understand this point, first recall Forelli’s notation: \overline{W} is a compact bordered Riemann surface of genus p with q contours, W is of course its interior; $N(W, \zeta)$ is the class of holomorphic functions f on W with positive²⁴ real part ($\operatorname{Re} f > 0$) normalized by $f(\zeta) = 1$ at some fixed $\zeta \in W$ (it is easily verified that $N(W, \zeta)$ is convex and compact in the compact-open topology) [notion due to Arens/Fox, if I remember well???]; the symbol ∂ used above refers *not* to the boundary but to the set of all extreme points of a convex body, i.e. those points of the body not expressible as convex (=barycentric) combination $tx + (1 - t)y$ ($t \in [0, 1]$) of two (distinct) points x, y of the body. This is also the smallest subset of the body permitting its complete reconstruction via the convex-hull operation; finally $N_k(W, \zeta)$, for $k > 0$ a positive integer, is the subclass of $N(W, \zeta)$ consisting of functions that cover the right half-plane k times. ♣ having explained notation, it is plain to deduce Ahlfors’ result. Indeed from the cited properties of convexity and compactness for $N(W, \zeta)$ one deduces (via Krein-Milman) existence of extreme points, i.e. $\partial N(W, \zeta) \neq \emptyset$ (this issue is not explicit in Forelli’s paper, but so evident that it is tacit, cf. e.g., Heins’ commentary in 1985 [640, p.758]: “My paper [7](=Heins 1950 [634]) showed the existence of minimal positive harmonic functions on Riemann surfaces using elementary standard normal family results without the intervention of the Krein-Milman theorem²⁵ and gave applications to qualitative aspects of Pick-Nevanlinna interpolation on Riemann surfaces with finite topological characteristics and nonpointlike boundary components.” ♣ Now Forelli’s second inclusion implies immediately the desideratum (existence of circle

²⁴Of course the notation P instead of N could have been more appealing, yet Forelli had obviously to reserve the letter P for “probability measures”, to enter soon the arena! So imagine the “ N ” standing for non-negative real parts (which is incidentally more correct if we let penetrate the boundary behavior in the game).

²⁵Of course behind both techniques there is the paradigm of compactness in suitable function spaces, first occurring as a such in the related Hilbert’s investigation on the Dirichlet principle (add maybe Arzelà-Vitali to be fair, cf. e.g. Zaremba 1910 [1623]). So everything started to be solid after Hilbert 1900, and Montel 1907, etc.

maps of degree d such that $q \leq d \leq 2p + q$ ♠ note of course that the first set of the string, that is $N_q(W, \zeta)$, can frequently be empty. Consider e.g. \overline{W} be one-half of *Klein's Gürtelkurve*²⁶, that is any real plane smooth quartic, $C_4 \subset \mathbb{P}^2$, with two nested ovals, then $q = 2$ but quartics and more generally smooth plane curves of order m are known to be $(m - 1)$ -gonal. For an even simpler example, consider any bordered surface W with only one contour ($q = 1$) and of positive genus $p > 0$, then there cannot be a circle-map of degree $d = q = 1$ for a such would be an isomorphism (by the evident branched covering features of analytic maps), violating the topological complexity prompted by $p > 0$ ♠ several questions arise naturally from Forelli's work. A first one is the perpetual question about knowing if the method can recover the sharper bound $p + q$ ($\approx r + p$) of Gabard 2006 [463]. (Here and below \approx refers to notational conversion from Forelli's notation to the one used in the present paper). Again it is our belief that the ultimate convex geometry reduction of the problem (already explicit in Ahlfors) could be slightly improved so as to do this (compare below for more details). Another problem is to understand the distribution of degrees corresponding to extreme points of Forelli's convex body $\partial N(W, \zeta)$ (maybe call it the Carathéodory-Heins-Forelli body to reflect better the historical roots of the technique, brilliantly discussed in Heins 1985 [640]). For instance is the least degree half-plane map (equivalently circle map) always an extreme point, as the nebulous principle of economy (\approx least effort) could suggest? (Nature always tries to relax itself along an equilibrium position necessitating the minimum existential stress-tensor!?) Finally one would like to see the connection between Ahlfors extremals and the extreme points of Heins-Forelli. Of course there is a little tormenting routine to switch from the one to the others via a Möbius-Cayley transformation from the disc to the half-plane. Yet loosely it seems that Ahlfors functions are a subclass of the extreme points, for they former depend on less parameters. For instance as noted by Forelli in the special planar case $p = 0$, the above chain of inclusions collapses to give the clear-cut equation $\partial N(W, \zeta) = N_q(W, \zeta)$ characterizing the set of extreme points in, essentially, purely topological terms. Yet the Bieberbach-Grunsky theorem (1925 [147], or A. Mori [1040]) tell us that circle maps are in this case ($p = 0$) fairly flexible insofar that we can preassign one point on each contour and find a circle map (of degree q) taking those points over the same boundary point²⁷. Hence for large values of q such minimal degree circle maps depends on essentially q real parameters, whereas for Ahlfors maps we can only specify the basepoint undergoing maximum distortion (hence just 2 real free parameters). ♣ Finally some words about Forelli's method of proof: It uses some "functional analysis" in the form of measure theory. Specifically Radon measures are mentioned, and a proposition permitting to express extreme points of a body B specified by n linear integral conditions as combination of $(n + 1)$ extreme probability measures (cf. Prop. 2.1 for the exact statement identified as dating back to Rosenbloom 1952 [1300], [but in geometric substance a similar lemma is already employed in Heins 1950 [634], as well as in Ahlfors 1950 [19]). This is then specialized to the case where the space X is the boundary of the bordered surface ∂W ²⁸, and the n conditions amounts essentially to ask the vanishing of the periods along representatives of a homology basis of \overline{W} , consisting of $n := 2p + (r - 1)$ cycles. The crucial potential theory is done via the Poisson integral inducing a bijective map $\#: P(\partial W) \rightarrow h_+(W, \zeta)$ between probability measures on the boundary and positive harmonic functions normalized by taking ζ to 1. It is defined by $\mu^\#(w) = \int_{\partial W} Q(w, y) d\mu(y)$, where $Q(w, y)$ is the Poisson kernel of W ($w \in W, y \in \partial W$). Now to find and describe (extreme) half-plane maps in $\partial N(W, \zeta)$, we are reduced via the above correspondence to a special set B of measure verifying n integral equations. On applying (Rosenbloom's) proposition, the measure μ defined by $\mu^\# = \text{Ref}$ where $f \in N(W, \zeta)$ is decomposed as a convex sum (i.e. with positive coefficient t_k) of Dirac measures $\mu = \sum_1^m t_k \delta_k$ concentrated at some boundary points $y_k \in \partial W$, where $m \leq n + 1$. It follows by calculation (Poisson+Dirac's trick) that $\text{Ref}(z) = \sum_1^m t_k Q(z, y_k)$ (because integrating a function against the Dirac measure concentrated at some point just amounts evaluating the function at that point). Of course notice at this stage that the Poisson function $Q(w, y)$ is nothing else than the Green function with pole

²⁶This is German for belt (=ceinture) in French.

²⁷This is indeed quite trivial to see, if we know the Riemann(-Roch) inequality, cf. e.g. Gabard 2006 [463].

²⁸Of course any geometric topologist (or reasonable being) could find the writing $\partial \overline{W}$ semantically more precise, yet we follow Forelli's alleged notation.

pushed to the boundary (so the object that we manipulated during our attempt to decipher Ahlfors' proof). At this stage the proof is essentially finished. ♠ as a matter of details Forelli further discuss the construction of the Poisson kernel taking inspiration from techniques of Earle-Marden 1969 [385], using primarily the uniformization of Poincaré-Koebe. To sum up Forelli's is able to reprove existence of circle maps but needs uniformization, admittedly in a simple finitistic context. Of course Ahlfors proof seems to avoid this dependance, which is anyway perhaps not so dramatic. ♠ The latter issue should of course not detract us from the geometrical main aspect of the proof. First Forelli's proof uses heavily a little yoga between measures and harmonic functions converting the one to the others via the Poisson integral. This technique involves so Poisson, then Stieltjes and finally the so-called Herglotz-Riesz (1911 [650]) (representation) theorem, a special incarnation of Fischer-Riesz (1907). Of course the yoga in question boils down to the Dirichlet principle when the measure has continuous density so that Herglotz-Riesz is just the Dirichlet problem enhanced by Lebesgue integration. Of course all this is beautiful, yet probably not fully intrinsic to the problematic of half-plane (or the allied circle) maps, which can probably be arrived upon via more classical integration theories (and in particular the classical Dirichlet problem, plus the allied potential functions, Green's, Poisson's or whatever you like to call them). I personally used the term Red's function (somewhere in this text) as colorful contrast to evergreens tree, honoring George Green, but of course Poisson's function might be historically more accurate. (After all, human beings descend from fishes rather than vegetables, and Green himself quotes of course Poisson, and Dirichlet was a Poisson student). ♣ but now the key issue would be to penetrate even deeper in the geometry of Forelli's proof. Again the hearth of the problem is the possibility of expressing a certain point as convex combination of *at most* $(n + 1)$ points; in Forelli's treatment cf. Prop. 2.1, where however the "at most" proviso is not explicit but implicitly used later in the proof of Theorem 3.2. Like in our attempt to push Ahlfors proof down to recover Gabard's bound, we believe that a better inspection of this convex geometry could corroborate the possibility of locating half-plane maps of lower degree. The situation we have in mind is the following (to which we were reduced by reading carefully Ahlfors 1950 [19]): suppose we are given in $\mathbb{R}^n \approx g$ a collection of $q \approx r$ curves forming a balanced configuration (all \approx signs just amounts to conversion from Forelli's notation to the one used in the present text), in the sense that the convex hull encloses the origin, then it is of course possible to express the origin as convex sum of $\leq n + 1 \approx g + 1$ point (recovering thereby Ahlfors' result). However it must be also possible to be more economical by using a more special, lower-dimensional simplex, able to cover the origin with a smaller quantity of points. We hope that this is a problem of pure (Euclid/convex/Minkowski) geometry (perhaps involving some topological tricks like in the Borsuk-Ulam (ham-sandwich) theorem, which can concomitantly be proved via more simple center of masses considerations, cf. e.g. Fulton's book on "topology"). Alas I can only try to convince the reader by looking at the (very special) case where $n \approx g = 2$ coming (via $g = 2p + (r - 1)$) from the values $p = 1, r = 1$. Then we have one balanced circle in the plane \mathbb{R}^2 . If we follow Ahlfors, we just have the plain remark that there is $g + 1 = r + 2p = 1 + 2 \cdot 1 = 3$ points spanning a simplex covering the origin (which is trivial for dimensional reason), however it is evident that a more special and lucky constellation (Stonehenge alinement) of two points situated on the topological circle (Jordan curve) corresponding to the contour of the bordered surface, suffice to cover the origin with a 1-simplex, giving existence of a circle map of degree 2, like the $r + p$ bound predicted in Gabard 2006 [463] ♠ of course all we are saying does not detract the possibility that the extreme points studied by Forelli always contain an element landing in the highest possible degree $2p + q \approx 2p + r = g + 1$ ♠4

[450] J. E. Fornæss, N. Sibony, *Some open problems in higher dimensional complex analysis and complex dynamics*, Publ. Mat. 45 (2001), 529–547. [♠ p. 539: "Question 3.16. Can one embed all Stein Riemann surfaces as closed complex submanifolds of \mathbb{C}^2 ? (See [GS]=Globevnik-Stensones 1995 [529])"] ♠15

[451] O. Forster, *Riemannsche Flächen*, Springer, Berlin, 1977, 223 pp; English trans., available. [♠ sheaf-theoretic approach] ♠??

[452] F. Forstnerič, E. F. Wold, *Bordered Riemann surfaces in \mathbb{C}^2* , J. Math. Pures Appl. 91 (2009), 100–114. [♠ reduction of the big problem of embedding open Riemann surfaces in the affine plane to that of embedding compact bordered surfaces,

which looks more tractable due to its finitary nature, yet apparently completely out of reach] ♡9

- [453] F. Forstnerič, E.F. Wold, *Embeddings of infinitely connected planar domains in \mathbb{C}^2* , arXiv (2012). [♠ “Abstract. We prove that every circled(=circular) domain (=Koebe’s Kreisbereich) in the Riemann sphere admits a proper holomorphic embedding (=PHE) in \mathbb{C}^2 .” This is yet another spectacular advance on the proper embedding problem, giving insights on how to crack the general problem. (This may be restated as, p.1: “*Is every open Riemann surface biholomorphic to a smoothly embedded, topologically closed complex curve in \mathbb{C}^2 .*”) Of course, when combined the He-Schramm 1993 [629] uniformization result this gives the “Theorem 1.1.—*Every domain in the Riemann sphere with at most countably many boundary components, none of which are points, admits a PHE in \mathbb{C}^2 .*” p.2: This result gives a wide extension of the similar statement in finite connectivity due to Globevnik-Stensønes 1995 [529]. p.17: “There exists a Cantor set in \mathbb{P}^1 whose complement embeds PH into \mathbb{C}^2 (Orevkov 2008 [1139]), but it is an open problem whether this holds for each Cantor set.”] ♡??
- [454] J. Fourier, *Théorie analytique de la chaleur*, 1822. [♠ trigonometric series expansion of an arbitrary function (so-called Fourier series), despite some earlier appearance of them in works by Clairaut and Euler ♠ Fourier’s first work on the topic was presented to Paris Academy in 1807, yet rejected by Lagrange, Laplace and Legendre] ♡??
- [455] W.F. Fox, *Harmonic functions with arbitrary singularity*, Pacific J. Math. (1961), 153–164. [♠ discusses and rederives old results of Schwarz 1870, Koebe while pointing out to the developments made by Sario ♠ p.153 probably corroborates the intuition that the solvability of the Dirichlet principle on a compact bordered Riemann surface was first treated by Schwarz 1870] ♡??
- [456] A. Fraser, R. Schoen, *The first Steklov eigenvalue, conformal geometry, and minimal surfaces*, Adv. in Math. 226 (2011), 4011–4030. A50 [♣ applies Ahlfors 1950 [19] (and even Gabard 2006 [463]) to spectral theory, especially first Steklov eigenvalue. For higher eigenvalues, cf. Girouard-Polterovich 2012 [527], and for Dirichlet-Neumann eigenvalues, cf. Gabard 2011 [467].] ♡14
- [457] I. Fredholm, *Sur une classe d’équations fonctionnelles*, Acta Math. 27 (1903), 365–390. [♠ early influence of Abel (1823), then Neumann’s approach to the Dirichlet problem and Volterra (1896) where Neumann’s method was successfully applied to an integral equation] ♡285
- [458] R. Fricke, F. Klein, *Vorlesungen über die Theorie der automorphen Functionen*, Two volumes, Teubner, Leipzig, 1897, 1912, 634 pp., 668 pp.; Reprinted by Johnson Reprint Corp., New York and Teubner, Stuttgart, 1965. [♠ contains versions of RST (=Rückkehrstichtheorem), while the completion of the second volume seem to have received some helping hand from Paul Koebe ♠ p.180 ff. contains another account of the classification of Klein’s symmetric Riemann surfaces] ♡??
- [459] G. Fubini, *Il Principio di minimo e teoremi di esistenza per i problemi al contorno relativi alle equazioni alle derivate parziali di ordini pari*, Rend. Circ. Mat. Palermo (1907). [♠ cited in Zaremba 1910 [1623] as another extension (beside Beppo Levi 1906 [933] and Lebesgue 1907 [916]) of Hilbert’s resurrection of the Dirichlet principle] ♡??
- [460] B. Fuchs, *Sur la fonction minimale d’un domaine, I, II*, Mat. Sbornik N. S. 16 (58) (1945); 18 (60) (1946). [♠ quoted in Lehto 1949 [920] and consider the problem of least momentum, i.e. minimizing $\iint_B |f(z)|^2 d\omega$ under the side-condition $f(t) = 1$ at some interior point] ★★★[part I OK, part II still not found] ♡14
 ★ Alexandre Gabard (20 March 1975–10 Mai 2013+ ϵ) the present writer is officially a Ph.D. student of Daniel Coray, yet also influenced by such scholars as Felice Ronga, Claude Weber, Michel Kervaire, etc., and more recently Mathieu Baillif, David Gauld, André Haefliger and Henriques, Viro, Marin, Kharlamov, Huisman, etc. The work of the writer is characterized by a low level of depth, trying rather first to chatter what is common knowledge, before entering into obscure behaviorism (i.e., mouton-like assimilation of truths without being able to check the details, as most mathematicians do for economical facilities).
- [461] A. Gabard, *Topologie des courbes algébriques réelles: une question de Felix Klein*, L’Enseign. Math. 46 (2000), 139–161. [♠ furnish a complete answer to a question raised by Klein as a footnote to his Collected Papers (Ges. math. Abhandl.), using an inequality due to Rohlin 1978 [1290]. Previous (unpublished) work on the

- same question due to Kharlamov-Viro in the Leningrad seminar of topology supervised by V. A. Rohlin. Confirms incidentally a desideratum of Gross-Harris 1981 [552].] ♡1
- [462] A. Gabard, *Sur la topologie et la géométrie des courbes algébriques réelles*, Thèse, Genève, 2004. A50 [♣ includes the improved bound $r + p$ upon the degree of a circle map of a membrane of genus p with r contours. Up to minor redactional change this is the same as the next entry Gabard 2006 [463]] ♡1
- [463] A. Gabard, *Sur la représentation conforme des surfaces de Riemann à bord et une caractérisation des courbes séparantes*, Comment. Math. Helv. 81 (2006), 945–964. A50 (This result also appeared previously in the Ph. D. Thesis of the author published in 2004, cf. the previous item.) [♣ proposes an improved bound upon Ahlfors 1950 [19], as discussed in the previous item ♠ for an update regarding the question about the sharpness of the bound so obtained see Coppens 2011 [322] ♠ [03.10.12] all this is fairly good yet a certain discrepancy with Ahlfors’ viewpoint is annoying and much remains to be clarified ♠ [03.10.12] further one can wonder if there is not a Teichmüller-theoretic proof of the existence of such circle maps, paralleling that of Meis 1960 [993] in the case of closed surfaces, and reciprocally, one can wonder if Meis’s Riemannian bound cannot be proved (directly) via the topological method used in the present entry (Gabard 2006 [463])] ♡6, now 7
- [464] A. Gabard, *A separable manifold failing to have the homotopy type of a CW-complex*, arXiv 2006, and another (simpler?) proof suggested by the referee in, Archiv der Math. (2008). [♠ this little note was primarily intended to give a counterexample to an assertion made by Milnor in 1959, to the effect that all separable manifolds have the homotopy type of a CW-complex. Alas, this is completely wrong (as soon as one familiar with the Prüfer surface 1922–25). Notwithstanding, more mature knowledge of mine (ca. 2009) I realized that Milnor was not wrong at all, except that for him separable meant at that time second countable or metrizable (compare for instance some of his preprint ca. 1958–59 available on the net). So the explanation is simply that the term “separable” had a different meaning in the first half of the 20th century (up to some residues moving as high as Milnor’s 1959 article [1010])] ♡4, or 5
- [465] A. Gabard, D. Gauld, *Jordan and Schoenflies in non-metrical analysis situs*, arXiv 2010. [♠ [29.07.13] this is a modest but pleasant work emerging from the subconscious desire (of the writer), and progressively brought to consciousness during a visit of the 2nd writer (Gauld) in Parc Bertrand (where Isabelle Adjani is living). More seriously, it is the simple intuition that Jordan’s theorem should hold true in more general situations than in the plane (actually for the myriad of simply-connected, more generally dichotomic surfaces (but then it is almost a tautology). Seeking extreme generality always brings to an equivalence, which is just a logical tautology, not really worth emphasizing it.)] ♡0
- [466] A. Gabard, D. Gauld, *Dynamics of non-metric manifolds*, arXiv 2011. [♠ this is just cited for the proof of the implication: simply-connected \Rightarrow schlichtartig \Rightarrow orientable, which may be reduced to the five lemma] ♡2
- [467] A. Gabard, *Compact bordered Riemannian surfaces as vibrating membranes: an estimate à la Hersch-Yang-Yau-Fraser-Schoen*, arXiv 2011. A50 [♣ inspired by Fraser-Schoen 2011 [456], this adapts Hersch 1970 [651] (isoperimetric property of spherical vibrating membranes) to configurations of higher topological structure using the Ahlfors circle map with the bound of Gabard 2006 [463] ♠ notice an obvious (but superficial) connection with Gromov’s filling area conjecture (FAC) (1983 [547]) positing the minimality of the hemisphere among non-shortening membranes, hence it would be fine that conformal geometry/transplantation—enhanced perhaps by Weyl’s asymptotic law for the high vibratory modes (out of which we can ‘hear’ the area of the drum)—affords a proof, either geometric or acoustic, of FAC. This would maybe be a spectacular application of the Ahlfors map, or maybe some allied conformal maps, e.g. that of Witt-Martens [1602], [969], for non-orientable membranes. Recall indeed Gromov’s trick of cross-capping (à la von Dyck) the boundary contour of the membrane reduces the filling area problem (in genus zero) to Pu’s systolic inequality for the projective plane] ♡0
- [468] A. Gabard, *Ebullition in foliated surfaces vs. gravitational clumping*, arXiv 2011. [♣ not relevant to the present topic, but just cited for a Jordan separation argument via covering theory that can be ascribed to Riemann with some imagination] ♡0

- [469] A. Gabard, *Euler-Poincaré obstruction for pretzels with long tentacles à la Cantor-Nyikos*, arXiv, Dec. 2011. [♣ not relevant to the present topic, but just cited for some rudiment about Poincaré’s index formula for foliations] ♡0
- [470] A. Gabard, *Ahlfors circle maps: historical ramblings*, arXiv 2012. [♣ this is the present article available on the arXiv, but which soon afterward (2013) was expanded so has to reinforce the connection with Rohlin’s work on Hilbert’s 16th problem. The pivotal motivation for this junction between Ahlfors-Rohlin is Rohlin’s cryptical claim of total reality for certain $(M - 2)$ -sextics having a real scheme forcing the type I. Also instrumental for this expansion (of material) is the Rohlin conjecture (or at least the vestige thereof post Shustin) that a scheme of type I is maximal. This problem (still open) bears some connection with earlier speculations of Klein (1876) which however could not resist Shustin’s work 1985 [1411] (much based upon the Viro revolution as well as deep Bézout-style obstructions coming from Fiedler-Viro)] ♡0
- [471] A. Gabard, *A little scholium on Hilbert-Rohn via the total reality of M -curves: Riemann’s flirt with Miss Ragsdale*, arXiv 2013. [♣ this attempts to boils down Ragsdale conjecture to the total reality of M -curves (essentially due to Riemann) ♠ in the v.2, there is also a naive strategy attempting to make always the Arnold surface via a suitable local surgery] ♡0
- [472] D. Gaier, *Konforme Abbildung mehrfach zusammenhängender Gebiete durch direkte Lösung von Extremalproblemen*, Math. Z. 82 (1963), 413–419. G78 [♠ what sort of maps via which (extremal) method? Essentially the PSM via the Ritz-Ansatz (ca. 1908), à la Bieberbach-Bergman (1914/22), plus Nehari’s 1949 integral representation of such slit mappings] ♡??
- [473] D. Gaier, *Konstruktive Methoden der konformen Abbildung*, Ergebnisse d. Angew. Math. 3, Springer, Berlin, 1964. G78 [♠ Chap. III discusses in details the extremal properties of the Riemann mapping for a plane simply-connected region (distinct of \mathbb{C}), namely that the range of the map normalized by $f'(z_0) = 1$ has minimal area (first in Bieberbach 1914 [142]) or that the boundary of the range has minimal length (probably first in Szegő 1921 [1476]) ♠ this material was also presented (in book format) by Julia 1931 [735]]★ ♡283
- [474] D. Gaier, *Über ein Flächeninhaltsproblem und konforme Selbstabbildungen*, Rev. Roumaine Math. Pures Appl. 22 (1977), 1101–1105. [♠ cited for the same reasons as the next item and complement some details of it (especially in the sharpness of cross-references)] ♡2
- [475] D. Gaier, *Konforme Abbildung mehrfach zusammenhängender Gebiete*, Jber. d. Dt. Math.-Verein. 81 (1978), 25–44. [♠ p.34–35, §C, brilliant proof (of a fact discovered and briefly handled by Grötzsch 1931 [alas no precise cross-ref.]) via his *Flächenstreifenmethode* that “the” (non-unique!) map minimizing the area integral $\int \int |f'(z)|^2 d\omega$ (à la Bieberbach 1914 [142]–Bergman[n] 1922 [114], but extended to the multiply-connected setting) under the schlichtness proviso (and the normalizations $f(z_0) = 0, f'(z_0) = 1$) maps the domain upon a circular slitted disc (with concentric circular slits centered about the origin) ♠ Gaier’s proof is based upon a Carleman isoperimetric property of rings relating the modulus to the area enclosed by the inner contour, plus Bieberbach 1914 [142] (first area theorem) to the effect that a schlicht normed map ($f'(a) = 1$) from the disc inflates area, unless it is the identity ♣ a natural (naive?) question of the writer ([13.07.12]) is what happens if we relax schlichtness of the map? Do we recover an Ahlfors circle map? Try maybe to get the answer from the entry Garabedian-Schiffer 1949 [494]] ♡??
★ Vittorio Emanuele Galafassi (discepolo e successore del Brusotti) is the natural successor of Brusotti’s tradition in Italy.
- [476] V. E. Galafassi, *Sulle curve algebriche reali delle rigate razionali a generatrici reali*, Nota I e II, Rend. Accad. Lincei (8) 1 (1946), 827–831 e 922–927. [♠] ♡??
- [477] V. E. Galafassi, *Questioni di realtà sulle curve trigonali reali*, Annali di Matem. Ser. IV 27 (1948), 135–151. [♠ rather deep work quoting Harnack, Klein, Brusotti, etc. ♠ must perhaps be compared with Gross-Harris 1981 [552], or more recent work by say Coppens, Huisman, Ballico, etc] ♡??
- [478] V. E. Galafassi, *Classici e recenti sviluppi sulle superficie algebriche reali*, in: Colloque sur les questions de réalités en géométrie, Liège 1955, Paris Masson, 1956, 130–147. [♠ cited in Kharlamov 1986/96 [781].] ♡??

- [479] V. E. Galafassi, *Le questioni di realtà come sussidio in altri campi d'indagine*, Annali di Matem. Ser. IV 27 (1948), 135–151. [♠ a survey-like discourse not always easy to follow but certainly reviewing interesting work by Lewy 1938, Brusotti, B. Segre, etc. at the interface between PDE and real geometry ♠ (even) cited in Gudkov 1974 [579]] ♥??
- [480] T. W. Gamelin, M. Voichick, *Extreme points in spaces of analytic functions*, Canad. J. Math. 20 (1968), 919–928. A50 [♠ Ahlfors 1950 [19] is quoted several times through the paper, the most relevant being ♣ p. 926: “According to [1, § 4.2], there exist $r + 1$ ($r = g$ in our notation) points w_1, \dots, w_{r+1} on bR such that if B_j is the period vector of the singular function T_j corresponding to a unit point mass at w_j , then B_1, \dots, B_{r+1} are the vertices of a simplex in \mathbb{R}^r which contains 0 as an interior point.” ♣ This is indeed the geometric heart of Ahlfors’ existence proof of a circle map of degree $\leq g + 1 = r + 2p$ ♠ [28.09.12] the obvious game is whether one can lower the number of w_j to recover the degree predicted in Gabard 2006 [463] ♠ as to the content of this entry, it is involved with an extension of the de Leeuw-Rudin (1958 [357]) characterization of the extreme points of the unit ball of the disc-algebra $H^1(\Delta)$ as the outer functions of norm 1, and as usual this is obtained upon appealing to the Ahlfors map, or techniques closely allied to its existence-proof] ♥14
- [481] T. W. Gamelin, *Embedding Riemann surfaces in maximal ideal spaces*, J. Funct. Anal. 2 (1968), 123–146. [♠ p. 130: “Let R be a finite bordered Riemann surface with boundary Γ . Let A be the algebra of functions continuous on $R \cup \Gamma$ and analytic on R . Let φ be the evaluation at some point z_0 of R . Then the harmonic measure for z_0 on Γ is a unique Arens-Singer measure for ϕ on Γ . The spaces N_c consists of the boundary values along Γ of the analytic differentials on the doubled surface of R , the so-called Schottky differentials of R . The space N_c is finite-dimensional.” ♠ p. 133: “Since P admits a finite-sheeted covering map over $\{|\lambda| < 1\}$, P must be one-dimensional.” ♠ it is not clear (to Gabard) if this Gamelin argument makes tacit use of the Ahlfors map] ♥??
- [482] T. W. Gamelin, *Uniform algebras*, Prentice Hall, 1969. [♠ p. 195–200, analytic capacity as the first coefficient in the Laurent expansion of the Ahlfors function ♠ p. 197, existence and uniqueness of the Ahlfors function for a general open set in the plane ♠ p. 198, proof of the following convergence property of the Ahlfors function f_E of a compact plane set E (meaning the one, centered at ∞ , of the outer component of E , i.e. the component of the complement of E containing ∞): if E_n is decreasing sequence of compacta with intersection E , and f_n be the Ahlfors functions of E_n , then f_n converge to f uniformly on compact subsets of the outer component of E , and the corresponding analytic capacities converge $\gamma(E_n) \rightarrow \gamma(E)$ ♠ [21.09.12] this reminds perhaps one the famous conjecture (e.g. of Bing) about knowing if a descending sequence of plane (topological) discs must necessarily converge to a compactum satisfying the fixed-point property, even when the latter has the ugliest possible ‘dendrite’ shape ♠ one may wonder if function theory, especially boosted version of RMT, could crack the problem (this is of course just a naive challenge)]★ ♥??
- [483] T. W. Gamelin, *Localization of the corona problem*, Pacific J. Math. 34 (1970), 73–81. G78 ♥55
- [484] T. W. Gamelin, J. Garnett, *Distinguished homomorphisms and fiber algebras*, Amer. J. Math. ?? (1970), 455–474. [♠ p. 474 Ahlfors function mentioned as follows: “It is more difficult to relate the Shilov boundary of $H^\infty(D)$ to the Shilov boundaries of the fiber algebras. The problem is to decide whether the distinguished homomorphisms ϕ_λ lie in the Shilov boundary of $H^\infty(D)$. This question was resolved negatively by Zalcman [11](=1969 [1619]) for the domains he considered, because in this case the Ahlfors function of D could be seen to have unit modulus on the Shilov boundary of $H^\infty(D)$.”] ♥??
- [485] T. W. Gamelin, *The algebra of bounded analytic functions*, Bull. Amer. Math. Soc. 79 (1973), 1095–1108. A47, A50, G78 [♠ p. 1104: “The Ahlfors function tries hard to be unimodular on the boundary of an arbitrary domain.” The following result of Fisher is quoted (and reproved) “The Ahlfors function for a bounded domain D in \mathbb{C} has unit modulus on the Šilov boundary of $H^\infty(D)$.” ♠ circa 12 occurrences of “Ahlfors function” throughout the paper ♠ p. 1104: “Incidentally, the preceding proof [via the Šilov boundary] also establishes the uniqueness of the Ahlfors function.” ♠ p. 1104: “Combined with cluster value theory, Fisher’s theorem yields information on the Ahlfors function which is already sharper than

that which had been obtained by classical means.” p.1106–07: “if the harmonic measure for D is carried by the union of an at most countable number of boundary components of D , then the Ahlfors function G for D is inner; that is, the composition $G \circ \pi$ with the universal covering map $\pi: \Delta \rightarrow D$ has radial boundary values of unit modulus a.e. ($d\theta$). Without the hypothesis on the harmonic measure, the Ahlfors function needs not be inner, and an example is given in [17](=Gamelin, to appear) of a domain D with Ahlfors function G satisfying $|G \circ \pi| < 1$ a.e. ($d\theta$) on $\partial\Delta$.” ♣ the paper Ahlfors 1950 [19] is quoted in the following brief connection: “For dual extremal problems on Riemann surfaces, see [2](=Ahlfors 1950) and [36](=Royden 1962).” ♥3

[486] T. W. Gamelin, *Extremal problems in arbitrary domains*, Michigan Math. J. 20 (1973), 3–11. A50, G78 [♠ quoted in Hayashi 1987 [627] for the issue that the following property: “the natural map of a Riemann surface R into its maximal ideal space $\mathfrak{M}(R)$ (this is an embedding if we assume that the algebra $H^\infty(R)$ of bounded analytic functions separates points) is a homeomorphism onto an open subset of $\mathfrak{M}(R)$ ” has some application to the uniqueness of the Ahlfors function, as well as to its existence via Hayashi 1987 [627] ♠ Royden 1962 [1305] is cited instead of the original work Ahlfors 1950 [19] for the treatment of extremal problems on finite bordered Riemann surfaces] ♥12

[487] T. W. Gamelin, *Extremal problems in arbitrary domains, II*, Michigan Math. J. 21 (1974), 297–307. G78 [♠ p.297, Ahlfors function is quoted as follows: “Hejhal proof’s depends on the methods developed by Havinson 1961/64 [621], who proved the uniqueness of the Ahlfors function of arbitrary domains. Now there is in [4](=Gamelin 1973 [486]) an economical proof of Havinson’s theorem that depends on function-algebraic techniques (see also [3](=Gamelin 1972, La Plata Notas) and [5](=Gamelin 1973 [485]))] ♥2

[488] T. W. Gamelin, *The Shilov boundary of $H^\infty(U)$* , Amer. J. Math. 96 (1974), 79–103. [♠ p.79, the Ahlfors function is cited and the author finds a bounded domain in the plane whose Ahlfors function fails to be inner (violating thereby a guess formulated, e.g. in Rubel 1971 [1307]) ♠ let us quote the text (p.79): “Let U be a bounded domain in the plane, and let $H^\infty(U)$ be the algebra of bounded analytic functions on U , and $\mathfrak{M}(U)$ be its maximal ideal space. Our object here is to study the Shilov boundary $S(U)$ of $H^\infty(U)$. It will be shown that $S(U)$ is extremely disconnected, and that every positive continuous function on $S(U)$ is the modulus of a function in $H^\infty(U)$. Fisher [7](=1972 [440]) has shown that there exist nonconstant functions in $H^\infty(U)$ with unit modulus on $S(U)$. In fact, he proves that the Ahlfors function for U is unimodular. We will show that there is an abundant supply of unimodular functions in $H^\infty(U)$, sufficiently many to separate $S(U)$ from the points of $\mathfrak{M}(U) \setminus S(U)$ which are adherent to U . In the negative direction, we show that the property of having unit modulus on the Shilov boundary of $H^\infty(U)$ does not yield a great deal of information concerning the classical boundary values of functions in $H^\infty(U)$. In fact, an example is given of a reasonably well-behaved domain U with the following property: If f is any nonconstant function in $H^\infty(U)$ such that $\|f\| \leq 1$, then the lift of f to the open unit disc via the universal covering map has radial boundary values of modulus < 1 a.e. ($d\theta$).” ♠ the latter assertion specialized to an Ahlfors function (at some center) shows that the latter can fail to be inner (indeed not even hypo-inner in the sense of Rubel)] ♥11

[489] T. W. Gamelin, J. B. Garnett, L. A. Rubel, A. L. Shields, *On badly approximable functions*, J. Approx. Theory 17 (1976), 280–296. [♠ if F is a finite bordered Riemann surface, let $A(F)$ be the algebra of functions, analytic in the interior with continuous extension to the boundary $\Gamma := \partial F$. The boundary value map $A(F) \rightarrow C(\Gamma)$ is injective (upon splitting into real/imaginary parts and applying the uniqueness of the Dirichlet problem). The algebra $C(\Gamma)$ (complex-valued functions on the boundary Γ) is endowed with the sup-norm $\|\varphi\| = \sup_{z \in \Gamma} |\varphi(z)|$. Now given any $\varphi \in C(\Gamma)$ there must be a best analytic approximant $f \in A(F)$, that is minimizing $\|\varphi - f\|$. The authors (following Poreda 1972) call $\varphi \in C(\Gamma)$ *badly approximable* if its distance $d(\varphi, A(D))$ to the space $A(D)$ is equal to the norm $\|\varphi\|$. This amounts saying that the best analytic approximant of φ is 0 (zero function). ♠ [01.10.12] of course such badly approximable function are the opposite extreme of the boundary-values of an Ahlfors function (or of a circle map), since the latter coincide with their best analytic approximant. Despite this contrast, badly approximable functions are shown to have constant modulus along the boundary

(Theorem 1.2, p. 281) sharing a distinctive feature of circle maps, but deviates from them by having a small index (=winding number), namely $\text{ind}(\varphi) < 2p + (r - 1)$, where p is the genus and r the contour number of F . Precisely Theorem 8.1 (p. 294) states: “If $\varphi \in C(\Gamma)$ is badly approximable, then φ has nonzero constant modulus, and $\text{ind}(\varphi) < 2p + (r - 1)$.” The proof involves the theory of Toeplitz operators and reduces ultimately to the theory of Schottky differentials (forming a real vector space of dimension equal to the genus g of the double which is precisely the upper bound involved above). Hence the connection with Ahlfors 1950 [19] is evident (at least at some subconscious level), and accentuated by the numerous citations to the allied paper Royden 1962 [1305]. ♠ finally, let us maybe observe that the converse of the above statement (Theorem 8.1) can be foiled as follows: via Gabard 2006 [463] there is always a circle map f of degree $d \leq r + p$. Its boundary restriction $\partial f =: \varphi$ has index equal to this degree $\text{ind}(\varphi) = d \leq r + p < 2p + (r - 1)$, provided $p > 1$. Yet the map φ is not badly approximable, for by construction it admits a perfect analytic approximant.] ♡17

[490] T. W. Gamelin, *Cluster values of bounded analytic functions*, Trans. Amer. Math. Soc. 225 (1977), 295–306. [♠ several aspects of the Ahlfors function are discussed, and some new property (extending a result of Havinson) is given. To be more precise, we quote some extracts ♠ p.296: Recall that the Ahlfors function G of D , depending on the point $z_0 \in D$, is the extremal function for the problem of maximizing $|f'(z_0)|$ among all $f \in H^\infty(D)$ satisfying $|f| \leq 1$; G is normalized so that $G'(z_0) > 0$, and then G is unique. If ζ is an essential boundary point of D , then $|G| = 1$ on III_ζ (Šilov boundary). Furthermore, either $\lim_{D \ni z \rightarrow \zeta} |G(z)| = 1$ or $\text{Cl}(G, \zeta) = \overline{\Delta}$ (=closed unit disc). S. Ya. Havinson [7, Theorem 28] has proved that G assumes all values in Δ , with the possible exception of a subset of Δ of zero analytic capacity. ♠ p.297: we conclude the following sharper version of Havinson’s Theorem. **1.2 Corollary.** Let G be the Ahlfors function of D , and let ζ be an essential boundary point of D such that $\text{Cl}(G, \zeta) = \overline{\Delta}$. Then values in Δ are assumed infinitely often by G in every neighborhood of ζ , with the exception of those lying in a set of zero analytic capacity.] ♡4

[491] T. W. Gamelin, *Wolff’s proof of the corona theorem*, Israel J. Math. ?? (1980), ??–??. [♠ “Abstract. An expository account is given of T. Wolff’s recent elementary proof of Carleson’s Corona Theorem (1962). The Corona Theorem answers affirmatively a question raised by S. Kakutani (1957) as to whether the open unit disc in the complex plane is dense in the . . .”] ♡27

[492] T. W. Gamelin, M. Hayashi, *The algebra of the bounded analytic functions on a Riemann surface*, J. Reine Angew. Math. 382 (1987), 49–73. [♠ p.72 some sophisticated (but lucid) questions about the Grunsky-Ahlfors (abridged Grahl=Graal=Sangreal) extremal problem of maximizing the derivative $f'(p)$ among functions bounded-by-one $|f| \leq 1$ (where p is a given point and the derivative is taken w.r.t. a fixed local coordinates). The following questions are posed under the proviso that $H^\infty(R)$ separates points. **Problem 1.** For a fixed $p \in R$, is there an $f \in H^\infty(R)$ such that $f'(p) \neq 0$? If such an f exists, then any extremal function for the Grahl-problem normalized so that $f'(p) > 0$ is termed an *Ahlfors function* corresponding to p . **Problem 2.** For fixed $p \in R$, assume the Grahl-extremal problem is non-trivial. Is the Ahlfors function unique? Does it have unit modulus on the Shilov boundary of $H^\infty(R)$? ♠ the writer (Gabard) is not aware of any update on those questions, yet it may be emphasized that partial answers are sketched in Hayashi 1987 [627], namely that under the assumption that the natural map of R to its maximal ideal space $\mathfrak{M}(R)$ takes R homeomorphically onto an open set of $\mathfrak{M}(R)$, then existence and uniqueness of the Ahlfors function is ensured] ♡5

[493] M. Gander, G. Wanner, *From Euler, Ritz and Galerkin to modern computing*, (2012), 49–73. [♠ a historical survey about Galileo, Bernoulli, Euler, Lagrange, Chladni, . . . , Ritz, Galerkin and their influence upon modern computing] ♡??

[494] P. R. Garabedian, M. M. Schiffer, *Identities in the theory of conformal mapping*, Trans. Amer. Math. Soc. 65 (1949), 187–238. AS60, G78 [♠ p. 201, the problem of least area is considered (i.e. minimization of $\iint |f'(z)|^2 d\omega$) among all (not necessarily schlicht) mappings f normed by $f(a) = 0, f'(a) = 1$ defined on an n -connected domain ♠ it should be emphasized that the solution of this problem was stated (without proof) by Grunsky 1932 [560, p.140]; Grunsky’s influence is recognized in the introduction (p. 188), yet not made explicit at the relevant passage (p. 201, Problem I.) for the specific result of the least area map ♠ assert (without detailed

- proof) that the solution is at most n -valent ♠ alas it is not asserted that those least-area maps are circle maps (which looks a natural conjecture)] ♡50
- [495] P. R. Garabedian, *Schwarz's lemma and the Szegő kernel function*, Trans. Amer. Math. Soc. 67 (1949), 1–35. AS60, G78 [♠ includes the formula $f'(t) = 2\pi k(t, t)$ for the derivative of the Ahlfors function in terms of Szegő's kernel function, other expositions of the same result in Bergman 1950 [123], Garabedian-Schiffer 1950 [498] and Nehari 1952 [1081] ♠ at several crucial stage this paper makes use of topological arguments (hence a possible connection with Gabaredian 2006 [463] remains to be elucidated)] ♡104
- [496] P. R. Garabedian, *The sharp form of the principle of hyperbolic measure*, Ann. of Math. 51 (1950), 360–379. AS60, G78 [♣ claims to recover the full Ahlfors (1950 [19]) theorem on existence of circle maps (by deploying a large array of techniques blending from Teichmüller 1939 [1483], Grunsky 1940–42 [563], [564], Ahlfors 1947 [18] and the variational method of Schiffer/Hadamard), but the detailed execution is limited to the planar case, and only the same bound as Ahlfors 1950 [19] is obtained] ♡??
- [497] P. R. Garabedian, *The class L_p and conformal mapping*, Trans. Amer. Math. Soc. 69 (1950), 392–415. [♣] ♡16
- [498] P. R. Garabedian, M. M. Schiffer, *On existence theorems of potential theory and conformal mapping*, Ann. of Math. (2) 52 (1950), 164–187. G78 [♠ reprove RMT via the Bergman kernel (for smooth boundary, p. 164), but the general case follows by topological approximation (exhaustion) ♠ p. 182 points out that circle maps lye somewhat deeper than slit mappings ♠ p. 181 recover the circle map for domains (of finite-connectivity) ♠ recover also the parallel-slit mappings and cite Lehto 1949 [920] for equivalent work ♠ p. 182 coins the designation “circle mapping”, to which we adhere in this survey.] ♡??
- [499] P. R. Garabedian, *A new proof of the Riemann mapping theorem*. In: *Construction and Applications of Conformal Maps*, Proc. of a Sympos. held on June 22–25 1949, Applied Math. Series 18, 1952, 207–213. [♠ consider a (strange) least area problem yet without making very explicit the range of the geometry of the extremal function] ♡??
- [500] P. R. Garabedian, *Univalent functions and the Riemann mapping theorem*, Proc. Amer. Math. Soc. 61 (1976), 242–244. [♠ yet another new proof of RMT via an extremal problem and normal families ♠ also cited for the reasons annotated after de Possel 1939 [1224], namely the issue of avoiding the use of RMT in the extremal proof of PSM] ♡0?
 ★ Lars Gårding student of Marcel Riesz and professor of Lars Hörmander is notably celebrate for his rôle of prophet on the works of Petrovskii on systems of PDE's (compare Gårding's reminiscences in Petrovskii's Selected Papers 1986/96 [1171]).
- [501] L. Gårding, *The Dirichlet problem*, Math. Intelligencer 2 (1979/80), 43–53. [♠ historical survey of the Dirichlet problem with Poisson, Gauss 1839 [516], its influence upon Thomson 1847 [1489], Stokes (credited for the maximum principle?), Dirichlet, Riemann, Weierstrass, Schwarz, Neumann, Poincaré (balayage) and its modern ramification by Perron [1165] and Radó-Riesz 1925 [1236], up to Frostman, Beurling-Deny] ♡??
- [502] J. Garnett, *Positive length but zero analytic capacity*, Proc. Amer. Math. Soc. 24 (1970), 696–699. [♠ simplifies the example of Vitushkin 1957 [1543] by taking advantage of the homogeneity of the compactum which is a simple planar Cantor set obtained by keeping only the 4 corner squares of a subdivision of the unit-square in 4×4 congruent subsquares, and iterating ad infinitum ♠ compare Murai 1987 [1048] for another direct strategy (via Garabedian instead of Ahlfors) which is supposed to give more insight about the general problem] ♡40
- [503] J. Garnett, *Analytic capacity and measures*, Lecture Notes in Math. 297, Springer, Berlin, 1972, 138 pp. [♠ p. 18, Ahlfors function ♠ p. 36, Denjoy conjecture (cf. for its resolution Marshall [966] via Calderón mostly)] G78 ♡40
- [504] J. B. Garnett, *Bounded analytic functions*, Pure and Appl. Math. 96, Academic Press, New York, 1981. [♠ includes proofs of the corona theorem] ♡3019
- [505] J. Garnett, J. Verdera, *Analytic capacity, bilipschitz mappings and Cantor sets*, Math. Res. Lett. 10 (2003), 515–522. [♠] ♡??

- [506] A. M. Garsia, *Calculation of conformal parameters for some imbedded Riemann surfaces*, Pacific J. Math. 10 (1960), 121–165. [♠] ♥??
- [507] A. M. Garsia, *Imbedding of Riemann surfaces by canal surfaces*, Rend. Circ. Math. Palermo (2) 9 (1960), 313–333. [♠] ♥5
- [508] A. M. Garsia, E. Rodemich, *An imbedding of Riemann surfaces of genus one*, Pacific J. Math. 11 (1961), 193–204. [♠ p.193: “Theorem. Any compact Riemann surface of genus one can be C^∞ embedded in 3-space.” ♠ inspiration=Teichmüller 1944 [1486] and Ahlfors 1953/54 [23] ♠ extension of the result in the next entry Garsia 1961 [509]] ♥9
- [509] A. M. Garsia, *An imbedding of closed Riemann surfaces in Euclidean space*, Comment. Math. Helv. 35 (1961), 93–110. [♠ yet another brilliant student of Loewner; it is shown that any closed Riemann surface admits a conformal model in Euclid’s 3-space E^3 . [10.12.12] Upon taking taking the Schottky double, the same assertion holds true for bordered Riemann surfaces, and this is perhaps enough when E^3 is replaced by the more generous E^4 to settle the Forstnerič-Wold 2009 [452] desideratum that any compact bordered Riemann surface embeds holomorphically in \mathbb{C}^2 . [11.12.12] Warning: not at all enough for the image is merely a smooth surface, and not a complex analytic curve ♠ p.94: “The main result of the present paper is a proof that there exists in Euclidean space a conformally equivalent C^∞ model for every compact Riemann surface of genus $g \geq 2$.” Compare also Rüedy 1968 [1316] ♠ “The methods that we have followed are essentially an extension of those in [9]. However, here certain devices introduced by J. Nash in [13], together with some results of L. Ahlfors [2] and L. Bers [3] on spaces of Riemann surfaces are quite crucial. . .” ♠ to be fair the main technique permitting the breakthrough on this almost centennial problem conjectured by Klein (realizability of all Riemann surfaces as classical surface in E^3) is primarily Teichmüller theory, especially the 1944 paper [1486]. ♠ [19.12.12] Garsia’s result can be given the following metaphoric interpretation (for single people having the Riemann(\approx woman) surface) as sole sentimental partner during their whole life, e.g. Koebe who never married): in the vicinity of any surface embedded in Euclid’s 3-space E^3 one can realize any conformal structure via small variations confined to the normal bundle of the initial surface. This holds true for arbitrarily small thicknesses ε of the tubular neighborhood. Metaphorically, this amounts to say that if the Riemann surface becomes a woman surface (materialized by the skin of some naked woman) then a minim variation of the skin permits to explore all other (women) surfaces by epidermic bubbling, alas generically akin to a cellulite formation. ♠ This metaphor seems again to say something on the Forstnerič-Wold 2009 [452] desideratum. First we know (from Černe-Forstnerič 2002 [267]) that any topological type of bordered surface contains a representative holomorphically embedded in \mathbb{C}^2 . Applying the high-dimensional version of Garsia (due to Ko 1989 [813], plus subsequent articles) we can realize all Riemann surfaces within a normal tubular neighborhood via an (infimal) normal variation. This is akin to a cellulite bubbling, alas destroying a priori the holomorphic character of the initial model. However it is not to be excluded that better controlled vibrations of the pudding²⁹ permit to explore the full moduli space.] ♥32
- [510] A. M. Garsia, *On the conformal type of algebraic surfaces in euclidean space*, Comment. Math. Helv. 37 (1962–63), 49–60. [♠ “It has been an open question for some time whether or not the classical (i.e. C^2 surfaces) of Euclidean space (3-dimensional) exhaust all possible conformal types. In the non compact case the question is still open. [UPDATE: Rüedy 1971 [1317]] In the compact case it can be shown (see [1]=Garsia-Rodemich 1961 [508] and [2]=Garsia 1961 [509]) that among the C^∞ surfaces of Euclidean space there are surfaces conformally equivalent to any given compact Riemann surface.—In this paper we are to improve the results in [1] and [2]. It will be shown that for any given compact Riemann surface conformally equivalent models can be found among the algebraic surfaces of ordinary space. Here by “algebraic surface” we mean a surface satisfying an equation of the type $F(x, y, z) = 0$, where $F(x, y, z)$ is a real polynomial in its argument.—[...] it is not known whether or not the affine images of the tori of revolution contain all conformal types of surfaces of genus one.—Perhaps it should be noted that the ease with which the results in [2] and specially those of this paper are obtained illustrate once more the power of the Teichmüller results on quasiconformal mappings and

²⁹ “Les anglaises c’est comme le pudding, elles ne bougent pas quand on fait l’amour.” (Joke from Sherbrooke, learned from Gaston Boulé).

- the usefulness of the concept of Teichmüller space for the study of families of compact Riemann surfaces. ♠ of course in view of Garsia's result one would like to bound the degree of the representing algebraic surface..., for more on this cf. Pinkall 1985 [1182]] ♡12?
- [511] F. A. Garside, *The braid group and other groups*, Quart. J. Math. Oxford Ser. (2) 20 (1969), 235–254. [♠ work often cited by Orevkov and his disciples (e.g. Bruggallé) and apparently playing some role in Orevkov's recent advances on Hilbert's 16th.] ♡??
- [512] C. F. Gauss, *Disquisitiones arithmeticae* 1801. [♠ where congruence appears first at least symbolically, and connect this with say the Gudkov-Rohlin congruence mod 8 on Hilbert's 16th] ♡??
- [513] C. F. Gauss, 1811 (unpublished) correspondence with F. W. Bessel. [♠ complex integration and the formula $\frac{1}{2\pi i} \int_l \frac{dz}{z} = 1$, where l is a circle enclosing the origin] ♡??
- [514] C. F. Gauss, Allgemeine Auflösung der Aufgabe: die Theile einer gegebenen Fläche auf einer andern gegebenen Fläche so abzubilden, dass die Abbildung dem Abgebildeten in den kleinsten Theilen ähnlich wird. Als Beantwortung der von der königlichen Societät der Wissenschaften in Copenhagen für 1822 aufgegebenen Preisfrage, in: *Schumacher's Astronomische Abhandlungen*, Drittes Heft, pp. 1–30, Altona 1825. (Also in: Werke, Bd. 4, 189–216.) [♠ This is probably the only record in print which may be regarded as a weak (very local) forerunner of the RMT. This text was of course known to Riemann, while adumbrating the conformal plasticity of 2D-mappings ♠ in fact this Gauss text 1822/25 is the pre-big-bang, for it is the only reference cited in Riemann's Thesis 1851 [1253], who however had several other inspirators like Dirichlet, Cauchy, etc. ♠ some antecedents of this Gauss work is that by Lagrange 1779 [902] involved with a cartography problem, yet failing to prove, as Gauss do (in op. cit.), that locally any surface is conformally flat] ♡??
- [515] C. F. Gauss, *Disquisitiones generales circa superficies curvas*, 1827. [♠ concept of Gaussian (total) curvature, theorema egregium (the curvature K is isometry-invariant, e.g. under bending), etc.] ♡??
- [516] C. F. Gauss, *Allgemeine Lehrsätze in Beziehung auf die im verkehrten Verhältnisse des Quadrates der Entfernung wirkenden Anziehungs- und Abstossungs-Kräfte*, Magnetischer Verein (1839). Werke vol. 5, 195–242. [♠ a forerunner of the Dirichlet principle. This text was known to Riemann ♠ this Gauss work is supposed to lack in rigor, yet encompass the substance of the all potential theory (compare BreLOT 1952 [187] for a modern appreciation)] ♡46
- [517] P. M. Gauthier, M. Goldstein, *From local to global properties of subharmonic functions on Green spaces*, J. London Math. Soc. (2) 16 (1977), 458–466. [♠ p. 465, includes the following application of the Ahlfors function. Let $\bar{\Omega}$ be a compact bordered Riemann surface with interior Ω and contour $C = \partial\bar{\Omega}$. Given $f: C \rightarrow \bar{\mathbb{R}} = [-\infty, +\infty]$ an extended real-valued continuous function, one says that f is Dirichlet soluble if it continuously extends to $\bar{\Omega}$ so that its restriction to the interior Ω is harmonic. In this case, $f^{-1}(+\infty)$ is a closed set of HMZ (=harmonic measure zero). Now the authors shows the converse statement. Indeed, given $E \subset C$ closed and of HMZ, its image under an Ahlfors function (cf. Ahlfors 1950 [19]) $F: \bar{\Omega} \rightarrow \bar{\Delta}$ is a subset of the circumference $S^1 = \partial\bar{\Delta}$ of measure zero (Sard required?). According to Fatou 1906 [408] any null-set of the circle occurs as $u_1^{-1}(\infty)$ for a continuous function $u_1: \bar{\Delta} \rightarrow \bar{\mathbb{R}}$ harmonic in the interior. The composed map $u_1 \circ F$ has the desired properties ♠ note however that the trick of the Ahlfors function seems not well suited for reducing the Dirichlet problem (even with non-extended boundary values) on a compact bordered Riemann surface to the case of the disc where it is soluble via the Poisson integral (albeit this may have been a partial intention in Bieberbach 1925 [143])] ♡1
- [518] I. M. Gelfand, M. Kapranov, A. Zelevinsky, *Discriminants, Resultants*, Birkhäuser, 199X. [♠ cites Viro's theorem (and also one of the birth place of amoebas?)] ♡??
- [519] W.-D. Geyer, *Ein algebraischer Beweis des Satzes von Weichold über reelle algebraische Funktionenkörper*, In: *Algebraische Zahlentheorie* (Ber. Tagung Math. Forschungsinst. Oberwolfach, 1964), 83–98. [♠ includes a new proof of the theorem of Witt 1934 [1602]] ♡??
- [520] W.-D. Geyer, G. Martens, *Überlagerungen berandeter Kleinscher Flächen*, Math. Ann. 228 (1977), 101–111. A50 [♣ after Alling-Greenleaf 1969 [44], Ahlfors 1950

- [19] is also interpreted in terms of Klein's orthosymmetric real curves, specifically p.106: "Gewissermaßen als Umkehrung von a) ist das resultat von Ahlfors ([1], §4) anzusehen, wonach jede Kleinsche Fläche vom Typ $+(g, r)$ mit $r > 0$ eine $(g + 1)$ -blättrige verzweigte Überlagerung der zur reellen projectiven Geraden \mathbb{P}_1 gehörenden Kleinschen Fläche $\overline{\mathbb{C}}/\sigma$ (=Riemannsche Zahlenhalbkugel) ist." ♠ p.101: "Seit Klein [6, 12] zieht man zum Studium reeller algebraischer Funktionenkörper F einer Variablen mit Erfolg die zur Komplexifizierung von F gehörige Riemannsche Fläche, versehen mit einer antiholomorphen Involution a , heran, oder auch die Kleinsche Fläche [...].—Unter den algebraischen Körpererweiterungen $E|F$ gibt es gewisse, durch ihr Realitätsverhalten ausgezeichnete Typen, die zuerst von Knight in [7](=1969 [812]) betrachtet wurden. Wir nennen $E|F$ total reell, wenn über reellen Stellen von F nur reelle Stellen von E liegen. Da die reellen Stellen von F auf \mathfrak{R} eine disjunkte Vereinigung endlich vieler Kreise Z_1, \dots, Z_r bilden, induziert eine total reelle Erweiterung $E|F$ (unverzweigte) Überlagerungen der Z_i ." ♣ p.102: "Die Kleinsche Fläche $\mathfrak{K} = \mathfrak{R}/\sigma$ ist ebenfalls kompakt und zusammenhängend; sie ist genau dann orientierbar wenn $\mathfrak{R} - \mathcal{C}(\mathbb{R})$ unzusammenhängend ist [3,6](=Alling-Greenleaf 1971 [45], Klein 1882 [797]). Eine algebraische Kennzeichnung der Orientierbarkeit gab Ahlfors in [1](=1950 [19]): \mathfrak{K} ist genau dann orientierbar, wenn es eine Funktion $f \in F$ gibt, die nur auf $\mathcal{C}(\mathbb{R})$ reelle Werte annimmt." ♠ p.103: "Ein Morphismus $\varphi: \mathcal{B} \rightarrow \mathcal{C}$ reeller Kurven heißt *total reell*, wenn $\varphi^{-1}\mathcal{C}(\mathbb{R}) = \mathcal{B}(\mathbb{R})$ ist. Dann ist also eine Erweiterung $E|F$ reeller Funktionenkörper total reell, wenn jede reelle Stelle von F nur reelle Fortsetzungen hat, und ein Morphismus Kleinscher Flächen is total reell, wenn der Rand respektiert wird, d. h. nur Randpunkte auf Randpunkte abgebildet werden." ♥3/4
- [521] W.-D. Geyer, *Reelle algebraische Funktionen mit vorgegeben Null- und Polstellen*, Manuscripta Math. 22 (1977), 87–103. [♠ p.91: "Ein Morphismus $\varphi: Y \rightarrow X$ reeller Kurven heiÙe total reell, wenn $\varphi^{-1}X(K) = Y(K)$ ist, d.h. wenn alle reellen Stellen von $F = K(X)$ nur reelle Fortsetzungen in $E = K(Y)$ haben." ♥??
★ Patrick M. Gilmer, a student of P. Emery Thomas, well-known for his knot-theoretical approach to real curves.
- [522] P. Gilmer, *Algebraic curves in $RP^1 \times RP^1$* , Proc. Amer. Math. Soc. 113 (1991), 47–52. [♠ switching the Hilbert problem to $\mathbb{P}^1 \times \mathbb{P}^1$] ♥4
- [523] P. Gilmer, *Real algebraic curves and link cobordism*, Pacific J. Math. 153 (1992), 31–69. [♠ promise (in the next entry Gilmer 1996 [524]) a new derivation of the Gudkov-Rohlin congruence for M -curves, as well as the related congruence for $(M - 1)$ -curves] ♥6
- [524] P. Gilmer, *Real algebraic curves and link cobordism, II*, in: Topology of Real Algebraic Varieties and Related Topics, ed. by V. Kharlamov et al., Amer. Math. Soc. Transl. Ser. 2 173, Amer. Math. Soc., Providence, Ri, 1996, 73–84. [♠ new derivation of the Gudkov-Rohlin congruence for M -curves, as well as the related congruence for $(M - 1)$ -curves] ♥??
- [525] P. Gilmer, *Floppy curves with applications to real algebraic curves*, arXiv 1997. [♠ new derivation of one among five of Shustin's prohibition for M -octics, compare our Fig. 154 for the little impact of this contribution in the ocean of Russian contributions.] ♥??
- [526] P. Gilmer, *Arf invariant of real algebraic curves*, arXiv 2005, v.2. [♠ p. 14, a new derivation of an obstruction of Fiedler for octics is derived] ♥??
- [527] A. Girouard, I. Polterovich, *Steklov eigenvalues*, arXiv (2012). A50 [♣ extension of Fraser-Schoen 2011 [456] to higher eigenvalues] ♥0?
- [528] A. M. Gleason, *Function algebras*, Seminar on analytic functions, Institute for Advanced Study, Princeton, N. J., 1957. [♠ where the Gleason parts are defined as the equivalence classes of the following relation ♠ for an arbitrary function algebra A on a compact metrizable space X , let M be its maximal ideal space and S its Shilov boundary. Realizing A as a function algebra on M , two points $m_1, m_2 \in M$ are (Gleason) equivalent if $\sup\{|f(m_1)| : f(m_2) = 0, \|f\| \leq 1\} < 1$. ♠ for a connection with the Ahlfors map cf. e.g. O'Neill-Wermer 1968 [1117]] ♥??
- [529] J. Globevnik, B. Stensønes, *Holomorphic embeddings of planar domains in \mathbb{C}^2* , Math. Ann. 303 (1995), 579–597. [♠ it is show that any plane domain of finite connectivity without point-like (punktförmig) boundaries has a proper holomorphic embedding in the affine complex plane ♠ for a wide extension to infinite connectivity, cf. Forstnerič-Wold 2012 [453]] ♥??

- [530] L. Goldberg, *Catalan numbers and branched coverings by the Riemann sphere*, Adv. Math. 85 (1991), 129–144. [♠ cite in Sottile 2002 [1447]] ♡??
 ★ Golusin, student of Smirnov, well-known genius of function theory in Russia, who alas passed away much too early. His works bears close connection with those of Grunsky, and Grötzsch, and is the professor of the Leningrad Scholars (Lebdev-Millin) who supervised de Brange’s proof of the Bieberbach conjecture.
- [531] G. M. Golusin, *Auflösung einiger ebener Grundaufgaben der mathematischen Physik im Fall der Laplaceschen Gleichung und mehrfach zusammenhängender Gebiete, die durch Kreise begrenzt sind*, (Russian, German Summary) Mat. Sb. 41 (1934), 246–276. G78 [♣ Seidel’s summary: a harmonic function U of two real variables is sought exterior to the circles C_1, \dots, C_n , with $U(\infty)$ finite, which on C_k assumes preassigned continuous values f_k . The problem is reduced to the solution of a finite system of functional equations which are solved by successive approximations. The method is applied to solve Neumann’s problem and other similar problems for Laplace’s equation and for regions of the above type. The Green’s functions of such regions and the functions which map them on slit planes are determined]★ ♡??
- [532] G. M. Golusin, *Sur la représentation conforme*, (French, Russian Summary) Mat. Sb.=Rec. Math. 1 (43) (1936), 273–282. G78 [♣ p. 273, Lemme 1 gives another proof of a basic lemma about areas of rings under conformal maps ♠ Pólya-Szegő 1925 are cited, but it should go back to Carleman 1918 [243] ♠ for the relevance of this lemma to the least area problem of multi-connected under schlicht maps see Gaier 1977 [474] where a dissection process shows that a solution (non-unique!) to this problem effects a representation upon a circular slit disc ♠ incidentally the proof of Thm 1, p. 274 looks very akin to Gaier’s argument of 1977 [474]] ♡4?
- [533] G. M. Golusin, *Iterationsprozesse für konforme Abbildungen mehrfach zusammenhängender Bereiche*, (Russian, German Summary) Mat. Sb. N. S. 6 (48) (1939), 377–382. G78 [♣ Iterative methods are established by means of which a schlicht conformal map of regions of finite connectivity on some canonical domains is reduced to a sequence of conformal maps of simply-connected regions]★ ♡4?
- [534] G. M. Golusin, *Geometrische Funktionentheorie*, Übersetzung aus dem Russischen. Hochschulbücher f. Math. Bd. 31, Berlin, VEB Deutscher Verlag d. Wiss., 1957. English transl.: Geometric theory of functions of a complex variable, 1969. (Russian original published in 1952.) AS60, G78 [♠ p. 240–4, proof of a circle map in the schlicht(artig) case following Grunsky 1937–41 (potential-theoretic) ♠ p. 412–8, the extremal approach is presented (Ahlfors 1947 [18] is cited, and ref. to Grunsky 1940–42 [563, 564] where added by the German editors (probably Grunsky himself) ♠ p. 200–217 present a proof of Koebe’s KNP via the continuity method (approached via Brouwer’s invariance of the domain)] ♡194(German)/1274(English)
- [535] T. V. Goryacheva, G. M. Polotovskii, *Construction of $(M - 1)$ -curves of order 8*, Preprint, Gorki State Univ., Gorki, 1985=Manuscript No. 4441–85, deposited at VINITI, 1985 (Russian) R. Zh. Mat. 1985, 10A464. [♠ construction of 171 types of $(M - 1)$ -schemes of degree 8 probably by the Viro method; cited for this in Shustin 1990/91 [1419]] ♡??
- [536] T. Gouma, *Ahlfors functions on non-planar Riemann surfaces whose double are hyperelliptic*, J. Math. Soc. Japan 50 (1998), 685–695. A50 [♣ detailed study of the degrees of the Ahlfors map in the hyperelliptic case ♣ a complement (tour de force) is to be found in Yamada 2001 [1612] ♠ for an application to proper holomorphic embeddings in \mathbb{C}^2 , cf. Černe-Forstnerič 2002 [267] ♠ Köditz’s summary (MathReviews): “Let R be a finite bounded [=bordered] Riemann surface with genus p and q contours and let P be a point in R . The author studies the set of Ahlfors functions on R . These functions are the extremal functions obtained by maximizing the derivative $|f'(P)|$ (in some local parameter at P) in the class of holomorphic functions on R bounded by one. Each Ahlfors function has modulus 1 on the boundary of R and gives a complete³⁰ covering of the unit disk. It is known that the degree N of any Ahlfors function satisfies $q \leq N \leq 2p + q$ (Ahlfors, 1950=[19]). The set of degrees $N(R)$ of Ahlfors functions on a given Riemann surface R is not well known. In this paper, the author deals with Ahlfors functions

³⁰Jargon of Ahlfors-Sario 1960 [26, p. 42], implying that the map covers each point the same number of times (counting properly by multiplicity); but of course inspired by Stilow’s book 1938 [1455].

- on non-planar Riemann surfaces whose doubles are hyperelliptic. Among others, examples for such Riemann surfaces with $N(R) = \{2, 2p+q\}$ are constructed.”] ♡5
- [537] W. H. Gottschalk, *Conformal mapping of abstract Riemann surfaces*, Published by the author, Univ. of Pennsylvania, Philadelphia, 1949, 77p. ★ AS60 ♡??
- [538] L. B. Graïfer, S. Ja. Gusman, V. V. Dumkin, *An extremal problem for forms with singularities on Riemannian manifolds*, Perm. Gos. Univ. Učen. Zap. 218 (1969), 47–52. [♠ from MathReview (by Kiremidjian): “In 1950, Ahlfors showed that a number of extremal problems on compact subregions of open Riemann surfaces could be solved by studying the class of Schottky differentials [Ahlfors 1950 [19]; errata, MR 13, p.1138]. In recent years, certain aspects of Ahlfors’ work were investigated in the case of n -dimensional orientable differentiable manifolds [the second author, 1966]. In the present paper, the authors study the class of Schottky-Ahlfors forms with singularities.” ♠ so those cited works constitute a rare but foolhardy attempt to extend Ahlfors’ theory to higher dimensions ♠ perhaps one is prompted by the (naive!) question if one could formulate a theory able to (re)prove the famous 3D-conjecture of Poincaré-Perelman in its bordered incarnation: any compact bordered 3-manifold is topologically equivalent to the 3-ball, provided it is contractible or simply-connected and bounded by the 2-sphere (of course the modest antecedent being the fact that one can prove the Schoenflies theorem via RMT thanks to Osgood/Carathéodory) ♠ the Ahlfors function $W^3 \rightarrow \Delta^3$ has then perhaps to be a harmonic map with maximal distortion at some basepoint, and if the contours are surfaces distinct from the sphere then there is no chance to have a covering along the boundary, but otherwise e.g. for W^3 the interspace of two concentric spheres it is not difficult to visualize a 3D-avatar of the Ahlfors map (just by taking the revolution of a map from an annulus to the disc, cf. our Fig. in v2)] ♡??
- [539] J. Gray, *On the history of the Riemann mapping theorem*, Rend. Circ. Mat. Palermo (2) 34 (1994), 47–94. [♠ from Riemann to Koebe’s area, through Osgood, etc.] ♡13
- [540] J. Gray, M. Micallef, *The work of Jesse Douglas on minimal surfaces*, Bull. Amer. Math. Soc. (N.S.) 45 (2008), 293–302. [♠ contains several critiques (mostly raised by Tromba 1983 [1502]) about the rigor of the work of Douglas/Courant on the Plateau problem, especially when it comes to higher topological structure] ♡??
- [541] H. Grassmann, *Die lineare Ausdehnungslehre*, 1844. [♠ summarized in Brieskorn-Knörrer 1981/86 [189, p. 122]: “A very important contribution to the development of the manifold concept was made by H. Grassmann in [t]his work, in which he spoke of n -tuply extended manifolds for the first time and developed, among other things, modern n -dimensional analytic geometry and linear algebra, in which the mathematical theory structure is worked out in a coordinated-free way, allowing the simplest treatment of problems in n -dimensional geometry, and in other fields as well.”] ♡??
- ★★★ George Green (18XX–18XX), even if somewhat marginal during his lifetime, is famous for having introduced the so-called Green’s function and so count among one of the earliest pioneers in the edification of modern potential theory (beside Poisson, Gauss, Thomson=Kelvin, Dirichlet, Kirchhoff, Riemann, etc.)
- [542] G. Green, *An essay on the application of mathematical analysis to the theories of electricity and magnetism*. Printed for the Author by Whellhouse T. Nottingham, 1828, 72 pp. Also in: *Mathematical Papers of George Green*, Chelsea Publishing Co., 1970, 1–115; and reprinted in three parts in *J. Reine Angew. Math.* 39 (1850), 73–89; 44 (1852), 356–374; 47 (1854), 161–221. [♠ this Crelle reprint was organized by W. Thomson ♠ contains a form of the Dirichlet principle, presumably the first ever put in print ♠ as to the connection with our problem of the Ahlfors map, the connection is evident and implicit in Ahlfors 1950 paper [19], albeit the latter employs a variant of the Green’s function with “dipole” singularity placed at a boundary point] ♡121
- [543] G.-M. Greuel, U. Karras, *Families of varieties with prescribed singularities*. *Compositio Math.* 69 (1989), 83–110. [♠ often cited by the team Orevkov-Shustin] ♡??
- [544] P. Griffiths, J. Harris, *Principles of Algebraic Geometry*. Wiley, New York, 1978, 813 pp.; Wiley Classic Library edition, 1994; Russian transl., Vol. 1, Mir, Moscow, 1982. [♠ contains both an heuristic and formal proof of the $\lfloor \frac{g+3}{2} \rfloor$ gonality of closed Riemann surfaces of genus g , a result predicted since Riemann 1857 [1256] but only firmly validated in the modern era through the work of Meis 1960 [993] ♠ see

especially p.358, (special linear systems) and the proof presented is presumably quite close (??) to that of Kempf 1971 [757] ♡5802

- [545] P. Griffiths, J. Harris, *On the variety of special linear systems on a general algebraic curve*, Duke Math. J. 47 (1980), 233–272. [♠ p.236/7 gives a parameter count argument (via Riemann-Hurwitz and Riemann’s $3g - 3$ moduli) to show that “a general curve C of genus $g \geq 2$ cannot be expressed as a multiple cover of any curve C' of genus $g' \geq 1$.” ♠ this can be employed to show that the avatar of the Ahlfors map with range not a disc but a membrane of higher topological complexity fails generally to share the property of the usual circle-valued Ahlfors map of taking the boundary to the boundary] ♡??
- [546] M. Gromov, V. A. Rohlin, *Embeddings and immersions in Riemannian geometry*, Russian Math. Surv. 25 (1969), 1–57. [♠ p.14: “In Appendix 4 we show that the real projective plane with a metric of positive curvature, in particular, the elliptic plane, cannot be isometrically C^2 -embedded in \mathbb{R}^4 .”] ♡105
- [547] M. Gromov, *Filling Riemannian manifolds*, J. Differential Geom. 18 (1983), 1–147. [♠ present a modernized proof of the Loewner-Pu isosystolic inequality, by quoting Jenkins, hence indirectly Grötzsch, so back to Koebe–Poincaré, genealogically. Of course the uniformization required for Loewner (torus) and Pu (projective plane) are of a simpler nature, (Abel and Riemann, Schwarz resp.)] ♡513
- [548] M. Gromov, *Pseudoholomorphic curves in symplectic manifolds*, Invent. Math. 82 (1985), 307–347. [♠ when Gromov was ca. 37 at the top of his creativity (according to his own judgement), quite relevant to Hilbert’s 16th in the fingers of writers like Orevkov, Welschinger, Brugallé, etc.] ♡900
- [549] M. Gromov, *Spaces and questions*, Preprint (1999).
- [550] T. H. Gronwall, *Some remarks on conformal representation*, Ann. of Math. (2) (1914/15), 72–76. [♠ probably one of the first usage of the area-principle, cf. also Bieberbach 1914 [142], Bieberbach 1916 [145] and Faber 1916 [403]] ♡??
- [551] B. Gross, *Real algebraic curves and their Jacobians*, preprint, 1979. [♠ this is cited in Jaffee 1980[715], yet probably never appeared as a such but might have been phagocytosed in the next entry Gross-Harris 1981 [552]] ♡??
- [552] B. H. Gross, J. Harris, *Real algebraic curves*, Ann. Sci. École Norm. Sup. (4) 14 (1981), 157–182. [♠ modern account of Klein’s theory of real curves with many innovative ideas and viewpoints ♠ the question posed on p.177 about the number of ovals for dividing plane smooth curves easily follows from the ideas of Rohlin³¹ 1974/75 [1289], 1978 [1290], compare Gabard 2000 [461] for a detailed discussion] ♡147
- [553] A. Grothendieck, *Techniques de construction en géométrie analytique*, Sémin. H. Cartan 1960/61, Exp.7, 9–17, Paris, 1962. [♠ Teichmüller theory à la Grothendieck] ♡??
- [554] A. Grothendieck, *Techniques de construction et théorèmes d’existence en géométrie algébrique IV. Les schémas de Hilbert*. Sémin. Bourbaki 221, 1960/61. [♠] ♡??
- [555] A. Grothendieck, *Techniques de construction et théorèmes d’existence en géométrie algébrique V. Les schémas de Picard*. Sémin. Bourbaki 232, 1960/61. [♠] ♡??
- [556] A. Grothendieck, *Esquisse d’un programme*, 1984; reproduced in: L. Schneps and P. Lochak (eds), Geometric Galois Actions I. Around Grothendieck’s Esquisse d’un programme, London Math. Soc. Lecture Note Ser. 242, Cambridge Univ. Press, 1997, 5–48. [♠ Teichmüller, Thurston, legos, etc. plus the Belyi-Grothendieck theorem that a closed Riemann surface is defined over $\overline{\mathbb{Q}}$ iff it has only 3 ramifications over the sphere] ♡??
- ★★★ Herbert Grötzsch, student of Paul Koebe incarnating the quasi-conformal Wendepunkt in the theory of conformal maps as well as the apotheose of extremal problems, paving the way toward the trivialization of Teichmüller theory. This is probably one of the greatest genius in Germany of the 20th century, especially as he seems to have taken Klein’s Motto zurück zur Natur quite seriously,

³¹Some specialists from Grenoble (especially Emmanuel Ferrand) told me (ca. 1999/00) that the idea of filling the membrane by the insides of the ovals truly goes back to Arnold, which is probably essentially correct, yet Rohlin’s full credit for effecting the lovely perturbation and counting things properly is surely not at all affected.

as according to his student Nachruf (bei Herr Kühnau) Herbert liked spending much of his contemplative power upon looking at the progression of “Armeisen” (=ants=fourmis) colony. Without Grötzsch there is probably no Teichmüller theory, no quasi-conformal maps, no sound resolution of the moduli problem (except perhaps via the later route à la Kodaira-“Thurston”, etc). Alas, the writer confess to have accessed only a marginal portion of Grötzsch papers. Maybe, browsing through SUB Uni Göttingen should palliate this defect of our text.

- [557] H. Grötzsch, *Über einige Extremalprobleme der konformen Abbildung*, Ber. Verh. Sächs. Akad. Wiss. Leipzig 80 (1928), 497–502. AS60, G78 [♠ credited by Nehari 1953 [1082] for the solution of maximizing the derivative (distortion) at a given point of a multi-connected domain among schlicht functions bounded-by-one (extremals mapping upon a circular slit disc)] ♡??
- [558] H. Grötzsch, *Über konforme Abbildung unendlich vielfach zusammenhängender schlichter Bereiche mit endlich vielen Häufungsrandkomponenten*, Ber. Verh. Sächs. Akad. Wiss. Leipzig (1929), 51–86. AS60, G78 [♠ first proof of the circular slit disc mapping in infinite connectivity, see also Reich-Warschawski 1960 [1244] for more subsequent references] ♡??
- [559] H. Grötzsch, *Das Kreisbogenschlitztheorem der konformen Abbildung schlichter Bereiche*, Ber. Verh. Sächs. Akad. Wiss. Leipzig (1931), 238–253. AS60, G78 [♠ another proof of the circular slit disc mapping in infinite connectivity, compare Grötzsch 1929 [558]] ♡17
- [560] H. Grunsky, *Neue Abschätzungen zur konformen Abbildung ein- und mehrfach zusammenhängender Bereiche*, (Diss.) Schriften Math. Semin., Inst. angew. Math. Univ. Berlin 1 (1932), 95–140. [♠ [26.07.12] p.140, Grunsky announces (without proofs) the result that a suitable combination $c(\mathfrak{x}(\zeta; z) - \eta(\zeta; z))$ of the horizontal \mathfrak{x} (resp. vertical η) [those being the fraktur letters for x resp. y] slit-maps affords the solution to the problem of least area among all analytic functions normed by $f'(z) = 1$ ♠ on reading the rest of the paper it seems that the image might fail to be a disc, compare esp. p.135 where a similar least area problem is handled ♠ this topic is addressed again in Garabedian-Schiffer 1949 [494] and Nehari 1952 [1081]] AS60, G78 ♡??
- [561] H. Grunsky, *Über die konforme Abbildung mehrfach zusammenhängender Bereiche auf mehrblättrige Kreise*, Sitzungsber. Preuß. Akad. (1937), 40–46. AS60, G78 [♣ new potential-theoretic proof of the circle map for domains] ♡??
- [562] H. Grunsky, *Über die konforme Abbildung mehrfach zusammenhängender Bereiche auf mehrblättrige Kreise, II*, Abh. Preuß. Akad. Wiss. Math.-nat. Kl. 11 (1941), 1–8. AS60, G78 [♣ idem as the previous item] ♡??
- [563] H. Grunsky, *Eindeutige beschränkte Funktionen in mehrfach zusammenhängenden Gebieten I*, Jahresb. d. Deutsch. Math.-ver. 50 (1940), 230–255. G78 [♣ extremal-problem description of circle maps for domains] ♡??
- [564] H. Grunsky, *Eindeutige beschränkte Funktionen in mehrfach zusammenhängenden Gebieten II*, Jahresb. d. Deutsch. Math.-ver. 52 (1942), 118–132. G78 [♣ sequel of the previous item] ♡??
- [565] H. Grunsky, *Zur Funktionentheorie in mehrfach zusammenhängenden Gebieten*, Ber. Mathematikertagung Tübingen (1946), 68–69; in Coll. Papers, 245–6. G78 ♡??
- [566] H. Grunsky, *Nachtrag zu meinen Arbeiten über “Eindeutige beschränkte Funktionen in mehrfach zusammenhängenden Gebieten”*, Math. Z. 52 (1950), 852. G78 ♡17
- [567] H. Grunsky, *Über die Fortsetzung eines auf einer berandeten Riemannschen Fläche erklärten meromorphen Differentials*, Math. Nachr. 39 (1969), 87–96. [♣ one of the rare work by Grunsky concerned with bordered surfaces, yet it does not seem to reprove the existence of a circle map à la Ahlfors] ♡??
- [568] H. Grunsky, *Lectures on Theory of Functions in Multiply Connected Domains*, Studia Mathematica, Skript 4, Vandenhoeck and Ruprecht in Göttingen, 1978. [♣ all inclusive account but focusing to the case of domains (no Riemann surfaces)] ♡34/36

★ Dmitrii Andreevich Gudkov (1918–1992), student of Andronov and Petrovskii. Famous for his sextic solution to Hilbert’s 16th problem (1 st part thereof on the mutual arrangements of ovals), and in particular for its refutation of Hilbert’s conjecture that there is only two possible configurations in degree 6 (his own and the

earlier one due to Harnack 1876). Influential via his Gudkov hypothesis $\chi \equiv_8 k^2$ for M -curves of even degree $m = 2k$ over Arnold 1971 [59], hence also over Rohlin 1972, etc. This periodicity modulo 8 incarnates a whole new era, and Viro often wondered why it was not already conjectured by V. Ragsdale (ca. 1906 [1238]). Gudkov's students include Utkin, Polotovskii, Nebukina, Shustin, Korchagin. Gudkov also contributed to the construction of 2 new M -schemes of degree 8 (in 1971 [576] reported on our Fig. 153), that are nowadays easily covered by Viro's method (in its most basic incarnation of the dissipation of the 2 singularities of 4 coaxial ellipses). Gudkov is also famous for his deep investigation à la Newton-Zeuthen of quartic affine curves where the classification becomes much more tricky than in the projective realm.

- [569] D. A. Gudkov, *Establishing all existing types of non-singular plane algebraic curves of the sixth order with real coefficients*, Ph. D. Dissertation, Gorki, 1952. [♠ the title sounds slightly overambitious, compare comment in the next entry Gudkov 1954 [570]] ♡??
- [570] D. A. Gudkov, *The complete topological classification of non-singular real algebraic curves of the sixth order in the projective plane*, Dokl. Akad. Nauk SSSR 98 (1954), 521–524. [♠ albeit this paper contains some mistakes (too prohibitive), it must contain the first serious prohibitions via the Hilbert-Rohn method consolidated by Andronov-Pontrjagin theory of roughness (structural stability) ♠ thus the method is still of interest, and its charming power is perhaps only eclipsed by more topological variants of the Arnold-Rohlin era, e.g. Arnold 1971 [59] or Rohlin 1972/72 [1286] ♠ at any rate the work was received with scepticism, cf. (very optionally) the doubts expressed in Galafassi 1960 [479].] ♡??
- [571] D. A. Gudkov, *On certain questions in the topology of plane algebraic curves*, Mat. Sbornik (N.S.) 58 (1962), 95–127 (Russian). [♠ some overlap with Brusotti 1921 [204], yet an extension thereof to curves having “turning points” (=cusps) ♠ often cited as late as Orevkov-Shustin 2002 [1131]] ♡??
- [572] D. A. Gudkov, G. A. Utkin, M. L. Tai, *A complete classification of indecomposable curves of the fourth order*, Mat. Sbornik (N.S.) 69 (1966), 222–256 (Russian). [♠ the complete isotopic census (involving 99 species each beautiful to contemplate) announced in the title extending thereby to degree four Newton's census of five many species of (irreducible) cubics] ♡??
- [573] D. A. Gudkov, *On the topology of plane algebraic curves*, Doctor's Thesis, Gor'kii, 1969, 1–351. [♠ first disproof of Hilbert's conjecture about the nonexistence of the scheme $\frac{5}{7}5$. According to Polotovskii 1996 [1211]'s overview: “It is interesting to remark that the first proof of this fact in [18](=this entry) was extraordinarily complicated. It takes up 28 pages of text, is a “pure existence proof”, and was obtained by means of a combination of the Hilbert-Rohn method with quadratic transformations. Shortly after D. A. Gudkov suggested significantly simpler constructions of curves having this scheme, see [19](=1971 [576]), [21], [23].”] ♡??
- [574] D. A. Gudkov, *Complete topological classification of the disposition of ovals of a sixth order curve in the projective plane*, Gor'kov. Gos. Univ. Učen. Zap. Vyp. 87 (1969), 118–153. [♠ where Hilbert got corrected: first complete solution to Hilbert's 16th in degree 6 but the method of construction is extremely highbrow at this stage and went simplified in subsequent publication(s) by Gudkov ca. 1972] ♡??
- [575] D. A. Gudkov, G. A. Utkin, *The topology of sixth-order curves and fourth-order surfaces*, Gor'kov. Gos. Univ. Učen. Zap. Vyp. 87 (1969), 154–211; English transl., in: Nine papers on Hilbert's 16th problem, Amer. Math. Soc. Transl. (2) 112 (1978). [♠ where Hilbert got corrected by Gudkov: disproof of one of Hilbert's conjectures on the arrangement of ovals of plane M -sextic (that is Harnack-maximal). Gudkov corrected Hilbert's conjecture by including the newly discovered so-called Gudkov curve $\frac{2}{1}5$ and showed that only the trinity Harnack 1876 [607], Hilbert 1891 [661] and Gudkov's 1969 can exist, yielding a complete classification up to isotopy of M -sextics (when combined with the prohibition à la Hilbert-Rohn which Gudkov was the first to implement correctly in 1954 [570] upon combining the classical method with “roughness” à la Andronov-Pontrjagin) ♠ more generally this work contains a complete classification of all 56 isotopy classes realized by plane sextic (hence a complete solution to Hilbert's 16th problem), but the story does not end here (cf. e.g. Rohlin's 1978 enhancement by complex characteristics à la Klein, hence concomitant with Ahlfors, cf. our discussion in v.2 ♠ another subsequent step is Nikulin 1979/80 [1107] stronger rigid-isotopy classification of C_6

showing the completeness of the Klein-Rohlin invariants (the proof rests upon the whole apparatus of the complex-transcendental geometry of K3 surfaces, Torelli, etc.)] ♡??

- [576] D. A. Gudkov, *Construction of a new series of M -curves*, Dokl. Akad. Nauk SSSR 200 (1971), 1269–1272; English transl., Soviet Math. Dokl. 12 (1971), 1559–1563. [♠ Gudkov construction is reproduced (at least in abridged form) in Gudkov 1974/74 [579], in A'Campo 1979 [10] ♠ a series mean here one ascending through all degrees (like by Harnack, Hilbert, Brusotti, etc.) and so this article of Gudkov also contains a little contribution to Hilbert's 16th in degree $m = 8$, namely the construction of 2 schemes that were not known previously (cf. Fig. 154). Admittedly this is a very modest contribution, as compared to the flood of Viro's 1980 revolution.]★★★ ♡??
- [577] D. A. Gudkov, *Construction of a curve of degree 6 of type $\frac{5}{1}5$* , Izv. Vyssh. Uchebn. Zaved. Mat. 3 (1973), 28–36; English transl., Soviet Math. (Iz. VUZ) (1973). [♠ simplification in the disproof of Hilbert's conjecture on the arrangement of ovals of plane M -sextics (that is, Harnack-maximal). Gudkov corrected Hilbert's conjecture by including the newly discovered Gudkov curve (this contribution appears first in Gudkov's Doctor Thesis (1969 [573]), yet in a much more sophisticated way] ♡??
- [578] D. A. Gudkov, A. D. Krakhnov, *On the periodicity of the Euler characteristic of real algebraic $(M - 1)$ -manifolds*, Funkt. Anal. Prilozhen. 7 (1973), 15–19; English transl., Funct. Anal. Appl. 7 (1973), 98–102 [♠ same result as in Kharlamov 1973 [765], i.e. an obstruction on $(M - 1)$ -schemes via the congruence $\chi \equiv_s k^1 \pm 1$ for plane curves of degree $2k$, which is independent of the Hilbert-Rohn-Gudkov geometric method] ♡30
- [579] D. A. Gudkov, *The topology of real projective algebraic varieties*, Uspekhi Mat. Nauk 29 (1974), 3–79; English transl., Russian Math. Surveys 29 (1974), 1–79. [♠ a masterpiece survey full of historical details and mathematical tricks ♠ contains an extensive bibliography (157 entries) of early real algebraic geometry (in Germany, Italy and Russia), mostly in the spirit of Hilbert (by contrast to Klein's more Riemannian approach) ♠ p. 2 and p. 17 contain in my opinion a historical inaccuracy which imbued alas some of the subsequent literature (e.g. A'Campo 1979 [10, p. 01], Jaffee 1980 [715, p. 82]), namely Hurwitz 1891–92 is jointly credited for the intrinsic proof of Harnack's inequality ($r \leq g + 1$), while this goes back of course to Klein 1876 [795] (and not only Klein's 1892 lectures as cited by Gudkov) ♠ includes an impressive bibliography on real geometry involving such authors as Plücker, Schläfli, Klein, Gordan, Zeuthen, Harnack, Rohn, Hilbert, Hurwitz, Hulburt, Ragsdale, Wright, Kahn, Löbenstein, Brusotti, Beloch, Nagy, Biggiogero, Donald 1927 (not serious), Todd, Wieleitner, Coolidge, Comessatti, Petrowsky 1933, Cecioni 1936, Hilton 1936, Ehresmann 1937, Bieberbach 1939, Farina, Gigli, Galafassi 1940, B. Segre 1942, Gugliada, Conforto 1946, Bigi 1947, (Piazzola-Beloch 1948), Oleinik 1949, Habicht 1950, Roselli 1950, Adam 1951, Caputo 1952, Gallarati 1951, Fano 1953, Gudkov 1954, Nice 1955, Rosina 1956, Whitney 1957, Porcu 1958, Anisimova 1960, Milnor 1964, Thom 1965, Utkin 1966, Tai 1966, Arnold 1971, Rokhlin 1972, Kharlamov 1972, Krakhnov 1973, Polotovskii 1973. Additional references to adjacent topics via the following authors: Walker 1950, Busemann 1955, Bertini 1894, Nöther 1879, Kraus 1880, Chebotarev 1948, Morse 1925, Seifert-Threlfall 1933/50, Kronecker 1865, Hirzebruch-Mayer 1968, Milnor 1958, Serre 1970, Rokhlin 1971, Courant-Hilbert 1931, Borel 1960, Bredon 1968, Fáy 1957, Atiyah-Singer 1968, Hirzebruch 1962, Chern 1959, Weil 1958.] ♡??
- [580] D. A. Gudkov, *On the topology of algebraic curves on a hyperboloid*, Uspekhi Mat. Nauk 34 (1979), 26–32; English transl., Russian Math. Surveys 34 (1979), 27–35. [♠ p. 27: “Algebraic curves on a hyperboloid of one sheet have been studied for a long time. A start was made by Plücker and Chasles in the mid-nineteenth century (see [1], Ch. IV)=(Klein 1926 [808]). In a fundamental article [2](=Hilbert 1891 [661]) Hilbert proved [...]”] ♡12
- [581] D. A. Gudkov, *Generalization of a theorem of Brusotti for curves on a surface of second order*, Funkt. Anal. Prilozhen. 14 (1980), 20–24, 96; English transl., Funct. Anal. Appl. 14 (1980), 15–18. [♠ p. 15: “Brusotti [1](=1921 [204]) proved the following assertion in 1921.—*Brusotti's theorem*. If all the singular points of a curve F in the complex projective plane $\mathbb{C}P^2(x_0 : x_1 : x_2)$ are simple double points, then the simplifications of these singular points are independent.—This means that by adding an arbitrarily small term of degree m (with real coefficients) to the polynomial F , it is possible to get a curve Φ such that each real singular

- point of the curve F either remains or else simplifies in one of the two possible ways (depending on our choice, cf. [5]), and each pair of imaginary conjugate singular points either remains or vanishes (depending on our choice).” ♡**3**
- [582] D. A. Gudkov, E. I. Shustin, *Classification of non-singular curves of degree 8 on an ellipsoid*, in: Method in Qualitative Theory of Differential Equations, Gorky, 1980, 104–107. [♠ cited in Kharlamov’s survey 1986/96 [781].] ♡**3**
- [583] D. A. Gudkov, G. M. Polotovskii, *Stratification of a space of fourth-order curves. Contiguity of strata*, Uspekhi Mat. Nauk 42 (1987), 152. [♠] ♡??
- [584] D. A. Gudkov, *Plane real projective quartic curves*, in: Topology and Geometry–Rohlin Seminar, Lecture Notes in Math. 1346, Springer, Berlin, 1988, 341–347. [♠ cited in Shustin 1990/91 [1418] for a complete description of the discriminant of quartics ♠ presumably some overlap with the previous entry ♠ is this description of Gudkov compatible with our crazy disconnection result in v.2 [which is surely false, via the codimension-two argument discussed subsequently.]] ♡??
- [585] D. A. Gudkov, *Special forms of fourth order curves*, Part 1,2,3,4,5, Deposited in Vinity, (1988–1990), resp. pages number 36, 57, 67, 55, 30, so a total of 245 pages. [♠ cited in Korchagin-Weinberg 2005 [867]] ♡??
- [586] D. A. Gudkov, *N. I. Lobachevskii. Biographical enigmas*, Nizhnii Novgorod, 1992 (monograph in print). [♠ has this ever been published? probably cited from Polotovskii 1996 [1211].] ♡??
- [587] V. Guillemin, S. Sternberg, *Convexity properties of the moment mapping*, Invent. Math. 67 (1982), 491–513. [♠ often cited in the context of Viro’s method, e.g. in Risler 1992 [1264]]. ♡??
- [588] L. Guillou, A. Marin, *Une extension d’un théorème de Rohlin sur la signature*, C.R. Acad. Sci Paris Ser. A 285 (1977), 95–98. [♠ useful in correcting Rohlin’s proof of the Gudkov hypothesis $p - n \equiv k^2 \pmod{8}$ (compare Degtyarev-Kharlamov 2000 [355]) ♠ this paper is an announcement and more details are to be found in the book Guillou-Marin 1986 [589, p.97–118]] ♡??
- [589] L. Guillou, A. Marin, *A la recherche de la topologie perdue, I Du côté de chez Rohlin, II Le côté de Casson*, Progress in Math. 62, Birkhäuser, Boston, Basel, Stuttgart, 1986. [♠ contains French translation of Rohlin’s ground-breaking works in low-dimensional differential topology, plus some of its applications to real algebraic geometry] ♡??
- [590] R. C. Gunning, *Lectures on Riemann surfaces*. Princeton Acad. Press, Princeton, 1966. [♠] ★ ♡??
- [591] R. C. Gunning, R. Narasimhan, *Immersion of open Riemann surfaces*, Math. Ann. 174 (1967), 103–108. [♠ no directly visible connection with Ahlfors 1950, but there must be some link in the long run] ♡??
- [592] R. C. Gunning, *Lectures on Riemann surfaces: Jacobi varieties*, Princeton Univ. Press, Princeton, N.J., 1972, 189 pp. [♠ new (essentially topological?) proof of Meis’ result upon the gonality of complex curves (=closed Riemann surfaces) ♠ [21.06.12] the following extract of H. H. Martens’s review in MathReviews is capital for it brings the hope to gain a Teichmüller theoretic approach to the existence of circle maps with the best possible bounds (hence hinting how to recover Ahlfors and even Gabard 2006 [463] by an analytic (or rather geometric!) approach competing seriously with the naive topological proof of the writer): “A pièce de résistance is served in the appendix in the form of a proof of the existence of functions of order $\leq [\frac{1}{2}(g+3)]$ on any closed Riemann surface. This result was previously obtained by T. Meis 1960 [993] using Teichmüller space techniques, and it is a special case of the more general results of Kleiman-Laksov 1972 [788] and Kempf 1971 [757].” ★★★ ♡**556**
- [593] B. Gustafsson, *Quadrature identities and the Schottky double*, Acta Appl. Math. 1 (1983), 209–240. [♠ [13.10.12] can the theory be extended to non-planar domains?] ♡??
- [594] B. Gustafsson, *Applications of half-order differentials on Riemann surfaces to quadrature identities for arc-length*, J. Anal. Math. 49 (1987), 54–89. [♠] ♡??
- [595] A. Haas, *Linearization and mappings onto pseudocircle domains*, Trans. Amer. Math. Soc. 282 (1984), 415–429. [♠ Koebe’s Kreisnormierungsprinzip for positive genus, uniqueness complement in Maskit 1989 [980]] ♡??

- ★ Bertrand Haas, student of ? (Basel ca. 1999), well-known for advanced studies upon the T -construction of Itenberg and applications to Ragsdale. Also often quoted for a proof of Ragsdale within the context of maximal T -curves, so giving some additional evidence toward the truth of the still open Ragsdale conjecture for M -curves.
- [596] B. Haas, *Nouveaux contre-exemples à la conjecture de Ragsdale*, C. R. Acad. Sci Paris, Sér. I, Math. 320 (1995), 1507–1512. [♠ refinements of Itenberg’s breakthrough 1993 [695]] ♡??
- [597] B. Haas, *The Ragsdale conjecture for maximal T -curves*, Preprint (1997), Universität Basel. [♠ [27.04.13] if I interpret correctly the title this means that Ragsdale’s conjecture for M -curves, namely the estimate $|\chi|k^2$ cannot be disproved via Itenberg’s version of the patchwork (compare also Itenberg 2002 [707] and Itenberg-Shustin 2003 [708] for a corroboration of our interpretation). If so is the case this would be a good piece of experimental evidence toward the truth of Ragsdale. Alas, like any small perturbation method nothing seems to tell us that all curves arise through patchwork, and so we are forced to a theoretical attack. At the time of writing we have 2 vague strategies. The first involves the total reality à la Riemann (cf. Gabard 2013B [471]) and the second an attempt to make the Arnold surface always orientable by a surgery (cf. Gabard 2013B, v.2, yet nothing very serious for the moment)] ♡??
- [598] B. Haas, *Real algebraic curves and combinatorial constructions*, Ph.D. Thesis (1997), Universität Basel (January 1998). [♠] ♡??
- [599] B. Haas, *Ambient surfaces and T -fillings of T -curves*, arXiv 1999. [♠] ♡??
- [600] W. Habicht, *Topologische Eigenschaften reeller algebraischer Mannigfaltigkeiten*, Math. Ann. 122 (1950), 181–204. [♠ cited in Gudkov 1974 [579]] ♡??
- [601] J. Hadamard, *Sur le principe de Dirichlet*, Bull. Soc Math. France (1906). [♠ p.135 an example is given of a continuous function on the boundary of a domain such that none functions satisfying the boundary prescription has finite Dirichlet integral ♠ a similar example was given in Prym 1871 [1226], where a continuous function is given on the circle such that the harmonic function matching this boundary data (whose existence is derived by another procedure, e.g. the Poisson integral) has infinite Dirichlet integral ♠ of course, heuristically any Prym’s boundary data must be of the Hadamard type (precisely by virtue of the just corrupted Dirichlet principle!): if the harmonic solution explodes any vulgar solution (hence less economical) must explode as well] ♡??
- [602] J. Hadamard, *Mémoire sur le problème d’analyse relatif à l’équilibre de plaques élastiques encastrées*, Mémoires présentés par divers savants à l’Académie des Sciences 33 (1908), 128 pp. [♠ Discussion of the famous method, named after Hadamard, of variation of domains ♠ further developed by Schiffer especially] ♡??
- [603] E. Haeckel, *Kunstformen der Natur*, veröffentlicht zwischen 1899–1904 zunächst in einer Folge von zehn Heften. [♠ Discussion of the famous method, named after Hadamard, of variation of domains ♠ further developed by Schiffer especially] ♡??
- [604] G. Halphen, *Mémoire sur la classification des courbes gauche algébriques*, J. École Polytech. 52 (1882), 1–200. [♠ sharing the price with M. Noether] ♡??
- [605] R. S. Hamilton, *The Ricci flow on surfaces*, In: Mathematics and General Relativity (Santa Cruz, CA, 1986). Contemporary Mathematics 71, Amer. Math. Soc., Providence, 1988, 237–262. [♠ uniformization of surfaces via the 2D-Ricci flow (at least in the compact case)] ★★★ ♡??
- [606] M. Hara, M. Nakai, *Corona theorem with bounds for finitely sheeted disks*, Tôhoku Math. J. 37 (1985), 225–240. A50 [♣ applies Ahlfors mapping in a quantitative fashion (making use of its degree in contrast to Alling 1964 [40]) ♣ naive question (ca. Sept. 2011) can we improve the bounds by appealing instead to Gabard 2006 [463]] ♡5
- ★ Axel Harnack, a German of the Baltic who died prematurely, well-known for 2 important contribution. First, as student of Klein in 1876 he established the so-called Harnack inequality for which Klein (1876) had a more conceptual (topological) explanation directly based on the definition of Riemann’s genus (which Riemann does not called so), and also for the Harnack inequalities (1887) in potential theory that were quite pivotal to many to prove uniformization (Poincaré, Koebe, etc.) It is reported somewhere that Klein did not believed first in this phenomenon discovered by Harnack.

- [607] A. Harnack, *Ueber die Vieltheiligkeit der ebenen algebraischen Curven*, Math. Ann. 10 (1876), 189–198. [♠ a proof is given (via Bézout’s theorem) that a smooth plane real curve of order m possesses at most $g + 1 = \frac{(m-1)(m-1)}{2} + 1$ components (reellen Züge) and such Harnack-maximal curves are constructed for each degree via a method of small perturbation ♠ as everybody knows a more intrinsic proof was given by Klein 1876 [795] by simply appealing to Riemann’s definition of the genus as the maximum number of retrosections not morcellating the surface ♠ a more exotic derivation of the Harnack bound (using Riemann-Roch) is to be found in Enriques-Chisini 1915 [396], whose argument actually supplies a proof of the so-called Bieberbach-Grunsky theorem (cf. Bieberbach 1925 [147], Grunsky 1937 [561] and for instance A. Mori 1951 [1040]) which is the planar version of the Ahlfors map] ♡171
- [608] A. Harnack, *Die Grundlagen der Theorie des logarithmischen Potentials, und der eindeutigen Potentialfunktionen in der Ebene*, Teubner, Leipzig, 1887. ♡20
- [609] R. Hardt, D. Sullivan, *Variation of the Green function on Riemann surfaces and Whitney’s holomorphic stratification conjecture*, Publ. Math. I.H.E.S. (1989), 115–138. [♠ [10.08.12] the starting point of the paper (p. 115) is a representation of a Riemann surface as a k -sheeted branched covering of the unit disc (denoted B) with branch point a_1, \dots, a_l in $B_{1/2}$ (ball of radius one-half) ♠ this situation resembles sufficiently to Ahlfors 1950 [19] to ask if a precise connection can be made ♠ of course one may notice that a map of the type required (by Hardt-Sullivan) exists for any interior of a compact bordered Riemann surface: indeed take a Ahlfors map or just a circle map (existence ensured by Ahlfors 1950 [19], or other sources, e.g. Gabard 2006 [463]) and then upon post-composing by a power-map $z \mapsto z^n$ we may contract the modulus of the branch points to make them as small as we please upon choosing k large enough ♠ perhaps the dual game of looking at largest possible winding points should relate to the problem of finding the circle maps of lowest possible degrees ♠; at least one should be able to define a conformal invariant of a bordered surface F by looking at the largest possible modulus of a branch point of a circle map (of course composing with a disc-automorphism, the branch point can be made very close to 1, so one requires a normalization, e.g. mapping a base-point of F to 0) ♠ this defines a $[0, 1]$ -valued numerical invariant of a marked compact bordered Riemann surface (F, b) ; how does it depends on b when the latter is dragged through the (fixed) surface and does this invariant takes the value 0 only for when F is the disc ♠ as another variant without marking, we may always assume that 0 is nor ramified, and we may look for the largest radius free of ramification, this defines another numerical invariant taking values in $]0, 1]$; obviously it takes the value one only when F is topologically a disc (Riemann mapping theorem maybe in the variant firmly established by Schwarz) ♠ maybe in the spirit of Bloch there is an absolute (strictly) positive lower bound on this “schlicht radius” at least for prescribed topological characteristic (i.e. the invariant p and r counting the genus and the contours) ♠ call this constant $B_{p,r}$: how does it depend on p, r asymptotically (maybe convergence to 0 if $p, r \rightarrow \infty$); further is the infimum achieved by some surfaces, if so can we describe the extremal surfaces (naive guess the ramification is then cyclotomic); compare maybe work of Minda ca. 1983 for related questions] ♡??
- [610] G. H. Hardy, *On the mean modulus of an analytic function*, Proc. London Math. Soc. 14 (1915), 269–277. [♠] ♡??
- [611] A. N. Harrington, *Conformal mappings onto domains with arbitrarily specified boundary shapes*, J. d’Anal. Math. 41 (1982), 39–53. [♠ extension of Koebe’s KNP; similar result in Brandt 1980 [184] ♠ method: potential theory and (algorithmic) Brouwer’s fixed point ♠ variant of proof in Schramm 1996 [1370]] ♡??
- [612] J. Harris, *On the Severi problem*, Invent. Math. 84 (1986), 445–461. [♠ based on virtually the same idea as Severi 1921, and Brusotti 1921, cf. e.g. Shustin 1990/91 [1418]] ♡??
- [613] R. Hartshorne, *Algebraic Geometry*, Grad. Texts in Math. 49, Springer-Verlag, 1977. [♠ some elementary aspects of curves and surfaces via the sheaf theoretic approach (Leray, etc.)] ♡??
- [614] M. Hasumi, *Invariant subspaces for finite Riemann surfaces*, Canad. J. Math. 18 (1966), 240–255. [♠ extension of Beurling’s theorem (1949 [137]) for the disc to the case of finite bordered Riemann surface, yet without using the Ahlfors map, but cite Royden 1962 [1305] which is closely allied] ♡27

- [615] O. Haupt, *Ein Satz über die Abelschen Integrale 1. Gattung*, Math. Z. 6 (1920), 219–237. [♠ only cited for the Riemann parallelogram method, which bears (perhaps?) some resemblances with Gabard 2006 [463] ♠ work is influenced by Prym, tries to answer a question of Klein, further influence of Wirtinger, etc. ♠ for modern ramification cf. Gerstenhaber 1953] ♡??
- [616] F. Hausdorff, *Grundzüge der Mengenlehre*, 1914. [♠ after the long poetical carrier of Felix Hausdorff, and some forerunners like Bolzano, Cantor, Hilbert ca. 1900 (as cited in Weyl 1913), Fréchet 1906, F. Riesz ca. 1906, this is the first set-theoretical founding of the idea of generalized spaces via a neighborhood axiomatic (“une forêt d’ouverts” as says Mathieu Baillif Jan. 2013), permitting in particular to newcomers like Weyl, Radó to give a sordid idea of what a Riemann surfaces actually is. Then the route is paved for Veblen-Whitehead, Whitney, etc.] ♡??
- [617] S. Ya. Havinson, *On an extremal problem in the theory of analytic functions*, (Russian) Uspekhi Mat. Nauk. 4 (1949), 158–159. [♠]★ ♡7
- [618] S. Ya. Havinson, *On extremal properties of functions mapping a region on a multi-sheeted circle*, Doklady Akad. Nauk. SSSR (N.S.) 88 (1953), 957–959. (Russian.) AS60 ★ ♡??
- [619] S. Ya. Havinson, *Extremal problems for certain classes of analytic functions in finitely connected regions*, Mat. Sb. (N.S.) 36 (78) (1955), 445–478; Amer. Math. Soc. Transl. 5 (1957), 1–33. G78 [♠ generalized linear extremal problems (finite connectivity), i.e. maximization of the modulus of the derivative replaced by an arbitrary linear functional]★ ♡??
- [620] S. Ya. Havinson, G. C. Tumarkin, *Existence of a single-valued function in a given class with a given modulus of its boundary values in multiply connected domains*, (Russian), Izv. Akad. Nauk SSSR Ser. Mat. 22 (1958), 543–562. [♠ quoted in Khavinson 1984 [782, p. 378], and the same problem of prescribing the boundary modulus had been already treated by Grunsky 1942 [564]]★ ♡??
- [621] S. Ya. Havinson, *Analytic capacity of sets, joint nontriviality of various classes of analytic functions and the Schwarz lemma in arbitrary domains*, Mat. Sb. 54 (96) (1961), 3–50; English transl., Amer. Math. Soc. Transl. (2) 43 (1964), 215–266. A47, A50, G78 [♠ uniqueness of the (Ahlfors) extremal function for domains of infinite connectivity (similar work in Carleson 1967 [248]); but Khavinson’s work goes deeper (according to Hejhal 1972 [641]) into the study of the behavior of the extremal function] ♡14
- [622] S. Ya. Havinson, *Factorization theory for single-valued analytic functions on compact Riemann surfaces with boundary*, Uspekhi Math. Nauk. 44 (1989), 155–189; English transl., Russian Math. Surveys 44 (1989), 113–156. [♠ p. 117 explains the usual trick of annihilating the $2p + (h - 1)$ periods along essential cycles on a finite Riemann surface, for which we may take any $r - 1$ of the boundary contours, as well as meridians and parallels taken along each handle ♠ so this is quite close to our naive attempt to reprove Ahlfors’ theorem, compare v.2] ♡??
- [623] S. Ya. Havinson, *Duality relations in the theory of analytic capacity*, St. Petersburg Math. J. 15 (2004), 1–40. (Russian version published in 2003.) [♠ Ahlfors function appears on pp. 2, 11, 13, 20 ♠ the terminology “analytic capacity” (or “Ahlfors capacity”) is credited to V. D. Erokhin’s: “In accordance with V. D. Erokhin’s proposal (1958), the quantity $\gamma(F)$ has been called the *analytic capacity* or the *Ahlfors capacity* since that time.”] ♡0
- [624] N. S. Hawley, M. Schiffer, *Half-order differentials on Riemann surfaces*, Acta Math. 115 (1966), 199–236. [♠] ♡96
- [625] N. S. Hawley, M. Schiffer, *Riemann surfaces which are double of plane domains*, Pacific J. Math. 20 (1967), 217–222. G78 [♠] ♡low 2
- [626] N. S. Hawley, *Weierstrass points of plane domains*, Pacific J. Math. 22 (1967), 251–256. G78 [♠ addresses the question of the distribution of Weierstrass points upon the Schottky double of a plane domain. Precisely, for a planar membrane with hyperelliptic double, all W-points are located on the boundary. The author gives an example, derived from a real quartic with 4 ovals, whose W-points are not confined to the boundary. Such questions make good sense over positive genus membranes and are perhaps worth investigating further. Probably updates are already known, and one would like to explicit any possible relation between W-points and the degree of the Ahlfors function. Compare for this issue, Yamada 1978 [1609]] ♡1

- [627] M. Hayashi, *The maximal ideal space of the bounded analytic functions on a Riemann surface*, J. Math. Soc. Japan 39 (1987), 337–344. [♠ the following property: “the natural map of a Riemann surface R into its maximal ideal space $\mathfrak{M}(R)$ (this is an embedding if we assume that the algebra $H^\infty(R)$ of bounded analytic functions separates points) is a homeomorphism onto an open subset of $\mathfrak{M}(R)$ ” has some application to the uniqueness of the Ahlfors function (cf. Gamelin 1973 [486]), as well as to its existence ♠ the bulk of this paper consists in giving examples where this property fails answering thereby a question of Gamelin 1973] ♡11
- [628] Z.-X. He, *Solving Beltrami equation by circle packing*, Trans. Amer. Math. Soc. 322 (1990), 657–670. [♠ includes another proof of GKN (generalized Kreisnormierung) where a compact bordered Riemann surface is conformally mapped upon a circular domain in a space-form (=constant curvature) [of the same genus?] ♠ similar statement obtained by Haas 1984 [595] and Maskit 1989 [980] (curiously non-cited here)—maybe also Jost 1985 [731] ♠ perhaps the “syntax” of the main result (Thm 5.1, p.669) must be slightly corrected, probably by assuming the contours of $\partial\bar{\Omega}$ to bounds discs in the surface M (equivalently to be null-homotopic)] ♡24
- [629] Z.-X. He, O. Schramm, *Fixed points, Koebe uniformization and circle packings*, Ann. of Math. (2) 137 (1993), 369–406. [♠ the deepest advance upon the KNP=Kreisnormierungsprinzip (raised by Koebe 1908 UbaK3 [825]), which is established for countably many boundary components ♠ The general case is still unsettled today (2012), and maybe undecidable within ZFC? (just a joke, of course)] ♡87
- [630] Z.-X. He, O. Schramm, *On the convergence of circle packings to the Riemann map*, Invent. Math. 125 (1996), 285–305. [♠ improvement and generalization of the Rodin-Sullivan proof (1987 [1277]), making it logically independent of RMT (thus reproving it via the technology of circle packings) ♠ [08.10.12] what about the same game for the Ahlfors map?] ♡41
- [631] E. Heine, *Ueber trigonometrische Reihen*, J. Reine Angew. Math. 71 (1870), 353–365. [♠ the rôle of uniform convergence is emphasized (i.e. Weierstrass’ notion, yet first only familiar to his direct circle of students)] ♡37
- [632] M.H. Heins, *Extremal problems for functions analytic and single-valued in a doubly connected region*, Amer. J. Math. 62 (1940), 91–106. G78 [♠ quoted (joint with Carlson 1938 [250] and Teichmüller 1939 [1483]) in Grunsky 1940 [563] as one of the forerunners of the extremal problem for bounded analytic functions (alias Ahlfors map, subsequently)] ♡17
- [633] M. Heins, *On the iteration of functions which are analytic and single valued in a given multiply connected region*, Amer. J. Math. 63 (1941), 461–480. G78 [♠ regarded by Minda 1979 [1013, p.421] as the proper originator of the *annulus theorem* (i.e., an analytic self-map of an annulus can take the generator of the fundamental group only upon a 0 or ± 1 multiple of itself, and the ± 1 case forces the map to be a conformal automorphism)] ♡37
- [634] M. Heins, *A lemma on positive harmonic functions*, Ann. of Math. (2) 52 (1950), 568–573. AS60, G78 [♠ may contain another proof of the existence of the Ahlfors function (at least a circle map), yet not very clear which degree Heins’ argument supplies ♣ in fact since the quantity m appearing on p.571 for a generating system of the fundamental group is easily found to be $m = 2p + (r - 1)$ (where p is the genus and r the number of contours) it is quite likely (albeit the writer has no certitude!) that Heins’ method may reproduce (by specialisation) exactly Ahlfors upper bound upon the degree of a circle map ♠ [06.10.12] for a possible corroboration of this intuition, check also the subsequent paper Heins 1985 [639] which truly seems to get again the $r + 2p$ bound of Ahlfors (1950) ♠ treats Pick-Nevalinna interpolation for a bordered surface (extending the work of Garabedian 1949 [495])] ♡23
- [635] M. Heins, *Symmetric Riemann surfaces and boundary problems*, Proc. London Math. Soc. (3) 14A (1965), 129–143. [♠ looks closely allied to Ahlfors 1950 [19], which is not cited, but so are some direct descendants, Read 1958 [1243] and Royden 1962 [1305] ♠ enters into the category of “transplanting papers” where some result for the disc is lifted to a compact bordered surface (=membrane) ♠ in the present case M. Riesz’s theorem on the conjugate Fourier series, and the unique decomposition of $f \in L^p$ into interior/exterior Fatou boundary functions of functions in H_p] ♡6

- [636] M. Heins, *Hardy classes on Riemann surfaces*, Lecture Notes in Mathematics 98, Springer, 1969. [♠ p.59–65 contains a re-exposition of Heins 1950 [634], yielding probably an alternate proof of the Ahlfors circle maps]★★★ ♡77
- [637] M. Heins, *Nonpersistence of the Grenzkreis phenomenon for Pick-Nevanlinna interpolation on annuli*, Ann. Acad. Sci. Fenn. Ser. A. 596 (1975), 1–21. A50, G78 [♠ cited in Jenkins-Suita 1979 [719] ♠ from MathReviews: “Let A be a subset of the open unit disc Δ . Consider the family of functions f regular in Δ such that $|f| \leq 1$ on Δ and at each point of A , a specified initial Taylor section is assigned. For $b \in \Delta$, let $W(b)$ denote the set of values assumed by the functions of the family at b . [As Heins explains in the original article “ $W(b)$ is termed the *Wertevorrat* of the family at b .”] The Pick-Nevanlinna-Grenzkreis phenomenon asserts that if there is more than one function in the family and $b \in \Delta - A$, then the set $W(b)$ is a closed circular disc of positive radius. The author constructs a counter example to show that this is no longer true for multiply connected domains. Let Ω be the annulus $r < |z| < r^{-1}$ and let $B(c)$ denote the set of functions f , analytic in Ω , such that $|f| \leq 1$, $f(-1) = 0$ and $f'(-1) = c$, where c is small and positive. The author shows that in this case $W(b)$, $b \neq -1$, is a set with nonempty interior but is not a circle.—A result of Garabedian 1949 [495] asserts that if Ω is a domain of finite connectivity such that no boundary component reduces to a point and if the values of the function are assigned at a finite number of points, then the unique extremal function which takes at b a given value on $\text{Fr}W(b)$ maps Ω onto Δ with constant valency. The author shows that this remains true for his example although the initial Taylor section assigned is of order one at $z = -1$. There is also a general discussion of the problem in the general setting of Riemann surfaces with finite topological characteristics.” ♠ [07.10.12] as a modest task one may wonder if Heins’ paper reproves Ahlfors’ existence of circle maps of degree $\leq r+2p$. As a pessimistic remark it seems that there is a wide variety of extremal problems, somehow reflecting our mankind capitalistic/competitive aberration, making it unclear what the God given problem is, especially the one capturing circle maps of lowest possible degree ♠ more optimistically it is clear that there is a fascinating body of knowledge among such problems (interpolation by prescribed Taylor section). Given a finite Riemann surface \overline{F} (bordered), choose a finite set A each point being decorated by a Taylor section (w.r.t. a local uniformizer), look at all functions bounded-by-one matching the Taylor data. For any $b \in F - A$, define $W(b) \subset \Delta$ as the set of values assumed at b by functions of the family. ♠ as above we look at the function $f_{b,w}$ taking at b a given value w of the frontier of $W(b)$. Q1. Is then Garabedian’s result on the constant valency of $f_{b,w}: F \rightarrow \Delta$ true in this non-planar setting? If yes what is the degree of the corresponding circle map (Q2). Of course the case where $A = \{a\}$ is a singleton with Taylor section $f(a) = 0$ ($b \neq a$) and w chosen so as to maximize the modulus in the set $W(b)$ gives exactly the Ahlfors map $f_{a,b}$ studied in Ahlfors 1950 [19]. This induces (via the assignment $\overline{F} \mapsto |f_{a,b}(b)|$) a real-valued function $\mathcal{M}_{r,p} \rightarrow]0, 1[$ on the moduli space of surfaces with two marked points. One can dream about understanding the Morse theory of this function. ♠ The answer to our two naive questions (Q1, Q2) is apparently already in Heins’ paper, for Jenkins-Suita 1979 [719, p. 83] write: “Quite recently Heins [10](=1975 [637]) proved uniqueness of the extremal function f_0 which maximizes $\text{Re}(e^{i\theta} f(z_0))$ among the class of analytic functions f bounded by unity and with given Taylor sections [...] on a compact bordered Riemann surface Ω . He also proved the extremal f_0 maps Ω onto a finite sheeted covering of the unit disc and gave a bound on the number of sheets called the *Garabedian bound*.” ♠ [07.10.12] as a micro-objection the terming “Garabedian bound” is probably slightly unfair for Ahlfors as the latter probably knew it (in the case of a single interpolating point) without Garabedian’s helping hand (at least for circle maps, yet arguably not for the Ahlfors’ extremals) (cf. of course the acknowledgments to be found in Ahlfors 1950 [19], but see also Nehari 1950 [1078] where the Ahlfors upper bound $r + 2p$ is credited back to Ahlfors’ Harvard lectures in Spring 1948) ♣ [12.10.12] Heins’ statement is as follows (p.18): “(3) *The Garabedian bound*. We consider a determinate Pick-Nevanlinna problem relative to Ω with a finite set of data and denote the solution by f . [...] For an interpolation point b we let $\nu(b)$ denote the order of interpolation at b augmented by one. We let ν denote the sum of the $\nu(b)$ taken over the interpolation points b . The Euler characteristic of Ω will be denoted by χ . We shall show—**Theorem 8.2** *f has at most $\nu + \chi$ zeros counted by multiplicity.* ♣ this statement subsumes the upper estimate of Garabedian, but also that of Ahlfors: indeed Ahlfors extremal problem is the case where there is a single

interpolating point of order zero. So $\nu = 0 + 1 = 1$. Now given a bordered surface Ω of genus p with r contours, we have $\chi(\Omega) = 2 - 2p - r$ [beware that Heins seems to work with the old convention about the sign of the Euler characteristic, hence just change his formula to $\nu - \chi$]. So we get $\deg f \leq \nu - \chi = \nu - 2 + 2p + r \approx r + 2p$ (note a little arithmetical discrepancy from Ahlfors, surely easily explained) ♣ Heins' proof uses the following tools: • basic facts concerning Hardy classes on Riemann surfaces for which one is referred to Heins 1969 [636] • a variational formula of F. Riesz 1920 [1261] • the theorem of Cauchy-Read (cf. Read 1958 [1243]) • the Fatou boundary function, • the Green's function • the qualitative Harnack inequality ♠ a slightly different proof of a much related result (on "Garabedian bound") is given as Theorem 3 of Jenkins-Suita 1979 [719], which uses maybe less machinery (?), an instead of Read the closely allied paper Royden 1962 [1305]. Yet Jenkins-Suita's proof depend on Heins' proof when it comes to the "interpolation divisor" ♡5

[638] M. Heins, *Carathéodory bodies*, Comm. in honorem Rolf Nevanlinna LXXX annos nato, Ann. Acad. Sci. Fenn. Ser. A.I, Math. 2 (1976), 203–232. [♠ extension to the setting of finite Riemann surfaces of Carathéodory's theory on the "Variabilitätsbereich" (1907 [227], 1911 [228]) of coefficient of analytic functions with positive real part (bringing together Minkowski's theory of convex sets with complex function theory), while encompassing interpolation problems subsuming those of Pick-Nevalinna type] ★ ♡3

[639] M. Heins, *Extreme normalized analytic functions with positive real parts*, Ann. Acad. Sci. Fenn. Ser. A. I. Math. 10 (1985), 239–245. A50 [♠ localized via Bell 2009/11 [108] ♠ also quoted in Khavinson 1984 [782, p. 377] for another proof of the Bieberbach-Grunsky theorem ♠ Heins handles the more general non-planar case recovering probably the Ahlfors circle maps of 1950, and so seems indeed to be the case according to MathReviews (translated from Hervé's review in Zentralblatt): "Let P be the family of holomorphic functions f on a given Riemann surface S satisfying $\operatorname{Re} f > 0$ on S and $f(a) = 1$ for a given point $a \in S$. If S is the unit circle, the extremal elements of P are the functions $z \rightarrow (\eta + z)/(\eta - z)$, $|\eta| = 1$. If S is a bounded open plane region whose boundary consists of c analytic Jordan curve $\Gamma_1, \dots, \Gamma_c$, the author associates the extremal elements f_ζ of P with the system $\zeta = (\zeta_1, \dots, \zeta_c) \in \Gamma_1 \times \dots \times \Gamma_c$; $\operatorname{Re} f_\zeta$ is an appropriate linear combination of minimal harmonic functions > 0 on S with poles ζ_k , $k = 1, \dots, c$. This results extends to the case in which S is an open region of a compact Riemann surface of genus g , but here the real parts of the extremal element of P are linear combination of [AT MOST]³² $2g + c$ minimal positive harmonic functions on S ." ♠ [06.10.12] so it seems that this new work of Heins, albeit quite close to Heins 1950 [634], may be a bit more explicit and truly include the existence of (Ahlfors) circle map with the bound $r + 2p$ like Ahlfors 1950 [19] ♠ [06.10.12] it would be of course of primary importance to study if Heins' methods is susceptible of recovering the sharper $r + p$ bound asserted in Gabard 2006 [463] ♠ [12.10.12] after reading the original text, it must alas recognize that Heins' proof is not perfectly satisfactory, for when it comes to the case of positive genus, he writes simply (p. 243): "the corresponding developments of Section 3 [=planar case] may be paraphrased." ♠ hence the pedestrian reader will not find it easy to recover even Ahlfors basic (but deep) result from Heins' account. So let me try once to degage the substance of the argument, while trying to locate "en passant" those critical steps which in our opinion is not made explicit in Heins' exposition. (I shall use my notation hopefully for convenience of the reader.) We start as usual with \bar{F} a compact bordered Riemann surface of genus p and with r contours. Let $a \in F$ be some fixed interior point. Heins considers P the set of analytic functions f on F with $\operatorname{Re} f > 0$ and $f(a) = 1$. (The family P is convex and compact, hence admits extreme points by Krein-Milman. Actually we shall probably not need this, albeit being an interesting viewpoint.) Let $g := 2p + (r - 1)$ and $\gamma_1, \dots, \gamma_g$ be representatives of the homology group $H_1(F)$. For u harmonic on F , let $\pi(u)$ be the period vector given by $\pi(u) = (\int_{\gamma_1} \delta u, \dots, \int_{\gamma_g} \delta u)$, where δu is a certain abelian differential given by some local recipe. In fact it is perhaps more natural (and equivalent?) to define δu as the conjugate differential $(du)^*$. For $\zeta \in \partial F$, Heins considers (p. 241) u_ζ the minimal positive harmonic function on F vanishing on $\partial F - \{\zeta\}$ and normalized by $u_\zeta(a) = 1$. [Maybe here Heins still relies subconsciously on Martin 1941 [974], yet arguably this is nothing else that the Green's function with pole pushed to the boundary, what I called a Red's function, but perhaps calls it a Poisson function,

³²Gabard's addition

as may suggest the paper Forelli 1979 [449].] We seek to construct a half-plane map f by taking a combination $u = \sum_{k=1}^d \mu_k u_{\zeta_k}$ of such elementary potentials, with $\mu_k > 0$ while trying to arrange the free parameters (e.g. the $\zeta_k \in \partial F$) so as to kill all periods of $(du)^*$. If this can be achieved for some d , then $f = u + iu^*$ (where u^* is defined by integrating the differential $(du)^*$) supplies a half-plane map of degree d . (Recall indeed that u vanishes continuously on the boundary ∂F , except at the ζ_k which are catapulted to ∞ . Hence the map is boundary preserving and has therefore constant valency, here d .) To kill all periods, we may look at the map $\varphi: \partial F \xrightarrow{u} h(F) \xrightarrow{\pi} \mathbb{R}^g$, where $u(\zeta) = u_\zeta$ and $h(F)$ denotes the space of harmonic functions. At this stage it must be explained that the image $\varphi(\partial F)$ is “balanced”, i.e. not situated in a half space of \mathbb{R}^g . [I am not sure that Heins explains this in details.] If so then it is plain that there is a collection of $d \leq g + 1$ points (assume $d = g + 1$ if you want) on $\varphi(\partial F)$ spanning a simplex containing 0. This is just the principle that in Euclidean space of some dimension, a collection of one more points than the given dimension span a top-dimensional simplex with optimum occupation property of the territory (=Euclid space). Thus expressing the origin as convex combination of those $g + 1$ points we find scalars $\mu_k > 0$, which injected in the formula defining u , gives us an u meeting the requirement. This reproves Ahlfors 1950, but alas I still do not have a simple explanation for the balancing condition. Next the challenge, is of course to improve the geometry by remarking that clever placements of points may span a lower dimensional simplex yet still covering the origin. Hopefully one may reprove the $r + p$ upper bound of Gabard 2006 [463], along this path (which is essentially Ahlfors’ original approach).] ♡**3**

[640] M. Heins, *Extreme Pick-Nevanlinna interpolating function*, J. Math. Kyoto Univ. 25–4 (1985), 757–766. [♠ p. 758: “It is appropriate to cite instances of convexity considerations related to the present paper. The pioneer work of Carathéodory [2](=1907 [227]),[3](=1911 [228]) on coefficient problems for analytic functions with positive real part is, as far I am aware, the first bringing together of the Minkowski theory of convex sets and complex function theory. Extreme points are present in the fundamental work of R. S. Martin [12](=1941 [974]) on the representation of positive harmonic functions as normalized minimal positive harmonic functions. My paper [7](=Heins 1950 [634]) showed the existence of minimal positive harmonic functions on Riemann surfaces using elementary standard normal families results without the intervention of the Krein-Milman theorem and gave application to qualitative aspects of Pick-Nevanlinna interpolation on Riemann surfaces with finite topological characteristics and nonpointlike boundary components. Such Riemann surfaces will be termed *finite* Riemann surfaces henceforth. In [8](=Heins 1976 [638]) the Carathéodory theory cited above was extended to the setting of finite Riemann surfaces for interpolation problems subsuming those of Pick-Nevanlinna type. Forelli [5](=1979 [449]) has studied the extreme points of the family of analytic functions with positive real part on a given finite Riemann surface S normalized to take the value 1 at a given point of S . In my paper [9](=Heins 1985 [639]) the results of Forelli were supplemented by precise characterizing results for the case where the genus of S is positive.”] ♡**0**

[641] D. A. Hejhal, *Linear extremal problems for analytic functions*, Acta Math. 128 (1972), 91–122. **A50, G78** [♠ generalized extremal problem, existence as usual via normal families, and so uniqueness is given “a reasonably complete answer” (p. 93) ♠ p. 119 Royden 1962 [1305] is cited for another treatment of Ahlfors’ extremal problem] ♡**8**

[642] D. A. Hejhal, *Theta functions, kernel functions and Abelian integrals*, Memoirs Amer. Math. Soc. 129, 1972. [♠ quoted in Burbea 1978 [214], where like in Suita 1972 [1471] an application of the Ahlfors function is given to an estimation of the analytic capacity] ★ ♡**44**

[643] D. A. Hejhal, *Some remarks on kernel functions and Abelian differentials*, Arch. Rat. Mech. Anal. 52 (1973), 199–204. **G78** ♡**5**

[644] D. A. Hejhal, *Universal covering maps for variable regions*, Math. Z. 137 (1974), 7–20. **G78** [♠ just quoted for the philosophical discussion on p. 19, especially the issue that the (Koebe) Kreisnormierung (=circular mapping) [not to be confused with our circle maps!] is “*somewhat more involved* than the other canonical mappings, esp. the PSM] ♡**35**

[645] D. A. Hejhal, *Linear extremal problems for analytic functions with interior side conditions*, Ann. Acad. Sci. Fenn. Ser. A 586 (1974), 1–36. **G78** [♠ cited in Jenkins-Suita 1979 [719]] ★ ♡??

- [646] D. A. Hejhal, *On Schottky and Teichmüller spaces*, Adv. Math. 15 (1975), 133–156. [♠]★ ♥??
- [647] B. Heltai, *Symmetric Riemann surfaces, torsion subgroups and Schottky coverings*, Proc. Amer. Math. Soc. 100 (1987), 675–682. [♠] ♥??
- [648] ?. Henoch, *De Abelianarum Functionum Periodis*, Inaugural-Dissertation, Berlin. [♠ cited in both Hurwitz 1883 [688] and Weichold 1883 [1570], who both relax hyperellipticity from Henoch results on the periods of Abelian integrals on real algebraic curve, while extending also Klein’s general version for $g = 3$ (cf. Klein 1876 [794])] ♥??
- [649] K. Hensel, W. Landsberg, *Theorie der algebraischen Funktionen einer Variablen und ihre Anwendung auf algebraische Kurven und Abelsche Integrale*, Leipzig, 1902. [♠ contains the sharp estimate $[\frac{g+3}{2}]$ of Riemann-Brill-Noether upon the gonality of a closed surface, but the treatment is not considered as convincing (to contemporary scientists) until the work of Meis 1960 [993], compare e.g., H. H. Martens 1967 [973] and Kleiman-Laksov 1972 [788]] ♥28
- [650] G. Herglotz, *Über Potenzreihen mit positivem reellen Teil im Einheitskreis*, Ber. Verhandl. Sächs. Ges. Wiss. Leipzig 93 (1911), 501–511. [♠ yet another theorem in the disc susceptible (???) of a transplantation to finite bordered Riemann surface, try e.g. Agler-Harland-Raphael 2008 [12] (multi-connected planar domains), or Heins 1985 [640] ♠ Herglotz’s representation theorem is concerned with the so-called Poisson-Stieltjes representation for analytic functions on the unit disc Δ with ≥ 0 real part (simultaneous work by F. Riesz), and cf. the above cited work of Heins for an application (of Herglotz-Riesz 1911) to a description of extreme points of a class I of analytic function arising from a Pick-Nevanlinna interpolation problem involving functions $\Delta \rightarrow \{\text{Re}z > 0\}$: “Theorem 1. The extreme points of I [in the sense of convex geometry] are precisely the members of I having constant valence on $\{\text{Re}z > 0\}$, the value ν of the valence satisfying $1 + n < \nu < 1 + 2n$.” [n being the number of interpolation points] ♠ such results are probably extensible to the situation where the source (=disc Δ) is replaced by a finite bordered Riemann surface, and the resulting theory probably interacts with the Ahlfors map ♠ [13.10.12] in fact the Poisson-Stieltjes-Herglotz-Riesz representation formula is rather involved in another proof of Ahlfors circle maps, see for this Forelli’s brilliant account (1979 [449])] ♥115
- [651] J. Hersch, *Quatres propriétés isopérimétriques de membranes sphériques homogènes*, C. R. Acad. Sc. Paris 270 (1970), 1645–1648. [♠ contains 4 spectral (eigenvalues) inequalities for disc-shaped membranes emphasizing the extremality of resp. the round sphere, the hemisphere, the quarter of sphere and of the octant of sphere ♠ the first inequality has been extended via conformal transplantation to closed surfaces of higher topological type by Yang-Yau 1980 [1613] (who failed to take advantage of the well-known sharp gonality bound of Riemann-Meis (1960 [993]), but see El Soufi-Ilias 1983/84 [391]) ♠ the first inequality has been extended by Gabard 2011 [467] upon using the Ahlfors map ♠ [08.10.12] of course it would be also interesting trying to get extensions of the two remaining Hersch’s inequalities (involving the quarter of sphere and its octant resp.)] ♥141
- [652] J. Hersch, L. E. Payne, M. M. Schiffer *Some inequalities for Steklov eigenvalues*, Arch. Rat. Mech Anal. 57 (1973/74), 99–114. [♠ contain estimates of Steklov eigenvalues along the method of Szegő 1954 [1479], Weinstock 1954 [1578], Weinberger 1956 [1577], etc. (i.e. conformal transplantation) ♠ in the light of Fraser-Schoen’s article (2011 [456]) one can remark two things: (1) it is strange that the present paper does not cite the planar avatar of the Ahlfors map (that is the Bieberbach-Grunsky theorem); this is perhaps done subconsciously in §5.2, p. 106 (2) of course (at least since Fraser-Schoen’s paper 2011 [456]) it is obvious that the result can (via the Ahlfors map) be extended to bordered Riemann surfaces; for an exact implementation cf. Girouard-Polterovich 2012 [527]] ♥33
- [653] M. Hervé, *Quelques propriétés des transformations intérieures d’un domaine borné*, Ann. sci. École norm. sup. (3) 68 (1951), 125–168. G78 [♠ Grunsky’s works, as well as Ahlfors 1947 [18] are cited, and it could be nice to look for extensions to bordered surfaces] ♥12
- [654] R. A. Hidalgo, A. F. Costa, *Anticonformal automorphisms and Schottky coverings*, Ann. Acad. Sci. Fenn 26 (2001), 489–508. [♠] ♥7
- [655] R. A. Hidalgo, *Schottky uniformization of stable symmetric Riemann surfaces*, Notas de la Soc. Mat. de Chile (N.S.) 1 (2001), 82–91. [♠] ♥??

- [656] R. A. Hidalgo, *Real surfaces, Riemann matrices and algebraic curves*, In: *Complex Manifolds and Hyperbolic Geometry*, Guanajuato 2001, Contemp. Math. 311, Amer. Math. Soc., Providence, 2002. [♠ a neoclassical account on the Rückkehrstheorem of Klein 1882 ♠ question: is it sufficient to prove existence of Ahlfors circle maps?] ♡??
- [657] R. A. Hidalgo, B. Maskit, *On Klein-Schottky groups*, Pacific J. Math. 220 (2005), 313–328. [♠] ♡??
- [658] R. A. Hidalgo, B. Maskit, *On neoclassical Schottky groups*, Trans. Amer. Math. Soc. 358 (2006), 4765–4792. [♠] ♡??
- [659] R. A. Hidalgo, *On the retrosection theorem*, Proyecciones 27 (2008), 29–61. [♠ a neoclassical account on the Rückkehrstheorem of Klein 1882 ♠ question: is it sufficient to prove existence of Ahlfors circle maps?] ♡??
- [660] R. A. Hidalgo, *On the inverse uniformization problem: real Schottky uniformization*, Rev. Mat. Complut. 24 (2011), 391–420. [♠ p.394: “The reciprocal is valid by the retrosection theorem [13](=Koebe 1910 UAK2 [831]) (see [4](=Bers 1975 [128]) for a modern proof using quasiconformal deformation theory).”] ♡??
 ★★ David Hilbert (1863–1943) is a well-known mathematician born in Königsberg who started working on the topic of real curve in 1891 perhaps as his credit card for entering in Göttingen (supervised by Klein at that epoch). It seems that this Hilbert work may have revived Klein’s interest after the rush with Poincaré on uniformization in the early 1880’s.
- [661] D. Hilbert, *Über die reellen Züge algebraischen Kurven*, Math. Ann. 38 (1891), 115–138; or Ges. Abhandl., Bd.II. [♠ where Hilbert’s 16th problem (Paris 1900) starts taking shape, in the sense of asking for the isotopy classification of plane smooth real sextics in $\mathbb{R}P^2 = \mathbb{P}^2(\mathbb{R})$ ♠ a method of oscillation is given permitting to exhibit a new scheme of M -sextic not available via Harnack’s method of 1876 (this is nowadays called Hilbert’s method) which is quite powerful (but not omnipotent) to analyze the topology of plane (real) sextics ♠ in particular Hilbert develops the intuition that a sextic cannot have 11 unnested ovals, so must be nested yielding some noteworthy form of complexity of algebraic varieties ♠ a complete proof of this assertion will have to wait for a longue durée series of attempt by his own students Kahn 1909 [743] Löbenstein 1910 [950] and especially Rohn 1911–13 [1296]. All these attempts were judged unconvincing, and from the Russian rating agency not judged as sufficiently rigorous until the intervention of Petrovskii 1933–38 [1168] and Gudkov 1948–1969, cf. e.g. Gudkov 1974/74 [579] ♠ p. 418 (in Ges. Abh., Bd.II): “Diesen Fall $n = 6$ habe ich einer weiteren eingehenden Untersuchung unterworfen, wobei ich — freilich auf einem außerordentlich umständlichen Wege — fand, daß die elf Züge einer Kurve 6-ter Ordnung keinesfalls sämtlich außerhalb und voneinander getrennt verlaufen können. Dieses Resultat erscheint mir deshalb von Interesse, weil er zeigt, daß für Kurven mit der Maximalzahl von Zügen der topologisch einfachste Fall nicht immer möglich ist.” ♠ for the next episode in Hilbert’s pen, cf. Hilbert 1909 [668] where Hilbert ascribes to his students a complete proof of the result (inexistence of the unnested scheme of 11 ovals)] ♡??
- [662] D. Hilbert, *Grundlagen der Geometrie*, 1899. [♠] ♡??
- [663] D. Hilbert, *Mathematische Probleme*, Arch. Math. Phys. (3) 1 (1901), 213–237 or 43–63 [instable following the sources]; also in Ges. Abh., Bd.III, p.317. [♠ includes Hilbert’s 16th problem on the mutual disposition of ovals of plane curves (especially sextics), now completely solved by Gudkov ca. 1969, cf. Gudkov-Utkin 1969 [575] or Gudkov 1969 [574] ♠ More precisely Hilbert’s text reads as follows: **16. Problem der Topologie der algebraischer Kurven und Flächen.**—Die Maximalzahl der geschlossenen und getrennt liegenden Züge, welche eine ebene algebraische Kurve n -ter Ordnung haben kann, ist von Harnack (1876) bestimmt worden; es entsteht die weitere Frage nach der gegenseitigen Lage der Kurvenzüge in der Ebene. Was die Kurven 6. Ordnung angeht, so habe ich mich—freilich auf einem recht umständlichen Wege—davon überzeugt, daß die 11 Züge, die sie nach Harnack haben kann, keinesfalls sämtlich außerhalb von einander verlaufen dürfen [this is true, but the sequel turned out to be false cf. Gudkov 1969/72], sondern daß ein Zug existieren muß, in dessen Innerem ein Zug und in dessen Äusserem neun Züge verlaufen oder umgekehrt. *Eine gründliche Untersuchung der gegenseitigen Lage bei der Maximalzahl von getrennten Zügen scheint mir ebenso sehr von Interesse zu sein, wie die entsprechende Untersuchung über die Anzahl, Gestalt*

- und Lage der Mäntel einer algebraischen Fläche im Raume*—ist doch bisher noch nicht einmal bekannt, wieviel Mäntel eine Fläche 4. Ordnung des dreidimensionalen Raumes im Maximum wirklich besitzt [solution of this problem at most 10 components, cf. Kharlamov 1972/73 [764].] [vgl. Rohn 1886] [the latter proved only the bound of 12 components, and Utkin (1967) lowered Rohn’s estimate to 11].—Im Anschluß [...].] ♡??
- [664] D. Hilbert, *Über das Dirichletsche Prinzip*, Jahresb. d. Deutsch. Math.-ver. 8 (1900), 184–188. [♠ [08.10.12] the technological breakthrough based upon the “direct method” in the calculus of variation, where one directly minimizes the integral (without transiting to its first variation, alias Euler-Lagrange equation) via the idea of minimizing sequences implying a topologization of the space of test functions while checking its compactness (=Fréchet’s jargon) of the resulting family ♠ the method also differs from its predecessors Schwarz-Neumann-Poincaré where the problem was first solved for the disc and combinatorial tricks permitted proliferation to higher topological complexity] AS60 ♡??
- [665] D. Hilbert, *Über das Dirichletsche Prinzip*, Math. Ann. 59 (1904), 161–186. (Abdruck aus der Festschrift zur Feier des 150jährigen Bestehens der Königl. Gesellschaft der Wissenschaften zu Göttingen 1901.) AS60 ♡??
[♠ p.161 (Introd.): “Unter dem Dirichletschen Prinzip verstehen wir diejenige Schlußweise auf die Existenz einer Minimalfunktion, welche Gauss (1839)[=516], Thomson (1847)[=1489], Dirichlet (1856)[=of course much earlier, at least as early as when Riemann studied in Berlin, ca. 1849–50!] und andere Mathematiker zur Lösung sogenannter Randwertaufgaben angewandt haben und deren Unzulässigkeit zuerst von Weierstrass erkannt worden ist. [...] Durch das Dirichletsche Prinzip hat insbesondere Riemann die Existenz der überall endlichen Integrale auf einer vorgelegten Riemannschen Fläche zu beweisen gesucht. Ich bediene mich im folgenden dieses klassischen Beispiels zur Darlegung meines strengen Beweisverfahrens.”] ♡84
- [666] D. Hilbert, *Sur les problèmes futurs des mathématiques*, Compte rendu du deuxième Congrès internat. des Math., Paris, 1902, 59–114 (especially p.96). [♠ often cited by real geometers (e.g. Galafassi 1960 [479]), yet probably just a French translation of the German original.] ♡??
- [667] D. Hilbert, *Über das Dirichletsche Prinzip*, J. Reine Angew. Math. 129 (1905), 63–67. (Abdruck eines Vortrages aus dem Jahresb. d. Deutsch. Math.-ver. 8 (1900), 184–188.) AS60 ♡??
- [668] D. Hilbert, *Zur Theorie der konformen Abbildung*, Gött. Nachr. (1909), 314–323; Ges. Abh. 3, 73–80. G78 [♠ parallel-slit mapping including positive genus (and infinite connectivity) ♠ influenced much Courant, and also Koebe 1910 [830]] ♡8
- [669] D. Hilbert, *Über die Gestalt einer Fläche vierter Ordnung*, Gött. Nachr. (1909), 308–313; Ges. Abh. 2, 449–453. [♠ contains a good picture for the construction of Harnack-maximal sextic ♠ p.453, Hilbert ascribes to his students G. Kahn 1909 [743] and Löbenstein 1910 [950] a complete proof that a real sextic cannot have 11 unnested ovals (but that was not judged solid enough by subsequent workers, e.g. Rohn, Petrovskii, and Gudkov 1974 [579]): “[...] eine ebene Kurve 6-ter Ordnung hervorgehen, die aus elf außerhalb voneinander getrennt verlaufenden Zügen bestände. Daß aber eine solche Kurve nicht existiert, ist einer der tiefstliegenden Sätze aus der Topologie der ebenen algebraischen Kurven; derselbe ist kürzlich von G. Kahn und K. Loebenstein (Vgl. die Göttinger Dissertationen derselben Verfasserinnen.) auf einem von mir angegebenen Wege bewiesen worden.” ♠ nowadays there is five-minute proof of what Hilbert called one of the deepest problem in the topology of plane curves, via Rohlin’s formula ca. 1974–78 (cf. e.g. our v.2), yet we believe that there is perhaps also a proof via the Ahlfors map (in the special case due to Riemann-Schottky-Bieberbach-Grunsky). This would be a fantastic project] ♡??
- [670] D. Hilbert, S. Cohn-Vossen, *Anschauliche Geometrie*, Springer, Berlin, 1932. (Translation: Geometry and the Imagination) [♠] ♡??
- [671] S. Hildebrandt, H. von der Mosel, *Conformal mapping of multiply connected Riemann domains by a variational approach*, Adv. Calc. Var. 2 (2009), 137–183. [♠ new proof of the Kreisnormierung for (planar) domains via Plateau-style method ♠ question: can we apply the same method for the (Ahlfors) circle map? (cf. Courant 1939 [334] for the planar case [$p = 0$]) ♠ “Abstract. We show with a new variational approach that any Riemannian metric on a multiply connected schlicht

- domain in \mathbb{R}^2 can be represented by globally conformal parameters. This yields a “Riemannian version” of Koebe’s mapping theorem.”] ♡6
- [672] S. Hildebrandt, *Plateau’s problem and Riemann’s mapping theorem*, Milan J. Math. (2011), 67–79. [♠ survey putting in perspective several recent developments, including the previous item] ♡0
- [673] H. Hilton, *On the circuits of a plane sextic curve*, Rend. Circolo Mat. Palermo 60 (1936), 280–285. [♠ cited in Gudkov 1974 [579] and contains apparently critiques upon Donald’s oversimplified proof of Hilbert’s Ansatz of no nesting of M -sextics.] ♡??
- ★ Friedrich Hirzebruch, a student of H. Hopf primarily, well-known for his breakthrough on the signature formula (via Thom’s cobordism) and its application to the Hirzebruch-Riemann-Roch generalized theorem (extending Riemann-Roch-Noether-Castelnuovo-Enriques-Todd, etc.) to arbitrary dimensions. In the history of Hilbert’s 16th problem Hirzebruch is also pivotal for being involved (via Atiyah-Singer) in the first rigorous proof by Rohlin 1972 [1287] of the Gudkov hypothesis which imposes the 8-fold periodicity of the Euler characteristic of the Ragsdale membrane of even order curves.
- [674] F. Hirzebruch, *Topological methods in algebraic geometry*, Springer, 1978; translated from the Original German text *Neue topologische Methoden in der algebraischen Geometrie* ca. 1955. [♠ how to put Pontrjagin (characteristic classes), Thom, cobordism, the signature theorem, etc. into action to get the generalized Riemann-Roch theorem. Subsequent application to Gudkov’s hypothesis via Rohlin’s works.] ♡??
- [675] F. Hirzebruch, *The signature of ramified coverings*, in: Global Analysis (Papers in honor of K. Kodaira), University Press, Tokyo, 1969, 253–265. [♠ cited in Gudkov 1974 [579], and surely used at some stage by Russian scholars like Arnold or Rohlin (plus descendance Kharlamov, Viro, etc.)] ♡??
- [676] F. Hirzebruch, *The signature theorem: reminiscences and recreations*, in: Prospects in Mathematics (Annals of Math. Studies 70), Princeton University Press, Princeton, 1971, 3–31. [♠] ♡??
- [677] W. Hodge, *The Theory and Applications of harmonic integrals*, Cambridge, 1941. ♡??
- [678] K. Hoffman, *Banach spaces of analytic functions*, Prentice-Hall (Englewood Cliffs), 1962; Dover Reprint, 1988. ♡2566
- [679] M. Homma, *Separable gonality of a Gorenstein curve*, Math. Contemp. ca. 2004. [♠ cited in Ballico 2003 [87]] ♡??
- [680] M. Horikawa, *On deformations of holomorphic maps I*, J. Math. Soc. Japan 25 (1973), 372–396. [♠] ♡??
- ★ Johannes Huisman, student of J. Bochnak, ca. 1994, well-known for important contribution of real curves, surfaces, and the phenomenon of total reality.
- [681] J. Huisman, *Real quotient singularities and nonsingular real algebraic curves in the boundary of the moduli space*, Compos. Math. 118 (1999), 42–60. [♠] ♡??
- [682] J. Huisman, *Real Teichmüller spaces and moduli of real algebraic curves*, Contemp. Math. 253 (2000), 145–179. [♠] ♡??
- [683] J. Huisman, *On the geometry of algebraic curves having many real components*, Rev. Mat. Complut. 14 (2001), 83–92. [♠ p.87, Prop.3.2 contains an algebro-geometric proof of the so-called Bieberbach-Grunsky theorem (for antecedent along similar lines compare Enriques-Chisini 1915/18 [396], Bieberbach 1925 [147], and Wirtinger 1942 [1601]) ♠ of course Huisman’s paper goes much deeper by exploring the properties of linear series on Harnack-maximal curves (alias M -curves)] ♡17
- [684] J. Huisman, *Non-special divisors on real algebraic curves and embeddings into real projective spaces*, Ann. di Mat. 182 (2003), 21–35. [♠] ♡??
- [685] L. S. Hulburt, *A class of new theorems on the number and arrangement of the real branches of plane algebraic curves*, Amer. J. Math. 14 (1891/92?), 246–250. [♠ cited in Brusotti 1914, Wiman 1923 [1595], Gudkov 1974 [579]] ♡??
- [686] L. S. Hulburt, *Topology of algebraic curves*, Bull. New York Math. SOc. 1 (1892), 197–202. (Later Bull. Amer. Math. Soc. of course!) [♠ cited Gudkov 1974 [579]] ♡??

- [687] Ch. Huyghens, *Œuvres*, vol. 10, pp. 314, 326, 234. [♠ cited in Viro 1989/90 [1535, p.1111] as follows: “**4.5. Hyperbolism.**—In the constructions that follow an important role will be played by a certain birational transformation of the plane, the use of which goes back to Huyghens [37] and Newton [16](=Newton [1105]). Following Newton, we shall call this map a *hyperbolism* and shall denote it by the symbol *hy*. In homogeneous coordinates [NB: the latter came only in the Chasles-Plücker-Möbius era] it is given by the formula $hy(x_0 : x_1 : x_2) = (x_0x_1 : x_1^2 : x_0x_2)$, and in affine [...]”] ♡??
- ♠ Adolf Hurwitz, a student of Klein (and also Weierstrass), well-known for very deep work on all aspects of Riemann surfaces (and more), bounds on the automorphism, study of the so-called Hurwitz space parametrizing all branched cover with prescribed topology, etc. Also with Courant considerable as one of the father (beside maybe Faber according to Bieberbach 1957 [154]) of the length-area method so pivotal for Grötzsch, Ahlfors and the development of the quasi-conformal theory, leading to Teichmüller breakthrough (especially on the moduli problem).
- [688] A. Hurwitz, *Über die Perioden solcher eindeutiger, 2n-fach periodischer Funktionen, welche im Endlichen überall den Charakter rationaler Funktionen besitzen und reell sind für reelle Werte ihrer n Argumente*, J. Reine Angew. Math. 94 (1883), 1–20. (Math. Werke, Bd. I) [♠] ♡??
- [689] A. Hurwitz, *Über Riemannsche Flächen mit gegebenen Verzweigungspunkten*, Math. Ann. 39 (1891), 1–61. [♠ [13.10.12] if we fix a ramification divisor in the sphere of degree b and a mapping degree d there is finite number of Riemann surfaces F of Euler characteristic $\chi(F) = d\chi(S^2) - b$ having the prescribed topological behaviour (Hurwitz is able to make a fine study, using of course the monodromy and so to get upper bounds on the number of admissible maps). It seems evident that the game should extend in the bordered setting in the context of Ahlfors circle maps, which are truly (upon doubling) real maps of a special kind (totally real, saturated or separating) from Klein’s orthosymmetric real curves to the real projective line. Then one can try to adventure into similar group theoretical (combinatorial) games as did Hurwitz in the complex case (in fact Hurwitz himself give close attention to reality questions) ♠ a more modest question is whether a careful variation of branch points does not produce a quick “action-painting” or “sweeping out” proof of the existence of circle maps of lowest possible degree. ♠ as yet I was never able to proceed along this way, which looks yet a reasonable strategy for in the complex case such argument yield at least the right prediction about the gonality of complex curves as divinized by Riemann 1857 (cf. e.g. the heuristic count in Griffiths-Harris 1978 [544]). I remind clearly that this idea was suggested by Natanzon (Rennes ca. 2001), and in Rennes 2001/02 (Winter) Johan Huisman also presented to me a simple moduli parameter count somehow comforting the bound $r + p$ (when I suggested him the possibility of the sharpened $r + p$ bound); for the details of Huisman’s count cf.] ♡??
- [690] A. Hurwitz, *Über algebraische Gebilde mit eindeutigen Transformationen in sich*, Math. Ann. 41 (1893), 403–442; or Math. Werke, Bd. I, Funktionentheorie. [♠ it is proved that if a conformal self-map of a closed Riemann surface of genus > 1 induces the identity on the first homology group then the self-map is the identity. Historically, one may wonder how this formulation borrowed from Accola ca. 1966 is reliable for the language of homology was not yet “invented” at least in this precise context (recall Poincaré 1895, but of course a myriad of people used the term “homology” in different contexts, e.g. Jordan) ♠ despite this detail the assertion is correct] ♡??
- [691] A. Hurwitz, R. Courant, *Vorlesungen über allgemeine Funktionentheorie und elliptische Funktionen*, Grundle. der. Math. Wiss. 3, Springer-Verlag, Berlin, 1922. (Subsequent editions 1929, 1964, 706 pp.) [♠ contains another proof of the KN(=Kreisnormierung) in finite connectivity, according to Schiffer-Hawley [1355], also quoted for this purpose in Stout 1965 [1458] ♠ Ahlfors once said (recover the source!!) that it this in this book that he learned the length-area principle so fruitful in the theory of quasi-conformal maps (roughly the pendant of Grötzsch’s Flächenstreifenmethode)] ♡high?
- [692] Y. Imayoshi, *Holomorphic families of Riemann surfaces and Teichmüller spaces*, Ann. of Math. Stud., 1981. [♠] ♡27
- [693] M. S. Ioffe, *Extremal quasiconformal embeddings of Riemann surfaces*, Sib. Math. J. (1975), 520–537; English transl. 1976. [♠ Teichmüller theory for finite bordered surfaces (with optional punctures)] ♡5

- ★ Ilia Itenberg, student of Viro, notorious for his (severe) disproof of the Ragsdale conjecture via the variant of the patchwork construction called the T -construction (where T stands for “triangle/triangulation”).
- [694] I. V. Itenberg, *Curves of degree 6 with one nondegenerate double point and groups of monodromy of nonsingular curves*, in: Real Algebraic Geometry, Proceedings, Rennes 1991, Lecture Notes in Math. 1524, Springer-Verlag, Berlin, 1992. [♠] ♥??
- [695] I. V. Itenberg, *Contre-exemples à la conjecture de Ragsdale*, C. R. Acad. Sci. Paris (Sér. I) 317 (1993), 277–282. [♠ where Ragsdale conjecture is seriously destroyed, yet it remains intact in the case of M -curves, compare also Itenberg-Viro 1996 [701]] ♥??
- [696] I. V. Itenberg, E. Shustin *Newton polygons and singular points of real polynomial vector fields*, C. R. Acad. Sci. Paris (Sér. I) 319 (1994), 963–968. [♠] ♥??
- [697] I. V. Itenberg, *Counterexamples to Ragsdale conjecture and T -curves*, in: Contemp. Math. 182 (Proc. Conf. Real Alg. Geom., Dec. 17–21 1993, Michigan) AMS, Providence, RI, 1995, 55–72. [♠ compare also Itenberg-Shustin 2000 [702] for the same topic] ♥??
- [698] I. V. Itenberg, *Viro’s method and T -curves*, Preprint April 3, 1994 (downloadable from the net) 11 pp (+6 figures); published in: Algorithms in Algebraic Geometry and Applications, Pogr. in Math. 143, Birkhäuser, Basel, 1996, 177–192. [♠ p. 3: “A curve having the chart (T_*, L) is called a T -curve. This notion was introduced by S. Orevkov [Or](=Private communication [undated]).] ♥??
- [699] I. V. Itenberg, *Groups of monodromy of non-singular curves of degree 6*, in: Real Analytic and Algebraic Geometry (Trento 1992), 161–168, de Gruyter, Berlin, 1995. [♠ extending a private communication of Kharlamov, the monodromy groups (ovals permutation) of each chamber of the discriminant is described ♠ relies on Nikulin’s classification via K3 surfaces and uses Coxeter, Vinberg, etc.] ♥??
- [700] I. V. Itenberg, *Rigid isotopy classification of curves of degree 6 with one nondegenerate double point*, in: Topology of Manifolds and Varieties, Advances in Soviet Math. 18, Amer. Math. Soc., 1994, 193–208. (English) [♠ p. 196: “Proposition 2.1. Each empty oval of a nonsingular curve of degree 6 can be contracted and there is only one rigid-isotopy class of the result of such a degeneration.” ♠ the method employed seems to depend upon “Nikulin’s approach for obtaining rigid-isotopy classification of nonsingular curves of degree 6” (cf. p. 193) ♠ as noted by Viro (in the same volume, p. xiii): “I only want to formulate a conjecture, suggested by Itenberg’s Prop. 2.2: each empty oval of a nonsingular real algebraic plane projective curve can be contracted by a deformation of the curve in the class of curves of the same degree. According to Prop. 2.2, this is true for curves of degree 6. It is easy to check for curves of degree ≤ 5 . The first case for which it is unknown is the case of degree 7.” ♠ [08.01.13] In the same vein one can perhaps conjecture that any two ovals lying at the same depth can always coalesce to a single one.] ♥??
- [701] I. V. Itenberg, O. Viro, *Patchworking algebraic curves disproves the Ragsdale conjecture*, The Math. Intelligencer 18 (1996), 19–28. [♠ self-explanatory title ♠ contains (besides some fascinating historical sketches) in particular a formulation of the last vestige of Ragsdale’s conjecture which is still open for M -curves (as I learned personally from Th. Fiedler)] ♥70
- [702] I. Itenberg, E. Shustin, *Singular points and limit cycles of planar polynomial vector fields*, Duke Math. J. 102 (2000), 1–37. [♠ Viro’s method of patchwork turns its jacket against the 2nd part of Hilbert’s 16th, on Poincaré’s limit-cycles of polynomial vector fields ♠ [30.04.13] at the more modest scale it should be observed that any dividing curve occurs via Ahlfors theorem (1950) as a sort of gyroscope once swept out by a totally real pencil. So any orthosymmetric curve induces a sort of periodic dynamical system, and maybe there is here another connection with the 2nd part of Hilbert’s 16th.] ♥??
- [703] I. Itenberg, *On the number of even ovals of a nonsingular curve of even degree in $\mathbb{R}P^2$* , in: Topology, Ergodic Theory, Real Algebraic Geometry, Amer. Math. Soc. Transl. Ser. 2, 202, Amer. Math. Soc., Providence, RI, 2001, 121–129. [♠] ♥??
- [704] V. Itenberg, I. Itenberg, *Symmetric sextics on a real projective plane, and auxiliary conics*, Zap. Nauchn. Sem. St.-Petersburg. Otdel. Mat. Inst. Steklov. (POMI) 279 (Geom. i Topol. 6) 154–167, 248–249 (2001). [♠] ♥??
- [705] I. Itenberg, E. Shustin, *Combinatorial patchworking of real pseudoholomorphic curves*, in: Proc. of 8th Gökova Geometry-Topology Conference, 2001. [♠ compare also the next two entries for more details] ♥??

- [706] I. Itenberg, E. Shustin, *Combinatorial patchworking of real pseudo-holomorphic curves*, Turkish J. Math. 26 (2002), 27–51. [♠ crude summary: Viro’s method without convexity assumption leads to pseudoholomorphic curves à la Gromov 1985 [548]] ♥12
- [707] I. Itenberg, *Construction of real algebraic varieties*, Feb. 26, 2002, 19pp. [♠ a fascinating overview of Hilbert’s 16th (up to the degree 8 unsettled case) and the question of quintic surfaces (79 references)] ♥??
- [708] I. Itenberg, E. Shustin, *Viro theorem and topology of real and complex combinatorial hypersurfaces*, Israel J. Math. 133 (2003), 189–238. [♠ crude summary: Viro’s method without convexity assumption (e.g. C -curves) leads to flexible curves à la Viro (1984 [1529]), therefore obeying all known prohibition of topological origins, compare p.193: “Moreover, any real C -curve in $\mathbb{C}P^2$ can be smoothed into a flexible curve in the sense of Viro 1984 [1529]. As a corollary, we obtain that arbitrary T -curves satisfy all topological restrictions known for real algebraic curves.” This prose looks a bit sloppy for Viro and Fiedler also discovered obstruction of non-topological origins, which a priori are not verified for flexible curves. ♠ p.191: “On the other hand, there exist *non-convex* triangulations. The simplest example is shown in Figure 1 (see for instance [5]=Connelly-Henderson 1980). Moreover, no efficient criterion for the convexity of a triangulation is known. There are examples of T -curves beyond the range of of known algebraic curves [28](=Santos 1994 [1330], WARNING here the labels are shifted in the original text), and there is some similarity between T -curves and algebraic curves: up to degree 6 any projective T -curve is isotopic to an algebraic one of the same degree [8](=Loera-Wicklin 1998), and vice versa, any nonsingular algebraic curve of degree at most 6 in $\mathbb{R}P^2$ is isotopic to a projective T -curve of the same degree. T -curves satisfy some consequences of the Bézout theorem [8](=Loera-Wicklin 1998), the Harnack inequality [18,15](=Itenberg 1995?, Haas 1997 [597]), and the complex orientation formula [24](=Parenti 1999 [1158]). Maximal T -curves satisfy the Ragsdale type inequality [15](=Haas 1997 [597], Preprint Basel), which is not proved for maximal real algebraic curves. It is natural to ask whether any T -curve is isotopic to an algebraic curve of the same degree, and if not, how far T -curves may differ from algebraic ones.” ♠ to be specific one would like to know exactly what happens in degree $m = 8$, i.e. which among the M -schemes of the Viro-Orevkov table Fig. 154 can be realized via T -curves?] ♥??
- [709] C. Jacob, *Sur le problème de Dirichlet dans un domaine plan multiplement connexe et ses applications à l’hydrodynamique*, J. Math. Pures Appl. 18 (1939), 363–383. G78 [♠ cf. also the next entry] ♥1
- [710] C. Jacob, *Introduction mathématique à la mécanique des fluides*, 1959. (ca. 1286 pp.) [♠] ♥106
- [711] C. G. J. Jacobi, *Considerationes generales de transcendentibus Abelianis*, Crelle J. Reine Angew. Math. 9 (1832), 394–403. [♠ Jacobi inversion problem, and first place where jargon like Abelian integrals are employed] ♥??
- [712] C. G. J. Jacobi, *Theoremata nova algebraica circa systema duarum aequationum inter duas variables propositarum*, J. für Mathematik 14 (18XX), 281–288; or *Gesammelte Werke, III*, 285–294. [♠ cited in Petrovskii 1938 [1168] for the so-called Euler-Jacobi formula (and earlier in Kronecker 1865/95 [885]), as being one of the tool towards Petrovskii’s proof of the extended Hilbert-Rohn theorem forcing the presence of nesting in M -curves (though Petrovskii’s inequalities have a universal validity)] ♥??
- [713] S. Jacobson, *Pointwise bounded approximation and analytic capacity of open sets*, Trans. Amer. Math. Soc. 218 (1976), 261–283. [♠ the Ahlfors function appears on p.261, 272, 274 in the context of analytic capacity, which is examined from the angle of the semi-additivity question (Vitushkin) ♠ the latter aspect has meanwhile been settled in the seminal breakthrough of Tolsa 2003 [1496] giving also a complete (geometric) solution to Painlevé’s problem] ♥1
- [714] A. Jaffe, S. Klimek, L. Lesniewski, *Representation of the Heisenberg algebra on a Riemann surface*, Comm. Math. Phys. 126 (1990), 421–433. [♠] ♥??
- [715] H. Jaffee, *Real algebraic curves*, Topology 19 (1980), 81–87. [♠ p.82: “We state Harnack’s Theorem in a slightly strengthened form which is probably due to Hurwitz:—THEOREM 2. Let (X, ρ, g, r) be as in §1. The number c of components of the space $X - X^\rho$ is at most 2. If $c = 2$, then $r \leq 1 + g$ and $g - r$ is odd. If $c = 1$, then $r \leq g$.” ♠ of course this is historical non-sense, read “Klein” in place

- of “Hurwitz” ♠ [05.01.13] the explanation for this historical mistake (alas quite widespread in literature) seems to find its origin in Gudkov’s survey 1974/74 [579], where Klein’s priority is not sufficiently emphasized! ♠ otherwise the paper is quite pleasant albeit quite elementary, especially it cites (p. 86) a preprint of Gross 1979 [551] which probably was phagocytosed in Gross-Harris 1981 [552]] ♡??
- [716] P. Järvi, *On some function-theoretic extremal problems*, Complex Variables Theory Appl. 24 (1994), 267–270. [♠ related to the Ahlfors function]★ ♡1
- [717] J. A. Jenkins, *On the existence of certain general extremal metrics*, Ann. Math. (2) (1957). [♠] ♡129
- [718] J. A. Jenkins, *Some new canonical mappings for multiply-connected domains*, Ann. Math. (2) 65 (1957), 179–196. AS60, G78 [♠ new derivation of the parallel-slit maps (and radial avatar) in the slightly extended context of rectangular multiply-connected domains (resp. radioactive) domains bounded respectively by rectangles or by rectangles in polar coordinates ♠ technique: the classical continuity method à la Brouwer-Koebe, but augmented by some quasi-conformal technology (à la Grötzsch, etc.)] ♡4
- [719] J. A. Jenkins, N. Suita, *On the Pick-Nevalinna problem*, Kōdai Math. J. 2 (1979), 82–102. [♣ includes probably an extension and thus also a new derivation of the Ahlfors circle map, compare also Heins 1975 [637] who probably already achieves this goal] ♡0
- [720] J. A. Jenkins, N. Suita, *On analytic maps of plane domains*, Kōdai Math. J. 11 (1988), 38–43. [♣ for D a plane bordered surface, an analytic map $f: D \rightarrow \Delta$ to another bordered surface is called *boundary preserving* if it takes boundary to boundary. “A boundary preserving map $f: D \rightarrow \Delta$ covers the image domain finitely many times. It can also be extended to the doubles as $\hat{D} \rightarrow \hat{\Delta}$. Now the Seveli-deFranchis’ theorem³³ states finiteness for the number of nonconstant analytic maps between two closed Riemann surfaces of genera both > 1 , hence we get as a dividend finiteness for the above boundary preserving maps, as soon as the genus of the doubles are > 1 . ♠ p.40: “Since f is boundary preserving, f has no branch points on the boundary.”, this is completely akin to the Ahlfors map ♠ of course the problematic addressed by Jenkins-Suita extends directly to bordered surface of positive genus, and it could be nice to work out corresponding bounds] ♡0
- [721] M. Jeong, *The Szegő kernel and a special self-correspondence*, J. Korea Soc. Math. Educ. Ser. B: Pure Appl. Math. 5 (1998), 101–108. [♠ the Ahlfors map is briefly mentioned in the following connection: “Since the zeroes of the Szegő kernel are parts of the zeroes of the Ahlfors map and give rise to a particular basis for the Hardy space $H^2(b\Omega)$ (see [5]=Bell 1995 [101]), they can be the powerful tools for getting the properties of the mapping for planar domains.”] ♡0
- [722] M. Jeong, M. Taniguchi, *Bell representations of finitely connected planar domains*, Proc. Amer. Math. Soc. 131 (2002), 2325–2328. [♠ a problem posed by Bell (1999/2000) is given a positive answer, even in the following sharper form: “Theorem 1.2. *Every non-degenerate n -connected planar domain with $n > 1$ is mapped biholomorphically onto a domain defined by $\{|z + \sum_{k=1}^{n-1} \frac{a_k}{z-b_k}| < 1\}$ with suitable complex numbers a_k and b_k .” ♠ the philosophy of such Bell’s domain is a sort of reverse engineering: instead of constructing the Ahlfors function of a given domain one first gives the function f and define the domain as $|f(z)| < 1$ ♠ p.2326, it is observed that Bell’s domains depend on $2n - 2$ complex parameters (so $4n - 4$ real parameters) exceeding the $3g - 3 = 3(n - 1) - 3 = 3n - 6$ real moduli predicted by Riemann-Schottky-Klein-Teichmüller ♠ this discrepancy is explained by the fact “that every Bell domain is actually associated with an n -sheeted branched covering of the unit disk”, for knowing the a_k, b_k we may construct the circle-map $f(z) = z + \sum_{k=1}^{n-1} \frac{a_k}{z-b_k}$ (call it the Bell representation) ♠ of course the question arise of describing the “Ahlfors locus” (within the Hurwitz space) of those parameters a_k, b_k such that the Bell representation is actually an Ahlfors extremal function ♠ this problem is reposed again in Taniguchi 2004 [1481] ♠ from the more traditional point view, starting form an n -connected domain (with contours C_1, \dots, C_n) one can construct a circle map (of minimal degree n) by prescribing boundary points $p_i \in C_i$ mapping to $1 \in S^1$ (Bieberbach-Grunsky), thus roughly speaking circle maps depends over n parameters, whereas the Ahlfors functions f_a (or $f_{a,b}$) depend*

³³Severi perhaps? Try also Hurwitz??

- only on 2 real parameters (resp. 4) ♠ compare maybe Agler-Harland-Raphael [12] (and its MathReview summary) for a description of the Grunsky functions as the extreme points of the compact convex set of holomorphic functions with positive real parts normalized by $f(z_0) = 1$ for some fixed interior point] ♡12
- [723] M. Jeong, *The exact Bergman kernel and the extremal problem*, Kangweon-Kyungki Math. J. 13 (2005), 183–191. [♠ the Ahlfors map appears twice on p. 185–6] ♡0
- [724] M. Jeong, J.-W. Oh, M. Taniguchi, *Equivalence problem for annuli and Bell representations in the plane*, J. Math. Anal. Appl. 325 (2007), 1295–1305. [♠ the Ahlfors function is employed in the problem of determining the parameter for which a certain doubly connected domain of Bell, namely $|z + z^{-1}| < r$, is conformal to a circular (concentric) ring] ♡6
- [725] G. Jones, D. Singerman, *Belyi functions, hypermaps and Galois groups*, Bull. London Math. Soc. 28 (1996), 561–590. [♠] ♡??
- [726] P. W. Jones, D. E. Marshall, *Critical points of Green’s function, harmonic measure, and the corona problem*, Ark. Mat. 23 (1985), 281–314. A47, A50 [♠ p. 293–4 the Ahlfors function enters into the dance as follows: “We mention one more method for solving the corona problem. The previous methods have the drawback that Green’s function does not ignore subsets of $\partial\mathcal{R}$ which have zero analytic capacity and positive logarithmic capacity. To avoid this we can use Ahlfors’ function, A , instead. Ahlfors’ function for a point $\zeta_0 \in \mathcal{R}$ is defined by $A'_{\zeta_0}(\zeta_0) = \sup\{\operatorname{Re}f'(z_0) : f \in H^\infty(\mathcal{R}), \|f\|_\infty \leq 1\}$. [...] Ahlfors [1](=1947), [2](=1950) has shown that for our “nice” Riemann surfaces $|A_{\zeta_0}(\zeta)| = \exp\{-\sum_{j=0}^{n-1} g(\zeta, \zeta_j)\}$ for some points $\zeta_1, \dots, \zeta_{n-1} \in \mathcal{R}$. [...] Then all of the results of this section hold for the critical points of Ahlfors’ function $\{w_{j,k}\}$ as well as for the critical points of G . One can easily construct Riemann surfaces where $\sum_k G(\zeta_k, \zeta') = \infty$, so that the methods using the critical points of G will not work, yet this method using Ahlfors’ function gives solution to the corona problem. [...] We remark that we chose the Ahlfors function here because of its natural association with $H^\infty(\mathcal{R})$, but we could have chosen any function $F \in H^\infty(\mathcal{U})$ with $-\log|F(z)| = \sum_{j=1}^m G(\pi(z), \alpha_j)$, $\alpha_j \in \mathcal{R}$.” ♠ p. 286: “If \mathcal{R} is a planar domain, then it is a simple consequence of the argument principle that $G(\zeta, \pi(0))$ has $N - 1$ critical points (counting multiplicity), where N is the number of closed boundary curves. See e.g. [33](=Nehari 1952 [1081])³⁴ More generally, the number of critical points of G is the first Betti number, or the number of generators of the first singular homology group, of \mathcal{R} [46](=Widom 1971 [1591]), and hence is finite. See Walsh [44, Chap. VII](=Walsh 1950 [1563]) for more information concerning the location of the critical points.”] ♡36
- [727] P. W. Jones, T. Murai, *Positive analytic capacity but zero Buffon needle probability*, Pacific J. Math. 133 (1988), 99–114. [♠ self-explanatory, i.e. a counter-example to the Vitushkin conjecture (that a plane compactum is a Painlevé null-set iff it is invisible, i.e. a.e. projection of the set have zero length) ♠ note: the Buffon needle problem was solved by Crofton in 1868: if E is a compactum in the plane, let $|P_\theta(E)|$ be the Lebesgue measure of the orthogonal projection of E_θ on the line of angular slope θ and define the Crofton invariant as $CR(E) = \int_0^{2\pi} |P_\theta(E)| d\theta$. This quantity may be interpreted as the probability of the body E falling over a system of parallel lines equidistantly separated by the diameter of E] ♡36
- [728] P. W. Jones, *Square functions, Cauchy integrals, analytic capacity, and harmonic measure*, in: Proc. Conf. on Harmonic Analysis and Partial Differential Equations, El Escorial 1987, Lecture Notes in Math. 1384, Springer-Verlag, 1989, 24–68. [♠] ♡??
- [729] P. W. Jones, *Rectifiable sets and the travelling salesman problem*, Invent. Math. 102 (1990), 1–16. [♠] ♡??
- [730] C. Jordan, *Sur la déformation des surfaces*, J. Math Pures Appl. (2) 11 (1866), 105–109. [♠ after Möbius 1863 [1028] in the closed case, discuss a classification of compact orientable bordered surfaces, by the genus and the number of contours ♠ quoted in Klein’s lectures 1892/93 [803, p. 150], and in Weichold 1883 [1570, p. 330], who need the non-orientable case as well] ♡17
- [731] J. Jost, *Conformal mappings and the Plateau-Douglas problem in Riemannian manifolds*, J. Reine Angew. Math. 359 (1985), 37–54. [♠ reprove some results about conformal mapping (uniformization of real orthosymmetric curves) surely

³⁴Try also Nevanlinna.

well-known since Koebe's era (and conjectured by Klein) via the method of Plateau ♠ then attack and solve a very general case of Plateau's problem in a generality unifying the desire of Douglas (positive genus) and Morrey (curvy ambient Riemannian manifold instead of flat Euclid) ♠ reports also some of Tromba's critics over the solution of Courant to the Plateau-Douglas problem of higher genus ♣ it is not clear to the writer if such critics (of Tromba) affects as well the whole content of Courant's book 1950 [338] especially regarding the varied type of conformal maps ♠ at any rate Jost propose a parade using techniques of Mumford and Schoen-Yau, but the "meandrousness" of the resulting proof is slightly criticized in Hildebrandt-von der Mosel 2009 [671]] ♡36

- [732] J. Jost, *Two-dimensional geometric variational problem*, Wiley, New York, 1991. [♠ from Sauvigny's review in BAMS: "Chapter 3 deal with conformal representation of surfaces homeomorphic to the sphere S^2 , circular domains, and closed surfaces of higher genus. The proof is given by direct variational methods and not as usual by uniformization, completing a fragmentary proof of Morrey.] ♡??
- [733] G. Julia, *Sur la représentation conforme des aires simplement connexes*, C. R. Acad. Sci. Paris 182 (1926), 1314–1316. [♠ another characterization of the (Riemann) mapping function by a minimum principle] ♡??
- [734] G. Julia, *Développement en série de polynômes ou de fonctions rationnelles de la fonction qui fournit la représentation conforme d'une aire simplement connexe sur un cercle*, Ann. Éc. Norm. Sup. 44 (1927), 289–316. [♠ Seidel's summary: a determination of a sequence of polynomials is given which converges to the properly normed (Riemann) mapping function of a simply-connected region] ♡??
- [735] G. Julia, *Leçon sur la représentation conforme des aires simplement connexes*, Gauthier-Villars, Paris, 1931. [♠ one among the early book format exposition of the extremal properties of the Riemann mapping for a plane simply-connected region (distinct of \mathbb{C}), namely that the range of the map normalized by $f'(z_0) = 1$ has minimal area (first in Bieberbach 1914 [142]) or that the boundary of the range has minimal length (probably first in Szegő 1921 [1476]) ♠ for both those extremal principles see also the detailed treatment in the book Gaier 1964 [473]] ♡16
- [736] G. Julia, *Sur la représentation conforme des aires multiples connexes*, Ann. Sc. Norm. Sup. Pisa (2) 1 (1932), 113–138. G78 [♠ still in great admiration for Schottky 1877 [1366] and use Klein's jargon of orthosymmetry, yet confined to the case of domains ♠ however the main purpose is the study of a new sort of mapping introduced by de la Vallée Poussin (and which will in turn fascinate Walsh and Grunsky)] ♡??
- [737] G. Julia, *Reconstruction d'une surface de Riemann σ correspondant à une aire multiples connexe \mathcal{A}* , C. R. Acad. Sci. Paris 194 (1932), 423–425. AS60 ♡??
- [738] G. Julia, *Prolongement d'une surface de Riemann σ correspondant à une aire multiples connexe \mathcal{A}* , C. R. Acad. Sci. Paris 194 (1932), 580–583. AS60 ♡??
- [739] G. Julia, *Leçon sur la représentation conforme des aires multiples connexes*, Gauthier-Villars, Paris, 1934, 94 pp. AS60, G78 [♠] ♡20
- [740] G. Julia, *La représentation conforme des aires multiples connexes*, L'Enseign. Math. 33 (1935), 137–168. G78 [♠ survey from Riemann, Schottky 1877 [1366] through Hilbert 1909 [668], Koebe, up to the extremal treatments by de Possel and Grötzsch (slit mappings in infinite connectivity)] ♡??
- [741] G. Julia, *Quelques applications fonctionnelles de la topologie*, Reale Accademia d'Italia Fondazione A. Volta, Att dei Convegni 9 (1939), Rome, 1943, 201–306. AS60 [♠ cited in Ahlfors-Sario 1960]★★★ ♡??
- [742] M. Juurchescu, *A maximal Riemann surface, ????* ?? (1961?), 91–93. [♠ p. 91, a map between bordered Riemann surfaces taking boundary to boundary is termed *distinguished*] ♡3
- [743] G. Kahn, *Eine allgemeine Methode zur Untersuchung der Gestalten algebraischer Kurven*, Inaugural Dissertation, Göttingen, 1909. [♠ Dissertation under Hilbert (cf. e.g. Hilbert 1909 [669]), attempting to prohibit the real sextic scheme consisting of 11 unnested ovals ♠ considered non-rigorous in Gudkov 1974 [579] ♠ historical anecdote: Kahn's work as well as the related Thesis by Löbenstein 1910 [950] were instead considered as rigorous in Hilbert 1909 [669]] ♡??
- [744] S. Kakutani, *Rings of analytic functions*, Lectures on functions of a complex variable, 71–83, Univ. of Michigan Press, Ann Arbor, 1955. [♠]★ ♡??

- [745] C. Kalla, Ch. Klein, *On the numerical evaluation of algebro-geometric solutions to integrable equations*, Nonlinearity 25 (2012), 569–596. [♠] ♥5
- [746] C. Kalla, Ch. Klein, *Computation of the topological type of a real Riemann surface*, arXiv (2012). [♠] ♥0
- [747] L. V. Kantorovič, *FOUR ARTICLES IN FRENCH in the period 33–34 including multi-connected and potentially based upon Bieberbach’s method* ★★★ ♥??
- [748] L. V. Kantorovič, V.I. Krylov, *Methods for the approximate solution of partial differential equations*, Leningrad–Moscow, 1936, Russian. [♠ Chap.V is devoted to conformal mapping. §1 is introductory. §2 takes up the method of Bieberbach (1914 [142]) which reduces the problem of conformal mapping to a minimum principle (for the area). This is then solved by Ritz’s method. In §3 a second extremal property for mapping functions is discussed and Ritz’s method is again applied §4 takes up orthogonal polynomials of Szegö and Bochner-Bergman types and applies them to the above minimizing problems.] ★★★ ♥??
- [749] V. Karimipour, A. Mostafazadeh, *Lattice topological field theory on nonorientable surfaces*, J. Math. Phys. 38 (1997), 49–66. [♠] ♥??
- [750] M. G. Katz, S. Sabourau, *Hyperellipticity and systoles on Klein surfaces*, Geom. Dedicata 159 (2012), 277–293. [♠] ♥??
- [751] S. Katz, C.-C. M. Liu, *Enumerative geometry of stable maps with Lagrangian boundary conditions and multiple covers of the disc*, Geom. Topol. Monogr. 8 (2006), 1–47; reproduced from: Adv. in Theoret. Math. Phys. 5 (2002), 1–49. [♠] ♥100?
- [752] M. V. Keldysh, M. A. Lavrentief, *Sur la représentation conforme des domaines limités par des courbes rectifiables*, Ann. Sci. Éc. Norm. Sup. 54 (1937), 1–38. [♠ only the case of simply-connected domains bounded by a rectifiable Jordan curve in the plane, but deep questions about the boundary behavior of the Riemann map φ as well as the Smirnov problem of deciding when the harmonic function $\log |\varphi'(w)|$ is representable in the unit-disc by the Poisson integral of its (limiting) values on the circumference] ♥??
- [753] M. V. Keldysh, *Sur la résolubilité et la stabilité du problème de Dirichlet*, C. R. Acad. Sci. URSS 18 (1938), ???–??? (French). [♠ quoted in Walsh-Sinclair 1965] ★★★ ♥??
- [754] M. V. Keldysh, *Sur l’approximation en moyenne quadratique des fonctions analytiques*, Mat. Sb. (N.S.) 5 (1939), 391–401. [♠ quoted in Walsh-Sinclair 1965] ★★★ ♥??
- [755] M. V. Keldysh, *Conformal mappings of multiply connected domains on canonical domains*, (Russian) Uspehi Mat. Nauk 6 (1939), 90–119. G78 [♠ a survey of the developments in the field, up to 1939] ♥??
- [756] O. D. Kellogg, *Foundations of potential theory*, Grundle. d. math. Wiss. 31, Springer, Berlin, 1929. [♠ “Introduction to fundamentals of potential functions covers: the force of gravity, fields of force, potentials, harmonic functions, electric images and Green’s function, sequences of harmonic functions, fundamental existence theorems, the logarithmic potential, and much more.”] ♥2284
- [757] G. Kempf, *Schubert methods with an application to algebraic curves*, Stichting mathematisch centrum, Amsterdam, 1971. [♠ the first (simultaneous with Kleiman-Laksov 1972 [788]) existence proof of special divisors in the general case, extending thereby the result of Meis 1960 [993]] ♥??
 ★ Johannes Kepler (1571–1630), a contemporary of Galileo (1564–1642), was born in Weil der Stadt (close to Stuttgart). He studied in Tübingen mathematics, astronomy, and theology. Then he visited Tycho Brahe in Prag (the famous Dane astronomer)
- [758] Johannes Kepler, *Astronomia nuova*, Heidelberg, E. Vögelin, 1609. [♠ announcement of Kepler’s first two laws of astronomy (1) the planets move about the sun in elliptical orbits with the sun at one focus, and (2) the radius vector joining a planet to the sun sweeps out equal areas in equal times. ♠ this breakthrough of Kepler was based on the deep experimental data collected by Tycho Brahe the Dane scholar working in Prague.] ♥??
- [759] Johannes Kepler, *Harmonices Mundi Libri V*, 1619. [♠ where the third law is formulated: “3. die Quadrate dre Planetenumlaufzeiten sind proportional den Kuben der mittleren Entfernungen zur Sonne.”] ♥??

- [760] B. Kerékjártó, *Vorlesungen über Topologie I, Flächen Topologie*, Springer, Berlin, 1923. [♠ a seminal work (Part II never occurred) with parcelled appreciation (disliked by Lefschetz but admired by Weyl) ♠ cited in Natanzon 1993 [1070, p. 268] for the basic result that one may lift a complex structure under a branched covering ♠ [30.12.12] boosting somewhat the method one could hope to reprove so the Ahlfors theorem] ♡??
 ★★★ Kleiner Gabard as he joked to write, when he noticed that our modest work was somewhat overinfluenced by the genius of Düsseldorf (Felix Klein 1849–1924). More pragmatically, it is not coincidence that Grosser Kervaire was born in the same Polish city as one of the big hero of the present theory, namely Stefan Bergman, which in philosophical substance can either be either zipped to Bieberbach 1914 or to E. Schmidt the professor of Heinz Hopf, in turn that of Kervaire.
- [761] M. Kervaire, J. Milnor, *On 2-spheres in 4-manifolds*, Proc. Nat. Acad. Sci. U.S.A. 47 (1961), 1651–1657. [♠ as noted in Kronheimer-Mrowka 1994 [886]] ♡??
- [762] N. Kerzman, E. M. Stein, *The Cauchy kernel, the Szegő kernel, and the Riemann mapping function*, Math. Ann. 236 (1978), 85–93. [♠ quite influential, especially over Bell] ♡??
- [763] G. Khajalia, *Sur la représentation conforme des domaines doublement connexes*, (French) Mat. Sb. N. S. 8 (1940), 97–106. G78 [♠ Seidel’s summary: the problem of mapping a doubly connected finite region on a circular ring is reduced to minimizing an area integral for a certain class of functions. If the region is accessible from without, then a sequence of minimal rational fractions converges uniformly to the desired mapping function ♠ in fact the condition in question seems to ensure the least area map (minimizing $\int \int_B |f'(z)|^2 d\omega$) to be schlicht and maps it upon the concentric circular ring $1 < |w - w_0| < R$, thus the problem is different from that à la Bieberbach-Bergman handled in Kufareff 1935/37 [891] where the least area map is not univalent ♠ a naive question [05.08.12] is whether Khajalia’s method could perform the Kreisnormierung in higher connectivity] ♡??
 ★ Viatcheslav Kharlamov, an eminent student of V. A. Rohlin, famous for having solved (in 1972 [764]) the second quarter of Hilbert’s 16th problem, namely the maximum number of components that a real quartic surface in 3-space can have. Answer 10, and not just 12 as Rohn was able to bound in 1886 (Rohn 1886 [1293]) which was the upper-bound known at the day of Hilbert’s report at the Paris Congress (1900).
- [764] V. M. Kharlamov, *The maximum number of components of a surface of degree 4 in $\mathbb{R}P^3$* , Funkt. Anal. Prilozhen. 6 (1972), 101; English transl., Funct. Anal. Appl. 6 (1973), 345–346. [♠ besides Gudkov 1969, yet another solution to one part of Hilbert’s 16th problem (or even Rohn 1886 [1293]) asking for the maximum number of “sheets” of a 4th order surface in 3D-space (Kharlamov’s answer 10 appears already in his Master Thesis 1972, while Rohn 1886 only produced the estimate ≤ 12) ♠ Kharlamov’s solution of this part of Hilbert’s 16th combines the Petrovskii-Oleinik inequality (1949 [1170]) and the Hirzebruch-Atiyah-Singer formula, plus some elements of Smith’s theory namely that a Galois-maximal involution on a manifold induces identity on the (co)homology mod 2 and the divisibility by 8 of the signature of an unimodular even integral bilinear form] ♡??
- [765] V. M. Kharlamov, *New congruences for the Euler characteristic of real algebraic manifolds*, Funkt. Anal. Prilozhen. 7 (1973), 74–78; English transl., Funct. Anal. Appl. 7 (1973), 147–150. [♠ cited in Wilson 1978 [1594] for an $(M - 1)$ -avatar (i.e. $p - n = k^2 \pm 1 \pmod{8}$) of the Gudkov-Rohlin congruence modulo 8 (i.e. $p - n = k^2 \pmod{8}$)] ♡??
- [766] V. M. Kharlamov, *Generalized Petrovskii inequality*, Funkt. Anal. Prilozhen. 9 (1974), 50–56; English transl., Funct. Anal. Appl. 9 (1974), ?–?. [♠] ♡??
- [767] V. M. Kharlamov, *Generalized Petrovskii inequality II*, Funkt. Anal. Prilozhen. 10 (1975), 93–94; English transl., Funct. Anal. Appl. 10 (1975), ?–?. [♠] ♡??
- [768] V. M. Kharlamov, *The Additional congruences for the Euler characteristic of even dimensional real algebraic varieties*, Funkt. Anal. Prilozhen. 9 (1975), ?–?; English transl., Funct. Anal. Appl. 9 (1975), 134–141. [♠ somewhat sloppily cited in Trilles 2003 [1501] for a proof of the RKM-congruence ensuring type I, but alas in Rohlin 1978 where the result is stated for the first time the proof is said to be not yet published. Arguably with some extra efforts this paper by Kharlamov can be used to derive a proof of RKM, yet details needs probably to worked out.] ♡??

- [769] V. M. Kharlamov, *The topological type of nonsingular surfaces in $\mathbb{R}P^3$ of degree four*, Funkt. Anal. Prilozhen. 10 (1976), 55–68; English transl., Funct. Anal. Appl. 10 (1976), 295–305. [♠ topological classification of nonsingular quartics surfaces in 3-space resting on the theory of K3 surfaces (via Tyurina, but *not* via Torelli’s theorem of Pyatetsky-Shapiro-Shafarevich 1971/71 [1229])] ♡??
- [770] V. M. Kharlamov, *Isotopic types of nonsingular surfaces of fourth degree in $\mathbb{R}P^3$* , Funkt. Anal. Prilozhen. 12 (1978), 86–87; English transl., Funct. Anal. Appl. ? (197?), ?–?. [♠] ♡??
- [771] V. M. Kharlamov, *Petrovskii’s inequalities for real plane curves*, Uspekhi Mat. Nauk 33 (1978), 146. [♠] ♡??
- [772] V. M. Kharlamov, *Real algebraic surfaces*, Proc. Internat. Congr. of Mathematicians, Helsinki, 1978, 421–428. [♠] ♡??
- [773] V. M. Kharlamov, O. Ya. Viro, *Congruences for real algebraic curves with singularities*, Uspekhi Mat. Nauk 35 (1980), 154–155; English transl., ?? (198?), ?–?. [♠ cited in Kharlamov-Viro 1988/91 [778]] ♡??
- [774] V. M. Kharlamov, *On the number of components of an M -surface of degree 5 in $\mathbb{R}P^3$* , Proc. of the XVI Soviet Algebraic Conference, Leningrad, 1981 (Russian). [♠ contains a proof of the estimate $b_0 \leq 25$ for the number of components of a real quintic in 3-space, and construct a surface with $b_0 = 21$ ♠ presently the best upper-bound realized presently is $b_0 = 23$, compare Bihan 1999 [161] and Orevkov 20XX [1127], yet the cases $b_0 = 24, 25$ are still wide open] ♡??
- [775] V. M. Kharlamov, *Rigid classification up to isotopy of real plane curves of degree 5*, Funkt. Anal. Prilozhen. 15 (1981), 88–89; English transl., Funct. Anal. Appl. 15 (1981), 73–74. [♠ as a historical curiosity the same result in degree 6 was effected earlier in Nikulin 1979/80 [1107]] ♡??
- [776] V. M. Kharlamov, *On the classification of non-singular surfaces of degree 4 in $\mathbb{R}P^3$ with respect to rigid isotopies*, Funkt. Anal. Prilozhen. 18 (1984), 49–56; English transl., Funct. Anal. Appl. 18 (1984), 49–56. [♠ a rigid isotopy classification of quartics surfaces paralleling somehow the rigid isotopy classification of sextic curves due to Nikulin 1979 [1107] on the basis of Rohlin 1978 decoration via Klein’s types of Gudkov’s (1969) census.] ♡??
- [777] V. M. Kharlamov, *The topology of real algebraic manifolds (commentary on papers No. 7,8)*, in: I. G. Petrovskii Selected Works, Systems of Partial Differential Equations, Algebraic Geometry, Nauka, Moscow, 1986, 465–493; see also an English translation (with slight imprecisions) published in Kharlamov 1996 [781]. [♠ cited in Kharlamov-Viro XXXX (undated) [779] (p.15) as supplying a *detailed discussions of the content and impact of Petrovskii’s work.*] ♡??
- [778] V. M. Kharlamov, O. Viro, *Extensions of the Gudkov-Rohlin congruence*, in: Topology and Geometry, Rohlin Seminar, edited by O. Ya. Viro, 1984–86, Lecture Notes in Math. 1346, Springer (1988 or 1991? CHECK DATE), 357–406. [♠ p. 359: “type I or dividing” ♠ contains a good discussion of the trinity of congruence mod 8 (Gudkov-Rohlin, Gudkov-Krakhnov-Kharlamov, (Rohlin-)Kharlamov-Marin) and an extension thereof to singular curves ♠ if one is only interested in the smooth case it is not clear if the proposed proof is the optimal route ♠ for the classical smooth case it is perhaps still advisable to refer back to the 2nd (correct proof) by Rohlin, or the first one as repaired in Marin 1979 [963]] ♡??
- [779] V. M. Kharlamov, O. Viro, *Easy reading on topology of real plane algebraic curve*, UNDATED but (ca. 1978–2013), i.e. a shortened version of the book planned (but apparently never completed) by Rohlin-Kharlamov-Viro. [♠ [21.03.13] p. 15, contains valuable information on Ragsdale, yet overlapping with Itenberg-Viro 1996 [701]. It seems to me (Gabard) that one-half of the Ragsdale conjecture follows from Thom³⁵, cf. Lemma in v.2, and so answers one half of question 10.E posed on p. 15 (where incidentally it seems to me that there is the same misprint as in Itenberg-Viro 1996 [701])] ♡??
- [780] V. M. Kharlamov, O. Viro, *Towards the maximal number of componenets of a non-singular surface of degree 5 in $\mathbb{R}P^3$* , in: Transl. AMS, Ser. 2, vol. 173, 1996, 111–118. [♠ discusses the problem of the maximum number of component for a quintic surface, notably the bound $b_0 \leq 25$ (cf. also Kharlamov 1981 [774]) and

³⁵[26.03.13] This is a misconception of Gabard, that was corrected in Fiedler’s letter dated [21.03.13].

- present the construction of a quintic surface with $b_0 = 22$ components ♠ for a progression to $b_0 = 23$, cf. Bihan 1999 [161] and Orevkov 20XX [1127]] ♡??
- [781] V. M. Kharlamov, *Topology of real algebraic manifolds*, in: I. G. Petrowsky, Selected works, Part 1, System of Partial Differential Equations and Algebraic Geometry, Classics of Soviet Mathematics, vol. 5, 1996, 111–118. [♠ a brilliant survey of Petrovskii’s work in the field and its ramification (Arnold, Rohlin, etc.)] ♡??
- [782] D. Khavinson, *On removal of periods of conjugate functions in multiply connected domains*, Michigan Math. J. 31 (1984), 371–379. A50 [♠ p. 377 reproves the Bieberbach-Grunsky-Ahlfors theorem in the planar case while quoting Heins 1950 [634] and using the classical device of annihilating “the periods of the conjugate function”] ♡8
- [783] A. G. Khovanskii, *Newton polygons and toric manifolds*, Funkts. Anal. i Prilozhen. 11 (1977), 56–67; English transl., Funct. Anal. Appl. 11 (1977), 289–296. [♠ often cited in the context of Viro’s method, e.g. in Viro 89/90 [1535], Risler 1992 [1264]]. ♡??
- [784] A. G. Khovanskii, *Newton polygons (resolution of singularities)*, Contemp. Prob. in Math. 22, Moscow, 1983, 206–239. [♠ cited in Viro 89/90 [1535]]. ♡??
- [785] R. Kirby, *Problems in low-dimensional topology*, 1970, updated in 1995 (available on the net). [♠ Thom’s conjecture is mentioned as Problem 4.36, where the proof of Kronheimer-Mrowka 1994 and Morgan-Szabó-Taubes 1995 are cited] ♡464
- [786] G. Kirchhoff, *Über das Gleichgewicht und die Bewegung einer elastischen Scheibe*, J. Reine Angew. Math. 40 (1850), 51–88. [♠ Riemann was aware of this ref. in connection to the Dirichlet principle (cf. Neuenschwander 1981 [1085]), yet never mentions it in print ♠ the next big revolution is Ritz, see Gander-Wander 2012 [493] for a thorough “mise en perspective”] ♡464
- [787] S. Kirsch, *Transfinite diameter, Chebyshev constant and capacity*, in: Handbook of Complex Analysis, Elsevier, 2005. A50 [♠ extract from the web (whence no page): “Ahlfors generalized Garabedian’s result to regions on Riemann surfaces [2](=Ahlfors 1950 [19]); see Royden’s paper [159](=1962 [1305]) for another treatment as well as further references to the literature.” ♠ compare (if you like) our (depressive) dissident section in v.2 for a complete list of “dissident” authors having apparently (like me) some pain to digest Ahlfors proof, and therefore cross-citing often Royden ♠ “Abstract. The aim of the present chapter is to survey alternate descriptions of the classical transfinite diameter due to Fekete and to review several generalizations of it. Here we lay emphasis mainly on the case of one complex variable. We shall generalize this notion. . .”]★★ ♡9
- [788] S. L. Kleiman, D. Laksov, *On the existence of special divisors*, Amer. J. Math. 94 (1972), 431–436. [♠ cite Riemann 1857 [1256], Hensel-Landsberg 1902 [649] for linear series of dimension 1, and Brill-Noether 1874 [190], Severi 1921 [1394] in the general case ♠ supplies an existence proof of its title via Schubert calculus, Poincaré’s formula, some EGA (=Grothendieck), and a bundle constructed in Kempf’s Thesis ♠ compare Kempf 1971 [757] for a simultaneous solution of the same fundamental problem ♠ [08.10.12] since this Kempf-Kleiman-Laksov result includes as a special case the result of Meis 1960 [993], it enables one eradicating Teichmüller theory from the gonality problem (this is not so surprising for Poincaré’s formula is essentially “homology theory” (intersection theory) specialized to the Jacobian variety, and the theta-divisor, image the $(g - 1)$ -symmetric power $C^{(g-1)}$ of the curve into the Jacobian via the Abel map ♠ thus roughly speaking (and with some imagination) we are back to the method used in Gabard 2006 [463] ♠ for less arrogant looseness it would be nice to adapt the methods of Kempf/Kleiman-Laksov to the problem of the Ahlfors mapping with sharp bounds (i.e. like in Gabard 2006 [463] granting of course the latter to be correct, else)] ♡73
- [789] S. L. Kleiman, D. Laksov, *Another proof of the existence of special divisors*, Acta Math. 132 (1974), 163–176. [♠ cite Gunning’s work of 1972 [592] as an alternative to Meis’ (for linear series of dimension 1) ♠ novel proof via the theory of singularities of mappings (Thom polynomial, Porteous’ formula, plus influence of Mattuck) ♠ [08.10.12] like in the previous entry, try again to specialize the Thom-Porteous technique to the context of real algebraic geometry (orthosymmetric curve à la Klein) so as to recover the circle maps of Ahlfors 1950 [19], optionally with the bound of Gabard 2006 [463] ♠ of course the view point of special divisors (=essentially those moving in linear systems g_d^r of dimensions higher than predicted by Riemann’s inequality $\dim |D| \deg D - g$ (due to the g constraints imposed by

Abelian differentials) seems to indicate that the theory of the Ahlfors map is just the top of a much larger iceberg, probably already partially explored by experts (Coppens, Huisman, Ballico, Martens, Monnier, etc.) ♡63

★ Felix Klein (May 25, 1849–June 22, 1925, aged 76), one of the leading mathematicians in Germany in the latter half of the 19th century. Born in Düsseldorf and graduated at Bonn (by Plücker), Klein went to study in Paris. In 1872, Professor at Erlangen, and in 1886 in Göttingen (until his death). His accomplishments covers all aspects of mathematics, but his main field was geometry. Bird’s-eye view of all the then known field of geometry from the standpoint of group theory, referred to as the Erlangen program, where both Euclidean and non-Euclidean geometry are included in projective geometry. Spent the greatest of his energy in the field of automorphic functions. [All this prose is borrowed from the Japanese encyclopedia EDM [393].] More informally, the influence of Klein is evident both upon Arnold, Rohlin. Earlier the influence on Teichmüller is transparent, and Klein is probably the first serious candidate beside Riemann and Schottky for the paradigm of total reality.

[790] F. Klein, *Über die sogenannte Nicht-Euklidische Geometrie*, Math. Ann. 4 (1871), also in Ges. math. Abh. I, 244–253. [♠] ♡??

[791] F. Klein, *Über Flächen dritter Ordnung*, Math. Ann. 6 (1873), also in Ges. math. Abh. II, 11–62. [merely cited for Plücker 1839 [1187] as being the oldest user (recorded) of the method of “small perturbation”, compare also Gudkov 1974/74 [579] whose first entry in his Refs. list is Plücker 1839 ♠ “Wenn eine Kurve mit Doppelpunkten gezeichnet vorliegt, so kann man aus ihr Kurven derselben Ordnung ohne Doppelpunkt oder mit weniger Doppelpunkten schematisch ableiten, indem man die in den Doppelpunkten oder einigen derselben zusammenstoßenden Kurvenäste durch ähnlich verlaufende, sich nicht treffende ersetzt. Nach diesem ebenso einfachen als fruchtbaren Prinzip [footnote=Wer diese Prinzip zuerst verwendet hat, läßt sich bei dessen großer Selbstverständlichkeit wohl kaum feststellen. Dem Verf. is dasselbe, sowie namentlich das Beispiel der Erzeugung einer Kurve n -ter Ordnung aus n geraden Linien, von Plücker her bekannt: vgl. z. B. dessen Theorie der algebraischen Kurven (1839), in welcher fortwährend ähnliche Überlegungen angewandt werden.] erhält man z. B. ohne weiteres die beiden Grundformen der ebenen Kurven dritter Ordnung, wenn [...]”] ♡??

[792] F. Klein, *Bemerkungen über den Zusammenhang der Flächen*, (zwei Aufsätze aus den Jahren 1874 und 1875/76), Math. Ann. 7, 9 (1874, 1875/76), also in Ges. math. Abh. II, 63–77. [♠ some discussions with Ludwig Schläfli about the topology of surfaces (especially in the non-orientable case) ♠ taken together with the earlier works of Riemann, Möbius 1860/63 [1028] and Jordan 1866 [730] this constitutes a complete classification of finite(=compact) surfaces be they orientable or not, bordered or closed ♠ this classification is of course instrumental to Klein’s classification of the topology of real algebraic curves (equivalently symmetric Riemann surfaces), as discussed in Klein 1876 [795], Klein 1882 [797] or Klein 1892 [801], as well as in Weichold 1883 [1570]] ♡??

[793] F. Klein, *Über eine neue Art der Riemannschen Flächen* (Erste Mitteilung), Math. Ann. 7 (1874), also in Ges. math. Abh. II, 89–98. [♠ first apparition of some “new” types of Riemann surface, which later will evolve to the concept of “Klein surfaces”, but at this stage this is merely a synthetic visualization of the complex locus of a plane curve defined over the reals upon the real projective plane via the map assigning the unique real point of an imaginary line. Also this is not yet “*was ich den “echten” Riemann zu nennen pflege*” as Klein expresses himself in the Introd. to volume 2 of his Coll. Papers [807, p. 5] ♠ however it is obvious that this mode of representation is almost forgotten by now and perhaps it could be useful in the future (e.g., to reprove the Rohlin inequality saying that plane dividing curves have at least as many ovals than their half degree, cf., e.g., Gabard 2000 [461] for more details and the original refs.)] ♡??

[794] F. Klein, *Über den Verlauf der Abelschen Integrale bei den Kurven vierten Grades* (Erster Aufsatz), Math. Ann. 10 (1876); also in Ges. math. Abh. II, 99–135. ♡??

[795] F. Klein, *Über eine neue Art von Riemannschen Flächen* (Zweite Mitteilung), Math. Ann. 10 (1876), also in Ges. math. Abh. II, 136–155. [♠ p. 154 the first place where the dichotomy of “dividing” curves appears, under the designation “Kurven der ersten Art/zweiten Art” depending upon whether its Riemann surface is divided or not by the real locus (this is from where derived the Russian terminology type I/II) [hopefully Klein came up later with the better terminology ortho-

- vs. diasymmetric!] ♠ p.154 contains also the first intrinsic proof of the Harnack inequality (1876) ♥28
- [796] F. Klein, *Ueber die conforme Abbildung von Flächen*, Math. Ann. 19 (1882), 159–160. [♠ a lovely announcement of the next item [797], showing a little influence of Schwarz (Ostern 1881). NB: item not reproduced in the Ges. math. Abh.] ♥??
- [797] F. Klein, *Über Riemann's Theorie der algebraischen Funktionen und ihrer Integrale* B. G. Teubner, Leipzig, 1882. AS60 [♠ a masterpiece where Klein's theory reaches full maturity ♠ long-distance influence upon Teichmüller 1939 [1484] (moduli problems including the case of possibly non-orientable surfaces, alias Klein surfaces since Alling-Greenleaf), and Douglas 1936–39 [372, 374] and also Comessatti 1924/26 [308], Cecioni 1933 [263], etc. ♣ evident (albeit subconscious) connection with Ahlfors 1950 [19], yet first made explicit (in-print) only by Alling-Greenleaf 1969 [44] (to the best of the writer's knowledge)] ♥60
- [798] F. Klein, *Über eindeutige Funktionen mit linearen Transformationen in sich. Erste Mitteilung*. Math. Ann. 19 (1882); also in *Gesammelte mathematische Abhandlungen. Dritter Band*. 1923, Reprint Springer-Verlag, 1973, 622–626. ♥??
- [799] F. Klein, *Über eindeutige Funktionen mit linearen Transformationen in sich. Zweite Mitteilung*. Math. Ann. 20 (1882); also in *Gesammelte mathematische Abhandlungen. Dritter Band*. 1923, Reprint Springer-Verlag, 1973, 627–629. ♥??
- [800] F. Klein, *Neue Beiträge zur Riemannschen Funktionentheorie*, Math. Ann. 21 (1882/83); also in *Gesammelte mathematische Abhandlungen. Dritter Band*. 1923, Reprint Springer-Verlag, 1973, 630–710. ♥??
- [801] F. Klein, *Über Realitätsverhältnisse bei der einem beliebigen Geschlechte zugehörigen Normalkurve der φ* , Math. Ann. 42 (1892), 1–29. [♠ this means the canonical embedding by holomorphic differentials into \mathbb{P}^{g-1} , which is like the Gauss map of the Abel embedding normalized through translation within the Jacobi torus ♠ an incredible interplay between the intrinsic geometry of the symmetric Riemann surface (including its topological characteristics) and the real enumerative issues allied to the canonical embedding, compare Gross-Harris 1981 [552] as the most cited best modern counterpart] ♥??
- [802] F. Klein, *Riemannsche Flächen, I*. Vorlesung, gehalten während des Wintersemesters 1891–92, Göttingen 1892, Neuer unveränderter Abdruck, Teubner, Leipzig 1906. (Lithographed.) AS60 [♠] ♥??
- [803] F. Klein, *Riemannsche Flächen, II*. Vorlesung, gehalten während des Sommersemesters 1892, Göttingen 1893, Neuer unveränderter Abdruck, Teubner, Leipzig 1906. AS60 [♠ for those not overwhelmed by German prose and hand-writings, these lecture notes gives a very exciting view over Klein's lectures and a good supplement to his papers. NB: these 2 items are *not* reprinted in the Ges. math. Abh., and somewhat hard-to-find in Switzerland but well-known in Russia, cf. e.g. Gudkov [579] and Natanzon 1990 [1069], plus also in some US references, of course] ♥??
- [804] F. Klein, *Lectures on Mathematics*, the Evanston Colloquium, Amer. Math. Soc., Providence, RI, 1911 (copyright by Macmillan and Co., 1893). [♠ cited in Korchagin-Weinberg 2005 [867] for the issue that Klein regards Newton has having a clear-cut conception of projective geometry through his *Enumeratio Linearum Tertii Ordinis*. Specifically, all curves of the 3rd order can be erived by central projection from five fundamental types.] ♥??
- [805] F. Klein, et al. *Zu den Verhandlungen betreffend automorphe Funktionen, Karlsruhe am 27. September 1911. Vorträge und Referate von F. Klein, L. E. J. Brouwer, P. Koebe, L. Bieberbach und E. Hilb*. Jahresb. d. Deutsch. Math.-verein. 21 (1912), 153–166. [♠ an account of the dramatic events occurring in 1911, when Brouwer was able to re-crack the uniformization (of Poincaré-Koebe, at least in the reasonable near to compact context) via topological methods (viz. invariance of domain) implementing thereby the old dream of Klein-Poincaré (or vice versa if you prefer)] ♥??
- [806] F. Klein, *Gesammelte mathematische Abhandlungen. Zweiter Band*. 1922, Reprint Springer-Verlag, 1973. AS60 ♥??
- [807] F. Klein, *Gesammelte mathematische Abhandlungen. Dritter Band*. 1923, Reprint Springer-Verlag, 1973. AS60, G78 ♥??

- [808] F. Klein, *Vorlesungen über die Entwicklung der Mathematik im 19. Jahrhundert, Teil I*. Die Grundlehren der mathematischen Wissenschaften in Einzeldarstellungen, Bd. 24, Springer-Verlag, Berlin, 1926; Russian transl., *Lektsii o razvitiu matematiki v XIX stoletii*, ONTI, Moscow-Leningrad, 1937. [♠ where according to the legend Arnold learned all his background about mathematics ♠ often cited, e.g. by Arnold, Gudkov, etc.] ♡??
- [809] T. Klotz, *Imbedding compact Riemann surfaces in 3-space*, Pacific J. Math. 11 (1961), 1035–1043. [♠ cited in Garsia 1961 [509] as follows: “Some interesting results on C^∞ imbeddings in the higher genus case have been obtained by T. Klotz in [10](=this paper). This author is almost successful in proving that the set of Riemann surfaces of a given genus $g \geq 2$ which can be imbedded in Euclidean space is open [footnote 2: using the results of Kuiper it could be shown that it is dense.] in the Teichmüller topology. Perhaps we should point out that from some of the results of the present paper one obtains the arguments that are needed to complete her proof.”] ♡??
- [810] M. Knebusch, *On real algebraic curves over real closed fields. I*, Math. Z. 150 (1976), 49–70. [♠] ♡??
- [811] M. Knebusch, *On real algebraic curves over real closed fields. II*, Math. Z. 151 (1976), 189–205. [♠] ♡??
- [812] J. T. Knight, *Riemann surfaces of field extensions*, Proc. Cambridge Philos. Soc. 65 (1969), 635–650. [♠ cited in Geyer-Martens?, Monnier 2007] ♡??
- [813] S.-K. Ko, *Embedding Riemann surfaces in Riemannian manifolds*, University of Connecticut, Dissertation, Aug. 1989. [♠ it is shown that every compact (=closed) Riemann surface admits a conformal embedding in any preassigned Riemannian manifold of dimension ≥ 3 . Compare also the treatment in Ko 2001 [816]] ♡??
- [814] S.-K. Ko, *Embedding bordered Riemann surfaces in Riemannian manifolds*, J. Korean Math. Soc. 30 (1993), 465–484. [♠ §0, Introd.: “Around 1960, A. Garsia ([6]=1961 [509]) proved that every compact Riemann surface can be conformally immersed in Euclidean 3-space \mathbb{R}^3 . He stated that he had found a realization of every compact surface as a classical surface although Klein required that classical surfaces be embedded. [Garsia’s proof uses Teichmüller’s idea, results, and constructions inspired by Nash’s embedding theorem and Brouwer’s fixed point theorem.]³⁶—In 1970, Rüedy extended Garsia’s result to open Riemann surfaces S by applying Garsia’s techniques to compact exhaustions of S ([16]=Rüedy 1971 [1317]) and later³⁷ he proved that every compact Riemann surface can be conformally embedded in \mathbb{R}^3 ([17]=Rüedy 1971 [1318], [18]=Rüedy 1968 [1316]).” ♠ [10.12.12] It is not clear (to Gabard) if this reflects the real history, for Rüedy himself seems always to ascribe the full embedded result to Garsia, yet perhaps by over-modesty in case Ko’s description is correct!?? ♠ next: “In 1989, author apply³⁸ Teichmüller theory to prove that we can find a conformally equivalent model surface in an orientable Riemannian manifold \mathfrak{M} of $\dim \mathfrak{M} \geq 3$ for every compact Riemann surface ([8]=Ko 1989 [813]).—Here we prove the *extension of the Embedding theorem for compact Riemann surfaces (Ko [8]=Ko 1989 [813]) to finite topological type Riemann surfaces in orientable Riemannian manifolds.*] ♡7
- [815] S.-K. Ko, *Embedding open Riemann surfaces in Riemannian manifolds*, J. Geom. Anal. 9 (1999), 119–141. [♠ like in the previous entry the author persists in his assertion that Garsia only obtained immersed conformal maps to classical surfaces, while ascribing the embedded results again to Rüedy. ♠p.119 (abstract): “Any open Riemann surface has a conformal model in any orientable Riemannian manifold. Precisely, we will prove that, given any open Riemann surface, there is a conformally equivalent model in a prespecified orientable Riemannian manifold [of $\dim \geq 3$].”] ♡3
- [816] S.-K. Ko, *Embedding compact Riemann surfaces in Riemannian manifolds*, Houston J. Math. 27 (2001), 541–577. [♠ seems to be a published account of the result arrived at in the Ph.D. Dissertation of the writer (Ko 1989 [813]); i.e. p541 (abstract): “Any compact Riemann surface has a conformal model in any orientable Riemannian manifold. Precisely, we will prove that, given any open

³⁶This prose is bracketed as it seems to be verbatim copied from Rüedy 1971 [1317].

³⁷It seems to be rather earlier!??

³⁸No attempt to correct the English, since Gabard’s English is even more indigest than the everything what has been ever written.

- Riemann surface, there is a conformally equivalent model in a prespecified orientable Riemannian manifold [of $\dim \geq 3$]. The techniques we use include Garsia's Continuity Lemma, Brouwer's Fixed Point Theorem along with techniques from Teichmüller theory.] ♡??
- [817] S. Kobayashi, N. Suita, *On analytic diameters and analytic centers of compact sets*, Trans. Amer. Math. Soc. 267 (1981), 219–228. A47, A50 [♠ Ahlfors function and the allied conceptions of Vitushkin (analytic diameter and center), plus negative answers to several of Minsker's questions (cf. Minsker 1974 [1018])] ♡1
- [818] S. Kobayashi, *On analytic centers of compact sets*, Kodai Math. J. 5 (1982), 318–328. A47, A50 [♠ second derivative variant of the Ahlfors function developed along conceptions of Vitushkin (analytic diameter and center) and Minsker] ♡??
- [819] B. Köck, D. Singerman, *Real Belyi theory*, Quarterly J. Math. 58 (2007), 463–478. [♠ “Abstract. We develop a Belyi-type theory that applies to Klein surfaces, that is (possibly non-orientable) surfaces with boundary which carry a dianalytic structure. In particular, we extend Belyi's famous theorem from Riemann surfaces to Klein surfaces.”] ♡??
- [820] P. Koebe, *Über konforme Abbildung mehrfach zusammenhängender ebener Bereiche, insbesondere solcher Bereiche, deren Begrenzung von Kreisen gebildet wird*, Jahrb. d. Deutsch. Math.-Ver. 15 (1906), 142–153. [♠ special cases of the KN=Kreismormierung] ♡??
- [821] P. Koebe, *Über konforme Abbildung mehrfach zusammenhängender ebener Bereiche*, Jahrb. d. Deutsch. Math.-Ver. 16 (1907), 116–130. [♠ special cases of the KN=Kreismormierung] ♡??
- [822] P. Koebe, *Über die Uniformisierung reeller algebraischer Kurven*, Gött. Nachr. (1907), 177–190. [♠ self-explanatory and relies heavily on Klein's ortho- and di-symmetry] ♡??
- [823] P. Koebe, *Über die Uniformisierung beliebiger analytischer Kurven*, Gött. Nachr. (1907), 191–210. [♠ joint with Poincaré 1907 [1195], the first acceptable and accepted proof of uniformization of open Riemann surfaces (alias analytical curves, by opposition to algebraic reflecting compactness, in the jargon of Fréchet) ♠ key ingredient the “Verzerrungssatz”, for which Koebe confess some little “coup de pouce” from the colleague Carathéodory] ♡??
- [824] P. Koebe, *Über die Uniformisierung beliebiger analytischer Kurven, (2. Mitt.)*, Gött. Nachr. (1907), 633–669. [♠ another proof of the general uniformization inspired by the reading of Poincaré's account, and using methods of Schwarz (esp. the Gürtelförmigverschmelzung)] ♡??
- [825] P. Koebe, *Über die Uniformisierung beliebiger analytischer Kurven, (3. Mitt.)*, Gött. Nachr. (1908), 337–358. [♠ discusses other types of uniformizations, and put forward the KNP, which he is already able to prove (in finite connectivity, or even in infinite connectivity under special symmetry), but no detailed arguments] ♡??
- [826] P. Koebe, *Über die Uniformisierung der algebraischen Kurven durch automorphe Funktionen mit imaginärer Substitutionsgruppe*, Gött. Nachr. (1909), 68–76. [♠ announce other types of uniformization formulated by Klein] ♡??
- [827] P. Koebe, *Über die Uniformisierung beliebiger analytischer Kurven, (4. Mitt.)*, Gött. Nachr. (1909), 324–361. ♡??
- [828] P. Koebe, *Ueber die Uniformisierung der algebraischen Kurven, I* Math. Ann. 67 (1909), 145–224. [♠ detailed proof] ♡??
- [829] P. Koebe, *Über die konforme Abbildung mehrfach zusammenhängender Bereiche* Jahrb. d. Deutsch. Math.-Ver. 19 (1910), 339–348. [♠ contains the general case of the KN in finite connectivity, via 2 methods: Überlagerungsfläche and the so-called Koebe iteration method ♠ again no complete proof but the convergence is ensured by the “Verzerrungssatz” ♠ full details only much latter in 1920–22? [841] (according, e.g., to Bieberbach 1968 [156]) ♠ p.339: “Den Hauptgegenstand dieser und des gegenwärtigen Vortrages bildet das Problem der konformen Abbildung eines $(p + 1)$ -fach zusammenhängenden Bereiches auf einen von $p + 1$ Vollkreisen begrenzten Bereich, ein Problem, welches in der Literatur zuerst bei Schottky (Dissertation, Berlin 1875, umgearbeitet erschienen in Crelle 1877) in seiner bekannten Doktordissertation auftritt, jedoch früher bereits von Riemann in Betracht gezogen worden ist, wie aus seiner nachgelassenen Schriften hervorgeht.”] ♡??

- [830] P. Koebe, *Über die Hilbertsche Uniformisierungsmethode*, Gött. Nachr. (1910), 59–74. ♡??
- [831] P. Koebe, *Ueber die Uniformisierung der algebraischen Kurven, II* Math. Ann. 69 (1910), 1–81. ♡??
- [832] P. Koebe, *Begründung der Kontinuitätsmethode im Gebiete der konformen Abbildung und Uniformisierung. (Voranzeige)*, Nachr. Königl. Ges. Wiss. Gött., Math.-phys. Kl. (1912), 879–886. [♠ self-explanatory, but compare the practically simultaneous work of Brouwer 1912 [193], plus the announcements in 1911 [805]]
- [833] P. Koebe, *Ueber eine neue Methode der konformen Abbildung und Uniformisierung*, Nachr. Königl. Ges. Wiss. Gött., Math.-phys. Kl. (1912), 844–848. [♠ introduction of the Schmiegunungsverfahren (osculation method?)] ♡??
- [834] P. Koebe, *Begründung der Kontinuitätsmethode*, Ber. Math. Math.-phys. Kl. Sächs. Akad. Wiss. Leipzig 64 (1912), 59–62. ♡??
- [835] P. Koebe, *Ränderzuordnung bei konformer Abbildung*, Gött. Nachr. (1913), 286–288. [♠ contests the heavy reliance upon Lebesgue’s measure theory in Carathéodory’s proof (1912) of the boundary behavior of the Riemann mapping for Jordan curves, by appealing to a device of Schwarz] ♡??
- [836] P. Koebe, *Ueber die Uniformisierung der algebraischen Kurven, IV (Zweiter Existenzbeweis der allgemeinen kanonischen uniformisierenden Variablen: Kontinuitätsmethode)*, Math. Ann. 75 (1914), 42–129. ♡??
- [837] P. Koebe, *Abhandlungen zur Theorie der konformen Abbildung, I, die Kreisabbildung des allgemeinsten einfach und zweifach zusammenhängenden schlichten Bereichs und die Ränderzuordnung bei konformer Abbildung*, J. Reine Angew. Math. 145 (1915), 177–223. [♠ uses the word “Kreisabbildung” which is perhaps first coined in Bieberbach 1914 [142]] ♡??
- [838] P. Koebe, *Abhandlungen zur Theorie der konformen Abbildung, IV*, Acta Math. 41 (1918), 305–344. [♠ first existence proof of the circular/radial slit maps for domains of finite connectivity (general case in Grötzsch 1931 [559]); subsequent proof in Reich-Warschawski 1960 [1244]] ♡??
- [839] P. Koebe, *Über die Strömungspotentiale und die zugehörigen konformen Abbildungen Riemannscher Flächen*, Gött. Nachr. (1919), 1–46. ♡??
- [840] P. Koebe, *Abhandlungen zur Theorie der konformen Abbildung. VI. (Abbildung mehrfach zusammenhängender schlichter Bereiche auf Kreisbereiche. Uniformisierung hyperelliptischer Kurven. Iterationsmethoden)*, Math. Z. 7 (1920), 235–301. ♡??
- [841] P. Koebe, *Abbildung beliebiger mehrfach zusammenhängender schlichter Bereiche auf Kreisbereichen*, Math. Z. 7 (1922), 116–130. ♡??
- [842] P. Koebe, ????, Acta Math. ?? (1928), ??–??. ♡??
- [843] P. Koebe, *Das Wesen der Kontinuitätsmethode*, Deutsche Math. 1 (1936), 859–879. G78 [♠ survey-like with many refs.] ★★★ ♡??
- [844] H. Köditz, St. Timmann, *Ranschlichte meromorphe Funktionen auf endlichen Riemannschen Flächen*, Math. Ann. 217 (1975), 157–159. G78 [♣ supply a proof of a circle map (without bound) using techniques of Behnke-Stein ♣ criticizes and demolishes an earlier argument of Tietz 1955 [1491] intended to give another treatment of the Ahlfors circle map] ♡??
- [845] ?. Kohn, *Spezielle ebene algebraische Kurven [Erster Teil: Ebene Kurven dritter und vierter Ordnung]*, Encyclopädie der Math. Wiss., III, 2, Heft 4. [♠ cited in Brusotti 1913 [201]] ♡??
- [846] G. Kokarev, *Variational aspects of Laplace eigenvalues on Riemannian surfaces*, arXiv:1103.2448, 2011. [♠ Abstract: We study the existence and properties of metrics maximising the first Laplace eigenvalue among conformal metrics of unit volume on Riemannian surfaces. We describe a general approach to this problem (and its higher eigenvalue versions) via the direct ...] ♡4
- [847] J. Kóllar, *The topology of real and complex algebraic varieties*, Adv. Stud. Pure Math. 31 (2001), Math. Soc. Japan, 127–145. ♡??
- [848] Y. Komatu, *Identities concerning canonical conformal mappings*, Kōdai math. Sem. Rep. 3 (1953), 77–83. ♡??

- [849] W. Koppelman, *The Riemann-Hilbert problem for finite Riemannian surfaces*, Comm. Pure Appl. Math. 12 (1959), 13–35. [♠ work oft cited in the investigation of the Slovenian school, see e.g. Černe-Forstnerič 2002 [267] ♠ “The problem of finding a function, analytic in some domain D , for a given relation between the limiting values of its real and imaginary parts on the boundary of D was originally mentioned by Riemann in his dissertation [12]. Here we shall treat the special case where . . .”]★★★ ♡27
- ★ Anatoly B. Korchagin, student of Gudkov 1st Thesis and Viro? for the Leningrad Dissertation?), well-known in particular for the discovery of $1+19=20$ maximal schemes in degree 8, the last 19 of them by a variant of Viro’s method using the dissipation of the Z_{15} -singularity (chandler like) (and refuting thus severely a too hasty conjecture of Viro, compare our Fig. 154). This is a pivotal contribution toward the completion of Hilbert’s 16th in degree 8. Further Korchagin is the main contributor of Hilbert’s 16th in degree $m = 9$ with many pivotal results on his active, those being more recently supplemented by results of Orevkov 1999 and Fiedler-Le Touzé 2002 [424], 2009 [426]. Alas the case $m = 9$ still appears to contain major gaps since of the about 1227 logically possible M -nonics.
- [850] A. B. Korchagin, *New possibilities in Brusotti’s method for the construction of M -curves of degrees ≥ 8* , In: Methods of Qualitative Theory of Differential Equations (in Russian), Gorki Univ. Press, Gorki (1978), 149–159. [♠ contains the construction of one M -scheme of degree 8 among the menagerie of 104 logically possible after the Fiedler-Viro obstruction ♠ so this looks a drop of water in the ocean, but this was the first progress after the classical methods of Harnack, Hilbert, Wiman and somehow a prelude to the revolution under preparation in Viro 1980 [1527] (after which only 52 cases remained undecided) ♠ since 2002 (Orevkov 2002 [1129]) only 6 cases among the 104 remains unsettled] ♡??
- [851] A. B. Korchagin, *M -curves of degree 9: nonrealizability of 12 types*, in: Methods of Qualitative Theory of Diff. Equ., Lobatchevskii Univ., 1985, 72–76. (Russian.) [♠ cited in Le Touzé 2010 [427], yet probably just a droplet in the ocean yet the first of this type after Rohlin-Mishachev, Fiedler.] ♡??
- [852] A. B. Korchagin, *On the reduction of singularities and the classification of non-singular affine sextics*, Deposited at VINITI (1986), no. 1107-B86, 1–18. (Russian.) [♠ probably one among the early initiation of this theory with further developments in Korchagin-Shustin 88/89 [861]]★ ♡??
- [853] A. B. Korchagin, *M -curves of degree 9: New prohibitions*, Math. Notes 39 (1986), 277–293. [♠ beside Bézout, and Rohlin-Mishachev this is the last “universal” obstruction determining Korchagin’s universe of 1227 nonic M -schemes where further prohibition went detected by Orevkov 1999, Le Touzé 2002 [424], 2009 [426].]★ ♡??
- [854] A. B. Korchagin, *M -curves of 9th degree: construction of 141 curves*, Manuscript No. 7459-B86, deposited at VINITI (1986), 1–73 (Russian). [♠] ♡??
- [855] A. B. Korchagin, *M -curves of 9th degree: realizability of 32 types*, Manuscript No. 2566-B87, deposited at VINITI (1987), 1–17 (Russian). [♠] ♡??
- [856] A. B. Korchagin, *M -curves of 9th degree: realizability of 24 types*, Manuscript No. 3049-B87, deposited at VINITI (1987), 1–17 (Russian). [♠] ♡??
- [857] A. B. Korchagin, *M -curves of 9th degree: realizability of 167 types*, Manuscript No. 7884-B87, deposited at VINITI (1987), 1–69 (Russian). [♠ on summing the contribution of all the 4 previous VINITI paper we reach a total of $141 + 32 + 24 + 167 = 364$ types. The next development are to be found in Korchagin 1991 [862] and Korchagin 1996 [863], where the number of constructed schemes expanded to 404. After that see Orevkov 2003 [1134] where 62 (or 65?) more schemes went constructed.] ♡??
- [858] A. B. Korchagin, *On the isotopy classification of M -curves of degree 9 in the projective plane*, Author’s Summary of Candidate’s dissertation, Leningrad State Univ., Leningrad, 1988. (Russian). [♠ cited in Shustin 1990/91 [1419] for the construction of M -schemes in degree 8, yet the more accessible source for this material seems to be Korchagin 1989 [860]]★ ♡??
- [859] A. B. Korchagin, *Isotopy classification of plane seventh degree curves with the only singular point Z_{15}* , In: Topology and Geometry—Rohlin’s Seminar, Lect. Notes in Math. 1346, 407–426, Springer, Berlin, 1988. [♠ include a classification of the dissipation of the Z_{15} -singularity (along Viro’s method), that is quite essential in Shustin’s construction of new schemes along Viro’s method (albeit Shustin’s original proof may have differed somewhat).] ♡??

- [860] A. B. Korchagin, *New M -curves of degrees 8 and 9*, Dokl. Akad. Nauk SSSR 306 (1989), 1038–1041; English Transl. in Soviet Math. Doklady 39 (1989), 569–572. [♠ this is an essential contribution to Hilbert’s 16th in degree 8 where 19 new M -schemes are realized, so that when combined with the article Korchagin 1978 [850] where [only] one M -scheme was constructed by a variant of Brusotti, the writer Korchagin scores the record number of realizations with 20 schemes, giving him the Silver Médaille right after the Gold Médaille of Viro scoring 42 schemes (as early as 1980 [1527]). The Bronze Médaille goes—with 7 schemes—to E. Shustin 1985/87 [1409] and 1988 [1415]. After those smart guys, the next best scorers are Hilbert=4, Chevallier=4, Harnack=2, Gudkov=2, Wiman=1, Orevkov=1 (of course as time advances an exponential corrector term should probably boost the contribution of Orevkov). [28.04.13] Presently (since Orevkov 2002[1129]), it remains only 6 schemes to be realized, so this ranking should be nearly stabilized. Conjecture: all remaining 6 are prohibited (via the method of total reality due to Riemann)! So counting negatively the prohibition we get Riemann=−6, and conjecturally all prohibitions are explained via the method of total reality, in particular the Fiedler-Viro obstruction (of Viro 1980 [1527], proved in detail somewhat later in Viro 1983/84 [1532]). Needless say we are far to implement this for the moment [02.05.13].]★♡??
- [861] A. B. Korchagin, E. I. Shustin, *Affine curves of degree 6 and smoothing of non-degenerate six-fold singular points*, Izv. Akad. Nauk SSSR 52 (1988), 1181–1199; English transl., Math. USSR-Izvestia 33 (1989), 501–520. [♠ cited in Orevkov 2002 [1129] for containing the best available in print description of Viro’s obstruction playing a major role toward the resolution of Hilbert’s 16th in degree 8. *spadesuit* regarding the classification of affine M -sextics there is some mistakes corrected in Orevkov 1998 [1118] [1119], compare for this verdict e.g. Polotovskii 2000 [1214, p. 233].]★♡??
- [862] A. B. Korchagin, *Constructions of new M -curves of the 9th degree*, Lecture Notes in Math. 1524 (1991), 407–426. [♠ contains a tabulation toward the census of M -curves of degree 9 (nonics) with minor misprints reported in Orevkov 2003 [1134]]♡??
- [863] A. B. Korchagin, *Smoothing of 6-fold singular points and constructions of 9th degree M -curves*, Amer. Math. Soc. Transl. 173 (1996), 141–155. [♠]♡??
- [864] A. B. Korchagin, The first part of Hilbert’s sixteenth problem: history and main results, in: *Visiting Scholars’ Lectures–1997*, Math. Series 19, Texas Technical University, 1997, 85–140. [♠ cited in Chevallier 2002 [282] for an overview of the 78 many M -octics known to be realized prior to Chevallier’s intervention in 2002, and of the 13 schemes that were at that time not known to be realized. After Chevallier 2002 (4 constructions), and Orevkov 2002 (1 construction and 2 prohibitions) this list now reduces to $13 - 4 - 3 = 6$ undecided schemes. ♠ also cited in Orevkov 2002 [1130]]★♡??
- [865] A. B. Korchagin, *Restrictions on arrangements of ovals of projective algebraic curves of odd degree*, Proc. Amer. Math. Soc. 129 (2000), 363–370. [♠ describe new (?) obstructions in degree $m = 4k + 1$ (so including $m = 9$) via the classical method of Rohlin-Fiedler-Viro, but alas despite an apparent great clarity of the text it is not completely clear if it results new obstruction in the case $m = 9$.]♡??
- [866] A. B. Korchagin, D. A. Weinberg, *The isotopy classification of affine quartic curves*, Rocky Mountain J. Math. 32 (2002), 255–347. [♠ present an avatar of Newton’s census for cubics as extended to degree 4 building over all the previously known material (from Newton to the recent works by D. A. Gudkov plus collaborators). Specifically, (1) there is 42 classes of irreducible projective quartics (essentially known to Zeuthen and extending the 5 cubics of Newton [smooth: bifolium or unifolium, singular: cuspidal, nodal, solitary node.]), (2) all projective quartic curves contains 66 classes, (3) affine quartic curves contains 647 classes (while Newton’s cubics gives 59 such classes), and (4) the topological type of the pair (\mathbb{R}^2, C_4) contains exactly 516 classes.]♡??
- [867] A. B. Korchagin, D. A. Weinberg, *Quadric, cubic and quartic cones*, Rocky Mountain J. Math. 35 (2005), 1627–1656. [♠ a brilliant survey from ancient Greece to Newton and Zeuthen/Gudkov/Korchagin-Weinberg]♡??
- [868] A. Korn, *Application de la méthode de la moyenne arithmétique aux surfaces de Riemann*, C. R. Acad. Sci. Paris 135 (1902), 94–95. AS60 [♠]★★★♡??

- [869] A. Korn, *Sur le problème de Dirichlet pour des domaines limités par plusieurs contours (ou surfaces)*, C. R. Acad. Sci. Paris 135 (1902), 231–232. ★★AS60 ♡??
- [870] A. Korn, *Über die erste und zweite Randwertaufgabe der Potentialtheorie*, Rend. Circ. Mat. Palermo 35 (1913), 317–323. [♠ application of the authors’s theory of the asymmetrical kernel to the first and second boundary value problem of potential theory and its resolution by the method of the arithmetical mean (C. Neumann, Robin) leading anew to the solution predicted by Poincaré 1896 [1194], which the author first succeeded in 1901 after appealing to a result of Zaremba (1901)] ♡??
- [871] I. Kra, *Maximal ideals in the algebra of bounded analytic functions*, ???? 31 (1967), 83–88. A50 [♠ Ahlfors 1950 [19] is applied to a characterization of “point-like” maximal ideals in the function algebra ♠ more precisely Ahlfors is cited on p.85 as follows (yet without precise control on the degree except for its finiteness): “Lemma 5. Let X be a finite domain of the Riemann surface W . Then for each discrete sequence $\{x_n\} \subset X$, there exists an $f \in B(X)$ [=the ring of bounded holomorphic functions, cf. p.83] such that $\lim_{n \rightarrow \infty} f(x_n)$ does not exist.—*Proof.* Ahlfors [1](=1950 [19]) has shown that there exists a mapping p , analytic in a neighborhood of $\text{Cl}X$, that is an N -to-one covering of the closed unit disc, for some positive integer N . Moreover $p|X$ is an N -to-one covering of the interior of the closed unit disc, and $p|\text{Cl}X - X$ is an N -to-one covering of the unit circle. Because $\text{Cl}X$ is compact we may assume (by choosing a subsequence) that $x_n \rightarrow x \in \text{Cl}X - X$. Then $p(x_n) \rightarrow 1$ [modulus missing??] and $|p(x_n)| < 1$. Again, we may choose a subsequence such that $p(x_n)$ is distinct [???] and infinite and constitutes an interpolating sequence (see Hoffman [6, pp.194–204]). Choose a bounded analytic function f on the unit disc such that $f(p(x_{2n+1})) = 0$ and $f(p(x_{2n})) = 1$ for $n = 0, 1, 2, \dots$. Then $f \circ p \in B(X)$, and $\lim_{n \rightarrow \infty} (f \circ p)(x_n)$ does not exist. [q.e.d.]” ♠ p.87: “Theorem 2 is a generalization of Theorem 1, because every boundary point of a finite domain is an essential singularity for some bounded holomorphic function. The unit disc certainly has this property. The general case is reduced to the unit disc *via* any Ahlfors maps. (See the proof of Lemma 5.)” ♡0
- [872] I. Kra, *Automorphic Forms and Kleinian Groups*, Benjamin, Reading, Mass., 1972, 464 pp. [♠] ♡??
- [873] G. Kramer, *Introduction à l’analyse des lignes courbes*, Jeneva 1750. [♠ cited in Gudkov 1988 [584].] ♡??
- [874] S. G. Krantz, *The Carathéodory and Kobayashi metrics and applications in complex analysis*, Amer. Math. Monthly 115 (2008), 304–329. [♠ p.311 brief mention of the Ahlfors function and as it is connected to the Carathéodory metric; for more on the Ahlfors function the reader is referred to Fisher 1983 [442] or the book Krantz (2006)] ♡??
- ★ V. A. Krasnov, a Galois-cohomologist in Russia. Especially spectacular seems to be his derivation (which we had not the time to check in detail) of the Kharlamov-Rohlin orthosmmetric criterion via the shifted Gudkov-type congruence $\chi \equiv_8 k^2 + 4$ obtained in 1993/94 [878]
- [875] V. A. Krasnov, *Generalized Petrovskii’s inequality in the case of odd degree*, Funkt. Anal. Prilozhen. 10 (1976), 41–48. [♠] ♡??
- [876] V. A. Krasnov, *Albanese mapping for real algebraic varieties*, Mat. Zametki 32 (1982), 365–374; English transl., Math. Notes 32 (1983), 661–666. [♠] ♡??
- [877] V. A. Krasnov, *Albanese map for GMZ varieties*, Mat. Zametki 35 (1984), 739–747; English transl., Math. Notes 35 (1984), 391–396. [♠] ♡??
- [878] V. A. Krasnov, *Algebraic cycles on a real algebraic GM-manifold and their applications*, Russian original (1993); English transl., Russian Acad. Sci. Izv. Math. 43 (1994), 141–160. [♠ this looks to be a tour-de-force as the author seems able to reprove via algebraic nonsense the ortho-symmetrizing Kharlamov-Marin congruence $\chi \equiv_8 k^2 + 4$ which in principle is as deep as the Gudkov-Rohlin congruence and so uses either Rohlin’s theorem on spin 4-manifolds (cf. Marin’s implementation 1978/80 [963]), or the Hirzebruch-Atiyah-Singer index formula (2nd [correct!] proof of Rohlin) ♠ more precisely Krasnov’s proof seems to use rational equivalence, homology, GM=Galois-maximal manifold, and a decomposition theorem for cycles homologous to 0 (Thm 02), which seems able to reproduce result by Kharlamov 1975 for the $\chi(X(\mathbb{R}))$ of $(M - 1)$ - and $(M - 2)$ -manifolds while even complementing by the case of $(M - 3)$ -varieties, and finally recovering the Kharlamov-Marin criterion of orthosymmetry. ♠ other tools include a theory of characterisitic classes

- for vector bundles detailed in Krasnov 1991, the 2nd Grothendieck cohomology spectral sequence (after Grothendieck 1957, Tôhoku article), some trivial lemmas à la Kharlamov on the signature of unimodular even integral forms, on p.152 it seems that Rohlin’s congruence $\chi(X(\mathbb{R})) \equiv_{16} \sigma(X(\mathbb{C}))$ is used (so here some angel geometry is injected in the proof, a bit like in Gauss’s proof of the theorem fundamental of algebra:=existence of roots to univariate polynomials), the Rohlin congruence is used once more on p.154, and ultimately the consideration of the double plane ramified along the curve is employed ★ in substance it seems that the proof (apart from excessive Grothendieckization) may be quite close to the original one of Kharlamov (cited in Rohlin 1978 but alas non-published)] ♡??
- [879] L. Kraus, *Note über aussergewöhnliche Specialgruppen auf algebraischen Curven*, Math. Ann. 16 (1880), 245–259. [♠ cited in Gudkov 1974 [579].] ♡??
- [880] D. Kraus, O. Roth, *Critical points, the Gauss curvature equation and Blaschke products*, arXiv (2011). A47, G78 [♠ p.15 the Ahlfors map is mentioned] ♡??
- [881] S. Kravetz, *On the geometry of Teichmüller spaces and the structure of their modular groups*, Ann. Acad. Sci. Fenn. Ser. A I Math. Dissertationes 278 (1959), 1–35. [♠ according to Natanzon 1999 [1072, p.1101], this Kravetz’s paper was employed in Earle’s 1971 [387] description of the topological structure of the components of the moduli space of real algebraic curves as being each diffeomorphic to $\mathbb{R}^{3g-3}/\text{Mod}_{g,r,\varepsilon}$ for a suitable discrete (modular) group. Earle’s proof used the theory of quasiconformal maps, but relied on a Kravetz’s theorem “which turned out latter to be wrong”. Still according to Natanzon (*loc. cit.*) “A correct proof based on the theory of quasiconformal maps was obtained in Seppälä 1978 [1383].”] ♡??
- [882] ?. Krazer, *Lehrbuch der Thetafunktionen*, Teubner, 1903. [♠ student of Prym, in turn student of Riemann] ♡??
- [883] I. M. Krichever, S. P. Novikov, *Virasoro-Gelfand-Fuchs type algebras, Riemann surfaces, operator theory of closed strings*, J. Geom. Phys. 5 (1988), 631–661. [♠] ♡??
- [884] L. Kronecker, *Über die Diskriminante algebraischer Funktionen*, Crelles J. 91 (1881). [♠] ♡??
- [885] L. Kronecker, *Über einige Interpolationsformeln für ganze Funktionen mehrerer Variablen*, Werke Leipzig 1895, Bd. I [Gelesen in der Akad. d. Wiss. am 21. Dec. 1865], S. 133–141. [♠ quoted in Petrovskii 1938 [1168] as one of the tool involved in the proof of the Petrovskii’s inequalities, where Kronecker’s work connects to the so-called Euler-Jacobi (interpolation) formula ♠ Discriminant, elimination, Lagrange’s interpolation, Determinant, Eliminationstheorie, Jacobi’schen Relationen, Euler’schen Gleichungen ♠ cite Jacobi 18XX [712] ♠ critique to a work of Betti making a too liberal use of the Jacobi formula, cite the work of Liouville ♠ cite Rosenhain (a well-known student of Jacobi) famous for a special case of Jacobi’s inversion, and mention also Borchardt 1860] ♡??
- [886] P. B. Kronheimer, T. S. Mrowka³⁹, *The genus of embedded surfaces in the projective plane*, Math. Res. Letters 1 (1994), 797–808. [♠ a proof of the Thom conjecture on the genus of smooth surfaces embedded in the complex projective plane, via Gauge theory (Donaldson theory, etc.) ♠ this has some modest relevance to Hilbert’s 16th problem, cf. e.g. Theorem (in v2) in this text ♠ the special degree 3 case of Thom’s conjecture was known to Kervaire-Milnor 1961 [761]] ♡??
- [887] V. Krylov, *Une application des équations intégrales à la démonstration de certains théorèmes de la théorie des représentations conformes*, (Russian, French Summary) Rec. Math. de Moscou [Mat. Sb.] 4 (1938), 9–30. G78 [♠ Seidel’s summary: the problem of mapping conformally a region of connectivity n , bounded by n analytic contours, on various canonical domains is reduced to the problem of solving a system of simultaneous integral equations] ♡??
- [888] T. Kubo, *Bounded analytic functions in a doubly connected domain*, Mem. Coll. Sci. Univ. Kyoto, A. 26 (1951), 211–223. ♡??
- [889] T. Kubota, *Über konforme Abbildungen. I.*, Science Reports Tôhoku Imperial Univ. ser. I, 9 (1920), 473–490. [♠ quoted in Grunsky 1932 [560, p.135] for the simply-connected case of an extension of Bieberbach’s first Flächensatz]★★ ♡4
- [890] T. Kubota, *Über konforme Abbildungen. II.*, Science Reports Tôhoku Imperial Univ. ser. I, 10 (1921). [♠]★ ♡??

³⁹Means “mouche” in Polish

- [891] P. Kufareff, *Über das zweifach zusammenhängende Minimalgebiet*, Bull. Inst. Math. et Mec. Univ. de Tomsk 1 (1935–37), 228–236. [♠ quoted in Lehto 1949 [920] and Bergman 1950 [123], and akin to the works of Zarankiewicz 1934 [1620, 1621] ♠ Seidel’s summary: a minimal problem is set up for functions analytic and single-valued in a circular ring and the mapping effected by the minimizing function is discussed] ★ ★★ ♡??
- [892] R. Kühnau, *Über die analytische Darstellung von Abbildungsfunktionen, insbesondere von Extremalfunktionen der Theorie der konformen Abbildung*, J. Reine Angew. Math. 228 (1967), 93–132. G78 [♠ p.95–96 proposes a contribution to a question raised by Garabedian-Schiffer 1949 [494] related to the representation of the so-called Schottky function (via *Normalabbildungsfunktionen*) ♠ Kühnau alludes to several (subsequent) work of Schottky where the circle maps should appear again? (no precise refs. hence requires some detective work)] ♡??
- [893] R. Kühnau, *Geometrisch-funktionentheoretische Lösung eines Extremalproblems der konformen Abbildung, I, II*, J. Reine Angew. Math. 229 (1967), 131–136; 237 (1969), 175–180. G78 [♠] ♡??
- [894] R. Kühnau, *Herbert Grötzsch zum Gedächtnis*, Jber. d. Dt. Math.-Verein. 99 (1997), 122–145. [♠ alas, cited merely for the matter of the “quasi-conformal” jargon, as occurring apparently first (the jargon, not the concept) in Carathéodory 1914 [233]] ♡??
- [895] V. S. Kulikov, *Epimorphicity of the period map for K3 surfaces*, Uspekhi Mat. Nauk 32 (1977), 257–258. (Russian) [♠ employed in Nikulin’s (1979/80 [1107]) rigid-isotopy classification of plane real sextics, and also cited in Kharlamov 1984 [776]] ♡??
- [896] Z. Kuramochi, *A remark on the bounded analytic function*, Osaka Math. J. 4 (1952), 185–190. A50, AS60 [♣ p. 189 seems to reprove the result of Ahlfors 1950 [19] about the existence of a circle map of degree $\leq r + 2p$ by using the Green’s function (while generalizing a method of Nehari 1951 [1080] for the case of plane domains) ♠ unfortunately Kuramochi’s paper is written in some mysterious tongue (the Nipponenglish), and despite its moderate size (of ca. 5 pages) it contains several dozens of misprints obstructing seriously its readability ♠ despite our critical comments this work is quoted in Ahlfors-Sario 1960 [26] so should probably be not completely science-fictional ♠ it would perhaps be desirable (in case this paper emerged from some solid underlying structure) to undertake a polishing of this Kuramochi paper to improve its readability] ♡??
- [897] A. Kuribayashi, *On analytic families of compact Riemann surfaces with non-trivial automorphisms, ??? ??* (1966), 119–165. [♣ Teichmüller theory à la Ahlfors-Bers, plus an influence of Shimura ♠ p. 133: “Thm 2.17. There exists one and only one Riemann surface up to conformal equivalence which has group of automorphism of order 168 among compact Riemann surfaces of genus 3.” ♠ is this uniqueness new? perhaps already in Hurwitz?] ♡28
- [898] Y. Kusunoki, *Über die hinreichenden Bedingungen dafür, dass eine Riemannsche Fläche nullberandet ist*, Mem. Coll. Sci. Univ. Kyoto 28 (1952), 99–108. AS60 [also cited in Sario-Nakai [1336] CHECK ♠ an application of Ahlfors 1950 [19] (and the older predecessor Bieberbach 1925 [147]) is given to the type problem] ♡0
- [899] Y. Kusunoki, *Contributions to Riemann-Roch’s theorem*, Kyoto J. Math. ? (1958), ?–?. A50 [♠ Ahlfors 1950 [19] is cited] ♡15
- [900] Y. Kusunoki, *Square integrable normal differentials on Riemann surfaces*, J. Math. Kyoto Univ. 3 (1963), 59–69. A50 [♠ Ahlfors 1950 [19] is cited on p. 64, in the following connection (as usual many “notatio”): “If R is a bordered surface with p contours, $\{A_n, B_n, C_\nu\}_{n=1, \dots, g; \nu 1, \dots, p-1}$ is admissible for $\Gamma_0 = \Gamma_{aS} = \Gamma_{AB} \oplus \Gamma_C$ and P_γ gives a one-to-one mapping of $\Gamma_0 = \Gamma'_0$ to $(2g + p - 1)$ -dimensional vector space by (II) (Ahlfors [1](=1950 [19])).”] ♡6
- [901] M. P. Kuvaev, P. P. Kufarev, *An equation of Löwner’s type for multiply connected regions*, Tomskii gos. Univ. Uč. Zap. Mat. Meh. 25 (1925), 19–34. G78 ★ ★★ ♡??
- [902] J.-L. Lagrange, *???*, 1779. [♠ a source often quoted e.g. by Koebe [ca. 1910, in Math. Ann.], and Monastyrsky 1987/99 [1030] where one reads (p. 15): “It is noteworthy that Joseph-Louis Lagrange (1736–1813) obtained the Cauchy-Riemann equations conditions also in 1779, also in connection with the solution to a cartographic problem.”] ♡??
- [903] J.-L. Lagrange, *Mecanique analytique*, 2 volumes, Paris, 1788. [♠] ♡??

- [904] J.-L. Lagrange, *Theorie des fonctions analytiques*, Paris, 1797, 2ème édition 1813. [♠] ♥??
- [905] E. Landau, *Einige Bemerkungen über schlichte Abbildung*, Jahresb. Dt. Math.-Verein. 34 (1926), 239–243. [♠] ♥??
- [906] H. J. Landau, R. Osserman, *On analytic mappings of Riemann surfaces*, J. Anal. Math. (1960), 249–279. [♠ p.266 contains the basic lemma that an analytic map taking the boundary to the boundary is a (full) branched covering (this follows directly from the local behavior of such maps and bears a certain relevance to the Ahlfors circle map) ♠ however the paper does not seem to supply an existence proof of the Ahlfors map ♠ in fact it is worth reproducing the text faithfully (p.265): “We now turn to the problem of mapping one Riemann surface into another. We shall need a lemma which, in a special case, was proved by Radó [12](=Radó 1922 [1230]). Let us recall that a sequence of points in a Riemann surface is said to tend to the boundary if the sequence has no limit points in R^{40} . We shall say that a map f of one Riemann surface R_1 into another, R_2 , takes the boundary into the boundary if for every sequence of points in R_1 which tends to the boundary, the image sequence tends to the boundary of R_2 . Let us note that if R_1 and R_2 are relatively compact regions on Riemann surfaces, the above definition coincides exactly with the usual notion of mapping the boundary into the boundary.—**Lemma 3.1:** *Let R_1 and R_2 be any two Riemann surfaces and f an analytic map of R_1 into R_2 which takes the boundary into the boundary. Then f maps R_1 onto R_2 , and every points of R_2 is covered the same number of times, counting multiplicities.* ♠ for this basic lemma see also the treatments in Stoilow 1938 [1455, Chap. VI] and Ahlfors-Sario 1960 [26, p.41, 21B.] ♥25
- [907] G. Landsberg, *Algebraische Untersuchungen über den Riemann-Roch Satz*, Math. Ann. 50 (1898), 333–380. [♠ drifting the transcendental theory toward arithmetization] ♥??
- [908] G. Landsberg, *Über das Analogon des Riemann-Roch Satz in der Theorie der algebraischen Zahlen*, Math. Ann. 50 (1898), 577–582. [♠] ♥??
- [909] Laplace, *Système du monde*, (1796). [♠ where the Laplacian occurs first; Laplace seems of course to have been one of the greatest admirer of Euler] ♥??
- [910] Laplace, *Traité de mécanique céleste*, (1796). [♠] ♥??
- [911] M. Lavrentieff, *On the theory of conformal mapping*, Trav. Inst. phys.-math. Stekloff 5 (1934), 159–245. [♠ cited in Schiffer 1950 [1350]] ★★★ ♥??
- [912] P. D. Lax, *Reciprocal extremal problems in function theory*, Comm. Pure Appl. Math. 8 (1955), 437–453. G78 [♠ extract from Rogosinski’s review (MathReview): “This principle is dual to one used for similar problems by the reviewer and H. S. Shapiro (=Rogosinski-Shapiro 1953 [1283]); both principles are easy interpretations of the Hahn-Banach extension theorem in the complex case. [...] This important paper is somewhat marred by numerous misprints and a rather loose presentation.”] ★ ♥10
- [913] R. F. Lax, *On the dimension of the varieties of special divisors*, Illinois J. Math. 19 (1975), 318–324. [♠ extract from H. H. Martens’s review (MathReview): “The proof is inspired by the methods of T. Meis 1960 [993], and the paper contains, in addition to the author’s results, a very useful review of Meis’ monograph, which is rather difficult to obtain.”] ★ ♥??
- [914] R. Le Vavasieur, *Sur la représentation conforme de deux aires planes à connexion multiple, d’après M. Schottky*, Ann. Fac. Sci. Toulouse (2) 4 (1902), 45–100. G78 [♠ re-expose the results of Schottky 1877 [1366]] ♥??
- [915] H. Lebesgue, *Intégrale, Longueur, Aire*, Annali di Mat. 7 (1902), 231–358. [♠ Lebesgue’s Thesis, where Lebesgue’s integration and the allied geometry is introduced (yet another descendant of Riemann) ♠ Fatou 1906 [408], F. Riesz 1907 and Carathéodory 1912 [230] are the best illustration of the rôle of measure theory in (complex) function theory, a rôle disputed by Koebe at least in the early steps (compare Gray’s fine analysis [539])] ♥??
- [916] H. Lebesgue, *Sur le principe de Dirichlet*, Rend. Circ. Mat. Palermo 24 (1907), 371–402. [♠ extension of Hilbert’s solution to the Dirichlet problem by allowing general boundaries, cf. also Zaremba 1910 [1623] for possible simplifications and (Beppo Levi 1906 [933] and Fubini 1907 [459] for related contributions of the same

⁴⁰Perhaps it would be better to say no accumulation point.

- period ♠ further (quasi-ultimate) simplifications in Perron 1923 [1165], in turn simplified in Radó-Riesz 1925 [1236]] ♡??
- ★★ Solomon Lefschetz well-known for contributions at the interface of algebraic topology (à la Riemann-Betti-Poincaré) and algebraic geometry, plus works on the foundations of homology theory, and ultimately in the qualitative theory of differential equations (alias dynamical flows). As far as the author knows Lefschetz never really did real algebraic geometry, yet his work has indirect impact upon this topic via Comessatti's works or even those of Petrovskii, e.g. the famous paper on lacuna of hyperbolic systems of PDE's (1945 [1169]).
- [917] S. Lefschetz, *On certain numerical invariants of algebraic varieties with applications to Abelian varieties*, (Prix Bordin 1919), Trans. Amer. Math. Soc. 22 (1921), 327–482. [♠ cited and used by Comessatti 1928 [310]] ♡??
- [918] S. Lefschetz, *L'analysis situs et la géométrie algébrique*, Gauthier-Villars (Collec. Borel), Paris, 1924. [♠] ♡??
- [919] J. Lehner, M. Newman, *On Riemann surfaces with maximal automorphism groups*, Glasgow Math. J. 8 (1967), 102–112. [♠] ♡??
- [920] O. Lehto, *Anwendung orthogonaler Systeme auf gewisse funktionentheoretische Extremal- und Abbildungsprobleme*, Ann. Acad. Sci. Fenn. Ser. A. I. 59 (1949), 51 pp. [♠ new existence proof of parallel-slit mappings via the Bergman kernel (and so in particular of RMT, answering thereby the old desideratum of Bieberbach 1914 [142]-Bergman 1922 [114]-Bochner 1922 [175]); equivalent work in Garabedian-Schiffer 1950 [498] ♠ p. 48 reproves the identity $B(z) = 1/S(w(z) - w^*(z))$ (expressing the least area map as combination of the two Schlitzfunktionen w and w^*) announced by Grunsky 1932 [560] ♣ p. 41 seems to show that the least area map is a circle map] ♡15
- [921] O. Lehto, K.I. Virtanen, *Quasiconformal mappings in the plane*, 2nd edition, Springer-Verlag, Berlin, 1973. [♠] ♡??
- [922] O. Lehto, *Univalent functions and Teichmüller spaces*, Springer-Verlag, Berlin, 1986. [♠] ♡??
- [923] O. Lehto, *On the life and work of Lars Ahlfors*, Math. Intelligencer (1998), 4–8. [♠ p. 7: “In this same paper (1953/54), Ahlfors also defined the notion which he called Teichmüller space.”] ♡XX
- [924] G. W. Leibniz, *Characteristica Geometrica*, 1679. [♠ beside Descartes (pseudo?)-anticipation of the Euler characteristic theorem for spherical polyhedrons ($V - E + F = 2$), this is oft regarded as the first “topological” text, summarized as follows in Monastyrsky 1987/99 [1030], p. 89: “In 1679 Leibniz published [t]his famous book [...], in which (in modern terms) he tried to study the topological rather than the metric characteristics of properties of figures. He wrote that, aside from the coordinate representation of figures, ‘we are in need of another analysis, purely geometric or linear, which also defines the position (situs), as algebra defines magnitude.’ It is interesting to note that Leibniz tried to interest Christiaan Huygens (1629–1695) in his work, but the latter showed little enthusiasm. This was the first (albeit unsuccessful) attempt to interest a physicist in topology.” ♠ so this Leibniz's text must be the first place where the term “analysis situs” appears in embryo, then rebaptized “Topologie” in Listing 1847 [937] (yet receiving only slow acceptance, say in the 1920's, e.g. Riemann, Poincaré, etc. used exclusively the term “analysis situs”).] ♡??
- [925] G. W. von Leibniz, *Nuova Methodus pro Maximis et Minimis*, i. Acta Eruditorum, Leipzig, Christoph Günther, 1684. [♠ traditionally regarded as the first text on “calculus”] ♡??
- [926] F. Leja, *Une méthode de construction de la fonction de Green appartenant à un domaine plan quelconque*, C.R. Acad. Sci. Paris 198 (1934), 231–234. [♠ Seidels' summary: a method for constructing the Green's function of an arbitrary region is given. The approximating functions are closely related to Lagrange polynomials] ♡??
- [927] F. Leja, *Construction de la fonction analytique effectuant la représentation conforme d'un domaine plan quelconque sur le cercle*, Math. Ann. 111 (1935), 501–504. [♠ Seidel's summary: for a given bounded simply-connected [sic!]? region in the plane (of the complex variable z), a sequence of elementary functions is constructed which tends to the [Riemann] mapping function of the region] ♡??

- [928] F. Leja, *Sur une suite de polynômes et la représentation conforme d'un domaine plan quelconque sur le cercle*, Annales Soc. Polonaise de Math. 14 (1936), 116–134. [♠ Seidel's summary: a set of polynomials is obtained by means of which the mapping function of a region D , with $z = \infty$ as interior point, on $|w| > 1$ can be expressed. If D is simply-connected, the map is one-to-one (schlicht) ♠ question (of Gabard) and if not, does it relates to the map of Riemann-Bieberbach-Grunsky-Ahlfors (cf. e.g. Bieberbach 1925 [147] and Ahlfors 1947 [18])]★★ ♡??
- [929] E. A. Leontovich-Andronova, *On some analogies between plane algebraic curves and plane algebraic dynamical systems*, Dokl. Akad. Nauk SSSR 129 (1959), 503–506. [♠ of course the analogy is one of long standing (it suffice to remember both parts of Hilbert's 16th), yet we suggest ([10.08.13]) a more concrete avatar through the dynamics allied to a Riemann-Bieberbach-Grunsky map allied to the phenomenon of total reality (e.g. as described in Gabard 2013B [471]). One can dream that we properly explored this theorem of Riemann (rendu synthetic by killing all intrusion of analysis if one likes à bit in the spirit of Clebsch-Brill-Noether and so the vicissitude allied to Dirichlet's principle) one can build the tool for new prohibitions in high order cases $m \geq 8$ which are still fairly mysterious despite the actual state of knowledge either baser on the theory of complex orientations à la Rohlin-Fiedler-Viro or homological methods and double covers à la Arnold-Viro, or now supplemented by the more elaborate Orevkov theory involving braids and link theory.]★★ ♡??
- [930] J. Lewittes, *Automorphisms of compact Riemann surfaces*, Amer. J. Math. (1963), 738–752. [♠]★ ♡??
- [931] J. Lewittes, *Riemann surfaces and the theta function*, Acta Math. 111 (1964), 37–61. [♠] ♡??
- [932] H. Lewy, *A propriety of spherical harmonics*, Amer. J. Math. 60 (1938), 555–560. [♠ a work on PDE's with ramification in real geometry (cf. for instance Galafassi's survey (1960 [479]))] ♡??
- [933] B. Levi, *Sul Principo di Dirichlet*, Rend. Circ. Mat. Palermo (1906). [♠ cited in Zaremba 1910 [1623] an extension of Hilbert's resurrection of the Dirichlet principle] ♡??
- [934] P. Li, S.-T. Yau, *A new conformal invariant and its application to the Willmore conjecture and the first eigenvalue of a compact surface*, Invent. Math. 69 (1982), 269–291. [♠ p. 272 claims a result along the line of the Witt-Martens mapping theorem for symmetric surfaces without fixed points, but the Li-Yau argument appears as sketchy, or maybe even invalid according to Ross 1997 [1301]] ♡**high 250?**
- [935] J.-L. Lions, *Remarks on reproducing kernels and some function spaces*, In: Function Spaces, Interpolation Theory and Related topics, Proceedings, Lund, Sweden, 2000, Walter de Gruyter, 2002, 49–59. [♠ present the definition of the reproducing kernel in the general setting due to Aronszajn (p. 50): “This definition is due to N. Aronszajn [1](=Aronszajn [73]) who studied general properties of reproducing kernels.—In particular cases, such notions have been introduced by S. Bergman [2](=1922 [114]), G. Szegő [11](=1921 [1476]), M. Schiffer [9](=1946 [1347]), S. Zaremba [12](=1908 [1622]), where the corresponding reproducing kernels are computed and estimated; cf. N Aronszajn, loc. cit., and P. Garabedian [3](=1949 [495]).” ♠ p. 56: “All these kernels can be computed by the same strategy as above. But we have not been able to recover by this method the results of P. Garabedian [3](=1949 [495]), which give the connection between $S(x, b)$ and $B(x, b)$.”] ♡2
- [936] J. Liouville, *Mémoire sur quelques propositions générales de géométrie et sur la théorie de l'élimination dans les équations algébriques*, J. de mathématiques 6, 345–411. [♠ cited in Kronecker 1865/95 [885] for an extension of Jacobi's relations to the case of an arbitrary number of equations, hence paving the way toward Petrovskii's bound on the Euler characteristic of the Ragsdale membrane] ♡2
- [937] J.B. Listing, *Vorstudien zur Topologie*, Göttinger Studien, 1847. [♠ influenced by Descartes, Leibniz 1679 [924], Euler, Gauss, etc. and influential upon Riemann (who attended in 1850 a seminar on mathematical physics run by W. Weber, Listing, Stern, and Ulrich), cf. e.g. p. 9 of Monastyrsky 1987/99 [1030], as well as upon Tait and Kelvin] ♡??
- [938] M. S. Li Chiavi, *Sulla rappresentazione conforme delle aree pluriconnesse appartenenti a superficie di Riemann su un'opportuna superficie di Riemann su cui siano*

- esequiti dei tagli paralleli*, Rend. Sem. Mat. Univ. Padova 3 (1932), 95–107. AS60
 [♠ Maria Stella Li Chiavi is a student of Cecioni] ♡low 0?
- [939] L. Lichtenstein, *Randwertaufgaben der Theorie der linearen partiellen Differentialgleichungen zweiter Ordnung vom elliptischen Typus. II*, J. Reine Angew. Math. 143 (1913), 51–105. [♠ quoted in Nevanlinna 1939 [1096] for Schwarz’s alternating procedure recasted as the solution of an integral equation through successive approximations] ♡high?
- [940] L. Lichtenstein, *Zur Theorie der konformen Abbildung nichtanalytischer, singularitätenfreier Flächenstücke auf ebene Gebieten*, Bull. Internat. Acad. Sci. Cracovie, Cl. Sci. Math. Nat. Ser. A. (1916), 192–217. AS60 [♠ an extension of Gauss 1825 [514] (local isothermic coordinates), simultaneous work by Korn] ★★★ ♡high?
- [941] L. Lichtenstein, *Zur konformen Abbildung einfach zusammenhängender schlichter Gebiete*, Archiv der Math. u. Physik 25 (1917), 179–180. [♠ Seidels’ summary: the problem of mapping conformally on a circle a simply-connected region bounded by a simple closed curve with continuous curvature is reduced to the solution of a linear integral equation] ★★★ ♡high?
- [942] L. Lichtenstein, *Neuere Entwicklung der Potentialtheorie. Konforme Abbildung*, Encykl. d. math. Wiss. II, 3., 1. Hälfte, 177–377. Leipzig, B. G. Teubner, 1919. G78 [♠ should contain another proof of the Kreisnormierung in finite connectivity, according to Hawley-Schiffer 1962 [1355]] ★ ♡43
- [943] B. V. Limaye, *Blaschke products for finite Riemann surfaces*, Studia Math. 34 (1970), 169–176. [♠ the paper starts with a little manipulation amounting to annihilate the periods of a conjugate differential, hence quite in line with say Ahlfors 1950 [19], yet does not seem to reprove the existence result of a circle map] ♡4
- [944] B. V. Limaye, *Ahlfors function on triply connected domains*, J. Indian Math. Soc. 37 (1973), 125–135. G78 ★ ♡??
- [945] I. Lind, *An iterative method for conformal mappings of multiply-connected domains*, Ark. Mat. 4 (1963), 557–560. G78 [♠ another proof of PSM (due to Schottky 1877, Cecioni 1908 [260], Hilbert 1909 [668], Koebe, etc.) via iterative scheme à la Koebe (who uses rather this device for the harder Kreisnormierung)] ♡??
- [946] E. Lindelöf, *Memoire sur la théorie des fonctions entières de genre fini*, 1902. [♠] ♡??
- [947] K. Lindemann, *Untersuchungen über den Riemann-Roch’schen Satz*, Teubner 1879. [♠ criticized by Noether 1879+ ε [1110].] ♡??
- [948] M. Lindner, *Über Mannigfaltigkeiten ebener Kurven mit Singularitäten*, Archiv. Math. 28 (1977), 603–610. [♠ cited e.g. in Shustin 1990/91 [1418] ♠ seems to contain a variant of the Severi-Brusotti description of the discriminant.] ♡??
- [949] F. Lippich, *Untersuchungen über den Zusammenhang der Flächen im Sinne Riemann’s*, Math. Ann. 7 (1874), 212–230. AS60 [♠ topology of surfaces, overlaps slightly with Möbius and Jordan 1866 [730], but no cross-citations] ♡??
 ★ Nicolai Ivanovitch Lobatchevskii (1793–1856), geometry with infinitely many parallels through a given points (1829, 18330, etc.). Compare Gudkov’s historical studies of his work.
- [950] K. Löbenstein, *Über den Satz, dass eine ebene algebraische Kurve 6. Ordnung mit 11 sich einander ausschliessenden Ovalen nicht existiert*, Inaugural Dissertation, Göttingen, 1910. [♠ Dissertation under Hilbert, attempting to prohibit the real sextic scheme consisting of 11 unnested ovals ♠ considered non-rigorous in Gudkov 1974 [579], albeit it was in Hilbert’s view (cf. Hilbert 1909 [669])] ♡??
- [951] O. Lokki, *Über Existenzbeweise einiger mit Extremaleigenschaft versehenen analytischen Funktionen*, Ann. Acad. Sci. Fenn. Ser. A. I. 76 (1950), 15 pp. AS60, G78 ★ ♡??
- [952] B. Lund, *Subalgebras of finite codimension in the algebra of analytic functions on a Riemann surface*, Pacific J. Math. 51 (1974), 495–497. AS60 [♠ quotes Ahlfors’ existence of a circle map (termed therein unimodular function) and cite also Royden’s proof of 1962 [1305] ♠ the paper itself is devoted to the following result: if a uniform subalgebra A of $A(R)$ the algebra of all analytic functions on the interior of a compact bordered Riemann surface \bar{R} and continuous up to its boundary included contains a circle map, then A has finite codimension in $A(R)$ ♠ question: what about the converse? If the codimension is zero this boils down to Ahlfors 1950 [19]] ♡2

- [953] J. Lüroth, *Note über Verzweigungsschnitte und Querschnitte in einer Riemann'schen Fläche*, Math. Ann. 3 (1871), 181–184. AS60 [♠ considered as sketchy by Clebsch 1872 [298], and consequently supplemented with more details] ♡??
- [954] A. M. Macbeath, *On a theorem of Hurwitz*, Proc. Glasgow Math. Assoc. 5 (1961), 90–96. [♠ construction of infinite families of surfaces for which Hurwitz's bound $84(g-1)$ is attained] ♡??
- [955] A. M. Macbeath, *Generators of the linear fractional groups*, Proc. Sympos. Pure Math. (Houston, 1967). [♠ construction of infinite families of surfaces for which Hurwitz's bound $84(g-1)$ is attained] ♡??
- [956] A. M. Macbeath, *The classification of non-euclidean plane crystallographic groups*, Canad. J. Math. 19 (1967), 1192–1205. [♠] ♡??
- [957] A. J. Macintyre, W. W. Rogosinski, *Extremum problems in the theory of analytic functions*, Acta Math. 82 (1950), 275–325. [♠ this enters into our specialized picture as follows: this paper, joint with Rogosinski-Shapiro 1953 [1283], and Rudin 1955 [1310] constitutes a stream influencing the production of the paper of Read 1958 [1243] and Royden 1962 [1305], where a new existence-proof of the Ahlfors map is given via functional analytic tools (Hahn-Banach) ♠ challenge [30.09.12] upon assuming that Gabard 2006 [463] is true, prove it via Hahn-Banach (good luck!)] ★ ♡??
- [958] F. Maitani, Y. Kusunoki, *Canonical functions on open Riemann surfaces*, Complex Variables and Elliptic Equations (1992). [♠ The canonical functions are meromorphic functions with a finite number of poles and their real parts are, roughly speaking, constant on each ideal boundary component of an open Riemann surface. The existence and geometrical: properties of such functions have been ...] ♡3
- [959] B. Manel, *Conformal mapping of multiply connected domains on the basis of Plateau's problem*, Revista Univ. Nac. Tucuman 3 (1942), 141–149. G78 [♠ title essentially self-explanatory modulo the question of knowing which types of mappings are handled: Kreisnormierung, circle map, or some slit mappings?] ★ ♡??
- [960] W. Mangler, *Die Klassen von topologischen Abbildungen einer geschlossenen Fläche auf sich*, Math. Z. 44 (1939), 541–554. [♠ oft quoted, e.g. by Teichmüller] ♡??
- [961] Yu. I. Manin, *Superalgebraic curves and quantum strings*, Trudy Mat. Inst. Steklov. 183 (1990), 126–138; English transl., Proc. Steklov Inst. Math. 183 (1991), 149–162. [♠] ♡??
- [962] A. Marden, *On homotopic mappings of Riemann surfaces*. Ann of Math. (2) (1969), 1–8. [♠ Lemma 2 (on unlimited branched covering surfaces) is probably akin to the well-known lemma ascribed to Radó 1922 [1230], compare Landau-Osserman 1960 [906]] ♡35
- [963] A. Marin, *Quelques remarques sur les courbes algébriques planes réelles*. In: Séminaire sur la géométrie algébrique réelle. Publ. Math. Univ. Paris VII, 1979, 51–86. (Circulated as Preprint no. 2205, Orsay, 1979.) [♠ where the writer (Gabard) learned about the Rohlin inequality $r \geq m/2$, which does not appear in print by Rohlin although quite easily derived from Rohlin's formula in Rohlin 1978 [1290]. For more details, cf. Gabard 2000 [461] and the refs. therein or Corollary (in v2) (in this text). ♠ besides Marin's text contains several other key contribution (the Marin-Fiedler locking device to get obstruction on rigid isotopy, as well as clean proof of the Gudkov-Rohlin congruence plus the allied shifted mod 8 congruence $\chi \equiv_8 k^2 + 4$ forcing type I of $(M-2)$ -curves)] ♡??
- [964] A. Marin, *Sur un théorème de Cheponkus*, in: Real Analytic and Algebraic Geometry, Proceedings Trento, 1988 (Eds. M Galbiati, A. Tognoli). Springer, Lecture Notes in Math., 1420, 191–193. [♠ contains a corrected version of a theorem of Cheponkus (unsuitably proved in the original), as well as a proof of Klein's intuition that curves of type I cannot acquire a new oval by continuous deformation of the coefficients. ♠ [26.03.13] in fact it seems to me that Marin's statement is slightly stronger than Klein's original (unproved) assertion inasmuch as Klein 1876 [795] supposed that the curve traverses the discriminant across an isolated double point (with imaginary conjugate tangents), alias solitary double points in the Russian jargon of Arnold, Viro, etc.] ♡??
- [965] D. E. Marshall, *An elementary proof of the Pick-Nevalinna interpolation theorem*, Mich. Math. J. [♠] ♡35

- [966] D. E. Marshall, *Removable sets for bounded analytic functions*, In: *Linear and complex analysis problem book*. Lecture Notes in Mathematics 1043. Springer, Berlin, 1984, 2233–2234. CHECK PAGINATION incompatible with Murai 1990/91 [1049] [♠ if I do not mistake this is the first place where it is explained why Calderón’s achievement (Calderón 1977 [222] on the L^p -continuity of the singular integral operator with a Cauchy kernel on a smooth curve) implies the so-called Denjoy conjecture (Denjoy 1909 [360]) about the removability of a closed set lying on a rectifiable curve being equivalent to the vanishing of its length ♠ historical detail: Murai 1990/91 [1049, p. 904–905] seems to ascribe the Denjoy conjecture to Calderón-Havin-Marshall using the (cryptical) abbreviation CHM on p.905 (but quotes only the present text of Marshall) ♠ the Calderón-to-Denjoy implication is obtained by combining classical results of Garabedian, Havinson with Davie’s reduction of the Denjoy conjecture to the C^1 -case, completing thereby the proof of Denjoy’s conjecture ♠ in fact, Denjoy announced this as a theorem, but his proof turned out to be erroneous (compare Marshall [966] or Melnikov 1975/76 [995, p. 691] or Verdera 2004 [1517, p. 29]) ♠ alas, people rarely say explicitly who located the gap in Denjoy’s claim (this is a non-trivial historical quiz), but maybe Ahlfors-Beurling 1950 [20, p. 122] are good candidates, yet they do not criticize directly Denjoy but rather establish the special case of Denjoy’s conjecture for linear and then analytic curves] ♡??
- [967] G. Martens, *Komponentenzerfüllende abelsche Erweiterungen reeller algebraischer Funktionenkörper einer Variablen*, Diss. Univ. Heidelberg, 1974. [♠ cited in Martens 1975 [968], and might be the first place where the phrasing “total reell” appears in print] ♡??
- [968] G. Martens, *Galoisgruppen über aufgeschlossenen reellen Funktionenkörpern*, Math. Ann. 217 (1975), 191–199. [♠ p.197: total reality (“total reelle Galois Erweiterungen” are defined in the context of Galois extensions of real function fields)] ♡??
- [969] G. Martens, *Minimale Blätterzahl bei Überlagerungen Kleinscher Flächen über der projectiven Ebene*, Archiv der Math. 30 (1978), 481–486. [♠ sharp bound upon the degree of the Witt mapping ♠ differential geometric application in Ross 1999 [1301]] ♡4?
- [970] G. Martens, *Die Zerlegungscharaktere abelscher total reeller Erweiterungen reeller Funktionenkörper einer Variablen*, J. Reine Angew. Math. ?? (ca. 1978), ??–??. [♠ quoted in Geyer-Martens 1977 [520]] ♡??
- [971] G. Martens, *Funktionen von vorgegebener Ordnung auf komplexen Kurven*, J. Reine Angew. Math. 320 (1980), 68–85.
- [972] H.. Martens, *A new proof of Torelli’s theorem*, Ann. of Math. (2) 78 (1963), 107–111. [♠] ♡??
- [973] H. H. Martens, *On the varieties of special divisors on a curve*, J. Reine Angew. Math. 227 (1967), 111–120. [♠ self-explanatory title, but do not prove the existence of special divisors] ♡??
- [974] R. S. Martin, *Minimal positive harmonic functions*, Trans. Amer. Math. Soc. 49 (1941), 137–172. AS60 [♠ plays a fundamental rôle in Heins 1950 [634], who seems to offer an alternative proof of the existence of a circle map as the one of Ahlfors 1950 [19]] ♡??
- [975] M. Maschler, *Minimal domains and their Bergman kernel function*, Pacific J. Math. 6 (1956), 501–516. [♠] ♡19
- [976] M. Maschler, *Classes of minimal and representative domains and their kernel functions*, Pacific J. Math. 9 (1959), 763–782. [♠ contain (according to entry Maschler 1959 [977, p. 173]) a description of the geometric shapes of minimal domains (i.e. essentially the range of the least area maps) in the case of doubly-connected domains] ♡8
- [977] M. Maschler, *Analytic functions of the classes L^2 and l^2 and their kernel functions*, Rend. Circ. Mat. Palermo (2) 8 (1959), 163–177. [♠ p.173 seems to assert that the range of the least area maps are unknown for domains of connectivity higher than 2 ♠ still on p.173 Kufarev 1935/37 [891] is credited for establishing that the least area map in the case of doubly-connected domains is not univalent, but schlicht upon a (two sheeted) Riemann surface] ♡1
- [978] B. Maskit, *The conformal group of a plane domain*, Amer. J. Math. 90 (1968), 718–722. G78 [♠ proves two results to the effect that any plane domain (resp.

- Riemann surface of [finite] genus g) conformally embeds into either the sphere or a closed Riemann surface of the same genus so that, under this embedding, every conformal automorphism of the original surface is the restriction of one of the compactified closed surface ♠ the proof proceeds (via exhaustion) by reduction to the case of finite Riemann surfaces, previously established by the author] ♡??
- [979] B. Maskit, *Moduli of marked Riemann surfaces*, Bull. Amer. Math. Soc. (1974). [♠] ♡35
- [980] B. Maskit, *Canonical domains on Riemann surfaces*, Proc. Amer. Math. Soc. 106 (1989), 713–721. [♠ Kreisnormierung for surfaces supplementing the uniqueness lacking in the existence proof in Haas 1984 [595]] ♡??
- [981] J. Mateu, X. Tolsa, J. Verdera, *The planar Cantor sets of zero analytic capacity and the local $T(b)$ -theorem*, J. Amer. Math. Soc. 16 (2002), 19–28. [♠ a complete characterization of the sets in the title is given via a little incursion of the Ahlfors function (on p. 25) ♠ [23.09.12] since Vitushkin and especially Garnett 1970 [502] it is known that the $1/4$ -Cantor set has $\gamma = 0$ (zero analytic capacity), but positive length. More generally one may consider a λ -Cantor set $E(\lambda)$ for $0 < \lambda < 1/2$ (obtained by keeping only the four subsquares of length λ pushed to the 4 corners of the unit-square and iterating ad infinitum) and ask about the ‘critical temperature’, i.e. the smallest λ such that $\gamma(E(\lambda)) > 0$ ♠ the critical value λ is precisely $\lambda = 1/4$, as follows from Theorem 1 of the cited work, describing more generally the case of a Cantor set $E(\lambda)$ associated to a sequence $\lambda = (\lambda_n)_{n=1}^{\infty}$ with variable λ_n (in the range $]0, 1/2[$) ♠ naive question: in the case where λ is constant (self-similar Cantor set) can we describe the behavior of $\gamma(E(\lambda))$ as a function $]0, 1/2[\rightarrow]0, +\infty[$: is it monotone, bounded, analytic or at least derivable (especially at the critical value)? ♠ naive answers: monotone most probably, bounded also certainly namely by γ of the unit square corresponding to $E(1/2)$] ♡??
- [982] P. Matildi, *Sulla rappresentazione conforme di domini appartenenti a superficie di Riemann su di un tipo canonico assegnato*, Ann. Scuola Norm. Super. Pisa (2) 14 (1945), (1948), 81–90. AS60 [♣ this paper (read by writer only the 13.07.12) seems to establish the existence of a circle map (*cerchio multiplo*) for compact bordered Riemann surface having only *one* contour. Thus with some imagination this may be regarded as a precursor of the Ahlfors circle map. (Recall that Ahlfors was well aware of this paper at least subsequently for it is cited in Ahlfors-Sario 1960 [26], alas without detailed comment.) Matildi also proposes a bound on the degree of the mapping whose dependence upon the topology is, however, not made completely explicit. He proposes namely, the degree $\lambda \leq n(2n - 3)$, where n is the minimum degree of a projective-plane model for the Schottky-double of the given membrane. Perhaps it would be useful to estimate his bound purely in term of the topology (via basic algebraic geometry) ♣ an extension of Matildi’s work to the case of membranes having several contours is claimed in Andreotti 1950 [53], but it still hard to decide if ti really cover the Ahlfors theorem of 1950] ♡0
- [983] S. Matsuoka, *Nonsingular algebraic curves in $RP^1 \times RP^1$* , Trans. Amer. Math. Soc. ?? (1991–93 ca. CHECK), ?–?. [♠ Hilbert’s problem in $\mathbb{P}^1 \times \mathbb{P}^1$, while extending to this context the Gudkov-Rohlin congruence and inequalities of Petrovskii and Arnold, compare also Gilmer 1991 [522] for some simplification based upon an adaptation of Marin’s proof of the Gudkov-Rohlin congruence] ♡??
- [984] S. Matsuoka, *The configuration of the M -curves of degree $(4, 4)$ in $RP^1 \times RP^1$ and periods of real $K3$ surfaces*, Hokkaido Math. J. 19 (1990), 359–376. [♠ Hilbert’s problem in $\mathbb{P}^1 \times \mathbb{P}^1$, while extending to this context the Gudkov-Rohlin congruence and inequalities of Petrovskii and Arnold] ♡??
- [985] P. Mattila, *Smooth maps, null-sets for integralgeometric measure and analytic capacity*, Ann. of Math. (2) 123 (1986), 303–309. [♠ includes a counterexample to the original formulation of Vitushkin’s conjecture (E removable iff purely unrectifiable, i.e. the intersection with any curve of finite length has zero 1-dimensional Hausdorff measure H^1) ♠ Mattila’s counterexample has $H^1(E) = \infty$ (infinite length) ♠ for the validation of Vitushkin’s conjecture in the case $H^1(E) < \infty$, see G. David 1998 [344]] ♡??
- [986] P. Mattila, M. S. Melnikov, J. Verdera, *The Cauchy integral, analytic capacity and uniform rectifiability*, Ann. of Math. (2) 144 (1996), 127–136. A47 [♠ analytic capacity, Ahlfors function and a step forward in understanding Painlevé null-sets geometrically ♠ for the complete solution see Tolsa 2003 [1496]] ♡133

- [987] R. Mazzeo, M. Taylor, *Curvature and uniformization*, Israel J. Math. 130 (2002), 323–346. [♠ uniformization via Liouville’s equation (Schwarz’s strategy, cf. also Bieberbach 1916 [144]), as we know since Koebe (Überlagerungsfläche) this gives then the Kreisnormierung, cf. e.g. Bergman 1946 [120]] ♡??
- [988] S. McCullough, *The trisecant identity and operator theory*, Integr. Equat. Oper. Theory 25 (1996), 104–127. [♠ pp.113–5: discussion of the Ahlfors function along the lines of Fay 1973 [409] and p. 125 mentions Bell’s result 1991 [99] that the zeros of Ahlfors function are distinct if the center a is chosen near enough the boundary ♠ [20.09.12] as we already observed once, it could be interesting to investigate if Bell’s result extends to bordered surfaces (compact) of positive genus $p > 0$. Of course in this case the degree of the Ahlfors map may jump from points to points (within the Ahlfors range $r \leq \deg \leq r + 2p$), and this phenomenology is probably connected with deep algebro-geometric or differential-geometric invariants of the surface (Weierstrass points, etc.), compare the work of Yamada 2001 [1612] and Gouma 1998 [536] for the hyperelliptic context (phenomenology of the mutation of the Ahlfors maps and their fluctuating degree upon dragging away the basepoint) ♠ maybe it could be also worth looking if Bell’s result is somehow connected to Solynin’s result (2007 [1445]) about the confinement of the zeros of the Green’s function inside a compactum when the pole is dragged through the surface ♠ at first sight, this looks quite plausible in view of Ahlfors formula (cf. 1947 [18] and 1950 [19]) that if f is a circle map with zeros at t_1, \dots, t_d then $\log |f(z)|$ matches a superposition of Green’s functions with poles at the t_i , i.e. $\log |f(z)| = \sum_{i=1}^d G(z, t_i)$, since both functions vanish on the contours and present the same singularities at the t_i ♠ since it is not the critical points of the individual Green’s function, but those of the superposed Green’s functions which are responsible for the ramification of f , a direct application of Solynin looks hazardous ♠ still, one may wonder if the ramification of the Ahlfors map stay likewise trapped within a compactum upon dragging the center a of the Ahlfors map f_a through the membrane] ♡??
- [989] ?. McDonald, *On the ovals of a sextics curve*, Amer. J. Math. ?? (1927), ?–?. [♠ despite being heavily criticized in Gudkov 1974 [579] as lacking in rigor, this text still appears to us as closest to the our simple heuristic proof of Hilbert’s Ansatz of nesting for a sextic curve. Indeed recall that our short argument (found ca. January 2013) for this is simply to claim that an M -sextic without nesting (i.e. with eleven ovals lying each external to each other) produces by simultaneous contraction of all its ovals a splitting of the underlying Riemann surface in two conjugate cubic curves $C_3 \cup C_3^c$ intersecting in 11 points overwhelming thereby Bézout’s nine intersections. Apart little phraseological complication McDonald’s text comes quite close to this simple pseudo-proof whose defect is only that we lack an explicit existence proof of the required contraction. Of course the latter can be perhaps derived from Itenberg’s result 1994 [700] yet involving a highbrow dependance upon Nikulin and so on the Torelli theorem à la Pyatetsky-Shapiro/Shafarevich [1229]. Further we seem to remember that Gudkov promised (in 1974 [579]) an explicit demolition of McDonald’s argument to be found in Hilton 1936 [673], what we could could not find in print. (Hilton rather demolish Wright’s paper of 1907 [1606]).]★ ♡??
- [990] A. D. Mednykh, *Nonequivalent coverings of Riemann surfaces with a prescribed ramification type*, Sibirsk Mat. Zh. 25 (1984), 120–142. [♠]★ ♡??
- [991] A. D. Mednykh, *Determination of the number of nonequivalent coverings on a compact Riemann surface*, Doklady SSSR 239 (19??), 269–271. [♠ cited in Natanzon 1993 [1070] as akin to Hurwitz 1891 [689]]★ ♡??
- [992] A. D. Mednykh, *Branched coverings of Riemann surfaces whose branch orders coincide with the multiplicity*, Comm. in Algebra 18 (1990), 1517–1533. [♠]★ ♡??
 ★ Theodor Meis, seems to be a student of the Münster school (Behnke-Stein, etc.) well-known for his work on the conformal mapping of a closed Riemann surface to the sphere with the minimum possible number of sheet (Blätterzahl). Basically Meis’ result is due to Riemann, Brill-Noether but one of those classical writer seem credited of a tangible demonstration by contemporary workers, and Meis is regarded as the first rigorous demonstration. Of course the sibylline critics to Riemann are akin to those about moduli first seriously settled via Teichmüller’s standpoint, hence the reliance of Meis upon Teichmüller should be no surprise.
- [993] Th. Meis, *Die minimale Blätterzahl der Konkretisierung[en] einer kompakten Riemannschen Fläche*, Schriftenreihe des Math. Inst. der Univ. Münster, Heft 16 (1960). [♠ a much quoted—but hard-to-find—source where the gonality of a general closed Riemann surface of genus g is found to be the bound predicted by

Riemann, Brill-Noether, etc., namely $[\frac{g+3}{2}] \diamond$ Meis belongs to the Münster school (Behnke–Stein, etc.) ♣ [04.10.12] it seems probable that the technique employed by Meis (which involves Teichmüller theory according to secondary sources, e.g. H. H. Martens’ MathReview of Gunning 1972 [592]) could be adapted to the context of bordered surfaces and thus lead to a new proof of the Ahlfors map, even perhaps with the sharp bound given in Gabard 2006 [463] ♠ this seems to us to be a task of primary importance, but lacking a copy of Meis article we were relegated to make some general speculations (cf. Sec. in v.2 which we summarize briefly) ♠ the basic idea is to develop a “relative” Teichmüller theory not for pairs of Riemann surfaces of the same topological type (hence relatable by a “möglichst konform” diffeomorphism effecting the minimum distortion upon infinitesimal circles), but for just one Riemann surface which we try to express as a branched cover of the sphere (or the disc) for a fixed mapping degree d , while exhibiting the (quasiconformal) map of least distortion. Measuring this least dilatation, we get instead of the usual Teichmüller metric (distance) on the moduli space, a Teichmüller temperature ε_d (or potential) whose vanishing amounts to the possibility of expressing the given surface as a (conformal!) branched cover of the disc (or the sphere), thereby resolving the Ahlfors mapping problem (or the Riemann–Meis problem) depending on the bordered or closed context. [As a matter of convention the distortion (eccentricity of infinitesimal ellipses is ≥ 1 and this is converted in values ≥ 0 upon taking the logarithm)] ♠ in fact upon looking at the gradient flow of the Teichmüller temperature (trajectories of steepest descent orthogonal to the isothermic hypersurfaces $\varepsilon_d = \text{const.}$) we get a flow on the moduli space (M_g , if closed or $M_{p,r}$, if bordered) with the net effect of improving the gonality of each individual surface during its evolution ♠ as the Teichmüller space is a cell one can hope to derive the existence of stagnation point of the flow by the usual Poincaré–Brouwer–Hopf index formula giving so an existence-proof of a conformal map. However this is a bit artificial for the existence of low degree maps is usually evident (looking at hyperelliptic surfaces and their bordered avatars). Of course it must perhaps be ensured that the flow only stagnates when the temperature vanishes (i.e. no saddle points nor sinks of positive temperature) ♠ in such favorable circumstances any closed surface of genus g would flow toward a hyperelliptic model representing the smallest possible gonality (=two) ♠ likewise, in the bordered context one expects that any membrane of type (p, r) converges to a membrane of least possible gonality, that is r (excepted when $r = 1$ and $p > 0$ where the least topological degree is 2) ♠ admittedly, all this does not readily reprove Meis’ gonality (nor that of Ahlfors–Gabard) but maybe it is a first step toward a solution along this path, which—we repeat—should be found in the work of Meis (which in substance is nothing else than a relative (or ramified) version of classical Teichmüller theory) ♠ perhaps the flow we are speaking about is not logically needed in Meis’ proof but it can certainly enhance the game ♠ basically for each d the continuity of the temperature function shows that the set of d -gonal surfaces is closed in the moduli space M_g , and since the set is nonempty as soon as $d \geq 2$ (hyperelliptic models) it suffices to show that it is open when d is appropriately large. The expected value for d is $[\frac{g+3}{2}]$ (resp. $r+p$ in the bordered case of $M_{p,r}$), yet it is precisely here that some idea is required ♠ naively if the degree is high enough one disposes of enough free parameters to make variations exploring locally the full moduli space ♠ alternatively one can perhaps argue that the temperature function ε_d is real-analytic on M_g so that it would suffice to check its vanishing on a small parametric (open) ball consisting of Riemann surfaces with explicitly given equations (this resembles perhaps Meis’ approach through the little I know of it via indirect sources, e.g. R. F. Lax 1975 [913]) ♠ Finally, we could access this text the [08.05.13], via the site SUB Uni Göttingen.]★ ♡30

[994] M. S. Melnikov, *Structure of the Gleason part of the algebra $R(E)$* , Funkt. Anal. Prilozhen. 1 (1967), 97–100; English transl. (1968), 84–86. [♠ p. 86, Ahlfors function via Vitushkin 1958 [1542] ♠ the paper itself is devoted to giving another proof (via the apparatus of analytic capacity) of Wilken’s theorem that the Gleason part of the algebra $R(E)$ (of uniform limits on a compactum $E \subset \mathbb{C}$ of the rational functions of the variable z) consists either of one point (and is then a peak point), or it has positive area] ♡??

[995] M. S. Melnikov, S. O. Sinanyan, *Aspects of approximation theory for functions of one complex variable*, Itogi Nauki i Tekhniki 4 (1975), 143–250; English transl. in J. Soviet Math. 5 (1976), 688–752. [♠ Vitushkin’s theory (i.e., uniform approximation

- by rational functions) and its relation to the Ahlfors function and the allied analytic capacity] ♡??
- [996] M. S. Melnikov, *Analytic capacity: discrete approach and curvature of measure*, Sb. Math. 186 (1995), 827–846. A47 [♠ analytic capacity (p. 827), Ahlfors function (p. 830, 838) and introduction of the concept of the curvature of a (positive Borel) measure in the plane [Menger curvature], which enables a new proof of Denjoy’s conjecture (without using Calderón’s L^2 -estimates for the singular Cauchy integral) ♠ this technique of Melnikov is also instrumental in Tolsa’s solution (2003 [1496]) of the (full) Painlevé problem] ♡103
- [997] M. S. Melnikov, J. Verdera *A geometric proof of the L^2 boundedness of the Cauchy integral on Lipschitz graphs*, Internat. Math. Research Notices 7 (1995), 325–331. [♠ another approach to Calderón 1977 [222]] ♡??
 ★ Menaechmus (ca. 350 B.C.–350) traditionally regarded as the first writer to describe the classification of conic sections (through the geometric approach). For a good perspective of how this geometric idea of cones latter developed by Apollonius (-225), Newton ca. 1667, Zeuthen 1873, Klein, Gudkov for curves of higher order, cf. Korchagin-Weinberg 2005 [867].
- [998] O. Mengoni, *Die konforme Abbildung, gewisser Polyeder auf die Kugel*, Monatsh. f. Math. u. Phys. 44 (1936), 159–185. [♠ Seidel’s summary: the paper is a contribution to the problem of conformal mapping of simply-connected closed polyhedra upon the sphere. According to H. A. Schwarz, this problem can be reduced to the determination of a number of constants from a set of transcendental equations. It is shown that the explicit solution can be determined in a number of cases not considered by Schwarz. The paper concludes with a discussion of the results from the viewpoint of numerical computations] ★ ♡??
- [999] S. N. Mergelyan, *Uniform approximations to functions of a complex variable*, Amer. Math. Soc. Transl. 1001 (1954). ♡high
- [1000] H. Meschkowski, *Beziehungen zwischen den Normalabbildungsfunktionen der Theorie der konformen Abbildung*, Math. Z. 55 (1951), 114–124. G78 ♡1
- [1001] H. Meschkowski, *Über die konforme Abbildung gewisser Bereiche von unendlich hohen Zusammenhang auf Vollkreisbereiche, I*, Math. Ann. 123 (1951), 392–405. AS60, G78 [♠ some infinite connectivity cases of KNP, via iterative methods à la Koebe and area estimates due to Rengel 1932/33 [1248]] ♡??
- [1002] H. Meschkowski, *Über die konforme Abbildung gewisser Bereiche von unendlich hohen Zusammenhang auf Vollkreisbereiche, II*, Math. Ann. 124 (1952), 178–181. AS60, G78 [♠ sequel of the previous paper, building again over a Rengel (1932/33 [1248]) area estimate for 4-gons and using Grötzsch’s (1929 [558]) mapping of a domain of infinite connectivity upon a Kreisschlitzbereich, reducing therefore the general study to this special case] ♡??
- [1003] H. Meschkowski, *Einige Extremalprobleme aus der Theorie der konformen Abbildung*, Ann. Acad. Sci. Fenn. Ser. A. I. 117 (1952), 12 pp. AS60, G78 [♠ which mappings?, essentially all types, but relies heavily on previous works of Garabedian-Schiffer and Nehari ♠ mention the issue that there is no known extremal problem yielding the Koebe Kreisnormierung, for an update on this question see several works of Schiffer via Fredholm eigenvalues] ♡??
- [1004] H. Meschkowski, *Verzerrungssätze für mehrfach zusammenhängende Bereiche*, Compositio Math. 53 (1953), 44–59. G78 [♠ Kreisbogenschlitz map, and somewhat relevant to the point discussed in Gaier 1978 [475] ♠ more precisely shows that the Ahlfors-type problem of maximizing the derivative among *schlicht* function bounded-by-one gives a conformal map upon a Kreisschlitzbereich (=circular slit disc). See also Reich-Warschawski 1960 [1244]] ♡0
 ★ Grisha Mikhalkin, student of O. Viro and then of S. Akbulut (himself a student of R. Kirby), well-known for revolutionary insights on a topic on which the writer has zero-knowledge (extension of Rohlin’s formula to other surfaces than the plane (cf. also Zvonilov 1980), amoeba, simple Harnack curves, Brusotti’s bases, tropical geometry, Mikhalkin correspondence in tropical enumerative geometry (based on a suggestion of Kontsevich), etc.).
- [1005] G. Mikhalkin, *Adjunction inequality for real algebraic curves*, arXiv (1994); and published in 1997 as [1007]. [♠ as pointed out by Th. Fiedler (letter of the 9 March in v2), this paper of Mikhalkin seems to be one of the earliest application of the Thom conjecture to Hilbert’s 16th] ♡??

- [1006] G. Mikhalkin, *The complex separation of real surfaces and extensions of Rokhlin congruence*, Invent. Math. 118 (1994), 197–222. [♠] ♥??
- [1007] G. Mikhalkin, *Adjunction inequality for real algebraic curves*, Math. Res. Lett. 4 (1997), 45–52. [♠ application of Thom’s conjecture to Hilbert’s 16th, but according to a philosophy (we learned from Fiedler) yields nothing new for a single curve but certainly does for arrangements of curves] ♥??
- [1008] G. Mikhalkin, *Real algebraic curves, the moment map and amoebas*, Ann. of Math. (2) 151 (2000), 309–326. [♠] ♥??
- [1009] I. P. Millin, *The method of areas for schlicht functions in finitely connected domains*, (Russian) Trudy Mat. Inst. Steklov 94 (1968), 90–121. G78 [♠ cited in Grunsky 1978 [568, p. 185], hence possibly relevant to the issue discussed in Gaier 1978 [475]] ★★★ ♥??
 ★ John Milnor (1930–∞) a well known student of Whitney growing in Fine Hall hill (Princeton) notorious for his detection of exotic smoothness structures on S^7 (by combining results of Pontrjagin, Thom, Hirzebruch and Reeb) and many other seminal contributions to topology, geometry, measure theory, dynamical systems, etc. In real algebraic geometry, also contributed to (coarse) upper-bounds on the number of components of real algebraic manifolds (as opposed to sharp[er] ones due to Petrovskii-Oleinik (at least so is the verdict of Arnold). Especially relevant to Hilbert’s 16th is the joint note with Kervaire (1961) establishing the degree 3 case of Thom’s conjecture on the genus of smooth surface in the 4-manifold $\mathbb{C}P^2$. Hence Hilbert’s nesting Ansatz for sextics can be derived from pure (differential) topology.
- [1010] J. Milnor, *On spaces having the homotopy type of CW complexes*, Trans. Amer. Math. Soc. ? (1959), ?–?. [♠ states the result that a metric manifolds has always the homotopy type of a CW-complex, building over result of the Polish and Swede school (Kuratowski, Borsuk, Hanner), cf. also the more detailed implementation in Palais 1962 ♠ be careful about terminology, Milnor states this result under the assumption of separability, yet if this means (as it does presently) existence of a denumerable dense part, then there is some simple counter-example of Prüfer described in Gabard 2006/08 [464]] ♥??
- [1011] J. Milnor, *On the Betti numbers of real varieties*, Proc. Amer. Math. Soc. 15 (1964), 275–280. [♠ cf. also Thom 1965 [1488]] ♥??
- [1012] J. Milnor, *Singular points of complex hypersurfaces*, Princeton Univ. Press, New York, 1968. [♠ often cited by patchworkers especially Korchagin 1988 [859] paving the way toward the new series of 19 many M -schemes of degree 8.] ♥??
- [1013] C. D. Minda, *The Aumann-Carathéodory rigidity constant for doubly connected regions*, Kodai Math. J. 2 (1979), 420–426. A47 [♠ p. 422 an elementary existence-proof of the Ahlfors function is given in the case of an annulus $A := \{z : 1/R < |z| < R\}$ conjointly with the fact that the map is uniquely prescribed by its two zeros a, b (up to rotation) subjected to the relation $|ab| = 1$ ♠ one can wonder if in this case the circle maps of minimum degree (here $r = 2$, i.e. two contours) coincide exactly with the Ahlfors map f_a maximizing the distortion at a (both depends upon 2 real parameters) ♠ p. 424, still in the annulus case an explicit expression of the Ahlfors function is given in terms of the theta function, in a way analogous to work of Robinson 1943 [1270] and Abe 1958 [1] ([03.10.12] compare maybe also Golusin 1952/57 [534]) ♠ this is then applied to give an explicit formula for the Aumann-Carathéodory rigidity constant (1934 [78]) ♠ p. 420, another proof of the so-called annulus theorem is given (quoting the variety of proofs due to H. Huber 1951, Jenkins 1953, Kobayashi 1970, Landau-Osserman 59/60 [906], Reich 1966, Schiffer 1946), but emphasizing that the present proof is patterned along Heins 1941 [633] showing “that the annulus theorem should properly be traced back to Heins’ work”] ♥??
- [1014] C. D. Minda, *The hyperbolic metric and coverings of Riemann surfaces*, Pacific J. Math. 84 (1979), 171–182. A50 [♠ Ahlfors 1947 [18] and 1950 [19] are cited as follows (p. 180): “A function \tilde{f} in $\mathcal{B}(X)$ which maximizes $|\tilde{f}'(p)|$ is called an Ahlfors function ([1](=1947), [2](=1950)) and $c_B(p) = \max\{|\tilde{f}'(p)| : \tilde{f} \in \mathcal{B}(X)\}$ is called the analytic capacity metric.” ♠ from the abstract (freely and perhaps loosely reproduced): given two Riemann surfaces X, Y endowed with their hyperbolic metrics, the principle of hyperbolic metric (aka Schwarz-Pick-Ahlfors lemma) says that any analytic map $f : X \rightarrow Y$ is a contraction. “Moreover, equality holds if and only if f is an (unbranched, unlimited) covering of X onto Y ” ♠ [04.10.12]

the latter property is essentially topological so applies to any Ahlfors map (even in the extended sense of—what we call—circle maps). We could then lift the hyperbolic (Riemann-Poincaré) metric on the disc to the bordered surface. Alas the ramification creates singularities (in this metric attached to a circle map), so that we certainly do not recover the hyperbolic metric on the interior of the bordered surface. The other way around we may assume uniformization (recall that the interior of any bordered surface is hyperbolic) and try to investigate the metric properties of varied circle maps. In particular is there any special feature related to the circle maps of smallest degree (alias the separating gonality in Coppens 2011 [322])? Also, given a point $p \in F$ (in the interior) there is a unique Ahlfors map f_p from F to the disc maximizing the derivative and since f_p is “étale” at p we get the above mentioned capacity metric which is more negatively curved than the hyperbolic metric (cf. Suita and Burbea’s papers). Unfortunately the degree of the Ahlfors function is quite mysterious (being subjected to spontaneous quantum fluctuations), but since everything is encoded in the hyperbolic metric there must be an algorithm which given the input of F with the marked point p computes the degree of f_p in terms of the intrinsic geometry of F ♠ Some very vague guesses: given p there is a homology basis consisting of loops all based at p , and by compactness a smallest “systolic-type” system of such curves of minimal total length probably individually consisting of geodesics; this gives a real number and [pure guess] its integer part is the degree of f_p . Variant: there is a compact bordered surface capturing all the homology (plus the given point p) whose finite volume(=area) ♠ Further once the hyperbolic metric is introduced on F any Ahlfors map at p gives a stretching factor at p which by the principle of contraction is ≤ 1 , and we get a (probably continuous) function $\delta: F \rightarrow]0, 1]$ of F measuring this distortion. Does the function extends to the boundary ∂F ? (and could it be harmonic??). Intuitively when the degree of f_p is low one may expect that the distortion is high. On the other hand there is largest schlicht disc centered at the origin where f_a is unramified, but beware that ramification may come from another point than p lying above the origin. So the right viewpoint is that there is a maximal disc centered at p which is ramificationless.] ♡10

[1015] C. D. Minda, *The image of the Ahlfors function*, Proc. Amer. Math. Soc. 83 (1981), 751–756. [♠ Ahlfors function for domains of infinite connectivity ♠ p. 751: “Ahlfors [1](=1947 [18]) showed that $h(\Omega) = B$ [i.e. the Ahlfors function is surjective on the disc B] for regions Ω of finite connectivity that have no trivial boundary components. More precisely, he proved that h expresses Ω as an n -sheeted branched covering of B , where n is the order of connectivity of Ω . In the general situation Havinson 1961/64 [621] and Fisher 1969 [439] demonstrated that $B \setminus h(\Omega)$ has analytic capacity zero; [...]. It is not difficult to give an example of a region Ω such that $B \setminus h(\Omega) \neq \emptyset$. For example, let K be a closed set of B which has analytic capacity zero and $\Omega = B \setminus K$. If $0 \in \Omega$, then the Ahlfors function h for Ω and 0 is the identity function, so $h(\Omega) = B \setminus K$. The question of the size of $B \setminus h(\Omega)$ becomes more interesting if it is required that Ω be a maximal region for bounded holomorphic functions in the sense of Rudin 1955 [1309]. [→ Recall Rudin’s definition (p. 333): “A boundary point x of D [=domain in the Riemann sphere] is said to be *removable* if for every $f \in B(D)$ [=bounded analytic function] there exists a neighborhood V of x such that f can be extended to V . By an *essential* boundary point of D we mean one that is not removable. If every boundary point of D is essential, we say that D is *maximal*.”] For such a maximal region Ω , Fisher 1972 [440] raised the question of whether the Ahlfors function must map Ω onto B . Rödning 1977 [1280] answered this question in the negative by exhibiting a maximal region Ω and a point $p \in \Omega$ such that the Ahlfors function for Ω and p omitted two values in Ω . We shall extend Rödning’s result by showing that an Ahlfors function for a maximal region can actually omit a fairly general discrete set of values in B .” ♠ p. 755: “Therefore, it is still an open question whether the Ahlfors function for a maximal region can actually omit an uncountable set of zero analytic capacity.” ♠ [05.10.12] an update (positive answer) is implied by Yamada 1992 [1611] where an example is given where the omitted set of the Ahlfors function has positive logarithmic capacity (hence uncountable, because sets of logarithmic capacity zero are stable under countable unions, see e.g. Tsuji 1959 [1506])] ♡2

[1016] C. D. Minda, *Bloch constant for meromorphic functions*, Math. Z. ?? (1982), ??–??. [♠ “Our geometric approach to the construction of an upper bound is more elementary and clearly shows the analogy with the Ahlfors-Grunsky example. [...]

Let $XXXX$ be a compact bordered Riemann surface with genus g and m boundary components.”] ♡9

- [1017] H. Minkowski, *Raum und Zeit*, Jahresb. d. Deutsch. math. Verein. (1909). [♠ light extrapolation of Einstein 1905, paving the way toward general relativization. ♠ das vierdimensionale Raum-Zeit-Kontinuum as a Riemannization of Einstein’s stories (1905) ♠ the saga continued with H. Weyl’s *Raum, Zeit und Materie*] ♡??
- [1018] S. Minsker, *Analytic centers and analytic diameters of planar continua*, Trans. Amer. Math. Soc. 191 (1974), 83–93. [♠ the Ahlfors function is mentioned twice on p. 91, 92 ♠ the paper itself contains results about analytic centers and analytic diameters (concepts arising in Vitushkin’s work on rational approximation)] ♡2
- [1019] N. M. Mishachev, *Complex orientations of plane M -curves of odd degree*, Funkt. Anal. Prilozhen. 9 (1975), 77–78; English transl., Funct. Anal. Appl. 9 (1975), 342–345. [♠ adaptation of Rohlin’s complex orientation formula to odd degrees] ♡??
- [1020] I. P. Mitjuk, *The principle of symmetrization for multiply connected regions and certain of its applications*, (Russ.) Ukrain. Mat. Ž 17 (1965), 46–54; Amer. math. Soc. Transl. 73, 73–85. G78 ★ ♡??
- [1021] I. P. Mitjuk, *The inner radius of a region and various properties of it*, (Russ.) Ukrain. Mat. Ž 17 (1965), 117–122; Amer. math. Soc. Transl. ??, ??–??. [♠ a formula expressing the inner radius $r(G, 0)$ of a domain G containing the origin and bounded by n analytic Jordan curves is given in terms of the Ahlfors function $F_G(z, 0)$ (normalized as usual by $F_G(0, 0) = 0$ and $F'_G(0, 0) > 0$) and the Green’s function $g_G(z, 0)$ ♠ the formula reads $r(G, 0) = \frac{1}{F'_G(0, 0)} \exp(\sum_{k=1}^{n-1} g_G(0, z_k))$, where z_k are the $n - 1$ extra zeros of the Ahlfors function ♠ related material in Bandle-Flucher 1996 [91]] ★★★ ♡??
- [1022] I. P. Mitjuk, *Extremal properties of meromorphic functions in multiply connected domains*, Ukrain. Mat. Ž 20 (1968), 122–127; Amer. math. Soc. Transl. 76, 116–120. A47 [♠ Ahlfors’ function occurs thrice: twice on p. 116 and once on p. 117 and is applied to obtain a connection between the inner radius and the transfinite diameter] ♡??
- [1023] Y. Miyahara, *On relations between conformal mappings and isomorphisms of spaces of analytic functions on Riemann surfaces*, J. Math. Soc. Japan 31 (1979), 373–389. A50 [♣ on p. 375, Ahlfors 1950 [19] is cited for a result on the existence of a basis of analytic Schottky differentials whose periods along a canonical homology basis are calibrated to Kronecker’s delta. Hence the discussion is not directly relevant to the circle map, yet the general construction is quite akin (Green’s function, period of the conjugate differential, etc.) ♠ p. 380, one reads: “Let g be a nonconstant function in $A(S')$ satisfying $|g| = 1$ on $\partial S'$. (This is a so-called inner function.)” ♠ the existence of a such a map follows (perhaps) from Ahlfors 1950, and if so the author perhaps fails to emphasize this issue adequately] ♡0
- [1024] Y. Miyahara, *On local deformations of a Banach space of analytic functions on a Riemann surface*, J. Math. Soc. Japan 40 (1988), 425–443. A50 [♣ on p. 436, Ahlfors 1950 [19] is cited in essentially the same context as for the previous entry, i.e. Miyahara 1979 [1023]] ♡0
- [1025] H. Mizumoto, *On conformal mapping of a Riemann surface onto a canonical covering surface*, Kōdai Math. Sem. Rep. 12 (1960), 57–69. A50, G78 [♣ an essentially topological proof of (Ahlfors) circle maps is given, recovering the same degree $r + 2p$ as Ahlfors 1950 [19] ♣ for a (possible) improvement to $r + p$, cf. Gabard 2006 [463] ♠ in case Mizumoto’s argument is solid, this seems to be a much underestimated paper as it is quoted by 0 according to the electronic counters, but it is in Grunsky 1978 [568]] ♡0

★ August Ferdinand Moebius is well-known for the so-called Moebius band (also creditable to Gauss or Listing), and concerning our present topic for the key distinction (1851 [1027]) between paare und unpaare Züge (alias ovals vs. pseudo-lines) when it comes to study how a circle is embedded in the (real) projective plane $\mathbb{R}P^2$. Compare also the related work von Staudt 1847 [1554]. This distinction (and the relevant intersection theory) plays a key role in all works on the topic starting with Harnack’s, as well as in our synthetic version of the Riemann-Bieberbach-Grunsky theorem as implemented in Gabard 2013B [471]. Likewise notorious is Moebius early work on the topology of surfaces (1863 [1028] but ready as early 1860 when loosing the Parisian contest for linguistical issues), which seems to have no antecedent beside by the intuition of Riemann, (Gauss?), etc. As is well-known this

Theorie der elementaren Verwandschaft is justly regarded as forerunner of Morse theory (ca. 1925).

- [1026] A. F. Möbius, ??, ?? (1827), ??-??. [♠ homogeneous coordinate, parallel work by Plücker and Feuerbach in the same year 1827] ♡??
- [1027] A. F. Möbius, *Ueber die Grundformen der Linien der dritten Ordnung*, Abh. K. Sächs. Gesellschaft der Wiss. 1 (1851), pp. 81; also in: (Möbius Werke II, Leipzig 1880, 80–176. [♠ cited in Hilbert 1891 [661] for the elementary property of what we call now “ovals” versus “pseudolines” (then called “paare und unpaare Curvenzüge”) and also in Harnack 1876 (p. 190), but not in Zeuthen 1874 [1628] who only cites von Staudt 1847 [1554], and also in Brusotti 1952 [206]] ♡??
- [1028] A. F. Möbius, *Theorie der elementaren Verwandschaft*, Ber. Verhandl. Königl. Sächs. Gesell. d. Wiss., mat.-phys. Klasse 15 (1863), 18–57. (Möbius Werke II). [♠ a revolutionnary paper fixing the bases of “Morse theory” and classifying en passant the closed orientable surfaces, ♠ followed by Jordan 1866 [730], and vital to Klein’s theory of symmetric surfaces. Of course according to Klein (cf. 1892 [803]), this topological classification must have been known to Riemann] ♡??
- [1029] H. Mohrmann, *Über das Büschel von ebenen Kurven 3. Ordnung mit neun reellen Grundpunkten*, Math. Ann. ?? (1912), 319–340. [♠ cite Hilbert 1891 and Rohn 1911 and cited by Brusotti, but (curiously) not in Gudkov 1974. ♠ the article has a pleasnt introduction which in Russian language could be stated by saying that there is no decomposable sextic $6 = 3 + 3$ of bidegree (3, 3) such that the two cubics with two ovals have there pseudo-lines maximally intersecting in 9 points ordered in the same fashion along both circuits (simple oscillation without meanders) and so that both ovals are unnested. Indeed if such an arrangement of 2 cubics existed, then by the usual smoothing method (later called Brusotti’s theorem) we could derive a non-singular sextic with 11 unnested ovals, but this is prohibited by Hilbert/Rohn. ♠ [11.07.13] the paper cited contains a rather deep investigation of pencil of cubics, and so it could be of some relevance in establishing Rohlin’s claim of total reality of the (suitable) pencil of cubics on the $(M - 2)$ -sextic with $\chi \equiv_8 k^2 + 4$.] ♡??
- [1030] M. Monastyrsky, *Riemann, Topology and Physics*, 1st edition 1987; Second Edition 1999, Reprint in 2008, Modern Birkhäuser Classics (Part I of the 1st ed., Moscow, 1979). [♠ p. 20: “The concluding remarks in the dissertation show that the general nature of the problem of analytic functions on arbitrary multiconnected domains was already clear to Riemann.” ♠ compare for similar remarks Klein 1882 [797], Klein 1892 [803] ♣ p. 72: “Riemann’s note, “Equilibrium of electricity on circular cylinders”, evidently dates to this same period. The problem of the distribution of electrical charge in cylindrical conductors leads to the purely mathematical problem of solving Laplace’s equation in a simply connected⁴¹ domain with prescribed boundary condition. Here for the first time automorphic functions arise.” ♠ [26.12.12] quoting Weierstrass: “To the question, Can one really obtain anything directly applicable from those abstract theories with which today’s contemporary mathematicians occupy themselves?, I can answer that Greek mathematicians studied the properties of conic sections in a purely theoretical way long before the time when anyone could foresee that these curves represent the paths along which the planets move. I believe that many more functions with such properties will be found; for example, the well-known θ -functions of Jacobi make it possible, on the one hand, to find the number of squares into which any given number decomposes, thereby making it possible to rectify an arc of ellipse, and, on the other hand, they make it possible to find the true law of the oscillations of a pendulum.”] ♡??
- [1031] G. Monge, *Feuille d’analyse*, 1795. [♠ Monge is especially known for the study of curvature lines on ellipsoid, and as recently been regarded by the Brazilian experts, as a serious foruner of Poincaré when it comes to qualitative theory of differential equations (dynamical systems)] ★ ♡??
- [1032] A. F. Monna, *Dirichlet’s principle. A mathematical comedy of errors and its influence on the development of analysis*, Oosthoek, Scheltema, and Holkema, Utrecht, 1975. ★ ♡??
- [1033] J.-P. Monnier, *Divisors on real curves*, Adv. Geom. 3 (2003), 339–360. [♠ compare for a partial rejection of Monnier’s conjecture the discussion in Coppens-Martens 2010 [320]] ♡??

⁴¹Read perhaps multiconnected to be more faithful to Riemann’s original text.

- [1034] P. Montel, *Sur les suites infinies de fonctions*, Ann. École Norm. Sup. (3) 4 (1907), 233–304. [♠ Montel’s Thesis building over Arzelá, Vitali, Lebesgue, etc. leading to the concept of “normal families”, pivotal in the resolution of extremal problems involving bounded functions (e.g. the so-called Ahlfors function) ♠ the nomenclature “normal families” was coined afterwards in Montel 1913 [1035] ♠ simultaneous related work appeared independently by Koebe ca. 1907 in relation with his distortion theorem, compare e.g. the historical analysis of Bieberbach 1968 [156, p.150–151] who writes: “Beim Beweis wird nun neben dem Viertelsatz ein allgemeiner Konvergenzsatz benutzt. Das ist nichts anderes als das, was man in Montels Theorie der Normalen Funktionenfamilien, heute kurz den *Vitalischen Reihensatz* nennt. Koebe hat ihn selbständig entdeckt [11](=Koebe 1908 UbaK3 [825]). Er leitet ihn aus der Wurzel ab, die auch den anderen Forschern die Anregung gab: Hilberts Arbeit über das Dirichletsche Prinzip (1901) und die vierte Mitteilung über Integralgleichung (1906) des gleichen Forschers. [...]” ♡??
- [1035] P. Montel, ???, C.R. Acad. Sci. Paris 153 (1911), 996–998. [♠ where the nomenclature “normal families” appears first in the literature] ♡??
- [1036] P. Montel, *Leçons sur les familles normales de fonctions analytiques et leurs applications*, Gauthier-Villars, Paris, 1927. [♠ Montel’s treatise on the subject which appeared 20 years after the subject began] ♡185
- [1037] G. Moore, N. Seiberg, *Classical and quantum conformal field theory*, Commun. Math. Phys. 123 (1989), 177–254. [♠ p.178: “The Riemann surface can be formed by sewing a number of three holed spheres (a.k.a. trinions).” [this jargon is due to Möbius 1860/63 [1028]]] ♡920
- [1038] J. W. Morgan, Z. Szabó, C.H. Taubes, *The generalized Thom conjecture*, Preprint 1995; cf. also next entry [♠ cited in Kirby’s list 1970–95 [785], as another (independent of Kronheimer-Mrowka’s) proof of the Thom conjecture] ♡??
- [1039] J. W. Morgan, Z. Szabó, C. H. Taubes, *A product formula for the Seiberg-Witten invariants and the generalized Thom conjecture*, J. Differ. Geometry 44 (1996), 706–788. [♠ proof of a generalized Thom conjecture for smooth holomorphic curves with $C \cdot C \geq 0$ (nonnegative self-intersection) in an arbitrary Kähler surface (or even a symplectic 4-manifolds) ♠ p.707: “The Thom conjecture and very similar generalizations of it have been established independently by Kronheimer-Mrowka; see [4](=Kronheimer-Mrowka 1994 [886]).”] ♡??
- [1040] A. Mori, *Conformal representation of multiply connected domain on many-sheeted disc*, J. Math. Soc. Japan 2 (1951), 198–209. AS60, G78 [♣ reprove the circle map (ascribed to Bieberbach/Grunsky) via potential theory (Green’s function), plus a mixture of linear algebra and topology (homology) ♠ Lemma 1 gives also an “iff” condition for a group of points in the interior to be the fibre of a circle map (in terms of harmonic measure) (compare Fedorov 1991 [410] for a similar game) ♠ [26.09.12] it would be nice(?) to extend such a characterization to the positive genus case, and try to recover the Gabard bound $r + p$ by this procedure] ♡3
- [1041] C. B. Morrey, *Multiple Integrals in the Calculus of Variations*, Grundlehren der math. Wissenschaften 130, Springer-Verlag, Berlin, 1966. [♠ includes a proof of Koebe’s Kreisnormierung via a Plateau-style approach (extending thereby Douglas’ derivation (1931 [371]) of the RMT) ♠ however some little gaps in the execution are noticed (but filled) by Jost 1985 [731], cf. also Hildebrandt-von der Mosel 2009 [671] ♠ [07.10.12] it is tempting to conjecture that the Plateau-style approach should also have something to say about the Ahlfors circle maps (cf. Courant 1939 [334] for the planar case, i.e. the Bieberbach-Grunsky theorem), however to (my knowledge) it was never attempted to tackle the case of positive genus ($p > 0$)] ♡??
- [1042] M. Morse, *Relations between the critical points of a real function of n independent variables*, Trans. Amer. Math. Soc. 27 (1925), 345–396. [♠ critical point theory, cited in Petrowsky 1938 [1168] as one of the tool used in the proof of the Petrovskii’s inequalities. ♠ historical antecedents by Moebius 1863 [1028], Cayley, Maxwell, etc. and along the tradition of Poincaré-Birkhoff.] ♡??
- [1043] M. Morse, M. Heins, *Topological methods in the theory of a function of a complex variable*, Bull. Amer. Math. Soc. ?? (1947), 1–14. [♠ p.1: “The modern theory of meromorphic functions has distinguished itself by the fruitful use of the instruments of modern analysis and in particular by its use of the theories of integration. Its success along the latter line has perhaps diverted attention from some of the more finitary aspects of the theory which may be regarded as fundamental.”] ♡65

- [1044] M. Morse, *La construction topologique d'un réseau isotherme sur une surface ouverte*, J. Math. Pures Appl. (9) 35 (1956), 67–75. AS60 ★ ♡??
 ★ D. Mumford, student of O. Zariski, well-known for his deep investigation on algebraic geometry, mixing classics and moderns viewpoints (e.g., Grothendieck).
- [1045] D. Mumford, *Theta characteristics of an algebraic curve*, Ann. Sci. École Norm. Sup. (4) 4 (1971), 181–192. [♠] ♡??
- [1046] D. Mumford, *Curve and Their Jacobians*, The University of Michigan Press, Ann Arbor, 1975, 104 pp; reprinted in the “Red Book of Varieties and Schemes”, 2nd Edition, Lecture Notes in Math. 1358, Springer, 1999. [♠] ♡??
- [1047] D. Mumford, *Algebraic Geometry I, Complex projective varieties*, Grundlehren d. Math. Wiss. 221, Springer, 1976. [♠] ♡??
- [1048] T. Murai, *Construction of H^1 functions concerning the estimate of analytic capacity*, Bull. London Math. Soc. 19 (1987), 154–160. [♠ p.154 mentions the Ahlfors function (via Garnett’s book 1972 [503, p.18]) and its indirect rôle in Garnett’s 1970 [502] exposition (of Vitushkin’s 1959 example [1543] of a set of positive length but vanishing analytic capacity), but then Murai prefers to switch to the so-called Garabedian function to derive a direct proof of the vanishing of the analytic capacity] ♡??
- [1049] T. Murai, *Analytic capacity for arcs*, In: Proceedings of the International Congress of Mathematicians, Kyoto, Japan, 1990, 901–911, The Mathematical Soc. of Japan, 1991. A47 [♠ 3 occurrences of the Ahlfors function, on p.902 (via Garnett 1970 [502, p.24]), p.904, p.905 ♠ seems to ascribe the Denjoy conjecture to Calderón-Havin-Marshall using the (cryptical) abbreviation CHM on p.905 (but quotes only Marshall [966])] ♡??
- [1050] T. Murai, *The arc-length variation of analytic capacity and a conformal geometry*, Nagoya Math. J. 125 (1992), 151–216. A47 [♠ 4 occurrences of the Ahlfors function, on p.152, 159, 191, 199 ♠ analytic capacity (of a compact plane set) and its variation under a small change of the compactum E (theory of Hadamard-Schiffer), with apparently a connection to Löwner’s differential equation] ♡??
- [1051] P. J. Myrberg, *Über die Existenz der Greenschen Funktionen auf einer gegebenen Riemannschen Fläche*, Acta Math. 61 (1933), 39–79. AS60 [♠] ♡??
- [1052] S. Nagura, *Kernel functions on Riemann surfaces*, Kōdai Math. Sem. Rep. (9) 35 (1951), 73–76. AS60 [♠ theory of the Bergman kernel on a Riemann surface using an exhaustion by compact bordered subregions with analytic boundaries] ♡??
- [1053] J. Sz. Nagy, *Über die reellen Züge algebraischer ebener und räumlicher Kurven*, Math. Ann. 77 (1916), 416–428. [♠ cited in Gudkov 1974 [579]] ♡??
- [1054] M. Nakai, *The corona problem on finitely sheeted covering surfaces*, Nagoya Math. J. 92 (1983), 163–173. A50 [♠ p.164: “As is well known these surfaces [=finite open Riemann surfaces] are represented as unbounded finitely sheeted covering surfaces of the unit disk Δ (cf. e.g. Ahlfors [1](=1950 [19])).” ♠ comment of Gabard [12.09.12]: it may appear as a bit unfair that Alling’s works are omitted in the bibliography of this work, and more specifically Gamelin’s accreditation of the bordered corona on p.164 looks historically erroneous in view of the earlier work of Alling 1964 [40], and Alling 1965 [41] (for full details)] ♡2
- [1055] M. Nakai, 1985 see Hara-Nakai 1985 [606].
- [1056] M. Nakai, *Valuations on meromorphic functions of bounded type*, Trans. Amer. Math. Soc. 309 (1988), 231–252. A50 [♠ Ahlfors 1950 [19] is cited in the following context (of valuation-theoretic stability) on p.240: “The following is due to Frank Forelli [4](=private communication) to whom the author is very grateful for many valuable suggestions and information:—EXAMPLE 1. *Any finitely sheeted disc is stable.*—The result follows immediately from Theorem 1 [*an unlimited finite covering surface is stable iff its base is*] and Theorem 2 [*the open unit disc is stable*]. Plane regions bounded by finitely many mutually disjoint nondegenerate continua are finitely sheeted disks by the Bieberbach-Grunsky theorem (cf. e.g. [16](=Tsuji 1959/75 [1506])) or more generally finite open Riemann surfaces are finitely sheeted disks by the Ahlfors theorem [1](=Ahlfors 1950 [19]). Here a finite open Riemann surface is a surface obtained from a closed surface by removing a finite number of mutually disjoint nondegenerate continua. Hence as a special case of the above example we have—COROLLARY. *Finite open Riemann surfaces are stable.*” ♠ the notion of stability involved is the following (p.231): “Any valuation on the field

- $M(W)$ of single-valued meromorphic functions on a Riemann surface W is a point valuation (Iss'ssa 1966). What happens to valuations on subfields of $M(W)$? An especially interesting subfield in this context is the field $M^\infty(W)$ of meromorphic functions of bounded type on W (cf. [2](=Alling 1968)) ♠ the exact definition is given on p. 232: "A single-valued meromorphic function f on a Riemann surface W is said to be of bounded type if $f = \frac{g}{h}$ on W where g and h are bounded holomorphic functions on W with $h \neq 0$." ♠ p. 232/4: "We say that a Riemann surface W is stable if $M^\infty(W)$ is nontrivial and any valuation on $M^\infty(W)$ is a point valuation." ♠ [29.09.12] roughly it seems that this notion of stability leads to a theory quite parallel to that of the corona problem, for the above positive (finitistic) result of Nakai is quite parallel to that of Alling 1964 [40] in the "coronal realm" and further the open question are similar e.g. p. 241: "OPEN PROBLEM 2. *Is there any stable plane region of infinite connectivity?*" ♠ however in the Corona problem it is still an open problem whether any plane region satisfies the corona theorem, but here Nakai (p. 241) gives a nonstable plane region "obtained from the punctured open unit disc Δ_0 by removing a sequence of mutually disjoint closed disks with centers on the positive real axis that accumulates only at $z = 0$ (a [so-called] Zalcman L -domains [17](=Zalcman 1969 [1619]))" ♡??
- [1057] M. Namba, *Geometry of Projective Algebraic Curves*, Marcel Dekker, New York and Basel, 1984. [♠ a textbook on curves via a mixture of transcendent and algebro-geometric recipes (browsed through it ca. 1998–2000, so cannot remember exactly the content)] ♡??
- [1058] D. Nash, *Representing measures and topological type of finite bordered Riemann surfaces*, Trans. Amer. Math. Soc. 192 (1974), 129–138. (Dissertation Berkeley, Advisor: Sarason) A50 [♠ cite Ahlfors 1950 [19], yet apparently not within the main-body of the text ♠ given \bar{R} a finite bordered surface, let A be the usual hypo-Dirichlet algebra consisting of functions continuous on the bordered surface and holomorphic on its interior R . For a point $a \in R$, let e_a be the corresponding evaluation. A representing measure for e_a is a positive Borel measure m of total mass one supported on ∂R such that $f(a) = \int_{\partial R} f dm$ for all $f \in A$. The collection of all such measures form a compact convex set \mathfrak{M}_a . The paper shows some connections between the topology and even the conformal type of the surface R and the geometry of the convex body \mathfrak{M}_a of representing measures. It is shown that if \mathfrak{M}_a has an isolated extreme point, then R must be a planar surface. ♠ let g be the genus of R and s the number of contours, Theorem 1.2 states: "If $g = 0$ and $s = 3$, then \mathfrak{M}_a has precisely four extreme points if a lies on one of three distinguished analytic arcs, and \mathfrak{M}_a is strictly convex if a lies off these arcs. If $g = s = 1$, then \mathfrak{M}_a is strictly convex for all $a \in R$." ♠ [28.09.12] it seems evident that this article (using such concepts as harmonic measure, Green's function, Schottky differentials, convex bodies, etc.) must bear some close connection with Ahlfors 1950 [19], and it would be nice if the degree of the Ahlfors map f_a (at a) could somehow be related to the geometry of the body \mathfrak{M}_a] ♡4
- [1059] S. M. Natanzon, *Invariant lines of Fuchsian groups and moduli of real algebraic curves*, Candidate (Ph.D.) dissertation, Moscow, 1974. (Russian) [♠] ♡??
- [1060] S. M. Natanzon, *Moduli of real algebraic curves*, Uspekhi Mat. Nauk 30 (1975), 251–252. (Russian) [♠ it is shown (in line with Klein's intuition or Teichmüller's work 1939 [1484]) that all real algebraic curves of a given topological type (g, k, ε) (viz. genus, invariant "ovals" and the "dividing" type) form a connected space of dimension $3g - 3$ ♠ for an English translation see also Natanzon 1978/80 [1062]] ♡??
- [1061] S. M. Natanzon, *Automorphisms of the Riemann surface of an M -curve*, Funkts. Anal. i Prilozhen. 12 (1978), 82–83; English transl. Funct. Anal. Appl. 12 (1978), 228–229. [♠] ♡??
- [1062] S. M. Natanzon, *Moduli spaces of real curves*, Trudy Moskov. Mat. Obshch. 37 (1978), 219–253; English transl., Trans. Moscow Math. Soc. 37 (1980), 233–272. [♣ modernized account of the theory of Klein 1882 [797] and Teichmüller 1939 [1484] ♠ compare also nearly parallel work by Seppälä 1978 [1383]]★★ ♡33
- [1063] S. M. Natanzon, *Spaces of real meromorphic functions on real algebraic curves*, Dokl. Akad. Nauk SSSR 279 (1984), 803–805; English transl., Soviet. Math. Dokl. 30 (1984), 724–726. [♣ contains a topological description of real meromorphic function, cf. also the subsequent note Natanzon 1987/88 [1065] and full details in Natanzon 1993 [1070]] ♡??

- [1064] S. M. Natanzon, *Topological classification of pairs of commuting antiholomorphic involutions of Riemann surfaces*, Russian Math. Surveys 41 (1986), 159–160. [♠ p. 159: “It is well known that the topological equivalence class of a pair (P, α) consisting of a compact [orientable] surface P and an orientation-reversing involutory homeomorphism $\alpha: P \rightarrow P$ is determined by the genus $g = g(P)$ of P , the number of ovals $k = \|P^\alpha\|$, and whether the set $P - P^\alpha$ is connected ($\varepsilon = 0$) or not ($\varepsilon = 1$). The triple (g, k, ε) is called the *topological type* of (P, α) . For such triples the Weichold [read Klein to be slightly more accurate] relation hold (see [4](=Weichold 1883 [1570]), [5](=Natanzon 1978 [1062])):—(1) $0 \leq k \leq g$ when $\varepsilon = 0$,—(2) $1 \leq k \leq g + 1$ and $k \equiv g + 1 \pmod{2}$ when $\varepsilon = 1$.] ♡??
- [1065] S. M. Natanzon, *Real meromorphic functions on real algebraic curves*, Dokl. Akad. Nauk SSSR 297 (1987), ?–?; English transl., Soviet. Math. Dokl. 36 (1988), 425–427. [♣ contains a fine topological study of real meromorphic functions (using the method of Clebsch 1873 [298]), yet (apparently) without reproving Ahlfors theorem ♠ [30.12.12] the proofs seem only sketched, but it is of utmost interest to assimilate better this and subsequent works by Natanzon (e.g. Natanzon 1993 [1070])] ♡??
- [1066] S. M. Natanzon, *Finite groups of homeomorphisms of surfaces and real forms of complex algebraic curves*, Trudy Moskov. Mat. Obsh. 51 (1988), 3–53. [♠ inspiration Clebsch 1873 [298] and Hurwitz 1891 [689]]★★ ♡??
- [1067] S. M. Natanzon, *Spinor bundles over real algebraic curves*, Uspekhi Mat. Nauk 44 (1989), 165–166; English transl., Russian Math. Surveys 44 (1989), 208–209. [♣] ♡??
- [1068] S. M. Natanzon, *Prymians of real curves and their applications to the effective-ization of Schrödinger operators*, Funkt. Anal. Prilozhen. 23 (1989), 41–56; English transl., Funct. Anal. Appl. 23 (1989), 33–45. [♣]★★ ♡??
- [1069] S. M. Natanzon, *Klein surfaces*, Uspekhi Mat. Nauk 45 (1990), 47–90; English transl., Russian Math. Surveys 45 (1990), 43–108. [♣ contains an extensive bibliography, through which—if I remember accurately—I discovered circa 2001 the papers Alling-Greenleaf 1969 [44] and Geyer-Martens 1977 [520] which pointed out to me the connection between Klein’s dividing curves and the Ahlfors map of Ahlfors 1950 [19] (i.e. circle maps) ♠ “The structure of a Klein surface is an analogue of the complex-analytic structure for surfaces with boundary and non-orientable surfaces. Similar to the way in which the theory of compact Riemann surfaces gives an adequate language for the description of complex . . .”] ♡42
- [1070] S. M. Natanzon, *Topology of 2-dimensional coverings and meromorphic functions on real and complex algebraic curves*, Selecta Math. (formerly Sovietica) 12 (1993), 251–291; Originally published in: Trudy Sem. Vektor. Tenzor. Anal. 23 (1988), 79–103; and ibidem 24 (1991), 104–132. [♠] ♡??
- [1071] S. M. Natanzon, *Moduli of Riemann surfaces, Hurwitz-type spaces, and their superanalogs*, Uspekhi Mat. Nauk 54 (1997), 61–116; English transl., Russian Math. Surveys 54 (1999), 61–117. [♠] ♡??
- [1072] S. M. Natanzon, *Moduli of real algebraic surfaces, and their superanalogues. Differentials, spinors, and Jacobian of real curves*, Uspekhi Mat. Nauk 54 (1997), 3–60; English transl., Russian Math. Surveys 54 (1999), 1091–1147. [♠ real algebraic curves (à la Klein-Weichold), antiholomorphic involution and its action upon all structures allied to the Riemann surface (vector bundles, Jacobians, Prymians and so on), topological invariants and the corresponding moduli spaces, inspiration=mathematical physics (solitons, string theory, etc.) ♠ p.1092: “According to standard definitions, a *real algebraic curve* is a pair (P, τ) , where P is a complex algebraic curve (that is, a compact Riemann surface) and $\tau: P \rightarrow P$ is an antiholomorphic involution. The category of real algebraic curves is isomorphic to the category of Klein surfaces [1](=Alling-Greenleaf 1971 [45]), [35](=Natanzon 1990 [1069]). Investigations of real algebraic curves were started by Klein [25] (=1892=Vorles. Gött.⁴² [802], [803]) and Weichold 1883 [1570]. For a long time thereafter researchers studied only plane algebraic curves⁴³, that is, real curves embedded in $\mathbb{R}P^2$. The systematic study

⁴²Easy to sharpen as Klein 1876 [795].

⁴³This is especially true under the Russian perspective, yet in the West workers were a bit more universalist, e.g. Koebe 1907 [822], J. Douglas 1936 [372], Teichmüller 1939 [1484], Ahlfors 1950 [19], Schiffer-Spencer 1954 [1352], etc.

of “general” real algebraic curves was renewed only in the seventies [1](=Alling-Greenleaf 1971 [45]), [16](=Earle 1971 [387]), [20](=Gross-Harris 1981 [552]), [31]–[33](=Natanzon 1974 [1059], 1975 [1060], 1978/80 [1062]), [48](=Seppälä 1978 [1383]). The method of algebraic-geometric integration of works by S.P. Novikov and his school, posed a number of new problems in the theory of real curves and significantly stimulated the development of this theory [10](=Cherednik 1980 [274]), [12]–[14](=Dubrovin 1987/88 [382], Dubrovin-Natanzon 1982 [380], Dubrovin-Natanzon 1988 [383]), [34](=Natanzon 1989 [1068]), [37](=Natanzon 1992), [42](=Natanzon 1995). Conformal field theory and, in particular, string theory [9](=Carey-Hannabuss 1996 [242]), [23](=Jaffe-Klimek-Lesniewski 1990 [714]), [24](=Karimipour-Mostafazadeh 1997 [749]), [49](=Vajsburd-Radul 1991 [1512]) has become another area of applications of real curves.”] ♡??

- [1073] S. M. Natanzon, B. Shapiro, A. Vainshtein, *Topological classification of generic real rational functions*, arXiv (2001) or J. Knot Theory Ramif. 11 (2002), 1063–1075. [♣ § 3.1, p. 7 (arXiv pagination) titled “On the space of branched covering of a hemisphere by a Riemann surface with boundary” should evidently bears some strong connection with Ahlfors theory. In fact the authors describe the “set $\mathcal{H}_{g,m}^k$ of all generic degree m branched coverings of the form $f: P \rightarrow \Lambda^+$ ” where P is a topological surface of genus g with k contours and Λ^+ is the upper hemisphere $\{z \in \overline{\mathbb{C}} : \text{Im}(z) \geq 0\}$. ♠ [21.10.12] this space is of course thought of as a Hurwitz space and it may be partitioned according to the varied multi-degrees of the restricted maps along the k contours, which are indexed by partitions (m_1, \dots, m_k) of m . The corresponding subspace of the Hurwitz space having fixed bordered degree (m_1, \dots, m_k) is shown to be connected (via an extension of the Lüroth-Clebsch theorem). ♠ alas, it is not clear to me (Gabard) if the article shows an Ahlfors-type existence result, amounting to the non-emptiness of $\mathcal{H}_{g,m}^k$ for m sufficiently large (cf. Ahlfors 1950 [19], or Gabard 2006 [463]). But note that the surface is here only topological, so that the viewpoint is different! Yet perhaps compatible if one lifts the complex structure of the disk/hemisphere via all topological maps obtaining a “variable” Riemann surface with enough free moduli to realize all of them, recovering so perhaps Ahlfors’ theorem via an Hurwitz-type strategy. (I clearly remember to have discussed this idea with Natanzon in a 2001 Rennes conference, but as yet never managed to deduce an existence proof corroborating either Ahlfors 1950 or Gabard 2006.) The argument could start as follows: set \mathcal{H}_g^k the set of all branched covers of the disc (without specified degree). Lifting the complex structure, gives a map $\mathcal{H}_g^k \rightarrow M_{g,k}$ to the moduli space of bordered surfaces of type (g, k) (=genus, number of contours). The latter is probably continuous and one would like to show (by a topological argument akin to the continuity method made rigorous by Brouwer-Koebe) that the map is onto when restricted to the Hurwitz space of degree m , for some suitable value of m . Of course the lack of compactness of the moduli space may suggest to invoke a Deligne-Mumford compactification? Alternatively one can maybe avoid compactification via a clopen argument based on Brouwer’s invariance of the domain] ♡??
- [1074] Z. Nehari [né Willi Weisbach], *Analytic functions possessing a positive real part*, Duke Math. J. 15 (1948), 165–178. G78 [♠ cites the result of Bieberbach 1925 [147], Grunsky 1937–41 [561, 562], Ahlfors 1947 [18], i.e. only planar domains via extremal methods] ♡10
- [1075] Z. Nehari, *The kernel function and canonical conformal maps*, Duke Math. J. 16 (1949), 165–178. AS60, G78 [♠ integral representation of the varied slit-mappings (parallel/circular slits or circular holes) via the Bergman kernel]★★ ♡8
- [1076] Z. Nehari, *The radius of univalence of an analytic function*, Amer. J. Math. 71 (1949), 845–852. G78 [♠ application of the Ahlfors function 1947 [18] and of Garabedian’s identity $2\pi F'(z) = K(z, z)$ (Szegő kernel) to the problem of determining the radius of univalence to some families of analytic functions on multi-connected domains, generalizing thereby sharp estimates of Landau for bounded functions in the unit-circle] ♡4
- [1077] Z. Nehari, *On bounded analytic functions*, Proc. Amer. Math. Soc. 1 (1950), 268–275. AS60, G78 [♠ alternative (simplified, but lucky-guess type) derivation of Ahlfors 1947 [18] and Garabedian 1949 [495] results around the Schwarz’s lemma via potential theory (Green’s function) and the Szegő kernel] ♡12
- [1078] Z. Nehari, *Conformal mapping of open Riemann surfaces*, Trans. Amer. Math. Soc. 68 (1950), 258–277. AS60, G78 [♣ the paper starts with the historically interesting fact that the main result in Ahlfors 1950 [19] was already presented in

- Spring 1948 at Harvard (multiply-covered circle with number of sheets not exceeding $(r + 2p)$) ♣ contains various type of slit mappings (parallel vs. circular or radial), where the first type is given an elementary proof whereas the second requires Jacobi inversion (cf. Ahlfors' in MathReviews) [Incidentally one may wonder whether the first (parallel-slit) result is not already implicit in Hilbert 1909 [668]?] ♣ ♠ p. 267: "Representation of the Ahlfors mapping in terms of the kernel function." ♠ NB: some part of this paper are criticized by Tietz 1955 [1491], but himself is critiqued later so it is not clear who (and what) is right and how reliable those papers are ♣ the writer asserted in Gabard 2006 [463, p.946], that Nehari and Tietz may have conjectured the improved bound $r + p$ upon the degree of a circle map, yet on more mature thought this assignment may be a bit cavalier. We leave the competent readers make their own opinion] ♡3
- [1079] Z. Nehari, *Bounded analytic functions*, Bull. Amer. Math. Soc. 57 (1951), 354–366. A50, G78 [♣ an interesting survey of the Ahlfors' extremal function (the name appears on p. 357) emphasizing its relation to other domain functions such as the kernel functions and the Green's function] ♡6
- [1080] Z. Nehari, *Extremal problems in the theory of bounded analytic functions*, Amer. J. Math. 73 (1951), 78–106. G78 [♠ only multiply-connected domains, but the methodology is extended to the positive genus case by Kuramochi 1952 [896], which seems to recover Ahlfors' 1950 result [19] with the same upper-bound] ♡??
- [1081] Z. Nehari, *Conformal Mapping*, Mac Graw-Hill, New York, 1952. (Dover reprint 1975.) AS60, G78 [♠ only the planar case (domains)] ♡1431
- [1082] Z. Nehari, *Some inequalities in the theory of functions*, Trans. Amer. Math. Soc. 75 (1953), 256–286. G78 [♠ p. 264–65 another derivation of the fact (ascribed to Grötzsch 1928 [557] and Grunsky 1932 [560]) that the mapping maximizing the derivative at some inner point of a multi-connected domain amongst schlicht functions bounded-by-one (i.e. $|f| \leq 1$) is a circular slit mapping] ♡??
- [1083] Z. Nehari, *An integral equation associated with a function-theoretic extremal problems*, J. Anal. Math. 4 (1955), 29–48. [not quoted in AS60 nor in G78] [♠ p. 36 cite Bieberbach 1925 [147] (i.e. existence of a circle map of degree equal to the number of contours for a planar domain) and find a brilliant application of it to bound the the number of linearly independent solutions of a certain extremal problem. It seems realist to expect that this Nehari argument could be widely generalized by using Ahlfors 1950 [19] (and optionally Gabard 2006 [463]) in place of Bieberbach 1925 (*loc. cit.*). However the writer [Gabard, 30.07.12] does not understand why the inequality advanced by Nehari on p. 36 ought to be strict (as the integration is taking place within the contours where the modulus of the Bieberbach(-Ahlfors) function is unity! Hence try to locate the bug... ♠ in fact helped by an article of Leung 2007 (On an isoperimetric . . .) it seems that Nehari's argument is hygienical modulo correcting the misprint on p. 29 that C_1 should be a subset of the (open) domain D (instead of the asserted contour C) [this is in agreement with the reviews generated by MR and ZB] ♠ then everything looks more plausible, and there is some hope to extend Nehari's arguments to the more general setting of bordered surfaces—compare our treatment in Sec. of v2] ♡1
- [1084] E. Neuenschwander, *Lettres de Bernhard Riemann à sa famille*, Cahiers du séminaire d'histoire des mathématiques 2 (1981), 85–131. ♡??
- [1085] E. Neuenschwander, *Über die Wechselwirkungen zwischen der französischen Schule, Riemann und Weierstraß. Eine Übersicht mit zwei Quellenstudien*, Arch. History Exact Sci. 24 (1981), 221–255. [♠ Cauchy, Puiseux 1850, Weierstrass and the geometrization by Riemann] ♡??
- [1086] C. Neumann, *Das Dirichletsche Prinzip in seiner Anwendung auf die Riemannschen Flächen*, Leipzig bei B. G. Teubner, 1865. ★ [♠ probably—together with the next item—one of the first place where the jargon "Riemann surface" is used in history] ♡??
- [1087] C. Neumann, *Vorlesungen über Riemanns Theorie der Abelschen Integrale*, Leipzig bei B. G. Teubner, 1865. [♠ (For the Zweite Auflage, cf. 1884 [1089]. ♠ seems to post- resp. anti-cipate what is called nowadays the Riemann-Hurwitz relation (cf. e.g. the discussion in Scholz 1999 [1365])] ♡??
- [1088] C. Neumann, *Neumann's Untersuchungen über das Logarithmische und Newton'sche Potential*, (Referat des Verfasser). Math. Ann. 13 (1878), 255–300. ♡??

- [1089] C. Neumann, *Vorlesungen über Riemanns Theorie der Abelschen Integrale*, Zweite Auflage, 1884, 472 pp. AS60 ★ [♠ contains, e.g., the first purely topological proof of the (so-called) Riemann-Hurwitz relation, according to Laugel’s French translation of Riemann’s Werke, p. 164.] ♡??
- [1090] C. Neumann, *Über die Methode des arithmetischen Mittels insbesondere über die Vervollkommnungen, welche die betreffende Poincaré’schen Untersuchungen in letzter Zeit durch die Arbeiten von A. Korn und E. R. Neumann erhalten haben*, Math. Ann. 54 (1900), 1–48. AS60 ★ ♡??
- [1091] R. Nevanlinna, *Ueber beschränkte analytische Funktionen, die in gegebenen Punkten vorgeschriebene Werte annehmen*, Ann. Acad. Sci. Fenn. BXV (1919), 71 pp. [♠ Nevanlinna’s first paper on the so-called Pick-Nevanlinna interpolation ♠ for a connection with the Ahlfors map (or generalization thereof) cf. e.g. Jenkins-Suita 1979 [719] ♠ as to Pick’s work cf. Pick 1916 [1181]] ♡??
- [1092] R. Nevanlinna, *Ueber beschränkte analytische Funktionen*, Comm. in honorem Ernesti Leonardi Lindelöf, Ann. Acad. Sci. Fenn. A XXXII (1929), 75 pp. [♠ Nevanlinna’s second paper on the so-called Pick-Nevanlinna interpolation ♠ same comment as for the previous entry [1091]] ♡??
- [1093] R. Nevanlinna, *Das harmonische Mass von Punktmengen und seine Anwendung in der Funktionentheorie*, C. R. Huitième Congr. Math. Scand., Stockholm, 1934, 116–133. AS60 ★ [♠ presumably the first place where the name “harmonic measure” appears, the concept going back at least to H. A. Schwarz (compare, e.g. Sario-Nakai 1970 [1336])] ♡??
- [1094] R. Nevanlinna, *Eindeutige analytische Funktionen*, 1936. AS60 [♠]★★ ♡??
- [1095] R. Nevanlinna, *Über die Lösbarkeit des Dirichletschen Problems für eine Riemannsche Fläche*, Nachr. zu Gött. 1 (1939), 181–193. [♠ cited in BreLOT-Choquet 1951 [186], but the case of open Riemann surfaces]★★[ZB OK] ♡??
- [1096] R. Nevanlinna, *Über das alternierende Verfahren von Schwarz*, J. Reine Angew. Math. 180 (1939), 121–128. [♠ Seidel’s summary: the convergence of the alternating procedure of Schwarz is proved under more general conditions on the boundary of the region than those considered by Schwarz and the problem is reformulated as a method of successive approximation applied to a certain integral equation] ♡??
- [1097] R. Nevanlinna, *Quadratisch integrierbare Differentiale auf einer Riemannschen Mannigfaltigkeit*, Ann. Acad. Sci. Fenn. Ser. A. I. 1 (1941), 34 pp. AS60 [♠ an indispensable prerequisite to understand Kusunoki 1952 [898]: application of the Ahlfors mapping to the type problem.]
- [1098] R. Nevanlinna, *Über die Neumannsche Methode zur Konstruktion von Abelschen Integralen*, Comment. Math. Helv. 22 (1949), 302–316. AS60
- [1099] R. Nevanlinna, *Uniformisierung*, Zweite Auflage, Grundlehren der math. Wiss. 64, Springer, 1953, 391 pp. (The Second edition to which we refer, published in 1967) AS60 [♠ p.148–150, contains a very illuminating implementation of Schwarz’s alternating method applied to the problem of constructing harmonic functions with prescribed singular behavior, in particular the Green’s function of a compact bordered surface] ♡??
- [1100] D. J. Newman, ???, Trans. Amer. Math. Soc. 92 (1959), 501–507. [♠ like the very deep corona problem, Newman’s characterization of interpolating sequence (also studied by Carleson, cf. e.g. Hoffman 1962 [678] for more historical details) is yet another paradigm which can be lifted from the disc to more general finite bordered Riemann surface via appeal to the Ahlfors map, as shown by Stout, cf. e.g. his second implementation in Stout 1967 [1460]] ♡??
- ★ Isaac Newton (16XX–17XX) is the well-known scientist famous for works on gravitation, etc. and his geometrical works on cubic curves. From one of our stand-point Newton may be regarded as having an implicit working aptitude with isotopies (which after all lies implicit behind his classification works on the shape of cubics), compare e.g. the discussion in Korchagin-Weinberg 2005 [867]. As a such Newton may be regarded as one of the early forerunner of Hilbert’s 16th problem (i.e. topology of plane curves). Also pivotal is Newton’s achievement to derive Kepler’s law from the supposition of a force acting along the inverse square law (cf. Newton 1687 (Principia) [1102]). Historically, it may also be argued that Newton might have been one of the first adherent to Descartes methods of coordinates, yet returning later to a more geometric approach.

- [1101] I. Newton, *Analysis of the properties of cubic curves and their classification by species*, in: The Mathematical Papers of Isaac Newton (D. T. Whiteside, ed.), vol. 2, Cambridge Univ. Press, 1968, pp. 3–89. [♠ cited as follows in Korchagin-Weinberg 2005 [867, p. 1629]: “The introduction of the Cartesian coordinate system in the early 17th century was one of the most dramatic events in the history of mathematics. Even the classification of conic sections was subject to a revision, as it found a new beauty in the form of equations. [Da darf man mistrauisch sein!]. Isaac Newton eagerly embraced the new coordinate method and wrote his first manuscript on cubic curves in late 1667 (or early 1668) [33]=(the present entry). He returned to this subject again and again throughout his life, obtaining at least three important classifications, consisting of 5, 59 and 78 equivalence classes.”] ♡??
- [1102] I. Newton, *Philosophiæ Naturalis Principia Mathematica*, London, Joseph Streater, Royal Society, 1687. [♠ accomplish the first derivation of Kepler’s law via the postulation of a central force acting upon the planets along Robert Hooke’s (1635–1703) earlier supposition of a force acting by the inverse square law. In August 1684, Halley visited Cambridge, and posed Newton the problem who immediately answered that he could prove ellipticity of the trajectory from the inverse square law. The big synthesis was done and the geometrization of mechanics complete. For another (Feynman’s) proof of this Newton synthesis of Kepler and Hooke, cf. Gerhard Wanner’s book “Geometry by its history.”] ♡??
- [1103] I. Newton, *Enumeration linearum tertii ordinis*. Appendix to *Treatise on Optics*, London, 1704, 138–162; also in: The Mathematical Papers of Isaac Newton (D. T. Whiteside, ed.), vol. 7, Cambridge Univ. Press, 1976, pp. 565–645. [♠ cited in Gudkov 1988 [584] and Korchagin-Weinberg 2005 [867] ♠ contains Newton’s famous classification of cubic curves into 72 or rather 78 species (if one adds the 4 cases discovered by Stirling 1717 [1454] and the 2 ones due to Nicole 1731 [1106])] ♡??
- [1104] I. Newton, *The final ‘Geometriæ libri duo’*, in: The Mathematical Papers of Isaac Newton (D. T. Whiteside, ed.), vol. 7, Cambridge Univ. Press, 1976, pp. 402–469. [♠ cited in Gudkov 1988 [584] and Korchagin-Weinberg 2005 [867]] ♡??
- [1105] I. Newton, *The method of fluxions and infinite series with applications to the geometry of curves*, in: The Mathematical Papers of Isaac Newton, Cambridge Univ. Press, 1967. [♠] ♡??
- [1106] F. (François) Nicole, *Mémoires de l’Académie Royale des Sciences*, Année MD-CCXXXI (1731), Paris, 1733. [♠ discussed in Korchagin-Weinberg as supplying the first rigorous proof of Newton’s classification in five singular-isotopy classes of irreducible cubic cones. ♠ adds also 2 types of affine cubics that were missed in Newton’s *Enumeratio* (1704) [1103]] ♡??
- [1107] V. V. Nikulin, *Integral symmetric bilinear forms and some of their applications*, *Izv. Akad. Nauk SSSR Ser. Mat.* 43 (1979), 111–177; English transl., *Math. USSR Izv.* 14 (1980), 103–167. [♠ cited by many (e.g. Fiedler 1982/83 [415, p. 168]) for “the strict/rigid-isotopy classification of curves of degree six” showing that the real scheme enhanced by the type in the sense of Klein 1876 (and Rohlin 1978) affords a complete invariant of the rigid-isotopy class of sextics ♠ the proof employs the apparatus of complex K3 surfaces, especially the version of Torelli’s theorem due to Pyatetsky-Shapiro-Shafarevich 1971/71 [1229] as well via remarks of Kharlamov the profound description in Rohlin 1978 [1290] of complex topological characteristics (i.e. Klein’s orthosymmetry) in the realm of real plane sextic ♠ quite strangely Rohlin’s 1978 paper is not even cited in Nikulin’s albeit it is logically used (for the assertion made on p. 107), namely: “As a supplement to Gudkov’s isotopic classification [42](=Gudkov-Utkin 1969 [575]) of plane sextics, we shall show that this classification differs from the coarse projective classification(=rigid-isotopy) only for the following sequence of ovals(=real schemes): $\frac{8}{1}, \frac{4}{1}4, 9, \frac{5}{1}1, \frac{3}{1}3, \frac{1}{1}5, \frac{4}{1}, \frac{2}{1}2$, while each of these listed ovals corresponds to precisely two coarse projective equivalence classes (see [...]).” ♠ this is, of course, precisely the list of indefinite schemes as listed in Rohlin 1978 [1290] (upon which Nikulin rests without reproving it)] ♡??
- [1108] V. V. Nikulin, *Involutions of integral quadratic forms and their applications to real algebraic geometry*, *Izv. Akad. Nauk SSSR Ser. Mat.* 47 (1983), 109–188; English transl., *Math. USSR Izv.* 22 (1984), 99–172. [♠ just cited for the nomenclature “separating” (on p. 158)] ♡??
- [1109] T. Nishino, *L’existence d’une fonction analytique sur une variété analytique complexe à deux dimensions*, *Publ. RIMS, Kyoto Univ.* 18 (1982), 387–419. A50

- [♠ applies Ahlfors 1950 [19] to complex surfaces (4 real dimensions), and specifically the existence of an analytic function under a suitable assumption ♠ Nishino's result was quickly extended by himself to arbitrary dimensions, yet during the process it seems that the relevance of Ahlfors 1950 [19] disappeared] ♡4
- [1110] M. Noether, *Ueber die Schnittpunktsysteme einer algebraischen Curve mit nicht-adjungirten Curven*, Math. Ann. 15 (1879/80), 507–528. [♠ direct critiques to Lindemann's treatment (1879 [947]) of Riemann-Roch. ♠ cited in Gudkov 1974 [579].] ♡??
- [1111] M. Noether, *Zur Grundlegung der Theorie der algebraischen Raumcurven*, Verlag d. Königl. Akad. d. Wiss., Berlin, 1882, 120 pp. [♠ price shared with Halphen 1882 [604]] ♡??
- [1112] W. Nuij, *A note on hyperbolic polynomials*, Math. Scand. 23 (1968), 69–72. [♠ proof that two smooth plane curves with a deep nest are rigidly isotopic in the space of all algebraic curves ♠ cited in Vinnikov 1993 [1521], who points out also the proof of Dubrovin 1983 [381] and also in Viro 1986/86 [1534, p. 74]: “In conclusion I state an old result on rigid-isotopy, which for a long time was not known to experts in the topology of real algebraic manifolds. In 1968, Nuij [24](=this entry) proved that any two hypersurfaces of degree m in $\mathbb{R}P^n$ containing $[m/2]$ spheres totally ordered by inclusion are rigidly isotopic. Recently Dubrovin [5](=1983 [381]) obtained this result for the case of plane curves by a different method.” ♠ (from an e-mail of Shustin [26.01.13]) By the way, another (well) known connected chamber consists of hyperbolic curves (i.e. those which have totally real intersection with lines of certain pencil) - this is a consequence of Nuij W. A note on hyperbolic polynomials. Math. Scandinavica 23 (1968), no. 1, 69–72. ♠ it remains of course to inspect if there is any connection between Nuij and Gårding the great expert of Petrovskii's 1945 work ([1169]) on lacunas of PDE's.] ♡??
- [1113] B. G. Oh, *A short proof of Hara and Nakai's theorem*, Proc. Amer. Math. Soc. 136 (2008), 4385–4388. A50 [♠ Ahlfors 1950's result on circle maps is used in a quantitative version of the corona ♠ question of the writer (since Sept. 2011): is it possible to exploit the improved bound of Gabard 2004/06 [463] in this sort of game ♠ p. 4387, Ahlfors 1950 [19] is cited as follows: “**Theorem 3** (Ahlfors [1](=Ahlfors 1950 [19])). *Suppose R is a finitely⁴⁴ bordered Riemann surface with $g(R) = g$ and $b(R) = b$. Then there exists an m -sheeted branched covering map $f: R \rightarrow \mathbb{D}$, called the Ahlfors map, such that $b \leq m \leq 2g + b$.”] ♡0*
- [1114] M. Ohtsuka, *Dirichlet problems on Riemann surfaces and conformal mappings*, Nagoya Math. J. 3 (1951), 91–137. AS60 [♠] ♡??
★ Olga Oleinik, a student of Petrovskii, working like the teacher on the topology of real algebraic varieties and PDE.
- [1115] O. A. Oleinik, *Estimates of the Betti numbers of real algebraic hypersurfaces*, Mat. Sb. 28 (1951), 635–640 (Russian). [♠] ♡??
- [1116] O. A. Oleinik, *On the topology of real algebraic curves on an algebraic surface*, Mat. Sb. 29 (1951), 133–156 (Russian). [♠] ♡??
- [1117] B. V. O'Neill, Jr., J. Wermer *Parts as finite-sheeted coverings of the disk*, Amer. J. Math. 90 (1968), 98–107. A50 [♠ p. 98, the paper is started by citing Ahlfors 1950 [19] and mentions the alternative proof of Royden 1962 [1305] ♠ the Ahlfors' function is given an application to Gleason parts (certain analytic discs in the maximal ideal space) extending thereby a previous disc-result of Wermer 1964 ♠ p. 98, it is emphasized that E. Bishop 196 5 [165] gave an abstract version of Ahlfors' extremal problem in the context of function algebra on a compact space X (i.e. an algebra of complex-valued continuous functions containing the constants, separating the points, and closed under uniform convergence)] ♡2/3
★ Stepa[n] Orevkov, student of ?, well-known for several breakthrough in Hilbert's 16th problem in the (critical) degree $m = 8$ (or even $m = 9$), notably a method of obstruction based on knot theory and braids, which prohibits 2 schemes of degree 8, as well for a complete classification of pseudoholomorphic real curves (à la Gromov) were the relaxed pseudo-Hilbert's 16th is now completely solved (cf. Orevkov 2002 [1130]). The latter article still affords the best results known to date on the classical algebraic case (where the almost-complex structure is integrable).
- [1118] S. Yu. Orevkov, *A new affine M -sextic*, Funct. Anal. Appl. 32 (1998), 141–143. [♠ it is interesting to note that this work (as well as the next entry) will be later used to construct new M -curves of degree 9 (compare Orevkov 2003 [1134]).] ♡??

⁴⁴Read “finite” to be more conventional.

- [1119] S. Yu. Orevkov, *A new affine M -sextic, II*, Russian Math. Surveys 53 (1998), 1099–1101. [♠] ♥??
- [1120] S. Yu. Orevkov, *Asymptotic number of triangulations with vertices in Z^2* , J. Combin. Th., Ser. A 86 (1999), 200–203. [♠ probably motivated by the Viro-Ienberg construction] ♥??
- [1121] S. Yu. Orevkov, *Link theory and oval arrangements of real algebraic curves*, Topology 38 (1999), 779–810. [♠ can be realized holomorphically, pseudo-holomorphically, holomorphically, pseudo-holomorphically, etc. ♠ where a revolutionary technique of prohibition (based upon Artin, Fox-Milnor, etc.) is elaborated offering new insights upon Hilbert’s 16th notably in the (critical) degree 8] ♥??
- [1122] S. Yu. Orevkov, *Projective conics and M -quintics in general position with a maximally intersecting pair of ovals*, Math. Notes 65 (1999), 528–532. [♠] ♥??
- [1123] S. Yu. Orevkov, G. M. Polotovskii, *Projective M -cubics and M -quartics in general position with a maximally intersecting pair of ovals*, St. Petersburg Math. J. 11 (2000), 837–852. [♠] ♥??
- [1124] S. Yu. Orevkov, *Link theory and new restrictions for M -curves of degree 9*, Funkt. Anal. Prilozhen. 34 (2000), 84–87; English transl. Funct. Anal. Appl. 34 (2000), 229–231. [♠ new prohibition of $16=9+7$ new M -schemes in degree 9 among a menagerie of 1227 logically possible cases (after Korchagin’s tabulation involving Bézout, Rohlin-Mishachev, and his own Korchagin restrictions of 1986 [853]). ♠ this is an announcement with full details supplied in Orevkov 2005 [1137] (where two more M -schemes are prohibited).] ♥??
- [1125] S. Yu. Orevkov, *Complex orientations of M -curves of degree 7*, Preprint (19XX); published in: *Topology, Ergodic Theory, Real Algebraic Geometry. Rokhlin’s Memorial*. Amer. Math. Soc. Transl. ser. 2, 202 (2001), 215–227. [♠ completion of the classification of M -schemes of degree 7, supplementing the joint census Le Touzé-Orevkov ♠ 2 of the six M -schemes of degree 8 resisting to the settlement of Hilbert’s 16th are explicitly listed as $4(1, 2\frac{14}{1})$ and $14(1, 2\frac{4}{1})$, but shown to be realized pseudo-holomorphically.] ♥??
- [1126] S. Yu. Orevkov, *Quasipositivity test via unitary representations of braid groups and its applications to real algebraic curves*, J. Knot Th. Appl. 10 (2001), 1005–1023. [♠ p.1005, mentions Florens’s completion of the classification of complex schemes of degree 7.] ♥??
- [1127] S. Yu. Orevkov, *Real quintic surface with 23 components*, Preprint, UNDATED (20XX); cf. also C. R. Acad. Sci. Paris, Sér. I 333 (2001), 115–118. [♠ construction of a quintic with 23 components like Bihan’s example 1999 [161], but sharpening a bit the embeddability issue of the surface in \mathbb{P}^3 (and not just after deformation of the complex-analytic structure like in Bihan’s “numerical” example) ♠ it is still open if a quintic with 24 or even 25 (the maximum permissible by virtue of Kharlamov building upon Smith’s theory, the Comessatti-Petrovskii-Oleinik estimate and some algebra of unimodular forms) of components exists] ♥??
- [1128] S. Yu. Orevkov, O. Ya. Viro, *Congruence modulo 8 for real algebraic curves of degree 9*, Preprint Univ. Paul Sabatier, Toulouse (2001); published either in Comm. Moscow Math. Soc. 2001, or with more details on Orevkov’s homepage. [♠ cited in Fiedler-Le Touzé 2002 [424] for the prohibition of 35 cases among the 1227 logically possible schemes tabulated by Korchagin in degree 9 ♠ actually this article is usually published with inverted co-authorship as Viro-Orevkov.] ♥??
- [1129] S. Yu. Orevkov, *Classification of flexible M -curves of degree 8 up to isotopy*, Preprint, Univ. Paul Sabatier, Toulouse (2001); or Geom. Funct. Anal. 12 (2002), 723–755. [♠ includes a complete isotopy classification of pseudo-holomorphic M -curves ♠ alas the original Hilbert’s 16th for holomorphic=algebraic curve seems to contain 6 questionable cases, hard to tackle ♠ [28.04.13] it would be nice to see if this unpleasant state of affairs can be remedied via the method of total reality due to Riemann 1857 [1258], compare Gabard 2013B [471] for some more details ♠ p. 723: “After the studies of Fiedler, Viro, Shustin, Korchagin, and Chevallier, there remained only 9 real schemes whose realizability was open, namely [he gives the explicit list]. Here we exclude two of them. ♠ p. 725: “The 6 schemes whose algebraic realizability is still unknown are marked with an asterisk. Near each real scheme, we indicate the author of its first realization.”] ♥26
- [1130] S. Yu. Orevkov, *New M -curve of degree 8*, Funkt. Anal. i Prilozhen. 36 (2002), 83–87; English transl. Funct. Anal. Appl. ? (2003?), ?–?. [♠ construction of one

M -scheme namely $7(1, 2\frac{11}{1})$ not previously known to be realized, which in view of the previous entry (Orevkov 2002 [1129]) reduces the number of questionable schemes to a list of 6 and which is still the present state of the art (up to this date). It is not clear at all how much time-consuming the settlement of those 6 cases will be.] ♡1

- [1131] S. Yu. Orevkov, E. Shustin, *Flexible, algebraically unrealizable curves: Rehabilitation of Hilbert-Rohn-Gudkov approach*, Preprint no. 196, Univ. Paul Sabatier, Toulouse (2000); or J. Reine Angew. Math. 551 (2002), 145–172. [♠] ♡??
- [1132] S. Yu. Orevkov, *Construction of arrangements of an M -quartic and an M -cubic with a maximal intersection of an oval and the odd branch*, (2002); or ???, ?-?. [♠ a tour-de-force in enumeration theory (involving Saint-Exupéry) with lovely pictures, yet probably still not a definitive classification whose significance for pure M -curves looks dubious as everything is already settled in degree $m = 7$ since Viro. It looks nonetheless interesting to see how many of Viro’s scheme are accessible through the classical method à la Brusotti.] ♡??
- [1133] S. Yu. Orevkov, V. M. Kharlamov, *Asymptotic growth of the number of classes of real plane algebraic curves as the degree grows*, J. Math. Sciences 113 (2003), 666–674. [♠ p.666 seems to contain the fact that the invisible discriminant has codimension explaining thereby the connectedness of the empty chamber, compare our lemma in v2.] ♡??
- [1134] S. Yu. Orevkov, *Riemann existence theorem and construction of real algebraic curves*, Ann. Fac. Sci. Toulouse Math. 12 (4) (2003), 517–531. [♠ construction of many new M -schemes in degree 9 (precisely 65 if I count well, in slight contrast to the 62 credited by Le Touzé 2002 [424]) by using Riemann’s existence theorem, Grothendieck’s dessins d’enfants, and arithmetics (Birch-Chowla-Hall-Schinzl, Davenport, Stothers, Zannier, Zvonkin). This Orevkov’s tour-de-force uses Korchagin 1996 [863] description of maximal dissipations of a simple 6-fold (singular) points, to which two additional dissipations were constructed in Orevkov 98/99 (the 2 papers on affine M -sextics [1118], [1119]).] ♡??
- [1135] S. Yu. Orevkov, E. Shustin, *Pseudoholomorphic algebraically unrealizable curves*, Mosc. Math. J. 3 (3) (2003), 1053–1083. [♠ Abstract. We show that there exists a real non-singular pseudoholomorphic sextic curve in the affine plane which is not isotopic to any real algebraic sextic curve. This result completes the isotopy classification of real algebraic affine M -curves of degree 6. [...] ♠ hence complete the isotopic census of affine plane M -sextics into 35 many types (where actually only one isotopy class was not known but is now prohibited).] ♡7
- [1136] S. Yu. Orevkov, *Some examples of real algebraic and real pseudoholomorphic curves*, ?? (2003 OR MORE), ?-?. [♠ preprint version giving a nice picture of Wiman’s octic] ♡??
- [1137] S. Yu. Orevkov, *Plane real algebraic curves of odd degree with a deep nest*, J. Knot Th. Ramif. (2005). [♠ 2 new M -prohibitions in degree $m = 9$ by using apparently only Rohlin-Mishachev, Fielder alternating rule, and Orevkov’s (complex orientation) formula derived via braid theory.] ♡4
- [1138] S. Yu. Orevkov, *Arrangements of an M -quintic with respect to a conic that maximally intersects its odd branch*, Algebra i Analiz 19 (2007), ?-?; English transl.: St. Petersburg Math. J. 19 (2008), 625–674. [♠ p.637 (Prop. 1.1) contains a proof of (what I call on recommendation of Kharlamov-Viro 1999’s e-mail) the Rohlin inequality stipulating that a dividing plane curve of degree m satisfies $r \geq m/2$, and that if this is sharp (passing eventually to $(m + 1)/2$ when m is odd) then the curve is a deep nest (which Orevkov likes to call hyperbolic, probably for reasons deeper than the Bézoutian linear total reality, say perhaps rooted in Nuij’s theorem 1968 [1112]). Note yet that this notion of hyperbolicity differs from that coined in Rohlin 1978, of when the oval contains more than one smaller oval, so that the porous inside is at least binion (of double at least of genus 2) in the sense Möbius 1863 [1028] ♠ of course this Prop. 1.1 of Orevkov is not new, and appears to my knowledge first in Marin 1979 [963], but was surely well-known earlier to Rohlin, albeit he does not state it explicitly in Rohlin 1978 [1290]. ♠ somewhat loosely (say like in Gabard 2000 [461]) or in this text (v2) Orevkov leaves as an exercise the odd-degree case. It would be nice at the occasion to write down the proof via Mishachev’s variant of Rohlin’s formula. ♠ p.670: “In my opinion, the new proof is simpler and “more reliable” than the old one (unfortunately proofs based on the Hilbert-Rohn method sometimes have mistakes because some case of possible degeneration are missed; [...]).] ♡0

- [1139] S. Yu. Orevkov, *Proper analytic embedding of $\mathbb{C}P^1$ minus a Cantor set into \mathbb{C}^2* , Uspehki Math. Nauk 63 (2008), 155–156; English transl.: Russian Math. Surveys 63 (2008), 168–169. [♠ shows the result of the title, but as pointed out in Forstnerič-Wold 2012 [453, p. 17] it is an open problem whether this holds for each Cantor set.] ♡0
- [1140] S. Yu. Orevkov, *Curves in the plane???*, Hand-written notes by Gabard of a 2-days-course held by Orevkov in Geneva, Batelle institute, (ca. 8 hours), ca. 2011. [♠ hand-notes of lectures held by Orevkov in Geneva (Séminaire Fables Géométrique, directed by Mikhalkin) ♠ the course started by basics (Harnack inequality, Rohlin’s formula, etc.) up to the last advances of Orevkov on pseudoholomorphic realizations, Ferrari’s formula, etc. Alas, I should still try to recover these notes and fears that I was not sufficiently interested in the topic at that time so that my notes might be of little value ♠ of course most of the material should be recoverable from Orevkov’s publications] ♡0
- [1141] S. Yu. Orevkov, *Some examples of real algebraic and real pseudoholomorphic curves*, in: Perspectives in Analysis, Geometry and Topology, 2012, Springer or maybe Birkhäuser. [♠ includes the last advances on Hilbert’s 16th for $m = 9$, namely the construction of 10 new M -schemes by a clever twist of Viro’s method of gluing/patchwork.] ♡2
- [1142] D. Orth, *On holomorphic families of holomorphic maps*, Nagoya Math. J. 39 (1970), 29–37. [♠ p.33, Ahlfors 1950 is cited as follows: “Ahlfors [1](=1950 [19]) has shown the existence of a holomorphic map f from a bordered Riemann surface with finite genus and a finite number of boundary components onto a full covering surface $S \xrightarrow{\pi} D$ of the unit disk. N. Alling [2] has shown that $\pi \circ f|U$ is a covering map of D near ∂D for some open neighborhood U of ∂X . Theorem 2.–4. can be thought of as concerning holomorphic families of such maps.”] ♡0
- [1143] B. Osgood, *Notes on the Ahlfors mapping of a multiply connected domain*, Unpublished (?) manuscript (available from the web), undated (estimated date in the range 1993/2005). [♠ pleasant re-exposition of the neo-expressionist sort of the Ahlfors-Garabedian theory (inspired by Bell, Kerzman-Stein, etc.), in particular the formula for the Ahlfors function as the ratio of the Szegő kernel divided by the Garabedian kernel] ♡??
- [1144] W. F. Osgood, *On the existence of the Green’s function for the most general simply connected plane region*, Trans. Amer. Math. Soc. 1 (1900), 310–314. AS60 ♡??
- [1145] W. F. Osgood, *Jordan curve of positive area*, Trans. Amer. Math. Soc. 4 (1903), 107–112. [♠ shows how pathological Jordan curve can be] ♡??
- [1146] W. F. Osgood, E. H. Taylor, *Conformal transformations on the boundary of their regions of definition*, Trans. Amer. Math. Soc. 14 (1913), 277–???. ♡??
- [1147] W. F. Osgood, *Existenzbeweis betreffend Funktionen, welche zu einer eigentlichen diskontinuierlichen automorphen Gruppe gehören*, Palermo Rend. 35 (1913), 103–106. AS60 ♡??
- [1148] R. Osserman, *Riemann surfaces of class A*, Trans. Amer. Math. Soc. 82 (1956), 217–245. [♠] ♡??
- [1149] R. Osserman, *A hyperbolic surface in 3-space*, Proc. Amer. Math. Soc. 7 (1956), 54–58. AS60 [♠ example of a function $\mathbb{R}^2 \rightarrow \mathbb{R}$, whose graph (endowed with the Euclidean metric) defines a surface of hyperbolic type, i.e. conformally equivalent to the disc, answering thereby a question of Ch. Loewner, reported by L. Bers in 1951 on the occasion of the 100th Birthday of Riemann’s Thesis] ♡??
- [1150] A. Ostrowski, *Mathematische Miscellen XV. Zur konformen Abbildung einfach zusammenhängender Gebiete*, Jahresb. Deutsch. Math.-Ver. 38 (1929), 168–182. [♣ omitted in both AS60 and G78; however this (joint with Carathéodory 1928 [236]) is the simply-connected version of the Ahlfors map] ♡??
- [1151] K. Ott, *Über die Konstruktion monogener analytischer Funktionen mit vorgegebenen Unstetigkeitsstellen auf der Riemann’schen Fläche*, Monatsh. Math. 4 (1893), 367–375. AS60 ★ ♡??
- [1152] M. P. Ovchintsev, *Optimal recovery of functions of class E_p , $1 \leq p \leq \infty$, in multiply connected domains*, Siberian Math. J. 37 (1996), 288–307. [♣ p.293, three occurrences of “Ahlfors function” for m -connected domains; in particular Prop. 1 asserts the existence of neighborhoods of the boundary contours such that if z_0 lies in one of these neighborhood then the extra zeros of the Ahlfors function lie one-by-one in the other domains; in particular it seems likely that such neighborhoods can be chosen pairwise disjoint, in which case we recover a result of Bell 1991 [99]] ♡??

- [1153] M. Ozawa, *On bounded analytic functions and conformal mapping, I*, Kōdai Math. J. (1950), 33–36. G78 ♡??
- [1154] M. Ozawa, *A supplement to “Szegő kernel function on some domains of infinite connectivity”*, Kōdai Math. J. 13 (1961), 215–218. G78 [♠ p.215: “Let D be an n -ply connected analytic domain and $\mathfrak{B}(D)$ be the class of regular functions in D whose moduli are bounded by the value 1. In $\mathfrak{B}(D)$ there exists, up to rotation, a unique extremal function by which the maximum $\max_{\mathfrak{B}(D)} |f'(z_0)|$ for a fixed point is attained. This extremal function $F(z, z_0)$ maps D onto the n times covered unit disc [1](=Ahlfors 1947 [18]), [3](=Garabedian 1949 [495]), [4](=Garabedian-Schiffer 1950 [498]), [9](=Nehari 1950 [1077]), [11](=Schiffer 1950 [1349]). In $\mathfrak{B}(D)$ there exists an infinite number of essentially different functions which map D onto the n times covered unit disc [2](=Bieberbach 1925 [147]), [5](=Grunsky 1937 [561]), [8](=Mori 1951 [1040]).”] ♡??
- [1155] P. Painlevé, *Sur les lignes singulières des fonctions analytiques*, Ann. Fac. Sci. Toulouse 2 (1888), 130 pp. G78 [♠ the classical Painlevé problem, interest revived through the work of Ahlfors 1947 [18] and complete solution in Tolsa 2003 [1496]] ♡??
- [1156] P. Painlevé, *Sur la théorie de la représentation conforme*, C. R. Acad. Sci. Paris 112 (1891), 653–657. [♠ one of the first study of the boundary behavior of the Riemann mapping for a domain bounded by a smooth Jordan curve ♠ same holds true for a general (topological) Jordan domain, cf. Osgood and Carathéodory] ♡??
- [1157] H. Pajot, *Analytic capacity, rectifiability, Menger curvature and the Cauchy integral*, Lecture Notes in Math. 1799, Springer-Verlag, Berlin, 2002. [♠]★ ♡??
★ Paula Parenti, a student of Galbiati and Itenberg, well-known for work about T -curves (combinatorial type criterion, Rohlin’s formula, etc.)
- [1158] P. Parenti, *Combinatorics of dividing T -curves*, Tesi di dottorato, Pisa, (1996), 133 pp. Tutori: Galbiati, Itenberg [♠ combinatorial construction of curves with a control of the type, building upon Viro’s method (early 1980’s) and the special case thereof called the T -construction ♠ contains a combinatorial version of Rohlin’s formula for T -curves ♠ CHECK DATE; e.g. dated 1999 in Itenberg-Shustin 2003 [708] ♠ the main result of Parenti’s thesis namely the verification of Rohlin’s formula for T -curves can be subsumed to the more general philosophy of Itenberg-Viro 2002 that T -curves (without convexity) are flexible curves in the sense of Viro, hence subjected to Rohlin’s formula]★ ♡1
- [1159] P. Parenti, *Symmetric orientations of dividing T -curves*, Geom. Dedicata 101 (2003), 129–151. [♠ p. 150, Thm 5.5 affords a combinatorial type I criterion in terms of evenness of each vertices of the triangulation; it is a pleasant exercise to apply this to the Itenberg-Viro 1996 example reproduced on our plate (in v.2).]★ ♡??
- [1160] P. Parenti, *Rohlin’s formula for dividing T -curves*, Beiträge Alg. Geom. 45 (2004), 329–351. [♠ published version of a portion of the Thesis 199X [1160] ♠ p.329 (Abstract) “In this work we prove that Rohlin’s formula holds for dividing primitive T -curves constructed with arbitrary (not necessary convex) triangulations.”]★ ♡??
- [1161] S. Paris, *An extremal property of Rokhlin’s inequality for real algebraic curves*, Math. Ann. 304 (1996), 613–620. [♠]★ ♡1
- [1162] J. Parkkonen, V. Ruuska, *Finite degree holomorphic covers of compact Riemann surfaces*, Acta Math. Sinica, English Ser. 23 (2007), 89–94. [♠ “A conjecture of Ehrenpreis (1970) states that any two compact Riemann surfaces of genus ≥ 2 have finite degree unbranched holomorphic covers that are arbitrarily close in moduli space. Here we prove a weaker result ...”] ♡1
- [1163] M. Parreau, *Sur les moyennes des fonctions harmoniques et analytiques et la classification des surfaces de Riemann*, Ann. Inst. Fourier (Grenoble) 3 (1951), 103–197. A50 [♠ Ahlfors 1950 [19] is briefly cited in two footnotes ♠ the work also contains a study of Hardy classes on Riemann surfaces extending the classical Hardy-Riesz’s brothers theory for the disc, and some overlap is to be found with the (subsequent) work of Rudin 1955 [1310]]★ ♡153
- [1164] D. Pecker, *An imaginary construction of real curves*, Preprint, Univ. Paris 6, 1992 [♠ cited in Risler 1992 [1265]]★ ♡153
- [1165] O. Perron, *Eine neue Behandlung der ersten Randwertaufgabe für $\Delta u = 0$* , Math. Z. 18 (1923), 42–54. AS60 [♠ a new solution to the Dirichlet problem (using

- Poisson and Lebesgue's integration) yielding the result in the same generality on the boundary (cf. p. 53–54) as those obtained by Lebesgue 1907 [916], Courant 1914 [329] and Lichtenstein (1916), but further very much simplified in Radó-Riesz 1925 [1236] (according to e.g., Carathéodory 1937 [238, p. 710]) ♠ the paper is concluded by the simple remark (already made by Zaremba 1910 [1623]) that the Dirichlet problem does not permit isolated boundary component (reducing to an isolated point), e.g. the punctured disc with boundary prescription 1 on the circumference and 0 at the center does not admit a harmonic extension, since otherwise the mean value property would be violated (intuitively a punktförmig radiator is too insignificant to induce a heat flow equilibrium) ♠ on the other hand this paper tolerates non-schlicht surfaces covering multiply the plane and therefore may be regarded as a suitable treatment of the Dirichlet problem on a compact bordered Riemann surface (given abstractly à la (Riemann-Prym-Klein)-Weyl-Radó), compare for this well-known affiliation the following ref. given backwardly in time: Radó 1925 [1235], Weyl 1913 [1585], and Klein 1882 [797] ♡??
- [1166] K. Petri, *Über die invariante Darstellung algebraischer Funktionen einer Veränderlichen*, Math. Ann. 88 (1923), 242–289. [♠] ♡??
- ★ Ivan Georgievich Petrovskii (1901–1973) is a Russian Academician notorious for deep contributions to real algebraic geometry (1933/38), then joint work with Oleinik ca. 1949 [often sharper according to Arnold than those of Thom/Milnor ca. 1964 [1488], [1011], but also in part anticipated by Comessatti, ca. 1931 [312]], to PDE, and on the problem of the number cycle limits of polynomial vector fields (especially of degree 2) [joint work with Landis, which turned out to be (severely) refuted by Chinese experts]. Petrovskii's contributions includes what is probably the first rigorous proof of Hilbert's Ansatz of no nesting for plane sextics via a spectacular extension to all degrees (without any antecedents apart maybe some guessing in Ragsdale's work 1906 [1238]). As a historical detail, some experts (e.g. Kharlamov 86/96 [781], or Viro 86 [1534]) are pleased to notice that Rohlin's theory of complex orientations was slightly anticipated by Petrovskii (as early as 1945, cf. Petrovskii 1945 [1169]), yet without penetrating as deep as Rohlin. Actually, reading the paper one really needs much imagination to get any substantial piece of information from Petrovskii's text.
- [1167] I. G. Petrovsky [Petrovskii], *Sur la topologie des courbes réelles et algébriques*, C. R. Acad. Sci. Paris 197 (1933), 1270–1273. [♠ announcement of results with proofs detailed in the next entry (Petrovsky 1938 [1168])] ♡??
- [1168] I. G. Petrovsky [Petrovskii], *On the topology of real plane algebraic curves*, Ann. of Math. (2) 39 (1938), 189–209. (in English of course.) [♠ where the jargon *M*-curve is coined, and where some obstruction is given (using the Euler-Jacobi interpolation formula), yielding perhaps the first proof, e.g. of the fact (first enunciated by Hilbert, Rohn, etc.) that a plane sextic cannot have 11 unnested ovals ♠ note however that Petrovskii validates Rohn's proof of 1911 by writing on p. 189: "After a series of attempts the above mentioned theorem announced by Hilbert was at last proved in 1911 by K. Rohn(=Rohn 1911 [1295])." This contrast with Gudkov's latter diagnostic (e.g. in Gudkov 1974 [579]) that even Rohn's proof was not logically complete, though the method fruitful when suitably consolidated with Russian conceptions of roughness.] ♡??
- [1169] I. G. Petrovskii, *On the diffusion of waves and the lacunas for hyperbolic equations*, Mat. Sb. 17 (1945), 289–370. (in English!) [♠ cited in Viro 1986/86 [1534, p. 58] as a forerunner of Rohlin's complex orientations for dividing curves; idem in Kharlamov 1996 [781, p. 121] where we read: "Petrovsky [45] introduced complex orientations in connection with lacunas for partial differential equations; [...]"] ♡??
- [1170] I. G. Petrovskii, O. A. Oleinik, *On the topology of real algebraic surfaces*, Izv. Akad. Nauk SSSR, Ser. Matem. 13 (1949), 389–402. (Russian) [♠ contains a proof of the Petrovskii-Oleinik inequality which is involved in the proof by Kharlamov 1972/73 [764] of 10 as being the sharp estimation upon the number of components a quartic surface may exhibit (answering thereby one part of Hilbert's 16th problem) ♠ historiographically, it seems that the Petrovskii-Oleinik inequality was (slightly) anticipated by Comessatti (compare, e.g., Degtyarev-Kharlamov 1997 [354])] ♡69/77
- [1171] I. G. Petrovskii, *Selected Works, Part I, Systems of Partial Differential Equations and Algebraic Geometry*, Edited by O. A. Oleinik, Translated from the Rus-

- sian by G. A. Yosifan, Gordon and Breach Publ., 1996. (Russian original 1986.)
 [♠] ♡69/77
- [1172] P. del Pezzo, *Sulle superficie di Riemann relative alle curve algebrice*, Palermo Rend. 6 (1892), 115–126. AS60 [♠ presumably one among the first reaction to the reality works of F. Klein outside his direct circle of student (Harnack, Hurwitz, Weichold)] ♡??
- [1173] A. Pfluger, *Ein alternierendes Verfahren auf Riemannschen Flächen*, Comment. Math. Helv. 30 (1956), 265–274. AS60 [♠] ♡??
- [1174] A. Pfluger, *Theorie der Riemannschen Flächen*, Grundlehren der math. Wiss. 89, Springer, Berlin, 1957, 248 pp. A50, AS60, G78 [♠ quotes the article Ahlfors 1950 [19] at several places (p.126, 181, 185, 202) yet never in close connection with the circle map paradigm ♠ of course the book itself is a masterpiece of Swiss-German architecture and we do not attempt to summarize its broad content] ♡??
 ♠ Emile Picard (18XX–19XX) is well-known for Picard’s theorem in function theory (1879), his work on algebraic surfaces (later recasted by Lefschetz, etc.).
- [1175] E. Picard, *Sur une propriété des fonctions entières*, C.R. Acad. Sci. Paris 88 (1879), 1024–1027. [♠ where the famous Picard theorem appears first (a nonconstant entire function (on \mathbb{C}) omits at most one value, for otherwise lifting to the universal covering Δ of $S^2 - \{3\text{rmp}\}$ we get $\mathbb{C} \rightarrow \Delta$ a bounded analytic function violating Liouville’s theorem) ♠ widespread influence over Borel 1896, Schottky, Landau 1904, Lindelöf 1902 [946], Phragmén, Iversen, Montel, Bloch, Littlewood, Nevanlinna 1923, Ahlfors, Sario, etc. ♠ [07.10.12] since \mathbb{C} is the punctured sphere and Liouville’s theorem may be interpreted as Riemann’s removable singularity for bounded analytic function, one can also state that any analytic function defined on a punctured closed Riemann surface omits at most 3 values, but this is completely wrong for the monodromy principle does not apply anymore] ♡??
- [1176] E. Picard, *De l’équation $\Delta u = ke^u$ sur une surface de Riemann fermée*, J. Math. Pures Appl. (4) 9 (1893), 273–291. AS60 [♠ supply an attempt to uniformize via the so-called Liouville equation, such a strategy seems to follow a problem suggested by H. A. Schwarz; for a modern execution of this programme cf. Mazzeo-Taylor 2002 [987] (and also a related work of Bieberbach 1916 [144])] ♡??
- [1177] E. Picard, *Traité d’analyse, Vol. II, Fonctions harmoniques et fonctions analytiques. Introduction à la théorie des équations différentielles, intégrales abéliennes et surfaces de Riemann*, Gauthier-Villars, Paris 1892. Reedited 1926, 624 pp. AS60 [♠ contains a treatment of Schottky’s theory of 1877 (cited e.g. in Le Vavasour 1902 [914], Cecioni 1908 [260] and Schiffer-Spencer 1954 [1352])] ♡??
- [1178] E. Picard, G. Simart, *Théorie des fonctions algébriques de deux variables indépendantes*, Paris, Gauthier-Villars, 1897–1906. [♠] ♡??
- [1179] E. Picard, *Sur la représentation conforme des aires multiples connexes*, Ann. École Norm. (3) 30 (1913), 483–488. G78 [♠ a brilliant re-exposition of Schottky 1877 [1366], which was much appreciated by Julia 1932 [736]] ♡??
- [1180] E. Picard, ?????, Ann. École Norm. (3) 30 (1915), 483–488. [♠ yet another brilliant re-exposition of the Riemann mapping theorem via the Green’s function] ♡??
- [1181] G. Pick, *Ueber die Beschränkungen analytischen Funktionen, welche durch vorgegebene Funktionswerte bewirkt werden*, Math. Ann. 77 (1916), 7–23. [♠ the beginning of so-called Pick-Nevanlinna interpolation, and see Heins 1975 [637] or Jenkins-Suita 1979 [719] for an extension to finite bordered Riemann surface offering an overlap (indeed an extension) of the Ahlfors map] ♡??
- [1182] U. Pinkall, *Hopf tori in S^3* , Invent. Math. 81 (1985), 379–386. [♠ p. 379: “Corollary. Every compact Riemann surface of genus one can be conformally embedded in \mathbb{R}^3 as an algebraic surface of degree 8.—Garsia [2](=1962/63 [510]) had shown that every compact Riemann surface (of any genus) can be conformally embedded in \mathbb{R}^3 as an algebraic surface, but his method of proof was not constructive and he therefore did not obtain bounds for the degree of this surface.” ♠ this result does not seem to answer the Garsia question (1962/63 [510]) if the image can always be chosen among torus of revolution twisted by an affine transformation of 3-space. In this case the degree would be four. ♠ for each genus g we can define the Garsia degree $d(g)$ as the smallest integer d such that each surface F_g conformally embeds as an algebraic surface of degree $\leq d$. In fact from Garsia’s theorem (1962/63 *loc. cit.*) it is not perfectly clear that there is a uniform bound depending only on

- the topology. (So in general $d(g)$ is possibly ill-defined.) Of course $d(0) = 2$ (every sphere is conformal to the round 2-sphere, Riemann, Schwarz 1870); $d(1) \leq 8$ (Pinkall 1985, *op. cit.*), but is this sharp?, in general do somebody know a bound on $d(g) \leq ???$ ♡184
- [1183] U. Pirl, *Über isotherme Kurvenscharen vorgegebenen topologischen Verlaufs und ein zugehöriges Extremalproblem der konformen Abbildung*, Math. Ann. 133 (1957), 91–117. G78 ♠ (another well-known student of Herbert Grötzsch) ♡??
- [1184] J. A. F. Plateau, *Statique expérimentale et théorique des liquides soumis aux seules forces moléculaires*, Gauthier-Villars, Paris, 1873. ♠ ♡??
- [1185] J. Plemelj, *Ein Ergänzungssatz zur Cauchy'schen Integraldarstellung analytischer Funktionen, Randwerte betreffend*, Monats. f. Math. u. Phys. 19 (1908), 205–210. ♠ quoted in Nehari 1955 [1083] ♡??
- [1186] J. Plücker, *System der analytischen Geometrie*, Berlin, 1835. ♠ quoted in Brieskorn-Knörrer 1981/86 [189] ♡??
- [1187] J. Pücker, *Theorie der algebraischen Curven*, Bonn 1839. ♠ cited by all the masters, e.g. Zeuthen 1874 [1628, p. 415], Klein 1873 [791], Gudkov 1974/74 [579] ♠ according to Klein 1873 [791] might be one of the first place where the method of small perturbation is mentioned ♠ p.253, contains a conjecture on the number of real bitangents to a quartic as taking only the values 28, 16, 8, 4, 0, the last case of which was prohibited in Zeuthen 1874 [1628] ♡??
- [1188] H. Poincaré, *Mémoire sur les fonctions fuchsienues*, Acta Math. 1 (1882), 193–294. AS60 ♡??
- [1189] H. Poincaré, *Sur un théorème général de la théorie des fonctions*, Bull. Soc. Math. France 11 (1883), 112–125. G78 ♠ proposes (and succeeds partially) to uniformize not only algebraic, but also analytic curves (=open, a priori highly transcendental, Riemann surfaces). Programm completed in Poincaré 1907 [1195], independently Koebe 1907 [823]. ♡??
- [1190] H. Poincaré, *Sur les groupes des équations linéaires*, Acta Math. 4 (1884), 201–311. ♠ ♡??
- [1191] H. Poincaré, *Sur les équations aux dérivées partielles de la physique mathématique*, Amer. J. Math. 12 (1890), 211–294. ♠ where the *méthode du balayage* is first introduced ♡??
- [1192] H. Poincaré, *Analysis Situs*, J. École Polytechnique 1 (1895), 1–121. ♠ embryo of modern homology theory, quite relevant to problems of conformal mappings (especially circle maps), e.g. in Gabard 2006 [463] ♡??
- [1193] H. Poincaré, *Sur la méthode de Neumann et le problème de Dirichlet*, C. R. Acad. Sci. Paris 120 (1895), 347–352. AS60 ♠ ♡??
- [1194] H. Poincaré, *La méthode de Neumann et le problème de Dirichlet*, Acta Math. 20 (1896), 59–142. AS60 ♠ it seems that the method in question, may in turn goes back to Gauss 1839 [516] ♠ ♡??
- [1195] H. Poincaré, *Sur l'uniformisation des fonctions analytiques*, Acta Math. 31 (1907), 1–63. AS60, G78 ♠ simultaneously with Koebe 1907 [823] uniformize arbitrary complex analytic curves (equivalently open Riemann surfaces), completing the 1883 desideratum of Poincaré in [1189], revived in Hilbert's 22th problem] ♡??
- ★ G. M. Polotovskii, one of the eminent student of D. A. Gudkov (ca. 1975) and also earlier of Evgeniya Aleksandrovna Leontovich-Andronova, well-known for his deep investigations along Hilbert's 16th, especially for his spectacular census of not just M -curves, but also paying attention to $(M - 1)$ - and $(M - 2)$ -schemes of degree 8. Especially, pleasant and popular is his 1988 survey [1209] which is much based on Viro's revolution but contained also and interesting retrograde-like remark (p.460) to the effect that certain $(M - 1)$ -schemes are apparently not subsumed to Viro's method. The situation perhaps changed meanwhile since Korchagin's intervention. Polotovskii is also much involved in reflection centering around Rohlin's maximality conjecture, and so his publication are of uttermost relevance to the present survey.
- [1196] G. M. Polotovskii, *Algorithm for determining the topological type of a rough plane algebraic curve of even degree*, in: Qualitative Methods in the Theory of Differential Equations, Gor'kii (1973). ♠ cited in Gudkov 1974 [579]. ♡??

- [1197] G. M. Polotovskii, *Problem of topological classification of the disposition of ovals of nonsingular algebraic curves in the projective plane*, in: Methods of the Qualitative Theory of Differential Equations [in Russian], Vol. 1, Gorki (1975), 101–128. (Russian) ♠ cited in Viro 1980 [1527] for being (beside Brusotti 1916 [202]) the first article proposing a general way to encode schemes by a symbolical device (probably due in substance to Gudkov), and recited again for this purpose in Viro 1983/84 [1532] ♠ Personal opinion (of Gabard [02.05.13] and earlier already), of course all this symbolism is a bit awkward for the beginner and in reality the full harmony of those symbols only appears when all symbols are aggregated upon a single table (or pyramid). On comparing the notation of Gudkov-Polotovskii with that of Viro it should be soon apparent that Viro’s notation (which is the most popular in the present days) is a bit cumber containing a lot of extraneous symbols like “angled brackets” and “□”. For instance if you compare Orevkov’s table 2002, with our Fig. 154 we hope to convince even the vivid adherent of Viro’s symbolism that the one of Gudkov-Polotovskii is more convenient hence more suited to the depiction of great pyramids. ♠ also cited in Korchagin 1996 [863] as an early (pre-Viro) contribution to the construction of M -nonics (degree $m = 9$).] ♡??
- [1198] G. M. Polotovskii, *A catalogue of M -reducible [decomposed/decomposing] curves of order 6*, Dokl. Akad. Nauk SSSR 236 (1977), 548–551; English transl., Soviet Math Dokl. 18 (1977), 1241–1245. [♠ reducible curves (aka split or decomposable) curves are relevant to the dissipation of singularity (e.g. dissipating N_{15} amounts to classify sextic decomposing as a quintic plus a line, i.e. an affine quintic) and those can enter the scene of Viro’s method of gluing. Compare e.g. Polotovskii 1992 [1210]. ♠ here a complete census of the curve given in the title is given. For more detailed proofs cf. also Kuzmenko-Polotovskii 1996 []] ♡??
- [1199] G. M. Polotovskii, *Complete classification of M -decomposed curves of 6-th degree in real projective plane*, Gorki Univ. (1978), 1–103. Deposited in VINITI 24.04.78, N 1349–78 Dep. [♠ 103 pages? Yes apparently. ♠ cited in Polotovskii 1988 survey [1209] or in Polotovskii 1992 [1210].] ♡??
- [1200] G. M. Polotovskii, *$(M - 1)$ - and $(M - 2)$ -decomposing curves of 6th degree*, in: Methods of the Qualitative Theory of Differential Equations, Gorki (1978), 130–148. (Russian) [♠ cited in Polotovskii 1992 [1210].] ♡??
- [1201] G. M. Polotovskii, *Topological classification of split curves of degree 6*, Candidate’s Dissertation Gor’kii, 1979. [♠ cited from Viro 89/90 [1535]] ♡??
- [1202] G. M. Polotovskii, *$(M - 2)$ -curves of order 8 and some conjectures*, Uspekhi Mat. Nauk SSSR 36 (1981), 235–236. [Translation ??] [♠ contains some observation on Rohlin’s conjecture, that were ultimately employed in Shustin 1985/85 [1411] to disprove one implication of Rohlin’s conjecture (in degree 8); compare also Polotovskii-Shustin 1984 [1204]]★★★ ♡??
- [1203] G. M. Polotovskii, *On the classification of $(M - 2)$ -curves of order 8*, in: Methods of the Qualitative Theory of Differential Equations, Gorki (1983), 127–138. [♠ cited in Viro’s survey 1986 [1534, p. 77] for the construction (via the new Viro method) of 327 schemes by $(M - 2)$ -curve of degree 8]★★★ ♡??
- [1204] G. M. Polotovskii, E. I. Shustin, *Construction of counterexamples to a conjecture of Rohlin*, Uspekhi Mat. Nauk. 39 (1984), 113. (Russian) [English version not available apparently.] [♠ located via Shustin 1990/91 [1419] and seem to be a forerunner of the famous disproof in Shustin 1985 [1411] ♠ also cited in Polotovskii 1988 [1209]] ♡??
- [1205] G. M. Polotovskii, *$(M - 2)$ -curves of 8-th degree: constructions, open problems*, Gorki Univ. (1984), 1–194. Deposited in VINITI 13.02.85, N 1185–85 Dep. [♠ 194 pages? (yes apparently) ♠ much cited in Polotovskii 1988 survey [1209] when it comes to details that are hopefully fairly easy to reconstruct.] ♡??
- [1206] T. V. Goryacheva, G. M. Polotovskii, *Construction of $(M - 1)$ -curves of order 8*, Preprint, Gorki State Univ., Gorki, 1985=Manuscript No. 4441–85, deposited at VINITI, 1985 (Russian) R. Zh. Mat. 1985, 10A464. [♠ construction of 171 types of $(M - 1)$ -schemes of degree 8 probably by the Viro method; cited for this in Shustin 1990/91 [1419]. Albeit this number looks impressive this exercise must be fairly straightforward adaptation of the methodology used in the case of M -curves in our Sec. 2.1. At the occasion it should be extremely interesting to make tables, especially if the three levels of M - $(M - 1)$ - and $(M - 2)$ -curves can be contemplated simultaneously on a plate of the paper-format A2 approximatively (i.e. 4 times the format A4). Then one should try to contemplate the truth of Rohlin’s maximality

- conjecture (type I scheme=pure orthosymmetry implies maximality). So one should imagine our Fig. 154 with some sublevels containing more schemes with $(M - 1)$ or $(M - 2)$ many ovals.] ♡??
- [1207] G. M. Polotovskii, A. V. Tscherbakova, *On construction of $(M - 3)$ -curves of 8-th degree*, Gorki Univ. (1985), 1–23. Deposited in VINITI 24.06.85, N 4440–85 Dep. [♠ also cited in Polotovskii 1988 survey [1209].] ♡??
- [1208] G. M. Polotovskii, *Relation between rigid isotopy class of a nonsingular curve of 5-th degree in $\mathbb{R}P^2$ and its position with respect to a line*, Funkts. Anal. Appl. 20 (1986), 87–88. [♠ cited in Polotovskii 1988 survey [1209].] ♡??
- [1209] G. M. Polotovskii, *On the classification of nonsingular curves of degree 8*, In: Topology and Geometry–Rohlin Seminar, Lect. Notes in Math. 1346, Springer, Berlin, 1988, 455–485. [♠ a fundamental contribution (survey) to Hilbert’s 16th in degree $m = 8$, where attention is also given to non-maximal curves; note that apparently Polotovskii himself is not directly responsible of any construction of M -curves, cf. e.g. our Table of scorers (Fig. 153) ♠ this survey is frequently cited, e.g. in Risler 1992 [1265] and offers pleasant pictures of Viro’s method, and of “petals”. In the overall the survey looks a bit outdated after the contribution of Korchagin 1989 [860], but is still valuable reading. In it we learn in particular the following points. First, the schematic-symbolism which Viro ascribes to Polotovskii, is really due to Gudkov (1974), compare footnote p. 457. More seriously, the Gudkov(-Polotovskii) symbolism is recognized to have the slight typographical disadvantage of not being writable on a single line (cf. the same footnote), yet upon changing it slightly the Gudkov symbolism can stand on one one line and becomes more compact than Viro’s, e.g. write $(1, \frac{\alpha}{1}\beta)\gamma$ instead of the cumbersome $\frac{\alpha\beta}{1}\gamma$ (and it is against our freewill that we take the pain to write down Viro’s symbol $\langle 1 \langle 1 \langle \alpha \rangle \sqcup \beta \rangle \sqcup \gamma \rangle$ which in our opinion contains too much extraneous symbols). It is evident that “our” (=Gudkov’s) version of the Gudkov(-Polotovskii) symbolism is more compact than Viro’s. In this respect Polotovskii cites very carefully Brusotti’s older probably outdated symbolism, cf. Brusotti 1914–15–16 [202].] ♡7
- [1210] G. M. Polotovskii, *On the classification of decomposing plane algebraic curves*, In: Real Algebraic Geometry, Proceedings, Rennes 1991, Lect. Notes in Math. 1524, Springer, Berlin, 1992[?], 52–74. [♠ an interesting survey full of open question and potentially relevant to Hilbert’s 16th in degree 8, via the idea due to Shustin 1983 (cf. p. 56) that any dissipation(=smoothing) of the 5-fold ordinary point N_{16} amounts to the gluing of any (smooth) affine quintic. So it is explained how Viro 1980 obtained some smoothings of N_{16} , while Shustin 1983 described all of them. Still on p. 56: “Hilbert 16th on non-singular curves was advanced essentially by such smoothings.”] ♡??
- [1211] G. M. Polotovskii, *Dimitrii Andreevich Gudkov*, in: Topology of Real Algebraic Varieties and Related Topics, Amer. Math. Soc. Transl. 173, 1996, 1–9. [♠ survey of Gudkov’s contributions with an exhaustive list of his scientific works] ♡??
- [1212] G. M. Polotovskii, T. V. Kuzmenko, [alphabetical order reversed by Gabard] *Classification of curves of degree 6 decomposing into a product of M -curves in general position*, in: Topology of Real Algebraic Varieties and Related Topics, Amer. Math. Soc. Transl. (2) 173, 1996, 165–177. [♠ more detailed exposition of the result announced in Polotovskii 1977/77 [1198].] ♡??
- [1213] G. M. Polotovskii, A. A. Binstein, [reversed alphabetic order (forced by Gabard) to keep all Polotovskii contributions gathered sequentially] *On the mutual arrangement of a conic and a quintic in the real projective plane*, in: ???, Amer. Math. Soc. Transl. 200, 2000, 63–72. [♠ nice and fascinating pictures as usual in the field and the paper concludes with the recent advances due to Orevkov. ♠ it seems to us that the same problem in degree $6 + 2$ is of uttermost maybe as a way to create new M -octics, compare our Fig. 127 where we constructed heuristically an M -octic not yet known to be realized.] ♡??
- [1214] G. M. Polotovskii, *On the classification of decomposable 7-th degree curve*, in: ???, Contemporary Mathematics 253, 2000, 219–234. [♠ nice and fascinating text pointing to several earlier mistake in earlier literature (e.g. Korchagin-Shustin 1989/90 []), including those detected by Orevkov.] ♡??
- [1215] G. M. Polotovskii, M. A. Gushchin, A. N. Korobeinikov, [reversed alphabetic order (due to Gabard) to keep all Polotovskii contributions gathered sequentially] *Patchworking arrangements of a cubic and a quartic*, J. Math. Sciences 113 (2003),

- 795–803. [♠ yet another advance on the problem of decomposing curve of degree 7 (here $7 = 3 + 4$).] ♡??
- [1216] Ch. Pommerenke, *Über die analytische Kapazität*, Archiv der Math. 11 (1960), 270–277. [♠ some estimates of the analytic capacity (defined as in Ahlfors 1947 [18]) and its connection to Schiffer’s span 1943 [1346] ♠ uses heavily Ahlfors-Beurling 1950 [20] and Nehari 1952 [1081]] ♡??
- [1217] H. Poritsky, *Some industrial applications of conformal mapping*. In: *Construction and Applications of Conformal Maps*, Proc. of a Sympos. held on June 22–25 1949, Applied Math. Series 18, 1952, 207–213. [♠ quoted for a joke about free-hand drawings] ♡??
- [1218] R. de Possel, *Sur le prolongement des surfaces de Riemann*, C. R. Acad. Sci. Paris 186 (1928), 1092–1095. AS60 [♠ problem of deciding when an (open) Riemann surface can be continued to a larger one ♠ relates to work of Radó 1924 [1234], and Bochner 1927 [176]] ♡??
- [1219] R. de Possel, *Sur le prolongement des surfaces de Riemann*, C. R. Acad. Sci. Paris 187 (1929), 98–100. AS60 [continuation of the previous work in the spirit of Radó and Bochner] ♡??
- [1220] R. de Possel, *Zum Parallelschlitztheorem unendlich-vielfach zusammenhängender Gebiete*, Gött. Nachr. (1931), 199–202. AS60, G78 [♠ proof of the parallel-slit mapping à la Schottky 1877 [1366]-Cecioni 1908 [260]-Hilbert 1909 [668]-Koebe 1910 [830]-Courant 1910/12 [328], via an extremal problem (method analogous to Carathéodory 1928 [236], but uses also the Flächensatz of Bieberbach) ♠ of course Schottky-Cecioni are not cited as they only treats the case of finite connectivity ♠ it is noteworthy that the similar problem for the Kreisnormierung is still unsolved in full generality. This supports once more the philosophy advanced by Garabedian-Schiffer 1950 [498] that parallel-slit mappings are easier than circle maps]
- [1221] R. de Possel, *Quelques problèmes de représentation conforme*, J. École Polytech. (2) 30 (1932), 1–98. AS60, G78 [♠ parallel (as well as radial) slit maps in the case of domains via an extremal problem ♠ some little details of it seem to be criticized in Ahlfors-Beurling 1950 [20]] ♡??
- [1222] R. de Possel, *Sur quelques propriétés de la représentation conforme des domaines multiples connexes, en relation avec le théorème des fentes parallèles*, Math. Ann. 107 (1932), 496–504. AS60, G78 [♠ again parallel-slits via an extremal problem, overlap with work by Grötzsch] ♡??
- [1223] R. de Possel, *Sur les ensembles de type maximum, et le prolongement des surfaces de Riemann*, C. R. Acad. Sci. Paris 194 (1932), 98–100. AS60 [♠ still relates to work of Radó, and Bochner and reports some mistakes in the previous notes] ♡??
- [1224] R. de Possel, *Sur la représentation conforme d’un domaine à connexion infinie sur un domaine à fentes parallèles*, J. Math. Pures Appl. (9) 18 (1939), 285–290. AS60, G78 [♠ as noted in Burckel 1979 [217], this de Possel paper affords a trick to circumvent the reliance upon RMT in his 1931 proof of the PSM through an extremum problem, similar trick in Garabedian 1976 [500]] ★★★ ♡??
- [1225] W. Pranger, *Extreme points in the Hardy class H^1 of a Riemann surface*, Canad. J. Math. 23 (1971), 969–976. A50 [♠ Ahlfors 1950 [19] is quoted twice: on p. 975 for certain decompositions and on p. 976: “On a compact bordered surface R the periods of the conjugate of a function which is harmonic on R and continuous on its closure may be specified arbitrarily (see [1, p. 110]=Ahlfors 1950 [19, p. 110])] ♡0
- [1226] F. E. Prym, *Zur Integration der Differentialgleichung $\frac{\partial^2 u}{\partial x^2} + \frac{\partial^2 u}{\partial y^2} = 0$* , J. Reine Angew. Math. 73 (1871), 340–364. [♠ p. 361–364, an example is given of a continuous function on the unit-circle whose harmonic extension to the disc has infinite Dirichlet integral! (The existence of such an extension is established directly in the first part of the paper, independently of Schwarz’s 1870 [1374] solution based upon Poisson’s integral.) This Prym’s example is nothing less than a counterexample to the Dirichlet principle (as formulated, e.g., in Grube’s text [367]=redaction of Dirichlet’s lectures). Compare Elstrodt-Ulrich 1999 [392, p. 285]. Prym emphasizes at the end of his paper (p. 364) that Riemann himself never committed such a “basic” mistake, but (still on p. 364) Prym formulates an implicit critique to all contemporary attempts to rescue the Dirichlet principle based on the tacit assumption of finiteness of the Dirichlet integral, presumably including the one of Weber

- 1870 [1567] (who is however not directly attacked for diplomatique reasons) ♠ a related example (where any continuous function matching the boundary data has infinite Dirichlet integral) is due to Hadamard 1906 [601] ♠ such counter-example affects directly the Dirichlet-Riemann argument of minimizing the Dirichlet integral, and seems to destroy as well H. Weber’s attempt (1870 [1567]) to consolidate Riemann’s proof ◊ student of Riemann, who played a pivotal rôle as well in explaining to Klein, that Riemann himself did not confined his attention to surfaces spread over the plane but included a more organical mode leading to the “abstract” Riemann surfaces, compare Klein 1882 [797] ♡??
- [1227] P. M. Pu, *Some inequalities in certain nonorientable Riemannian manifolds*, Pacific J. Math. 2 (1952), 55–71. [♠ includes a proof of the isosystolic estimates for the projective plane $\mathbb{R}P^2$ (by adapting the method of Loewner 1949 for the torus) stating that the round elliptical metric has the best systolic ratio (i.e. is the more robust less susceptible to dye from a “Herzinfarkt”: that is $sys^2/area \leq (\pi)^2/2\pi = \pi/2 = 1.570796327\dots$) ♠ this results implies directly the Gromov filling conjecture for genus $p = 0$, upon cross-capping the boundary contour (cf. Gromov 1983 [547])] ♡??
- [1228] V. A. Puiseux, *Recherches sur les fonctions algébriques*, Journal de Math. 1 15 (1850), 365–480. [♠ study of the algebraic equation $f(z, u) = 0$ (f a polynomial), poles, branch points, concept of essential singularities (where the Laurent series expansion contains an infinity of negative terms, e.g. $e^{1/z}$ at $z = 0$) ♠ independent investigations of the same material by Weierstraß] ♡??
- [1229] I. I. Pyatetsky-Shapiro, I. R. Shafarevich, *A Torelli theorem for algebraic surfaces of type K3*, Izv. Akad. Nauk SSSR Ser. Mat. 35 (1971), 530–572; English transl., Math. USSR Izv. 5 (1971), ?–?. [♠ used by Nikulin 1979/80 [1107] in his rigid-isotopy classification of plane sextic via Klein-Rohlin’s type (I/II=ortho- vs. dia-symmetry)] ♡??
- [1230] T. Radó, *Zur Theorie der mehrdeutigen konformen Abbildung*, Acta Szeged 1 (1922), 55–64. G78 [♠ quoted in Landau-Osserman 1960 [906], who ascribe to Radó the basic fact that an analytic map taking boundary to boundary is a full covering surface taking each value a constant number of times ♠ hence this Radó bears an obvious connection to the Ahlfors map, albeit it does not reprove its existence when the target surface is the disc] ♡14
- [1231] T. Radó, *Über die Fundamentalabbildung schlichter Gebiete*, Acta Sci. Math. Szeged 1 (1922/23), 240–251; cf. also Fejér’s Ges. Arb. 2, 841–842. G78 [♣ supplies in print an argument of Fejér-Riesz proving RMT via an extremal problem (maximization of the derivative), perfected in Carathéodory 1928 [236] and Ostroski 1929 [1150] ♣ this constitutes the underlying background for the extremal methods used by Grunsky and Ahlfors, leading ultimately to Ahlfors 1950 [19]] ♡??
- [1232] T. Radó, *Bemerkung zu einem Unitätssatz der konformen Abbildung*, Acta litt. ac. scient. Univ. Hung. 1 (1923), 101–103. G78 ♡??
- [1233] T. Radó, *Über die konforme Abbildung schlichter Gebiete*, Acta litt. ac. scient. Univ. Hung. 2 (1924), 47–60. G78 ♡??
- [1234] T. Radó, *Über eine nicht fortsetzbare Riemannsche Mannigfaltigkeit*, Math. Z. 20 (1924), 1–6. AS60 ♡high?
- [1235] T. Radó, *Über den Begriff der Riemannschen Fläche*, Acta Szeged 2 (1925), 101–121. AS60 [♠ aside from Weyl 1913 [1585] (“sheaf theoretic”) this supplies the first (modern) definition of an “abstract” Riemann surface, modulo Klein who anticipated the “atlas” idea quite explicitly in [802] (“Dachziegelige Überdeckung”). [CHECK, pages] Klein knew it essentially since Prym indicated him how Riemann saw the story, as reported, e.g., in the introduction of Klein 1882 [797]. ♠ compare also the discussion in Remmert 1998 [1247] ♠ besides the article contains a bunch of results: triangulability of surfaces (via what is nowadays known as the Schoenflies theorem), existence of non-metric surfaces following the (unpublished) construction of Prüfer (ca. 1922)] ♡??
- [1236] T. Radó, F. Riesz, *Über die erste Randwertaufgabe für $\Delta u = 0$* , Math. Z. 22 (1925), 41–44. [♠ supplies drastic simplifications over Perron’s method (Perron 1923 [1165]) according to Carathéodory 1937 [238, p. 710]] ♡high?
- [1237] T. Radó, *Subharmonic functions*, Berlin, 1937. ♡??
- ★ Virginia Ragsdale (1870–1945) came to visit Klein and Hilbert ca. 1903 in Göttingen and completed her Ph.D. in Bryn Mawr in 1906.

- [1238] V. Ragsdale, *On the arrangement of the real branches of plane algebraic curves*, Amer. J. Math. 28 (1906), 377–404. [♠ formulation of the Ragsdale conjecture saying that if $m = 2k$, and p, n are the number of even resp. odd ovals then $p \leq \frac{3k(k-1)}{2} + 1$ and $n \leq \frac{3k(k-1)}{2}$. This conjecture was disproved by Itenberg in 2000 using Viro’s patchworking (in degree 10) ★ however the case of M -curves is still open amounting to the estimate $|\chi| \leq k^2$]★ ♥111
- [1239] Z. Ran, *Families of plane curves and their limits: Enriques’ conjecture and beyond*, Ann. of Math. (2) 130 (1989), 121–157. [♠ cited in Shustin 1990/91 [1418].] ♥??
- [1240] H. E. Rauch, *Weierstrass points, branch points, and the moduli of Riemann surfaces*, Comm. Pure Appl. Math. 12 (1959), 543–560. [♠]★ ♥111
- [1241] H. E. Rauch, *A transcendental view of the spaces of algebraic Riemann surfaces*, Bull. Amer. Math. Soc. 71 (1965), 1–39. [♠ the cream of the theory (Riemann, Teichmüller, Ahlfors, etc. revisited)] ♥??
- [1242] A. H. Read, *Conjugate extremal problems of class $p = 1$* , Ann. Acad. Sci. Fenn., A.I., 250/28 (1958), 8 pp. AS60, G78 ♥??
- [1243] A. H. Read, *A converse to Cauchy’s theorem and applications to extremal problems*, Acta Math. 100 (1958), 1–22. A50, G78 [♣ an alternative proof of Ahlfors 1950 [19] is given via Hahn-Banach ♣ subsequent work via a similar approach in Royden 1962 [1305] ◇ we probably do not need to recall that both Royden and Read were students of Ahlfors] ♥22
- [1244] E. Reich, S. E. Warschawski, *On canonical conformal maps of regions of arbitrary connectivity*, Pacific J. Math. 10 (1960), 965–985. G78 [♠ like Meschkowski 1953 [1004] (which is not cited!) shows that the Ahlfors-type problem of maximizing the derivative among *schlicht* function bounded-by-one gives a conformal map upon a Kreisschlitzbereich (=circular slit disc). This analysis is also based upon Rengel’s inequality, or a variant thereof closer to Grunsky’s Thesis 1932] ♥28
- [1245] H. J. Reiffen, *Die differentialgeometrischen Eigenschaften der invarianten Distanzfunktion von Carathéodory*, Schrift Math. Inst. Univ. Münster 26 (1963). [♠ quoted e.g. in Burbea 1977 [212]]★ ♥??
- [1246] R. Remmert, *Funktionentheorie 2*, Grundwissen Mathematik 6, Springer-Lehrbuch, 1991. (1. unveränderter Nachdruck 1992 der 1. Auflage.) ♥??
- [1247] R. Remmert, *From Riemann surfaces to complex spaces*, Séminaire et Congrès 3, Société Math. de France, 1998, 203–241. ♥??
- [1248] E. Rengel, *Über einige Schlitztheoreme der konformen Abbildung*. (Diss.), Schriften math. Semin., Inst. angew. Math. d. Univ. Berlin 1 (1932/33), 140–162. AS60, G78 ★ ♥??
- [1249] E. Rengel, *Existenzbeweise für schlichte Abbildungen mehrfach zusammenhängender Bereiche auf gewisse Normalbereiche*, J.-Ber. Deutsche Math.-verein. 44 (1934), 51–55. AS60, G78 [♠ via the extremal problem method in vogue at the time obtain the existence of the circular/radial slit maps for domain of finite connectivity (cf. also de Possel, and Grötzsch) ♠ the terminology “Normalbereiche” goes back to Weierstrass, compare Schottky’s Thesis 1877 [1366] ♠ this paper shows the existence of a *schlicht* mapping of a finitely-connected domain upon a circular slit disk ♠ antecedent in Koebe 1918, see also Reich-Warschawski 1960 [1244]] ♥18
- [1250] H. Renggli, *Zur konformen Abbildung auf Normalgebiete*, (Diss. ETH Zürich) Comment. Math. Helv. 31 (1956), 5–40 AS60, G78 [♠ limited to plane domains, where the various slit mappings are reproved via an extremal problem involving the extremal length, Montel’s normal families are used] ♥??
- [1251] M. von Renteln, *Friedrich Prym (1841–1915) and his investigations on the Dirichlet problem*, Suppl. Rend. Circ. Mat. Palermo 44 (1996), 43–55 [♠ detailed discussion of Prym’s counterexample to the (naive) Dirichlet principle (compare Prym 1871 [1226])]★★★ ♥4
- [1252] S. Richardson, *Hele-Shaw flows with time-dependent free boundaries involving a multiply-connected fluid region*, European J. Appl. Math. 12 (2001), 571–599 [♠] ♥??
- [1253] B. Riemann, *Grundlagen für eine allgemeine Theorie der Functionen einer veränderlichen complexen Grösse*. Inauguraldissertation Göttingen, 1851. In: Ges. math. Werke 1876/1892/1990 [1260]. [♣ first proof of RMT, some bad tongues claim that the proof is dubious (even abstraction made of the difficulty allied to the Dirichlet principle), whereupon Riemann reacted with [1257]] ♥??

- [1254] B. Riemann, *Über die Hypothesen, welche der Geometrie zugrunde liegen*. Habilitationsvortrag 1854, first published in: *Abhandlungen der Königl. Ges. d. Wiss. Göttingen* 13 (1867), reproduced in *Ges. math. Werke* [1260]. [♠ a breathtaking generalization of geometry, ramifying to the eclectic topic of Riemannian geometry, Dedekind, Beltrami, Ricci, etc., up to Gromov, Perelman, etc.] ♡??
- [1255] B. Riemann, *Fragment aus der Analysis Situs*. circa 1852/53. Published In: *Ges. math. Werke* [1260]. [♠ a first attempt to generalize the connectivity number to high-dimensional manifolds, leads to the work of Betti, and Poincaré 1895 [1192]] ♡??
- [1256] B. Riemann, *Theorie der Abel'schen Functionen*, *Crelle J. Reine Angew. Math.* 54 (1857), ?-?. In: *Ges. math. Werke* [1260, 88–142]. [♠ contains in particular the statement that any (or at least one with general moduli?) closed Riemann surface of genus g maps conformally to the sphere with $\leq [\frac{g+3}{2}]$ sheets ♠ this assertion not accepted by modern geometers until Meis 1960 [993] ♣ p. 116, some historical hints given by Riemann shows an involvement with conformal maps of multiply-connected regions (maybe even surfaces) as early as Fall 1851 (up to Begin 1852), but then he was sidetracked to another topic] ♡??
- [1257] B. Riemann, *Bestimmung einer Function einer veränderlichen complexen Grösse durch Grenz- und Unstetigkeitsbedingungen*, *Crelle J. Reine Angew. Math.* 54 (1857), 111–114. [♣ after Riemann 1851 [1253] the second (more solid, but less romantic) proof of RMT, of course in retrospect not sound until Hilbert's resurrection of the Dirichlet principle] ♡??
- [1258] B. Riemann, *Gleichgewicht der Electricität auf Cylindern mit Kreisförmigem Querschnitt und parallelen Axen. Conforme Abbildung von durch Kreise begrenzten Figuren* (Nachlass XXVI). In: *Ges. math. Werke* [1260, p. 472–476]. G78 [♣ the first version of the “Ahlfors map” in the planar case (perhaps confined to the case of circular domains) ♠ for subsequent works see primarily Schottky 1875/77 [1366], Bieberbach 1925 [147], Grunsky 1937–41/40–42, Ahlfors 1947–50 [19]] ♡??
- [1259] B. Riemann, *Ueber das Verschwinden der Thetafunctionen*, ?? ?? (1865), ?-?. In: *Ges. math. Werke* [1260, ?-?]. [♠ another complete solution to the problem of inverting Abelian integrals ♠ Schottky's problem (1903): what conditions must be imposed on the Riemann matrices to arise as period matrices ♠ full effective solution in Shiota 1986] ♡??
- [1260] B. Riemann, *Gesammelte mathematische Werke, wissenschaftlicher Nachlass und Nachträge*, Nach der Ausgabe von H. Weber und R. Dedekind, Teubner, Leipzig, 1876; neu herausgegeben von R. Narasimhan, Springer-Verlag, Berlin, 1990. [♠ the first edition 1876 (as well as the subsequent editions) contains the first publication of Riemann's Nachlass ([1258] estimated 1857/58), where existence of circle maps is proven for planar surfaces, especially in the case of a domain bounded by circles] AS60 ♡??
- [1261] F. Riesz, *Ueber Potenzreihen mit vorgeschriebenen Anfangsgliedern*, *Math. Z.* 18 (1923), 87–95. [♠ cited in Heins 1975 [637], who employs a Riesz variational formula to derive another proof of Ahlfors' circle maps with upper control upon the degree ♠ in fact the cited variational formula of F. Riesz, was given by him for the case $p = 1$ (Hardy classes index) and for the disc Δ . However it is available suitably modified for any (finite) bordered Riemann surface and all possible Hardy classes indexes $1 \leq p < \infty$. (source=p.20 of the just cited Heins work, where for details one must probably browse Heins 1969 [636])] ♡??
- [1262] F. Riesz, *Über die Randwerte einer analytische Funktion*, *Math. Z.* 18 (1923), 87–95. [♠] ♡??
- [1263] F. Riesz, *Sur les fonctions subharmoniques et leur rapport à la théorie du potentiel*, *Acta Math.* 54 (1930), 321–360. [♠ somehow inspired by Perron 1923 [1165]] ♡??
★ J.-J. Risler, student of ?, one among the leading expert of the French School (Marin, Chevallier, Coste-Roy, Le Touzé, etc.) of real geometry.
- [1264] J.-J. Risler, *Les nombres de Betti des ensembles algébriques réels, une mise au point*, *Gazette des math.* ?? (1992), ?-?. [♠] ♡??
- [1265] J.-J. Risler, *Construction d'hypersurfaces réelles [d'après Viro]*, *Sém. N. Bourbaki*, no. 763 (1992–93). [♠ often quoted by the experts, e.g. Itenberg 2002 [707] ♠ contains a proof of Viro's theorem, and a (correct) enumeration of the size of the universe of all M -octics, namely $91 = 102 - 6 - 5$, where 6 are prohibited by

- Viro (unpublished apart the announcement in Viro 1986), and 5 are prohibited by Shustin (1990/91 [1419] along a variant of Viro’s obstruction) ♠ at this time 78 maximal schemes were constructed (the last in date being Shustin’s and Korcha-gin’s) so that 13 cases remained open. Meanwhile four M -curves were constructed in Chevallier 2002 [282] and one in Orevkov 2002, plus 2 prohibited in Orevkov 2002 [1129] so that the list of 13 is now reduced to 6, for their geography compare our Fig. 154, which is essentially based upon Orevkov 2002, yet slightly more illuminating by showing also the prohibitions (as well as removing an essential misprint, accreditation to Viro of a scheme due to Hilbert.) ♡??
- ★ E. Ritter, student of Felix Klein, very eminent for deep study on the moduli space and automorphic functions, which alas died prematurely when crossing the Atlantic (after reaching New York). Ritter is the hero in particular of S. Bochner (cf. his text on “Americana” devoted to the well-known US-philosopher Charles Pierce).
- [1266] E. Ritter, *Die multiplicativen Formen auf algebraischem Gebilde beliebigen Geschlechts mit Anwendung auf die Theorie der automorphen Formen*, Math. Ann. 44 (1894), 261–374. [♠] ♡??
- ★ Walt[h]er Ritz, well-known superhero of modern computing (along people like Galerkin, etc.) and for his controversy with A. Einstein, compare Gander-Wanner 2012 [493] for a ampler discussion. For our restricted perspective Ritz may be regarded as the direct inspirator of Bieberbach 1914, hence Bergman 1922, and so Ahlfors 1950. The boucle is closed!
- [1267] W. Ritz, ???, ??? ?? (1908), ??-??. [♠ inspired Bieberbach 1914 [142], who in turn inspired Bergman 1922 [114], which had some influence on Ahlfors 1950 [19] ♠ for a brilliant discussion of Ritz work *per se* cf. Gander-Wanner 2012 [493]] ♡??
- [1268] ?? Robertson, *On the theory of univalent functions*, Ann. of Math. 37 (1936), 374–408. [♠ contains a simple derivation of the Bieberbach conjecture $|a_n| \leq n|a_1|$ for starlike regions via the Schwarz-Christoffel formula] ♡330
- [1269] G. Robin, *Sur la distribution de l’électricité à la surface des conducteurs fermés et des conducteurs ouverts*, Ann. Sci. École Norm. Sup. 3 (1886), 3–58. [♠] ♡??
- [1270] R. M. Robinson, *Analytic functions in circular rings*, Duke Math. J. 10 (1943), 341–354. G78 [♠ quoted in Minda 1979 [1013] in connection with the theta function expression of the Ahlfors function of an annulus ♠ for this see also Golusin 1952/57 [534] ♠ also quoted in Jenkins-Suita 1979 [719]] ♡??
- [1271] R. M. Robinson, *Hadamard’s three circles theorem*, Bull. Amer. Math. Soc. 50 (1944), 795–802. G78 [♠]★★ ♡??
- [1272] G. Roch, *Ueber die Anzahl der willkürlichen Constanten in algebraischen Functionen*, Crelle J. Reine Angew. Math. 64 (1865), 372–376. ♡??
- [1273] R. Rochberg, *Almost isometries of Banach spaces and moduli of Riemann surfaces*, Duke Math. J. ?? (1973), ??-??. [♠ compact bordered Riemann surfaces] ♡11
- [1274] R. Rochberg, *Deformation of uniform algebras on Riemann surfaces*, Pacific J. Math. 121 (1986), 135–181. A50 [♠ on p. 142 Ahlfors 1950 [19] is cited as follows: Ahlfors has shown that given S in \mathcal{S} [the set of all connected finite bordered Riemann surfaces, cf. p. 135] and x, y in $S \setminus \partial S$ there is a function $F = F_{x,y}$ in $A(S)$ which has $|F| = 1$ identically on ∂S , $F(x) = 0$, $F(y) \neq 0$, and F maps S onto the closed unit disk in an m to one manner (counting multiplicity). Furthermore, if g denotes the genus of S and c the number of components of ∂S , then F can be selected so that m satisfies $c \leq m \leq 2g + c$. ♠ on the same page the Ahlfors’ bound ($r + 2p$ in our notation) is applied to a problem a bit too technical to be summarized here, and naively one could ask if the improved bound $r + p$ of Gabard 2006 [463] could be applied to Rochberg’s work. This is not evident because a lowest possible degree map does not a priori separates two points prescribed in advance (hence we have not pursued the issue further)] ♡9
- [1275] B. Rodin, L. Sario, *Principal functions*, Princeton, van Nostrand, 1968. G78 ★★
- [1276] B. Rodin, *The method of extremal length*, Bull. Amer. Math. Soc. 80 (1974), 587–606. G78 [♠ p. 590 Teichmüller listed (without reference!) amongst the contributor to the Löwner-Pu systolic inequality? ♠ if this is true it would be nice to localize the precise source] ♡28

- [1277] B. Rodin, D. Sullivan *The convergence of circle packings to the Riemann mapping*, J. Differ. Geom. 26 (1987), 349–360. [♠ building over work of Koebe 1936 (not cited), Andreev 1970 and Thurston 1985, develop a convergence proof of (finitistic) approximation by circle packings of the Riemann mapping ♣ an obvious desideratum would be to implement a similar proof for the case of the Ahlfors function on compact bordered Riemann surface] ♡??
- [1278] E. Röding, *Konforme Abbildung endlicher Riemannscher Flächen auf kanonische Überlagerungsflächen der Zahlenkugel*, Diss. Würzburg, 1972, 71 S. G78 [♠ this entry is cited on the “critical” page 198 of Grunsky 1978 [568], according to which it gives a generalization to Riemann surfaces of the Bieberbach-Grunsky theorem (i.e. circle map in the planar case) ♠ in particular, it could be the case that Röding reproves the existence of an Ahlfors circle map, yet probably this is not the case ♠ perhaps this aspect has been subsequently published in Röding 1977 [1281]] ★ ♡??
- [1279] E. Röding, *Nichtschlichte konforme Abbildung[en] unendlich vielfach zusammenhängender Teilgebiete der Ebene*, Arch. d. Math. 26 (1975), 391–397. G78 [♠ infinite connectivity analog of the “Riemann-Bieberbach” mapping theorem.] ♡??
- [1280] E. Röding, *Über die Wertannahme der Ahlforsfunktion in beliebigen Gebieten*, Manusc. Math. 20 (1977), 133–140. G78 ♡??
- [1281] E. Röding, *Über meromorphe Funktionen auf endlichen Riemannschen Flächen vom Betrag eins auf den Randlinien*, Math. Nachr. 78 (1977), 309–318. G78 ♡??
- [1282] M. Roggero, *Real divisors on real curves*, Le Matematiche 54 (1999), 67–76. [♠ “...every divisor [on a smooth real algebraic curve having a nonempty real part], which is linearly equivalent to its conjugate, is also equivalent to a divisor supported on a set of real points.” ♠ this resembles slightly the reformulation of Ahlfors theorem given in Gabard 2006 [463], but differs substantially for Roggero’s result applies also to diasymmetric curves (with real points) ♠ p. 75–76: an example is given of a smooth real plane quartic such that every line intersect the (supposed nonempty) real locus in at most 2 points; evidently such a curve has at most one oval and another such example is the Fermat quartic $x^4 + y^4 = 1$] ♡1
- [1283] W. W. Rogosinski, H. S. Shapiro, *On certain extremum problems for analytic functions*, Acta Math. 90 (1953), 287–318. [♠ this article pertains to our topic (of the Ahlfors map) inasmuch as it may have influenced some new generation existence-proof (of “abstract” functional analytic character) of the Ahlfors map (where Hahn-Banach takes over the rôle of Euler-Lagrange), like those of Read 1958 [1243], and the popular version of Royden 1962 [1305]] ♡??
 ★★ Vladimir Abramovich Rohlin (1919–1984, 65 years old) is one of the big hero of 20th century mathematics (measure and ergodic theory, differential topology, real algebraic geometry, etc.).
- [1284] V. A. Rohlin, *New results in the theory of 4-dimensional manifolds*, Dokl. Akad. Nauk SSSR 84 (1952), 221–224; French transl. available in Guillou-Marin 1986 [589]. [♠ seminal result of 4D-differential topology on the divisibility by 16 of a simply-connected manifold with even intersection form ♠ this (suitably generalized) turned out to be relevant to Hilbert’s 16th problem yielding a proof of the Gudkov hypothesis, cf. Rohlin 1972/72 [1286]] ♡??
- [1285] V. A. Rohlin, *Two-dimensional submanifolds of 4-dimensional manifolds*, Funkt. Anal. Prilozhen. 5 (1971), 48–60; English transl., Funct. Anal. Appl. 5 (1971), ?–?. [♠ a slight extension of Rohlin’s theorem (1952) to non-spin manifolds via the congruence $x(F) - \sigma(X^4) \equiv 8\text{Arf}(F) \pmod{16}$ (where $x(F)$ is the normal Euler number and σ the signature), generalizing the 2-sphere case of Kervaire-Milnor 1961 [761] ♠ this tool turned out to be pivotal to prove the Gudkov hypothesis, cf. the next entry Rohlin 1972/72 [1286], which alas contains a little gap (bridged in Marin 1979 [963])] ♡??
- [1286] V. A. Rohlin, *Proof of a conjecture of Gudkov*, Funkt. Anal. Prilozhen. 6 (1972), 62–64; English transl., Funct. Anal. Appl. 6 (1972), 136–138. [♠ the congruence in question (nowadays known as the Gudkov-Rohlin congruence) states that a plane M -curve of order $2k$ satisfies $\chi = p - n \equiv k^2 \pmod{8}$ ♠ when particularized to degree 6 it affords a new “elementary” solution to Hilbert’s 16th problem (free from the vicissitudes allied to the Hilbert-Rohn-Gudkov method) ♠ alas Rohlin’s first proof contains a little flaw (cf. next ♠) though being essentially correct using the seminal Rohlin’s divisibility by 16 of the signatures of spin 4-manifolds

(even forms of intersection on the 2-dimensional homology) ♠ from Kharlamov-Viro 1988/91 [778, p. 361]: “Three proofs of the Gudkov-Rohlin congruence have been published. They are due to V. A. Rohlin [16](=1972/72 [1286]=Proof of Gudkov’s hypothesis), [17](=[1287]=Congruence modulo 16 in Hilbert’s 16th problem) and A. Marin [12](=1979/80 [963]). The third [12](=Marin *loc. cit.*) appears to be an improvement of the first. The example considered by Marin [12](=*loc. cit.*) seems to show that there is no correct proof of (1.A)[=Gudkov’s hypothesis] which is closer to Rohlin’s argument than Marin’s proof.—Marin’s [12] and Rohlin’s second [17] approaches [are] based on quite different techniques. Rohlin’s proof work in any dimension while no generalization of Marin’s proof to higher dimensions is known. Nevertheless the approaches seem to be closely related. Rohlin asked his students to find a relation and said that an understanding of it might lead to essential progress.” ♠ from Degtyarev-Kharlamov 2000 [355, p. 736]: “In Rokhlin’s first paper [97](=this entry) there is a mistake in the proof of Gudkov’s conjecture. However the approach in the paper, namely, using characteristic surfaces in a 4-manifold to evaluate the signature mod 16, became a powerful method in the study of real algebraic curves. It was used by Marin, who together with Guillou (see [46](=Guillou-Marin 1977 [588])) extended Rokhlin’s signature formula to non-orientable characteristic surfaces and thus corrected the mistake.” ♠ in point 5 of Rohlin’s note, the author explains how a congruence due to Whitney (1941) can be used to derive a proof of Arnold’s congruence $\chi \equiv k^2 \pmod{4}$; for another proof via Rohlin’s formula cf. (v.2)] ♡??

[1287] V. A. Rohlin, *Congruence modulo 16 in Hilbert’s sixteenth problem*, Funkt. Anal. Prilozhen. 6 (1972), 58–64; English transl., Funct. Anal. Appl. 6 (1972), 301–306. [♠ severe restriction upon the isotopy classification of M -curves reinforcing earlier work of Petrovskii 1938 [1168] and Arnold 1971 [59]] ♡??

[1288] V. A. Rohlin, *Congruence modulo 16 in Hilbert’s sixteenth problem, II*, Funkt. Anal. Prilozhen. 7 (1973), 91–92; English transl., Funct. Anal. Appl. ? (197?), ?–?. [♠] ♡??

[1289] V. A. Rohlin, *Complex orientations of real algebraic curves*, Funkt. Anal. Prilozhen. 8 (1974), 71–75; English transl., Funct. Anal. Appl. 8 (1974), 331–334. [♠ present a general method of closing the one half of a dividing real plane curve by piecing together real discs to construct a closed membrane, whose (fundamental) homology class yields via intersection theory a certain numerical relation known as Rohlin’s complex orientation formula. The latter implies the striking fact that a dividing curve exhibits at least as many ovals as the half value of its degree(=order). This answers a question of Klein, made more explicit in Gross-Harris 1981 [552]. Compare Gabard 2000 [461] for more details. NB: In this seminal paper, Rohlin treats only the case of M -curve(=Harnack-maximal) (the general formula being written down in the next entry Rohlin 1978 [1290], but the proof is easy to adapt). ♠ Rohlin’s formula also prohibits many (but not all) M -schemes of sextics (e.g. that consisting of eleven unnested ovals) supplying so a 5 minutes proof of the tricky theorem of Hilbert (1891–00–08), which he was never able to complete himself (or with his numerous students)] ♡??

[1290] V. A. Rohlin, *Complex topological characteristics of real algebraic curves*, Uspekhi Mat. Nauk. 33 (1978), 77–89; translation: Russian Math. Surveys 33 (1978), 85–98. [♠ shows strikingly that Rohlin discovered Klein’s work at a very late stage (despite the fact that Klein is generously quoted e.g. in Gudkov 1974 [579]), but with great happiness apparently (p. 85): “As I learned recently, more than hundred years ago, the problems of this article occupied Klein, who succeeded in coping with curves of degree $m \leq 4$ (see [4](=Klein 1922 [806]), p. 155).” ♠ p. 93–94 prove the result that a real plane curve with a nest of maximal depth is dividing, via an argument which (in our opinion) can be slightly simplified as follows ♠ given $C_m \subset \mathbb{P}^2$ a nonsingular curve of degree m with a deep nest then projecting the curve from any point chosen in the innermost oval gives a morphism $C_m \rightarrow \mathbb{P}^1$ whose fibers over real points are totally real. Hence there is an induced map between the imaginary loci $C_m(\mathbb{C}) - C_m(\mathbb{R}) \rightarrow \mathbb{P}^1(\mathbb{C}) - \mathbb{P}^1(\mathbb{R})$ and it follows that C_m is dividing (just by using the fact that the image of a connected set is connected). q.e.d. (this argument avoids the consideration of the canonical fibering pr: $\mathbb{C}P^2 - \mathbb{R}P^2 \rightarrow S^2$ envisaged by Rohlin) ♠ p. 94: “If A_1 and A_2 belong to type I, then the question is rather complicated, in general, but Fiedler first noted that everything is radically simplified when $s = m_1 m_2$ [i.e. all intersections are real]. Namely, in this situation, A belongs to type I” ♠ some interesting question

is raised on p.95: “**3.9 A conjecture about real schemes of type I.** A study of the available factual material suggests that possibly a real scheme belongs to type I iff it is *maximal*, that is, it is not part of a larger real scheme of the same degree. This conjecture is true for $m \leq 6$, and there is much to be said in its favour for $m > 6$. There is an allusion to it in Klein: see [4], p. 155 (=Klein 1922=Ges. Math. Abh. II [806]).” [31.12.12] Gabard’s guess: perhaps this conjecture of Klein-Rohlin follows from Ahlfors theorem translated in terms of total reality (intuitively having a total pencil, no real circuit can be added for otherwise Bézout would be corrupted, yet perhaps this is too naive, cf. our Sec. in v.2. ♠ *Warning.* p. 788 of Degtyarev-Kharlamov 2000 [355] one reads: “**Digression: real rational curves.** As far as we know, the following problem is still open: is it possible to draw an irreducible real rational curve (or more precisely a connected component of it) of degree q through any set of $3q - 1$ real points in general position? In [99](=Rohlin 1978 [1290]) the question is answered in the affirmative; however, the proof has never been published; possibly it contained a gap.” ♡??

[1291] V. A. Rohlin, *New inequalities in the topology of real plane algebraic curves*, Uspekhi Mat. Nauk. 14 (1980), 37–43; translation: Russian Math. Surveys ?? (198?), ??-??. [♠] ♡??

[1292] V. A. Rohlin, *Two aspects of the topology of real algebraic curves*, Proc. Leningrad Internat. Topology Conf., Nauka, Leningrad, 1983; (translation available?). [♠ cited in Viro 1986/86 [1534]] ♡??

★ Kurt Rohn, student of ?, well-known for his study of the topology of real curves and surfaces as early as 1886 (prior to Hilbert’s intervention in the field), notably for an extension of Hilbert’s obstruction of the unnested sextic 11 to the maximally nested one $\frac{10}{1}$. He is also well-known for the famous Hilbert-Rohn method which affords substantial information on Hilbert’s 16th, yet whose importance is partially (at least in degree 6) eclipsed by the (differential topological) congruence of the Gudkov-Arnold-Rohlin era. For one of the rehabilitation of the method cf. Orevkov-Shustin 2000/02 [1131]. In our opinion it could be interesting to see how much the Hilbert-Rohn method can be subsumed to the method of total reality (Riemann, Schottky, Klein, Biebrerbach, Grunsky, Teichmüller, Ahlfors). Recall that it is still an open problem to understand what happens in degree 8 (6 schemes among a menagerie of 104 being still undecided, cf. our Fig. 154 for the state-of-the-art after Orevkov 2002).

[1293] K. Rohn, *Flächen vierter Ordnung hinsichtlich ihrer Knotenpunkte und ihrer Gestaltung*, Preisschriften der Fürstlich Jablonowskischen Gesellschaft, Leipzig, 1886, 1–58; also in [abridged form] in Math. Ann. 29 (1887), 81–96. [♠ contains a proof that a quartic surface in 3-space has at most 12 components, this estimate was improved to 11 in Utkin 1967 [1509] (a student of Gudkov) and reached its definitive sharpness as ≤ 10 in Kharlamov 1972/73 [764]] ♡??

[1294] K. Rohn, *Die Maximalzahl von Ovalen bei einer Fläche 4. Ordnung*, Leipzig Ber. 63 (1911), 423–440. [♠ cited in many surveys like Galafassi 1960 [479], Gudkov 1974 [579], etc.] ♡??

[1295] K. Rohn, *Die ebenen Kurven 6. Ordnung mit elf ovalen*, Leipzig Ber. 63 (1911), 540–555. [♠ cited in Petrovsky 1938 [1168] and considered there as the first rigorous proof of Hilbert’s announced theorem that an M -sextic cannot have all its 11 ovals lying unnested. However Gudkov (e.g. in 1974 [579]) is more severe and does not consider Rohn’s proof as complete. ♠ [18.03.13] perhaps nowadays the most expediting way to prove this Hilbert-Rohn theorem is via Rohlin’s formula for complex orientations, which proves more generally that any M -curve (of even degree) has some nesting provided its degree $m = 2k \geq 6$. The first proof of this statement (and much more) goes really back to Petrovskii’s seminal inequalities of 1933/38, cf. Petrovskii 1933/38 [1168]] ♡??

[1296] K. Rohn, *Die Maximalzahl und Anordnung der Ovale bei der ebenen Kurve 6. Ordnung und bei der Fläche 4. Ordnung*, Math. Ann. 73 (1913), 177–229. [♠] ♡??

[1297] H. Röhrl, *Unbounded coverings of Riemann surfaces and extensions of rings of meromorphic functions*, Trans. Amer. Math. Soc. 107 (1963), 320–346. [♠ cited in Alling 1965 [41], and one may wonder about a connection with Ahlfors 1950, i.e. the “unbounded covering” in question (cf. definition on p.328) are probably related to circle maps, at least extended versions thereof where the target is not necessarily the unit disc of course Röhrl’s notion is quite standard, albeit the terminology is far from uniformized, cf. e.g. Ahlfors-Sario’s “complete covering surfaces” (in

- 1960=[26, p.42] themselves patterned after Stoilow’s “total coverings” ♠ alas, it does not seem that Röhrl reproves Ahlfors result (which would have been pleasant in view of Röhrl great familiarity with Meis’ work 1960 [993]) ♡??
- [1298] F. Ronga, *Analyse réelle post-élémentaire*, Presses polytechniques romandes, 1999. [♠ cited for the picture in v.2] ♡??
- [1299] A. Rosenblatt, *Untersuchungen über die Gestalten der algebraischen Kurven sechster Ordnung*, Bull. Acad. Sciences de Cracovie (Math.) (1910), 635–676. [♠ cited in Brusotti 1914 [201] and again in Brusotti 1952 [206], or in Galafassi 1960 [479] (where the text is dated 1911).] ♡??
- [1300] P. C. Rosenbloom, *Quelques classes de problèmes extrémaux*, Bull. Soc. Math. France 80 (1952), 183–215. [♠ this worked is cited in Forelli 1979 [449], where it is employed to derive another existence-proof of circle-maps with the same control upon the degree as in Ahlfors 1950 [19]] ♡??
- [1301] M. Ross, *The second variation of nonorientable minimal submanifolds*, Trans. Amer. Math. Soc. 349 (1997), 3093–3104. [♠ p.3097 criticizes the argument of Li-Yau 1982 [934] for the Witt-Martens mapping ♠ gives differential geometric application of it to (non-orientable) minimal surfaces] ♡??
- [1302] M.-F. Roy, *The role of Hilbert’s problem in real algebraic geometry*, Undated notes XXXX, 13pp. [♠ a general survey of 3 of Hilbert’s problem allied to real geometry (17th due to Minkowski and solved by Artin 1925, 16th solved by Gudkov in 1969 and not in 1971 as asserted in the text, but admittedly Gudkov’s first proof was so esoteric that nobody believed it, not even Petrovskii or Arnold) and finally the 10th on the algorithmic decision of a solution to Diophantine equations (negatively solved by Matiyasevich in 1972) ♠ p.5 mentions the role of Thom’s conjecture in Hilbert’s 16th via the paper Mikhalkin 1997 [1007]] ♡??
- [1303] H. L. Royden, *Harmonic functions on open Riemann surfaces*, Trans. Amer. Math. Soc. 73 (1952), 40–94. A50 [♣ this is, in substance, the author’s Thesis [Harvard University, 1951] (under Ahlfors) ♠ it contains very deep material “sufficient condition for the hyperbolic type in term of a triangulation of the surface” (causing a great admiration by Pfluger, etc.), yet from our finitistic perspective the paper seems to contain little about the Ahlfors map, for this issue see rather the subsequent paper Royden 1962 [1305]] ♡??
- [1304] H. L. Royden, *Rings of meromorphic functions*, Proc. Amer. Math. Soc. 9 (1958), 959–965. [♣ this article is often credited by Alling to be the first employment of Ahlfors map as a technique to lift truths from the disc to more general finite bordered surfaces, e.g. in the Acknowledgements of Alling 1965 [41] or in Alling’s review of Stout 1965 [1458] one reads: “The third technique is dependent on the existence of the Ahlfors map P (=1950 [19]), which maps a compact bordered Riemann surface \bar{R} , finite-to-one, onto \bar{U} . This gives rise to the algebraic approach, for the adjoint of P is an isomorphism of $H_\infty(U)$ into $H_\infty(R)$, the extension being finite and very tractable. This approach was apparently first used by Royden 1958 [=this entry]=[1304]]. Later it was utilized extensively by the reviewer, who working independently of the author[=Stout], announced his extension of Carleson’s corona result to R [...]”]★★ ♡??
- [1305] H. L. Royden, *The boundary values of analytic and harmonic functions*, Math. Z. 78 (1962), 1–24. [♣ re-prove the existence and properties of the Ahlfors function via Hahn-Banach, along the path of Read 1958 [1243]] ♡57/62
- [1306] L. A. Rubel, J. V. Ryff, *The bounded weak-star topology and the bounded analytic functions*, J. Funct. Anal. 5 (1970), 167–183. A47, A50 [♣]★★★NY(only-MR) ♡29
- [1307] L. A. Rubel, *Bounded convergence of analytic functions*, Bull. Amer. Math. Soc. 77 (1971), 13–24. A47, A50 [♣ p.18 the two works of Ahlfors 1947 [18], 1950 [19] are quoted in connection with the following problem about inner functions: “In the case of the general region G [supposed (cf. p.17) to support nonconstant bounded analytic functions and to enclose no removable singularities for all bounded analytic functions], one would guess that the solution, known to exist, of any of several extremal problems would be inner, and consequently hypo-inner. For example, choose a point $z_0 \in G$ and consider $f \in B_H(G)$ [i.e. the space of bounded analytic function] so that $\|f\|_\infty \leq 1$ and $f(z_0) = 0$, and maximize $|f'(z_0)|$. The extremal function is the so-called Ahlfors function, and in case G is finitely connected, it is known [2](=Ahlfors 1947 [18]), [3](=Ahlfors 1950 [19]) to be inner.” ♠ let us recall

- definitions (cf. p.17–18): a bounded analytic function on the disc $F \in B_H(D)$ is *inner* if $\|F\|_\infty \leq 1$ and if its Fatou radial limit function $F^*(e^{i\theta}) = \lim_{r \rightarrow 1} F(re^{i\theta})$ has unit modulus for almost all θ (w.r.t. usual arc length). It is said to be *hypo-inner* if the Fatou limit has unit modulus for a set of θ of positive measure. For a function on a general domain G , $f \in B_H(G)$, the notions of inner and hypo-inner are transposed via precomposition with the universal covering map $D \rightarrow G$. ♠ now as to Rubel’s guess, it seems to be answered in the negative in Gamelin 1973 [485, p.1107], with details to be found in Gamelin 1974 [488] ♥13/6
- [1308] L. A. Rubel, *Some research problems about algebraic differential equations*, Trans. Amer. Math. Soc. 280 (1983), 43–52. [♣ p.47 the Ahlfors function is mentioned as follows: “To prepare the way for the next problem, we shall define the *Ahlfors function*. If G is a (presumably multiply connected) region and z_0 is a point in G , we define the Ahlfors function α_{z_0} with *basepoint* z_0 as the (unique)solution of the following extremal problem: (i) $\alpha(z_0) = 0$, (ii) $|\alpha(z)| \leq 1$ for all $z \in G$, (iii) $\alpha'(z_0)$ is as large as it can be for the class of functions satisfying (i) and (ii). In case G is simply-connected, α_{z_0} becomes the Riemann map of G onto D that takes z_0 to 0, with positive derivative there. *Problem 11. Suppose α_{z_0} is hypotranscendental, and let $z_1 \in G$ be another base point. Must α_{z_1} be hypotranscendental too?*] ♥??
- [1309] W. Rudin, *Some theorems on bounded analytic functions*, Trans. Amer. Math. Soc. 78 (1955), 333–342. A47, G78 [♠ new (simpler) proof of an (unpublished) theorem of Chevalley-Kakutani stating that a plane domain B such that for each of its boundary-point p there is a bounded analytic function on B possessing at p a singularity is determined (modulo a conformal transformation) by the ring of all bounded analytic functions on B ♠ the proof makes uses of general results of Ahlfors 1947 [18], yet apparently no use is made of the Ahlfors function] ♥??
- [1310] W. Rudin, *Analytic functions of class H^p* , Trans. Amer. Math. Soc. 78 (1955), 46–66. A47 [♠] ♥149
- [1311] W. Rudin, *The closed ideals in an algebra of continuous functions*, Canad. J. Math. 9 (1957), 426–434. [♠ proof of an unpublished result of Beurling describing the ideal theory of the algebra $A(\bar{\Delta})$ of continuous function on the closed disc analytic on its interior ♠ for extensions of this Beurling-Rudin result to compact bordered surfaces, cf. Voichick 1964 [1546], Limaye’s Thesis 1968 and Stanton 1971 [1451] (who makes use of the Ahlfors map) ♠ for an extension to non-orientable Klein surfaces (where no Ahlfors map are available!), see Alling-Limaye 1972 [46]] ♥??
- [1312] W. Rudin, *Pairs of inner functions on finite Riemann surfaces*, Trans. Amer. Math. Soc. 140 (1969), 423–434. [♠ inner function as a synonym of the (Ahlfors) circle maps] ♥??
- [1313] W. Rudin, *Real and complex analysis*, McGraw-Hill. [♠] ♥8982
- [1314] L. Rudolph, *Algebraic functions and closed braids*, Topology 22 (1983), 191–202. [♠ where the notion of quasi-positivity starts emerging and will ca. 15 years later starts to play a tremendous role in Orevkov’s last advances upon Hilbert’s 16th in degree 8 (2 new prohibitions in the ocean of 104 logically possible M -schemes, yet 2 very noticeable ones since the residue of ignorance reduced to 9 cases prior to Orevkov’s intervention!)] ♥??
- [1315] L. Rudolph, *Some topologically locally-flat surfaces in the complex projective plane*, Comment. Math. Helv. 59 (1984), 592–599. [♠ locally-flat counterexamples to Thom’s conjecture (based upon work of Freedman) ♠ p.593 contains the sharpest historical information I am aware of about the terminology “Thom conjecture”, namely: “Professor Thom has remarked (personal communication, November 19, 1982) that the conjecture perhaps more properly belongs to folklore.” ♠ As far as I know the designation “Thom conjecture” appears first in Kirby’s problem list (1970) [785]] ♥??
- [1316] R. Ruedy, *Einbettungen Riemannscher Flächen in den dreidimensionalen euklidischen Raum*, Comment. Math. Helv. 43 (1968), 417–442. [♠ p.417: “Flächen im Sinne der elementaren Differentialgeometrie können zu Riemannschen Flächen gemacht werden, indem man die iostheremen Parameter als lokale Koordinaten benutzt. Diese Struktur nennt man die *natürliche*, weil genau diese lokalen Darstellung winkeltreu sind.—F. Klein warf schon 1882 in seiner Schrift *Über Riemanns Theorie der algebraischen Funktionen und ihrer Integrale* das Problem auf, ob sich jede Riemannsche Fläche konform und bijektiv auf eine solche differentialgeometrische Fläche abbilden lasse.—Der Weg zu diesem überraschend

schwierig zugänglichen Problem wurde durch die fundamentalen Arbeiten von Teichmüller geöffnet; aber erst um 1960 gelang der Beweis für den folgenden Satz:—
 EMBEDDUNGSSATZ VON GARSIA. *Jede kompakte Riemannsche Fläche ist konform äquivalent zu einer differentialgeometrischen Fläche, die reelle-algebraisch im dreidimensionalen euklidischen Raum eingebettet ist.*] ♡??

- [1317] R. Ruedy, *Embeddings of open Riemann surfaces*, Comment. Math. Helv. 46 (1971), 214–225. [♠ p. 214: “In the final section of his famous thesis Riemann states that in his investigations the branched covering surfaces of the plane could be replaced by smooth orientable surfaces embedded in Euclidean 3-space. [...] In his lectures Felix Klein emphasized the concept of viewing classical surfaces as Riemann surfaces, ... It was also he who asked in 1882 if every Riemann surface were conformally equivalent to a classical surface. [F. Klein, *Ges. math. Abh.*, Bd. 3 (Springer 1923), p. 502 and p. 635.]—For a long time the only result in this direction were that every compact Riemann surface of genus zero is conformally equivalent to the sphere, every non-compact planar (schlichtartig) surface is conformally equivalent to a subregion of the plane, and a compact Riemann surface of genus 1 is conformally equivalent to a ring surface provided its modulus is purely imaginary (see [16]=Weyl 1913/65 [1585], 3. Auflage).—The first result beyond these facts was obtained by Teichmüller in [15](=1944 [1486]), where he applied his theory of spaces of Riemann surfaces to the embedding problem. He could show that not all compact embedded surfaces of genus 1 are conformally equivalent to ring surfaces. More important than this result was the method by which he obtained it: He deformed an embedded surface by moving each point along the normal line and studied the dependence of the modulus of the deformed surface on the deformation.—Around 1960 Garsia constructed a surprisingly large class of compact Riemann surfaces whose moduli could be determined ([5](=1960 [506]),[6](=1960 [507])). But he succeeded in answering Klein’s question in the affirmative for all compact Riemann surfaces only when he abandoned his beautiful models and embarked on Teichmüller’s road. His proof in [7](=Garsia-Rodemich 1961 [508]) and [8](=Garsia 1961 [509]) is an ingenious combination of Teichmüller’s ideas and results, constructions inspired by Nash’ isometric embeddings, and Brouwer’s fixed point theorem.—We will see in this paper that his methods are even strong enough to prove this theorem for noncompact surfaces too. [...], we may formulate our theorem as follows:—EMBEDDING THEOREM. *Every Riemann surface R is conformally equivalent to a complete classical surface. A model can be constructed by deforming any topologically equivalent complete classical surface X in the direction of the normals. X is complete, if X is a closed subset of Euclidean space.—A nontrivial corollary (due to R. Osserman) follows, if R is the unit disc and $X = \mathbb{C}$: For a suitable real-valued C^∞ -function f the classical surface represented by $(x, y) \rightarrow (x, y, f(x, y))$, $x + iy \in \mathbb{C}$, is hyperbolic.”] ♡26*
- [1318] R. Ruedy, *Deformations of embedded Riemann surfaces*, Ann. of Math. Studies 66, 1971. [♠] ♡??
- [1319] S. Saitoh, *The kernel functions of Szegő type on Riemann surface*, Kodai Math. Sem. Rep. 24 (1972), 410–421. [♠ Bergman kernel on compact bordered Riemann surfaces] ♡??
- [1320] S. Saitoh, *The exact Bergman kernel and the kernels of Szegő*, Pacific J. Math. 71 (1977), 545–557. [♠ Bergman kernel on compact bordered Riemann surfaces] ♡??
- [1321] S. Saitoh, *The Bergman norm and the Szegő norm*, Trans. Amer. Math. Soc. 249 (1979), 261–279. [♠ Bergman kernel on compact bordered Riemann surfaces] ♡??
- [1322] S. Saitoh, *A characterization of the adjoint L -kernel of Szegő type*, Pacific J. Math. 96 (1981), 489–493. [♠ compact bordered Riemann surfaces, Green’s function and reproducing kernel] ♡0
- [1323] S. Saitoh, *Theory of reproducing kernels and its applications*, Pitman Res. Notes in Math Series 189, 1988. x+157 pp. [♠ reproducing kernel in the abstract united exposition of Aronszajn 1950 [73], followed by a specialization to the case of multiply connected plane domains (esp. Garabedian’s L -kernel as the solution to an extremal problem for the Dirichlet integral)] ♡386
- [1324] S. Saitoh, *Theory of reproducing kernels; applications to approximate solutions of bounded linear operator equations on Hilbert spaces*, Amer. Math. Soc. Transl., 2010. [♠ mentions the “Ahlfors function”] ♡4

- [1325] M. Sakai, *On constants in extremal problems of analytic functions*, Kodai Math. Sem. Report 21 (1969), 223–225. [♠ p.223 seems to consider the problem of minimizing the Dirichlet integral $D[f] = \int \int_W df \cdot \overline{df^*}$ among the analytic functions f on a Riemann surface W normalized by $f(t) = 0$ and $f'(t) = 1$ (w.r.t. some local uniformizer) [see also Schiffer-Spencer 1954 [1352]] ♠ alas nothing seems to be asserted about the range of the least area mapping (in particular we still wonder if it is a circle map as looks plausible in view of the simply-connected case treated in Bieberbach 1914 [142])] ♡??
- [1326] G. Salmon, *A Treatise on the Analytic Geometry of Three Dimensions*, Hodge, Smith & Co., 1882. [♠] ♡0
- [1327] T. Salvemini, *Sulla rappresentazione conforme delle aree piane pluriconnesse su una superficie di Riemann di genere zero in cui sono siano eseguiti dei tagli paralleli*, Ann. Scuola Norm. Super. Pisa (1) 16 (1930), 1–34. [♠ just cited to mention that Schottky’s proof of PSM relied on a parameter count not completely justified at his time] ♡0
- [1328] M. V. Samo[k]hin, *On some questions connected with the problem of existence of automorphic analytic functions with given modulus of boundary values*, Mat. Sb. 111 (1980); English transl.: Math. USSR Sbornik 39 (1981), 501–518. [♠ p.505 occurrence of the Ahlfors function as an example of non-constant function in H^∞ whose Gelfand transform is unity on the Šilov boundary of H^∞ , p.509: “We used an Ahlfors function to “knock down” the growth of the function...”, p.512: another occurrence of the Ahlfors function] ♡??
- [1329] M. V. Samokhin, *Cauchy’s integral formula in domains of arbitrary connectivity*, Sb. Math. 191 (2000), 1215–1231. [♠ From the Abstract: An example of a simply-connected domain with boundary of infinite length is constructed such that for fairly general functionals on H^∞ no extremal function (including the Ahlfors function) can be represented as a Cauchy potential] ♡??
- [1330] F. Santos, *Improved counterexamples to the Ragsdale conjecture*, Preprint, Universidad de Cantabria, 1994. [♠ refinement of Itenberg 1993 [695], compare the discussion in Itenberg 2002 [707]] ♡??
- [1331] D. Sarason, *Representing measures for $R(X)$ and their Green’s functions*, J. Funct. Anal. 7 (1971), 359–385. [♠ some questions asked in the paper are answered in Nash 1974 [1058]] ♡??
- [1332] L. Sario, *A linear operator method on arbitrary Riemann surfaces*, Trans. Amer. Math. Soc. 72 (1952), 281–295. A50 [♠ perhaps first a general remark about Sario: to the best of my knowledge none of Sario’s papers (or books) works out a reproof of Ahlfors circle maps, albeit he is often gravitating around closely related or even more grandiose (i.e. foundational) paradigms. Quite ironically, much of the impulse and modernity along the Nevanlinna-Sario tradition finds its starting point in the Schwarz alternating method (which seemed outdated after Hilbert 1900 [664] “direct” resolution (=resuscitation) of the Dirichlet principle) ♠ Ahlfors 1950 [19] is cited in the bibliography yet apparently not within the text] ♡??
- [1333] L. Sario, *Extremal problems and harmonic interpolation on open Riemann surfaces*, Trans. Amer. Math. Soc. 79 (1955), 362–377. A50 [♠ Ahlfors 1950 [19] is cited on p.364 as follows: “Concerning extremal problems for differentials, the reader is referred to the comprehensive study [1](=1950 [19]) by Ahlfors.” ♠ “The ultimate purpose of the present paper is to study interpolation of harmonic and analytic functions on open Riemann surfaces W . We shall, however, first take a less restricted viewpoint and consider, in general, extremal problems on Riemann surfaces.” ♠ the bulk of the paper is a reduction of a certain extremal problem over very general open Riemann surfaces to the special case of compact bordered surface (with analytic contours) via the usual exhaustion trick] ♡6
- [1334] L. Sario, *Strong and weak boundary components*, J. Anal. Math. 5 (1956/57), 389–398. [♠ quoted in Reich-Warschawski 1960 [1244] for another proof of Grötzsch’s extension to infinite connectivity of the Kreisbogenschlitztheorem] ♡18
- [1335] L. Sario, K. Oikawa, *Capacity Functions*, Grundlehren d. math. Wiss. 149, Springer, Berlin, 1969. A47, A50, G78 [♠ Ahlfors 1950 [19] is cited at three places: pp.46, 110, 175, where this last citation come closest to our interest (but the discussion seems to be confined to plane regions W , cf. p.175 (top)). ♠ We cite the relevant extract (p.175): “Concerning the quantity c_B , Schwarz’s lemma give us the unique function minimizing $M[F]$ if W is simply-connected. The problem

has not been solved completely for an arbitrary region W . However, Carleson [1](=1968 [248]) established the uniqueness of the minimizing function if $c_B > 0$. For a regular region W (in which case $c_B > 0$), further results have been obtained by Ahlfors [1](=1947 [18]), [2](=1950 [19]), Garabedian [1](=1949 [495]), and Nehari [2](=1951 [1079]), [3](=1952 [1081]). For the function minimizing $M[F]$, they obtained a characterization which in particular implies that the function maps W onto an n -sheeted disk of radius $1/c_B$, where n is the connectivity of W ; note that this property does not in turn characterize the minimizing function. Garabedian and Nehari further derived a relationship with Szegő's kernel function (Szegő [1](=1921 [1476]), Schiffer [5](=1950 [1349])). However, we shall not go into a more detailed discussion of these interesting results." ♥102

- [1336] L. Sario, M. Nakai, *Classification Theory of Riemann Surfaces*, Grundlehren d. math. Wiss. 164, Springer, Berlin, 1970, 446 pp. A47, A50, G78 [♠ cite the work Ahlfors 1950 [19] in the bibliography (p. 412), but not in the main body of the text (sauf erreur!) ♠ p. 452, the article by Kusunoki 1952 [898] (where the Ahlfors map of a bordered surface is applied to the so-called "type problem") is cited (and as far as I know this is the *unique* citation of Kusunoki's work throughout the world literature). Alas, Kusunoki's work does not seem to be quoted inside the main body of the text. ♠ p. 332: "The concept of harmonic measure was introduced by Schwarz [1](=Ges. math. Abh. 1890) and effectively used by Beurling [1](=1935 [136]). Nevanlinna [1](=1934 [1093]) coined the phrase "harmonic measure" and introduced the class of "nullbounded" surfaces characterized by the vanishing of the harmonic measure. That this class coincides with the class O_G of "parabolic" surfaces was shown by Myrberg [2](=1933 [1051]) for surfaces of finite genus." ♥??
- [1337] S. Scheinberg, *Hardy spaces and boundary problems in one complex variables*, Ph. D. Thesis, Princeton University, 1963. [♠ includes a proof of the corona theorem on annuli, cf. also Stout 1965 [1458]]★ ♥??
- [1338] W. Scherrer, *Zur Theorie der endlichen Gruppen topologischer Abbildungen von geschlossenen Flächen in sich*, Comment. Math. Helv. 1 (1929), 69–119. [♠ cited in Trilles 2003 [1501]; who is Scherrer? a student of Hopf?, H. Kneser, Dehn?]* ♥?? ♠ Ludwig Schläfli (18XX–18XX) is a well-known Swiss-German scientist (Bern) scoring the heaviest brain ever met ca. 1.9 kg? for only 157 cm of body height. He is famous for his deep work on conformal representation (early origin of the continuity method later used by Klein, Poincaré, Koebe, Brouwer, etc.) and overlapping with the contribution of Schwarz-Christoffel). Contributed also to our topic via his work on real cubic surfaces (anticipating so the era of Zeuthen-Klein-Harnack-Hilbert) paving the way to Hilbert's 16th problem.
- [1339] L. Schläfli, *On the distribution of surfaces of the third order into species, in reference to the absence or presence of singular points, and the reality of their lines*, Philos. Trans. Roy. Soc. London 153 (1863), 195–241. [♠ classification of cubic surfaces into 5 species depending on the number of real lines (either 27, 15, 7, 3, 3). This work of Schläfli inspired several generation of geometers including Klein 1873 [791], Zeuthen 1875 [1629] and Todd 1930 [1495]] ♥??
- [1340] L. Schläfli, ???, Ann. di Mat. (2) 5 (1872), 289–295; (2) 7 (1875), 193–195 [♠ citec in Brusotti 1952 [206]] ♥??
- [1341] E. Schmidt, *Entwicklung willkürlicher Funktionen nach Systemen vorgeschriebener ???*, Math. Ann. 63 (1907), 433–476. [♠ quoted in Nehari 1955 [1083]] ♥??
- [1342] E. Schmidt, *Zur Theorie der linearen und nichtlinearen Integralgleichungen*, Math. Ann. 64 (1907), 161–174. [♠ quoted in Bergman 1950 [123]] ♥?? ★ Max Menahem Schiffer (19XX-19XX) one of the key figure of conformal mappings throughtout the 20st century flirting with the conception of Bergman, Garabedian, etc.
- [1343] M. Schiffer, *Sur les domaines minima dans la théorie des transformations pseudo-conformes*, C.R. Acad. Sci. Paris 207 (1938), 112–115. [♠ quoted in Maschler 1956 [975, p.506] for the issue that minimal domains satisfy the mean value property; thus perhaps if ranges of least area maps are minimal domains we may hope that by virtue of a theorem of XXX-Schiffer (cited in the introd. of Aharonov-Shapiro 1976 [13]) the least area map is a circle map [02.08.12] ♠ also quoted in Bergman 1947 [121, p.32] for the issue that for a proof of the partial result that for starlike domains the least area map effects the Riemann mapping upon the circle]★★★ ♥??

- [1344] M. Schiffer, *Sur un théorème de la représentation conforme*, C. R. Acad. Sci. Paris 207 (1938), 520–522. AS60, G78 [♠ located via Reich-Warschawski 1960 [1244], who cite the paper for another proof of Grötzsch’s extension 1929–1931 [559] to infinite connectivity of the Kreisschlitzbereich mapping of Koebe 1918 [838] ♠ contains indeed a proof based upon an extremal problem of the circular slit map, yet the argument seems to depend upon the longer paper Schiffer 1937/38 [1345]] ♡3
- [1345] M. Schiffer, *A method of variation within the family of simple functions*, Proc. London Math. Soc. (2) 44 (1937/38), 432–449. AS60, G78 [♠ principle of areas (Flächensatz) of Bieberbach-Faber ♠ quotes Grötzsch 1930 and extends a result of Marty 1934] ♡145
- [1346] M. Schiffer, *The span of multiply connected domains*, Duke Math. J. 10 (1943), 209–216. AS60, G78 ★ ♡??
- [1347] M. Schiffer, *The kernel function of an orthonormal system*, Duke Math. J. 13 (1946), 529–540. G78 ★ ★★ [♠ establish for domains an identity relating the Bergman kernel to the Green’s function] ♡??
- [1348] M. Schiffer, *An application of orthonormal functions in the theory of conformal mapping*, Amer. J. Math. 70 (1948), 147–156. AS60, G78 [♠ new derivation via the Bergman kernel of inequalities of Grunsky’s Thesis 1932, which were previously derived by variational methods] ♡??
- [1349] M. Schiffer, *Various types of orthogonalization*, Duke Math. J. 17 (1950), 329–366. ★★ ★ ♡??
- [1350] M. Schiffer, *Some recent developments in the theory of conformal mapping*, Appendix to R. Courant, 1950 [338], 249–324. [♠ an extremely readable survey of several trends in potential theory, including the Green-Dirichlet yoga, the kernel method and some of the allied extremal problems, plus the method of extremal length and schlicht functions] ♡??
- [1351] M. Schiffer, *Variational methods in the theory of conformal mapping*, Proc. Internat. Congr. Math., Cambridge, Mass., 1950, (1952), 233–240. G78 [♠ survey of variational methods] ♡??
- [1352] M. Schiffer, D. C. Spencer, *Functionals of Finite Riemann Surfaces*, Princeton Mathematical Series, Princeton University Press, 1954. [♣ [noticed the 26.07.12] on p.135 the authors consider the problem of the least-area map (normed at a point q) for a compact bordered Riemann surface ♣ it would be extremely desirable to know if the extremal map is a circle map, and if it relates to the Ahlfors function described in Ahlfors 1950 [19]] ♡282/302
- [1353] M. Schiffer, *Extremum problems and variational methods in conformal mapping*, Proc. Internat. Congr. Math., Stockholm, 1958, 211–231. G78 [♠ p.229 suggest a new proof (via Fredholm) of Schottky’s famous circular mapping (i.e. Kreisnormierung): details to be found in the next voluminous paper] ♡??
- [1354] M. Schiffer, *Fredholm eigenvalues of multiply connected domains*, Pacific J. Math. 9 (1959), 211–269. G78 [♠ includes a new proof (via an extremum problem involving the Fredholm determinant) of the Schottky-Koebe Kreisnormierung; for yet another proof cf. the next item [1355]] ♡??
- [1355] M. Schiffer, N. S. Hawley, *Connections and conformal mapping*, Acta Math. 107 (1962), 175–274. G78 [♠ p.183–189 includes yet another proof of the Schottky-Koebe Kreisnormierung (finite-connectivity) via an extremum problem of the Dirichlet type] ♡47
- [1356] M. Schiffer, *Fredholm eigenvalues and conformal mapping*, Rend. Mat. e Appl. (5) 22 (1963), 447–468. G78 [♠ which mappings? the method must be the same as the previous item] ♡??
- [1357] M. Schiffer, G. Springer, *Fredholm eigenvalues and conformal mapping of multiply connected domains*, J. Anal. Math. 14 (1965), 337–378. G78 ♡??
- [1358] M. Schiffer, *Half-order differentials on Riemann surfaces*, J. SIAM Appl. Math. 14 (1966), 922–934. AS60, G78 [♠ summary of research joint with Hawley, ♠ immediate generalization for the Bergman kernel for any closed Riemann surface to be found in Schiffer-Spencer 1954 [1352] ♠ contour integration introduced by Riemann himself] ♡4

- [1359] M. Schifman, *The Plateau problem for non-relative minima*, Ann. of Math. (2) 40 (1939), 834–854. [♠ Seidel’s summary: the problem of mapping a region bounded by a simple closed curve with a continuously turning tangent is reduced to that of minimizing a functional, somewhat similar to that of Douglas (cf. Douglas 1931 [371]). This functional has an electrostatic interpretation which may provide an effective mechanical method for the determination of conformal maps] ♡??
- [1360] M. Schifman, *Uniqueness theorems for conformal mapping of multiply connected domain*, Proc. Nat. Acad. Sci. U. S. A. 27 (1941), 137–139. G78 [♠ quoted in Bergman 1950 [123]] ♡??
- [1361] P. Schmutz, *Riemann surfaces with shortest geodesics of maximal length*, Geom. Funct. Anal. 3 (1993), 564–631. [♠] ♡??
- [1362] P. Schmutz-Schaller, *Geometry of Riemann surfaces based on closed geodesics*, Bull. Amer. Math. Soc. 35 (1998), 193–214. [♠... Extremal problems have been considered in similar contexts; see in particular Bollobás [9] for extremal graphs and Ahlfors [3] for extremal problems in conformal geometry. ...] ♡69
- [1363] A. Schönflies, *Über gewisse geradlinig begrenzte Stücke Riemann’scher Flächen*, Nachr. Akad. Wiss. Göttingen (1892), 257–267. ★ [♠ detected via AS60.] ♡??
- [1364] E. Scholz, *Geschichte des Mannigfaltigkeitsbegriff von Riemann bis Poincaré*. Birkhäuser, 1980. [♠] ♡??
- [1365] E. Scholz, *The concept of manifold, 1850–1950*. Chapter 2, in: History of Topology, 25–64. Elsevier, 1999 [♠ p.26: “Also leading mathematicians like Cauchy and Gauss started to use geometrizing language in \mathbb{R}^n in publications (Cauchy, 1847) or lecture courses (Gauß, 1851/1917). Gauss, in his lecture courses, even used the vocabulary of $(n - k)$ -dimensional manifolds (*Mannigfaltigkeiten*), but still restricted in his context to affine subspaces of the n -dimensional real space (Gauß, 1851/1917, pp.477ff.). There is no reason to doubt that Riemann got at least some vague suggestion of how to generalize the basic conceptual frame for geometry along these lines from Gauss and developed it in a highly independent way.” ♠ p.36: “In geometric function theory divers authors contributed to a refined understanding of the rôle of topological concepts, in particular C. Neumann with his calculation of the connectivity of a Riemann surface from the winding orders of branch points [Neumann 1865 [1087]], Lüroth, Clebsch and Clifford with their normalized representation during the 1870-s for branched coverings of $P_1(\mathbb{C})$, which represent a Riemann surface with given number of leaves, given loci and winding numbers of branch points.”] ♡??
- [1366] F. Schottky, *Ueber die conforme Abbildung mehrfach zusammenhängender ebener Flächen*, (Diss. Berlin 1875) Crelle J. für die Math. 83 (1877), 300–351. AS60, G78 [♣ after Riemann 1857/58 [1258], the first existence proof of the Ahlfors map in the planar case ♠ contains in germ all type of mapping like the Circle mapping, the Kreisnormierung plus the parallel-slit maps ♠ the only drawback is a certain confinement to planar regions, but this will be quickly relaxed in Klein 1882 [797] ♠ regarding the rigor of proofs, the appreciation are rather random, compare Cecioni 1908 [260] and Grunsky 1978 who ascribes the first rigorous proof of the PSM to Cecioni] ♡??
- [1367] F. Schottky, *Ueber eindeutige Functionen mit linearen Transformationen in sich. (Auszug aus einem Schreiben an Herrn F. Klein.)* Math. Ann. 19 (1882), ?–?. ♡??
- [1368] F. Schottky, *Ueber eindeutige Functionen mit linearen Transformationen in sich*, Math. Ann. 20 (1882), 293–300. AS60 ★ ♡??
- [1369] F. Schottky, *Zur Frage: Haben die Klassenfunktionen Differentialgleichungen*, Sitz.-Ber. Peuß. Akad. Wiss., math.-phys. Kl. (1922), 414–423. [♠ cited in Grunsky 1978 [568, p.197] as follows: “Considering meromorphic functions on D with real boundary values (which he later called “Klassenfunktionen”, [476](=this entry); now they are called Schottky functions) and proving the existence of a real algebraic relation between any two of them, he disclosed an intimate relation between problems in multiply connected domains and the theory of algebraic functions. The most concise expression of this relation is the idea of the “Schottky double” of a multiply connected domain (or of any finite Riemann surface) with analytic boundary; this is a compact Riemann surface, gained by identifying boundary points of two replicas ...”] ★ ♡??

- [1370] O. Schramm, *Conformal uniformization and packings*, Israel J. Math. 93 (1996), 399–428. [♠ new proof of the Brandt-Harrington (1980 [184] and 1982 [611]) generalization of Koebe’s KNP via a topological method (mapping degree), plus the PSM (parallel slit maps) and some other gadgets] ♡??
- [1371] K. Schüffler, *Zur Fredholmtheorie des Riemann-Hilbert-Operator*, Arch. Math. 47 (1986), 359–366. [♠ p.359: “Ausgehend von dem bekannten klassischen Riemann-Hilbert Randwertproblem [8,S.181 ff](=Vekua 1963 [1519]) betrachten wir den Operator $RH: A^m(\Omega) \rightarrow H^{m-1/2}(\partial\Omega, \mathbb{R})$, $RH(f) := \operatorname{Re}(\bar{\lambda}f)|_{\partial\Omega}$. [...] das Symbol “ A^m ” bezeichne den Sobolevraum $H^{m,2}$ der auf Ω holomorphen Funktionen, $m \geq 2$; die komplexwertige Funktion λ sei nullstellenfrei (auf $\partial\Omega$) und o.E. glatt.—Es ist bekannt, daß der Operator RH für glattberandete, endliche Riemannsche Flächen ein Fredholmoperator ist. Sien Index hängt sowohl von der Topologie von Ω (Anzahl der Randkomponenten und Geschlecht) als vom “geometrischen Index, dem Argumentzuwachs $\kappa(\lambda) = \Delta \arg(\lambda)/2\pi \in \mathbb{Z}$ von λ beim positiven Durchlaufen von $\partial\Omega$ ab (siehe [8, S.189]=Vekua 1963 [1519])” ♠ [17.10.12] this seems connected to the Ahlfors map, by taking λ its boundary restriction] ♡2
- [1372] H. A. Schwarz, *Ueber einige Abbildungsaufgaben*, Crelle J. für die Math. 70 (1869), 105–120. [♠ introduces the principle of symmetry ♣ solves special case of the RMT by hand] ♡??
- [1373] H. A. Schwarz, *Zur Theorie der Abbildung*, Züricher Vierteljahrsschrift (1869/70); also (theilweise umgearbeitet ca. 1890) in Ges. Abh. II, 108–132. ♡??
- [1374] H. A. Schwarz, *Ueber die Integration der partiellen Differentialgleichung $\frac{\partial^2 u}{\partial x^2} + \frac{\partial^2 u}{\partial y^2} = 0$ für die Fläche eines Kreises*, Züricher Vierteljahrsschrift (1870), 113–128; reprinted (or rather integrated) in the longer paper Schwarz 1872 [1377]. [♠ this entry is the first rigorous solution to the Dirichlet problem to have appeared in print (for the very special case of the disc) and via usage of the Poisson integral (occurring in several publications dated 1820–23–27–29–31–35) ♠ see also Prym 1871 [1226] for an essentially simultaneous resolution (which however turned out to have less impact on the future events)] ♡??
- [1375] H. A. Schwarz, *Ueber einen Grenzübergang durch alternirendes Verfahren*, Züricher Vierteljahrsschrift (1870), 272–286; also in Ges. Abh. II, 133–143. ♡??
- [1376] H. A. Schwarz, *Ueber die Integration der partiellen Differentialgleichung $\frac{\partial^2 u}{\partial x^2} + \frac{\partial^2 u}{\partial y^2} = 0$ unter vorgeschriebenen Grenz- und Unstetigkeitsbedingungen*, Berliner Monatsb. (1870), 767–795; or Ges. Abh. Bd. II, 144–171 [♠ p.167–170 uniqueness of the conformal structure on the 2-sphere] ♡??
- [1377] H. A. Schwarz, *Zur Integration der partiellen Differentialgleichung $\frac{\partial^2 u}{\partial x^2} + \frac{\partial^2 u}{\partial y^2} = 0$* , Crelle J. für die Math. 74 (1872), 218–253; or Ges. Abh. II, 175–210.
- [1378] Ch. A. Scott, *On the circuit of plane curves*, Trans. Amer. Math. Soc. 3 (1902), 388–398. [♠ contains a pleasant discussion of Cayley and the obstruction of finding a line avoiding a projective sextics (Ronga’s curve)] ♡??
- [1379] A. Sebbar, Th. Falliero, *Equilibrium points of Green’s function for the annulus and Eisenstein series*, Proc. Amer. Math. Soc. 135 (2007), 313–328. [♠ p.314: “By the classical Hopf’s lemma, the normal derivative of the Green’s function is positive on the boundary [of a multi-connected domain], and one may ask if there is a compact set [in the domain], independent of the pole, containing all the equilibrium points of the Green’s function.” ♠ a positive answer to this problem is supplied by Solynin 2007 [1445]] ♡4
 ★ Benjamino Segre contributed to several aspects of real geometry (cubic surfaces, forme armoniche e loro hessiane, algebre, sistemi di forme quadratiche (nel campo reale), plans graphiques algébriques non desarguésiens, correspondences crémoniennes topologiques, etc.), topics in which we are not at all specialized so we omit precise cross-references, but see Galafassi 1960 [479] for a little survey).
- [1380] B. Segre, *Sui moduli delle curve poligonali, e sopra un complemento al teorema di esistenza di Riemann*, Math. Ann. 100 (1928), 537–551. ♡??
- [1381] W. Seidel, *Bibliography of numerical methods in conformal mapping*. In: *Construction and Applications of Conformal Maps*, Proc. of a Sympos. held on June 22–25 1949, Applied Math. Series 18, 1952, 269–280. [♠ a useful compilation of (old) conformal maps literature emphasizing the numerical methods, and out of which we borrowed several summaries] ♡??

- [1382] H.L. Selberg, *Ein Satz über beschränkte endlichvieldeutige analytische Funktionen*, Comment. Math. Helv. 9 (1937), 104–108. [♠ quoted in Hayashi-Nakai 1988]★★★[CHECK] ♡??
- [1383] M. Seppälä, *Teichmüller spaces of Klein surfaces*, Ann. Acad. Sci. Fenn. Ser. A I Math. Dissertationes 15 (1978), 1–37. [♠] ♡??
- [1384] M. Seppälä, *Quotient of complex manifolds and moduli spaces of Klein surfaces*, ?? (198?), ?–?. [♠] ♡??
- [1385] M. Seppälä, R. Silhol, *Moduli spaces for real algebraic curves and real abelian varieties*, Math. Z. 201 (1989), 151–165. [♠ modernization of Klein’s resp. Comessatti’s theories] ♡45
- [1386] M. Seppälä, *Real algebraic curves in the moduli spaces of complex curves*, Compos. Math. 74 (1990), 259–283. [♠] ♡??
- [1387] M. Seppälä, *Moduli spaces of stable real algebraic curves*, Ann. Sci. Éc. Norm. Sup. 24 (1991), 519–544. [♠] ♡33
- [1388] M. Seppälä, *Computation of period matrices of real algebraic curves*, Discr. Comput. Geom. (1994). [♠ Abstract. In this paper we derive a numerical method which allows us to compute periods of differentials on a real algebraic curve with real points. This leads to an algorithm which can be implemented on a computer and can be used to study the Torelli mapping numerically.] ♡18
 ★ Francesco Severi is mainly a (pure=complex) geometer, yet showing some episodic interest for real geometry (e.g. in Severi 1921 (Vorlesungen) [1394]). However Severi has indirect major impact on real geometry through his influence upon both Italian masters of the reality discipline, namely Brusotti and Comessatti (both strongly resting on works by Severi).
- [1389] F. Severi, *Sulle corrispondenze fra i punti d’una curva algebrica*, Memorie della R. Acc. di Torino 64 (1903), 1–49. [♠ cited in Comessatti 1928 [310]] ♡??
- [1390] F. Severi, *Sulle superficie che rappresentano le coppie di punti d’una curva algebrica*, Atti della R. Acc. di Torino 38 (1903). [♠ cited in Comessatti 1928 [310]] ♡??
- [1391] F. Severi, *Sulla totalità delle curve algebriche tracciate sopra una superficie algebrica*, Math. Ann. 62 (1906), 194–223. [♠ cited in Comessatti 1928 [206] and probably modernized in works by Zariski, Mumford, etc.] ♡??
- [1392] F. Severi, *Sulla classificazione delle curve algebriche e sul teorema di esistenza di Riemann*, Rend. Acc. Lincei (5) 24 (1915), 877–888, 1011–1020. [♠ cited in Brusotti 1952 [206]] ♡??
- [1393] F. Severi, *Nuovi contributi alla teoria dei sistemi continui di curve appartenenti ad una superficie algebrica*, Rend. Acc. Lincei (5) 25 (1916), 459–471, 551–562. [♠ cited in Brusotti 1952 [206]] ♡??
- [1394] F. Severi, *Vorlesungen über algebraische Geometrie*, Leipzig, Teubner, 1921. [♠ p. 159 re-proves the upper bound for the gonality of a complex curve (according to Segre 1928 [1380]), but for the “modern standards” the first accepted proof is that of Meis 1960 [993] ♠ contains a brief discussion of Klein’s theory of real algebraic curves ♠ Anhang F also contains the complex case of Brusotti’s theorem (1921 [204]) on the independence of smoothing nodal curves ♠ the same ideas where used in Harris’ proof on the irreducibility of the variety of plane curves of fixed degree and prescribed genus] ♡??
- [1395] F. Severi, *Sul teorema di esistenza di Riemann*, Rend. Circ. Mat. Palermo 46 (1922), 105–116. ♡??
- [1396] F. Severi, *Conferencia general sobre la geometria algebraica*, Revista Mat. Hispano-Americana 8 (1926). [♠ cited in Comessatti 1928 [310]] ♡??
- [1397] G. B. Shabat, V. A. Voevodsky, *Equilateral triangulations of Riemann surfaces and curves over algebraic number fields*, Doklady SSSR 304 (1989), 265–268; Soviet Math. Dokl. 39 (1989), 38–41. [♠ geometric translation of Belyi-Grothendieck’s theorem that a curve is defined over $\overline{\mathbb{Q}}$ iff it ramifies only over 3 points of the sphere. Question: can one extend this to Ahlfors maps in the bordered case cf. Sec. (in v.2) for a pessimist answer, yet probably all real curves are to be integrated. So what about real Riemann surfaces with an equilateral triangulation invariant under complex conjugation. So the vertices occurs as \mathbb{Q} -rational points? etc.]★ ♡??

- [1398] G.B. Shabat, V.A. Voevodsky, *Drawing curves over number fields*, in: Grothendieck Festschrift, Birkhäuser. ♡??
- [1399] I.R. Shafarevich, *Basic Algebraic Geometry*, NAuka, Moscow, 1972; English transl., Die Grundlehren der math. Wiss. in Einzeldarstellungen, Bd. 213, Springer-Verlag, Berlin, 1974. (many subsequent reeditions) [♠ contain a lovely picture of a real elliptic curve (with two real circuits) acted upon by complex conjugation (I confess that this little picture is actually, besides some theory told by Felice Ronga and Daniel Coray, the very origin of my modest involvement with the topic of real algebraic curves)] ♡??
- [1400] C.S. Sheshadri, *Space of unitary vector bundles on a compact Riemann surface*, Ann. of Math. 85 (1967). [♠] ♡??
- [1401] M. Shiba, K. Shibata, *Singular hydrodynamical continuations of finite Riemann surfaces*, Kyoto J. Math. (1985). [♠ The present study arose, in close relationships to a series of our investigations [16],[17] and [18], from an attempt to embed an arbitrary open Riemann surface of finite genus into another closed Riemann surface of the same genus, so that the prolongation of the ...] ♡5
- [1402] G.E. Shilov, *On rings of functions with uniform convergence*, Ukrain. Mat. Ž. 3 (1951), 404–411. [♠]★ ♡??
- [1403] V.V. Shokurov, *The Noether-Enriques theorem on canonical curves*, Mat. Sb. Nov. Ser. 86 (1971), 367–408; English transl., Math. USSR Sb. 15 (1972), 361–401. [♠]★ ♡??
 ★★★ Eugenii Shustin, a student of D. A. Gudkov, obtained both a refutation of one side of Rohlin’s maximality conjecture (hence of Klein’s semi-hypothesis that curves of type II can always gain an oval by champagne-bubbling out a solitary node) as well as essential results toward the completion of Hilbert’s 16th in degree 8 (construction of $6+1=7$ schemes by either his own or then a variant of the Viro method and prohibition of 5 schemes by extending another (prohibitive) method of Viro).
- [1404] E.I. Shustin, *The Hilbert-Rohn method and bifurcation [smoothings] of complicated singular points of curves of degree 8*, Uspekhi Mat. Nauk 38 (1983), 157–158 [or 158–159?]; English transl., ?? (not available apparently). [♠ this with other subsequent works by Shustin (notably 1983 [1407] and 1985 [1410]) completed Viro’s dissipations of the singularity N_{16} (five-fold point) by the gluing of any non-singular affine quintic.]★ ♡??
- [1405] E.I. Shustin, *On the varieties of singular algebraic curves*, in: Methods of qualitative theory of differential equations, Gorky State Univ., 1983, 148–163 (in Russian). English translation: *On manifolds of singular algebraic curves*, Selecta Math. Sov. 10 (1991), 27–37. [♠]★ ♡??
- [1406] E.I. Shustin, *On application of Hilbert-Rohn method to investigations of curves of 8-th degree*, Gorki Univ. (1983). Deposited in VINITI 23.05.83, N 2745–83 Dep., 63–84. [♠ cited in Polotovskii’s 1988 survey [1209] especially on p. 470 for affording a special technique worked out by Shustin affording prohibitions apparently complementing those of Rohlin-Fiedler derived from the theory of complex orientations (Klein and Rohlin basically). So there is here an interesting fight between Klein-Rohlin-Viro-Kharlamov-Fiedler and Hilbert-Rohn-Gudkov-Shustin. This deserves to be studied in more details. Cf. maybe Orevkov-Shustin 2002 [1131] (rehabilitation of Hilbert-Rohn).] ♡??
- [1407] E.I. Shustin, *Real smoothings of simple 5-fold singular point*, Gorki Univ. (1983). Deposited in VINITI 29.12.83, N 6872–83 Dep., 1–21. [♠ cited in Polotovskii 1988 survey [1209] ♠ probably similar dissipation were worked out by Viro somewhat earlier? (answer to be found in Polotovskii 1992 [1210], where it is remarked (p. 56) that Shustin completed Viro’s list of dissipation in 1983).] ♡??
- [1408] E.I. Shustin, *Gluing of singular algebraic curves*, in: Methods of qualitative theory. Gorky Univ. Press, Gorky, 1985, 116–128 (Russian). [♠]★ ♡??
- [1409] E.I. Shustin, *Independent removal [Independence of smoothings] of singular points and new M-curves of degree 8*, Uspekhi Mat. Nauk 40 (1985), 212 (Russian); English transl., ?? [not available]. [♠ where 6 new M-schemes in degree 8 are constructed by a clever twist of Viro’s method or rather “from results of investigation of smoothing of point of quadratic contact of four non-singular real branches”, but reproved à la Viro in Shustin 1988 [1415]. Right after Shustin discovered one more scheme. For full details (in English) of this announcement, cf.

- Shustin 1988 [1415] or our Fig. 121 ♠ for the diagrammatic of this important and all related contributions cf. our Fig. 154.]★ ♡??
- [1410] E.I. Shustin, *The Hilbert-Rohn method and smoothings of singular points of real algebraic curves*, Dokl. Akad. Nauk SSSR 31 (1985), 33–36; English transl., Soviet Math. Doklady 31 (1985), 282–286. [♠ should be one of the standard reference for Hilbert-Rohn’s method. As a philosophical detail we quote from Shustin 90/91 ICM [1418, p.566]: “At last we’ll mention the Hilbert-Rohn method (see [8,20](=Gudkov 74, Shustin 85=this entry)), which allows to construct or prohibit certain classe or real curves.” ♠ it would be interesting to know which one exactly for instance in degree $m = 8$.]★★ ♡??
- [1411] E.I. Shustin, *Counterexamples to a conjecture of Rokhlin*, Funkt. Anal. Prilozhen 19 (1985), 94–95; English transl., Funct. Anal. Appl. 19 (1985), 162–163. [♠ counterexamples in degree 8 to Rohlin’s conjecture (type I iff maximal), based on earlier work by Polotovskii [1202] compare the discussion in Viro 1986/86 [1534] ♠ [25.01.13] this note also implies a counterexample to an Ansatz of Klein 1876 [795], to the effect that nondividing curves could always win a supplementary oval by crossing a solitary node. In fact Shustin’s note uses predominantly a Bézout-like obstruction for M -octics due to Viro 1983 [1532] extending the one of Fiedler 1982/83 [415]. In Shustin’s disproof, the counterexample is an $(M - 2)$ -curve, which (either itself or more likely one of its $(M - 1)$ -enlargements) is maximal but of type II. ♠ [25.01.13] I do not know if Klein’s Ansatz has some chance to be true in degree 7. ♠ nor do I know if it could old for $(M - 2)$ -curves, or more generally all curves except possibly $(M - 1)$ -curves. Compare Orevkov’s remark in Sec. in v.2, which seems to prompt that there is some open problem here.] ♡??
- [1412] E.I. Shustin, *Hyperbolic and minimal smoothings of singular points*, in: Methods of qualitative theory. Gorky Univ. Press, Gorky, 1986, 165–174 (Russian). [♠ cited in SHustin 90/91 ICM [1418].] ♡??
- [1413] E.I. Shustin, *Versal deformations in the space of plane curves of a fixed degree*, Funkt. Anal. Prilozhen 21 (1987), 90–91; English transl. in Funct. Anal. Appl. 21 (1987), 82–84. [♠] ♡??
- [1414] E.I. Shustin, *A new M -curve of degree 8*, Mat. Zametki 42 (1987), 180–186; English transl., Math. Notes 42 (1987), 606–610. [♠ this is perhaps the paper to which Orevkov is referring to in Sec. in v.2 ♠ this conjointly with the next (older) paper (1985/88) places Shustin as the Bronze medallist of Hilbert’s 16th in degree $m = 8$, by scoring 7 schemes right after Viro 1980 (42 schemes=Gold medal), and Korchagin 1978/88/89 (20 schemes=Siver medal). As only 6 schemes remains undecided after Orevkov 2002 [1129], there is little chance that the podium will change within the next years (except of course if Chevallier—scoring now 4 schemes (Chevallier 2002 [282])—is suddenly able to construct at least 4 of the remaining 6 schemes to beat suddenly Shustin’s seven) ♠ alas, our impression is that this paper is hard-to-read just because it misses to give an adequate picture of the singular octic used to create the Shustin’s M -octic $4\frac{5}{1}\frac{5}{1}\frac{5}{1}$. ♠ the paper also contains an independence result of smoothing (à la Brusotti-Viro, yet logically not covered by the formers) which is much used by Orevkov. However the article also contains some assertion on affine sextics that were refuted in Orevkov 1998II [1119].] ♡??
- [1415] E.I. Shustin, *Mew M - and $(M - 1)$ -curves of degree 8*, in: Rohlin Seminar (O. Viro et al., eds.) Lect. Notes in Math. 1346 (1988), 487–493. [♠ construction of 6 new M -schemes in degree 8 by a variant of Viro’s method and the dissipation of a pair of Z_{15} -singularities on a global singular octic constructed by the trick of hyperbolism à la Huyghens-Newton-Cremona-Gudkov-Viro. Compare our Fig. 121 for a quick visualization of this important contribution.] ♡5
- [1416] E.I. Shustin, *Toward isotopy classification of affine M -curves of degree 6*, in: Methods of Qualitative Theory of Differential Equations, Gorky State Univ., 1988, 97–105 (in Russian). [♠ cited, e.g., in Polotovskii 00 [1214], and probably synthesized in Korchagin-Shustin 89/90 [861].] ★ ♡??
- [1417] E.I. Shustin, *Smoothness and irreducibility of varieties of singular algebraic curves*, in: Arithmetic and geometry of algebraic varieties. Saratov Univ. Press/Kuibyshev branch, Kuibyshev, 1989, 102–117. [♠] ♡??
- [1418] E.I. Shustin, *Geometry of discriminant and topology of algebraic curves*, in: Proc. Internat. Congr. Math., Kyoto, Japan, 1990, Math. Soc. Japan. (1991), 559–567. [♠ p. 566: “[...] the complete description of discriminant in the space of plane real quartics curves and complete classification of inflexion point arrangements on

- these curves [9](=Gudkov 1988 [584]).” ♠ p.566: “It should also be noted that there is M -curve of degree 8, whose constructions does not satisfy conditions of Viro method and is based on Theorem 4 [22](=Shustin 1987 [1414]).” ♡??
- [1419] E. I. Shustin, *New restrictions on the topology of real curves of degree a multiple of 8*, Math. USSR-Izvestiya 37 (1991), 421–443. [♠ contains a new prohibition essential in the completion of Hilbert’s 16th in degree $m = 8$] ♡??
- [1420] E. I. Shustin, *On manifolds of singular algebraic curves*, Selecta Math. Soviet. 10 (1991), 27–37; this is the English transl., of the Russian original dating back to 1983. [♠] ♡??
- [1421] E. I. Shustin, *Topology of real plane algebraic curves*, in: Proc. Internat. Conf. Real Algebraic Geometry, Rennes, June 24–29 1991, Lect. Notes in Math. 1524, Springer, 1992, 97–109. [♠ survey like but probably important to read to get a good view of this active period with big progresses upon Hilbert’s 16th in degree $m = 8$] ♡8
- [1422] E. I. Shustin, *Real plane algebraic curves with prescribed singularities*, Topology 32 (1993), 845–856. [♠] ♡??
- [1423] E. I. Shustin, *Gluing of singular and critical points*, Topology 37 (1998), 195–217. [♠] ♡??
- [1424] E. I. Shustin, *Lower deformations of isolated hypersurface singularities*, Algebra Analiz 10/11(?) (1999), 221–249; English transl., St. Petersburg Math. J. 11 (2000), 883–908. [♠ cited in Chevallier 2002 [282] in his construction of four new M -schemes in degree 8, for a Riemann-Roch style argument which is however supplied to by an alternative (Newton-style) treatment in Chevallier (*loc. cit.*)] ♡??
- [1425] E. I. Shustin, *Patchworking singular algebraic curves, non-Archimedean amoebas and enumerative geometry*, arXiv (13 May 2005), v.7, 50 pp. [♠] ♡??
- [1426] R. J. Sibner, *Uniformization of symmetric Riemann surfaces by Schottky groups*, (Diss.) Trans. Amer. Math. Soc. 116 (1965), 79–85. G78 [♣ new proofs of the Rückkehrschnitttheorem (retrosection theorem) and the Kreisnormierung=KNP via quasiconformal mappings techniques (Ahlfors-Bers)=Teichmüller modernized; as oft emphasized in our text (cf. Sec. in v2) this might be the route through which one can hope to reprove the Ahlfors mapping via the original method of Klein (as cryptically asserted in Teichmüller 1941 [1485])] ♡??
- [1427] R. J. Sibner, *Symmetric Fuchsian groups*, Amer. J. Math. 90 (1968), 1237–1259. [♠] ♡??
- [1428] R. J. Sibner, *Remarks on the Koebe Kreisnormierungsproblem*, Comment. Math. Helv. 43 (1968), 289–295. G78 [♣ quasiconformal reduction of KNP: can every plane domain be deformed quasiconformally onto a circle domain? (still open today June 2012)] ♡??
- [1429] R. J. Sibner, *An elementary proof of a theorem concerning infinitely connected domains*, Proc. Amer. Math. Soc. 37 (1973), 459–461. G78 [♠ simplifies by circumventing the usage of quasi-conformal techniques (normal family proof instead) an earlier proof of the fact that any domain of infinite connectivity admits a conformally equivalent model bounded by analytic contours (Jordan curves) ♠ as probably just a matter of nomenclature it is not perfectly clear (to the writer) if this is obtained for all domains (as stated e.g. in Grunsky’s review (1978) [568, p.196] of this work) or if the assertion is only established in the case of countably many boundary components (cf. the parenthetical proviso on p.459 of *opera cit.*) ♠ of course the real dream of Koebe (Kreisnormierung) would be that all these Jordan contours are ultimately circles!] ♡??
- [1430] J. Siebeck, *Ueber eine neue analytische Behandlungsweise der Brennpunkte*. *J. Reine Angew. Math.* 64 (1865), 175–182. [♠] ♡??
- [1431] L. Siebenmann, *The Osgood-Schoenflies theorem revisited*, Russian Math. Surveys 60 (2005), 645–672. See also the online version available in the Hopf archive: <http://hopf.math.purdue.edu/cgi-bin/generate?/Siebenmann/Schoen-02Sept2005> (from which a number of the editors misprints have been removed.)[♠ contains a brilliant historical discussion of the contribution due to the complex analytic community (Osgood, Carathéodory) upon the so-called Schoenflies theorem about the bounding disc property of plane Jordan curves] ♡16
- [1432] C. L. Siegel, *Topics in Complex Function Theory*, Vols. I–III. John Wiley and Sons, Inc., New York, 1960, 1971, 1973. [♠] ♡??

- [1433] J.-C. Sikorav, *Proof that every torus with one hole can be properly holomorphically embedded in \mathbb{C}^2* , preprint, October 1997 (unpublished). [♠ self-explanatory title, and see Černe-Forstnerič for an extension of Sikorav’s result]★ ♡??
 ★ Robert Silhol, student of ?, a well-known expert of French real geometry working on several fronts (algebraic surfaces, Riemann surfaces, etc., cf. also his joint paper with Sepällä, Buser, etc.)
- [1434] R. Silhol, *Real algebraic surfaces*, Lecture Notes in Math. 1392, Springer-Verlag, 1989. [♠] ♡30
- [1435] R. Silhol, *Compactifications of moduli spaces in real algebraic geometry*, Invent. Math. (1992). [♠ It is probably useful to begin this paper by explaining why an approach, specific to real algebraic geometry, is necessary for Moduli problems. We will only be concerned in this paper, with the moduli problems for curves and abelian varieties (but the remarks we ...)]★ ♡30
- [1436] R. Silhol, *The Schottky problem for real genus 3 M-curves*, Math. Z. 236 (2001), 841–881. [♠]★ ♡7
- [1437] R.R. Simha, *The Carathéodory metric of the annulus*, Proc. Amer. Math. Soc. 50 (1975), 162–166. A50, G78 [♠ write down everything (Ahlfors function, Carathéodory metric) in the case of an annulus] ♡13
- [1438] S. O. Sinanjan, *Approximation by polynomials in the mean with respect to area*, Mat. Sbornik 82 (1970); English transl.: Math USSR Sbornik 11 (1970), 411–421. [♠ p.416: “Let $\phi(z)$ be an Ahlfors p -function of the set E : $\gamma_p(E, \phi) = \gamma_p(E)$, $\phi \in A_E^p$. Such a function exists due to the compactness of the set A_E^p .” ♠ p.420 one further occurrence of the Ahlfors function] ♡??
- [1439] D. Singerman, *Automorphisms of compact non-orientable Riemann surfaces*, Proc. London Math. Soc. (3) 10 (1969), 376–394. G78 [♠ “Using the definition of a Riemann surface, as given for example by Ahlfors-Sario, one can prove that all Riemann surfaces are orientable. However by modifying their definition one can obtain structures on non-orientable surfaces. In fact non-orientable Riemann surfaces have been considered by Klein and Teichmüller amongst others. The problem we consider here is to look for the largest possible groups of automorphisms of compact non-orientable Riemann surfaces and we find that this throws light on the corresponding problem for orientable Riemann surfaces, which was first considered by Hurwitz [1](=1893 [690]). He showed that the order of a group of automorphisms of compact orientable Riemann surface of genus g cannot be bigger than $84(g - 1)$. This bound he knew to be attained because Klein had exhibited a surface of genus 3 which admitted $PSL(2, 7)$ as its automorphism group, and the order of $PSL(2, 7)$ is $168 = 84(3 - 1)$. More recently Macbeath [5,3](=1967 [955], =1961 [954]) and Lehner and Newman [2](=1967 [919]) have found infinite families of compact orientable surfaces for which the Hurwitz bound is attained, and in this paper we shall exhibit some new families.”]★★★ ♡55
- [1440] D. Singerman, *Mirrors on Riemann surfaces*, Contemp. Math. 184 (1995), 411–417. [♠]★ ♡??
- [1441] V. Singh, *An integral equation associated with the Szegő kernel function*, Proc. London Math. Soc. (3) 10 (1960), 376–394. G78 [♠]★★★ ♡??
- [1442] D. E. Smith, *On the classification of 7th degree M-curves with the maximum number of point of intersections of the odd branch with a line*, Thesis, downloaded from the web, yet undated, probably ca. 2005. [♠ contains an interesting picture of all affine sextics, but seems fairly distant to a complete classification of all affine septics. As this problem includes the unsolved problem of M -octics (via our Fig. 134) it is fairly unlikely that this classification is close to a completion. Actually, it seems that even one stairs below in degree $1 + 6$ the classification of affine M -sextics is still a big puzzle (albeit it seems that only ca. 3 arrangements are still in doubts). Perhaps beside our version Smith’s table showing the original contributions of Harnack, Gudkov, Viro, Korchagin, Shustin, Orevkov (Fig. 135, where we added the 2nd scheme of Orevkov 1998II [1119]), it seems that the last advances on this problem is a prohibition of Le Touzé-Orevkov 2002 [425] ruling out one configuration among the 3 still in doubts.] ♡??
- [1443] E. P. Smith, *The Garabedian function of an arbitrary compact set*, Pacific J. Math. 51 (1974), 289–300. G78 [♠ Ahlfors function is mentioned in its usual connection with the analytic capacity (p.289, 290) ♠ Gamelin’s summary in 1973 [485]: “Recently E. Smith [43](=the present entry Smith 1974 [1443]) settled a

problem left open by S. Ya. Havinson [26](=Havinson 1961/64 [621]), proving that if domains D_n with analytic boundaries increase to an arbitrary domain D , then the Garabedian functions of the D_n converge normally. The limiting function depends only on D and on the point z_0 , and it is accordingly called the Garabedian function of D . In order to study the subadditivity problem for analytic capacity, Smith had been led to investigate the dependence of the Szegő kernel on certain perturbations of domains with analytic boundaries. The result on the Garabedian function dropped out as a special dividend. There is now the problem of simplifying Smith's proof, and of freeing the result from Hilbert space considerations, in order to extend the theorem to more general extremal problems. ADDED IN PROOF. A simple proof, which still depends on Hilbert space considerations, has been given by N. Suita 1973 (= [1472])" ♥??

★ P. A. Smith, student of G. Birkhoff ca. 1927, well-known for Smith theory (homology of periodic transformation groups) which affords a homological derivation of the Harnack inequality and extension thereof to higher dimensional real manifolds (compare Thom 1964/65 [1488]).

[1444] P. A. Smith, *Fixed points of periodic transformations*, Appendix to S. Lefschetz, Algebraic Topology, Amer. Math. Soc Colloquium Publ. 27, Amer. Math. Soc., New York, 1942. [♠] ♥??

[1445] A. Yu. Solynin, *A note on equilibrium points of Green function*, Proc. Amer. Math. Soc. 136 (2008), 1019–1021. [♠ given a finitely connected planar domain, it is shown that there is a “universal” compactum (inside the domain) containing all critical points of the Green's functions $G(z, t)$ whatever the location of the pole t is (answering thereby a question of Sebbar-Falliero 2007 [1379]) ♣ question (Gabard [11.08.12]): does this fantastic result extends to (compact) bordered surfaces ♠ further there must be a minimum Solynin's compactum K , what can be said about its shape, area, etc. ♠ considering the example of a ring (annulus, say circular to simplify) it seems evident that upon dragging the pole around the hole the unique critical point of Green will rotate (being roughly located at the “antipode”), thus it seems that Solynin's compactum will be a sub-annulus in this case ♠ maybe in general the inclusion of K into the domain is a homotopy equivalence] ♥??

[1446] A. J. Sommese, *Real algebraic spaces*, Ann. Scuola Norm. Sup. Pisa 4 (1977), 599–612. [♠] ♥??

[1447] F. Sottile, *Enumerative real algebraic geometry*, DIMACS Series in Discrete Mathematics and Theoretical Computer Science (2002). [♠] ♥??

[1448] M. L. Soum, *Construction de courbes algébriques réelles de degré 7*, (2001/2), Mémoire de DEA (French). [♠ cited in Brugallé 2005/07 [197] and seems to contain a complete list of construction of septic curves with control upon the (Klein's) types I vs. II; similar work in Le Touzé's DEA 1997 [422]] ♥??

[1449] A. Speiser, *Über symmetrische analytische Funktionen*, Comment. Math. Helv. 16 (1944), 105–114. AS60 [♠ not symmetric in the “reality” sense of Felix Klein, so a priori no link with Ahlfors 1950 [19]] ♥??

[1450] G. Springer, *Introduction to Riemann surfaces*, Addison-Wesley, Reading, Mass., 1957, 307 pp. [♠ contains a discussion of the Schottky double, the Prüfer surface, etc.] ♥??

★ Stanton a student of Royden, himself in turn of Ahlfors.

[1451] Ch. M. Stanton, *The closed ideals in a function algebra*, Trans. Amer. Math. Soc. 154 (1971), 289–300. AS0 [♠ a clear-cut application of the Ahlfors function (mapping) is given to a “bordered surface” extension of a “disc result” of Beurling (unpublished)—Rudin (1957) (telling that—in the function algebra $A(W)$ of functions analytic in the interior and continuous up to the boundary—every closed ideal is the closure of a principal ideal) ♠ this extension was actually first derived by Voichick 1964 [1546], via the more complicated universal covering whose uniformizing map presents rather complicated boundary behavior ♠ p. 293, as Royden's student, the author points out that Ahlfors result is re-proved in Royden 1962 [1305] (this is not an isolated attitude, cf. Sec. in v.2 for an exhaustive list) ♠ p. 289, the author remarks that similar use of Ahlfors' theorem was initiated by Alling 1965 [41] and Stout (in the corona realm) ♠ naive question of the writer [08.08.12]: is it reasonable to expect that the same Ahlfors-Alling lifting procedure conducts to an extension of Fatou's theorem about existence of radial limits a.e. from the disc to a bordered surface: the notion of radiality is simple to define (orthogonality to the boundary), yet a function on the bordered surface does not

descend to one on the disc via the Ahlfors branched covering (thus rather a method of localization is required, and the problem is surely well treated by several authors (e.g. Heins, Voichick 1964, Gamelin (localization of the corona), etc.) UPDATE [12.09.12]: see also Alling 1966 [42, p.345], who claims that Fatou is trivial to extend upon appealing to the Ahlfors map ♠ [08.08.12] in the same vein it should be noted that the Ahlfors function shows some weakness for instance in the problem of solving the Dirichlet problem which in the disc-case can be cracked via the Poisson formula (H. A. Schwarz's coinage) and one could hope to lift the solution to the bordered surface via the Ahlfors map. Alas, for given boundary values along the contours of the bordered surface there is no naturally defined procedure to descend the data along the boundary of the disc (implying a failure of the naive lifting trick). Consequently, the Dirichlet problem (for a bordered surface) lies somewhat deeper than the Ahlfors function, since it is probably well-known that the Ahlfors function may be derived from Dirichlet (or its close avatar the Green's functions), see our Sec. in v.2 where we shall attempt to redirect to the first-hand sources implementations (Grunsky (planar case), Ahlfors, maybe Cecioni's students, and Heins 1950 [634].] ♥5

[1452] Ch. M. Stanton, *Bounded analytic functions on a class of open Riemann surfaces*, Pacific J. Math. 59 (1975), 557–565. [♠ p. 559 uses the terminology Myrberg surface for a concept closely allied to the Ahlfors function in the sense of our circle maps] ♥??

[1453] K. Stein, *Topics on holomorphic correspondences*, Rocky Mountain J. Math. 2 (1972), 443–463. [♠ Ahlfors 1950 [19] is cited on p. 457: “By a theorem of Ahlfors [1](=1950 [19]) there is always a meromorphic function $\varphi: \widehat{R}_0 \rightarrow \overline{\mathbb{C}}$ [from the double of a bordered surface to the sphere] such that $R_0 = \{\xi \in \widehat{R}_0 : |\varphi(\xi)| < 1\}$; hence R_0 is a distinguished polyhedral domain in \widehat{R}_0 .”] ♥20

[1454] J. Stirling, *Lineae tertii ordinis Newtonianæ*, ?? (1717), ??. [♠ completes 4 cases of cubics missed by Newton] ♥??

[1455] S. Stoilow, *Leçons sur les principes topologiques de la théorie des fonctions analytiques*, Gauthier-Villars, Paris 1938. (Second edition in 1956; Russian translation 1964.) [♠ includes in particular a notion of “total Riemann covering”, defined by asking that any sequence tending to the boundary has an image tending to the boundary. This topological behaviour subsumes of course those of Ahlfors circle maps. ♠ of course Stoilow's concept is also implicit in Radó 1922 [1230], as one sees e.g. from Landau-Osserman's account (1960 [906]) ♠ from Grunsky's Review (JFM): “in die Definition der Mannigfaltigkeit wird dabei kein Abzählbarkeitsaxiom aufgenommen; es folgt der Beweis des Brouwerschen Satzes von der Invarianz des inneren Punktes nach *Lebesgue-Sperner*. [...] Zur Verdeutlichung dienen Beispiele nicht orientierbarer Fläche sowie ein von *Prüfer* stammendes Beispiel einer nicht triangulieren zweidimensionalen Mannigfaltigkeit (in der Formel Zeile 11 v. u. S. 72 findet sich ein störender Druckfehler: [...]).” ♠ In fact most relevant to our purpose (of the Ahlfors map) is Chap. VI of the book, which Grunsky (loc. cit.) summarizes as follows: “Ferner werden innere Abbildungen einer Riemannschen Fläche R auf eine andere, S , betrachtet. Eine solche heißt eine totale Überdeckung von S durch R , wenn jede Punktfolge aus R , die keine kompakte Teilfolge enthält (die “gegen den Rand strebt”) in eine ebensolche übergeht. Die Überdeckung ist dann auch vollständig, d. h. *jeder* Punkt von S wird überdeckt, und außerdem auch jeder gleich oft.”] ♥??

[1456] S. Stoilow, *Sur les surfaces de Riemann normalement exhaustibles et sur le théorème des disques pour ces surfaces*, Compositio Math. 7 (1940), 428–435. [♠] ♥??

[1457] S. Stoilow, *Einiges über topologische Funktionentheorie auf nicht orientierbaren Flächen*, Rev. Roumaine Math. Pures Appl. 19 (1974), 503–506. [♠] ♥??

[1458] E. L. Stout, *Bounded holomorphic functions on finite Riemann surfaces*, Trans. Amer. Math. Soc. 120 (1965), 255–285. A50 [♠ on p. 263 (and 272), Ahlfors 1950 [19] is quoted as follows (without precise bound): “In order to establish our result, we shall need to make use of a result of Ahlfors [1](=Ahlfors 1950 [19]). For an alternative proof, one may consult Royden [15](=Royden 1962 [1305]). Theorem 3.1 *There exists a function P holomorphic on a neighborhood of \bar{R} which maps R onto the open unit disc in an one-to-one manner for some n and which satisfies $|P| = 1$ on ∂R .*” ♠ first it is evident that “one-to-one” is a misprint that should be read as “ n -to-one” ♠ the paper addresses primarily the corona problem (overlapping

- with Alling 1964 [40]) and the allied interpolation, notably an extension of the celebrated results of Carleson and Newman on interpolation sets for the disc (i.e. those subsets enjoying the property that every bounded complex-valued function on E can be extended to a bounded analytic function on the disc)] ♡37
- [1459] E. L. Stout, *On some algebras of analytic functions on finite open Riemann surfaces*, Math. Z. 92 (1966), 366–379; with Corrections in: Math. Z. 95 (1967), 403–404. A50 [♠ cite Ahlfors 1950 [19] twice, on p.366: “Let R be a finite open Riemann surface whose boundary Γ consists of N analytic, pairwise disjoint, simple closed curves. Let η be an analytic mapping from R onto U , the open unit disc which is holomorphic on a neighborhood of \overline{R} and which is of modulus one on Γ . That such functions exist was first established by Ahlfors [1](=Ahlfors 1950 [19]); another proof of their existence is in the paper [12](=Royden 1962 [1305]).” Then on p.375: “Ahlfors [1] has shown that if z_0, z_1 are distinct points of R (neither in Γ), then any solution of the extremal problem $\sup\{|f(z_0)| : f \text{ in } H_\infty[R], f(z_1) = 0, \|f\| \leq 1\}$ is an inner function in $A[R]$. Thus inner functions separate points on R” ♠ quoted by Fedorov, for using “inner function” as a synonym of “circle map”] ♡23
- [1460] E. L. Stout, *Interpolation on finite open Riemann surfaces*, Proc. Amer. Math. Soc. 18 (1967), 274–278. A50 [♠ p. 274, Ahlfors 1950 is quoted as follows: “It is convenient to make use of an *Ahlfors map* for R , i.e., a function continuous on \overline{R} and holomorphic in R which is constantly of modulus one on Γ . The existence of such function was established by Ahlfors in [1](=Ahlfors 1950 [19]); an alternative proof of their existence is in [4](=Royden 1962 [1305])” ♠ The Ahlfors map (and the machinery of uniformization) are again utilized to lift the characterization of interpolating sets for the disc (available from the celebrated results of Carleson, Newman, cf. also Hoffman 1962 [678]). The main theorem states that a subset $E \subset R$ of a finite open Riemann surface is an interpolating set for R iff $\inf_{z \in E} d_R(z, E) > 0$, where $d_R(z, E) := \sup\{|f(z)| : f \in H_\infty(R), f|_{E-\{z\}} = 0, \|f\|_R \leq 1\}$. For convenience, recall that the subset E is called an interpolation set for R if every bounded complex-valued function on E can be extended to a bounded analytic function on R .] ♡2
- [1461] E. L. Stout, *Inner functions, doubles and special analytic polyhedra*, Amer. J. Math. 94 (1972), 343–365. A50 [♠ p. 345 credits Heins 1950 [634] for another (beside Ahlfors’ 1950 [19]) elegant [sic] construction of inner functions on compact bordered surfaces] ♡0!
- [1462] E. Study, W. Blaschke, *Vorlesungen über ausgewählten Gegenstände der Geometrie*, vol. 2, Konforme Abbildung einfach zusammenhängender Bereiche, Teubner, Leipzig, 1912. [♠ closely related to Carathéodory’s seminal study of the boundary behaviour of the Riemann map along an arbitrary Jordan curve and the more general theory of prime ends] ♡??
- [1463] A. Stray, *Approximation by analytic functions which are uniformly continuous on a subset of their domain of definition*, Amer. J. Math. 99 (1977), 787–800. [♠ p. 797 brief apparition of the Ahlfors function via cross-reference to Gamelin 1969 [482]] ♡0
- [1464] K. Strebel, *Über das Kreisnormierungsproblem der konformen Abbildung*, Ann. Acad. Sci. Fenn. Ser. A. I. 101 (1951), 22 pp. A560, G78 [◇ Kurt Strebel is a student of R. Nevanlinna (who taught frequently in Zürich)] ★ ♡??
- [1465] K. Strebel, *Über die konforme Abbildung von Gebieten unendlich hohen Zusammenhangs, (I. Teil)*, Comment. Math. Helv. 27 (1952), 101–127 G78 [♣ partial results on the Kreisnormierung in infinite connectivity] ♡??
- [1466] K. Strebel, *Ein Klassifizierungsproblem für Riemannsche Fläche vom Geschlecht 1*, Arch. Math. 48 (1987), 77–81. [♣ p. 77: “Herr K. Schöffler benötigt in seiner Arbeit [2] zur Theorie der Minimalflächen vom Geschlecht 1 den Satz, daß jeder p -fach gelochte Torus auf einen ebensolchen mit kreisförmigen Löchern konform abgebildet werden kann, und daß eine solche Abbildung durch diese geometrische Forderung im wesentlichen eindeutig bestimmt ist. Dabei wird der Torus durch die komplexe Ebene \mathbb{C} modulo einer Translationsgruppe dargestellt, und die Kreisförmigkeit der Löcher ist ebenfalls in \mathbb{C} gemeint.” ♠ [17.10.12] one naturally wonders about higher genera than one (where one must probably interpret the Kreisförmigkeit within the hyperbolic plane/disc), and it seems that such positive genus instances of the Kreisnormierung are also handled in Haas 1984 [595]] ♡7

- [1467] V. Strehl, *Minimal transitive products of transpositions—the reconstruction of a proof by A. Hurwitz*, Sem. Lothar. Combinat. 37 (1996), Art. B37c, 12 pp. [♠ modern reconstruction of Hurwitz’s count of the number of Riemann surfaces having prescribed ramification, cf. also Ekedahl-Lando-Shapiro-Vainshtein 2001 [390]] ♡7
- [1468] D. J. Struik, *Outline of a history of differential geometry II*, Isis 20 (1933), 161–191. [♠ Gauss 1844 (and even F. T. Schubert) are credited for the nomenclature “conformal” as follows, p.164: “Of Gauss’ contribution to notation and nomenclature we mention the symbols E, F, G, D, D', D'' for what we now call the coefficients of the first and second fundamental differential form, and the word “conformal”. (6a)=footnote=(6a) In the first paper on higher geodesy, 1844: “ich werde daher dieselben conforme Abbildungen oder Übertragungen nennen, indem ich diesem sonst vagen Beiworte eine mathematisch scharf bestimmte Bedeutung beilege” [Werke IV, p.262]. The word is indeed, already used by F. T. Schubert, “De projectione sphaeroidis ellipticae geographica”, *Nova Acta Petr.*, p. 130–146, see Cantor IV, p. 575.”] ♡??
- [1469] T. Sugawa, *Unified approach to conformally invariant metrics on Riemann surfaces*, Proc. of the Second ISAAC Congress, Vol. 2 (Fukuoka, 1999), 1117–1127, Int. Soc. Anal. Appl. Comput., 8, Kluwer Acad. Publ., Dordrecht, 2000. [♠ the Ahlfors function is mentioned on p. 5: “The quantity $c_R(p)$ is sometimes called the analytic capacity. An extremal function $f: R \rightarrow \mathbb{D}$ satisfying $|df|(p) = c_R(p)$ is usually called the *Ahlfors function* at p and known to be unique up to unimodular constants (see [4](=Fisher 1983 [442])). We remark that the condition $c_R(p) = 0$ at some point p need not imply that $c_R(p) = 0$ at every point p in the case that R is non-planar. A counterexample was constructed by Virtanen [13](=Virtanen 1952 [1541]) (see also [10,X. 2K]=Sario-Oikawa 1969 [1335]).” ♠ the article as whole present an unified framework to the interplay between conformally invariant metrics and extremal problems emphasizing the contractive property of holomorphic maps (à la Schwarz-Pick-Ahlfors) ♠ more precisely several metrics are presented culminating to their comparison as

$$a \leq s \stackrel{\text{AB50S69}}{\leq} c \leq \left\{ \begin{array}{l} \leq r \stackrel{\text{Bu79}}{\leq} k \\ \stackrel{\text{HeSu72}}{\leq} b \leq q \end{array} \right\} \leq h,$$

where a stands for Ahlfors-Beurling 1950 [20], s for span (or Schiffer!), c for Carathéodory(-Reiffen) (or for analytic capacity), r for Robin (or logarithmic capacity), k for Kobayashi, b for Bergman, q for quadratic differentials (Grötzsch-Teichmüller!), h for Hahn ♠ the inequality AB50S69 is due to Ahlfors-Beurling 1950 [20] for the planar case and in general to Sakai 1969/70 [1325] ♠ inequality Bu79 is due to Burbea 1979 [215] ♠ inequality HeSu72 is due to Hejhal 1972 [642, p. 106] (case of finite bordered surface) and Suita 1972 [1471] in general ♡??

- [1470] T. Sugawa, *An explicit bound for uniform perfectness of the Julia sets of rational maps*, Math. Z. 238 (2001), 317–333. [♠ the Ahlfors map is briefly mentioned as follows: “In fact, for a finitely connected planar domain U whose boundary consists of Jordan curves, it is known that there exists a branched holomorphic covering map from U onto the unit disk (e.g. the Ahlfors map). Thus L_U cannot be estimated from below by only the data of W (in this case $L_W = +\infty$).”] ♡2
- [1471] N. Suita, *Capacities and kernels on Riemann surfaces*, Arch. Rat. Mech. Anal. 46 (1972), 212–217. [♠] ♡??
- [1472] N. Suita, *On a metric induced by analytic capacity*, Kodai Math. Sem. Report 25 (1973), 215–218. G78 [♠ Ahlfors function à la Havinson 1961/64 [621], i.e. for domains $D \notin O_{AB}$ (i.e. supporting nonconstant bounded analytic functions), analytic capacity and conformal metrics ♠ the metric in question is also known as the Carathéodory metric (cf. e.g., Grunsky 1940 [563])] ♡17
- [1473] N. Suita, *On a class of analytic functions*, Proc. Amer. Math. Soc. 43 (1974), 249–250. G78 [♠ p. 249, the Ahlfors function is discussed as follows: “If $\Omega \notin O_{AB}$ [i.e. Ω is a plane region having a nonconstant bounded analytic function], there exist the extremal functions $A(z)$ which maximize $|f'(z_0)|$ in \mathfrak{B}_0 [the class of analytic functions f such that $f(z_0) = 0$ and $|f(z)| \leq 1$]. Those functions are called the *Ahlfors functions* which are unique save for rotations [3](=Havinson 1961/64 [621]).” ♠ the note includes a counterexample to an (erroneous) claim made by Ahlfors-Beurling 1950 [20] about the compactness of the class \mathfrak{E}_0 of those analytic functions in a plane region $\Omega \notin O_{AB}$ vanishing at $z_0 \in \Omega$ and such that $1/f$ omits a set of values of area $\geq \pi$] ♡??

- [1474] N. Suita, *On a metric induced by analytic capacity, II*, Kodai Math. Sem. Report 27 (1976), 159–162. A47 [♠ the Ahlfors function appears on p.160 and 161 ♠ for a plane region $\Omega \notin O_{AB}$ (i.e. supporting nonconstant bounded analytic functions) it was known (Suita 1973 [1472] via “making use of a supporting metric due to Ahlfors 1938”) that the curvature $\kappa(\zeta)$ of the metric $ds_B = c_B(\zeta)|d\zeta|$ induced by analytic capacity $c_B(\zeta) = \sup |f'(\zeta)|$ in the class of functions bounded-by-one (=stretching factor of the Ahlfors function at ζ) is ≤ -4 ♠ the present article rederives this estimate ($\kappa \leq -4$) by a limiting/exhaustion argument reducing to the case of a regularly bounded finitely connected domain which is analyzed via Bergman’s method of minimal integrals, but making also extensive use of Garabedian’s sharp analysis (our opinion!) ♠ the novelty of the present article is that the ‘Bergman-Garabedian method’ gives the “more precise estimation $\kappa(\zeta) < -4$ ” for regions with more than one contour ♠ paraphrase (p.161): “the equality $\kappa(\zeta) = -4$ at one point $\zeta \in \Omega$ implies that Ω is conformally equivalent to the unit disc.” ♠ [23.09.12] maybe it would be worth looking if Suita’s work extends to finite bordered surfaces (the problem being that quantity $|f'(\zeta)|$ depends on a local uniformizer), yet it seems that the theory is extensible (cf. e.g. Sugawa 1999/00 [1469]) ♡??
- [1475] N. Suita, A. Yamada, *On the Lu Qi-keng conjecture*, Proc. Amer. Math. Soc. 59 (1976), 222–224. [♠ “We shall give a complete answer to the Lu Qi-keng conjecture for finite Riemann surfaces. Our result is that every finite Riemann surface which is not simply-connected is never a Lu Qi-keng domain, i.e. the Bergman kernel $K(z, t)$ of it has zeros for suitable t ’s.”] ♡28
- [1476] G. Szegő, *Über orthogonale Polynome, die zu einer gegebenen Kurve der komplexen Ebene gehören*, Math. Z. 9 (1921), 218–270 G78 [♠ Szegő kernel representation of the Riemann mapping (p.245) ♠ like Bergmann 1922 [114] or Bochner 1922 [175] it is confessed (p.249) that the method does not duplicate a new existence proof of the Riemann mapping (this had to wait upon Garabedian and Lehto 1949 [920]) ♠ what is the geometric interpretation (i.e. the allied extremal problem): answer of course it is just that of minimizing the integral $\int_C |f(z)|^2 ds$, where integration is taken along the contour C of the domain (and ds is its Bogenelement)] ♡high?
- [1477] G. Szegő, *Über die Randwerte einer analytischer Funktion*, Math. Ann. 84 (1921), 232–244 [♠] ♡??
- [1478] G. Szegő, *Verallgemeinerung des ersten Bieberbachschen Flächensatzes auf mehrfach zusammenhängende Gebiete*, Sitz.-Ber. Preuß. Akad. d. Wiss., math.-phys. Kl. (1928), 477–481 G78 [♠ can we do the same on a Riemann surface? and relate this to a Bergman-style proof of the Ahlfors map?] ★★★ ♡??
- [1479] G. Szegő, *Inequalities for certain eigenvalues of a membrane of given area*, J. Rat. Mech. Anal. 3 (1954), 343–356 [♠ one of the early implementation of the conformal transplantation method to vibratory/elasticity problem; for wide extensions cf. Hersch 1970 [651], Yang-Yau 1980 [1613] and Fraser-Schoen 2011 [456], the last article effecting the junction with the Ahlfors map] ♡104?
- [1480] J. Tagamlizki, *Zum allgemeinen Kreisnormierungsprinzip der konformen Abbildung*, Ber. Verhandl. Sächs. Akad. Wiss., math.-phys. Kl. 95 (1943), 111–132. G78 ★ ♡??
- [1481] M. Taniguchi, *Bell’s result on, and representations of finitely connected planar domains*, Some Japanese fonts 1352 (2004), 47–53. [♠ survey of several results of Bell on the Ahlfors function and concludes by some questions about Bell representations, i.e. a certain family of canonical domains admitting an evident proper holomorphic map to the disc] ★ ♡??
- [1482] T. J. Tegtmeier, A. D. Thomas, *The Ahlfors map and Szegő kernel for an annulus*, Rocky Mountain J. Math. 29 (1999), 709–723. [♠ contains some lovely pictures of Ahlfors function in the case of an annulus] ♡??
- ★★★ Oswald Teichmüller (1913–1943), only thirty years old until dying somewhere on the Russian front. Both his political fanaticism and mathematical skills look dangerous, and more seriously the worker is involved in several developments (mostly based upon Grötzsch-Lavrentieff-Ahlfors method of quasi-conformal maps or better möglichst konform maps effecting the least possible distortion of infinitesimal circle into ellipse) and in the long run influential upon Thurston, etc. However it is not completely clear if the theory in question is an absolute prerequisite. For an alternative boring Frenchy-Japanese treatment of the moduli problem,

one can certainly cook out something from Leray-Cartan-(Serre) (i.e. the panzer of sheaves, which Germans like to see as originating by Weyl 1913 [1585], probably with right), and the deformation theory of Kodaira involving the 1st cohomology group of the tangent bundle (a bit akin to Thurston’s earthquakes).

- [1483] O. Teichmüller, *Eine Verschärfung des Dreikreisesatzes*, Deutsche Math. 4 (1939), 16–22. G78 [♠ quoted (joint with Carlson 1938 [250]) in Grunsky 1940 [563] as a forerunner of the extremal problem for bounded analytic functions \diamond Oswald Teichmüller (1913–1943) is formally a student of Hasse, but his interest shifted to function theory (presumably due to lectures held in Göttingen ca. 1935 by R. Nevanlinna) and then joined ca. 1937 Berlin where Bieberbach was located] $\heartsuit??$
- [1484] O. Teichmüller, *Extremale quasikonforme Abbildungen und quadratische Differentialiale*, Abh. Preuß. Akad. Wiss. math.-naturw. Kl. 22 (1939), 1–197; also in the Collected Papers, 335–531. AS60, G78 [♠ discusses in details the Klein dictionary between symmetric surfaces and bordered Riemann surfaces through the *Verdopplung* (=Schottky-Klein double) ♠ discusses moduli in a way quite anticipated in Klein 1882 [797], modulo of course the usual Riemann-style heuristics] \heartsuit **193**
- [1485] O. Teichmüller, *Über Extremalprobleme der konformen Geometrie*, Deutsche Math. 6 (1941), 50–77; also in Collected Papers, 554–581. AS60, G78 [♣ a mention is made (without proof and a cryptical unreferenced allusion to Klein) of a statement which could be interpreted as a forerunner of the Ahlfors circle map ♠ despite long searches, the writer (Gabard) was unable—on the basis of printed evidence—to adhere conclusively to Teichmüller’s accreditation of the result to Klein, compare Sec. in v.2 for more tergiversations ♠ the original Teichmüller text reads as follows (p.554–5): “Wir beschäftigen uns nur mit **orientierten endlichen Riemannschen Mannigfaltigkeiten**. Diese können als Gebiete auf geschlossenen orientierten Riemannschen Flächen erklärt werden, die von endlich vielen geschlossenen, stückweise analytischen Kurven begrenzt werden. Sie sind entweder geschlossen, also selbst geschlossene orientierte Riemannsche Flächen, die man sich endlichvielblättrig über eine z -Kugel ausgebreitet vorstellen darf, oder berandet. Im letzteren Falle, kann man sie nach Klein⁴⁵ durch konforme Abbildung auf folgende Normalform bringen: ein endlichvielblättriges Flächenstück über der oberen z -Halbebene mit endlich vielen Windungspunkten, das durch Spiegelung an der reellen Achse eine symmetrische geschlossene Riemannsche Fläche ergibt; [...] —(So läßt sich z. B. jedes Ringgebiet, d. h. jede schlichtartige endliche Riemannsche Mannigfaltigkeit mit zwei Randkurven, konform auf eine zweiblättrige Überlagerung der oberen Halbebene mit zwei Verzweigungspunkte abbilden.)” ♠ Another puzzle would be to know if Teichmüller’s text exerted some influence over Ahlfors subsequent findings (1950 [19]). Possibly yes, but note the absence of cross-citation until Ahlfors-Sario 1960 [26]. All this should by no mean polish the originality of Ahlfors achievement which looks substantially sharper by controlling the mapping degree.] $\heartsuit??$
- [1486] O. Teichmüller, *Beweis der analytischen Abhängigkeit des konformen Moduls einer analytischen Ringflächenschar von den Parametern*, Deutsche Math. 7 (1944), 309–336; also in Collected Papers, ??–??. [♠ quoted in Rüedy 1971 [1317] as the technological forerunner of the Garsia embedding result] $\heartsuit??$
- [1487] O. Teichmüller, *Gesammelte Abhandlungen, Collected Papers*, Herausgegeben von L. V. Ahlfors und F. W. Gehring, Springer Verlag, Berlin, 1982. $\heartsuit??$
★★★ René Thom, well known for his deep philosophical works on cobordism (Hirzebruch), surgery (Milnor-Kervaire), singularities (Whitney, Arnold), morphogenesis, catastrophe, etc, especially relevant to our present topic of the Hilbert’s 16th is the so-called Thom conjecture stating that the genus of a smooth surface is minimized by algebraic curves in the complex projective plane for a given homology class degree. Also much relevant is Thom’s influence upon Marcel Berger (ca. 1962) when it came to the systolic problem. Of course all this was much anticipated by German scholars in particular Teichmüller, cf e.g. the historical looping in Rodin 1974 BAMS [1276] who quite originally ascribes to Teichmüller a good part of the Loewner-Pu mouvanse.
- [1488] R. Thom, *Sur l’homologie des variétés algébriques réelles*, in: Differential and Combinatorial Topology, Symposium in honor of Marston Morse, Princeton Univ.

⁴⁵Big challenge: find where? Possibly this is not to be found in Klein and Teichmüller (probably lacking a good library during the war time) sloppily extrapolated what he remembered from his Klein reading (namely reality of Riemann surfaces, yet as far as we know never the total reality of orthosymmetric curves).

- Press, Princeton, N. J., 1965, 255–265. [♠ cf. also a related work by J. Milnor 1964 [1011]] ♡??
- [1489] W. Thomson (later Lord Kelvin), *Sur une équation aux différences partielles qui se présente dans plusieurs questions de physique mathématique*, J. Math. Pures Appl. 12 (1847), 493–496. [♠ one of the early apparition of the Dirichlet principle, cf. also Green 1928 [542], Gauss 1839 [516], Kirchhoff 1850 [786], Riemann 1851–57–57 [1253, 1256, 1257] and Dirichlet as edited by Grube 1876 [367]] ♡??
- [1490] W. Thurston, *The geometry and topology of 3-manifolds*, Princeton University Notes, Princeton, N. J., 1979. [♠ circle packing theorem, cf. precise citations e.g. in He 1990 [628], i.e. especially Corollary 13.6.2 and Theorem 13.7.1 (circle packing theorem)] ♡high 800?
- [1491] H. Tietz, *Eine Normalform berandeter Riemannscher Flächen*, Math. Ann. 129 (1955), 44–49. A50, AS60, G78 [♣ cite Ahlfors 1950 [19] and Nehari 1950 [1078], then criticizes the arguments of the latter ♣ seems to reprove a sort of circle map for bordered surfaces inspired by Ahlfors (but with the desideratum of schlichtness along the boundary), alas Tietz’s argument is criticized (and apparently destroyed) in Köditz-Timmann 1975 [844] ♠ Grunsky 1978 [568, p. 198] also seems to approve the Köditz-Timmann critique for he cites the (present) paper Tietz 1955 [1491], but right after add the parenthetical proviso “(cf. [266])”, that is Köditz-Timmann ♠ despite those defects the prose of the introduction is brilliant and worth quoting (especially as it emphasizes the historical rôle of Ahlfors 1950 [19], note however that Tietz seems to neglect both the Italian works as well as the cryptical allusion in Teichmüller 1941 [1485]): “Die Existenz eindeutiger analytischer Funktionen auf Riemannschen Flächen⁴⁶ bedeutet, daß jede Klasse konformäquivalenter Riemannscher Flächen “realisiert” werden kann durch Überlagerungsflächen der Zahlenebene. Damit stellt sich die Frage nach besonders einfachen Realisierungen oder Normalformen⁴⁷.—Das wichtigste Ergebnis zu dieser Frage ist der Riemannsche Abbildungssatz, der sie für einfach-zusammenhängende Riemannsche Flächen beantwortet⁴⁸. Einen Schritt weiter gehen die Schlitztheoreme, die von den topologischen Voraussetzungen des Riemannschen Abbildungssatzes nur die Schlichtartigkeit der Riemannschen Fläche beibehalten. Hierher gehört auch der Satz, daß jede berandete schlichtartige Riemannsche Fläche einem mehrfach überdeckten Kreis mit geeigneten Verzweigungsschnitten, die den Rand nicht treffen, konformäquivalent ist⁴⁹.—Die Frage nach kanonischen Riemannschen Flächen im Falle höheren Geschlechtes ist erst in letzter Zeit von Herrn AHLFORS [1](=1950 [19]) angeschnitten und von Herrn NEHARI [2](=1950 [1078]) systematisch behandelt worden:—Herr AHLFORS zeigt, daß jede berandete Riemannsche Fläche realisiert werden kann als mehrfach überdeckter Einheitskreis, während Herr NEHARI die Schlitztheoreme auf diesen Fall überträgt⁵⁰. [...]—Es erscheint wünschenswert, eine Normalform für berandete Riemannschen Flächen zu besitzen, die—im Gegensatz zur AHLFORSSchen—sicherstellt, daß das Bild jeder einzelnen Randkurve schlicht über die Linie des Einheitskreises liegt. [...]” ♣ Tietz concludes his paper (p. 49) as follows: “Die selben Überlegungen, die zu unserem Abbildungssatz führten, ermöglichen auch einen neuen Existenzbeweis für die Ahlforsche Normalform, wiederum jedoch ohne eine Schranke für die Anzahl der benötigten Blätter zu ergeben.” so this would be another (weak) version of Ahlfors, alas it seems that Tietz’s arguments were the object of critics, cf. Köditz-Timmann 1975 [844]] ♡3
- [1492] H. Tietz, *Zur Realisierung Riemannscher Flächen*, Math. Ann. 128 (1955), 453–458. AS60 [♠ with corrections in the next entry [1493]] ♡??
- [1493] H. Tietz, *Berechtigung der Arbeit “Zur Realisierung Riemannscher Flächen”*, Math. Ann. 129 (1955), 453–458. AS60 ♡??
- [1494] St. Timmann, *Kompakte berandete Riemannsche Flächen*, Diss. Hannover, 1969, 56 S. G78 [♠ this entry is cited on the “critical” page 198 of Grunsky 1978 [568], according to which it gives a generalization to Riemann surfaces of

⁴⁶If the surface is open this the non-trivial result of Behnke-Stein 1947/49 [96].

⁴⁷This jargon goes back to Weierstrass (vgl. etwa Schottky 1877 [1366]).

⁴⁸Maybe here one can pinpoint about a confusion with the uniformization of Klein-Poincaré-Koebe.

⁴⁹This is essentially the theorem of Bieberbach-Grunsky (with antecedent by Riemann and Schottky).

⁵⁰Compare maybe also Hilbert and Courant for similar works

- the Bieberbach-Grunsky theorem (i.e. circle map in the planar case) ♠ in particular, it could be the case that Timmann’s reproves the existence of an Ahlfors circle map, yet probably this is not the case] ★ ♡??
- [1495] J. A. Todd, *On questions of reality for certain geometrical loci*, Proc. London Math. Soc. (2) 32 (1930), 449–487. [♠ fairly pleasant text quoting works by Du Val 1928, Segre 1884 (pencil of quadrics with base a quartic surface with 16 lines) where the question of their reality is discussed, Schläfli’s work on the cubic surface is (re)visited from yet another perspective different from Klein’s (1873)] ♡??
- [1496] X. Tolsa, *Painlevé’s problem and the semiadditivity of analytic capacity*, Acta Math. 190 (2003), 105–149. A47 [♠ complete solutions of both problems of the title are given, the first being usually regarded as implicitly posed in Painlevé 1888 [1155] (albeit nobody was ever able to locate the precise place, see e.g. Rubel 1971 [1307] or Verdera 2004 [1517] for why) and the second emanated from Vitushkin’s advanced studies in the 1960’s ♠ the introduction contain a historical sketch, from Ahlfors 1947 [18], Vitushkin 1950’s to Murai 1988 [1048], Melnikov 1995 [996] (curvature of measures), G. David 1998 [344] (solution of Vitushkin’s conjecture), etc.] ♡164
- [1497] G. Toumarkine, S. Havinson, *Propriétés qualitatives des solutions des problèmes extrémaux de certains types*, In: Fonctions d’une variable complexe. Problèmes contemporains. Paris 1962, p. 73. [♠ survey containing a quite complete bibliography] ♡??
- [1498] S. Treil, *Estimates in the corona theorem and ideals of H^∞ : a problem of T. Wolff*, J. Anal. Math. 87 (2002), 481–495. [♠ improved lower estimates for the solution of the corona problem, but with still a large gap up the upper bound of Uchiyama 1980 (cf. esp. p. 494)] ♡8
- [1499] C. L. Tretkoff, M. D. Tretkoff, *Combinatorial group theory, Riemann surfaces and differential equations*, In: *Contribution to Group Theory*, Contemp. Math. 33, 467–519. Amer. Math. Soc., Providence, 1984. [♠]★ ♡??
★ Sebastien Trilles, student of Th. Fiedler (Ph.D. ca. 2001).
- [1500] S. Trilles, *Symétrie et entrelacs de courbes réelles algébriques*, 2001, Thèse doctorale (Toulouse?). [♠] ♡??
- [1501] S. Trilles, *Topologie des $(M - 2)$ -courbes réelles symétriques*, Bull. London Math. Soc. 35 (2003), 161–178. [♠ p. 161, cite Kharlamov 1975 [768] for a proof of the RKM-congruence forcing type I, yet this contradicts a bit the unpublishedness mentioned in Rohlin 1978; ♠ otherwise the article contain many interesting remark; for instance the fact (or idea) that via Smith theory any chamber pas the discriminant contains a symmetric curves (i.e. invariant under a mirror) ♠ cite Fiedler’s unpublished result (Fiedler 1994 [421]) that a symmetric M -curves satisfies a strengthened Gudkov-style congruence mod 16, namely $\chi \equiv_{16} k^2$. This can be used a serious tool to show that Gudkov’s curve is asymmetric (compare our Sec. in v.2 were we also suspected this issue)] ♡??
- [1502] A. Tromba, *On Plateau’s problem for minimal surfaces of higher genus in \mathbb{R}^n* , SFB 72-Preprint 580, Bonn, 1983. [♠ doubts expressed about the validity of Douglas and Courant for the Plateau problem in the case of higher topological structure, compare Jost 1985 [731]] ★★★ ♡??
- [1503] A. Tromba, *Dirichlet’s energy on Teichmüller’s moduli space and the Nielsen realization problem*, Math. Z. 222 (1996), 451–464. [♠]★★ ♡??
- [1504] V. V. Tsanov, *On hyperelliptic Riemann surfaces and doubly generated function algebras*, C. R. Acad. Bulgare Sci. 31 (1978), 1249–1252. [♠ quoted in Černe-Forstnerič 2002 [267]]★★ ♡??
- [1505] M. Tsuji, *A simple proof of Bieberbach-Grunsky’s theorem*, Comment. math. Univ. St. Paul 4 (1956), 29–32. G78 [♠ Nehari’s review (in MR): “A new proof of the classical result that there exists a $(1, n)$ conformal mapping of a plane domain D of connectivity n onto the unit circle which carries a given point on each of the boundary components of D into the same point of the unit circumference.”] ★ ♡??
- [1506] M. Tsuji, *Potential theory in modern function theory*, Tokyo, Maruzen, 1959. (Chelsea edition 1975.) ★ G78 [♠ contains apparently yet another proof of the Bieberbach-Grunsky theorem, perhaps the same as in the previous item]★ ♡high?
- [1507] A. W. Tucker, *Branched and folded coverings*, Bull. Amer. Math. Soc. 42 (1936), 859–862. [♠]★ ♡??

- [1508] G. Tumarkin, see Toumarkine.
- [1509] G. A. Utkin, *??*, Dokl. Akad. Nauk SSSR 175 (1967), 40–43. [♠ contains an improved bound namely 11 upon Rohn’s estimate ≤ 12 (Rohn 1886 [1293]) upon the number of component of a quartic surface in 3-space; for the definitive (sharp) estimate ≤ 10 , cf. Kharlamov 1972/73 [764]] ♡??
- [1510] G. A. Utkin, *Construction of an M -surface of fourth order in $\mathbb{R}P^3$* , Funkts. Anal. 8 (1974), 91–92. [♠] ♡??
- [1511] N. X. Uy, *On Riesz transforms of bounded functions of compact support*, Michigan Math. J. 24 (1977), 169–175. [♠ p.170 the Ahlfors function (referenced via Gamelin’s book 1969 [482]) is involved in a theorem involving the Riesz transform] ♡??
- [1512] L. Vajsburd, A. Radul, *Non-orientable strings*, Comm. Math. Phys. 135 (1991), 413–420. [♠ real algebraic (diasymmetric) curves as applied to string theory, more related refs. in Natanzon 1999 [1072]] ♡??
- [1513] Ch. de la Vallée Poussin, *Sur la représentation conforme des aires multiplement connexes*, Ann. École Norm. (3) 47 (1930), 267–309 G78 ♡??
♠ Oswald Veblen (18XX–19XX) is known for his (first?) rigorous proof of the Jordan curve theorem, and his early work on the foundation of algebraic topology (alias analysis situs). Notorious joint works with Alexander, Whitehead, etc.
- [1514] O. Veblen, *Analysis Situs*, (The Cambridge colloquium 1916), Amer. Math. Soc., New York, 1922. [♠ one of the first attempt to expose combinatorial topology (à la Poincaré) in a systematic fashion. Work cited in e.g. Comessatti 1928 [310].] ♡??
- [1515] J. Verdera, *Removability, capacity and approximation*, in: Complex Potential Theory, NATO ASI Series, Kluwer Acad. Publ., Dordrecht, 1994, 419–473. [♠] ♡??
- [1516] J. Verdera, *The L^2 boundedness of the Cauchy integral and Menger curvature*, Contemp. Math. 277 (2001), 139–158. [♠] ♡??
- [1517] J. Verdera, *Ensembles effaçables, ensembles invisibles et le problème du voyageur de commerce, ou comment l’analyse réelle aide l’analyse complexe*, Gazette des Math. 101 (2004), 21–49 A47 [♠ a thorough survey about Painlevé null-sets including the following points: ♠ Painlevé’s problem about searching a geometric characterization of null-sets (nobody ever found an explicit formulation in Painlevé’s writings, but Ahlfors 1947 [18] may be considered as the father of the modern era (introduction of the analytic capacity and insistence upon pure geometric conditions) ♠ Tolsa’s resolution (ca. February 2003) of Painlevé’s problem (via bilipchitzian invariance of analytic capacity) is mentioned ♠ p. 29: the Denjoy conjecture (i.e., a compactum of a rectifiable curve is a (Painlevé) null-set iff its length is zero). This conjecture was cracked by the seminal work of Calderón 1977 [222] as was made explicit in a note of Marshall ♠ the (Vitushkin)-Garnett 1970 [502] example of the $1/4$ -Cantor set is discussed: this has positive length (because a certain projection is a full segment) but is a null-set (removable) ♠ this is used to motivate Besicovitch’s notion of “invisible sets”, i.e. those projecting to sets of zero-length along almost every angular direction ♠ Vitushkin’s conjecture: a compactum of the plane is a null-set iff it is invisible (alas, there is counter-examples of Mattila, and Jones-Murai 1988 [727]), yet the direct sense is true if finite length (as follows from the Denjoy conjecture solved since Calderón), hence ♠ weak Vitushkin conjecture (1967): among compacta of finite length, the null-sets coincide with the invisible sets. This was completed in G. David 1998 [344] upon combining a chain of contributions: Christ 1990, Mattila-Melnikov-Verdera 1996 [986] and Jones 1990] ♡1
- [1518] I. N. Vekua, *Generalized analytic functions*, Pergamon Press, Oxford, 1962. [♠ an account of the theory of the Beltrami equation, with roots going back to Gauss, Korn, Lichtenstein, Morrey, Lavrentiev, Bojarski, Lehto, Ahlfors and Bers, etc.] ♡??
- [1519] I. N. Vekua, *Verallgemeinerte analytische Funktionen*, Berlin 1963 [♠ Riemann-Hilbert problem on finite bordered Riemann surfaces (and the allied Fredholm theory), cf. also Koppelman 1959 [849] Schüffler 1986 [1371]] ♡??
- [1520] H. Villat, *Le problème de Dirichlet dans une aire annulaire*, Rend. Circ. Mat. Palermo 33 (1912), 149 [♠ a brief proof of Villat’s formula in Komatu (1945)] ♡??

[1521] V. Vinnikov, *Self-adjoint determinantal representations of real plane curves*, Math. Ann. 296 (1993), 453–479. [♠ a brilliant presentation of the theory of Klein-Weichold of real curves and simplified proof of results of Dubrovin-Natanzon, discusses complex orientations (à la Rohlin) ♠ mentions the result that a real plane curve with a nest of maximal depth is dividing (via Rohlin 1978 [1290, p.93]), whose argument can (in our opinion) can be slightly simplified as follows ♠ given $C_m \subset \mathbb{P}^2$ a nonsingular curve of degree m with a deep nest then projecting the curve from any point chosen in the innermost oval gives a morphism $C_m \rightarrow \mathbb{P}^1$ whose fibers over real points are totally real, hence there is an induced map between the imaginary loci and it follows that C_m is dividing (just by using the fact that the image of a connected set is connected). q.e.d. (N.B.: this is exactly Rohlin’s argument except that we avoid the consideration of the canonical fibering $\text{pr}: \mathbb{C}P^2 - \mathbb{R}P^2 \rightarrow S^2$ envisaged by Rohlin) ♠ p.478 mentions the result of Nuij 1968 [1112]: “any two real smooth plane curves of degree n having a nest of ovals of maximal depth are *rigidly isotopic* (i.e. belongs to the same component in the space of all real smooth plane curves of degree n)” ♠ [30.09.12] I vaguely remember of a sharper question (result?) asking if the space of deeply nested curves is not even a (contractible) cell ♠ [02.10.12] probably this question was rather asked for ovalless real curves, yet the idea (coming to me only today) is that the π_1 (fundamental group) of any chamber (=component of the complement of the discriminant hypersurface $D \subset |\mathcal{O}_{\mathbb{P}^2}(m)| = |mH|$ consisting of all singular curves) must act on the set of ovals of any fixed plane curves. Hence when there is no oval or a nest (not necessarily of maximal depth) then the induced (monodromy) permutation must be trivial and consequently there is no obstruction to the chamber having a simple topology. More generally this applies when there are several nests of different depths (then again nothing can be permuted). In contrast when there is collection of non-nested ovals (or two nests of the same depth) then there is no obstruction to there permutability (e.g. imagine a quartic with 4 ovals resulting from the smoothing of two conics then by rotating the plane we can achieve a transitive permutation of cyclic type). But probably the monodromy group of this quartic is bigger. How large exactly? ♠ a problem would be to count the number of component of $|mH| - D$ and if possible to describe the complex encoding the adjacency relation between the different chambers ♠ of course in the general question of describing the monodromy of a given curve, one can exploit Rohlin’s idea of the complex orientation in the case where the curve is dividing, as the latter must probably be conserved during an isotopy-loop (up to reversion). If so then for the 4 ovals quartic we get an obstruction to there complete permutability, and the monodromy group is not the full symmetric group \mathfrak{S}_4 . Naively two ovals gyrate clock-wise and two anti-clock-wise (draw the complex orientations by doing sense preserving smoothings), yet since $\mathbb{R}P^2$ is nonorientable nothing is secure (i.e. the clockwise can continuously mutate in the anti-clock-wise)? (of course all this must be described somewhere with more care!) ♠ as in Nuij’s result one can ask when the real scheme (Rohlin’s jargon) determine unambiguously the isotopy type (or what is the same a unique chamber). A naive (probably wrong) guess is that if the monodromy is trivial, then the chamber is unique] ♡73

[1522] V. Vinnikov, *Commuting operators and function theory on a Riemann surface*, In: Holomorphic spaces (Berkeley 1995), MSRI Publications 33, 1998. A50 [♠ p.468, Ahlfors 1950 is briefly cited as a mapping onto the upper half-plane, and is applied to problems of operator theory and maybe as well to a generalization of the Riesz-Nevanlinna-Smirnov factorization ♠ compare optionally Havinson 1989/89[622] where a similar desideratum was found to be difficult (and unsolved?) ♠ from the abstract: “In the late 70’s M. S. Livsic has discovered that a pair of commuting nonselfadjoint operators in a Hilbert space, with finite nonhermitian ranks, satisfy a polynomial equation with constant (real) coefficients; . . .”, whence the link with real curves (à la Klein) and therefore with Ahlfors] ♡16

★★★ Oleg Yanovich Viro (born Mai 1948), student of Rohlin (ca. 1975) first works in topology and then drifted toward real geometry (back-and-forth), bringing arguably the most fundamental contributions to Hilbert’s 16th ever observed (since the basic and less basic results of Harnack, Klein, Hilbert, Gudkov, Arnold, Rohlin). So the writer in question surely belongs to top of the firmament of the 16 superstars of the topic, again (0) Zeuthen, Klein (1) Harnack, (2) Hilbert, (3) Rohn, (4) Petrovskii, (5) Gudkov, (6) Arnold, (7) Rohlin, (8) Kharlamov, (9) Viro, (10) Fiedler, (11) Polotovskii, (12) Shustin, (13) Korchagin, (14) Itenberg, (15) Chevallier, (16) Orevkov. Within this 16 workers Hilbert’s 16th is nearly

settled in degree 8, compare Orevkov 2002 [1129]. More seriously, Viro's seminal contributions are best known for his dissipation method of complicated singularities (alias patchworking), yet in reality it is less well-known (to the grand public at least) how important Viro's work is at the prohibitive level. Everything started with Rohlin and Fiedler, but Viro added incredibly severe obstructions permitting first to solve Hilbert's 16th in degree 7, and to gain great advances of the case of degree $m = 8$ which as usual in the next great jump complexity. As a rule passing from $m = 2k$ to $m = 2k + 1$ is nearly trivial but jumping to the next even degree $m = 2k + 2$ is always a great jump. Here Viro's genius is best exemplified in the worldwide web literature in our text, cf. especially our Fig. 154 and Fig. 5 showing both the full great impact of Viro's prohibition in a snapshot view that was never so clearly shown in literature due to typographical constraint of editors. The only improvement expectable now is to complete the 6 cases left undecided as now (after Orevkov 2002 [1129]). To improve this situation one could dream of an unified way to derive the Fiedler-Viro and 2nd Viro prohibition, as well as Shustin's avatars and the 2 obstructions of Orevkov (all this is best visualized on our two figures just cited). One possible candidate is the paradigm of total reality due basically to Riemann in the schlichtartig=(M -curve case). Sorry for ascribing more importance to the jargon of Koebe (1907) than that of Petrovskii (1938)! Who came first deserves priority! If this is feasible we suspect that the very simple phenomenon of total reality discussed in Gabard 2013B [471] should explain all M -prohibitions in degree 8, i.e. Fiedler-Viro, Viro, Shustin plus Orevkov, and also some of the yet undecided case (in case any of them is prohibited) along an unified geometric formalism. Understanding this probably merely requires combinatorial skills. Then Hilbert's 16th will be solved in degree 8, especially if we are able to rule out the 6 remaining schemes. For the more general philosophy (arbitrary $m \geq 8$ and not just M -schemes), cf. our introduction, which especially emphasizes the operation of satellites, hence a sort of higher arithmetics regulating the whole series of Gudkov pyramids by transferring type I schemes through satellitization from one pyramid to all others of higher degrees. This gives a telescope of pyramids all related together and interacting in a globalized world (ecosystem). MISHA

- [1523] O. Ya. Viro, *Generalization of the inequalities of Petrovskii and Arnold to curves with singularities*, Uspekhi Mat. Nauk 33 (1978), 145–146. [♠] ♥??
- [1524] O. Ya. Viro, *Construction of M -surfaces*, Funkt. Anal. i Prilozhen 13 (1979), 71–72; English Transl. in: ??? [♠] ♥??
- [1525] O. Ya. Viro, *Construction of multicomponent real algebraic surfaces*, Dokl. Akad. Nauk SSSR 248 (1979), 279–282; English transl., Soviet Math. Dokl. 20 (1979), 991–995. [♠] ♥??
- [1526] O. Ya. Viro, V. M. Kharlamov, *Congruences for real algebraic curves with singularities*, Uspekhi Mat. Nauk SSSR 35 (1980), 154–155; English Transl., Russian Math. Surveys 35 (1980), ??–??. [♠ cited in Polotovskii 1988 [1209] when it comes to Hilbert's 16th in degree 8, but not clear if this is really relevant. At any rate full details of this Viro-Kharlamov announcement are probably worked out in Kharlamov-Viro 1988/91 [778].] ♥??
- [1527] O. Ya. Viro, *Curves of degree 7, curves of degree 8, and the Ragsdale conjecture*, Dokl. Akad. Nauk SSSR 254 (1980), 1305–1310; English Transl., Soviet Math. Dokl. 22 (1980), 566–570. [♠ contains a complete solution of Hilbert's 16th in degree 7 and revolutionary advances upon the case of degree 8 (still open in 2013, e.g. 6 types of M -octics are not yet known to be realized, cf. e.g. Kharlamov-Viro XXXX [779] or better Orevkov 2002 [1129] which represents the state of the art (up to present days[=April 2013] it seems). ♠ the present article is merely an announcement and some work is required to understand properly all what Viro achieved at this period, cf. e.g. our Fig. 154 and the text around it for a detailed exposition of Viro's work.] ♥??
- [1528] O. Ya. Viro, *Generalization of Klein's formula and wave fronts*, Uspekhi Mat. Nauk 36 (1981), 233; English Transl., Russian Math. Surveys 36 (1981), ??–??. [♠] ♥??
- [1529] O. Ya. Viro, *Gluing of plane real algebraic curves and construction of curves of degree 6 and 7*, in: Topology, Proc. Leningrad 1982, Lect. Notes in Math. 1060, 1984, 185–200. [♠ this is a detailed exposition of the resolution of Hilbert's 16th in degree 7 (announced in Viro 1980).] ♥??

- [1530] O. Viro, *Progress over the last five years in the topology of real algebraic varieties*, Proc. Internat. Congr. of Mathematicians, Warsaw 1983, 525–611. (Russian?)
 [♠ probably a more expanded version of the same material is to be found in Viro 1986/86 [1534]] ♡??
- [1531] O. Viro, *Real varieties with prescribed topological properties*, Doct. Thesis, LOMI, Leningrad Univ., 1983; English transl. of Chap. 1, as “Patchworking real algebraic varieties”, available on the web, cf. [1537] [♠ under the direction of V. A. Rohlin ♠ English translation promised in Risler 1992 [1265], cf. perhaps Viro 1982/84/94 [1537]] ♡??
- [1532] O. Ya. Viro, *Real plane curves of degree 7 and 8: new prohibitions*, Izv. Akad. Nauk SSSR, Ser. Mat. 47 (1983), 1135–1150; English Transl., Math. USSR Izv. 23 (1984), 409–422. [♠ cited in Shustin 1985/85 [1411] for his counterexample to Rohlin’s maximality conjecture ♠ another point of this paper is that it completes the isotopy classification of septics, thereby cracking the next case of Hilbert’s 16th problem. This is based on work of 1979 by Viro, where after a bunch of constructions (along his revolutionory method of dissipation/patchwork) it remained him to prohibit the scheme $\langle J \sqcup 1(14) \rangle$. This was done using auxiliary curves of degree 2 and the theory of complex orientations. The resulting classification involves $121 = 11^2$ real schemes (cf. e.g. Viro 1989/90 [1535, p. 1124]). ♠ [24.01.13] try at the occasion to draw the corresponding pyramid. [Cf. Fig. 161.] Another idea: try to prohibit Viro’s scheme $\langle J \sqcup 1(14) \rangle$ via CCC (collective contraction conjecture of empty ovals, cf. Sec. in v.2, yet looks difficult unless another idea appears ♠ by Marin 1979 [963] (or Fiedler) we know that such schemes even when enriched by the type (or the stronger complex orientations) do not encodes unambiguously the rigid-isotopy class, hence the rigid-isotopy classification is even much harder and probably still unsolved, compare e.g. Viro 2008 [1539]. As a pure guessing (of Gabard) one could expect something like $512 = 2^9$ chambers in degree $m = 7$???) ♡??
- [1533] O. Ya. Viro, *Gluing of algebraic hypersurfaces, smoothing of singularities and construction of curves*, In: Proc. Leningrad Int. Topology Conf. (Aug. 1982), Nauka, Leningrad, 1983, 149–197 (Russian); English Transl., [not available apparently]. [♠ cited in Kharlamov-Viro 1988/91 [778] ♠ this is apparently the first place where the 42 new M -schemes of degree 8 were constructed by Viro along his 1980 announcement; English version of this text are perhaps to be found in subsequent publications, maybe Viro 1989 [1535] ♠ for the present state of the problem where only 6 schemes remain, cf. Orevkov 2002 [1129] ♠ this article is also cited in Shustin for Viro’s construction of 8 new M -schemes (not realized before Viro), but alas for the moment I missed 6 of them, and as far as I know full details are not covered by Viro 89/90. So this Russian source is still probably fairly invaluable, as we are not yet able (date=[07.05.13]) to construct those six schemes, cf. Fig. 154. Of course since it is merely a matter of seeing the picture of the singular octic, a Russian version of the article is amply sufficient, and the latter article should be available on Oleg’s home-page.] ♡??
- [1534] O. Viro, *Progress in the topology of real algebraic varieties over the last six years*, Uspekhi Mat. Nauk 41 (1986), 45–67; English Transl., Russian Math. Surveys 41 (1986), 55–82. [♠ “Contents. Introduction 55 §1. Real algebraic curves as complex objects 57 §2. Numerical characteristics and encoding of schemes of curves 59 §3. Old restrictions on schemes of curves 60 §4. New restrictions on schemes of curves 63 §5. Klein’s assertion 67 §6. ...” ♠ this is beside Rohlin 1978 [1290] one of the most impressive (and pleasant-to-read survey) ever written ♠ [01.05.13] just a detail, after mature thinking Viro’s prose on p.67: “More than 100 years ago Klein (1876) wrote in a slightly unclear manner that a curve of type I does not permit any development.” This looks to us a bit sloppy criticism of Klein, and it seems necessary (for any German linguist) to take the defense of Felix, because Klein’s assertion is actually very clear-cut, namely he merely asserts that a curve of type I cannot gain an oval by crossing the discriminant along a solitary node. By the way the “more literal” interpretation of Viro/Marin on p. 68 that a curve of type I cannot gain an oval by crossing the discriminant is a actually a deformation of Klein’s original formulation, yet slightly stronger logically. It emerges from a recent e-mail discussion with Marin (Sec. in v.2) that himself did not noticed that his statement was actually logically stronger than Klein’s original.] ♡107
- [1535] O. Ya. Viro, *Real algebraic plane curves: constructions with controlled topology*, Alg. i Analiz 1 (1989), 1–73; English transl., Leningrad Math. J. 1 (1990), 1059–

1134. [♠ includes a complete solution of Hilbert’s 16th problem for M -curves up to orders $m \leq 7$ (which goes back to Viro 1979/80 [1527], but which is now first presented in nearly full details and in English)] ♡??
- [1536] O. Ya. Viro, V. I. Zvonilov, ???, *Alg. i Analiz* 4 (1993), 539–548; English transl., *Leningrad Math. J.* 4 (1993), ?–?. [♠ cited in Orevkov 2000 [1124].] ♡??
- [1537] O. Ya. Viro, *Patchworking real algebraic varieties*, Preprint, Uppsala University, usually dated 1994 or 1995, available at <http://www.math.uu.se/~oleg> [♠] ♡??
- [1538] O. Ya. Viro, S. Yu. Orevkov, *Congruence modulo 8 for real algebraic curves of degree 9*, *Uspekhi Mat. Nauk* 56 (2001), 137–138; English transl., *Russian Math. Surveys* 56 (2001), 770–771. Cf. also an extended version available from Orevkov’s homepage (in 4 pages instead of 2) where the proof is presented in some more details. [♠ This albeit presented as a modest extensions of results of Kharlamov-Viro (extending the Gudkov’s style congruences to singular curves) from the early 80’s seems to include new prohibition on M -schemes of degree 9. For a partial discussion of this cf. an article by Fiedler-Le Touzé.] ♡??
- [1539] O. Ya. Viro, *From the sixteenth Hilbert problem to tropical geometry*, *Japan. J. Math.* 3 (2008), 185–214. [♠ a general survey discussing in particular the solution of Hilbert’s 16th problem for M -curves up to orders $m \leq 7$ (after Viro ca. 1980)] ♡22
 ★ K. I. Virtanen, student of R. Nevanlinna, yet another representant of the powerful Finnish school of function theory, involved in the classification of open Riemann surface (as was the trend in the late 1940’s early 1950’s).
- [1540] K. I. Virtanen, *Über die Existenz von beschränkten harmonischen Funktionen auf offenen Riemannschen Flächen*, *Ann. Acad. Sci. Fenn. Ser. A. I.* 75 (1950), 8 pp. A50, A560 [cite Ahlfors 1950 [19] in a footnote (p. 6) as follows: “Zusatz b.d. Korr.: Die Extremalfunktion η_n findet sich auch bei Ahlfors 1950 (= [19]).” ♠ yet this function is only a harmonic function, hence not the (analytic) Ahlfors map we are focused upon. In particular Virtanen’s paper does not reproves the existence of the Ahlfors maps, its main purpose being rather to establish the inclusion $O_{HB} \subset O_{HD}$ in the so-called classification theory of open Riemann surfaces] ♡??
- [1541] K. I. Virtanen, *Über Extremalfunktionen auf offenen Riemannschen Flächen*, *Ann. Acad. Sci. Fenn. Ser. A. I.* 141 (1952), 7 pp. A560 [Ahlfors 1950 [19] is cited maybe?] ♡??
- [1542] A. G. Vitushkin, *Analytic capacity of sets and some of its properties*, *Dokl. Akad. Nauk SSSR* 123 (1958), ?–?. (Russian) [♠ cited in Melnikov 1967 [994] for the definition of the Ahlfors function] ♡??
- [1543] A. G. Vitushkin, *Example of a set of positive length but zero analytic capacity*, *Dokl. Akad. Nauk SSSR* 127 (1959), 246–249. (Russian) [♠ compare also the (simplified) construction in Garnett 1970 [502], who warns us that Vitushkin’s paper contains many typographical errors ♠ the basic theorem “zero analytic capacity whenever zero linear measure” is a classical theorem of Painlevé (cf. e.g. Ahlfors 1947 [18, p. 2], a simple application of Cauchy’s formula)] ♡??
- [1544] A. G. Vitushkin, *Analytic capacity of sets in problems of approximation theory*, *Uspekhi Mat. Nauk* 22 (1967), 141–199; English transl.: *Russian Math. Surveys* 22 (1967), 139–200. A47 [♠ Ahlfors function appears on p. 142 ♠ formulation of the problem of the semi-additivity of analytic capacity solved (jointly with the older Painlevé problem on the geometric characterization of removable singularities) in Tolsa 2003 [1496]] ♡219
- [1545] Vo Dang Thao, *Über einige Flächeninhaltsformeln bei schlichtkonformer Abbildung von Kreisbogenschlitzgebieten*, *Math. Nachr.* 74 (1976), 253–261. [♠ cited in Alenicyan 1981/82 [38]] ★★★ ♡low 4
- [1546] M. Voichick, *Ideals and invariant subspaces of analytic functions*, *Trans. Amer. Math. Soc.* 111 (1964), 493–512. [♠ bounded analytic functions, nontangential boundary values (almost everywhere), inner function, Beurling’s invariant subspace theorem extended to finite Riemann surfaces (tools: Harnack’s principle, Fatou’s theorem, plus Read 1958 [1243] and Royden 1962 [1305] (both direct descendants of Ahlfors 1950 [19]), but the link if any is masked behind “une propice brume d’analyse fonctionnelle”) ♠ similar work by Hasumi 1966 [614] ♠ Voichick’s work also contains a “bordered” extension of the Beurling-Rudin description of closed ideals in the disc algebra, for which result Stanton 1971 [1451] proposes another route hinging on the use of the Ahlfors map] ♡39/55

- [1547] M. Voichick, L. Zalcman, *Inner and outer functions on Riemann surfaces*, Proc. Amer. Math. Soc. 16 (1965), 1200–1204. [♠ factorization theory in the Hardy classes H^p for finite bordered Riemann surfaces extending the classical theory (Hardy and the Riesz brothers) on the disc (antecedent by Parreau, Rudin 1955 [1310], and Royden 1962 [1305]), inner function, Blaschke product, Green’s function, etc. ♠ naively speaking one could hope that the Ahlfors function alone is a sufficient tool to lift the truth from the disc to the bordered surface, yet the implementation usually diverge slightly (here by using the universal covering to effect the reduction to the classical disc case)] ♡39
- [1548] M. Voichick, *Extreme points of bounded analytic functions of infinitely connected regions*, Proc. Amer. Math. Soc. 11 (1966), 83–86. A50, G78 [♠ p.1369, cite Ahlfors 1950 [19] for the existence of a negative harmonic function whose harmonic conjugate has prescribed periods ♠ this page contains an acrobatical implementation of the usual yoga attempting to annihilate periods to ensure single-valuedness (hence quite close to Ahlfors’ existence-proof of a circle map) ♠ p.1367: “It should be noted that Gamelin in [2](=to appear=and seems to have appeared under extended coauthoring, namely Gamelin-Voichick 1968 [480]) characterized the extreme points of the unit ball of $H^\infty(R)$ when R is a finite bordered Riemann surface.”] ♡8
- [1549] M. Voichick, *Invariant subspaces on Riemann surfaces*, Canad. J. Math. 18 (1966), 399–403. [♠]★★ ♡8
- [1550] V. Volterra, *Sul Principo di Dirichlet*, Palermo Rend. 11 (1897), 83–86. AS60 [♠] ♡??
- [1551] B.L. van der Waerden, *Topologie und Uniformisierung der Riemannschen Flächen*, Ber. Verh. Sächs. Akad. Wiss. Leipzig Math.-Phys. Kl. 93 (1941), 147–160. AS60 [♠ cf. also Carathéodory 1950 [241] and ref. therein, esp. to Reichardt.] ★ ♡??
- [1552] B.L. van der Waerden, *Einführung in die algebraische Geometrie*, Die Grundlehren der math. Wiss. in Einzeldarstellungen, Bd. 51, Springer-Verlag, Berlin, 1973. (Zweite Auflage of the 1939 original). [♠ p.223, Riemann-Roch in der Brill-Noetherschen Fassung, etc.] ♡??
- [1553] W. von Dyck, *Beiträge zur Analysis situs. I Aufsatz, Ein- und zwidimensionale Mannigfaltigkeiten*, Math. Ann. (1888), 457–512. [♠ contains an account of what was known at that time (nearly definitive results) on the topology of surfaces, as well a historical account of the theory of foliation. The sole possible forerunner of that period is Poincaré 1885, which in our opinion (albeit not perfectly organized) is sometimes more digest than Dyck’s account, especially when it comes to the “Poincaré” index formula, which can perhaps only be regarded as anticipated by masters like Cauchy, Gauss, Riemann, Kronecker] ♡??
- [1554] K.G. Ch. von Staudt, *Geometrie der Lage*, Nürnberg 1847. [♠ often cited by early worker in the topology of real curves, for the notion of ovals and pseudo-line (even vs. odd circuit), i.e. isotopy classification of a circle in the real projective plane ♠ so cited e.g. in Harnack 1876 [607], Hilbert 1891 [661], Brusotti 195X [205] ♠ this seems to be a masterwork being even cited in the histogram Boyer-Merzbach [183] of selected works marking the history of all Mathematics] ♡??
- [1555] J. Wahl, *Deformations of plane curves with nodes and cusps*, Amer. J. Math. 96 (1974), 529–577. [♠ cited e.g. in Shustin 1990/91 [1418]] ♡??
- [1556] R.J. Walker, *Algebraic Curves*. Dover Publications, Inc., New York, 1962; unabridged and corrected reprint of the work first published as Princeton Mathematical Series 13. Princeton University Press, Princeton, N.J., 1950; 2nd ed. published by Springer-Verlag, New York, 1978. [♠ often cited by Russian scholar starting from Gudkov (and his successors Korchagin, Shustin, etc.)] ♡??
- [1557] C. T. C. Wall, *Is every quartic a conic of conics?*, Math. Proc. Cambridge Philos. Soc. 109 (1991); 419–424. [♠ cited in Sottile 2002 ♠ there is also regarding the work of Wall an interesting general overlap with those of the Gorki school around Gudkov, compare maybe Polotovskii 1996 [1211] (or some other source which I forgot)] ♡??
- [1558] J.L. Walsh, *The approximation of harmonic functions by harmonic polynomials and by harmonic rational functions*, Bull. Amer. Math. Soc. 35 (1929), 499–544. [♠ quoted via Axler’s review (BAMS) of Fisher’s book, for the harmonic conjugate as generally multiple-valued with periods]★★★ ♡??

- [1559] J.L. Walsh, *Interpolation and functions analytic interior to the unit circle*, Trans. Amer. Math. Soc. 34 (1932), 523–556. [♠ Pick-Nevalinna like still in the disc but see Heins 1975 [637] for an extension subsuming (in principle) the theory of the Ahlfors map]★♡??
- [1560] J.L. Walsh, *Approximation by polynomials in the complex domain*, Mémorial des Sci. Math. 73 (1935), 1–72. [♠ formulates a general formalism of best approximation which encloses as special cases the least area interpretation of the Riemann mapping of Bieberbach 1914 [142], as well as generalizations of Julia, and many other workers including Kubota, Wirtinger, Kakey, F. Riesz (cf. esp. p.61) ♠ further on p.64 it is emphasized that (at time) virtually nothing was known for multiply-connected regions (this had to wait over Grunsky, Ahlfors, etc.)] ♡??
- [1561] J.L. Walsh, *On the shape of level curves of Green's function*, Amer. Math. Monthly 44 (1937), 202–213. [♠]★★★♡??
- [1562] J.L. Walsh, *The critical points of linear combinations of harmonic functions*, Bull. Amer. Math. Soc. ?? (1948), 196–205. A47 [♠ p.196: “In various extremal problems of function theory the critical points of linear combinations of Green's functions and harmonic measures are of significance (See for instance M. Schiffer 1946; L. V. Ahlfors 1947 [18].) ♠ p.205: “In connection with the methods we are using, a remark due to Bôcher (1904) is appropriate: “The proofs of the theorems which we have here deduced from mechanical intuition can readily be thrown, without essentially modifying their character, into purely algebraic form. The mechanical problem must nevertheless be regarded as valuable, for it suggests not only the theorems but also the method of proof.” ”] ♡??
- [1563] J.L. Walsh, *The location of critical points*, Amer. Math. Soc. Colloq. Publ. 34, 1950. [♠ Chap. VII is quoted in Jones-Marshall 1985 [726] “for more information on the location of the critical points” [of the Green's function]] ♡??
- [1564] J.L. Walsh, *Note on least-square approximation to an analytic function by polynomials, as measured by a surface integral*, Proc. Amer. Math. Soc. 10 (1959), 273–279. ♡??
- [1565] J.L. Walsh, *History of the Riemann mapping theorem*, Amer. Math. Monthly 80 (1973), 270–276. [♠ a brilliant essay, which on p.273 mentions briefly the counterexamples to the “naive” Dirichlet principle cooked by Prym 1871 and Hadamard 1906 (the precise links are not given but are Prym 1871 [1226] and Hadamard 1906 [601])] ♡??
- [1566] S. Warschawsky, *Über einige Konvergenzsätze aus der Theorie der konformen Abbildung*, Nachr. Ges. Wiss. Göttingen (1930), 344–369. AS60 ★ ♡??
★ Heinrich Weber, a student (or at least a close disciple) of Riemann (especially pivotal in our context for having transcribed Riemann's Nachlass out of poorly organized hand-notes).
- [1567] H. Weber, *Note zu[m] Riemann's Beweis des Dirichlet'schen Prinzips*, J. Reine Angew. Math. 71 (1870), 29–39. AS60 [♠ an attempt is made to complete the reasoning of Riemann to establish the Dirichlet principle ♠ this work is quoted in Ahlfors-Sario's masterpiece [26], but Weber's work seems to be subjected to serious objections (according to Zaremba 1910 [1623]) including the basic one of Weierstrass about the existence of a minimum value for the Dirichlet integral ♠ further [as our attempt to make Zaremba's objections more explicit] on p.30 (line 4) Weber makes the tacit assumption that he can find a function u matching the boundary values and of *finite* Dirichlet integral: this is however violently attacked by the Hadamard 1906 [601] counterexample of a boundary data all of whose matching functions explode to infinite Dirichlet integral ♠ a weaker result of this type was already obtained by Prym 1871 [1226] who gave a continuous function on the unit-circumference whose harmonic extension to the disc (existence via e.g. Poisson) has infinite Dirichlet integral ♠ can we characterize such exploding functions? Maybe in terms of wild oscillations (can a such be differentiable (probably recall the wild functions à la Köpcke–Denjoy, etc.), C^1 (=continuously derivable), etc.)
◇ H. Weber albeit not a direct student of Riemann, was regarded as one of the efficient successor (e.g. by Thieme, compare Elstrodt-Ulrich [392]). Weber played a pivotal rôle (joint with Dedekind) in editing Riemann's Werke (including the Nachlass [1258]), and replaced Clebsch who desisted from this task due to health problems] ♡??
- [1568] H. Weber, *Lehrbuch der Algebra*, Bd. I und II. Friedrich Vieweg und Sohn Verlag, Braunschweig, 1898/99. [♠ Galois theory made in Germany, etc.] ♡??

- [1569] H. Weber, *Lehrbuch der Algebra*, Bd. III. Friedrich Vieweg und Sohn Verlag, Braunschweig, 1908. [♠ Vorwort (p. VII): “Dagegen habe ich, einem mehrfach an mich herangetretenen Wunsche entsprechend, einen Abriß der Theorie der algebraischen Funktionen auf arithmetischer Grundlage beigefügt, der sich im wesentlichen an die Abhandlung von Dedekind und mir im 92. Bande von Crelles Journal anschließt, aber durch Anwendung der Theorie der Functionale, auf die ich im zweiten Bande der Theorie der algebraischen Zahlen gegründet habe, wie mir scheint, eine Vereinfachung erreicht.”] ♡??
 ★ Guido Weichold, a student of Felix Klein, who add the honor to be the first writer using Klein’s prose “ortho- dia-symmetrisch”. Apart from the next entry the writer is not aware of any other work by this writer.
- [1570] G. Weichold, *Ueber symmetrischen Riemann’sche Flächen und die Periodicitätsmoduln der zugehörigen Abel’schen Normalintegrale erster Gattung*, Z. Math. Phys. 28 (1883), 321–351. [♠ exposes the theory of Klein’s symmetric surfaces in full detail (basing the topological study upon the Möbius-Jordan classification [730]), and do some more subtle things with period matrices ♠ this latter object is re-treated in Klein 1892 [801], and will influence the work of Comessatti 1924/26 [308] ◇ Guido Weichold was a student of Klein, who seems to have been strongly attracted to the topic of symmetric Riemann surfaces through Klein’s lectures. Apparently, Weichold did not pursued his research on this topic] ♡45
 ★ Karl Weierstrass, needs not being introduced (just keep in mind his admiration for Abel, his competition with Riemann, notably that he never managed to publish a general solution to Jacobi inversion problem outside of the special hyperelliptic case [cf. his letters to Sonja Kowalevskaya], and his (little, nearly prohibitive) role upon the Schottky’s thesis which rediscovers Riemann’s phenomenon of total reality for schlichtartig [=planar] membranes).
- [1571] K. Weierstrass, *Über das sogenannte Dirichletsche Princip*. In: Werke vol. 2, Mayer & Müller, 49–54, 1895. gelesen in der Königl. Akademie der Wissenschaften am 14. Juli 1870. [♠ a little objection to the Dirichlet principle, yet with disastrous repercussions ♠ resurrection by Hilbert 1900, etc. [664] ◇ Karl Weierstrass needs not to be introduced. Formally a student of Gudermann, he came across the problem of Jacobi inversion, but unfortunately never published his solution (probably being slightly devanced by Riemann 1857 in this respect). Of course as the whole Riemann approach was for a long time subjected to critics, it would have been of prior interest to know what can be achieved through the pure Weierstrass conceptions collapsing to a sort of arithmetics of power series] ♡??
- [1572] K. Weierstrass, *Vorlesungen 1875/76*. In: Werke, Bd. IV. [♠ algebraic and Abelian functions] ♡??
- [1573] A. Weil, *The field of definition of a variety*, Amer. J. Math. 78 (1956), 509–524. [♠] ♡??
- [1574] A. Weil, *Modules des surfaces de Riemann*, Sémin. Bourbaki, Mai (1958). [♠ Teichmüller et cie.] ♡??
- [1575] G.G. Weill, *Reproducing kernels and orthogonal kernels for analytic differentials on Riemann surfaces*, Pacific J. Math. 12 (1962), 729–767. [♠ refers to Ahlfors-Sario 1960 [26] for the Bergman kernel on Riemann surfaces, other source includes Schiffer-Spencer 1954 [1352] ◇ Weill is a student of Sario (Ph.D.) ca. 1962] ♡7
- [1576] D. A. Weinberg, *The topological classification of cubic curves*, Rocky Mountain J. Math. 18 (1988), 665–679. [♠ must give some fascinating historical comments on Newton’s census like in Korchagin-Weinberg 2005 [867]] ♡??
- [1577] H. F. Weinberger, *An isoperimetric inequality for the N -dimensional free membrane problem*, J. Rat. Mech. Anal. 5 (1956), 633–636. [♠ inspired by Szegő, but starts to give a more topological argument but the existence of balanced test functions; culminate to Fraser-Schoen 2011 [456], where the junction with the Ahlfors map is made explicit] ♡??
- [1578] R. Weinstock, *Inequalities for a classical eigenvalue problem*, J. Rat. Mech. Anal. 3 (1954), 745–753. [♠ inspired by Szegő, but Steklov eigenvalues; culminate in Fraser-Schoen 2011 [456], where the junction with the Ahlfors map is made explicit] ♡??
- [1579] G. Weiss, *Complex methods in harmonic analysis*, Amer. Math. Monthly 77 (1970), 465–474. [♠]★★★ ♡??
 ★ Welschinger, student of V. Kharlamov.

- [1580] J.-Y. Welschinger, *Courbes algébriques réelles et courbes flexible sur les surfaces réglées de base $\mathbb{C}P^1$* , Proc. London Math. Soc. (3) 85 (2002), 367–392. [♠] ♡??
- [1581] J. Wermer, *Function rings and Riemann surfaces*, Ann. of Math. (2) 67 (1958), 45–71. [♠]★★★ ♡??
- [1582] J. Wermer, *Rings of analytic functions*, Ann. of Math. (2) 68 (1958), 550–561. [♠]★★★ ♡??
- [1583] J. Wermer, *Analytic disks in maximal ideal spaces*, Amer. J. Math. 86 (1964), 161–170. [♠]★★★ ♡??
- [1584] H. Weyl. *Das asymptotische Verteilungsgesetz der Eigenwerte linearer partieller Differentialgleichungen*, Math. Ann. 71 (1912), 441–479. [♠ the so-called Weyl’s (asymptotic) law asserting that one can hear the area of a drum ♠ naive conjecture [ca. Mai 2011] can this Weyl’s law be employed as tool to prove the Gromov filling area conjecture (eventually in conjunction with an Ahlfors map to make the usual conformal transplantation of vibratory modes, cf. e.g. Fraser-Schoen 2011 [456] for the first implementation of Ahlfors’ circle maps in spectral theory)] ♡high?
- [1585] H. Weyl. *Die Idee der Riemannschen Fläche*, B. G. Teubner, Leipzig und Berlin 1913. ♡high?
- [1586] H. Weyl. *Ueber das Pick-Nevanlinnasche Interpolationsproblem und sein infinitesimales Analogon*, Ann. of Math. (2) 36 (1935), 230–254. [♠] ♡??
- [1587] H. Weyl. *The method of orthogonal projection in potential theory*, Duke Math. J. 7 (1940), 411–440. AS60 ★ ♡??
- [1588] H. Whitney, *On the topology of differentiable manifolds*, Univ. of Michigan Lectures (1941), 101–141, cf. also Collected Papers. [♠ cited in Rohlin 1972/72 [1286] for the congruence $2\chi(F) + x(F) \equiv \sigma(M^4) \pmod{4}$ between the normal Euler number $x(F)$ and the signature σ of a 4-manifold, which is applied to rederive Arnold’s congruence; for another proof along Rohlin’s formula, cf. v.2] ♡??
- [1589] H. Whitney, *Complex analytic varieties*, Addison Wesley Publ. Company, Reading, Mass. 1972. [♠] ♡??
- [1590] H. Widom. *Extremal polynomials associated with a system of curves in the complex plane*, Adv. Math. 3 (1969), 127–232. [♠]★★ ♡??
- [1591] H. Widom, *H_p sections of vector bundles over Riemann surfaces*, Ann. of Math. (2) 94 (1971), 304–324. AS60 [♠ the geometric quintessence of the paper seems to be Lemma 6 (p.320), created with apparently some helping hand from Royden, and amounting to prescribe (modulo 2π) the periods of the conjugate differential of a superposition of (modified) Green’s functions ♠ albeit Ahlfors 1950 [19] is not directly cited, a certain technological “air de famille” transpires throughout the execution ♠ alas, Widom’s argument (pp.320–1) seems to give only a poor control upon the number of poles ζ_k required, and is therefore unlikely to reprove Ahlfors 1950 [19] by specializing to the trivial line bundle case ♠ but of course, Widom do something quite grandiose and so the real depth of the work cannot be appreciated by focused comparison with Ahlfors 1950 [19] ♠ in particular Widom (re)discover a certain class of open Riemann surfaces (alias of Parreau-Widom) type which are characterized by a moderate growth of the Betti number during the cytoplasmic expansion generated by levels of the Green’s function, which turns out to be a very distinguished class of Riemann surfaces where paradigms like the corona, etc. extends reasonably] ♡35
- [1592] H. Wileitner, *Algebraische Kurven, t. I, II*, Leipzig, Sammlung Göschen, Walter de Gruyter & Co., Berlin-Leipzig, 1930. [♠ cited in Gudkov 1974 [579] and in Gudkov 1988 [584].] ♡??
- [1593] R. J. Wille, *Sur la transformation intérieure d’une surface non orientable dans le plan projectif*, Indagationes Math. 56 (1953), 63–65. [♠ probably a nonorientable avatar of Stoilow’s work, and maybe related to Witt 1934 [1602]]★★★ ♡??
- ★ G. Wilson, student of ?, well-known for his popular survey explaining some of the recent advances made by the Russian school, while cleaning a bit some of their statements (notably extended version of Arnold’s congruence mod 4, detection of a mistake in Rohlin 1972=1st proof of Gudkov’s hypothesis, and especially a type I criterion via an extremal property of Arnold’s strong variant of Petrovskii, cf. Rohlin 1978).

- [1594] G. Wilson, *Hilbert's sixteenth problem*, Topology 17 (1978), 53–73. [♠ discusses Klein's orthosymmetry (as dividing curves) and ask whether the dividing character of a real plane curve may be recognized by sole inspection of its real locus, p. 67: "I do not know if one can tell whether or not X divides by examining only the real part $X_{\mathbb{R}} \subset \mathbb{R}P^2$." ♠ Our partisan answer (compare Gabard 2004 [462, p. 7]) is a decided *yes*, posited by Ahlfors theorem ♠ however this is pure existence theory and some algorithmic recipes still deserve to be implemented at the occasion. For related efforts cf. e.g. Kalla-Klein 2012 [745]] ♡??
- ★ Anders Wiman (1865–1959, aged 94) (Upsala, Schweden) is a well-known contributor to Hilbert's 16th (with his 1923 paper), notably the construction of one scheme in degree 8. His article contains also an explicit study of what can be derived in degree 7, 8 from Hilbert's method. Additionally, near the end of his article Wiman extrapolates also à la Rohlin Klein's maximality conjecture so as to speculate on the maximality of all satellites of his series of M -schemes. Hence the role of Wiman along the philosophy of our present text can hardly be underestimated and was quite shamefully omitted by us in v.2 (April 2013) of our text. So we see a great constellation Klein–Wiman–Rohlin against Hilbert–Rohn–Gudkov, where roughly put Riemann's complexification governs the destiny of the distribution of real ovals. At this stage contemplating our genealogy map (Fig. 164) we got surprised (due to our failing memory) that Wiman is of course one of the major figure in analysis too in Sweden, namely his Ph.D. is dated 1892 and he is nothing less than Beurling's advisor (Ph.D. 1933). More universally Wiman made many contributions to the field of algebraic geometry (curves with collineations, ruled surfaces, finite subgroups of Cremona, etc.), number theory (abelian class field theory) and finished his career with the arithmetics of cubic curves.
- [1595] A. Wiman, *Über die reellen Züge der ebenen algebraischen Kurven*, Math. Ann. 90 (1923), 222–228. [♠ as explained in Viro 1980/80 [1527], this method of Wiman leads to interesting schemes in degree 8 (not accessible to Harnack or Hilbert's method) but actually just one of them ♠ also during a short conversation with Mikhalkin [16.04.13], Grisha pointed out that Wiman's doubling construction may bear some analogy with the operation of satellites (as introduced in this text [of Gabard]) ♠ Wiman's work seems to contain some overlap with Ragsdale work (1906), which is erroneously presented as "Herr Ragsdale" [cf. Zusatz bei der Korrektur, p. 228], while it is a Miss, and cite also the work by Hulburt, yet seems to overcome their obstruction to use ground curves other than line or ellipses in the vibration method. Nowadays it seems that the method of Wiman is subsumed to that of Viro, but perhaps still deserves to be studied at the occasion. ♠ p. 224 states the result (probably already in Ragsdale) that for each odd order there is an M -curve without nesting. ★ p. 227 is especially crucial [09.05.13] and corroborate Mikhalkin's guess (oral communication 16 April 2013, after Cimasoni's Talk) that Wiman may be regarded as a forerunner of Gabard's satellites conjecture (and the allied Rohlin's maximality principle), namely Wiman writes: "Kurven von der Ordnung $2rn$, welche reelle Züge von der oben beschprochenen Anzahl und gegenseitigen Lage enthalten, dürften [note the conditional] nach der Terminologie des Herrn F. Klein immer orthosymmetrisch sein, so daß keine weiteren reellen Züge bei denselben vorkommen können. Für $n = 2$, läßt sich dies unmittelbar beweisen. [...]" The sequel is merely the Bézout-saturation of the satellite of the quadri-foolium. So here to paraphrase Wiman's conjecture in our language we can say that he conjectures that the satellites of his M -schemes are maximal. To understand this a bit it is worth stating Wiman's result (p. 226) as follows: for each even degree $m = 2k$ there is an M -curve (Wiman's) whose scheme is a "triangle" of $\frac{(k-1)(k-2)}{2}$ many nests of depth 2 plus a "square" of k^2 many outer ovals. For $k = 1, 2, 3, 4, \dots$ this sequence is easily visualized, as the conic, the quadri-foolium quartic (of Plücker-Zeuthen), the Harnack sextic $\frac{1}{1}9$, and then the Wiman octic $16\frac{1}{1}\frac{1}{1}$.] ♡??
- [1596] J. Winkelmann, *Non-degenerate maps and sets*, Math. Z. (2005), 783–795. A50 [♠ [27.09.12] Ahlfors 1950 [19] is cited, yet not within the main-body of the text, but its companion Bell 1992 [100] is cited for the same purpose. In fact Winkelmann's article only uses the planar case of the Ahlfors function, hence citing Ahlfors 1947 [18] may have been more appropriate (yet recall that the latter article contains a little gap fixed in Ahlfors 1950 [19, p. 123, footnote]) ♠ the author gives the following lovely application of the Ahlfors map of a plane bounded domain ♠ call a holomorphic map *dominant* if it has dense image, and a complex manifold universally dominant (UDO) if it admits a dominant map to any irreducible complex

space. The author shows first that the unit disc Δ is UDO (Cor. 3, p. 786), and via the Ahlfors function this implies more generally that any complex manifold admitting a nonconstant bounded analytic function (BAF) is UDO. Here are the details. ♠ first if the complex manifold is UDO, then it dominates the unit disc Δ , and so it carries a nonconstant BAF. Conversely, let $f: X \rightarrow \mathbb{C}$ be a nonconstant BAF then $f(X)$ is a bounded domain. (It is crucial here to assume X connected, for X the disjoint union of say two Riemann spheres carries a nonconstant BAF, yet fails to be UDO.) Now observe the following fact. **Lemma.** *The Ahlfors map f_a at a of the bounded domain $G \ni a$ is dominant.—Proof.* If not, then the map $f_a: G \rightarrow \Delta$ misses a little disc $D \subset \Delta$ not overlapping the origin (recall that $f_a(a) = 0$). Since the identity map restricted to the ring $\Delta - \overline{D}$ is bounded-by-one (hence admissible in the extremal problem), it follows that the Ahlfors map for the ring centered at 0, say g_0 , has a derivative with modulus strictly larger than unity, i.e. $|g'_0(0)| > |(id)'(0)| = 1$. But then the composed map $(g_0 \circ f_a)$ effects the stretching $|(g_0 \circ f_a)'(a)| = |(g'_0(f_a(a)) \cdot f'_a(a))| = |g'_0(0) \cdot f'_a(a)| > |f'_a(a)|$, violating the extremal property of f_a . q.e.d.—♠ At this stage it may be observed that the Ahlfors map of a bounded domain needs not be surjective. Consider indeed the unit disc Δ punctured at say $1/2$, then the Ahlfors function of $\Delta - \{1/2\}$ centered at 0, denoted f_0 , is the identity (up to a rotation). Indeed, since a (pointlike) puncture is a removable singularity for BAF any function admitted in the extremal problem extends analytically across the whole unpunctured disc. More generally, the Ahlfors map is insensitive to the puncturing of a removable singularity (alias Painlevé null sets), e.g. Cantor's $1/4$ -set described in Garnett 1970 [502] ♠ back to Winkelmann's argument, the above lemma applied to $G := f(X)$ gives a dominant map f_a to the disc, hence a dominant map $X \rightarrow f(X) \rightarrow \Delta$. Summarizing: *any complex manifold X supporting a nonconstant BAF dominates the disc.* ♠ Perhaps one could try to improve this by using the surjectivity of the Ahlfors map for a domain of finite connectivity (without pointlike boundaries), assuming e.g. that X has a finitely generated fundamental group π_1 . Alas, this does not seem to imply automatically that $\pi_1(f(X))$ is of finite generation and we need of course to control the shape of the image $f(X)$, which has to be a finite region bounded by Jordan curves ♠ finally since the disc Δ dominates any irreducible complex space Y (of course the definition of the latter must be calibrated so as to avoid non-metric complex manifolds of Calabi-Rosenlicht of the Prüfer type, at least those specimens which are not separable), the composition $X \rightarrow f(X) \rightarrow \Delta \rightarrow Y$ yields the desired dominant map showing that X is UDO. This completes Winkelmann's proof.] ♡5

- [1597] W. Wirtinger, *Untersuchungen über Thetafunktionen*, Teubner, 1895. ♡??
- [1598] W. Wirtinger, *Algebraische Funktionen und ihre Integrale*, Enzykl. d. math. Wiss. 2₂ (1902), 115–175. AS60 ♡??
- [1599] W. Wirtinger, *Über die konforme Abbildung der Riemannschen Flächen durch Abelsche Integrale besonders bei $p = 1, 2$* , Denkschr. Wien (1909), 22 pp. AS60 ♡??
- [1600] W. Wirtinger, *Über eine Minimalaufgabe im Gebiete der analytischen Funktionen*, Monatsh. Math. u. Phys. 39 (1932), 377–384. [♣ quoted p. 269 of Schiffer 1950 [1350] for a the first notice of a certain reproducing kernel property, also quoted in Bergman 1950 [123] ♠ poses (and solves via the Green's function) the problem of the best analytic approximation f in L^2 -norm $\int \int_B |f - \Phi|^2 d\omega$ of a given continuous function Φ] ♡4
- [1601] W. Wirtinger, *Zur Theorie der konformen Abbildung mehrfach zusammenhängender ebener Flächen*, Abh. Preuß. Akad. Wiss. math.-nat. Kl. 4 (1942), 1–9. AS60, G78 [♣ reproves the theorem of Riemann-Schottky-Bieberbach-Grunsky (=RSBG), i.e. the schlicht(artig) case of the Ahlfors map, via algebraic functions (i.e. Riemann-(Roch) essentially)] ♡low 0
- [1602] E. Witt, *Zerlegung reeller algebraischer Funktionen in Quadrate*, J. Reine Angew. Math. 171 (1934), 4–11. [♣ contains a sort of non-orientable version of the Riemann/Ahlfors map. Subsequent developments in Geyer 1964/67 [519] and Martens 1978 [969]] ♡??
- [1603] E. Witten, *Two dimensional gravity and intersection theory on the moduli space*, Survey in Differential Geometry, Leigh Univ., 1991, 243–310. [♠] ♡??
- [1604] J. J. Wolfart, *The 'obvious' part of Belyi's theorem and Riemann surfaces with many automorphisms*, In: *Geometric Galois Actions, 1*, London Math. Soc. Lecture Note Series 242, 1997. [♣] ♡48

- [1605] S. Wolpert, *The length spectra as moduli for compact Riemann surfaces*, Ann. of Math. (2) (1979). [♣] ♥105
- [1606] I.E. Wright, *The ovals of the plane sextic curves*, Amer. J. Math. 29 (1907), 305–308. [♠ claim to prove Hilbert’s Ansatz of nesting (impossibility to have no nesting for M -sextics), yet apparently not rigorous according to Gudkov 1974 [579]] ♥??
- [1607] J.E. Wright, *Nodal cubics through eight given points*, J. London Math. Soc. (?) ?? (1907), 52–57. [♠ contains some consideration on pencils of cubics that could be useful for Rohlin’s total reality claim on the “maximal” (in the sense of Rohlin) $(M - 2)$ -sextics. The article cites only Clebsch 1866 and contains the jargon of “acnodes” which Russians (Arnold, Viro, etc.) term “solitary nodes”. In German, we (=Klein) says isolierte reelle Doppeltangente. Who coined this jargon (also employed in McDonald 1927 [989])? Cayley?] ♥??
- [1608] D.V. Yakubovich, *Real separated algebraic curves, quadrature domains, Ahlfors type functions and operator theory*, J. Funct. Anal. 236 (2006), 25–58. A50 [♣ contains also (after Alling-Greenleaf [44]) a clear-cut formulation of the Klein-Ahlfors correspondence: i.e. a curve is dividing/separating iff it maps to the line in a totally real fashion (i.e. real fibres are entirely real)] ♥2?
- [1609] A. Yamada, *On the linear transformations of Ahlfors functions*, Kodai Math. J. 1 (1978), 159–169. A50 [♣ evaluate the degree of the Ahlfors function at the Weierstrass points of a non-planar hyperelliptic membrane as taking the maximum value permissible, i.e. $r + 2p = g + 1$] ♥3
- [1610] A. Yamada, *A remark on the image of the Ahlfors function*, Proc. Amer. Math. Soc. 88 (1983), 639–642. [♠ domains of infinite connectivity ♠ p.639 (abstract extract): “By an example we show that the complement in the unit disc of the image of the Ahlfors function for Ω and p can be a fairly general set of logarithmic capacity zero.”] ♥1
- [1611] A. Yamada, *Ahlfors functions on Denjoy domains*, Proc. Amer. Math. Soc. 115 (1992), 757–763. [♠ domains of infinite connectivity ♠ p.757: “The main result of our paper gives a necessary and sufficient condition for a subset of the unit disc to be the omitted set of the Ahlfors function F for some maximal Denjoy domain and ∞ such that F is a covering onto its image. As a corollary we give examples of omitted sets of Ahlfors functions that have positive logarithmic capacity.” ♠ [05.10.12] if I don’t mistake Yamada’s example thus answers a question by Minda 1981 [1015, p.755] about knowing if the Ahlfors function can “omit an uncountable set”. (Recall indeed that sets of zero logarithmic capacity are stable under countable unions, cf. p.762, where Yamada refers to Tsuji 1959 [1506, p.57].)] ♥??
- [1612] A. Yamada, *Ahlfors functions on compact bordered Riemann surfaces*, J. Math. Soc. Japan 53 (2001), 261–283. A50 [♣ establish a conjecture of Gouma 1998 [536] to the effect that the Ahlfors degree of a hyperelliptic membrane centered outside the Weierstrass points always degenerates to the minimum value 2] ♥1
- [1613] P.C. Yang, S.-T. Yau, *Eigenvalues of the Laplacian of compact Riemann surfaces and minimal submanifolds*, Ann. Sc. Norm. Sup. di Pisa (4) 7 (1980), 55–63. [♠ applies conformal branched covering of *closed* Riemann surfaces to the sphere and the trick of conformal transplantation to generate test functions yielding an estimate of the first three Laplace eigenvalues of a closed Riemann surface considered as a vibrating membrane. Inspiration Szégo, Hersch 1970 [651], but goes somewhat deeper as there is no fear of multi-sheetedness ♠ for an adaptation of Yang-Yau’s method to bordered surfaces via the Ahlfors map see Fraser-Schoen 2011 [456], or some derived products like Gabard 2011 [467] or Girouard-Polterovich 2012 [527]] ♥250?
- [1614] O. Yavuz, *Invariant subspaces for Banach space operators with a multiply connected spectrum*, Integr. Equ. Oper. Theory 58 (2007), 433–446. [♠ p.439–440, the Ahlfors function (via Fisher’s book 1983 [442]) is employed to extend a result on the existence of invariant subspaces for operators with a multiply-connected spectrum (previously known when the spectrum contained the unit-circle)] ♥??
- [1615] O. Yavuz, *A reflexivity result concerning Banach space operators with a multiply connected spectrum*, Integr. Equ. Oper. Theory 68 (2010), 473–485. [♠ p.475–6, Ahlfors function via Fisher’s book 1983 [442]] ♥??

- [1616] N. X. Yu, *On Riesz transforms of bounded function of compact support*, Michigan Math. J. 24 (1977), 169–175. [♠ p.170, Ahlfors function via Carleson’s book 1967 [248, Chapter VIII]] ♡??
- [1617] L. Zalcman, *Analytic capacity and rational approximation*, Lecture Notes in Math. 50, Springer-Verlag, Berlin–New York, 1968. A50 [♠] ♡116
- [1618] L. Zalcman, *Analytic functions and Jordan arcs*, Proc. Amer. Math. Soc. 19 (1968), 508. [♠] ♡??
- [1619] L. Zalcman, *Bounded analytic functions on domains of infinite connectivity*, Trans. Amer. Math. Soc. 144 (1969), 241–270. [♠] ♡56
- [1620] K. Zarankiewicz, *Sur la représentation conforme d’un domaine doublement connexe sur un anneau circulaire*, C.R. Acad. Sci. Paris 198 (1934), 1347–1349. [♠ Seidel’s summary: method for the effective construction of the conformal mapping of a doubly connected domain upon a circular ring, via orthogonal systems (Bergman kernel) ♠ consider (with Bergman [no precise cross-ref.]) the problem of maximizing the modulus of $f(t)$ among functions with L^2 -norm bounded by 1: $\int \int_B |f(z)|^2 \leq 1$] ♡??
- [1621] K. Zarankiewicz, *Über ein numerisches Verfahren zur konformen Abbildung zweifach zusammenhängender Gebiete*, Zeitschr. f. angew. Math. u. Mech. 14 (1934), 97–104. [♠ Seidel’s summary: a detailed account is given of the method indicated in Zarankiewicz 1934 [1620], i.e. Bergman kernel style numerical device to compute the conformal map of a doubly connected domain ♠ oft quoted e.g. in Lehto 1949 [920], Bergman 1950 [123]]★★★ ♡??
- [1622] S. Zarembo, *Sur le calcul numérique des fonctions demandées dans le problème de Dirichlet et le problème hydrodynamique*, Bull. Inst. Acad. Sci. Cracovie (1908), 125–195. [♠ quoted (e.g.) in Lions 2000/02 [935] as one of the very early apparition of the notion of reproducing kernel] ♡??
- [1623] S. Zarembo, *Sur le principe de Dirichlet*, Acta Math. ? (1910), 293–316. [♠ Hadamard’s 1906 [601] counterexample to the Dirichlet principle is cited (but not the earlier one of Prym 1871 [1226]) and further (p.294) asserts that Weber’s 1869/70 [1567] attempt to consolidate Riemann’s proof is subjected to serious objections ♠ unfortunately, Zarembo does not make explicit any objection, but it is implicit that he has in mind the Weierstrass critique (of a functional not achieving a minimum) and further Weber’s tacit assumption that the Dirichlet integral is finite is violently attacked by the Hadamard 1906 [601] counterexample of a boundary data all of whose matching functions have infinite Dirichlet integral (of course, Prym 1871 [1226] is a sufficient torpedo to destroy completely Weber’s argumentation) ♠ notice that Arzelà 1897 [74] has to be counted as a forerunner of Hilbert’s triumph of all the difficulty of the question (in certain particular cases), and mentions the remarkable extensions due to B. Levi 1906 [933], Fubini 1907 [459] and Lebesgue 1907 [916], while proposing to recover those results through a simpler method without loosing anything essential to their generality] ♡??
- [1624] O. Zariski, *On the problem of existence of algebraic functions of two variables possessing a given branch curve*, Amer. J. Math. 51 (1929), 305–328. [♠] ♡??
- [1625] O. Zariski, *Algebraic surfaces*, Springer, New York, 1971. (With Appendices by D. Mumford.) [Original edition 1935.] [♠ one of the classical bible on algebraic surfaces (theory of Noether, Castelnuovo-Enriques, Picard-Lefschetz, Severi-Neron, Zariski, etc.)] ♡??
- [1626] R. Zarrow, *Anticonformal automorphisms of compact Riemann surfaces*, Proc. Amer. Math. Soc. 54 (1976), 162–164. [♠ cf. little corrections in Costa 1996 [324]] ♡4
 ★ Hieronymus Georg Zeuthen (1839–1920), virtually a student of Chasles in Paris (1863), well-known for essential contribution to geometry (Zeuthen-Segre invariant which is just a disguised Euler characteristic, etc.), and especially pivotal for his influence upon Klein’s works somehow synthesizing the work of Riemann, and the topological concepts of Gauss-Möbius-Listing, with algebraic curves à la Plücker, Zeuthen (1874) seems also to be the first to employ the name “oval” adhered to by Harnack 1876, Hilbert 1891 (Züge), etc., up to the modern era (e.g. Petrovskii, Arnold 1971, etc.). For an appreciation of Zeuthen’s contributions cf. M. Noether’s Nachruf (1920 in Math. Annalen).
- [1627] H. G. Zeuthen, *Almindelige Egenskaber ved Systemer af plane Kurver*, Danske Videnskabernes Selskabs Skrifter, Naturvidenskabelig og Mathematisk, Afd. 10 Bd. IV, (1873), 286–293. [♠ quoted in Sottile 2002 [1447]] ♡??

- [1628] H. G. Zeuthen, *Sur les formes différentes des courbes du quatrième ordre*, Math. Ann. 7 (1874), 410–432. (+Tafel I, II, Fig. 1,2,3,4,5) [♠ a work who inspired much of Klein investigation ♠ cite von Staudt (Geometrie der Lage) ♠ uses the term “ovale” ♠ p. 411: “Une courbe du quatrième ordre (*quartique*) a, au plus, quatre branches externes l’une à l’autre, ou deux branches dont l’une se trouve dans la partie du plan interne à l’autre, et dans ce dernier cas la branche interne ne peut avoir des tangentes doubles ou d’inflexion.—Car s’il en était autrement on pourrait construire des coniques rencontrant la courbe en plus de 8 points, ou des droites la rencontrant en plus de 4 points.” (This is the sort of Bézout-type argument out of which will emerge the Harnack inequality 1876 [607]), yet the full intrinsic grasp (especially the interpretation via Riemann surfaces) will be effected through Klein’s work 1876 [795] ♠ p. 412: “Nous appelons ici réelle toute courbe dont l’équation ne contient que des coefficients réels.” ♠ p. 428, cite Geiser and the yoga between cubic surface and quartic curves, which is instrumental in Klein 1876 to make the rigid-isotopy classification of quartic curves.] ♡??
- [1629] H. G. Zeuthen, *Études des propriétés de situation des surfaces cubiques*, Math. Ann. 8 (1875), 1–30. [♠ also quoted by Klein 1876, as to complete the rigid-isotopy classification of quartics by reduction to the case of cubics (Schläfli 1863 [1339] and Klein 1873 [791])] ♡??
- [1630] M. Zhang, Y. Li, W. Zeng, X. Gu, *Canonical conformal mapping for high genus surfaces with boundaries*, Computers Graphics 36 (2012), 417–426. [♠ completely in line with our present topic, and use high powered machinery like Koebe’s iteration and (Yau-Hamilton’s) Ricci flow for conformal theoretic purposes ♠ can we adapt such algorithms to the (Ahlfors) circle map] ♡??
- [1631] V. A. Zmorovič, *The generalization of the Schwarz formula for multiply connected domains*, (Ukrainian) Dokl. Akad. Nauk Ukrain. SSR 7 (1962), 853–856. [♠ quoted in Khavinson 1984 [782]]★★ ♡??
★ V. I. Zvonilov, student of Rohlin ca. 1978, well-known for important contribution (compare e.g. Rohlin 1978 [1290]).
- [1632] V. I. Zvonilov, *The inequalities of Kharlamov and the inequalities of Petrovskii-Oleinik*, Funkt. Anal. Prilozhen. 9 (1975), 69–70. [♠] ♡??
- [1633] V. I. Zvonilov, *A stronger version of the inequality of Petrovskii and Arnold for curves of odd degree*, Funkt. Anal. Prilozhen. 13 (1979), 31–39. [♠] ♡??
- [1634] V. I. Zvonilov, *Complex topological characteristics of real algebraic curves on surfaces*, Funkt. Anal. Prilozhen. 16 (1982), 56–57; English transl. in Funct. Anal. Appl. 16 (1982), 202–204. [♠]★ ♡??
- [1635] V. I. Zvonilov, *Complex orientations of real algebraic curves with singularities*, Dokl. Akad. Nauk SSSR 268 (1983), 22–26; English transl., Soviet Math. Dokl. 27 (1983), 14–17. [♠]★ ♡??
- [1636] V. I. Zvonilov, *Complex topological characteristics of real algebraic curves on a hyperboloid and an ellipsoid*, Funkt. Anal. Prilozhen. ?? (1986), ?–?; English transl. in Funct. Anal. Appl. ?? (1986), ?–?. [♠ cf. perhaps also the next entry]★ ♡??
- [1637] V. I. Zvonilov, *Complex topological invariants of real algebraic curves on a hyperboloid and on an ellipsoid*, St. Petersburg Math. J. 3 (1992), 1023–1024. [♠ cited in Trilles 2003 [1501]]★ ♡??

Alexandre Gabard
 Université de Genève
 Section de Mathématiques
 2-4 rue du Lièvre, CP 64
 CH-1211 Genève 4
 Switzerland
 alexandregabard@hotmail.com

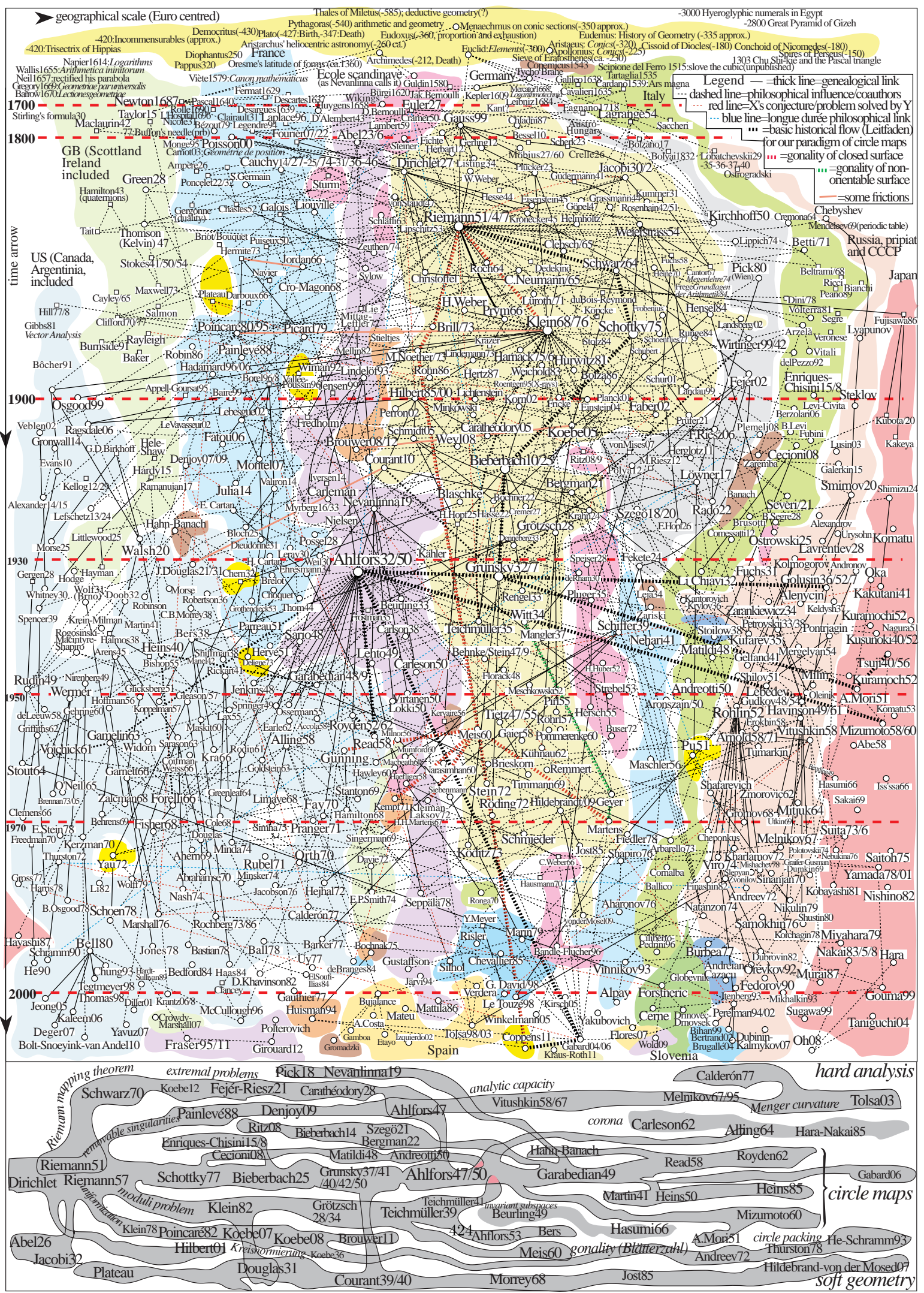

Figure 164: The authors involved in this bibliography (and genealogy)