

Robust Supervisory Control for Uniting Two Output-Feedback Hybrid Controllers with Different Objectives

Ricardo G. Sanfelice and Christophe Prieur

Abstract

The problem of robustly, asymptotically stabilizing a point (or a set) with two output-feedback hybrid controllers is considered. These control laws may have different objectives, e.g., the closed-loop systems resulting with each controller may have different attractors. We provide a control algorithm that combines the two hybrid controllers to accomplish the stabilization task. The algorithm consists of a hybrid supervisor that, based on the values of plant's outputs and (norm) state estimates, selects the hybrid controller that should be applied to the plant. The accomplishment of the stabilization task relies on an output-to-state stability property induced by the controllers, which enables the construction of an estimator for the norm of the plant's state. The algorithm is motivated by and applied to robust, semi-global stabilization problems uniting two controllers.

I. INTRODUCTION

Background and Motivation

Many control applications cannot be solved by means of a single state-feedback controller. As a consequence, control algorithms combining more than one controller have been thoroughly investigated in the literature. Particular attention has been given to the problem of uniting local and global controllers, in which two control laws are used: one that is supposed to work only locally, perhaps guaranteeing good performance, and another that is capable of steering the system trajectories to a neighborhood of the operating point, where the local control law works. Different strategies are possible to tackle this problem. In [21], this problem is solved by patching together a local optimal controller and a global controller designed using backstepping. In [17], a static time-invariant controller was designed by smoothly blending global and local controllers. In [2], two control-Lyapunov functions are combined to design a global stabilizer for a class of nonlinear systems.

The use of discrete dynamics may be necessary when piecing together local and global controllers (e.g., see the example in [22], where local and global continuous-time controllers cannot be united using a continuous-time supervisor). This additional requirement leads to a control scheme with mixed discrete/continuous dynamics, see [30], [22], and [10], where controllers to piece together two given state-feedback laws are proposed. Based on these techniques, different applications have been considered, such as the stabilization of the inverted pendulum [27] and the position and orientation of a mobile robot [26]. These ideas have been extended in [25] to allow for the combination of multi-objective controllers, including state-feedback laws as well as open-loop control laws. More recently, they have also been extended to the case when, rather than state-feedback, only output-feedback controllers are available [24]. A trajectory-based approach for the design of robust multi-objective controllers that regulate a particular output to zero while keeping another output within a prescribed limit was introduced in [9]. In the context of performance, a trajectory-based approach was also employed in [8] to generate dwell-time and

Department of Aerospace and Mechanical Engineering, University of Arizona 1130 N. Mountain Ave, AZ 85721, USA (Tel: 520-626-0676; e-mail: sricardo@u.arizona.edu). Research partially supported by the National Science Foundation under CAREER Grant no. ECS-1150306 and by the Air Force Office of Scientific Research under Grant no. FA9550-12-1-0366.

Department of Automatic Control, Gipsa-lab, 961 rue de la Houille Blanche, BP 46, 38402 Grenoble Cedex, France (e-mail: christophe.prieur@gipsa-lab.grenoble-inp.fr). Research partially supported by HYCON2 Network of Excellence "Highly-Complex and Networked Control Systems," grant agreement 257462.

hysteresis-based control strategies that guarantee an input-output stability property characterizing closed-loop system performance.

In this paper, we study the robust stabilization of nonlinear systems of the form

$$\mathcal{P}: \quad \dot{\xi} = f_p(\xi, u_p) \quad \xi \in \mathbb{R}^{n_p}, \quad u_p \in \mathbb{R}^{m_p} \quad (1)$$

via the combination of two hybrid controllers that use only measurements of outputs of the plant. The motivation of such a problem is twofold. On the one hand, the impossibility of robustly stabilizing an equilibrium point (or set) with smooth or discontinuous control laws (see, e.g., [3]) precludes utilizing uniting controllers that combine smooth or discontinuous (non-hybrid) state-feedback laws. On the other hand, the typical limitation of measuring all of the plant variables for state-feedback control demands the use of output-feedback controllers as well as the use of multiple controllers that can be combined in a systematic manner to accomplish a given task. These challenges emerge in stabilization problems with information and actuation constraints. For instance, in motion planning of autonomous vehicles for navigation in cluttered environments, in addition to unavoidable input constraints, obstacles introduce topological constraints that restrict the sensing range. In such scenarios, control algorithms may combine information from multiple sensors and select the most appropriate control strategy to execute. Due to the different properties induced by the individual controllers in such applications, we refer to the problem studied in this paper as the problem of uniting two output-feedback hybrid controllers with different objectives, where one of the controllers steers the trajectories to a set (this is the objective of the global controller) and another controller asymptotically stabilizes a different target set (this is the objective of the local controller); cf. [9].

Contributions

We propose a hybrid controller to solve the problem of uniting two output-feedback laws with different objectives. Figure 1 depicts the proposed solution, which consists of supervising the two output hybrid controllers, which are denoted by \mathcal{K}_0 and \mathcal{K}_1 , with “local” and “global” stabilizing capabilities, respectively. By combining a discrete and several continuous states, for any compact set of initial conditions, we design a robustly stabilizing supervisory algorithm with a basin of attraction containing the given compact set of initial conditions, i.e., the controller renders a target set semi-globally asymptotically stable. The supervisory algorithm consists of a hybrid controller, which is denoted by \mathcal{K}_s , and uses logic-based switching to unite controllers \mathcal{K}_0 and \mathcal{K}_1 . Our approach builds from the ideas in [24] on uniting output-feedback continuous-time controllers and in [18], [19], [15], [26] on supervisory control algorithms.

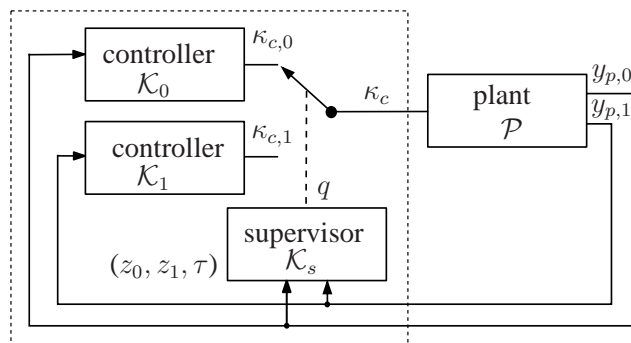

Fig. 1. Proposed control approach for Problem (\star).

The features of the proposed hybrid supervisor include:

- *Uniting of hybrid controllers:* controllers \mathcal{K}_0 and \mathcal{K}_1 are not restricted to being continuous-time controllers; instead, they can be hybrid controllers involving continuous and discrete variables. In this

way, the proposed solution extends the technique of uniting two continuous-time controllers available in the literature to the case when the individual controllers are hybrid, which, in turn, permits applying the uniting method to plants that cannot be robustly stabilized by smooth or discontinuous control laws.

- *Controllers with different objectives:* controllers \mathcal{K}_0 and \mathcal{K}_1 can have different objectives in the sense that they may stabilize different attractors. This enables the systematic design of controllers that steer trajectories to a certain point (or set) from where local controllers can take over and stabilize the desired point (or set). This procedure has been heuristically used in robotic applications [4].
- *Output feedback without underlying input-output-to-state stability assumption on the plant:* for the solution of the uniting problem of interest (see Problem (\star) in Section III) the proposed hybrid supervisor requires an output-to-state stability property for each of the closed-loop systems resulting when the individual controllers are used. This assumption is weaker than the input-output-to-state stability condition on the plant in [24]. The mechanism enabling this relaxation is a timer state included in the proposed hybrid supervisor.

In this work, each of the output-feedback hybrid controllers is known to confer certain properties to each of the resulting closed-loop systems: the first controller renders, for the plant state, a target compact set locally asymptotically stable, while the second controller renders a particular compact set attractive. As a difference to the controllers in [25], [9], [8], the individual controllers can be hybrid and their objectives given in terms of compact sets rather than equilibrium points (the latter feature actually enables the use of hybrid controllers as these typically stabilize sets larger than a single point; see [13] for a discussion). Note that as a difference to [8], where switching times are optimally computed, the objective of the proposed hybrid supervisor is to robustly stabilize a desired compact set. Our construction exploits the fact that, as established in [29] for continuous-time nonlinear systems and generalized to hybrid systems in [6], [5], this property implies the existence of an estimator of the norm of the state. We work within the hybrid systems framework of [13] (see also [11], [14]) and employ results on robust asymptotic stability reported in [14]. Two examples involving systems with input constraints and limited information are used throughout the paper to illustrate the application of our results.

Organization of the paper

The remainder of the paper is organized as follows. After basic notation is introduced, Section II presents a short description of the framework used for analysis. The main result follows in Section III. This section starts by introducing the problem to be solved, the proposed formulation of a solution, and the required assumptions. In addition to presenting a design procedure for the supervisor, it establishes a robust stability property of the closed-loop system. Examples are introduced throughout the paper to illustrate the ideas. In Section IV, the proposed hybrid supervisor is applied to the systems in these examples.

We use the following notation and definitions throughout the paper. \mathbb{R}^n denotes n -dimensional Euclidean space. $\mathbb{R}_{\geq 0}$ denotes the nonnegative real numbers, i.e., $\mathbb{R}_{\geq 0} = [0, \infty)$. \mathbb{N} denotes the natural numbers including 0, i.e., $\mathbb{N} = \{0, 1, \dots\}$. \mathbb{B} denotes the open unit ball in Euclidean space centered at the origin. Given a vector $x \in \mathbb{R}^n$, $|x|$ denotes the Euclidean vector norm. Given a set S , \bar{S} denotes its closure. Given a set $S \subset \mathbb{R}^n$ and a point $x \in \mathbb{R}^n$, $|x|_S := \inf_{y \in S} |x - y|$. The notation $F : S \rightrightarrows S$ indicates that F is a set-valued map that maps points in S to subsets of S . For simplicity in the notation, given vectors x and y , we write, when convenient, $[x^\top y^\top]^\top$ with the shorthand notation (x, y) . A function $\alpha : \mathbb{R}_{\geq 0} \rightarrow \mathbb{R}_{\geq 0}$ is said to belong to the class \mathcal{K} if it is continuous, zero at zero, and strictly increasing. A function $\alpha : \mathbb{R}_{\geq 0} \rightarrow \mathbb{R}_{\geq 0}$ is said to belong to the class \mathcal{K}_∞ if it belongs to the class \mathcal{K} and is unbounded. A function $\beta : \mathbb{R}_{\geq 0} \times \mathbb{R}_{\geq 0} \rightarrow \mathbb{R}_{\geq 0}$ is said to belong to class \mathcal{KL} if it is nondecreasing in its first argument, nonincreasing in its second argument, and $\lim_{s \searrow 0} \beta(s, t) = \lim_{t \rightarrow \infty} \beta(s, t) = 0$. A function $\beta : \mathbb{R}_{\geq 0} \times \mathbb{R}_{\geq 0} \times \mathbb{R}_{\geq 0} \rightarrow \mathbb{R}_{\geq 0}$ is said to belong to class \mathcal{KLL} if, for each $r \in \mathbb{R}_{\geq 0}$, the functions $\beta(\cdot, \cdot, r)$ and $\beta(\cdot, r, \cdot)$ belong to class \mathcal{KL} .

II. HYBRID SYSTEMS PRELIMINARIES

In this paper, we consider hybrid systems as in [13], [12], where solutions can evolve continuously (flow) and/or discretely (jump) depending on the continuous and discrete dynamics of the hybrid systems, and the sets where those dynamics apply. In general, a hybrid system \mathcal{H} is given by data (h, C, F, D, G) and can be written in the compact form

$$\mathcal{H} : \begin{cases} \dot{\chi} & \in F(\chi) & \chi \in C \\ \chi^+ & \in G(\chi) & \chi \in D \\ y & = h(\chi), \end{cases}$$

where χ is the state taking values from \mathbb{R}^n , the set-valued map F defines the continuous dynamics on the set C and the set-valued map G defines the discrete dynamics on the set D . The notation χ^+ indicates the value of the state χ after a jump¹. The function h defines the output. Solutions to \mathcal{H} will be given on hybrid time domains, which are subsets E of $\mathbb{R}_{\geq 0} \times \mathbb{N}$ that, for every $(T, J) \in E$, $E \cap ([0, T] \times \{0, 1, \dots, J\})$ can be written as $\bigcup_{j=0}^{J-1} ([t_j, t_{j+1}], j)$ for some finite sequence of times $0 = t_0 \leq t_1 \dots \leq t_J$. A solution to \mathcal{H} will consist of a hybrid time domain $\text{dom } \chi$ and a hybrid arc $\chi : \text{dom } \chi \rightarrow \mathbb{R}^n$, which is a function with the property that $\chi(t, j)$ is locally absolutely continuous on $I_j := \{t : (t, j) \in \text{dom } \chi\}$ for each $j \in \mathbb{N}$, satisfying the dynamics imposed by \mathcal{H} . More precisely, the following hold:

(S1) For each $j \in \mathbb{N}$ such that I_j has nonempty interior

$$\begin{aligned} \chi(t, j) &\in C && \text{for all } t \in [\min I_j, \sup I_j] \\ \dot{\chi}(t, j) &\in F(\chi(t, j)) && \text{for almost all } t \in I_j; \end{aligned} \quad (2)$$

(S2) For each $(t, j) \in \text{dom } \chi$ such that $(t, j+1) \in \text{dom } \chi$,

$$\chi(t, j) \in D, \quad \chi(t, j+1) \in G(\chi(t, j)). \quad (3)$$

Hence, solutions are parameterized by (t, j) , where t is the ordinary time and j corresponds to the number of jumps. A solution χ to \mathcal{H} is said to be *complete* if $\text{dom } \chi$ is unbounded, *Zeno* if it is complete but the projection of $\text{dom } \chi$ onto $\mathbb{R}_{\geq 0}$ is bounded, and *maximal* if there does not exist another hybrid arc χ' such that χ is a truncation of χ' to some proper subset of $\text{dom } \chi'$. For more details about this hybrid systems framework, we refer the reader to [13].

When the data (h, C, F, D, G) of \mathcal{H} satisfies the conditions given next, hybrid systems are well posed in the sense that they inherit several good structural properties of their solution sets. These include sequential compactness of the solution set, closedness of perturbed and unperturbed solutions, etc. We refer the reader to [14] (see also [11]) and [28] for details on and consequences of these conditions.

Definition 2.1: (Well-posed hybrid systems) The hybrid system \mathcal{H} with data (h, C, F, D, G) is said to be well posed if it satisfies the following hybrid basic conditions: the sets C and D are closed, the mappings $F : C \rightrightarrows \mathbb{R}^n$ and $G : D \rightrightarrows \mathbb{R}^n$ are outer semicontinuous and locally bounded,² $F(x)$ is nonempty and convex for all $x \in C$, $G(x)$ is nonempty for all $x \in D$, and $h : \mathbb{R}^n \rightarrow \mathbb{R}^m$ is continuous.

III. UNITING TWO OUTPUT-FEEDBACK HYBRID CONTROLLERS USING A HYBRID SUPERVISOR

A. Problem statement, solution approach, and assumptions

We consider the stabilization of a compact set for nonlinear control systems of the form (1) with only measurements of two outputs $y_{p,0}$ and $y_{p,1}$ given by functions of the state h_0 and h_1 , respectively, where f_p is a continuous function. That is, we are interested in solving the following problem:

¹Precisely, $\chi^+ = \chi(t, j+1)$.

²A set-valued mapping G defined on \mathbb{R}^n is *outer semicontinuous* if for each sequence $x_i \in \mathbb{R}^n$ converging to a point $x \in \mathbb{R}^n$ and each sequence $y_i \in G(x_i)$ converging to a point y , it holds that $y \in G(x)$. It is *locally bounded* if, for each compact set $\mathcal{M} \subset \mathbb{R}^n$ there exists $\mu > 0$ such that $\bigcup_{x \in \mathcal{M}} G(x) \subset \mu \mathbb{B}$.

(\star) Given compact sets $\mathcal{A}_0, \mathcal{M}_0 \subset \mathbb{R}^{n_p}$ and continuous functions h_0, h_1 defining outputs $y_{p,0} = h_0(\xi)$ and $y_{p,1} = h_1(\xi)$ of (1), design an output feedback controller that renders \mathcal{A}_0 asymptotically stable with a basin of attraction containing \mathcal{M}_0 .³

As shown in Figure 1, the proposed approach to solve this problem consists of supervising two output hybrid controllers, which are denoted by \mathcal{K}_0 and \mathcal{K}_1 , with ‘‘local’’ and ‘‘global’’ stabilizing capabilities, respectively, which are properties that will be made precise below. The supervisory algorithm consists of a hybrid controller, which is denoted by \mathcal{K}_s , that uses logic-based decision making to unite controllers \mathcal{K}_0 and \mathcal{K}_1 . The individual controllers \mathcal{K}_0 and \mathcal{K}_1 have state ζ_0 and ζ_1 , both in \mathbb{R}^{n_c} , respectively.⁴ For each $i \in \{0, 1\}$, the hybrid controller $\mathcal{K}_i = (\kappa_{c,i}, C_{c,i}, f_{c,i}, D_{c,i}, g_{c,i})$ is given by

$$\mathcal{K}_i : \begin{cases} \dot{\zeta}_i &= f_{c,i}(u_{c,i}, \zeta_i) & (u_{c,i}, \zeta_i) \in C_{c,i} \\ \zeta_i^+ &\in g_{c,i}(u_{c,i}, \zeta_i) & (u_{c,i}, \zeta_i) \in D_{c,i} \\ y_{c,i} &= \kappa_{c,i}(u_{c,i}, \zeta_i), \end{cases} \quad (4)$$

where $\zeta_i \in \mathbb{R}^{n_c}$ is the i -th controller’s state, $u_{c,i} \in \mathbb{R}^{m_{c,i}}$ the i -th controller’s input, $C_{c,i}$ and $D_{c,i}$ are subsets of $\mathbb{R}^{m_{c,i}} \times \mathbb{R}^{n_c}$, $\kappa_{c,i} : \mathbb{R}^{n_c} \rightarrow \mathbb{R}^{m_p}$ is the i -th controller’s output, $f_{c,i} : C_{c,i} \rightarrow \mathbb{R}^{n_c}$, and $g_{c,i} : D_{c,i} \rightarrow \mathbb{R}^{n_c}$. For each $i \in \{0, 1\}$, the i -th controller \mathcal{K}_i measures the plant’s output $y_{p,i} = h_i(\xi)$ only and, via the assignment $u_{c,i} = y_{p,i}$, $u_p = y_{c,i}$ defines the hybrid closed-loop system denoted by $(\mathcal{P}, \mathcal{K}_i) = (h_i, C_i, f_i, D_i, g_i)$ with state $(\xi, \zeta_i) \in \mathbb{R}^n$, $n = n_p + n_c$, and given by

$$\begin{aligned} \begin{bmatrix} \dot{\xi} \\ \dot{\zeta}_i \end{bmatrix} &= f_i(\xi, \zeta_i) := \begin{bmatrix} f_p(\xi, \kappa_{c,i}(h_i(\xi), \zeta_i)) \\ f_{c,i}(h_i(\xi), \zeta_i) \end{bmatrix} & (\xi, \zeta_i) \in C_i, \\ \begin{bmatrix} \xi^+ \\ \zeta_i^+ \end{bmatrix} &\in g_i(\xi, \zeta_i) := \begin{bmatrix} \xi \\ g_{c,i}(h_i(\xi), \zeta_i) \end{bmatrix} & (\xi, \zeta_i) \in D_i, \\ y_i &= h_i(\xi), \end{aligned} \quad (5)$$

where y_i is the output,

$$\begin{aligned} C_i &:= \{(\xi, \zeta_i) : \xi \in \mathbb{R}^{n_p}, (h_i(\xi), \zeta_i) \in C_{c,i}\}, \\ D_i &:= \{(\xi, \zeta_i) : \xi \in \mathbb{R}^{n_p}, (h_i(\xi), \zeta_i) \in D_{c,i}\}. \end{aligned}$$

(An assignment different from $u_{c,i} = y_{p,i}$, $u_p = y_{c,i}$ will be employed when a hybrid supervisor is used – see Theorem 3.5.) We say that the controller \mathcal{K}_i is well posed when the resulting closed-loop system from controlling the plant (1) with continuous right-hand side is well posed as in Definition 2.1.

The controllers \mathcal{K}_i are assumed to induce the properties that, for $i = 0$, a compact set $\mathcal{A}_0 \times \Phi_0 \subset \mathbb{R}^n$, where $\Phi_0 \subset \mathbb{R}^{n_c}$, is locally asymptotically stable for $(\mathcal{P}, \mathcal{K}_0)$ and, for $i = 1$, a compact set $\mathcal{A}_1 \times \Phi_1 \subset \mathbb{R}^n$, $\Phi_1 \subset \mathbb{R}^{n_c}$, is attractive for $(\mathcal{P}, \mathcal{K}_1)$. For a combination of both controllers to work, the set \mathcal{A}_1 will have to be contained in the plant component of the basin of attraction of \mathcal{K}_0 . In such a case, the said properties of \mathcal{K}_0 and \mathcal{K}_1 readily suggest that, when far away from \mathcal{A}_0 , \mathcal{K}_1 can be used to steer the plant’s state to a region from where \mathcal{K}_0 can be used to asymptotically stabilize \mathcal{A}_0 . However, these controllers cannot be combined using supervisory control techniques in the literature (see, e.g., [26] and the references therein) due to being hybrid and to the lack of full measurements of ξ . We resolve this issue by designing two norm observers. The existence of such observers is guaranteed when the hybrid controllers induce an output-to-state stability (OSS) property. More precisely, this OSS property assures the existence of an (smooth) exponential-decay OSS-Lyapunov function V_i with respect to $\mathcal{A}_i \times \Phi_i$ for $(\mathcal{P}, \mathcal{K}_i)$; see [6, Theorem 3.1]. As defined in [6, Definition 2.2], $V_i : \mathbb{R}^n \rightarrow \mathbb{R}_{\geq 0}$ is such that there exist class- \mathcal{K}_∞ functions $\alpha_{i,1}, \alpha_{i,2}$, class- \mathcal{K} function γ_i , and $\varepsilon_i \in (0, 1]$ satisfying: for all $(\xi, \zeta_i) \in \mathbb{R}^n$,

$$\alpha_{i,1}(|(\xi, \zeta_i)|_{\mathcal{A}_i \times \Phi_i}) \leq V_i(\xi, \zeta_i) \leq \alpha_{i,2}(|(\xi, \zeta_i)|_{\mathcal{A}_i \times \Phi_i}); \quad (6)$$

³It is desired that the basin of attraction of the closed-loop system contains \mathcal{M}_0 when projected onto \mathbb{R}^{n_p} .

⁴The case where the hybrid controllers have a dynamical state ζ_0 (respectively, ζ_1) in a set $\mathbb{R}^{n_{c0}}$ (respectively, $\mathbb{R}^{n_{c1}}$) of different dimension $n_{c0} \neq n_{c1}$ can be treated similarly by embedding both sets into the set of larger dimension.

for all $(\xi, \zeta_i) \in C_i$,

$$\langle \nabla V_i(\xi, \zeta_i), f_i(\xi, \zeta_i) \rangle \leq -\varepsilon_i V_i(\xi, \zeta_i) + \gamma_i(|h_i(\xi)|); \quad (7)$$

for all $(\xi, \zeta_i) \in D_i$,

$$\max_{g \in g_i(\xi, \zeta_i)} V_i(g) - V_i(\xi, \zeta_i) \leq -\varepsilon_i V_i(\xi, \zeta_i) + \gamma_i(|h_i(\xi)|). \quad (8)$$

The next assumption guarantees that the resulting closed-loop systems $(\mathcal{P}, \mathcal{K}_0)$ and $(\mathcal{P}, \mathcal{K}_1)$ satisfy these properties.

Assumption 3.1: Given a compact set $\mathcal{A}_0 \subset \mathbb{R}^{n_p}$ and continuous functions $f_p : \mathbb{R}^{n_p} \times \mathbb{R}^{m_p} \rightarrow \mathbb{R}^{n_p}$, $h_0 : \mathbb{R}^{n_p} \rightarrow \mathbb{R}^{m_{c,0}}$, $h_1 : \mathbb{R}^{n_p} \rightarrow \mathbb{R}^{m_{c,1}}$, where $h_0(\xi) = 0$ for all $\xi \in \mathcal{A}_0$, assume there exist compact sets $\mathcal{A}_1 \subset \mathbb{R}^{n_p}$, $\Phi_0, \Phi_1 \subset \mathbb{R}^{n_c}$, where $h_1(\xi) = 0$ for all $\xi \in \mathcal{A}_1$, such that:

1) A well-posed hybrid controller $\mathcal{K}_0 =$

$(\kappa_{c,0}, C_{c,0}, f_{c,0}, D_{c,0}, g_{c,0})$ for the plant output $y_{p,0} = h_0(\xi)$ inducing the following properties exists:

- a) **Stability:** For each $\varepsilon > 0$ there exists $\delta > 0$ such that every solution (ξ, ζ_0) to $(\mathcal{P}, \mathcal{K}_0)$ with $|(\xi(0, 0), \zeta_0(0, 0))|_{\mathcal{A}_0 \times \Phi_0} \leq \delta$ satisfies $|(\xi(t, j), \zeta_0(t, j))|_{\mathcal{A}_0 \times \Phi_0} \leq \varepsilon$ for all $(t, j) \in \text{dom}(\xi, \zeta_0)$;⁵
- b) **Attractivity:** There exists $\mu > 0$ such that every solution (ξ, ζ_0) to $(\mathcal{P}, \mathcal{K}_0)$ with $|(\xi(0, 0), \zeta_0(0, 0))|_{\mathcal{A}_0 \times \Phi_0} \leq \mu$ is complete and satisfies

$$\lim_{t+j \rightarrow \infty} |(\xi(t, j), \zeta_0(t, j))|_{\mathcal{A}_0 \times \Phi_0} = 0;$$

- c) **Output-to-state stability (OSS):** The hybrid system $(\mathcal{P}, \mathcal{K}_0)$ with output $y_{p,0} = h_0(\xi)$ is output-to-state stable with respect to $\mathcal{A}_0 \times \Phi_0$. Let V_0 denote an OSS-Lyapunov function associated with this property, and let $\gamma_0 \in \mathcal{K}$ and $\varepsilon_0 > 0$ satisfy (7) and (8) with $i = 0$. Let $\varepsilon_{0,b} > 0$ define an estimation of the basin of attraction \mathcal{B}_0 of $(\mathcal{P}, \mathcal{K}_0)$ of the form $\{(\xi, \zeta_0) : V_0(\xi, \zeta_0) \leq \varepsilon_{0,b}\}$.

2) A well-posed hybrid controller $\mathcal{K}_1 =$

$(\kappa_{c,1}, C_{c,1}, f_{c,1}, D_{c,1}, g_{c,1})$ for the plant output $y_{p,1} = h_1(\xi)$ inducing the following properties exists:

- a) **Attractivity:** Every maximal solution (ξ, ζ_1) to $(\mathcal{P}, \mathcal{K}_1)$ is complete and satisfies

$$\lim_{t+j \rightarrow \infty} |(\xi(t, j), \zeta_1(t, j))|_{\mathcal{A}_1 \times \Phi_1} = 0;$$

- b) **Output-to-state stability:** The hybrid system $(\mathcal{P}, \mathcal{K}_1)$ with output $y_{p,1} = h_1(\xi)$ is output-to-state stable with respect to $\mathcal{A}_1 \times \Phi_1$. Let V_1 denote an OSS-Lyapunov function associated with this property.

3) There exist $\varepsilon_{0,a}, \varepsilon_{1,b} > 0$ such that $\varepsilon_{0,a} < \varepsilon_{0,b}$ and, for each solution (ξ, ζ_0) to $(\mathcal{P}, \mathcal{K}_0)$ from

$$\{\xi \in \mathbb{R}^{n_p} : V_1(\xi, \zeta_1) \leq \varepsilon_{1,b}, \zeta_1 \in \Phi_1\} \times \Phi_0,$$

we have

$$\gamma_0(|h_0(\xi(t, j))|) < \varepsilon_{0,a} \varepsilon_0 \quad \forall (t, j) \in \text{dom}(\xi, \zeta_0). \quad (9)$$

Remark 3.2: Assumption 3.1 assures the existence of individual controllers with enough properties so that the uniting problem of interest is at all solvable and the proposed approach provides a solution to it. More precisely, items 1.a and 1.b are required so that the local stability requirement in Problem (\star) is attainable while 2.a is needed so that the semi-global stability requirement therein can be met. The other assumptions are particular to our proposed solution. Items 1.c and 2.b are imposed so that norm observers can be constructed. Item 3 permits the combination of the two controllers using a hybrid supervisor by ensuring that the compact set \mathcal{A}_1 , which is the plant component of the set rendered attractive with the controller \mathcal{K}_1 , is included in the basin of attraction of the closed-loop system with the controller \mathcal{K}_0 . In this way, $\mathcal{A}_0 \times \Phi_0$ can be asymptotically stabilized once \mathcal{K}_1 steers the plant state nearby \mathcal{A}_1 . Note

⁵The plant state ξ is parameterized by (t, j) since it is a state component of the hybrid system $(\mathcal{P}, \mathcal{K}_0)$, whose solutions are defined on hybrid time domains.

that items 1.a, 1.b, and 2.a are the hybrid version of the assumptions in [24]. Items 1.c and 2.b relax the assumptions in [24] as rather than asking for input-output-to-state stability (IOSS) of the plant, they impose OSS properties of the closed-loop systems $(\mathcal{P}, \mathcal{K}_0)$ and $(\mathcal{P}, \mathcal{K}_1)$.

The stabilizing property induced by controller \mathcal{K}_0 in Assumption 3.1 holds when the nonlinear system is locally stabilizable to the set \mathcal{A}_0 by hybrid feedback. Note that hybrid feedback permits stabilizing a larger class of systems than standard continuous feedback. Examples of systems that can be asymptotically stabilized by hybrid feedback include the nonholonomic integrator and Artstein circles [23], the pendubot [25], and rigid bodies [16]. The attractivity property induced by the controller \mathcal{K}_1 in Assumption 3.1 holds when the trajectories of the plant can be asymptotically steered to the set \mathcal{A}_1 (contained in the basin of attraction of the local controller). Note that, as a difference to controller \mathcal{K}_0 , it is not required for controller \mathcal{K}_1 to render the said set stable. This feature of the proposed controller allows for the design of \mathcal{K}_0 and \mathcal{K}_1 separately, being item 3 of Assumption 3.1 a common design constraint.

Next, we introduce an example and associated control problem for which the supervision of two controllers with properties as in Assumption 3.1 will be applied.

Example 3.3: Consider the stabilization of the point $\{\xi^*\}$ for the point-mass system $\dot{\xi} = u_p$, where $\xi \in \mathbb{R}^2$ is the state and $u_p = [u_1 \ u_2]^\top$ is the control input.⁶ A controller is to be designed to solve the following control problem: guarantee that the solutions to the plant avoid a neighborhood around the point $\bar{\xi}$, which is given by $\mathcal{N} = \bar{\xi} + \hat{\alpha}\mathbb{B}$ and represents an obstacle, and that converge to the target point ξ^* . Convergence to the target can be attained by steering the solutions in the clockwise or in the counter-clockwise direction around the obstacle, depending on the initial condition. Measurements of the distance to the target may not be available from points where the target is not visible due to the presence of the obstacle. Due to the topological constraint of the stabilization task and the limited measurements, a single controller or a controller uniting two controllers with the same objectives would be difficult to design.

To solve the stated control problem, functions defining potential fields capturing the presence of the obstacle and vanishing at some point ξ° from where the target is visible, i.e., from points where there is a “line-of-sight” to the target point ξ^* , can be generated. Then, a gradient descent controller can be designed to steer the state of the point-mass system to nearby the intermediate point ξ° . In this way, the point ξ° would define the set \mathcal{A}_1 and the gradient-descent controller would define \mathcal{K}_1 . This controller would use measurements of the functions defining the potential fields as well as their gradients. These functions would define the plant’s output $y_{p,1}$. A particular construction of a hybrid controller implementing a robust gradient-descent-like strategy and satisfying the conditions in Assumption 3.1.2 is given in Section IV-B. To satisfy the conditions in Assumption 3.1.1, a “local” controller capable of asymptotically stabilizing ξ^* from nearby ξ° would play the role of the controller \mathcal{K}_0 above, with \mathcal{A}_0 given by $\{\xi^*\}$. Due to ξ° being at a location unobstructed by the obstacle, this controller could use relative position measurements to the target, which would define the plant’s output $y_{p,0}$. Item 3 of Assumption 3.1 will be satisfied by placing \mathcal{A}_1 in the basin of attraction induced by \mathcal{K}_0 . \triangle

As pointed out in Remark 3.2, items 1.c and 2.b in Assumption 3.1 assure OSS the existence of exponential-decay OSS-Lyapunov functions with respect to $\mathcal{A}_i \times \Phi_i$ for $(\mathcal{P}, \mathcal{K}_i)$. As stated in [5, Proposition 2], a norm estimator for the state (ξ, ζ_i) (and, hence, for ξ) exists. A particular construction is

$$\begin{aligned} \dot{z}_i &= -\varepsilon_i z_i + \gamma_i (|h_i(\xi)|) & (\xi, \zeta_i) \in C_i, \\ z_i^+ &= (1 - \varepsilon_i) z_i + \gamma_i (|h_i(\xi)|) & (\xi, \zeta_i) \in D_i. \end{aligned} \quad (10)$$

In fact, given a solution (ξ, ζ_i) to $(\mathcal{P}, \mathcal{K}_i)$, using (7) and (8), for each $j \in \mathbb{N}$ and for almost all $t \in I_j$, I_j with nonempty interior, $(t, j) \in \text{dom}(\xi, \zeta_i)$, we have

$$\frac{d}{dt} (V_i(\xi(t, j), \zeta_i(t, j)) - z_i(t, j)) \leq$$

⁶See [9] where the problem of stabilizing a unicycle while ensuring obstacle avoidance is studied.

$$-\varepsilon_i (V_i(\xi(t, j), \zeta_i(t, j)) - z_i(t, j)),$$

and, for each $(t, j) \in \text{dom}(\xi, \zeta_i)$ such that $(t, j + 1) \in \text{dom}(\xi, \zeta_i)$, we have

$$V_i(\xi(t, j + 1), \zeta_i(t, j + 1)) - z_i(t, j + 1) \leq (1 - \varepsilon_i)(V_i(\xi(t, j), \zeta_i(t, j)) - z_i(t, j)).$$

Using the upper bound in (6), it follows that, for all $(t, j) \in \text{dom}(\xi, \zeta_i)$, $V_i(\xi(t, j), \zeta_i(t, j)) \leq z_i(t, j) + \exp(-\varepsilon_i t)(1 - \varepsilon_i)^j (V_i(\xi(0, 0), \zeta_i(0, 0)) - z_i(0, 0)) \leq z_i(t, j) + \exp(-\varepsilon_i t)(1 - \varepsilon_i)^j (\alpha_{i,2}(|(\xi(0, 0), \zeta_i(0, 0))|_{\mathcal{A}_i \times \Phi_i}) - z_i(0, 0))$. Assuming, without loss of generality, that $\alpha_{i,2}(s) \geq s$ for all $s \geq 0$ and defining $\beta_i(s, t, j) := 2 \exp(-\varepsilon_i t)(1 - \varepsilon_i)^j \alpha_{i,2}(s)$ gives for any solution (ξ, ζ_i) to $(\mathcal{P}, \mathcal{K}_i)$

$$V_i(\xi(t, j), \zeta_i(t, j)) \leq z_i(t, j) + \beta_i(|(\xi(0, 0), \zeta_i(0, 0))|_{\mathcal{A}_i \times \Phi_i} + |z_i(0, 0)|, t, j). \quad (11)$$

The following bound on $|(\xi(t, j), \zeta_i(t, j))|_{\mathcal{A}_i \times \Phi_i}$ follows with (6):

$$|(\xi(t, j), \zeta_i(t, j))|_{\mathcal{A}_i \times \Phi_i} \leq \alpha_{i,1}^{-1}(z_i(t, j) + \beta_i(|(\xi(0, 0), \zeta_i(0, 0))|_{\mathcal{A}_i \times \Phi_i} + |z_i(0, 0)|, t, j))$$

for all $(t, j) \in \text{dom}(\xi, \zeta_i)$.

The following example illustrates the construction of a norm observer for a nonlinear system. This observer will be used in the design of a hybrid supervisor in Section IV-A.

Example 3.4: Consider the nonlinear system

$$\dot{\xi} = f_p(\xi, u_p) := \begin{bmatrix} -\xi_1 + (u_1 - \xi_2)\xi_1^2 \\ -\xi_2 + \xi_1^2 + \bar{\alpha} + u_2 \end{bmatrix}, \quad (13)$$

where $\xi \in \mathbb{R}^2$ is the state and $u_p = [u_1 \ u_2]^\top$ is the control input. An output-feedback controller has been designed for this system in [1].⁷ Measurements of ξ_1 and ξ_2 are available but not simultaneously. Consider a controller \mathcal{K}_0 given by a static feedback controller that measures $h_0(\xi) := \xi_1$ to stabilize ξ to $\mathcal{A}_0 = \{(0, 0)\}$. Following (4), an example of such a controller is defined by $n_c = 0$, $\kappa_{c,0}(\xi) := [0, -\bar{\alpha}]^\top$, and no dynamical state (i.e., $C_{c,0} = D_{c,0} = \emptyset$ and $f_{c,0}, g_{c,0}$ are arbitrary). For $V_0(\xi) = \frac{1}{2}\xi^\top \xi$, it follows that, for all $\xi \in \mathbb{R}^2$,⁸

$$\begin{aligned} \langle \nabla V_0(\xi), f_p(\xi, \kappa_{c,0}(\xi)) \rangle &= -\xi_1^2 - \xi_1^3 \xi_2 - \xi_2^2 + \xi_1^2 \xi_2 \\ &\leq -V_0(\xi) + \xi_1^4 (1 + \xi_1^2). \end{aligned} \quad (14)$$

Then, a norm observer for $|\xi|_{\mathcal{A}_0}$ is given by $\dot{z}_0 = -z_0 + \gamma_0(|h_0(\xi)|)$ with $\gamma_0(s) = s^4(1 + s^2)$ for all $s \geq 0$. This norm estimator and the controller \mathcal{K}_0 above are such that Assumption 3.1.1 holds. \triangle

In the next section, we provide a solution to Problem (\star) that consists of a hybrid supervisor coordinating, using control logic and norm observers, the two (well-posed) output-feedback hybrid controllers \mathcal{K}_0 and \mathcal{K}_1 .

B. Proposed Control Strategy

As depicted in Figure 1, we propose a hybrid controller \mathcal{K}_s to supervise \mathcal{K}_0 and \mathcal{K}_1 . This hybrid controller, referred to as the hybrid supervisor, is designed to perform the uniting task as follows:

A) Apply the hybrid controller \mathcal{K}_1 when the estimate of $|\xi|_{\mathcal{A}_1}$ is away from the origin.

⁷For the case $\bar{\alpha} = 0$, dynamic output feedback laws for outputs given by ξ_1 or ξ_2 that globally asymptotically stabilize the origin in \mathbb{R}^2 have been proposed in [1].

⁸Using Young's inequality to obtain $\xi_1^3 \xi_2 \leq \xi_1^6 + \frac{1}{4}\xi_2^2$ and $\xi_1^2 \xi_2 \leq \xi_1^4 + \frac{1}{4}\xi_2^2$.

B) Permit estimate of $|\xi|_{\mathcal{A}_1}$ to converge.

C) Apply \mathcal{K}_0 when the estimate of $|\xi|_{\mathcal{A}_1}$ is close enough to zero.

To accomplish these tasks, the supervisor has a discrete state $q \in \mathcal{Q} := \{0, 1\}$ and a timer state $\tau \in \mathbb{R}$ with reset threshold $\tau^* > 0$. The constant τ^* is a design parameter of the hybrid supervisor. The dynamics of the state q are designed to indicate that the controller \mathcal{K}_q is connected to the plant. While the accomplishment of tasks **A)**-**C)** with the proposed hybrid supervisor requires finitely many jumps in the state q , the number of jumps in q depends on the initial conditions as well as on the dynamics of the closed-loop system. A hybrid supervisor implementing tasks **A)**-**C)** is presented next.

1) *Supervision of Controller \mathcal{K}_1 ($q = 1$):* Item 2.a of Assumption 3.1 implies that for every solution (ξ, ζ_1) to $(\mathcal{P}, \mathcal{K}_1)$ we have

$$\lim_{t+j \rightarrow \infty} \gamma_1(|h_1(\xi(t, j))|) = 0.$$

Using (10) for $i = 1$, it follows that z_1 also approaches zero, and that, eventually, when t or j are large enough, $|\xi|_{\mathcal{A}_1}$ is small enough. This suggests that the supervisor should apply \mathcal{K}_1 until, eventually, z_1 is small enough. This can be implemented as follows:

- Flow according to

$$\begin{aligned} \dot{\xi} &= f_p(\xi, \kappa_{c,1}(h_1(\xi), \zeta_1)), \quad \dot{\zeta}_0 = 0, \quad \dot{\zeta}_1 = f_{c,1}(h_1(\xi), \zeta_1), \\ \dot{z}_0 &= 0, \quad \dot{z}_1 = -\varepsilon_1 z_1 + \gamma_1(|h_1(\xi)|), \quad \dot{q} = 0, \quad \dot{\tau} = 1 \end{aligned} \quad (15)$$

when, for a design parameter $\varepsilon_{1,a} > 0$, either one of the following conditions hold:

$$(\xi, \zeta_1) \in C_1, \quad \zeta_0 \in \Phi_0, \quad z_0 = 0, \quad z_1 \geq \varepsilon_{1,a}, \quad q = 1, \quad (16)$$

or

$$(\xi, \zeta_1) \in C_1, \quad \zeta_0 \in \Phi_0, \quad z_0 = 0, \quad z_1 \geq 0, \quad q = 1, \quad \tau \leq \tau^*. \quad (17)$$

- Jump according to

$$\begin{aligned} \xi^+ &= \xi, \quad \zeta_0^+ \in \Phi_0, \quad \zeta_1^+ \in \Phi_1, \\ z_0^+ &= 0, \quad z_1^+ = 0, \quad q^+ = 0, \quad \tau^+ = 0 \end{aligned} \quad (18)$$

when

$$\zeta_0 \in \Phi_0, \quad z_0 = 0, \quad \varepsilon_{1,a} \geq z_1 \geq 0, \quad q = 1, \quad \tau \geq \tau^*. \quad (19)$$

The flows defined in (15) enforce, in particular, that q remains constant and that the estimate of $|\xi|_{\mathcal{A}_1}$ converges. Condition (16) allows flows when the estimate of $|\xi|_{\mathcal{A}_1}$ is not small enough, while, when condition (19) holds, the state q is set to 0 so that \mathcal{K}_0 is applied. The state ζ_0 is updated to any value in Φ_0 and the estimator state z_0 is reset to zero. These selections are to properly initialize \mathcal{K}_0 . However, to guarantee that the state ζ_1 converges to Φ_1 , the state is reset to any point in Φ_1 .

Due to the impossibility of measuring ξ , it is not possible to ensure that ξ is such that (ξ, ζ_0) is in the basin of attraction \mathcal{B}_0 after jumps from $q = 1$ to $q = 0$ occur. Hence, it could be the case that there are jumps from $q = 0$ back to $q = 1$. The logic in (15)-(19) uses the timer τ to guarantee convergence of the state to \mathcal{B}_0 . The condition $\tau \leq \tau^*$ in (17) allows the estimate $|\xi|_{\mathcal{A}_1}$ to converge by enforcing that, perhaps after a few jumps to $q = 0$ and back to $q = 1$, ξ eventually is so that (ξ, ζ_0) is in the said basin of attraction. The conditions involving z_0 in (16), (17), and (19) force z_0 to remain at zero along solutions with $q = 1$. These choices facilitate the establishment of our main result in Section III-C. A procedure to design the controller parameters is given in Section III-D.

2) *Supervision of Controller \mathcal{K}_0 ($q = 0$):* From item 1 of Assumption 3.1 and (10) for $i = 0$, it follows that $z_0(t, j)$ approaches zero as $\gamma_0(|h_0(\xi(t, j))|)$ approaches zero. Furthermore, when $z_0 \leq \varepsilon_{0,a}$, $\zeta_0 \in \Phi_0$, and t or j are large enough, it follows from (11) for $i = 0$ and items 1.b and 3 in Assumption 3.1 that after jumps to $q = 0$, (ξ, ζ_0) will be in the set

$$\{(\xi, \zeta_0) : V_0(\xi, \zeta_0) \leq \varepsilon_{0,b}\}, \quad (20)$$

which, by definition of $\varepsilon_{0,b}$, is a subset of the basin of attraction of $(\mathcal{P}, \mathcal{K}_0)$. Then, the supervisor is designed to apply \mathcal{K}_0 as long as z_0 is smaller or equal than $\varepsilon_{0,a}$, and when is larger or equal to that parameter, a jump to $q = 1$ is triggered. Note that the logic for $q = 1$ eventually forces flows for at least τ^* units of time, which allows t or j to become large enough, and with that, guarantee that (ξ, ζ_0) is eventually in the set (20). This mechanism is implemented as follows:

- Flow according to

$$\begin{aligned} \dot{\xi} &= f_p(\xi, \kappa_{c,0}(h_0(\xi), \zeta_0)), \dot{\zeta}_0 = f_{c,0}(h_0(\xi), \zeta_0), \\ \dot{\zeta}_1 &= 0, \quad \dot{z}_0 = -\varepsilon_0 z_0 + \gamma_0(|h_0(\xi)|), \\ \dot{z}_1 &= 0, \quad \dot{q} = 0, \quad \dot{\tau} = 0 \end{aligned} \quad (21)$$

$$\text{when } \begin{cases} (\xi, \zeta_0) \in C_0, & \zeta_1 \in \Phi_1, & \varepsilon_{0,a} \geq z_0 \geq 0, \\ z_1 = 0, & q = 0, & \tau = 0. \end{cases} \quad (22)$$

- Jump according to

$$\begin{aligned} \xi^+ &= \xi, & \zeta_0^+ &\in \Phi_0, & \zeta_1^+ &\in \Phi_1, & z_0^+ &= 0, \\ z_1^+ &= 0, & q^+ &= 1, & \tau^+ &= 0, \end{aligned} \quad (23)$$

when

$$\zeta_1 \in \Phi_1, \quad z_0 \geq \varepsilon_{0,a}, \quad z_1 = 0, \quad q = 0, \quad \tau = 0. \quad (24)$$

As (15), the flows defined in (21) enforce, in particular, that q remains constant and that the estimate of $|\xi|_{\mathcal{A}_0}$ converges. In fact, condition (22) allows flows when the estimate of $|\xi|_{\mathcal{A}_0}$ is small enough, permitting it to converge. When condition (24) holds, a jump back to $q = 1$ occurs. As explained below (19), in particular, such a jump would occur when, after a jump from $q = 1$ to $q = 0$, the state (ξ, ζ_0) is not in \mathcal{B}_0 . The state ζ_1 is updated to any value in Φ_1 and the estimator state z_1 is reset to zero. These selections properly initialize \mathcal{K}_1 and enable our main result in Section III-C.

3) *Closed-loop system:* We are now ready to write the resulting closed loop as a hybrid system. The closed-loop hybrid system has state $\chi = (\xi, \zeta_0, \zeta_1, z_0, z_1, q, \tau) \in \mathbb{R}^{n_p} \times \mathbb{R}^{n_c} \times \mathbb{R}^{n_c} \times \mathbb{R}_{\geq 0} \times \mathbb{R}_{\geq 0} \times \mathcal{Q} \times \mathbb{R}_{\geq 0} =: X$. Collecting the definitions in Sections III-B.1 and III-B.2, the resulting closed-loop system, which is denoted by \mathcal{H}_{cl} , has dynamics given as follows:

$$\begin{aligned} \dot{\chi} &= \begin{bmatrix} f_p(\xi, \kappa_{c,q}(h_q(\xi), \zeta_q)) \\ (1-q)f_{c,0}(h_0(\xi), \zeta_0) \\ q f_{c,1}(h_1(\xi), \zeta_1) \\ (1-q)(-\varepsilon_0 z_0 + \gamma_0(|h_0(\xi)|)) \\ q(-\varepsilon_1 z_1 + \gamma_1(|h_1(\xi)|)) \\ 0 \\ q \end{bmatrix} =: F(\chi), \quad \chi \in \tilde{C}, \\ \chi^+ &\in G_0(\chi) \cup G_1(\chi) \cup G_s(\chi) =: G(\chi), \quad \chi \in \tilde{D}, \end{aligned}$$

where: for each $q = 0$, $(\xi, \zeta_0) \in D_0$

$$G_0(\chi) = \begin{bmatrix} \xi \\ g_{c,0}(h_0(\xi), \zeta_0) \\ \zeta_1 \\ (1 - \varepsilon_0)z_0 + \gamma_0(|h_0(\xi)|) \\ z_1 \\ q \\ \tau \end{bmatrix},$$

$G_0(\chi) = \emptyset$ otherwise; for each $q = 1$, $(\xi, \zeta_1) \in D_1$

$$G_1(\chi) = \begin{bmatrix} \xi \\ \zeta_0 \\ g_{c,1}(h_1(\xi), \zeta_1) \\ z_0 \\ (1 - \varepsilon_1)z_1 + \gamma_1(|h_1(\xi)|) \\ q \\ \tau \end{bmatrix},$$

$G_1(\chi) = \emptyset$ otherwise; for each $\chi \in D_{s,a} \cup D_{s,b}$,

$$G_s(\chi) = (\xi, \Phi_0, \Phi_1, 0, 0, 1 - q, 0),$$

$G_s(\chi) = \emptyset$ otherwise;

$$\begin{aligned} \tilde{C} &:= \{\chi : (\xi, \zeta_q) \in C_q\} \cap (C_{s,a} \cup C_{s,b} \cup C_{s,c}), \\ C_{s,a} &:= \{\chi : \zeta_1 \in \Phi_1, \varepsilon_{0,a} \geq z_0 \geq 0, z_1 = 0, q = 0, \tau = 0\}, \\ C_{s,b} &:= \{\chi : \zeta_0 \in \Phi_0, z_0 = 0, z_1 \geq \varepsilon_{1,a}, q = 1\}, \\ C_{s,c} &:= \{\chi : \zeta_0 \in \Phi_0, z_0 = 0, z_1 \geq 0, q = 1, \tau \leq \tau^*\}, \\ \tilde{D} &:= \{\chi : (\xi, \zeta_q) \in D_q\} \cup D_{s,a} \cup D_{s,b}, \\ D_{s,a} &:= \{\chi : \zeta_1 \in \Phi_1, z_0 \geq \varepsilon_{0,a}, z_1 = 0, q = 0, \tau = 0\}, \\ D_{s,b} &:= \{\chi : \zeta_0 \in \Phi_0, z_0 = 0, \varepsilon_{1,a} \geq z_1 \geq 0, q = 1, \tau \geq \tau^*\}. \end{aligned}$$

The flow map F is defined in terms of the discrete state q to “select” the appropriate flow dynamics when \mathcal{K}_0 and \mathcal{K}_1 are applied. The flow set \tilde{C} allows flow when both (ξ, ζ_q) is in the flow set C_q and the conditions for flow imposed by the hybrid supervisor are satisfied. The latter are given in (22), (16), and (17), which are captured in the sets $C_{s,a}$, $C_{s,b}$, and $C_{s,c}$, respectively. The jump maps G_0 , G_1 , and G_s above are defined to execute the jumps of the individual hybrid controllers when their state jumps due to $(h_q(\xi), \zeta_q) \in D_{c,q}$ or when reset of the appropriate states is required by the supervisor jump sets $D_{s,a}$ and $D_{s,b}$, which are given in (24) and (19), respectively. Note that since $g_{c,q}$ is only defined on $D_{c,q}$, the set-valued maps G_0 and G_1 are nonempty at points χ with components in $D_{c,q}$. For each $i = 0, 1$, the functions γ_i and constants ε_i are obtained from the OSS properties of $(\mathcal{P}, \mathcal{K}_i)$ imposed in Assumption 3.1. Existence of parameters $\varepsilon_{1,a}$ and τ^* guaranteeing a solution to Problem (\star) is established in the next section. A design method for these parameters is given in Section III-D.

C. Nominal Properties of Closed-loop System

Our main result is as follows.

Theorem 3.5: (semi-global asymptotic stability) *Suppose Assumption 3.1 holds. Then, for each compact set $\mathcal{M} \subset X$ of initial conditions there exists an output-feedback hybrid supervisor \mathcal{K}_s such that the compact set*

$$\mathcal{A}_s := \mathcal{A}_0 \times \Phi_0 \times \Phi_1 \times \{0\} \times \{0\} \times \{0\} \times \{0\}$$

is asymptotically stable for the closed-loop system \mathcal{H}_{cl} with a basin of attraction containing \mathcal{M} ; i.e., for each $\epsilon > 0$ there exists $\delta > 0$ such that each solution χ to \mathcal{H}_{cl} with $|\chi(0,0)|_{\mathcal{A}_s} \leq \delta$ satisfies $|\chi(t,j)|_{\mathcal{A}_s} \leq \epsilon$ for all $(t,j) \in \text{dom } \chi$, and every maximal solution χ to \mathcal{H} with $\chi(0,0) \in \mathcal{M}$ is complete and satisfies $\lim_{t+j \rightarrow \infty} |\chi(t,j)|_{\mathcal{A}_s} = 0$.

Proof: By the continuity of f_p , h_i , and $\kappa_{c,i}$ for each $i = 0, 1$ imposed by Assumption 3.1, and continuity of γ_i , F is continuous. By the regularity properties of $g_{c,i}$ guaranteed by well posedness of \mathcal{K}_i and continuity of h_i from Assumption 3.1, compactness of Φ_i for each $i = 0, 1$, and the definition of the set-valued map G , $G : \tilde{D} \rightrightarrows X$ is outer semicontinuous, locally bounded, and nonempty for all points in \tilde{D} . By closedness of C_q and D_q guaranteed by well posedness of \mathcal{K}_i and continuity of h_i , \tilde{C} and \tilde{D} are closed sets. This establishes that the hybrid supervisor is such that the closed-loop system is a well-posed hybrid system. Moreover, the construction of \mathcal{K}_s is such that solutions to the closed-loop system \mathcal{H}_{cl} exist from points in $\mathbb{R}^{n_p} \times \mathbb{R}^{n_c} \times \mathbb{R}^{n_c} \times \mathbb{R}_{\geq 0} \times \mathbb{R}_{\geq 0} \times \mathcal{Q} \times \mathbb{R}_{\geq 0}$.

Now we show that \mathcal{A}_0 is attractive from \mathcal{M} . By the attractivity property induced by \mathcal{K}_1 in Assumption 3.1.2.a and Assumption 3.1.3, for every maximal solution χ to \mathcal{H}_{cl} from $\tilde{C} \cup \tilde{D}$ with $q(0,0) = 1$ there exists $(T, J) \in \text{dom } \chi$ such that $\chi(T, J) \in D_{s,b}$. By definition of G , there exists $J' > J$, $(T, J') \in \text{dom } \chi$ such that $\chi^* = \chi(T, J') \in C_{s,a}$. Let χ' be the tail of the maximal solution χ from (T', J') onwards. With some abuse of notation, every maximal solution χ' to \mathcal{H}_{cl} , with $\chi'(0,0) \in C_{s,a}$ (in particular, with $\chi'(0,0) = \chi^*$) and $(\xi'(0,0), \zeta'_0(0,0))$ in the set (20), is complete and, by Assumption 3.1.1.a and b, satisfies $\lim_{t+j \rightarrow \infty} |\xi'(t,j)|_{\mathcal{A}_0} = 0$. If $(\xi'(t,j), \zeta'_0(t,j))$ never reaches (20), we claim that there exists (t,j) such that $z'_0(t,j) > \varepsilon_{0,a}$, and then, by the definition of D and G , q is mapped to 1. Suppose not. Then, the solution χ' remains in $C_{s,a}$ for all $(t', j') \in \text{dom } \chi'$ such that $t' + j' \geq t + j$, which implies that $z'_0(t', j') \leq \varepsilon_{0,a}$ since the norm estimator (10) for $i = 0$ remains on. Then, since $\varepsilon_{0,a} < \varepsilon_{0,b}$, from (11) for $i = 0$, there exists large enough $t + j$, $(t, j) \in \text{dom } \chi'$, such that $V_0(\xi'(t,j), \zeta'_0(t,j)) \leq \varepsilon_{0,b}$. This is a contradiction. Then, a jump to $q = 1$ occurs. By the construction of $C_{s,c}$ and $D_{s,b}$, the closed-loop system will remain at $q = 1$ for at least τ^* units of time. Repeating this argument if needed, the fact that the norm estimator (10) for $i = 1$ guarantees that the estimates converge (even when reset to zero) implies that, eventually, a jump to $q = 0$ will occur with (ξ, ζ_0) in the set (20). Note that this is the case due to the fact that there are finitely many jumps from $q = 0$ to $q = 1$ and back, as the following result guarantees.

Lemma 3.6: *There exist positive parameters τ^* , $\varepsilon_{1,a}$, and $\varepsilon_{1,b}$ such that there is no nondecreasing sequence of times⁹ $\{(t'_n, j'_n)\}_{n \in \mathbb{N}} \in \text{dom } \chi$ for which, for all $n \in \mathbb{N}$,*

$$q(t'_{2n}, j'_{2n}) = 0, \quad q(t'_{2n+1}, j'_{2n+1}) = 1. \quad (25)$$

Proof: By contradiction, suppose that there exist a complete solution χ and a nondecreasing sequence $\{(t'_n, j'_n)\}_{n \in \mathbb{N}} \in \text{dom } \chi$, which can always be chosen so that (25) holds, $j'_0 > 0$, $z_0(t'_0, j'_0) = 0$, flows with $q = 0$ occur with $(t, j) \in \text{dom } \chi$, $t \in [t'_{2n}, t'_{2n+1})$, and flows with $q = 1$ occur with $(t, j) \in \text{dom } \chi$, $t \in [t'_{2n+1}, t'_{2n+2})$, $n \in \mathbb{N}$. Due to the dynamics of the timer τ , which enforces that the time between two jumps from $q = 1$ to $q = 0$ of the supervisor have t 's separated by at least $\tau^* > 0$ seconds, the solution cannot be Zeno (see Section II for a definition of Zeno solutions). It follows that, for each $n \in \mathbb{N}$,

$$\begin{aligned} (t'_n, j'_n - 1) &\in \text{dom } \chi, \quad (t'_n, j'_n) \in \text{dom } \chi, \\ z_0(t'_{2n+1}, j'_{2n+1} - 1) &\geq \varepsilon_{0,a}, \quad z_1(t'_{2n+2}, j'_{2n+2} - 1) \leq \varepsilon_{1,a}. \end{aligned} \quad (26)$$

⁹In the sense that $t'_{n+1} + j'_{n+1} \geq t'_n + j'_n$ for all $n \in \mathbb{N}$.

By considering the restriction on $\{(t, j) \in \text{dom } \chi' : t \in [t'_{2n+1}, t'_{2n+2}], q(t, j) = 1\}$ of the solution χ as a solution to $(\mathcal{P}, \mathcal{K}_1)$ issuing from $\chi(t'_{2n+1}, j'_{2n+1})$, we get, from (11) with $i = 1$ and (26), that $V_1(\xi(t'_{2n+2}, j'_{2n+2}-1), \zeta_1(t'_{2n+2}, j'_{2n+2}-1)) \leq z_1(t'_{2n+2}, j'_{2n+2}-1) + \beta_1(|(\xi(t'_{2n+1}, j'_{2n+1}), \zeta_1(t'_{2n+1}, j'_{2n+1}))|_{\mathcal{A}_1 \times \Phi_1} + |z_1(t'_{2n+1}, j'_{2n+1})|, \delta'_{2n+2}) \leq \varepsilon_{1,a} + \beta_1(|(\xi(t'_{2n+1}, j'_{2n+1}), \zeta_1(t'_{2n+1}, j'_{2n+1}))|_{\mathcal{A}_1 \times \Phi_1}, \delta'_{2n+2})$, where $\delta'_s = (t'_s - t'_{s-1}, j'_s - j'_{s-1} - 1)$ and we have used the fact that $z_1(t'_{2n+1}, j'_{2n+1}) = 0$. Due to the expression of G_s , we have $\xi(t'_{2n+2}, j'_{2n+2}) = \xi(t'_{2n+2}, j'_{2n+2}-1)$ and $\zeta_1(t'_{2n+2}, j'_{2n+2}) \in \Phi_1$. Then, since $j'_{2n+2} > 0$ and $|(\xi, \zeta_1)(t'_{2n+2}, j'_{2n+2})|_{\mathcal{A}_1 \times \Phi_1} = |\xi(t'_{2n+2}, j'_{2n+2})|_{\mathcal{A}_1}$, using (6) we obtain

$$\alpha_{1,1}(|(\xi, \zeta_1)(t'_{2n+2}, j'_{2n+2})|_{\mathcal{A}_1 \times \Phi_1}) \leq V_1(\xi(t'_{2n+2}, j'_{2n+2} - 1), \zeta_1(t'_{2n+2}, j'_{2n+2} - 1)).$$

Using (26) we get

$$|(\xi, \zeta_1)(t'_{2n+2}, j'_{2n+2})|_{\mathcal{A}_1 \times \Phi_1} \leq \alpha_{1,1}^{-1}(\varepsilon_{1,a} + \beta_1(|(\xi, \zeta_1)(t'_{2n+1}, j'_{2n+1})|_{\mathcal{A}_1 \times \Phi_1}, \delta'_{2n+2})). \quad (27)$$

In the same way, from (11) with $i = 0$ we have, for each n , $V_0(\xi(t'_{2n+1}, j'_{2n+1}), \zeta_0(t'_{2n+1}, j'_{2n+1})) \leq z_0(t'_{2n+1}, j'_{2n+1} - 1) + \beta_0(|(\xi, \zeta_0)(t'_{2n}, j'_{2n})|_{\mathcal{A}_0 \times \Phi_0} + |z_0(t'_{2n}, j'_{2n})|, \delta'_{2n+1})$. This implies

$$|(\xi, \zeta_0)(t'_{2n+1}, j'_{2n+1})|_{\mathcal{A}_0 \times \Phi_0} \leq \alpha_{0,1}^{-1}(z_0(t'_{2n+1}, j'_{2n+1} - 1) + \beta_0(|(\xi, \zeta_0)(t'_{2n}, j'_{2n})|_{\mathcal{A}_0 \times \Phi_0}, \delta'_{2n+1})), \quad (28)$$

where we have used the fact that $z_0(t'_{2n}, j'_{2n}) = 0$. Since $q(t'_0, j'_0) = 0$ by construction of the sequence (t'_n, j'_n) , we have, from (28), $|(\xi, \zeta_0)(t'_1, j'_1)|_{\mathcal{A}_0 \times \Phi_0} \leq \alpha_{0,1}^{-1}(z_0(t'_1, j'_1 - 1) + \beta_0(|(\xi, \zeta_0)(t'_0, j'_0)|_{\mathcal{A}_0 \times \Phi_0}, \delta'_1))$ and, from (27), $|(\xi, \zeta_1)(t'_2, j'_2)|_{\mathcal{A}_1 \times \Phi_1} \leq \alpha_{1,1}^{-1}(\varepsilon_{1,a} + \beta_1(|(\xi, \zeta_1)(t'_1, j'_1)|_{\mathcal{A}_1 \times \Phi_1}, \delta'_2))$, which implies

$$|(\xi, \zeta_1)(t'_2, j'_2)|_{\mathcal{A}_1 \times \Phi_1} \leq \alpha_{1,1}^{-1}(\varepsilon_{1,a} + \beta_1(\Delta + \alpha_{0,1}^{-1}(z_0(t'_1, j'_1 - 1) + \beta_0(|(\xi, \zeta_0)(t'_0, j'_0)|_{\mathcal{A}_0 \times \Phi_0}, \delta'_1)), \delta'_2)), \quad (29)$$

where $\Delta = \max_{x \in \mathcal{A}_0 \times \Phi_0, y \in \mathcal{A}_1 \times \Phi_1} |x - y|$, which denotes the maximal distance between the sets $\mathcal{A}_0 \times \Phi_0$ and $\mathcal{A}_1 \times \Phi_1$, which is finite since both sets are compact. Consider the compact set \mathcal{M} in the assumption of Theorem 3.5. Due to (12), there exists a compact set containing all solutions of $(\mathcal{P}, \mathcal{K}_0)$ starting from \mathcal{M} . By this compactness property, the values $\Delta_1 := \max z_0(t, j)$ and $\Delta_2 = \max |(\xi, \zeta_0)(t, j)|_{\mathcal{A}_0 \times \Phi_0}$ are finite, where the maximum are taken on $\{(t, j) \in \text{dom } \chi : \chi \text{ is a solution of } (\mathcal{P}, \mathcal{K}_0) \text{ starting from } \mathcal{M}\}$. Therefore, either there does not exist a sequence $\{(t'_n, j'_n)\}_{n \in \mathbb{N}} \in \text{dom } \chi$ satisfying (25), or there exists such a sequence and inequality (29) holds. However, in this latter case, using $\max\{t'_1 + j'_1, t'_2 + j'_2\} < \tau^*$, pick $\tau^* > 0$ and $\varepsilon_{1,a}, \varepsilon_{1,b}$ such that

$$\alpha_{1,2}(\alpha_{1,1}^{-1}(\varepsilon_{1,a} + \bar{\beta}_1(\Delta + \alpha_{0,1}^{-1}(\Delta_1 + \bar{\beta}_0(\Delta_2, \tau^*)), \tau^*)) \leq \varepsilon_{1,b} \quad (30)$$

where $\bar{\beta}_i(s, t) := 2 \exp(-\varepsilon_i t) \alpha_{i,2}(s)$, $i = 0, 1$. Then, using (6) with $i = 1$, we get $V_1(\xi(t'_2, j'_2), \zeta_1(t'_2, j'_2)) \leq \varepsilon_{1,b}$. With (9), since $\zeta_1(t'_2, j'_2) \in \Phi_1$ and $\zeta_0(t'_2, j'_2) \in \Phi_0$, we get $\gamma_0(h_0(\xi(t'_2, j'_2))) < \varepsilon_{0,a} \varepsilon_0$. Since the supervisor uses \mathcal{K}_0 at (t'_2, j'_2) and Assumption 3.1.3 implies that, along solutions, $\dot{z}_0 < -\varepsilon_0 z_0 + \varepsilon_{0,a} \varepsilon_0$, we have that $z_0(t, j) < \varepsilon_{0,a}$ for all future (t, j) . Then, no future jump of the supervisor is possible, which is a contradiction, showing that there is no sequence satisfying (25). \blacksquare

By the attractivity properties of the basin of attraction of and completeness of solutions to $(\mathcal{P}, \mathcal{K}_0)$, it follows that every maximal solution converges to \mathcal{A}_s . Hence, solutions are bounded. By the construction of the jump map in equation (18), the state ζ_1 converges to Φ_1 while z_1 and τ_0 converge to zero. To conclude the proof, note that the local stability properties induced by \mathcal{K}_0 and the property $h_0(\mathcal{A}_0) = 0$ imply that \mathcal{A}_s is stable. \blacksquare

Remark 3.7: Note that when assuming the existence of a norm-observer for \mathcal{P} (and not a pair of norm-observers for \mathcal{P} in closed loop with \mathcal{K}_0 and with \mathcal{P} in closed loop with \mathcal{K}_1 as in Assumption 3.1), we obtain a globally asymptotic stabilizing hybrid controller \mathcal{K}_s . Indeed, following the proof of Theorem 3.5 with this additional assumption, we may strength the result of Lemma 3.6 and obtain that there is no nondecreasing sequence of times satisfying (25) for any initial condition (globally). With such a detectability assumption, the obtained result would be close in spirit to [24], but generalizes it since [24] pertains to the problem of uniting continuous-time controllers with same objectives.

D. A Design Procedure

Theorem 3.5 guarantees the existence of an output-feedback hybrid supervisor solving Problem (\star) . While this result does not explicitly provide values of the supervisor parameters, the steps in its proof provide guidelines (potentially conservative) on how to choose these parameters. When exponential-decay OSS-Lyapunov functions and associated functions certifying the OSS properties in Assumption 3.1 are available (see (6)-(8)), the design procedure in the following result is a consequence of the arguments in the proof of Theorem 3.5.

Corollary 3.8: (design procedure) *Suppose Assumption 3.1 holds. The output-feedback hybrid supervisor \mathcal{K}_s with parameters $\varepsilon_{0,a}$, $\varepsilon_{1,b}$, and τ^* designed following the next steps solves Problem (\star) .*

- Step 1) Let $\varepsilon_{0,b} > 0$ such that $\Gamma_0 := \{(\xi, \zeta_0) : V_0(\xi, \zeta_0) \leq \varepsilon_{0,b}\}$ is a subset of the basin of attraction \mathcal{B}_0 for the asymptotic stabilization of $\mathcal{A}_0 \times \Phi_0$ with \mathcal{K}_0 .*
- Step 2) Choose $\varepsilon_{0,a} > 0$ and $\varepsilon_{1,b} > 0$ so that $\varepsilon_{0,a} < \varepsilon_{0,b}$, $\Gamma_1 := \{\xi \in \mathbb{R}^{n_p} : V_1(\xi, \zeta_1) \leq \varepsilon_{1,b}, \zeta_1 \in \Phi_1\} \times \Phi_0$ is a subset of Γ_0 , and every solution (ξ, ζ_0) to $(\mathcal{P}, \mathcal{K}_0)$ from Γ_1 satisfies $\gamma_0(|h_0(\xi(t, j))|) < \varepsilon_{0,a}\varepsilon_0$ for all $(t, j) \in \text{dom}(\xi, \zeta_0)$.*
- Step 3) Design $\varepsilon_{1,a} > 0$ and $\tau^* > 0$ such that*

$$\alpha_{1,2}(\alpha_{1,1}^{-1}(\varepsilon_{1,a} + \bar{\beta}_1(\Delta + \alpha_{0,1}^{-1}(\Delta_1 + \bar{\beta}_0(\Delta_2, \tau^*)), \tau^*)) \leq \varepsilon_{1,b}.$$

where $\Delta = \max_{x \in \mathcal{A}_0 \times \Phi_0, y \in \mathcal{A}_1 \times \Phi_1} |x - y|$, $\Delta_1 = \max z_0(t, j)$, $\Delta_2 = \max |(\xi, \zeta_0)(t, j)|_{\mathcal{A}_0 \times \Phi_0}$ for each solution (ξ, ζ_0) to $(\mathcal{P}, \mathcal{K}_0)$ from \mathcal{M} (projected onto $\mathbb{R}^{n_p} \times \mathbb{R}^{n_c}$), and $\bar{\beta}_i(s, t) = 2 \exp(-\varepsilon_i t) \alpha_{i,2}(s)$ for each $i = 0, 1$.

Note that the condition in Step 3 can always be satisfied by picking small enough parameter $\varepsilon_{1,a}$, which defines the threshold for z_1 to switch from $q = 1$ to $q = 0$, and large enough parameter τ^* , which forces flows with controller \mathcal{K}_1 until the timer reaches such value. Such selections have the effect of enlarging the time the controller \mathcal{K}_1 is in the loop, making it possible that, after a jump from $q = 1$ to $q = 0$, the state of the plant is such that controller \mathcal{K}_0 stabilizes $\mathcal{A}_0 \times \Phi_0$ without further jump back to $q = 1$. Note that the condition in Step 3 is a consequence of the proof of Lemma 3.6, which guarantees that there are finitely many jumps from $q = 0$ to $q = 1$ and back (but does not quantify the number of such jumps). The design procedure and, in particular, the tuning of $\varepsilon_{1,a}$ and τ^* are illustrated in Section IV-A when revisiting Example 3.4.

E. Robustness of the Closed-loop System

The following model of the plant with perturbations is considered

$$\dot{\xi} = f_p(\xi, u + d_1) + d_2 \quad (31)$$

with outputs $y_{p,0} = h_0(\xi) + d_3$ and $y_{p,1} = h_1(\xi) + d_4$, where d_1 corresponds to actuator error, d_2 captures unmodeled dynamics, and d_3, d_4 represent measurement noise.¹⁰ Then, denoting by \tilde{d}_i the signals d_i extended to the state space of χ , the overall closed-loop system \mathcal{H}_{cl} results in a perturbed hybrid system, which is denoted by $\tilde{\mathcal{H}}_{cl}$, with dynamics

$$\begin{aligned} \dot{\chi} &= F(\chi + \tilde{d}_1) + \tilde{d}_2 & \chi + \tilde{d}_1 &\in \tilde{C} \\ \chi^+ &\in G(\chi + \tilde{d}_1) + \tilde{d}_2 & \chi + \tilde{d}_1 &\in \tilde{D}. \end{aligned}$$

The following result asserts that the stability of the closed-loop system is robust to a class of perturbations. It follows from the asymptotic stability property established in Theorem 3.5 and the fact that the construction of the hybrid supervisor leads to a well-posed closed-loop system.

Theorem 3.9: (stability under perturbations) *Suppose Assumption 3.1 holds. Then, there exists $\beta \in \mathcal{K}\mathcal{L}\mathcal{L}$ such that, for each $\varepsilon > 0$ and each compact set $\mathcal{M} \subset X$, there exists $\delta > 0$ such that for each measurable $\tilde{d}_1, \tilde{d}_2 : \mathbb{R}_{\geq 0} \rightarrow \delta\mathbb{B}$ every solution χ to $\tilde{\mathcal{H}}_{cl}$ with $\chi(0,0) \in \mathcal{M}$ satisfies*

$$|\chi(t,j)|_{\mathcal{A}_s} \leq \beta(|\chi(0,0)|_{\mathcal{A}_s}, t, j) + \varepsilon \quad \forall (t,j) \in \text{dom } \chi.$$

Proof: By Theorem 6.5 in [14], there exists $\beta \in \mathcal{K}\mathcal{L}\mathcal{L}$ such that all solutions χ to \mathcal{H}_{cl} satisfy $|\chi(t,j)|_{\mathcal{A}_s} \leq \beta(|\chi(0,0)|_{\mathcal{A}_s}, t, j)$ for all $(t,j) \in \text{dom } \chi$. Consider the perturbed hybrid system $\tilde{\mathcal{H}}_{cl}$. Since $\tilde{d}_1(t), \tilde{d}_2(t) \in \delta\mathbb{B}$ for all $t \geq 0$, the closed-loop system $\tilde{\mathcal{H}}_{cl}$ can be written as

$$\begin{aligned} \dot{\chi} &\in F_\delta(\chi) & \chi &\in C_\delta \\ \chi^+ &\in G_\delta(\chi) & \chi &\in D_\delta, \end{aligned} \tag{32}$$

where $F_\delta(\chi) := \overline{c\circ}F(\chi + \delta\mathbb{B}) + \delta\mathbb{B}$,

$G_\delta(\chi) := \{\eta : \eta \in \chi' + \delta\mathbb{B}, \chi' \in G(\chi + \delta\mathbb{B})\}$,

$C_\delta := \{\chi : (\chi + \delta\mathbb{B}) \cap \tilde{C} \neq \emptyset\}$, and

$D_\delta := \{\chi : (\chi + \delta\mathbb{B}) \cap \tilde{D} \neq \emptyset\}$. This hybrid system corresponds to an outer perturbation of \mathcal{H}_{cl} and satisfies (C1), (C2), (C3), and (C4) in [14] (see Example 5.3 in [14] for more details). Then, the claim follows by Theorem 6.6 in [14] since, for each compact set \mathcal{M} of the state space and each $\varepsilon > 0$, there exists $\delta^* > 0$ such that for each $\delta \in (0, \delta^*]$, every solution χ_δ to (32) from \mathcal{M} satisfy, for all $(t,j) \in \text{dom } \chi_\delta$, $|\chi_\delta(t,j)|_{\mathcal{A}_s} \leq \beta(|\chi_\delta(0,0)|_{\mathcal{A}_s}, t, j) + \varepsilon$. ■

Remark 3.10: The stability and attractivity assumptions imposed in Theorem 3.5 and Theorem 3.9 can be further relaxed as in [24]. In particular, the attractivity induced by \mathcal{K}_1 can be relaxed to be semi-global and practical (by adapting the considered compact set $\mathcal{M} \subset X$ to these “semi-global and practical” properties). Also, it can be relaxed to allow the individual controllers to have solutions that are bounded but not complete, as long as the solutions to the closed-loop system are all complete. Lastly, note that Theorem 3.9 gives a qualitative robustness result. When focusing on specific nonlinear systems (such as linear systems with saturation at the input), estimations of basins of attraction of individual continuous-time controllers have been used in [24] and thus it may be possible, for this class of specific nonlinear systems, to derive qualitative results and more explicit bounds for the robustness issue.

IV. EXAMPLES

The proposed control algorithm piecing together two output-feedback hybrid controllers is applicable to numerous control systems where the design of a single robust stabilizing controller is difficult or even impossible. Such applications include the stabilization of the inverted position of the single pendulum [27], the inverted position of the pendubot [25], the position and orientation of a mobile robot [26], and the

¹⁰ The exogenous signals d_i , $i = 1, \dots, 4$, are given on hybrid time domains, and in general, their value can jump at jump times. For exogenous signals $d_i(t)$, that is, given by functions of time, given a hybrid time domain S it is possible to define, with some abuse of notation, $d_i(t,j) := d_i(t)$ for each $(t,j) \in S$. Solutions to hybrid systems with the perturbations above is understood similarly to the concept of solution defined in Section II.

synchronization of Lorenz oscillators [8]. An implementation of the proposed controller in a real-world system will result in a logic-based algorithm that triggers the discrete updates of the variables $z_0, z_1, q,$ and τ by checking via if/else statements if the variables and measurements are in the jump set \tilde{D} . In such situations, the algorithm will update the values of the variables at the next time step. For an example of such an implementation, see [20].

Next, we revisit Examples 3.3 and 3.4.

A. Stabilization with constrained inputs and limited information

Consider the stabilization of the origin of (13) in Example 3.4. Suppose that the inputs are constrained to $u_1 u_2 = 0$ and that $\bar{\alpha}$ is a constant satisfying $|\bar{\alpha}| \in (0, \frac{\sqrt{3}}{3})$. Measurements of ξ_1 and ξ_2 are available but not simultaneously. Due to these constraints, the task of designing a single controller or a controller uniting two controllers with the same objectives for the stabilization of the origin is daunting. However, a hybrid controller \mathcal{K}_s , as presented in this paper, can be designed to accomplish this task by coordinating two controllers, \mathcal{K}_0 and \mathcal{K}_1 , with different objectives. Consider the controller \mathcal{K}_0 in Example 3.4 which consists of a static feedback controller that measures $h_0(\xi) := \xi_1$ to stabilize ξ to $\mathcal{A}_0 = (0, 0)$. From (14), it can be verified that $\{\xi : V_0(\xi) \leq \frac{1}{6}\} \subset \mathcal{B}_0$, with \mathcal{B}_0 being the basin of attraction for \mathcal{K}_0 . Since $|\bar{\alpha}| \in (0, \frac{\sqrt{3}}{3})$, we have that $V_0((0, \bar{\alpha})) < \frac{1}{6}$ and thus the point $(0, \bar{\alpha})$ is in the interior of \mathcal{B}_0 . A controller \mathcal{K}_1 can be designed to steer the solutions to $\mathcal{A}_1 := (0, \bar{\alpha})$. From (14), it follows that the point $(0, \bar{\alpha})$ belongs to the interior of \mathcal{B}_0 ; hence item 3 in Assumption 3.1 holds. Let $h_1(\xi) := \xi_2 - \bar{\alpha}$. The controller \mathcal{K}_1 is given as in (4) with $n_c = 0$, $\kappa_{c,1}(\xi) := [h_1(\xi) + \bar{\alpha}, 0]^\top$, and no dynamical state (i.e., $C_{c,1} = D_{c,1} = \emptyset$ and $f_{c,1}, g_{c,1}$ are arbitrary). With this controller, the function $V_1(\xi) = \frac{1}{4}\xi_1^4 + \frac{1}{2}(\xi_2 - \bar{\alpha})^2$ satisfies, for all $\xi \in \mathbb{R}^2$, $\langle \nabla V_1(\xi), f_p(\xi, \kappa_{c,1}(\xi)) \rangle \leq -V_1(\xi)$, from where a norm observer for $|\xi|_{\mathcal{A}_1}$ follows; e.g., we can use $\dot{z}_1 = -z_1$. Then, Assumption 3.1 holds with $m_{c,0} = m_{c,1} = 1$, $\Phi_0 = \Phi_1 = \emptyset$, $\varepsilon_0 = 1$, and $\varepsilon_1 = 1$. Then, using Theorem 3.5 there exists a hybrid supervisor \mathcal{K}_s such that the origin of (13) is asymptotically stable. Following Section III-B.3, the closed-loop system has state $\chi = (\xi, z_0, z_1, q, \tau) \in \mathbb{R}^2 \times \mathbb{R} \times \mathbb{R} \times \mathcal{Q} \times \mathbb{R} =: X$ and is given by¹¹

$$F(\chi) := \begin{bmatrix} \begin{bmatrix} -\xi_1 + (\kappa_{c,q}^1(\xi) - \xi_2)\xi_1^2 \\ -\xi_2 + \xi_1^2 + \bar{\alpha} + \kappa_{c,q}^2(\xi) \end{bmatrix} \\ (1-q)(-z_0 + |h_0(\xi)|^4(1 + |h_0(\xi)|^2)) \\ -q z_1 \\ 0 \\ q \end{bmatrix},$$

$$G(\chi) := [\xi^\top \ 0 \ 0 \ 1 - q \ 0]^\top, \quad \tilde{C} := C_{s,a} \cup C_{s,b} \cup C_{s,c},$$

$$\begin{aligned} C_{s,a} &:= \{\chi : \varepsilon_{0,a} \geq z_0 \geq 0, z_1 = 0, q = 0, \tau = 0\}, \\ C_{s,b} &:= \{\chi : z_0 = 0, z_1 \geq \varepsilon_{1,a}, q = 1\}, \\ C_{s,c} &:= \{\chi : z_0 = 0, z_1 \geq 0, q = 1, \tau \leq \tau^*\}, \end{aligned}$$

$$\tilde{D} := D_{s,a} \cup D_{s,b},$$

$$\begin{aligned} D_{s,a} &:= \{\chi : z_0 \geq \varepsilon_{0,a}, z_1 = 0, q = 0, \tau = 0\}, \\ D_{s,b} &:= \{\chi : z_0 = 0, \varepsilon_{1,a} \geq z_1 \geq 0, q = 1, \tau \geq \tau^*\}. \end{aligned}$$

Figure 2 shows a trajectory to the closed-loop system when $\bar{\alpha} = \frac{1}{4}$, $\varepsilon_{0,a} = \varepsilon_{1,a} = 0.01$, $\tau^* = 1$, and $\mathcal{M}_0 = 10\mathbb{B}$, which are parameters found numerically. The trajectory starts from $\xi(0, 0) = (3, -3)$ with controller \mathcal{K}_1 connected to the plant ($q = 1$), which steers the plant component to a neighborhood of the

¹¹ We denote the i -th component of $\kappa_{c,q}$ by $\kappa_{c,q}^i(\xi)$, $i = 1, 2, q = 0, 1$.

origin. At about $(t, j) \approx (4.65, 0)$, z_1 reaches $\varepsilon_{1,a}$ and τ is above τ^* , triggering a jump to $q = 0$. In that mode, the local controller steers the plant component to zero, z_0 approaches zero, and the other controller components remain at zero. Figure 3 shows a trajectory to the closed-loop system with $q(0, 0) = 0$ and $\xi(0, 0) = (30, -30)$. In this case, a jump of the supervisor to $q = 1$ occurs initially.¹² Since after the jump z_1 is mapped to zero, z_1 remains at zero for the remainder of the solution, jumps back to $q = 0$ are triggered every τ^* seconds, with instantaneous jumps back to $q = 1$ until the local controller is capable of stabilizing \mathcal{A}_0 .

The design procedure in Corollary 3.8 can be used to systematically select parameters $\varepsilon_{1,a}$ and τ^* . In this way, we follow the steps proposed therein with $\bar{\alpha} = \frac{1}{4}$ and $\mathcal{M}_0 = 10\mathbb{B}$. Since, as shown earlier, we have $\{\xi : V_0(\xi) \leq \frac{1}{6}\} \subset \mathcal{B}_0$, then we pick $\varepsilon_{0,b} = \frac{1}{6}$ in Step 1 and define Γ_0 . When $\frac{4}{27} \leq \varepsilon_{0,a} < \varepsilon_{0,b}$ and $\varepsilon_{1,b} \leq 0.015$, we have that the conditions in Step 2 hold. In fact, solutions ξ from Γ_0 satisfy $|\xi(t, j)| \leq \frac{\sqrt{3}}{3}$ for all $(t, j) \in \text{dom } \xi$ and, since $\gamma_0(s) = s^4(1 + s^2)$, we have $\gamma_0(|h_0(\xi(t, j))|) \leq \frac{4}{27}$. Moreover, a simple check on level sets indicates that $\Gamma_1 := \{\xi \in \mathbb{R}^2 : V_1(\xi) \leq 0.015\} \subset \Gamma_0$. To pick $\varepsilon_{1,a}$ and τ^* in Step 3, we first obtain the following values after straightforward computations: $\Delta = |\bar{\alpha}|$, $\Delta_1 = \varepsilon_{0,a}$, $\Delta_2 = \alpha_{0,1}^{-1}(\varepsilon_{0,a} + 2\alpha_{0,2}(10 + \varepsilon_{0,a}))$, $\alpha_{0,1}^{-1}(s) = (2s)^{1/2}$, $\alpha_{0,2}(s) = \frac{1}{2}s^2$, and $\alpha_{1,1}^{-1}(s) = 2 \max\{s^{1/4}, s^{1/2}\}$. Using $\varepsilon_{0,a} = \frac{4}{27}$, then the condition in Step 3 is satisfied with $\varepsilon_{1,a} = 0.00005$ and $\tau^* = 15$. Figure 4 shows a simulation of the closed-loop system with these parameters, which indicates that convergence to the origin occurs after only one jump.

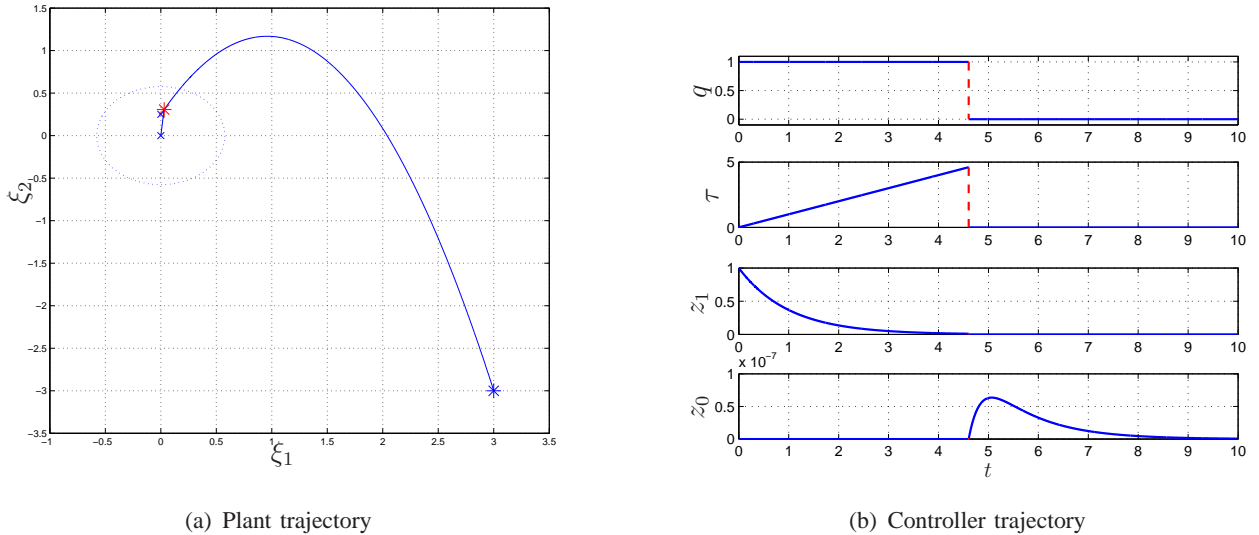

Fig. 2. Plant and controller states of a closed-loop trajectory. (a) Plant component $\xi(t, j)$ for (13) from $\xi(0, 0) = (3, -3)$, $q(0, 0) = 1$, $\tau(0, 0) = z_0(0, 0) = 0$, $z_1(0, 0) = 1$. Dotted lines denote an estimate of \mathcal{B}_0 , \star (red) the jump from $q = 1$ to 0, and \times the sets $\mathcal{A}_1 = (0, \bar{\alpha})$ and $\mathcal{A}_0 = (0, 0)$, with $\bar{\alpha} = \frac{1}{4}$. (b) Controller states of hybrid supervisor \mathcal{K}_s . The dashed lines represent the jumps in the variables. Controller parameters: $\varepsilon_{0,a} = \varepsilon_{1,a} = 0.01$, and $\tau^* = 1$.

B. Stabilization under topological obstructions

Consider the stabilization of the point $\mathcal{A}_0 := \{\xi^*\}$, for the point-mass system in Example 3.3. Following the discussions therein, the measurements available are

$$\begin{aligned} y_1 &= h_1(\xi) := (\varphi_1(\xi), \nabla \varphi_1(\xi), \varphi_2(\xi), \nabla \varphi_2(\xi)) \quad \forall \xi \in \mathbb{R}^2, \\ y_2 &= h_2(\xi) := \xi \quad \forall \xi \in \xi^* + \varepsilon\mathbb{B} \end{aligned} \quad (33)$$

¹²Dashed (red) lines denote jumps in the state components.

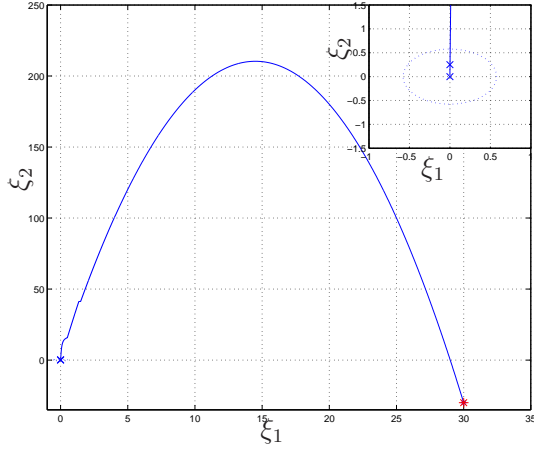

(a) Plant trajectory and zoom around origin

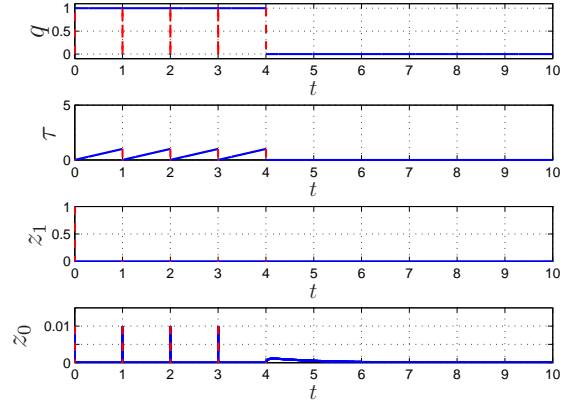

(b) Controller trajectory

Fig. 3. Plant and controller states of a closed-loop trajectory. (a) Plant component $\xi(t, j)$ for (13) from $\xi(0, 0) = (30, -30)$, $q(0, 0) = \tau(0, 0) = z_0(0, 0) = 0$, $z_1(0, 0) = 1$. Dotted lines denote an estimate of \mathcal{B}_0 , \star (red) the jump from $q = 1$ to 0, and \times the sets $\mathcal{A}_1 = (0, \bar{\alpha})$ and $\mathcal{A}_0 = (0, 0) (= \mathcal{A})$, with $\bar{\alpha} = \frac{1}{4}$. (b) Controller states of hybrid supervisor \mathcal{K}_s . The dashed lines represent the jumps in the variables. Controller parameters: $\varepsilon_{0,a} = \varepsilon_{1,a} = 0.01$, and $\tau^* = 1$.

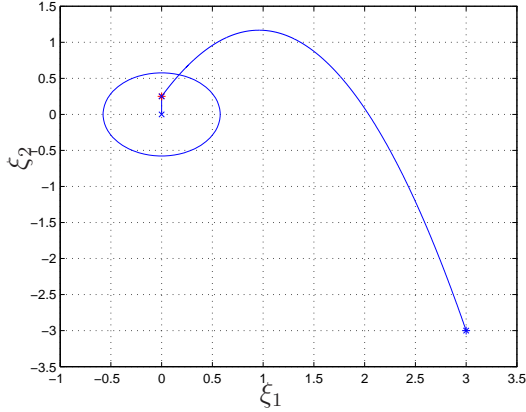

(a) Plant trajectory

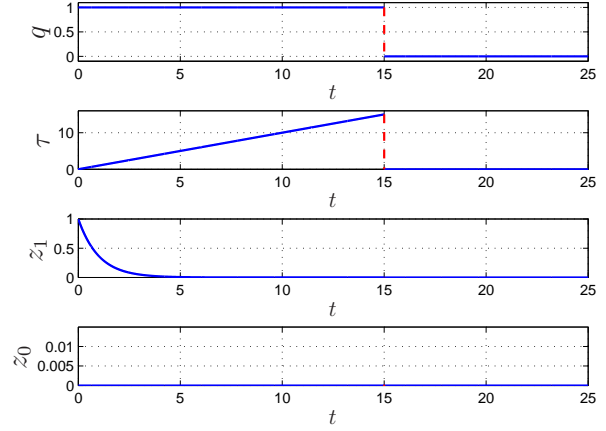

(b) Controller trajectory

Fig. 4. Plant and controller states of a closed-loop trajectory. (a) Plant component $\xi(t, j)$ for (13) from $\xi(0, 0) = (3, -3)$, $q(0, 0) = 1$, $\tau(0, 0) = z_0(0, 0) = 0$, $z_1(0, 0) = 1$. Dotted lines denote an estimate of \mathcal{B}_0 , \star (red) the jump from $q = 1$ to 0, and \times the sets $\mathcal{A}_1 = (0, \bar{\alpha})$ and $\mathcal{A}_0 = (0, 0)$, with $\bar{\alpha} = \frac{1}{4}$. (b) Controller states of hybrid supervisor \mathcal{K}_s . The dashed lines represent the jumps in the variables. Controller parameters: $\varepsilon_{0,a} = \frac{4}{27}$, $\varepsilon_{1,a} = 0.00005$, and $\tau^* = 15$.

for some $\varepsilon > 0$, where φ_i , $i = 1, 2$, are continuously differentiable functions given by

$$\varphi_i(\xi) := \frac{1}{2}(\xi - \xi^\circ)^\top (\xi - \xi^\circ) + B(d_i(\xi))$$

with $B : \mathbb{R}_{\geq 0} \rightarrow \mathbb{R}$ a continuously differentiable function defined as $B(z) := \max\{0, (z - 1)^2 \ln \frac{1}{z}\}$ and $d_i : \mathbb{R}^2 \rightarrow \mathbb{R}_{\geq 0}$ a continuously differentiable function that measures the distance from any point in O_i to the set \mathcal{N} . These functions define “potential” functions relative to the intermediate target point ξ° that include the presence of the obstacle. The sets \mathcal{N} for $\hat{\alpha} = 0.07$ and $\bar{\xi} = (1, 0)$, \mathcal{A}_0 for $\{\xi^*\} = \{(4, -\frac{1}{4})\}$, and O_i given by $O_1 = \{\xi \in \mathbb{R}^2 : |\xi_1| - 1.1 \geq \xi_2\}$, $O_2 = \{\xi \in \mathbb{R}^2 : |\xi_1| + 1.1 \leq \xi_2\}$ are depicted in

Figure 5. The point ξ° is the point at which φ_i vanishes. The local controller can measure the full state ξ in the neighborhood $\mathcal{A}_0 + \varepsilon\mathbb{B}$ for $\varepsilon = 1$.

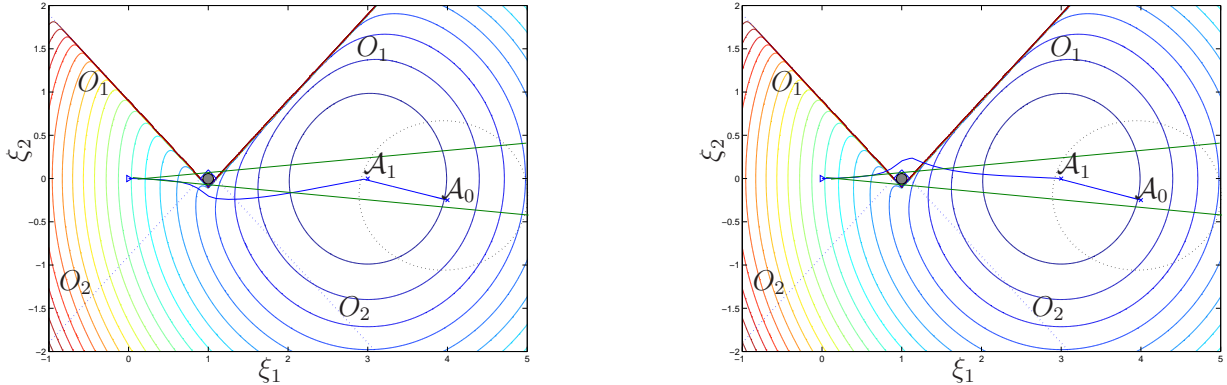

(a) Plant trajectory with initial conditions $\xi(0,0) = 0$, $q(0,0) = 1$, $\zeta_1(0,0) = 1$, steered below the obstacle using $\kappa_1(\xi, 1)$ while in $\zeta_1 = 1$.

(b) Plant trajectory with initial conditions $\xi(0,0) = 0$, $q(0,0) = 1$, $\zeta_1(0,0) = 2$, steered above the obstacle using $\kappa_1(\xi, 2)$ while in $\zeta_1 = 2$.

Fig. 5. Trajectories $\xi(t, j)$ to point-mass system with hybrid supervisor \mathcal{K}_s . Dotted circle denotes an estimate of \mathcal{B}_0 and \times the sets $\mathcal{A}_1 = \{(3, 0)\}$ and $\mathcal{A}_0 = \{(4, -\frac{1}{4})\}$. The set O_1 is the region below the upper “wedge,” while the set O_2 is the region above the lower “wedge,” which is depicted in dotted line. The cone emanating from the initial condition depicts that, initially, the target point is not in the line-of-sight of the point-mass system. The controller parameters used are $\mu = 1.1$ and $\lambda = 0.09$.

We design a hybrid supervisor \mathcal{K}_s to coordinate two output-feedback controllers. The controller while in mode $q = 1$ is hybrid with a discrete state $\zeta_1 \in \{1, 2\}$ evolving continuously according to $\dot{\zeta}_1 = 0$. The target stabilization set for this controller is taken to be $\mathcal{A}_1 = \{\xi^\circ\}$. Let $\mu > 1, \lambda \in (0, \mu - 1)$. The following hybrid controller defines the feedback law $\mathcal{K}_1 \kappa_{c,1}(\xi, \zeta_1) := -\nabla\varphi_{\zeta_1}(\xi)$ when $(\xi, \zeta_1) \in C_{c,1}$, where

$$C_{c,1} := \{(\xi, \zeta_1) \in \cup_{\zeta_1 \in \{1,2\}} (O_{\zeta_1} \times \{\zeta_1\}) : \varphi_{\zeta_1}(\xi) \leq \mu \min_{\zeta_1 \in \{1,2\}} \varphi_{\zeta_1}(\xi)\}$$

$$\varphi_{\zeta_1}(\xi) \leq \mu \min_{\zeta_1 \in \{1,2\}} \varphi_{\zeta_1}(\xi)$$

and has discrete dynamics given by

$$\zeta_1^+ \in G_1(y_1, \zeta_1) := \{\zeta_1' \in \{1, 2\} : \varphi_{\zeta_1}(\xi) \geq (\mu - \lambda)\varphi_{\zeta_1'}(\xi)\}$$

when $(\xi, \zeta_1) \in D_{c,1}$, where

$$D_{c,1} := \{(y_1, \zeta_1) : \varphi_{\zeta_1}(\xi) \geq (\mu - \lambda) \min_{\zeta_1' \in \{1,2\}} \varphi_{\zeta_1'}(\xi)\}.$$

The design parameters of the controller \mathcal{K}_1 are μ and λ .

Take $V(\xi, \zeta_1) = \varphi_{\zeta_1}(\xi)$, then with the \mathcal{K}_1 dynamics we obtain, with $\gamma' := (\mu - \lambda)^{-1}$, $\gamma' \in (0, 1)$, $\rho(s) = s^2$,

$$V(\xi, \zeta_1') \leq \gamma' V(\xi, \zeta_1) \quad \forall \zeta_1' \in G_1(\xi, \zeta_1), \quad \forall (\xi, \zeta_1) \in D_{c,1},$$

and, $\forall (\xi, \zeta_1) \in C_{c,1}$,

$$\langle \nabla V(\xi, \zeta_1'), f_p(\xi, \kappa_1(\xi, \zeta_1)) \rangle \leq -2V(\xi, \zeta_1).$$

Global asymptotic stability of \mathcal{A}_1 (on $C_{c,1} \cup D_{c,1}$) follows, from where a norm observer for $|\xi|_{\mathcal{A}_1}$ exists; e.g., we can use $\varepsilon_1 = 1 - \gamma'$ and any class- \mathcal{K} function γ_1 for the norm observer in (10). The local controller to use in mode $q = 0$ is a static, continuous-time feedback of the form $\kappa_{c,0}(\xi) := -\xi + \xi^*$. Local asymptotic stability of \mathcal{A}_0 follows with basin of attraction $\mathcal{A}_0 + \varepsilon\mathbb{B}$ and $\dot{z}_0 = -z_0$ is a norm observer for $|\xi|_{\mathcal{A}_0}$.

Figure 5 depicts trajectories to the plant with the proposed hybrid supervisor for two different initial conditions of the state ζ_1 of the controller \mathcal{K}_1 . The trajectories converge first to a neighborhood of \mathcal{A}_1 , and when z_1 becomes small enough, a jump to \mathcal{K}_0 is triggered and the trajectories converge to \mathcal{A}_0 .

V. CONCLUSION

A solution to a general uniting problem was formulated and exercised in examples. The controllers considered can be hybrid, nonlinear, output-feedback, and have different objectives. The solution consists of constructing a well-posed hybrid supervisor that appropriately combines two hybrid controllers to accomplish the task. In addition to stability and attractivity properties, to guarantee the existence of norm estimators, the individual controllers are assumed to induce an output-to-state stability property. Robustness of the full closed-loop system is asserted via results for perturbed hybrid systems. Examples illustrating the design methodology of the hybrid supervisor were presented. The proposed algorithm can also be used for waypoint navigation and loitering control of unmanned aerial vehicles [7]. The proposed solution does not assume a detectability property for the plant and thus, in contrast to [24], a global norm observer may not exist. When this stronger property is assumed, the proposed hybrid supervisor achieves robust, global asymptotic stability. Moreover, the attractivity property in Assumption 3.1 can be relaxed to a semi-global, practical attractivity property.

REFERENCES

- [1] V. Andrieu and L. Praly. A unifying point of view on output feedback designs for global asymptotic stabilization. *Automatica*, 45(8):1789–1798, 2009.
- [2] V. Andrieu and C. Prieur. Uniting two control Lyapunov functions for affine systems. *IEEE Transactions on Automatic Control*, 55(8):1923–1927, 2010.
- [3] R. W. Brockett. *Differential Geometric Control Theory*, chapter Asymptotic stability and feedback stabilization, pages 181–191. Birkhauser, Boston, MA, 1983.
- [4] R. R. Burridge, A. A. Rizzi, and D. E. Koditschek. Toward a systems theory for the composition of dynamically dexterous robot behaviors. In *International Symposium on Robotics Research*, volume 7, pages 149–161. MIT PRESS, 1996.
- [5] C. Cai and A. R. Teel. A globally detectable hybrid system admits a smooth OSS-Lyapunov function. In *American Control Conference*, pages 4049–4054, 2006.
- [6] C. Cai and A. R. Teel. Output-to-state stability for hybrid systems. *Systems & Control Letters*, 60:62–68, 2011.
- [7] D. W. Smith III and R. G. Sanfelice. A hybrid control strategy for waypoint transitioning and loitering of unmanned aerial vehicles. Submitted to 2014 American Control Conference.
- [8] D. Efimov, A. Loria A., and E. Panteley. Robust output stabilization: Improving performance via supervisory control. *International Journal of Robust and Nonlinear Control*, 21(10):1219–1236, 2011.
- [9] D. Efimov, A. Loria, and E. Panteley. Multigoal output regulation via supervisory control: Application to stabilization of a unicycle. In *Proc. 2009 American Control Conference*, 2009.
- [10] D. V. Efimov. Uniting global and local controllers under acting disturbances. *Automatica*, 42:489–495, 2006.
- [11] R. Goebel, J.P. Hespanha, A.R. Teel, C. Cai, and R.G. Sanfelice. Hybrid systems: generalized solutions and robust stability. In *Proc. 6th IFAC Symposium on Nonlinear Control Systems*, pages 1–12, 2004.
- [12] R. Goebel, R. G. Sanfelice, and A. R. Teel. *Hybrid Dynamical Systems: Modeling, Stability, and Robustness*. Princeton University Press, New Jersey, 2012.
- [13] R. Goebel, R.G. Sanfelice, and A.R. Teel. Hybrid dynamical systems. *IEEE Control Systems Magazine*, 29(2):28–93, April 2009.
- [14] R. Goebel and A.R. Teel. Solutions to hybrid inclusions via set and graphical convergence with stability theory applications. *Automatica*, 42(4):573–587, 2006.
- [15] J. P. Hespanha, D. Liberzon, and A. S. Morse. Supervision of integral-input-to-state stabilizing controllers. *Automatica*, 38:1327–335, 2002.
- [16] C. G. Mayhew, R. G. Sanfelice, and A. R. Teel. Quaternion-based hybrid controller for robust global attitude tracking. *IEEE Transactions on Automatic Control*, 56(11):2555–2566, November 2011.
- [17] P. Morin, R.M. Murray, and L. Praly. Nonlinear rescaling of control laws with application to stabilization in the presence of magnitude saturation. In *Proc. 4th IFAC Symposium on Nonlinear Control Systems*, Enschede, the Netherlands, 1998.
- [18] A. S. Morse. Supervisory control of families of linear set-point controllers - Part 1: Exact matching. *IEEE Transactions on Automatic Control*, 41:1413–1431, 1996.
- [19] A. S. Morse. Supervisory control of families of linear set-point controllers - Part 2: Robustness. *IEEE Transactions on Automatic Control*, 42:1500–1515, 1997.
- [20] R. O’Flaherty, R. G. Sanfelice, and A. R. Teel. Robust global swing-up of the pendubot via hybrid control. In *Proc. 27th American Control Conference*, pages 1424–1429, 2008.
- [21] Z. Pan, K. Ezal, A.J. Krener, and P.V. Kokotovic. Backstepping design with local optimality matching. *IEEE Transactions on Automatic Control*, 46(7):1014–1027, 2001.

- [22] C. Prieur. Uniting local and global controllers with robustness to vanishing noise. Math. Control Signals Systems, 14:143–172, 2001.
- [23] C. Prieur, R. Goebel, and A. R. Teel. Hybrid feedback control and robust stabilization of nonlinear systems. IEEE Transactions on Automatic Control, 52(11):2103–2117, November 2007.
- [24] C. Prieur and A.R. Teel. Uniting local and global output feedback controllers. IEEE Transactions on Automatic Control, 56(7):1636–1649, 2011.
- [25] R. G. Sanfelice and A. R. Teel. A “throw-and-catch” hybrid control strategy for robust global stabilization of nonlinear systems. In Proc. 26th American Control Conference, pages 3470–3475, 2007.
- [26] R. G. Sanfelice, A. R. Teel, and R. Goebel. Supervising a family of hybrid controllers for robust global asymptotic stabilization. In Proc. 47th IEEE Conference on Decision and Control, pages 4700–4705, 2008.
- [27] R. G. Sanfelice, A. R. Teel, R. Goebel, and C. Prieur. On the robustness to measurement noise and unmodeled dynamics of stability in hybrid systems. In Proc. 25th American Control Conference, pages 4061–4066, 2006.
- [28] R.G. Sanfelice, R. Goebel, and A.R. Teel. Generalized solutions to hybrid dynamical systems. ESAIM: Control, Optimisation and Calculus of Variations, 14(4):699–724, 2008.
- [29] E. D. Sontag and Y. Wang. Output-to-state stability and detectability of nonlinear systems. Systems & Control Letters, 29:279–290, 1997.
- [30] A.R. Teel and N.Kapoor. Uniting global and local controllers. In Proc. European Control Conference, 1997.