

Twisted Injectivity in PEPS and the Classification of Quantum Phases

Oliver Buerschaper

September 18, 2018

Abstract

We introduce a class of projected entangled pair states (PEPS) which is based on a group symmetry twisted by a 3-cocycle of the group. This twisted symmetry gives rise to a new standard form for PEPS from which we construct a family of local Hamiltonians which are gapped, frustration-free and include fixed points of the renormalization group flow. Moreover, we advance the classification of 2D gapped quantum spin systems by showing how this new standard form for PEPS determines the emergent topological order of these local Hamiltonians. Specifically, we identify their universality class as DIJKGRAAF-WITTEN topological quantum field theory (TQFT).

1 Introduction

1.1 Background

A central topic in condensed matter physics is understanding the universality classes of Hamiltonians with an energy gap above their ground state(s). Here two physical systems are defined to be in the same universality class if they can be connected by a smooth path of gapped local Hamiltonians (i.e. by quasi-adiabatic evolution) [1, 2].

Recently, in 1D a complete classification of gapped quantum spin systems has been obtained using matrix product states (MPS) [3] and their parent Hamiltonians [4]. This remarkable achievement has largely been possible for the following reasons: there is an area law for the entanglement entropy of gapped quantum spin chains [5, 6], there is a normal form for MPS [7], and most importantly, there is *no intrinsic* topological order in 1D, only symmetry protected topological order. In other words, in the absence of (physical) symmetry all ground states of gapped quantum spin chains are equivalent to product states under quasi-adiabatic evolution.

In 2D the situation turns out to be much more intricate. First and foremost, there is *both* intrinsic [8, 9, 10, 11, 12, 13, 14] *and* symmetry protected topological order [15, 16, 17, 18, 19], as well as nontrivial blends of these kinds of order [20, 21]. Second, there is no area law for gapped quantum spin systems in 2D (or higher) which follows from the gap alone. Third, proving the very existence of a gap is notoriously hard in 2D. Finally, tensor network methods generalizing MPS to 2D, like projected entangled pair states (PEPS), turn out to be considerably

more challenging than in 1D, if only because contracting PEPS is not efficient in general [22] and a condition known as injectivity does not automatically imply a gap for the parent Hamiltonian of a PEPS. As far as understanding universality classes is concerned the lack of a normal form for PEPS (or for any other local description of ground states) arguably poses the most formidable challenge.

Much more can be said once we restrict our attention to a remarkable class of 2D quantum spin systems in which the gap is provably stable against *any* small enough perturbation [23, 24]. In fact, this unconditional stability under quasi-adiabatic evolution may be taken as a definition of intrinsic topological order. It then follows that a whole range of low energy features, both *local* and *global*, will also survive the perturbation, i.e. are characteristic of the universality class. Unfortunately, locally computable invariants of the ground states [23, 25, 26] reveal only partial information about the kind of topological order [27]. Not surprisingly, global invariants [28, 29] are potentially much more valuable for identifying the universality class of a system. Along these lines, representations of the modular group [10] are believed to completely describe intrinsic topological order, and compelling numerical evidence [13, 30, 31, 32] suggests that these are indeed stable. However, it is far from clear how these global invariants *emerge* from the microscopic interactions, or from a yet to be discovered *local* normal form for low energy states. As far as PEPS are concerned, a first step towards solving this problem has been made by studying PEPS with a virtual group symmetry and a certain standard form derived from it [33].

In this article we generalize this approach and present a) a large subclass of PEPS which is based on a new standard form and b) a continuous family of corresponding parent Hamiltonians which are gapped, frustration-free and include fixed points of the renormalization group flow. We advance the classification of 2D gapped quantum spin systems by showing how this new standard form for PEPS determines the emergent topological order in the system.

1.2 Results

More precisely, our new standard form for PEPS fits into the existing picture as follows. Decompose any PEPS tensor A as $A = QW$ where Q is positive and W is a partial isometry, called the isometric form in [4]. A major part of classifying all PEPS consists in identifying all possible isometric (or standard) forms W in order to eventually obtain a complete normal form for PEPS. The only standard forms W identified so far are the *block-diagonal* and the *G -isometric* form where G is a finite group [4]. While the former standard form describes some kind of local symmetry breaking, the latter describes the universality class of quantum double models $D(G)$ [34]. Here we extend the virtual group symmetry underlying the G -isometric standard form [33] to a *twisted* virtual group symmetry where the twist ω is a 3-cocycle of the group G . As our first main result we obtain the subclass of (G, ω) -injective tensors together with the new (G, ω) -isometric standard form for PEPS.

Furthermore we employ this new standard form for PEPS to construct a continuous family of gapped, frustration-free Hamiltonians whose interaction terms do *not* commute. Nevertheless we can show rigorously that this family lies in the universality class of twisted gauge theory (twisted quantum double models) [35, 36, 37, 38]. We proceed in three steps. First, we show that the parent Hamiltonian of an arbitrary (G, ω) -injective PEPS on a torus has a ground state

degeneracy which is given by the number of so called c^ω -regular pair conjugacy classes of G . Second, we show that parent Hamiltonians of (G, ω) -isometric PEPS describe time slices in DIJKGRAAF-WITTEN topological quantum field theory (TQFT) [35], only depend on the cohomology class of the twist ω , and have commuting projections as interaction terms. This clearly identifies the above universality class. Finally, we use quasi-adiabatic evolution to lift all interesting features of the fixed point Hamiltonians of the previous step to the so called *almost* (G, ω) -isometric PEPS. As our second main result, this procedure yields the desired family of gapped, frustration-free Hamiltonians whose intrinsic topological order is determined by our new standard form for PEPS.

1.3 Structure

This article is structured as follows. In Section 2 we introduce (G, ω) -injective tensors via a virtual symmetry expressed as matrix product operators (MPO). We also study the space of quantum states that emerges from arbitrary (G, ω) -injective tensors on a torus within the usual PEPS formalism. In Section 3 we construct the parent Hamiltonians corresponding to (G, ω) -injective tensors. In Section 4 we identify our new (G, ω) -isometric standard form for PEPS and study the properties of their parent Hamiltonians. In Section 5 we turn to *almost* (G, ω) -isometric tensors and obtain the desired family of gapped, frustration-free Hamiltonians. We conclude with a discussion and an outlook on open questions in Section 6.

2 Twisted Injectivity

2.1 Branched Tensors

Definition 1 (Branched polygon). *A branching structure on a polygon is an acyclic orientation of its edges.*

Definition 2 (Branched tensor). *Let G be a finite group and p be an n -polygon with a branching structure. A branched tensor (A_i) is a tensor with elements $(A_i)_{\alpha_1 \dots \alpha_n} \in \mathbb{C}$ for $\alpha_k \in G$ and $i = 1, \dots, N$ together with the branching structure of p .*

For reasons to become clear later we will usually duplicate each index α_k . For example, this gives a particular branched triangle tensor:

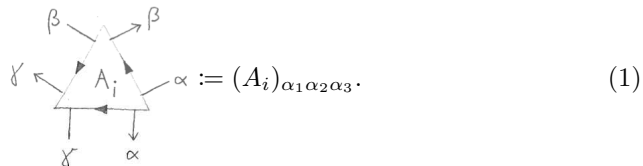

$$(1) \quad := (A_i)_{\alpha_1 \alpha_2 \alpha_3}.$$

Given a branched tensor $(A_i)_{\alpha_1 \dots \alpha_n}$, we may naturally associate with it the linear map

$$A := \sum_i \sum_{\alpha_k \in G} (A_i)_{\alpha_1 \dots \alpha_n} |i\rangle \langle \alpha_1, \dots, \alpha_n|$$

from the *virtual* space $\mathbb{C}G \otimes \cdots \otimes \mathbb{C}G$ to the local *physical* space \mathcal{H}_p (of the polygon p). We will use

$$\mathcal{L}_p := \text{im}(A)$$

to denote the physical subspace generated from the virtual level.¹ Frequently we will also consider branched tensors $(\tilde{A}^i)_{\alpha_1 \dots \alpha_n}$ in order to describe linear maps from the local physical space to the virtual space:

$$\tilde{A} := \sum_i \sum_{\alpha_k \in G} (\tilde{A}^i)_{\alpha_1 \dots \alpha_n} |\alpha_1, \dots, \alpha_n\rangle \langle i|.$$

As is customary, we will usually not distinguish between the tensors and their corresponding maps.

2.2 Twisted Symmetry as Matrix Product Operator

We first define a twisted group action on the virtual boundary of a branched tensor in terms of an MPO.

Definition 3 (Twisted symmetry MPO). *Let $\omega \in H^3(G, \text{U}(1))$. For each $g \in G$ the tensors $T_+^\omega(g)$ and $T_-^\omega(g)$ whose only non-vanishing elements read*

$$\begin{array}{c} \alpha g \quad \alpha g \\ \uparrow \quad \uparrow \\ \alpha \leftarrow \boxed{} \leftarrow \beta \\ \downarrow \quad \downarrow \\ \alpha \quad \alpha \end{array} := \omega(\alpha\beta^{-1}, \beta, g)^{-1}, \quad (2)$$

$$\begin{array}{c} \alpha g \quad \alpha g \\ \uparrow \quad \uparrow \\ \alpha \leftarrow \boxed{} \leftarrow \beta \\ \downarrow \quad \downarrow \\ \alpha \quad \alpha \end{array} := \omega(\beta\alpha^{-1}, \alpha, g), \quad (3)$$

respectively define an MPO $V^\omega(g)$ acting on the virtual boundary of a branched tensor via

$$\langle \alpha_1, \dots, \alpha_n | V^\omega(g) | \beta_1, \dots, \beta_n \rangle := \begin{array}{c} \alpha_1 \quad \alpha_2 \quad \dots \quad \alpha_n \\ \uparrow \quad \uparrow \quad \dots \quad \uparrow \\ \boxed{} \rightarrow \boxed{} \rightarrow \dots \rightarrow \boxed{} \\ \downarrow \quad \downarrow \quad \dots \quad \downarrow \\ \beta_1 \quad \beta_2 \quad \dots \quad \beta_n \end{array} \cdot \quad (4)$$

Remark 1. We can write the MPO $V^\omega(g)$ in a slightly different way so that its “input” and “output” become more apparent:

$$\begin{array}{c} \beta_2 \\ \uparrow \quad \uparrow \\ \alpha_2 \quad \alpha_2 \\ \downarrow \quad \downarrow \\ \beta_1 \end{array} \begin{array}{c} \alpha_1 \\ \uparrow \\ \alpha_1 \\ \downarrow \\ \beta_1 \end{array} = \begin{array}{c} \alpha_2 \\ \uparrow \\ \alpha_2 \\ \downarrow \\ \beta_1 \end{array} \begin{array}{c} \alpha_1 \\ \uparrow \\ \alpha_1 \\ \downarrow \\ \beta_1 \end{array} \cdot \quad (5)$$

¹While we may always choose $\mathcal{H}_p = \mathcal{L}_p$ to make A surjective locally we will have $\mathcal{L}_{p \cup p'} \subsetneq \mathcal{H}_{p \cup p'}$ once we contract tensors (A_i) and (B_j) corresponding to p and p' .

This naturally extends to all other branched polygons beyond the one shown here. \square

Proposition 1. *The MPOs $\{V^\omega(g) \mid g \in G\}$ form a unitary representation of G .*

Proof. We may assume that the MPO acts on the virtual boundary of the branched triangle tensor (1) without loss of generality. Suppressing duplicate indices we have

$$V^\omega(g) = \sum_{\alpha, \beta, \gamma \in G} \frac{\omega(\gamma\alpha^{-1}, \alpha g^{-1}, g)}{\omega(\beta\alpha^{-1}, \alpha g^{-1}, g)\omega(\gamma\beta^{-1}, \beta g^{-1}, g)} |\alpha g^{-1}, \beta g^{-1}, \gamma g^{-1}\rangle \langle \alpha, \beta, \gamma|. \quad (6)$$

From the 3-cocycle relation (52) it is not difficult to show that $V^\omega(g_1)V^\omega(g_2) = V^\omega(g_1g_2)$ for all ω and $g_i \in G$.

Finally we obtain

$$\begin{aligned} V^\omega(g^{-1}) &= \sum_{\alpha, \beta, \gamma \in G} \frac{\omega(\gamma\alpha^{-1}, \alpha g, g^{-1})}{\omega(\beta\alpha^{-1}, \alpha g, g^{-1})\omega(\gamma\beta^{-1}, \beta g, g^{-1})} |\alpha g, \beta g, \gamma g\rangle \langle \alpha, \beta, \gamma| \\ &= \sum_{\alpha, \beta, \gamma \in G} \frac{\omega(\beta\alpha^{-1}, \alpha, g)\omega(\gamma\beta^{-1}, \beta, g)}{\omega(\gamma\alpha^{-1}, \alpha, g)} \frac{\omega(\gamma\alpha^{-1}, \alpha, e)}{\omega(\beta\alpha^{-1}, \alpha, e)\omega(\gamma\beta^{-1}, \beta, e)} \\ &\quad |\alpha g, \beta g, \gamma g\rangle \langle \alpha, \beta, \gamma| \\ &= \sum_{\alpha, \beta, \gamma \in G} \frac{\omega(\beta\alpha^{-1}, \alpha, g)\omega(\gamma\beta^{-1}, \beta, g)}{\omega(\gamma\alpha^{-1}, \alpha, g)} |\alpha g, \beta g, \gamma g\rangle \langle \alpha, \beta, \gamma| \\ &= V^\omega(g)^\dagger \end{aligned}$$

for any ω and $g \in G$. Here we repeatedly used (52) to derive

$$\frac{\omega(\gamma\alpha^{-1}, \alpha, e)}{\omega(\beta\alpha^{-1}, \alpha, e)\omega(\gamma\beta^{-1}, \beta, e)} = \frac{1}{\omega(\beta, e, e)\omega(\beta^{-1}, \beta, e)} = \frac{1}{\omega(e, \beta, e)} = 1.$$

The last equality is indeed true because every 3-cocycle ω is equivalent to a *normalized* 3-cocycle $\tilde{\omega}$ for some 2-cochain ϕ , hence:

$$\omega(e, \beta, e) = \tilde{\omega}(e, \beta, e) \frac{\phi(e, \beta)\phi(\beta, e)}{\phi(e, \beta)\phi(\beta, e)} = 1.$$

\square

Corollary 1. *Let n be the length of the virtual boundary. The map*

$$\mathcal{P}^\omega := \frac{1}{|G|} \sum_{g \in G} V^\omega(g) \quad (7)$$

is a Hermitian projection onto the (G, ω) -symmetric subspace with rank $|G|^{n-1}$.

Definition 4 (Virtual symmetry). A branched tensor (A_i) is called (G, ω) -symmetric if

$$(8)$$

for all $g \in G$, or equivalently, if

$$A\mathcal{P}^\omega = A \quad (9)$$

where the underlying branching structure of \mathcal{P}^ω is that of the virtual boundary of A .

We can contract branched tensors along common boundary edges (by contracting the respective virtual indices), as long as those edges have the same orientation.

Lemma 1 (Concatenation of twisted symmetry). Any contraction $(P_{ij\dots}) := (A_i B_j \dots)$ of compatible (G, ω) -symmetric tensors $(A_i), (B_j), \dots$ is again (G, ω) -symmetric and the twisted symmetry MPO only depends on the virtual boundary of P .

Proof. Let us first focus on two (G, ω) -symmetric triangle tensors (A_i) and (B_j) contracted along a common oriented edge. Without loss of generality we assume

$$(P_{ij}) = (A_i B_j) = \gamma \quad (10)$$

and leave the orientation of the boundary edges implicit. Using the (G, ω) -symmetry of the individual tensors and the identity

$$(11)$$

we obtain

$$(P_{ij}) = \text{Diagram 1} = \text{Diagram 2}$$

where all virtual symmetry tensors are of type (g, ω) . Note that (11) equally holds for a downward interior edge and arbitrarily oriented boundary edges. This is because the only virtual symmetry tensors that depend on the orientation of the interior edge are the upper left and lower right ones. It is not difficult to see that these always cancel.

Let us now show that the virtual symmetry only depends on *open* indices at the virtual boundary. Suppressing irrelevant edge orientations we have the identity

$$\text{Diagram 3} = \text{Diagram 4} \quad (12)$$

because the two leftmost virtual symmetry tensors always cancel. It is immediately clear that this also holds for a downward interior edge as well as arbitrarily oriented boundary edges.

Without loss of generality we may now assume that the contracted tensor (P_{ijk}) has the form

$$\text{Diagram 5} \quad (13)$$

After applying the (G, ω) -symmetry to each triangle tensor individually we can push the virtual symmetry to the boundary by employing (11) twice, followed by one application of (12). This easily generalizes to arbitrary contracted tensors P . \square

Definition 5 (Twisted injectivity). A (G, ω) -symmetric tensor (A_i) is called

(G, ω) -injective if there exists a tensor (\tilde{A}^i) such that

$$\sum_i \begin{array}{c} \beta' \\ \nearrow \\ \tilde{A}^i \\ \searrow \\ \alpha' \end{array} \begin{array}{c} \beta \\ \nearrow \\ A_i \\ \searrow \\ \alpha \end{array} = \langle \alpha', \beta', \gamma' | \mathcal{P}^\omega | \alpha_1, \alpha_2, \alpha_3 \rangle, \quad (14)$$

or equivalently,

$$\tilde{A}A = \mathcal{P}^\omega \quad (15)$$

where the underlying branching structure of both \tilde{A} and \mathcal{P}^ω is that of the virtual boundary of A .

Lemma 2 (Concatenation of twisted injectivity). *Any contraction $(P_{ij\dots}) := (A_i B_j \dots)$ of compatible (G, ω) -injective tensors $(A_i), (B_j), \dots$ is again (G, ω) -injective.*

Proof. It suffices to prove the claim for two (G, ω) -injective triangle tensor (A_i) and (B_j) contracted along a common oriented edge as in (10). Setting

$$(\tilde{P}^{ij})_{\alpha_1 \dots \alpha_4} := |G| \begin{array}{c} \beta \\ \nearrow \\ \tilde{A}^j \\ \searrow \\ \delta \end{array} \begin{array}{c} \beta \\ \nearrow \\ \tilde{B}^k \\ \searrow \\ \alpha \end{array}$$

we obtain

$$\begin{aligned} \tilde{P}P &\simeq |G| \sum_{j,k} \begin{array}{c} \beta' \\ \nearrow \\ \tilde{A}^j \\ \searrow \\ \delta' \end{array} \begin{array}{c} \beta \\ \nearrow \\ \tilde{B}^k \\ \searrow \\ \alpha \end{array} \\ &= \frac{1}{|G|} \sum_{g,h \in G} \begin{array}{c} \beta' \\ \nearrow \\ \delta' \end{array} \begin{array}{c} \beta \\ \nearrow \\ \delta \end{array} \begin{array}{c} \beta \\ \nearrow \\ \delta \end{array} \begin{array}{c} \beta \\ \nearrow \\ \alpha \end{array} \\ &= \frac{1}{|G|} \sum_{g \in G} \begin{array}{c} \beta \\ \nearrow \\ \delta \end{array} \begin{array}{c} \beta \\ \nearrow \\ \delta \end{array} \begin{array}{c} \beta \\ \nearrow \\ \alpha \end{array} \end{aligned}$$

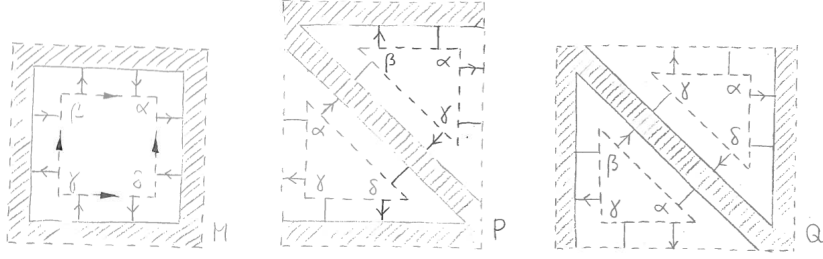

Figure 1: The closure tensor elements $\langle \alpha_1, \dots, \alpha_4 | M \rangle$, $\langle \alpha_1, \dots, \alpha_4 | P \rangle$ and $\langle \alpha_1, \dots, \alpha_4 | Q \rangle$.

$$\begin{aligned}
 &= \frac{1}{|G|} \sum_{g \in G} \text{Diagram} (g, \omega) \\
 &= \mathcal{P}^\omega
 \end{aligned}$$

where we used (14) in the second step and (11) in the last one. \square

2.3 Closure on a Torus

There are different ways to close a (minimal) torus and obtain a quantum state:

$$|\psi(M)\rangle := \sum_{j,k} \text{Diagram} |j, k\rangle, \quad (16)$$

$$|\psi(P)\rangle := \sum_{j,k} \text{Diagram} |j, k\rangle, \quad (17)$$

$$|\psi(Q)\rangle := \sum_{j,k} \text{Diagram} |j, k\rangle. \quad (18)$$

We are interested in states whose closure cannot be “detected” locally. In

other words, we would like to study those states which can be simultaneously expressed using *any* of the possible closures.

Definition 6. For all $\alpha, g, h \in G$ with $hg = gh$ let $\lambda_X(\alpha; g, h) \in \mathbb{C}$. Define tensors $M(g, h)$, $P(g, h)$ and $Q(g, h)$ by

$$\langle \alpha, \alpha g, \alpha gh, \alpha h | M(g, h) \rangle := \lambda_M(\alpha; g, h), \quad (19)$$

$$\langle \alpha, \alpha g, \alpha gh, \alpha h | P(g, h) \rangle := \lambda_P(\alpha; g, h), \quad (20)$$

$$\langle \alpha, \alpha g, \alpha gh, \alpha h | Q(g, h) \rangle := \lambda_Q(\alpha; g, h), \quad (21)$$

all other elements being zero.

Remark 2. So far we have only specified which tensor elements do *not* vanish, but left their actual value completely undetermined. In particular, we have not specified any relation between the three functions λ_X . We will do so in due course. \square

Lemma 3.

$$\begin{aligned} & \{ |\psi(M)\rangle | M \} \cap \{ |\psi(P)\rangle | P \} \cap \{ |\psi(Q)\rangle | Q \} \\ & = \text{span} \{ |\psi(M(g, h))\rangle | g, h \in G \wedge hg = gh \}. \end{aligned} \quad (22)$$

Proof. Without loss of generality we study a minimal torus consisting of two (G, ω) -injective triangle tensors (A_j) and (B_k) .

Let us first show that the right hand side is contained in the left hand side. Indeed, given the closure tensor $M(g, h)$ we have

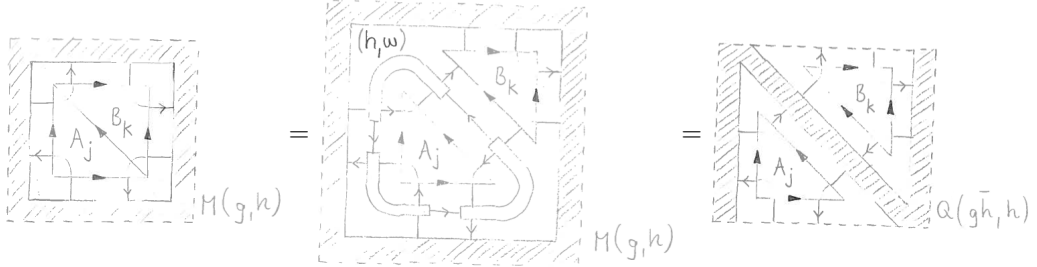

if we set

$$\lambda_Q(\alpha; gh^{-1}, h) := \lambda_M(\alpha; g, h) \frac{\omega((h^{-1})^\alpha, \alpha g, h)}{\omega((gh^{-1})^\alpha, \alpha, h) \omega((g^{-1})^\alpha, \alpha g, h)}.$$

Similarly one can show that $|\psi(M(g, h))\rangle = |\psi(P(g, g^{-1}h))\rangle$ for some appropriately chosen $\lambda_P(\alpha; g, h)$.

Now we want to show that the left hand side is contained in the right hand side. We may assume that all closure tensors M , P , and Q are (G, ω) -symmetric, i.e. $\mathcal{P}^\omega |X\rangle = |X\rangle$, because the triangle tensors are. Suppose $|\psi(M)\rangle = |\psi(P)\rangle = |\psi(Q)\rangle$ for some closures M , P and Q . We can access the closure M and express it in terms of P by applying a certain “inverse” map to

$|\psi(M)\rangle = |\psi(P)\rangle$. Then we obtain

$$\begin{aligned}
\langle \alpha, \beta, \gamma, \delta | M \rangle &= \frac{1}{|G|} \sum_{g \in G} \text{Diagram 1} \\
&= |G| \sum_{j,k} \text{Diagram 2} \\
&= |G| \sum_{j,k} \text{Diagram 3} \\
&= \frac{1}{|G|} \sum_{g,h \in G} \delta_{\alpha h, \beta g} \delta_{\gamma g, \delta h} \text{Diagram 4} \\
&= \sum_{h \in G} \delta_{\beta, \alpha h} \delta_{\gamma, \delta h} \frac{\omega(\alpha \beta^{-1}, \beta, h) \omega(\beta \delta^{-1}, \delta, h)}{\omega(\alpha \delta^{-1}, \delta, h)} \\
&\quad \frac{1}{|G|} \sum_{g \in G} \frac{\omega(\alpha \beta^{-1}, \beta h, g) \omega(\beta h \gamma^{-1}, \gamma, g)}{\omega(\alpha h \delta^{-1}, \delta, g) \omega(\delta \gamma^{-1}, \gamma, g)} \langle \alpha h g, \beta h g, \gamma g, \delta g | P \rangle \\
&= \sum_{h \in G} \delta_{\beta, \alpha h} \delta_{\gamma, \delta h} \frac{\omega(\alpha \beta^{-1}, \beta, h) \omega(\beta \delta^{-1}, \delta, h)}{\omega(\alpha \delta^{-1}, \delta, h)} \langle \alpha h, \beta h, \gamma, \delta | P \rangle.
\end{aligned} \tag{23}$$

We would like to express the closure P in terms of Q now. This can be

achieved by applying a slightly different “inverse” map to $|\psi(P)\rangle = |\psi(Q)\rangle$:

$$\begin{aligned}
 \langle \alpha, \beta, \gamma, \delta | P \rangle &= |G| \sum_{j,k} \text{diagram}_1 \text{diagram}_2 \\
 &= |G| \sum_{j,k} \text{diagram}_3 \text{diagram}_4 \\
 &= \frac{1}{|G|} \sum_{g,h \in G} \delta_{\alpha h, \delta g} \delta_{\beta h, \gamma g} \text{diagram}_5 \\
 &= \sum_{h \in G} \delta_{\delta, \alpha h} \delta_{\gamma, \beta h} \frac{\omega(\alpha \beta^{-1}, \beta, h) \omega(\beta \gamma^{-1}, \gamma, h)}{\omega(\alpha \gamma^{-1}, \gamma, h)} \langle \alpha h, \alpha, \gamma, \gamma h | Q \rangle.
 \end{aligned}
 \tag{24}$$

The diagrams in the equation are as follows:

- diagram₁**: A vertex with four legs labeled α (top), β (left), γ (bottom), and δ (right). A diagonal line with arrows pointing towards the vertex is labeled \tilde{A}^j .
- diagram₂**: A vertex with four legs labeled α (top), β (left), γ (bottom), and δ (right). A diagonal line with arrows pointing away from the vertex is labeled \tilde{B}^k .
- diagram₃**: A vertex with four legs labeled α (top), β (left), γ (bottom), and δ (right). A diagonal line with arrows pointing towards the vertex is labeled \tilde{A}^j .
- diagram₄**: A vertex with four legs labeled α (top), β (left), γ (bottom), and δ (right). A diagonal line with arrows pointing away from the vertex is labeled \tilde{B}^k .
- diagram₅**: A square region with a diagonal line from top-left to bottom-right. The top-left corner is labeled (g, ω) and the bottom-right corner is labeled (h, ω) . The top edge has legs βh and αh . The bottom edge has legs γg and δg . The diagonal line has arrows pointing towards the top-right corner.

Finally, we would like to express Q in terms of M . As before, we can do this by applying a certain “inverse” map to $|\psi(Q)\rangle = |\psi(M)\rangle$:

$$\langle \alpha, \beta, \gamma, \delta | Q \rangle = |G| \sum_{j,k} \text{diagram}_1 \text{diagram}_2$$

The diagrams in the equation are as follows:

- diagram₁**: A vertex with four legs labeled α (top), β (left), γ (bottom), and δ (right). A diagonal line with arrows pointing towards the vertex is labeled \tilde{A}^j .
- diagram₂**: A vertex with four legs labeled α (top), β (left), γ (bottom), and δ (right). A diagonal line with arrows pointing away from the vertex is labeled \tilde{B}^k .

$$\begin{aligned}
&= \frac{1}{|G|} \sum_{g,h \in G} \delta_{\gamma h, \beta g} \delta_{\delta h, \alpha g} \\
&\quad \text{(Diagram: A square box with a hatched border labeled M. Inside, two paths are shown. The top path is labeled (g, \omega) and the bottom path is labeled (h, \omega). Arrows indicate directions. Labels \alpha, \beta, \gamma, \delta are placed at various points along the paths. The paths are connected by vertical lines on the left and right sides.)} \\
&= \sum_{g \in G} \delta_{\gamma, \beta g} \delta_{\delta, \alpha g} \frac{\omega(\beta \gamma^{-1}, \gamma, g)}{\omega(\alpha \gamma^{-1}, \gamma, g) \omega(\beta \alpha^{-1}, \alpha, g)} \langle \alpha, \beta g, \gamma g, \delta | M \rangle. \quad (25)
\end{aligned}$$

Substituting (24) and (25) in (23) we obtain

$$\langle \alpha, \beta, \gamma, \delta | M \rangle = \sum_{g,h \in G} \delta_{hg, gh} \delta_{\beta, \alpha g} \delta_{\gamma, \alpha gh} \delta_{\delta, \alpha h} \langle \alpha, \alpha g, \alpha gh, \alpha h | M \rangle. \quad (26)$$

In other words, we have found that any (G, ω) -symmetric closure tensor M must obey the condition $\mathcal{T}|M\rangle = |M\rangle$ where the projection \mathcal{T} is given by

$$\mathcal{T} := \sum_{g,h \in G} \delta_{hg, gh} \sum_{\alpha \in G} |\alpha, \alpha g, \alpha gh, \alpha h\rangle \langle \alpha, \alpha g, \alpha gh, \alpha h|. \quad (27)$$

Thus $|M\rangle$ lives in the common eigenspace² of the two projections \mathcal{P}^ω and \mathcal{T} :

$$\mathcal{T}\mathcal{P}^\omega|M\rangle = |M\rangle = \mathcal{P}^\omega\mathcal{T}|M\rangle. \quad (28)$$

It is not difficult to verify that the vectors

$$|M(g, h)\rangle = \sum_{\alpha \in G} \lambda_M(\alpha; g, h) |\alpha, \alpha g, \alpha gh, \alpha h\rangle \quad (29)$$

span the image of the projection \mathcal{T} *independently* of their coefficients $\lambda_M(\alpha; g, h)$. Indeed, one has $\mathcal{T}|M(g, h)\rangle = |M(g, h)\rangle$ and $\langle M(g, h) | M(g', h') \rangle = \delta_{g, g'} \delta_{h, h'} |G|$. Since the projection \mathcal{P}^ω will be applied by the triangle tensors automatically, we are done. \square

Definition 7 (*c*-regularity). *Let c be a twisted 2-cocycle on a finite group G .*

1. *A pair $(g, h) \in G \times G$ is called c -regular if $h \in Z(g)$ and $c_g(h, x) = c_g(x, h)$ for all $x \in Z(g, h)$.*
2. *A pair conjugacy class $\mathcal{C}(g, h) = \{(g^t, h^t) \mid t \in G\}$ is called c -regular if (g, h) is a c -regular pair.*

Remark 3. This definition of a c -regular pair conjugacy class is well-defined: if the representative (g, h) is a c -regular pair, then so are all other pairs (g^t, h^t)

²Note that the projections \mathcal{P}^ω and \mathcal{T} do *not* necessarily commute in the entire vector space of closures, however, they *do* commute in their common eigenspace (trivially).

[Lemma 6]. Furthermore, if the twisted 2-cocycle c' differs from c by a twisted 2-coboundary

$$(d\epsilon_g)(x, y) := \frac{\epsilon_g(x)\epsilon_{x^{-1}gx}(y)}{\epsilon_g(xy)} \quad (30)$$

then (g, h) is a c -regular pair if and only if it is c' -regular [Lemma 7]. Hence the notion of a c -regular pair conjugacy class only depends on the (twisted) cohomology class of c . Obviously, $hg = gh$ holds for any c -regular pair (g, h) . Thus if the (twisted) cohomology class of c is trivial then the above definition reduces to the commuting pair conjugacy classes of [33]. \square

Let us now focus on the particular twisted 2-cocycle c^ω which we obtain from the original 3-cocycle ω by setting

$$c_g^\omega(x, y) := \frac{\omega(g, x, y)\omega(x, y, {}^{xy}g)}{\omega(x, {}^xg, y)}. \quad (31)$$

One can easily check that $\omega' \sim \omega$ as 3-cocycles implies $c^{\omega'} \sim c^\omega$ as twisted 2-cocycles [Lemma 8], however, the converse is *not* true³.

Also one has that (g, h) is a c^ω -regular pair if and only if (h, g) is, hence the definition is symmetric [Lemma 9].

Proposition 2. *A basis of the closure space of (G, ω) -injective tensors on a minimal torus corresponds bijectively to c^ω -regular pair conjugacy classes $\mathcal{C}(g, h)$.*

Proof. We will verify the claim in three steps. First, we choose certain coefficients $\lambda_M(\alpha; g, h)$ such that the virtual (G, ω) -action on the closure states $|M(g, h)\rangle$ becomes particularly simple. As noted above this does not affect the space spanned by the $|M(g, h)\rangle$ at all (but merely yields different spanning sets for the image of \mathcal{T}). Second, we will use these particular states to build manifestly (G, ω) -symmetric closure states $|M'(g, h)\rangle$, i.e. implement the second projection \mathcal{P}^ω explicitly. Third, we will show that any two such states from pairs (g, h) and (g^t, h^t) are identical, that they vanish unless (g, h) is a c^ω -regular pair and that states from distinct c^ω -regular pair conjugacy classes are linearly independent.

For the first step it will be convenient to set

$$\lambda_M(\alpha; g, h) := \frac{\omega(\alpha, g, h)\omega((g^{-1})^\alpha, \alpha g, h)}{\omega(\alpha, h, g)\omega((h^{-1})^\alpha, \alpha h, g)} \quad (32)$$

for all $hg = gh$. Indeed, for this choice we can show that

$$V^\omega(s)|M(g, h)\rangle = \eta_g(h, s)|M(g^s, h^s)\rangle \quad (33)$$

holds for any $s \in G$. Here we defined for all $x \in Z(g)$ and $y \in G$

$$\eta_g(x, y) := \frac{c_g^\omega(y^{-1}, x^y)}{c_g^\omega(x, y^{-1})} = \frac{\omega(g, y^{-1}, x^y)\omega(y^{-1}, x^y, g^y)\omega(x, g, y^{-1})}{\omega(g, x, y^{-1})\omega(y^{-1}, g^y, x^y)\omega(x, y^{-1}, g^y)}. \quad (34)$$

The validity of (33) can be seen from the non-vanishing matrix elements

$$\langle \alpha, \alpha g^s, \alpha(gh)^s, \alpha h^s | V^\omega(s) | M(g, h) \rangle = \mu(\alpha; g, h, s) \lambda_M(\alpha s; g, h)$$

³For example, all nontrivial 3-cocycles of \mathbb{Z}_n , $\mathbb{Z}_n \times \mathbb{Z}_n$ and D_m for m odd yield trivial 2-cocycles $c^\omega \sim 1$.

where

$$\mu(\alpha; g, h, s) = \frac{\omega((g^{-1})^{\alpha s}, \alpha g^s, s) \omega((h^{-1})^{\alpha s}, \alpha (gh)^s, s)}{\omega((h^{-1})^{\alpha s}, \alpha h^s, s) \omega((g^{-1})^{\alpha s}, \alpha (gh)^s, s)},$$

and the fact that

$$\frac{\mu(\alpha; g, h, s) \lambda_M(\alpha s; g, h)}{\lambda_M(\alpha; g^s, h^s)} = \eta_g(h, s)$$

[Lemma 12].

As a second step, we may simply use (33) in order to apply the second projection \mathcal{P}^ω and obtain the manifestly (G, ω) -symmetric states

$$|M'(g, h)\rangle := \frac{1}{|G|} \sum_{s \in G} \eta_g(h, s) |M(g^s, h^s)\rangle. \quad (35)$$

Turning to the third step, we find that

$$|M'(g^t, h^t)\rangle = \frac{1}{\eta_g(h, t)} |M'(g, h)\rangle$$

for all $t \in G$ [Lemma 10], hence all states within the same commuting pair conjugacy class are identical. As a trivial consequence, should $|M'(g, h)\rangle$ vanish for a certain commuting pair (g, h) then it does so for the entire pair conjugacy class $\mathcal{C}(g, h)$. But are there states $|M'(g, h)\rangle$ which actually vanish? We obtain

$$\langle M'(g, h) | M'(j, k) \rangle = \sum_{s \in G} \frac{1}{\eta_g(h, s)} \delta_{j, g^s} \delta_{k, h^s} \quad (36)$$

for all $hg = gh$ and $kj = jk$ [Lemma 10]. In particular, we have the norm

$$\| |M'(g, h)\rangle \|^2 = \sum_{s \in Z(g, h)} \frac{1}{\eta_g(h, s)} = \begin{cases} |Z(g, h)| & \text{if } (g, h) \text{ is } c^\omega\text{-regular,} \\ 0 & \text{else,} \end{cases}$$

where the last equality follows from [35, 38]. In other words, the state $|M'(g, h)\rangle$ vanishes unless the pair (g, h) is c^ω -regular. Hence focussing on c^ω -regular pairs (g, h) and (j, k) it is obvious from (36) that closure states from distinct c^ω -regular pair conjugacy classes are orthogonal, thus linearly independent. \square

Theorem 1 (Closure space). *A basis of the closure space of (G, ω) -injective tensors on an arbitrary torus corresponds bijectively to c^ω -regular pair conjugacy classes $\mathcal{C}(g, h)$.*

Furthermore, the dimension of this closure space only depends on the twisted cohomology class of c^ω .

Proof. We first show the analogue of Lemma 3. Define the ‘‘cross’’ tensor $m(g, h)$ by

$$\lambda_m(\alpha, \beta, \gamma; g, h) := \left\langle \begin{array}{c} \alpha h \\ \alpha h \quad \alpha gh \\ \alpha \quad \beta \\ \alpha \quad \alpha g \\ \gamma \end{array} \right\rangle := \frac{\omega(\alpha, g, h) \omega(\beta g^{-1} \alpha^{-1}, \alpha g, h)}{\omega(\alpha, h, g) \omega(\alpha \gamma^{-1}, \gamma, g)}, \quad (37)$$

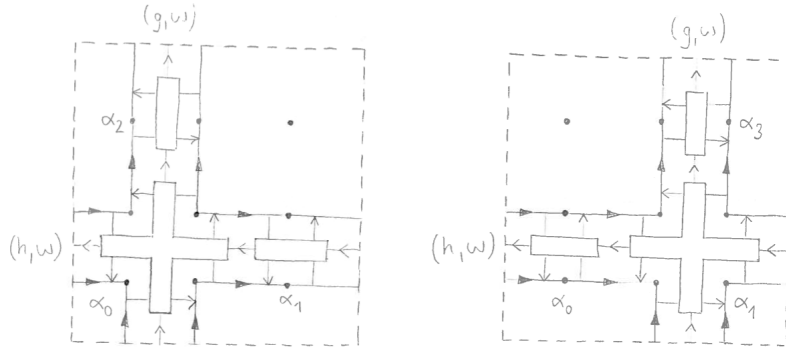

Figure 2: The closure tensors $M_0(g, h)$ and $M_1(g, h)$.

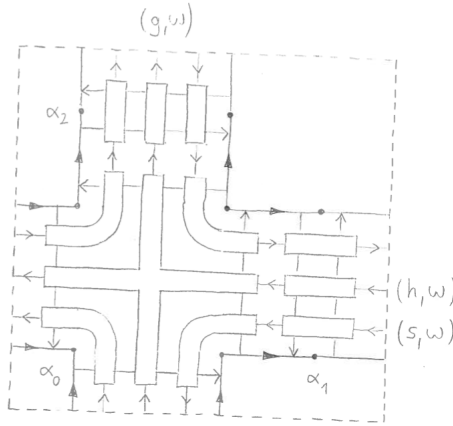

Figure 3: The (G, ω) -action on the closure state $|M_0(g, h)\rangle$.

with all other elements being zero. Note that this tensor depends on the orientation of the virtual boundary at the input side of each MPO ring. It is possible to define this tensor consistently for other orientations than the one shown here.

We can evaluate the elements of the closure tensor $M_0(g, h)$ in Figure 2 by contracting its building blocks. Let us call the result $\lambda_{M_0}(\alpha_0, \alpha_1, \alpha_2; g, h)$. Using the twisted virtual symmetry one may check that $M_0(g, h)$ can be deformed freely to other closure tensors like $M_1(g, h)$ *without* any change to its building blocks. Similarly, one can define P - and Q -like closures and show that any closure can be deformed freely into any other, for any fixed cellulation of the torus with (G, ω) -injective tensors. This proves the \supset part. We leave the \subset part to the reader.

We now extend Proposition 2, i.e. we show that the (G, ω) -action on the closure states of an arbitrary torus is identical to (33), which immediately yields the claimed basis of the closure space. Without loss of generality, consider the closure state

$$|M_0(g, h)\rangle = \sum_{\alpha_i \in G} \lambda_{M_0}(\alpha_0, \alpha_1, \alpha_2; g, h) |\alpha_0, \alpha_1, \alpha_0 g, \alpha_2 g, \alpha_0 g h, \alpha_1 h, \alpha_0 h, \alpha_2\rangle,$$

see Figure 2. Applying the twisted virtual symmetry as in Figure 3 one may show that

$$\frac{\langle \alpha_0, \alpha_1, \alpha_0 g^s, \alpha_2 g^s, \alpha_0 (gh)^s, \alpha_1 h^s, \alpha_0 h^s, \alpha_2 |V^\omega(s)|M_0(g, h)\rangle}{\lambda_{M_0}(\alpha_0, \alpha_1, \alpha_2; g^s, h^s)} = \eta_g(h, s),$$

which indeed implies (33). We can then construct the symmetric closure states $\{|M'_0(g, h)\rangle\}$ and select a basis like in Proposition 2. \square

Remark 4. Observe that we can obtain a closure of the minimal torus from the “cross” tensor $m(g, h)$ via

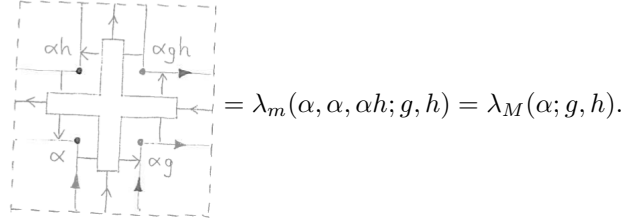

This illuminates our particular choice of coefficients in the proof of Proposition 2. \square

Example 1. Let $G = \mathbb{Z}_2 \times \mathbb{Z}_2 \times \mathbb{Z}_2$ and \mathcal{L}^ω the closure space of (G, ω) -injective tensors on a torus. There exists a 3-cocycle ω such that

$$\dim \mathcal{L}^\omega = 22 < |G|^2 = \dim \mathcal{L}.$$

This clearly shows that the closure space of (G, ω) -injective tensors may be significantly smaller than the one for G -injective tensors, i.e. the untwisted case. \square

3 Parent Hamiltonians

Any PEPS $|\psi\rangle$ whose local tensor for region R is (A_i) has a reduced density operator ρ_R with $\text{supp}(\rho_R) \subset \mathcal{L}_R$. It is then clear that every Hamiltonian

$$H = \sum_v h_v \quad (38)$$

where $h_v \geq 0$ acts on the region R_v , i.e. all polygons around the vertex v of the cellulation, is a parent Hamiltonian of the PEPS $|\psi\rangle$ if $\mathcal{L}_v \subseteq \ker(h_v)$. Furthermore, such a Hamiltonian is frustration-free, i.e. $h_v |\psi\rangle = 0$.

In order to grow local ground states into global ground states while keeping their properties under tight control we need the following result.

Theorem 2 (Intersection). *Let R_1 and R_2 be regions with a nontrivial intersection $R = R_1 \cap R_2$. Let (A_i) , (B_j) , (C_k) be compatible (G, ω) -injective tensors such that the contraction $(A_i B_j)$ corresponds to R_1 , $(B_j C_k)$ to R_2 and B_j to R .*

Then

$$(\mathcal{L}_{R_1} \otimes \mathcal{H}_{R_2 \setminus R}) \cap (\mathcal{H}_{R_1 \setminus R} \otimes \mathcal{L}_{R_2}) = \mathcal{L}_{R_1 \cup R_2}. \quad (39)$$

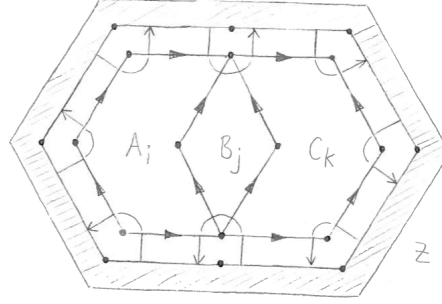

Figure 4: Intersecting regions R_1 and R_2 corresponding to (G, ω) -injective tensors $(A_i B_j)$ and $(B_j C_k)$ respectively. Each such region R_v is naturally associated with a vertex v of the cellulation.

Proof. Without loss of generality let us focus on regions R_v as shown in Figure 4. We will only prove the \subset part of the claim since the other inclusion is obvious.

Let $\text{ttr}(A_i, B_j, C_k, Z)$ denote the element of the contracted tensor of Figure 4. Then we clearly have

$$\mathcal{L}_{R_1 \cup R_2} = \left\{ \sum_{i,j,k} \text{ttr}(A_i, B_j, C_k, Z) |i, j, k\rangle \mid Z \right\}, \quad (40)$$

and

$$\mathcal{L}_{R_1} \otimes \mathcal{H}_{R_2 \setminus R_1} = \left\{ \sum_{i,j,k} \left(\text{Diagram of } R_1 \text{ and } R_2 \setminus R_1 \text{ with tensors } A_i, B_j, C_k \text{ and } X_k \right) |i, j, k\rangle \mid X_k \right\}, \quad (41)$$

$$\mathcal{H}_{R_1 \setminus R_2} \otimes \mathcal{L}_{R_2} = \left\{ \sum_{i,j,k} \left(\text{Diagram of } R_1 \setminus R_2 \text{ and } R_2 \text{ with tensors } Y_i, B_j, C_k \text{ and } Y_i \right) |i, j, k\rangle \mid Y_i \right\}. \quad (42)$$

As before we may assume that (X_k) , (Y_i) and Z are (G, ω) -symmetric. In order

to simplify notation set

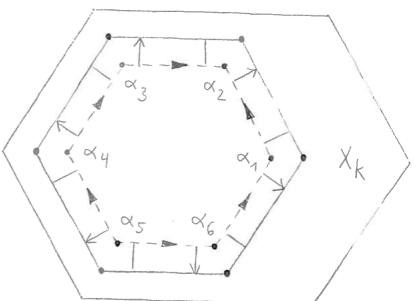
$$\langle \alpha_1, \dots, \alpha_6 | X_k \rangle :=$$

The diagram shows a large hexagon labeled X_k . Inside it, a smaller hexagon is formed by dashed lines. The edges of this inner hexagon are directed and labeled α_1 through α_6 in a clockwise direction starting from the right side.

Intersecting the subspaces (41) and (42) we obtain

$$\langle \alpha_1, \dots, \alpha_6 | X_k \rangle$$

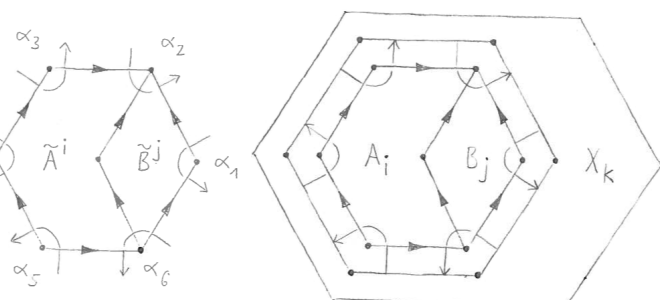
$$= \sum_{i,j} \alpha_4$$

The first diagram shows the hexagonal lattice with regions \tilde{A}^i and \tilde{B}^j indicated by dashed lines. The corresponding lattice diagram shows regions A_i and B_j with arrows indicating the flow of α_4 .

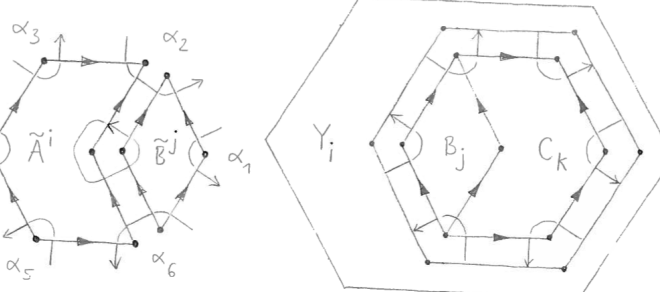
$$= \sum_{i,j} \alpha_4$$

The second diagram shows the hexagonal lattice with regions \tilde{A}^i and \tilde{B}^j and a central region β . The corresponding lattice diagram shows regions Y_i , B_j , and C_k with arrows indicating the flow of α_4 .

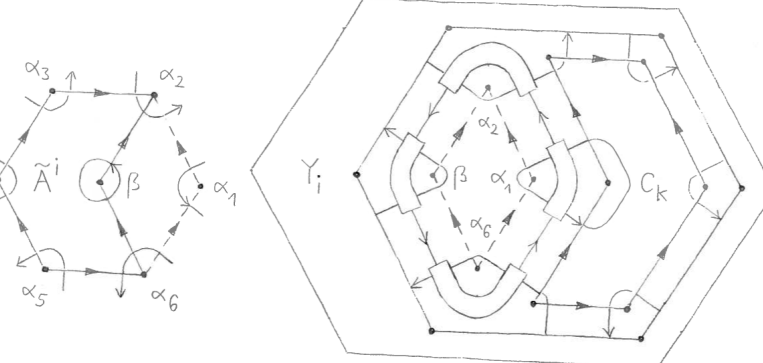
$$= \sum_{i,\beta} \alpha_4$$

The third diagram shows the hexagonal lattice with regions \tilde{A}^i and \tilde{B}^j and a central region β . The corresponding lattice diagram shows regions Y_i , β , α_1 , and C_k with arrows indicating the flow of α_4 .

$$\begin{aligned}
&= \sum_{i,\beta} \alpha_4 \left(\begin{array}{c} \alpha_3 \uparrow \quad \alpha_2 \\ \tilde{A}^i \quad \beta \\ \alpha_5 \quad \alpha_6 \end{array} \right) \left(\begin{array}{c} Y_i \\ \beta \quad \alpha_1 \quad C_k \\ \alpha_6 \end{array} \right) \\
&= \sum_{i,\beta} \alpha_4 \left(\begin{array}{c} \alpha_3 \uparrow \quad \alpha_2 \\ \tilde{A}^i \quad \beta \\ \alpha_5 \quad \alpha_6 \end{array} \right) \left(\begin{array}{c} Y_i \\ \beta \quad \alpha_1 \quad C_k \\ \alpha_6 \end{array} \right) \\
&= \langle \alpha_1, \dots, \alpha_6 | (C_k Z) \rangle
\end{aligned}$$

where we defined Z via

$$\langle \alpha_1, \dots, \alpha_8 | Z \rangle := \sum_{i,\beta} \alpha_4 \left(\begin{array}{c} \alpha_3 \uparrow \quad \alpha_2 \quad \alpha_1 \\ \tilde{A}^i \quad \beta \\ \alpha_5 \quad \alpha_6 \quad \alpha_7 \quad \alpha_8 \end{array} \right) \left(\begin{array}{c} Y_i \\ \beta \quad \alpha_1 \quad \alpha_8 \\ \alpha_6 \quad \alpha_7 \end{array} \right)$$

□

Now if the local kernels of the Hamiltonian *coincide* with the local subspaces generated by the tensors, i.e. $\ker(h_v) = \mathcal{L}_v$, then Theorem 2 ensures that no undesired states occur in the (local) ground state space as we grow a region R_v step by step until we cover the whole surface. Hence on a torus the ground

states of such a parent Hamiltonian are exactly given by the closure space of Theorem 1.

4 Twisted Isometry

4.1 Standard Form

As has been observed in [4, 39], any PEPS tensor can be decomposed into a partial isometry W and a deformation Q . In the context of twisted virtual symmetry this means

Lemma 4. *Every (G, ω) -injective tensor A can be written as*

$$A = Q\mathcal{P}^\omega \quad (43)$$

where Q is a positive map.

Proof. We may restrict the map $A: \mathbb{C}G \otimes \cdots \otimes \mathbb{C}G \rightarrow \mathcal{H}$ to $\mathcal{A}: \text{im}(\mathcal{P}^\omega) \rightarrow \mathcal{H}$ so that $A = \mathcal{A}\mathcal{P}^\omega$. Then \mathcal{A} is clearly invertible. The polar decomposition $\mathcal{A} = UQ$ with $Q = \sqrt{\mathcal{A}^\dagger \mathcal{A}}$ positive and $U = \mathcal{A}Q^{-1}$ unitary then yields $A \simeq Q\mathcal{P}^\omega$ because we are free to ignore local unitaries at the physical level. \square

Definition 8 (Standard form). *The projection \mathcal{P}^ω is called the (G, ω) -isometric standard form.*

Let us focus on (G, ω) -isometric tensors A for the moment.

4.2 Dijkgraaf-Witten Form

The concept of (G, ω) -isometric triangle tensors has a very nice interpretation in terms of time slices in (discrete) DIJKGRAAF-WITTEN topological quantum field theory in $(2 + 1)$ dimensions [35]. Its central ingredient is the partition function which is constructed from a branched triangulation of the space-time 3-manifold by colouring the edges and assigning weights to the tetrahedra of the triangulation. Let us briefly review how these weights are defined.

Let Δ_{ijkl} be a tetrahedron with ordered vertices $i < j < k < l$. Then a branching structure is given as follows: for any two vertices $i < j$ draw an oriented edge $(i \rightarrow j)$ from i to j . Any such branched tetrahedron can be assigned an orientation $\text{sgn}(\Delta_{ijkl}) = \pm 1$ by looking at the face Δ_{jkl} formed by the vertices $j < k < l$ from the direction of the smallest vertex i : if the majority of edges points in counterclockwise direction we set $\text{sgn}(\Delta_{ijkl}) := 1$, otherwise $\text{sgn}(\Delta_{ijkl}) := -1$. We can colour the tetrahedron Δ_{ijkl} by assigning $g_{ji} \in G$ to each oriented edge $(i \rightarrow j)$. Naturally we set $g_{ij} := g_{ji}^{-1}$. Furthermore we require this colouring to have *flat connections* everywhere, i.e. each branched face Δ_{ijk} with vertices i, j and k satisfies

$$g_{ij}g_{jk}g_{ki} = e. \quad (44)$$

Finally we assign the following amplitude to any branched, coloured tetrahedron Δ_{ijkl} :

$$\psi(\Delta_{ijkl}) := \omega(g_{lk}, g_{kj}, g_{ji})^{\text{sgn}(\Delta_{ijkl})}. \quad (45)$$

We can define a (G, ω) -isometric triangle tensor via the amplitude of its associated tetrahedron Δ_{0ijk} . In the following we set $g_i := g_{i0}$ and focus on a particular vertex ordering without loss of generality.

Definition 9 (DIJKGRAAF-WITTEN form). *Let $g_1, g_2, g_3 \in G$. Then*

$$(46)$$

with the physical index (g_{21}, g_{32}, g_{31}) is called a DIJKGRAAF-WITTEN triangle tensor.

In other words, the above tensor defines the map

$$A_{\text{DW}}^\omega = \sum_{g_i \in G} \omega(g_3 g_2^{-1}, g_2 g_1^{-1}, g_1)^{-1} |g_2 g_1^{-1}, g_3 g_2^{-1}, g_3 g_1^{-1}\rangle \langle g_1, g_2, g_3| \quad (47)$$

due to the flat connection condition $g_{ij} = g_i g_j^{-1}$ for each of the three side faces of the tetrahedron. It is not difficult to prove that every such tensor is indeed (G, ω) -isometric.

Lemma 5. *Every DIJKGRAAF-WITTEN triangle tensor is (G, ω) -isometric.*

Proof. The virtual (G, ω) -symmetry of A_{DW}^ω is obvious from the Pachner 4–1 move

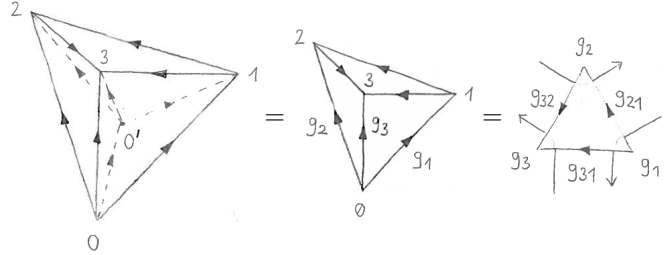

Furthermore, we can invert A_{DW}^ω (on the image of \mathcal{P}^ω) using its adjoint. This is easily seen once we glue the tetrahedron representing A_{DW}^ω and its mirror image representing $(A_{\text{DW}}^\omega)^\dagger$ along their physical faces and apply a Pachner 2–3 move:

$$(A_{\text{DW}}^\omega)^\dagger A_{\text{DW}}^\omega = \sum_{g_i, g'_i \in G} |g'_1, g'_2, g'_3\rangle \langle g_1, g_2, g_3|$$

$$\begin{aligned}
&= \sum_{g \in G} \sum_{g_i \in G} \sum_3 \text{Diagram} \left| g_1 g, g_2 g, g_3 g \right\rangle \langle g_1, g_2, g_3 | \\
&= \sum_{g \in G} \sum_{g_i \in G} \sum_3 \text{Diagram} \left| g_1 g, g_2 g, g_3 g \right\rangle \langle g_1, g_2, g_3 | \\
&= \sum_{g \in G} \sum_{g_i \in G} \frac{\omega(g_3 g_1^{-1}, g_1 g, g^{-1})}{\omega(g_2 g_1^{-1}, g_1 g, g^{-1}) \omega(g_3 g_2^{-1}, g_2 g, g^{-1})} \left| g_1 g, g_2 g, g_3 g \right\rangle \langle g_1, g_2, g_3 | \\
&= |G| \mathcal{P}^\omega
\end{aligned}$$

where $g^{-1} := g_{0'0}$. This proves the claim. \square

We can now easily translate between the standard form \mathcal{P}^ω and the form A_{DW}^ω by applying a unitary map at the physical level. In the forward direction this unitary map is simply A_{DW}^ω itself since $A_{\text{DW}}^\omega \mathcal{P}^\omega = A_{\text{DW}}^\omega$, in the backward direction it is $(A_{\text{DW}}^\omega)^\dagger / |G|$ because of the above.

4.3 Cohomology Classes

What happens if we change $\omega \mapsto \omega' = \omega d\phi$ in a (G, ω) -isometric tensor? Let us first look at a DIJKGRAAF-WITTEN triangle tensor for ω' . As is well known, the 3-coboundary $d\phi$ consists of four 2-cochains ϕ which can naturally be attached to the faces of the tetrahedron Δ_{0ijk} . Distinguishing between the physical face and the virtual ones we obtain

$$A_{\text{DW}}^{\omega'} = U_\phi A_{\text{DW}}^\omega V_\phi \quad (48)$$

where

$$U_\phi := \sum_{\alpha, \beta, \gamma \in G} \phi(\beta, \alpha) |\alpha, \beta, \gamma\rangle \langle \alpha, \beta, \gamma|, \quad (49)$$

$$V_\phi := \sum_{\alpha, \beta, \gamma \in G} \frac{\phi(\gamma \alpha^{-1}, \alpha)}{\phi(\gamma \beta^{-1}, \beta) \phi(\beta \alpha^{-1}, \alpha)} |\alpha, \beta, \gamma\rangle \langle \alpha, \beta, \gamma|, \quad (50)$$

are unitaries whose underlying branching structure is that of A_{DW}^ω .

It is now straightforward to check that the standard forms for (G, ω) - and (G, ω') -isometric tensors are related by

$$\mathcal{P}^{\omega'} = V_\phi^\dagger \mathcal{P}^\omega V_\phi \simeq \mathcal{P}^\omega V_\phi \quad (51)$$

since we are allowed to ignore local unitaries at the physical level. Note that we cannot pull V_ϕ to the physical level since it does not necessarily commute with \mathcal{P}^ω . However, upon contracting the tensors with each other and the closure tensors, the V_ϕ will cancel at the virtual level. This establishes the following

Proposition 3. *Any transformation $\omega \mapsto \omega' \sim \omega$ corresponds to local unitary transformations of (G, ω) -isometric PEPS.*

4.4 Parent Hamiltonians

Proposition 4. *Parent Hamiltonians of (G, ω) -isometric PEPS consist of commuting projections.*

Proof. Let A_v be the (G, ω) -isometric map associated with the region R_v . Note that we may need to contract several (G, ω) -isometric PEPS tensors to obtain A_v . It is not difficult to show that the interaction terms h_v

$$h_v := \text{id}_v - A_v A_v^\dagger$$

are Hermitian projections with $\ker h_v = \mathcal{L}_v$.

Now assume that two overlapping interaction terms h_1 and h_2 are associated with the regions R_1 and R_2 of Figure 4. Let us abbreviate $\tilde{h}_v := A_v A_v^\dagger$. We have

$$\langle i', j', k' | \tilde{h}_1 | i, j, k \rangle = \delta_{kk'} \sum_{\alpha_1, \gamma} \alpha_4$$

and $\langle i', j', k' | \tilde{h}_2 | i, j, k \rangle$ similarly. Then

$$\langle i', j', k' | \tilde{h}_1 \tilde{h}_2 | i, j, k \rangle$$

$$= \sum_{\tilde{\alpha}_1, \tilde{\beta}, \tilde{\gamma}} \sum_{\alpha_1, \beta, \gamma} \tilde{\alpha}_4 \begin{array}{c} \tilde{\alpha}_3 \nearrow \\ \tilde{\alpha}_2 \nearrow \\ \tilde{\alpha}_4 \curvearrowright A_{i'} \\ \tilde{\alpha}_5 \searrow \\ \tilde{\alpha}_6 \searrow \\ \tilde{\alpha}_4 \curvearrowleft B_{j'} \\ \tilde{\alpha}_5 \searrow \\ \tilde{\alpha}_6 \searrow \end{array} \tilde{\gamma} \begin{array}{c} \tilde{\alpha}_3 \nearrow \\ \tilde{\alpha}_2 \nearrow \\ \tilde{\alpha}_4 \curvearrowright (A^\dagger)^i \\ \tilde{\alpha}_5 \searrow \\ \tilde{\alpha}_6 \searrow \\ \tilde{\alpha}_4 \curvearrowleft \tilde{\beta} \\ \tilde{\alpha}_5 \searrow \\ \tilde{\alpha}_6 \searrow \end{array}$$

$$\left(\sum_l \tilde{\beta} \begin{array}{c} \tilde{\alpha}_2 \nearrow \\ \tilde{\alpha}_1 \nearrow \\ \tilde{\alpha}_4 \curvearrowright (\tilde{B}^\dagger)^l \\ \tilde{\alpha}_5 \searrow \\ \tilde{\alpha}_6 \searrow \\ \tilde{\alpha}_4 \curvearrowleft \tilde{\gamma} \\ \tilde{\alpha}_5 \searrow \\ \tilde{\alpha}_6 \searrow \end{array} \beta \begin{array}{c} \alpha_2 \nearrow \\ \alpha_1 \nearrow \\ \alpha_4 \curvearrowright B_l \\ \alpha_5 \searrow \\ \alpha_6 \searrow \\ \alpha_4 \curvearrowleft \gamma \\ \alpha_5 \searrow \\ \alpha_6 \searrow \end{array} \right) \gamma \begin{array}{c} \alpha_2 \nearrow \\ \alpha_1 \nearrow \\ \alpha_4 \curvearrowright C_{k'} \\ \alpha_5 \searrow \\ \alpha_6 \searrow \\ \alpha_4 \curvearrowleft \alpha_8 \\ \alpha_5 \searrow \\ \alpha_6 \searrow \end{array} \beta \begin{array}{c} \alpha_2 \nearrow \\ \alpha_1 \nearrow \\ \alpha_4 \curvearrowright (\tilde{B}^\dagger)^j \\ \alpha_5 \searrow \\ \alpha_6 \searrow \\ \alpha_4 \curvearrowleft (\tilde{C}^\dagger)^k \\ \alpha_5 \searrow \\ \alpha_6 \searrow \end{array}$$

$$= \frac{1}{|G|} \sum_{\tilde{\alpha}_3, \tilde{\alpha}_4, \tilde{\alpha}_5} \sum_{\alpha_1, \beta, \gamma} \sum_{g \in G} \tilde{\alpha}_4 \begin{array}{c} \tilde{\alpha}_3 \nearrow \\ \tilde{\alpha}_2 \nearrow \\ \tilde{\alpha}_4 \curvearrowright A_{i'} \\ \tilde{\alpha}_5 \searrow \\ \tilde{\alpha}_6 \searrow \\ \tilde{\alpha}_4 \curvearrowleft B_{j'} \\ \tilde{\alpha}_5 \searrow \\ \tilde{\alpha}_6 \searrow \end{array} \gamma g \begin{array}{c} \alpha_2 \nearrow \\ \alpha_1 \nearrow \\ \alpha_4 \curvearrowright C_{k'} \\ \alpha_5 \searrow \\ \alpha_6 \searrow \\ \alpha_4 \curvearrowleft \alpha_8 \\ \alpha_5 \searrow \\ \alpha_6 \searrow \end{array}$$

$$\beta \begin{array}{c} \alpha_2 \nearrow \\ \alpha_1 \nearrow \\ \alpha_4 \curvearrowright (\tilde{B}^\dagger)^j \\ \alpha_5 \searrow \\ \alpha_6 \searrow \\ \alpha_4 \curvearrowleft (\tilde{C}^\dagger)^k \\ \alpha_5 \searrow \\ \alpha_6 \searrow \end{array}$$

$$\beta \begin{array}{c} \alpha_2 \nearrow \\ \alpha_1 \nearrow \\ \alpha_4 \curvearrowright (\tilde{B}^\dagger)^j \\ \alpha_5 \searrow \\ \alpha_6 \searrow \\ \alpha_4 \curvearrowleft (\tilde{C}^\dagger)^k \\ \alpha_5 \searrow \\ \alpha_6 \searrow \end{array}$$

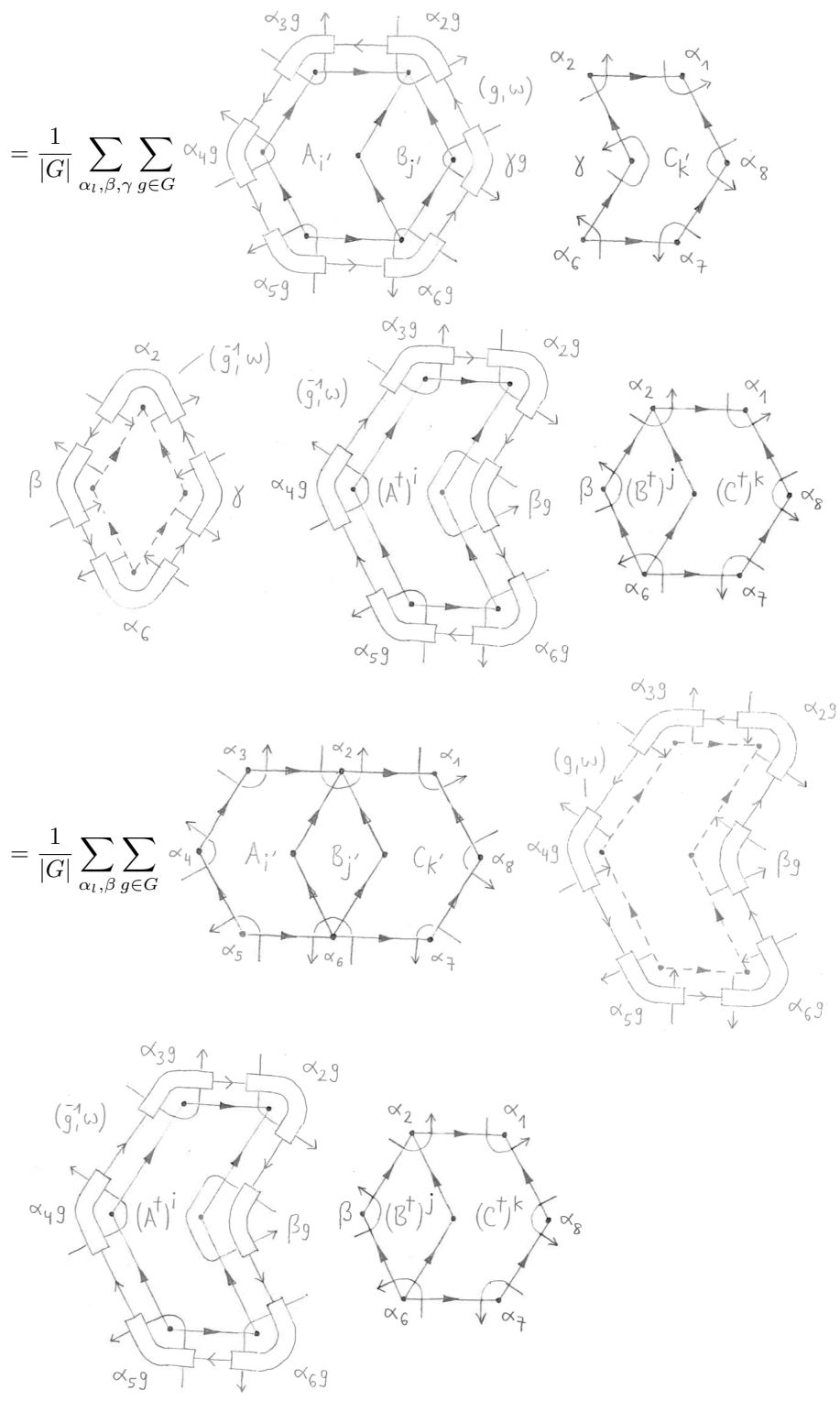

$$= \sum_{\alpha_i} \left(\begin{array}{c} \alpha_3 \uparrow \\ \alpha_2 \uparrow \\ \alpha_1 \uparrow \\ \alpha_4 \leftarrow \\ \alpha_5 \downarrow \\ \alpha_6 \downarrow \\ \alpha_7 \downarrow \\ \alpha_8 \leftarrow \\ A_{i'} \quad B_{j'} \quad C_{k'} \end{array} \right) \left(\begin{array}{c} \alpha_3 \uparrow \\ \alpha_2 \uparrow \\ \alpha_1 \uparrow \\ \alpha_4 \leftarrow \\ \alpha_5 \downarrow \\ \alpha_6 \downarrow \\ \alpha_7 \downarrow \\ \alpha_8 \leftarrow \\ (A^\dagger)^i \quad (B^\dagger)^j \quad (C^\dagger)^k \end{array} \right)$$

This same argument can readily be applied to $\langle i', j', k' | \tilde{h}_2 \tilde{h}_1 | i, j, k \rangle$, hence we have shown that $[\tilde{h}_1, \tilde{h}_2] = [h_1, h_2] = 0$. \square

5 Gapped Paths and Almost Twisted Isometry

Let $\{A, \dots\}$ be a set of compatible (G, ω) -injective tensors. Can we connect the parent Hamiltonians of

$$|\psi(A, \dots)\rangle = Q \otimes \dots |\psi(\mathcal{P}^\omega, \dots)\rangle$$

and $|\psi(\mathcal{P}^\omega, \dots)\rangle$ by quasi-adiabatic evolution, i.e. are they in the same universality class? Under what circumstances can we remove the positive maps Q ?

It is known that this question hinges on the existence of an energy gap in the thermodynamical limit which is notoriously difficult to prove in two dimensions. Already for the case of completely trivial virtual symmetry, i.e. for $(G, \omega) \simeq (\{e\}, 1)$ which is known as the injective case, there are examples of PEPS whose parent Hamiltonians are gapless [40, 41], in sharp contrast to injective MPS. As we have shown, parent Hamiltonians of (G, ω) -isometric PEPS tensors *do* have a gap in the thermodynamic limit, hence the deformations Q cannot be removed in general without changing the nature of the gap. However, it was shown in [4] that all positive maps Q in a neighbourhood of the identity *can* be removed by quasi-adiabatic evolution.

Definition 10. A (G, ω) -injective tensor (with standard decomposition $Q\mathcal{P}^\omega$) is called almost (G, ω) -isometric if Q is in a neighbourhood of the identity.⁴

Theorem 3. The universality class of parent Hamiltonians associated with almost (G, ω) -isometric PEPS only depends on the cohomology class of ω .

Proof. Let us first look at the PEPS themselves. Let $\{A, \dots\}$ and $\{A', \dots\}$ be sets of almost (G, ω) - and (G, ω') -isometric tensors respectively. Assume that both sets agree on the virtual boundaries of their tensors. Since all Q' are in a neighbourhood of the identity we can reduce each local tensor A' to the standard form $\mathcal{P}^{\omega'}$ by evolving the state $|\psi(A', \dots)\rangle$ quasi-adiabatically. If $\omega' \sim \omega$ we may subsequently turn $\mathcal{P}^{\omega'}$ into \mathcal{P}^ω by Proposition 3. Finally, we deform each local tensor \mathcal{P}^ω by Q to obtain the state $|\psi(A, \dots)\rangle$.⁵

⁴This neighbourhood is defined via the spectrum of Q [4].

⁵Alternatively, we have $A' = Q'\mathcal{P}^{\omega'} \simeq Q'_\phi \mathcal{P}^\omega V_\phi \simeq Q'_\phi \mathcal{P}^\omega =: A$. Here we set $Q'_\phi := V_\phi Q' V_\phi^\dagger$, the first equivalence is due to a local unitary at the physical level and the second one due to contraction at the virtual level. Note that $Q'_\phi \neq Q'$ since Q' and V_ϕ do *not* commute in general, however, Q'_ϕ and Q' have the same spectrum. Thus A' is almost (G, ω') -isometric if and only if A is almost (G, ω) -isometric.

We have just shown that the states $|\psi(A, \dots)\rangle$ and $|\psi(A', \dots)\rangle$ are equivalent under quasi-adiabatic evolution. This immediately carries over to their respective parent Hamiltonians. \square

Clearly, the Hamiltonians of Theorem 3 are gapped (because they are equivalent to parent Hamiltonians at the (G, ω) -isometric point), frustration-free and their interaction terms do not commute (because of the deformations Q). The universality class is determined by the (G, ω) -isometric point and the cohomology class of ω , i.e. by the new standard form \mathcal{P}^ω . This point corresponds to a coarse-grained time slice of the DIJKGRAAF-WITTEN TQFT, or equivalently, to a coarse-grained twisted quantum double model.

6 Discussion and Outlook

In this article we presented a new standard form for PEPS, which is based on the twisted action of a finite group on the virtual boundary of a tensor. Each group element g acts via an MPO $V^\omega(g)$. As long as the twist ω is nontrivial *each* such MPO is entangled, i.e. it has a virtual bond dimension $D = |G| > 1$. While V^ω is still a *linear* representation on the tensor product of virtual spaces (along the virtual boundary), the twist ω modifies the associativity between those tensor factors nontrivially, which affects the symmetric subspace. The nontrivial interplay between this twisted symmetric subspace and the different (periodic) boundary conditions on a torus is what can accommodate for the many new universality classes compared to the untwisted case [33].

In fact, the symmetric subspace is the fundamental object. The twisted group action is merely a tool to consistently describe a family of virtual subspaces which grow at the correct asymptotic rate as the tensor network is grown (which is nothing but the intersection condition of Theorem 2). For example, the (possibly twisted) action of certain Hopf algebras [42] also leads to a consistent family of subspaces and describes yet another kind of intrinsic topological order in two dimensions. In general, it may be more convenient to define the family of virtual subspaces in terms of projections with certain relations rather than by an explicit algebraic action. Indeed, it should be possible to derive a suitable family of virtual projections for any TURAEV-VIRO invariant [43, 44] by generalizing the correspondence between (G, ω) -isometric tensor networks and the $(2 + 1)$ -dimensional DIJKGRAAF-WITTEN partition function outlined in this article. The flatness condition for triangles will have to be replaced by the fusion rule of a spherical fusion category, and since two edges of a flat triangle may no longer determine the third one uniquely, additional indices will be required for the MPO describing the projections. This virtual “symmetry” will turn out to be the one arising in (tensor network representations of) the ground states [45, 46] of general LEVIN-WEN models [11, 47]. As such it will provide a standard form for PEPS which further generalizes the one introduced in this article.

We also presented a family of gapped, frustration-free Hamiltonians with non-commuting interaction terms whose universality class is determined by the new standard form \mathcal{P}^ω for PEPS. Previously, this class has mainly been studied using two approaches: quantum field theory [35, 36, 37] and exactly solved models [38, 20]. In the first approach it is not always clear whether a particular field theory can actually be implemented by a microscopic Hamiltonian. The

second approach yields comparatively simple Hamiltonians which consist of commuting projections. Our results address both these shortcomings and may thus provide a promising route for further progress in the classification of 2D gapped quantum spin systems.

It is a very interesting question how this classification of $(2 + 1)$ -dimensional phases via virtual “symmetry” needs to be extended to incorporate (physical) symmetry protection or higher dimensions.

Acknowledgements

The author acknowledges stimulating discussions with Ignacio Cirac, Zheng-Cheng Gu, Alexander Kirillov Jr., David Pérez-García, Norbert Schuch and Frank Verstraete. He would also like to thank Guifré Vidal for valuable comments on an earlier version of this manuscript.

This research was supported in part by Perimeter Institute for Theoretical Physics. Research at Perimeter Institute is supported by the Government of Canada through Industry Canada and by the Province of Ontario through the Ministry of Research and Innovation.

References

- [1] Xie Chen, Zheng-Cheng Gu, and Xiao-Gang Wen. “Local unitary transformation, long-range quantum entanglement, wave function renormalization, and topological order”. In: *Phys. Rev. B* 82.15, 155138 (2010). DOI: [10.1103/PhysRevB.82.155138](https://doi.org/10.1103/PhysRevB.82.155138).
- [2] Sven Bachmann et al. “Automorphic equivalence within gapped phases of quantum lattice systems”. In: *Commun. Math. Phys.* 309.3 (2011), pp. 835–871. DOI: [10.1007/s00220-011-1380-0](https://doi.org/10.1007/s00220-011-1380-0).
- [3] Xie Chen, Zheng-Cheng Gu, and Xiao-Gang Wen. “Classification of gapped symmetric phases in one-dimensional spin systems”. In: *Phys. Rev. B* 83.3, 035107 (2011). DOI: [10.1103/PhysRevB.83.035107](https://doi.org/10.1103/PhysRevB.83.035107).
- [4] Norbert Schuch, David Pérez-García, and J. Ignacio Cirac. “Classifying quantum phases using matrix product states and projected entangled pair states”. In: *Phys. Rev. B* 84.16, 165139 (2011). DOI: [10.1103/PhysRevB.84.165139](https://doi.org/10.1103/PhysRevB.84.165139).
- [5] Matthew B. Hastings. “An area law for one-dimensional quantum systems”. In: *J. Stat. Mech.* 2007.8, P08024 (2007). DOI: [10.1088/1742-5468/2007/08/P08024](https://doi.org/10.1088/1742-5468/2007/08/P08024).
- [6] Itai Arad et al. “An area law and sub-exponential algorithm for 1D systems”. In: (2013). arXiv:[1301.1162](https://arxiv.org/abs/1301.1162) [quant-ph].
- [7] David Pérez-García et al. “Matrix product state representations”. In: *Quant. Inf. Comp.* 7.5&6 (2007), pp. 401–430.
- [8] Daniel C. Tsui, Horst L. Störmer, and Arthur C. Gossard. “Two-dimensional magnetotransport in the extreme quantum limit”. In: *Phys. Rev. Lett.* 48.22 (1982), pp. 1559–1562. DOI: [10.1103/PhysRevLett.48.1559](https://doi.org/10.1103/PhysRevLett.48.1559).

- [9] Robert B. Laughlin. “Anomalous quantum HALL effect: an incompressible quantum fluid with fractionally charged excitations”. In: *Phys. Rev. Lett.* 50.18 (1983), pp. 1395–1398. DOI: [10.1103/PhysRevLett.50.1395](https://doi.org/10.1103/PhysRevLett.50.1395).
- [10] Alexei Y. Kitaev. “Anyons in an exactly solved model and beyond”. In: *Ann. Phys.* 321.1 (2006), pp. 2–111. DOI: [10.1016/j.aop.2005.10.005](https://doi.org/10.1016/j.aop.2005.10.005).
- [11] Michael A. Levin and Xiao-Gang Wen. “String-net condensation: a physical mechanism for topological phases”. In: *Phys. Rev. B* 71.4, 045110 (2005). DOI: [10.1103/PhysRevB.71.045110](https://doi.org/10.1103/PhysRevB.71.045110).
- [12] Simeng Yan, David A. Huse, and Steven R. White. “Spin-liquid ground state of the $S = 1/2$ KAGOME HEISENBERG antiferromagnet”. In: *Science* 332.6034 (2011), pp. 1173–1176. DOI: [10.1126/science.1201080](https://doi.org/10.1126/science.1201080).
- [13] Yi Zhang et al. “Quasi-particle statistics and braiding from ground state entanglement”. In: *Phys. Rev. B* 85.23, 235151 (2012). DOI: [10.1103/PhysRevB.85.235151](https://doi.org/10.1103/PhysRevB.85.235151).
- [14] S. A. Parameswaran, Rahul Roy, and Shivaji L. Sondhi. “Fractional quantum HALL physics in topological flat bands”. In: (2013). arXiv:[1302.6606](https://arxiv.org/abs/1302.6606) [[cond-mat.str-el](https://arxiv.org/abs/1302.6606)].
- [15] Andreas P. Schnyder et al. “Classification of topological insulators and superconductors”. In: *AIP Conference Proceedings*. LANDAU Memorial Conference. Vol. 1134. 2009, pp. 10–21. DOI: [10.1063/1.3149481](https://doi.org/10.1063/1.3149481).
- [16] Alexei Y. Kitaev. “Periodic table for topological insulators and superconductors”. In: *AIP Conference Proceedings*. LANDAU Memorial Conference. Vol. 1134. 2009, pp. 22–30. DOI: [10.1063/1.3149495](https://doi.org/10.1063/1.3149495).
- [17] M. Zahid Hasan and Charles L. Kane. “Topological insulators”. In: *Rev. Mod. Phys.* 82.4 (2010), pp. 3045–3067. DOI: [10.1103/RevModPhys.82.3045](https://doi.org/10.1103/RevModPhys.82.3045).
- [18] Xiao-Liang Qi and Shou-Cheng Zhang. “Topological insulators and superconductors”. In: *Rev. Mod. Phys.* 83.4 (2011), pp. 1057–1110. DOI: [10.1103/RevModPhys.83.1057](https://doi.org/10.1103/RevModPhys.83.1057).
- [19] Xie Chen et al. “Symmetry protected topological orders and the group cohomology of their symmetry group”. In: *Phys. Rev. B* 87.15, 155114 (2013). DOI: [10.1103/PhysRevB.87.155114](https://doi.org/10.1103/PhysRevB.87.155114).
- [20] Andrej Mesaros and Ying Ran. “Classification of symmetry enriched topological phases with exactly solvable models”. In: *Phys. Rev. B* 87.15, 155115 (2013). DOI: [10.1103/PhysRevB.87.155115](https://doi.org/10.1103/PhysRevB.87.155115).
- [21] Ling-Yan Hung and Xiao-Gang Wen. “Quantized topological terms in weak-coupling gauge theories with a global symmetry and their connection to symmetry-enriched topological phases”. In: *Phys. Rev. B* 87.16, 165107 (2013). DOI: [10.1103/PhysRevB.87.165107](https://doi.org/10.1103/PhysRevB.87.165107).
- [22] Norbert Schuch et al. “Computational complexity of projected entangled pair states”. In: *Phys. Rev. Lett.* 98.14, 140506 (2007). DOI: [10.1103/PhysRevLett.98.140506](https://doi.org/10.1103/PhysRevLett.98.140506).
- [23] Sergey Bravyi, Matthew B. Hastings, and Spyridon Michalakis. “Topological quantum order: stability under local perturbations”. In: *J. Math. Phys.* 51.9, 093512 (2010). DOI: [10.1063/1.3490195](https://doi.org/10.1063/1.3490195).

- [24] Spyridon Michalakis and Justyna Pytel. “Stability of frustration-free Hamiltonians”. In: (2011). arXiv:[1109.1588](https://arxiv.org/abs/1109.1588) [[quant-ph](#)].
- [25] Alexei Y. Kitaev and John Preskill. “Topological entanglement entropy”. In: *Phys. Rev. Lett.* 96.11, 110404 (2006). DOI: [10.1103/PhysRevLett.96.110404](https://doi.org/10.1103/PhysRevLett.96.110404).
- [26] Michael A. Levin and Xiao-Gang Wen. “Detecting topological order in a ground state wave function”. In: *Phys. Rev. Lett.* 96.11, 110405 (2006). DOI: [10.1103/PhysRevLett.96.110405](https://doi.org/10.1103/PhysRevLett.96.110405).
- [27] Steven T. Flammia et al. “Topological entanglement R ENYI entropy and reduced density matrix structure”. In: *Phys. Rev. Lett.* 103.26, 261601 (2009). DOI: [10.1103/PhysRevLett.103.261601](https://doi.org/10.1103/PhysRevLett.103.261601).
- [28] Matthew B. Hastings. “LIEB-SCHULTZ-MATTIS in higher dimensions”. In: *Phys. Rev. B* 69.10, 104431 (2004). DOI: [10.1103/PhysRevB.69.104431](https://doi.org/10.1103/PhysRevB.69.104431).
- [29] Matthew B. Hastings and Xiao-Gang Wen. “Quasiadiabatic continuation of quantum states: The stability of topological ground-state degeneracy and emergent gauge invariance”. In: *Phys. Rev. B* 72.4, 045141 (2005). DOI: [10.1103/PhysRevB.72.045141](https://doi.org/10.1103/PhysRevB.72.045141).
- [30] Łukasz Cincio and Guifr e Vidal. “Characterizing topological order by studying the ground states on an infinite cylinder”. In: *Phys. Rev. Lett.* 110.6, 067208 (2013). DOI: [10.1103/PhysRevLett.110.067208](https://doi.org/10.1103/PhysRevLett.110.067208).
- [31] Michael P. Zaletel, Roger S. K. Mong, and Frank Pollmann. “Topological characterization of fractional quantum HALL ground states from microscopic Hamiltonians”. In: *Phys. Rev. Lett.* 110.23, 236801 (2013). DOI: [10.1103/PhysRevLett.110.236801](https://doi.org/10.1103/PhysRevLett.110.236801).
- [32] W. Zhu, Donna N. Sheng, and F. Duncan M. Haldane. “Minimal entangled states and modular matrix for fractional quantum HALL effect in topological flat bands”. In: (2013). arXiv:[1305.2255](https://arxiv.org/abs/1305.2255) [[cond-mat.str-el](#)].
- [33] Norbert Schuch, J. Ignacio Cirac, and David P erez-Garc a. “PEPS as ground states: degeneracy and topology”. In: *Ann. Phys.* 325.10 (2010), pp. 2153–2192. DOI: [10.1016/j.aop.2010.05.008](https://doi.org/10.1016/j.aop.2010.05.008).
- [34] Alexei Y. Kitaev. “Fault-tolerant quantum computation by anyons”. In: *Ann. Phys.* 303.1 (2003), pp. 2–30. DOI: [10.1016/S0003-4916\(02\)00018-0](https://doi.org/10.1016/S0003-4916(02)00018-0).
- [35] Robbert Dijkgraaf and Edward Witten. “Topological gauge theories and group cohomology”. In: *Commun. Math. Phys.* 129.2 (1990), pp. 393–429. DOI: [10.1007/BF02096988](https://doi.org/10.1007/BF02096988).
- [36] Mark de Wild Propitius. “(Spontaneously broken) Abelian CHERN-SIMONS theories”. In: *Nucl. Phys. B* 489.1–2 (1997), pp. 297–359. DOI: [10.1016/S0550-3213\(97\)00005-9](https://doi.org/10.1016/S0550-3213(97)00005-9).
- [37] Ling-Yan Hung and Xiao-Gang Wen. “Quantized topological terms in weakly coupled gauge theories and their connection to symmetry protected topological phases”. In: (2012). arXiv:[1211.2767](https://arxiv.org/abs/1211.2767) [[cond-mat.str-el](#)].
- [38] Yuting Hu, Yidun Wan, and Yong-Shi Wu. “Twisted quantum double model of topological phases in two dimensions”. In: *Phys. Rev. B* 87.12, 125114 (2013). DOI: [10.1103/PhysRevB.87.125114](https://doi.org/10.1103/PhysRevB.87.125114).

- [39] Martin Schwarz et al. “Preparing topological PEPS on a quantum computer”. In: (2012). arXiv:[1211.4050](https://arxiv.org/abs/1211.4050) [[quant-ph](#)].
- [40] Frank Verstraete et al. “Criticality, the area law, and the computational power of projected entangled pair states”. In: *Phys. Rev. Lett.* 96.22, 220601 (2006). DOI: [10.1103/PhysRevLett.96.220601](https://doi.org/10.1103/PhysRevLett.96.220601).
- [41] Matthew B. Hastings and Tohru Koma. “Spectral gap and exponential decay of correlations”. In: *Commun. Math. Phys.* 265.3 (2006), pp. 781–804. DOI: [10.1007/s00220-006-0030-4](https://doi.org/10.1007/s00220-006-0030-4).
- [42] Oliver Buerschaper et al. “A hierarchy of topological tensor network states”. In: *J. Math. Phys.* 54.1, 012201 (2013). DOI: [10.1063/1.4773316](https://doi.org/10.1063/1.4773316).
- [43] Vladimir G. Turaev and Oleg Y. Viro. “State sum invariants of 3-manifolds and quantum 6j-symbols”. In: *Topology* 31.4 (1992), pp. 865–902. DOI: [10.1016/0040-9383\(92\)90015-A](https://doi.org/10.1016/0040-9383(92)90015-A).
- [44] John W. Barrett and Bruce W. Westbury. “Invariants of piecewise-linear 3-manifolds”. In: *Trans. Amer. Math. Soc.* 348.10 (1996), pp. 3997–4022. DOI: [10.1090/S0002-9947-96-01660-1](https://doi.org/10.1090/S0002-9947-96-01660-1).
- [45] Zheng-Cheng Gu et al. “Tensor-product representations for string-net condensed states”. In: *Phys. Rev. B* 79.8, 085118 (2009). DOI: [10.1103/PhysRevB.79.085118](https://doi.org/10.1103/PhysRevB.79.085118).
- [46] Oliver Buerschaper, Miguel Aguado, and Guifré Vidal. “Explicit tensor network representation for the ground states of string-net models”. In: *Phys. Rev. B* 79.8, 085119 (2009). DOI: [10.1103/PhysRevB.79.085119](https://doi.org/10.1103/PhysRevB.79.085119).
- [47] Alexander A. Kirillov Jr. “String-net model of TURAEV-VIRO invariants”. In: (2011). arXiv:[1106.6033](https://arxiv.org/abs/1106.6033) [[math.AT](#)].

A Group cohomology

A.1 3-Cocycles

A 3-cocycle ω on a finite group G is a function $G \times G \times G \rightarrow \text{U}(1)$ which satisfies

$$\omega(a, b, c)\omega(a, bc, d)\omega(b, c, d) = \omega(ab, c, d)\omega(a, b, cd) \quad (52)$$

for all $a, b, c, d \in G$.

Recall that a 3-cocycle can be obtained from any 2-cochain ϕ via

$$(\text{d}\phi)(a, b, c) := \frac{\phi(a, bc)\phi(b, c)}{\phi(a, b)\phi(ab, c)}. \quad (53)$$

This is in fact called a 3-coboundary. We regard two 3-cocycles ω and ω' that only differ by a 3-coboundary $\text{d}\phi$ as equivalent, i.e. ω and ω' are in the same cohomology class. The set of such cohomology classes forms an Abelian group $H^3(G, \text{U}(1))$.

A 3-cocycle $\tilde{\omega}$ is called *normalized* if $\tilde{\omega}(1, b, c) = \tilde{\omega}(a, 1, c) = \tilde{\omega}(a, b, 1) = 1$ for all $a, b, c \in G$. Every 3-cocycle ω is equivalent to a normalized 3-cocycle $\tilde{\omega}$ for

some ϕ . In particular, this means:

$$\omega(1, b, c) = \frac{\phi(1, bc)}{\phi(1, b)}, \quad (54)$$

$$\omega(a, 1, c) = \frac{\phi(1, c)}{\phi(a, 1)}, \quad (55)$$

$$\omega(a, b, 1) = \frac{\phi(b, 1)}{\phi(ab, 1)}. \quad (56)$$

A.2 Twisted 2-Cocycles

Recall that a twisted 2-cocycle c on a finite group G is a function $G \times G \times G \rightarrow \mathbb{U}(1)$ which satisfies

$$c_g(x, y) c_g(xy, z) = c_g(x, yz) c_{x^{-1}gx}(y, z) \quad (57)$$

for all $g, x, y, z \in G$.

Let us record some useful properties of twisted 2-cocycles.

Lemma 6. *Let $g, h \in G$ with $hg = gh$.*

Then for all $t \in G$ and $x \in Z(g^t, h^t)$:

$$\frac{c_{g^t}(h^t, x)}{c_{g^t}(x, h^t)} = \frac{c_g(h, {}^t x)}{c_g({}^t x, h)}. \quad (58)$$

In particular, (g, h) is a c -regular pair if and only if (g^t, h^t) is a c -regular pair.

Proof. Note first that $x \in Z(g^t, h^t)$ is equivalent to ${}^t x \in Z(g, h)$. Repeatedly using (57) we then obtain

$$\begin{aligned} \frac{c_{g^t}(h^t, x)}{c_{g^t}(x, h^t)} &= \frac{c_g(ht^{-1}, x) c_g(t^{-1}, h^t)}{c_g(t^{-1}, h^t x)} \frac{c_g(t^{-1}, x h^t)}{c_g(t^{-1} x, h^t) c_g(t^{-1}, x)} \\ &= \frac{c_g(ht^{-1}, x) c_g(t^{-1}, h^t)}{c_g(t^{-1} x, h^t) c_g(t^{-1}, x)} \\ &= \frac{c_g(t^{-1}, x) c_g(h, t^{-1} x)}{c_g(h, t^{-1})} \frac{c_g(t^{-1}, h^t)}{c_g(t^{-1} x, h^t) c_g(t^{-1}, x)} \\ &= \frac{c_g(h, {}^t x t^{-1})}{c_g(h, t^{-1})} \frac{c_g(t^{-1}, h^t)}{c_g({}^t x t^{-1}, h^t)} \\ &= \frac{c_g(h {}^t x, t^{-1}) c_g(h, {}^t x)}{c_g({}^t x, t^{-1})} \frac{c_g({}^t x, t^{-1})}{c_g(t^{-1}, h^t) c_g({}^t x, h t^{-1})} \frac{c_g(t^{-1}, h^t)}{c_g(h, t^{-1})} \\ &= \frac{c_g(h {}^t x, t^{-1}) c_g(h, {}^t x)}{c_g({}^t x, h t^{-1}) c_g(h, t^{-1})} \\ &= \frac{c_g({}^t x h, t^{-1}) c_g(h, {}^t x)}{c_g({}^t x, h t^{-1}) c_g(h, t^{-1})} \\ &= \frac{c_g(h, t^{-1}) c_g({}^t x, h t^{-1})}{c_g({}^t x, h)} \frac{c_g(h, {}^t x)}{c_g({}^t x, h t^{-1}) c_g(h, t^{-1})} \\ &= \frac{c_g(h, {}^t x)}{c_g({}^t x, h)}. \end{aligned}$$

□

Lemma 7. *Let ϵ a function $G \times G \rightarrow \mathbb{U}(1)$ and*

$$c'_g(x, y) = (c_g d\epsilon_g)(x, y) := c_g(x, y) \frac{\epsilon_g(x) \epsilon_{x^{-1}gx}(y)}{\epsilon_g(xy)}. \quad (59)$$

Then

1. c' is a twisted 2-cocycle.
2. A pair (g, h) is c -regular if and only if it is c' -regular.

Proof. The first claim follows directly from (57).

The second claim follows from

$$c'_g(h, x) = c_g(h, x) \frac{\epsilon_g(h) \epsilon_{h^{-1}gh}(x)}{\epsilon_g(hx)} = c_g(x, h) \frac{\epsilon_g(x) \epsilon_{x^{-1}gx}(h)}{\epsilon_g(xh)} = c'_g(x, h)$$

for $h \in Z(G)$ and all $x \in Z(g, h)$. □

A.3 Twisted 2-Cocycles from 3-Cocycles

We turn to the particular twisted 2-cocycles (31) which are defined in terms of (ordinary) 3-cocycles.

Lemma 8. *Let ω be a 3-cocycle on a finite group. Then*

1. c^ω is a twisted 2-cocycle.
2. If ω is normalized, then so is c^ω .
3. If $\omega' = \omega d\phi$ for any 2-cochain ϕ , then $c^{\omega'} = c^\omega d\epsilon$ with

$$\epsilon_g(x) = \frac{\phi(x, xg)}{\phi(g, x)}. \quad (60)$$

Proof. The first statement follows from (52) and (57), the second statement is obvious. The third claim follows from (53) by a simple calculation. □

Lemma 9. *One has*

1. A pair (g, h) is c^ω -regular if and only if (h, g) is.
2. Every pair (g, g) is c^ω -regular.

Proof. By definition, a c^ω -regular pair (g, h) is equivalent to requiring $hg = gh$ and

$$\frac{c_g^\omega(h, x)}{c_g^\omega(x, h)} = \frac{\omega(g, h, x)\omega(h, x, g)\omega(x, g, h)}{\omega(h, g, x)\omega(g, x, h)\omega(x, h, g)} = 1 \quad (61)$$

for all $x \in Z(g, h)$.

1. It is easily seen from (61) that

$$\frac{c_g^\omega(h, x)}{c_g^\omega(x, h)} = \left(\frac{c_h^\omega(g, x)}{c_h^\omega(x, g)} \right)^{-1},$$

and the claim follows directly.

2. Obvious from (61). □

A.4 Properties of η

We need to study the properties of $\eta_g(x, y)$ as defined by (34) in two situations: first for the general case $y \in G$ and then for the special case $y \in Z(g, x)$. In the following we always assume that $x \in Z(g)$.

Lemma 10. *Let $y \in G$. Then*

$$\eta_{g^t}(x^t, yt^{-1}) = \frac{\eta_g(x, y)}{\eta_g(x, t)}. \quad (62)$$

holds for all $t \in G$.

Proof. It will be most convenient to prove this directly from the twisted 2-cocycle property of c^ω without invoking (31). Hence the following will in fact hold for arbitrary twisted 2-cocycles c :

$$\begin{aligned} \eta_{g^t}(x^t, yt) &= \frac{c_{g^t}(t\bar{y}, x^y)}{c_{g^t}(x^t, t\bar{y})} \\ &= \frac{c_g(\bar{t}, t\bar{y}) c_g(\bar{y}, x^y)}{c_g(\bar{t}, tx\bar{y})} \frac{c_g(\bar{t}, tx\bar{y})}{c_g(\bar{t}, x^t) c_g(x\bar{t}, t\bar{y})} \\ &= \frac{c_g(\bar{t}, t\bar{y}) c_g(\bar{y}, x^y)}{c_g(\bar{t}, x^t)} \frac{1}{c_g(x\bar{t}, t\bar{y})} \\ &= \frac{c_g(\bar{t}, t\bar{y}) c_g(\bar{y}, x^y)}{c_g(\bar{t}, x^t)} \frac{c_g(x, \bar{t})}{c_g(x, \bar{y}) c_{\bar{x}gx}(\bar{t}, t\bar{y})} \\ &= \frac{c_g(\bar{y}, x^y)}{c_g(x, \bar{y})} \frac{c_g(x, \bar{t})}{c_g(\bar{t}, x^t)} \\ &= \frac{\eta_g(x, y)}{\eta_g(x, t)}. \end{aligned}$$

Note that we repeatedly applied (57) in the above derivation. □

Now we turn to the special case.

Lemma 11. *Let $y \in Z(g, x)$. Then*

$$\eta_x(g, y) = \eta_g(x, y)^{-1}, \quad (63)$$

$$\eta_g(y, x) = \eta_g(x^{-1}, y^{-1})^{-1}. \quad (64)$$

Proof. Note first that the assumption is equivalent to requiring $xg = gx \wedge yg = gy \wedge yx = xy$, in other words, all arguments of η mutually commute. Next we see that (34) simplifies to

$$\eta_g(x, y) = \frac{c_g^\omega(y^{-1}, x)}{c_g^\omega(x, y^{-1})} = \frac{\omega(g, y^{-1}, x) \omega(y^{-1}, x, g) \omega(x, g, y^{-1})}{\omega(y^{-1}, g, x) \omega(g, x, y^{-1}) \omega(x, y^{-1}, g)}. \quad (65)$$

from where one can immediately verify both claims. □

Lemma 12.

$$\eta_g(x, e) = 1. \quad (66)$$

Proof. It is immediate from (54), (55) and (56) that (34) simplifies to

$$\eta_g(x, e) = \frac{\omega(g, e, x)\omega(e, x, g)\omega(x, g, e)}{\omega(g, x, e)\omega(e, g, x)\omega(x, e, g)} = 1.$$

□