

A quantum algorithm for obtaining the energy spectrum of a physical system using a resonating probe qubit

Hefeng Wang*

Department of Applied Physics, Xi'an Jiaotong University, Xi'an 710049, China

We present a quantum algorithm for obtaining the energy spectrum of a physical system. A qubit is coupled to a n -qubit quantum register that represents the system to form a register R . We prepare R in a general reference state and construct a general operator that excites R from the reference state to the state space of the system. A probe qubit is coupled to R such that the probe exhibits a dynamical response only when it resonates with a transition between the reference state and the energy eigenstates of the system. By varying the probe's frequency, the energy spectrum and the eigenstates of the system can be obtained. In this algorithm, no initial guess on the eigenstate of the system is required.

PACS numbers: 03.67.Ac, 03.67.Lx

INTRODUCTION

A fundamental problem in the field of many-body systems is to find efficient ways of simulating Schrödinger equations. The main difficulty is that the dimension of the Hilbert space describing a system of n -particles scales exponentially with n (the size of the system). This makes a direct numerical simulation of a large system intractable. On a quantum computer, however, the number of qubits required to simulate the system increases linearly with the size of the system.

One of the quantum algorithms for obtaining the eigenvalues and eigenvectors of a system is the phase estimation algorithm (PEA) [1–5]. In the PEA, one has to make an initial guess on the eigenstates of the system, and prepare this state as the input for the algorithm. In general, the initial guess state of a physical system can be obtained through the mean field theory. One can use a Hartree-Fock (HF) wave function of the system, which can be obtained efficiently on a classical computer, as the initial guess state. The HF wave function can be spanned by the eigenstates of the system. The success probability of the PEA depends on the overlap of the initial guess state with the real eigenstates of the system. In many cases, however, such as the bond-dissociation process in chemistry or that related to the excited states of a system, it can become impossible to have a HF wave function that has any substantial overlap with the desired eigenstate [4]. The reason for this is that in these cases, the HF wave function is not able to describe the system even qualitatively correct.

In Ref. [6], we proposed another quantum algorithm for obtaining the energy spectrum of a physical system. It obtains directly the energy differences between energy levels. In this algorithm, the initial state does not need to have large overlap with any particular eigenstate of

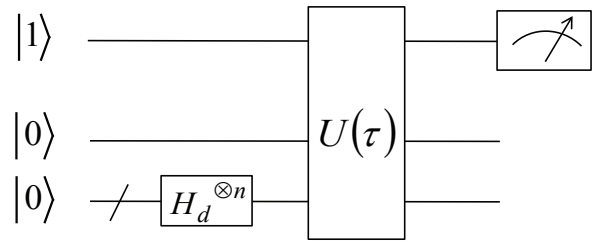

FIG. 1: Quantum circuit for obtaining the energy spectrum of a physical system. The first line represents a probe qubit. H_d represents the Hadamard gate, and $U(\tau)$ is a time evolution operator driven by a Hamiltonian given in Eq. (2). The last n qubit represent the system whose spectrum is to be obtained.

the system. But one must prepare an initial guess state that has large overlap with one of the eigenstates of the system to achieve high efficiency. One then construct an excitation operator that guide the system to any desired states. The excitation operator depends on the initial state that is chosen and the part of the energy spectrum that is of interest.

In this paper, we present a quantum algorithm that obtains the energy spectrum of a quantum system, without having any priori knowledge about the system except its Hamiltonian. In this algorithm, for an arbitrary physical system, one starts from a general reference state and apply a general excitation operator to obtain the energy spectrum of the system. One does not need to make a guess on any energy eigenstates of the system.

THE ALGORITHM

First we prepare a quantum register R , which contains a qubit and an n -qubit quantum register that represents the system. We design a Hamiltonian \tilde{H} with the form:

$$\tilde{H} = \begin{pmatrix} \alpha I_N & 0 \\ 0 & H_S \end{pmatrix}, \quad (1)$$

*Correspondence to wanghf@mail.xjtu.edu.cn

where I_N is the N -dimensional identity operator, and $N = 2^n$; α is a parameter that is set as a reference point for the eigenenergy of the system; H_S is the Hamiltonian of the system. \tilde{H} acts on the state space of the quantum register R .

Then we let a probe qubit couple to R , and construct a Hamiltonian H for the whole system of the form

$$H = \frac{1}{2}\omega\sigma_z + \tilde{H} + c\sigma_x \otimes A, \quad (2)$$

where the first term is the Hamiltonian of the probe qubit, the second term is the Hamiltonian of the quantum register R , and the third term describes the interaction between the probe qubit and R . Here, ω is the frequency of the probe qubit ($\hbar = 1$), and c is the coupling strength between the probe qubit and R , whereas σ_x and σ_z are Pauli matrices. The operator A acts on the state space of \tilde{H} and plays the role of an excitation operator. This operator contains N terms, which provide all possible excitations that excite R from the subspace of αI_N to the subspace of H_S ,

$$A = \frac{1}{\sqrt{N}}(A_1 + A_2 + \dots + A_N), \quad (3)$$

where $A_1 = \sigma_x \otimes I_2 \otimes I_2 \otimes \dots \otimes I_2$, $A_2 = \sigma_x \otimes I_2 \otimes \dots \otimes I_2 \otimes \sigma_x$, \dots , $A_{n+1} = \sigma_x \otimes \sigma_x \otimes I_2 \otimes I_2 \otimes \dots \otimes I_2$, $A_{n+2} = \sigma_x \otimes I_2 \otimes \dots \otimes I_2 \otimes \sigma_x \otimes \sigma_x$, $A_{n+3} = \sigma_x \otimes I_2 \otimes \dots \otimes \sigma_x \otimes I_2 \otimes \sigma_x$, \dots , $A_N = \sigma_x \otimes \sigma_x \otimes \dots \otimes \sigma_x \otimes \sigma_x$, and I_2 is the two-dimensional identity operator. Although the operator A has an exponentially large number of terms, it can be implemented at a polynomial cost as

$$A = \sigma_x \otimes \left[\frac{1}{\sqrt{2}}(I_2 + \sigma_x) \right]^{\otimes n}. \quad (4)$$

We prepare the quantum register R in a reference state

$$|\Psi_0\rangle = \frac{1}{\sqrt{N}} \sum_{j=1}^N |\varphi_j\rangle = \frac{1}{\sqrt{N}} \sum_{j=1}^N |0\rangle \otimes |j-1\rangle, \quad (5)$$

where $|j-1\rangle$ are the computational basis in the subspace of I_N , and $|0\rangle = \begin{pmatrix} 1 \\ 0 \end{pmatrix}$. This is achieved by initializing R in state $|0\rangle^{\otimes(n+1)}$ and applying the operator $I_2 \otimes H_d^{\otimes n}$, where H_d is the Hadamard gate. The states $|\varphi_j\rangle$ are the eigenstates of \tilde{H} with eigenvalues of α and with a degeneracy of N ; therefore, the reference state $|\Psi_0\rangle$ has an eigenvalue $E_0 = \alpha$.

We make a guess on the range of the transition frequency between the reference state $|\Psi_0\rangle$ and the eigenstates of the system, $[\omega_{\min}, \omega_{\max}]$. We then discretize this frequency range into j intervals, where each interval has a width of $\Delta\omega = (\omega_{\max} - \omega_{\min})/j$, and the frequencies are given by $\omega_k = \omega_{\min} + k\Delta\omega$, $k = 0, \dots, j-1$. The frequency ω is taken from the frequency set ω_k . For a

frequency ω_k of the probe qubit, we let the entire system evolve with the Hamiltonian shown in Eq. (2) for time τ . After that, we read out the state of the probe qubit. Once we observe a decay of the probe qubit, it indicates that the last n -qubits of the quantum register R collapse to one of the the energy eigenstates of the system. We repeat the procedure many times to obtain the decay probability of the probe qubit. Then we change the probe frequency and repeat this procedure until we cover all the frequencies in the range $[\omega_{\min}, \omega_{\max}]$.

The algorithm procedure is summarized as follows: (i) prepare the probe qubit in its excited state $|1\rangle$ and the $(n+1)$ -qubit quantum register R in state $|0\rangle^{\otimes(n+1)}$; (ii) apply operator $I_2 \otimes H_d^{\otimes n}$ on R , therefore R is transformed into state $|\Psi_0\rangle$; (iii) implement the time evolution operator $U(\tau) = \exp(-iH\tau)$; (iv) read out the state of the probe qubit; (v) perform steps (ii) – (iv) many times in order to obtain good statistics and calculate the decay probability of the probe qubit; (vi) repeat steps (i)–(v) for different frequencies of the probe qubit. The quantum circuit for steps (i) – (iv) is shown in Fig. 1.

EFFICIENCY OF THE ALGORITHM

The efficiency of the algorithm is defined as the number of times that the circuit in Fig. 1 must be run to obtain the decay probability, P_{decay} . The number of times that the circuit must be run must be at least proportional to $1/P_{\text{decay}}$. The decay probability of the probe qubit has been discussed in Ref. [6]. In our algorithm, we only consider the excitation from the reference state $|\Psi_0\rangle$ to the j -th eigenstate $|\Psi_j\rangle = |1\rangle|\psi_j\rangle$, $j = 1, 2, \dots, N$ of the quantum register R . $|\psi_j\rangle$, $j = 1, 2, \dots, N$ are the j -th eigenstate of the system with eigenvalue E_j . With the probe qubit frequency being set to ω_k , the decay probability of the probe qubit becomes

$$P_{\text{decay}} = \sin^2\left(\frac{\Omega_{0j}\tau}{2}\right) \frac{Q_{0j}^2}{Q_{0j}^2 + (E_j - E_0 - \omega_k)^2}, \quad (6)$$

where $Q_{0j} = 2c|\langle\Psi_j|A|\Psi_0\rangle|$, and $\Omega_{0j} = \sqrt{Q_{0j}^2 + (E_j - E_0 - \omega_k)^2}$. In this process, the system is excited from the state $|\Psi_0\rangle$ to the state $|\Psi_j\rangle$, and the probe decays to its ground state. The eigenstate in the state space of the quantum register R can be spanned in computational basis as

$$|\Psi_j\rangle = \sum_{k=1}^N d_{jk}|\varphi_k\rangle = \sum_{k=1}^N d_{jk}|1\rangle|k\rangle. \quad (7)$$

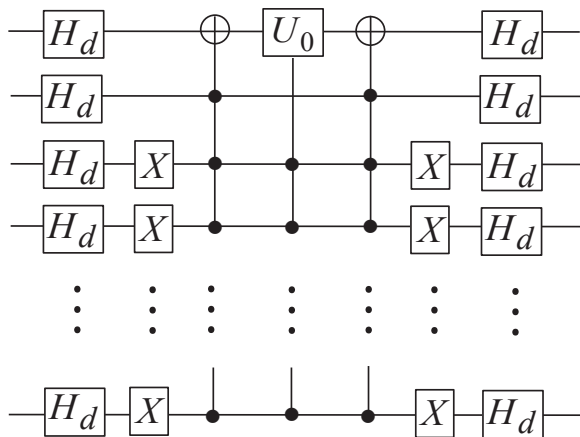

FIG. 2: Quantum circuit for implementing the unitary operator $e^{-i(c\sigma_x \otimes A)\tau/L}$, where operator A is given in Eq. (4) and σ_z is the Pauli matrices $U_0 = e^{i\sqrt{2^n}c\tau/L\sigma_z}$.

Then Q_{0j} can be written as

$$\begin{aligned} Q_{0j} &= 2c|\langle\Psi_j|A|\Psi_0\rangle| \\ &= 2c\sum_{l=1}^N\sum_{k=1}^N\frac{1}{\sqrt{N}}d_{jk}|\langle 1|k|A|\varphi_l\rangle| \\ &= 2c\sum_{k=1}^N d_{jk}. \end{aligned} \quad (8)$$

then

$$\Omega_{0j} = \sqrt{4c^2\left(\sum_{k=1}^N d_{jk}\right)^2 + (E_j - E_0 - \omega_k)^2}. \quad (9)$$

From above we can see that the decay probability, and therefore the efficiency of the algorithm, depends on the coupling strength c and the evolution time τ . In general, c is set to be small and the evolution time τ is set to be large.

IMPLEMENTATION OF THE ALGORITHM

In the algorithm, we must implement the time evolution operator $U(\tau) = \exp(-iH\tau)$. The operator $U(\tau)$ can be implemented based on the Trotter-Suzuki formula [7]:

$$U(\tau) = \left[e^{-i\frac{1}{2}\omega\sigma_z\tau/L} e^{-i\tilde{H}\tau/L} e^{-i(c\sigma_x \otimes A)\tau/L} \right]^L + O\left(\frac{1}{L}\right), \quad (10)$$

where L does not depend on the size of the problem. L can be made sufficiently large such that the error is bounded by some threshold [8].

In Eq. (10), the unitary operator $e^{-i\frac{1}{2}\omega\sigma_z\tau/L}$ is diagonal and can be implemented efficiently. The second

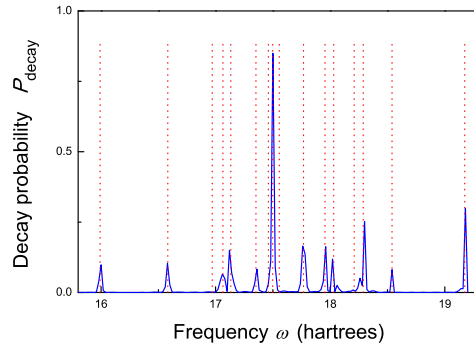

FIG. 3: (Color online) Transition frequency spectrum between the reference state, $|\Psi_0\rangle$, and the 16 eigenstates of the water molecule. The blue solid curve represents the decay probability of the probe qubit at different frequencies with the coupling coefficient $c = 0.002$ and the evolution time $\tau = 1200$. The frequency for the probe qubit is set in the range $\omega \in [15.8, 19.2]$, and is divided into 170 equal intervals. The red dotted vertical lines represent the known transition frequencies between the reference state and all the 16 states of the water molecule.

term can be treated as a controlled- U_S ($C-U_S$) operation, where $U_S = e^{-iH_S\tau/L}$. H_S is a Hamiltonian that involves two-body interaction, and can be simulated efficiently on a quantum simulator. Therefore the second term of the unitary operator can also be implemented efficiently. For the unitary operator $e^{-i(c\sigma_x \otimes A)\tau/L}$, the Hamiltonian $c\sigma_x \otimes A$ involves many-body interaction. In Ref. [9], it was shown that a many-body interaction Hamiltonian can be simulated efficiently by a Hamiltonian with two-body interactions. The unitary operator $e^{-i(c\sigma_x \otimes A)\tau/L}$ can be implemented using the circuit shown in Fig. 2. In the circuit, the $(n+1)$ and n -qubit controlled unitary operators can be implemented efficiently with $O(n^2)$ elementary gates [10]. Therefore the implementation of $U(\tau)$ scales polynomially with the size of the system.

EXAMPLE

In the following, we present an example to simulate how the algorithm would perform for solving the Schrödinger equation of a system that we only know its Hamiltonian.

Using the example in Ref. [6] for obtaining the energy spectrum of water molecule, considering the C_{2V} and 1A_1 symmetries. The Hamiltonian for the water molecule is given in Ref. [11] and shown below. The HF wave function for the ground state of the water molecule is $(1a_1)^2(2a_1)^2(1b_2)^2(3a_1)^2(1b_1)^2$. Using the STO-3G basis set [11] and freezing the first two a_1 orbitals, we construct a model space with 1A_1 symmetry that includes the $3a_1, 4a_1, 1b_1$ and $1b_2$ orbitals. Here, we consider only

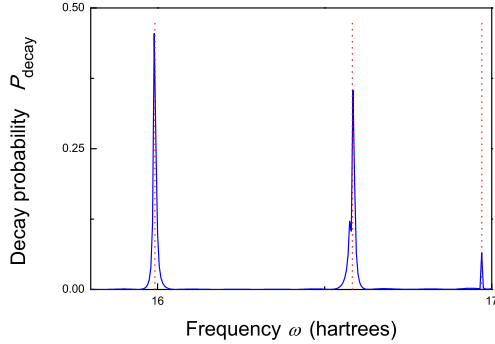

FIG. 4: (Color online) Same as in Fig. 3, except the frequency of the probe qubit is set in the range $\omega \in [15.8, 17.0]$, and is divided into 240 equal intervals.

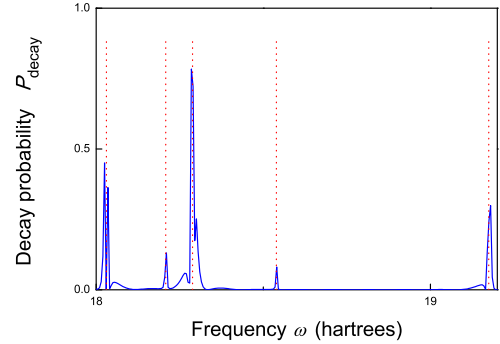

FIG. 6: (Color online) Same as in Fig. 3, except $c = 0.001$ and $\tau = 2400$. The frequency of the probe qubit is set in the range $\omega \in [18.0, 19.2]$, and is divided into 240 equal intervals.

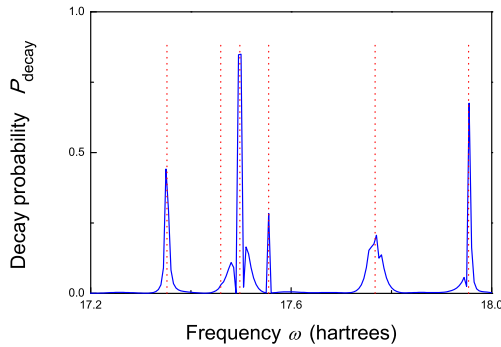

FIG. 5: (Color online) Same as in Fig. 3, except the frequency of the probe qubit is set in the range $\omega \in [17.2, 18.0]$, and is divided into 160 equal intervals.

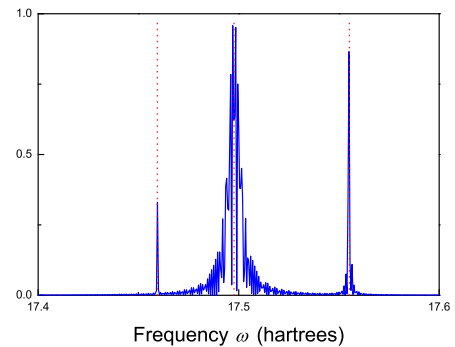

FIG. 7: (Color online) Same as in Fig. 3, except $c = 0.001$ and $\tau = 20000$. The frequency of the probe qubit is set in the range $\omega \in [17.4, 17.6]$, and is divided into 400 equal intervals.

single and double excitations to the external space, and for simplicity, we remove two of the highest excitations. The dimension of the state space of the water molecule is 16. Therefore at least 4 qubits are required to simulate the water molecule in this calculation.

The Hamiltonian of the water molecule in the form of second quantization is

$$H = \sum_{p,q} \langle p | T + V_N | q \rangle a_p^\dagger a_q - \frac{1}{2} \sum_{p,q,r,s} \langle p | \langle q | V_e | r \rangle | s \rangle a_p^\dagger a_q^\dagger a_r a_s, \quad (11)$$

where $|p\rangle$ is the one-particle state, a_p^\dagger is its fermionic creation operator, and T , V_N , and V_e are the one-particle kinetic operator, nuclear attraction operator and the two-particle electron repulsion operator, respectively.

We set the reference energy $E_0 = \alpha = -100$, and vary the frequency of the probe qubit in the range $\omega \in [15.8, 19.2]$, which is divided into 170 intervals. The coupling strength and the evolution time are set as $c = 0.002$ and $\tau = 1200$ (here we measure energies in units of Hartree and time in units of Hartree $^{-1}$). We then run

the algorithm and obtain the spectrum for the transition frequencies between the reference state and the eigenstate of water molecule. The results are shown in Fig. 3. From the figure we can see that four peaks (the 3rd, 7-th, 9-th, and 13-th) are missing, and the rest of the spectrum obtained using our algorithm are in good agreement with the known transition frequency spectrum (in red) of the water molecule.

In the following we show how to find the four missing peaks.

More accurate results can be obtained by increasing the density of the frequency points in certain region. First we vary the frequency of the probe qubit in the range $\omega \in [15.8, 17.0]$, which is divided into 240 intervals, and run the algorithm. The results are shown in Fig. 4. We can see that the 3rd peak at $\omega = 16.9705$ appears this time. We then vary the frequency of the probe qubit in the range $\omega \in [17.2, 18.0]$, which is divided into 160 intervals, and run the algorithm, from the results shown in Fig. 5, we can see that the 9-th peak at $\omega = 17.5552$ appears. We vary the frequency of the probe

qubit in the range $\omega \in [18.0, 19.2]$, which is divided into 240 intervals, and set $c = 0.001$ and the evolution time $\tau = 2400$. From the results shown in Fig. 6, we can see that the 13-th peak at $\omega = 18.2082$ appears.

In the case where the term $\sum_{k=1}^N d_{jk}$ is small (therefore the term Q_{0j} is small), increasing the evolution time τ can help to find the peak that is missing. For the 7-th eigenstate of the system, we have $\sum_{k=1}^N d_{jk} = 0.0305153$, which is very small. We vary the frequency of the probe qubit in the range $\omega \in [17.4, 17.6]$, which is divided into 400 intervals, we set $c = 0.001$ and $\tau = 20000$, and run the algorithm. The results are shown in Fig. 7. We can see the 7-th peak at $\omega = 17.4594$ appears.

Now all the expected peaks are clearly visible through the variation of the coupling strength c , the evolution time τ , and increase the density of frequency points in certain frequency ranges.

DISCUSSION

We have presented a quantum algorithm for obtaining the energy spectrum of a physical system, which we only know its Hamiltonian. In this algorithm, one does not have to make an initial guess on the energy eigenstates of a physical system as in Refs. [2] and [6]. Unlike in the PEA, one does not need to run a classical calculation to obtain an initial state.

As discussed in Ref. [6], the number of frequency points that need to be used in the algorithm is proportional to the frequency range, therefore scales polynomially with the system size. Each single run of the algorithm is essentially a quantum simulation of the dynamics, which scales polynomially with the size of the system [12]. Once the “energy levels of interest” is specified, and their number is small (or at least not exponentially large), the complexity of the algorithm does not grow exponentially with the size of the system.

As we have demonstrated in the example, by varying the coupling strength c , the evolution time τ , and increasing the density of the frequency points, one can obtain the entire energy spectrum of a physical system. To obtain accurate results, we need to set c to be small and the evolution time τ to be large such that the change of the system remains observable. Note that for eigenstates that have anti-symmetric symmetry, our algorithm cannot obtain their energy spectrum. As shown in Eq. (8),

in such cases, the term Q_{0j} is zero, such that the decay probability of the probe qubit is zero. The algorithm can also be used to prepare any desired energy eigenstate of a physical system. Once a decay of the probe qubit to its ground state occurred, it indicates that the last n -qubits of the quantum register R collapse to one of the the energy eigenstates of the system.

In our algorithm, one cannot tell whether a given energy level is degenerate or not. And it will be difficult to separate the near-degenerate states. In these cases, by applying our algorithm, once the probe qubit collapse to its ground state, the system is in a superposition of the degenerated states. One can use this state as the input to the PEA to resolve the eigenenergy and the corresponding eigenstates.

We thank Sahel Ashhab and L.-A. Wu for helpful discussions. This work was supported by “the Fundamental Research Funds for the Central Universities” of China and the National Nature Science Foundation of China (Grant No. 11275145).

-
- [1] A. Y. Kitaev, e-print arXiv: quant-ph/9707021, 1997.
 - [2] D. S. Abrams and S. Lloyd, *Phys. Rev. Lett.* **83**, 5162 (1999).
 - [3] A. Aspuru-Guzik, A. D. Dutoi, P. J. Love, and M. Head-Gordon, *Science* **309**, 1704 (2005).
 - [4] H. Wang, S. Kais, A. Aspuru-Guzik, and M. R. Hoffmann, *Phys. Chem. Chem. Phys.* **10**, 5388 (2008).
 - [5] A. M. Childs and W. van Dam, *Rev. Mod. Phys.* **82**, 1 (2010).
 - [6] H. Wang, S. Ashhab, and F. Nori, *Phys. Rev. A* **85**, 062304 (2012).
 - [7] M. Nielsen, I. Chuang, *Quantum Computation and Quantum Information* (Cambridge Univ. Press, Cambridge 2000).
 - [8] S. Lloyd, *Science* **273**, 1073-1078 (1996).
 - [9] S. Bravyi, D. P. DiVincenzo, D. Loss, and B. M. Terhal, *Phys. Rev. Lett.* **101**, 070503 (2008).
 - [10] A. Barenco, *et al.*, *Phys. Rev. A* **52**, 3457 (1995).
 - [11] A. Szabo and N. Ostlund, *Modern Quantum Chemistry: Introduction to advanced Electronic Structure Theory* (McGraw-Hill, New York, 1989).
 - [12] A. Kitaev, A. H. Shen, and M. N. Vyalyi. *Classical and quantum computation, Graduate studies in Mathematics* Vol. **47**. American Mathematical Society, Providence, RI, 2002.