

# Opinion dynamics under opposition

Steffen Eger

## Abstract

We study a DeGroot-like opinion dynamics model in which agents may oppose other agents. As an underlying motivation, in our setup, agents want to adjust their opinions to match those of the agents they follow (their ‘ingroup’ or those they trust) and, in addition, they want to adjust their opinions to match the ‘inverse’ of those of the agents they oppose (their ‘outgroup’ or those they distrust). Our paradigm can account for a variety of phenomena such as consensus, neutrality, disagreement, and (functional) polarization, depending upon network (multigraph) structures and specifications of deviation functions, as we demonstrate, both analytically and by means of simple simulations. Psychologically and socio-economically, we interpret opposition as arising either from rebels; countercultures; rejection of the norms and values of disliked others, as ‘negative referents’; or, simply, distrust.

## 1 Introduction

On many issues of everyday life, such as economic, political, social, or religious agendas, disagreement among individuals is pervasive: whether or not Iraq had weapons of mass destructions [68], the scientific standing of evolution, whether taxes/social subsidies/unemployment benefits/(lower bounds on) wages should be increased or decreased, the right course of government in general, the effectiveness of alternative (or ‘standard’) medicine such as homeopathy, the effectiveness and appropriateness of death penalty, etc., are all highly debated despite the fact that plenty of data bearing on these issues is available.<sup>1</sup> In fact, in certain contexts such as the political arena, disagreement is ‘built in’ into and part of the system of opinion exchange. Yet, it has been observed that, contradicting this factual basis, the phenomenon of disagreement is not among the predictions of, in the social and economic context, renown and widely used theoretical models of opinion dynamics, whether they are based on fully rational, *Bayesian*, agents or boundedly rational or *non-Bayesian* actors (see, e.g., the discussions in [4, 2, 79]). Namely, in these models, a standard prediction is that agents tend toward a *consensus opinion*, that is, that all agents eventually hold the same opinion (or belief)<sup>2</sup> about any specific issue. Typically, this applies to both Bayesian frameworks — which is the reason why Acemoglu and Ozdaglar (2011) [4] call them “[no] natural framework[s] for understanding persistent disagreement” (p. 6) — and non-Bayesian setups such as the famous DeGroot model of opinion dynamics [26], where consensus obtains as long as the social network wherein agents communicate with each other is strongly connected (and aperiodic).<sup>3</sup>

Concerning the non-Bayesian DeGroot model, as we consider in this work, a few amendments have more recently been suggested which are capable of producing disagreement among agents. In one strand of literature, models including a *homophily* mechanism, whereby agents limit their communication to individuals whose opinions are not too different from their own, can reproduce patterns of opinion diversity and disagreement [46, 47, 48, 25].<sup>4</sup> In another strand, Acemoglu and colleagues [4, 79] introduce two types

<sup>1</sup>Some of our examples are taken from Golub and Jackson (2012) [42] and Acemoglu and Ozdaglar (2011) [4]. We also note, however, that the ‘scope’ of disagreement in society is disputed in the relevant literature, see, e.g., Baldassari and Bearman (2007) [9].

<sup>2</sup>Typically, in the literature, the term *belief* is used when there exists a *truth* for an agenda, and the term *opinion* is used when truth is not explicitly modeled, although this may vary from author to author and discipline to discipline. In this work, where we only consider the latter situation, we typically say that agents hold *opinions* on issues, but we take the freedom to occasionally use both terms interchangeably.

<sup>3</sup>For a recent discussion of the ‘problem of consensus’, see, e.g., Acemoglu and Ozdaglar (2011) [4]; for an early discussion of the problem, see, e.g., Abelson (1964) [1].

<sup>4</sup>However, much depends on the precise modeling of homophily. If homophily means that agents with distinct opinions *never* talk to each other, then disagreement is a likely outcome. However, if homophily is modeled in such a way that agents with distinct beliefs only place low(er) trust weights upon each other, then, again, agreement is a standard prediction, see,

of agents, *regular* and *stubborn*, whereby the latter never update their opinions but ‘stubbornly’ retain their old beliefs, which may be considered an autarky condition; multiple stubborn agents with distinct opinions on a certain agenda may then draw society toward distinct opinion clusters. Such stubborn agents, it is argued, may appear in the form of opinion leaders, (propaganda) media, or political parties that wish to influence others without receiving any feedback from them. Ultimately, the assumption of stubbornness appears problematic, however, since complete autarky in reality probably very rarely obtains (cf. the famous ‘no man is an island’ condition according to which agents are generally interconnected, even in fragmented societies [4]).<sup>5</sup>

In this work, we investigate an alternative explanation of disagreement. We consider a non-Bayesian DeGroot-like opinion dynamics model where agents are related with each other via *two types of links*: one link type represents the usual ‘weight’ that one agent places upon another in DeGroot learning models — these weights, in DeGroot models, typically represent ‘trust’ between agents, importance, or simply a ‘listening/connectedness structure’ and are given by real numbers, and, in our model, have the interpretation of strength or intensity of relationship between two agents — and the other link type represents whether or not agents *oppose* each other, whereby opposition is given as a functional relationship (‘endomorphism’, a mapping from the set of possible opinions to itself) on opinions. In short, in our model, one link type represents *kind of relationship* between agents (opposition or not) and the other represents *intensity of relationship*. The non-opposition case, which we also refer to as *following* (‘one agent *follows* another agent’s opinion’), is the simple situation where an agent maps another agent’s opinion to itself via the identity function and corresponds to the standard operation — although not usually explicated — in DeGroot learning models. The opposition case, which we also refer to as *deviation* or *deviating* (‘one agent *deviates from* another agent’s opinion’) is our model’s novel ingredient: in its most abstract form, it simply means that an agent *inverts* another agent’s opinions via an endomorphism that is *not the identity function*. Then, after inverting or not, agents take a *weighted arithmetic average*, as in standard DeGroot learning models, of all other agents’ possibly inverted opinion signals. This process of inverting or not and subsequent averaging is repeated *ad infinitum* and one of the questions we ask is about the limiting results of the mechanism: e.g., in the limit, will agents tend toward a consensus or will they disagree?

Our model is probably most easily understood in the setup of a ‘binary voter’ model where only two possible opinions are available (candidate A or B; policy A or B; etc.). Here, the opposition case necessarily means that, if agent  $i$  opposes agent  $j$ ,  $i$  will invert  $j$ ’s opinion to B, provided that  $j$  holds opinion A, and to A otherwise. Agent  $i$  does so for all of his neighbors, leaving the opinions of agents he follows unchanged, and then averages these (possibly inverted) opinions in order to form his next period opinion; of course, in the discrete case, averaging by arithmetic means may not be well-defined and here, we would, e.g., instead consider the operation of  $i$  adopting the (weighted) majority opinion of his neighbors’ possibly inverted opinion signals. As indicated, we thus allow agents to have both individual neighborhoods (whom they are connected with at all) and individual opposition behavior (whom they follow/deviate from), while, as a first approximation and for simplicity reasons, we do not allow agents to have individual deviation functions, that is, the choice of deviation function is fixed within a population of agents.

Opposition behavior, or deviating, as we have sketched, may be a plausible behavioral assumption from a variety of viewpoints. Firstly, as discussed, in politics, for example, opposition toward members of other parties, most typically the governing party in charge, is so common that opposition may even be considered ‘blind’ [52, 22], negating whatever opinions competitors hold. Secondly, deviating from an opinion signal may also be plausible when an agent is (suspected of) lying; see, for instance, in the economics context, the abundance of experimental evidence from cheap-talk games [40, 70, 76]. In the following, we discuss four more possible justifications of opposition (that are related both to each other and the justifications brought forth thus far), one based on the concept of *rebels* who derive utility from making different choices than (certain) other agents; one based on the concept of *countercultures* like hippies, punks, etc., that inherently tend to counteract mainstream beliefs, actions, and opinions (in

---

e.g., Pan (2010) [69].

<sup>5</sup>As still another explanation of disagreement in DeGroot learning models, it might be argued that even the standard model predicts consensus only as a *limiting* result and that, for all finite intermediate communication stages, disagreement is in fact in accordance with the model. Golub and Jackson (2012) [42] seem to adhere to this interpretation. Problematic about this is that the standard models typically not only imply (full) agreement in the long run but also ‘ $\epsilon$ -agreement’ within short periods of time.

political terms, countercultures may be thought of as playing the opposition parties' roles); one based on the concept of *rejection* of the norms of disliked interaction partners, as has been outlined, e.g., in psychology and sociology, as an important motivation underlying human behavior; and one based on the concept of *distrust*, whereby opposition is thought of as arising from a distrusting stance toward (certain) others, which may include the supposition that certain others are not truthful.

- It has been argued that some agents, e.g., *rebels*, in contrast to *conformists* (see the models of Cao, Yang, Qu, and Yang (2011) [18] and Jackson (2009) [51], p.271), may derive utility simply from the fact of making *different* (opinion) choices than their neighbors. Cao, Yang, Qu, and Yang (2011) [18] argue that an attitude of negation, rebelism, may be merely '(intellectually) fashionable', quoting Krugman on his defense of free trade [56] as saying that some intellectuals attack the concept in question, free trade, merely for the reason that "in a culture that always prizes the avant-garde, attacking that icon [free trade] is seen as a way to seem daring and unconventional." In Zhang, Cao, Qin, and Yang (2013) [82], rebels and conformists are interpreted within a 'fashion' context.
- Opposition of opinions and beliefs of others may also arise in the context of the phenomenon of *countercultures*. In fact, counterculture, as defined by Yinger (1977) [81] refers to a group of individuals who hold "a set of norms and values [...] that sharply contradict the dominant norms and values of the society of which that group is a part" (p.833) and who stand "in sharp opposition to the prevailing culture" (p. 834).<sup>6</sup> Accordingly, members of a counterculture define their norms, values, opinions and beliefs *negatively* (or *invertedly*) with respect to the norms, values, opinions, and beliefs held by the 'mainstream culture', at least with respect to certain agendas. This aspect of functional opposition is also emphasized by Davis (1971) [24] who states that "[...] hippies, too, are an instance *par excellence* of a contraculture whose *raison d'être* [...] lies in its members' almost studied inversion of certain key middle class American values and practices." Essentially, thus, countercultures do not simply ignore the opinions of others, but rely on them, as their contrast. It has also been claimed that countercultures are an invariant force in human history (see the discussion in Yinger (1977) [81] and others), present in ancient and tribal societies as well as throughout the modern era (including, in more recent times, the hippies, the rock experience or Hare Krishna), with prominent relevance, e.g., in modern arts.<sup>7</sup> Finally, countercultures have been said to be the ultimate drivers, via their dialectic opposition of current beliefs, behind change (see the discussion and references in Yinger (1977) [81]).
- Opposition is also closely related to what has, a.o., been termed *rejection* of beliefs, actions, and values of others. According to this concept, agents change their normative systems to become more dissimilar to interaction partners they dislike (cf. Abelson (1964) [1], Kitts (2006) [53], Tsuji (2002) [77]; cf. also Groeber, Lorenz, and Schweitzer (2013) [43]) insofar as disliked others may serve as 'negative referents' who inspire contrary behavior (see the discussion in Kitts (2006) [53]). For example, in the simulational study of Fent, Groeber, and Schweitzer (2007) [35], agents maximize utility functions that include positive terms for their *ingroup* members — that is, agents strive to choose norms or traits similar to those of their ingroup — and negative terms for their *outgroup* members — that is, agents, in addition, strive to choose norms or traits dissimilar to those of their outgroup, which entails both attractive and repulsive forces acting upon agents. We note that ingroup favoritism and outgroup 'discrimination' are important and well-established notions in social psychology (see, for instance, Brewer (1979) [14], Castano, Yzerbyt, Bourguignon, and Seron (2002) [19]) that have also more recently been included in economists' models (cf., e.g., in an experimental context, Charness, Rigotti, and Rustichini (2007) [21], Fehrler and Kosfeld (2013) [34], etc.).

We also note that in social network theory, antagonistic relationships between agents are nothing novel, with early work in this context dating back to the 1940's and 1950's already (see Chapter 5 in Beasley and Kleinberg (2010) [12] and references therein). Applications have ranged from

---

<sup>6</sup>Yinger (1977) [81] also gives the terms *reversal*, *inversion*, and *opposition* as being definitoric for countercultures, see also Yinger (1960) [80].

<sup>7</sup>In particular, it is contended that countercultures are particularly prominent under conditions of the modern society — rapid economic growth; rapid importation of new ideas, techniques, and goods; sharp increase in life's possibilities; lower participation in intimate and supporting social circles; a loss of meaning in the deepest symbols and rituals of society; etc.

international relations (alliances vs. hostile relations) and trust/distrust much in the same way as we indicate below. Often, the concept of *signed networks* (network links have negative or positive ‘signs’) has been used to model both positive and negative influences. Novel in our context is the application of these notions to the problem of *opinion dynamics*, but see also our discussion in Section 2.

- *Distrust*.<sup>8</sup> Opposition, or deviating, may also be thought of as arising from *distrust* between agents, e.g., in the form of *distrusting belief-integrity* (in our situation, believing that the other person does not tell the truth), *institution-based distrust* (believing that appropriate, e.g. legal, structural conditions that are conducive to situational success are not in place), or, generally, a *disposition to distrust*, also referred to as *distrusting stance* or *suspicion to distrust* (a consistent tendency to not be willing to depend on general others across a broad spectrum of situations and persons).<sup>9</sup> In fact, as shown by Mellinger (1956) [62] (see also the typology of Newcomb (1953) [67]), distrust in communication may lead to *aggression* in a sender-receiver setting, that is, to a maximizing of (presumed) disagreement between sender and receiver, which may entail that, e.g., the receiver deviates from the signal sent by the receiver; see also the recent evidence from cheap-talk games under situations of distrust (cf. Rode (2010) [70]), where it is shown that distrust may lead to a larger deviation rate among receivers.

As concerns the implications of distrust, distrust in communication may be beneficial, in particular, because distrust may prevent harm from distrusters (e.g., preventing them from making the ‘wrong’ decision in cheap talk games; for a more general setting, see, e.g., Schul, Mayo, and Burnstein (2008) [74]). However, too much distrust may lead to paranoid cognitions, as McKnight and Chervany (2001) [61] emphasize, where “no matter what the other party says or does, their actions and words are interpreted negatively”, so that “a balance of trust and distrust is important” (p.45). We also point out that distrust may be a more severe issue in certain institutional settings<sup>10</sup> than in others; in particular, it has apparently become more prevalent in recent times [28, 65, 72, 8].<sup>11</sup>

The outline of this work is as follows. First, to illustrate key concepts and ideas, we start with a ‘discrete majority voting DeGroot model’ where, in each period, agents adopt their neighbors’ weighted majority opinion, where, as throughout our paper, we allow agents to invert the opinions of certain other agents. In this discrete model, the set of possible opinions is finite or even binary (‘candidate A or B’), and, to our knowledge, the analysis of the repeated weighted majority voter model alone, even without opposition, is a novel setting.<sup>12</sup> Subsequent to the discrete setup, we consider the continuous model where agents hold opinions that lie in a convex subset of the real line and update by taking weighted arithmetic averages of their peers’ opinions. In general, the differences between the discrete and the continuous setups are, firstly, that the discrete model is ‘more robust’ to changes, both in the opinion vectors and the structure of the social networks; this comes as no surprise since, to sketch an example, if 90 neighbors of an agent  $i$  hold opinion A and 10 hold opinion B, then  $i$  will favor A over B even when a moderate or large quantity of his neighbors change their mind, while, in the continuous case, arbitrarily small changes in neighbors’ opinions may always impact  $i$ ’s opinion. Secondly, from a modeler’s perspective, the continuous model is simpler to analyze because of the availability of strong mathematical theorems in this case (e.g., results on limits of iterates of continuous functions, continuous fixed-point theorems, spectra of (linear) operators, etc.). Accordingly, in the discrete model, we will content ourselves with results on opinion profiles agents can, or cannot, converge to (fixed-points of the opinion update operators), while in the continuous model, we in addition study actual dynamics. Concerning positive results, both the discrete and the continuous version of our opposition DeGroot model allow the following outcome scenarios.

---

<sup>8</sup>As one particular example, which can also be subsumed under the notion of countercultures, of ‘large-scale’ distrust, modern conspiracy culture, which distrusts ‘conventional’ and ‘official’ explanations of the order of things (such as the assassination of John F. Kennedy, the 9/11 attacks, etc.), may be cited, cf. Aupers (2013) [8].

<sup>9</sup>Here, we follow the distrust typology of McKnight and Chervany (2001) [61].

<sup>10</sup>For example, in anarchy, dictatorship, etc.; to make a case, Mishler and Rose (1997) [64] call distrust the “predicted legacy of Communist rule”, see also Howard (2002) [50].

<sup>11</sup>Trust, or distrust, is clearly also related to income; see, e.g., Ananyev and Guriev (2013) [7] and references therein, and to personal experiences [66].

<sup>12</sup>The binary voter (DeGroot) model considered in Yildiz, Acemoglu, Ozdaglar, Saberi, and Scaglione [79] is of a much different nature than our approach since it considers agents who randomly adopt one of the neighbors’ opinions, rather than by averaging via majority rule.

- **Consensus:** In the discrete model, opposition may have no impact at all as long as the groups of agents that agents oppose are not ‘influential enough’; thus, insofar as the non-opposition model can generate consensus profiles as limits of DeGrootian opinion updating, our opposition model may entail the same patterns, in this situation. A similar outcome can be observed in the continuous model. Here, if the groups of agents that agents follow (agents’ ‘ingroups’) *are* ‘influential enough’, then agents can reach arbitrary consensus profiles that depend on their initial opinions in the same way as in the standard DeGroot model. In particular, we give sufficient conditions under which agents can (and do) reach such consensus profiles and we show that consensus opinions are, in this situation, given by a weighted linear combination of initial opinions where the weights represent the social influence of the agents (Section 6.2).
- **Neutrality:** As an important special case of a consensus, we show that both in the discrete and the continuous model, agents can reach a ‘neutral’ consensus profile. Neutrality means that the opinions in the consensus profile ‘admit no opposite’ (of course, this depends on the specification of the deviation endomorphism). We think of such opinions as ‘undisputable’, ‘uncontroversial’ or, simply, ‘neutral’. We also show that both in the discrete and the continuous model, agents can *only* attain neutral consensus profiles as long as agents’ outgroups are, again, ‘influential enough’ in that the weights that agents assign them (a single one suffices) exceed a certain threshold. Moreover, for the continuous model under *affine-linear* deviation functions, we show that our opposition model *typically* leads agents to neutral consensus profiles, as limits of the updating dynamics; we give necessary and sufficient conditions on when this happens.

To say another word on neutral consensus opinions, we also think of this result as a particular kind of ‘withdrawal’ of opinion that has empirically, e.g., been observed in situations of distrust in communication (cf. Mellinger (1956) [62]). In fact, if opinions are generally distrusted (opposed/inverted), then it may be safest to utter an opinion neutral enough to admit no opposite (such as ‘I don’t know’, rather than affirmation or negation); at least, it may be an equilibrium in which no one has a unilateral incentive to defect, even though, of course, neutrality may not be desirable from a ‘truth perspective’, as we discuss in the conclusion.

- **Disagreement:** If opposition is ‘hard enough’ or if the distribution of deviation endomorphisms satisfies a certain pattern (which we call ‘anti-opposition bipartite’) agents may disagree forever (cf. Example 4.5) and their opinions may even cyclically repeat. Hard opposition may also lead to heavy short-term fluctuations of opinions (cf. Kramer (1971) [54]) as Figure 5 illustrates. In the discrete model, disagreement (or non-consensus) may typically occur both in the non-opposition as well as in the opposition setup, although disagreement likelihood tends to increase with opposition (cf. Figure 9).
- **Polarization:** As a special case of disagreement, we show that a certain distribution of deviation endomorphisms (which we call ‘opposition bipartite’) admits *polarization* as a fixed-point of opinion updating dynamics. By polarization, we mean that agents’ opinions cluster in two distinct regimes of the opinion space. For the continuous model and for affine-linear deviation endomorphisms, we derive necessary and sufficient conditions under which opinion dynamics always lead to polarization, no matter the agents’ initial opinions. Our models admit, moreover, *functional polarization* in which what the two groups of agents believe are opposites of each other rather than arbitrary, unrelated, disagreeing opinions. Functional polarization would plausibly be the predicted outcome under countercultural opposition, for example, as our above discussion suggests.

As our work’s highlight and main theorem, we present, in Theorem 6.2, necessary and sufficient conditions on when agents, in our setup, polarize, reach a neutral consensus, and diverge (another special case of disagreement), for arbitrary initial opinions of agents, as limit results of our DeGroot-like ‘opposition’ opinion dynamics process; the theorem holds for the special case when the deviation endomorphism has a form we call ‘soft opposition’ (which yields networks, or ‘multigraphs’, that correspond to the signed networks discussed in the social networks theory literature) and when the network within which agents communicate is symmetric. Our necessary and sufficient conditions are purely in the language of graph theory, which renders them clear and attractive.

The structure of this work is as follows. In Section 2, we survey variants of DeGroot learning proposed in recent years. In Section 3, we outline our model mathematically. In this context, we also give different

economic justifications of our opposition DeGroot learning process and detail possible choices of deviation endomorphisms. Before outlining our main findings and their proofs in Sections 5, on the discrete DeGroot model, and 6, on the continuous variant, we introduce definitions and further mathematical notation and concepts in Section 4. We also give a few introductory examples there. Finally, we conclude in Section 7.

## 2 Related Work

Early and frequently cited predecessors of DeGrootian opinion dynamics are French (1956) [36] and Harary (1959) [44], although the now famous ‘averaging’ model of opinion and consensus formation has only been popularized through the seminal work of DeGroot (1974) [26]. At about the same time, Lehrer and Wagner [78, 58, 57] have developed a model of rational consensus formation in society that, in both its implications and its mathematical structure, is very similar to the DeGroot model, although behaviorally substantiated in more detail. Friedkin and Johnson (1990) [37] and Friedkin and Johnson (1999) [38] develop models of social influence that generalize the DeGroot model. In more recent years, a renewed interest in the DeGroot model of opinion and consensus formation has emerged, leading to a number of extensions proposed. For example, DeMarzo, Vayanos, and Zwiebel (2002) [27], besides sketching psychological justifications of DeGroot learning, discuss time-varying weights on own beliefs that capture, e.g., the idea of a ‘hardening of positions’: over time, individuals may be more inclined to rely on their own beliefs rather than on those of their peers. Noteworthy are moreover the models of Deffuant, Neau, Amblard, and Weisbuch (2000) [25] and of Hegselmann and Krause (2002) [46], both of which are very similar in spirit; the two models mainly differ from each other in that, in the former, two randomly determined agents, rather than all agents, update opinions in each time step. The postulate of both models is that agents take only those individuals with ‘similar’ opinions into account (that is, assign them positive weights), which may be considered a tenet of homophily. In Hegselmann and Krause (2002) [46], this leads to very interesting patterns of opinion formation in which, most prominently, the paradigms of plurality, polarization and consensus are observed, depending on specific parametrizations (most importantly, the definition of similarity, i.e., whether people are tolerant or not toward other opinions, affects which opinion pattern emerges). There is much research that directly relates to the Hegselmann and Krause (2002) [46] model, from various disciplines; see, e.g., Hegselmann and Krause (2005) [47], Hegselmann and Krause (2006) [48], Douven and Riegler (2009a) [30], Douven and Riegler (2009b) [31], Douven and Riegler (2010) [32], Groeber, Lorenz and Schweitzer (2013) [43], and many others. As we have mentioned, whether homophily leads to disagreement may substantially depend on the specification of homophily. For example, Pan (2010) [69] discusses a homophily variant in which agents assign trust weights to other agents *in proportion* to agents’ current opinion distance — rather than by assigning uniform trust weights for agents within a fixed distance to own beliefs and *zero* trust weights to agents outside that radius,<sup>13</sup> as done in the Hegselmann and Krause models and in Deffuant, Neau, Amblard, and Weisbuch [25] — which typically entails a consensus, in the limit. Homophily and DeGroot learning is also investigated in Golub and Jackson (2012) [42], where the relationship between the speed of DeGrootian learning and homophily is discussed; in this model, homophily is modeled by designing random networks where the link probability between different groups is non-uniform, and is, in fact, higher between individuals of the same group.<sup>14</sup> Here, only networks that lead to a consensus are analyzed. Further extensions of the classical DeGroot model include Golub and Jackson (2010) [41], whose contribution is to analyze weight structures such that DeGroot learners whose initial beliefs are *stochastically centered around truth* converge to a consensus that is correct, and the works of Daron Acemoglu and colleagues. For example, Acemoglu, Ozdaglar and ParandehGheibi (2010) [5] distinguish between regular and forceful agents (the latter influence others disproportionately), such as, in an economic interpretation, monopolistic media, and Acemoglu, Como, Fagnani, and Ozdaglar [2] distinguish between regular and stubborn agents (the latter never update); in Yildiz, Acemoglu, Ozdaglar, Saberi, and Scaglione [79], a discrete version of the DeGroot model with stubborn agents is analyzed in which regular agents randomly adopt one of their neighbors’ binary opinions. Concerning the ‘consensus problem’, forceful agents do generally not entail long-term disagreement between agents, and stubborn agents, trivially, entail long-term disagreement

<sup>13</sup>This means that there is no communication whatsoever between agents whose opinions are ‘too distant’.

<sup>14</sup>A crucial difference between this model and the other homophily variants is that homophily is endogenous in the latter, while it is exogenous in the Golub and Jackson (2012) [42] model.

only if they are exogenously ‘hard-wired’ to hold distinct initial opinions.<sup>15</sup>

Another interesting DeGroot variant is discussed in Buechel, Hellmann and Klößner (2012) [15] and Buechel, Hellmann and Klößner (2013) [16] where agents’ *stated opinions* may differ from their *true* (or private) opinions and where it is assumed that agents generally wish to state an opinion that is close to that of their reference group even if their true opinions may be very different (which is the ‘conformity’ aspect of their model); a similar approach is given in Buechel, Hellmann and Pichler (2012) [17], where DeGroot learning is applied to an overlapping generations model in which parents transmit traits to their children. These papers are related to our own work in that, in both cases, agents may deviate from (other) agents’ opinion signals. In our work, *receivers* may deviate from the signals sent by senders, and in Buechel, Hellmann and Klößner (2013) [16] *senders* may deviate from their own true opinions. Moreover, since the latter model also allows *counter-conformity* (and not only conformity), it, too, incorporates an ‘opposition modus’, as in our model. It does, however, not induce long-term disagreement for strongly connected and closed groups of agents, instead leading them to a consensus or to a divergence of opinions rather than to a stable polarization.<sup>16</sup> A further modeling that comes close to our own approach, and which constitutes a specialization of our setup,<sup>17</sup> is the work of Cao, Yang, Qu and Yang (2011) [18], who study ‘rebels’ in a DeGroot learning setting. In their case, rebels are agents who hold views that invert *the average opinion of their neighbors*, which is equivalent, from our perspective, to opposing everyone but one’s self. In this model, compared with our approach, since rebels have no ingroup other than themselves, long-term polarization does not ensue. Cao, Yang, Qu and Yang (2011) [18] show that their framework generally, except for very special cases, entails a ‘doctrine of the mean’ in which agents tend toward holding ‘mean opinions’ (in our terminology, agents hold neutral opinions).<sup>18,19</sup>

Social learning is also discussed in various other strands of literature, beyond the DeGroot opinion dynamics model, such as in herding models (cf. Banerjee (1992) [10], Gale and Kaiv (2003) [39], Banerjee and Fudenberg (2004) [11]), where agents usually converge to holding the same belief as to an optimal action. This conclusion generally applies to the observational learning setting (cf. Rosenberg, Solan and Vieille (2006) [71], Acemoglu, Dahleh, Lobel, and Ozdaglar (2008) [3]), where agents are observing choices and/or payoffs of other agents over time and are updating accordingly. See also the references and the discussion in Golub and Jackson (2010) [41]. General overviews over social learning, whether Bayesian or non-Bayesian, whether based on communication or observation, are, in the economics context, for example given in Lobel (2000) [59] and Acemoglu and Ozdaglar (2011) [4].

## 3 Model

### 3.1 The basic setup

For the continuous DeGroot model as we discuss, let  $S$  be a convex subset of the real numbers, that is,  $\sum_j \alpha_j x_j \in S$  for all finite numbers of elements  $x_j \in S$  and all weights  $\alpha_j \in [0, 1]$  such that  $\sum_j \alpha_j = 1$ . Below, we will usually think of  $S$  as the whole of  $\mathbb{R}$  or of some (closed and bounded) interval  $[\alpha, \beta]$  for  $\alpha \leq \beta$ . For the discrete ‘majority voting’ DeGroot model, we let  $S$  be any finite set, without further restrictions.

A set  $[n] = \{1, 2, \dots, n\}$  of  $n$  agents forms opinions about an agenda  $X$  where all opinions on  $X$  lie in  $S$ . Initially, each agent  $i = 1, \dots, n$  has an exogenously specified initial opinion  $b_i(0)$  on  $X$ . Then, agents interact — that is, update their opinions — according to a weighted social ‘multigraph’. One type of interaction patterns is represented via an  $n \times n$  interaction (or ‘importance’) matrix  $\mathbf{W}$ , where  $W_{ij} > 0$  indicates that  $i$  pays attention to  $j$  and where the size of  $W_{ij}$  indicates the *intensity* of relationship

<sup>15</sup>The concept of ‘stubbornness’ does also not provide insight into inter-group antagonisms, as we consider.

<sup>16</sup>The ‘problem’ is that the model admits no ingroup/outgroup structure as in our framework. Agents want to conform/counter-conform to a *single* reference group, without having possible adversary relations to *different* groups.

<sup>17</sup>In terms of modeling, not in terms of results.

<sup>18</sup>This result is due to the fact that their mode of opposition is always ‘soft opposition’, as we define below.

<sup>19</sup>There are still other papers, from various different disciplines, that incorporate ideas of adversary relationships in the opinion formation process. For example, Zhang, Cao, Qin, and Yang (2013) [82] interpret ‘rebels’ in a fashion context. Fent, Groeber, and Schweitzer (2007) [35] study a simulational model incorporating an ingroup/outgroup mechanism. Finally, Fan, Li, Wang, Jiang, and Li (2012) [33] discuss opinion dynamics on *signed* networks in a simulational context, where the signs represent friendly and antagonistic relationships. They quote Mao Zedong on this issue as saying: “We should oppose what enemies support, and support what enemies oppose”. See also the work of Altafini (2013) [6] and Shi, Proutiere, Johansson, Baras, and Johansson (2013) [75].

between  $i$  and  $j$ . We allow matrix  $\mathbf{W}$  to be asymmetric, that is,  $W_{ij}$  need not necessarily be equal to  $W_{ji}$ . Of crucial importance is also a second type of links between agents, namely, link types that indicate whether agents *follow* or *deviate from* each other; the latter represents opposition behavior. Following is encoded by the identity function  $F : S \rightarrow S$ , with  $F(x) = x$  for all  $x \in S$ . Opposition is encoded by a deviation function  $D : S \rightarrow S$ , where we leave the form of  $D$  open other than that it not be the identity function. Note that if  $S$  is finite with cardinality  $|S| = m$ , there are  $m! - 1 = m \cdot (m - 1) \cdot \dots \cdot 1 - 1$  possible choices for  $D$ . Now, for all agents  $i$  and  $j$ ,  $i$  either follows or deviates from  $j$ ; we summarize these patterns in an  $n \times n$  matrix  $\mathbf{F}$  with  $F_{ij} \in \{F, D\}$ . Again,  $\mathbf{F}$  need not be symmetric. Also beware the difference between  $\mathbf{F}$  and  $\mathbf{W}$ ; the matrix  $\mathbf{W}$  is an  $n \times n$  matrix of real numbers,  $\mathbf{W} \in \mathbb{R}^{n \times n}$ , while  $\mathbf{F}$  is an  $n \times n$  matrix of functions from  $S$  to  $S$ , that is,  $\mathbf{F} \in \{\phi \mid \phi : S \rightarrow S\}^{n \times n}$ . We also call the entries in  $\mathbf{F}$  *endomorphisms* because both the domain and the range of the functions are identical. As discussed in Section 1, the case  $F_{ij} = D$  may result from a variety of circumstances, such as that  $i$  is a rebel, that  $i$  disagrees with  $j$  in the form of, e.g., countercultural opposition, that  $j$  belongs to  $i$ 's outgroup, or simply, that  $i$  distrusts  $j$ 's opinion signal for reasons some of which we have suggested in the named section, but whose source we leave, ultimately, open. We assume moreover that  $F_{ij}$ , like  $W_{ij}$ , is exogenously given and remains static over time, that is, agents do not change their attitude toward other agents. We also presuppose, as indicated, that agents truthfully report their opinions at each time period  $t$  and that all opinion signals are observable by all agents.

To describe opinion dynamics, in the continuous case, agents repeatedly take weighted arithmetic averages of their neighbors' (possibly inverted) opinion signals. Denoting by  $b_i(t) \in S$  the opinion at time  $t = 0, 1, 2, \dots$  of agent  $i$  on issue  $X$ , opinions thus evolve according to

$$b_i(t+1) = \sum_{j=1}^n W_{ij} \cdot F_{ij}(b_j(t)), \quad (3.1)$$

for all  $i = 1, \dots, n$  and all discrete time periods  $t = 0, 1, 2, 3, \dots$ . Rewriting the updating process (3.1) in 'matrix notation', we have

$$\mathbf{b}(t+1) = (\mathbf{W} \circ \mathbf{F})(\mathbf{b}(t)), \quad (3.2)$$

where we let the 'operator'  $\mathbf{W} \circ \mathbf{F}$  act on a vector  $\mathbf{b} \in S^n$  in the manner prescribed in (3.1), i.e.,  $((\mathbf{W} \circ \mathbf{F})(\mathbf{b}))_i = \sum_{j=1}^n W_{ij} \cdot F_{ij}(b_j)$ . Equation (3.2) may again be rewritten as,

$$\mathbf{b}(t) = (\mathbf{W} \circ \mathbf{F})^t(\mathbf{b}(0)), \quad (3.3)$$

by which we denote the  $t$ -fold application of operator  $\mathbf{W} \circ \mathbf{F}$  on  $\mathbf{b}(0)$ , that is,  $f^t(\mathbf{b}) = f(\dots f(f(\mathbf{b})))$ , where  $f = \mathbf{W} \circ \mathbf{F}$ .

**Remark 3.1.** In case  $\mathbf{F}$  is the  $n \times n$  matrix of identity functions, updating process (3.3) collapses to the standard DeGroot learning model where  $(\mathbf{W} \circ \mathbf{F})^t$  is simply the  $t$ -th matrix power of matrix  $\mathbf{W}$ .

**Remark 3.2.** For short, we will usually write  $(\mathbf{W} \circ \mathbf{F})\mathbf{b}$  instead of  $(\mathbf{W} \circ \mathbf{F})(\mathbf{b})$ .

In the discrete case, we consider the following updating process,

$$b_i(t+1) = \arg \max_{s \in S} \sum_{j=1}^n W_{ij} \mathbf{1}(F_{ij}, b_j(t))(s), \quad (3.4)$$

where  $\mathbf{1}(r, t) = 1$  if  $r = t$  and zero otherwise. In other words, at time  $t + 1$ , agent  $i$  adopts the weighted majority opinion among his neighbors at time  $t$ . Note that, in Equation (3.4), there may be no unique maximum in which case further specification is necessary (see below). For both the discrete and the continuous case, we use the compact notations (3.2) and (3.3).

As concerns intensity weights  $W_{ij}$ , we require weights to be non-negative,  $W_{ij} \geq 0$ , with  $W_{ij} = 0$  indicating that agent  $i$  ignores agent  $j$  (note that in this case, it does not matter whether  $F_{ij} = F$  or  $F_{ij} = D$ ). Usually, we also assume that  $\mathbf{W}$  is *row-stochastic*, that is,  $0 \leq W_{ij} \leq 1$ , for all  $i, j \in [n]$ , and for all  $i \in [n]$ ,  $\sum_{j=1}^n W_{ij} = 1$ , but, in some contexts, we drop this requirement and, thus, specify weight restrictions as we analyze the models.

We finally note that opinion evolution under process (3.2) may be visualized by operations in a *multigraph* as in Figure 3 below (Section 4), where there are two possible types of links between agent nodes.

## 3.2 Justifications of the DeGroot learning process

### Myopic best-response updating

As has been pointed out by Golub and Jackson (2012) [42], the standard DeGroot learning model may have an interpretation as a myopic best-response updating in a pure coordination game (for a more general setup, see Groeber, Lorenz, and Schweitzer (2013) [43]). In our framework, the updating process may be interpreted as resulting from a mix of a coordination game and an anti-coordination game. For example, in the continuous case, if agents  $i = 1, \dots, n$  have utilities on beliefs  $\mathbf{b} = (b_1, \dots, b_n) \in S^n$  as

$$\begin{aligned} u_i(\mathbf{b}) &= - \sum_{j=1}^n W_{ij} (b_i - F_{ij}(b_j))^2 \\ &= - \sum_{j:i \text{ follows } j} W_{ij} (b_i - b_j)^2 - \sum_{j:i \text{ opposes } j} W_{ij} (b_i - D(b_j))^2, \end{aligned} \quad (3.5)$$

then best-response dynamics — for each agent  $i$ , maximizing utility (3.5) with respect to  $b_i$  — precisely prescribes the updating process (3.1) as long as importance weights  $W_{ij}$  are such that  $\mathbf{W}$  is row-stochastic.<sup>20</sup> One interpretation of the utility functions (3.5) is that agent  $i$  has disutility from making different opinion choices than neighbors he follows and has disutility from not deviating from, in the manner described by deviation function  $D$ , the opinion choices of neighbors he opposes. We note that when  $F_{ij} = F$  for all  $i, j \in [n]$ , then each consensus  $(c, \dots, c)^\top \in S^n$  is a Nash equilibrium of the normal form game  $([n], S^n, u_i(\cdot))$  because, in this situation, all agents' utility functions are at a maximum. When  $F_{ij} = D$  for some agents  $i, j \in [n]$ , but deviation function  $D$  has a fixed-point,  $D(x_0) = x_0$  for some  $x_0 \in S$ , then consensus  $(x_0, \dots, x_0)^\top$  is a Nash equilibrium of (3.5) for the same reason. Below, in Sections 5 and 6, we show that such equilibria are the only consensus Nash equilibria in this situation and we provide sufficient conditions when, in the analytically tractable situation where  $D(x)$  is affine-linear, opinion updating process (3.3) leads agents precisely to such a consensus Nash equilibrium. We note that since, by our discussion, the operator  $\mathbf{W} \circ \mathbf{F}$  in opinion updating process (3.2) retrieves best responses of agents, under utility functions  $u_i(\cdot)$  as in (3.5), to an opinion profile  $\mathbf{b}(t)$ , the fixed points of  $\mathbf{W} \circ \mathbf{F}$  — that is, the point  $\mathbf{b}$  such that  $(\mathbf{W} \circ \mathbf{F})(\mathbf{b}) = \mathbf{b}$  — are, by definition of a Nash equilibrium, the Nash equilibria of the normal form games  $([n], S^n, u_i(\cdot))$ , since, for each such a fixed-point, all players in  $[n]$  play best responses to the other players' actions (opinions). In the subsequent sections, we pursue the task of finding  $(\mathbf{W} \circ \mathbf{F})$ 's fixed points in more detail.

In the discrete case, we may think of agents having utility functions

$$\begin{aligned} u_i(\mathbf{b}) &= - \sum_{j=1}^n W_{ij} (1 - \mathbf{1}(F_{ij}(b_j), b_i)) \\ &= - \sum_{j:i \text{ follows } j} W_{ij} (1 - \mathbf{1}(b_j, b_i)) - \sum_{j:i \text{ opposes } j} W_{ij} (1 - \mathbf{1}(D(b_j), b_i)) \\ &= - \sum_{j:i \text{ follows } j, b_i \neq b_j} W_{ij} - \sum_{j:i \text{ opposes } j, b_i \neq D(b_j)} W_{ij}, \end{aligned} \quad (3.6)$$

where, again, we let  $\mathbf{1}(r, t) = 1$  if  $r = t$  and zero otherwise. Namely, in case of utility functions of the form (3.6), a best response of agent  $i$  with respect to the opinion vector  $\mathbf{b} = (b_1, \dots, b_n)^\top$  is to choose the weighted majority opinion of his neighbors' (possibly inverted) opinion signals.

### Boundedly rational Bayesian learning

In another interpretation — which, however, requires that there exist truths  $\mu$  for topics  $X$ , which we do not assume in our modeling — for the continuous model, as outlined by DeMarzo, Vayanos, and Zwiebel (2003) [27] for the situation when  $F_{ij}$  is the identity function for all agents  $i, j \in [n]$ , the updating process (3.1) may be rationalized as follows.<sup>21</sup> Agents initially receive noisy signals  $b_i(0) = \mu + \epsilon_i$  about issue  $X$ , where  $\epsilon_i$  is a noise term with expectation zero and where  $\mu$  is the true value of  $X$ . Then, agents

<sup>20</sup>Moreover, this presupposes that  $W_{ii} = 0$ .

<sup>21</sup>We follow here the argumentation structure given in Golub and Jackson (2012) [42].

$i = 1, \dots, n$  hear the opinions of the agents with whom they are connected, assigning subjective precisions (inverse of variance)  $\pi_{ij}$  to agents  $j$ ; if  $i$  is not connected with  $j$ , then agent  $i$  assigns precision  $\pi_{ij} = 0$ . In the case where the signals are normally distributed, Bayesian updating from independent signals at  $t = 1$  implies the updating rule (3.1) with  $W_{ij} = \frac{\pi_{ij}}{\sum_{k=1}^n \pi_{ik}}$ , since this weight structure yields the minimum variance convex combination of  $n$  independent normally distributed random variables, each with mean  $\mu$ . As agents may not be connected with all other agents, e.g., due to exogenous constraints or costs, they will generally wish to continue to communicate and update based on their neighbors' evolving beliefs, since this allows them to incorporate indirect information.<sup>22</sup> The behavioral aspect of this model concerns updating after time period  $t = 1$ . A Bayesian agent would adjust the updating procedure to account for the possible duplication of information and for the "cross-contamination" of his neighbors signals. In contrast, continuing to use the updating rule (3.1), which treats all information as 'new', can be seen as a boundedly rational heuristic that addresses the complexity involved in fully Bayesian updating and that is in accordance with the psychological condition DeMarzo, Vayanos and Zwiebel (2003) [27] refer to as 'persuasion bias', the failure to adjust properly for information repetition.

Allowing  $F_{ij}$  to take a 'deviation form' may then require an additional behavioral assumption, namely, that the 'true signals' to be considered by agents  $i = 1, \dots, n$  in updating are not  $b_j(t)$  but, instead,  $F_{ij}(b_j(t))$ . In other words, this would mean to assume, from the perspective of agent  $i$ , that agent  $j$  receives initial signal  $b_j(0)$  such that  $F_{ij}(b_j(0))$  has the form  $\mu + \epsilon_j$  (which might be plausible, e.g., when agent  $j$  is a liar or when his signal has been 'corrupted' or 'distorted', by whatever mechanism, as perceived by agent  $i$ ); subsequently, sticking to the same updating rule and weighting structure would correspond, again, to the discussed bounded rationality heuristic.

### Aggregation theory

A third motivation for the continuous DeGrootian updating model (3.1), initially again for  $F_{ij} = F$  for all  $i, j \in [n]$ , revolves around theoretical results from economic aggregation theory. We briefly sketch the essence of the argument here. Aggregation theory is concerned with the problem of finding a function  $G$  that maps 'opinions' of  $n$  experts on  $m$  topics (so far, we have considered a single topic  $X$ ) to a 'joint' set of opinions on the  $m$  topics. Importantly, the opinions on the  $m$  topics must obey a 'funding restriction' such as probabilistic coherence: for example, the  $m$  topics might be  $m$  states of the world and the opinions might be probability assignments to the  $m$  states, one set of assignments for each expert, such that the sum of the probabilities, per expert, over all states, is one (the funding restriction). The purpose of the aggregator  $G$  is then, in this case, to assign a probability distribution over  $m$  states to each valid  $n \times m$  matrix of probability distributions that captures the opinions of the  $n$  experts on the  $m$  states. Classic theorems from aggregation theory (see, for example, [60, 58, 73, 29, 49]) then state that if  $G$  satisfies two apparently very intuitive and mild criteria, independence and unanimity,  $G$  is a *convex combination* of the opinions of the  $n$  experts. Unanimity means that if all experts agree on one topic,  $G$  must preserve this consensus. Independence (of irrelevant alternatives) means that  $G_j$ , the  $j$ -th component of  $G$ , depends only on the opinions of the  $n$  experts on the  $j$ -th topic.

Thus, by the classical theorems mentioned, an apparently 'rational' way to aggregate the opinions of the  $n$  agents would be by means of weighted averages, as in the updating process (3.1). In fact, this (or similar) argumentation has been extensively made use of by Lehrer and Wagner [78, 58, 57] in the 1970s and 1980s as a justification for DeGroot-like opinion formation processes.<sup>23</sup> As in the justification based on boundedly rational Bayesian learning, allowing a deviation function may then be just an additional behavioral assumption about which signals (e.g.,  $b_j$  or  $D(b_j)$ ) are to be aggregated in a rational way.<sup>24</sup>

<sup>22</sup>Such indirect information may also be captured even when  $i$  is in fact connected with *all* other agents  $j$ , due to the different precisions that agents may assign other agents.

<sup>23</sup>However, the argumentation appears problematic from at least two perspectives. First, the named theorems hold only for  $m \geq 3$ . Secondly, why agents should stick, repeatedly, to the same weighted averaging updating rule is unexplained, particularly, since, as outlined before, this implies that they double count information.

<sup>24</sup>This argumentation, if valid, could then also be used to justify why agents should take a weighted *arithmetic* average of the beliefs of all other agents, rather than some different 'mean function' such as the harmonic, geometric, or quadratic mean. In fact, the mathematics literature has provided an infinitude of different mean functions (see, for example, Hardy, Littlewood, and Pólya (1934) [45]), and, for instance, Krause and Hegselmann and Krause [55, 47] discuss DeGroot-like updating processes with a variety of different weighted averages.

### 3.3 Deviation functions

As indicated, the case when  $i$  follows  $j$  is naturally modeled by letting  $F_{ij}$  be the identity,  $F_{ij}(x) = x$  for all  $x \in S$ , that is,  $i$  precisely follows the signal sent by  $j$ . Contrarily, the choice of deviation function  $D$  that models opposition has been left unspecified so far. To define a few workable candidates, we first consider the discrete case when  $S$  is the finite set  $S = \{A_1, \dots, A_K\}$ , for  $K \geq 1$ . If  $S$  is an arbitrary (finite) set, then any choice of  $D : S \rightarrow S$  (which is not the identity function) seems equally plausible — as mentioned, there are  $|S|! - 1$  possibilities to specify  $D$  — so we consider the situation when the elements in  $S$  have some *meaning*, at least in a relative sense, as when  $S$  is *linearly ordered* by some ordering relationship  $<$  on  $S$  such that, without loss of generality,  $A_1 < A_2 < \dots < A_K$ .

**Example 3.1.** Of course, when  $S$  is a finite subset of the real numbers (or integers), the usual  $<$  relation on the reals (or integers) constitutes a natural linear order. Further interesting examples might arise in the case when  $S$ , e.g., consists of (discrete) probabilistic propositions about likelihoods of events such as when  $S = \{\text{“impossible”}, \text{“unlikely”}, \text{“possible”}, \text{“likely”}, \text{“certain”}\}$ , which may be thought of as probabilistically ordered, i.e., “impossible”  $<$  “unlikely”, etc. Other such examples might include:

- $S = \{\text{“disagree”}, \text{“agree”}\}$ , which may be thought of as being ordered by a ‘consent’ relationship,
- $S = \{\text{“false”}, \text{“true”}\}$ , which may be thought of as being ordered by a ‘trueness’ relationship,
- $S = \{\text{“hate”}, \text{“dislike”}, \text{“neutral”}, \text{“like”}, \text{“love”}\}$ , which may be thought of as being ordered by a ‘emotional attitude’ relationship,
- $S = \{\text{“strong reject”}, \text{“reject”}, \text{“borderline”}, \text{“accept”}, \text{“strong accept”}\}$ , which may be thought of as being ordered by a ‘degree of acceptedness’ (at journals, conferences, etc.) relationship, etc.

If  $S$  is so ordered (by  $<$ ), we consider two natural, as we think, examples of deviation functions. The first one we call ‘hard opposition’: it is the deviation function that maps opinions to the ‘extreme’ opinions  $A_1$ , the smallest element of  $S$ , and  $A_K$ , the largest element of  $S$ .

**Example 3.2** (Hard opposition). *Hard opposition* models that an agent  $i$  maps another agent  $j$ ’s opinion to one of the two ‘extreme’ opinions  $A_1$  and  $A_K$ , depending on the ‘location’ of  $j$ ’s opinion. Formally, we assume that there exists  $\bar{A} \in S$  such that  $D(x) = A_1$  if  $\bar{A} < x$ , for  $x \in S$ , and  $D(x) = A_K$  if  $x < \bar{A}$ . When  $x = \bar{A}$ , we either assume that  $D(x) = x$  ( $D$  has a fixed point) or, conventionally,  $D(x) = A_K$  or  $D(x) = A_1$ . For our above specified choices of  $S$ , this might mean, for instance,

- for  $S = \{\text{“disagree”}, \text{“agree”}\}$ :  $D(\text{“agree”}) = \text{“disagree”}$ ,  $D(\text{“disagree”}) = \text{“agree”}$ , with  $\bar{A} = \text{“agree”}$ ,
- for  $S = \{\text{“hate”}, \text{“dislike”}, \text{“neutral”}, \text{“like”}, \text{“love”}\}$ :  $D(x) = \text{“love”}$  whenever  $x = \text{“hate”}, \text{“dislike”}$  and  $D(x) = \text{“hate”}$  whenever  $x = \text{“like”}, \text{“love”}$ . For  $\bar{A} = \text{“neutral”}$ , we might let  $D(\text{“neutral”}) = \text{“neutral”}$ ,

and so on.

Our next ‘natural’ choice of deviation function, we call “soft opposition” (or ‘tit for tat’ opposition). It models the situation when “more moderate” opinions are mapped to “more moderate” inverted opinions; equivalently, more extreme opinions are mapped to more extreme opinions on the ‘other end’ of the opinion spectrum.

**Example 3.3** (Soft opposition). By *soft opposition*, we mean a deviation function where there is a ‘moderate’ center opinion  $\bar{A}$  such that  $D$  maps opinions  $x$  more to the extremes (on the opposite site of the opinion spectrum, whereby  $\bar{A}$  is the focal point) the more distant they are to  $\bar{A}$ . For instance, we might have  $A_1 < A_2 < \dots < A_k < \bar{A} < A_{k+1} < \dots < A_K$  with  $D(A_i) = A_{K-i+1}$  and  $D(A_{K-i+1}) = A_i$ , for  $i = 1, \dots, k$ , and  $D(\bar{A}) = \bar{A}$ . If  $S$  has even cardinality, we may think of  $\bar{A}$ , slightly imprecise, as an ‘imagined’ additional element of  $S$  for which  $D$  is undefined.

For our above examples, this might mean,

- for  $S = \{\text{“disagree”}, \text{“agree”}\}$ :  $D(\text{“agree”}) = \text{“disagree”}$ ,  $D(\text{“disagree”}) = \text{“agree”}$ , with  $\bar{A}$  an ‘imagined’ focal point between “disagree” and “agree” (soft opposition and hard opposition may coincide if  $S$  has only two elements),

- for  $S = \{\text{“hate”}, \text{“dislike”}, \text{“neutral”}, \text{“like”}, \text{“love”}\}$ :  $D(\text{“hate”}) = \text{“love”}$ ,  $D(\text{“dislike”}) = \text{“like”}$ ,  $D(\text{“neutral”}) = \text{“neutral”}$ ,  $D(\text{“like”}) = \text{“dislike”}$ ,  $D(\text{“love”}) = \text{“hate”}$ , with  $\bar{A} = \text{“neutral”}$ .

In Figure 1, we schematically sketch soft and hard opposition in the discrete case. In the continuous

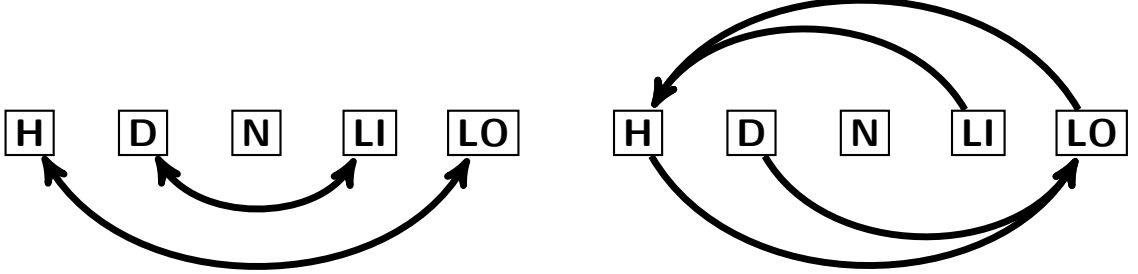

Figure 1: Schematic illustration for soft (left) and hard (right) opposition on the set  $S = \{\text{“hate”}, \text{“dislike”}, \text{“neutral”}, \text{“like”}, \text{“love”}\}$ . Elements  $x \in S$  are abbreviated with initial letters.

case, when  $S$  is a convex subset of the real line that is in addition closed and bounded — that is,  $S$  is an interval  $[\alpha, \beta]$ , with  $\alpha, \beta \in \mathbb{R}$  — hard opposition naturally corresponds to solving the maximization problem, for all  $x$  different from  $\frac{\alpha+\beta}{2}$ ,

$$D(x) = \operatorname{argmax}_{b \in [\alpha, \beta]} |b - x|, \quad (3.7)$$

which has a unique solution for all such  $x$ , namely,  $\alpha$  and  $\beta$ , respectively. Thus, in the continuous case, hard opposition can be thought of as arising from the principle to maximize disagreement, in an *absolute distance sense*, with an agent that is opposed. Slightly problematic, from an analytical perspective, would be here that  $D$  has, in the situation of hard opposition, a discontinuity at  $\frac{\alpha+\beta}{2}$ , no matter the definition of  $D$  for this point, which potentially makes it less attractive as a modeling choice.

Soft opposition would in the continuous case of  $S = [\alpha, \beta]$  naturally correspond to the operation,

$$D(x) = \alpha + \beta - x. \quad (3.8)$$

which defines a continuous function and has a fixed point at  $\frac{\alpha+\beta}{2}$ . Moreover, in the case of  $S = [0, 1]$ , when  $S$  is the unit interval, soft opposition may be stochastically interpreted as probabilistic inversion, which can be thought of as disagreeing, with agent  $j$ , on all truth conditions for issue  $X$ , so that it is apparently also an instance of the tenet to maximize disagreement. In the case of  $S = [-\beta, \beta]$ , soft opposition has the simple functional form  $D(x) = -x$ , which makes it an apparently very convenient and tractable candidate of a deviation function.

We graphically illustrate deviation choices (3.7), together with some variations, and (3.8) in Figure 2, for  $S = [-1, 1]$ .

## 4 Definitions, preliminaries and notation

We now define a couple of important concepts to be used in the remainder of this work. We start with definitions relating to deviation functions and to the operator  $\mathbf{W} \circ \mathbf{F}$ . Throughout, we let  $S$  be an arbitrary non-empty set, the *opinion spectrum* or *opinion space*.

**Definition 4.1.** Let  $Y$  be an arbitrary set and let  $Q$  be an arbitrary function  $Q : Y \rightarrow Y$ . By  $\operatorname{Fix}(Q)$ , we denote the set of fixed points of  $Q$ , that is, the set of all  $x \in Y$  such that  $Q(x) = x$ .

Note that, in this work, we only consider  $Y = S$  and  $Y = S^n$ . Our next definition simply restates what a deviation function is.

**Definition 4.2.** We call a function  $D : S \rightarrow S$  *deviation function* (or *opposition function*) if  $\operatorname{Fix}(D) \subsetneq S$ , that is, if there exist elements  $x \in S$  such that  $D(x) \neq x$ .

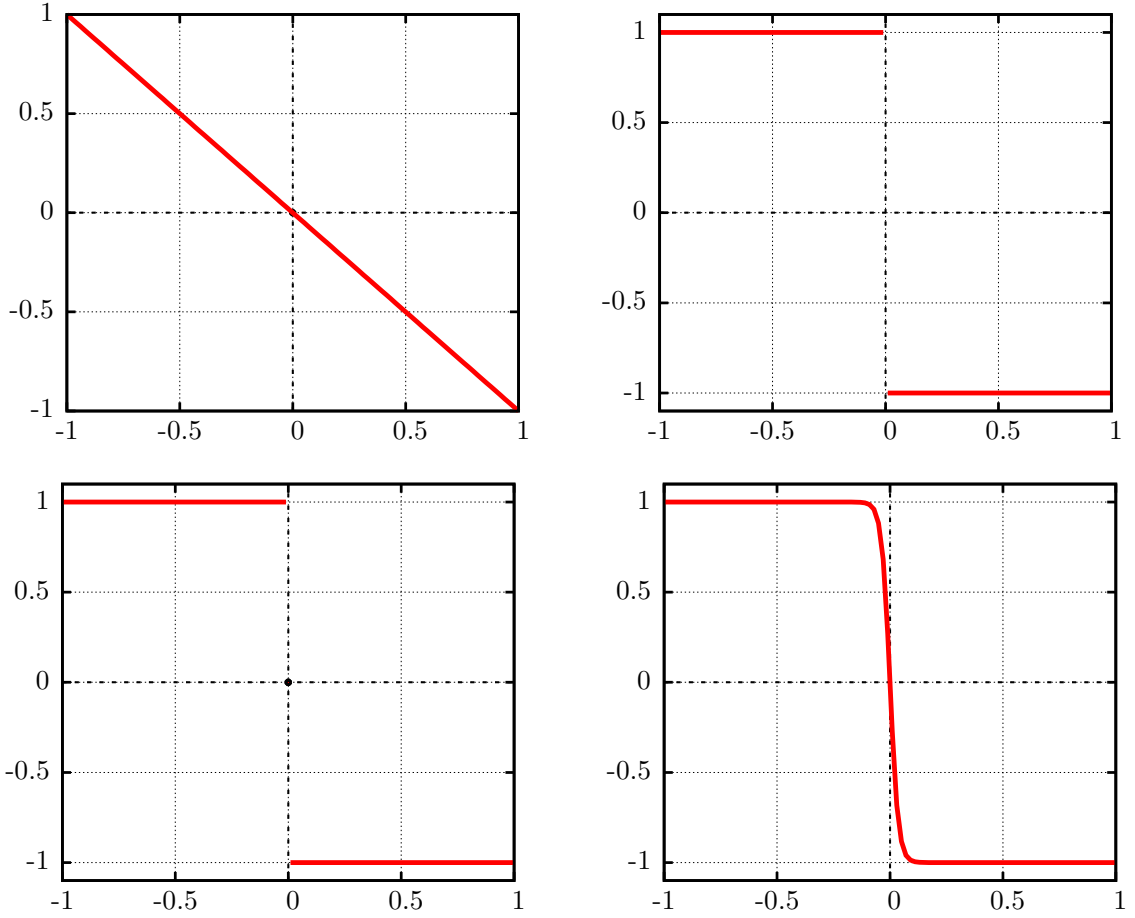

Figure 2: Deviation functions on  $S = [\alpha, \beta] = [-1, 1]$ . Top left: Soft opposition  $D(x) = \alpha + \beta - x = -x$  on  $S$ . Top right: Hard opposition on  $S$ . Bottom left: Hard opposition with fixed-point  $D(0) = 0$ . Bottom right: A continuous extension of bottom left.

The points which  $D$  fixes, we call ‘neutral opinions’. In an economic interpretation, neutral opinions may be thought of as opinions that ‘allow no opposite’ or that are ‘undisputable’. For instance, if  $S$  were the set {“Yes”, “Nay”, “Undecided”}, then probably “Undecided” were a good candidate of a neutral opinion. If  $D$  admits no neutral opinions, we call  $D$  ‘radical’.

**Definition 4.3.** We call an opinion  $x \in S$  for which  $D(x) = x$  *neutral*.

**Definition 4.4.** If  $\text{Fix}(D) = \emptyset$ , we call  $D$  *radical*.

If two opinions are ‘opposites’ of each other, from the perspective of deviation function  $D$ , we call them ‘opposing viewpoints’.

**Definition 4.5.** We call  $a, b \in S$  *opposing viewpoints* if  $D(a) = b$  and  $D(b) = a$ .

Next, we define mathematical convergence of opinion updating process (3.3). Our definition applies both to the discrete and the continuous setup. Semantically, convergence means that each agent tends toward a ‘limiting opinion’ — rather than, e.g., changing his mind indefinitely — under repeated opinion updates as described by the updating processes in Section 3.

**Definition 4.6.** We say that  $\mathbf{W} \circ \mathbf{F}$  is *convergent for opinion vector*  $\mathbf{b}(0) \in S^n$  if  $\lim_{t \rightarrow \infty} (\mathbf{W} \circ \mathbf{F})^t \mathbf{b}(0)$  exists. Moreover, we say that  $\mathbf{W} \circ \mathbf{F}$  *induces a consensus for opinion vector*  $\mathbf{b}(0)$  if  $\mathbf{W} \circ \mathbf{F}$  is convergent for  $\mathbf{b}(0)$  and  $\lim_{t \rightarrow \infty} (\mathbf{W} \circ \mathbf{F})^t \mathbf{b}(0)$  is a *consensus*, that is, a vector  $\mathbf{c} \in S^n$  with all entries identical.

**Definition 4.7.** We say that  $\mathbf{W} \circ \mathbf{F}$  is *convergent* if  $\mathbf{W} \circ \mathbf{F}$  is convergent for *all* initial opinion vectors  $\mathbf{b}(0) \in S^n$ . Moreover, we say that  $\mathbf{W} \circ \mathbf{F}$  *induces a consensus* if  $\mathbf{W} \circ \mathbf{F}$  induces a consensus for *all* initial opinion vectors  $\mathbf{b}(0) \in S^n$ .

**Remark 4.1.** In the discrete case, when  $S$  is a finite set and operation  $(\mathbf{W} \circ \mathbf{F})\mathbf{b}$  refers to a majority update operation, convergence of  $\mathbf{W} \circ \mathbf{F}$  — if indeed it obtains — obtains after a finite amount of time. This is because the sequence  $(\mathbf{b}(t))_{t \in \mathbb{N}}$ , with  $\mathbf{b}(t) = (\mathbf{W} \circ \mathbf{F})^t \mathbf{b} \in S^n$ , cannot consist of an infinite number of *different* opinion vectors in this case and must, in fact, repeat after time  $|S|^n$  at the latest. In other words, if  $S$  is finite,  $\mathbf{b}(t_0) = \mathbf{b}(s_0)$ , for some distinct time points  $t_0$  and  $s_0$ . Let  $\bar{s}$  be the smallest time point such that  $\mathbf{b}(\bar{s}) = \mathbf{b}(\bar{t})$ , for some  $\bar{t} > \bar{s}$ . Then, obviously, if and only if  $\bar{t} = \bar{s} + 1$ ,  $\mathbf{W} \circ \mathbf{F}$  is convergent (for  $\mathbf{b}(0)$ ); otherwise,  $(\mathbf{W} \circ \mathbf{F})^t \mathbf{b}(0)$  ‘cycles’.

**Remark 4.2.** We also note that, if  $\mathbf{W} \circ \mathbf{F}$  is convergent, then  $\mathbf{b}(\infty) := \lim_{t \rightarrow \infty} (\mathbf{W} \circ \mathbf{F})^t \mathbf{b}(0)$  is a fixed-point of  $\mathbf{W} \circ \mathbf{F}$  as long as  $\mathbf{W} \circ \mathbf{F}$  is a continuous operator:

$$(\mathbf{W} \circ \mathbf{F})\mathbf{b}(\infty) = (\mathbf{W} \circ \mathbf{F}) \lim_{t \rightarrow \infty} (\mathbf{W} \circ \mathbf{F})^t \mathbf{b}(0) = \lim_{t \rightarrow \infty} (\mathbf{W} \circ \mathbf{F})^{t+1} \mathbf{b}(0) = \mathbf{b}(\infty).$$

Continuity, in turn, depends on the matrix  $\mathbf{F}$  and, in particular, on  $D(x)$  (since, certainly,  $F(x) = x$  is a continuous function). If  $S$  is finite and  $\mathbf{W} \circ \mathbf{F}$  is convergent (for  $\mathbf{b}(0)$ ), then  $\mathbf{b}(\infty)$  is a fixed-point of  $\mathbf{W} \circ \mathbf{F}$  no matter the specification of  $\mathbf{F}$ , by Remark 4.1. Fixed-points of  $\mathbf{W} \circ \mathbf{F}$  are interesting, for instance, because they constitute Nash equilibria of the coordination games given in Section 3 as justifications of our DeGroot learning model.

As a short-hand for subsequent sections, we introduce the following convenient notations, before proceeding to more conceptual definitions again.

**Definition 4.8.** Let  $A \subseteq [n]$  be a subset of the set of agents and let  $i \in [n]$  be a particular agent. We denote by  $W_{i,A} := \sum_{j \in A} W_{ij}$  the total weight mass  $i$  assigns to group  $A$ .

**Definition 4.9.** For  $i = 1, \dots, n$ , we denote by  $\mathcal{O}_i$  the set of agents that agent  $i$  opposes. Formally,  $\mathcal{O}_i = \{j \in [n] \mid F_{ij} = D\}$ . We also call  $\mathcal{O}_i$  “ $i$ ’s opposed set/group of agents” or “ $i$ ’s *outgroup*”. By  $\mathcal{F}_i$ , we denote the set of agents that  $i$  follows,  $\mathcal{F}_i = \{j \in [n] \mid F_{ij} = F\}$ . We also call  $\mathcal{F}_i$  “ $i$ ’s *ingroup*”.

Clearly, it holds that  $\mathcal{O}_i \cap \mathcal{F}_i = \emptyset$  and  $\mathcal{O}_i \cup \mathcal{F}_i = [n]$  for all  $i \in [n]$ .

Next, we formally introduce *networks* because of their relationship to our ‘matrix’ operators  $\mathbf{W} \circ \mathbf{F}$ .

**Definition 4.10** ((Weighted) Network). A *network*, or *graph*, is a tuple  $G = (V, E)$  where  $V$  is a finite set and  $E \subseteq V \times V = \{(u, v) \mid u \in V, v \in V\}$ . We call  $V$  the *vertices* or *nodes* of graph  $G$  and  $E$  the *edges* or *links* of  $G$ . Moreover, we call the network  $G$  *weighted* if there exist *weights*  $w_{uv}$  for each edge  $(u, v) \in E$ .<sup>25</sup>

We note that the edges of a network  $G$  represent a relationship between nodes (agents, in our case), namely, whether or not two nodes are connected; weights generalize this binary relationship. In a *multigraph*, instead of having only one link type between nodes, there may exist multiple link types.

**Definition 4.11** ((Weighted) Multigraph). A *multigraph* is a tuple  $G = (V, \mathcal{E})$  where  $V$  is a finite set and  $\mathcal{E} = (E, m)$  is a multiset of ordered pairs of nodes, that is, with each edge  $(u, v) \in E$  is associated its cardinality  $m((u, v)) \in \{1, 2, 3, \dots\}$  (the number of link types between nodes  $u$  and  $v$ ). We call the multigraph  $G$  *weighted* if with each of the  $m((u, v))$  edge types of edge  $(u, v)$  is associated a ‘weight’  $w_{uv}^k$ , for  $k = 1, \dots, m((u, v))$ .

Now, the operator  $\mathbf{W} \circ \mathbf{F}$  of opinion updating process (3.2) can be thought of as representing a weighted multigraph  $G = (V, \mathcal{E})$ , where  $V = [n] = \{1, \dots, n\}$  is the set of agent nodes;  $\mathcal{E} = (E, m)$ , where  $E$  denotes the social neighborhoods of agents (who is connected with whom),  $m((u, v)) = 2$  for all  $(u, v) \in E$  and  $w_{uv}^1 = W_{uv}$  and  $w_{uv}^2 = F_{uv}$ . We let  $(u, v) \in E$  if and only if  $W_{uv} > 0$ . For an illustration,

see Figure 3, where  $\mathbf{W} = \begin{pmatrix} 0 & 1 & 0 & 0 \\ 0 & 0 & 1 & 0 \\ 1/2 & 0 & 0 & 1/2 \\ 0 & 0 & 0 & 1 \end{pmatrix}$  and  $\mathbf{F} = \begin{pmatrix} F & F & F & F \\ F & F & F & F \\ F & F & F & D \\ F & F & F & F \end{pmatrix}$ .

<sup>25</sup>Weights may typically be real numbers but, initially, we more generally allow them to be arbitrary mathematical objects.

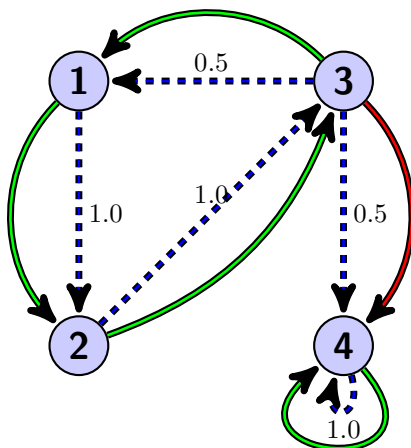

Figure 3: Multigraph as a representation of an operator  $\mathbf{W} \circ \mathbf{F}$ . Dashed blue links denote weights; green and red links denote following and deviating, respectively.

In the continuous DeGroot model, that is, when  $\mathbf{F}$  is the  $n \times n$  matrix of identity functions, as is well known, the concepts of graphs are useful when discussing the convergence of operators  $\mathbf{W} \circ \mathbf{F}$ . Namely, in this case, updating process (3.3) corresponds to a power updating process with a *nonnegative* matrix  $\mathbf{W} \circ \mathbf{F} = \mathbf{W}$  (each entry is nonnegative). This situation has been extensively analyzed by the German mathematicians Oskar Perron (1880-1975) and Georg Frobenius (1849-1917) around the turn of the 19th century, and also later in the field of *Markov chain theory*. Although the main results are well-known and have, e.g., been summarized both in the mathematics literature as well as in economics contexts (prominently, e.g., in Golub and Jackson (2010) [41]), we very briefly indicate some of them here as well, both in order to introduce useful terminology and to sketch some basic insights about results on the standard DeGroot model. To restate the results, we first need to define a few properties of networks, which we cite from Golub and Jackson (2010) [41].

**Definition 4.12.** A *walk* in a network  $G = (V, E)$  is a sequence of nodes  $i_1, i_2, \dots, i_K$ , not necessarily distinct, such that  $(i_k, i_{k+1}) \in E$  for all  $k \in \{1, \dots, K-1\}$ .

A *path* is a walk consisting of distinct nodes.

A *cycle* is a walk  $i_1, \dots, i_K$  such that  $i_1 = i_K$ . The *length* of cycle  $i_1, \dots, i_K$  is defined to be  $K-1$ . A cycle is called *simple* if the only node appearing twice is  $i_1 = i_K$ .

**Definition 4.13.** The graph  $G = (V, E)$  is said to be *strongly connected* if there is a path in  $G$  from any node to any other node.

**Definition 4.14.** The graph  $G = (V, E)$  is said to be *aperiodic* if the greatest common divisor of the lengths of its simple cycles is 1. We call  $G$  *periodic* if it is not aperiodic.

**Remark 4.3.** We remark that we generally use the same terminology — ‘strongly connected’, ‘aperiodic’, etc. — whether we speak of multigraphs or ordinary graphs. In the case of multigraphs, when using the mentioned terminology, we refer to the ordinary graphs  $G = (V, E)$  underlying the multigraphs  $G = (V, \mathcal{E} = (E, m))$ . Moreover, since we treat operators  $\mathbf{W} \circ \mathbf{F}$  and the corresponding multigraphs as ‘isomorphic’, or, simply, identical, we may also speak of  $\mathbf{W} \circ \mathbf{F}$  as ‘strongly connected’, etc.

Now, we are ready to state one of the main theorems for the DeGroot updates (3.3) in the non-opposition case. We assume that  $\mathbf{W}$  is row-stochastic.

**Theorem 4.1.** Consider the opinion updating process (3.3) with  $F_{ij} = F$  for all  $i, j \in [n]$ , where  $F$  is the identity function. Let the multigraph corresponding to the operator  $\mathbf{W} \circ \mathbf{F} = \mathbf{W}$  — an ordinary graph — be strongly connected and aperiodic. Then  $\mathbf{W} \circ \mathbf{F}$  is convergent and induces a consensus.

Our first example is a negative illustration of Theorem 4.1, i.e., it illustrates that if the assumptions of the theorem are not satisfied, then its consequences need not be satisfied as well. It is the classic example of a periodic network where agents’ opinions oscillate.

**Example 4.1.** Let  $n = 2$  and let  $\mathbf{W}$  and  $\mathbf{F}$  be the following matrices,

$$\mathbf{W} = \begin{pmatrix} 0 & 1 \\ 1 & 0 \end{pmatrix}, \quad \mathbf{F} = \begin{pmatrix} F & F \\ F & F \end{pmatrix},$$

where  $F$  is the identity function. The directed graph corresponding to  $\mathbf{W} \circ \mathbf{F}$  is shown in Figure 4. Obviously, this graph is periodic since all cycles have length 2. Moreover, with notation as in Equations (3.2) and (3.3), we have  $\mathbf{W} \circ \mathbf{F} = \mathbf{W}$  and

$$\mathbf{W}^t = \begin{cases} \begin{pmatrix} 0 & 1 \\ 1 & 0 \end{pmatrix} & \text{if } t \text{ is odd,} \\ \begin{pmatrix} 1 & 0 \\ 0 & 1 \end{pmatrix} & \text{if } t \text{ is even.} \end{cases}$$

Hence, matrix  $\mathbf{W}$  does not converge.

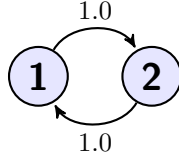

Figure 4: The graph corresponding to Example 4.1. Since  $F_{ij} = F$  for all  $i, j \in [n]$ , we draw the graph as an ordinary graph, rather than as a multigraph.

More intricate necessary and sufficient conditions for convergence and consensus (than given in Theorem 4.1) in the non-opposition setup are, for instance, presented in Golub and Jackson (2010) [41], and references therein. Hence, as far as strong results for the non-opposition case have already been established, in the current work, we generally analyze the situation when  $\mathbf{W} \circ \mathbf{F}$  is a ‘proper’ multigraph, that is, where  $F_{ij} = D$  for some agents  $i$  and  $j$ , so that some agents oppose some others.

**Example 4.2.** To see, however, first, that Theorem 4.1 may be false in the discrete weighted majority voter model, consider  $S = \{A, B\}$  and  $n = 3$ . Let agents adopt the majority opinion among their neighbors and, in case of a tie, adopt opinion, say,  $B$ . Let  $\mathbf{W}$  and  $\mathbf{F}$  be the matrices

$$\mathbf{W} = \begin{pmatrix} \frac{1}{2} & 0 & \frac{1}{2} \\ 0 & \frac{1}{2} & \frac{1}{2} \\ \frac{1}{3} & \frac{1}{3} & \frac{1}{3} \end{pmatrix}, \quad \mathbf{F} = \begin{pmatrix} F & F & F \\ F & F & F \\ F & F & F \end{pmatrix}.$$

In other words, everyone follows everyone else; agent 1’s neighborhood consists of agents 1 and 3, each of whom he weighs equally; and so on. Clearly,  $\mathbf{W} \circ \mathbf{F} = \mathbf{W}$  and the graph corresponding to matrix  $\mathbf{W}$  is strongly connected and aperiodic so that the assumptions of Theorem 4.1 are satisfied. If agents start with initial opinions, say,  $(A, A, B)^\top$ , then the sequence of opinion vectors generated by updating process (3.2) reads as:

$$\begin{pmatrix} A \\ A \\ B \end{pmatrix} \mapsto_{\mathbf{W} \circ \mathbf{F}} \begin{pmatrix} B \\ B \\ A \end{pmatrix} \mapsto_{\mathbf{W} \circ \mathbf{F}} \begin{pmatrix} B \\ B \\ B \end{pmatrix} \mapsto_{\mathbf{W} \circ \mathbf{F}} \begin{pmatrix} B \\ B \\ B \end{pmatrix} \mapsto_{\mathbf{W} \circ \mathbf{F}} \dots$$

which is in accordance with Theorem 4.1. If, in contrast, agents start with initial opinions, say,  $(A, B, A)^\top$ , then the sequence of opinion vectors generated by updating process (3.2) reads as:

$$\begin{pmatrix} A \\ B \\ A \end{pmatrix} \mapsto_{\mathbf{W} \circ \mathbf{F}} \begin{pmatrix} A \\ B \\ A \end{pmatrix} \mapsto_{\mathbf{W} \circ \mathbf{F}} \dots$$

which, consequently, does not lead to a consensus.

In the next sections, we discuss the discrete model in more depth. Now, we briefly sketch some more aspects, including examples, relating to the continuous DeGroot model where agents update by taking weighted arithmetic averages of other agents' previous opinion signals. In this context, we first note that important fixed-point theorems from mathematics and economics allow us to make statements with regard to the behavior of opinion updating process (3.3) in the continuous case. These results may be applied in case operator  $\mathbf{W} \circ \mathbf{F}$  satisfies certain conditions, as we outline.

**Definition 4.15.** Let  $(Y, \|\cdot\|)$  be a metric space. A function  $f : Y \rightarrow Y$  is called a *contraction mapping* on  $Y$  if there exists  $\gamma \in [0, 1)$  such that

$$\|f(x) - f(y)\| \leq \gamma \|x - y\|,$$

for all  $x, y \in Y$ .

**Theorem 4.2** (Banach fixed point theorem). Let  $(Y, \|\cdot\|)$  be a non-empty complete metric space and  $f : Y \rightarrow Y$  a contraction mapping on  $Y$ . Then  $f$  has a unique fixed-point  $x^*$  in  $Y$ . Furthermore,  $x^*$  can be found as the limit of the sequence  $(x(t))_{t \in \mathbb{N}}$ , defined via  $x(t) = f^t(x_0)$ , for any  $x_0 \in Y$ .

The beauty of Theorem 4.2 in our context is that it tells us that opinion update process  $(\mathbf{W} \circ \mathbf{F})^t \mathbf{b}(0)$  converges, when  $\mathbf{W} \circ \mathbf{F}$  is a contraction mapping, to the unique fixed point of  $\mathbf{W} \circ \mathbf{F}$ , that is, to the unique Nash equilibrium of the coordination games outlined in Section 3. Note, however, that limiting opinions are in this case independent of initial opinions, as the theorem tells.

Interestingly, in case  $\mathbf{W} \circ \mathbf{F}$  is an affine-linear map, whether or not  $\mathbf{W} \circ \mathbf{F}$  is a contraction mapping can be fully determined via the well-known notion of eigenvalues, which we introduce now.

**Definition 4.16.** Let  $\mathbf{A} \in \mathbb{R}^{n \times n}$  be an  $n \times n$  matrix. An eigenvalue of  $\mathbf{A}$  is any value  $\lambda \in \mathbb{C}$  such that

$$\mathbf{A}\mathbf{x} = \lambda\mathbf{x}$$

for some non-zero vector  $\mathbf{x} \in \mathbb{R}^n$ . The set of distinct eigenvalues of matrix  $\mathbf{A}$  is called its *spectrum* and denoted by  $\sigma(\mathbf{A})$ . By  $\rho(\mathbf{A})$ , we denote the *spectral radius* of  $\mathbf{A}$ , the largest absolute value of all the eigenvalues of  $\mathbf{A}$ ,

$$\rho(\mathbf{A}) = \max\{|\lambda| \mid \lambda \in \sigma(\mathbf{A})\}.$$

Then, the following holds in case  $\mathbf{W} \circ \mathbf{F}$  allows a representation as an affine-linear operator, that is, for all  $\mathbf{x} \in S^n$ ,

$$(\mathbf{W} \circ \mathbf{F})\mathbf{x} = \mathbf{A}\mathbf{x} + \mathbf{d},$$

where  $\mathbf{A}$  is an  $n \times n$  matrix and  $\mathbf{d}$  is an  $n$ -vector.

**Theorem 4.3.** If  $\mathbf{W} \circ \mathbf{F}$  is affine-linear of the form  $(\mathbf{W} \circ \mathbf{F})\mathbf{x} = \mathbf{A}\mathbf{x} + \mathbf{d}$ , then  $\mathbf{W} \circ \mathbf{F}$  is a contraction mapping if and only if  $\rho(\mathbf{A}) < 1$ .

*Proof.* See, e.g., [http://web.mit.edu/dimitrib/www/Appendixes\\_Abstract\\_DP.pdf](http://web.mit.edu/dimitrib/www/Appendixes_Abstract_DP.pdf). □

**Remark 4.4.** If  $\mathbf{W} \circ \mathbf{F}$  is affine-linear of the form  $(\mathbf{W} \circ \mathbf{F})\mathbf{x} = \mathbf{A}\mathbf{x} + \mathbf{d}$ , then we call  $(\mathbf{A}, \mathbf{d})$  the (*affine-linear*) *representation* of  $\mathbf{W} \circ \mathbf{F}$ .

To apply Theorem 4.3 to our setup, consider the following example.

**Example 4.3.** Let  $n = 2$ ,  $S = [0, 1]$  and let

$$\mathbf{W} = \begin{pmatrix} a & b \\ c & d \end{pmatrix}, \quad \mathbf{F} = \begin{pmatrix} F & D \\ F & F \end{pmatrix},$$

where  $D$  is probabilistic inversion,  $D(x) = 1 - x$  for all  $x \in S$ , and where  $a + b = c + d = 1$ . We note that, in this situation,  $\mathbf{W} \circ \mathbf{F}$  can be written in the following form

$$(\mathbf{W} \circ \mathbf{F})\mathbf{x} = \underbrace{\begin{pmatrix} a & -b \\ c & d \end{pmatrix}}_{=: \mathbf{A}} \mathbf{x} + \begin{pmatrix} b \\ 0 \end{pmatrix},$$

as the reader can easily verify. For instance, for  $a = d = \frac{2}{3}$ ,  $b = c = \frac{1}{3}$ , the two eigenvalues of matrix  $\mathbf{A}$  are  $\frac{2}{3} \pm \frac{1}{3}i$ , both of which have absolute value  $\sqrt{\frac{5}{9}} < 1$ . Thus,  $\mathbf{W} \circ \mathbf{F}$  is a contraction mapping and opinion updating process (3.3) accordingly converges to the unique fixed-point of  $\mathbf{W} \circ \mathbf{F}$ , by the Banach fixed-point theorem, Theorem 4.2. Clearly,  $\mathbf{b} = (\frac{1}{2}, \frac{1}{2})^\top$  is a fixed-point of  $\mathbf{W} \circ \mathbf{F}$  and, by our reasoning, it is thus the unique fixed-point to which opinions converge.

**Example 4.4.** Taking the same example as Example 4.3, except for  $S$  and the deviation function, which we now specify as  $S = [-1, 1]$  and  $D(x) = -x$ , we find that  $\mathbf{b} = (0, 0)^\top$  is the unique fixed-point of  $\mathbf{W} \circ \mathbf{F}$ , in this situation, to which opinions converge. Opinion dynamics  $\mathbf{b}(t) = (\mathbf{W} \circ \mathbf{F})^t \mathbf{b}(0)$ , for  $t = 0, \dots, 50$ , are sketched in Figure 5 for two different initial opinions  $\mathbf{b}(0)$ . We generally find that agent 1's opinions oppose agent 2's opinion in that they tend toward another direction of the opinion space, but that opposition becomes weaker as agent 2's opinions become more 'neutral' (which is the essence of what 'soft opposition' means).

**Example 4.5.** Now, we consider again the same example as Example 4.3, except for  $S$  and  $D$ , which we specify as  $S = [-1, 1]$  and  $D$  is hard opposition on  $S$ ; conventionally, we let  $D(0) = 1$ . Opinion dynamics are sketched in Figure 5. Rather than convergence (to consensus) as in Examples 4.3 and 4.4, we now find fluctuating and periodic opinion dynamics. We also find a phase shift in the opinion trajectories of both agents: whenever agent 2's opinions, which 'mimic' agent 1's opinion values, increase (in the opinion space  $S$ ), agent 1's opinions decrease, and vice versa.

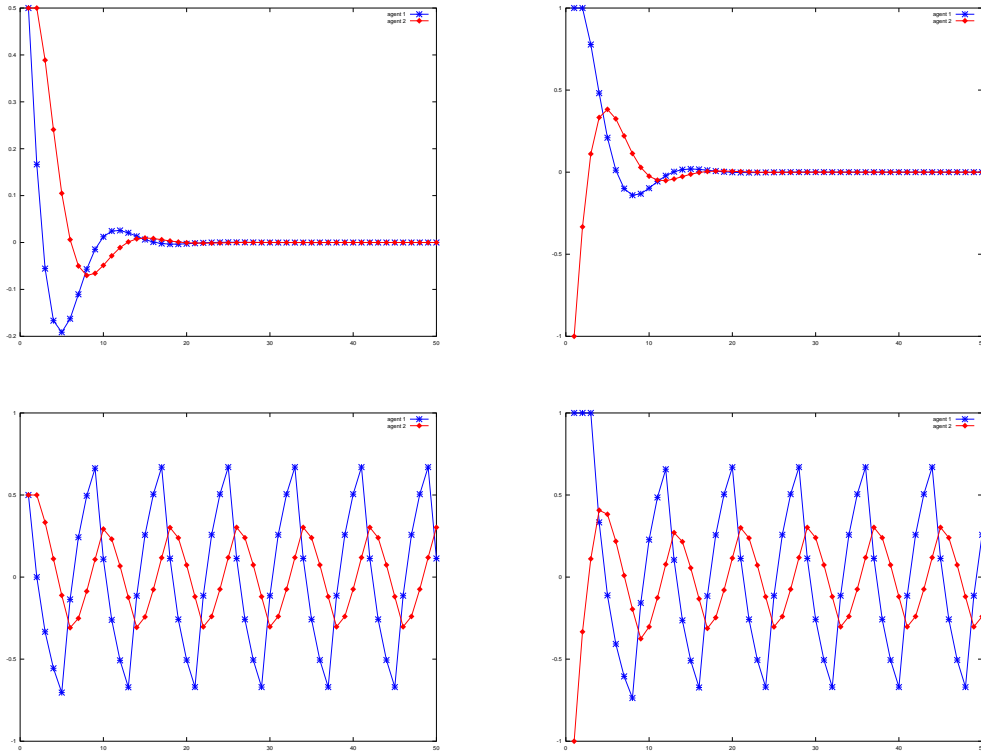

Figure 5: Opinion dynamics  $\mathbf{b}(t)$  for Examples 4.4 and 4.5 with  $a = d = \frac{2}{3}$ ,  $b = c = \frac{1}{3}$  for  $\mathbf{W}$  as in Example 4.3. Top: Example 4.4 with  $\mathbf{b}(0) = (1/2, 1/2)^\top$  and  $\mathbf{b}(0) = (1, -1)^\top$ , respectively. Bottom: Example 4.5 with  $\mathbf{b}(0) = (1/2, 1/2)^\top$  and  $\mathbf{b}(0) = (1, -1)^\top$ , respectively.

**Example 4.6.** As our final example, let  $\mathbf{W}$  be arbitrary row-stochastic and let  $\mathbf{F}$  be such that  $F_{ij} = D$  for all  $i, j \in [n]$  ('everyone opposes everyone else'). Let  $D(x) = -x$  be soft opposition on  $S = [-\beta, \beta]$ .

Then  $(\mathbf{A}, \mathbf{d}) = (-\mathbf{W}, \mathbf{0})$  such that

$$\mathbf{A}^t = \begin{cases} \mathbf{W} & \text{if } t \text{ is even,} \\ -\mathbf{W} & \text{if } t \text{ is odd.} \end{cases}$$

Consequently,  $(\mathbf{W} \circ \mathbf{F})^t \mathbf{b}(0) = \mathbf{A}^t \mathbf{b}(0)$  oscillates as long as  $\mathbf{W}^t \mathbf{b}(0)$  converges to a non-zero limit point, which typically holds, e.g., when  $\mathbf{b}(0) \neq \mathbf{0}$  and  $\mathbf{W}$  is strongly connected and aperiodic.

The same result holds true when  $D$  is hard opposition and agents, e.g., start with a consensus other than a fixed-point of  $D$ , no matter the structure of row-stochastic  $\mathbf{W}$ .

As Theorem 4.3 states, if  $\mathbf{W} \circ \mathbf{F}$  is affine-linear with representation  $(\mathbf{A}, \mathbf{d})$ , the spectral radius of matrix  $\mathbf{A}$  is of crucial importance for determining whether opinions converge or not, in our setup. When  $\mathbf{d} = \mathbf{0}$  ( $\mathbf{W} \circ \mathbf{F}$  is linear), a more general result than Theorem 4.3 on convergence of the operator  $\mathbf{W} \circ \mathbf{F}$ , which also includes the situation when  $\rho(\mathbf{A}) = 1$ , is the following.

**Theorem 4.4** (Meyer (2000) [63], p.630). For  $\mathbf{A} \in \mathbb{R}^{n \times n}$ ,  $\lim_{t \rightarrow \infty} \mathbf{A}^t$  exists if and only if

$$\rho(\mathbf{A}) < 1, \quad \text{or else,}$$

$$\rho(\mathbf{A}) = 1 \text{ and } \lambda = 1 \text{ is the only eigenvalue on the unit circle, and } \lambda = 1 \text{ is semisimple,}$$

where an eigenvalue is called *semisimple* if its algebraic multiplicity equals its geometric multiplicity. The *algebraic multiplicity* of an eigenvalue  $\lambda$  is the number of times it is repeated as a root of the characteristic polynomial  $\chi(\lambda) = \det(\mathbf{A} - \lambda \mathbf{I}_n)$ , where  $\mathbf{I}_n$  is the  $n \times n$  identity matrix. The *geometric multiplicity* is the number of linearly independent eigenvectors associated with  $\lambda$ .

The below two results, the latter of which is known as *Schur's inequality*, bound the spectral radius of a matrix  $\mathbf{A}$  in terms of matrix  $p$ -norms, as we define now, and in terms of its entries.

**Definition 4.17.** The  $p$ -norm, for  $p \in \mathbb{R} \cup \{\infty\}$ ,  $p \geq 1$ , of a matrix  $\mathbf{A}$  is defined as

$$\|\mathbf{A}\|_p = \max_{\mathbf{x} \neq \mathbf{0} \in \mathbb{R}^n} \frac{\|\mathbf{A}\mathbf{x}\|_p}{\|\mathbf{x}\|_p},$$

where  $\|\mathbf{x}\|_p = (\sum_{i=1}^n |x_i|^p)^{1/p}$  for a vector  $\mathbf{x} \in \mathbb{R}^n$ . As special cases,  $\|\mathbf{A}\|_1$  is the maximum absolute column sum of  $\mathbf{A}$  and  $\|\mathbf{A}\|_\infty$  is the maximum absolute row sum of  $\mathbf{A}$ .

**Theorem 4.5.** It holds that

$$\rho(\mathbf{A}) \leq \|\mathbf{A}\|_p$$

for any  $p \geq 1$ . Furthermore, it holds that

$$\sum_{i=1}^n |\lambda_i|^2 \leq \sum_{i,j} |A_{ij}|^2,$$

where  $\lambda_1, \dots, \lambda_n$  are the (not necessarily distinct) eigenvalues of matrix  $\mathbf{A}$ .

## 5 The discrete majority voting DeGroot model

In a sense, the discrete majority voting DeGroot process is much harder to analyze than its continuous counterpart since the opinion update operator poses more problems here: in the continuous case, if  $\mathbf{F}$  is linear, then  $\mathbf{W} \circ \mathbf{F}$  is a linear operator and, in any case,  $\mathbf{W} \circ \mathbf{F}$  represents a continuous operator as long as the functions in  $\mathbf{F}$  are continuous. Thus, all in all, we content ourselves in the following with deriving results on fixed-points of the operator  $\mathbf{W} \circ \mathbf{F}$ ; as mentioned, these fixed-points constitute Nash equilibria of the coordination games outlined as justifications of the DeGroot learning process. Throughout, we assume that  $\mathbf{W}$  is row-stochastic and that the opinion space  $S = \{A_1, A_2, \dots\}$  contains at least two elements. Moreover, we need the following assumption in order for operator  $\mathbf{W} \circ \mathbf{F}$  to be well-defined in the discrete case, namely, the existence of *tie-breaking* elements that discriminate between any choices of opinions.

**Assumption 5.1** (Tie-breaking element). Let  $M \subseteq S$  be an arbitrary non-empty subset of the opinion space. We assume that there exists  $b \in M$  such that, in case of a (weighted) tie between the elements of  $M$ , agents adopt opinion  $b$  as an opinion update rather than any of the other elements in  $M$ .

**Example 5.1.** If  $S$  is ordered by a ordering relation  $<$ , a natural notion of a tie-breaking element would be the largest (or smallest) element of any  $M \subseteq S$ .

## Influential groups, decisive groups and persistent disagreement

We start this discussion with three very simple examples, Examples 5.2, 5.3, and 5.4, before considering results of a general nature in Proposition 5.1 and thereafter. In Example 4.2, we have already seen that — in the situation when  $\mathbf{F}$  consists of identity functions exclusively — strong connectedness and aperiodicity of the networks  $\mathbf{W}$  are not sufficient conditions for  $\mathbf{W}$  to induce a consensus, unlike in the continuous case. We now demonstrate by way of illustration that if  $\mathbf{W}$  is periodic, then, like in the continuous case,  $\mathbf{W}$  may not converge.

**Example 5.2.** Let  $\mathbf{W}$  and  $\mathbf{F}$  be the matrices,

$$\mathbf{W} = \begin{pmatrix} 0 & \frac{1}{2} & \frac{1}{2} \\ 1 & 0 & 0 \\ 1 & 0 & 0 \end{pmatrix}, \quad \mathbf{F} = \begin{pmatrix} F & F & F \\ F & F & F \\ F & F & F \end{pmatrix}.$$

Network  $\mathbf{W}$  is periodic, as can easily be verified, since all simple cycles have length 2. Then:

$$\begin{pmatrix} A \\ B \\ B \end{pmatrix} \mapsto_{\mathbf{W} \circ \mathbf{F}} \begin{pmatrix} B \\ A \\ A \end{pmatrix} \mapsto_{\mathbf{W} \circ \mathbf{F}} \begin{pmatrix} A \\ B \\ B \end{pmatrix} \mapsto_{\mathbf{W} \circ \mathbf{F}} \cdots,$$

where  $A, B \in S$ . In other words, whenever agent 1, on the one hand, and agents 2 and 3, on the other hand, disagree initially, disagreement will perpetuate forever, under the social network  $\mathbf{W} \circ \mathbf{F}$ . As in the continuous case, this is due to the cyclical information structure in network  $\mathbf{W} \circ \mathbf{F}$  whereby agent 1 derives her information from agents 2 and 3, who, in turn, listen to agent 1.

Now, we consider the opposition case when  $F_{ij} = D$  for some agents  $i, j \in [n]$  and some deviation function  $D$ . Interestingly, we notice that opposition may play a similar role as periodicity in the above example and, thus, may prevent convergence. We discuss this example below, too, when we talk about *anti-opposition bipartite* networks.

**Example 5.3.** Let  $\mathbf{W}$  be any strictly positive matrix — that is, each entry is positive — and let  $\mathbf{F}$  be the matrix,

$$\mathbf{F} = \begin{pmatrix} D & F & F \\ F & D & D \\ F & D & D \end{pmatrix},$$

where  $D$  is not the identity function. Note that matrix  $\mathbf{F}$  has a very similar structure as matrix  $\mathbf{W}$  in the previous example. In fact, if we replace zero entries in  $\mathbf{W}$  from Example 5.2 by ‘ $D$ ’ and positive entries by ‘ $F$ ’,  $\mathbf{W}$  is transformed into  $\mathbf{F}$ . Now, let  $A, B \in S$  be opposing viewpoints, that is,  $D(A) = B$  and  $D(B) = A$ . Then, as the reader may verify,

$$\begin{pmatrix} A \\ B \\ B \end{pmatrix} \mapsto_{\mathbf{W} \circ \mathbf{F}} \begin{pmatrix} B \\ A \\ A \end{pmatrix} \mapsto_{\mathbf{W} \circ \mathbf{F}} \begin{pmatrix} A \\ B \\ B \end{pmatrix} \mapsto_{\mathbf{W} \circ \mathbf{F}} \cdots,$$

precisely as in Example 5.2. This shows that, under opposition,  $\mathbf{W} \circ \mathbf{F}$  may not even converge, even when  $\mathbf{W}$  is strongly connected and aperiodic, as long as  $\mathbf{F}$  satisfies a certain ‘aperiodicity’ condition (as well as  $D$ ).

Next, we consider the example where opposition is ‘marginal’ in that only a few agents deviate from the opinion signals of a few others.

**Example 5.4.** Let  $n = 3$  and let  $\mathbf{F}$  be the matrix,

$$\mathbf{F} = \begin{pmatrix} F & D & F \\ F & F & F \\ F & F & F \end{pmatrix}, \quad (5.1)$$

where  $D$  is an arbitrary deviation function, and let  $\mathbf{W}$  be uniform, for example,

$$\mathbf{W} = \frac{1}{3} \begin{pmatrix} 1 & 1 & 1 \\ 1 & 1 & 1 \\ 1 & 1 & 1 \end{pmatrix},$$

so that everyone weighs everyone else equally. Then, any consensus opinion profile  $(A, A, A)^\top$ , with  $A \in S$ , is a fixed-point of  $\mathbf{W} \circ \mathbf{F}$ , as in the non-opposition case. Hence, in the discrete model, ‘a bit of opposition’ may not necessarily be an obstacle to consensus formation, something that is *not* true (in the same manner) for the continuous setup, as we discuss below. Still, even in this model, opposition does matter for the given example; e.g., for  $D(A) = B$  and  $D(B) = A$ , we have  $(A, A, B)^\top \mapsto_{\mathbf{W} \circ \mathbf{F}} (B, A, A)^\top \mapsto_{\mathbf{W} \circ \mathbf{F}} (B, A, A)^\top$ , while in the non-opposition analogue of  $\mathbf{W} \circ \mathbf{F}$  where  $F_{12} = F$ , we have  $(A, A, B)^\top \mapsto (A, A, A)^\top \mapsto (A, A, A)^\top$ .

The last example raises two questions. Firstly, may opposition have no impact at all in that results are always the same as in the non-opposition scenario, for specific networks  $\mathbf{W} \circ \mathbf{F}$ ? Secondly, in the case of opposition, what are requirements on the weight structure  $\mathbf{W}$  that prevent consensus formation?

The latter question has a simple solution. It requires, for example, the following result which states that the set of consensus fixed of points of  $\mathbf{W} \circ \mathbf{F}$  coincides with the set of neutral opinions of  $D$  provided that some agent assigns ‘too large weight mass’ to agents he opposes. We first define the concept of consensus vectors.

**Definition 5.1.** Let  $\mathcal{C}$  be the set of consensus opinion vectors in  $S^n$ , i.e.,  $\mathcal{C} = \{(a_1, \dots, a_n)^\top \in S^n \mid a_1 = \dots = a_n\}$ .

**Proposition 5.1.** Let  $\mathbf{W} \circ \mathbf{F}$  be an arbitrary operator. Then, for any  $c \in S$ ,

$$c \in \text{Fix}(D) \implies (c, \dots, c)^\top \in \text{Fix}(\mathbf{W} \circ \mathbf{F}).$$

Moreover, if  $W_{i, \mathcal{O}_i} > \frac{1}{2}$  for some  $i \in [n]$ , then, for all  $c \in S$ ,

$$c \notin \text{Fix}(D) \implies (c, \dots, c)^\top \notin \text{Fix}(\mathbf{W} \circ \mathbf{F}).$$

In other words, if  $W_{i, \mathcal{O}_i} > \frac{1}{2}$  for some  $i \in [n]$ , then

$$\text{Fix}(D) = P_1[\text{Fix}(\mathbf{W} \circ \mathbf{F}) \cap \mathcal{C}],$$

where  $P_1$  projects consensus vectors  $(c, \dots, c)^\top \in \mathcal{C}$  to  $c \in S$ .

*Proof.* Let  $\mathbf{c} = (c, \dots, c)^\top$ .

If  $c = D(c)$ , then, clearly, by definition of  $\mathbf{W} \circ \mathbf{F}$ ,  $(\mathbf{W} \circ \mathbf{F})\mathbf{c} = \mathbf{c}$ .

Conversely, let  $i \in [n]$  with  $W_{i, \mathcal{O}_i} > \frac{1}{2}$  and let  $D(c) \neq c$ . Then, for agent  $i$ , the weight of opinion  $D(c)$  is larger than  $1/2$ . Thus, her updated opinion will be  $D(c)$  rather than  $c$ , after applying operator  $\mathbf{W} \circ \mathbf{F}$ . Thus,  $(\mathbf{W} \circ \mathbf{F})\mathbf{c} \neq \mathbf{c}$ .  $\square$

**Remark 5.1.** For an agent  $i$ , we call a group of agents  $\mathcal{N}$  that satisfies the requirement  $W_{i, \mathcal{N}} > \frac{1}{2}$  as in Proposition 5.1 *decisive for agent  $i$*  as it may decide  $i$ ’s opinion provided that agents in  $\mathcal{N}$  agree.

As a simple Corollary to Proposition 5.1, we find that the possible consensus limiting opinions of  $\mathbf{W} \circ \mathbf{F}$ , denoted by,

$$\text{Lim}(\mathbf{W} \circ \mathbf{F}) \cap \mathcal{C} = \{\mathbf{b} \in S^n \mid \mathbf{b} = \lim_{t \rightarrow \infty} (\mathbf{W} \circ \mathbf{F})^t \mathbf{b}(0), \text{ for some } \mathbf{b}(0) \in S^n\} \cap \{(a_1, \dots, a_n)^\top \in S^n \mid a_1 = \dots = a_n\},$$

are given by the set of fixed points of  $D$  as long as at least one agent has ‘too much distrust’. In other words, under opposition, agents can only converge to consensus vectors in which the consensus value is a neutral opinion if some agent’s opposed group of agents is decisive for him. If, in addition,  $D$  is radical, opinion dynamics (3.3), in the discrete weighted majority setup, cannot induce a consensus. Hence, under these conditions, disagreement will be persistent.

**Corollary 5.1.** Let  $\mathbf{W} \circ \mathbf{F}$  be such that for some agent  $i \in [n]$  the group of agents he opposes is decisive for him. Then,

$$P_1[\text{Lim}(\mathbf{W} \circ \mathbf{F}) \cap \mathcal{C}] = \text{Fix}(D).$$

In particular, if  $D$  is radical,  $\text{Fix}(D) = \emptyset$  and (3.3) never converges to a consensus.

*Proof.* Limits of  $\mathbf{W} \circ \mathbf{F}$  are, in the discrete case, fixed-points of  $\mathbf{W} \circ \mathbf{F}$  by Remark 4.2, that is,  $\text{Lim}(\mathbf{W} \circ \mathbf{F}) = \text{Fix}(\mathbf{W} \circ \mathbf{F})$ . Accordingly, if  $\mathbf{W}_{i, \mathcal{O}_i} > \frac{1}{2}$  for some  $i \in [n]$ , then, by Proposition 5.1,  $\text{Fix}(D) = P_1[\text{Fix}(\mathbf{W} \circ \mathbf{F}) \cap \mathcal{C}] = P_1[\text{Lim}(\mathbf{W} \circ \mathbf{F}) \cap \mathcal{C}]$ . □

**Example 5.5.** The conditions  $W_{i, \mathcal{O}_i} > \frac{1}{2}$  and fixed-point freeness of  $D$  might appear overly strong. Assuming a probabilistic analysis, for the moment, we find that fixed-point freeness is more likely the smaller the size of the opinion space,  $m = |S|$ . For  $m = 2$ , we have 1 fixed-point free deviation function  $D$  on  $\{A, B\}$ , among  $m! - 1 = 1$  candidates (that is, all possible specifications of  $D$  are fixed-point free). For  $m = 3$ , there are 2 fixed-point free functions, among  $m! - 1 = 5$  candidates, which is 40%. As  $m$  becomes large, this fraction approximates  $1/3$ , as is well-known.<sup>26</sup> Now, assuming  $D$  is radical, we want to estimate the probability that  $W_{i, \mathcal{O}_i} > \frac{1}{2}$  for some  $i \in [n]$ . For simplicity, let us assume that  $W_{ij} = \frac{1}{n}$  for all  $i, j \in [n]$ , and that each agent  $i \in [n]$  randomly opposes other agents  $j \in [n]$  with probability  $p \in [0, 1]$ , that is,  $P[F_{ij} = D] = p$ ; we assume independence across both  $i$  and  $j$ . Then, the probability that  $W_{i, \mathcal{O}_i} \leq \frac{1}{2}$  equals the probability that  $X \leq \frac{n}{2}$  where  $X$  is binomially distributed with parameters  $n$  ( $n$  trials) and  $p$  (success probability, that  $i$  opposes  $j$ , is  $p$ ). Let  $P(n; p)$  denote this probability, which equals  $\sum_{k \leq \frac{n}{2}} \binom{n}{k} p^k (1-p)^{n-k}$ . Then, the probability that all agents have  $W_{i, \mathcal{O}_i} \leq \frac{1}{2}$  is just  $P(n; p)^n$ . Consequently, the probability that there is an agent with  $W_{i, \mathcal{O}_i} > \frac{1}{2}$  is  $1 - P(n; p)^n$ . In Figure, 6 we plot this likelihood for  $p = 0.30$ ,  $p = 0.35$ ,  $p = 0.40$ ,  $p = 0.45$  and  $p = 0.50$ . Interestingly, there appears to be a bifurcation value —  $p_0 = 0.50$  — such that if  $p \geq p_0$ , the probability that at least one agent has  $W_{i, \mathcal{O}_i} > \frac{1}{2}$  goes to 1 as  $n \rightarrow \infty$ , while if  $p < p_0$  the same probability converges to zero as  $n \rightarrow \infty$ . Hence, if  $p \geq p_0$ , for example, the probability that at least one agent's outgroup is decisive for him converges to 1 as  $n \rightarrow \infty$ . Thus, under fixed-point freeness of  $D$ , disagreement among such agents will obtain almost surely as  $n \rightarrow \infty$ .

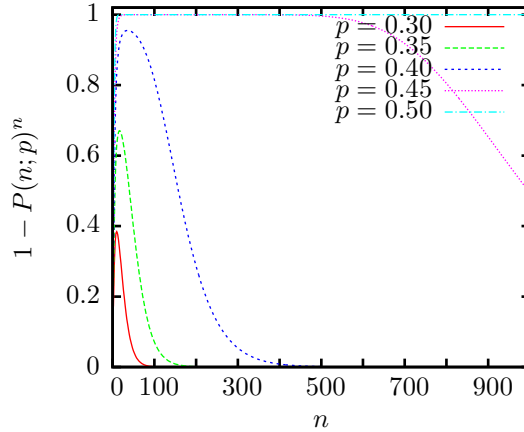

Figure 6: Probability  $1 - P(n; p)^n$  that at least one agent  $i \in [n]$  has  $W_{i, \mathcal{O}_i} > \frac{1}{2}$  as a function of  $n$  and for five values of  $p$ . Description in text, Example 5.5.

A simple other condition that prevents the operator  $\mathbf{W} \circ \mathbf{F}$  from inducing a consensus is, for example, the following. This condition is weaker than the previous because it says that disagreement obtains for *some* initial opinion vectors, while fixed-point freeness and decisiveness of outgroups, as discussed above, imply that disagreement obtains for *all* initial opinion vectors.

<sup>26</sup>See, e.g., [http://www.math.umn.edu/~garrett/crypto/Overheads/06\\_perms\\_otp.pdf](http://www.math.umn.edu/~garrett/crypto/Overheads/06_perms_otp.pdf)

**Proposition 5.2.** If all agents oppose a certain agent,  $j'$ , and otherwise  $F_{ij} = F$  for all  $i, j \in [n]$  with  $j \neq j'$ , then  $\mathbf{W} \circ \mathbf{F}$  does not induce a consensus (that is, there exists  $\mathbf{b}(0) \in S^n$  such that  $\lim_{t \rightarrow \infty} (\mathbf{W} \circ \mathbf{F})^t \mathbf{b}(0)$  is not a consensus).

*Proof.* Since  $D$  is not the identity, there exists  $c$  such that  $c \neq D(c)$ . Then a fixed-point of  $\mathbf{W} \circ \mathbf{F}$  is given by  $\mathbf{b}(0) = (D(c), \dots, D(c), \underbrace{c}_{j'}, D(c), \dots, D(c))^\top$ .  $\square$

**Remark 5.2.** The last proposition also holds under the weaker assumption  $W_{i, \mathcal{F}_i} + W_{ij'} > \frac{1}{2}$  for all  $i = 1, \dots, n$ .

Now, to answer the first question — whether opposition may have no effect at all, in our current setup — let  $\mathbf{F}_{D \rightarrow F}$  denote the matrix with all  $D$ 's replaced by  $F$ 's, i.e., the network links  $\mathbf{F}$  with opposition ‘inverted’ to following. Then, it is easy to see that, in fact,  $\mathbf{W} \circ \mathbf{F}$  and  $\mathbf{W} \circ \mathbf{F}_{D \rightarrow F}$  may entail the exactly same limiting opinion results under opinion updating process (3.3).

**Example 5.6.** Let  $n = 4$ , for example, and consider the operator  $\mathbf{W} \circ \mathbf{F}$ ,

$$\mathbf{W} = \begin{pmatrix} \frac{3}{4} & \frac{1}{12} & \frac{1}{12} & \frac{1}{12} \\ \star & \star & \star & \star \\ \star & \star & \star & \star \\ \star & \star & \star & \star \end{pmatrix}, \quad \mathbf{F} = \begin{pmatrix} F & D & D & D \\ F & F & F & F \\ F & F & F & F \\ F & F & F & F \end{pmatrix},$$

where the weight structure of agents 2 to 4 may be arbitrarily specified; important is agent 1, who opposes agents 2 to 4, while the remaining agents follow all agents  $j = 1, 2, 3, 4$ . Then, no matter the opinion profile  $\mathbf{b} \in S^n$ ,  $(\mathbf{W} \circ \mathbf{F})\mathbf{b} = (\mathbf{W} \circ \mathbf{F}_{D \rightarrow F})\mathbf{b}$ , which is obvious, since agent 1 assigns so much weight mass to himself (and follows himself) that he always adopts his own current opinion signal, no matter the opinion signals of agents 2 to 4. Consequently,  $\lim_{t \rightarrow \infty} (\mathbf{W} \circ \mathbf{F})^t \mathbf{b}(0) = \lim_{t \rightarrow \infty} (\mathbf{W} \circ \mathbf{F}_{D \rightarrow F})^t \mathbf{b}(0)$  for all  $\mathbf{b}(0) \in S^n$ .

**Example 5.7.** In the last example, agent  $i = 1$  had assigned herself more than 50% weight mass (and followed herself) such that it is clear that her own current opinion always determines her next period opinion. A slightly more subtle example is the following, where none of the agents that  $i$  follows has more than 50% weight mass.

$$\mathbf{W} = \begin{pmatrix} \frac{40}{100} & \frac{30}{100} & \frac{21}{100} & \frac{9}{100} \\ \star & \star & \star & \star \\ \star & \star & \star & \star \\ \star & \star & \star & \star \end{pmatrix}, \quad \mathbf{F} = \begin{pmatrix} F & F & F & D \\ F & F & F & F \\ F & F & F & F \\ F & F & F & F \end{pmatrix}.$$

Here, whenever two of the three agents 1, 2, 3 agree, agent 1 adopts their opinion in the next period, irrespective of agent 4's opinion. If all three agents disagree, agent 1 adopts her own current opinion in the next period, irrespective of agent 4's opinion. Hence,  $\lim_{t \rightarrow \infty} (\mathbf{W} \circ \mathbf{F})^t \mathbf{b}(0) = \lim_{t \rightarrow \infty} (\mathbf{W} \circ \mathbf{F}_{D \rightarrow F})^t \mathbf{b}(0)$  for all  $\mathbf{b}(0) \in S^n$ .

There are, however, conditions on  $\mathbf{W}$  that ensure that opposition ‘matters’. One such condition is the following, whose idea is similar in spirit to that of Proposition 5.1, namely, it refers to ‘too large weight mass’ assigned to opposed agents. Before we state the proposition, we define the concept of an *influential group*.

**Definition 5.2.** Let an agent  $i \in [n]$  be fixed. We call a group  $\mathcal{N} \subseteq [n]$  *influential for agent  $i$*  if there exist two sets of agents  $\mathcal{N}_1 \subseteq [n]$  and  $\mathcal{N}_2 \subseteq [n]$  such that  $(\mathcal{N}, \mathcal{N}_1, \mathcal{N}_2)$  is a partition of  $[n]$  (pairwise disjoint and whose union is  $[n]$ ) and

$$W_{i, \mathcal{N}_1} + W_{i, \mathcal{N}} > \frac{1}{2} \quad \text{and} \quad W_{i, \mathcal{N}_2} + W_{i, \mathcal{N}} > \frac{1}{2}. \quad (5.2)$$

**Remark 5.3.** An influential group  $\mathcal{N}$  for agent  $i$  is precisely what its name suggests: it may influence agent  $i$ 's opinion. For instance, if agents in  $\mathcal{N}_1$  hold opinion  $A$  and agents in  $\mathcal{N}_2$  hold opinion  $B$ , then agents in  $\mathcal{N}$  may ‘turn the scales’.

**Remark 5.4.** If  $\mathcal{N}$  is decisive for agent  $i$ , then it is influential for  $i$ .

**Proposition 5.3.** For some agent  $i \in [n]$ , let the group  $\mathcal{O}_i$  of agents he opposes be influential for  $i$ , then it holds that

$$(\mathbf{W} \circ \mathbf{F})\mathbf{b} \neq (\mathbf{W} \circ \mathbf{F}_{D \rightarrow F})\mathbf{b}$$

for at least one opinion vector  $\mathbf{b} \in S^n$ .

*Proof.* Since  $\mathcal{O}_i$ , the agents  $i$  opposes, is an influential group, there is a partition  $(\mathcal{O}_i, \mathcal{N}_1, \mathcal{N}_2)$  such that (5.2) holds; of course,  $i$  follows agents in  $\mathcal{N}_1$  and  $\mathcal{N}_2$ . Let  $S = \{A, B, \dots\}$  consist of at least two elements and let, without loss of generality,  $D(B) = A$ . Let  $\mathbf{b}$  be an opinion vector such that agents in  $\mathcal{N}_1$  hold opinion  $A$ , agents in  $\mathcal{N}_2$  hold opinion  $B$  and agents in  $\mathcal{O}_i$  hold opinion  $B$ . Then

$$((\mathbf{W} \circ \mathbf{F})\mathbf{b})_i = A,$$

since  $W_{i, \mathcal{N}_1} + W_{i, \mathcal{O}_i} > \frac{1}{2}$  and  $D(B) = A$ , and

$$((\mathbf{W} \circ \mathbf{F}_{D \rightarrow F})\mathbf{b})_i = B,$$

since  $W_{i, \mathcal{N}_2} + W_{i, \mathcal{O}_i} > \frac{1}{2}$ . □

**Example 5.8.** Many examples of  $\mathbf{W}$  and  $\mathbf{F}$  that satisfy the assumptions of Proposition 5.3 come to mind. One might be, for instance,

$$\mathbf{W} = \begin{pmatrix} \frac{1}{4} & \frac{1}{3} & \frac{1}{4} & \frac{1}{6} \\ \star & \star & \star & \star \\ \star & \star & \star & \star \\ \star & \star & \star & \star \end{pmatrix}, \quad \mathbf{F} = \begin{pmatrix} F & D & F & F \\ \star & \star & \star & \star \\ \star & \star & \star & \star \\ \star & \star & \star & \star \end{pmatrix}.$$

Then, one partition as required by Proposition 5.3 is  $\mathcal{N}_1 = \{1\}$ ,  $\mathcal{N}_2 = \{3, 4\}$ ,  $\mathcal{O}_i = \{2\}$  with  $W_{i, \mathcal{N}_1} = \frac{1}{4}$ ,  $W_{i, \mathcal{N}_2} = \frac{5}{12}$ , and  $W_{i, \mathcal{O}_i} = \frac{1}{3}$ . Hence,

$$W_{i, \mathcal{N}_1} + W_{i, \mathcal{O}_i} = \frac{1}{4} + \frac{1}{3} = \frac{7}{12} > \frac{1}{2}, \quad \text{and} \quad W_{i, \mathcal{N}_2} + W_{i, \mathcal{O}_i} = \frac{5}{12} + \frac{1}{3} = \frac{3}{4} > \frac{1}{2}$$

so that, indeed,  $\mathcal{O}_i$  is influential for  $i = 1$ .

If we impose slightly more structure on  $D$ , we may give slightly more general conditions under which opposition ‘matters’.

**Proposition 5.4.** Let there exist a non-fixed point  $B$  of  $D$  such that  $B$  is the tie-breaking element of  $\{B, D(B)\}$ . Moreover, for some agent  $i \in [n]$ , let the set  $\mathcal{O}_i$  of agents he opposes be influential’ in the following manner. Rather than requirement (5.2), we assume the weaker form

$$W_{i, \mathcal{N}_1} + W_{i, \mathcal{O}_i} > \frac{1}{2} \quad \text{and} \quad W_{i, \mathcal{N}_2} + W_{i, \mathcal{O}_i} \geq \frac{1}{2}. \quad (5.3)$$

Then, it holds that

$$(\mathbf{W} \circ \mathbf{F})\mathbf{b} \neq (\mathbf{W} \circ \mathbf{F}_{D \rightarrow F})\mathbf{b}$$

for at least one opinion vector  $\mathbf{b} \in S^n$ .

*Proof.* As in the proof of Proposition 5.1, let  $\mathbf{b}$  such that agents in  $\mathcal{N}_1$ ,  $\mathcal{N}_2$ , and  $\mathcal{O}_i$  hold opinions  $A = D(B)$ ,  $B$ , and  $B$ , respectively. □

We note that both hard opposition and soft opposition as specified in Section 3, and which assume an order  $<$  on  $S$ , satisfy the condition on  $D$  specified in the last proposition under the ‘natural notion’ of tie-breaking element, cf. Example 5.1, as largest (or smallest) element of  $M \subseteq S$ . For instance, choose  $B = \max S$ , whence, since  $D(B) = \min S$ ,  $B$  is the tie-breaking element of  $\{B, D(B)\}$ . Moreover, we note that weight requirement (5.3) in Proposition 5.4 is always satisfied in the case of uniform weights  $\mathbf{W}$ , which reproduces the ordinary (‘unweighted’) majority updating setup, when some agent  $i$  opposes at least one agent  $j$ . In other words, in the ordinary (‘unweighted’) majority updating setup, opposition always has an effect as long as  $D$  is, e.g., soft or hard opposition. This is what our next example shows more formally.

**Example 5.9.** Let  $n \in \mathbb{N}$  and let  $\mathbf{W} \circ \mathbf{F}$  be such that there exists an agent  $i$  with  $W_{ij} = \frac{1}{n}$  for all agents  $j = 1, \dots, n$  and let  $|\mathcal{O}_i| \geq 1$ . We show that  $\mathcal{O}_i$  is influential' for  $i$  in the sense of requirement (5.3). To see this, let  $\mathcal{F}_i$  be the set of agents that agent  $i$  follows. If  $\mathcal{F}_i$  has even cardinality, let  $\mathcal{N}_1$  and  $\mathcal{N}_2$  be an arbitrary partition of  $\mathcal{F}_i$  with  $|\mathcal{N}_1| = |\mathcal{N}_2|$ . Then, clearly,  $W_{i,\mathcal{N}_k} + W_{i,\mathcal{O}_i} > \frac{1}{2}$  for  $k = 1, 2$ . If  $\mathcal{F}_i$  has odd size, let  $\mathcal{N}_1$  and  $\mathcal{N}_2$  be an arbitrary partition of  $\mathcal{F}_i$  such that  $|\mathcal{N}_1| = |\mathcal{N}_2| + 1$ . Then clearly,  $W_{i,\mathcal{N}_1} + W_{i,\mathcal{O}_i} > \frac{1}{2}$  and  $W_{i,\mathcal{N}_2} + W_{i,\mathcal{O}_i} \geq \frac{1}{2}$ . Hence,  $\mathcal{O}_i$  is influential' for  $i$ .

To be more precise on the example, let, e.g.,

$$\mathbf{W} = \begin{pmatrix} \frac{1}{5} & \frac{1}{5} & \frac{1}{5} & \frac{1}{5} & \frac{1}{5} \\ \star & \star & \star & \star & \star \\ \star & \star & \star & \star & \star \\ \star & \star & \star & \star & \star \\ \star & \star & \star & \star & \star \end{pmatrix}, \quad \mathbf{F} = \begin{pmatrix} F & F & D & D & F \\ \star & \star & \star & \star & \star \\ \star & \star & \star & \star & \star \\ \star & \star & \star & \star & \star \\ \star & \star & \star & \star & \star \end{pmatrix}.$$

Hence, for  $i = 1$ , choose  $\mathcal{N}_1 = \{1, 2\}$ , for example, and  $\mathcal{N}_2 = \{5\}$ , and  $\mathcal{O}_i$ , the set of agent  $i$  opposes, is  $\mathcal{O}_i = \{3, 4\}$ . Clearly,  $W_{i,\mathcal{N}_1} + W_{i,\mathcal{O}_i} = \frac{2}{5} + \frac{2}{5} > \frac{1}{2}$  and  $W_{i,\mathcal{N}_2} + W_{i,\mathcal{O}_i} = \frac{1}{5} + \frac{2}{5} > \frac{1}{2}$  so that  $\mathcal{O}_i$  is indeed influential' for  $i$ . Moreover, to have, in addition, the assumptions on  $D$  in Proposition 5.4 be satisfied, let, e.g.,  $S = \{A, B, C\}$  with  $D(C) = A$ ,  $D(B) = B$ , and  $D(A) = C$ , where  $A < B < C$  (note that  $D$  is soft opposition on  $S$ ) and larger opinions are tie-breakers; then,  $C$ , a non-fixed point of  $D$ , is the tie-breaking element of  $\{C, D(C) = A\}$ . Hence, all assumptions of Proposition 5.4 are satisfied, and, accordingly, also its consequences. By the proof of the proposition,  $\mathbf{b} = (A, A, C, C, C)^\top$  satisfies  $(\mathbf{W} \circ \mathbf{F})\mathbf{b} \neq (\mathbf{W} \circ \mathbf{F}_{D \rightarrow F})\mathbf{b}$ . In fact,

$$((\mathbf{W} \circ \mathbf{F})\mathbf{b})_i = A,$$

while

$$((\mathbf{W} \circ \mathbf{F}_{D \rightarrow F})\mathbf{b})_i = C.$$

**Remark 5.5.** We may summarize Propositions 5.1 to 5.4 as follows. First, we find that, in the discrete majority voting model, opposition may have no effect at all in that the same outcomes can obtain as in the setting without opposition (Examples 5.6 and 5.7). Intuitively and from the examples, we feel that this must be related to the weight mass agents assign to opposed agents. Propositions 5.3 and 5.4 then show that opposition begins to matter once a single agent assigns 'large enough' weight mass  $W_{i,\mathcal{O}_i}$  to opposed agents, i.e., his outgroup is influential for him. Weight mass requirements are not strong: they are satisfied for the ordinary ('unweighted') majority opinion update model, for example (see Example 5.9). Finally, Proposition 5.1 and Corollary 5.1 indicate that if  $W_{i,\mathcal{O}_i}$  exceeds a critical value —  $\frac{1}{2}$  in this setup; the group of agents  $i$  opposes becomes decisive for him — opposition becomes 'poisonous' in that it precludes consensus formation in the DeGroot learning model as long as, in addition, deviation function  $D$  is 'radical' in that it has no fixed points. In other words, if  $D$  is radical and if a single agent's outgroup is decisive for him, disagreement among agents (within a period or between periods) is the prediction of our discrete DeGrootian opinion dynamics model, no matter the initial opinions of agents. Fixed-point freeness may not be too surprising an occurrence, however, as the example of the binary model, with  $S = \{A, B\}$ , suggests. Here, the only legitimate specification of  $D$  is fixed-point free. Moreover, even if  $D$  is not radical, Proposition 5.1 shows that, in the case of opposition, agents can only attain neutral consensus opinions as long as a single agent has sufficient 'distrust'. If  $\text{Fix}(D)$  is small, as we would typically expect, most consensus opinions can, accordingly, never be attained.

## Polarization

We now investigate *polarization* as an outcome of our opinion updating dynamics. Note that, in real societies, polarization on many agendas is frequently observed such as whether the Christian churches, or the law, should allow condoms or gay marriages. In fact, as we have discussed, polarizing viewpoints may occur, prominently, in the political arena and in the situation of 'countercultural' subsocieties, with respect to the viewpoints held by the 'mainstream' culture. We first define the concept formally.

**Definition 5.3** ((Functional) Polarization). We call an opinion vector  $\mathbf{p} \in S^n$  a *polarization* if  $\mathbf{p}$  consists of two distinct elements  $a, b \in S$  exclusively.

We call an opinion vector  $\mathbf{p} \in S^n$  a *functional polarization* if  $\mathbf{p}$  is a polarization and  $a$  and  $b$  are opposing viewpoints.

The concept of functional polarization, which depends on the definition of deviation function  $D$ , captures the notion of ‘opposing viewpoints’ expressed in a polarization vector  $\mathbf{p}$ , while an ‘ordinary’ polarization vector may consist of disagreeing viewpoints solely, that stand in no relationship to each other. Next, we define network structures that are sufficient for inducing polarization opinion vectors.

**Definition 5.4** (Opposition bipartite operator  $\mathbf{W} \circ \mathbf{F}$ ). We call the operator  $\mathbf{W} \circ \mathbf{F}$  on  $n$  agents *opposition bipartite* if there exists a partition  $(\mathcal{N}_1, \mathcal{N}_2)$  of the set of agents  $[n]$  into two disjoint non-empty subsets —  $[n] = \mathcal{N}_1 \cup \mathcal{N}_2$ , with  $\mathcal{N}_1 \cap \mathcal{N}_2 = \emptyset$ ,  $\mathcal{N}_i \neq \emptyset$ , for  $i = 1, 2$  — such that agents in  $\mathcal{N}_i$  follow each other, for  $i = 1, 2$ , while for all agents  $i_0 \in \mathcal{N}_i$ ,  $i_1 \in \mathcal{N}_{-i}$ , for  $i = 1, 2$ , it holds that  $i_0$  deviates from  $i_1$ .

**Remark 5.6.** What we call ‘opposition bipartite’ operator — or at least a special case of our concept — has also been called ‘balanced’ signed network in the literature (cf. Beasley and Kleinberg (2010) [12]). Note that, in an opposite bipartite partitioning, we only take into account links for which  $W_{ij} > 0$ . To clarify, if  $(\mathcal{N}_1, \mathcal{N}_2)$  is a respective partition, then, for instance, if  $i, j \in \mathcal{N}_1$  and  $W_{ij} = 0$ , we ignore whether  $F_{ij} = F$  or  $F_{ij} = D$ .

**Definition 5.5** (Anti-Opposition bipartite operator  $\mathbf{W} \circ \mathbf{F}$ ). We call the operator  $\mathbf{W} \circ \mathbf{F}$  on  $n$  agents *anti-opposition bipartite* if there exists a partition  $(\mathcal{N}_1, \mathcal{N}_2)$  of the set of agents  $[n]$  into two disjoint non-empty subsets such that agents in  $\mathcal{N}_i$  deviate from each other, for  $i = 1, 2$ , while for all agents  $i_0 \in \mathcal{N}_i$ ,  $i_1 \in \mathcal{N}_{-i}$ , for  $i = 1, 2$ , it holds that  $i_0$  follows  $i_1$ .

An example of an opposition bipartite operator is given in Example 5.10 below. An example of an anti-opposition bipartite operator is given in Examples 5.12 below and 5.3 above. A schematic illustration of both concepts is given in Figure 7.

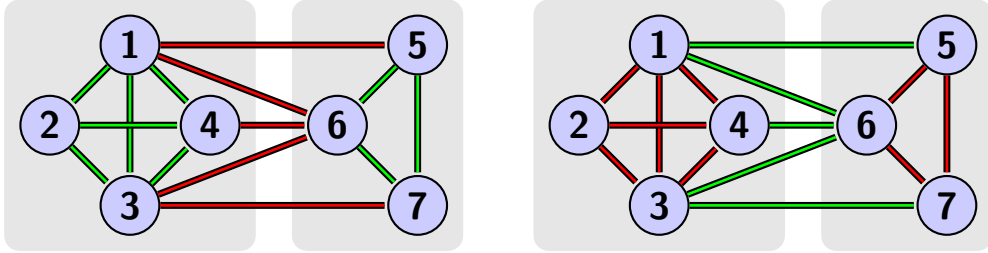

Figure 7: Schematic illustration of the concepts of opposition bipartite and anti-opposition bipartite operators. We omit network links referring to weights  $\mathbf{W}$  for clarity and we also draw links as undirected for the same reason. We omit links  $F_{ij}$  where  $W_{ij} = 0$ . Red links denote opposition, green links following.

We now show that opposition bipartite networks have polarization opinion vectors as fixed-points.

**Proposition 5.5.** Let  $\mathbf{W} \circ \mathbf{F}$  be opposition bipartite and let  $a, b \in S$  be opposing viewpoints. Then, there exists a polarization opinion vector  $\mathbf{p}$  consisting of opinions  $a$  and  $b$  such that  $(\mathbf{W} \circ \mathbf{F})\mathbf{p} = \mathbf{p}$ .

*Proof.* Let  $\mathcal{N}_1$  and  $\mathcal{N}_2$  be the partition of the agent set  $[n] = \{1, \dots, n\}$  such that agents in  $\mathcal{N}_i$ ,  $i = 1, 2$ , follow each other, while agents across the two sets oppose each other. Let  $a, b \in S$  be such that  $D(a) = b$  and  $D(b) = a$ . Moreover, let  $\mathbf{p}$  be such that each agent in  $\mathcal{N}_1$  holds opinion  $a$  (or  $b$ ) and each agent in  $\mathcal{N}_2$  holds opinion  $b$  (or  $a$ ). Then, for each agent  $i_1 \in \mathcal{N}_1$ , all neighbors’ (possibly inverted) opinion signals are  $a$  (or  $b$ ) and analogously for agents  $i_2 \in \mathcal{N}_2$ .  $\square$

**Example 5.10.** Let  $\mathbf{W}$  be arbitrary. Consider

$$\mathbf{F} = \begin{pmatrix} F & F & D & D \\ F & F & D & D \\ D & D & F & F \\ D & D & F & F \end{pmatrix}.$$

Clearly,  $\mathbf{W} \circ \mathbf{F}$  is opposition bipartite; for example, take  $\mathcal{N}_1 = \{1, 2\}$  and  $\mathcal{N}_2 = \{3, 4\}$ . Moreover, let  $S = \{\text{“impossible”}, \text{“unlikely”}, \text{“possible”}, \text{“likely”}, \text{“certain”}\}$  as above with  $D$  as soft opposition. Then  $\mathbf{p} = (\text{“unlikely”}, \text{“unlikely”}, \text{“likely”}, \text{“likely”})^\top$  is a polarization fixed-point of  $\mathbf{W} \circ \mathbf{F}$ , amongst others.

Note that Proposition 5.5 would also be true under weaker conditions such as a ‘perturbed opposition bipartite operator’, as we define in the following.

**Definition 5.6** (Perturbed opposition bipartite operator). We call the operator  $\mathbf{W} \circ \mathbf{F}$  on  $n$  agents *perturbed opposition bipartite* if there exists a partition  $(\mathcal{N}_1, \mathcal{N}_2)$  of the set of agents  $[n]$  into two disjoint non-empty subsets such that for each agent  $i = 1, \dots, n$ , there exists a group of agents  $A_i \cup B_i \subseteq [n]$ , with  $A_i \subseteq \mathcal{N}_1$  and  $B_i \subseteq \mathcal{N}_2$  and  $i$  follows agents in  $A_i$  and deviates from agents in  $B_i$ , such that the group  $A_i \cup B_i$  is decisive for  $i$ , i.e.,  $W_{i, A_i \cup B_i} > \frac{1}{2}$ .

**Example 5.11.** Consider

$$\mathbf{W} = \frac{1}{4} \begin{pmatrix} 1 & 1 & 1 & 1 \\ 1 & 1 & 1 & 1 \\ 1 & 1 & 1 & 1 \\ 1 & 1 & 1 & 1 \end{pmatrix}, \quad \mathbf{F} = \begin{pmatrix} F & F & D & F \\ D & F & D & D \\ D & D & D & F \\ D & F & F & F \end{pmatrix},$$

Taking  $\mathcal{N}_1 = \{1, 2\}$  and  $\mathcal{N}_2 = \{3, 4\}$ , we see that  $\mathbf{W} \circ \mathbf{F}$  is perturbed opposition bipartite. For example, for agent 1, we would, e.g., have  $A_1 = \{1, 2\}$ ,  $B_1 = \{3\}$  with  $W_{1, A_1 \cup B_1} = \frac{3}{4} > \frac{1}{2}$ ; for agent 2, e.g.,  $A_2 = \{2\}$  and  $B_2 = \{3, 4\}$  and  $W_{2, A_2 \cup B_2} = \frac{3}{4} > \frac{1}{2}$ , etc. Perturbed opposition bipartite networks also have polarization vectors as fixed-points, as seen in this example, e.g.:

$$\begin{pmatrix} \text{“unlikely”} \\ \text{“unlikely”} \\ \text{“likely”} \\ \text{“likely”} \end{pmatrix} \mapsto_{\mathbf{W} \circ \mathbf{F}} \begin{pmatrix} \text{“unlikely”} \\ \text{“unlikely”} \\ \text{“likely”} \\ \text{“likely”} \end{pmatrix}.$$

Anti-opposition bipartite networks induce oscillating, or fluctuating, opinion updates (cf. Kramer (1971) [54]), very similar to ordinary periodic networks as discussed above.

**Proposition 5.6.** Let  $\mathbf{W} \circ \mathbf{F}$  be anti-opposition bipartite and let  $a, b \in S$  be opposing viewpoints. Then, there exist polarization opinion vectors  $\mathbf{p}, \bar{\mathbf{p}} \in S^n$  consisting of opinions  $a$  and  $b$  in a complementary manner —  $p_i = D(\bar{p}_i)$  and  $\bar{p}_i = D(p_i)$  for all  $i = 1, \dots, n$  — such that  $(\mathbf{W} \circ \mathbf{F})\mathbf{p} = \bar{\mathbf{p}}$  and  $(\mathbf{W} \circ \mathbf{F})\bar{\mathbf{p}} = \mathbf{p}$ .

*Proof.* Let  $\mathcal{N}_1$  and  $\mathcal{N}_2$  be the partition of the agent set  $[n] = \{1, \dots, n\}$  such that agents in  $\mathcal{N}_i$ ,  $i = 1, 2$ , deviate from each other, while agents across the two sets follow each other. Let  $a, b \in S$  be such that  $D(a) = b$  and  $D(b) = a$ . Moreover, let  $\mathbf{p}$  be such that each agent in  $\mathcal{N}_1$  holds opinion  $a$  (or  $b$ ) and each agent in  $\mathcal{N}_2$  holds opinion  $b$  (or  $a$ ) and let  $\bar{\mathbf{p}}$  have a complementary distribution of  $a$ ’s and  $b$ ’s. Then, for each agent  $i_1 \in \mathcal{N}_1$ , all neighbor’s (possibly inverted) opinion signals are  $b$  (or  $a$ ) and analogously for agents  $i_2 \in \mathcal{N}_2$ .  $\square$

**Example 5.12.** Let  $\mathbf{W}$  be arbitrary. Consider

$$\mathbf{F} = \begin{pmatrix} D & D & F & F \\ D & D & F & F \\ F & F & D & D \\ F & F & D & D \end{pmatrix}.$$

Clearly,  $\mathbf{W} \circ \mathbf{F}$  is anti-opposition bipartite; for example, take  $\mathcal{N}_1 = \{1, 2\}$  and  $\mathcal{N}_2 = \{3, 4\}$ . For  $\mathbf{p}$  as in Example 5.10, we have

$$\begin{pmatrix} \text{“unlikely”} \\ \text{“unlikely”} \\ \text{“likely”} \\ \text{“likely”} \end{pmatrix} \mapsto_{\mathbf{W} \circ \mathbf{F}} \begin{pmatrix} \text{“likely”} \\ \text{“likely”} \\ \text{“unlikely”} \\ \text{“unlikely”} \end{pmatrix} \mapsto_{\mathbf{W} \circ \mathbf{F}} \begin{pmatrix} \text{“unlikely”} \\ \text{“unlikely”} \\ \text{“likely”} \\ \text{“likely”} \end{pmatrix} \mapsto_{\mathbf{W} \circ \mathbf{F}} \dots$$

Of course, we could, in addition, define a concept of ‘perturbed anti-opposition bipartite operator’ and easily see that Proposition 5.6 also holds under this weaker concept, but we omit the details here because of analogy with the concept of ‘perturbed opposition bipartite operator’.

Since neither fluctating opinion updates nor polarization constitute a consensus, we have the following simple corollary to Propositions 5.5 and 5.6.

**Corollary 5.2.** Let  $\mathbf{W} \circ \mathbf{F}$  be (perturbed) opposition bipartite or anti-opposition bipartite. Then there exist initial opinion vectors  $\mathbf{b}(0) \in S^n$  such that  $\mathbf{W} \circ \mathbf{F}$  does not induce a consensus for  $\mathbf{b}(0)$ . If  $\mathbf{W} \circ \mathbf{F}$  is anti-opposition bipartite, then there exist initial opinion vectors  $\mathbf{b}(0) \in S^n$  such that  $\mathbf{W} \circ \mathbf{F}$  does not even converge for  $\mathbf{b}(0)$ .

We conclude with an example of how to induce more general polarization outcomes, between more than two groups of agents, and a simulation of the discrete weighted majority opinion updating model (3.3). In the latter example, rather than discussing (possible or impossible) fixed points of operators, we simulate *actual* dynamics.

**Example 5.13.** We briefly discuss how to induce, in a general manner, polarizing viewpoints between more than two groups of agents as fixed-points of the operator  $\mathbf{W} \circ \mathbf{F}$ . One way to achieve such more fragmented opinion and belief systems in society in our setup is to endow the different groups with *different* deviation functions  $D_k : S \rightarrow S$ , where  $k$  ranges over the groups (or agents). In essence, these different deviation functions would represent distinct interpretations of what the opposite of a certain opinion value  $a \in S$  is. For example, one group might interpret opposition in a radical manner, allowing  $D_k$  to have no fixed-points while other groups may be more ‘tolerant’, leaving some opinion values unchanged, even in opposition modus.<sup>27</sup>

To make a concrete example, let  $S = \{A, B, C, \dots\}$  and consider three different groups with distinct deviation functions  $D_1(x) = A$ ,  $D_2(x) = B$ ,  $D_3(x) = C$  for all  $x \in \{A, B, C\}$  (or even all  $x \in S$ ). For instance, group 1 might always deviate to an extreme left wing opinion, at least within the set  $\{A, B, C\}$ , provided that it deviates from certain agents; group 2 to a moderate position in the opinion space; and group 3 to an extreme right wing position. Let, e.g.,

$$\mathbf{W} = \frac{1}{6} \begin{pmatrix} 1 & 1 & 1 & 1 & 1 & 1 \\ 1 & 1 & 1 & 1 & 1 & 1 \\ 1 & 1 & 1 & 1 & 1 & 1 \\ 1 & 1 & 1 & 1 & 1 & 1 \\ 1 & 1 & 1 & 1 & 1 & 1 \\ 1 & 1 & 1 & 1 & 1 & 1 \end{pmatrix}, \quad \mathbf{F} = \begin{pmatrix} F & F & F & D_1 & D_1 & D_1 \\ F & F & F & D_1 & D_1 & D_1 \\ F & F & F & D_1 & D_1 & D_1 \\ D_2 & D_2 & D_2 & F & D_2 & D_2 \\ D_3 & D_3 & D_3 & D_3 & F & F \\ D_3 & D_3 & D_3 & D_3 & F & F \end{pmatrix}.$$

We then have a partition  $(\mathcal{N}_1, \mathcal{N}_2, \mathcal{N}_3)$  of the agent set —  $(\{1, 2, 3\}, \{4\}, \{5, 6\})$  in the example — such that agents within each subset  $\mathcal{N}_i$  follow each other and agents across the subsets deviate from each other, applying their specific choices of deviation functions. It is easy to check that, e.g.,  $\mathbf{p} = (A, A, A, B, C, C)^\top$  is a fixed-point of  $\mathbf{W} \circ \mathbf{F}$ , constituting a ‘generalized’ polarization opinion vector.

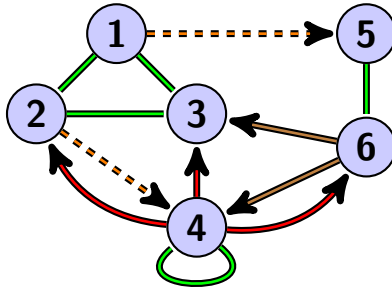

Figure 8: Graphical illustration of Example 5.13. Groups have individualized deviation functions, in different colors. We omit many links for clarity.

<sup>27</sup>A generalization is to let the deviation endomorphisms depend, not only on the agents who oppose, but also on the opposed agents.

**Example 5.14.** To visualize the likelihood of a consensus in our current setup, we plot in Figure 9 the following quantities. We run a simulation where we choose weights  $W_{ij}$  from a uniform random distribution on  $(0, 1)$  and then normalize in order for  $\mathbf{W}$  to be row-stochastic. We draw  $F_{ij}$  according to the Bernoulli distribution  $P[F_{ij} = D] = p$ , with  $p \in [0, 1]$ . We let  $D$  be hard opposition on the set  $S = \{-\alpha, -\alpha + 1, \dots, 0, \dots, \alpha - 1, \alpha\}$ , for  $\alpha \in \{1, 2, 3\}$ ; conventionally, we let  $D(0) = 0$ . For  $n$  agents ( $n = 5$  in the figure), we then iterate over all possible distributions of initial opinion profiles  $\mathbf{b}(0) \in S^n$  — there are  $|S|^n$  different such profiles — and determine the fraction of profiles that result in a consensus among the  $|S|^n$  total initial opinion profiles, that is, for which it holds that  $\lim_{t \rightarrow \infty} (\mathbf{W} \circ \mathbf{F})\mathbf{b}(0)$  is a consensus. In the figure, we plot this fraction as a function of  $p$ ; the displayed curves are averages over 20 simulations. We note that the probability of a consensus appears to be a decreasing function of  $p$ , opposition likelihood, as we expect. In the case of hard opposition, at least, consensus likelihood obviously decreases in  $\alpha$ , the ‘size’ of  $S$ .

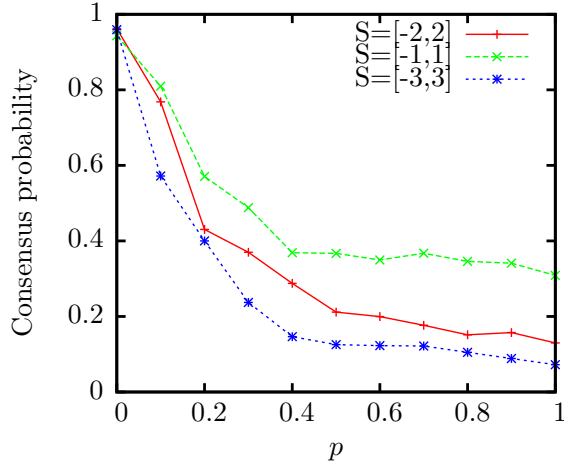

Figure 9: Consensus probability as a function of  $p$ . Description in the text.

## 6 The continuous DeGroot model

### 6.1 The requirement $\sum_{j=1}^n W_{ij} = 1$

At first, we consider here the condition when the importance matrix  $\mathbf{W}$  is row-stochastic, that is,

$$0 \leq W_{ij} \leq 1, \quad \text{and,} \quad \sum_{j=1}^n W_{ij} = 1 \quad (6.1)$$

for all  $i = 1, \dots, n$ . As mentioned, this means that the weights that agents assign each other are normalized to unity, which is the usual assumption in DeGroot-like models.

**Proposition 6.1.** Let  $\mathbf{W} \circ \mathbf{F}$  be an arbitrary operator. Then, for any  $c \in S$ ,

$$c \in \text{Fix}(D) \implies (c, \dots, c)^\top \in \text{Fix}(\mathbf{W} \circ \mathbf{F}).$$

Moreover, if  $W_{i, \phi_i} > 0$  for some  $i \in [n]$ , then, for all  $c \in S$ ,

$$c \notin \text{Fix}(D) \implies (c, \dots, c)^\top \notin \text{Fix}(\mathbf{W} \circ \mathbf{F}).$$

In other words, if  $W_{i, \phi_i} > 0$  for some  $i \in [n]$ , then

$$\text{Fix}(D) = P_1[\text{Fix}(\mathbf{W} \circ \mathbf{F}) \cap \mathcal{C}].$$

*Proof.* Let  $\mathbf{c} = (c, \dots, c)^\top$ .

If  $c = D(c)$  for some  $c \in S$ , then clearly  $(\mathbf{W} \circ \mathbf{F})\mathbf{c} = \mathbf{c}$  by the definition of  $\mathbf{W} \circ \mathbf{F}$  since for each agent  $i \in [n]$ ,

$$((\mathbf{W} \circ \mathbf{F})\mathbf{c})_i = \sum_{j \in \mathcal{F}_i} W_{ij}c + \sum_{j \in \mathcal{O}_i} W_{ij}D(c) = c \sum_{j \in [n]} W_{ij} = c = (\mathbf{c})_i.$$

Conversely, let  $c \neq D(c)$  for some  $c \in S$ . Let  $i \in [n]$  be such that  $F_{ij} = D$  and  $W_{ij} > 0$  for some  $j \in [n]$ . If  $\mathbf{c} = (c, \dots, c)^\top$  were a fixed-point of  $\mathbf{W} \circ \mathbf{F}$ , then

$$c = \sum_{j \in \mathcal{O}_i} W_{ij}D(c) + \sum_{j \in \mathcal{F}_i} W_{ij}c = D(c)W_{i, \mathcal{O}_i} + c(1 - W_{i, \mathcal{O}_i}),$$

which implies that

$$0 = W_{i, \mathcal{O}_i}(D(c) - c),$$

which is impossible since  $W_{i, \mathcal{O}_i} > 0$  by assumption.  $\square$

As a simple corollary to Proposition 6.1, we find that the possible consensus limiting opinions of  $\mathbf{W} \circ \mathbf{F}$  are given by the set of fixed points of  $D$  when  $D$  is continuous. In other words, under opposition, agents can only converge to consensus vectors in which the consensus value is a neutral opinion. The corollary mimics the corresponding ‘discrete case’ corollary in the same way that Proposition 6.1 mimics Proposition 5.1, *mutatis mutandis*.

**Corollary 6.1.** Let  $D$  be continuous. Then, if  $W_{i, \mathcal{O}_i} > 0$  for some  $i \in [n]$ ,

$$P_1[\text{Lim}(\mathbf{W} \circ \mathbf{F}) \cap \mathcal{C}] = \text{Fix}(D).$$

In particular, if  $D$  is radical,  $\text{Fix}(D) = \emptyset$  and (3.3) never converges to a consensus.

*Proof.* If  $D$  is continuous, limits of  $\mathbf{W} \circ \mathbf{F}$  are fixed-points of  $\mathbf{W} \circ \mathbf{F}$  by Remark 4.2, that is,  $\text{Lim}(\mathbf{W} \circ \mathbf{F}) = \text{Fix}(\mathbf{W} \circ \mathbf{F})$ . Accordingly, if  $W_{i, \mathcal{O}_i} > 0$  for some  $i \in [n]$ , then, by Proposition 6.1,  $\text{Fix}(D) = P_1[\text{Fix}(\mathbf{W} \circ \mathbf{F}) \cap \mathcal{C}] = P_1[\text{Lim}(\mathbf{W} \circ \mathbf{F}) \cap \mathcal{C}]$ .  $\square$

**Remark 6.1.** As in the discrete case, the proposition may imply long-run disagreement, for all initial opinions, for instance, when  $D$  is fixed point free.

By Brouwer’s fixed point theorem, however, stated in the appendix,  $D$  always has a fixed point as long as  $S$  is convex (our standard assumption) and compact and  $D$  is continuous. Hence, in this situation, updating process (3.3) always converges to at least one consensus opinion vector, given appropriate initial opinions, even under opposition. But also note, however, that one of our prime exemplars of a deviation function, hard opposition, is not a continuous function.

**Remark 6.2.** We mention the following generalization of Corollary 6.1 in case agents have individualized deviation functions  $D_i : S \rightarrow S$  as in Example 5.14. In this situation, if each  $D_i$  is continuous and if  $W_{i, \mathcal{O}_i} > 0$  for all  $i$  in a subset  $A \subseteq [n]$ , then

$$P_1[\text{Lim}(\mathbf{W} \circ \mathbf{F}) \cap \mathcal{C}] = \bigcap_{i \in A} \text{Fix}(D_i),$$

which implies that  $P_1[\text{Lim}(\mathbf{W} \circ \mathbf{F}) \cap \mathcal{C}] = \emptyset$  as soon as two  $D_i, D_{i'}$ , have disjoint sets of fixed-points. Of course, this generalization already applies to Proposition 6.1 such that  $P_1[\text{Fix}(\mathbf{W} \circ \mathbf{F}) \cap \mathcal{C}] = \bigcap_{i \in A} \text{Fix}(D_i)$  whenever  $W_{i, \mathcal{O}_i} > 0$  for all  $i$  in  $A$ .

We now want to study *actual* limiting behavior of opinion updating process (3.3), that is, we ask: what does (3.3) converge to (if it converges), rather than what can it possibly converge to (if at all)? An analytically (more or less) tractable situation arises when  $S = [\alpha, \beta]$  and  $D$  is soft opposition,  $D(x) = \alpha + \beta - x$  for all  $x \in S$ . In this case,  $D$  is affine-linear and, as may be clear and as we also show in the proof of Proposition 6.2 below, then also  $\mathbf{W} \circ \mathbf{F}$  is affine-linear, allowing the representation, for all  $\mathbf{x} \in S^n$ ,

$(\mathbf{W} \circ \mathbf{F})\mathbf{x} = \mathbf{A}\mathbf{x} + \mathbf{d}$ , for some matrix  $\mathbf{A} \in \mathbb{R}^{n \times n}$  and some vector  $\mathbf{d} \in \mathbb{R}^n$ . As we have indicated in Section 4, and, in particular, in Theorem 4.3, in this situation, if matrix  $\mathbf{A}$  has spectral radius smaller than 1, then  $\mathbf{W} \circ \mathbf{F}$  is a contraction mapping and, thus, by the Banach fixed point theorem,  $(\mathbf{W} \circ \mathbf{F})^t \mathbf{b}(0)$  converges to the unique fixed point of  $\mathbf{W} \circ \mathbf{F}$ . Now, by Proposition 6.1, the fixed points of  $\mathbf{W} \circ \mathbf{F}$  comprise the fixed points of  $D$ , that is, the neutral opinions. As we can easily verify, soft opposition  $D$  has precisely one fixed-point, namely,  $c = \frac{\alpha + \beta}{2}$ , from which we consequently conclude that, in the situation of the Banach fixed point theorem,  $\mathbf{W} \circ \mathbf{F}$  induces the consensus  $(c, \dots, c)^\top$ , for all initial opinion vectors  $\mathbf{b}(0) \in S^n$ . This is our next proposition.

**Proposition 6.2.** Let  $S = [\alpha, \beta]$  and let  $D$  be soft opposition. Then,  $\mathbf{W} \circ \mathbf{F}$  is an affine-linear operator of the form  $\mathbf{A}\mathbf{x} + \mathbf{d}$ . If  $\rho(\mathbf{A}) < 1$ , then  $\mathbf{W} \circ \mathbf{F}$  induces the unique consensus  $\frac{\alpha + \beta}{2}$ , for all initial opinion profiles  $\mathbf{b}(0) \in S^n$ .

*Proof.* The proposition is clear, except maybe for the representation of  $\mathbf{W} \circ \mathbf{F}$  as an affine-linear operator. For agent  $i = 1, \dots, n$ , we have

$$\begin{aligned} ((\mathbf{W} \circ \mathbf{F})\mathbf{x})_i &= \sum_{j \in \mathcal{F}_i} W_{ij} x_j + \sum_{j \in \mathcal{O}_i} W_{ij} D(x_j) = \sum_{j \in \mathcal{F}_i} W_{ij} x_j + \sum_{j \in \mathcal{O}_i} W_{ij} (\alpha + \beta - x_j) \\ &= \sum_{j \in \mathcal{F}_i} W_{ij} x_j + \sum_{j \in \mathcal{O}_i} (-W_{ij}) x_j + (\alpha + \beta) \sum_{j \in \mathcal{O}_i} W_{ij} \\ &= \sum_{j \in \mathcal{F}_i} W_{ij} x_j + \sum_{j \in \mathcal{O}_i} (-W_{ij}) x_j + (\alpha + \beta) W_{i, \mathcal{O}_i}. \end{aligned}$$

Thus, we can set  $\mathbf{A} \in \mathbb{R}^{n \times n}$ ,  $\mathbf{d} \in \mathbb{R}^n$  with

$$A_{ij} = \begin{cases} W_{ij} & \text{if } F_{ij} = F, \\ -W_{ij} & \text{if } F_{ij} = D, \end{cases}, \quad d_i = (\alpha + \beta) W_{i, \mathcal{O}_i}. \quad (6.2)$$

□

**Example 6.1.** Examples that satisfy the assumptions of Proposition 6.2 are, for instance, given in Examples 4.3 and 4.4 above.

Next, we show that in case  $D$  is soft opposition on  $S = [\alpha, \beta]$ , we come ‘quite close’ to having the condition  $\rho(\mathbf{A}) < 1$  satisfied, in case  $\mathbf{W}$  is row-stochastic.

**Proposition 6.3.** Let  $S = [\alpha, \beta]$  and let  $D$  be soft opposition. Then, for the operator  $\mathbf{W} \circ \mathbf{F}$  with the representation  $(\mathbf{A}, \mathbf{d})$ , we have

$$\rho(\mathbf{A}) \leq 1.$$

*Proof.* Consider matrix  $\mathbf{A}$  as defined in (6.2). We have, for all  $i = 1, \dots, n$ ,  $\sum_{j=1}^n |A_{ij}| = \sum_{j=1}^n W_{ij} = 1$ , and therefore,

$$\|\mathbf{A}\|_\infty = 1,$$

where  $\|\cdot\|_\infty$  is the row sum norm, defined in Definition 4.17. Moreover, by Theorem 4.5, it holds that

$$\rho(\mathbf{A}) \leq \|\mathbf{A}\|_p,$$

for any  $p$ -norm and any matrix  $\mathbf{A}$ . □

**Remark 6.3.** If  $F_{ij} = F$  for all  $i, j \in [n]$ , then  $\mathbf{A} = \mathbf{W}$  by (6.2) and  $\rho(\mathbf{A}) = \rho(\mathbf{W}) = 1$  such that  $\mathbf{W} \circ \mathbf{F}$  never is a contraction mapping in this case. To see that  $\rho(\mathbf{W}) = 1$  is easy: any non-zero consensus is a fixed-point of a row-stochastic matrix such that there exists an eigenvalue  $\lambda = 1$  of  $\mathbf{W}$ . In other words, *in the original DeGroot opinion dynamics model, without opposition,  $\mathbf{W} \circ \mathbf{F}$  cannot be a contraction mapping.*

A crucial question is, of course, what the condition  $\rho(\mathbf{A}) < 1$  in Proposition 6.2 actually *means* in terms of multigraph structure. Below, in Proposition 6.6, we consider this question for the situation when  $\mathbf{A}$  is strictly positive in each entry, and, in Theorem 6.2, in the situation when  $\mathbf{A}$  is symmetric and when  $A_{ii} = 0$ . In short, the condition  $\rho(\mathbf{A}) < 1$ , which is the ‘Banach fixed point theorem condition’, is equivalent, under the named assumptions, to the condition that the multigraph  $\mathbf{W} \circ \mathbf{F}$  is ‘unbalanced’ in that, e.g., two agents  $A$  and  $B$  have mutual friends but their friendship networks are not identical such that, e.g.,  $A$  opposes a friend of  $B$ . Apparently, this causes some inconsistency in the network — e.g., a violation of ‘friendship transitivity’ — and, ultimately, leads agents to neutrality, where everyone holds an uncontroversial opinion.<sup>28</sup>

## Polarization

As in the discrete majority model, we now discuss polarization of opinions. Our first proposition is identical to the corresponding proposition in the discrete case.

**Proposition 6.4.** Let  $\mathbf{W} \circ \mathbf{F}$  opposition bipartite and let  $a, b \in S$  be opposing viewpoints. Then, there exists a polarization opinion vector  $\mathbf{p}$  of opinions  $a$  and  $b$  such that  $(\mathbf{W} \circ \mathbf{F})\mathbf{p} = \mathbf{p}$ .

*Proof.* Let  $\mathcal{N}_1$  and  $\mathcal{N}_2$  be the partition of the agent set  $[n] = \{1, \dots, n\}$  such that agents in  $\mathcal{N}_i$ ,  $i = 1, 2$ , follow each other, while agents across the two sets oppose each other. Let  $a, b \in S$  be such that  $D(a) = b$  and  $D(b) = a$ . Moreover, let  $\mathbf{p}$  be such that each agent in  $\mathcal{N}_1$  holds opinion  $a$  (or  $b$ ) and each agent in  $\mathcal{N}_2$  holds opinion  $b$  (or  $a$ ). Then, for each agent  $i_1 \in \mathcal{N}_1$ :

$$((\mathbf{W} \circ \mathbf{F})\mathbf{p})_{i_1} = \sum_{j \in \mathcal{N}_1} W_{i_1 j} a + \sum_{j \in \mathcal{N}_2} W_{i_1 j} D(b) = a \left( \sum_{j \in \mathcal{N}_1} W_{i_1 j} + \sum_{j \in \mathcal{N}_2} W_{i_1 j} \right) = a = p_{i_1} = (\mathbf{p})_{i_1},$$

and analogously for agents in  $\mathcal{N}_2$ . □

Our next proposition is a strengthening of the above in the case  $D$  is affine-linear. Namely, in this situation, we can give conditions such that  $\mathbf{W} \circ \mathbf{F}$  converges to a polarization, no matter the initial opinions  $\mathbf{b}(0)$ , as long as  $\mathbf{F}$  is opposition bipartite.

**Proposition 6.5.** Let  $D$  be soft opposition on  $S = [\alpha, \beta]$  such that  $\mathbf{W} \circ \mathbf{F}$  is affine-linear with representation  $(\mathbf{A}, \mathbf{d})$ . Then, if  $\mathbf{F}$  is opposition bipartite,  $\lambda = 1$  is an eigenvalue of  $\mathbf{A}$ . If  $\lambda = 1$  is the only eigenvalue of  $\mathbf{A}$  on the unit circle and if  $\lambda = 1$  has algebraic multiplicity of 1, then  $\lim_{t \rightarrow \infty} (\mathbf{W} \circ \mathbf{F})^t \mathbf{b}(0) = \mathbf{p}$  for some polarization opinion vector  $\mathbf{p}$  (that depends on  $\mathbf{b}(0)$ ) and all initial opinion vectors  $\mathbf{b}(0) \in S^n$ .

*Proof.* We prove the proposition in the case  $\beta > 0$  and  $\alpha = -\beta$ .

To show that  $\lambda = 1$  is an eigenvalue of  $\mathbf{A}$  is simple. We need  $\mathbf{A}\mathbf{x} = \mathbf{x}$  for some  $\mathbf{x}$ . Let  $a, b$  such that  $a = -b$  with  $a \neq 0$ . Now, let  $x_i = b$  if  $i \in \mathcal{N}_1$  and  $x_i = a$  if  $i \in \mathcal{N}_2$ , for all  $i = 1, \dots, n$ , where  $(\mathcal{N}_1, \mathcal{N}_2)$  is the partition of the agent set  $[n]$  that arises since  $\mathbf{F}$  is opposition bipartite. Then, clearly,  $\mathbf{A}\mathbf{x} = \mathbf{x}$ . Now, since  $\lambda = 1$  is the only eigenvalue of  $\mathbf{A}$  on the unit circle and since  $\lambda = 1$  is semisimple (since the algebraic multiplicity  $m_a$  of  $\lambda$ , which is 1, equals the geometric multiplicity  $m_g$ , since  $m_a \geq m_g$  in general and  $m_g \geq 1$  in our situation),  $\lim_{t \rightarrow \infty} \mathbf{A}^t$  converges by Theorem 4.4. Moreover, it is well-known that  $\mathbf{A}^t \mathbf{b}(0)$  converges to an eigenvector of  $\mathbf{A}$  corresponding to  $\lambda = 1$  in this situation, for any  $\mathbf{b}(0)$  (see, e.g. Meyer (2000) [63], p.630). Since the eigenspace corresponding to  $\lambda = 1$  has dimension 1 (geometric multiplicity of  $\lambda = 1$  of 1) and since  $\mathbf{x}$  as above is a polarization eigenvector, each eigenvector of  $\mathbf{A}$  corresponding to  $\lambda = 1$  is a polarization. □

**Remark 6.4.** Again, the proposition is abstract in that it gives conditions on the spectral radius of matrix  $\mathbf{A}$  that ensure polarization but does not state what these conditions mean in terms of multigraph structure. In Theorem 6.2 below, we fill this gap and characterize, in graph theoretic terms, the condition, for instance, “ $\lambda = 1$  is the only eigenvalue of  $\mathbf{A}$  on the unit circle and has algebraic multiplicity of 1”.

**Remark 6.5.** For the subsequent analysis, let  $S = [-\beta, \beta]$  for convenience such that  $\mathbf{d} = \mathbf{0}$ .

How does  $\mathbf{p}(\infty) := \mathbf{p} = \lim_{t \rightarrow \infty} (\mathbf{W} \circ \mathbf{F})^t \mathbf{b}(0)$  in Proposition 6.5 depend on the initial opinions  $\mathbf{b}(0)$ ? One way to think of this limiting polarization is in terms of *social influence* vectors  $\mathbf{s} \in \mathbb{R}^n$  such that

<sup>28</sup>E.g., polarization cannot be upheld because of such inconsistencies as indicated.

$\|s\|_1 = \sum_{k=1}^n |s_k| = 1$  (cf. Jackson (2009) [51], Golub and Jackson (2010) [41]). Denoting the two opposing viewpoints  $a$  and  $b$  (with  $D(b) = -b = a$  and  $D(a) = -a = b$ ) in polarization vector  $\mathbf{p}(\infty)$  by  $a(\infty)$  and  $b(\infty)$ , respectively, and assuming that a relationship

$$\begin{aligned} a(\infty) &= \mathbf{s}^\top \mathbf{b}(0) = \sum_{i=1}^n s_i b_i(0), \\ b(\infty) &= \bar{\mathbf{s}}^\top \mathbf{b}(0) = \sum_{i=1}^n D(s_i) b_i(0), \end{aligned}$$

exists, for all initial opinions vectors  $\mathbf{b}(0)$  — that is, limiting polarization is a linear combination of agents' initial opinions where  $|s_i|$  denotes the *social influence* (proper) of agent  $i = 1, \dots, n$  and  $\text{sgn}(s_i) \in \{\pm 1\}$  denotes group membership of  $i \in [n]$  — we then have

$$\mathbf{s}^\top \mathbf{b}(0) = a(\infty) = \mathbf{s}^\top (\mathbf{A}\mathbf{b}(0))$$

since  $a(\infty)$  is the same whether we start from  $\mathbf{b}(0)$  or  $\mathbf{A}\mathbf{b}(0)$ . But since this must hold for any  $\mathbf{b}(0)$ , we have

$$\mathbf{s}^\top = \mathbf{s}^\top \mathbf{A},$$

or, equivalently,

$$\mathbf{s} = \mathbf{A}^\top \mathbf{s},$$

such that  $\mathbf{s}$  is simply an eigenvector of matrix  $\mathbf{A}^\top$  (corresponding to the eigenvalue  $\lambda = 1$ ). In other words, in order to compute  $\mathbf{p}(\infty)$  given  $\mathbf{b}(0)$ , it might be possible to compute the eigenvector  $\mathbf{s}$  of  $\mathbf{A}^\top$  corresponding to  $\lambda = 1$  and then apply  $\mathbf{s}$  to  $\mathbf{b}(0)$  in the form  $\mathbf{s}^\top \mathbf{b}(0)$  to derive one limiting viewpoint and in the form  $\bar{\mathbf{s}}^\top \mathbf{b}(0)$  to derive the other. Hence, since social influence is given by an eigenvector of  $\mathbf{A}^\top$ , social influence of agents is measured by *eigenvector centrality* (cf. Bonacich (1972) [13]), in the current setting, in a very similar way as in the original DeGroot opinion dynamics model.

We give the following detailed example for Proposition 6.5 and the subsequent remark.

**Example 6.2.** Let  $n = 2$  and let

$$\mathbf{W} = \begin{pmatrix} \frac{3}{4} & \frac{1}{4} \\ \frac{1}{2} & \frac{1}{2} \end{pmatrix}, \quad \mathbf{F} = \begin{pmatrix} F & D \\ D & F \end{pmatrix},$$

Let  $D$  be soft opposition on  $S = [\alpha, \beta]$ . We first note that  $\mathbf{W} \circ \mathbf{F}$  is opposition bipartite, e.g., with  $\mathcal{N}_1 = \{1\}$ ,  $\mathcal{N}_2 = \{2\}$ . Moreover, the affine-linear representation of  $\mathbf{W} \circ \mathbf{F}$  is given by

$$\mathbf{A} = \begin{pmatrix} \frac{3}{4} & -\frac{1}{4} \\ -\frac{1}{2} & \frac{1}{2} \end{pmatrix}, \quad \mathbf{d} = (\alpha + \beta) \begin{pmatrix} \frac{1}{4} \\ \frac{1}{2} \end{pmatrix};$$

note that we assume that  $\alpha = -\beta$  such that  $\mathbf{d} = \mathbf{0}$ . The eigenvalues of matrix  $\mathbf{A}$  are determined as the roots of the characteristic polynomial  $\chi(\lambda) = \det(\mathbf{A} - \lambda \mathbf{I}_n)$  where  $\mathbf{I}_n$  is the  $n \times n$  identity matrix. We have,

$$\chi(\lambda) = \left(\frac{3}{4} - \lambda\right)\left(\frac{1}{2} - \lambda\right) - \frac{1}{8} = \frac{1}{4} - \frac{5}{4}\lambda + \lambda^2 = (\lambda - 1)\left(\lambda - \frac{1}{4}\right).$$

Hence,  $\lambda = 1$  and  $\lambda = \frac{1}{4}$  are the two eigenvalues of  $\mathbf{A}$ . Thus,  $\lambda = 1$  is the only eigenvalue on the unit circle and the algebraic multiplicity of  $\lambda = 1$  is 1 since the exponent of  $(\lambda - 1)$  in  $\chi(\lambda)$  is 1. Hence,  $\lim_{t \rightarrow \infty} (\mathbf{W} \circ \mathbf{F})^t \mathbf{b}(0)$  is a polarization for any  $\mathbf{b}(0) \in S^n$ , by Proposition 6.5. To determine the influence vector  $\mathbf{s}$ , we need to compute the normalized eigenvector of  $\mathbf{A}^\top$  corresponding to  $\lambda = 1$ . It is easy to see that  $\mathbf{s} = \left(\frac{2}{3}, -\frac{1}{3}\right)^\top$  is the searched for normalized unit vector since  $\mathbf{A}^\top \mathbf{s} = \mathbf{s}$ . Now, one sees how  $\mathbf{s}$  captures social influence: agent 1 is apparently more influential, since he weighs himself higher, than

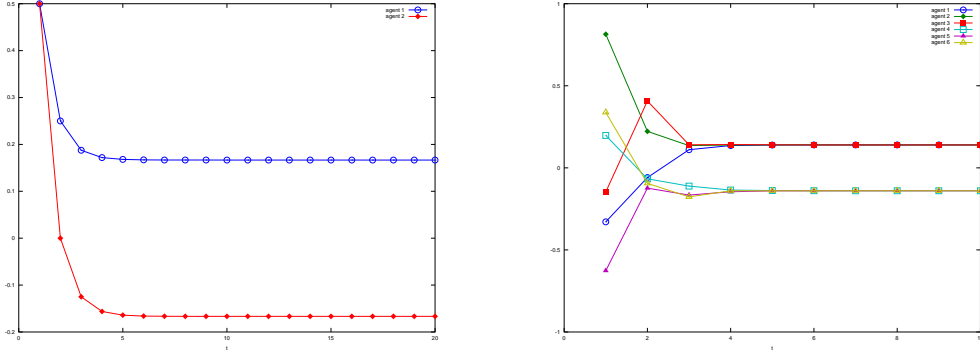

Figure 10: Left:  $\mathbf{b}(t)$ , for  $t = 0, \dots, 20$ , for the process discussed in Example 6.2. Right:  $\mathbf{b}(t)$ , for  $t = 0, \dots, 10$ , for a random  $6 \times 6$  matrix  $\mathbf{W}$  (such that  $\mathbf{W} \circ \mathbf{F}$  satisfies the conditions of Proposition 6.5) and an opposition bipartite network  $\mathbf{F}$  and random initial opinions  $\mathbf{b}(0) \in [-1, 1]^6$ .

agent 2 ( $3/4$  self-weight vs.  $1/2$ ); accordingly, his influence weight in  $\mathbf{s}$  is larger in absolute value,  $\frac{2}{3} > \frac{1}{3}$ . Then, limiting opinions are simply given by,

$$\begin{aligned} a(\infty) &= \frac{2}{3}b_1(0) - \frac{1}{3}b_2(0), \\ b(\infty) &= -\frac{2}{3}b_1(0) + \frac{1}{3}b_2(0). \end{aligned}$$

For instance, if agents start with the consensus  $\mathbf{b}(0) = (\frac{1}{2}, \frac{1}{2})^\top$ , they will end up at the polarization  $\mathbf{p}(\infty) = (\frac{1}{6}, -\frac{1}{6})^\top$ . In Figure 10, we illustrate opinion dynamics for this setup and for a random opposition bipartite multigraph.

Next, we show that ‘opposition bipartiteness’ is a very delicate condition in the continuous model that, if slightly violated, does not lead agents to a polarization but, rather, to a neutral consensus (or to divergence), in the situation when  $D$  is soft opposition. To this end, we define the notion of ‘opposition (anti-)equivalent’ agents.

**Definition 6.1.** We call two agents  $i_0, i_1 \in [n]$  *opposition equivalent* if  $F_{i_0j} = F_{i_1j}$  for all  $j \in [n]$ .

We call two agents  $i_0, i_1 \in [n]$  *opposition anti-equivalent* if  $F_{i_0j} = \neg F_{i_1j}$  for all  $j \in [n]$ , where we let  $\neg D = F$  and  $\neg F = D$ .

Note that these two notions are closely related, e.g., to opposition bipartite networks. Namely, in the latter situation, there exist two groups of agents  $\mathcal{N}_1$  and  $\mathcal{N}_2$  such that for all  $i_0, i_1 \in \mathcal{N}_1$ ,  $i_0$  and  $i_1$  are opposition equivalent (and follow each other) while for all  $i_0 \in \mathcal{N}_1$  and  $i_1 \in \mathcal{N}_2$ ,  $i_0$  and  $i_1$  are opposition anti-equivalent.

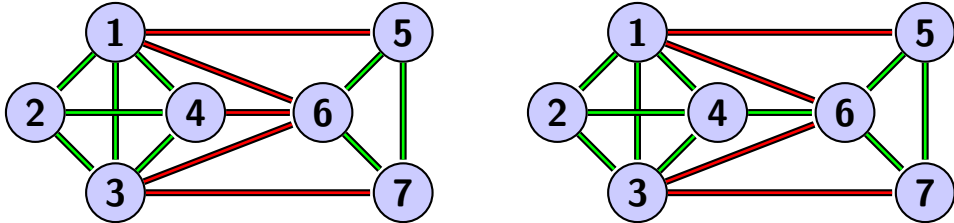

Figure 11: Balanced and unbalanced networks. The left network is opposition bipartite (balanced) while the right is not. In particular, agents 3 and 4 have mutual ‘friends’ (agents 1, 2) while agent 6 is in 3’s outgroup and 4’s ingroup.

**Proposition 6.6.** Let  $D$  be soft opposition on  $S = [\alpha, \beta]$ . Let  $\mathbf{W} > 0$ , entry-wise. Let  $(\mathbf{A}, \mathbf{d})$  be the representation of  $\mathbf{W} \circ \mathbf{F}$ . Assume that  $\mathbf{A}$  has no complex eigenvalues (on the unit circle). Then, if there exist agents  $i_0$  and  $i_1$  such that  $i_0$  and  $i_1$  are neither opposition equivalent nor opposition anti-equivalent, then  $\mathbf{W} \circ \mathbf{F}$  induces the consensus  $\frac{\alpha+\beta}{2}$ , for all initial opinion vectors  $\mathbf{b}(0)$ .

*Proof.* By Proposition 6.3,  $\rho(\mathbf{A}) \leq 1$ . We want to exclude the case  $\rho(\mathbf{A}) = 1$ . This means we want to exclude that  $\pm 1 \in \sigma(\mathbf{A})$  since  $\mathbf{A}$  has no complex eigenvalues on the unit circle by assumption. For all agents  $i = 1, \dots, n$  and any vector  $\mathbf{x} \in \mathbb{R}^n$  with  $\|\mathbf{x}\|_\infty = \max_{i \in [n]} |x_i|$ , it holds that

$$|A_{i1}x_1 + \dots + A_{in}x_n| \leq |A_{i1}| |x_1| + \dots + |A_{in}| |x_n| < (|A_{i1}| + \dots + |A_{in}|) \|\mathbf{x}\|_\infty = \|\mathbf{x}\|_\infty$$

unless  $|x_1| = \dots = |x_n|$  (since  $W_{ij} = |A_{ij}|$  is strictly positive by assumption, for all  $i, j \in [n]$ ), in which case equality may hold instead of  $<$ . Thus, if it does not hold that  $|x_1| = \dots = |x_n|$ , then  $\mathbf{A}\mathbf{x} = \mathbf{x}$  or  $\mathbf{A}\mathbf{x} = -\mathbf{x}$  are impossible since both imply that  $\|\mathbf{A}\mathbf{x}\|_\infty = \|\mathbf{x}\|_\infty$ , contradicting  $\|\mathbf{A}\mathbf{x}\|_\infty < \|\mathbf{x}\|_\infty$ .

So, consider  $\mathbf{x}$  with  $|x_1| = \dots = |x_n|$ . Without loss of generality, we may assume that  $\|\mathbf{x}\|_\infty = 1$  such that  $\mathbf{x}$  is a vector with entries 1, either with positive or negative sign. In this case, for agent  $i_0$ ,

$$\sum_{j=1}^n A_{i_0 j} \underbrace{x_j}_{\in \{\pm 1\}} = x_{i_0} \in \{\pm 1\}$$

implies that, by the structure of matrix  $\mathbf{A}$  (row-stochasticity of  $\mathbf{W}$  and  $A_{ij} \neq 0$  for all  $i, j \in [n]$ ), all summands  $A_{i_0 j} x_j$  on the left-hand side of the last equation must have the same sign, either positive or negative. But then, for agent  $i_1$ , it cannot be that  $\sum_{j=1}^n A_{i_1 j} \underbrace{x_j}_{\in \{\pm 1\}} \in \{\pm 1\}$ , since some summands of the

left-hand side of this equation must have opposite signs since  $i_0$  and  $i_1$  are neither opposition equivalent nor opposition anti-equivalent. Thus, under the assumptions of the proposition,  $\mathbf{A}\mathbf{x} = \mathbf{x}$  or  $\mathbf{A}\mathbf{x} = -\mathbf{x}$  cannot hold for any  $\mathbf{x} \in \mathbb{R}^n$  and, thus,  $\mathbf{A}$  has no eigenvalues  $\pm 1$ , whence  $\rho(\mathbf{A}) < 1$  and  $\mathbf{W} \circ \mathbf{F}$  is a contraction mapping.  $\square$

**Remark 6.6.** Proposition 6.6 gives less abstract conditions for convergence to a neutral consensus than we have outlined before and which were based on the size of the spectral radius of matrix  $\mathbf{A}$  in the affine-linear representation of  $\mathbf{W} \circ \mathbf{F}$ . Namely, in the situation of the proposition — e.g., with all weights  $W_{ij}$  strictly positive and no complex eigenvalues on the unit circle — a spectral radius of  $\mathbf{A}$  strictly smaller than 1 is implied by the condition that two agents  $i_0$  and  $i_1$  are ‘misaligned’ in the sense that there are two distinct agents  $A$  and  $B$  such that  $i_0$  and  $i_1$  have the same relation to  $A$  but inverse relationships to  $B$ . For example,  $A$  might both be in  $i_0$ ’s and  $i_1$ ’s ingroup, while  $B$  is in  $i_0$ ’s ingroup and in  $i_1$ ’s outgroup; consider Figure 11 for an example. It is clear that such a configuration causes the corresponding multigraph to be ‘unbalanced’ because of ‘contradicting’ friendship/animosity relationships since, in the example made,  $i_0$ ’s and  $i_1$ ’s ingroups are overlapping but not identical. Accordingly, agents do not polarize but converge to a neutral consensus. Thus, neutrality may be perceived of as resulting from a lack of balance which would otherwise induce polarizations, in this context.

In the following beautiful theorem, Theorem 6.1, we generalize our above observation to the case when the multigraph underlying  $\mathbf{W} \circ \mathbf{F}$  is strongly connected and aperiodic, rather than fully connected. The theorem, together with its generalization in Theorem 6.2, gives an *exhaustive classification of results* on convergence of  $(\mathbf{W} \circ \mathbf{F})^t \mathbf{b}(0)$  in case  $\mathbf{W} \circ \mathbf{F}$  is strongly connected (and aperiodic); as restraining conditions, we merely assume that  $W_{ii} = 0$  and that  $A_{ij} = A_{ji}$ , that is, *intensity and kind of relationship are symmetric*. The more general cases are left for ongoing research. Our theorem is based, to a significant degree, on the corresponding results given in Altafini (2013) [6], who analyzes a very similar situation as we, but considers the (time-)continuous process  $\dot{\mathbf{x}} = -\mathbf{L}\mathbf{x}$ , rather than the (time-)discrete model  $\mathbf{b}(t+1) = (\mathbf{W} \circ \mathbf{F})\mathbf{b}(t)$ , as we investigate.

As to the results, the theorem shows that agents polarize *if and only if* the operator  $\mathbf{W} \circ \mathbf{F}$  is opposition bipartite; that agents diverge *if and only if* the operator  $\mathbf{W} \circ \mathbf{F}$  is anti-opposition bipartite; and, finally, that agents reach a neutral consensus *if and only if* none of the former two conditions hold.

We first state the following simple lemma.

**Lemma 6.1.** Let  $\mathbf{W} \circ \mathbf{F}$  be an arbitrary multigraph. Then,  $\mathbf{W} \circ \mathbf{F}$  is opposition bipartite if and only if  $\mathbf{W} \circ \bar{\mathbf{F}}$  is anti-opposition bipartite, where  $\bar{\mathbf{F}}$  is the matrix with entries  $\bar{F}_{ij} = \neg F_{ij}$ .

*Proof.* See Figure 7, in Section 5, for a graphical proof.  $\square$

If  $D$  is soft opposition on  $S = [-\beta, \beta]$ , let  $(\mathbf{A}, \mathbf{0})$  be the representation of  $\mathbf{W} \circ \mathbf{F}$ . Then, the lemma specializes to the statement that  $(\mathbf{A}, \mathbf{0})$  is opposition bipartite if and only if  $(-\mathbf{A}, \mathbf{0})$  is anti-opposition bipartite.

**Theorem 6.1.** Let  $D$  be soft opposition on  $S = [-\beta, \beta]$  for some  $\beta > 0$ . Let  $\mathbf{W} \circ \mathbf{F}$  be an arbitrary operator such that  $W_{ii} = 0$  for all  $i \in [n]$ . Let  $(\mathbf{A}, \mathbf{0})$  be the affine-linear representation of  $\mathbf{W} \circ \mathbf{F}$  and assume, moreover, that  $\mathbf{A}$  is symmetric. Assume that  $\mathbf{W} \circ \mathbf{F}$  is strongly connected (since  $\mathbf{A}$  is symmetric, we might also simply say ‘connected’) and aperiodic. Then:

- (i)  $\mathbf{W} \circ \mathbf{F}$  induces a polarization if and only if  $\mathbf{W} \circ \mathbf{F}$  is opposition bipartite.
- (ii)  $\mathbf{W} \circ \mathbf{F}$  diverges if and only if  $\mathbf{W} \circ \mathbf{F}$  is anti-opposition bipartite.
- (iii)  $\mathbf{W} \circ \mathbf{F}$  induces a neutral consensus if and only if  $\mathbf{W} \circ \mathbf{F}$  is neither opposition bipartite nor anti-opposition bipartite.

*Proof.* The theorem follows from the following facts. (i) If  $\mathbf{W} \circ \mathbf{F}$  induces a polarization, then, necessarily,  $1 \in \sigma(\mathbf{A})$ . But, (1)  $1 \in \sigma(\mathbf{A}) \iff \mathbf{W} \circ \mathbf{F}$  is opposition bipartite. Conversely, let  $\mathbf{W} \circ \mathbf{F}$  be opposition bipartite. Then, (2)  $|\mathbf{A}|$  — the matrix with entries  $|A_{ij}|$  — and  $\mathbf{A}$  are *isospectral*, that is, they have the same eigenvalues and with the same associated multiplicities. Now, (3) a strongly connected and aperiodic row-stochastic matrix  $|\mathbf{A}|$  has exactly one eigenvalue on the unit circle,  $\lambda = 1$ , with algebraic and geometric multiplicity of 1. Therefore,  $\mathbf{A}$  has exactly one eigenvalue on the unit circle,  $\lambda = 1$ , with algebraic and geometric multiplicity of 1 and, consequently, converges by Theorem 4.4. Moreover, since each polarization vector  $\mathbf{x}$  with  $x_i = 1$  if  $i \in \mathcal{N}_1$  and  $x_i = -1$  if  $i \in \mathcal{N}_2$  satisfies  $\mathbf{A}\mathbf{x} = (\mathbf{W} \circ \mathbf{F})\mathbf{x} = \mathbf{x}$  when  $\mathbf{W} \circ \mathbf{F}$  is opposition bipartite with partition  $(\mathcal{N}_1, \mathcal{N}_2)$ ,  $\mathbf{W} \circ \mathbf{F}$  induces a polarization.

Part (ii) follows from the fact that  $1 \in \sigma(\mathbf{A}) \iff \mathbf{W} \circ \mathbf{F}$  is opposition bipartite and the fact that  $\mathbf{W} \circ \mathbf{F}$  with representation  $\mathbf{A}$  is opposition bipartite if and only if  $-\mathbf{A}$  is anti-opposition bipartite by Lemma 6.1. Thus,  $-1 \in \sigma(\mathbf{A}) \iff \mathbf{W} \circ \mathbf{F}$  is anti-opposition bipartite, whence  $\mathbf{A}$  diverges by Theorem 4.4.

Finally, part (iii) follows since if  $\mathbf{W} \circ \mathbf{F}$  is neither opposition bipartite nor anti-opposition bipartite, then, by our above reasonings,  $\pm 1 \notin \sigma(\mathbf{A})$ , and since  $\mathbf{A}$  is symmetric,  $\mathbf{A}$  has no complex eigenvalues, whence  $\rho(\mathbf{A}) < 1$  and, thus,  $\mathbf{W} \circ \mathbf{F}$  is a contraction mapping. Consequently,  $\mathbf{W} \circ \mathbf{F}$  induces the unique neutral consensus  $(c, \dots, c)$  by Banach’s fixed point theorem, Theorem 4.2, where  $c = 0$  due to the choice of  $D$ .

Now, fact (3) is a classical theorem for row-stochastic matrices, which is, e.g., based on the famous Perron-Frobenius theorem; in our context, it is given by combining Theorems 4.1 and 4.4, for example. We prove facts (2) and (3) in the appendix, Lemmas A.1, A.2, and A.3, respectively.  $\square$

It is a well-known fact that graphs can be partitioned into strongly connected and closed groups of nodes and the (possibly empty) ‘rest of the world’ (cf., e.g., Jackson (2009) [51], Buechel, Hellmann, and Klößner (2013) [16]). Hence, in the setup of Theorem 6.1,  $\mathbf{W} \circ \mathbf{F}$  can be partitioned into precisely such a structuring. Then, if the underlying graphs corresponding to each strongly connected group in the partition satisfy aperiodicity, Theorem 6.1 may be applied to determine limits of  $\mathbf{W} \circ \mathbf{F}$ .

**Example 6.3.** Let  $n = 12$  and let  $\mathbf{W} \circ \mathbf{F}$  be such that  $\mathbf{A}$  has the form

$$\mathbf{A} = \begin{pmatrix} \mathbf{C}_1 & \mathbf{0} & \mathbf{0} & \mathbf{0} \\ \mathbf{0} & \mathbf{C}_2 & \mathbf{0} & \mathbf{0} \\ \mathbf{0} & \mathbf{0} & \mathbf{C}_3 & \mathbf{0} \\ & \mathbf{r}^\top & & \end{pmatrix},$$

where

$$\mathbf{C}_1 = \frac{1}{2} \begin{pmatrix} 0 & -1 & -1 \\ -1 & 0 & 1 \\ -1 & 1 & 0 \end{pmatrix}, \quad \mathbf{C}_2 = \frac{1}{3} \begin{pmatrix} 0 & 1 & -1 & 1 \\ 1 & 0 & 1 & -1 \\ -1 & 1 & 0 & 1 \\ 1 & -1 & 1 & 0 \end{pmatrix}, \quad \mathbf{C}_3 = \frac{1}{3} \begin{pmatrix} 0 & 1 & 1 & 1 \\ 1 & 0 & 1 & 1 \\ 1 & 0 & 1 & -1 \\ 1 & 1 & -1 & 0 \end{pmatrix},$$

and  $\mathbf{r}$  is the vector with  $r_3 = -0.6$ ,  $r_9 = 0.4$  and  $r_j = 0$  for all other  $j \in [n]$ . The multigraph corresponding to  $\mathbf{W} \circ \mathbf{F}$  is shown in Figure 12. From this we see that, within all closed and strongly connected groups, the underlying graphs are aperiodic such that Theorem 6.1 may be applied to the strongly connected groups. Hence, we know that, no matter the initial opinions, agents  $\{1, 2, 3\}$  will polarize since their underlying multigraph is opposition bipartite — we have, e.g.,  $\mathcal{N}_1 = \{1\}$  and  $\mathcal{N}_2 = \{2, 3\}$ . Groups  $\{4, 5, 6, 7\}$  and  $\{8, 9, 10, 11\}$  will either diverge or reach a neutral consensus. Since the group  $\{4, 5, 6, 7\}$  is anti-opposition bipartite, it will, in fact, diverge and since the group  $\{8, 9, 10, 11\}$  is, in fact, neither opposition bipartite nor anti-opposition bipartite, it will reach a neutral consensus. The ‘rest of the world’, agent 12, will attain a limit opinion that is a linear combination of the opinions of agents  $\{1, 2, 3\}$  and  $\{8, 9, 10, 11\}$  — the latter attain a neutral consensus. We plot a sample evolution of the corresponding opinion dynamics

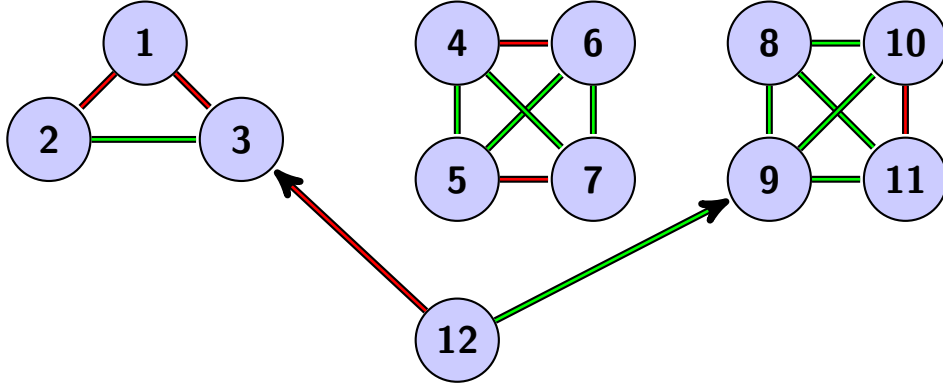

Figure 12: Description in text. As usual, we omit links corresponding to weights from the multigraphs, simply indicating links corresponding to opposition/following behavior. For convenience, we color following in green and deviating in red. All links are undirected unless indicated by a respective arrow.

in Figure 13.

Now, we want to characterize limit behavior of a strongly connected  $\mathbf{W} \circ \mathbf{F}$  in case  $\mathbf{W} \circ \mathbf{F}$  is *periodic*, rather than aperiodic. For this, we need the insight that the concepts of ‘opposition-bipartiteness’ and ‘anti-opposition bipartite’ collapse if and only if  $\mathbf{W} \circ \mathbf{F}$  is periodic. Figure 14 illustrates.

**Lemma 6.2.** A strongly connected multigraph  $\mathbf{W} \circ \mathbf{F}$  is periodic if and only if it is both opposition-bipartite and anti-opposition bipartite.

*Proof.* If  $\mathbf{W} \circ \mathbf{F}$  is aperiodic,  $\mathbf{W} \circ \mathbf{F}$  cannot be both opposition bipartite and anti-opposition bipartite because this would contradict Theorem 6.1, parts (i) and (ii), according to which the two concepts are distinct in this case (strongly connected and aperiodic opposition bipartite multigraphs have eigenvalues  $\lambda = 1$  on the unit circle and no other, there, while anti-opposition bipartite multigraphs have eigenvalues  $\lambda = -1$  on the unit circle and no other, there).

Conversely, assume that  $\mathbf{W} \circ \mathbf{F}$  is periodic and assume that  $\mathbf{W} \circ \mathbf{F}$  is opposition bipartite with partition  $(\mathcal{N}_1, \mathcal{N}_2)$ . Then, the crucial aspect to note is that there can be no triangles in  $\mathbf{W} \circ \mathbf{F}$ , that is, nodes  $i, j, k \in [n]$  such that  $W_{ij} > 0$ ,  $W_{jk} > 0$  and  $W_{ik} > 0$  for otherwise — note that  $\mathbf{W} \circ \mathbf{F}$  is symmetric — there would be a simple cycle of length 3 in  $\mathbf{W} \circ \mathbf{F}$ , whence the greatest common divisor of all simple cycles would be 1 (a symmetric connected graph trivially has simple cycles of length 2), contradicting that  $\mathbf{W} \circ \mathbf{F}$  is periodic.

Hence, construct an anti-opposition bipartite partition of  $\mathbf{W} \circ \mathbf{F}$  from  $(\mathcal{N}_1, \mathcal{N}_2)$  as follows. Let  $\tilde{\mathcal{N}}_1$  and  $\tilde{\mathcal{N}}_2$  be empty sets. Take  $a \in \mathcal{N}_1$ , put it in  $\tilde{\mathcal{N}}_1$ , together with all its ‘enemies’ and put the ‘friends’ of  $a$  in

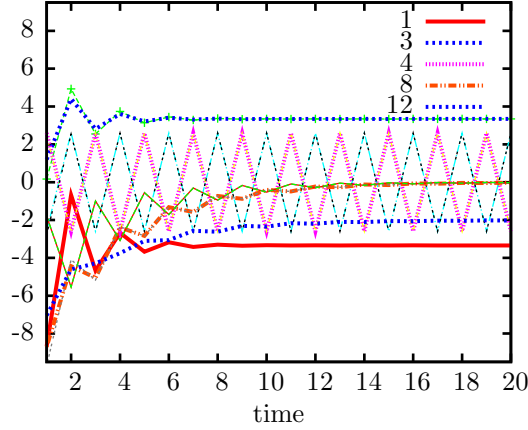

Figure 13: Sample opinion dynamics for Example 6.3. We see polarization, neutrality, and divergence, as well as an agent — agent 12, the ‘rest of the world’ — who holds an opinion that is a linear combination of the opinions of member 1 of group  $\{1, 2, 3\}$  and of member 9 of group  $\{8, 9, 10, 11\}$ . Selected agents highlighted.

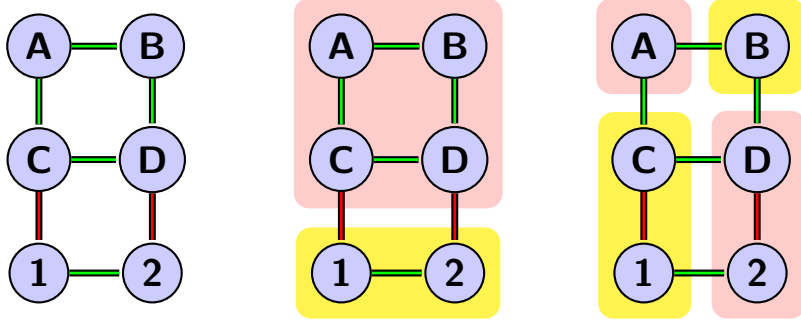

Figure 14: ‘Re-arranging’ an opposition bipartite partitioning of a strongly connected periodic multigraph to obtain an anti-opposition bipartite partitioning, Lemma 6.2 at work. Left: The periodic multigraph. Middle: The original opposition-bipartite partitioning  $(\mathcal{N}_1, \mathcal{N}_2)$ . Right: Choosing the sets  $\tilde{\mathcal{N}}_1$  and  $\tilde{\mathcal{N}}_2$  of the anti-opposition bipartite partitioning.

$\tilde{\mathcal{N}}_2$ . Consider any friend  $c$  of any friend  $b$  of  $a$  (other than  $a$ ). Clearly, since there are no triangles in  $\mathbf{W} \circ \mathbf{F}$ ,  $a$  and  $c$  are in no friendship relation. Hence, put  $c$  in  $\tilde{\mathcal{N}}_1$  as well ( $c$  might have negative relationships with the other nodes in  $\tilde{\mathcal{N}}_1$ , which does not violate the conditions of anti-opposition bipartiteness). Continue until all nodes are covered with  $c$  taking the role of  $a$  at the beginning of the process and note that no condition of anti-bipartiteness is ever violated during the process.

By an analogue procedure, anti-opposition bipartiteness may be converted into opposition bipartiteness in the case of strongly connected periodic multigraphs.  $\square$

With Theorem 6.1 and the lemma, we obtain the following corollary, which takes care of the periodicity case of  $\mathbf{W} \circ \mathbf{F}$ .

**Corollary 6.2.** Let  $D$  be soft opposition on  $S = [-\beta, \beta]$  for some  $\beta > 0$ . Let  $\mathbf{W} \circ \mathbf{F}$  be an arbitrary operator such that  $W_{ii} = 0$  for all  $i \in [n]$ . Let  $(\mathbf{A}, \mathbf{0})$  be the affine-linear representation of  $\mathbf{W} \circ \mathbf{F}$  and assume, moreover, that  $\mathbf{A}$  is symmetric. Assume that  $\mathbf{W} \circ \mathbf{F}$  is strongly connected (or, since  $\mathbf{A}$  is symmetric, simply ‘connected’) and periodic. Then:

- (i)  $\mathbf{W} \circ \mathbf{F}$  diverges if and only if  $\mathbf{W} \circ \mathbf{F}$  is opposition bipartite.
- (ii)  $\mathbf{W} \circ \mathbf{F}$  induces a neutral consensus if and only if  $\mathbf{W} \circ \mathbf{F}$  is not opposition bipartite.

*Proof.* Putting all results together, we obtain the following equivalences for symmetric, strongly connected and periodic multigraphs  $\mathbf{W} \circ \mathbf{F}$  with representation  $\mathbf{A}$ :

$$\mathbf{W} \circ \mathbf{F} \text{ is not OBIP} \iff \pm 1 \notin \sigma(\mathbf{A}) \iff \rho(\mathbf{A}) < 1 \iff \lim_{t \rightarrow \infty} (\mathbf{W} \circ \mathbf{F})^t \mathbf{b}(0) = \mathbf{0} \forall \mathbf{b}(0) \in S^n,$$

where we let OBIP abbreviate ‘opposition bipartite’. The equivalences prove the corollary. The first equivalence follows from the fact that  $\mathbf{W} \circ \mathbf{F}$  is OBIP if and only if  $1 \in \sigma(\mathbf{A})$  and  $\mathbf{W} \circ \mathbf{F}$  is anti-OBIP if and only if  $-1 \in \sigma(\mathbf{A})$  for strongly connected multigraphs. Hence, by Lemma 6.2,  $\pm 1 \in \sigma(\mathbf{A})$  if and only if  $\mathbf{W} \circ \mathbf{F}$  is OBIP for strongly connected and periodic multigraphs. The second equivalence follows since  $\mathbf{A}$  is symmetric, whence it has no other potential eigenvalues than  $\pm 1$  on the unit circle.  $\square$

Therefore, since periodicity and aperiodicity are mutually exclusive properties, we have fully characterized limit properties of strongly connected  $\mathbf{W} \circ \mathbf{F}$  in the case of soft opposition  $D$  on  $S = [-\beta, \beta]$  and where we assume that the linear representation  $\mathbf{A}$  of  $\mathbf{W} \circ \mathbf{F}$  satisfies symmetry and  $A_{ii} = 0$ . We summarize our findings in the following theorem.

**Theorem 6.2.** Let  $D$  be soft opposition on  $S = [-\beta, \beta]$  for some  $\beta > 0$ . Let  $\mathbf{W} \circ \mathbf{F}$  be an arbitrary operator such that  $W_{ii} = 0$  for all  $i \in [n]$ . Let  $(\mathbf{A}, \mathbf{0})$  be the affine-linear representation of  $\mathbf{W} \circ \mathbf{F}$  and assume, moreover, that  $\mathbf{A}$  is symmetric. Assume that  $\mathbf{W} \circ \mathbf{F}$  is strongly connected. Then:

- (i)  $\mathbf{W} \circ \mathbf{F}$  diverges if and only if  $\mathbf{W} \circ \mathbf{F}$  is anti-opposition bipartite.
- (ii)  $\mathbf{W} \circ \mathbf{F}$  induces a polarization if and only if  $\mathbf{W} \circ \mathbf{F}$  is opposition bipartite and aperiodic.
- (iii)  $\mathbf{W} \circ \mathbf{F}$  induces a neutral consensus if and only if it is neither opposition bipartite nor anti-opposition bipartite.

**Remark 6.7.** The fact that polarization requires ‘exact’ balance (opposition bipartiteness) and admits not a ‘grain of unbalancedness’, as stated in Theorem 6.1, may appear odd since one might expect, in reality, small perturbations to balance (e.g., small-scale intra-group antagonisms or individual friendships among enemies) to be the rule, rather than the exception, particularly in large enough systems. We note that this result is, however, to a large part, due to the continuous opinion spectrum and the averaging updating process that we have considered in this section. If the reader thinks that reality is better perceived of as being discrete, with weighted majority voting a more plausible opinion updating mechanism, then we note that, as we have shown, the discrete model *is* in fact robust against small perturbations such that polarizing viewpoints can be Nash equilibria in this case even if the underlying multigraphs exhibit (marginal) unbalancedness.

## 6.2 The requirement $W_{i, \mathcal{F}_i} = 1 + W_{i, \mathcal{O}_i}$

We have seen that, in the continuous model, agents cannot reach a non-neutral consensus, under opposition. This is unlike in the discrete case, where the same conclusion requires a certain ‘weight mass condition’, namely, that at least one agent’s outgroup is decisive for him. One way to interpret this, consistent across both models, is to say that in the continuous model, under the row-stochasticity assumption,  $W_{i, A} > 0$  already means that group  $A \subseteq [n]$  is decisive for agent  $i$ , rather than  $W_{i, A} > \frac{1}{2}$  as in the discrete model. In this interpretation, one way to ‘address’ the issue of reaching non-neutral consensus opinions is to either restrict the weight mass assigned to opposed agents (e.g., demanding that  $W_{i, \mathcal{O}_i} \leq \frac{1}{2}$  in the discrete model) or to enlarge the weight mass assigned to trusted agents. In the continuous model, we would be forced to consider the latter option since requiring that  $W_{i, \mathcal{O}_i} \leq 0$  would be tantamount to resorting to the standard DeGroot model, without opposition.

In the following, we sketch one possibility for agents to reach non-neutral consensus opinions in the continuous model, even under the presence of opposition. We do so for a very special but important instance of opposition function  $D$ , namely, soft opposition on  $\mathbb{R}$ , that is,  $D(x) = -x$  (see below on why we need to extend  $S$  to  $\mathbb{R}$ , in this situation). In this setup, a weight mass requirement that allows non-neutral consensus formation can be read off from the proof of Proposition 6.1, which illustrates what ‘goes wrong’ under the row-stochasticity assumption. Namely, assuming that  $D(c) \neq c$  ( $c$  is a non-neutral

opinion), in order for  $\mathbf{c} = (c, \dots, c)^\top$  to be a fixed-point of  $\mathbf{W} \circ \mathbf{F}$  it must hold that:

$$c = \sum_{j \in \mathcal{F}_i} W_{ij}c + \sum_{j \in \mathcal{O}_i} W_{ij}D(c) = \sum_{j \in \mathcal{F}_i} W_{ij}c - \sum_{j \in \mathcal{O}_i} W_{ij}c = c \left( \sum_{j \in \mathcal{F}_i} W_{ij} - \sum_{j \in \mathcal{O}_i} W_{ij} \right)$$

or, equivalently,

$$1 = \sum_{j \in \mathcal{F}_i} W_{ij} - \sum_{j \in \mathcal{O}_i} W_{ij} = W_{i, \mathcal{F}_i} - W_{i, \mathcal{O}_i}. \quad (6.3)$$

Now, if  $W_{i, \mathcal{O}_i} > 0$ , this requirement can never be satisfied if we additionally require row-stochasticity of  $\mathbf{W}$ , which means that  $1 = W_{i, \mathcal{F}_i} + W_{i, \mathcal{O}_i}$ . If, instead of row-stochasticity, we demanded the following weight sum restriction,

$$W_{i, \mathcal{F}_i} = 1 + W_{i, \mathcal{O}_i}, \quad (6.4)$$

then (6.3) would trivially be satisfied and, consequently, even non-neutral opinions could be consensus outcomes of opinion updating process (3.3). Comparing this with the requirement of row-stochasticity, which reads, in other form,

$$W_{i, \mathcal{F}_i} = 1 - W_{i, \mathcal{O}_i}, \quad (6.5)$$

we find that

- under the row-stochasticity requirement (6.5), opposition ‘takes away’ weight mass from followed agents, while
- under requirement (6.4), opposition ‘increases’ the weight mass that must be assigned to followed agents. In other words, under requirement (6.4), the more an agent opposes her outgroup, the more is she required to follow, or trust, her ingroup in order for her to have her ‘trust balance’ cleared. In this sense, it is clear that (6.4) facilitates attaining a non-neutral consensus, compared with requirement (6.5). In addition,
- under requirement (6.4), all agents  $i = 1, \dots, n$  are ‘generally trusting’, that is, they assign more weight mass to their ingroup than to their outgroup. Opposition is less strong an incentive than is following one’s ingroup.

From a mathematical perspective, requirement (6.4) is more problematic because even if  $S$  is a convex set, a weighted combination of elements of  $S$  where weights satisfy (6.4) need not be an element of  $S$ , since convex sets are guaranteed to be closed only under *convex combinations* of their elements, that is, where weights are taken from the unit simplex. Thus, to make this model mathematically well-defined, we need to think of  $S$  as the whole real line  $\mathbb{R}$ .

From an economic perspective, of our three justifications of DeGroot learning given in Section 3, weight requirement (6.4) fails two, namely, the justification based on boundedly rational Bayesian learning and the justification relating to aggregation theory because, in both instances, unit simplex weights are assumed. It does not fail the justification based on myopic best-response updating, since if we define agent  $i$ ’s utility on opinion vector  $\mathbf{b}$  as

$$u_i(\mathbf{b}) = - \sum_{j \in \mathcal{F}_i} W_{ij}(b_i - Wb_j)^2 - \sum_{j \in \mathcal{O}_i} W_{ij}(b_i - WD(b_j))^2, \quad (6.6)$$

where  $W = \sum_{j=1}^n W_{ij}$ , then myopic best-response updating retrieves our learning rule (3.1) with weight sum restriction (6.4). One interpretation that we may give utility structure (6.6) is that agents have disutility from making opinion choices different from (positively) scaled opinion choices of agents they follow and that agents have disutility from not deviating from (positively) scaled opinion choices of agents they oppose.

In the sequel, we very briefly analyze the variant of the DeGroot model just introduced, thereby showing that this model allows agents, in a number of cases, to attain non-neutral consensus vectors as limits of the DeGroot opinion updating process.

### Sufficient conditions for convergence to consensus

**Proposition 6.7.** Let  $D$  be soft opposition on  $S = \mathbb{R}$ . Then  $\mathbf{W} \circ \mathbf{F}$  is (affine-)linear and let  $(\mathbf{A}, \mathbf{0})$  be its representation. If  $\mathbf{W}$  satisfies (6.4), then  $1 \in \sigma(\mathbf{A})$ . Moreover, if  $\rho(\mathbf{A}) = 1$  and  $\lambda = 1$  is the only eigenvalue of  $\mathbf{A}$  on the unit circle and if  $\lambda = 1$  has algebraic multiplicity of 1, then  $\lim_{t \rightarrow \infty} (\mathbf{W} \circ \mathbf{F})^t \mathbf{b}(0)$  is a consensus for all  $\mathbf{b}(0) \in S^n$ .

*Proof.* As in (6.2),  $\mathbf{A}$  is the matrix with  $A_{ij} = W_{ij}$  if  $F_{ij} = F$  and  $A_{ij} = -W_{ij}$  if  $F_{ij} = D$  for all  $i, j \in [n]$ . Moreover, we note that, under weight sum restriction (6.4),

$$\sum_{j=1}^n A_{ij} = \sum_{j \in \mathcal{F}_i} A_{ij} + \sum_{j \in \mathcal{O}_i} A_{ij} = \sum_{j \in \mathcal{F}_i} W_{ij} - \sum_{j \in \mathcal{O}_i} W_{ij} = W_{i, \mathcal{F}_i} - W_{i, \mathcal{O}_i} = 1$$

for all  $i = 1, \dots, n$ . In other words, the row sum of each row  $i$  of  $\mathbf{A}$  is 1. But then,  $\mathbf{A}\mathbf{x} = \mathbf{x}$  for any  $\mathbf{x} \in \mathbb{R}^n$  such that  $x_1 = \dots = x_n$ . Thus,  $1 \in \sigma(\mathbf{A})$ . As in the proof of Proposition 6.5, algebraic multiplicity of  $\lambda = 1$  of 1 and  $\lambda = 1$  being the only eigenvalue on the unit circle, together with  $\rho(\mathbf{A}) = 1$ , imply that  $\mathbf{W} \circ \mathbf{F}$  induces a consensus for any  $\mathbf{b}(0) \in S^n$ , by Theorem 4.4.  $\square$

**Remark 6.8.** In the proof, we have seen that weight sum restriction (6.4) implies that  $\sum_{j=1}^n A_{ij} = 1$  for all  $i = 1, \dots, n$ . In contrast, under weight sum restriction (6.5), as discussed in the previous subsection, rows of  $\mathbf{A}$  satisfy

$$\sum_{j=1}^n |A_{ij}| = 1,$$

for all  $i = 1, \dots, n$ , as can easily be verified.

**Remark 6.9.** Analogously as in Remark 6.5, if the assumptions of Proposition 6.7 hold, limiting consensus is given by

$$\mathbf{b}(\infty) = \mathbf{s}^\top \mathbf{b}(0) = \sum_{i=1}^n s_i b_i(0),$$

where  $\mathbf{s}$  is the eigenvector of  $\mathbf{A}^\top$  corresponding to  $\lambda = 1$ . The vector  $\mathbf{s}$  encodes social influence of the agents  $i = 1, \dots, n$ .

**Example 6.4.** Let  $n = 3$  with

$$\mathbf{W} = \begin{pmatrix} \frac{2}{3} & \frac{1}{3} & \frac{2}{3} \\ \frac{1}{2} & \frac{1}{2} & \frac{1}{3} \\ \frac{1}{3} & \frac{1}{3} & \frac{1}{3} \end{pmatrix}, \quad \mathbf{F} = \begin{pmatrix} F & D & F \\ F & F & F \\ F & F & F \end{pmatrix},$$

where  $D$  is soft opposition on  $S = \mathbb{R}$ . Obviously, for each agent, weight sum restriction (6.4) is satisfied; e.g., for agent  $i = 1$ , we have

$$W_{i, \mathcal{F}_i} = \frac{2}{3} + \frac{2}{3} = \frac{4}{3} = 1 + \frac{1}{3} = 1 + W_{i, \mathcal{O}_i}.$$

Then  $\mathbf{A}$  has the structure

$$\mathbf{A} = \begin{pmatrix} \frac{2}{3} & -\frac{1}{3} & \frac{2}{3} \\ \frac{1}{2} & \frac{1}{2} & \frac{1}{3} \\ \frac{1}{3} & \frac{1}{3} & \frac{1}{3} \end{pmatrix}.$$

The eigenvalues of  $\mathbf{A}$  are 1 and  $\frac{1}{4} \pm \frac{1291}{4000}i$ . Thus, since there are three distinct eigenvalues of a  $3 \times 3$  system, each eigenvalue has algebraic multiplicity of 1, and, obviously, 1 is the only eigenvalue on the unit circle and  $\rho(\mathbf{A}) = 1$ . Hence,  $\mathbf{W} \circ \mathbf{F}$  induces a consensus by Proposition 6.7. The limit consensus is obtained by computing  $\mathbf{s}^\top \mathbf{b}(0)$  where  $\mathbf{s} = (\frac{1}{2}, 0, \frac{1}{2})^\top$ , i.e.,

$$\mathbf{b}(\infty) = \sum_{i=1}^n s_i b_i(0) = \frac{1}{2} b_1(0) + \frac{1}{2} b_3(0).$$

For instance, if agents start with initial opinions  $\mathbf{b}(0) = (1, 2, -2)^\top$ , they will end up at the consensus vector  $(-\frac{1}{2}, -\frac{1}{2}, -\frac{1}{2})^\top$ . We illustrate dynamics for this setup in Figure 15.

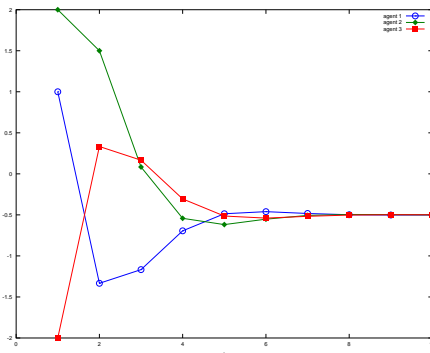

Figure 15: Opinions  $\mathbf{b}(t)$ , for  $t = 0, \dots, 10$ , for the process discussed in Example 6.4.

## 7 Conclusions

Opinions are important in an economic context (and other contexts) since they shape the demand for products, set the political course, and guide, in general, socio-economic behavior. Models of opinion dynamics model how individuals form opinions or beliefs about an underlying state or a discussion topic. Typically, in the social networks literature, subjects may communicate with other individuals, their peers, in this context, enabling them to aggregate dispersed information. Bayesian models of opinion formation assume that agents form their opinions in a fully rational manner and have an accurate ‘model of the world’ at their disposal, both of which are questionable and unrealistic assumptions, if compared with actual social learning processes of human individuals (cf. Chandrasekhar, Larreguy, and Xandri [20], Corazzini, Pavesi, Petrovich, and Stanca (2012) [23], etc.). Non-Bayesian models, and most prominently the classical DeGroot model of opinion formation, while also not unproblematic (cf. Acemoglu and Ozdaglar (2011) [4]), posit that agents employ simple ‘rule-of-thumb’ heuristics to integrate the opinions of others. Unfortunately, both the non-Bayesian and Bayesian paradigms typically lead individuals to a consensus, which apparently contradicts the facts as people disagree with others on many issues of (everyday) life. In the context of DeGroot learning models, some works have sought to address this issue, either by assuming a homophily principle whereby agents limit their communication to those who hold similar opinions as themselves or by introducing stubborn agents, modeling, e.g., opinion leaders, who never update their opinions. Both approaches are, again, debatable since the approach based on stubborn agents assumes truly autark individuals and models based on homophily can typically neither explain short-term opinion fluctuations (see the discussion in Acemoglu, Como, Fagnani, and Ozdaglar [2]), nor functional disagreement whereby disagreeing opinions are, in fact, opposing viewpoints rather than arbitrary and unrelated. Finally, the homophily models that can account for disagreement rely on the condition that some subsets of society do not communicate with, or learn from, each other, at least from some time point onward, as in the model based on stubborn agents — a requirement that we find problematic since it is difficult to imagine subsets of society without *any* mutual influence.<sup>29</sup> In any case, models based on homophily and stubborn agents both ignore *negative* relationships between individuals as potential sources for conflict and disagreement.

In the current work, we have investigated opinion dynamics under opposition, as (such) a potentially alternative explanation for disagreement. In our setup, agents are driven by two forces: they want to adjust their opinions to match those of the agents they follow (their ‘ingroup’ or those they trust) and, in addition, they want to adjust their opinions to match the ‘inverse’ of those of the agents they oppose (their ‘outgroup’ or those they distrust). Best responses in this setting lead us to a DeGroot-like opinion updating process whereby agents form their next period opinions via weighted arithmetic averages of their neighbors’ (possibly inverted) opinion signals. Our paradigm can account for a variety of phenomena such as consensus, neutrality, disagreement, and (functional) polarization, depending upon network (multigraph) structures and specifications of deviation functions, as we have demonstrated, both analytically and by means of simple simulations. Psychologically and socio-economically, we have

<sup>29</sup>Particularly in today’s ‘globalized world’.

interpreted opposition as arising either from rebels; countercultures; rejection of the norms and values of disliked others, as ‘negative referents’; or, simply, distrust.

One issue that has been left undiscussed so far is the fact that, possibly unlike social norms and values, opinions oftentimes (though probably far less than always) admit a ‘truth’ against which they may be evaluated; accordingly, some research papers (e.g., Golub and Jackson (2010) [41]) have asked for the conditions under which agents may converge to a consensus that is even correct. Under opposition, as we have specified, such a convergence to a correct consensus is severely compromised, as we have indicated. Namely, if agents converge to a consensus at all, then, as seen, such a consensus is typically a neutral consensus. In the continuous approach, if the opinion spectrum is a dense subset of the real line and the set of neutral opinions is, as we might plausibly assume, small (e.g., finite or even a singleton), then, from a probabilistic perspective, chances for agents of reaching a correct consensus are virtually zero. Alternatively, if agents disagree, or, more specifically, polarize, then, of course, at most one group of agents can be correct but, given a functional dependence of limiting opinions, we would expect none to be.

Finally, concerning future research directions within our context, both weight links and opposition links between agents,  $\mathbf{W}$  and  $\mathbf{F}$ , have been assumed exogenous in the current work. Prospectively, it might be worthwhile to consider endogenous link formation processes. In particular, the origin and evolution of opposition behavior, and its relation to agents’ opinions and external factors, such as, most importantly, to external truth, might be of interest, among other things.

## Appendix A Theorems and proofs

**Theorem A.1** (Brouwer’s fixed point theorem). Let  $K \subseteq \mathbb{R}$  be convex and compact and let  $f : K \rightarrow K$ . Then,  $f$  has a fixed point.

**Lemma A.1.** Let  $D$  be soft opposition on  $S = [-\beta, \beta]$ , for some  $\beta > 0$ . Let  $\mathbf{W} \circ \mathbf{F}$  be an arbitrary operator with representation  $\mathbf{A}$  such that  $A_{ii} = 0$  and  $A_{ij} = A_{ji}$ . Then,  $\mathbf{W} \circ \mathbf{F}$  is opposition bipartite if and only if there exists a diagonal matrix  $\Delta$  such that  $\Delta \mathbf{A} \Delta = |\mathbf{A}|$ , where  $|\mathbf{A}|$  denotes the matrix with entries  $|A_{ij}|$ .

*Proof.* Let  $\mathbf{W} \circ \mathbf{F}$  be opposition bipartite with partition  $(\mathcal{N}_1, \mathcal{N}_2)$ . Choose  $\Delta_{ii} = 1$  if  $i \in \mathcal{N}_1$  and  $\Delta_{ii} = -1$  if  $i \in \mathcal{N}_2$ . Then, as one can verify,  $\Delta \mathbf{A} \Delta = |\mathbf{A}|$ .

Conversely, let  $\Delta \mathbf{A} \Delta = |\mathbf{A}|$  so that  $|A_{ij}| = \Delta_{ii} \Delta_{jj} A_{ij}$ . Hence, if  $A_{ij} \neq 0$ ,  $\Delta_{ii}, \Delta_{jj} \in \{\pm 1\}$ . Choose  $i \in \mathcal{N}_1$  if  $\Delta_{ii} = 1$  and  $i \in \mathcal{N}_2$  otherwise.  $\square$

**Lemma A.2.** Let  $|\mathbf{A}| = \Delta \mathbf{A} \Delta$  as in Lemma A.1. Then  $\mathbf{A}$  and  $|\mathbf{A}|$  have the same eigenvalues with the same multiplicities.

*Proof.* Since  $\Delta^{-1} = \Delta$ ,  $\Delta \mathbf{A} \Delta^{-1}$  represents a similarity transformation.  $\square$

**Lemma A.3.** Let  $D$  be soft opposition on  $S = [-\beta, \beta]$ , for some  $\beta > 0$ . Let  $\mathbf{W} \circ \mathbf{F}$  an arbitrary operator with representation  $\mathbf{A}$  such that  $A_{ii} = 0$  and  $A_{ij} = A_{ji}$ . Then,  $\mathbf{W} \circ \mathbf{F}$  is opposition bipartite if and only if  $\lambda = 1$  is an eigenvalue of  $\mathbf{A}$ .

*Proof.* Altafini (2013) [6], Lemma 1, shows that  $0 \in \sigma(\mathbf{L})$  if and only if  $\mathbf{A}$  is opposition bipartite where  $\mathbf{L} = \mathbf{I}_n - \mathbf{A}$ . Clearly,  $1 \in \sigma(\mathbf{A}) \iff 0 \in \sigma(\mathbf{L})$ .  $\square$

## References

- [1] R. P. Abelson. Mathematical models of the distribution of attitudes under controversy. In N. Frederiksen and H. Gulliksen, editors, *Contributions to mathematical psychology*, pages 142–160. Rinehart Winston, New York, 1964.
- [2] D. Acemoglu, G. Como, F. Fagnani, and A. Ozdaglar. Opinion fluctuations and disagreement in social networks. *Mathematics of Operations Research*, forthcoming.

- [3] D. Acemoglu, M. A. Dahleh, I. Lobel, and A. Ozdaglar. Bayesian learning in social networks. *Review of Economic Studies*, 78:1201–1236, 2011.
- [4] D. Acemoglu and A. Ozdaglar. Opinion dynamics and learning in social networks. *Dynamic Games and Applications*, 1:3–49, 2011.
- [5] D. Acemoglu, A. Ozdaglar, and A. ParandehGheibi. Spread of (mis)information in social networks. *Games and Economic Behavior*, 70:194–227, 2010.
- [6] C. Altafini. Consensus problems on networks with antagonistic interactions. *IEEE Transactions on Automatic Control*, 58, 2013.
- [7] M. Ananyev and S. Guriev. Causal effect of income on trust: Evidence from the 2009 crisis in Russia. Working Paper, 2013.
- [8] S. Aupers. ‘Trust no one’: Modernization, paranoia and conspiracy culture. *European Journal of Communication*, 27:22–34, 2012.
- [9] D. Baldassari and P. Bearman. Dynamics of political polarization. *American Sociological Review*, 72:784–811, 2007.
- [10] A. V. Banerjee. A simple model of herd behavior. *Quarterly Journal of Economics*, 107:797–817, 1992.
- [11] A. V. Banerjee and D. Fudenberg. Word-of-mouth learning. *Games and Economic Behavior*, 46:1–22, 2004.
- [12] D. Beasley and D. Kleinberg. *Networks, Crowds, and Markets: Reasoning about a Highly Connected World*. Cambridge University Press, Cambridge, UK, 2010.
- [13] P. Bonacich. Factoring and weighting approaches to status scores and clique identification. *The Journal of Mathematical Sociology*, 2:113–120, 1972.
- [14] M. B. Brewer. In-group bias in the minimal intergroup situation: A cognitive-motivational analysis. *Psychological Bulletin*, 86:307–324, 1979.
- [15] B. Buechel, T. Hellmann, and S. Klößner. Opinion dynamics under conformity. Working Paper, 2012.
- [16] B. Buechel, T. Hellmann, and S. Klößner. Opinion dynamics and wisdom under conformity. Working Paper, 2013.
- [17] B. Buechel, T. Hellmann, and M. Pichler. The dynamics of continuous cultural traits in social networks. Working Paper, 2012.
- [18] Z. Cao, M. Yang, X. Qu, and X. Yang. Rebels lead to the doctrine of the mean: Opinion dynamic in a heterogeneous deGroot model. In *The 6th International Conference on Knowledge, Information and Creativity Support Systems*, pages 29–35, Beijing, China, 2011.
- [19] E. Castano, V. Yzerbyt, D. Bourguignon, and E. Seron. Who may enter? The impact of in-group identification on in-group/out-group categorization. *Journal of Experimental Social Psychology*, 38:315–322, 2002.
- [20] A. G. Chandrasekhar, H. Larreguy, and J. P. Xandri. Testing models of social learning on networks: Evidence from a lab experiment in the field. Working Paper, 2012.
- [21] G. Charness, L. Rigotti, and A. Rustichini. Individual behavior and group membership. *American Economic Review*, 97:1340–1352, 2007.
- [22] G. L. Cohen. Party over policy: The dominating impact of group influence on political beliefs. *Journal of Personality and Social Psychology*, 85:808–822, 2003.

- [23] L. Corazzini, F. Pavesi, B. Petrovich, and L. Stanca. Influential listeners: An experiment on persuasion bias in social networks. *European Economic Review*, 56:1276–1288, 2012.
- [24] F. Davis. *On Youth Subcultures: The Hippie Variant*. General Learning Press, New York, 1971.
- [25] G. Deffuant, D. Neau, F. Amblard, and G. Weisbuch. Mixing beliefs among interacting agents. *Advances in Complex Systems*, 3:87–98, 2000.
- [26] M. H. DeGroot. Reaching a consensus. *Journal of the American Statistical Association*, 69(345):118–121, 1974.
- [27] P. M. DeMarzo, D. Vayanos, and J. Zwiebel. Persuasion bias, social influence, and unidimensional opinions. *The Quarterly Journal of Economics*, 118(3):909–968, August 2003.
- [28] M. Deutsch. *The resolution of conflict: Constructive and destructive processes*. Yale University Press, New Haven CT, 1973.
- [29] F. Dietrich and C. List. Opinion pooling on general agendas. Working Paper, 2008.
- [30] I. Douven and A. Riegler. Extending the Hegselmann-Krause model ii. *Proceedings of ECAP 2009*, 2009.
- [31] I. Douven and A. Riegler. Extending the Hegselmann-Krause model iii: From single beliefs to complex belief states. *Episteme*, 6:145–163, 2009.
- [32] I. Douven and A. Riegler. Extending the Hegselmann-Krause model i. *The Logic Journal of the IGPL*, 18:323–335, 2010.
- [33] P. Fan, P. Li, H. Wang, Z. Jiang, and W. Li. Opinion interaction network: Opinion dynamics in social networks with heterogeneous relationships. In *ISI-KDD '12 Proceedings of the ACM SIGKDD Workshop on Intelligence and Security Informatics Article*, Beijing, China, 2012.
- [34] S. Fehrler and M. Kosfeld. Can you trust the good guys? Trust within and between groups with different missions. Working Paper, 2013.
- [35] T. Fent, P. Groeber, and F. Schweitzer. Coexistence of social norms based on in- and out-group interactions. *Advances of Complex Systems*, 10:271–286, 2007.
- [36] J. R. French. A formal theory of social power. *Psychological Review*, 63:181–194, 1956.
- [37] N. E. Friedkin and E. C. Johnsen. Social influence and opinions. *Journal of Mathematical Sociology*, 15:193–205, 1990.
- [38] N. E. Friedkin and E. C. Johnsen. Social influence networks and opinion change. *Advances in group processes*, 16:1–29, 1999.
- [39] D. Gale and S. Kariv. Bayesian learning in social networks. *Games and Economic Behavior*, 45:329–346, 2003.
- [40] U. Gneezy. Deception: The role of consequences. *American Economic Review*, 95:384–394, 2005.
- [41] B. Golub and M. O. Jackson. Naïve learning in social networks and the wisdom of crowds. *American Economic Journal: Microeconomics*, 2:112–149, 2010.
- [42] B. Golub and M. O. Jackson. How homophily affects the speed of learning and best-response dynamics. *The Quarterly Journal of Economics*, 127:1287–1338, 2012.
- [43] P. Groeber, J. Lorenz, and F. Schweitzer. Dissonance minimization as a microfoundation of social influence in models of opinion formation. *Journal of Mathematical Sociology*, 2013.
- [44] F. Harary. A criterion for unanimity in French’s theory of social power. *Studies in social power*, 1959.

- [45] G. H. Hardy, J. E. Littlewood, and G. Pólya. *Inequalities*. Cambridge University Press, Cambridge, 1934.
- [46] R. Hegselmann and U. Krause. Opinion dynamics and bounded confidence: models, analysis and simulation. *J. Artificial Societies and Social Simulation*, 5(3), 2002.
- [47] R. Hegselmann and U. Krause. Opinion dynamics driven by various ways of averaging. *Computational Economics*, 25(4):381–405, 2005.
- [48] R. Hegselmann and U. Krause. Truth and cognitive division of labour: First steps towards a computer aided social epistemology. *Journal of Artificial Societies and Social Simulation*, 9(3):10, 2006.
- [49] F. Herzberg. An algebraic approach to general aggregation theory: Propositional-attitude aggregators as MV-homomorphisms. Working Paper, 2011.
- [50] M. M. Howard. Postcommunist civil society in comparative perspective. *Demokratizatsiya*, pages 285–305, 2002.
- [51] M. O. Jackson. *Social and Economic Networks*. Princeton University Press, Princeton, 2009.
- [52] M. P. Jones. *Electoral Laws and the Survival of Presidential Democracies*. University of Notre Dame Press, Notre Dame, 1995.
- [53] J. A. Kitts. Social influence and the emergence of norms amid ties of amity and enmity. *Simulation Modelling Practice and Theory*, 14:407–422, 2006.
- [54] G. H. Kramer. Short-term fluctuations in U.S. voting behavior, 1896–1964. *American Political Science Review*, 65:131–143, 1971.
- [55] U. Krause. Compromise, consensus, and the iterations of means. *Elemente der Mathematik*, 64:1–8, 2009.
- [56] P. Krugman. Ricardo’s difficult idea. Paper for Manchester conference on free trade, March 1996. Available on his official web page.
- [57] K. Lehrer. Rationality as weighted averaging. *Synthese*, 57:283–295, 1983.
- [58] K. Lehrer and C. Wagner. Rational consensus in science and society. *Reidel, Dordrecht*, 1981.
- [59] J. Lobel. Economists’ models of learning. *Journal of Economic Theory*, 94:241–261, 2000.
- [60] K. J. McConway. Marginalization and linear opinion pools. *Journal of the American Statistical Association*, 76(374):410–414, 1981.
- [61] D. H. McKnight and N. L. Chervany. Trust and distrust definitions: One bite at a time. In R. Falcone, M. Singh, and Y. Tan, editors, *Trust in Cyber-Societies: Integrating the Human and Artificial Perspectives*, pages 27–54. Springer, Berlin, 2001.
- [62] G. D. Mellinger. Interpersonal trust as a factor in communication. *The Journal of Abnormal and Social Psychology*, 52:304–309, 1956.
- [63] C. D. Meyer. *Matrix analysis and applied linear algebra*. SIAM, Philadelphia, 2000.
- [64] W. Mishler and R. Rose. Trust, distrust and skepticism: Popular evaluations of civil and political institutions in post-communist societies. *The Journal of Politics*, 59:418–451, 1997.
- [65] S. Mitchell. *The official guide to American Attitudes: Who thinks what about the issues that shape our lives*. New Strategist Publications, Ithaca, New York, 1996.
- [66] V. Nee, S. Opper, and H. Holm. Trust and economic behavior in a low-trust society. Working Paper, 2013.

- [67] T. M. Newcomb. An approach to a theory of communicative acts. *Psychological Review*, pages 393–404, 1953.
- [68] W. P. Opinion. Iraq: The separate realities of republicans and democrats. Technical report, World Public Opinion, Washington DC, 2006. available at <http://www.worldpublicopinion.org/pipa/articles/brunitedstatescanadara/186.php>.
- [69] Z. Pan. Trust, influence, and convergence of behavior in social networks. *Mathematical Social Sciences*, 60:69–78, 2010.
- [70] J. Rode. Truth and trust in communication. An experimental study of behaviour under asymmetric information. *Games and Economic Behavior*, 68:325–338, 2010.
- [71] D. Rosenberg, E. Solan, and N. Vieille. Informational externalities and convergence of behavior. *Preprint*, 2006.
- [72] J. B. Rotter. Generalized expectancies for interpersonal trust. *American Psychologist*, 26, 1971.
- [73] Rubinstein and Fishburn. Algebraic aggregation theory. *Journal of Economic Theory*, 38, 1986.
- [74] Y. Schul, R. Mayo, and E. Burnstein. The value of distrust. *Journal of Experimental Social Psychology*, 44:1293–1302, 2008.
- [75] G. Shi, A. Proutiere, M. Johansson, J. S. Baras, and K. H. Johansson. The evolution of beliefs over signed social networks. Available at <http://arxiv.org/pdf/1307.0539.pdf>, 2013.
- [76] M. Sutter. Deception through truth telling?! Experimental evidence from individuals and teams. *The Economic Journal*, 119:47–60, 2009.
- [77] R. Tsuji. Interpersonal influence and attitude change toward conformity in small groups: a social psychological model. *Journal of mathematical sociology*, 26:17–34, 2002.
- [78] C. Wagner. Consensus through respect: A model of rational group decision-making. *Philosophical studies: An international Journal for Philosophy in the Analytic Tradition*, 34:335–349, 1978.
- [79] E. Yildiz, D. Acemoglu, A. Ozdaglar, A. Saberi, and A. Scaglione. Discrete opinion dynamics with stubborn agents. *Operations Research*, submitted.
- [80] J. M. Yinger. Contraculture and subculture. *American Sociological Review*, 25:625–635, 1960.
- [81] J. M. Yinger. Countercultures and social change. *American Sociological Review*, 42:833–853, 1977.
- [82] B.-Y. Zhang, Z.-G. Cao, C.-Z. Qin, and X.-G. Yang. Fashion and homophily, 2013. Available at SSRN: <http://ssrn.com/abstract=2250898> or <http://dx.doi.org/10.2139/ssrn.2250898>.