

Bifix codes and the finite index basis property

Valérie Berthé¹, Clelia De Felice³, Francesco Dolce², Dominique Perrin²,
Christophe Reutenauer⁴, Giuseppina Rindone²

¹CNRS, Université Paris 7, ²Université Paris Est,
³Università degli Studi di Salerno, ⁴Université du Québec à Montréal

May 3, 2019 3 h 58

Abstract

We describe in this paper a connection between bifix codes, interval exchange transformations and free groups. This is in the spirit of the connection established previously for Sturmian words instead of interval exchange transformations. We prove as a main result that for the set F of factors of a regular interval exchange transformation, a finite bifix code X on the alphabet A is F -maximal of F -degree d if and only if it is the basis of a subgroup of degree d of the free group on A . The proof uses the fact that, in a regular interval exchange set, the sets of first return words form a basis of a free group.

Contents

1	Introduction	2
2	Preliminaries	4
2.1	Recurrent sets	4
2.2	Bifix codes	5
3	Neutral sets	6
3.1	The neutrality condition	6
3.2	The Cardinality Theorem	7
4	Tree sets	10
4.1	The tree condition	11
4.2	The planar tree condition	14
4.3	The strong tree condition	15
5	Interval exchange sets	18
5.1	Interval exchange transformations	18
5.2	Regular interval exchange transformations	20

5.3	Natural coding	20
5.4	Bifix codes and interval exchanges	25
5.5	Bifix codes and regular transformations	28
6	Finite index basis sets	30
6.1	Main result	30
6.2	Automata	32
6.3	Incidence graph	35
6.4	Coset automaton	37
6.5	Proof of the Basis Theorem	38

1 Introduction

Interval exchange transformations were introduced by Oseledec [18] following an earlier idea of Arnold [2]. These transformations form a generalization of rotations of the circle.

In this paper we study a relation between interval exchange transformations and bifix codes. The paper is a continuation of the paper with part of the present list of authors on bifix codes and Sturmian words [5]. We understand here by Sturmian words the generalization to arbitrary alphabets, often called strict episturmian words or Arnoux-Rauzy words (see the survey [13]), of the classical Sturmian words on two letters.

The starting point of this research is the observation that the family of Sturmian sets is not closed under decoding by a maximal bifix code, even in the more simple case of the code formed of all words of fixed length n . Actually, the decoding of the Fibonacci word (which corresponds to a rotation of angle α) by blocks of length n is an interval exchange transformation corresponding to a rotation of angle $n\alpha$ coded on $n + 1$ intervals. This has lead us to consider the set of factors of interval exchange transformations, called interval exchange sets.

One of the results proved in this paper is that the family of regular interval exchange sets is closed under decoding by a maximal bifix code (Theorem 5.21).

This result invited us to try to extend to regular interval exchange transformations the results relating bifix codes and Sturmian words.

As a main result, we prove that, under natural hypotheses satisfied by a regular interval exchange set F , a finite bifix code X on the alphabet A is F -maximal of F -degree d if and only if it is the basis of a subgroup of degree d of the free group on A (Theorem 6.1 called below the Basis Theorem).

We actually introduce several classes of sets of words on $k + 1$ letters having all $kn + 1$ elements of length n for all $n \geq 0$. The smallest class (BS) is formed of the Sturmian sets on a binary alphabet, that is with $k = 1$ (see Figure 1.1). It is contained both in the class of regular interval exchange sets (denoted RIE) and of Sturmian sets (denoted S). The next one is the class of sets satisfying the tree condition, called tree sets, which contains the two previous ones. Finally,

the class of sets satisfying the neutrality condition called neutral sets contains the previous one.

The proof for regular interval exchange sets uses the property, proved in [7], that the sets of first return words form a basis of the free group (this result is referred to below as the Return Theorem).

We have tried in all the paper to use the weakest of these conditions to prove our results. As an example, we prove that, under the neutrality condition, any finite F -maximal bifix code of F -degree d has $1 + d(\text{Card}(A) - 1)$ elements (Theorem 3.4 called below the Cardinality Theorem).

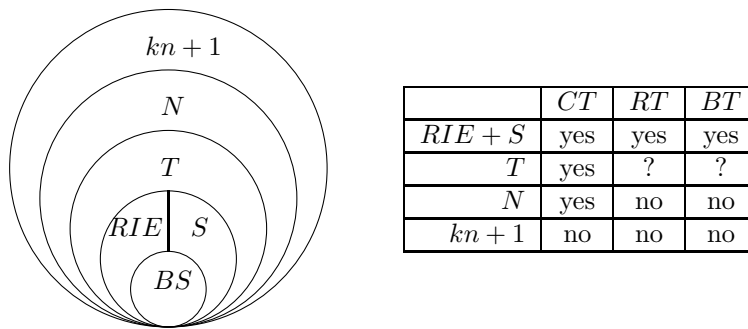

Figure 1.1: The classes of sets on $k + 1$ letters: Binary Sturmian (BS), Regular interval exchange (RIE), Sturmian (S), Tree (T), Neutral (N), of complexity $kn + 1$

For each class the array on the right of Figure 1.1 indicates whether (with the additional hypothesis of uniform recurrence) it satisfies the Cardinality Theorem (CT), the Return Theorem (RT) or the Basis Theorem (BT). All these classes are distinct. Moreover, it can be shown that the intersection of RIE and S is reduced to BS . Indeed, Sturmian sets on more than two letters are not the factors of an interval exchange transformation with each interval labeled by a distinct letter (the construction in [3] allows to obtain the Sturmian sets of 3 letters as an exchange of 7 intervals labeled by 3 letters). The class RIE is closed under decoding by a maximal bifix code (Corollary 5.22).

This leaves open therefore the identification of a class of sets containing the Sturmian sets and closed under decoding by a maximal bifix code for which the Basis Theorem is true.

Our main result holds for the class of tree sets F on an alphabet A which are uniformly recurrent, and satisfy the condition that the set of first right return words to any word in F is a basis of the free group on A .

The paper is organised as follows.

In Sections 3 and 4, we introduce the neutrality and the tree condition. These conditions are satisfied by Sturmian sets and, as shown in Section 5, by regular interval exchange sets.

We also introduce a variant of the tree condition called the planar tree condition. We prove that both the tree condition and the planar tree condition imply a stronger version of themselves (Propositions 4.6 and 4.9).

In Section 5, we recall some notions concerning interval exchange transformations. We state the result of Keane [16] which proves that regularity is a sufficient condition for the minimality of such a transformation (Theorem 5.3).

We introduce the relation between interval exchange transformations and bifix codes. We prove that the transformation associated with a finite F -maximal bifix code is an interval exchange transformation (Proposition 5.17). We also prove a result concerning the regularity of this transformation (Theorem 5.21).

In Section 6 we prove the Basis Theorem characterizing the bases of subgroups of finite index of the free group included in a regular interval exchange set F (Theorem 6.3) which is proved in [5] for a Sturmian set F . The proof follows the same path as the corresponding one for Sturmian sets. Several intermediary results hold under the weaker assumption that the set F satisfies the tree condition (Propositions 6.15 and 6.17). The final argument uses the fact that, in a regular interval exchange set, the sets of first return words form a basis of the free group (Theorem 4.16 in [7]).

2 Preliminaries

In this section, we first recall some definitions concerning words. We give the definition of recurrent and uniformly recurrent sets of words. We also give the definitions and basic properties of bifix codes (see [5] for a more detailed presentation).

2.1 Recurrent sets

Let A be a finite nonempty alphabet. All words considered below, unless stated explicitly, are supposed to be on the alphabet A . We denote by A^* the set of all words on A . We denote by 1 or by ε the empty word. A set of words is said to be *factorial* if it contains the factors of its elements.

Let F be a set of words on the alphabet A . For $w \in F$, we denote

$$\begin{aligned} L(w) &= \{a \in A \mid aw \in F\} \\ R(w) &= \{a \in A \mid wa \in F\} \\ E(w) &= \{(a, b) \in A \times A \mid awb \in F\} \end{aligned}$$

and further

$$\ell(w) = \text{Card}(L(w)), \quad r(w) = \text{Card}(R(w)), \quad e(w) = \text{Card}(E(w)).$$

A word w is *right-extendable* if $r(w) > 0$, *left-extendable* if $\ell(w) > 0$ and *biextendable* if $e(w) > 0$. A factorial set F is called *right-essential* (resp. *left-essential*, resp. *biessential*) if every word in F is right-extendable (resp. left-extendable, resp. biextendable).

A word w is called *right-special* if $r(w) \geq 2$. It is called *left-special* if $\ell(w) \geq 2$. It is called *bispecial* if it is both right and left-special.

A set of words is *recurrent* if it is factorial and if for every $u, w \in F$ there is a $v \in F$ such that $uvw \in F$. A recurrent set $F \neq \{1\}$ is biessential.

A set of words F is said to be *uniformly recurrent* if it is factorial and if, for any word $u \in F$, there exists an integer $n \geq 1$ such that u is a factor of every word of F of length n . A uniformly recurrent set is recurrent.

A *morphism* $f : A^* \rightarrow B^*$ is a monoid morphism from A^* into B^* . If $a \in A$ is such that the word $f(a)$ begins with a and if $|f^n(a)|$ tends to infinity with n , there is a unique infinite word denoted $f^\omega(a)$ which has all words $f^n(a)$ as prefixes. It is called a *fixpoint* of the morphism f .

A morphism $f : A^* \rightarrow A^*$ is called *primitive* if there is an integer k such that for all $a, b \in A$, the letter b appears in $f^k(a)$. If f is a primitive morphism, the set of factors of any fixpoint of f is uniformly recurrent (see [12] Proposition 1.2.3 for example).

An infinite word is *episturmian* if the set of its factors is closed under reversal and contains for each n at most one word of length n which is right-special. It is a *strict episturmian* word if it has exactly one right-special word of each length and moreover each right-special factor u is such that $r(u) = \text{Card}(A)$.

A *Sturmian set* is a set of words which is the set of factors of a strict episturmian word. Any Sturmian set is uniformly recurrent (see [5]).

Example 2.1 Let $A = \{a, b\}$. The Fibonacci word is the fixpoint $x = abaababa\dots$ of the morphism $f : A^* \rightarrow A^*$ defined by $f(a) = ab$ and $f(b) = a$. It is a Sturmian word (see [17]). The set $F(x)$ of factors of x is the *Fibonacci set*.

Example 2.2 Let $A = \{a, b, c\}$. The Tribonacci word is the fixpoint $x = f^\omega(a) = abacaba\dots$ of the morphism $f : A^* \rightarrow A^*$ defined by $f(a) = ab$, $f(b) = ac$, $f(c) = a$. It is a strict episturmian word (see [14]). The set $F(x)$ of factors of x is the *Tribonacci set*.

2.2 Bifix codes

A *prefix code* is a set of nonempty words which does not contain any proper prefix of its elements. A suffix code is defined symmetrically. A *bifix code* is a set which is both a prefix code and a suffix code.

A *coding morphism* for a prefix code $X \subset A^+$ is a morphism $f : B^* \rightarrow A^*$ which maps bijectively B onto X .

Let F be a factorial set of words. A prefix code $X \subset F$ is F -maximal if it is not properly contained in any prefix code $Y \subset F^1$.

We denote by X^* the submonoid generated by X . A set $X \subset F$ is *right F -complete* if any word of F is a prefix of a word in X^* . A prefix code is F -maximal if and only if it is right F -complete (Proposition 3.3.2 in [5]).

Similarly a bifix code $X \subset F$ is F -maximal if it is not properly contained in a bifix code $Y \subset F$. For a recurrent set F , a finite bifix code is F -maximal as a

¹Note that in this paper we use \subset to denote the inclusion allowing equality.

bifix code if and only if it is an F -maximal prefix code (see [5], Theorem 4.2.2). For a uniformly recurrent set F , any finite bifix code $X \subset F$ is contained in a finite F -maximal bifix code (Theorem 4.4.3 in [5]).

A *parse* of a word w with respect to a set X is a triple (v, x, u) such that $w = vxu$ where v has no suffix in X , u has no prefix in X and $x \in X^*$. We denote by $\delta_X(w)$ the number of parses of w . By definition, the F -degree of X , denoted $d_F(X)$, is the maximal number of parses of a word in F . It can be finite or infinite.

Let X be a bifix code. The number of parses of a word w is also equal to the number of suffixes of w which have no prefix in X and the number of prefixes of w which have no suffix in X (see Proposition 6.1.6 in [6]).

The set of *internal factors* of a set of words X , denoted $I(X)$ is the set of words w such that there exist nonempty words u, v with $uwv \in X$.

Let F be a recurrent set and let X be a finite F -maximal bifix code of F -degree d . A word $w \in F$ is such that $\delta_X(w) < d$ if and only if it is an internal factor of X , that is

$$I(X) = \{w \in F \mid \delta_X(w) < d\}$$

(Theorem 4.2.8 in [5]). Thus any word of X of maximal length has d parses. This implies that the F -degree d is finite.

Example 2.3 Let F be a recurrent set. For any integer $n \geq 1$, the set $F \cap A^n$ is an F -maximal bifix code of F -degree n .

3 Neutral sets

In this section, we introduce the neutrality condition and neutral sets. We prove a theorem concerning the cardinality of an F -maximal bifix code in a neutral set F (Theorem 3.4).

3.1 The neutrality condition

We say that a word $w \in F$ is *neutral* with respect to a set of words F if

$$e(w) = \ell(w) + r(w) - 1.$$

We will use the following elementary result.

Lemma 3.1 *Let F be a factorial set. A word $w \in F$ is neutral if and only if $r(w) - 1 = \sum_{a \in L(w)} (r(aw) - 1)$.*

Proof. This follows directly from the fact that

$$\sum_{a \in L(w)} (r(aw) - 1) = e(w) - \ell(w).$$

■

A biextendable word is called *ordinary* if $E(w) \subset a \times A \cup A \times b$ for some $(a, b) \in E(w)$ (see [8], Chapter 4). If F is biessential any ordinary word is neutral. Indeed, one has $E(w) = (a \times (R(w) \setminus b)) \cup ((L(w) \setminus a) \times b) \cup (a, b)$ and thus $e(w) = \ell(w) + r(w) - 1$.

For example, in a Sturmian set, any word is ordinary.

We say that F satisfies the *neutrality condition* if it is factorial and every biextendable word $w \in F$ is neutral. We also say that F is a *neutral set*.

The function $n \mapsto \text{Card}(F \cap A^n)$ is called the *complexity* of F .

Proposition 3.2 *The complexity of a neutral set F is $kn+1$ with $k = \text{Card}(F \cap A) - 1$.*

Proof. Assume that F satisfies the neutrality condition. We have $\text{Card}(F \cap A^n) = kn + 1$ for $n \leq 1$. Next, assuming that it is true for $n \geq 1$, we have

$$\begin{aligned} \text{Card}(F \cap A^{n+1}) &= \sum_{w \in A^{n+1} \cap F} e(w) = \sum_{w \in A^{n+1} \cap F} (\ell(w) + r(w) - 1) \\ &= \text{Card}(F \cap A^n) + \text{Card}(F \cap A^n) - \text{Card}(F \cap A^{n-1}) \\ &= k(n+1) + 1 \end{aligned}$$

showing the property for $n+1$. ■

Note that if the complexity of F is $kn+1$, then

$$\sum_{x \in F \cap A^{n-1}} (\ell(x) - 1) = k. \quad (3.1)$$

Indeed, we have $\sum_{x \in F \cap A^{n-1}} (\ell(x) - 1) = \text{Card}(F \cap A^n) - \text{Card}(F \cap A^{n-1}) = k$.

We now give an example of a set of complexity $2n+1$ on an alphabet with three letters which does not satisfy the neutrality condition.

Example 3.3 Let $A = \{a, b, c\}$. The *Chacon word* on three letters is the fixpoint $x = f^\omega(a)$ of the morphism f from A^* into itself defined by $f(a) = abc$, $f(b) = bc$ and $f(c) = abc$. Thus $x = aabcaabcbcabcb \dots$. The *Chacon set* is the set F of factors of x . It is of complexity $2n+1$ (see [12] Section 5.5.2).

It does not satisfy the neutrality condition because the word $w = abc$ is such that $L(w) = \{a, c\}$, $R(w) = \{a, b\}$ and $E(w) = \{(a, a), (c, a), (a, b), (c, b)\}$. Since $e(w) = \ell(w) + r(w)$, the word w is not neutral.

3.2 The Cardinality Theorem

The following result is proved in [5] in the less general case of a Sturmian set.

Theorem 3.4 *Let F be a recurrent set containing A and let $X \subset F$ be a finite F -maximal bifix code of F -degree d . If F satisfies the neutrality condition, then $\text{Card}(X) = 1 + d(\text{Card}(A) - 1)$.*

Note that, for a recurrent neutral set F , a bifix code $X \subset F$ may be infinite since this may happen for a Sturmian set F (see [5]).

We consider rooted trees with the usual notions of root, node, child and parent. The following lemma is well-known as a lemma on trees relating the number of its leaves to the sum of the degrees of its internal nodes.

Lemma 3.5 *Let X be a prefix code and let P be the set of its proper prefixes. Then $\text{Card}(X) = 1 + \sum_{p \in P} (r(p) - 1)$.*

We order the nodes of a tree from the parent to the child and thus we have $m \leq n$ if m is a descendant of n .

Lemma 3.6 *Let T be a finite tree with root r on a set N of nodes, let $d \geq 1$, and let π, α be functions assigning to each node an integer such that*

- (i) *for each internal node n , $\pi(n) = \sum \pi(m)$ where the sum runs over the children of n ,*
- (ii) *for each leaf m of T , one has $\sum_{m \leq n} \alpha(n) = d$.*

Then $\sum_{n \in N} \alpha(n)\pi(n) = d\pi(r)$.

Proof. We use an induction on the number of nodes of T . If T is reduced to its root, then $d = \alpha(r)$ implies $\alpha(r)\pi(r) = d\pi(r)$ and the result is true. Assume that it holds for trees with less nodes than T . Since T is finite, there is a node such that all its children are leaves of T . Let m be such a node. Since $\sum_{x \leq n} \alpha(n) = \alpha(x) + \sum_{m \leq n} \alpha(n)$ has the same value for each child x of m , the value $v = \alpha(x)$ is the same for all children of m . Let T' be the tree obtained from T by deleting all children of m . Let N' be the set of nodes of T' . Let π' be the restriction of π to N' and let α' be defined by

$$\alpha'(n) = \begin{cases} \alpha(n) & \text{if } n \neq m \\ \alpha(m) + v & \text{otherwise.} \end{cases}$$

It is easy to verify that T', π' and α' satisfy the same hypotheses. Then

$$\begin{aligned} \sum_{n \in N} \alpha(n)\pi(n) &= \sum_{n \in N' \setminus m} \alpha(n)\pi(n) + \alpha(m)\pi(m) + \sum_{x \leq m} v\pi(x) \\ &= \sum_{n \in N' \setminus m} \alpha'(n)\pi'(n) + \alpha(m)\pi(m) + v \sum_{x \leq m} \pi(x) \\ &= \sum_{n \in N' \setminus m} \alpha'(n)\pi'(n) + (\alpha(m) + v)\pi(m) \\ &= \sum_{n \in N' \setminus m} \alpha'(n)\pi'(n) + \alpha'(m)\pi'(m) = \sum_{n \in N'} \alpha'(n)\pi'(n) \end{aligned}$$

whence the result by the induction hypothesis. ■

Proof of Theorem 3.4. Let k be larger than the lengths of the words of X .

Let N be the set of words of F of length at most k . By considering each word w as the father of aw for $a \in A$, the set N can be considered as a tree T with root the empty word ε . The leaves of T are the elements of F of length k .

For $w \in N$, set $\pi(w) = r(w) - 1$ and let

$$\alpha(n) = \begin{cases} 1 & \text{if } n \text{ is a proper prefix of } X \\ 0 & \text{otherwise.} \end{cases}$$

Let us verify that the conditions of Lemma 3.6 are satisfied. Let u be in N . Then by Lemma 3.1 $\sum_{a \in L(u)} (r(au) - 1) = r(u) - 1$. This implies that $\sum_{au \in F} \pi(au) = \pi(u)$ showing that condition (i) is satisfied.

Let w be a leaf of T , that is a word of F of length k . Since k is larger than the maximal length of the words of X , the word w is not an internal factor of X and thus it has d parses with respect to X and thus has d suffixes which are proper prefixes of X . Thus $\sum_{w \leq u} \alpha(u) = d$. Thus condition (ii) is also satisfied.

By Lemma 3.6, we have $\sum_{n \in N} \alpha(n) \pi(n) = d\pi(\varepsilon)$. Let P be the set of proper prefixes of X . By definition of α , we have $\sum_{n \in N} \alpha(n) \pi(n) = \sum_{p \in P} \pi(p)$ and thus by definition of π , $d\pi(\varepsilon) = d(\text{Card}(A) - 1) = \sum_{p \in P} (r(p) - 1)$. By Lemma 3.5, we have $\text{Card}(X) = 1 + \sum_{p \in P} (r(p) - 1)$ and thus we obtain $\text{Card}(X) = 1 + d(\text{Card}(A) - 1)$ which is the desired conclusion. ■

We illustrate Theorem 3.4 in the following example.

Example 3.7 Let $B = \{x, y, z, t\}$. Let G be the set of words on the alphabet B represented in Figure 3.1 on the left. The set G can be extended by adding words of length 5 and more, to a recurrent set still denoted G which satisfies the neutrality condition (see Example 5.25).

The tree of right-special words is represented on the right in Figure 3.1 with the value of r indicated at each node. The bifix codes $Y = \{xx, xyx, xz, xt, y, zx, tx\}$ and $Z = \{x, yxy, yxz, zxxz, ztxt, txxz, txy\}$ are G -maximal and have both G -degree 2. In agreement with Theorem 3.4, we have $\text{Card}(Y) = \text{Card}(Z) = 1 + 2(\text{Card}(B) - 1) = 7$. The codes Y and Z are represented in Figure 3.2. The right-special proper prefixes p of Y and Z are indicated in black in Figure 3.2 with the value of $r(p) - 1$ indicated for each one. In agreement with Lemma 3.6, the sum of the values of $r(p) - 1$ is 6 in both cases.

The following example shows that Theorem 3.4 may be false for a set F of complexity $kn + 1$ on an alphabet with $k + 1$ letters which does not satisfy the neutrality condition.

Example 3.8 Consider again the Chacon set F of Example 3.3. Let $X = F \cap A^4$ and let Y be the F -maximal bifix code of F -degree 4 represented in Figure 3.3 which is obtained from X by internal transformation with respect to $w = abc$ (see [5] for the definition of the internal transformation). The bifix code Y has 10 elements and thus Theorem 3.4 is not satisfied.

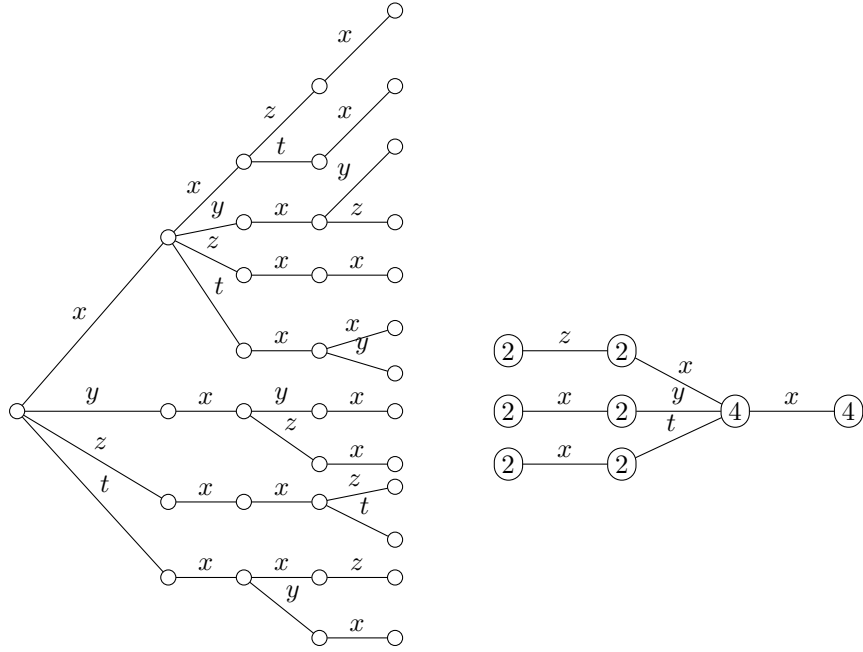

Figure 3.1: A set G satisfying the neutrality condition and the tree of right-special words.

4 Tree sets

We introduce in this section the tree condition and a variant called the planar tree condition. Each of these conditions has a stronger version called the strong tree (resp. planar tree) condition. We prove that the tree condition implies the strong tree condition (Proposition 4.6) and that the planar tree condition implies the strong planar tree condition (Proposition 4.9)

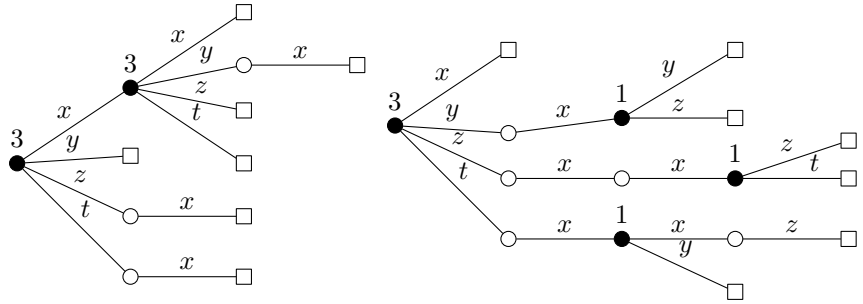

Figure 3.2: Two G -maximal bifix codes of G -degree 2.

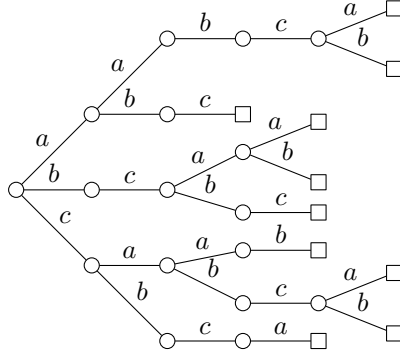

Figure 3.3: An F -maximal bifix code of F -degree 4.

4.1 The tree condition

For a biextendable word w , we consider the undirected graph $G(w)$ on the set of vertices which is the disjoint union of $L(w)$ and $R(w)$ with edges the pairs $(a, b) \in E(w)$.

Recall that an undirected graph is a tree if it is connected and acyclic.

We say that F satisfies the *tree condition* if it is biessential and if for every word $w \in F$, the graph $G(w)$ is a tree. We also say that F is a *tree set*.

Note that for a biessential set F , the graph $G(w)$ is a tree for any ordinary word w (but $G(w)$ can be a tree although w is not ordinary).

Note that a biessential set F satisfies the tree condition if and only if the graph $G(w)$ is a tree for every bispecial word w . Indeed, if w is not bispecial, then $G(w)$ is always a tree.

Example 4.1 A Sturmian set F satisfies the tree condition. Indeed, F is biessential and every bispecial word is ordinary.

Clearly the tree condition implies the neutrality condition. The following example shows that the converse is not true.

Example 4.2 Let $A = \{a, b, c\}$ and let F be the set of factors of $a^* \{bc, bcbc\} a^*$. The set F is biessential. One has $F \cap A^2 = \{aa, ab, bc, cb, ca\}$. It satisfies the neutrality condition. Indeed the empty word is neutral since $e(\varepsilon) = \text{Card}(F \cap A^2) = 5 = \ell(\varepsilon) + r(\varepsilon) - 1$. Next, the only nonempty bispecial words are bc and a^n for $n \geq 1$. They are neutral since $e(bc) = 3 = \ell(bc) + r(bc) - 1$ and $e(a^n) = 3 = \ell(a^n) + r(a^n) - 1$. However, F does not satisfy the tree condition since the graph $G(\varepsilon)$ contains a cycle (see Figure 4.1).

In the last example, the set is not recurrent. We present now an example, due to Julien Cassaigne [9], of a uniformly recurrent neutral set which is not a tree set.

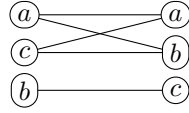

Figure 4.1: The graph $G(\varepsilon)$ for the set F .

Example 4.3 Let $A = \{a, b, c, d\}$ and let σ be the morphism from A^* into itself defined by

$$\sigma(a) = ab, \sigma(b) = cda, \sigma(c) = cd, \sigma(d) = abc.$$

Let F be the set of factors of the infinite word $\sigma^\omega(a)$ (see Figure 4.2 on the left). Since σ is primitive, F is uniformly recurrent. We will show that all the nonempty words of F are neutral. We will use some properties of the set

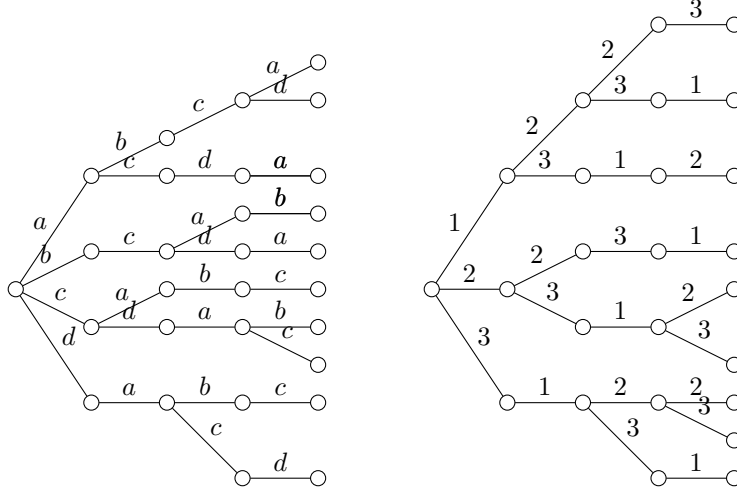

Figure 4.2: The sets F and G .

$X = \sigma(A)$. Observe first X is a suffix code. It has even the stronger property that distinct words of X end with distinct letters. The set X is not a prefix code but satisfies the following weaker property. If $x, x', y \in X$ and $y' \in X^*$ are such that xy is a prefix of $x'y'$, then $x = x'$ (the set X said to be *weakly prefix*).

As a third property, the set X has *synchronizing pairs*. A pair u, v of words is synchronizing if for all words p, q , if $puvq \in X^*$, then $pu, vq \in X^*$. For example (c, a) is a synchronizing pair.

Note that if (r, s) and (u, v) are synchronizing pairs, then $qrstuvw \in F$ implies $stu \in X^*$

We first show the following properties.

1. If a left-special word of length at least 5 begins with a (resp. c), it begins with $abcda$ (resp. $cdabc$).
2. If a right-special word of length at least 5 ends with a (resp. c), it ends with $abcda$ (resp. $cdabc$).

Indeed, the left-special words of length at most 5 beginning with a are the prefixes of $abcd a$. This implies that any left-special word beginning with a begins with $abcd a$.

The three other assertions can be proved in an analogous way.

Let us now show that any nonempty bispecial word of F is neutral. We use an induction on the length of the word to prove that the graph of a nonempty bispecial word is, according to its first and last letter, equal to one of the eight graphs of Figure 4.3. The assertion is true for words of length at most 4 since a , c , abc and cda are the bispecial words of length at most 4.

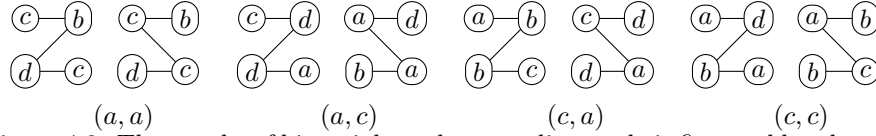

Figure 4.3: The graphs of bispecial words, according to their first and last letter.

Assume that v is a bispecial word of length at least 5. Assume first that v begins and ends with a . As seen previously, v begins and ends with $abcd a$.

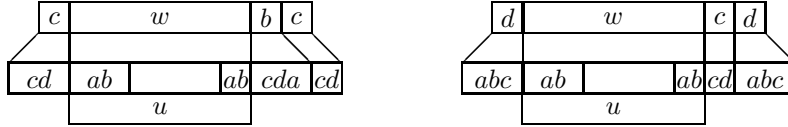

Figure 4.4: A bispecial word beginning and ending with a .

Set $v = ucda$. Since (d, ab) and (b, cd) are synchronizing and since $cd u cda \in F$, we have $u = \sigma(w)$ with $cw \in F$. Since $cv \in F$, and since (c, a) is synchronizing, we have also $abc v \in F$. Thus $dw \in F$ (see Figure 4.4 on the left).

Next, we have $vb \in F$. Since (d, a) is synchronizing, we have $wcd \in F$ and $vbc \in F$ (see Figure 4.4 on the right). Similarly, since $vc \in F$, we have $wbc \in F$ and $vcd \in F$ (see Figure 4.4 on the left). Thus w is a bispecial word which begins and ends with a shorter than v . By induction hypothesis, the graph of w is equal to one of the two first graphs of Figure 4.3. In both cases, we have $cwb, dwc \in F$ and thus $dvc, cvb \in F$. Next $dwb \in F$ if and only if $cvc \in F$. Thus $G(w)$ is one of the graphs if and only if $G(v)$ is the other one. This proves the property in this case.

The other cases are treated similarly.

Let $B = \{1, 2, 3\}$ and let $\tau : A^* \rightarrow B^*$ be defined by

$$\tau(a) = 12, \quad \tau(b) = 2, \quad \tau(c) = 3, \quad \tau(d) = 13.$$

Let G be the set of factors of the infinite word $\tau(\sigma^\omega(a))$ (see Figure 4.2 on the right).

The set $Y = \tau(A)$ is a prefix code. It is not a suffix code but it is weakly suffix, which means that the reversal of Y is weakly prefix.

Let $g : \{a, c\}A^* \cap A^*\{a, c\} \rightarrow B^*$ be the map defined by

$$g(w) = \begin{cases} 3\tau(w) & \text{if } w \text{ begins and ends with } a \\ 3\tau(w)1 & \text{if } w \text{ begins with } a \text{ and ends with } c \\ 2\tau(w) & \text{if } w \text{ begins with } c \text{ and ends with } a \\ 2\tau(w)1 & \text{if } w \text{ begins with } c \text{ and ends with } c \end{cases}$$

It can be verified, using the fact that Y is a prefix and weakly suffix code, that the set of nonempty bispecial words of G is the union of $2, 31$ and of the set $g(S)$ where S is the set of nonempty bispecial words of F . One may verify that the words of $g(S)$ are neutral. Since the words $2, 31$ are also neutral, the set G is neutral. It is uniformly recurrent since F is uniformly recurrent. The set G does not satisfy the tree condition since the graph $G(\varepsilon)$ is not connected (see Figure 4.5).

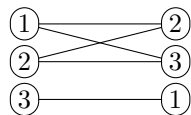

Figure 4.5: The graph $G(\varepsilon)$ for the set G .

4.2 The planar tree condition

Let $<_1$ and $<_2$ be two orders on A . For a set F and a word $w \in F$, we say the the graph $G(w)$ is *compatible* with the orders $<_1$ and $<_2$ if for any $(a, b), (c, d) \in E(w)$, one has

$$a <_1 c \implies b \leq_2 d.$$

Thus, placing the vertices of $L(w)$ ordered by $<_1$ on a line and those of $R(w)$ ordered by $<_2$ on a parallel line, the edges of the graph may be drawn as straight noncrossing segments, resulting in a planar graph.

We say that a biessential set F satisfies the *planar tree condition* with respect to two orders $<_1$ and $<_2$ on A if for any $w \in F$, the graph $G(w)$ is a tree compatible with $<_1, <_2$.

The following example shows that the Tribonacci set does not satisfy the planar tree condition.

Example 4.4 Let F be the Tribonacci set (see example 2.2). The words a, aba and $abacaba$ are bispecial. Thus the words $ba, caba$ are right-special and the words $ab, abac$ are left-special. The graphs $G(\varepsilon), G(a)$ and $G(aba)$ are shown in Figure 4.6. One sees easily that it not possible to find two orders on A making the three graphs planar.

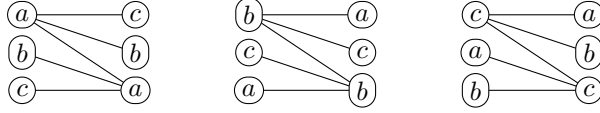

Figure 4.6: The graphs $G(\varepsilon)$, $G(a)$ and $G(aba)$ in the Tribonacci set.

4.3 The strong tree condition

Let F be a set. For $w \in F$, let $U \subset A^*$ be a finite suffix code and let $U(w) = \{\ell \in U \mid \ell w \in F\}$. Let $V \subset A^*$ be a finite prefix code and let $V(w) = \{r \in V \mid wr \in F\}$. Let $G_{U,V}(w)$ be the following undirected graph. The set of vertices is made of two disjoint copies of $U(w)$ and $V(w)$. The edges are the pairs (ℓ, r) for $\ell \in U(w)$ and $r \in V(w)$ such that $\ell wr \in F$. The graph $G(w)$ defined previously corresponds to the case where $U, V = A$.

Example 4.5 Let F be the Fibonacci set. Let $w = a$, $U = \{aa, ba, b\}$ and let $V = \{aa, ab, b\}$. The graph $G_{U,V}(w)$ is represented in Figure 4.7.

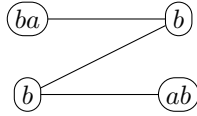

Figure 4.7: The graph $G_{U,V}(w)$.

We say that F satisfies the *strong tree condition* if it is biessential and if for every triple w, U, V with $w \in F$, U a finite maximal suffix code and V a finite maximal prefix code, the graph $G_{U,V}(w)$ is a tree. Note that we might as well use for U a finite F -maximal suffix code and for V a finite F -maximal prefix code. Clearly the strong tree condition implies the tree condition. The following result shows that they are actually equivalent.

Proposition 4.6 *If a set satisfies the tree condition, it satisfies the strong tree condition.*

The proof uses the following lemma.

Lemma 4.7 *Let F be a biessential set. Let $w \in F$, let U be a finite suffix code and let V be a finite prefix code. Assume that there exists $\ell \in F$ such that $\ell w \in F$ and $A\ell \subset U$. Set $U' = (U \setminus A\ell) \cup \ell$. If the graphs $G_{U',V}(w)$ and $G_{A,V}(\ell w)$ are trees then $G_{U,V}(w)$ is a tree.*

Proof. Since F is left-essential, there is a letter $a \in A$ such that $a\ell w \in F$ and thus $a\ell \in U(w)$. Let us first show that $G_{U,V}(w)$ is connected.

Step 1. As a preliminary step, let us show that for each $r \in V$ such that $\ell wr \in F$, there is a path from $a\ell$ to r in $G_{U,V}(w)$. Indeed, since the graph $G_{A,V}(\ell w)$ is connected there is a path from a to r in this graph. Thus there is a path from $a\ell$ to r in $G_{U,V}(w)$.

Step 2. As a second step, let us show that for any $m \in U'(w) \setminus \ell$ and $r \in V(w)$, there is a path from m to r in $G_{U,V}(w)$. Indeed there is a path from m to r in $G_{U',V}(w)$. For each edge of this path of the form (ℓ, s) , by Step 1, there is a path from al to s in the graph $G_{U,V}(w)$. Thus there is a path from m to r in $G_{U,V}(w)$.

Step 3. In the same way as above, for each $r \in V(w)$, there is a path from al to r in $G_{U,V}(w)$.

Consider now $m \in U(w)$ and $r \in V(w)$. If $m \notin Al$, then $m \in U'(w) \setminus \ell$ and thus, by Step 2, there is a path from m to r in $G_{U,V}(w)$. Next, assume that $m = bl$ with $b \in A$. Since $G_{A,V}(\ell w)$ is connected, there is a path from b to a in $G_{A,V}(\ell w)$ and thus a path from m to al in $G_{U,V}(w)$. By Step 3, there is a path from al to r in $G_{U,V}(w)$. Thus there is a path from m to r in $G_{U,V}(w)$.

Assume now that $G_{U,V}(w)$ contains a cycle C . If the cycle does not use a vertex in U' , it defines a cycle in the graph $G_{A,V}(\ell w)$ obtained by replacing each vertex al by a vertex a . Since $G_{A,V}(\ell w)$ is a tree, this is impossible. If it uses a vertex of U' it defines a cycle of the graph $G_{U',V}(w)$ obtained by replacing each vertex al by ℓ . This is impossible since $G_{U',V}(w)$ is a tree. Thus $G_{U,V}(w)$ is a tree. ■

Proof of Proposition 4.6. Let F be a set satisfying the tree condition. Let U be a finite maximal suffix code and let V be a finite maximal prefix code. We show by induction on the sum of the lengths of the words in U, V that for any $w \in F$, the graph $G_{U,V}(w)$ is a tree. Let $w \in F$.

If $U, V = A$, the property is true since F satisfies the tree condition.

Otherwise, assume for example that U contains words of length at least 2. Since U is a finite maximal suffix code, there is a word $\ell \in A^*$ such that $Al \subset U$. Let $U' = (U \setminus Al) \cup \ell$. If $\ell w \notin F$, then $G_{U,V}(w) = G_{U',V}(w)$ and thus the conclusion holds.

Otherwise, by induction hypothesis, the graphs $G_{U',V}(w)$ and $G_{A,V}(\ell w)$ are trees. By lemma 4.7, the graph $G_{U,V}(w)$ is a tree. ■

The following corollary shows that if one uses codes U, V which are not maximal, the corresponding graph will not always be connected but it will still be acyclic.

Corollary 4.8 *If a set F satisfies the tree condition, then for every $w \in F$, every finite suffix code U and every finite prefix code V , the graph $G_{U,V}(w)$ is acyclic.*

Proof. Let U' (resp. V') be a finite maximal suffix (resp. prefix) code containing U (resp. V). Since F satisfies, by Proposition 4.6, the strong tree condition, the graph $G_{U',V'}(w)$ is a tree. Since $G_{U,V}(w)$ is a subgraph of $G_{U',V'}(w)$ it is acyclic. ■

Given an order $<$ on the alphabet A , the corresponding *lexicographic order* on words is defined by $u < v$ if u is a proper prefix of v or if $u = paq, v = pbr$ for

some words p, q, r and letters a, b such that $a < b$. A reverse *lexicographic order* is defined symmetrically by $u < v$ if u is a proper suffix of v or if $u = qas, v = rbs$ for some words q, r, s and letters a, b such that $a < b$.

Let $<_1$ be a reverse lexicographic order and $<_2$ be a lexicographic order. For a word $w \in F$, a finite suffix code $U \subset A^*$ and a finite prefix code $V \subset A^*$, we say that the graph $G_{U,V}(w)$ is compatible with the orders $<_1$ and $<_2$ if for any edges $(u, v), (u', v')$ of $G_{U,V}(w)$, one has

$$u <_1 u' \implies v \leq_2 v'.$$

Thus, as for the tree condition, the compatibility with the orders $<_1$ and $<_2$ expresses the fact that $G_{U,V}(w)$ may be drawn as a planar tree if U is ordered according to $<_1$ and V is ordered according to $<_2$.

We say that a biessential set F satisfies the strong planar tree condition with respect to $<_1$ and $<_2$ if, for any $w \in F$, any finite maximal suffix code $U \subset A^*$ and any finite maximal prefix code $V \subset A^*$, the graph $G_{U,V}(w)$ is a tree compatible with $<_1$ and $<_2$.

The following result shows that the planar tree condition is equivalent to the strong one. We assume given a reverse lexicographic order $<_1$ and a lexicographic order $<_2$.

Proposition 4.9 *If a set satisfies the planar tree condition with respect to $<_1$ and $<_2$, it satisfies the strong planar tree condition with respect to the same orders.*

Proof. Let F be a set satisfying the planar tree condition with respect to $<_1$ and $<_2$. Let $w \in F$, let $U \subset A^*$ be a finite maximal suffix code and let $V \subset A^*$ be a finite maximal prefix code. We show by induction on the sum of the lengths of the words in U, V that for any $w \in F$ the graph $G_{U,V}(w)$ is a tree compatible with the orders $<_1$ and $<_2$.

If $U, V = A$, the property is true since F satisfies the planar tree condition.

Otherwise, assume for example that U contains words of length at least 2. Since U is a finite maximal suffix code, there is a word ℓ such that $A\ell \subset U$. Let $U' = (U \setminus A\ell) \cup \ell$. If $\ell w \notin F$, then $G_{U,V}(w) = G_{U',V}(w)$ and thus the conclusion holds. Otherwise, by Lemma 4.7, the graph $G_{U,V}(w)$ is a tree.

Consider two edges $(u, v), (u', v')$ of $G_{U,V}(w)$. Assume that $u <_1 u'$. We show that $v \leq_2 v'$. This implies that $G_{U,V}(w)$ is compatible with $<_1, <_2$ and thus our conclusion.

If $u, u' \notin A\ell$, then $u, u' \in U'$ and thus $v <_2 v'$ since $G_{U',V}(w)$ is compatible with $<_1, \leq_2$ by induction hypothesis.

Next, assume that $u \in A\ell$ and $u' \notin A\ell$. Since $<_1$ is a reverse lexicographic order, we have $\ell <_1 u$ and thus $\ell <_1 u'$. Since (ℓ, v) is an edge of $G_{U',V}(w)$ and since $G_{U',V}(w)$ is compatible with $<_1, <_2$, this implies that $v \leq_2 v'$.

The case $u \notin A\ell, u' \in A\ell$ is symmetrical.

Assume finally that $u, u' \in A\ell$. Set $u = a\ell$ and $u' = a'\ell$. Then $(a, v), (a', v')$ are edges of $G_{A,V}(\ell w)$. Since by induction hypothesis $G_{A,V}(\ell w)$ is compatible with $<_1, <_2$, we have $v \leq_2 v'$. ■

We end this section with a consequence of Proposition 4.6.

Corollary 4.10 *Let F be recurrent tree set and let $f : B \rightarrow X$ be a coding morphism for an F -maximal finite bifix code X . If F is a tree set, then $f^{-1}(F)$ is a tree set.*

Proof. Since F is recurrent, it is biessential. It implies that $f^{-1}(F)$ is also biessential. Indeed, let $u \in f^{-1}(F)$ and let $v = f(u)$. Let r, s be words of F longer than all words of X such that $rvs \in F$. Let r' (resp. s') be the suffix of r (resp. the prefix of s) which is in X . Then $f^{-1}(r')uf^{-1}(s')$ is in $f^{-1}(F)$. This shows that $f^{-1}(F)$ is biessential.

Let $u \in f^{-1}(F)$ and let $v = f(u)$. Since F is a tree set, it satisfies the strong tree condition by Proposition 4.6. Since X is a finite F -maximal bifix code, it is both an F -maximal suffix code and an F -maximal prefix code. Thus the graph $G_{X,X}(v)$ is a tree. Since $G(u)$ is isomorphic with $G_{X,X}(v)$, it is also a tree. Thus $f^{-1}(F)$ is a tree set. ■

The following example shows that, under the hypotheses of Corollary 4.10, when F is a Sturmian set, the set $f^{-1}(F)$ need not be Sturmian.

Example 4.11 Let $A = \{a, b, c\}$ and let F be the Tribonacci set. The set F is Sturmian and thus is a uniformly recurrent tree set. Let $X = F \cap A^2$ and let f be the coding morphism for X defined by $f(x) = aa$, $f(y) = ab$, $f(z) = ac$, $f(t) = ba$, $f(u) = ca$. Then, by Corollary 4.10, the set $f^{-1}(F)$ is a tree set. It is not Sturmian because y and t are right-special.

5 Interval exchange sets

In this section, we recall the definition and the basic properties of interval exchange transformations. We discuss the relation with bifix codes and we show that the class of regular interval exchange sets is closed under inverse images by coding morphisms of finite maximal bifix codes (Corollary 5.22).

5.1 Interval exchange transformations

Let us recall the definition of an interval exchange transformation (see [10] or [8]).

A *semi-interval* is a nonempty subset of the real line of the form $[\alpha, \beta[= \{z \in \mathbb{R} \mid \alpha \leq z < \beta\}$. Thus it is a left-closed and right-open interval. For two semi-intervals Δ, Γ , we denote $\Delta < \Gamma$ if $x < y$ for any $x \in \Delta$ and $y \in \Gamma$.

Let $(A, <)$ be an ordered set. A partition $(I_a)_{a \in A}$ of $[0, 1[$ in semi-intervals is *ordered* if $a < b$ implies $I_a < I_b$.

Let A be a finite set ordered by two total orders $<_1$ and $<_2$. Let $(I_a)_{a \in A}$ be a partition of $[0, 1[$ in semi-intervals ordered for $<_1$. Let λ_a be the length of I_a . Let $\mu_a = \sum_{b \leq_1 a} \lambda_b$ and $\nu_a = \sum_{b \leq_2 a} \lambda_b$. Set $\alpha_a = \nu_a - \mu_a$. The *interval*

exchange transformation relative to $(I_a)_{a \in A}$ is the map $T : [0, 1[\rightarrow [0, 1[$ defined by

$$T(z) = z + \alpha_a \quad \text{if } z \in I_a.$$

Observe that the restriction of T to I_a is a translation onto $J_a = T(I_a)$, that μ_a is the right boundary of I_a and that ν_a is the right boundary of J_a . We additionally denote by γ_a the left boundary of I_a and by δ_a the left boundary of J_a . Thus

$$I_a = [\gamma_a, \mu_a[, \quad J_a = [\delta_a, \nu_a[.$$

Since $a <_2 b$ implies $J_a <_2 J_b$, the family $(J_a)_{a \in A}$ is a partition of $[0, 1[$ ordered for $<_2$. In particular, the transformation T defines a bijection from $[0, 1[$ onto itself.

An interval exchange transformation relative to $(I_a)_{a \in A}$ is also said to be on the alphabet A . The values $(\alpha_a)_{a \in A}$ are called the *translation values* of the transformation T .

Example 5.1 Let R be the interval exchange transformation corresponding to $A = \{a, b\}$, $a <_1 b$, $b <_2 a$, $I_a = [0, 1 - \alpha[$, $I_b = [1 - \alpha, 1[$. The transformation R is the rotation of angle α on the semi-interval $[0, 1[$ defined by $R(z) = z + \alpha \bmod 1$.

Since $<_1$ and $<_2$ are total orders, there exists a unique permutation π of A such that $a <_1 b$ if and only if $\pi(a) <_2 \pi(b)$. Conversely, $<_2$ is determined by $<_1$ and π and $<_1$ is determined by $<_2$ and π . The permutation π is said to be *associated* to T .

If we set $A = \{a_1, a_2, \dots, a_s\}$ with $a_1 <_1 a_2 <_1 \dots <_1 a_s$, the pair (λ, π) formed by the family $\lambda = (\lambda_a)_{a \in A}$ and the permutation π determines the map T . We will also denote T as $T_{\lambda, \pi}$. The transformation T is also said to be an s -interval exchange transformation.

It is easy to verify that the family of s -interval exchange transformations is closed by composition and by taking inverses.

Example 5.2 A 3-interval exchange transformation is represented in Figure 5.1. One has $A = \{a, b, c\}$ with $a <_1 b <_1 c$ and $b <_2 c <_2 a$. The associated permutation is the cycle $\pi = (abc)$.

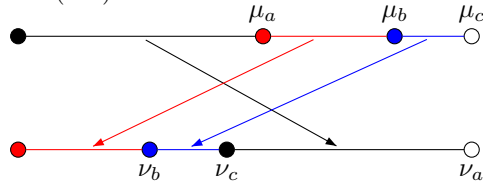

Figure 5.1: A 3-interval exchange transformation

5.2 Regular interval exchange transformations

The *orbit* of a point $z \in [0, 1[$ is the set $\{T^n(z) \mid n \in \mathbb{Z}\}$. The transformation T is said to be *minimal* if for any $z \in [0, 1[$, the orbit of z is dense in $[0, 1[$.

Set $A = \{a_1, a_2, \dots, a_s\}$ with $a_1 <_1 a_2 <_1 \dots <_1 a_s$, $\mu_i = \mu_{a_i}$ and $\delta_i = \delta_{a_i}$. The points $0, \mu_1, \dots, \mu_{s-1}$ form the set of *separation points* of T , denoted $\text{Sep}(T)$.

An interval exchange transformation $T_{\lambda, \pi}$ is called *regular* if the orbits of the nonzero separation points μ_1, \dots, μ_{s-1} are infinite and disjoint. Note that the orbit of 0 cannot be disjoint of the others since one has $T(\mu_i) = 0$ for some i with $1 \leq i \leq s$.

A regular interval exchange transformation is also said to satisfy the *idoc* condition (where idoc stands for infinite disjoint orbit condition).

Note that since $\delta_2 = T(\mu_1), \dots, \delta_s = T(\mu_{s-1})$, T is regular if and only if the orbits of $\delta_2, \dots, \delta_s$ are infinite and disjoint.

As an example, the 2-interval exchange transformation of Example 5.1 which is the rotation of angle α is regular if and only if α is irrational. The following result is due to Keane [16].

Theorem 5.3 (Keane) *A regular interval exchange transformation is minimal.*

The converse is not true. Indeed, consider the rotation of angle α with α irrational, as a 3-interval exchange transformation with $\lambda = (1 - 2\alpha, \alpha, \alpha)$ and $\pi = (132)$. The transformation is minimal as any rotation of irrational angle but it is not regular since $\mu_1 = 1 - 2\alpha$, $\mu_2 = 1 - \alpha$ and thus $\mu_2 = T(\mu_1)$.

The following necessary condition for minimality of an interval exchange transformation is useful. A permutation π of an ordered set A is called *decomposable* if there exists an element $b \in A$ such that the set B of elements strictly less than b is nonempty and such that $\pi(B) = B$. Otherwise it is called *indecomposable*. If an interval exchange transformation $T = T_{\lambda, \pi}$ is minimal, the permutation π is indecomposable. Indeed, if B is a set as above, the set of orbits of the points in the set $S = \cup_{a \in B} I_a$ is closed and strictly included in $[0, 1[$.

The following example shows that the indecomposability of π is not sufficient for T to be minimal.

Example 5.4 Let $A = \{a, b, c\}$ and λ be such that $\lambda_a = \lambda_c$. Let π be the transposition (ac) . Then π is indecomposable but $T_{\lambda, \pi}$ is not minimal since it is the identity on I_b .

5.3 Natural coding

Let T be an interval exchange transformation relative to $(I_a)_{a \in A}$. For a given real number $z \in [0, 1[$, the *natural coding* of T relative to z is the infinite word $\Sigma_T(z) = a_0 a_1 \dots$ on the alphabet A defined by

$$a_n = a \quad \text{if} \quad T^n(z) \in I_a.$$

For a word $w = b_0 b_1 \cdots b_{m-1}$, let I_w be the set

$$I_w = I_{b_0} \cap T^{-1}(I_{b_1}) \cap \cdots \cap T^{-m+1}(I_{b_{m-1}}). \quad (5.1)$$

Note that each I_w is a semi-interval. Indeed, this is true if w is a letter. Next, assume that I_w is a semi-interval. Then for any $a \in A$, $T(I_{aw}) = T(I_a) \cap I_w$ is a semi-interval since $T(I_a)$ is a semi-interval by definition of an interval exchange transformation. Since $I_{aw} \subset I_a$, $T(I_{aw})$ is a translate of I_{aw} , which is therefore also a semi-interval. This proves the property by induction on the length.

Set $J_w = T^m(I_w)$. Thus

$$J_w = T^m(I_{b_0}) \cap T^{m-1}(I_{b_1}) \cap \cdots \cap T(I_{b_{m-1}}). \quad (5.2)$$

In particular, we have $J_a = T(I_a)$ for $a \in A$. Note that each J_w is a semi-interval. Indeed, this is true if w is a letter. Next, for any $a \in A$, we have $T^{-1}(J_{wa}) = J_w \cap I_a$. This implies as above that J_{wa} is a semi-interval and proves the property by induction. We set by convention $I_\varepsilon = J_\varepsilon = [0, 1[$. Then one has for any $n \geq 0$

$$a_n a_{n+1} \cdots a_{n+m-1} = w \iff T^n(z) \in I_w \quad (5.3)$$

and

$$a_{n-m} a_{n-m+1} \cdots a_{n-1} = w \iff T^n(z) \in J_w \quad (5.4)$$

Let $(\alpha_a)_{a \in A}$ be the translation values of T . Note that for any word w ,

$$J_w = I_w + \alpha_w \quad (5.5)$$

with $\alpha_w = \sum_{j=0}^{m-1} \alpha_{b_j}$ as one may verify by induction on $|w| = m$. Indeed it is true for $m = 1$. For $m \geq 2$, set $w = ua$ with $a = b_{m-1}$. One has $T^m(I_w) = T^{m-1}(I_w) + \alpha_a$ and $T^{m-1}(I_w) = I_w + \alpha_u$ by the induction hypothesis and the fact that I_w is included in I_u . Thus $J_w = T^m(I_w) = I_w + \alpha_u + \alpha_a = I_w + \alpha_w$. Equation (5.5) shows in particular that the restriction of $T^{|w|}$ to I_w is a translation.

If T is minimal, one has $w \in F(\Sigma_T(z))$ if and only if $I_w \neq \emptyset$. Thus the set $F(\Sigma_T(z))$ does not depend on z (as for Sturmian words, see [17]). Since it depends only on T , we denote it by $F(T)$. When T is regular (resp. minimal), such a set is called a *regular interval exchange set* (resp. a minimal interval exchange set).

Let X be the set of all $\Sigma_T(z)$ for $z \in [0, 1[$ and let S be the shift on X . Then we have the following commutative diagram.

$$\begin{array}{ccc} [0, 1[& \xrightarrow{T} & [0, 1[\\ \downarrow \Sigma_T & & \downarrow \Sigma_T \\ X & \xrightarrow{S} & X \end{array}$$

The pair (X, S) is a *symbolic dynamical system*, formed of a topological space X and a continuous transformation S . Such a system is said to be minimal if the only closed subsets invariant by S are \emptyset or S . It is well-known that (X, S) is minimal if and only if $F(S)$ is uniformly recurrent (see for example [17] Theorem 1.5.9). The transformation T is minimal if and only if the symbolic dynamical system (X, S) is minimal (see [8] page 392). Thus, we obtain the following statement.

Proposition 5.5 *For any minimal interval exchange transformation T , the set $F(T)$ is uniformly recurrent.*

Note that for a minimal interval exchange transformation T , the map Σ_T is injective (see [16] page 30).

The following is an elementary property of the intervals I_u which will be used below. We denote by $<_1$ the lexicographic order induced by the order $<$.

Proposition 5.6 *One has $I_u <_1 I_v$ if and only if $u <_1 v$ and u is not a prefix of v .*

Proof. For a word u and a letter a , it results from (5.1) that $I_{ua} = I_u \cap T^{-|u|}(I_a)$. Since $(I_a)_{a \in A}$ is an ordered partition, this implies that $(T^{|u|}(I_u) \cap I_a)_{a \in A}$ is an ordered partition of $T^{|u|}(I_u)$. Since the restriction of $T^{|u|}$ to I_u is a translation, this implies that $(I_{ua})_{a \in A}$ is an ordered partition of I_u . Moreover, for two words u, v , it results also from (5.1) that $I_{uv} = I_u \cap T^{-|u|}(I_v)$. Thus $I_{uv} \subset I_u$.

Assume that $u <_1 v$ and that u is not a prefix of v . Then $u = \ell a s$ and $v = \ell b t$ with a, b two letters such that $a <_1 b$. Then we have $I_{\ell a} <_1 I_{\ell b}$, with $I_u \subset I_{\ell a}$ and $I_v \subset I_{\ell b}$ whence $I_u <_1 I_v$.

Conversely, assume that $I_u <_1 I_v$. Since $I_u \cap I_v = \emptyset$, the words u, v cannot be comparable for the prefix order. Set $u = \ell a s$ and $v = \ell b t$ with a, b two distinct letters. If $b <_1 a$, then $I_v <_1 I_u$ as we have shown above. Thus $a <_1 b$ which implies $u <_1 v$. ■

We denote by $<_2$ the order on A^* defined by $u <_2 v$ if u is a proper suffix of v or if $u = w a z$ and $v = t b z$ with $a <_2 b$. Thus $<_2$ is the lexicographic order on the reverse of the words induced by the order $<_2$ on the alphabet.

We denote by π the morphism from A^* onto itself which extends to A^* the permutation π on A . Then $u <_2 v$ if and only if $\pi^{-1}(\tilde{u}) <_1 \pi^{-1}(\tilde{v})$.

The following statement is the analogue of Proposition 5.6.

Proposition 5.7 *Let $T_{\lambda, \pi}$ be an interval exchange transformation. One has $J_u <_2 J_v$ if and only if $u <_2 v$ and u is not a suffix of v .*

Proof. Let $(I'_a)_{a \in A}$ be the family of semi-intervals defined by $I'_a = J_{\pi(a)}$. Then the interval exchange transformation T' relative to (I'_a) with translation values $-\alpha_a$ is the inverse of the transformation T . The semi-intervals I'_w defined by Equation (5.1) with respect to T' satisfy $I'_w = J_{\pi(\bar{w})}$ or equivalently $J_w =$

$I'_{\pi^{-1}(\tilde{w})}$. Thus, $J_u <_2 J_v$ if and only if $I'_{\pi^{-1}(\tilde{u})} <_1 I'_{\pi^{-1}(\tilde{v})}$ if and only if (by Proposition 5.6) $\pi^{-1}(\tilde{u}) <_1 \pi^{-1}(\tilde{v})$ or equivalently $u <_2 v$. ■

A map $\pi : A^* \rightarrow [0, 1]$ such that $\pi(\varepsilon) = 1$ and for any word w

$$\sum_{a \in A} \pi(aw) = \sum_{a \in A} \pi(wa) = \pi(w).$$

is called an *invariant probability distribution* on A^* .

Let $T_{\lambda, \pi}$ be an interval exchange transformation. For any word $w \in A^*$, denote by $|I_w|$ the length of the semi-interval I_w defined by Equation (5.1). Set $\lambda(w) = |I_w|$. Then $\lambda(\varepsilon) = 1$ and for any word w

$$\sum_{a \in A} \lambda(aw) = \sum_{a \in A} \lambda(wa) = \lambda(w).$$

Thus λ is an invariant probability distribution.

Example 5.8 Let F be the set of factors of the Fibonacci word. It is the natural coding of the rotation of angle $\alpha = (3 - \sqrt{5})/2$ with respect to α (see [17], Chapter 2). The values of the map λ on the words of length at most 4 in F are indicated in Figure 5.2.

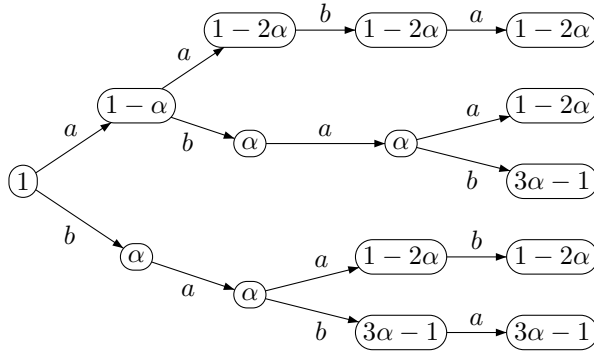

Figure 5.2: The invariant probability distribution on the Fibonacci set.

The following result is proved in [11] with a converse (see below).

Proposition 5.9 *Let T be an interval exchange transformation on A ordered by $<_1$ and $<_2$. If T is regular, the set $F(T)$ satisfies the planar tree condition with respect to $<_2$ and $<_1$.*

Proof. Assume that T is a regular interval exchange transformation relative to $(I_a, \alpha_a)_{a \in A}$. Let x be the natural coding of T relative to $z \in [0, 1[$ and let $F = F(x)$.

Since T is minimal, w is in F if and only if $I_w \neq \emptyset$. Thus, one has

- (i) $b \in R(w)$ if and only if $I_w \cap T^{-|w|}(I_b) \neq \emptyset$ and
- (ii) $a \in L(w)$ if and only if $J_a \cap I_w \neq \emptyset$.

Condition (i) holds because $I_{wb} = I_w \cap T^{-|w|}(I_b)$ and condition (ii) because $I_{aw} = I_a \cap T^{-1}(I_w)$, which implies $T(I_{aw}) = J_a \cap I_w$. In particular, (i) implies that $(I_{wb})_{b \in R(w)}$ is an ordered partition of I_w with respect to $<_1$.

For $a, a' \in L(w)$, there is a unique path in $G(w)$ from a to a' which is the sequence a_1, b_1, \dots, a_n with $a_1 = a$ and $a_n = a'$ with $a_1 <_2 a_2 <_2 \dots <_2 a_n$, $b_1 <_1 b_2 <_1 \dots <_1 b_{n-1}$ and $J_{a_i} \cap I_{wb_i} \neq \emptyset$, $J_{a_{i+1}} \cap I_{wb_i} \neq \emptyset$ for $1 \leq i \leq n-1$ (see Figure 5.3). Note that the hypothesis that T is regular is needed here since otherwise the right boundary of J_{a_i} could be the left boundary of I_{wb_i} . Thus $G(w)$ is a tree. It is compatible with $<_2, <_1$ since the above shows that $a <_2 a'$ implies that the letters b_1, b_{n-1} such that $(a, b_1), (a', b_{n-1}) \in E(w)$ satisfy $b_1 \leq_1 b_{n-1}$. ■

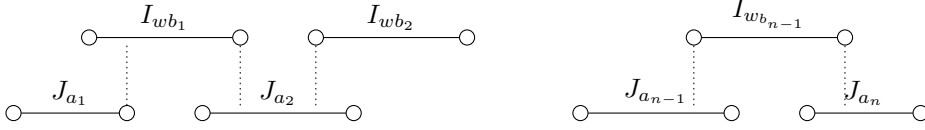

Figure 5.3: A path from a_1 to a_n in $G(w)$.

Since a set satisfying the tree condition satisfies the neutrality condition, we obtain the following well-known corollary.

Corollary 5.10 *If F is a regular interval exchange set, then $\text{Card}(F \cap A^n) = n(\text{Card}(A) - 1) + 1$ for all $n \geq 0$.*

The main result of [11] states that a uniformly recurrent set F on an alphabet A is a regular interval exchange set if and only if $A \subset F$ and there exists two orders $<_1$ and $<_2$ on A such that the following conditions are satisfied for any word $w \in F$.

- (i) The set $L(w)$ (resp. $R(w)$) is formed of consecutive elements for the order $<_2$ (resp. $<_1$).
- (ii) For $(a, b), (c, d) \in E(w)$, if $a <_2 c$, then $b \leq_1 d$.
- (iii) If $a, b \in L(w)$ are consecutive for the order $<_2$, then the set $R(aw) \cap R(bw)$ is a singleton.

It is easy to see that a biessential set F containing A satisfies (ii) and (iii) if and only if it satisfies the planar tree condition. Actually, in this case, it automatically satisfies also condition (i). Indeed, let us consider a word w and $a, b, c \in A$ with $a <_1 b <_1 c$ such that $wa, wc \in F$ but $wb \notin F$. Since $b \in F$ there is a (possibly empty) suffix v of w such that $vb \in F$. We choose v of maximal length. Since $wb \notin F$, we have $w = uv$ with u nonempty. Let d be the last letter of u . Then we have $dva, dvc \in F$ and $dvb \notin F$. Since $G(v)$ is a tree and $b \in R(v)$, there is a letter $e \in L(v)$ such that $evb \in F$. But $e <_2 d$ and $d <_2 e$ are both impossible since $G(v)$ is compatible with $<_2$ and $<_1$. Thus we reach a contradiction.

This shows the following reformulation of the main result of [11].

Theorem 5.11 (Ferenczi, Zamboni) *A set F is a regular interval exchange set on the alphabet A if and only if it is uniformly recurrent, contains A and satisfies the planar tree condition.*

The next example shows that there are uniformly recurrent tree sets which are neither Sturmian nor regular interval exchange sets.

Example 5.12 Let F be the Tribonacci set on the alphabet $A = \{a, b, c\}$ and let $f : \{x, y, z, t, u\}$ be the coding morphism for $X = F \cap A^2$ defined in Example 4.11. The set $G = f^{-1}(F)$ is a tree set which is not Sturmian (see Example 4.11). It is not a regular interval exchange set. Indeed, for any right-special word w of G , one has $r(w) = 3$. This is not possible in a regular interval exchange set T since, Σ_T being injective, the length of the interval J_w tends to 0 as $|w|$ tends to infinity.

5.4 Bifix codes and interval exchanges

The following result is a particular case of a result from [5] (Proposition 3.3.4).

Proposition 5.13 *Let F be a recurrent set and let λ be an invariant probability distribution on F . For any finite F -maximal prefix code X , one has $\sum_{x \in X} \lambda(x) = 1$.*

Let T be a minimal interval exchange transformation relative to $(I_a)_{a \in A}$. Set $F = F(T)$.

The following statement is connected with Proposition 5.13.

Proposition 5.14 *Let X be a finite F -maximal prefix code ordered by $<_1$. The family $(I_w)_{w \in X}$ is an ordered partition of $[0, 1[$.*

Proof. By Proposition 5.6, the sets (I_w) for $w \in X$ are pairwise disjoint. Let λ be the invariant probability distribution on F defined by $\lambda(w) = |I_w|$. By Proposition 5.13, we have $\sum_{w \in X} \lambda(w) = 1$. Thus the family $(I_w)_{w \in X}$ is a partition of $[0, 1[$. By Proposition 5.6 it is an ordered partition. ■

Example 5.15 Let T be the rotation of angle $\alpha = (3 - \sqrt{5})/2$. The set $F = F(T)$ is the Fibonacci set. The set $X = \{aa, ab, b\}$ is an F -maximal prefix code (see Figure 5.4). The partition of $[0, 1[$ corresponding to X is

$$I_{aa} = [0, 1 - 2\alpha[, \quad I_{ab} = [1 - 2\alpha, 1 - \alpha[, \quad I_b = [1 - \alpha, 1[.$$

The values of the lengths of the semi-intervals (the invariant probability distribution) can also be read on Figure 5.2.

A symmetric statement holds for an F -maximal suffix code, namely that the family $(J_w)_{w \in X}$ is an ordered partition of $[0, 1[$ for the order $<_2$ on X .

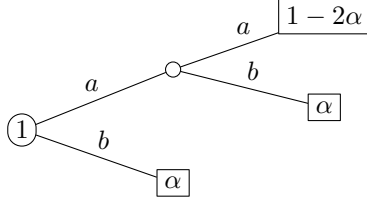

Figure 5.4: The prefix code X

Proposition 5.16 *If X is a finite F -maximal bifix code, the families $(I_w)_{w \in X}$ and $(J_w)_{w \in X}$ are ordered partitions of $[0, 1[$, relatively to the orders $<_1$ and $<_2$ respectively.*

Proof. This results from Proposition 5.14 and its symmetric and the fact that a finite F -maximal bifix code is both an F -maximal prefix code and an F -maximal suffix code. ■

Let T be a minimal interval exchange transformation relative to $(I_a)_{a \in A}$. Let $(\alpha_a)_{a \in A}$ be the translation values of T . Let x be an infinite word on A which is a natural coding of T . Set $F = F(x)$. Let X be a finite F -maximal bifix code on the alphabet A .

Let T_X be the transformation on $[0, 1[$ defined by

$$T_X(z) = T^{|u|}(z) \quad \text{if } z \in I_u$$

with $u \in X$. The transformation is well-defined since, by Proposition 5.16, the family $(I_u)_{u \in X}$ is a partition of $[0, 1[$.

Let $f : B^* \rightarrow A^*$ be a coding morphism for X . Let $(K_b)_{b \in B}$ be the family of semi-intervals indexed by the alphabet B with $K_b = I_{f(b)}$. We consider B as ordered by the orders $<_1$ and $<_2$ induced by f . Let T_f be the interval exchange transformation relative to $(K_b)_{b \in B}$. Its translation values are $\beta_b = \sum_{j=0}^{m-1} \alpha_{a_j}$ for $f(b) = a_0 a_1 \cdots a_{m-1}$. The transformation T_f is called the *transformation associated* with f .

Proposition 5.17 *One has $T_f = T_X$.*

Proof. By Proposition 5.16, the family $(K_b)_{b \in B}$ is a partition of $[0, 1[$ ordered by $<_1$. For any $w \in X$, we have by Equation (5.5) $J_w = I_w + \alpha_w$ and thus T_X is the interval exchange transformation relative to $(K_b)_{b \in B}$ with translation values β_b . ■

In the sequel, under the hypotheses of Proposition 5.17, we consider T_f as an interval exchange transformation. In particular, the natural coding of T_f relative to $z \in [0, 1[$ is well-defined.

Example 5.18 Let F be the Fibonacci set. It is the set of factors of the Fibonacci word, which is a natural coding of the rotation of angle $\alpha = (3 - \sqrt{5})/2$

relative to α (see Example 5.8). Let $X = \{aa, ab, ba\}$ and let f be the coding morphism defined by $f(u) = aa$, $f(v) = ab$, $f(w) = ba$. The two partitions of $[0, 1[$ corresponding to T_f are

$$I_u = [0, 1 - 2\alpha[, \quad I_v = [1 - 2\alpha, 1 - \alpha[, \quad I_w = [1 - \alpha, 1[$$

and

$$J_v = [0, \alpha[, \quad J_w = [\alpha, 2\alpha[, \quad J_u = [2\alpha, 1[$$

The first row of Table 5.1 gives the two orders on X . The next two rows give

$(X, <_1)$	$(X, <_2)$
aa, ab, ba	ab, ba, aa
$a, baab, bab$	$bab, baab, a$
aa, aba, b	b, aba, aa

Table 5.1: The two orders on the three F -maximal bifix codes of F -degree 2

the two orders for each of the two other F -maximal bifix codes of F -degree 2.

Let T be an minimal interval exchange transformation on the alphabet A . Let x be the natural coding of T relative to some $z \in [0, 1[$. Set $F = F(x)$. Let X be a finite F -maximal bifix code. Let $f : B^* \rightarrow A^*$ be a morphism which maps bijectively B onto X . The *decoding* of the infinite word x with respect to f is the infinite word y on the alphabet B such that $x = f(y)$.

Proposition 5.19 *The decoding of x with respect to f is the natural coding of the transformation associated to f relative to z : $\Sigma_T(z) = f(\Sigma_{T_f}(z))$.*

Proof. Let $y = b_0b_1\cdots$ be the decoding of x with respect to f . Set $x_i = f(b_i)$ for $i \geq 0$. Then, for any $n \geq 0$, we have

$$T_f^n(z) = T^{|u_n|}(z) \tag{5.6}$$

with $u_n = x_0 \cdots x_{n-1}$. Indeed, this is true for $n = 0$. Next $T_f^{n+1}(z) = T_f(y)$ with $y = T_f^n(z)$. Arguing by induction, we have $y = T^{|u_n|}(z)$. Since $x = u_n x_n x_{n+1} \cdots$, y is in I_{x_n} by (5.3). Thus by definition of T_f , $T_f(y) = T^{|x_n|}(y)$ and we obtain $T_f^{n+1}(z) = T^{|x_n|}(T^{|u_n|}(z)) = T^{|u_{n+1}|}(z)$ proving (5.6). Finally, for $u = f(b)$ with $b \in B$,

$$b_n = b \iff x_n = u \iff T^{|u_n|}(z) \in I_u \iff T_f^n(z) \in I_u = K_b.$$

showing that y is the natural coding of T_f relative to z . ■

Example 5.20 Let T, α, X and f be as in Example 5.18. Let $x = abaababa \cdots$ be the Fibonacci word. We have $x = \Sigma_T(\alpha)$. The decoding of x with respect to f is $y = vwvwv \cdots$.

5.5 Bifix codes and regular transformations

The following result shows that for the coding morphism f of a finite F -maximal bifix code, the map $T \mapsto T_f$ preserves the regularity of the transformation.

Theorem 5.21 *Let T be a regular interval exchange transformation and let $F = F(T)$. For any finite F -maximal bifix code X with coding morphism f , the transformation T_f is regular.*

Proof. Set $A = \{a_1, a_2, \dots, a_s\}$ with $a_1 <_1 a_2 <_1 \dots <_1 a_s$. We denote $\delta_i = \delta_{a_i}$. By hypothesis, the orbits of $\delta_2, \dots, \delta_s$ are infinite and disjoint. Set $X = \{x_1, x_2, \dots, x_t\}$ with $x_1 <_1 x_2 <_1 \dots <_1 x_t$. Let d be the F -degree of X .

For $x \in X$, denote by δ_x the left boundary of the semi-interval J_x . For each $x \in X$, it follows from Equation (5.2), that there is an $i \in \{1, \dots, s\}$ such that $\delta_x = T^k(\delta_i)$ with $0 \leq k < |x|$. For $1 \leq i \leq s$, let

$$X_i = \{x \in X \mid \delta_x = T^k(\delta_i), \text{ for some } k \text{ with } 0 \leq k < |x|\}$$

We will verify that the family $(X_i)_{2 \leq i \leq s}$ is a partition of $X \setminus x_1$ in sets with d elements. Let us prove first that $X \setminus x_1 = \cup_{i=2}^s X_i$. Indeed, set $Y = \cup_{i=2}^s X_i$.

For $x \in X_1$, let k with $0 \leq k < |x|$ be such that $\delta_x = T^k(\delta_1)$. If $k < |x| - 1$, then $\delta_x = T^k(\delta_1) = T^{k+1}(0)$ since $\delta_1 = T(0)$. Since $0 = \delta_i$ for some $i \in \{2, \dots, s\}$, we have $x \in Y$ in this case. Finally, if $i = 1$ and $k = |x| - 1$, then $\delta_x = T^k(\delta_1) = T^{|x|}(0)$, which implies that $x = x_1$.

Next, since T is regular, the sets X_i are pairwise disjoint. Finally, for each $x \in X_i$, let k be such that $\delta_x = T^k(\delta_i)$ and $0 \leq k < |x|$. Then, by Equation (5.4), the prefix of length k of $\Sigma_T(\delta_i)$ is a proper suffix of X . Since $\Sigma_T(\delta_i)$ has d prefixes which are proper suffixes of X , this implies that $\text{Card}(X_i) \leq d$. Thus

$$\text{Card}(X) - 1 \leq \sum_{i=2}^s \text{Card}(X_i) \leq d(s - 1)$$

Since $\text{Card}(X) = d(s - 1) + 1$ by Theorem 3.4, this implies that each X_i for $2 \leq i \leq s$ has d elements.

We will now finally show that the orbits of $\delta_{x_2}, \dots, \delta_{x_t}$ for the transformation T_f are infinite and disjoint. Assume that $\delta_{x_p} = T_f^n(\delta_{x_q})$ for some $p, q \in \{2, \dots, t\}$ and $n \in \mathbb{Z}$. Interchanging p, q if necessary, we may assume that $n \geq 0$. Let $i, j \in \{2, \dots, s\}$ be such that $\delta_{x_p} = T^k(\delta_i)$ with $0 \leq k < |x_p|$ and $\delta_{x_q} = T^\ell(\delta_j)$ with $0 \leq \ell < |x_q|$. Since $T^k(\delta_i) = T_f^n(T^\ell(\delta_j)) = T^{m+\ell}(\delta_j)$ for some $m \geq 0$, we cannot have $i \neq j$ since otherwise the orbits of δ_i, δ_j for the transformation T intersect. Thus $i = j$. Since $\delta_{x_p} = T^k(\delta_i)$, we have $\Sigma_T(\delta_i) = u\Sigma_T(\delta_{x_p})$ with $|u| = k$, u proper suffix of x_p . And since $\delta_{x_p} = T_f^n(\delta_{x_q})$, we have $\Sigma_T(\delta_{x_p}) = x\Sigma_T(\delta_{x_q})$ with $x \in X^*$. Since on the other hand $\delta_{x_q} = T^\ell(\delta_i)$, we have $\Sigma_T(\delta_i) = v\Sigma_T(\delta_{x_q})$ with $|v| = \ell$ and v a proper suffix of x_q . But since v cannot have a suffix in X , $v = ux$ implies $x = 1$ and thus $n = 0$ and $p = q$. This concludes the proof. \blacksquare

The following corollary shows that the class of regular interval exchange sets is closed under taking inverse images by coding morphisms of maximal bifix codes.

Corollary 5.22 *Let F be a regular interval exchange set. If f is a coding morphism of a finite F -maximal bifix code the set $f^{-1}(F)$ is a regular interval exchange set.*

Proof. Let T be a regular interval exchange transformation such that $F = F(T)$. By Theorem 5.21, T_f is a regular interval exchange transformation. We show that $f^{-1}(F) = F(T_f)$, which implies the conclusion.

Let $x = \Sigma_T(z)$ for some $z \in [0, 1[$ and let $y = f^{-1}(x)$. Then $F = F(x)$ and $F(T_f) = F(y)$. For any $w \in F(y)$, we have $f(w) \in F(x)$ and thus $w \in f^{-1}(F)$. This shows that $F(T_f) \subset f^{-1}(F)$. Conversely, let $w \in f^{-1}(F)$ and let $v = f(w)$. Since $F = F(x)$, there is a word u such that uv is a prefix of x . Set $z' = T^{|u|}(z)$ and $x' = \Sigma_T(z')$. Then v is a prefix of x' and w is a prefix of $y' = f^{-1}(x')$. Since T_f is regular, it is minimal and thus $F(y') = F(T_f)$. This implies that $w \in F(T_f)$. ■

Since a regular interval exchange set is uniformly recurrent, Corollary 5.22 implies in particular that if F is regular interval exchange set and f a coding morphism of a finite F -maximal bifix code, then $f^{-1}(F)$ is uniformly recurrent. This is not true for an arbitrary uniformly recurrent set F , as shown by the following example.

Example 5.23 Set $A = \{a, b\}$ and $B = \{u, v\}$. Let F be the set of factors of $(ab)^*$ and let $f : B^* \rightarrow A^*$ be defined by $f(u) = ab$ and $f(v) = ba$. Then $f^{-1}(F) = u^* \cup v^*$ which is not recurrent.

Note in contrast that, by a result proved in [1], if x is a recurrent word and $f : B^* \rightarrow A^*$ is an injective morphism such that $f(B) = F(x) \cap A^n$ for some $n \geq 1$, then $f^{-1}(x)$ is a recurrent word (Theorem 10.8.7).

We illustrate the proof of Theorem 5.21 in the following example.

Example 5.24 Let T be the rotation of angle $\alpha = (3 - \sqrt{5})/2$. The set $F = F(T)$ is the Fibonacci set. Let $X = \{a, baab, babaabab, babaabaabab\}$. The set X is an F -maximal bifix code of F -degree 3 (see [5]). The values of the μ_{x_i} and δ_{x_i} are represented in Figure 5.5.

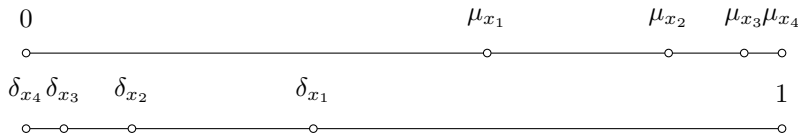

Figure 5.5: The transformation associated with a bifix code of F -degree 3.

The infinite word $\Sigma_T(0)$ is represented in Figure 5.6. The value indicated on the word $\Sigma_T(0)$ after a prefix u is $T^{|u|}(0)$. The three values $\delta_{x_4}, \delta_{x_2}, \delta_{x_3}$ correspond to the three prefixes of $\Sigma_T(0)$ which are proper suffixes of X .

$$\Sigma_T(0) = \overset{\delta_{x_4}}{\vdots} a \ a \ \overset{\delta_{x_2}}{\vdots} a \ a \ b \ a \ \overset{\delta_{x_3}}{\vdots} a \ \dots$$

Figure 5.6: The infinite word $\Sigma_T(0)$.

Example 5.25 Let F be the Fibonacci set and let $X \subset F$ be the F -maximal bifix code of F -degree 3 defined by $X = \{a, baabaab, baabab, babaab\}$. We consider the alphabet $B = \{x, y, z, t\}$ and the morphism $f : B^* \rightarrow A^*$ defined by $f(x) = a$, $f(y) = baabaab$, $f(z) = baabab$, $f(t) = babaab$. The set $G = f^{-1}(F)$ is the set considered in Example 3.7. It is a regular interval exchange set and thus both recurrent and neutral.

6 Finite index basis sets

In this section, we state and prove the main result of this paper (Theorem 6.1). The proof uses a graph called the incidence graph of a bifix code. We prove that if F is a tree set, the incidence graph of a bifix code $X \subset F$ is acyclic (Proposition 6.15).

6.1 Main result

Let F be a recurrent set. For $w \in F$, let $\Gamma_F(w) = \{x \in F \mid wx \in F \cap A^+w\}$ be the set of *right return words* to w and let $R_F(w) = \Gamma_F(w) \setminus \Gamma_F(w)A^+$ be the set of *first right return words* to w .

Note that a recurrent set F is uniformly recurrent if and only if the set $R_F(w)$ is finite for any $w \in F$. Indeed, if N is the maximal length of the words in $R_F(w)$ for a word w of length n , then any word of length $N + n$ contains an occurrence of w . The converse is obvious.

We denote by $\langle X \rangle$ the subgroup generated by a set of words X .

We say that F has the *finite index basis property* if the following holds. A finite bifix code $X \subset F$ is an F -maximal bifix code of F -degree d if and only if it is a basis of a subgroup of index d of the free group on A . Moreover, in this case, $X^* \cap F = \langle X \rangle \cap F$. We also say that F is a *finite index basis set*.

We will prove the following result.

Theorem 6.1 *Any recurrent set F on the alphabet A such that*

- (i) *F is a tree set,*

(ii) *the set of first right return words to any $w \in F$ is a basis of the free group on A*

has the finite index basis property.

Note that the Cardinality Theorem (Theorem 3.4) holds for a set F satisfying the finite index basis property. Indeed, by Schreier's formula a basis of a subgroup of index d of a free group on s generators has $(s - 1)d + 1$ elements (actually we use Theorem 3.4 in the proof of Theorem 6.1).

Note also that, by the above remark on first return words, condition (ii) implies that the set F is not only recurrent but also uniformly recurrent.

Before proving Theorem 6.1, we first list some important corollaries. The first one is the main result of [5].

Corollary 6.2 *A Sturmian set has the finite index basis property.*

Proof. A Sturmian set is uniformly recurrent. It satisfies condition (i) since all its words are ordinary and condition (ii) by Theorem 6.5.2 of [5]. ■

The second corollary is the main result of this paper.

Corollary 6.3 *A regular interval exchange set has the finite index basis property.*

Proof. A regular exchange set is minimal by Theorem 5.3 and thus uniformly recurrent by Proposition 5.5. It satisfies the tree property by Proposition 5.9. Finally, it satisfies condition (ii) by Theorem 4.16 of [7]. ■

The following examples shows that Theorem 6.3 may be false for a set F which does not satisfy some of the hypotheses.

The first example is a uniformly recurrent set which is not neutral.

Example 6.4 Let F be the Chacon set (see Example 3.3). We have seen that F is not neutral and thus not a tree set. The set $F \cap A^2 = \{aa, ab, bc, ca, cb\}$ is an F -maximal bifix code of F -degree 2. It is not a basis since $ca(aa)^{-1}ab = cb$. Thus F does not satisfy the finite index basis property.

In the second example, the set is neutral but not a tree set and is not uniformly recurrent.

Example 6.5 Let F be the set of Example 4.2. It is not a tree set (and it is not either uniformly recurrent). The set $F \cap A^2$ is the same as in the Chacon set. Thus F does not satisfy the finite index basis property.

In the last example we have a uniformly recurrent set which is neutral but not a tree set.

Example 6.6 Let G be the set on the alphabet $B = \{1, 2, 3\}$ of Example 4.3. We have seen that G is neutral but not a tree set. Thus condition (i) of Theorem 6.1 is not satisfied.

One has $R_G(2) = \{2, 312, 31312\}$. The group generated by $R_G(2)$ has the basis $\{31, 2\}$, which is not a basis of the free group on $\{1, 2, 3\}$. Thus condition (ii) is not satisfied either. Let $X = G \cap B^2$. We have $X = \{12, 13, 22, 23, 31\}$. The set X is not a basis since $13 = 12(22)^{-1}23$. Thus F does not satisfy the finite index basis property.

We have no example of a uniformly recurrent tree set which does not have the finite index basis property.

We close this section with a property showing that condition (i) in Theorem 6.1 is necessary.

Proposition 6.7 *A biessential set F such that $F \cap A^n$ is a basis of the subgroup $\langle A^n \rangle$ for all $n \geq 1$ is a tree set.*

Proof. Set $k = \text{Card}(A) - 1$. Since A^n generates a subgroup of index n , the hypothesis implies that $\text{Card}(A^n \cap F) = kn + 1$ for all $n \geq 1$. Consider $w \in F$ and set $m = |w|$. The set $X = AwA \cap F$ is included in $F \cap A^{m+2}$. Thus X is a basis of the subgroup $\langle X \rangle$.

This implies that the graph $G(w)$ is acyclic. Indeed, assume that $(a_1, b_1, \dots, a_p, b_p)$ is a cycle in $G(w)$ with $p \geq 2$, $a_i \in L(w)$, $b_i \in R(w)$ for $1 \leq i \leq p$ and $a_1 \neq a_p$. Then $a_1wb_1, a_2wb_1, \dots, a_pwb_p, a_1wb_p \in X$. But

$$a_1wb_1(a_2wb_1)^{-1}a_2wb_2 \cdots a_pwb_p(a_1wb_p)^{-1} = 1$$

contradicting the fact that X is a basis.

Since $G(w)$ is an acyclic graph with $\ell(w) + r(w)$ vertices and $e(w)$ edges, we have $e(w) \leq \ell(w) + r(w) - 1$. But then

$$\begin{aligned} \text{Card}(A^{m+2} \cap F) &= \sum_{w \in A^m \cap F} e(w) \leq \sum_{w \in A^m \cap F} (\ell(w) + r(w) - 1) \\ &\leq 2 \text{Card}(A^{m+1} \cap F) - \text{Card}(A^m \cap F) \\ &\leq k(m+2) + 1. \end{aligned}$$

Since $\text{Card}(A^{m+2} \cap F) = k(m+2) + 1$, we have $e(w) = \ell(w) + r(w) - 1$ for all $w \in A^m$. This implies that $G(w)$ is a tree for all $w \in F$. Thus F is a tree set. \blacksquare

6.2 Automata

We denote $\mathcal{A} = (Q, i, T)$ a deterministic automaton with Q as set of states, $i \in Q$ as initial state and $T \subset Q$ as set of terminal states. For $p \in Q$ and $w \in A^*$, we denote $p \cdot w = q$ if there is a path labeled w from p to the state q and $p \cdot w = \emptyset$ otherwise.

The set *recognized* by the automaton is the set of words $w \in A^*$ such that $i \cdot w \in T$. A set of words is *rational* if it is recognized by a finite automaton.

All automata considered in this paper are deterministic and we call them simply automata.

The automaton \mathcal{A} is *trim* if for any $q \in Q$, there is a path from i to q and a path from q to some $t \in T$.

An automaton is called *simple* if it is trim and if it has a unique terminal state which coincides with the initial state.

An automaton $\mathcal{A} = (Q, i, T)$ is *complete* if for any state $p \in Q$ and any letter $a \in A$, one has $p \cdot a \neq \emptyset$.

For a set $X \subset A^*$, we denote by $\mathcal{A}(X)$ the *minimal automaton* of X . The states of $\mathcal{A}(X)$ are the nonempty sets $u^{-1}X = \{v \in A^* \mid uv \in X\}$ for $u \in A^*$. For $u \in A^*$ and $a \in A$, one defines $(u^{-1}X) \cdot a = (ua)^{-1}X$. The initial state is the set X and the terminal states are the sets $u^{-1}X$ for $u \in X$.

Let $X \subset A^*$ be a prefix code. Then there is a simple automaton $\mathcal{A} = (Q, 1, 1)$ that recognizes X^* . Moreover, the minimal automaton of X^* is simple.

Let X be a prefix code and let P be the set of proper prefixes of X . The *literal automaton* of X^* is the simple automaton $\mathcal{A} = (P, 1, 1)$ with transitions defined for $p \in P$ and $a \in A$ by

$$p \cdot a = \begin{cases} pa & \text{if } pa \in P, \\ 1 & \text{if } pa \in X, \\ \emptyset & \text{otherwise.} \end{cases}$$

One verifies that this automaton recognizes X^* .

A simple automaton $\mathcal{A} = (Q, 1, 1)$ is said to be *reversible* if for any $a \in A$, the partial map $\varphi_{\mathcal{A}}(a) : p \mapsto p \cdot a$ is injective. This condition allows to construct the *reversal* of the automaton as follows: whenever $q \cdot a = p$ in \mathcal{A} , then $p \cdot a = q$ in the reversal automaton. The state 1 is the initial and the unique terminal state of this automaton. Any reversible automaton is minimal [19]. The set recognized by a reversible automaton is generated by a bifix code.

An automaton $\mathcal{A} = (Q, 1, 1)$ is a *group automaton* if for any $a \in A$ the map $\varphi_{\mathcal{A}}(a) : p \mapsto p \cdot a$ is a permutation of Q . When Q is finite, a reversible automaton which is complete is a group automaton.

The following result is from [19] (see also Exercise 6.1.2 in [6]).

Proposition 6.8 *Let $X \subset A^+$ be a bifix code. The following conditions are equivalent.*

- (i) $X^* = \langle X \rangle \cap A^*$;
- (ii) *the minimal automaton of X^* is reversible.*

Let $\mathcal{A} = (Q, i, T)$ be a deterministic automaton. A *generalized path* is a sequence $(p_0, a_1, p_1, a_2, \dots, p_{n-1}, a_n, p_n)$ with $a_i \in A \cup A^{-1}$ and $p_i \in Q$, such that for $1 \leq i \leq n$, one has $p_{i-1} \cdot a_i = p_i$ if $a_i \in A$ and $p_i \cdot a_i = p_{i-1}$ if $a_i \in A^{-1}$. The *label* of the generalized path is the element $a_1 a_2 \cdots a_n$ of the free group A° .

Note that if $\mathcal{A} = (Q, 1, 1)$, the set of labels of generalized paths from 1 to 1 in \mathcal{A} is a subgroup of A° . It is called the *subgroup described by \mathcal{A}* .

A path in an automaton is a particular case of a generalized path. In the case where \mathcal{A} has a unique terminal state which is equal to the initial state, the submonoid of A^* recognized by \mathcal{A} is contained in the subgroup of A° described by \mathcal{A} .

Example 6.9 Let $\mathcal{A} = (Q, 1, 1)$ be the automaton defined by $Q = \{1, 2\}$, $1 \cdot a = 1 \cdot b = 2$ and $2 \cdot a = 2 \cdot b = \emptyset$. The submonoid recognized by \mathcal{A} is $\{1\}$. The subgroup described by \mathcal{A} is the cyclic group generated by ab^{-1} .

The following result is proved in [5].

Proposition 6.10 *Let \mathcal{A} be a simple automaton and let X be the prefix code generating the submonoid recognized by \mathcal{A} . The subgroup described by \mathcal{A} is generated by X . If moreover \mathcal{A} is reversible, then $X^* = \langle X \rangle \cap A^*$.*

For any subgroup H of A° , the submonoid $H \cap A^*$ is generated by a bifix code. A subgroup H of A° is *positively generated* if there is a set $X \subset A^*$ which generates H . In this case, the set $H \cap A^*$ generates the subgroup H . Let X be the bifix code which generates the submonoid $H \cap A^*$. Then X generates the subgroup H . This shows that, for a positively generated subgroup H , there is a bifix code which generates H . The following result is proved in [5].

Proposition 6.11 *For any positively generated subgroup H of A° , there is a unique reversible automaton \mathcal{A} such that H is the subgroup described by \mathcal{A} .*

The reversible automaton \mathcal{A} such that H is the subgroup described by \mathcal{A} is called the *Stallings automaton* of the subgroup H . It can also be defined for a subgroup which is not positively generated (see [4] or [15]).

The following result is proved in [5].

Proposition 6.12 *The following conditions are equivalent for a submonoid M of A^* .*

- (i) M is recognized by a group automaton with d states.
- (ii) $M = \varphi^{-1}(K)$, where K is a subgroup of index d of a group G and φ is a surjective morphism from A^* onto G .
- (iii) $M = H \cap A^*$, where H is a subgroup of index d of A° .

If one of these conditions holds, the minimal generating set of M is a maximal bifix code of degree d .

A bifix code Z such that Z^* satisfies one of the equivalent conditions of the proposition 6.12 is called a *group code*.

The following proposition shows in particular that a subgroup of finite index is positively generated. For a proof, see [5].

Proposition 6.13 *Let H be a subgroup of finite index of A° . The minimal automaton \mathcal{A} of $H \cap A^*$ is a group automaton which describes the subgroup H . Let X be the group code such that \mathcal{A} recognizes X^* . The subgroup generated by X is H .*

Example 6.14 The set A^d is a group code by Proposition 6.12(ii). Thus it is a maximal bifix code of degree d . The intersection of the subgroup generated by A^d with A^* is the submonoid generated by A^d (Proposition 6.13). It is composed of the words with length a multiple of d .

6.3 Incidence graph

Let X be a set, let P be the set of its proper prefixes and S be the set of its proper suffixes. Set $P' = P \setminus 1$ and $S' = S \setminus 1$. Recall from [5] that the incidence graph of X is the undirected graph G defined as follows. The set of vertices is the *disjoint union* of P' and S' . The edges of G are the pairs (p, s) for $p \in P'$ and $s \in S'$ such that $ps \in X$. As in any undirected graph, a connected component of G is a maximal set of vertices connected by paths.

The following result is proved in [5] in the case of a Sturmian set (Lemma 6.3.3).

Proposition 6.15 *Let F be a tree set, let $X \subset F$ be a bifix code and let G be the incidence graph of X .*

- (i) *The graph G is acyclic.*
- (ii) *The intersection of P' (resp. S') with each connected component of G is a suffix (resp. prefix) code.*

Proof. We call a path reduced if it does not use equal consecutive edges. Let us prove by induction on $n \geq 1$ that if $s \in S'$ and $t \in S'$ (resp. $p \in P'$ and $q \in P'$) are connected by a reduced path of length $2n$ in G , then s, t are not prefix-comparable (resp. p, q are not suffix-comparable). This proves both (i) and (ii).

The property holds for $n = 1$. Indeed, a reduced path of length 2 from $s \in S'$ to $t \in S'$ has the form s, q, t with $qs, qt \in X$. Since the path is reduced, $s \neq t$ and since X is prefix, s and t are not prefix-comparable. The proof for prefixes is similar.

Let $n \geq 2$. A path of length $2n$ from $s \in S'$ to $t \in S'$ is a sequence

$$v_1, u_1, v_2, \dots, u_n, v_{n+1}$$

with $s = v_1$ and $t = v_{n+1}$ such that the $2n$ words defined for $1 \leq i \leq n$ by

$$x_{2i-1} = u_i v_i, \quad x_{2i} = u_i v_{i+1}$$

are in X . Moreover, since the path is reduced, one has $x_j \neq x_{j+1}$ for $1 \leq j < 2n$.

Arguing by contradiction, assume that v_1 and v_{n+1} are prefix-comparable. We may assume that v_1 is a prefix of v_{n+1} . The other case is symmetric. Two

elements of the set $U = \{u_1, \dots, u_n\}$ are connected by a path of length at most $2n - 2$ (using elements of $\{v_2, \dots, v_n\}$). Thus, by induction hypothesis, U is a suffix code. Similarly, the elements of the set $V = \{v_1, \dots, v_n\}$ are connected by a path of length at most $2n - 2$ (using elements of $\{u_1, \dots, u_{n-1}\}$). Thus V is a prefix code. By Corollary 4.8, the graph $G_{U,V}(\varepsilon)$ is acyclic. But since v_1 is a prefix of v_{n+1} , we have $u_n v_1 \in F$ and thus $G_{U,V}(\varepsilon)$ contains the cycle $u_1, v_1, u_2, \dots, v_n, u_n, v_1$, a contradiction. ■

Let X be a bifix code and let P be the set of proper prefixes of X . Consider the equivalence θ_X on P which is the transitive closure of the relation formed by the pairs $p, q \in P$ such that $ps, qs \in X$ for some $s \in A^+$. Such a pair corresponds, when $p, q \neq 1$, to a path (p, s, q) in the incidence graph of X . Thus a class of θ_X is either reduced to the empty word or it is the intersection of $P \setminus 1$ with a connected component of the incidence graph of X .

The following property relates the equivalence θ_X with the right cosets of $H = \langle X \rangle$. It is Proposition 6.3.5 in [5].

Proposition 6.16 *Let X be a bifix code, let P be the set of proper prefixes of X and let H be the subgroup generated by X . For any $p, q \in P$, $p \equiv q \pmod{\theta_X}$ implies $Hp = Hq$.*

Let $\mathcal{A} = (P, 1, 1)$ be the literal automaton of X^* . We show that the equivalence θ_X is compatible with the transitions of the automaton \mathcal{A} in the following sense.

The following is proved in [5] (Lemma 6.3.6 and Lemma 6.4.2) in the case of a Sturmian set F .

Proposition 6.17 *Let F be a tree set. Let $X \subset F$ be a bifix code and let P be the set of proper prefixes of X . Let $p, q \in P$ and $a \in A$ be such that $pa, qa \in P \cup X$. Then in the literal automaton of X^* , one has $p \equiv q \pmod{\theta_X}$ if and only if $p \cdot a \equiv q \cdot a \pmod{\theta_X}$.*

Proof. Assume first that $p \equiv q \pmod{\theta_X}$. Let $(u_0, v_1, u_1, \dots, v_n, u_n)$ be a path in the incidence graph G of X with $p = u_0$, $u_n = q$. The corresponding words in X are $u_0 v_1, u_1 v_1, u_1 v_2, \dots, u_n v_n$. We may assume that the words u_i are pairwise distinct, and that the v_i are pairwise distinct. Moreover, since $pa, qa \in P \cup X$ there exist words v, w such that $pav, qaw \in X$. Set $v_0 = av$ and $v_{n+1} = aw$.

By Proposition 6.15, the set $U = \{u_0, u_1, \dots, u_n\}$ is a suffix code. Let a_i be the first letter of v_i for $0 \leq i \leq n + 1$ and set $v_i = a_i v'_i$.

Then in the graph $G_{U,A}(\varepsilon)$, there is a cycle $(a_0, u_0, a_1, \dots, a_n, u_n, a_{n+1})$. Since U is a suffix code and since F satisfies the tree condition, this forces $a_i = a$ for $1 \leq i \leq n$.

Assume first that $pa, qa \in P$. Then $(u_0 a, v'_1, u_1 a, \dots, v'_n, u_n a)$ is a path from pa to qa in G . This shows that $pa \equiv qa \pmod{\theta_X}$.

Next, suppose that $pa \in X$ and thus that $v_0 = a$. By Proposition 6.15, the set $V = \{v_0, v_1, \dots, v_{n+1}\}$ is a prefix code. Since $v_0 = a$ and each v_i begins with

a , this forces $v_i = a$ for $0 \leq i \leq n + 1$. In particular $w = \varepsilon$ and thus $qa \in X$. Thus $p \cdot a = q \cdot a$.

Conversely, if $pa \equiv qa \pmod{\theta_X}$, assume first that $pa, qa \in P$. Then there is a path $(u_0, v_1, \dots, v_n, u_n)$ in G with $u_0 = pa$ and $u_n = qa$. By Proposition 6.15, the set $V = \{v_1, \dots, v_n\}$ is a prefix code. Let a_i be the last letter of u_i for $0 \leq i \leq n$ and set $u_i = u'_i a_i$. Then in the graph $G_{A,V}(\varepsilon)$, there is a cycle $(a, v_1, a_1, v_2, \dots, a_n, v_n, a)$. Since F satisfies the strong tree condition, this forces $a_i = a$ for $1 \leq i \leq n$. Thus $(p, av_1, u'_1, \dots, q)$ is a path in G , showing that $p \equiv q \pmod{\theta_X}$.

Finally, if $pa, qa \in X$, then (p, a, q) is a path in G and thus $p \equiv q \pmod{\theta_X}$. ■

6.4 Coset automaton

Let F be a tree set and let $X \subset F$ be a bifix code. We introduce a new automaton denoted \mathcal{B}_X and called the *coset automaton* of X . Let R be the set of classes of θ_X with the class of 1 still denoted 1. The coset automaton of X is the automaton $\mathcal{B}_X = (R, 1, 1)$ with set of states R and transitions induced by the transitions of the literal automaton $\mathcal{A} = (P, 1, 1)$ of X^* . Formally, for $r, s \in R$ and $a \in A$, one has $r \cdot a = s$ in the automaton \mathcal{B} if there exist p in the class r and q in the class s such that $p \cdot a = q$ in the automaton \mathcal{A} .

Observe first that the definition is consistent since, by Lemma 6.17, if $p \cdot a$ and $p' \cdot a$ are nonempty and p, p' are in the same class r , then $p \cdot a$ and $p' \cdot a$ are in the same class. Since the class $p \cdot a$ is uniquely defined, the automaton is indeed deterministic.

Observe next that if there is a path from p to p' in the automaton \mathcal{A} labeled w , then there is a path from the class r of p to the class r' of p' labeled w in \mathcal{B}_X .

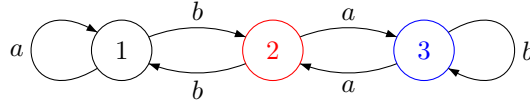

Figure 6.1: The automaton \mathcal{B}_X .

Example 6.18 For the code X of Example 5.24, the automaton \mathcal{B}_X has three states. State 2 is the class containing b , and state 3 is the class containing ba . The bifix code generating the submonoid recognized by this automaton is $Z = a \cup b(ab^*a)^*b$. Observe that the word bb is in Z^* but it is not in X^* .

The following result shows that the coset automaton of X is the Stallings automaton of the subgroup generated by X .

Lemma 6.19 *Let F be a tree set, and let $X \subset F$ be a bifix code. The coset automaton \mathcal{B}_X is reversible and describes the subgroup generated by X . Moreover $X \subset Z$, where Z is the bifix code generating the submonoid recognized by \mathcal{B}_X .*

Proof. Let $\mathcal{A} = (P, 1, 1)$ be the literal automaton of X and set $\mathcal{B}_X = (R, 1, 1)$. By Proposition 6.17, the automaton \mathcal{B}_X is reversible.

Let Z be the bifix code generating the submonoid recognized by \mathcal{B}_X . To show the inclusion $X \subset Z$, consider a word $x \in X$. There is a path from 1 to 1 labeled x in \mathcal{A} , hence also in \mathcal{B}_X . Since the class of 1 modulo θ_X is reduced to 1, this path in \mathcal{B}_X does not pass by 1 except at its ends. Thus x is in Z .

Let us finally show that the coset automaton describes the group $H = \langle X \rangle$. By Proposition 6.10, the subgroup described by \mathcal{B}_X is equal to $\langle Z \rangle$. Set $K = \langle Z \rangle$. Since $X \subset Z$, we have $H \subset K$. To show the converse inclusion, let us show by induction on the length of $w \in A^*$ that if, for $p, q \in P$, there is a path from the class of p to the class of q in \mathcal{B}_X with label w then $Hpw = Hq$. By Proposition 6.16, this holds for $w = 1$. Next, assume that it is true for w and consider wa with $a \in A$. Assume that there are states $p, q, r \in P$ such that there is a path from the class of p to the class of q in \mathcal{B}_X with label w , and an edge from the class of q to the class of r in \mathcal{B}_X with the label a . By induction hypothesis, we have $Hpw = Hq$. Next, by definition of \mathcal{B}_X , there is an $s \equiv q \pmod{\theta_X}$ such that $s \cdot a \equiv r \pmod{\theta_X}$. If $sa \in P$, then $s \cdot a = sa$, and by Proposition 6.16, we have $Hs = Hq$ and $Hsa = Hr$. Thus $Hpwa = Hqa = Hsa = Hr$. Otherwise, $sa \in X$ and $s \cdot a = r = 1$ because the class of 1 is a singleton. In this case, $Hsa = H = Hr$. This property shows that if $z \in Z$, then $Hza = H$, that is $z \in H$. Thus $Z \subset H$ and finally $H = K$. ■

6.5 Proof of the Basis Theorem

We first prove the following statement which is the last assertion of Theorem 6.1.

Proposition 6.20 *Let F be a tree set. Let $X \subset F$ be a finite F -maximal bifix code. Then $\langle X \rangle \cap F = X^* \cap F$.*

Proof. We have $X^* \cap F \subset \langle X \rangle \cap F$. To show the converse inclusion, consider the bifix code Z generating the submonoid recognized by the coset automaton \mathcal{B}_X associated to X .

Let us show that $Z \cap F = X$. By Lemma 6.19, we have $X \subset Z$ and thus $X \subset Z \cap F$. Since X is an F -maximal bifix code, this implies that $X = Z \cap F$.

Since any reversible automaton is minimal and since the automaton \mathcal{B}_X is reversible by Lemma 6.19, it is equal to the minimal automaton of Z^* . Let K be the subgroup generated by Z . By Proposition 6.8, we have $K \cap A^* = Z^*$.

This shows that

$$\langle X \rangle \cap F \subset K \cap F = K \cap A^* \cap F = Z^* \cap F = X^* \cap F.$$

The first inclusion holds because $X \subset Z$ implies $\langle X \rangle \subset K$. The last equality follows from the fact that if $z_1 \cdots z_n \in F$ with $z_1, \dots, z_n \in Z$, then each z_i is in F hence in $Z \cap F = X$. Thus $\langle X \rangle \cap F \subset X^* \cap F$, which was to be proved. ■

We denote by A° the free group on A .

Proof of Theorem 6.1. Assume first that X is an F -maximal bifix code of F -degree d . Let P be the set of proper prefixes of X . Let H be the subgroup generated by X .

Let $u \in F$ be a word such that $\delta_X(u) = d$, or, equivalently, which is not an internal factor of X . Let Q be the set of suffixes of u which are in P .

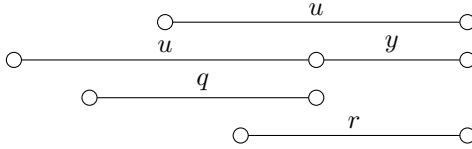

Figure 6.2: A word $y \in R_F(u)$.

Let us first show that the cosets Hq for $q \in Q$ are disjoint. Indeed, $Hp \cap Hq \neq \emptyset$ implies $Hp = Hq$. Any $p, q \in Q$ are comparable for the suffix order. Assuming that q is longer than p , we have $q = tp$ for some $t \in P$. Then $Hp = Hq$ implies $Ht = H$ and thus $t \in H \cap F$. By Proposition 6.20, since F is a tree set, this implies $t \in X^*$ and thus $t = \varepsilon$. Thus $p = q$.

Let

$$V = \{v \in A^\circ \mid Qv \subset HQ\}.$$

For any $v \in V$ the map $p \mapsto q$ from Q into itself defined by $pv \in Hq$ is a permutation of Q . Indeed, suppose that for $p, q \in Q$, one has $pv, qv \in Hr$ for some $r \in Q$. Then rv^{-1} is in $Hp \cap Hq$ and thus $p = q$ by the above argument.

The set V is a subgroup of A° . Indeed, $1 \in V$. Next, let $v \in V$. Then for any $q \in Q$, since v defines a permutation of Q , there is a $p \in Q$ such that $pv \in Hq$. Then $qv^{-1} \in Hp$. This shows that $v^{-1} \in V$. Next, if $v, w \in V$, then $Qvw \subset HQw \subset HQ$ and thus $vw \in V$.

We show that the set $R_F(u)$ is contained in V . Indeed, let $q \in Q$ and $y \in R_F(u)$. Since q is a suffix of u , qy is a suffix of uy , and since uy is in F (by definition of $R_F(u)$), also qy is in F . Since X is an F -maximal bifix code, it is an F -maximal prefix code and thus it is right F -complete. This implies that qy is a prefix of a word in X^* and thus there is a word $r \in P$ such that $qy \in X^*r$. We verify that the word r is a suffix of u . Since $y \in R_F(u)$, there is a word y' such that $uy = y'u$. Consequently, r is a suffix of $y'u$, and in fact the word r is a suffix of u . Indeed, one has $|r| \leq |u|$ since otherwise u is in the set $I(X)$ of internal factors of X , and this is not the case. Thus we have $r \in Q$ (see Figure 6.2). Since $X^* \subset H$ and $r \in Q$, we have $qy \in HQ$. Thus $y \in V$.

By condition (ii), the group generated by $R_F(u)$ is A° . Since $R_F(u) \subset V$, and since V is a subgroup of A° , we have $V = A^\circ$. Thus $Qw \subset HQ$ for any $w \in A^\circ$. Since $1 \in Q$, we have in particular $w \in HQ$. Thus $A^\circ = HQ$. Since $\text{Card}(Q) = d$, and since the right cosets Hq for $q \in Q$ are pairwise disjoint, this shows that H is a subgroup of index d . By Theorem 3.4 and in view of Schreier's Formula, X is a basis of H .

Assume conversely that the finite bifix code $X \subset F$ is a basis of the group $H = \langle X \rangle$ and that $\langle X \rangle$ has index d . Since X is a basis, by Schreier's Formula, we have $\text{Card}(X) = (k - 1)d + 1$, where $k = \text{Card}(A)$. The case $k = 1$ is

straightforward; thus we assume $k \geq 2$. Since F is uniformly recurrent, by Theorem 4.4.3 in [5], there is a finite F -maximal bifix code Y containing X . Let e be the F -degree of Y . By the first part of the proof, Y is a basis of a subgroup K of index e of A° . In particular, it has $(k-1)e+1$ elements. Since $X \subset Y$, we have $(k-1)d+1 \leq (k-1)e+1$ and thus $d \leq e$. On the other hand, since H is included in K , d is a multiple of e and thus $e \leq d$. We conclude that $d = e$ and thus that $X = Y$. ■

References

- [1] Jean-Paul Allouche and Jeffrey Shallit. *Automatic sequences*. Cambridge University Press, Cambridge, 2003. Theory, applications, generalizations.
- [2] V. I. Arnold. Small denominators and problems of stability of motion in classical and celestial mechanics. *Uspehi Mat. Nauk*, 18(6 (114)):91–192, 1963.
- [3] Pierre Arnoux and Gérard Rauzy. Représentation géométrique de suites de complexité $2n+1$. *Bull. Soc. Math. France*, 119(2):199–215, 1991.
- [4] Laurent Bartholdi and Pedro Silva. Rational subsets of groups. In *Handbook of Automata*. European science Foundation, 2011.
- [5] Jean Berstel, Clelia De Felice, Dominique Perrin, Christophe Reutenauer, and Giuseppina Rindone. Bifix codes and Sturmian words. *J. Algebra*, 369:146–202, 2012.
- [6] Jean Berstel, Dominique Perrin, and Christophe Reutenauer. *Codes and Automata*. Cambridge University Press, 2009.
- [7] Valérie Berthé, Clelia De Felice, Francesco Dolce, Dominique Perrin, Christophe Reutenauer, and Giuseppina Rindone. Return words in interval exchange transformations. 2013. in preparation.
- [8] Valérie Berthé and Michel Rigo. *Combinatorics, automata and number theory*, volume 135 of *Encyclopedia Math. Appl.* Cambridge Univ. Press, Cambridge, 2010.
- [9] Julien Cassaigne. 2013. Personal communication.
- [10] I. P. Cornfeld, S. V. Fomin, and Ya. G. Sinai. *Ergodic theory*, volume 245 of *Grundlehren der Mathematischen Wissenschaften [Fundamental Principles of Mathematical Sciences]*. Springer-Verlag, New York, 1982. Translated from the Russian by A. B. Sosinskiĭ.
- [11] Sébastien Ferenczi and Luca Q. Zamboni. Languages of k -interval exchange transformations. *Bull. Lond. Math. Soc.*, 40(4):705–714, 2008.
- [12] N. Pytheas Fogg. *Substitutions in dynamics, arithmetics and combinatorics*, volume 1794 of *Lecture Notes in Mathematics*. Springer-Verlag, Berlin, 2002. Edited by V. Berthé, S. Ferenczi, C. Mauduit and A. Siegel.
- [13] Amy Glen and Jacques Justin. Episturmian words: a survey. *Theor. Inform. Appl.*, 43:403–442, 2009.
- [14] Jacques Justin and Laurent Vuillon. Return words in Sturmian and episturmian words. *Theor. Inform. Appl.*, 34(5):343–356, 2000.
- [15] Ilya Kapovich and Alexei Myasnikov. Stallings foldings and subgroups of free groups. *J. Algebra*, 248(2):608–668, 2002.

- [16] Michael Keane. Interval exchange transformations. *Math. Z.*, 141:25–31, 1975.
- [17] M. Lothaire. *Algebraic Combinatorics on Words*. Cambridge University Press, 2002.
- [18] V. I. Oseledec. The spectrum of ergodic automorphisms. *Dokl. Akad. Nauk SSSR*, 168:1009–1011, 1966.
- [19] Christophe Reutenauer. Une topologie du monoïde libre. *Semigroup Forum*, 18(1):33–49, 1979.