

Derivation, interpretation, and analog modelling of fractional variable order derivative definition*

Dominik Sierociuk, Wiktor Malesza and Michal Macias

Institute of Control and Industrial Electronics, Warsaw University of Technology,
Koszykowa 75, Warsaw, Poland (e-mail: dsieroci@ee.pw.edu.pl;
wmalesza@ee.pw.edu.pl; michal.macias@ee.pw.edu.pl).

Abstract

The paper presents derivation and interpretation of one type of variable order derivative definitions. For mathematical modelling of considering definition the switching and numerical scheme is given. The paper also introduces a numerical scheme for a variable order derivatives based on matrix approach. Using this approach, the identity of the switching scheme and considered definition is derived. The switching scheme can be used as an interpretation of this type of definition. Paper presents also numerical examples for introduced methods. Finally, the idea and results of analog (electrical) realization of the switching fractional order integrator (of orders 0.5 and 1) are presented and compared with numerical approach.

1 Introduction

Fractional calculus is a generalization of traditional integer order integration and differentiation actions onto non-integer order fundamental operator. The idea of such a generalization has been mentioned in 1695 by Leibniz and L'Hospital. In the end of 19th century, Liouville and Riemann introduced

*Preprint submitted to Applied Mathematical Modelling, January 24, 2013

first definition of fractional derivative. However, only just in late 60' of the 20th century, this idea drew attention of engineers and mathematicians. Theoretical background of fractional calculus can be found in [1, 2, 3, 4, 5]. Basic analysis of fractional differential equations was presented in [6, 7, 8]. Fractional calculus was found a very useful tool for modelling behavior of many materials and systems, especially those based on the diffusion processes. One of such devices that can be modeled more efficiently by fractional calculus are ultracapacitors. Models of these electronic storage devices, whose capacity can be even thousands of Farads, based on fractional order models were presented in [9, 10, 11, 12].

Recently, the case when the order is changing in time, started to be intensively developed. The variable fractional order behaviour can be met for example in chemistry (when the properties of the system are changing due to chemical reactions), electrochemistry, and others areas. In [13], experimental studies of an electrochemical example of physical fractional variable order system are presented. In [14], the variable order equations were used to describe a history of drag expression. Papers [13, 15, 16] present methods for numerical realization of fractional variable order integrators or differentiators. The fractional variable order calculus also can be used to obtain variable order fractional noise [17], and to obtain new control algorithms [18]. Some properties of such systems are presented in [19]. In the paper [20], the variable order interpretation of the analog realization of fractional orders integrators, realized as domino ladders, was presented. The applications of variable order derivatives and integrals can be found also in signal processing [5].

The rest of the paper is organized as follows. Section 2 presents existing generalizations of Grunwald-Letnikov definition of fractional order derivatives. In Section 3, a switching scheme for practical implementation of variable order derivative is given and studied. Section 3 presents also a generalization of the matrix approach for switching order and derivation of identity of the switching scheme and the second type of definition. Section 4 presents numerical examples of the proposed methods compared to the analytical solutions. Finally, Section 5 presents an analog realization of the switched order integrator and comparison of obtained results to the numerical solutions.

2 Fractional variable order Grunwald-Letnikov type derivatives

As a base of generalization onto variable order derivative the following definition is taken into consideration:

Definition 1. *Fractional constant order derivative is defined as follows:*

$${}_0D_t^\alpha f(t) = \lim_{h \rightarrow 0} \frac{1}{h^\alpha} \sum_{r=0}^n (-1)^r \binom{\alpha}{r} f(t - rh),$$

where $n = \lfloor t/h \rfloor$.

According to this definition, one obtains: fractional derivatives for $\alpha > 0$, fractional integrals for $\alpha < 0$, and the original function $f(t)$ for $\alpha = 0$. For the case of order changing with time (variable order case), three types of definition can be found in the literature [21], [22]. The first one is obtained by replacing of constant order α by variable order $\alpha(t)$. In that approach, all coefficients for past samples are obtained for present value of the order and is given as follows:

Definition 2. *The 1st type of fractional variable order derivative is defined as follows:*

$${}_0D_t^{\alpha(t)} f(t) = \lim_{h \rightarrow 0} \frac{1}{h^{\alpha(t)}} \sum_{r=0}^n (-1)^r \binom{\alpha(t)}{r} f(t - rh).$$

In Fig. 1, plots of unit step function $1(t)$ derivatives (according to Def. 2) are presented for $\alpha_1(t) = -1$, $\alpha_2(t) = -2$, and

$$\alpha_3(t) = \begin{cases} -1 & \text{for } 0 \leq t < 1, \\ -2 & \text{for } 1 \leq t \leq 2. \end{cases} \quad (1)$$

The second type of definition assumes that coefficients for past samples are obtained for order that was present for these samples. In this case, the definition has the following form:

Definition 3. *The 2nd type of fractional variable order derivative is defined as follows:*

$${}_0D_t^{\alpha(t)} f(t) = \lim_{h \rightarrow 0} \sum_{r=0}^n \frac{(-1)^r}{h^{\alpha(t-rh)}} \binom{\alpha(t-rh)}{r} f(t - rh).$$

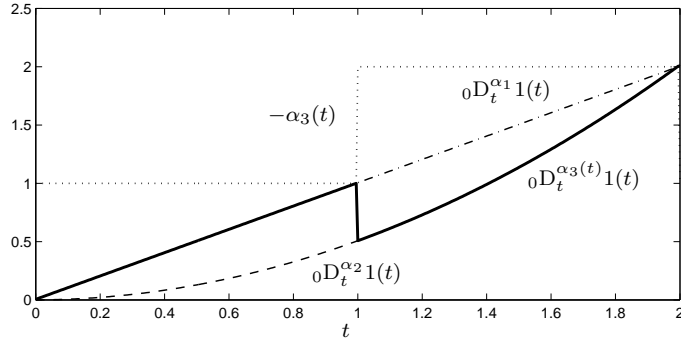

Figure 1. Plots of unit step function derivatives with respect to the 1st type derivative (given by Def. 2)

In Fig. 2, plots of unit step function derivatives (according to Def. 3) are presented for $\alpha_1(t) = -1$, $\alpha_2(t) = -2$, and $\alpha_3(t)$ given by (1). The

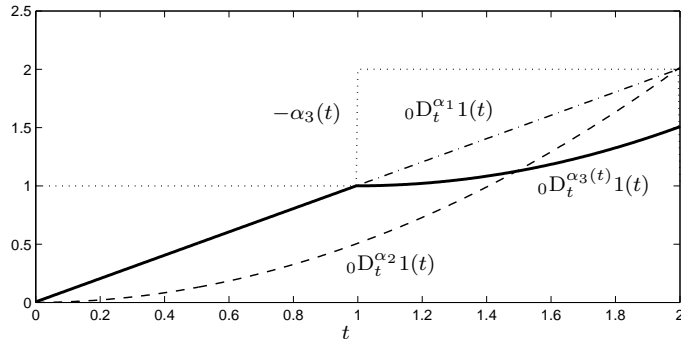

Figure 2. Plots of unit step function derivatives with respect to the 2nd type derivative (given by Def. 3)

third definition is less intuitive and assumes that coefficients for the newest samples are obtained respectively for the oldest orders. For such a case, the following definition applies:

Definition 4. *The 3rd type of fractional variable order derivative is defined as:*

$${}_0D_t^{\alpha(t)} f(t) = \lim_{h \rightarrow 0} \sum_{r=0}^n \frac{(-1)^r}{h^{\alpha(rh)}} \binom{\alpha(rh)}{r} f(t - rh).$$

In Fig. 3, plots of unit step function derivatives (according to Def. 4) are presented for $\alpha_1(t) = -1$, $\alpha_2(t) = -2$, and $\alpha_3(t)$ given by (1).

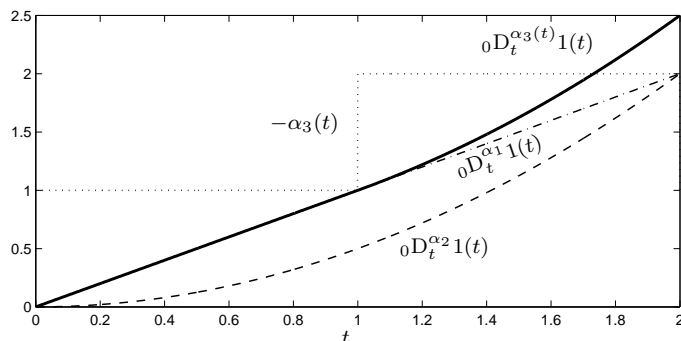

Figure 3. Plot of unit step function derivatives with respect to the 3rd type derivative (given by Def. 4)

From the comparison of the three types of derivatives, it can be seen from the plots presented above that there are crucial differences between the nature of derivatives of switching order (for constant order derivatives all the definitions yield the same behavior). Namely, in the case of the 1st type derivative, at the switching time instant, the derivative output “jumps” from the plot of constant order α_1 to the plot of constant order α_2 and keeps to follow it. In the case of the 2nd type derivative, at the switching time instant, the derivative output stops fitting the plot of constant order α_1 and starts to integrate like at the beginning of the plot of constant order α_2 but starting from another initial value. Concerning the 3rd type derivative, at the switching time instant, the plot of switching order derivative stops fitting the plot of constant order α_1 and does continue to integrate with constant order α_2 (without “jumping” to the plot of α_2 – unlike the 1st type derivative) like it is for the plot of constant order α_2 at the same time interval, i.e., for $t \geq 1$.

3 Practical implementation and numerical scheme of switched (variable) order derivative

In this section, the routines and schemes for switching order derivative are presented. For simplicity, we start with the simplest case of order switching, namely switching between two real arbitrary constant orders, e.g., α_1 and α_2 . Next, this idea will be generalized for a multiple-switching (variable order) case.

3.1 Simple-switching order case

The idea is depicted in Fig. 4, where all the switches S_i , $i = 1, 2$, change their positions depending on an actual value of $\alpha(t)$. If we want to switch from α_1 to α_2 , then, before switching time T , we have: $S_1 = b$, $S_2 = a$, and after this time: $S_1 = a$ and $S_2 = b$. At the instant time T , the derivative block of complementary order $\bar{\alpha}_2$ is pre-connected on the front of the current derivative block of order α_1 , where

$$\bar{\alpha}_2 = \alpha_2 - \alpha_1. \quad (2)$$

If $\bar{\alpha}_2 < 0$, then ${}_T D_t^{\bar{\alpha}_2}$ corresponds to integration of $f(t)$; and, if $\bar{\alpha}_2 > 0$, then ${}_T D_t^{\bar{\alpha}_2}$ corresponds to derivative of $f(t)$, with appropriate order $\bar{\alpha}_2$.

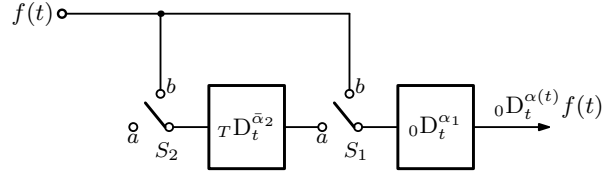

Figure 4. Structure of simple-switching order derivative (switching from α_1 to α_2)

Now, the numerical scheme corresponding to the above derivative switching structure is introduced. The matrix form of the fractional order derivative is given as follows [23, 24]:

$$\begin{pmatrix} {}_0 D_0^\alpha f(0) \\ {}_0 D_h^\alpha f(h) \\ {}_0 D_{2h}^\alpha f(2h) \\ \vdots \\ {}_0 D_{kh}^\alpha f(kh) \end{pmatrix} = \lim_{h \rightarrow 0} W(\alpha, k) \begin{pmatrix} f(0) \\ f(h) \\ f(2h) \\ \vdots \\ f(kh) \end{pmatrix},$$

where

$$W(\alpha, k) = \begin{pmatrix} 1 & 0 & 0 & \dots & 0 \\ w_{\alpha,1} & 1 & 0 & \dots & 0 \\ w_{\alpha,2} & w_{\alpha,1} & 1 & \dots & 0 \\ w_{\alpha,3} & w_{\alpha,2} & w_{\alpha,1} & \dots & 0 \\ \vdots & \vdots & \vdots & \dots & \vdots \\ w_{\alpha,k} & w_{\alpha,k-1} & w_{\alpha,k-2} & \dots & 1 \end{pmatrix}, \quad (3)$$

$W(\alpha, k) \in \mathbb{R}^{(k+1) \times (k+1)}$, $w_{\alpha,i} = \frac{(-1)^i \binom{\alpha}{i}}{h^\alpha}$, and $h = t/k$ is a time step, k is a number of samples.

Lemma 1. *For a switching order case, when the switch from order α_1 to order α_2 occurs at time T , the numerical scheme has the following form:*

$$\begin{pmatrix} {}_0D_0^{\alpha(t)} f(0) \\ {}_0D_h^{\alpha(t)} f(h) \\ \vdots \\ {}_0D_{(T-1)h}^{\alpha(t)} f(T h - h) \\ {}_0D_{Th}^{\alpha(t)} f(T h) \\ \vdots \\ {}_0D_{kh}^{\alpha(t)} f(kh) \end{pmatrix} = \lim_{h \rightarrow 0} W(\alpha_1, k) W(\bar{\alpha}_2, k, T) \begin{pmatrix} f(0) \\ f(h) \\ \vdots \\ f(T h - h) \\ f(T h) \\ \vdots \\ f(kh) \end{pmatrix},$$

where

$$W(\bar{\alpha}_2, k, T) = \begin{pmatrix} I_{T,T} & 0_{T,k-T+1} \\ 0_{k-T+1,T} & W(\bar{\alpha}_2, k - T) \end{pmatrix},$$

and

$$\alpha(t) = \begin{cases} \alpha_1 & \text{for } t < T, \\ \alpha_1 + \bar{\alpha}_2 & \text{for } t \geq T. \end{cases}$$

The order $\bar{\alpha}_2$, appearing above, is given by relation (2).

Proof. The signal incoming to the block of derivative α_1 can be described as follows

$$\begin{pmatrix} f(0) \\ f(h) \\ \vdots \\ f(T h - h) \\ {}_{Th}D_{Th}^{\bar{\alpha}_2} f(T h) \\ \vdots \\ {}_{Th}D_{kh}^{\bar{\alpha}_2} f(kh) \end{pmatrix} = \lim_{h \rightarrow 0} W(\bar{\alpha}_2, k, T) \begin{pmatrix} f(0) \\ f(h) \\ \vdots \\ f(T h - h) \\ f(T h) \\ \vdots \\ f(kh) \end{pmatrix}.$$

Until time T , the input of α_1 -block obtains the original function $f(t)$, so in matrix $W(\bar{\alpha}_2, k, T)$ we have an identity matrix. From time step T the input signal is passes through the block of derivative $\bar{\alpha}_2$ and we have the sub-matrix $W(\bar{\alpha}_2, k - T)$ that is responsible for starting the $\bar{\alpha}_2$ derivative action from

time T . That signal passes to the α_1 -block and has the following matrix form:

$$\begin{pmatrix} {}_0D_0^{\alpha(t)} f(0) \\ {}_0D_h^{\alpha(t)} f(h) \\ \vdots \\ {}_0D_{(T-1)h}^{\alpha(t)} f(T-1)h \\ {}_0D_{Th}^{\alpha(t)} f(Th) \\ \vdots \\ {}_0D_{kh}^{\alpha(t)} f(kh) \end{pmatrix} = \lim_{h \rightarrow 0} W(\alpha_1, k) \begin{pmatrix} f(0) \\ f(h) \\ \vdots \\ f(T-1)h \\ {}_{Th}D_{Th}^{\alpha_2} f(Th) \\ \vdots \\ {}_{Th}D_{kh}^{\alpha_2} f(kh) \end{pmatrix}.$$

□

Example 1. Consider integration of the unit step function $f(t) = 1(t)$, with the switching variable order $\alpha(t)$ taking value $\alpha_1 = -1$ until switching time $T = 4$, and after this time, order $\alpha_2 = -2$.

Numerical calculations performed for $k = 5$ yield:

$$W(\alpha_1, 5) = \begin{pmatrix} 1 & 0 & 0 & 0 & 0 & 0 \\ 1 & 1 & 0 & 0 & 0 & 0 \\ 1 & 1 & 1 & 0 & 0 & 0 \\ 1 & 1 & 1 & 1 & 0 & 0 \\ 1 & 1 & 1 & 1 & 1 & 0 \\ 1 & 1 & 1 & 1 & 1 & 1 \end{pmatrix}, \quad W(\bar{\alpha}_2, 5, 4) = \begin{pmatrix} 1 & 0 & 0 & 0 & 0 & 0 \\ 0 & 1 & 0 & 0 & 0 & 0 \\ 0 & 0 & 1 & 0 & 0 & 0 \\ 0 & 0 & 0 & 1 & 0 & 0 \\ 0 & 0 & 0 & 1 & 1 & 0 \\ 0 & 0 & 0 & 1 & 1 & 1 \end{pmatrix},$$

$$W(\alpha_1, 5)W(\bar{\alpha}_2, 5, 4) = \begin{pmatrix} 1 & 0 & 0 & 0 & 0 & 0 \\ 1 & 1 & 0 & 0 & 0 & 0 \\ 1 & 1 & 1 & 0 & 0 & 0 \\ 1 & 1 & 1 & 1 & 0 & 0 \\ 1 & 1 & 1 & 2 & 1 & 0 \\ 1 & 1 & 1 & 3 & 2 & 1 \end{pmatrix},$$

where $\bar{\alpha}_2 = -1$.

3.2 Multiple-switching (variable order) case

In general case, when there are many switchings between arbitrary orders, we have the following structure, presented in Fig. 5. When we switch from the

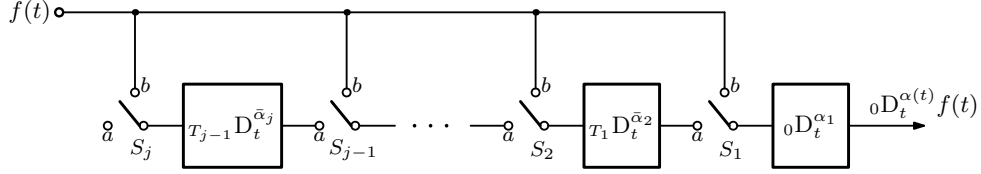

Figure 5. Structure of multiple-switching order derivatives

order α_{j-1} to the order α_j at the switch-time instant T_{j-1} , for $j = 2, 3, \dots$, we have to set:

$$S_i = \begin{cases} a & \text{for } i = 1, \dots, j-1, \\ b & \text{for } i = j, \end{cases}$$

and the pre-connected derivative block (on the front of the previous term) is of the following complementary order:

$$\bar{\alpha}_j = \alpha_j - \alpha_{j-1},$$

where

$$\alpha_{j-1} = \alpha_1 + \sum_{k=1}^{j-2} \bar{\alpha}_{k+1}.$$

The numerical scheme describing the already presented general case of structure allowing to switch between an arbitrary number of orders is given below. What is very important, the numerical scheme of multiple-switching case (when order is switched in each sample time) is equivalent to the 2nd type of variable order derivative.

Theorem 1. *Switching order scheme presented in Fig. 5 is equivalent to the 2nd type of variable order derivative (given by Def. 3).*

Proof. Let us assume that the order of derivative changes with every time step. which gives a variable order derivative, and is given as follows:

$$\alpha_k = \sum_{j=0}^k \bar{\alpha}_j, \quad (4)$$

where, in this case, $\alpha_0 = \bar{\alpha}_0$ is a value of initial order. Using Lemma 1 the following numerical scheme is obtained

$$\begin{pmatrix} {}_0D_0^{\alpha(t)} f(0) \\ \vdots \\ {}_0D_{kh}^{\alpha(t)} f(kh) \end{pmatrix} = \prod_{j=0}^k W(\bar{\alpha}_j, k, jh) \begin{pmatrix} f(0) \\ \vdots \\ f(kh) \end{pmatrix}.$$

The first switching matrices can be described as the following block matrices:

$$\begin{aligned} W(\bar{\alpha}_0, k, 0)W(\bar{\alpha}_1, k, 1) &= \left(\begin{array}{c|c} 1 & 0_{1,k} \\ \hline R(\bar{\alpha}_0, 1) & W(\bar{\alpha}_0, k-1) \end{array} \right) \left(\begin{array}{c|c} 1 & 0_{1,k} \\ \hline 0 & W(\bar{\alpha}_1, k-1) \end{array} \right) \\ &= \left(\begin{array}{c|c} 1 & 0_{1,k} \\ \hline R(\bar{\alpha}_0, 1) & W(\bar{\alpha}_0 + \bar{\alpha}_1, k-1) \end{array} \right), \end{aligned}$$

where

$$R(\bar{\alpha}, i) = \begin{pmatrix} w_{\bar{\alpha},i} \\ w_{\bar{\alpha},i+1} \\ \vdots \end{pmatrix}$$

is a vector with coefficients given by (3). For a switching in the next sample time, we obtain the following numerical scheme:

$$\begin{aligned} &W(\bar{\alpha}_0, k, 0)W(\bar{\alpha}_1, k, 1)W(\bar{\alpha}_2, k, 2) \\ &= \left(\begin{array}{cc|c} 1 & 0 & 0_{1,k-1} \\ w_{\bar{\alpha}_0,1} & 1 & 0_{1,k-1} \\ \hline R(\bar{\alpha}_0, 2) & R(\bar{\alpha}_0 + \bar{\alpha}_1, 1) & W(\bar{\alpha}_0 + \bar{\alpha}_1, k-2) \end{array} \right) \left(\begin{array}{c|c} 1 & 0 \\ \hline 0 & 1 \\ 0 & 0 \end{array} \left| \begin{array}{c} 0_{1,k-1} \\ 0_{1,k-1} \\ W(\bar{\alpha}_2, k-1) \end{array} \right. \right) \\ &= \left(\begin{array}{cc|c} 1 & 0 & 0_{1,k-1} \\ w_{\bar{\alpha}_0,1} & 1 & 0_{1,k-1} \\ \hline R(\bar{\alpha}_0, 2) & R(\bar{\alpha}_0 + \bar{\alpha}_1, 1) & W(\bar{\alpha}_0 + \bar{\alpha}_1 + \bar{\alpha}_2, k-2) \end{array} \right). \end{aligned}$$

In the case of $k - th$ switchings of order, we have the following form of the switching matrix $W(\bar{\alpha}_0, k, 0)W(\bar{\alpha}_1, k, 1) \cdots W(\bar{\alpha}_k, k, k)$, i.e.,

$$\begin{pmatrix} 1 & 0 & 0 & \cdots & 0 \\ w_{\bar{\alpha}_0,1} & 1 & 0 & \cdots & 0 \\ w_{\bar{\alpha}_0,2} & w_{\bar{\alpha}_0+\bar{\alpha}_1,1} & 1 & \cdots & 0 \\ w_{\bar{\alpha}_0,3} & w_{\bar{\alpha}_0+\bar{\alpha}_1,2} & w_{\bar{\alpha}_0+\bar{\alpha}_1+\bar{\alpha}_2,1} & \cdots & 0 \\ \vdots & \vdots & \vdots & \cdots & \vdots \\ w_{\bar{\alpha}_0,k} & w_{\bar{\alpha}_0+\bar{\alpha}_1,k-1} & w_{\bar{\alpha}_0+\bar{\alpha}_1+\bar{\alpha}_2,k-2} & \cdots & 1 \end{pmatrix}$$

or shortly, using the relationship (4)

$$\begin{pmatrix} 1 & 0 & 0 & \dots & 0 & 0 \\ w_{\alpha_0,1} & 1 & 0 & \dots & 0 & 0 \\ w_{\alpha_0,2} & w_{\alpha_1,1} & 1 & \dots & 0 & 0 \\ w_{\alpha_0,3} & w_{\alpha_1,2} & w_{\alpha_2,1} & \dots & 0 & 0 \\ \vdots & \vdots & \vdots & \dots & \vdots & \vdots \\ w_{\alpha_0,k-1} & w_{\alpha_1,k-2} & w_{\alpha_2,k-3} & \dots & 1 & 0 \\ w_{\alpha_0,k} & w_{\alpha_1,k-1} & w_{\alpha_2,k-2} & \dots & w_{\alpha_{k-1},1} & 1 \end{pmatrix}.$$

The coefficients of the matrix above are identical with the coefficients given by Def. 3, which completes the proof. \square

4 Numerical examples

This section contains numerical examples of the proposed methods, computed in Matlab/Simulink environment, using the dedicated numerical routines [25], developed by the authors.

Example 2. *Let us consider a variable order integration of unit step function $f(t) = 1(t)$ with the following sequence of integer orders $\Lambda = \{-1, -2, -3, -1\}$ switched every one second, i.e.,*

$$\alpha(t) = \begin{cases} -1 & \text{for } 0 \leq t < 1, \\ -2 & \text{for } 1 \leq t < 2, \\ -3 & \text{for } 2 \leq t < 3, \\ -1 & \text{for } 3 \leq t \leq 4. \end{cases}$$

The analytical solution of such integration is the following

$$\begin{aligned} {}_0D_t^{\alpha(t)} f(t) &= \int_0^t \frac{f(\tau)(t-\tau)^{\alpha(\tau)-1}}{\Gamma(\alpha(\tau))} d\tau \\ &= \begin{cases} t & \text{for } 0 \leq t < 1, \\ \frac{1}{2}t^2 - t + \frac{3}{2} & \text{for } 1 \leq t < 2, \\ \frac{1}{6}t^3 - t^2 + 3t - \frac{11}{6} & \text{for } 2 \leq t < 3, \\ \frac{1}{2}t^2 - \frac{1}{2}t - \frac{1}{3} & \text{for } 3 \leq t \leq 4. \end{cases} \end{aligned}$$

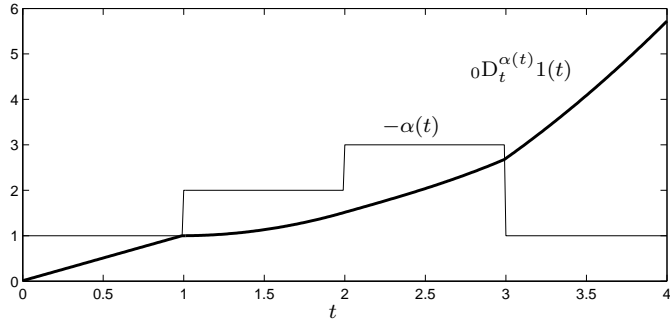

Figure 6. Plot of the variable order integral of unit step function (Ex. 2)

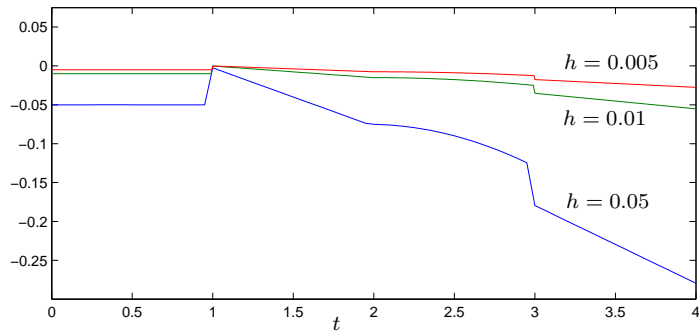

Figure 7. Errors between analytical and numerical solution for different integration steps (Ex. 2)

The plot of integration result is presented in Fig. 6. The difference between analytical and numerical solution, for different integration steps h , is depicted in Fig. 7.

Example 3. Let us consider a variable order integration of constant function $f(t) = 1(t)$ with the following sequence of fractional orders $\Lambda = \{-0.4, -1.8, -0.5, -2.5\}$ switched with every one second, i.e.,

$$\alpha(t) = \begin{cases} -0.4 & \text{for } 0 \leq t < 1, \\ -1.8 & \text{for } 1 \leq t < 2, \\ -0.5 & \text{for } 2 \leq t < 3, \\ -2.5 & \text{for } 3 \leq t \leq 4. \end{cases}$$

The analytical solution of such integration is the following

$${}_0D_t^{\alpha(t)} f(t) \approx \begin{cases} D_1 & \text{for } 0 \leq t < 1, \\ D_2 & \text{for } 1 \leq t < 2, \\ D_3 & \text{for } 2 \leq t < 3, \\ D_4 & \text{for } 3 \leq t \leq 4, \end{cases}$$

where

$$\begin{aligned} D_1 &= 1.127t^{0.4}, \\ D_2 &= 0.597(t-1)^{1.8} + 1.127(t^{0.4} - (t-1)^{0.4}), \\ D_3 &= 1.128\sqrt{t-2} + 0.597((t-1)^{1.8} - (t-2)^{1.8}) \\ &\quad + 1.127(t^{0.4} - (t-1)^{0.4}), \\ D_4 &= 0.3(t-3)^{2.5} + 0.597((t-1)^{1.8} - (t-2)^{1.8}) \\ &\quad + 1.128(\sqrt{t-2} - \sqrt{t-3}) + 1.127(t^{0.4} - (t-1)^{0.4}). \end{aligned}$$

The plot of integration result is presented in Fig. 8.

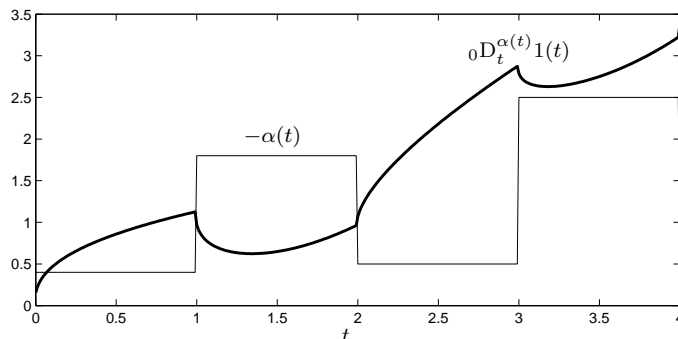

Figure 8. Plot of the variable order integral of constant function (Ex. 3)

5 Analog realization of the second type of fractional variable order derivative

5.1 Analog realization of the half order integral

In this paper, the following method of half order integrator implementation, introduced in [26] and meticulously investigated in [20, 27], will be used. The

scheme of this method is presented in Fig. 9.

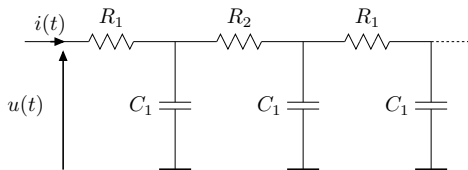

Figure 9. Domino ladder type analog model of half order integrator

Based on the observation, the values of R_1 and C_1 are chosen in order to satisfy the required low frequency limit. Value R_2 is chosen in order to satisfy the condition $R_1/R_2 \approx 0.25$, and the realization length m (number of branches) is chosen in order to satisfy required frequency range of the approximation.

5.2 Experimental setup

An analog realization of switching system directly based on the switching scheme given in Fig. 4 is presented in Fig. 10. This scheme can be easily extended to the switching rule presented in Fig. 5. The experimental setup was prepared in order to modelling simple-switching case. The structure of the half order integrator, used in the setup, is based on the domino ladder approximation presented in Section 5.1. However, the first order integrator is realized according to traditional scheme based on capacitor. Because, in both cases of realizations with operational amplifiers, the signals with inverted polarization were obtained. This required amplifiers with gain -1 for each integrator (amplifiers A_2 and A_4). Integrators based on amplifiers A_1 and A_3 contain gain resistors $R = 9.65k\Omega$ and impedances Z_1 and Z_2 chosen according to the type of realized orders. As a realization of switches S_1 and S_2 integrated analog switches DG303 were used. In order to obtain impedance order equal to -0.5 , the domino ladder approximation with the following elements $R_1 = 2k\Omega$, $R_2 = 8.2k\Omega$, $C_1 = 470nF$ and of implementation length $m = 100$, was used. The experimental circuit was connected to the dSPACE DS1104 PPC card with a PC.

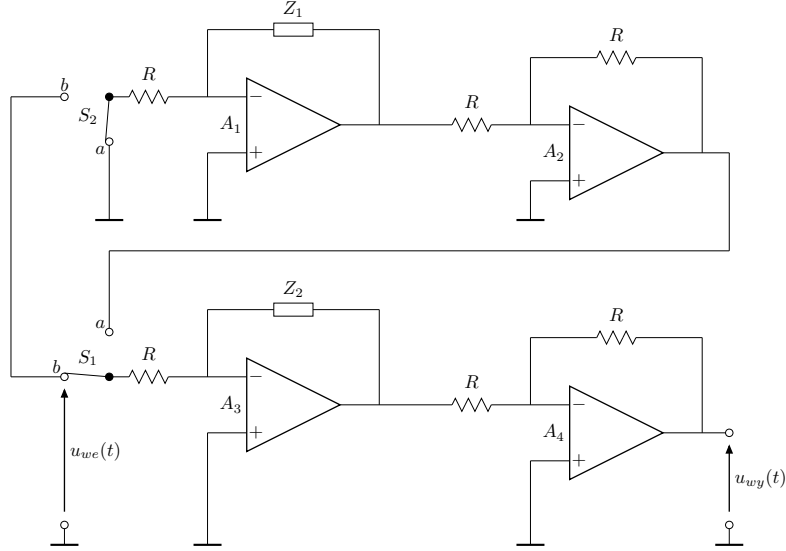

Figure 10. Analog realization of the 2nd type of fractional variable order integral

5.3 Experimental results

5.3.1 Switching between order $\alpha = -0.5$ and $\alpha = -1$

For a case of switching between order $\alpha = -0.5$ and $\alpha = -1$, in the structure presented in Fig. 10, both impedance Z_1 and Z_2 contains domino ladders structures each of order -0.5 . This implies that operational amplifiers A_1 and A_3 realize half order integrators circuits. Before switching, only one half order integrator is used and the whole system possesses -0.5 order. After switching, both half order integrators are connected in series, which results that the system order is equal to -1 .

The experimental results of integrator with switched orders from $\alpha = -0.5$ to $\alpha = -1$ compared with numerical results are presented in Fig. 11. The difference between numerical realization of the 2nd type derivative definition and its analog implementation is presented in Fig. 12. The sample time for all measurements was chosen as 0.01 sec and input signal was $u(t) = 0.01 \cdot 1(t)$. The parameters of analog models were obtained by identification based on time domain responses, separately for both orders. Obtained transfer function for the case of order $\alpha = -0.5$ (single half order integrator) is

$$G_1(s) = \frac{1}{0.058s^{0.5}}.$$

and for the case of order $\alpha = -1$ (both half order integrators in series connection)

$$G_2(s) = \frac{1}{0.041s},$$

The switching time was equal to 1 sec.

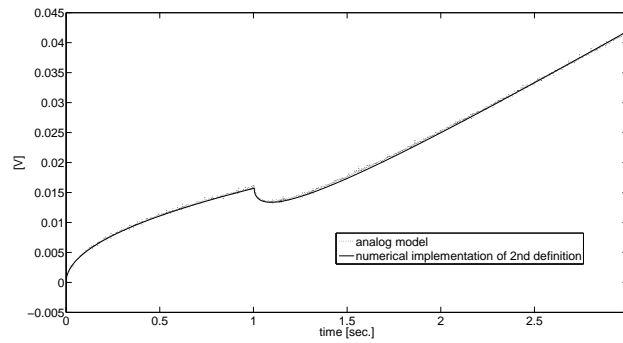

Figure 11. Results of analog and numerical implementation of switching order derivative from $\alpha = -0.5$ to $\alpha = -1$

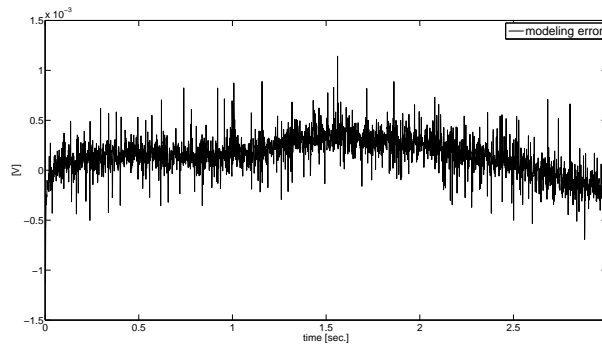

Figure 12. Difference between analog and numerical implementation of switching order derivative from $\alpha = -0.5$ to $\alpha = -1$

5.3.2 Switching between order $\alpha = -0.5$ and $\alpha = -1.5$

In this case, impedance Z_1 is the first order capacitor, and impedance Z_2 is a -0.5 order domino ladder. The experimental results of integrator with order switching from $\alpha = -0.5$ to $\alpha = -1.5$, compared to the numerical results,

are presented in Fig. 13. The difference between numerical realization of the 2nd type derivative definition and its analog implementation is presented in Fig. 14. By identification the following models were obtained. For order $\alpha = -0.5$

$$G_1(s) = \frac{1}{0.68s^{0.5}},$$

and for order $\alpha = -1.5$

$$G_2(s) = \frac{1}{0.0295s^{1.5}}.$$

The switching time was equal to 1 sec.

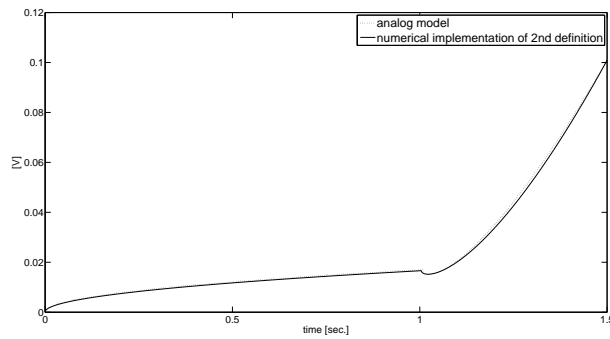

Figure 13. Results of analog and numerical implementation of switching order derivative from $\alpha = -0.5$ to $\alpha = -1.5$

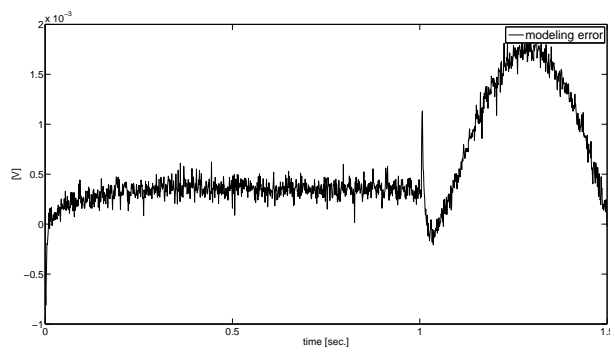

Figure 14. Difference between analog and numerical implementation of switching order derivative from $\alpha = -0.5$ to $\alpha = -1.5$

5.3.3 Switching between order $\alpha = -1$ and $\alpha = -1.5$

In this case, impedance Z_1 is a domino ladder of order -0.5 , and impedance Z_2 is the first order capacitor. The experimental results of integrator with order switching from $\alpha = -1$ to $\alpha = -1.5$, compared to the numerical results, are presented in Fig. 15. The difference between numerical realization of the 2nd type derivative definition and its analog implementation is presented in Fig. 16. By identification the following models were obtained. For order $\alpha = -1$

$$G_1(s) = \frac{1}{0.038s},$$

and for order $\alpha = -1.5$

$$G_2(s) = \frac{1}{0.027s^{1.5}}.$$

The switching time was equal to 0.7 sec.

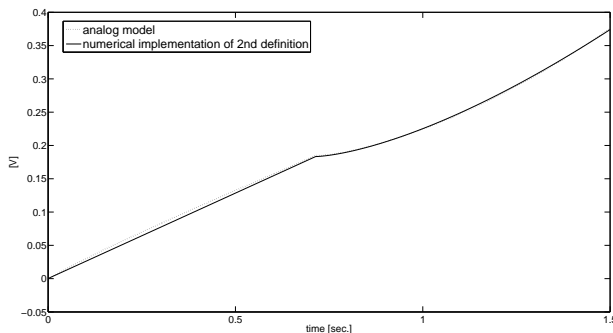

Figure 15. Results of analog and numerical implementation of switching order derivative from $\alpha = -1$ to $\alpha = -1.5$

6 Conclusions

The paper presented a switching scheme for the second type of variable order derivative. The numerical scheme, based on matrix approach, for that switching scheme was introduced and investigated. It was shown that obtained numerical scheme is equivalent to the 2nd type of fractional variable order derivative. This switching scheme can also be used as an interpretation of the second type of the definition. It is also worth to notice that

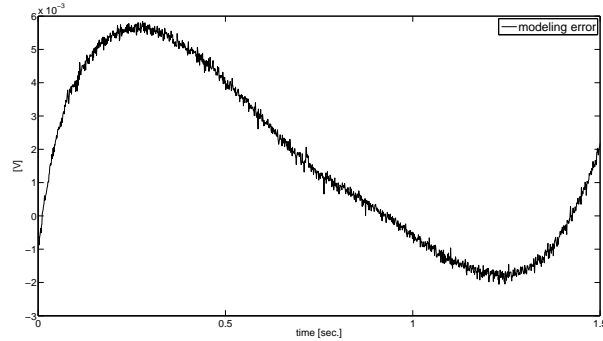

Figure 16. Difference between analog and numerical implementation of switching order derivative from $\alpha = -1$ to $\alpha = -1.5$

the rule given by the switching scheme can itself be a definition of a variable order derivative and the relation given by Def. 3 is just a consequence of this scheme. Presented interpretation allows to better understand behaviour of the definition and, in general, switching process in variable order systems. Based on this, it can give rise to more appropriate choice of definitions type, depending on particular application. Additionally, an analog modelling method of switched order integrator was introduced and examined. Obtained results were compared with the numerical implementation and show high accuracy of the introduced method.

Acknowledgment

This work was supported by the Polish National Science Center with the decision number DEC-2011/03/D/ST7/00260

References

- [1] K. B. Oldham, J. Spanier, The Fractional Calculus, Academic Press, 1974.
- [2] I. Podlubny, Fractional Differential Equations, Academic Press, 1999.
- [3] S. Samko, A. Kilbas, O. Marichev, Fractional Integrals and Derivative. Theory and Applications, Gordon & Breach Sci. Publishers, 1987.

- [4] C. A. Monje, Y. Chen, B. M. Vinagre, D. Xue, V. Feliu, *Fractional-order Systems and Controls*, Springer, 2010.
- [5] H. Sheng, Y. Chen, T. Qiu, *Signal Processing Fractional Processes and Fractional-Order Signal Processing*, Springer, London, 2012.
- [6] K. Sayevand, A. Golbabai, A. Yildirim, Analysis of differential equations of fractional order, *Applied Mathematical Modelling* 36 (9) (2012) 4356 – 4364.
- [7] S. Kazem, S. Abbasbandy, S. Kumar, Fractional-order legendre functions for solving fractional-order differential equations, *Applied Mathematical Modelling* 37 (7) (2013) 5498 – 5510.
- [8] A. Dzielinski, W. Malesza, Point to point control of fractional differential linear control systems, *Advances in Difference Equations*, doi:{10.1186/1687-1847-2011-13}.
- [9] H. El Brouji, J.-M. Vinassa, O. Briat, N. Bertrand, E. Woirgard, Ultracapacitors self discharge modelling using a physical description of porous electrode impedance, in: *Vehicle Power and Propulsion Conference, 2008. VPPC '08. IEEE, 2008*, pp. 1 –6. doi:10.1109/VPPC.2008.4677493.
- [10] A. Dzielinski, G. Sarwas, D. Sierociuk, Time domain validation of ultracapacitor fractional order model, in: *Decision and Control (CDC), 2010 49th IEEE Conference on, 2010*, pp. 3730 –3735. doi:10.1109/CDC.2010.5717093.
- [11] A. Dzielinski, G. Sarwas, D. Sierociuk, Comparison and validation of integer and fractional order ultracapacitor models, *Advances in Difference Equations*, doi:{10.1186/1687-1847-2011-11}.
- [12] R. Martin, J. Quintana, A. Ramos, I. de la Nuez, Modeling electrochemical double layer capacitor, from classical to fractional impedance, in: *Electrotechnical Conference, 2008. MELECON 2008. The 14th IEEE Mediterranean, 2008*, pp. 61 –66. doi:10.1109/MELCON.2008.4618411.
- [13] H. Sheng, H. Sun, C. Coopmans, Y. Chen, G. W. Bohannan, Physical experimental study of variable-order fractional integrator and differentiator, in: *Proceedings of The 4th IFAC Workshop Fractional Differentiation and its Applications FDA'10, 2010*.

- [14] L. Ramirez, C. Coimbra, On the variable order dynamics of the nonlinear wake caused by a sedimenting particle, *Physica D-Nonlinear Phenomena* 240 (13) (2011) 1111–1118.
- [15] C.-C. Tseng, Design and application of variable fractional order differentiator, in: *Proceedings of The 2004 IEEE Asia-Pacific Conference on Circuits and Systems*, Vol. 1, 2004, pp. 405–408.
- [16] C.-C. Tseng, S.-L. Lee, Design of variable fractional order differentiator using infinite product expansion, in: *Proceedings of 20th European Conference on Circuit Theory and Design (ECCTD)*, 2011, pp. 17–20.
- [17] H. Sheng, H. Sun, Y. Chen, T. Qiu, Synthesis of multifractional gaussian noises based on variable-order fractional operators, *Signal Processing* 91 (7) (2011) 1645–1650.
- [18] P. Ostalczyk, T. Rybicki, Variable-fractional-order dead-beat control of an electromagnetic servo, *Journal of Vibration and Control*.
- [19] P. Ostalczyk, Stability analysis of a discrete-time system with a variable-, fractional-order controller, *Bulletin of the Polish Academy of Sciences: Technical Sciences* 58 (4).
- [20] D. Sierociuk, I. Podlubny, I. Petras, Experimental evidence of variable-order behavior of ladders and nested ladders, *IEEE Transactions on Control Systems Technology* (in print).
- [21] C. Lorenzo, T. Hartley, Variable order and distributed order fractional operators, *Nonlinear Dynamics* 29 (1-4) (2002) 57–98. doi:{10.1023/A:1016586905654}.
- [22] D. Valerio, J. S. da Costa, Variable-order fractional derivatives and their numerical approximations, *Signal Processing* 91 (3, SI) (2011) 470–483. doi:{10.1016/j.sigpro.2010.04.006}.
- [23] I. Podlubny, Matrix Approach to Discrete Fractional Calculus, *Fractional Calculus and Applied Analysis* 3 (2000) 359–386.
- [24] I. Podlubny, A. Chechkin, T. Skovranek, Y. Chen, B. M. Vinagre Jara, Matrix approach to discrete fractional calculus II: Partial fractional differential equations, *Journal of Computational Physics*.

- [25] D. Sierociuk, Fractional Variable Order Derivative Simulink Toolkit, <http://www.mathworks.com/matlabcentral/fileexchange/38801-fractional-variable-order-derivative-simulink-toolkit> (2012).
- [26] D. Sierociuk, A. Dzielinski, New method of fractional order integrator analog modeling for orders 0.5 and 0.25, in: Proc. of the 16th International Conference on Methods and Models in Automation and Robotics (MMAR), 2011, 2011, pp. 137–141. doi:10.1109/MMAR.2011.6031332.
- [27] I. Petras, D. Sierociuk, I. Podlubny, Identification of parameters of a half-order system, Signal Processing, IEEE Transactions on 60 (10) (2012) 5561–5566. doi:10.1109/TSP.2012.2205920.