

# Improvement/Extension of Modular Systems as Combinatorial Reengineering (Survey)

Mark Sh. Levin \*

The paper describes development (improvement/extension) approaches for composite (modular) systems (as combinatorial reengineering). The following system improvement/extension actions are considered: (a) improvement of systems component(s) (e.g., improvement of a system component, replacement of a system component); (b) improvement of system component interconnection (compatibility); (c) joint improvement of system components(s) and their interconnection; (d) improvement of system structure (replacement of system part(s), addition of a system part, deletion of a system part, modification of system structure). The study of system improvement approaches involve some crucial issues: (i) scales for evaluation of system components and component compatibility (quantitative scale, ordinal scale, poset-like scale, scale based on interval multiset estimate), (ii) evaluation of integrated system quality, (iii) integration methods to obtain the integrated system quality.

The system improvement/extension strategies can be examined as selection/combination of the improvement action(s) above and as modification of system structure. The strategies are based on combinatorial optimization problems (e.g., multicriteria selection, knapsack problem, multiple choice problem, combinatorial synthesis based on morphological clique problem, assignment/reassignment problem, graph recoloring problem, spanning problems, hotlink assignment). Here, heuristics are used. Various system improvement/extension strategies are presented including illustrative numerical examples.

*Keywords:* modular systems, system design, systems engineering, engineering frameworks, combinatorial optimization, combinatorial reengineering, networked systems, heuristics

## Contents

<b>1</b>	<b>Introduction</b>	<b>2</b>
<b>2</b>	<b>Four System Improvement Situations</b>	<b>3</b>
2.1	Basic System Improvement Situation . . . . .	3
2.1.1	System Improvement/Modification . . . . .	3
2.1.2	System Extension . . . . .	5
2.2	Basic System Improvement Situation and Combinatorial Problems . . . . .	5
2.3	Additional System Improvement Situations . . . . .	5
<b>3</b>	<b>Approaches to System Evaluation and Improvement</b>	<b>5</b>
3.1	Spaces of System Quality and Improvement . . . . .	5
3.2	Towards Reoptimization [35] . . . . .	8
<b>4</b>	<b>Improvement by System Components</b>	<b>10</b>
4.1	Basic Framework . . . . .	10
4.2	Graph Vertex Recoloring Problem [33] . . . . .	11
<b>5</b>	<b>Modification of System Structure</b>	<b>12</b>
5.1	Modification of Tree-like Structures . . . . .	13
5.1.1	Hotlink Assignment Problems [40] . . . . .	13
5.1.2	Modification of Tree via Condensing of Weighted Edges [26,28,40] . . . . .	14

\*Mark Sh. Levin: Inst. for Inform. Transmission Problems, Russian Academy of Sciences; <http://www.mslevin.iitp.ru>; email: mslevin@acm.org

5.1.3	Transformation of Tree into Steiner Tree [40]	14
5.2	Augmentation Problem	16
5.3	Transformation of Morphological Structure	16
5.4	Transformation of Layered Structure	16
<b>6</b>	<b>Examples for Network Improvement/Extension [34]</b>	<b>17</b>
6.1	Network Hierarchy	17
6.2	Requirements/Criteria	17
6.3	Network Design/Development: Basic Problems	17
6.4	Network Improvement	18
6.5	Network Extension	19
<b>7</b>	<b>Conclusion</b>	<b>22</b>

## 1. Introduction

In recent two decades, the significance of system reengineering (i.e., issues of systems redesign, rebuilt, improvement, upgrade, extension) has been increased (e.g., [27,28,31,34,42,54]). This paper addresses systems development schemes (i.e., improvement/upgrade, extension) for composite (modular) systems (as combinatorial reengineering). Generally, the system improvement process is the following:

$$\text{Initial system}(s) \implies \text{Improvement process} \implies \text{Resultant (improved) system}(s).$$

The systems approaches can be considered as follows: (a) improvement of systems components and/or their interconnections, (b) improvement/extension of a system structure, (c) “space” (e.g., geographical) extension of a system as designing an additional system part, and (d) combined system improvement/extension.

A general approach to system development consists of the following (Fig. 1):

1. system improvement or modification (e.g., by components, by component interconnection, by system structure);
2. system extension as designing an additional system part and its integration with the basic system.

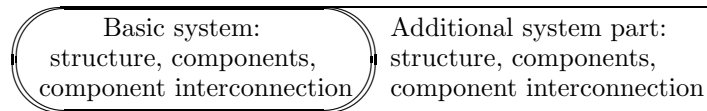

Fig. 1. System and additional part [34]

Fig. 2 depicts a hierarchy of general system improvement/development activities: (i) improvement of basic system, (ii) extension as designing of an additional system part, and (iii) coordinated improvement of basic system and designing an additional system part.

The set of basic system improvement/extension actions is the following: (a) improvement of systems component(s) (e.g., improvement of a system component, replacement of a system component); (b) improvement of system component interconnection (compatibility), (c) joint improvement improvement of system components(s) and their interconnection; (d) improvement of system structure (replacement of system part(s), addition of a system part, deletion of a system part, modification of system structure).

The system improvement/extension strategies are based on selection/combination of the improvement action(s) above (including modification of system structure). The strategies consist of combinatorial optimization problems (e.g., multicriteria selection, knapsack problem, multiple choice problem, combinatorial synthesis based on morphological clique problem, assignment/reassignment problem, graph recoloring problem, spanning problems, hotlink assignment) (e.g., [4,5,17,22,24,33,57]). Here, various algorithms (including heuristics) are used.

Note, system improvement/extension approaches involve some system evaluation crucial issues: (i) scales for evaluation of system components and component compatibility (quantitative scale, ordinal scale, poset-like scale, scale based on interval multiset estimate) (ii) evaluation of integrated system quality (i.e., scale/space of system total quality), (iii) integration methods to obtain the integrated system quality.

This paper is research survey. Various system improvement/extension strategies are presented. Special attention is targeted to networked systems. Numerical examples illustrate the described approaches.

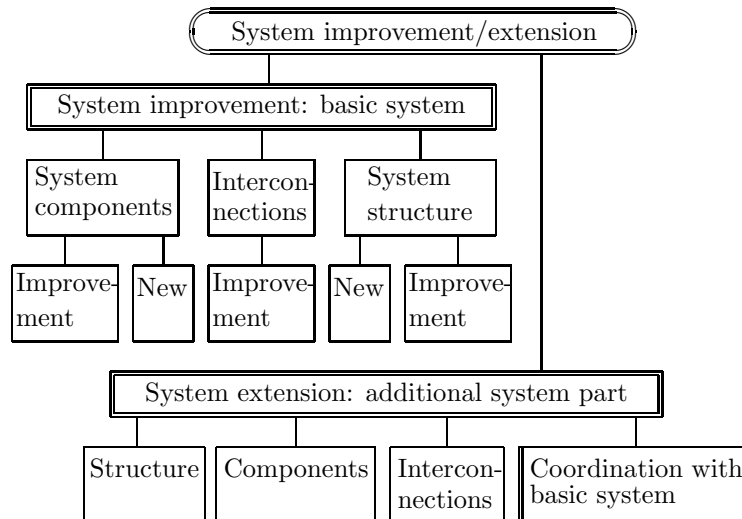

Fig. 2. Hierarchy of system development actions [34]

## 2. Four System Improvement Situations

### 2.1. Basic System Improvement Situation

The basic system improvement situation is depicted in Fig. 3 (one initial system and one resultant improved system).

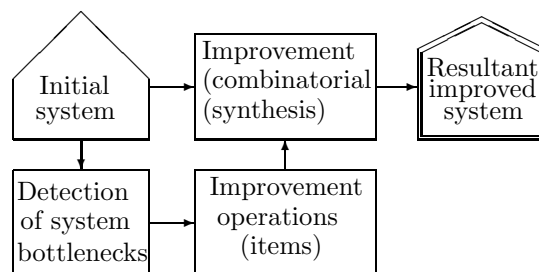

Fig. 3. Basic system improvement [28,31,34]

The following special cases can be considered for the above-mentioned basic system improvement situation (Fig. 3):

*Special case 1.* Improvement of systems components: (1.1) improvement of system elements, (1.2) improvement of system elements interconnection (i.e., compatibility), and (1.3) joint improvement of system elements and their compatibility.

*Special case 2.* Improvement as modification of system structure: (2.1) extension of system structure (i.e., addition of a system structure part), (2.2) modification system structure as deletion a system structure part, (2.3) modification of system structure (i.e., transformation: addition/deletion of elements, addition/deletion of element interconnections), and (2.4) joint case (i.e., deletion of a system part structure and addition of a system structure part, modification of system structure).

*Special case 3.* Extension of a system as designing an additional system part (i.e., additional system structure part and additional system elements).

*Special case 4.* Combination of the above-mentioned cases.

#### 2.1.1. System Improvement/Modification

In general, system improvement/modification processes are based on the following three action kinds (e.g., [28,31,34]): (i) improvement (modification, upgrade, addition) of a system component, (ii) improve-

ment of system components compatibility, (iii) change of a system structure. Some applied examples of system improvements for modular systems were presented in the following sources: (a) building (e.g., [31,42]), (b) information system (e.g., [28]), (c) human-computer systems (e.g., [31,30]), (d) communication protocols and standards (e.g., [43,49]), (e) management system for smart homes (e.g., [41,47]), and (f) communication networks (e.g., [34,45]).

Evidently, detection of *system bottlenecks* may be considered as a preliminary phase. Fig. 4 depicts an illustrative example for a component-based improvement process:  $S^a \Rightarrow S^b$  ( $X_1 \Rightarrow X_2$ ,  $Z_1 \Rightarrow Z_3$ ).

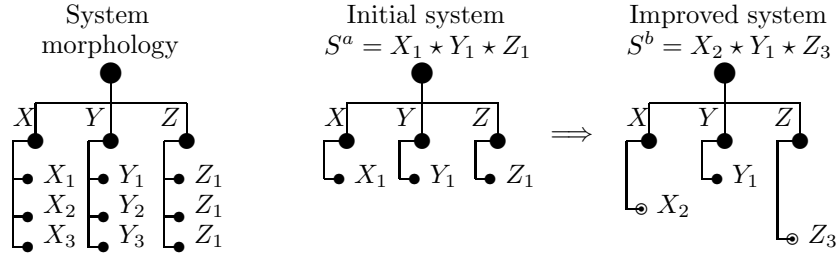

Fig. 4. System improvements (by components)

Table 1. Basic system improvement situation, underlying problems/models

Type of system improvement	Approaches	Underlying problems/models	Some sources
Case 1 (improvement of systems components): (1.1) improvement of system elements	Replacement, redesign	Knapsack-like problems, HMMD, assignment/allocation	[27,28,30] [31,33,37] [41,45]
(1.2) improvement of element compatibility	Replacement, redesign	Knapsack-like problems, HMMD, assignment/allocation	[28,31]
(1.3) joint improvement of system element(s) & compatibility	Combined approaches	Composite frameworks, graph recoloring, HMMD	[28,31,33] [37]
Case 2 (modification of system structure): (2.1) addition of system structure part	Addition	Knapsack-like problems, HMMD, hotlink assignment	[40,45]
(2.2) deletion of system structure part	Deletion	Knapsack-like problems, HMMD	[40]
(2.3) modification of system structure	Addition, deletion, aggregation/integration, restructuring	Spanning problems, knapsack-like problems, HMMD, recovering problems, augmentation problems, reoptimization	[26,28,35] [40,46,48]
(2.4) joint case	Combined approaches	Composite frameworks	[40]
Case 3 (addition of system part)	Design	Design frameworks, Knapsack-like problems, HMMD	[34,40]
Case 4 (combination of previous cases)	Combined approaches	Problem frameworks	[34,40]

### 2.1.2. System Extension

Generally, the system extension problem consists in designing an additional system part. Here, three basic extension strategies may be considered:

*I. Independent (separated) design.* Designing the additional system part. As a result, the new system will include two system parts (i.e., initial and additional).

*II. Generalized new design.* Designing a new “generalized” system, which involves the initial system part and additional system part (integrated design).

*III. Separated design with coordination.* Designing the additional system part, modification of the initial system part and coordination of initial system part and the new additional system part.

## 2.2. Basic System Improvement Situation and Combinatorial Problems

Table 1 contains a list of basic approaches and corresponding combinatorial optimization problems for the considered basic system improvement situation (Fig. 3).

### 2.3. Additional System Improvement Situations

In general, it is reasonable to consider the following additional system improvement situations:

- (a) aggregation: to obtain an improved system as aggregation of several initial systems (Fig. 5),
- (b) designing a set of improved systems (Fig. 6),
- (c) joint aggregation and designing the set of improved systems (Fig. 7).

In the case of multi-objective design approaches, designing the set of improved systems may be based on obtaining the Pareto-efficient solutions, which can be considered as the system set.

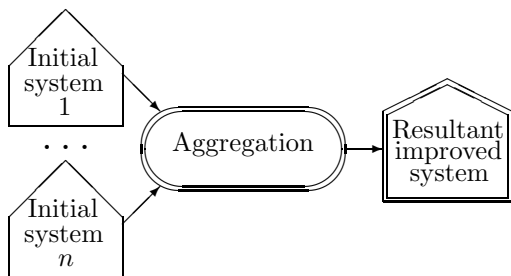

Fig. 5. System improvement as aggregation

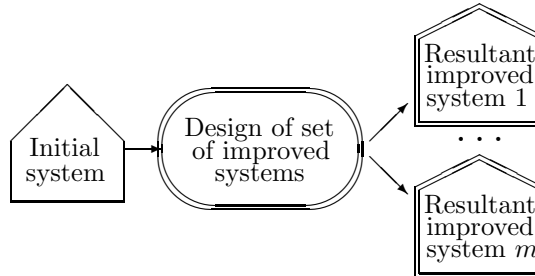

Fig. 6. Improvement to design a system set

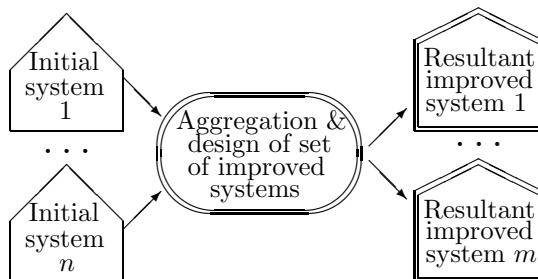

Fig. 7. Aggregation & design of system set

A recent survey of aggregation approaches to hierarchical modular systems is presented in [36]. In the case of multi-objective design approaches, designing the set of improved systems may be based on obtaining the Pareto-efficient solutions, which can be considered as the required system set (e.g., [28,31,33,36]).

## 3. Approaches to System Evaluation and Improvement

### 3.1. Spaces of System Quality and Improvement

Generally, system improvement process for composite (modular) systems consists in selection of system improvement actions (operations) to obtain increasing a generalized system “utility” (quality, excellence) while taking into account a total constraint(s) for costs of the improvement actions. Thus, it is necessary to consider the following issues:

- (i) assessment of the system “utility” (a “space” as a scale, multidimensional space, a poset/lattice),
- (ii) cost of the improvement actions,
- (iii) combinatorial improvement problem (e.g., multicriteria selection of the improvement actions, knapsack-like problem, combinatorial synthesis as selection and composition of the improvement actions).

Evidently, special multi-stage system improvement procedures can be considered as well.

System evaluation approaches include a method to integrate estimates for system components and estimates for system component interconnection (compatibility). Table 2 contains the basic approaches to evaluation of the total system “utility” (quality, excellence).

Table 2. Evaluation of total system quality

Method	Sources
1. “Utility” function for system quality (system components are assessed by quantitative/ordinal scales)	[15,22,58]
2. Multicriteria description for system quality	[22,55,57,58]
3. Poset-like scale for system quality:	[28,31,37]
3.1. Ordinal scales for system components and for components compatibility	
3.2. Ordinal scales for system components, poset-like scale for components compatibility	
4. Poset-like scale for system quality based on interval multiset estimates:	[38]
4.1. Multiset estimates for system components and ordinal estimates for components compatibility	
4.2. Multiset estimates for system components and multiset estimates for components compatibility	

Illustrations for the above-mentioned methods are the following:

**Method 1:** scale of system “utility” (Fig. 8), initial system  $S^a$  is transformed into improved system  $S^b$  where system “utility” is designated as  $N(S^a)$  ( $N(S^b)$ ).

**Method 2:** multicriteria case (two criteria), ideal point  $S^I$ , four Pareto-efficient solutions ( $S_1^p, S_2^p, S_3^p, S_4^p$ ) (Fig. 9), three improvement processes:

- (i) initial system  $S'$  is transformed into Pareto-efficient solution  $S_2^p$ ,
- (ii) initial system  $S'$  is transformed into ideal solution  $S^I$ .
- (iii) Pareto-efficient solution  $S_3^p$  is transformed into ideal solution  $S^I$ .

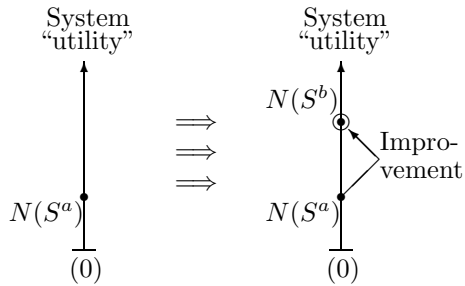

Fig. 8. Scale of “utility”, improvement

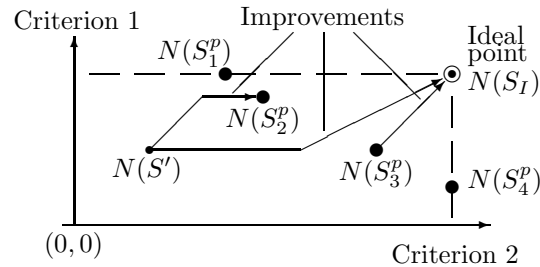

Fig. 9. Multicriteria “utility”, improvement

**Method 3:** poset-like scales (or lattices) for system quality (case 3.1) (e.g., [28,29,31,37]).

Here, Hierarchical Morphological Multicriteria Design (HMMD) approach is used [28,31,37], which is based on the morphological clique problem. The composite (modular, decomposable) system under examination consists of the components and their interconnections or compatibilities. The designations are: (1) design alternatives (DAs) for leaf nodes of the tree-like model; (2) priorities of DAs ( $r = \overline{1, k}$ ; 1 corresponds to the best level); (3) ordinal compatibility estimates for each pair of DAs ( $w = \overline{0, l}$ ;

$l$  corresponds to the best level). The system consists of design alternatives (DAs) for system parts ( $P(1), \dots, P(i), \dots, P(m)$ ):  $S = S(1) \star \dots \star S(i) \star \dots \star S(m)$  of DAs (one representative design alternative  $S(i)$ ), with non-zero pair interconnection (pair compatibility IC) between the selected DAs. A discrete space (poset, lattice) of the system excellence on the basis of the following vector is used:  $N(S) = (w(S); n(S))$ , where  $w(S)$  is the minimum of pairwise compatibility between DAs which correspond to different system components (i.e.,  $\forall P_{j_1}$  and  $P_{j_2}$ ,  $1 \leq j_1 \neq j_2 \leq m$ ) in  $S$ ,  $n(S) = (n_1, \dots, n_r, \dots, n_k)$ , where  $n_r$  is the number of DAs of the  $r$ th quality in  $S$  ( $\sum_{r=1}^k n_r = m$ ).

A three-component system  $S = X \star Y \star Z$  is presented as an illustrative example. Ordinal scale for elements (priorities) is  $[1, 2, 3]$ , ordinal scale for compatibility is  $[1, 2, 3]$ . For this case, Fig. 10 depicts the poset of system quality by components and Fig. 11 depicts an integrated poset with compatibility (each triangle corresponds to poset from Fig. 10). This is *case 3.1*.

Fig. 10 and Fig. 11 illustrate the improvement processes:

*Improvement A:* poset-like scale for total quality of system elements, (Fig. 10), initial system  $S^a$  ( $n(S^a) = (0, 2, 1)$ ) is transformed into improved system (by components)  $S^b$  ( $n(S^b) = (2, 0, 1)$ ).

*Improvement B:* integrated poset-like scale for total quality of system elements and their compatibility (ordinal scale is used for estimates of compatibility), ideal point  $S^I$ , three Pareto-efficient solutions ( $S_1^p$ ,  $S_2^p$ ,  $S_3^p$ ) (Fig. 11), three improvement processes:

- initial system  $S'$  is transformed into Pareto-efficient solution  $S_1^p$ ,
- initial system  $S'$  is transformed into ideal solution  $S^I$ , and
- Pareto-efficient solution  $S_3^p$  is transformed into ideal solution  $S^I$ .

Generally, the following layers of system excellence can be considered: (i) ideal point; (ii) Pareto-efficient points; and (iii) a neighborhood of Pareto-efficient DAs (e.g., a composite decision of this set can be transformed into a Pareto-efficient point on the basis of a simple improvement action(s) as modification of the only one element). The compatibility component of vector  $N(S)$  can be considered on the basis of a poset-like scale too (as  $n(S)$ ) ([29,31]). In this case, the discrete space of system excellence will be an analogical lattice.

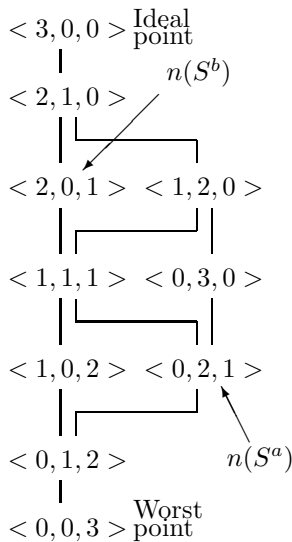

Fig. 10. System quality by elements  $n(S)$

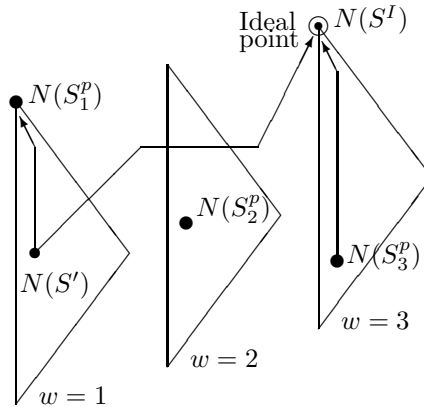

Fig. 11. System quality with compatibility  $N(S)$

**Method 4:** In [38], analogical poset-like system quality domains have been suggested in the case of interval multi-set estimates for DAs (or/and for system compatibility). Fig. 12 depicts the poset-like scale for the interval multiset estimate (3 position, 3 assessment element).

This system evaluation case can be used for the previous method 3. On the other hand, this system evaluation approach can be very useful for system improvement by components and system extension. Here, the total system estimate (i.e., estimate of system quality) is considered as the following approaches to aggregation of interval estimates of system components [38]: (a) an integrated interval multiset estimate, (b) median-like interval multiset estimate.

Fig. 13 depicts an example of this kind of system transformation (reconfiguration): (a) replacement of component:  $X_1 \Rightarrow X_2$ , (b) deletion of component:  $Z_1$ , (c) addition of two-component part:  $U \star V$ . Interval multiset estimates for system components and for system quality are depicted in parentheses (Fig. 13). Median-like interval multiset estimate is used for evaluation of the system quality.

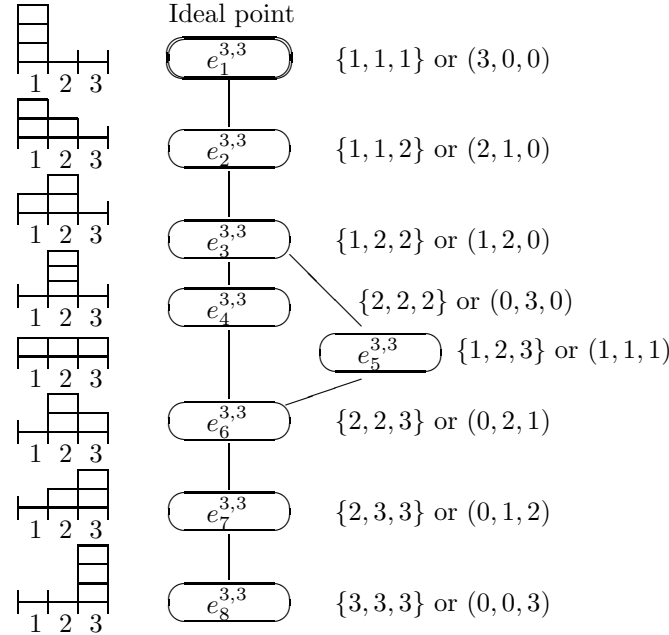

Fig. 12. Scale, estimates [38]

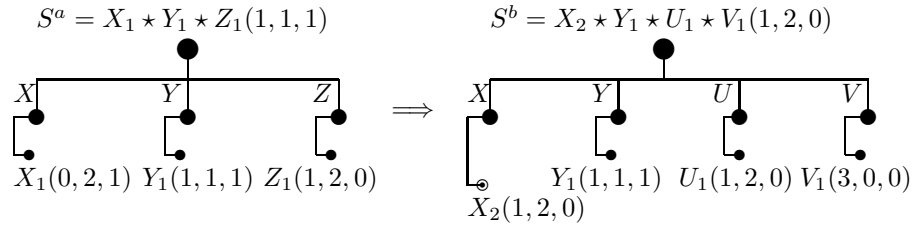

Fig. 13. System improvements (by components and by extension)

### 3.2. Towards Reoptimization [35]

In recent several years, a special class of combinatorial optimization problems as “reoptimization” has been studied for several well-known problems (Table 3). In general, the reoptimization problem is formulated as follows:

*Given:* (i) an instance of the combinatorial problem over a graph and corresponding optimal solution, (ii) some “small” perturbations (i.e., modifications) on this instance (e.g., node-insertion, node-deletion).

*Question:* Is it possible to compute a new good (optimal or near-optimal) solution subject to minor modifications?

Table 3. Studies of reoptimization

Combinatorial optimization problem	Sources
1. Minimum spanning tree problem	[9]
2. Traveling salesman problems	[1,2]
3. Steiner tree problems	[5,13]
4. Covering problems	[6]
5. Shortest common superstring problem	[7]



A survey of complexity issues for reoptimization problems is presented in [8]. Mainly, the problems belong to class of NP-hard problems and various approximation algorithms have been suggested.

Another approach to modification in combinatorial optimization problems as “restructuring” has been suggested in [35]. The approach corresponds to many applied reengineering (redesign) problems in existing modular systems. The restructuring process is illustrated in Fig. 14 [35]. Here, modifications are based on insertion/deletion of elements (i.e., elements, nodes, arcs) and changes of a structure as well. Two main features of the restructuring process are examined: (i) a cost of the initial problem solution restructuring (i.e., cost of the selected modifications), (ii) a closeness the obtained restructured solution to a goal solution.

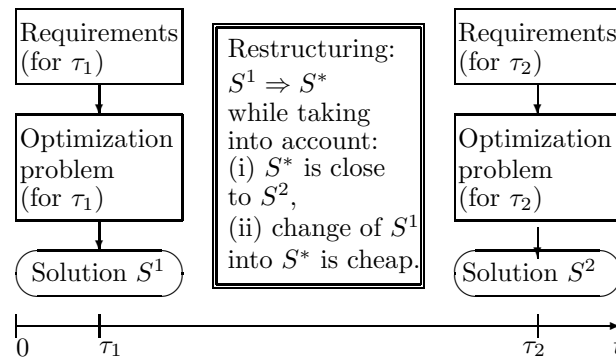

Fig. 14. Illustration for restructuring process [35]

The optimization problem is solved for two time moments:  $\tau_1$  and  $\tau_2$  to obtain corresponding solutions  $S^1$  and  $S^2$ . The examined restructuring problem consists in a “cheap” transformation (change) of solution  $S^1$  to a solution  $S^*$  that is very close to  $S^2$ . In [35], this restructuring approach is described and illustrated for the following combinatorial optimization problems: knapsack problem, multiple choice problem, assignment problem, spanning tree problems.

Fig. 15 depicts the restructuring problem [35].

Let  $P$  be a combinatorial optimization problem with a solution as structure  $S$  (i.e., subset, graph),  $\Omega$  be initial data (elements, element parameters, etc.),  $f(P)$  be objective function(s). Thus,  $S(\Omega)$  be a solution for initial data  $\Omega$ ,  $f(S(\Omega))$  be the corresponding objective function. Let  $\Omega^1$  be initial data at an initial stage,  $f(S(\Omega^1))$  be the corresponding objective function.  $\Omega^2$  be initial data at next stage,  $f(S(\Omega^2))$  be the corresponding objective function.

As a result, the following solutions can be considered: (a)  $S^1 = S(\Omega^1)$  with  $f(S(\Omega^1))$  and (b)  $S^2 = S(\Omega^2)$  with  $f(S(\Omega^2))$ . In addition it is reasonable to examine a cost of changing a solution into another one:  $H(S^\alpha \rightarrow S^\beta)$ . Let  $\rho(S^\alpha, S^\beta)$  be a proximity between solutions  $S^\alpha$  and  $S^\beta$ , for example,  $\rho(S^\alpha, S^\beta) = |f(S^\alpha) - f(S^\beta)|$ . Note, function  $f(S)$  is often a vector function. Finally, the restructuring problem is (a basic version):

*Find solution  $S^*$  while taking into account the following:*

- (i)  $H(S^1 \rightarrow S^*) \rightarrow \min$ , (ii)  $\rho(S^*, S^2) \rightarrow \min$  (or constraint).

Thus, the basic optimization model can be considered as the following:

$$\min \rho(S^*, S^2) \quad s.t. \quad H(S^1 \rightarrow S^*) \leq \hat{h},$$

where  $\hat{h}$  is a constraint for cost of the solution change.

Proximity function  $\rho(S^*, S^2)$  can be considered as a vector function (analogically for the solution change cost). The situation will lead to a multicriteria restructuring problem (i.e., searching for a Pareto-efficient solutions).

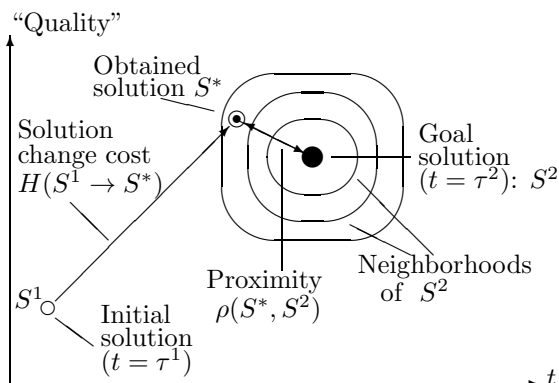

Fig. 15. Illustration for restructuring problem [35]

## 4. Improvement by System Components

### 4.1. Basic Framework

Generally, system improvement by components is based on improvement/replacement of system element. The basic framework to system improvement by system components can be considered as follows:

*Stage 1.* Detection of system bottlenecks set.

*Stage 2.* Generation of system improvement actions (i.e., improvement of DA, improvement of interconnection between DAs) and their assessment.

*Stage 3.* Formulation of the system improvement problem as combinatorial optimization problem as selection/combination of improvement actions (model: multiple choice problem or HMMD in the case of interconnection between the actions).

*Stage 4.* Solving the system improvement problem.

An example of combinatorial synthesis of composite five-component system is presented in Fig. 16. Here, HMMD is used (e.g., [28,31,33,37]). Ordinal quality of DAS are depicted in Fig. 16 (in parentheses, scale: [1, 2, 3, 4]). Table 4 contains ordinal compatibility estimates (scale: [0, 3]).

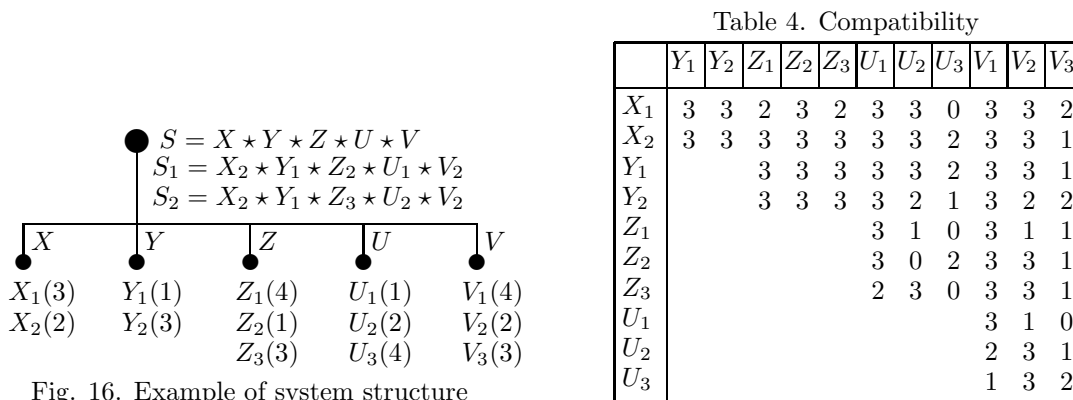

Fig. 16. Example of system structure

The resultant composite Pareto-efficient DAs are the following (Fig. 17):

(a)  $S_1 = X_2 * Y_1 * Z_2 * U_1 * V_2$ ,  $N(S_1) = (1; 3, 2, 0, 0)$  and

(b)  $S_2 = X_2 * Y_1 * Z_3 * U_2 * V_2$ ,  $N(S_2) = (3; 2, 2, 1, 0)$ .

Table 5 contains some bottlenecks and improvement actions. Further, it is possible to examine a combinatorial synthesis problem to design a system improvement plan based on the pointed out improvement actions (multiple choice problem or HMMD in the case of interconnection between the actions).

The improvement procedure based on multiple choice problem for  $S_2$  is considered. It is assumed improvement actions are compatible. Table 6 contains improvement actions and their illustrative estimates (ordinal scales).

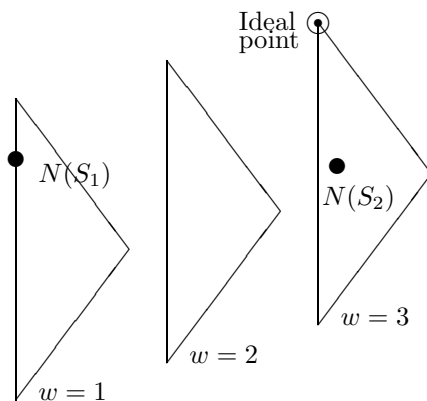

Fig. 17. Poset of system quality

Table 5. Bottlenecks and improvement actions

Composite DAs	Bottlenecks		Actions $w/r$
	DAs	IC	
$S_2 = X_2 \star Y_1 \star Z_3 \star U_2 \star V_4$	$X_2$		$2 \Rightarrow 1$
$S_2 = X_2 \star Y_1 \star Z_3 \star U_2 \star V_4$	$Z_3$		$3 \Rightarrow 2$
$S_2 = X_2 \star Y_1 \star Z_3 \star U_2 \star V_4$	$Z_3$		$3 \Rightarrow 1$
$S_2 = X_2 \star Y_1 \star Z_3 \star U_2 \star V_4$	$U_2$		$2 \Rightarrow 1$
$S_2 = X_2 \star Y_1 \star Z_3 \star U_2 \star V_2$	$V_2$	$(U_1, V_2)$	$2 \Rightarrow 1$
$S_1 = X_2 \star Y_1 \star Z_2 \star U_1 \star V_2$			$1 \Rightarrow 3$

Table 6. Improvement alternatives

	DA	Improvement action	Binary variable	Cost $a_{ij}$	Profit $c_{ij}$
1	$X_2$	None	$x_{11}$	0	0
2	$X_2$	$2 \Rightarrow 1$	$x_{12}$	3	4
3	$Z_3$	None	$x_{21}$	0	0
4	$Z_3$	$3 \Rightarrow 2$	$x_{22}$	1	2
5	$Z_3$	$3 \Rightarrow 1$	$x_{23}$	5	4
6	$U_2$	None	$x_{31}$	0	0
7	$U_2$	$2 \Rightarrow 1$	$x_{32}$	4	4
8	$V_2$	None	$x_{41}$	0	0
9	$V_2$	$2 \Rightarrow 1$	$x_{42}$	2	4

The multiple choice problem is:

$$\max \sum_{i=1}^4 \sum_{j=1}^{q_i} c_{ij} x_{ij} \quad s.t. \quad \sum_{i=1}^4 \sum_{j=1}^{q_i} a_{ij} x_{ij} \leq b, \quad \sum_{j=1}^{q_i} x_{ij} = 1 \quad \forall i = \overline{1, 4}, \quad x_{ij} \in \{0, 1\}.$$

Clearly,  $q_1 = 2$ ,  $q_2 = 3$ ,  $q_3 = 2$ ,  $q_4 = 2$ . Some examples of the resultant improvement solutions are (a simple greedy algorithm was used; the algorithm is based on ordering of elements by  $c_i/a_i$ ):

- (1)  $b^1 = 1$ :  $(x_{11} = 1, x_{22} = 1, x_{31} = 1, x_{41} = 1)$ , value of objective function  $c^{b^1} = 2$ ,  $N(S_2^{b^1}) = (3; 2, 3, 0, 0)$ ;
- (2)  $b^2 = 2$ :  $(x_{11} = 1, x_{21} = 1, x_{31} = 1, x_{42} = 1)$ ,  $c^{b^2} = 4$ ,  $N(S_2^{b^2}) = (3; 3, 1, 1, 0)$ ;
- (3)  $b^3 = 7$ :  $(x_{11} = 1, x_{23} = 1, x_{31} = 1, x_{42} = 1)$ ,  $c^{b^3} = 8$ ,  $N(S_2^{b^3}) = (3; 3, 2, 0, 0)$ ; and
- (4)  $b^4 = 14$ :  $(x_{12} = 1, x_{23} = 1, x_{32} = 1, x_{42} = 1)$ ,  $c^{b^4} = 16$ ,  $N(S_2^{b^4}) = (3; 5, 0, 0, 0)$ .

#### 4.2. Graph Vertex Recoloring Problem [33]

Now, a simplified illustrative version of system improvement by components will be presented as graph vertex recoloring problem [33]. In recent years, graph recoloring problems have been examined (e.g.,

[3,4,18,51,52]). Here, the basic problem formulation is the following. There are the following: graph  $G = (A, E)$  ( $|A| = n$ ), set of colors  $X = \{x_1, \dots, x_k\}$ , and initial *color configuration* for graph  $G$ :  $C^o(G) = \{C^o(a_1), \dots, C^o(a_i), \dots, C^o(a_n)\}$ ,  $C^o(a_i) \in X \quad \forall a_i \in A \quad (i = \overline{1, n})$ . Let  $d_{a_i}(x_{\delta_1}, x_{\delta_2})$  ( $\delta_1 = \overline{1, k}$ ,  $\delta_2 = \overline{1, k}$ ) be a nonnegative recoloring cost matrix for each vertex (i.e., individual recoloring cost matrix  $\forall a_i \in A$ ). For graph  $G$ , a goal *color configuration*  $C^g(G)$  or a set of goal *color configurations*  $\{C^g(G)\}$  are used as well. Now, for each two *color combination* ( $C^1(G)$  and  $C^2(G)$ ) it is possible to consider an integrated cost (the cost of recoloring), e.g., as an additive function  $D(C^1(G), C^2(G)) = \sum_{i=1}^n d_{a_i}(C^1(a_i), C^2(a_i))$ . In addition, it is necessary to consider a proximity of two *color configurations*:  $\rho(C^{\beta_1}(G), C^{\beta_2}(G))$ . Thus, the following transformation chain is examined:

$$C^o(G = (A, E)) \Rightarrow C^*(G = (A, E)) \Rightarrow C^g(G = (A, E))$$

where  $C^*(G = (A, E))$  is a resultant *color configuration*.

Generally, it is reasonable to examine two generalized objectives: (i) the cost of transformation  $C^o(G) \Rightarrow C^*(G)$  and (ii) the quality of proximity between  $C^*(G)$  and  $C^g(G)$  (or  $\{C^g(G)\}$ ). Assessment of the cost and proximity above can be based on various approaches (e.g., additive function, minimization, 'min/max' function, vector function).

Now, the basic problem of graph recoloring can be considered as follows:

*Find the new color configuration  $C^*(G)$  for a given graph  $G = (A, E)$  to minimize the proximity of the resultant graph coloring configuration  $C^*(G(A, E))$  to the goal coloring configuration of graph  $C^g(G(A, E))$  while taking into account the limited integrated cost of the recoloring ( $\leq \overline{D}$ ):*

$$\min_{\{C(G=(A,E))\}} \rho(C^*(G), C^g(G))$$

$$s.t. \quad D(C^o(G), C^*(G)) \leq \overline{D}, \quad C^*(a_i) \neq C^*(a_j) \quad \forall (a_i, a_j) \in E, \quad i \neq j.$$

Fig. 18 illustrates the graph (vertex) recoloring problem:

$$C^o(G) = (P_2 \star Q_3 \star U_3 \star V_2 \star W_1) \Rightarrow C^*(G) = (P_1 \star Q_2 \star U_2 \star V_1 \star W_3).$$

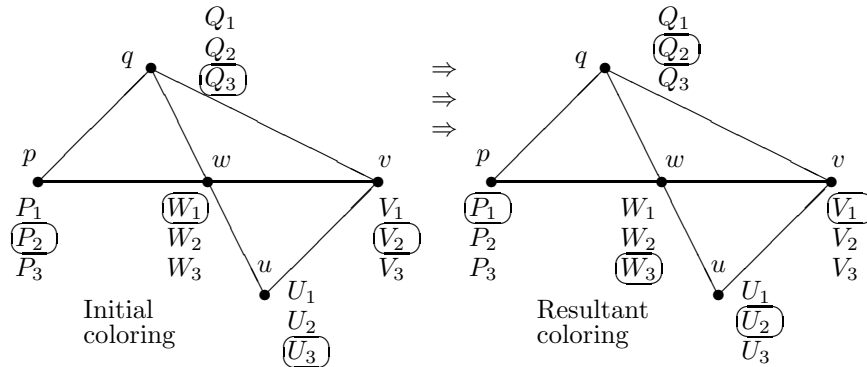

Fig. 18. Example of vertex recoloring [33]

## 5. Modification of System Structure

Modification of system structures is a crucial and complex combinatorial problem:

$$\text{Initial system structure} \Rightarrow \text{Modification process} \Rightarrow \text{Final system structure}$$

Table 7 contains a list of basic problems, which are targeted to modification of structures.

Table 7. Modification of structures

Problem	Initial structure	Resultant structure	Source
1.Modification of tree-like structures:			
1.1.Hotlink assignment problems	Tree-like structure	Tree-like structure with additional link from root	[10,11,16] [19,24,40]
1.2.Modification of tree via condensing weighted vertices	Weighted tree	Weighted tree with aggregated vertices	[26,28,40]
1.3.Transformation of tree into Steiner tree	Tree	Steiner tree	[40,46,48]
2.Transformation of morphological structure	Morphological structure	Morphological structure with required properties	[28,31,40]
3.Transformation of layered structure	Layered structure	Layered structure with required properties	
4.Augmenation problem	Connected graph	Connected graph with required properties (e.g., increased connectivity)	[14,23]

## 5.1. Modification of Tree-like Structures

### 5.1.1. Hotlink Assignment Problems [40]

In general, “hotlink assignment problem” is a network upgrade problem (e.g., [16]):

*Find additional new arc(s) to the initial graph in order to insert shortcuts and decrease the expected path length.*

Mainly, the problem is examined for trees. Let  $T = (A, E)$  be a directed tree with maximum degree  $d$ , rooted at a node  $r_0 \in A$  (elements of  $A$  correspond to Web sites, elements of  $E$  correspond to hyperlinks). A node weight equals its access (search) frequency (probability). It is assumed that required information is contained at leaf nodes (for simplicity). The length of the search for node  $v \in A$  equals the number of links in the path from  $r_0$  to  $v$ .

Let  $T_u = (A_u, E_u)$  be a subtree of  $T$  ( $A_u \subseteq A, E_u \subseteq E$ ), rooted at node  $u \in A$  (here  $u$  is not the son of  $r_0$ ). Thus, additional direct link (“hotlink”) will be as follows:  $(r_0, u)$ . In this case, a path to all leaf nodes in  $T_u$  will be smaller.

Fig. 19 illustrates the simplest version of “hotlink assignment” problem.

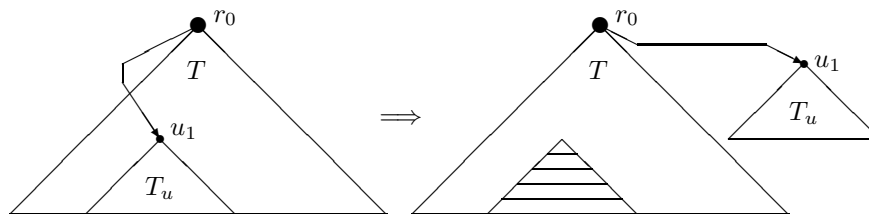

Fig. 19. Hotlink assignment problem (one hotlink) [40]

Some versions of the problem are presented in Table 8. Mainly, “hotlink assignment” problems belong to class of NP-hard problems (e.g., [19]). Many approximation algorithms have been suggested for the problems (including FPTAS) (e.g., [24,50]).

Table 8. Hotlink assignment problems

Problem	Source
1. Basic hotlink assignment	[10,56]
2. Single hotlink assignment	[12,24]
3. Hotlinks only for leafs	[19]
4. Multiple hotlink assignment	[12,16]
5. Dynamic hotlink assignment	[11]

**5.1.2. Modification of Tree via Condensing of Weighted Edges [26,28,40]**

This section describes briefly transformation of a tree (with weights of vertices and weights of edge/arcs) via integration (condensing) of some neighbor vertices while taking into account a constraint for a total weight of the maximum tree tail (i.e., length from root to a leaf vertex). The problem was firstly formulated for designing an overlay structure of a modular software system in [26]. The integration of software modules requires additional memory, but allows to decrease a time (i.e., frequency) of loading some corresponding modules. Other applications of the problem can be examined as well, e.g., hierarchical structure of data, call problem, hierarchical information structure of Web-sites. This problem is illustrated in Fig. 20 and Fig. 21 by an example for designing the over-lay structure on the basis of module integration, when different software or data modules can apply the same parts of RAM. A new kind of FPTAS for the above-mentioned combinatorial optimization problem (a generalization of multiple choice problem over a tree-like structure and special constraints) was suggested in [26].

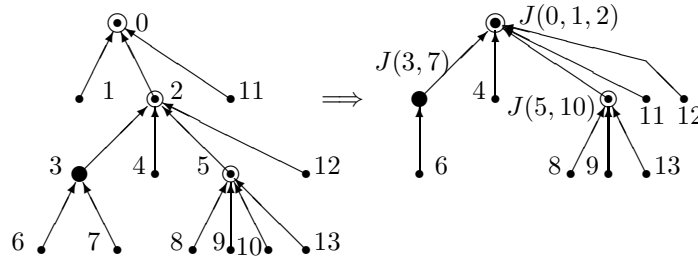

Fig. 20. Integration of software modules (over-lay structure) [40]

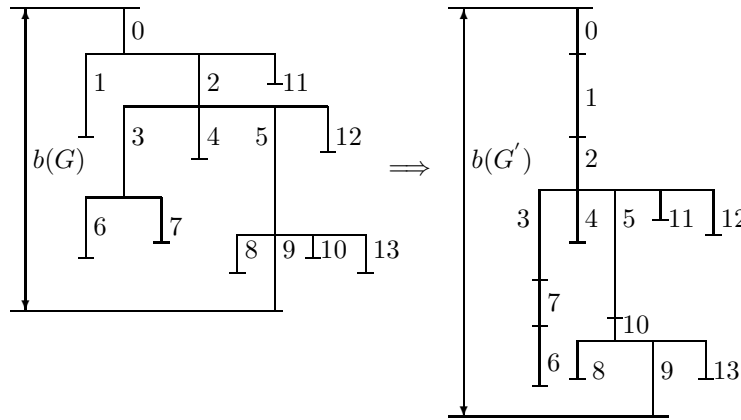

Fig. 21. Usage of memory (RAM) [40]

**5.1.3. Transformation of Tree into Steiner Tree [40]**

Recently, two multicriteria problems for transformation of a tree into Steiner tree have been examined: (1) multicriteria problem for transformation of an initial tree into Steiner tree [46] and (2) multicriteria problem for transformation of an initial tree into Steiner tree while taking into account a cost of Steiner vertices [48]. Here, the transformation of a tree  $T = (A, E)$  into Steiner tree  $S = (A', E')$  is considered as addition of Steiner points into an initial tree (or a preliminary built spanning tree) while taking into

account the following: “cost” (required resource) of each Steiner point, generalized “profit” of each Steiner point, total resource constraint (i.e., total “cost” of the selected Steiner points). The material is based on [40]. A simplest case is considered when Steiner points for triangles are only examined. Evidently, vector-like “cost” and “profit” can be used as well. The solving scheme is the following:

*Stage 1.* Identification (e.g., expert judgment, clustering) of  $m$  regions (clusters, groups of neighbor nodes) in the initial tree  $T$  for possible addition of Steiner points.

*Stage 2.* Generation of possible Steiner points (candidates) and their attributes (i.e., cost of addition, “profit”).

*Stage 3.* Formulation of multiple choice problem for selection of the best additional Steiner points while taking into account resource constraint(s):

$$\max \sum_{i=1}^m \sum_{j=1}^{q_i} c_{ij} x_{ij} \quad s.t. \quad \sum_{i=1}^m \sum_{j=1}^{q_i} a_{ij} x_{ij} \leq b, \quad \sum_{j=1}^{q_i} x_{ij} = 1, \quad x_{ij} \in \{0, 1\};$$

where  $i$  is the index of region ( $i = \overline{1, m}$ ),  $q_i$  is the number of versions for addition of Steiner points in region  $i = \overline{1, m}$ ,  $j$  is the index of version for addition of Steiner points in region ( $j = \overline{1, q_i}$ ),  $x_{ij}$  is binary variable that equals 1 if version  $j$  in region  $i$  is selected,  $b$  is a total constraint for the required resources (i.e., a total “cost”).

*Stage 4.* Solving the multiple choice problem to obtain the resultant Steiner tree  $S$ .

A numerical illustrative example illustrates the scheme. Initial tree is (Fig. 22):  $T = (A, E)$ ,  $A = \{1, 2, 3, 4, 5, 6, 7, 8, 9, 10, 11\}$ . Four regions are defined (Fig. 22): region 1:  $\{1, 2, 3, 4\}$ ; region 2:  $\{4, 6, 7\}$ ; region 3:  $\{4, 5, 6, 9, 11\}$ ; and region 4:  $\{7, 8, 10\}$ . The considered Steiner points are the following (Fig. 22): region 1:  $s_{11}, s_{12}$ ; region 2:  $s_{21}$ ; region 3:  $s_{31}, s_{32}$ ; and region 4:  $s_{41}$ . Table 9 contains initial data for multiple choice problem: binary variables and corresponding attributes (required resource as “cost”, possible “profit”). The corresponding multiple choice is:

$$\max \sum_{i=1}^4 \sum_{j=1}^{q_i} c_{ij} x_{ij} \quad s.t. \quad \sum_{i=1}^4 \sum_{j=1}^{q_i} a_{ij} x_{ij} \leq b, \quad \sum_{j=1}^{q_i} x_{ij} = 1, \quad x_{ij} \in \{0, 1\}.$$

An obtained solution (i.e., as set of additional Steiner points) is the following (a simple greedy heuristic was used) (Fig. 22):  $b_1 = 2.9$ ;  $\bar{x}_{b_1}$ :  $x_{12} = 1, x_{21} = 1, x_{32} = 1, x_{41} = 1$ , Steiner points  $Z_{b_1} = \{s_{11}, s_{31}\}$ , total (additive) “profit”  $\bar{c} = 5.5$ .

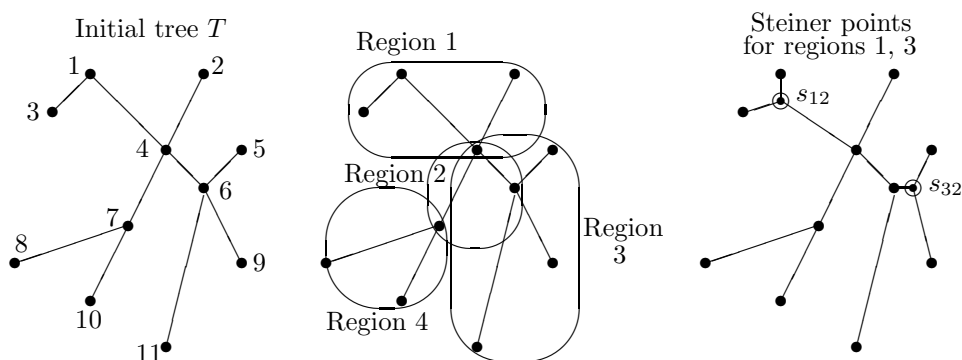

Fig. 22. Initial tree, regions (clusters), Steiner tree

Table 9. Data for multiple choice problem

Region	Binary variable	Steiner point	“Cost” $c_{ij}$	“Profit” $a_{ij}$
Region 1	$x_{11}$	None	0.0	0.0
	$x_{12}$	$s_{11}$	3.1	1.5
	$x_{13}$	$s_{12}$	1.2	1.4
Region 2	$x_{21}$	None	0.0	0.0
	$x_{22}$	$s_{21}$	2.0	1.3
Region 3	$x_{31}$	None	0.0	0.0
	$x_{32}$	$s_{31}$	2.4	1.4
	$x_{33}$	$s_{32}$	1.8	1.3
Region 4	$x_{41}$	None	0.0	0.0
	$x_{42}$	$s_{41}$	1.5	1.2

## 5.2. Augmentation Problem

Graph augmentation problem is a generalization of “hotlink assignment” problem (e.g., [14,23]). The goal is to modify an initial graph/network (e.g., by edges) such that the augmented graph will be satisfied some requirements (e.g., as increasing the connectivity).

## 5.3. Transformation of Morphological Structure

Morphological system structure was suggested for the extended version of morphological analysis (HMMD) and contains the following parts (e.g., [28,31,36,37,40]): (1) system hierarchy (e.g., a tree) (2) set of leaf nodes (i.e., system components), (3) sets of alternatives (DAs) for each system component; (4) estimates of the alternatives (ordinal as priority, interval, etc.), (5) compatibility estimates for alternative pairs. A numerical example of the morphological system structure was presented in Fig. 16 and Table 4. In general, the system morphological structure and its transformation are depicted in Fig. 23:  $S' \Rightarrow S''$ . Here, the following is transformed:

(a) system hierarchy (tree)  $T' \Rightarrow T''$ ,

(a) basic system components as leaf nodes  $L' = \{1, \dots, i, \dots, m'\} \Rightarrow L'' = \{1, \dots, i, \dots, m''\}$ .

The numerical example of system structure transformation (as system reconfiguration) was described in section 3.1 (Fig. 13).

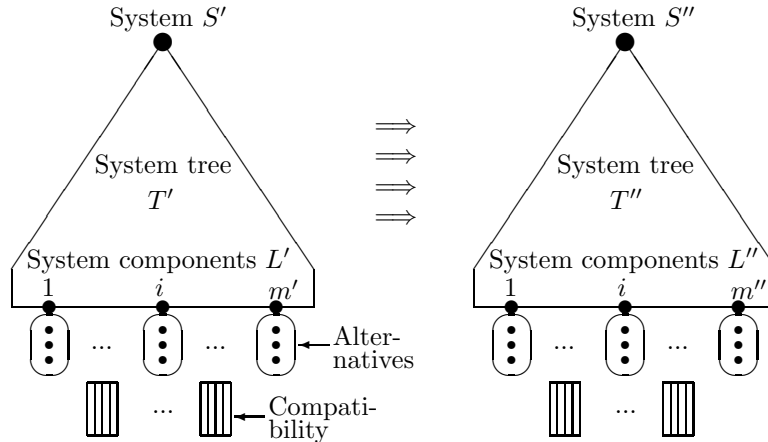

Fig. 23. Morphological system structure, its transformation

## 5.4. Transformation of Layered Structure

The multilayer system structure is examined as follows: (a) set of layers, (b) for each layer: set of nodes, topology over the nodes, (c) connection of nodes for neighbor layer.

Thus, the modification process of the layered structure can involve the following:



1. Modification of the layer-structure: (1.1) Addition of a layer, (1.2) Deletion of a layer.
  2. Modification of a layer: (2.1) addition of layer nodes, (2.2) deletion of layer nodes (2.3) modification for the layer topology (a network over the layer nodes).
  3. Modification of inter-layer connections (i.e., connection for nodes of neighbor layers): reassignment.
- Fig. 24 depicts the modification process  $S' \Rightarrow S''$ .  
 A numerical example for two-layered network will be presented later (extension of layers, reassignment).

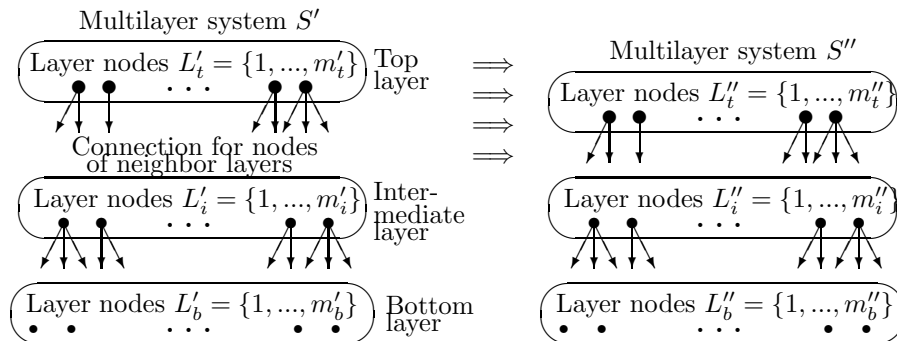

Fig. 24. Transformation of multilayer structure

## 6. Examples for Network Improvement/Extension [34]

### 6.1. Network Hierarchy

A traditional network hierarchy can be considered as follows (e.g., [25,53,59]): (a) international (multi-country, continent) network GAN; (b) metropolitan network MN; (c) wide area network WAN; and (d) local area network LAN. From the “engineering” viewpoint, hierarchical layers involve the following: (i) backbone network; (ii) global network as a set of interconnected network segments (including additional centers, cross-connections, and bridges); (iii) access network/network segment (cluster): bi-connected topology (about 20 nodes); and (iv) distributed network (a simple hard topology, e.g., bus, tree, ring).

A simplified example of a three-layer network hierarchy is the following: (a) “center” systems (e.g., hubs), (b) access points, and (c) distributed networks.

### 6.2. Requirements/Criteria

Contextual classification of the requirements to communication networks is considered as follows (e.g., [25,34]): (1) “user” requirements: cost, time characteristics, quality (information errors, reliability of connection); (2) system requirements: cost, reliability (or stability, redundancy, k-connectivity), manageability, maintainability, testability, modularity, adaptability, safety, and flexibility (e.g., reconfigurability); (3) mobility requirements; and (4) system evolution/development requirements: possibility for re-design (upgradeability).

On the other hand, it is possible to consider a correspondence of the requirements to network hierarchical layers, for example: (1) top layer: cost, safety (stability, reliability, redundancy, survivability), manageability, adaptability, flexibility, upgradeability; (2) medium layer: basic quality, reliability, and survivability; (3) bottom layer: basic quality (time, cost, etc.) and reliability.

### 6.3. Network Design/Development: Basic Problems

In Table 10, some basic problems are pointed out from the viewpoint of network layers and two types of activities: network design and network improvement/extension.

Thus, underlying combinatorial optimization problems (e.g., minimum spanning tree, minimum Steiner tree, covering, design of a k-connected topology, location/placement of network nodes, selection of some additional links as additional network edges, selection and location of additional network nodes) can be considered. In the numerical examples, the following combinatorial problems are used: (1) multiple criteria ranking (e.g., [28,39,57]), here our modification of outranking technique (Electre-like method) is used [39]; (2) clustering (e.g., [20]), here our modification of agglomerative algorithm is used [32]; (3) assignment/allocation problem (e.g., [17]), here our heuristic is used [44]; and (4) multicriteria multiple choice problem, (e.g., [17,21]), here our heuristic is used [45].

Table 10. Network layers and design/improvement problems

Network layer	Some basic structural design problems	Basic network improvement/extension design problems
System of hubs (centers)	Network topology design: (a) clustering (b) spanning tree/forest (c) Steiner tree (d) k-connected network (e) covering problem	(1) addition of hub(s) (center(s)) (2) addition of links (e.g., bridge(s)) (3) redesign of network topology
Network over gateways	Network topology design: (a) clustering (b) spanning tree/forest (c) Steiner tree (d) k-connected network (e) covering problem	(1) addition of access point(s) (2) addition of links (e.g., bridge(s)) (3) redesign of network topology
Access network	Network topology design: (a) clustering (b) spanning tree/forest (c) Steiner tree (d) 2-connected network (e) covering problem	(1) addition of access point(s) (2) addition of links (e.g., bridge(s)) (3) redesign of network topology
Distributed network	Last mile problem: (a) choice of topology (b) choice of connection (c) choice of access point	(1) addition of user(s) (2) addition of distributed network(s)

#### 6.4. Network Improvement

Here, a simplified example for improvement of Moscow phone network (at a macro level) is examined [34]. Table 11 contains the considered Moscow regions  $\{A_1, \dots, A_9\}$  and their estimates upon parameters (expert judgment, ordinal scale [1,10]): population  $P_1$ , level of an existing communication infrastructure  $P_2$ , and volume of the region array  $P_3$ .

Table 11. Regions, their estimates

	Region	Parameters		
		$P_1$	$P_2$	$P_3$
$A_1$	Central	10	10	9
$A_2$	South	8	9	10
$A_3$	South-west	6	7	4
$A_4$	South-east	3	8	8
$A_5$	North	4	4	5
$A_6$	North-east	1	1	9
$A_7$	North-west	4	5	4
$A_8$	West	5	6	4
$A_9$	East	2	4	5

After clustering (hierarchical clustering is used [32]), the following clusters are obtained:  $G^1 = \{A_1\}$ ,  $G^2 = \{A_2\}$ ,  $G^3 = \{A_3, A_8\}$ ,  $G^4 = \{A_4\}$ ,  $G^5 = \{A_5, A_7, A_9\}$ , and  $G^6 = \{A_6\}$ . Table 12 contains five development/improvement actions at the region level  $\{D_1, D_2, D_3, D_4, D_5\}$  ( $D_1$  corresponds to a case when activities are absent). The actions are evaluated upon criteria (ordinal scale [0.5], expert judgment): generalized profit ( $C_1$ ), complexity ( $C_2$ ), perspective profit ( $C_3$ ), and expenditure ( $C_4$ ).

Table 12. Development/improvement actions

	Development action	Criteria			
		$C_1$	$C_2$	$C_3$	$C_4$
$D_1$	None	0	0	0	0
$D_2$	New links	5	5	5	5
$D_3$	Reparation of links	2	2	2	2
$D_4$	Extension (new links and devices)	3	3	3	3
$D_5$	Deletion of old links	1	1	1	1

Fig. 25 depicts a two-stage solving scheme. A composite development plan is based on the following multicriteria multiple choice problem (a simplest greedy-like heuristic is used):

$$\max \sum_{i=1}^6 \sum_{j=1}^5 c_{ij}^1 x_{ij}, \quad \min \sum_{i=1}^6 \sum_{j=1}^5 c_{ij}^2 x_{ij}, \quad \max \sum_{i=1}^6 \sum_{j=1}^5 c_{ij}^3 x_{ij}, \quad \min \sum_{i=1}^6 \sum_{j=1}^5 c_{ij}^4 x_{ij}$$

$$s.t. \quad \sum_{i=1}^6 \sum_{j=1}^5 a_{ij} x_{ij} \leq b, \quad \sum_{j=1}^5 x_{ij} = 1 \quad i = \overline{1, 6}, \quad x_{ij} \in \{0, 1\}.$$

As a result, the following solution is obtained:  $S_1 = \langle D_4^1 \star D_3^2 \star D_5^3 \star D_4^4 \star D_1^5 \star D_1^6 \rangle$ . In the case of interconnections of solutions for neighbor regions, it is necessary to use combinatorial synthesis based on HMMD [28,31,37,38].

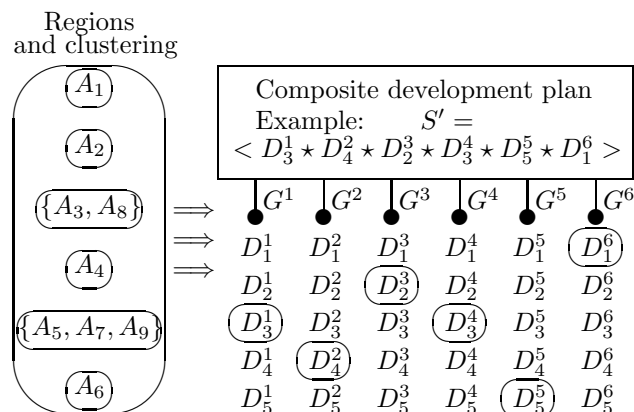

Fig. 25. Illustration for two-stage scheme [34]

### 6.5. Network Extension

Here, an applied example for a regional communication network is considered: (i) there exists a communication network for a region, (ii) it is needed to design an additional communication network for a neighbor region. Three extension strategies may be considered:

*Strategy I.* Designing the additional communication network (i.e., definition of possible positions for communication facilities, location of communication devices, definition of system modes, etc.) and synthesis of the obtained two networks.

*Strategy II.* Designing a new “generalized” communication network for an integrated region (i.e., the previous region and the additional regions, integrated design).

*Strategy III.* Designing the additional communication network for the neighbor region and modification of the communication network for the previous region as coordination between the network for previous region and neighbor regions (e.g., reconfiguration, replacement of communication layers, re-linking).

Note, the network extension approaches can be used for various hierarchical layers of a communication network.

Now, two extension strategies above at the layer of connection between users and access points (i.e., assignment of users to access points) are examined. Two regions (including users and access point) are considered: (i) initial regions (17 users and 3 access points, Table 13 and Table 14, Fig. 26) and (ii) additional regions (11 users and 3 access points, Table 13 and Table 14, Fig. 27). Two extension design strategies are considered: *strategy I* (separated design for initial region and for additional region) and *strategy II* (integrated design).

For the initial region, the following parameters are used: set of users  $\Psi = \{1, \dots, i, \dots, n\}$  ( $n = 17$ ), set of access points  $\Theta = \{1, \dots, j, \dots, m\}$  ( $m = 3$ ). Each user is described by parameter vector  $(x_i, y_i, z_i, f_i, p_i)$ , where vector components are as follows (Table 4): coordinates of user  $(x_i, y_i, z_i)$ , required frequency bandwidth  $f_i$  (scale: 1 Mbit/s ... 10 Mbit/s), priority  $p_i$  (ordinal scale [1,2,3], all user requirements are satisfied in case  $p_i = 1$ ), required reliability  $r_i$  (ordinal scale [1,10], 10 corresponds to maximum reliability). Analogically parameters of access points are considered (by index  $j$ , Table 5) including parameter  $n_j$  (maximal possible number of users under service).

Table 13. Data for initial region  
(a) users (b) access points

$i$	$x_i$	$y_i$	$z_i$	$f_i$	$p_i$	$r_i$	$j$	$x_j$	$y_j$	$z_j$	$f_j$	$n_j$	$r_j$
1	30	165	5	10	2	5	1	50	157	10	30	4	10
2	58	174	5	5	1	9	2	72	102	10	42	6	10
3	95	156	0	6	1	6	3	45	52	10	45	10	10
4	52	134	5	6	1	8							
5	85	134	3	6	1	7							
6	27	109	7	8	3	5							
7	55	105	2	7	2	10							
8	98	89	3	10	1	10							
9	25	65	2	7	3	5							
10	52	81	1	10	1	8							
11	65	25	7	6	2	9							
12	93	39	1	10	1	10							
13	172	26	2	10	2	7							

Thus, each pair “user-access point” (i.e.,  $(i, j), i \in \Psi, j \in \Theta$ ) can be described: (1) reliability  $r_{ij} = \min\{r_i, r_j\}$ , (2) distance  $l_{ij}$ , (3) priority  $p_{ij} = p_i$ , and (4) required bandwidth  $f_{ij} = f_i$ . In addition, a “connectivity” parameter is considered:  $\beta_{ij}$  equals 1 if  $l_{ij} \leq l$  and 0 otherwise ( $L$  corresponds to distance constraint). This parameter defines  $\forall i \in \Psi$  a subset of possible access points  $\Theta_i \subseteq \Theta$ . The assignment of user  $i$  to access point  $j$  is defined by Boolean variable  $x_{ij}$  ( $x_{ij} = 1$  in the case of assignment  $i$  to  $j$  and  $x_{ij} = 0$  otherwise). Thus, the assignment solution  $(\Psi \Rightarrow \Theta)$  is defined by Boolean matrix  $X = \|x_{ij}\|, i = \overline{1, n}, j = \overline{1, m}$ . Finally, the problem formulation is the following:

$$\begin{aligned} & \max \sum_{i=1}^n \sum_{j \in \Theta_i} r_{ij} x_{ij}, \quad \max \sum_{i=1}^n \sum_{j \in \Theta_i} f_{ij} x_{ij}, \quad \max \sum_{i=1}^n \sum_{j \in \Theta_i} p_{ij} x_{ij} \\ & \text{s.t.} \quad \sum_{i=1}^n f_{ij} x_{ij} \leq f_j \quad \forall j \in \Theta, \quad \sum_{i=1}^n x_{ij} \leq n_j \quad \forall j \in \Theta, \quad \sum_{j \in \Theta_i} x_{ij} \leq 1 \quad \forall i \in \Psi, \\ & x_{ij} \in \{0, 1\}, \quad \forall i = \overline{1, n}, \quad \forall j = \overline{1, m}, \quad x_{ij} = 0, \quad \forall i = \overline{1, n}, \quad j \in \{\Theta \setminus \Theta_i\}. \end{aligned}$$

Here, a simplified two-stage heuristic used: (i) transformation of vector estimate for each pair  $(i, j)$  into an ordinal estimate (by multicriteria ranking, ELECTRE-like technique), (ii) solving the obtained one-criterion assignment problem (by greedy algorithm). Thus, Fig. 26 depicts the obtained solution: an assignment of users to access points.

Fig. 27 depicts two regions: initial region, additional region, and corresponding assignment of users to access points. Here the assignment problems are solved separately for the initial region (assignment from Fig. 26) and for the additional region (i.e., *strategy I*).

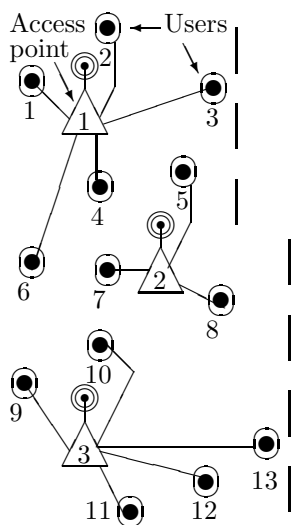

Fig. 26. Initial region [34]

Table 14. Data for additional region  
 (a) users (b) access points

$i$	$x_i$	$y_i$	$z_i$	$f_i$	$p_i$	$r_i$	$j$	$x_j$	$y_j$	$z_j$	$f_j$	$n_j$	$r_j$
14	110	169	5	7	2	5	4	150	165	10	30	5	15
15	145	181	3	5	2	4	5	140	112	10	32	5	8
16	170	161	5	7	2	4	6	147	47	10	30	5	15
17	120	140	6	4	2	6							
18	150	136	3	6	2	7							
19	175	125	1	8	3	5							
20	183	91	4	4	3	5							
21	135	59	4	13	3	4							
22	147	79	5	7	3	16							
23	172	26	2	10	2	7							
24	165	50	3	7	3	3							
25	127	95	5	7	2	5							

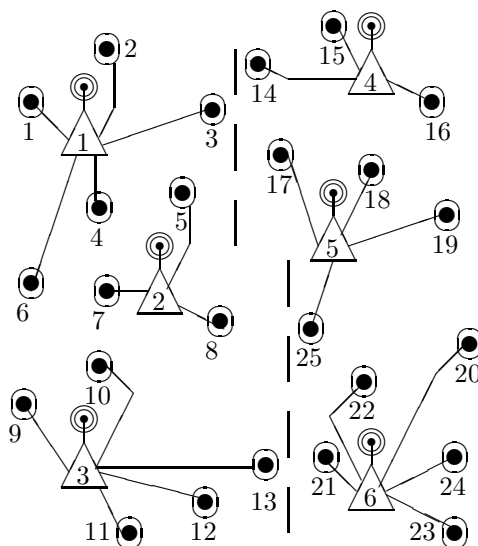

Fig. 27. Two regions: separated assignment [34]

Fig. 28 depicts the results of integrated (joint) design *strategy II*). Note, the following users are re-assigned: 3, 13, and 25. Generally, it may be reasonable (to decrease the dimensions of the problems under the solving process) to consider the following approach: (a) design (assignment) for the initial region, (b) design (assignment) for the additional region, (c) re-design (re-assignment) for users which belong to a border subregion, e.g., in the example (Fig. 27, Fig. 28) the user set involves the following users:  $\{3, 5, 8, 13, 14, 17, 21, 25\}$ .

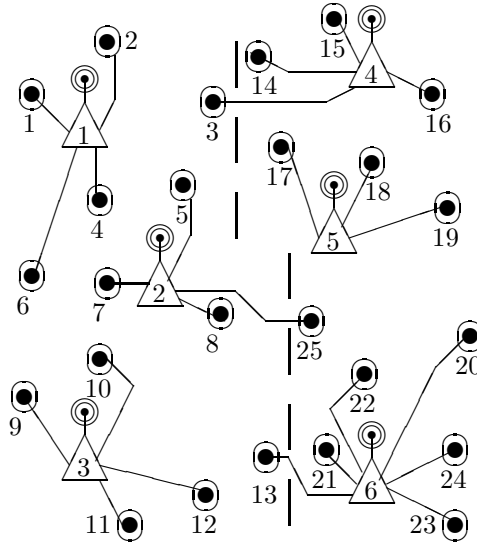

Fig. 28. Two regions: joint assignment [34]

## 7. Conclusion

The paper describes combinatorial approaches to system improvement/extension of modular systems. Basic system improvement/extension actions are described (e.g., improvement/replacement of system components, improvement/modification of system structure) and composite improvement/extension strategies. The described methods are based on combinatorial optimization problems (knapsack problem, multiple choice problem, assignment/allocation problem, spanning problems, hotlink assignment problem, etc.). Realistic numerical examples illustrate the described strategies.

In the future, it may be reasonable to consider the following research directions: (1) examination of various real-world applications, (2) examination of multi-stage system improvement/extension strategies, (3) special study of improvement/extension strategies for problem solving frameworks (e.g., [39]), (4) taking into account uncertainty, (5) special study of reoptimization/restructuring approaches, and (6) usage of the described system approaches in education (computer science, engineering, applied mathematics).

## REFERENCES

1. C. Archetti, L. Bertazzi, M.G. Speranza, Reoptimizing the traveling salesman problem. *Networks* 42(3) (2003) 154–159.
2. G. Austello, B. Escoffer, J. Monnot, V. Paschos, Reoptimization of minimum and maximum traveling salesman's tours. *J. of Discr. Algorithms* 7(4) (2009) 453–463.
3. E.H. Bachoore, H.L. Boldaender, *Convex Recoloring of Leaf-Colored Trees*. TR UU-CS-2006-010, Dept. of Inform. & CS, Utrecht Univ., 2006.
4. R. Bar-Yehuda, I. Feldman, D. Rawitz, Improved approximation algorithm for convex recoloring of trees. *Theory of Computing Systems* 43(1) (2008) 3–18
5. D. Bilo, H.-J. Bockenhauer, J. Hromkovic, R. Kralovic, T. Momke, P. Widmayer, A. Zych, Reoptimization of Steiner trees. In: J. Gudmundsson (ed), *Proc. of Scandinavian Workshop on Algorithm Theory SWAT'08*, LNCS 5124, Springer, (2008) 258–269.
6. D. Bilo, P. Widmayer, A. Zych, Reoptimization of weighted graph and covering problems. In: E.

- Bampis, M. Skutella (eds). *Proc. of 6th Int. Workshop on Approximation and Online Algorithms WAOA '08*, LNCS 5426, Springer, (2008) 201–213.
7. D. Bilo, H.-J. Bockenhauer, D. Komm, R. Kralovic, T. Momke, S. Seibert, A. Zych, Reoptimization of the shortest common superstring problem. *Algorithmica* 61(2) (2011) 227–251.
  8. H.-J. Bockenhauer, J. Hromkovic, T. Momke, P. Widmayer, On the hardness of reoptimization. In: V. Geffert, J. Karhumaki, A. Bertoni, B. Preneel, P. Navrat, M. Bielikova (eds), *34th International Conf. on Current Trends in Theory and Practice of Computer Science SOFSEM 2008*, LNCS 4910, Springer, (2008) 50–65.
  9. N. Boria, V.Ph. Paschos, Fast reoptimization for the minimum spanning tree problem. *J. of Discr. Algorithms* 8(3) (2010) 296–310.
  10. P. Bose, J. Czyzowicz, L. Gasieniec, E. Kranakis, D. Krizanc, A. Pelc, M.V. Martin, Strategies for hotlink assignments. *Int. Symp. on Algorithms and Computation (ISAAC'00)*, LNCS 1969, Springer, (2001) 23–34.
  11. K. Douieb, S. Langerman, Dynamic hotlinks. *Algorithmica* 50(2) (2008) 208–222.
  12. K. Douieb, S. Langerman, Near-entropy hotlink assignments. *Algorithmica* 58(2) (2010) 221–344.
  13. B. Escoffer, M. Milanic, V.Ph. Paschos, Simple and fast reoptimizations for Steiner tree problem. *Algorithmic Operations Research* 4(2) (2009) 86–94.
  14. K.P. Eswaran, R.E. Tarjan, Augmentation problems. *SIAM J. on Computing* 5(4) (1976) 653–665.
  15. P.C. Fishburn, *Utility Theory for Decision Making*, J.Wiley& Sons, New York, 1970.
  16. S. Fuhrmann, S.O. Krumke, H.-C. Wirth, Multiple hotlink assignment. In: A. Brandstadt, V.B. Le (Eds.), *WG 2001*, LNCS 2204, Springer, (2001) 189–200.
  17. M.R. Garey, D.S. Johnson, *Computers and Intractability. The Guide to the Theory of NP-Completeness*. W.H. Freeman and Company, San Francisco, 1979.
  18. S. Hack, G. Goos, Copy coalescing by graph recoloring. *ACM SIGPLAN Notices* 43(6) (2008) 227–237.
  19. T. Jacobs, On the complexity of optimal hotlink assignment. *Algorithmica* 62(3–4) (2012) 982–1005.
  20. A.K. Jain, M.N. Murty, P.J. Flynn, Data clustering: a review. *ACM Computing Surveys* 31(3) (1999) 264–323.
  21. H. Kellerer, U. Pferschy, D. Pisinger, *Knapsack Problems*. Springer, Berlin, 2004.
  22. R.L. Keeny, H. Raiffa, *Decisions with Multiple Objectives: Preferences and Value Tradeoffs*. J.Wiley& Sons, New York, 1976.
  23. S. Khuller, Approximation algorithms for finding highly connected subgraphs. In: D.S. Hochbaum (Ed.), *Approximation Algorithms for NP-hard Problems*. PWS Publishing Company, Boston, (1997) 236–265.
  24. E. Kranakis, D. Krizanc, S. Shende, Approximate hotlink assignment. In: *Proc. of 12th Ann. Int. Symp. on Algorithms and Computation*, LNCS 2223, Springer, (2001) 756–767.
  25. N.A. Kuznetsov, M.Sh. Levin, V.M. Vishnevsky, Some combinatorial optimization schemes for multi-layer network topology. In: *Electronic Proc. of 17th IMACS World Congress 2005*, Paris, France, Paper T4-I-42-0486. July 2005.
  26. M.Sh. Levin, An extremal problem of organization of data. *Eng. Cybern.* 19(5) (1981) 87–95.
  27. M.Sh. Levin, Improvement of decomposable systems. In: *Advances in Concurrent Engineering*, Toronto: Techpub., (1996) 319–325.
  28. M.Sh. Levin, *Combinatorial Engineering of Decomposable Systems*. Kluwer Academic Publishers, Boston, 1998.
  29. M.Sh. Levin, System synthesis with morphological clique problem: fusion of subsystem evaluation decisions. *Information Fusion* 2(3) (2001) 225–237.
  30. M.Sh. Levin, Towards analysis, adaptation, and planning of human-computer systems. *Applied Intelligence* 16(3) (2002) 235–247.
  31. M.Sh. Levin, *Composite Systems Decisions*. Springer, New York, 2006.
  32. M.Sh. Levin, Towards hierarchical clustering. In: V. Diekert, M. Volkov, A. Voronkov (eds), *CSR 2007*, LNCS 4649, Springer, (2007) 205–215.
  33. M.Sh. Levin, Combinatorial optimization in system configuration design. *Automation and Remote Control* 70(3) (2009) 519–561.
  34. M.Sh. Levin, Towards communication network development (structural system issues, combinatorial models). In: *2010 IEEE Region 8 Int. Conf. "SIBIRCON-2010"*, vol. 1, (2010) 204–208.

35. M.Sh. Levin, Restructuring in combinatorial optimization. Electronic preprint. 11 pp., Febr. 8, 2011. <http://arxiv.org/abs/1102.1745> [cs.DS]
36. M.Sh. Levin, Aggregation of composite solutions: strategies, models, examples. Electronic preprint. 72 pp., Nov. 29, 2011. <http://arxiv.org/abs/1111.6983> [cs.SE]
37. M.Sh. Levin, Morphological methods for design of modular systems (a survey). Electronic preprint. 20 pp., Jan. 9, 2012. <http://arxiv.org/abs/1201.1712> [cs.SE]
38. M.Sh. Levin, Multiset estimates and combinatorial synthesis. Electronic preprint. 30 pp., May 9, 2012. <http://arxiv.org/abs/1205.2046> [cs.SY]
39. M.Sh. Levin, Composite strategy for multicriteria ranking/sorting (methodological issues, examples). Electronic preprint. 24 pp., Nov. 9, 2012. <http://arxiv.org/abs/1211.2245> [math.OC]
40. M.Sh. Levin, Towards design of system hierarchy (research survey). Electronic preprint. 36 pp., Dec. 7, 2012. <http://arxiv.org/abs/1212.1735> [math.OC]
41. M.Sh. Levin, Modular design and improvement of management in smart homes with interval multiset estimates. *J. of Communications Technology and Electronics* 58(6) (2013) (accepted)
42. M.Sh. Levin, M.A. Danieli, Hierarchical decision making framework for evaluation and improvement of composite systems (example for building). *Informatika* 16(2) (2005) 213–240.
43. M.Sh. Levin, O. Kruchkov, O. Hadar, E. Kaminsky, Combinatorial systems evolution: example of standard for multimedia information. *Informatika* 20(4) (2009) 519–538.
44. M.Sh. Levin, M.V. Petukhov, Multicriteria assignment problem (selection of access points). In: *Proc. of 23rd Int. Conf. IEA/AIE 2010, "Trends in Applied Intelligent Systems"*, LNCS 6097, part II, Springer, Cordoba, (2010) 277–287.
45. M.Sh. Levin, A.V. Safonov, Towards modular redesign of networked system. In: *Proc. of Int. 2nd It. Conf. on Ultra Modern Telecommunication 'ICUMT 2010'*, Moscow, (2010) 109–114.
46. M.Sh. Levin, R.I. Nuriakhmetov, Multicriteria Steiner tree problem for communication network. Electronic preprint, 11 pp., Febr. 12, 2011. <http://arxiv.org/abs/1102.2524> [cs.DS]
47. M.Sh. Levin, A. Andrushevich, A. Klapproth, Improvement of building automation system. In: Mehrotra K.G. et al. (eds) *Proc. of 24th Int. Conf. IEA/AIE 2011*, LNCS 6704, Part II, Springer, (2011) 459–468.
48. M.Sh. Levin, A.A. Zamkovoy, Multicriteria Steier tree with the cost of Steiner vertices. *J. of Communications Technology and Electronics* 56(12) (2011) 1527–1542.
49. M.Sh. Levin, A. Andrushevich, R. Kistler, A. Klapproth, Combinatorial evolution and forecasting of communication protocol ZigBee, Electronic preprint. 6 pp., April 15, 2012. <http://arxiv.org/abs/1204.3259> [cs.NI]
50. R. Matichin, D. Peleg, Approximation algorithm for hotlink assignment in the greedy model. *Theor. Comput. Sci.* 383(1) (2004) 102–110.
51. S. Moran, S. Snir, Efficient approximation of convex recoloring. *J. of Comput. and System Sci.* 73(7) (2007) 1078–1089.
52. S. Moran, S. Snir, Convex recoloring of strings and trees: Definitions, hardness results and algorithms. *J. of Comput. and System Sci.* 74(5) (2008) 850–869.
53. M.W. Murhammer, K.-K. Lee, P. Motallebi, P. Borghi, K. Wozabal, *IP Network Design Guide, IBM Red Book*, 1999.
54. H. Noltmeier, H.-C. Wirth, S.O. Krumke, Network design and improvement. *ACM Computing Surveys* 32(3es) (1999) Art. no. 2.
55. V. Pareto, *Mannual of Political Economy*. (English translation), A. M. Kelley Publishers, New York, 1971.
56. M. Perkowitz, O. Etzioni, Towards adaptive web sites: conceptual framework and case study. *Computer Networks* 31(11-16) (1999) 1245–1258.
57. B. Roy, *Multicriteria Methodology for Decision Aiding*. Kluwer Academic Publishers, Dordrecht, 1996.
58. R.E. Steuer, *Multiple Criteria Optimization: Theory, Computation, and Application*. J.Wiley& Sons, New York, 1986.
59. A.S. Tanenbaum, *Computer Networks*. 4th ed., Prentice Hall PTR, NJ, 2002.