

Note on Combinatorial Engineering Frameworks for Hierarchical Modular Systems

Mark Sh. Levin *

The paper briefly describes a basic set of special combinatorial engineering frameworks for solving complex problems in the field of hierarchical modular systems. The frameworks consist of combinatorial problems (and corresponding models), which are interconnected/linked (e.g., by preference relation). Mainly, hierarchical morphological system model is used. The list of basic standard combinatorial engineering (technological) frameworks is the following: (1) design of system hierarchical model, (2) combinatorial synthesis ('bottom-up' process for system design), (3) system evaluation, (4) detection of system bottlenecks, (5) system improvement (re-design, upgrade), (6) multi-stage design (design of system trajectory), (7) combinatorial modeling of system evolution/development and system forecasting. The combinatorial engineering frameworks are targeted to maintenance of some system life cycle stages. The list of main underlying combinatorial optimization problems involves the following: knapsack problem, multiple-choice problem, assignment problem, spanning trees, morphological clique problem.

Keywords: modular systems, hierarchy, engineering frameworks, combinatorial optimization, system design, system life cycle, heuristics

1. Introduction

The frame approach for representing knowledge (i.e., collection of frames are linked together into frame-system) has been suggested by Marvin Minsky (e.g., [55]). In this approach, the frame corresponds to a data structure. In general, it is possible to consider the following three-component system: initial data/information, problem(s) (and corresponding models), and algorithm (or interactive procedure). For many complex applied problems, it is reasonable to examine special composite frameworks (i.e., composite solving schemes) consisting of problems (and corresponding models), which are interconnected/linked (e.g., by preference relation). For example, a basic simplified framework for data processing can be described as follows:

- (a) analysis of input data/information and preliminary processing;
- (b) processing; and
- (c) analysis of results.

Another example of a framework is well-known in decision making. Herbert Simon has suggested his framework for rational decision making (choice problem) (e.g., [60]): (i) the identification and listing of all the alternatives, (ii) determination of all the consequences resulting from each of the alternatives, and (iii) the comparison of the accuracy and efficiency of each of these sets of consequences. A modified version of this decision making framework is the following:

Stage 1. Analysis of the examined system/process, extraction of the problem.

Stage 2. Problem structuring:

- (2.1.) generation of alternatives,
- (2.2.) generation of criteria and a scale for each criterion.

Stage 3. Obtaining the initial information (estimates of the alternatives, preferences over the alternatives).

Stage 4. Solving process to obtain the decision(s).

Stage 5. Analysis of the obtained decision(s).

*Mark Sh. Levin: Inst. for Inform. Transmission Problems, Russian Academy of Sciences; <http://www.mslevin.iitp.ru>; email: mslevin@acm.org

On our opinion, there exists a trend to design, describe, and use a set of basic typical engineering (technological) frameworks (i.e., typical composite combinatorial solving schemes), which can be considered as basic standard blocks in systems research/design and in systems education (engineering, computer science, applied mathematics).

In recent decades, modular approaches have been used in all engineering domains. Thus, many systems can be designed from basic standard modules (e.g., software engineering, computer engineering, information engineering, method engineering, protocol engineering). Evidently, special combinatorial methods have to be studied and applied for system analysis/design at all stages of the system life cycles. The methods can have the following structure types: series, parallel, series-parallel, cascade-like. Here, two basic problems are very important: (1) partitioning the initial problem (or partitioning the examined system), (2) aggregation of solutions.

This note contains our attempt to describe the basic set of typical combinatorial engineering frameworks for hierarchical modular systems (with hierarchical structures). This approach is based on the following five-layer architecture (a modification of the architecture from [27]):

Layer 1. Basic combinatorial optimization problems (e.g., knapsack problem, multiple choice problem, multicriteria ranking/selection, clustering, minimum spanning tree, Steiner tree, clique problem).

Layer 2. Complex (e.g., multicriteria) combinatorial optimization problems (e.g., multicriteria knapsack problem, multicriteria multiple choice problem, multicriteria Steiner tree, morphological clique problem, design of multi-layer network topology).

Layer 3. Basic support frameworks (e.g., hierarchical design, aggregation of structures, restructuring of knapsack problem, restructuring of multiple choice problem).

Layer 4. Combinatorial engineering frameworks (consisting of a set of linked combinatorial problems) (e.g., hierarchical system modeling, design, evaluation, detection of bottlenecks, improvement, trajectory design, combinatorial evolution and forecasting).

Layer 5. Applied combinatorial engineering frameworks (e.g., modeling, design and improvement of components/parts for various applied systems).

Here, the basic set of standard combinatorial engineering (technological) frameworks for modular systems are described while taking into account the system life cycles (i.e., layer 4 above) [17,19]:

- (1) design of system hierarchical model,
- (2) combinatorial synthesis ('bottom-up' process for system design),
- (3) system evaluation,
- (4) detection of system bottlenecks (e.g., by system elements, by compatibility of system elements, by system structure),
- (5) system improvement (re-design, upgrade),
- (6) multi-stage design (design of system trajectory),
- (7) combinatorial modeling of system evolution/development and system forecasting.

The above-mentioned combinatorial synthesis is used as a basic combinatorial engineering framework. This framework is based on two approaches: (1) our modification of morphological analysis (Hierarchical Multicriteria Morphological Design HMMD) (e.g., [14,17,20,28,29]) or (2) multiple choice problem (e.g., [9,20,28,29]). HMMD and multiple choice problem are used with two kinds of estimates for design alternatives of system components/parts: (i) ordinal estimates (e.g., [14,17,20,28]), (ii) interval multiset estimates (e.g., [29,34]).

The material contains the author viewpoint to maintenance of modular hierarchical systems (i.e., physical systems, software, organizational systems, plans, composite solving strategy, system requirements, standards, communication protocols).

Some author's system applications are pointed out, for example: electronic shopping, Web-based system, decision support system, modular software, composite strategy for multicriteria ranking, integrated security system, telemetry system, two-floor building, control system for smart homes, system of political management, concrete technology, medical treatment, immunoassay technology, wireless sensor, communication protocol, and standard for multimedia information.

2. Preliminaries

In recent decades, standardization became to be a real basis for extensive examination of modular systems in all domains of engineering and information technology including all stages of system life cycle (e.g.,

system design, system maintenance, system testing, etc.). On the other hand, hierarchical approaches are power tools for modeling, analysis, and design of various systems. Fig. 1 depicts the considered domain as system applications, system hierarchical structure, and the basic set of combinatorial engineering frameworks for modular systems. A “two-dimensional” domain for relation between problem(s)/ model(s) and algorithm(s)/solving frameworks is shown in Fig. 2. This representation illustrates two system directions as an extension of traditional pair “problem/model - algorithm/solving procedure”. Our approach is based on typical combinatorial engineering frameworks as k-problem/k-model frameworks for modular systems. Thus, hierarchical modular system models and the above-mentioned combinatorial engineering frameworks are a fundamental for problem structuring and solving in real-world system applications.

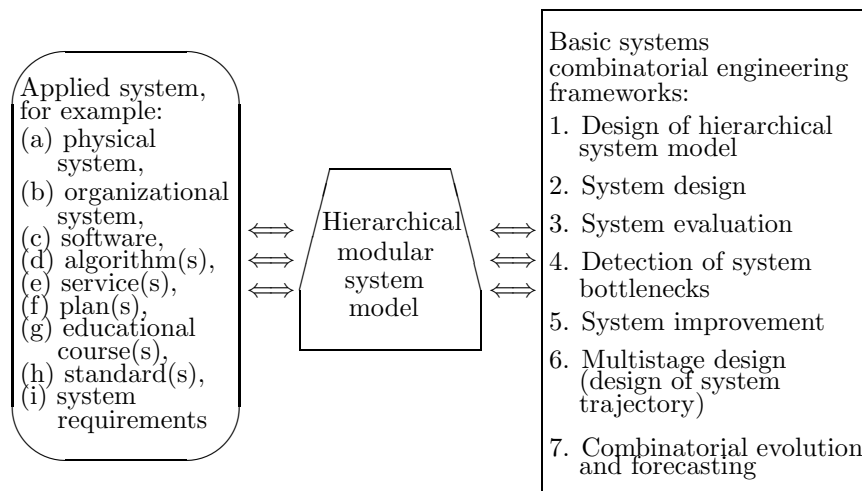

Fig. 1. System - hierarchical model - engineering frameworks

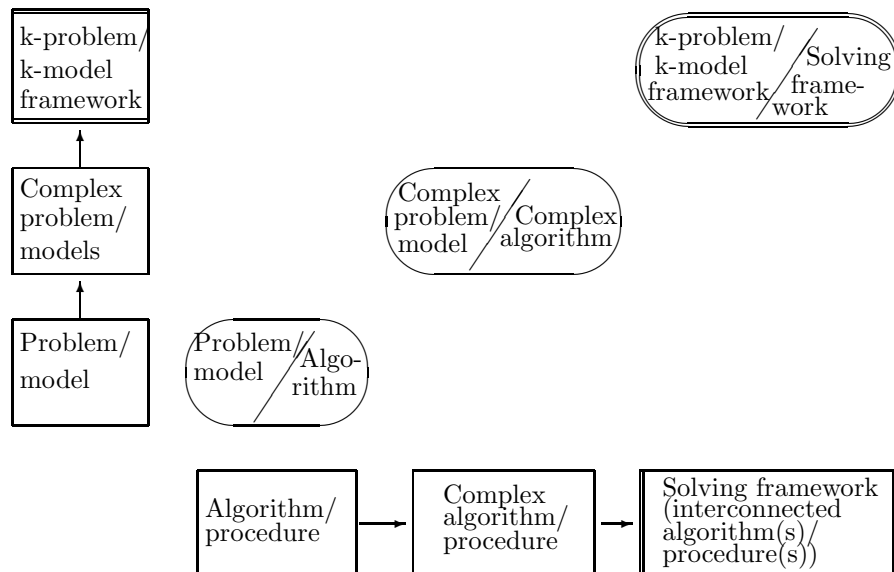

Fig. 2. Domain “Problem/model - Algorithm/solving framework”

3. Towards Hierarchies

Hierarchies play a central role in system science, in engineering, and in computer science (e.g., [6,7,8, 10,11,57,61]). Generally, it is reasonable to point out some basic types of hierarchies (e.g., [6,7,11,33]): (1) various kinds of trees (e.g., [6,11]); (2) organic hierarchy (i.e., with organic interconnection among children-vertices) [4]; (3) “morphological hierarchy” (e.g., [14,17,26,28]); and (4) multi-layer structures

(Fig. 3) (e.g., [3,27,33,54,58,61]).

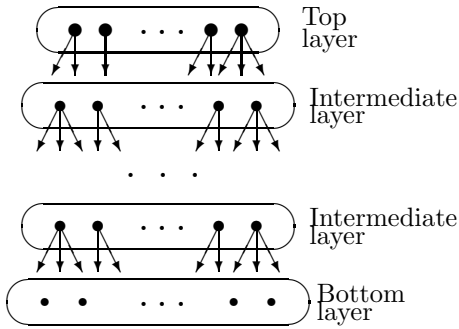

Fig. 3. Multilayer structure

A survey of design methods for hierarchical multi-layer structures is presented in [33]. In the case of trees, spanning tree problems are mainly used to design the tree-like hierarchy (e.g., minimum spanning tree problems, Steiner tree problems, maximum leaf spanning tree problem). Some methods for design of 'optimal' organizational hierarchies (mainly: trees) are examined as well (e.g., [2,56]). On the other hand, the following methods are used: various expert procedures, clustering (e.g., hierarchical clustering), ontology-based approaches, Approaches to design of hierarchical networks are based on special combinatorial optimization problems (e.g., [1,5,58,59]).

A general design framework for multi-layer structures can be considered as the following [33]:

Stage 1. Partitioning the initial set of nodes into layer subsets.

Stage 2. Design of a topology at each layer.

Stage 3. Connection between nodes of neighbor layers.

On the other hand, it is possible to present basic topology design problems from the viewpoint of multi-layer topology design (Table 1).

Table 1. Design approaches for multi-layer network

Basic problem	Layers	Additional problem(s)
1.Spanning tree (forest)	1.Root(s) 2.Transmission nodes 3.Lean nodes	
2.Steiner tree (forest)	1.Root(s) 2.Transmission nodes 3.Lean nodes	1.Selection/positioning of Steiner nodes
3.Maximum leaf nodes	1.Root 2.Transmission nodes 3.Lean nodes	1.Topology over transmission nodes
4.Connected dominating set	1.Dominating set 2.Lean nodes	1.Topology for dominating set (e.g., tree, path, paths, star, cycle)
5.Clustering	1.Cluster heads 2.Cluster nodes	1.Selection/assignment of cluster heads 2.Topology for set of cluster heads 3.Topology for set of cluster nodes (for each cluster)

Fig. 4 depicts an example of multi-layer structure as a six-layer communication network.

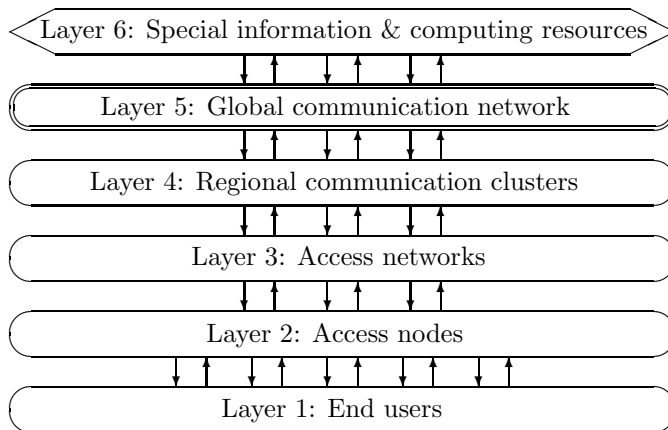

Fig. 4. Six-layer model of communication network

In our research projects, the above-mentioned special morphological hierarchy for system modeling is used (Fig. 5) (e.g., [14,17,26,28]).

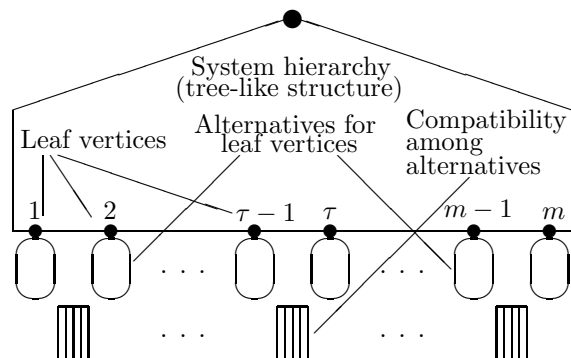

Fig. 5. “Morphological” system hierarchy [26,27]

4. Combinatorial Engineering Frameworks

The suggested combinatorial engineering frameworks (as basic “design frameworks”) can be used as support tools at various stages of system life cycle (Fig. 6). The extended list of the examined combinatorial engineering frameworks for modular systems is the following (e.g., [17,19]):

1. Design of a hierarchical system model (T_1).
2. Hierarchical modular system design (T_2):
 - 2.1. basic hierarchical modular system design to obtain a system version (T_{21}),
 - 2.2. hierarchical modular system design to obtain a family of system versions (T_{22}).
3. Evaluation of system (comparison, diagnostics, *etc.*) (T_3).
4. Detection of system bottlenecks (T_4).
5. Redesign (improvement, upgrade, adaptation) (T_5):
 - 5.1. basic system improvement (“1-1”) (T_{51}),
 - 5.2. system improvement to obtain a family of system versions (“1-m”) (T_{52}),
 - 5.3. basic aggregation of system versions into a resultant (aggregated) system (“n-1”) (T_{53}),
 - 5.4. aggregation of system versions into a resultant (aggregated) system (“n-m”) (T_{54}).
6. Multistage design (i.e., design of a system trajectory) (T_6).
7. Modeling of system development/evolution process (flow of system generations) and forecasting (T_7).

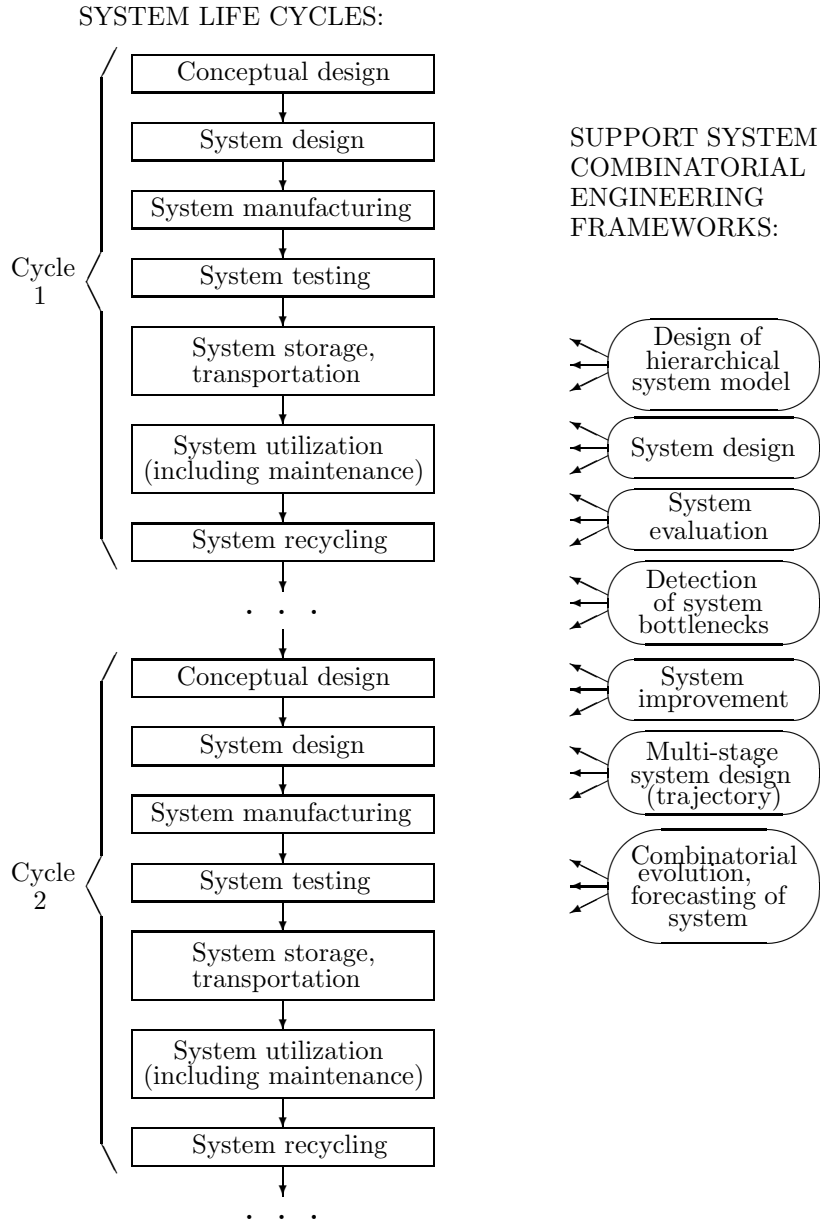

Fig. 6. Life cycles and combinatorial engineering frameworks

The frameworks above can be applied to systems, systems requirements, standards, plans, etc. (e.g., [14,17,26]). A generalized scheme of our research domain is presented in Fig. 7.

Mainly, several combinatorial engineering frameworks are often used together in applications, for example:

(i) design of system hierarchical model, system design, detection of system bottlenecks, system improvement;

(ii) design of system hierarchical model, detection of system bottlenecks, combinatorial evolution of the system, design of system forecasts, aggregation of the forecasts.

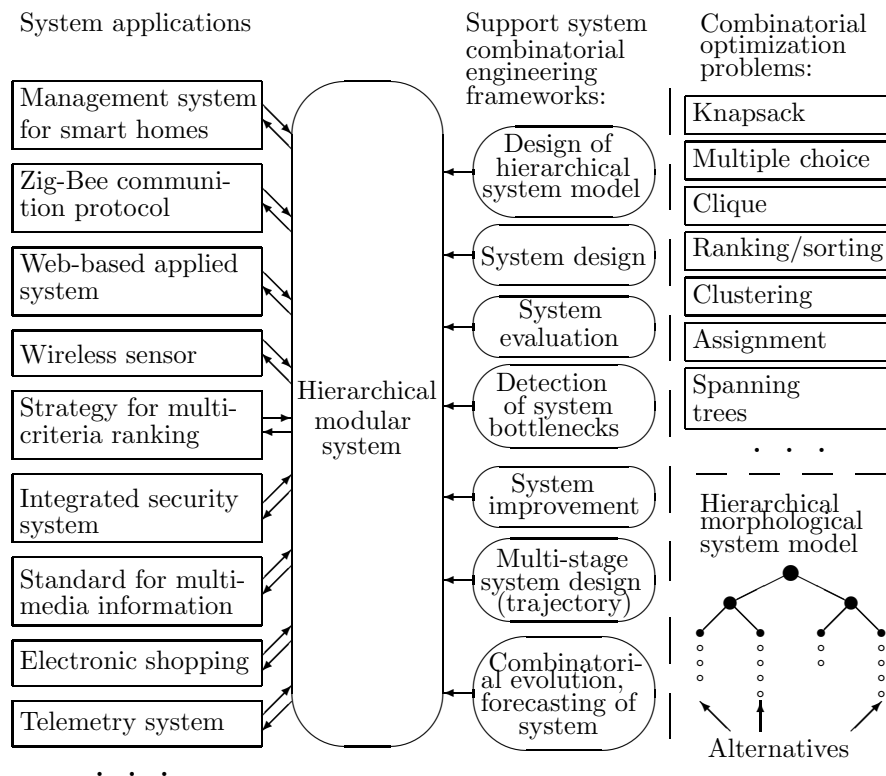

Fig. 7. Generalized scheme of examined domain

5. Conclusion

This paper describes a methodological viewpoint to the set of basic system combinatorial engineering frameworks for maintenance (modeling, design, improvement, etc.) of modular systems with a hierarchical morphological structure. Table 2 contains the list of combinatorial engineering frameworks and corresponding underlying combinatorial optimization problems and combinatorial engineering frameworks. It is necessary to note the system family design/improvement frameworks (T_{22} , T_{52} , T_{54}) require special additional research efforts. Some author's system design applications based on the combinatorial engineering frameworks are pointed out in Table 3. Evidently, the considered combinatorial engineering frameworks can be successfully applied in education (engineering, management, computer science, applied mathematics) including student-project based courses in system design (e.g., [18,21,23,24]).

In the future, it may be prospective to consider the following research directions:

I. Methodology:

- 1.1. examination of various network-like models (e.g., Petri nets) for modular systems;
- 1.2. further investigation of system evolution/development processes and system forecasting;
- 1.3. suggestion and investigation of combinatorial engineering frameworks (as special macro-heuristics) for well-known complex combinatorial optimization problems (e.g., timetabling, augmentation problem);
- 1.4. consideration of uncertainty and AI techniques;
- 1.5. special studies of dynamical systems.

II. Applications:

- 2.1. consideration of various applied systems (e.g., power systems, communication systems, various applied systems in social engineering);
- 2.2. special studies have to be targeted to financial engineering;
- 2.3. special tools have to be designed for individual modular educational systems for student usage;
- 2.4. special efforts have to be targeted to biomedical applications (e.g., diagnosis, medical treatment, etc.).

Table 2. Combinatorial engineering frameworks and their description

Combinatorial engineering framework	Description	
	General design framework	Underlying problems, frameworks
1.Design of system hierarchical model (T_1)	[33]	Spanning trees, assignment/allocation, clustering, multilevel network design
2.System design (T_2):	[14,17,20,26,28] [29]	Morphological clique, multiple choice, assignment/allocation, agreement problems
2.1.basic system design (one resultant version) (T_{21})		
2.2.system family design (several resultant versions) (T_{22})		
3.System evaluation (T_3)	[17]	Multicriteria ranking
4.Detection of bottlenecks (T_4)	[14,17]	Detection of critical components (e.g., multicriteria ranking, dominating set)
5.System improvement (T_5):	[14,17,20,22,26] [28,29]	T_1, T_2, T_3, T_4
5.1.basic system improvement, result: one version ("1-1") (T_{51})		
5.2.system improvement, result: several system versions ("1-m") (T_{52})		
5.3.aggregation of system versions: one resultant (aggregated) system ("n-1") (T_{53})		
5.4.aggregation of system versions: several resultant (aggregated) systems ("n-m") (T_{54})		
6.Multistage system design (design of system trajectory) (T_6)	[14,17,20,26,29]	T_1, T_2
7.System evolution, forecasting (T_7)	[17,34]	T_1, T_2, T_4, T_5

Table 3. System applications and combinatorial engineering frameworks

System application	Used frameworks							Source
	T_1	T_2	T_3	T_4	T_5	T_6	T_7	
1.Electronic shopping	*	*	*	*	*	*		[30]
2.Web-based system	*	*	*	*	*	*		[25,26]
3.Strategy for sorting (multicriteria ranking)	*	*						[14,32]
4.DSS COMBI	*						*	[12,14]
5.Modular software	*	*	*	*	*			[16,17]
6.Notebook	*	*			*			[26]
7.Regional network	*		*					[51]
8.GSM network	*	*						[28,43]
9.Telemetry system	*	*	*	*	*			[31,42]
10.Security system	*	*	*	*	*			[26,45]
11.Wireless sensor	*	*	*	*	*			[26,47,52]
12.System tests	*	*						[41]
13.Communication protocol	*	*	*	*	*	*	*	[35,46,53]
14.User interface	*	*						[13,14,15]
15.Two-floor building	*	*	*	*				[17,39]
16.Control in smart home	*	*	*	*	*			[36,49,50]
17.Combinatorial investment	*	*						[14,26]
18.Political management	*							[17,48]
19.Vibration conveyor	*	*						[14]
20.Geological planning	*	*						[14]
21.Concrete technology	*	*						[17,37]
22.Medical treatment	*	*						[17,38]
23.Educational programs	*	*	*	*	*	*	*	[14,17,26,34]
24.Standard in multimedia	*	*	*	*	*	*	*	[35,44]
25.Immunoassay technology	*	*						[17,40]

REFERENCES

1. A. Balakrishnan, T. magnanti, P. Mirchandani, A dual-based algorithm for multi-level network design. *Manag. Sci.* 40(5) (1994) 567–581.
2. H.H. Baligh, *Organization Structures: Theory and Design, Analysis and Prescription*, Springer, New York, 2006.
3. D.L. Belotserkovskii, V.M. Vishnevskii, New algorithm for generating a biconnected spanning subgraphs for topological optimization of data networks. *Autom. & Remote Control*, 58(1) (part 2), 88–97, 1997.
4. R.C.Conant, Information flows in hierarchical systems. *Int. J. of General Systems*, 1(1), 9–18, 1974.
5. J. Current, C. ReVelle, J. Cohon, The hierarchical network design problem. *EJOR* 27(1) (1986) 57–66.
6. M.R. Garey, D.S. Johnson, *Computers and Intractability. The Guide to the Theory of NP-Completeness*. W.H. Freeman and Company, San Francisco, 1979.
7. Y.Y. Haimes, K. Tarvainen, T. Shima, J. Thadathil, *Hierarchical Multiobjective Analysis of Large-Scale Systems*. Hemisphere Pub. Corp., New York, 1990.
8. D. Harel, STATECHARTS: A visual formalism for complex systems. *Science of Computer Programming*, 8(3), 231–274, 1987.
9. H. Kellerer, U. Pferschy, D. Pisinger, *Knapsack Problems*. Springer, Berlin, 2004.
10. C. Kemp, J.B. Tenenbaum, The discovery of structural form. *PNAS*, 105(31), 10687–10692, 2008.
11. D.E. Knuth, *The Art of Computer Programming*. vol. 1, 3rd ed., vol. 2, 3rd ed., vol. 3, 2nd ed., Addison Wesley, Reading, Mass., 1997 & 1998.

12. M.Sh. Levin, Hierarchical components of human-computer systems. In: Bass L.E., Gornostaev J., Unger C. (eds) *Human-Computer Interaction*, LNCS 753, Springer, pp. 37–52, 1993.
13. M.Sh. Levin, Hierarchical design of user interfaces. LNCS 876, Springer, 140-151, 1994.
14. M.Sh. Levin, Combinatorial Engineering of Decomposable Systems. Kluwer, Boston, 1998.
15. M.Sh. Levin, Towards analysis, adaptation, and planning of human-computer systems. *Applied Intelligence*, 16(3), 235–247, 2002.
16. M.Sh. Levin, Modular system synthesis: Example for composite packaged software. *IEEE Trans. SMC, Part C*, 35(4), 544–553, 2005.
17. M.Sh. Levin, Composite Systems Decisions. Springer, New York, 2006.
18. M.Sh. Levin, Course 'System design: structural approach'. In: *18th Int. Conf. Design Methodology and Theory DTM2006*, vol. 4a, Philadelphia, pp. 475–484, 2006.
19. Levin M.Sh. (2007) Combinatorial technological systems problems (examples for communication system). In: *Proc. of Int. Conf. on Systems Engineering and Modeling ICSEM-2007*, Israel, pp. 24–32
20. M.Sh. Levin, Combinatorial optimization in system configuration design. *Automation and Remote Control* 70(3) (2009) 519–561.
21. M.Sh. Levin, Student research projects in system design. In: *Proc. of 1st Int. Conf. CSEDU 2009*, Lisbon, Portugal, vol. 2, pp. 67–72, 2009.
22. M.Sh. Levin, Towards communication network development (structural system issues, combinatorial models). In: 2010 IEEE Region 8 Int. Conf. "SIBIRCON-2010", vol. 1, 2010, pp. 204–208.
23. M.Sh. Levin, Course on system design (structural approach). Electronic preprint, 22 pp., Febr. 19, 2011. <http://arxiv.org/abs/1103.3845> [cs.SE]
24. M.Sh. Levin, Towards k-set problem frameworks in education. In: *The 3rd Int. Conf. on Computer Supported Education CSEDU-2011*, The Netherlands, vol. 2, pp. 99-104, 2011.
25. M.Sh. Levin, Towards configuration of applied Web-based information system. Electronic preprint, 13 pp., Aug. 31, 2011. <http://arxiv.org/abs/3108.3865> [cs.SE]
26. M.Sh. Levin, Aggregation of composite solutions: strategies, models, examples. Electronic preprint. 72 pp., Nov. 29, 2011. <http://arxiv.org/abs/1111.6983> [cs.SE]
27. M.Sh. Levin, Four-layer framework for combinatorial optimization problems domain. *Advances in Engineering Software*, 42(12), 1089–1098, 2011.
28. M.Sh. Levin, Morphological methods for design of modular systems (a survey). Electronic preprint. 20 pp., Jan. 9, 2012. <http://arxiv.org/abs/1201.1712> [cs.SE]
29. M.Sh. Levin, Multiset estimates and combinatorial synthesis. Electronic preprint. 30 pp., May 9, 2012. <http://arxiv.org/abs/1205.2046> [cs.SY]
30. M.Sh. Levin, Towards electronic shopping of composite product. Electronic Preprint. 10 pp., March 3, 2012. <http://arxiv.org/abs/1203.0648> [cs.SE]
31. M.Sh. Levin, Composition of modular telemetry system with interval multiset estimates. Electronic preprint. 9 pp., July 25, 2012. <http://arxiv.org/abs/1207.6651> [cs.SY]
32. M.Sh. Levin, Composite strategy for multicriteria ranking/sorting (methodological issues, examples). Electronic preprint. 24 pp., Nov. 9, 2012. <http://arxiv.org/abs/1211.2245> [math.OC]
33. M.Sh. Levin, Towards design of system hierarchy (research survey). Electronic preprint. 36 pp., Dec. 7, 2012. <http://arxiv.org/abs/1212.1735> [math.OC]
34. M.Sh. Levin, Towards combinatorial evolution of composite systems. *Expert Systems with Applications*, 40(4), 1342–1351, 2013.
35. M.Sh. Levin, Modular approach to communication protocol and standard for multimedia information (survey). *J. of Communications Technology and Electronics*, 58(6), 2013 (accepted)
36. M.Sh. Levin, Modular design and improvement of management in smart homes with interval multiset estimates. *J. of Communications Technology and Electronics*, 58(6), 00–00, 2013 (accepted)
37. M.Sh. Levin, M.L. Nisnevich, Combinatorial scheme for management of life cycle: Example for concrete macrotechnology. *J. of Intell. Manuf.*, 12(4), 393–401, 2001.
38. M.Sh. Levin M.Sh., L.V. Sokolova, Hierarchical combinatorial planning of medical treatment. *Computer Methods and Programs in Biomedicine*, 73(1), 3–11, 2004.
39. M.Sh. Levin, M.A. Danieli, Hierarchical decision making framework for evaluation and improvement of composite systems (example for building). *Informatika*, 16(2), 213–240, 2005.
40. M.Sh. Levin, M. Firer, Hierarchical morphological design of immunoassay technology. *Computers in*

- Biology and Medicine*, 35(3), 229–245, 2005.
41. M.Sh. Levin, M. Last, Design of test inputs and their Sequences in multi-function system testing. *Appl. Intell.*, 25(1), 105–124, 2006.
 42. M.Sh. Levin, I.A. Khodakovskii, Structural design of the telemetry system. *Autom. & Remote Control*, 68(9), 1654–1661, 2007.
 43. M.Sh. Levin, R.O. Vishnitskiy, Towards morphological design of GSM network. *Inform. Processes*, 7(2), 183–190, 2007.
 44. M.Sh. Levin, O. Kruchkov, O. Hadar, E. Kaminsky, Combinatorial systems evolution: example of standard for multimedia information. *Informatika*, 20(4), 519–538, 2009.
 45. M.Sh. Levin, A.V. Leus, Configuration of integrated security system. *7th IEEE Int. Conf. on Industrial Informatics INDIN 2009*, Cardiff, UK, pp. 101–105, 2009.
 46. M.Sh. Levin, A. Andrushevich, R. Kistler, A. Klapproth, Combinatorial evolution of ZigBee protocol. In: *IEEE Region 8 Int. Conf. Sibircon 2010*, vol. 1, Irkutsk, pp. 314–319, 2010.
 47. M.Sh. Levin, A.V. Fimin, Configuration of alarm wireless sensor element. In: *Proc. of 2nd Int. Conf. on Ultra Modern Telecommunication 'ICUMT-2010'*, Moscow, pp. 924–928, 2010.
 48. M.Sh. Levin, O. Kudinov, On structured approach to political management. *Information Processes*, 11(4), 466–475, 2011, (in Russian).
 49. M.Sh. Levin, A. Andrushevich, A. Klapproth, Modular composition of management system for smart homes. Electronic preprint, 9 pp., Febr. 20, 2011. <http://arxiv.org/abs/1103.3844> [cs.SE]
 50. M.Sh. Levin, A. Andrushevich, A. Klapproth, Improvement of building automation system. In: Mehrotra K.G. et al. (eds) *Proc. of 24th Int. Conf. IEA/AIE 2011*, LNCS 6704, Part II, Springer, pp. 459–468, 2011.
 51. M.Sh. Levin, A.V. Safonov, Improvement of regional telecommunications networks. *J. of Communications Technology and Electronics*, 56(6), 770–778, 2011.
 52. M.Sh. Levin, A.V. Fimin, Design of modular wireless sensor. Electronic preprint. 7 pp., March 9, 2012. <http://arxiv.org/abs/1203.2031> [cs.SE]
 53. M.Sh. Levin, A. Andrushevich, R. Kistler, A. Klapproth, Combinatorial evolution and forecasting of communication protocol ZigBee, Electronic preprint. 6 pp., April 15, 2012. <http://arxiv.org/abs/1204.3259> [cs.NI]
 54. M.D. Mesarovic, D. Macko, Y. Takahara, *Theory of Hierarchical, Multilevel Systems*. Academic Press, New York and London, 1970.
 55. M. Minsky, A framework for representing knowledge. In: Winston P.H. (ed) *The Psychology of Computer Vision*. McGraw-Hill, New York, pp. 211–277, 1975.
 56. S. Mishin, Optimal organizational hierarchies in firms. *J. of Business Economics and Management*, 8(2), 79–99, 2007.
 57. J. Moses, Architecting engineering systems. In: van de Poel I., D Goldberg D.E. (eds) *Philosophy and Engineering*, Springer, pp. 275–284, 2010.
 58. C. Obreque, M. Donoso, G. Gutierrez, V. Marianov, A branch and cut algorithm for the hierarchical network design problem. *EJOR*, 200(1), 28–35, 2010.
 59. H. Pirkul, J. Current, V. Nagarajan, The hierarchical network design problem: A new formulation and solution procedures. *Transportation Science*, 25(3), 175–182, 1991.
 60. H.A. Simon, *Administrative Behavior: A Study of Decision-Making Processes in Administrative Organization*. 4rd ed., The Free Press, New York, 1997.
 61. A.S. Tanenbaum, *Structured Computer Organization*, 5th ed., Prentice Hall, Upper Saddle River, NJ, 2006.