

An analytic approach to the asymptotic variance of trie statistics and related structures

Michael Fuchs

Department of Applied Mathematics
National Chiao Tung University
Hsinchu, 300
Taiwan

Hsien-Kuei Hwang

Institute of Statistical Science
Institute of Information Science
Academia Sinica
Taipei 115
Taiwan

Vytas Zacharovas

Dept. Mathematics & Informatics
Vilnius University
Lithuania

July 23, 2018

Dedicated to the memory of Philippe Flajolet

Abstract

We develop analytic tools for the asymptotics of general trie statistics, which are particularly advantageous for clarifying the asymptotic variance. Many concrete examples are discussed for which new Fourier expansions are given. The tools are also useful for other splitting processes with an underlying binomial distribution. We specially highlight Philippe Flajolet's contribution in the analysis of these random structures.

1 Introduction

Coin-flipping is one of the simplest ways of resolving a conflict, deciding between two alternatives, and generating random phenomena. It has been widely adopted in many daily-life situations and scientific disciplines. There exists even a term “flippism.” The curiosity of understanding the randomness behind throwing coins or dices was one of the motivating origins of early probability theory, culminating in the classical book “*Ars Conjectandi*” by Jacob Bernoulli, which was published exactly three hundred years ago in 1713 (many years after its completion; see [91, 98]). When flipped successively, one naturally encounters the binomial distribution, which is pervasive in many splitting processes and branching algorithms whose analysis was largely developed and clarified through Philippe Flajolet's works, notably in the early 1980s, an important period marking the upsurge of the use of complex-analytic tools in the Analysis of Algorithms.

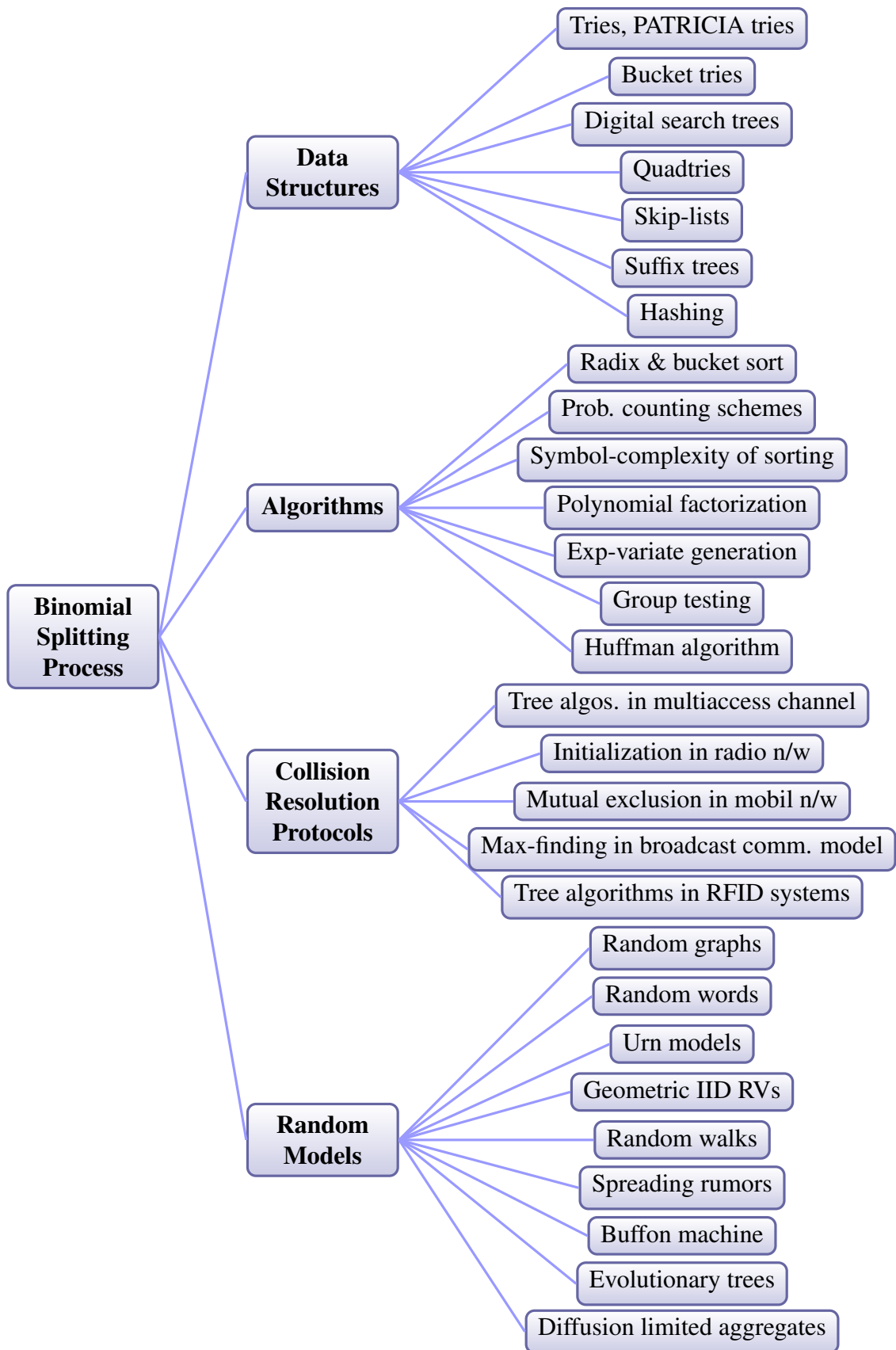

Figure 1: A tree rendering of the diverse themes pertinent to binomial splitting processes.

Technical content of this paper. This paper is a sequel to [54] and we will develop an analytic approach that is especially useful for characterizing the asymptotics of the mean and the variance of additive statistics of random tries under the Bernoulli model; such statistics can often be computed recursively by

$$X_n \stackrel{d}{=} X_{I_n} + X_{n-I_n}^* + T_n, \quad (1)$$

with suitable initial conditions, where T_n is known, X_n^* is an independent copy of X_n and I_n is the binomial distribution with mean pn , $0 < p < 1$.

Many asymptotic approximations are known in the literature for the variance of X_n , which has in many cases of interest the pattern

$$\frac{\mathbb{V}(X_n)}{n} = c \log n + c' + \left\{ \begin{array}{ll} P(\varpi \log n), & \text{if } \frac{\log p}{\log q} \in \mathbb{Q} \\ 0, & \text{if } \frac{\log p}{\log q} \notin \mathbb{Q}, \end{array} \right\} + o(1), \quad (2)$$

where c may be zero, ϖ depends on the ratio $\frac{\log p}{\log q}$ and $P(x) = P(x+1)$ is a bounded periodic function. However, known expressions in the literature for the periodic function P are rare due to the complexity of the problem, and are often either less transparent, or less explicit, or too messy to be stated. In many situations they are given in the form of one periodic function minus the square of the other. Our approach, in contrast, provides not only a systematic derivation of the asymptotic approximation (2) but also a simpler, explicit, independent expression for P , notably in the symmetric case ($p = q$). Further refinement of the $o(1)$ -term lies outside the scope of this paper and can be dealt with by the approach developed by Flajolet et al. in [34].

Binomial splitting processes. In general, the simple splitting idea behind the recursive random variable (1) (0 goes to the left and 1 goes to the right) has also been widely adopted in many different modeling processes, which, for simplicity, will be vaguely referred to as “*binomial splitting processes*” (BSPs), where binomial distribution and some of its extensions are naturally involved in the analysis; see Figure 1 for concrete examples of BSPs that are related to our analysis here. For convenience of presentation, we roughly group these structures in four categories: Data Structures, Algorithms, Collision Resolution Protocols, and Random Models.

To see the popularity of BSPs in different areas, we start from the recurrence ($q = 1 - p$)

$$a_n = \sum_{0 \leq k \leq n} \pi_{n,k} (a_k + a_{n-k}) + b_n, \quad \text{where } \pi_{n,k} := \binom{n}{k} p^k q^{n-k}, \quad (3)$$

which results, for example, from (1) by taking expectation. Here the “toll-function” b_n may itself involve a_j ($j = 0, 1, \dots$) but with multipliers that are exponentially small.

From an analytic point of view, the trie recurrence (3) translates for the Poisson generating function

$$\tilde{f}(z) := e^{-z} \sum_n \frac{a_n}{n!} z^n, \quad (4)$$

into the *trie functional equation*

$$\tilde{f}(z) = \tilde{f}(pz) + \tilde{f}(qz) + \tilde{g}(z), \quad (5)$$

with suitable initial conditions. Such a functional equation is a special case of the more general pattern

$$\sum_{0 \leq j \leq b} \binom{b}{j} \tilde{f}^{(j)}(z) = \alpha \tilde{f}(pz + \lambda) + \beta \tilde{f}(qz + \lambda) + \tilde{g}(z), \quad (6)$$

where $b = 0, 1, \dots$, and \tilde{g} itself may involve \tilde{f} but with exponentially small factors. When $b = 0$, one has a pure functional equation,

$$\tilde{f}(z) = \alpha \tilde{f}(pz + \lambda) + \beta \tilde{f}(qz + \lambda) + \tilde{g}(z), \quad (7)$$

while when $b \geq 1$, one has a differential-functional equation.

It turns out that the equation (6) covers almost all cases we collected (a few hundred of publications) in the analysis of BSPs the majority of which correspond to the case $b = \lambda = 0$. The cases when $b = 0$ and $\lambda > 0$ are thoroughly treated in [22, 80, 21, 56], and the cases when $b \geq 1$ are discussed in detail in [54] (see also the references cited there). We focus on $b = \lambda = 0$ in this paper. Since the literature abounds with equation (5) or the corresponding recurrence (3), we contend ourselves with listing below some references that are either standard, representative or more closely connected to our study here. See also [17, 19, 41] for some non-random contexts where (5) appeared.

Data Structures. Tries: [73, 77, 102]; PATRICIA tries: [61, 73, 101]; Quadtries and k -d tries: [32, 43]; Hashing: [20, 82, 39, 24]; Suffix trees: [60, 102].

Algorithms. Radix-exchange sort: [73]; Bucket selection and bucket sort: [76, 8]; Probabilistic counting schemes: [25, 30, 89, 27, 28]; Polynomial factorization: [39]; Exponential variate generation: [35]; Group testing: [47]; Random generation: [31, 94].

Collision resolution protocols. Tree algorithms in multiaccess channel: [3, 79, 83, 22, 80, 21, 26, 103]; Initialization in radio networks: [85, 99]; Mutual exclusion in mobil networks: [81]; Broadcast communication model: [105, 49, 7]; Leader election: [23, 63, 92]; Tree algorithms in RFID systems: [53, 86];

Random models. Random graphs: [2, 46, 100]; Geometric IID RVs (or order statistics): [18, 45, 74]; Cantor distributions: [10, 48]; Evolutionary trees: [1, 75]; Diffusion limited aggregates: [6, 78]; Generalized Eden model on trees: [13].

Asymptotics of most of the BSPs can nowadays be handled by standard *analytic* techniques, which we owe largely to Flajolet for initiating and laying down the major groundwork. We focus in this paper on analytic methods. Many elementary and probabilistic methods have also been proposed in the literature with success; see, for example, [14, 15, 62, 87, 102] for more information.

Flajolet's works on BSPs. We begin with a brief summary of Flajolet's works in the analysis of BSPs. For more information, see the two chapter introductions on *Digital Trees* (by Clément and Ward) and on *Communication Protocols* (by Jacquet) in *Philippe Flajolet's Collected Papers, Volume III* (edited by Szpankowski).

Flajolet published his first paper related to BSP in June 1982 in a paper jointly written with Dominique Sotteau entitled¹ “A recursive partitioning process of computer science” (see [38]). This first paper is indeed a review paper and starts with the sentence:

We informally review some of the algebraic and analytic techniques involved in investigating the properties of a combinatorial process that appears in very diverse contexts in computer science including digital sorting and searching, dynamic hashing methods, communication protocols in local networks and some polynomial factorization algorithms.

They first brought the attention of the generality of the same splitting principle in diverse contexts in their Introduction, followed by a systematic development of generating functions under different models ([38, Sec. 2: *Algebraic methods*]). Then a general introduction was given of the saddle-point method and Mellin transform to the Analysis of Algorithms ([38, Sec. 3: *Analytic methods*]). They concluded in the last section by giving applications of these techniques to one instance in each of the four areas mentioned above.

Such a synergistic germination of diverse research ideas

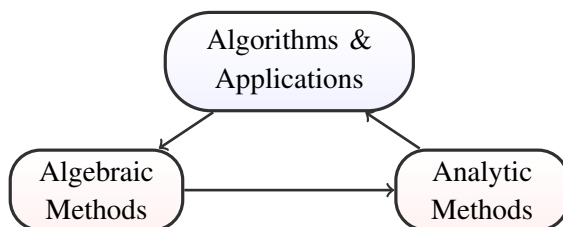

later expanded into a wide spectrum of applications and research networks (see Figure 2 for a plot of BSP-related themes). It was also fully developed and explored, and evolved into his theory of *Analytic Combinatorics*. Many of these *objects* become in his hands a *subject* of interest, and many follow-up papers continued and extended with much ease.

Analysis of algorithms (and particularly BSPs) in the pre-Flajolet era relied mostly on more elementary approaches (including Tauberian theorems; see [41]), with some sporadic exceptions in the use of the “Gamma-function method” (a particular case of Mellin transform): the height of random trees [11], the analysis of radix-exchange sort (essentially the external path length of random tries) given in [73, §5.2.2], PATRICIA tries and digital search trees [73, §6.3], odd-even merging [97], register function of random trees [66], analysis of carry propagation [72], and extendible hashing [20]. See Dumas’s chapter introduction (Chapter 4, Volume III) for a more detailed account.

Many asymptotic patterns such as (2), which most of us take for granted today, were far from being clear in the 1980’s, notably in engineering contexts. For example, the minute periodic fluctuations when $\log p / \log q$ is rational are often invisible in numerical calculations, leading possibly to wrong conclusions. Flajolet pioneered and developed systematic analytic tools to fully characterize such tiny perturbations, which he called “wobbles.” See [29] for more information.

Amazingly, most of the items in the big picture of Figure 2 were already discovered or clarified in the 1980’s in Flajolet’s published works with a few later themes aiming at finer

¹Note that the word “partitioning” is spelled as “partionning” in the title of [38], and as “partitionning” in the paper.

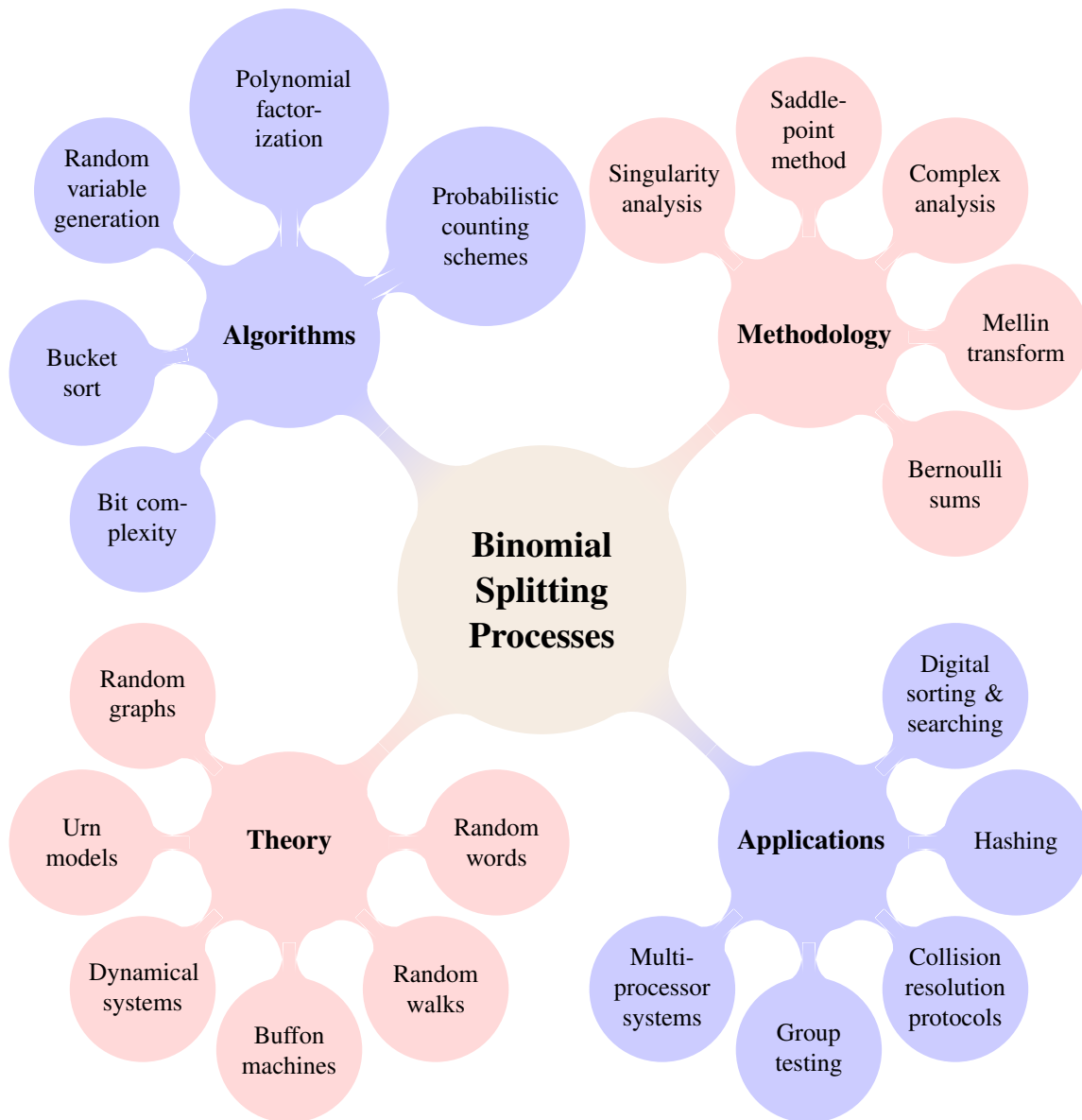

Figure 2: *The diverse themes and methodology developed (or mentioned) in Flajolet’s works that are connected to BSPs.*

improvements in results or more general stochastic models. Among these, the “digital process” and “probabilistic counting algorithms” became two of his favorite subjects of presentation, as can be seen from his webpage of lectures where about one third of talks are related to these two subjects.

This paper is organized as follows. We briefly introduce tries, functional equations and the analytic tools in the next section. We then develop more analytic tools we need in Section 3, the most difficult part being the proof of admissibility under Hadamard product. Then we focus on the characterization of the asymptotic variance of general trie statistics in the following sections. We also include PATRICIA tries in Section 7 and conclude this paper with a few remarks.

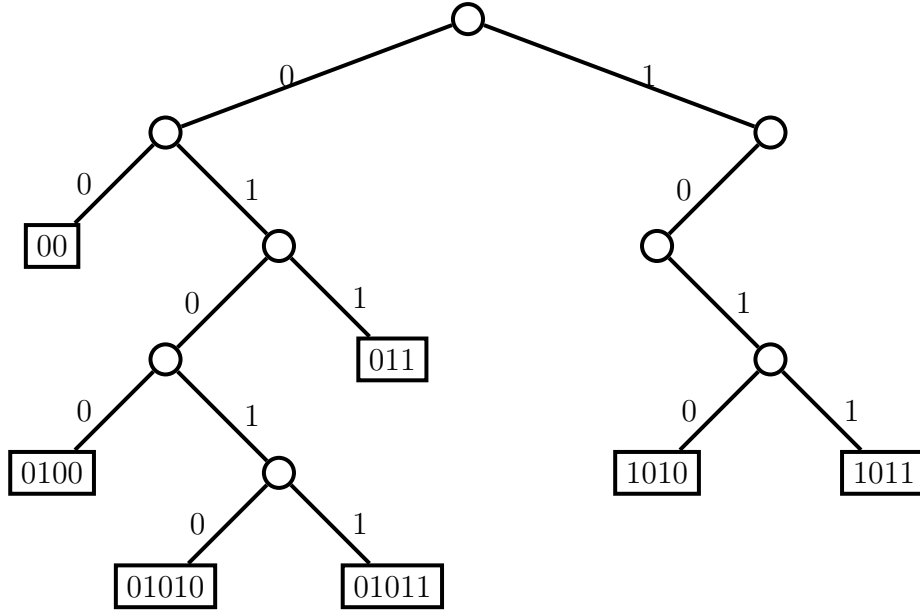

Figure 3: A trie of $n = 7$ records: the circles represent internal nodes and rectangles holding the records are external nodes.

2 Random tries, functional equations and asymptotic analysis

The design of an ordinary dictionary according to the alphabetical (or lexicographical) order induces itself a tree structure, which is also the splitting procedure used in many digital tree structures and bucketing algorithms such as tries and radix sort. Tries (coined by Fredkin [40], which is a mixture of “tree” and “retrieval”) were first introduced in computer algorithms by de la Briandais [12] in 1959, the same year when the radix-exchange sort (a digital realization of Quicksort) was proposed by Hildebrandt and Isbitz [51]; see [73, §6.3] for more information. Tries are one of the most widely adopted prototype data structures for words and strings, and admit a large number of extensions and variants.

Given a set of n random binary strings (each being a sequence of Bernoulli random variables with parameter p), we can recursively define the random trie associated with this set as follows. If $n = 0$, then the trie is empty; if $n = 1$, then the trie is composed of a single (external) node holding the input-string; if $n > 1$, then the trie contains three parts: a root (internal) node used to direct keys to the left (when the first bit of the string is 0) or to the right (when the first bit of the string is 1), a left sub-trie of the root for keys whose first bits are 0 and a right sub-trie for keys whose first bits are 1; strings directing to each of the two subtrees are constructed recursively as tries (but using subsequent bits successively). Thus tries are ordered, prefix trees. See Figure 3 for a trie of 7 keys.

Asymptotic analysis of the trie recurrence (3) is nowadays not difficult and a typical way of deriving asymptotic estimates starts with the Poisson generating function (4), which satisfies the functional equation (5) (when a_n does not grow faster than, say exponential), where $\tilde{g}(z)$ there depends on b_n and the initial conditions. From this, one sees that the Mellin transform of

$\tilde{f}(z)$

$$\mathcal{M}[\tilde{f}; s] := \int_0^\infty \tilde{f}(z) z^{s-1} dz$$

satisfies *formally*

$$\mathcal{M}[\tilde{f}; s] = \frac{\mathcal{M}[\tilde{g}; s]}{1 - p^{-s} - q^{-s}}.$$

Then the asymptotics of a_n can be manipulated by a two-stage analytic approach: first derive asymptotics of $\tilde{f}(z)$ for large $|z|$ by the inverse Mellin integral

$$\tilde{f}(z) = \frac{1}{2\pi i} \int_{\uparrow} \frac{\mathcal{M}[\tilde{g}; s] z^{-s}}{1 - p^{-s} - q^{-s}} ds, \quad (8)$$

where the integration path is some vertical line, and then apply the saddle-point method to Cauchy's integral formula (called *analytic de-Poissonization* [61])

$$a_n = \frac{n!}{2\pi i} \oint_{|z|=r} z^{-n-1} e^z \tilde{f}(z) dz \quad (r > 0). \quad (9)$$

This two-stage Mellin-saddle approach has been largely developed by Jacquet and Szpankowski (see [61]) and can in many real applications be encapsulated into one, called the Poisson-Mellin-Newton cycle in Flajolet's papers (see [33, 36])

$$a_n = \frac{n!}{2\pi i} \int_{\uparrow} \frac{\mathcal{M}[\tilde{g}; s]}{(1 - p^{-s} - q^{-s})\Gamma(n + 1 - s)} ds, \quad (10)$$

which is *formally* obtained by substituting (8) into (9) and by interchanging the order of integration.

Note that such a formal representation may be meaningless due to the divergence of the integral. One of the most useful tools in justifying the *exponential smallness* of $\mathcal{M}[\tilde{g}; s]$ at $c \pm \infty$ is Proposition 5 of Flajolet et al.'s survey paper [29] on Mellin transforms. For ease of reference, we call it the *Exponential Smallness Lemma* in this paper.

Exponential Smallness Lemma. [29, Prop. 5] *If, inside the sector $|\arg(z)| \leq \theta$ ($\theta > 0$), $f(z) = O(|z|^{-\alpha})$, as $z \rightarrow 0$, and $f(z) = O(|z|^{-\beta})$ as $|z| \rightarrow \infty$, then $\mathcal{M}[f; s] = O(e^{-\theta|\Im(s)|})$ holds uniformly for $\Re(s) \in \langle \alpha, \beta \rangle$.*

This simple Lemma is crucial in the development of our approach.

In various practical cases, the use of the Poisson-Mellin-Newton approach relies mostly on the so-called Rice's integral formula (or integral representation for finite differences) when the integral converges; see Figure 4 for a diagrammatic illustration.

Asymptotics of either of the two integrals (8) and (10) rely heavily on the singularities of the integrand, which in turn depends on the location of the zeros of the equation $1 - p^{-s} - q^{-s} = 0$. A detailed study of the zeros can be found in [21], and later in [17, 96]. While the dominant asymptotic terms are often easy to characterize when analytic properties of $\mathcal{M}[\tilde{g}; s]$ are known (owing largely to the systematic tools Flajolet and his coauthors developed), error analysis turned out to be highly challenging when $\log p / \log q$ is irrational; see [34].

These analytic tools are well-suited for computing the asymptotics of the mean, but soon become very messy when adopted for higher moments, which satisfy the same type of recurrences but with convolution terms that are often difficult to manipulate analytically. The

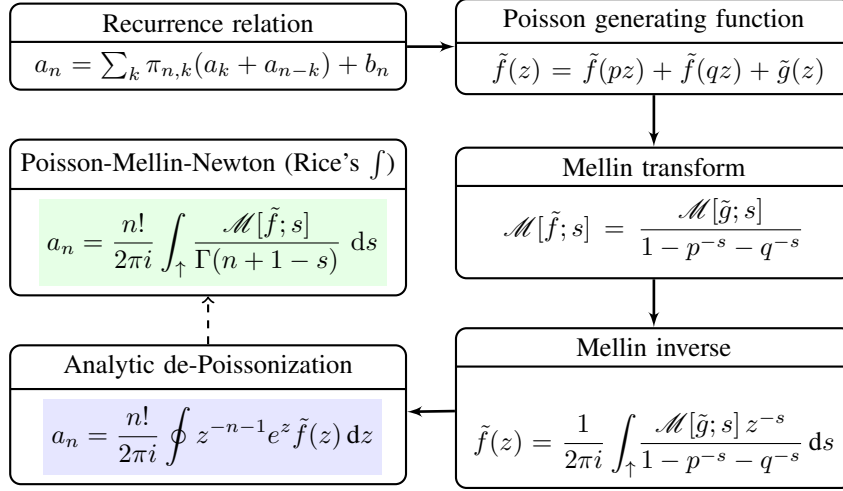

Figure 4: *The two analytic approaches to the asymptotics of a_n . Here $\pi_{n,k} := \binom{n}{k} p^k q^{n-k}$.*

situation becomes even worse when dealing with the variance or higher central moments because the high concentration of binomial distribution results in smaller variance, meaning more complicated cancelations in the desired asymptotic approximations have to be properly taken into account.

The key, crucial step of our approach to the asymptotic variance of trie statistics is to introduce, as in [54], the corrected Poissonized variance of the form

$$\tilde{V}(z) := \tilde{f}_2(z) - \tilde{f}_1(z)^2 - z \tilde{f}_1'(z)^2, \quad (11)$$

where \tilde{f}_1 and \tilde{f}_2 denote the Poisson generating functions of the first and the second moments, respectively. Such a consideration results in simpler Fourier series expansions for the periodic functions that appear in the asymptotic approximations due to the no-cancelation character, especially in the symmetric case. We will enhance this approach by introducing the class of *JS-admissible functions* as in our previous paper [54], a notion formulated from Jacquet and Szpankowski's works on analytic de-Poissonization (see [61]) and mostly inspired from Hayman's classical work [50] on saddle-point method (see also [37, §VIII.5]), via which many asymptotic approximations can be derived by checking only simple criteria of admissibility. The combined use leads to a very effective, systematic approach that can be easily adapted for diverse contexts where a similar type of analytic problems is encountered; see Sections 5 and 6 for some examples.

In general, polynomial growth rate for $\tilde{g}(z)$ for large $|z|$ implies the same for \tilde{f} in a small sector containing the real axis. The only exception is the functional-differential equation [2]

$$\tilde{f}'(z) = \tilde{f}(qz) + \tilde{g}(z),$$

for which the growth is of order $z^{c \log z}$ when \tilde{g} grows polynomially for large $|z|$. Note that this equation is a special case of the so-called "pantograph equations"; see [2] for more information.

Notations. Throughout this paper, $q = 1 - p$ and $0 < p < 1$. Also $h := -p \log p - q \log q$ denotes the entropy of the Bernoulli distribution. The splitting distribution I_n is a binomial distribution with mean pn . For brevity, we introduce the generic symbol $\mathcal{F}[G](x)$ to denote a

bounded periodic function of period 1 of the form

$$\mathcal{F}[G](x) = \left\{ \begin{array}{ll} h^{-1} \sum_{k \in \mathbb{Z} \setminus \{0\}} G(-1 + \chi_k) e^{2k\pi i x}, & \text{if } \frac{\log p}{\log q} \in \mathbb{Q} \\ 0, & \text{if } \frac{\log p}{\log q} \notin \mathbb{Q} \end{array} \right\}, \quad (12)$$

where $\chi_k = \frac{2rk\pi i}{\log p}$ when $\frac{\log p}{\log q} = \frac{r}{\ell}$ with $(r, \ell) = 1$. The average value of $\mathcal{F}[G]$ is zero and the Fourier series is always absolutely convergent (it is indeed infinitely differentiable for all cases we study).

3 JS-admissibility, Hadamard product and asymptotic transfer

We collect and develop in this section some technical preliminaries, which are needed later for our asymptotic analysis.

3.1 JS-admissible functions

We begin with recalling the definition and a few fundamental properties from [54] of JS-admissibility (a framework combining ideas from [50, 61]).

Definition 1. *Let $\tilde{f}(z)$ be an entire function. Then we say that $\tilde{f}(z)$ is JS-admissible and write $\tilde{f} \in \mathcal{JS}$ (or more precisely, $\tilde{f} \in \mathcal{JS}_{\alpha, \beta}$, $\alpha, \beta \in \mathbb{R}$) if for some $0 < \theta < \pi/2$ and $|z| \geq 1$ the following two conditions hold.*

(I) *(Polynomial growth inside a sector) Uniformly for $|\arg(z)| \leq \theta$,*

$$\tilde{f}(z) = O(|z|^\alpha (\log_+ |z|)^\beta),$$

where $\log_+ x := \log(1 + x)$.

(O) *(Exponential bound) Uniformly for $\theta \leq |\arg(z)| \leq \pi$,*

$$f(z) := e^z \tilde{f}(z) = O(e^{(1-\varepsilon)|z|}),$$

for some $\varepsilon > 0$.

The major reason of introducing JS-admissible functions is to provide a systematic analytic justification of the *Poisson heuristic* $a_n \sim \tilde{f}(n)$, where \tilde{f} is the Poisson generating function of a_n . We do not however pursue optimum conditions here for simplify and easy applications. On the other hand, since the conditions of admissibility we impose are strong, we can indeed provide a very precise asymptotic characterization of a_n .

Proposition 3.1 ([54]). *If $\tilde{f} \in \mathcal{JS}_{\alpha, \beta}$, then a_n satisfies the asymptotic expansion*

$$a_n = \sum_{0 \leq j < 2k} \frac{\tilde{f}^{(j)}(n)}{j!} \tau_j(n) + O(n^{\alpha-k} \log^\beta n), \quad (13)$$

for $k = 0, 1, \dots$, where the τ_j 's are polynomials of n of degree $\lfloor j/2 \rfloor$ given by

$$\tau_j(n) = \sum_{0 \leq l \leq j} \binom{j}{l} (-n)^l \frac{n!}{(n-j+l)!} \quad (j = 0, 1, \dots).$$

Note that the Poisson-Charlier expansion

$$a_n = \sum_{j \geq 0} \frac{\tilde{f}^{(j)}(n)}{j!} \tau_j(n)$$

converges as long as \tilde{f} is an entire function; see [54]. It is the asymptotic nature (13) that requires more regularity conditions, which can intuitively be seen by observing that $\tilde{f}^j(n) \asymp n^{-j} \tilde{f}(n)$ when $\tilde{f} \in \mathcal{JS}$; see [54].

The τ_j 's are closely connected to Charlier and Laguerre polynomials; see [54] for a more detailed discussion. The first few terms are given as follows.

$\tau_0(n)$	$\tau_1(n)$	$\tau_2(n)$	$\tau_3(n)$	$\tau_4(n)$	$\tau_5(n)$	$\tau_6(n)$
1	0	$-n$	$2n$	$3n(n-2)$	$-4n(5n-6)$	$-5n(3n^2-26n+24)$

The fact that $\tau_1 = 0$ indicates that much information is condensed in the dominant term $\tilde{f}(n)$.

At the generating function level, the usefulness of JS-admissible functions lies in the closure properties under several elementary operations.

Proposition 3.2 ([54]). *Let m be a non-negative integer and $\alpha \in (0, 1)$.*

- (i) $z^m, e^{-\alpha z} \in \mathcal{JS}$.
- (ii) If $\tilde{f} \in \mathcal{JS}$, then $\tilde{P}\tilde{f} \in \mathcal{JS}$ for any polynomial $\tilde{P}(z)$.
- (iii) If $\tilde{f} \in \mathcal{JS}$, then $\tilde{f}(\alpha z) \in \mathcal{JS}$.
- (iv) If $\tilde{f}, \tilde{g} \in \mathcal{JS}$, then $\tilde{f} + \tilde{g} \in \mathcal{JS}$.
- (v) If $\tilde{f}, \tilde{g} \in \mathcal{JS}$, then $\tilde{f}(\alpha z)\tilde{g}((1-\alpha)z) \in \mathcal{JS}$.
- (vi) If $\tilde{f} \in \mathcal{JS}$, then $\tilde{f}^{(m)} \in \mathcal{JS}$.

We will enhance these closure properties by proving that JS-admissibility is also closed under Hadamard product.

3.2 Asymptotic transfer

For our purposes, we need also a transfer theorem for entire functions satisfying the functional equation (5).

Proposition 3.3. *Let $\tilde{f}(z)$ and $\tilde{g}(z)$ be entire functions satisfying*

$$\tilde{f}(z) = \tilde{f}(pz) + \tilde{f}(qz) + \tilde{g}(z),$$

with $f(0)$ given. Then

$$\tilde{f} \in \mathcal{JS} \quad \text{if and only if} \quad \tilde{g} \in \mathcal{JS}.$$

Proof. The proof is similar to and simpler than that of Proposition 2.4 in [54]. Thus we only give the proof for (I). Define

$$\tilde{B}(r) := \max_{\substack{|z| \leq r \\ |\arg(z)| \leq \varepsilon}} |\tilde{f}(z)|.$$

Then

$$\tilde{B}(r) \leq \tilde{B}(pr) + \tilde{B}(qr) + O(r^\alpha (\log_+ r)^\beta + 1).$$

Now define a majorant function $\tilde{K}(r)$ by

$$\tilde{K}(r) = \tilde{K}(pr) + \tilde{K}(qr) + C(r^\alpha (\log_+ r)^\beta + 1),$$

where $C > 0$. Then $\tilde{B}(r) \leq \tilde{K}(r)$ for a sufficiently large $C > 0$, and by standard Mellin argument [29] or by the proof used in [95]

$$\tilde{K}(r) = \begin{cases} O(r), & \text{if } \alpha < 1; \\ O(r^\alpha (\log_+ r)^{\beta+1}), & \text{if } \alpha = 1; \\ O(r^\alpha (\log_+ r)^\beta), & \text{if } \alpha > 1. \end{cases}$$

This completes the proof. \blacksquare

We now refine the asymptotic transfer and focus on asymptotically linear functions.

Proposition 3.4. *Let \tilde{f} and \tilde{g} be entire functions related to each other by the functional equation $\tilde{f}(z) = \tilde{f}(pz) + \tilde{f}(qz) + \tilde{g}(z)$ with $f(0)$ given. Assume $0 < \theta < \pi/2$, $\alpha < 1$ and $\beta \in \mathbb{R}$.*

(a) *If $\tilde{g}(z) = O(|z|^\alpha (\log_+ |z|)^\beta)$, where the O -term holds uniformly for $|z| \geq 1$ and $|\arg(z)| \leq \theta$, then, as $|z| \rightarrow \infty$ in the same sector,*

$$\frac{\tilde{f}(z)}{z} = \frac{G(-1)}{h} + \mathcal{F}[G](r \log_{1/p} z) + o(1),$$

where the notations $\mathcal{F}[G](x)$ and r are defined in (12).

(b) *If $\tilde{g}(z) = cz + O(|z|^\alpha (\log_+ |z|)^\beta)$ uniformly for $|z| \geq 1$ and $|\arg(z)| \leq \theta$, then, as $|z| \rightarrow \infty$ in the same sector,*

$$\frac{\tilde{f}(z)}{z} = \frac{c}{h} \log z + h_0 + \mathcal{F}[G](r \log_{1/p} z) + o(1),$$

where

$$h_0 := \frac{c_0}{h} + \frac{c(p \log^2 p + q \log^2 q)}{2h^2}, \quad (14)$$

$G(s)$ is the meromorphic continuation of $\mathcal{M}[\tilde{g}; s]$, and

$$c_0 := \lim_{s \rightarrow -1} \left(G(s) + \frac{c}{s+1} \right).$$

Proof. Without loss of generality, we may assume that $\tilde{f}(0) = \tilde{f}'(0) = \tilde{g}(0) = \tilde{g}'(0) = 0$. Then both Mellin transforms exist in the strip $\langle -2, -1 \rangle$ and

$$\mathcal{M}[\tilde{f}; s] = \frac{G(s)}{1 - p^{-s} - q^{-s}}.$$

Note that $G(s)$ can be extended to a meromorphic function in the strip $\langle -2, -\alpha - \varepsilon \rangle$. In the case of (a), $G(s)$ is analytic on the line $\Re(s) = -1$ while in the case of (b) $G(s)$ has a unique simple pole on $\Re(s) = -1$ at $s = -1$ with the local expansion $G(s) = -c/(s+1) + c_0 + \dots$. Note that by applying the Exponential Smallness Lemma ([29, Prop. 5]), we have the estimate

$$|G(\sigma + it)| = O(e^{-\theta|t|}),$$

uniformly for large $|t|$ and $\sigma \in \langle -2, -\alpha - \varepsilon \rangle$. Thus the Proposition follows from standard Mellin analysis (see [29]) and known properties of the zeros of $1 - p^{-s} - q^{-s}$ (see [21]). ■

In the symmetric case when $p = q = 1/2$, both error terms $o(1)$ in the Proposition can be improved to $O(\max\{1, |z|^{\alpha-1}(\log|z|)^\beta\})$. Indeed, all error terms in such a case in this paper can be improved by standard argument; we focus instead on the Fourier series expansion in this paper.

3.3 A Hadamard product for Poisson generating functions

We need a new closure property for the analysis of the variance. Given two Poisson generating functions

$$\tilde{f}(z) = e^{-z} \sum_{n \geq 0} \frac{a_n}{n!} z^n \quad \text{and} \quad \tilde{g}(z) = e^{-z} \sum_{n \geq 0} \frac{b_n}{n!} z^n,$$

we define the *Hadamard product* of these two functions as

$$\tilde{h}(z) := \tilde{f}(z) \odot \tilde{g}(z) = e^{-z} \sum_{n \geq 0} \frac{a_n b_n}{n!} z^n.$$

This definition differs from but coincides with the usual one if we consider the corresponding exponential generating functions. We show that JS-admissibility is closed under the Hadamard product. The proof is subtle and delicate.

Proposition 3.5. *If $\tilde{f} \in \mathcal{JS}_{\alpha_1, \beta_1}$ and $\tilde{g} \in \mathcal{JS}_{\alpha_2, \beta_1}$, then $\tilde{h} \in \mathcal{JS}_{\alpha_1 + \alpha_2, \beta_1 + \beta_2}$. More precisely, we have*

$$\tilde{h}(z) = \tilde{f}(z)\tilde{g}(z) + z\tilde{f}'(z)\tilde{g}'(z) + O(|z|^{\alpha_1 + \alpha_2 - 2}(\log_+ |z|)^{\beta_1 + \beta_2}), \quad (15)$$

uniformly as $|z| \rightarrow \infty$ and $|\arg(z)| \leq \theta$, where $0 < \theta < \pi/2$.

Our proof indeed gives an asymptotic expansion for \tilde{h} ; we content ourselves with the statement of (15), which is sufficient for our purposes.

Proof. Let $f(z) := e^z \tilde{f}(z)$, $g(z) := e^z \tilde{g}(z)$ and $h(z) := e^z \tilde{h}(z)$. Also let $0 < \theta_0 < \pi/2$ be an angle where (I) holds for both $\tilde{f}(z)$ and $\tilde{g}(z)$. Note that conditions (I) and (O) remain true if θ_0 is replaced by an arbitrarily small but fixed angle $0 < \theta \leq \theta_0$ with a suitable choice of $\varepsilon = \varepsilon(\theta)$.

We prove the proposition in the special case when $\beta_1 = \beta_2 = 0$ since the proof in the general case remains the same with only additional logarithmic terms in the corresponding error estimates.

Define

$$J(z) := \sum_{n \geq 0} \frac{a_n b_n}{(n!)^2} z^{2n} = \frac{1}{2\pi} \int_{-\pi}^{\pi} f(ze^{it})g(ze^{-it}) dt.$$

Substituting here $z \rightarrow zu$, multiplying both sides by ue^{-u^2} , integrating from 0 to infinity and multiplying the result by $e^{-z^2}/2$, we obtain

$$\tilde{h}(z^2) = e^{-z^2} \sum_{n \geq 0} \frac{a_n b_n}{n!} z^{2n} = \frac{e^{-z^2}}{2} \int_0^{\infty} ue^{-u^2} J(zu) du.$$

We now fix a $0 < \theta < \theta_0$. We first show that $h(z)$ satisfies condition **(O)** for z lying outside the sector $|\arg(z)| \leq \theta$. Assume $\theta/2 \leq |y| \leq \pi/2$. Then

$$J(re^{iy}) = \frac{1}{2\pi} \int_{-\pi}^{\pi} f(re^{i(t+y)})g(re^{i(y-t)}) dt.$$

Note that **(I)** and **(O)** imply that

$$f(z) = O(|z|^{\alpha_1} + 1)e^{|z|}, \quad \text{and} \quad g(z) = O(|z|^{\alpha_2} + 1)e^{|z|}, \quad (16)$$

uniformly for $z \in \mathbb{C}$. Now making the change of variables $t \mapsto t - y$ and taking into account that the function under the integral sign is periodic, we see that

$$\begin{aligned} J(re^{iy}) &= \frac{1}{2\pi} \int_{-\pi}^{\pi} f(re^{it})g(re^{i(2y-t)}) dt \\ &= \frac{1}{2\pi} \int_{-y}^y f(re^{it})g(re^{i(2y-t)}) dt + O((r^{\alpha_2} + 1)e^{(2-\varepsilon)r}). \end{aligned}$$

Here we evaluated the integral over the region $|y| \leq |t| \leq \pi$ by the estimate $|f(re^{it})| = O(e^{(1-\varepsilon)r})$, which follows from **(O)**, and used the upper bound of (16) for $|g(re^{i(2y-t)})|$. In a similar way, we note that $0 < \theta/2 \leq |2y - t| \leq 3\pi/2$ whenever $|t| \leq |y|$ and $\theta \leq |y| \leq \pi/2$. This means that $z = re^{i(2y-t)}$ lies inside the sector $|\arg(z)| \geq \theta/2$ and as a consequence we can use estimates $|g(re^{i(2y-t)})| = O(e^{(1-\varepsilon)r})$ and $|f(re^{it})| = O((r^{\alpha_1} + 1)e^r)$ to evaluate the integral over the range $|t| \leq |y|$. Combining these estimates, we get

$$\begin{aligned} J(re^{iy}) &= O((r^{\alpha_1} + r^{\alpha_2} + 1)e^{(2-\varepsilon)r}) \\ &= O(e^{2\varepsilon_1 r}), \end{aligned}$$

where ε_1 is chosen such that $(2 - \varepsilon)/2 < \varepsilon_1 < 1$. This estimate yields

$$e^{r^2 e^{2iy}} \tilde{h}(r^2 e^{2iy}) = O\left(\int_0^{\infty} ue^{2\varepsilon_1 ru} e^{-u^2} du\right) = O\left(re^{\varepsilon_1^2 r^2}\right),$$

which implies, by replacing $r \rightarrow \sqrt{r}$ and $y \rightarrow y/2$, the estimate

$$e^{re^{iy}} \tilde{h}(re^{iy}) = O\left(re^{\varepsilon_1^2 r}\right),$$

in the region $\theta \leq |y| \leq \pi$ for any fixed $\theta > 0$. Thus condition **(O)** holds.

We now prove that $\tilde{h}(z)$ grows polynomially in the sector $|\arg z| \leq \theta$ with some sufficiently small $\theta > 0$.

Note that $|\arg(ze^{\pm it})| \geq \theta_0/4$ for all values of t and z such that $|\arg z| \leq \theta_0/4$ and $\pi \geq |t| \geq \theta_0/2$, which, by **(I)** and **(O)**, implies that $f(ze^{it}) = O(e^{\varepsilon_2|z|})$ and $g(ze^{it}) = O(e^{\varepsilon_2|z|})$ with a suitable choice of $\varepsilon_2 < 1$ for all z and t satisfying such restrictions. It follows that

$$J(z) = \frac{1}{2\pi} \int_{-\theta_0/2}^{\theta_0/2} e^{2z \cos t} \tilde{f}(ze^{it}) \tilde{g}(ze^{-it}) dt + O(e^{2\varepsilon_2|z|}),$$

when $|\arg z| \leq \theta_0/4$. Thus

$$\tilde{h}(z^2) = \frac{e^{-z^2}}{4\pi} \int_0^\infty u e^{-u^2} \int_{-\theta_0/2}^{\theta_0/2} e^{2zu \cos t} \tilde{f}(zue^{it}) \tilde{g}(zue^{-it}) dt du + O(|z|e^{\varepsilon_2^2|z|^2 - \Re(z^2)}). \quad (17)$$

Noting that $\Re(z^2) = \cos(2 \arg(z))|z|^2 \geq (1 - \arg(z)^2/2)|z|^2$, we then have

$$\tilde{h}(z^2) = I(z) + O(|z|e^{-(1-\varepsilon_2^2-\arg(z)^2/2)|z|^2}), \quad (18)$$

where $I(z)$ denotes the double integral

$$I(z) := \frac{1}{4\pi} \int_0^\infty u \int_{|t| \leq \theta_0/2} e^{-(u-z \cos t)^2 - z^2 \sin^2 t} \tilde{f}(zue^{it}) \tilde{g}(zue^{-it}) dt du.$$

Since $|\arg(z)| \leq \theta_0/4$, the arguments zue^{it} and zue^{-it} of the functions \tilde{f} and \tilde{g} lie inside the sector $|\arg(z)| \leq \theta_0$, which means that $\tilde{f}(zue^{it}) = O(|z|^{\alpha_1})$ and $\tilde{g}(zue^{-it}) = O(|z|^{\alpha_2})$.

Changing the order of integration and making a change of integration path from the interval $u \in (0, \infty)$ to the line $(0, z\infty)$ by mapping $u \mapsto uz \cos t$, we get

$$\begin{aligned} I(z) &= \frac{z^2}{4\pi} \int_{-\theta_0/2}^{\theta_0/2} \int_0^\infty e^{-z^2(u-1)^2 \cos^2 t - z^2 \sin^2 t} \tilde{f}(z^2 u e^{it} \cos t) \tilde{g}(z^2 u e^{-it} \cos t) u du \cos^2 t dt \\ &= O\left(|z|^2 \int_{-\theta_0/2}^{\theta_0/2} \int_0^\infty e^{-\Re(z^2)(u-1)^2 \cos^2(\theta_0/2) - \Re(z^2) \sin^2 t} (|z^2|u+1)^{\alpha_1} (|z^2|u+1)^{\alpha_2} u du dt\right) \\ &= O\left(|z|^2 \left(\int_0^\infty e^{-\Re(z^2)(u-1)^2 \cos^2(\theta_0/2)} (|z^2|u+1)^{\alpha_1+\alpha_2} u du\right) \int_{|t| \leq \theta_0/2} e^{-\Re(z^2) \sin^2 t} dt\right) \\ &= O\left(\frac{(|z|+1)^{2+2\alpha_1+2\alpha_2}}{\Re(z^2)}\right) \\ &= O(|z|^{2\alpha_1+2\alpha_2}), \end{aligned}$$

uniformly for large $|z|$ in the sector $|\arg(z)| \leq \theta_0/4$.

Applying this estimate to the expression (17) of $\tilde{h}(z^2)$, we obtain

$$\tilde{h}(z^2) = O(|z|^{2\alpha_1+2\alpha_2}).$$

Thus

$$\tilde{h}(z) = O(|z|^{\alpha_1+\alpha_2}).$$

for all $|\arg z| \leq \theta \leq \theta_0/2$, where θ is chosen to be small enough to ensure that the error term in (18) decreases exponentially fast. This proves the first part of the proposition.

To prove the finer estimate (15), we use the Taylor expansion

$$\tilde{f}(z) = \sum_{0 \leq j < N} \frac{\tilde{f}^{(j)}(w)}{j!} (w - z)^j + O\left(\max\{(|z| + 1)^{\alpha_1 - N}, (|w| + 1)^{\alpha_1 - N}\} |z - w|^N\right),$$

for any fixed $N \geq 1$. Applying this formula with $z \rightarrow z^2 u e^{it} \cos t$ and $w \rightarrow z^2$, we get

$$\begin{aligned} \tilde{f}(z^2 u e^{it} \cos t) &= \sum_{0 \leq j < N} \frac{\tilde{f}^{(j)}(z^2)}{j!} z^{2j} (u e^{it} \cos t - 1)^j \\ &\quad + O\left(\left(|z|^2(u + 1) + 1\right)^{\alpha_1} |u e^{it} \cos t - 1|^N\right), \end{aligned}$$

and a similar expression for \tilde{g} . Substituting these expressions with $N = 4$ into $I(z)$, we get

$$\begin{aligned} I(z) &= \frac{z^2}{4\pi} \int_{-\theta_0/2}^{\theta_0/2} \int_0^\infty e^{-z^2(u-1)^2 \cos^2 t - z^2 \sin^2 t} \tilde{f}(z^2 u e^{it} \cos t) \tilde{g}(z^2 u e^{-it} \cos t) u \, du \cos^2 t \, dt \\ &= \sum_{k, l \leq 3} \frac{\tilde{f}^{(k)}(z^2) \tilde{g}^{(l)}(z^2)}{k! l!} \cdot \frac{z^{2(1+k+l)}}{4\pi} \\ &\quad \times \int_{-\theta_0/2}^{\theta_0/2} \int_0^\infty e^{-z^2(u-1)^2 \cos^2 t - z^2 \sin^2 t} (u e^{it} \cos t - 1)^k (u e^{-it} \cos t - 1)^l u \, du \cos^2 t \, dt \\ &\quad + O\left(|z|^2 \sum_{\substack{0 \leq k, l \leq 4 \\ k+l > 3}} I_{\alpha_1 + \alpha_2, k+l}\right), \end{aligned} \tag{19}$$

where

$$I_{\rho, \kappa} := \int_{-\theta_0/2}^{\theta_0/2} \int_0^\infty e^{-z^2(u-1)^2 \cos^2 t - z^2 \sin^2 t} u \, du (|z|^2(u + 1) + 1)^\rho |u e^{it} \cos t - 1|^\kappa \, dt.$$

Applying now the inequality

$$|u e^{it} \cos t - 1| = |u \cos t - e^{-it}| = |u \cos t - \cos t + i \sin t| \leq |u - 1| + |t|,$$

we get

$$I_{\rho, \kappa} = O\left(\int_{-\theta_0/2}^{\theta_0/2} \int_0^\infty e^{-\Re(z^2)(u-1)^2 \cos^2 t - \Re(z^2) \sin^2 t} u (|z|^2(u + 1) + 1)^\rho (|u - 1|^\kappa + |t|^\kappa) \, du \, dt\right).$$

Note that $\Re(z^2) \geq |z|^2 \cos 2\theta$ and $\sin^2 t \geq c_1 t^2$ when $|\arg(z)| \leq \theta$ and $|t| \leq \theta_0/2$ for some constant $c_1 > 0$. Thus there exists a positive constant $c > 0$ such that

$$\Re(z^2)(u - 1)^2 \cos^2 t + \Re(z^2) \sin^2 t \geq c(u - 1)^2 |z|^2 + ct^2,$$

for $|\arg(z)| \leq \theta$ and $|t| \leq \theta_0/2$. It then follows that

$$\begin{aligned}
I_{\rho,\kappa} &= O \left(\int_{-\theta_0/2}^{\theta_0/2} \int_0^\infty e^{-c(u-1)^2|z|^2 - c|z|^2 t^2} u (|z|^2(u+1) + 1)^\rho (|u-1|^\kappa + |t|^\kappa) du dt \right) \\
&= O \left(\left(\int_0^\infty e^{-c(u-1)^2|z|^2} (|z|^2(u+1) + 1)^\rho |u-1|^\kappa u du \right) \int_{-\theta_0/2}^{\theta_0/2} e^{-c|z|^2 t^2} dt \right. \\
&\quad \left. + \left(\int_0^\infty e^{-c(u-1)^2|z|^2} (|z|^2(u+1) + 1)^\rho u du \right) \int_{-\theta_0/2}^{\theta_0/2} e^{-c|z|^2 t^2} |t|^\kappa dt \right) \\
&= O \left((|z|^2 + 1)^\rho |z|^{-\kappa-2} \right).
\end{aligned}$$

Substituting this bound in the error term of (19), we obtain

$$I(z) = \sum_{0 \leq k, l \leq 3} \frac{\tilde{f}^{(k)}(z^2) \tilde{g}^{(l)}(z^2)}{k!l!} S_{k,l} + O(|z|^{2\alpha_1 + 2\alpha_2 - 4}),$$

where

$$\begin{aligned}
S_{k,l} &= \frac{z^{2(1+k+l)}}{4\pi} \\
&\quad \times \int_{-\theta_0/2}^{\theta_0/2} \int_0^\infty e^{-z^2(u-1)^2 \cos^2 t - z^2 \sin^2 t} (ue^{it} \cos t - 1)^k (ue^{-it} \cos t - 1)^l u du \cos^2 t dt.
\end{aligned}$$

We can approximate the integral $S_{k,l}$ by reversing the order of the procedure by which we obtained it. First, making the change of variables $u \mapsto u/(z \cos t)$, we get

$$\begin{aligned}
S_{k,l} &= \frac{1}{4\pi} \int_{-\theta_0/2}^{\theta_0/2} \int_0^\infty e^{-(u-z \cos t)^2 - z^2 \sin^2 t} (zue^{it} - z^2)^k (zue^{-it} - z^2)^l u du dt \\
&= \frac{e^{-z^2}}{4\pi} \int_{-\pi}^\pi \int_0^\infty e^{-2zu \cos t} (zue^{it} - z^2)^k (zue^{-it} - z^2)^l ue^{-u^2} du dt \\
&\quad + O \left((1 + |z|^{k+l}) e^{\Re^2(z) \cos^2(\theta_0/2) - \Re(z^2)} \right) \\
&= \frac{e^{-z^2}}{4\pi} \int_0^\infty \left(\int_{-\pi}^\pi [e^{zue^{it}} (zue^{it} - z^2)^k] [e^{zue^{-it}} (zue^{-it} - z^2)^l] dt \right) ue^{-u^2} du \\
&\quad + O \left((1 + |z|^{k+l}) e^{\Re^2(z) \cos^2(\theta_0/2) - \Re(z^2)} \right) \\
&= e^{-z^2} \sum_{n \geq 0} \frac{\nu_{n,k} \nu_{n,l}}{n!} z^{2n} + O \left((1 + |z|^{k+l}) e^{\Re^2(z) \cos^2(\theta_0/2) - \Re(z^2)} \right),
\end{aligned}$$

where the $\nu_{n,k}$'s are defined by

$$\sum_{n \geq 0} \frac{\nu_{n,k}}{n!} w^n = e^w (w - z^2)^k.$$

In particular,

$$\begin{aligned}
S_{1,1} &= e^{-z^2} \left(z^4 + \sum_{n \geq 1} \frac{(n - z^2)^2}{n!} z^{2n} \right) + O \left((1 + |z|^2) e^{\Re^2(z) \cos^2(\theta_0/2) - \Re(z^2)} \right) \\
&= z^2 + O \left((1 + |z|^2) e^{\Re^2(z) \cos^2(\theta_0/2) - \Re(z^2)} \right).
\end{aligned}$$

Similarly,

$$S_{0,0} = 1 + O\left(e^{\Re^2(z) \cos^2(\theta_0/2) - \Re(z^2)}\right),$$

and

$$S_{m,n} = O\left((1 + |z|^{m+n})e^{\Re^2(z) \cos^2(\theta_0/2) - \Re(z^2)}\right),$$

whenever $m \neq n$. Therefore

$$\begin{aligned} \tilde{h}(z^2) &= I(z) + O\left((1 + |z|^{\alpha_1 + \alpha_2})e^{\Re^2(z) \cos^2(\theta_0/2) - \Re(z^2)}\right) \\ &= \tilde{f}(z^2)\tilde{g}(z^2) + z^2\tilde{f}'(z^2)\tilde{g}'(z^2) + O(|z|^{2\alpha_1 + 2\alpha_2 - 4}). \end{aligned}$$

Accordingly,

$$\begin{aligned} \tilde{h}(z) &= I(\sqrt{z}) + O\left((1 + |z|^{\alpha_1 + \alpha_2})e^{\Re^2(z) \cos^2(\theta_0/2) - \Re(z^2)}\right) \\ &= \tilde{f}(z)\tilde{g}(z) + z\tilde{f}'(z)\tilde{g}'(z) + O(|z|^{\alpha_1 + \alpha_2 - 2}). \end{aligned}$$

This proves the second part and completes the proof of the proposition. \blacksquare

4 Asymptotic variance of trie statistics

We address in this section the asymptotic variance of general trie statistics.

Let X_n be an additive shape parameter in a random trie of size n . Then X_n satisfies the following distributional recurrence

$$X_n \stackrel{d}{=} X_{I_n} + X_{n-I_n}^* + T_n \quad (n \geq 2), \quad (20)$$

where $I_n = \text{Binom}(n, p)$, $X_n \stackrel{d}{=} X_n^*$, and X_n, X_n^*, I_n, T_n are independent. Without loss of generality, we may assume that $X_0 = 0$ and $X_1 = 0$ (only minor modifications needed when under nonzero initial conditions). Changing the value of X_0 and X_1 affects only the mean but not the variance.

Consider first the moment-generating functions $M_n(y) := \mathbb{E}(e^{X_n y})$. Then, by (20),

$$M_n(y) = \mathbb{E}(e^{T_n y}) \sum_{0 \leq k \leq n} \pi_{n,k} M_k(y) M_{n-k}(y) \quad (n \geq 2),$$

where $\pi_{n,k} := \binom{n}{k} p^k q^{n-k}$. By taking derivatives, we obtain the recurrences for the first two moments ($\mu_n := \mathbb{E}(X_n)$ and $s_n := \mathbb{E}(X_n^2)$)

$$\begin{aligned} \mu_n &= \sum_{0 \leq k \leq n} \pi_{n,k} (\mu_k + \mu_{n-k}) + \mathbb{E}(T_n) \\ s_n &= \sum_{0 \leq k \leq n} \pi_{n,k} (s_k + s_{n-k}) + \mathbb{E}(T_n^2) \\ &\quad + 2 \sum_{0 \leq k \leq n} \pi_{n,k} (\mu_k \mu_{n-k} + \mathbb{E}(T_n) (\mu_k + \mu_{n-k})). \end{aligned} \quad (21)$$

Our major interest lies in the variance $\sigma_n^2 := \mathbb{V}(X_n)$, which also satisfies the same type of recurrence

$$\sigma_n^2 = \sum_{0 \leq k \leq n} \pi_{n,k} (\sigma_k^2 + \sigma_{n-k}^2) + \mathbb{V}(T_n) + \sum_{0 \leq k \leq n} \pi_{n,k} \Delta_{n,k}^2,$$

where $\Delta_{n,k} := \mu_k + \mu_{n-k} - \mu_n + \mathbb{E}(T_n)$.

Different approaches have been proposed to the asymptotics of σ_n^2 ; these include an elementary induction approach (see [7, 52]), the second-moment approach (see [67, 69, 70, 71]), Poissonized variance (by considering $\tilde{f}_2(z) - \tilde{f}_1^2(z)$) approach (see [59, 60, 76, 93, 77, 90]), (bivariate) characteristic function approach ([57, 77, 60]), and Schachinger's differencing approach [95].

The slight modification of our approach, which relies on (11), from the usual Poissonized variance one turns out to be very helpful and makes a significant difference, notably in the resulting expressions for the periodic functions, mostly because the cancelation is avoided (somehow incorporated in the generating functions).

4.1 Analytic schemes for the mean and the variance

The tools we developed in Section 3 are useful in establishing simple, general, analytic frameworks under which asymptotics of the mean and the variance can be easily derived by checking only a few sufficient conditions.

Asymptotics of the mean. Denote by $\tilde{f}_1(z)$ and $\tilde{g}_1(z)$ the Poisson generating function of $\mathbb{E}(X_n)$ and $\mathbb{E}(T_n)$, respectively. Then

$$\tilde{f}_1(z) = \tilde{f}_1(pz) + \tilde{f}_1(qz) + \tilde{g}_1(z),$$

with $\tilde{f}_1(0) = \tilde{f}_1'(0) = 0$.

Theorem 4.1. *Let $0 < \theta < \pi/2$, $\alpha < 1$ and $\beta \in \mathbb{R}$. If either $\tilde{g}_1 \in \mathcal{J}\mathcal{S}_{\alpha,\beta}$ or $\tilde{g}_1(z) \in \mathcal{J}\mathcal{S}$, and $\tilde{g}_1(z) = cz + O(|z|^\alpha (\log_+ |z|)^\beta)$ uniformly as $|z| \rightarrow \infty$ and $|\arg(z)| \leq \theta$, where $c \in \mathbb{R}$, then*

$$\frac{\mathbb{E}(X_n)}{n} = \frac{c}{h} \log n + d + \mathcal{F}[G_1](r \log_{1/p} n) + o(1),$$

where $d = G_1(-1)/h$ if $c = 0$ and $d = h_0$ (see (14)) if $c \neq 0$, $G_1(s) := \mathcal{M}[\tilde{g}_1; s]$ and the other notations are described as in Proposition 3.4.

Proof. Combining Propositions 3.1 and 3.3, we have

$$\mathbb{E}(X_n) = \sum_{0 \leq j < 2k} \frac{\tilde{f}_1^{(j)}(n)}{j!} \tau_j(n) + O(n^{1-k}),$$

for $k = 0, 1, \dots$. Then apply Proposition 3.4. \blacksquare

If the initial conditions are not zero, say $X_0 = a$ and $X_1 = b$, then we consider $\bar{f}_1(z) := \tilde{f}_1(z) - (b-a)z - a$, leading to the functional equation

$$\bar{f}_1(z) = \bar{f}_1(pz) + \bar{f}_1(qz) + \tilde{g}_1(z) + a(1 - (1+z)e^{-z}),$$

which results in an additional linear term for $\mathbb{E}(X_n)$ of the form

$$\left(b - a + \frac{a}{h} + a\mathcal{F}[G_0](c \log_{1/p} n)\right) n,$$

where $G_0(s) := -(s+1)\Gamma(s)$. Such an additional term is related to the expected size of tries; see Section 5.1.

Functional equations related to the variance. For the variance, we begin with the second moment. Let $\tilde{f}_2(z)$ and $\tilde{g}_2(z)$ be the Poisson generating function of $\mathbb{E}(X_n^2)$ and $\mathbb{E}(T_n^2)$, respectively. Then, by (21),

$$\tilde{f}_2(z) = \tilde{f}_2(pz) + \tilde{f}_2(qz) + 2\tilde{f}_1(pz)\tilde{f}_1(qz) + \tilde{g}_2(z) + \tilde{h}_2(z),$$

where

$$\begin{aligned} \tilde{h}_2(z) &= 2e^{-z} \sum_{n \geq 0} \mathbb{E}(T_n) \sum_{0 \leq k \leq n} \pi_{n,k} (\mu_k + \mu_{n-k}) \frac{z^n}{n!} \\ &= 2e^{-z} \sum_{n \geq 0} \mathbb{E}(T_n) \mu_n \frac{z^n}{n!} - 2e^{-z} \sum_{n \geq 0} (\mathbb{E}(T_n))^2 \frac{z^n}{n!}, \end{aligned} \quad (22)$$

the last two terms being Hadamard products.

Now, let

$$\begin{aligned} \tilde{V}_X(z) &:= \tilde{f}_2(z) - \tilde{f}_1(z)^2 - z\tilde{f}'_1(z)^2 \\ \tilde{V}_T(z) &:= \tilde{g}_2(z) - \tilde{g}_1(z)^2 - z\tilde{g}'_1(z)^2. \end{aligned}$$

Then by a straightforward computation

$$\tilde{V}_X(z) = \tilde{V}_X(pz) + \tilde{V}_X(qz) + \tilde{V}_T(z) + \tilde{\phi}_1(z) + \tilde{\phi}_2(z), \quad (23)$$

where

$$\begin{aligned} \tilde{\phi}_1(z) &:= \tilde{h}_2(z) - 2\tilde{g}_1(z) \left(\tilde{f}_1(pz) + \tilde{f}_1(qz) \right) - 2z\tilde{g}'_1(z) \left(p\tilde{f}'_1(pz) + q\tilde{f}'_1(qz) \right) \\ \tilde{\phi}_2(z) &:= pqz \left(\tilde{f}'_1(pz) - \tilde{f}'_1(qz) \right)^2. \end{aligned} \quad (24)$$

Ideas of our approach. We sketch here the underlying ideas used in our approach before presenting a simple analytic scheme for the asymptotics of the variance. We assume first that $\tilde{g}_1 \in \mathcal{JS}$. This implies the JS-admissibility of \tilde{f}_1 , and thus, by Proposition 3.1, we have the asymptotic expansion for the mean

$$\mu_n = \sum_{0 \leq j < 2k} \frac{\tilde{f}_1^{(j)}(n)}{j!} \tau_j(n) + O\left(\tilde{f}_1(n)n^{-k}\right) \quad (k = 1, 2, \dots).$$

If we also assume $\tilde{g}_2 \in \mathcal{JS}$, then we have the same type of expansion for $\mathbb{E}(X_n^2)$ with \tilde{f}_1 there replaced by \tilde{f}_2 . Thus (dropping error terms for convenience of presentation)

$$\sigma_n^2 \sim \sum_{0 \leq j < 2k} \frac{\tilde{f}_2^{(j)}(n)}{j!} \tau_j(n) - \left(\sum_{0 \leq j < 2k} \frac{\tilde{f}_1^{(j)}(n)}{j!} \tau_j(n) \right)^2.$$

Now substituting $\tilde{f}_2 = \tilde{V}_X + \tilde{f}_1^2 + z(\tilde{f}_1')^2$ yields formally

$$\sigma_n^2 \sim \tilde{V}_X(n) - \frac{n}{2}\tilde{V}_X''(n) - \frac{n^2}{2}\tilde{f}_1''(n)^2 + \dots,$$

under suitable growth conditions and a suitably chosen k . Thus the asymptotics of the variance is reduced to that of $\tilde{V}(n)$ and its derivatives. Further extensions of this approach are discussed in detail elsewhere.

Asymptotics of the variance. We now show that the variance of X_n can also be handled in a general way by reducing the required asymptotics to essentially checking conditions for JS-admissibility.

Theorem 4.2. *Let $0 < \theta < \pi/2, \alpha < 1$ and $\beta \in \mathbb{R}$. Assume $\tilde{g}_2 \in \mathcal{JS}$ and $\tilde{V}_T(z) = O(|z|^\alpha (\log_+ |z|)^\beta)$ as $|z| \rightarrow \infty$ in the sector $|\arg(z)| \leq \theta$.*

(a) *If $p = q = 1/2$, and $\tilde{g}_1 \in \mathcal{JS}_{\alpha,\beta}$ or $\tilde{g}_1 \in \mathcal{JS}_{1,0}$, then*

$$\frac{\mathbb{V}(X_n)}{n} = \frac{1}{\log 2} \sum_{k \in \mathbb{Z}} \Phi_1(-1 + \chi_k) n^{-\chi_k} + o(1), \quad (25)$$

where $\chi_k = \frac{2k\pi i}{\log 2}$ and $\Phi_1(s) = \mathcal{M}[\tilde{V}_T + \tilde{\phi}_1; s]$.

(b) *Assume $p \neq q$.*

(i) *If $\tilde{g}_1 \in \mathcal{JS}_{\alpha,\beta}$, then*

$$\frac{\mathbb{V}(X_n)}{n} = \frac{G(-1)}{h} + \mathcal{F}[G](r \log_{1/p} n) + o(1).$$

Here $G(s) = \Phi_1(s) + \Phi_2(s)$, where $\Phi_1(s) = \mathcal{M}[\tilde{V}_T + \tilde{\phi}_1; s]$ and $\Phi_2(s)$ is the analytic continuation of $\mathcal{M}[\tilde{\phi}_2; s]$.

(ii) *If $\tilde{g}_1 \in \mathcal{JS}$ and $\tilde{g}_1 = z + O(|z|^\alpha (\log_+ |z|)^\beta)$ uniformly as $|z| \rightarrow \infty$ and $|\arg(z)| \leq \theta$, then*

$$\begin{aligned} \frac{\mathbb{V}(X_n)}{n} &= \frac{pq \log^2(p/q)}{h^3} \log n + \frac{d}{h} + \frac{pq \log^2(p/q)(p \log^2 p + q \log^2 q)}{2h^4} \\ &\quad + \mathcal{F}[G](r \log_{1/p} n) + o(1), \end{aligned}$$

Here $G(s) = \Phi_1(s) + \Phi_2(s)$, where $\Phi_1(s) = \mathcal{M}[\tilde{V}_T + \tilde{\phi}_1; s]$ and $\Phi_2(s)$ is the meromorphic continuation of $\mathcal{M}[\tilde{\phi}_2; s]$, and $d = \Phi_1(-1) + \lim_{s \rightarrow -1} (\Phi_2(s) + pq \log^2(p/q)/(h^2(s+1)))$.

Proof. Since \tilde{V}_T is assumed to be small (less than linear), we first show that, under the assumptions of the theorem, both $\tilde{\phi}_1$ and $\tilde{\phi}_2$ are also small; see (23).

If $\tilde{g}_1 \in \mathcal{JS}_{\alpha,\beta}$, then $\tilde{f}_1 \in \mathcal{JS}_{1,0}$ by Theorem 4.1. These imply, by Proposition 3.5, that $\tilde{h}_2 \in \mathcal{JS}$ and

$$\begin{aligned} \tilde{h}_2(z) &= 2\tilde{g}_1(z)\tilde{f}_1(z) + 2z\tilde{g}_1'(z)\tilde{f}_1'(z) - 2\tilde{g}_1(z)^2 - 2z\tilde{g}_1'(z)^2 + O(|z|^{\alpha-1}(\log_+ |z|)^\beta) \\ &= 2\tilde{g}_1(z) \left(\tilde{f}_1(pz) + \tilde{f}_1(qz) \right) + 2z\tilde{g}_1'(z) \left(p\tilde{f}_1'(pz) + q\tilde{f}_1'(qz) \right) \\ &\quad + O(|z|^{\alpha-1}(\log_+ |z|)^\beta), \end{aligned}$$

uniformly as $|z| \rightarrow \infty$ and $|\arg(z)| \leq \theta$. It follows, by (24), that $\tilde{\phi}_1(z) = O(|z|^{\alpha-1} (\log_+ |z|)^\beta)$. Similarly, if $\tilde{g}_1 \in \mathcal{J}\mathcal{S}_{1,0}$, then $\tilde{h}_2 \in \mathcal{J}\mathcal{S}$ and $\tilde{\phi}_1(z) = O(\log_+ |z|)$ as $|z| \rightarrow \infty$ in the sector $|\arg(z)| \leq \theta$.

Without loss of generality, we may assume that all generating functions f involved here have the property that $f(0) = f'(0) = 0$.

Consider first $\tilde{V}_T + \tilde{\phi}_1$. By assumption and by the preceding analysis, we see that $\mathcal{M}[\tilde{V}_T + \tilde{\phi}_1; s]$ exists in the strip $\langle -2, -\alpha - \varepsilon \rangle$, with $\varepsilon > 0$ arbitrarily small. Thus we argue as in Proposition 3.4 and obtain (25). Note that $\theta > 0$ is crucial here.

We now turn to $\tilde{\phi}_2$, which is zero when $p = q$. So assume now $p \neq q$. If $\tilde{g}_1 \in \mathcal{J}\mathcal{S}_{\alpha,\beta}$, then its Mellin transform G_1 exists in the strip $\langle -2, -\alpha - \varepsilon \rangle$ and, by applying the Exponential Smallness Lemma, is exponentially small at $c \pm i\infty$. Thus from the integral representation

$$\tilde{f}'_1(pz) - \tilde{f}'_1(qz) = -\frac{1}{2\pi i} \int_{(-1-\varepsilon)} \frac{wG_1(w)(p^{-w-1} - q^{-w-1})}{1 - p^{-w} - q^{-w}} z^{-w-1} dw,$$

it follows that $\tilde{f}'_1(pz) - \tilde{f}'_1(qz) = o(1)$ and consequently by (24) $\tilde{\phi}_2(z) = o(|z|)$ as $|z| \rightarrow \infty$ and $|\arg(z)| \leq \theta$. Thus the Mellin transform $\Phi_2(s)$ of $\tilde{\phi}_2(z)$ exists in the strip $\langle -3, -1 \rangle$ and

$$\begin{aligned} \Phi_2(s) &= \frac{pq}{2\pi i} \int_{(-1/2)} \frac{(p^{-w} - q^{-w})(p^{w-1-s} - q^{w-1-s})}{(1 - p^{1-w} - q^{1-w})(1 - p^{w-s} - q^{w-s})} \\ &\quad \times (w-1)G_1(w-1)(s-w)G_1(s-w) dw. \end{aligned} \quad (26)$$

Note that

$$\frac{p^{-w} - q^{-w}}{1 - p^{1-w} - q^{1-w}} = \frac{-(1 - p^{-w}) + (1 - q^{-w})}{p(1 - p^{-w}) + q(1 - q^{-w})}.$$

If $\log p / \log q = r/\ell \in \mathbb{Q}$, where $(r, \ell) = 1$ are positive integers, then any zero of the form $2rk\pi i / \log p$ of the denominator is also a zero of the numerator. Thus the integration path can be moved to the imaginary axis.

By summing over all residues of poles with real parts less than $-\alpha$ (see [21] for a detailed study), we see that $\Phi_2(s)$ can be extended to a meromorphic function beyond the line $\Re(s) = -1$ which is analytic on $\Re(s) = -1$. Consequently, the asymptotic estimate in case (b)-(i) follows as in Proposition 3.4.

The analysis for the last part (ii) is similar with the only difference that now $\tilde{\phi}_2(z) = pq \log^2(p/q)z/h^2 + o(|z|)$ uniformly as $|z| \rightarrow \infty$ and $|\arg(z)| \leq \theta$. Hence, one can again extend $\mathcal{M}[\tilde{\phi}_2; s]$ to a meromorphic function beyond the line $\Re(s) = -1$, but there is a simple pole on $\Re(s) = -1$ at $s = -1$ with the singular expansion $\mathcal{M}[\tilde{\phi}_2; s] = -pq \log^2(p/q)/(h^2(s+1)) + d + \dots$. Thus similar arguments used in Proposition 3.4 apply. This completes the proof. \blacksquare

Calculation of the Fourier coefficients $\Phi_2(-1 + \chi_k)$. We outline here an approach by residue calculus to simplify the Fourier coefficients $\Phi_2(-1 + \chi_k)$, which will be applied several times later.

We begin with the integral representation (26), which we first shift to the imaginary axis.

Then, we use the following decomposition

$$\begin{aligned}\Phi_2(-1 + \chi_k) &= \frac{1}{2\pi i} \int_{(0)+} \left(\frac{1}{1 - p^{1-w} - q^{1-w}} + \frac{p^{1+w} - q^{1+w}}{1 - p^{1+w} - q^{1+w}} \right) \\ &\quad \times (w - 1)G_1(w - 1)(-1 + \chi_k - w)G_1(-1 + \chi_k - w) dw \\ &=: J_0 + J,\end{aligned}$$

where the integration contour $\int_{(0)+}$ is the imaginary axis but with a sufficiently small indentation to the right of each zero of the equation $1 - p^{1-it} - q^{1-it} = 0$ for real t (only one when $\frac{\log p}{\log q} \notin \mathbb{Q}$, and an infinity number of equally-spaced ones otherwise).

By the change of variables $w \mapsto \chi_k - w$ and then by moving the line of integration to the right, we have

$$\begin{aligned}J_0 &= \frac{1}{2\pi i} \int_{(0)-} \frac{(w - 1)G_1(w - 1)(-1 + \chi_k - w)G_1(-1 + \chi_k - w)}{1 - p^{1+w} - q^{1+w}} dw \\ &= -\frac{1}{h} \sum_{j \in \mathbb{Z}} (\chi_j - 1)G_1(\chi_j - 1)(-1 + \chi_{k-j})G_1(-1 + \chi_{k-j}) \\ &\quad + \frac{1}{2\pi i} \int_{(0)+} \frac{(w - 1)G_1(w - 1)(-1 + \chi_k - w)G_1(-1 + \chi_k - w)}{1 - p^{1+w} - q^{1+w}} dw,\end{aligned}$$

where the integration contour $\int_{(0)-} = -\int_{(0)+}$. The last integral equals

$$\frac{1}{2\pi i} \int_{(0)+} (w - 1)G_1(w - 1)(-1 + \chi_k - w)G_1(-1 + \chi_k - w) dw + J.$$

Note that

$$\frac{1}{2\pi i} \int_{(0)+} (w - 1)G_1(w - 1)(-1 + \chi_k - w)G_1(-1 + \chi_k - w) dw = \int_0^\infty \tilde{g}'_1(t)^2 t^{-1+\chi_k} dt.$$

Combining these relations, we obtain

$$\begin{aligned}\Phi_2(-1 + \chi_k) &= 2J - \frac{1}{h} \sum_{j \in \mathbb{Z}} (\chi_j - 1)G_1(\chi_j - 1)(-1 + \chi_{k-j})G_1(-1 + \chi_{k-j}) \\ &\quad + \int_0^\infty \tilde{g}'_1(t)^2 t^{-1+\chi_k} dt.\end{aligned}\tag{27}$$

To further simplify the integral J , we write

$$\tilde{g}_1(z) = \sum_{j \geq 2} \frac{\tilde{b}_j}{j!} z^j.$$

Then it follows from the Direct Mapping Theorem (see [29]) of Mellin transform that $G_1(s)$ can be extended to a meromorphic function to the left of $\Re(s) = -2$ with simple poles at $s = -j$, the residue there being equal to $\tilde{b}_j/j!$.

If we assume that $-(s-1)G_1(s-1)$ has no singularity to the right of imaginary axis, then we obtain

$$J = \sum_{j \geq 2} \frac{\tilde{b}_j(p^j + q^j)}{(j-1)!(1-p^j - q^j)} (j-2 + \chi_k) G_1(j-2 + \chi_k). \quad (28)$$

This and (27) will be useful later.

This procedure is very effective in many applications having linear variance (namely, the situation of Theorem 4.2 (b)-(i)); similar but slightly more involved arguments can be used in more general situations such as $n \log n$ -variance.

5 Applications

We apply or slightly modify the schemes developed in the previous sections to a few standard examples in the literature for which new results are proposed for the asymptotics of the variance.

5.1 Size of random tries

The size of a trie is defined to be the number of internal nodes used, which becomes a random variable when the input sequence is random. For example, eight internal nodes are used in the trie in Figure 3. Under our Bernoulli model, we see that the size X_n satisfies (1) with $X_0 = X_1 = 0$ and $T_n = 1$ for $n \geq 2$, where n denotes the total number of input keys (or external nodes). Under different guises and different initial conditions, this is the most studied random variable defined on tries or related structures in the literature, most of them dealing with the expected value and very few of them with the variance. See, for example, [5, 9, 15, 62, 79, 85, 99] and the references therein for the mean, and [59, 64, 65, 67, 68, 77, 93] for the variance.

Since $T_n = 1$, we have

$$\tilde{g}_1(z) = \tilde{g}_2(z) = 1 - (1+z)e^{-z}.$$

From Proposition 3.2, we see that both functions $\tilde{g}_1, \tilde{g}_2 \in \mathcal{I}\mathcal{S}_{0,0}$. Also we have

$$\tilde{V}_T(z) := \tilde{g}_2(z) - \tilde{g}_1^2(z) - z\tilde{g}_1'(z)^2 = e^{-z}(1+z - (1+2z+z^2+z^3)e^{-z}), \quad (29)$$

and (see (24))

$$\tilde{\phi}_1(z) = 2e^{-z} \left((1+z)(\tilde{f}_1(pz) + \tilde{f}_1(qz)) - z^2(p\tilde{f}_1'(pz) + q\tilde{f}_1'(qz)) \right). \quad (30)$$

Both functions are exponentially small for large $|z|$ with $\Re(z) > 0$.

The application of both Theorems 4.1 and 4.2 is straightforward. Since

$$G_1(s) = \mathcal{M}[\tilde{g}_1; s] = -(s+1)\Gamma(s),$$

we thus obtain, when $X_0 = X_1 = 0$,

$$\frac{\mathbb{E}(X_n)}{n} = \frac{1}{h} + \mathcal{F}[G_1](r \log_{1/p} n) + o(1),$$

a well-known result. When $X_0 = a$ and $X_1 = b$, then a direct modification of the same argument gives

$$\frac{\mathbb{E}(X_n)}{n} = b - a + (a + 1) \left(\frac{1}{h} + \mathcal{F}[G_1](r \log_{1/p} n) \right) + o(1).$$

As regards the variance, the functions involved become more complicated. We state our results by distinguishing between symmetric case $p = 1/2$ and asymmetric case $p \neq q$.

Theorem 5.1 (Symmetric case: $p = 1/2$). *The variance of the size of random symmetric tries satisfies asymptotically ($\chi_k := 2k\pi i / \log 2$)*

$$\frac{\mathbb{V}(X_n)}{n} = \frac{1}{\log 2} \sum_{k \in \mathbb{Z}} G(-1 + \chi_k) n^{-\chi_k} + o(1),$$

where the mean value of the periodic function is given by

$$\frac{G(-1)}{\log 2} = \frac{1}{\log 2} \left(\frac{1}{4} + 2 \sum_{j \geq 1} \frac{(-1)^j (j-1)}{2^j - 1} \right) \approx 0.845858623076001 \dots, \quad (31)$$

and for $k \neq 0$

$$G(-1 + \chi_k) = -\frac{\chi_k \Gamma(-1 + \chi_k) (1 + \chi_k)^2}{4} + 2 \sum_{j \geq 1} \frac{(-1)^j j (j + \chi_k - 1) \Gamma(j + \chi_k)}{(j+1)! (2^j - 1)}. \quad (32)$$

The numerical value in (31) coincides with that given in [93], where they derived the alternative expression

$$\frac{1}{2 \log 2} - \frac{1}{\log^2 2} - \frac{2}{\log 2} \sum_{j \geq 1} \frac{(-1)^j}{2^j - 1} - \frac{4\pi^2}{\log^3 2} \sum_{j \geq 1} \frac{j}{\sinh \frac{2j\pi^2}{\log 2}}; \quad (33)$$

see also [68]. This expression can also be derived by the simplification procedure for deriving (27) (see also Theorem 5.2 below). Equating the above two expressions yields the identity

$$\sum_{j \geq 1} \frac{(-1)^j j}{2^j - 1} = \frac{1}{8} - \frac{1}{2 \log 2} - \frac{2\pi^2}{\log^2 2} \sum_{j \geq 1} \frac{j}{\sinh \frac{2j\pi^2}{\log 2}}, \quad (34)$$

which can be proved directly by the residue calculus similar to that used in deriving (27). Of special mention here is that the series on the right-hand side is less than 1.1×10^{-10} , meaning that the first two terms on the right-hand side already provide a very accurate approximation to the series on the left-hand side. A third expression with the same numerical value is given in [77, Sec. 5.4]

$$\frac{1}{\log 2} \left(\frac{1}{2} + 2 \sum_{j \geq 1} \frac{1}{2^j + 1} \right) - \frac{1}{\log^2 2} - \frac{4\pi^2}{\log^3 2} \sum_{j \geq 1} \frac{j}{\sinh \frac{2j\pi^2}{\log 2}},$$

which can be obtained from (33) by the identity

$$\sum_{j \geq 1} \frac{1}{2^j + 1} = \sum_{j \geq 1} \frac{(-1)^{j-1}}{2^j - 1}.$$

Regarding the oscillating terms, Kirschenhofer and Prodinger derived in [68] (with terms slightly simplified and with minor corrections)

$$\begin{aligned}
G(-1 + \chi_k) &= -3\chi_k\Gamma(-1 + \chi_k) - (1 - \chi_k)(2 - \chi_k)\Gamma(\chi_k) \left(\frac{1}{2} - \sum_{j \geq 1} \frac{(\chi_k + j) \binom{-\chi_k}{j-1}}{(j+1)(2^j - 1)} \right) \\
&\quad - \frac{\chi_k\Gamma(1 + \chi_k)}{\log 2} - 2\Gamma(1 + \chi_k) \left(\frac{5 - \chi_k}{4(1 - \chi_k)} - \sum_{j \geq 1} \frac{(\chi_k + j + 1) \binom{-\chi_k - 1}{j-1}}{(j+1)(2^j - 1)} \right) \\
&\quad + \frac{1}{\log 2} \sum_{\substack{j+m=k \\ j,m \neq 0}} \chi_j\Gamma(-1 + \chi_j)\chi_m\Gamma(1 + \chi_m),
\end{aligned}$$

which is to be compared with our expression (32). Numerically, the amplitude of the oscillating part is bounded above by $\sum_{k \neq 0} |G(-1 + \chi_k)| / \log 2 \leq 1.7 \times 10^{-6}$; see Figure 5.

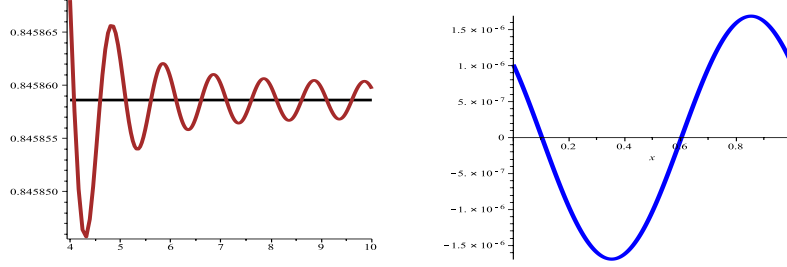

Figure 5: *Periodic oscillations of the variance when $p = 1/2$: $\mathbb{V}(X_n)/n$ in logarithmic scale (left) and the fluctuating part $\frac{1}{\log 2} \sum_{k \neq 0} G(-1 + \chi_k)e^{-2k\pi i x}$ (right).*

We now state the result in the asymmetric case.

Theorem 5.2 (Asymmetric case: $p \neq q$). *The variance of the size of random asymmetric tries satisfies*

$$\frac{\mathbb{V}(X_n)}{n} = \frac{G(-1)}{h} + \mathcal{F}[G](r \log_{1/p} n) + o(1),$$

where

$$\begin{aligned}
G(-1) &= \frac{1}{2} - \frac{1}{h} + 2 \sum_{j \geq 2} \frac{(-1)^j (p^j + q^j)}{1 - p^j - q^j} \\
&\quad - \begin{cases} \frac{1}{h \log p} \sum_{j \geq 1} \frac{4rj\pi^2}{\sinh \frac{2rj\pi^2}{\log p}}, & \text{if } \frac{\log p}{\log q} \in \mathbb{Q}; \\ 0, & \text{if } \frac{\log p}{\log q} \notin \mathbb{Q}, \end{cases} \tag{35}
\end{aligned}$$

and for $k \neq 0$ (only when $\frac{\log p}{\log q} \in \mathbb{Q}$)

$$\begin{aligned}
G(-1 + \chi_k) &= \chi_k\Gamma(-1 + \chi_k) \left(1 - \frac{\chi_k + 3}{2^{1+\chi_k}} \right) - \frac{1}{h} \sum_{j \in \mathbb{Z}} \Gamma(\chi_j + 1)\Gamma(\chi_{k-j} + 1) \\
&\quad - 2 \sum_{j \geq 1} \frac{(-1)^j (j + 1 + \chi_k)\Gamma(j + \chi_k) (p^{j+1} + q^{j+1})}{(j-1)!(j+1) (1 - p^{j+1} - q^{j+1})}. \tag{36}
\end{aligned}$$

These expressions also hold in the symmetric case. However, the expressions for the Fourier coefficients in Theorem 5.1 are simpler.

While the asymptotic pattern of the variance has long been known, the expressions for the Fourier coefficients have, as far as we were aware, never been stated before in the above explicit forms.

Consider, for concreteness, the special rational case when $q = p^2$. Then $p = (\sqrt{5} - 1)/2$ is the golden ratio. From (35), we see that the non-periodic dominant term for the ratio between the variance and n is given by

$$\begin{aligned} \frac{G(-1)}{h} &= \frac{1}{h} \left(\frac{1}{2} - \frac{1}{h} + 2 \sum_{j \geq 2} \frac{(-1)^j (p^j + p^{2j})}{1 - p^j - p^{2j}} - \frac{1}{h \log p} \sum_{j \geq 1} \frac{4j\pi^2}{\sinh \frac{2rj\pi^2}{\log p}} \right) \\ &\approx 1.00834\,52644\,70994\dots, \end{aligned}$$

which is larger than the symmetric case (31). In general, $G(-1) = G(-1; p)$ is a symmetric bath-tub-shaped function of p with its lowest value reached at $p = 0.5$. The fluctuation of the periodic part is bounded above in modulus by 7.3×10^{-8} ; see Figure 6.

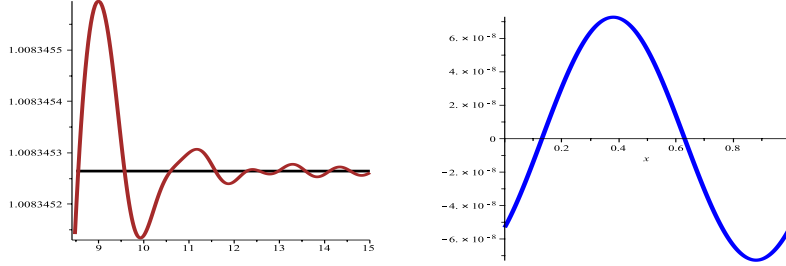

Figure 6: *Periodic oscillations of the variance when $p = (\sqrt{5} - 1)/2$: $\mathbb{V}(X_n)/n$ in logarithmic scale (left) and the fluctuating part $\mathcal{F}[G](x)$ (right).*

Proof of Theorem 5.1 and Theorem 5.2. We look first at $\Phi_1(s) = \mathcal{M}[\tilde{V}_T + \tilde{\phi}_1; s]$. By (29) and (30), we have

$$\Phi_1(s) = (s + 1)\Gamma(s) \left(1 - \frac{s^2 + 4s + 8}{2^{s+3}} \right) + 2Y_1(s),$$

where

$$Y_1(s) := \int_0^\infty z^{s-1} e^{-z} \left((1+z) \left(\tilde{f}_1(pz) + \tilde{f}_1(qz) \right) - z^2 \left(p\tilde{f}'_1(pz) + q\tilde{f}'_1(qz) \right) \right) dz. \quad (37)$$

To simplify this integral, we use the inverse Mellin integral

$$\tilde{f}_1(z) = -\frac{1}{2\pi i} \int_{(-\frac{3}{2})} \frac{(w+1)\Gamma(w)}{1 - p^{-w} - q^{-w}} z^{-w} dw,$$

which, by taking derivative with respect to z ,

$$\tilde{f}'_1(z) = \frac{1}{2\pi i} \int_{(-\frac{3}{2})} \frac{\Gamma(w+2)}{1 - p^{-w} - q^{-w}} z^{-w-1} dw. \quad (38)$$

Substituting these into (37) yields

$$\begin{aligned} Y_1(s) &= -\frac{1}{2\pi i} \int_{(-\frac{3}{2})} \frac{(w+1)((1+w)(s-w)+1)\Gamma(w)\Gamma(s-w)(p^{-w}+q^{-w})}{1-p^{-w}-q^{-w}} dw \\ &= \sum_{j \geq 1} \frac{(-1)^j j(j(j+s+1)-1)\Gamma(j+s+1)(p^{j+1}+q^{j+1})}{(j+1)!(1-p^{j+1}-q^{j+1})}, \end{aligned}$$

where the last expression is obtained by shifting the line of integration to the left and by collecting all the residues encountered.

In particular, when $p = 1/2$,

$$\begin{aligned} \Phi_1(s) &= (s+1)\Gamma(s) \left(1 - \frac{s^2+4s+8}{2^{s+3}} \right) \\ &\quad + 2 \sum_{j \geq 1} \frac{(-1)^j j(j(j+s+1)-1)\Gamma(j+s+1)}{(j+1)!(2^j-1)}, \end{aligned} \quad (39)$$

which proves (31) and (32).

We now consider $\Phi_2(s) = \mathcal{M}[\tilde{\phi}_2; s]$ (see (24)). By (26),

$$\Phi_2(s) = \frac{pq}{2\pi i} \int_{(0)} \frac{\Gamma(w+1)(p^{-w}-q^{-w})}{1-p^{1-w}-q^{1-w}} \cdot \frac{\Gamma(s-w+2)(p^{w-s-1}-q^{w-s-1})}{1-p^{w-s}-q^{w-s}} dw, \quad (40)$$

where we shifted the line of integration to the imaginary axis. Since the above function is also analytic on $\Re(s) = -1$, we can substitute $s = -1 + \chi_k$. The expressions (35) and (36) are then obtained by the simplification procedure that we used to derive (27) (for $\Phi_2(-1 + \chi_k)$) and (28) with $\tilde{g}_1(z) = 1 - (1+z)e^{-z}$ and $G_1(s) = -(s+1)\Gamma(s)$. ■

An alternative way of simplifying $\Phi_2(-1 + \chi_k)$ is to shift the line of integration of (40) to the left and collect all residues encountered. This then yields the somehow more complicated expression

$$\begin{aligned} \Phi_2(-1 + \chi_k) &= pq \sum_{j \geq 1} \frac{(-1)^{j-1} \Gamma(j + \chi_k + 1) (p^j - q^j) (p^{-j} - q^{-j})}{(j-1)!(1-p^{1+j}-q^{1+j})(1-p^{1-j}-q^{1-j})} \\ &\quad - \sum_{\omega_j} \frac{\Gamma(\omega_j + 1) \Gamma(-\omega_j + \chi_k + 1)}{p^{1+\omega_j} \log p + q^{1+\omega_j} \log q}, \end{aligned}$$

where ω_j runs over all zeros of $1 - p^{1+w} - q^{1+w} = 0$ with $\Re(\omega_j) < 0$, and we used the relation

$$\frac{pq(p^{\omega_j} - q^{\omega_j})(p^{-\omega_j} - q^{-\omega_j})}{1 - p^{1-\omega_j} - q^{1-\omega_j}} = 1.$$

Here the convergence of the second series follows from the exponential decay of Gamma function at $c \pm i\infty$ and the property that the zeros ω_j are isolated in nature (and equally spaced along vertical lines when $\frac{\log p}{\log q} \in \mathbb{Q}$); see [21] for details. Then we apply the same procedure for deriving (27) to further simplify the second series.

5.2 External path length

The cost of constructing tries is directly proportional to the external path length, which is the sum of all the distances between each external node (where keys are stored) to the root. For example, the external path length of the trie showed in Figure 3 equals $2+3+4\times 3+5\times 2 = 27$. Under the same Bernoulli model, the external path length is a random variable, still denoted by X_n , satisfying (1) with $T_n = n$. This implies that the Poisson generating functions of the first two moments of T_n are given by

$$\tilde{g}_1(z) = z(1 - e^{-z}) \quad \text{and} \quad \tilde{g}_2(z) = z(1 + z - e^{-z}).$$

Thus JS-admissibility of these two functions follows directly from Proposition 3.2. Also $\tilde{g}_1(z) = z + O(|z|^{-\delta})$ uniformly as $|z| \rightarrow \infty$ and $|\arg(z)| < \pi/2 - \varepsilon$ for all $\varepsilon, \delta > 0$. Moreover, $\tilde{V}_T(z) = ze^{-z}(1 - e^{-z}(1 - z + z^2))$ and

$$\tilde{\phi}_1(z) = e^{-z} \left(2z\tilde{f}_1(pz) + 2z\tilde{f}_1(qz) + 2pz(1-z)\tilde{f}'_1(pz) + 2qz(1-z)\tilde{f}'_1(qz) \right),$$

both being again exponential small.

For the expected value, we have $G_1(s) := \mathcal{M}[\tilde{g}_1; s] = -\Gamma(s+1)$ and thus

$$\lim_{s \rightarrow -1} \left(G_1(s) + \frac{1}{s+1} \right) = \gamma,$$

where γ is Euler's constant. Applying Theorem 4.1, we obtain

$$\frac{\mathbb{E}(X_n)}{n} = \frac{1}{h} \log n + \frac{\gamma}{h} + \frac{p \log^2 p + q \log^2 q}{2h^2} + \mathcal{G}[G_1](r \log_{1/p} n) + o(1).$$

While this result has been widely known and discussed (see, for example, [73, 57, 77]), the variance is rarely addressed (see [57, 58, 70]) due partly to its complexity and partly to methodological limitations.

Theorem 5.3. *The variance of the total external path length satisfies*

$$\frac{\mathbb{V}(X_n)}{n} = \frac{1}{\log 2} \sum_{k \in \mathbb{Z}} \Phi_1(-1 + \chi_k) n^{-\chi_k} + o(1),$$

in the symmetric case (when $p = 1/2$), and

$$\begin{aligned} \frac{\mathbb{V}(X_n)}{n} &= \frac{pq \log^2(p/q)}{h^3} \log n + \frac{d}{h} + \frac{pq \log^2(p/q)(p \log^2 p + q \log^2 q)}{2h^4} \\ &\quad + \mathcal{F}[G](r \log_{1/p} n) + o(1), \end{aligned}$$

in the asymmetric case, where $G = \Phi_1 + \Phi_2$ with Φ_1 , Φ_2 and d given below in (41), (43), and (42), respectively.

The proof follows the same pattern as that used for the size, details being omitted here. In particular, we have

$$\begin{aligned} \Phi_1(s) &= \Gamma(s+1) \left(1 - \frac{s^2 + s + 4}{2^{s+3}} \right) \\ &\quad + 2 \sum_{j \geq 1} \frac{(-1)^j (j(s+j) - 1) (p^{j+1} + q^{j+1}) \Gamma(s+j+1)}{j! (1 - p^{j+1} - q^{j+1})}, \end{aligned} \tag{41}$$

where

$$d = \Phi_1(-1) + pq \frac{\log^2(p/q)}{h^2} \left(\gamma + 1 + \frac{p \log^2 p + q \log^2 q}{2h} + \frac{\log p + \log q}{2} \right) + I_1(-1), \quad (42)$$

and for $k \neq 0$,

$$\Phi_2(-1 + \chi_k) = pq \frac{\log^2(p/q)}{h^2} (\chi_k - 1) \Gamma(\chi_k) + I_1(-1 + \chi_k), \quad (43)$$

where

$$\begin{aligned} I_1(-1) = & \frac{1}{4} - \log 2 + \frac{\pi^2}{6h} - \frac{1}{h} + \frac{p \log^3 p + q \log^3 q}{6h^2} + \frac{(p \log^2 p + q \log^2 q)^2}{4h^3} \\ & - 2 \sum_{j \geq 1} \frac{(-1)^j (j^2 - 1) (p^{j+1} + q^{j+1})}{j(1 - p^{j+1} - q^{j+1})} \\ & + \begin{cases} \frac{1}{h} \sum_{j \neq 0} (\chi_j^2 - 1) \Gamma(\chi_j) \Gamma(-\chi_j), & \text{if } \frac{\log p}{\log q} \in \mathbb{Q} \\ 0, & \text{if } \frac{\log p}{\log q} \notin \mathbb{Q} \end{cases}. \end{aligned}$$

and for $k \neq 0$,

$$\begin{aligned} I_1(-1 + \chi_k) = & \Gamma(\chi_k) \left(\chi_k - 1 + \frac{\chi_k^2 - 3\chi_k + 4}{2^{2+\chi_k}} \right) + \frac{2\Gamma(\chi_k)}{h} ((1 - \chi_k)(\psi(\chi_k + \gamma) - \chi_k) \\ & - \frac{1}{h} \sum_{j \neq 0, k} (\chi_j - 1) \Gamma(\chi_j) (\chi_{k-j} - 1) \Gamma(\chi_{k-j}) \\ & + 2 \sum_{j \geq 1} \frac{(-1)^{j-1} (j+1) (\chi_k + j - 1) \Gamma(\chi_k + j) (p^{j+1} + q^{j+1})}{j!(1 - p^{j+1} - q^{j+1})}. \end{aligned}$$

The Fourier series is new.

In particular, in the symmetric case the Fourier coefficients of the periodic function are given by

$$\frac{\Phi_1(-1)}{\log 2} = \frac{1}{\log 2} \left(\frac{1}{4} + \log 2 + 2 \sum_{j \geq 1} \frac{(-1)^j (j^2 - j - 1)}{j(2^j - 1)} \right) \approx 4.352906698945400 \dots,$$

and for $k \neq 0$

$$\frac{\Phi_1(-1 + \chi_k)}{\log 2} = \frac{(1 - \chi_k) \Gamma(\chi_k + 1)}{4} + 2 \sum_{j \geq 1} \frac{(-1)^j (j(j - 1 + \chi_k) - 1) \Gamma(j + \chi_k)}{j!(2^j - 1)}.$$

The above numerical value for $\Phi_1(-1)/\log 2$ is in accordance with that obtained in [70] where the authors derived the alternative expression

$$1 + \frac{1}{2 \log 2} - \frac{1}{\log^2 2} - \frac{2}{\log 2} \sum_{j \geq 1} \frac{(-1)^j (j+1)}{j(2^j - 1)} - \frac{4\pi^2}{\log^3 2} \sum_{j \geq 1} \frac{j}{\sinh \frac{2j\pi^2}{\log 2}}.$$

Equating them gives the same identity (34) as we encountered in the size of tries.

5.3 Radix sort

Bucketing is a common design paradigm used for sorting or selecting elements with specified properties; see [14]. For sorting purposes, a simple procedure, called *radix sort*, is to distribute elements into b buckets according to their values and then sort within each bucket recursively; see [73, 76]. Since we can always normalize elements into the unit interval, splitting into b buckets amounts to using b -ary digit expansion of each element and then distribute according to the leading digits. Thus the radix sorting process induces a trie with up to b branches at each node.

If we assume that the n elements to be sorted are independent and identically distributed uniform random variables (from the unit interval), then the cost X_n of radix sort (number of digit extractions needed to sort) satisfies (see [76])

$$\tilde{P}(z, y) = (1 - e^y)ze^{-z} + e^{-(1-e^y)z} \tilde{P}\left(\frac{e^y z}{b}, y\right)^b,$$

where $\tilde{P}(z, y) := e^{-z} \sum_{n \geq 0} \mathbb{E}(e^{X_n y}) z^n / n!$. This is nothing but the Poisson generating function for the external path length of random bucket tries with branching factor b (using b -ary expansion). All analysis above carries through and we have

$$\tilde{f}_1(z) = b\tilde{f}_1(z/b) + z(1 - e^{-z}),$$

and the corresponding $\tilde{V}(z) := \tilde{f}_2(z) - \tilde{f}_1(z) - z\tilde{f}'_1(z)$ satisfies

$$\tilde{V}(z) = b\tilde{V}(z/b) + \tilde{g}(z),$$

where

$$\tilde{g}(z) := e^{-z} \left(2bz\tilde{f}_1(z/b) + 2z(1 - z)\tilde{f}'_1(z/b) + z(1 - e^{-z}) + z^2 e^{-z}(1 - z) \right).$$

Then the Mellin transform of \tilde{g} is given by

$$\begin{aligned} G(s) &= \Gamma(s+1) \left(1 - 2^{-s-1} - s2^{-s-3} - s^2 2^{-s-3} \right) \\ &\quad + 2 \sum_{k \geq 1} \frac{(-1)^k \Gamma(s+k+1)}{k!(b^k - 1)} (k(s+k) - 1) \quad (\Re(s) > -2). \end{aligned} \quad (44)$$

It follows, by the same Mellin analysis and JS-admissibility, that ($\chi_k := 2k\pi i / \log b$)

$$\begin{aligned} \frac{\mathbb{E}(X_n)}{n} &= \log_b n + \frac{\gamma}{\log b} + \frac{1}{2} + \frac{1}{\log b} \sum_{k \in \mathbb{Z} \setminus \{0\}} \Gamma(\chi_k) n^{-\chi_k} + o(1) \\ \frac{\mathbb{V}(X_n)}{n} &= \frac{1}{\log b} \sum_{k \in \mathbb{Z}} G(-1 + \chi_k) n^{-\chi_k} + o(1). \end{aligned}$$

An expression for $G(s)$ was derived in [76, p. 755], which is more messy than (44). Indeed, one can simplify that expression and obtain

$$\begin{aligned} \frac{G(s)}{\Gamma(s+1)} &= 1 - 2^{-s-1} - s2^{-s-3} - s^2 2^{-s-3} \\ &\quad - 2(s+1)(s+2)U(s+3) + 2(s+1)U(s+2) + 2V(s+1), \end{aligned}$$

where $(U(s) = V(s - 1) - V(s))$

$$U(s) := \sum_{k \geq 1} b^{-k} (1 + b^{-k})^{-s}, \quad V(s) := \sum_{k \geq 1} (1 - (1 + b^{-k})^{-s}).$$

Such an expression for $G(s)$ is on the other hand also easily obtained from (44) by binomial theorem.

In particular, by (44),

$$G(-1) = \frac{1}{4} + \log 2 + 2 \sum_{k \geq 1} \left((b^k + 1)^{-2} + \log (1 + b^{-k}) \right).$$

From this we obtain the following numerical table.

b	$G(-1)/\log b \approx$
2	4.35290 66989 45400 60374
3	1.80839 11899 92781 96720
4	1.18266 25542 39848 25415
5	0.91013 81377 49170 45524
6	0.75883 87760 90906 35697
7	0.66265 99366 11117 50882
8	0.59600 35264 60033 23615
9	0.54696 00912 93530 34188
10	0.50926 08387 26247 61651

Thus *increasing the number of buckets in radix sort reduces the variance of the cost*, with the most drastic change from 2 to 3.

5.4 Peripheral path length

We define the *peripheral path length* of a tree as the sum of the fringe-sizes of all leaf-nodes, where the fringe-size of a leaf is defined to be the number of external nodes of the subtree rooted at its parent-node. This parameter was investigated in [16] where it was called the w -parameter. It was also studied in phylogenetics in the context of sum of all minimal clade sizes (see [4]).

If we define T_n

$$(T_n | I_n = k) = \begin{cases} n - 1, & \text{if } k = 1 \text{ or } k = n - 1 \\ 0, & \text{otherwise,} \end{cases}$$

for $n \geq 3$ and with $n - 1$ replaced by 2 for $n = 2$, then the peripheral path length X_n of random tries of n keys satisfies (1) with the initial conditions $X_0 = 0$ and $X_1 = 1$.

Since T_n depends on I_n , such a parameter does not directly fit in our schemes. However, the same approach applies. The moment generating function of X_n then has the recursive form

$$M_n(y) = \sum_{k \neq 1, n-1} \pi_{n,k} M_k(y) M_{n-k}(y) + e^{(n-1)y} n (pq^{n-1} + qp^{n-1}) M_{n-1}(y),$$

for $n \geq 2$ with $M_0(y) = 1$ and $M_1(y) = e^y$. It follows that

$$\begin{aligned}\tilde{g}_1(z) &= pqz^2(e^{-pz} + e^{-qz}) \\ \tilde{g}_2(z) &= pqz^2(2e^{-z} + (1 + qz)e^{-pz} + (1 + pz)e^{-qz}),\end{aligned}$$

which are both exponentially small and JS-admissible by Proposition 3.2. The function $\tilde{h}_2(z)$ (see (22)) is now given by

$$\begin{aligned}\tilde{h}_2(z) &= 2e^{-z} \sum_{n \geq 2} \sum_{0 \leq j \leq n} \pi_{n,k}(\mu_k + \mu_{n-k}) \mathbb{E}(T_n | I_n = k) \frac{z^n}{n!} \\ &= pqz^2 \left(2e^{-pz} \tilde{f}_1(qz) + 2e^{-qz} \tilde{f}_1(pz) + 2e^{-pz} \tilde{f}'_1(qz) + 2e^{-qz} \tilde{f}'_1(pz) \right. \\ &\quad \left. + 2e^{-pz} + 2e^{-qz} \right),\end{aligned}$$

which is also JS-admissible by Proposition 3.2. This gives rise to the following expression for $\tilde{\phi}_1(z)$ (see (24))

$$\begin{aligned}\tilde{\phi}_1(z) &= 2pqz^2 \left(-e^{-pz} \tilde{f}_1(pz) - e^{-qz} \tilde{f}_1(qz) + e^{-pz} + e^{-qz} \right. \\ &\quad \left. + (1 - 2p + pqz)e^{-qz} \tilde{f}'_1(pz) + (1 - 2q + pqz)e^{-pz} \tilde{f}'_1(qz) \right. \\ &\quad \left. - (2p - p^2z)e^{-pz} \tilde{f}'_1(pz) - (2q - q^2z)e^{-qz} \tilde{f}'_1(qz) \right).\end{aligned}$$

Finally,

$$\begin{aligned}\tilde{V}_T(z) &= pqz^2 \left(2(1 - 4pqz + pqz^2 - p^2q^2z^3)e^{-z} + (1 + qz)e^{-pz} + (1 + pz)e^{-qz} \right. \\ &\quad \left. - pqz(4 + z - 4pz + p^2z^2)e^{-2pz} - pqz(4 + z - 4qz + q^2z^2)e^{-2qz} \right).\end{aligned}$$

All these functions are exponentially small for large $|z|$ with $\Re(z) > 0$.

Observe that $G_1(s) := \mathcal{M}[\tilde{g}_1; s] = pq(p^{-s-2} + q^{-s-2})\Gamma(s+2)$. An application of Theorem 4.1 then gives

$$\frac{\mathbb{E}(X_n)}{n} = 1 + \frac{1}{h} + \mathcal{F}[G_1](r \log_{1/p} n) + o(1),$$

where the additional term 1 on the right-hand side arises from the initial condition.

Although Theorem 4.2 does not apply directly to the variance of X_n , the same method of proof works well as in Theorem 4.2 part (b)-(i), and we obtain

$$\frac{\mathbb{V}(X_n)}{n} = \frac{G(-1)}{h} + \mathcal{F}[G](r \log_{1/p} n) + o(1),$$

where a series-form for $G(s)$ can be derived as the discussions above. For simplicity, we have, in the symmetric case,

$$\begin{aligned}G(s) &= s(s+1)\Gamma(s) \left(2^{s+1}(s+3) - \frac{s^3 + 5s^2 + 22s + 24}{16} \right) \\ &\quad - 2^{s+2} \sum_{j \geq 1} \frac{(-1)^j \Gamma(s+j+2)}{(j-1)!(2^j-1)} (j(s+j+2) - j-1).\end{aligned}$$

In particular, the average value of the periodic function is given by

$$\frac{13}{8} - 2 \sum_{j \geq 1} \frac{(-1)^j j(j^2 - 1)}{2^j - 1} = \frac{13}{8} - 12 \sum_{j \geq 1} \frac{1}{4^j (1 + 2^{-j})^4} \approx 0.55730\ 49532\ 49505 \dots$$

Note that we can also derive the identity

$$2 \sum_{j \geq 1} \frac{(-1)^j j(j^2 - 1)}{2^j - 1} = \frac{1}{\log 2} - \frac{3}{8} + \frac{4\pi^2}{(\log 2)^4} \sum_{k \geq 1} \frac{k((2k\pi)^2 + (\log 2)^2)}{\sinh \frac{2k\pi^2}{\log 2}},$$

the series on the right-hand side being smaller than 6×10^{-9} .

5.5 Leader election (or loser selection)

The coin-flipping process is applicable to single out a leader in real life or in abstract models: every individual involved throws a coin and those who get head continue until only one is left; see [92]. In this case, the approach we use so far leads to extremely simple forms for the number of coin-flippings; this example thus has a more instructional value. Let X_n denote the total number of coin flippings used in the leader election procedure of n people. Then $X_0 = X_1 = 0$ and the exponential generating function $P(z, y) := \sum_{n \geq 0} \mathbb{E}(e^{X_n y}) z^n / n!$ satisfies

$$P(z, y) = (e^{yz/2} + 1) P\left(\frac{yz}{2}, y\right) - e^{yz/2} + (1 - y)z.$$

Instead of the usual Poisson generating function, we consider, as in [92], the Bernoulli generating function

$$\tilde{f}_m(z) := \frac{1}{e^z - 1} \sum_{n \geq 0} \frac{\mathbb{E}(X_n^m)}{n!} z^n.$$

Then $\tilde{f}_1(0) = 0$ and

$$\tilde{f}_1(z) = \tilde{f}_1(z/2) + z,$$

which gives the identity $\tilde{f}_1(z) = 2z$. Thus $\mathbb{E}(X_n) \equiv 2n$ for $n \geq 2$. Also the normalized function $\tilde{V} := \tilde{f}_2 - \tilde{f}_1^2 - z(\tilde{f}_1')^2$ satisfies

$$\tilde{V}(z) = \tilde{V}(z/2) + z + \frac{3z^2}{e^z - 1}.$$

Standard Mellin analysis yields

$$\tilde{V}(z) = 2z + \frac{\pi^2}{2 \log 2} + \frac{3}{\log 2} \sum_{k \in \mathbb{Z} \setminus \{0\}} \zeta(2 + \chi_k) \Gamma(2 + \chi_k) z^{-\chi_k} + O(|z|^{-1}),$$

as $|z| \rightarrow \infty$ in the half-plane $\Re(z) > 0$, where $\zeta(s)$ denotes Riemann's zeta function. Consequently, a similar de-Poissonization argument leads to

$$\sigma_n^2 = 2n + \frac{\pi^2}{2 \log 2} + \frac{3}{\log 2} \sum_{k \in \mathbb{Z} \setminus \{0\}} \zeta(2 + \chi_k) \Gamma(2 + \chi_k) n^{-\chi_k} + O(n^{-1}).$$

Thus, with an average of $2n$ coin-tossings and a \sqrt{n} -order of standard deviation, selecting a leader or a loser by such a naive splitting process is a very efficient procedure.

6 Further extensions

Since BSPs appear in a large number of diverse contexts, many extensions of our frameworks are possible. We briefly discuss some examples in this section.

6.1 Internal path length of random tries

If, instead of summing over all the distances between the root and each external node (where records are stored), we add up all the distance between the root and each internal node, then we have the system of recurrences for the number of internal nodes N_n (already discussed in Section 5.1) and the internal path length X_n in a random trie of n elements under the Bernoulli model

$$\begin{cases} N_n \stackrel{d}{=} N_{I_n} + N_{n-I_n}^* + 1 \\ X_n \stackrel{d}{=} X_{I_n} + X_{n-I_n}^* + N_{I_n} + N_{n-I_n}^*, \end{cases}$$

for $n \geq 2$, with initial conditions $N_0 = N_1 = I_0 = I_1 = 0$, where N_n^* and X_n^* are independent copies of N_n and X_n , respectively.

We will see that the variance changes completely its asymptotic behavior and is asymptotic to $n(\log n)^2$ weighted by a periodic function. This estimate is independent of the rationality of $\frac{\log p}{\log q}$. This was previously observed in [88] but with incomplete proof; see also the recent paper [44] for a study of Wiener index.

The asymptotics of the variance can be addressed by the same approach we used for the node-wise path length of random digital search trees in [54]. We begin with the moment generating function $M_n(u, v) = \mathbb{E}(e^{N_n u + X_n v})$, which satisfies the recurrence

$$M_n(u, v) = e^u \sum_{0 \leq k \leq n} \pi_{n,k} M_k(u + v, v) M_{n-k}(u + v, v) \quad (n \geq 2).$$

We then deduce that the Poisson generating functions of $\mathbb{E}(N_n)$ and $\mathbb{E}(X_n)$, denoted by $\tilde{f}_{1,0}(z)$ and $\tilde{f}_{0,1}(z)$, respectively, satisfy the functional equations

$$\begin{aligned} \tilde{f}_{1,0}(z) &= \tilde{f}_{1,0}(pz) + \tilde{f}_{1,0}(qz) + 1 - (1+z)e^{-z} \\ \tilde{f}_{0,1}(z) &= \tilde{f}_{0,1}(pz) + \tilde{f}_{0,1}(qz) + \tilde{f}_{1,0}(pz) + \tilde{f}_{1,0}(qz). \end{aligned}$$

Let $\tilde{f}_{2,0}(z)$, $\tilde{f}_{1,1}(z)$ and $\tilde{f}_{0,2}(z)$ denote the Poisson generating function of $\mathbb{E}(N_n^2)$, $\mathbb{E}(N_n X_n)$ and $\mathbb{E}(X_n^2)$, respectively. Then we define the Poissonized versions of the variance and the covariance as

$$\begin{aligned} \tilde{V}(z) &:= \tilde{f}_{2,0}(z) - \tilde{f}_{1,0}(z)^2 - z\tilde{f}'_{1,0}(z)^2 \\ \tilde{C}(z) &:= \tilde{f}_{1,1}(z) - \tilde{f}_{1,0}(z)\tilde{f}_{0,1}(z) - z\tilde{f}'_{1,0}(z)\tilde{f}'_{0,1}(z) \\ \tilde{W}(z) &:= \tilde{f}_{0,2}(z) - \tilde{f}_{0,1}(z)^2 - z\tilde{f}'_{0,1}(z)^2. \end{aligned}$$

A lengthy calculation then gives

$$\begin{aligned} \tilde{V}(z) &= \tilde{V}(pz) + \tilde{V}(qz) + \tilde{g}_{2,0}(z) \\ \tilde{C}(z) &= \tilde{C}(pz) + \tilde{C}(qz) + \tilde{V}(pz) + \tilde{V}(qz) + \tilde{g}_{1,1}(z) \\ \tilde{W}(z) &= \tilde{W}(pz) + \tilde{W}(qz) + 2\tilde{C}(pz) + 2\tilde{C}(qz) + \tilde{V}(pz) + \tilde{V}(qz) + \tilde{g}_{0,2}(z), \end{aligned}$$

where

$$\begin{aligned} \tilde{g}_{2,0}(z) := e^{-z} & \left\{ 2(1+z) \left(\tilde{f}_{1,0}(pz) + \tilde{f}_{1,0}(qz) \right) - 2z^2 \left(p\tilde{f}'_{1,0}(pz) + q\tilde{f}'_{1,0}(qz) \right) \right. \\ & \left. + 1 + z - (1 + 2z + z^2 + z^3)e^{-z} \right\} + pqz \left(\tilde{f}'_{1,0}(pz) - \tilde{f}'_{1,0}(qz) \right)^2 \end{aligned}$$

and

$$\begin{aligned} \tilde{g}_{1,1}(z) := e^{-z} & \left\{ (1+z) \left(\tilde{f}_{1,0}(pz) + \tilde{f}_{1,0}(qz) + \tilde{f}_{0,1}(pz) + \tilde{f}_{0,1}(qz) \right) \right. \\ & \left. - z^2 \left(p\tilde{f}'_{1,0}(pz) + q\tilde{f}'_{1,0}(qz) + p\tilde{f}'_{0,1}(pz) + q\tilde{f}'_{0,1}(qz) \right) \right\} \\ & + pqz \left(\tilde{f}'_{1,0}(pz) - \tilde{f}'_{1,0}(qz) \right) \left(\tilde{f}'_{1,0}(pz) - \tilde{f}'_{1,0}(qz) + \tilde{f}'_{0,1}(pz) - \tilde{f}'_{0,1}(qz) \right) \end{aligned}$$

and

$$\tilde{g}_{0,2}(z) := pqz \left(\tilde{f}'_{1,0}(pz) - \tilde{f}'_{1,0}(qz) + \tilde{f}'_{0,1}(pz) - \tilde{f}'_{0,1}(qz) \right)^2.$$

Then we have

$$\begin{aligned} \mathcal{M}[\tilde{f}_{1,0}; s] &= -\frac{(s+1)\Gamma(s)}{1-p^{-s}-q^{-s}} \\ \mathcal{M}[\tilde{f}_{0,1}; s] &= -\frac{(s+1)\Gamma(s)(p^{-s}+q^{-s})}{(1-p^{-s}-q^{-s})^2}. \end{aligned}$$

It follows that (already derived in Section 5.1)

$$\frac{\mathbb{E}(N_n)}{n} = \frac{1}{h} + \mathcal{F}[G_{1,0}](r \log_{1/p} n) + o(1),$$

where $G_{1,0}(s) = -(s+1)\Gamma(s)$. Similarly,

$$\begin{aligned} \frac{\mathbb{E}(X_n)}{n} &= \left(\frac{1}{h} + \mathcal{F}[G_{1,0}](r \log_{1/p} n) \right) \frac{\log n}{h} \\ &+ \frac{p \log^2 p + q \log^2 q}{h^3} + \frac{\gamma - 1}{h^2} - \frac{1}{h} + \frac{1}{h} \mathcal{F}[G_{0,1}](r \log_{1/p} n) + o(1), \end{aligned}$$

where (ψ being the derivative of $\log \Gamma$)

$$G_{0,1}(s) = \Gamma(s) \left(\left(\psi(s) + h - \frac{p \log^2 p + q \log^2 q}{h} \right) (1+s) + 1 \right).$$

By the same Mellin analysis, we obtain

$$\begin{aligned} \mathcal{M}[\tilde{V}; s] &= \frac{\Phi_1(s) + \Phi_2(s)}{1-p^{-s}-q^{-s}} \\ \mathcal{M}[\tilde{C}; s] &= \frac{1}{(1-p^{-s}-q^{-s})^2} \left((p^{-s} + q^{-s})(\Phi_1(s) + \Phi_2(s)) \right. \\ & \quad \left. + (1-p^{-s}-q^{-s})(G_2(s) + H_2(s)) \right) \\ \mathcal{M}[\tilde{W}; s] &= \frac{1}{(1-p^{-s}-q^{-s})^3} \left((p^{-s} + q^{-s})(1+p^{-s}+q^{-s})(\Phi_1(s) + \Phi_2(s)) \right. \\ & \quad \left. + 2(p^{-s} + q^{-s})(1-p^{-s}-q^{-s})(G_2(s) + H_2(s)) \right. \\ & \quad \left. + (1-p^{-s}-q^{-s})^2 H_3(s) \right), \end{aligned}$$

where

$$\begin{aligned}\Phi_1(s) &= \mathcal{M} \left[\tilde{g}_{2,0}(z) - pqz \left(\tilde{f}'_{1,0}(pz) - \tilde{f}'_{1,0}(qz) \right)^2 ; s \right] \\ G_2(s) &= \mathcal{M} \left[\tilde{g}_{1,1}(z) - pqz \left(\tilde{f}'_{1,0}(pz) - \tilde{f}'_{1,0}(qz) + \tilde{f}'_{0,1}(pz) - \tilde{f}'_{0,1}(qz) \right) ; s \right].\end{aligned}$$

and

$$\begin{aligned}\Phi_2(s) &= \mathcal{M} \left[pqz \left(\tilde{f}'_{1,0}(pz) - \tilde{f}'_{1,0}(qz) \right)^2 ; s \right] \\ H_2(s) &= \mathcal{M} \left[pqz \left(\tilde{f}'_{1,0}(pz) - \tilde{f}'_{1,0}(qz) \right) \left(\tilde{f}'_{0,1}(pz) - \tilde{f}'_{0,1}(qz) \right) ; s \right] \\ H_3(s) &= \mathcal{M} \left[pqz \left(\tilde{f}'_{0,1}(pz) - \tilde{f}'_{0,1}(qz) \right)^2 ; s \right].\end{aligned}$$

From these functions, we can derive, by the same arguments we used above, asymptotic approximations to the covariance of N_n and X_n , and the variance of X_n .

Theorem 6.1. *The variance of the internal path length of random tries satisfies*

$$\frac{\mathbb{V}(X_n)}{n} = F_{0,2}(r \log_{1/p} n) \frac{(\log n)^2}{h^2} + F_{0,2}^{[2]}(r \log_{1/p} n) \frac{\log n}{h} + F_{0,2}^{[3]}(r \log_{1/p} n) + o(1),$$

and the covariance of N_n and X_n satisfies

$$\frac{\text{Cov}(N_n, X_n)}{n} = F_{0,2}(r \log_{1/p} n) \frac{\log n}{h} + F_{1,1}^{[2]}(r \log_{1/p} n) + o(1),$$

where $F_{0,2}(x) = G(-1)/h + \mathcal{F}[G](x)$ with G given in Section 5.1, and the other $F_{\cdot,\cdot}^{[i]}$'s are either constants when $\frac{\log p}{\log q} \notin \mathbb{Q}$ or periodic functions with computable Fourier series when $\frac{\log p}{\log q} \in \mathbb{Q}$.

For simplicity, we give only the expressions in the symmetric case

$$\begin{aligned}F_{1,1}^{[2]}(x) &= -\frac{1}{(\log 2)^2} \sum_{k \in \mathbb{Z}} (G'_1(-1 + \chi_k) - G_2(-1 + \chi_k) \log 2) e^{2k\pi i x} \\ F_{0,2}^{[2]}(x) &= -\frac{2}{(\log 2)^2} \sum_{k \in \mathbb{Z}} (G'_1(-1 + \chi_k) - G_2(-1 + \chi_k) \log 2) e^{2k\pi i x} \\ F_{0,2}^{[3]}(x) &= \frac{1}{(\log 2)^3} \sum_{k \in \mathbb{Z}} (G''_1(-1 + \chi_k) - 2G'_2(-1 + \chi_k) \log 2) e^{2k\pi i x},\end{aligned}$$

where $G_1(s)$ is given in (39) and

$$G_2(s) = \sum_{j \geq 1} \frac{(-1)^j j \Gamma(s + j + 1)}{(j + 1)! (2^j - 1)^2} (2^j + 2)(j(j + 1 + s) - 1).$$

An intuitive interpretation of why the variance is of order $n(\log n)^2$ is as follows. Any path from the root of length k to an internal node contributes $1 + 2 + \dots + k = O(k^2)$ to the internal

path length. Since the expected values of both internal and external path lengths are of order $n \log n$, we see that most nodes lie at levels of order $\log n$, and these nodes thus contribute an order $n(\log n)^2$ to the variance.

In a completely similar manner, if Y_n denotes the peripheral path length where we change subtree-size to the sum of all internal nodes (instead of all external nodes), then we can derive the asymptotic approximations to the variance of Y_n and the covariance of Y_n and N_n , which are both linear

$$\begin{aligned}\frac{\mathbb{V}(Y_n)}{n} &= F_{0,2}^{[Y]}(r \log_{1/p} n) + o(1) \\ \frac{\text{Cov}(Y_n, N_n)}{n} &= F_{1,1}^{[Y]}(r \log_{1/p} n) + o(1),\end{aligned}$$

where the $F_{\cdot,\cdot}^{[Y]}$'s are either constants when $\frac{\log p}{\log q} \notin \mathbb{Q}$ or computable periodic functions when $\frac{\log p}{\log q} \in \mathbb{Q}$.

6.2 Contention resolution in multi-access channel using tree algorithms

There is an abundant literature on the subject and we are specially interested in the complexity of tree algorithms used in resolving the contention before either transmitting information to the common shared channel or performing certain tasks in a distributed computing environment. The tree algorithm (originally due to Capetanakis, Tsybakov and Mikhailov in the late 1970s) resolves the conflict (when more than one user is sending simultaneously his message to the common channel) by the outcome of a coin-flipping at each contender's site, similar to the splitting rule used for constructing a trie; see [3, 79, 83, 80, 103] for details. The analysis of the time needed for such algorithms to resolve the conflict of n contenders often leads to recurrences of the form (1) or its extensions. The expected value of the time to resolve all conflicts, which corresponds essentially to the size of random tries, has been widely addressed in the information-theoretic and communication literature, but there are very few papers on the variance; see [64, 65].

Consider the extended environment where each "coin" has r distinct outcomes with respective probabilities p_1, \dots, p_r , where $\sum_{1 \leq m \leq r} p_m = 1$ and none of them is zero. Then the time X_n to resolve the collision of n contenders satisfies (see [80])

$$\tilde{P}(z, y) = e^y \prod_{1 \leq m \leq r} \tilde{P}(p_m z, y) + (1 - e^y)(1 + z)e^{-z}, \quad (45)$$

where $\tilde{P}(z, y) := e^{-z} \sum_{n \geq 0} \mathbb{E}(e^{X_n y}) z^n / n!$. For simplicity, we consider a version with $X_0 = X_1 = 0$; the situation of nonzero initial conditions can be manipulated by extending the same arguments we use (only the mean will be altered, the variance remains the same). From (45), we obtain the functional equation for the Poisson generating function of $\mathbb{E}(X_n)$

$$\tilde{f}_1(z) = \sum_{1 \leq m \leq r} \tilde{f}_1(p_m z) + 1 - (1 + z)e^{-z},$$

with $\tilde{f}_1(0) = 0$, and, similarly, for $\tilde{V} := \tilde{f}_2 - \tilde{f}_1^2 - z(\tilde{f}_1')^2$,

$$\tilde{V}(z) = \sum_{1 \leq m \leq r} \tilde{V}(p_m z) + \tilde{g}(z),$$

with $\tilde{V}(0) = 0$, where

$$\begin{aligned}\tilde{g}(z) &= e^{-z} (1 + z - (1 + 2z + z^2 + z^3)e^{-z}) \\ &\quad + 2e^{-z} \left((1 + z) \sum_{1 \leq m \leq r} \tilde{f}_1(p_m z) - z^2 \sum_{1 \leq m \leq r} p_m \tilde{f}'_1(p_m z) \right) \\ &\quad + z \sum_{1 \leq m < l \leq r} p_m p_l \left(\tilde{f}'_1(p_m z) - \tilde{f}'_1(p_l z) \right)^2.\end{aligned}$$

Then all our analysis extends *mutatis mutandis* to these functional equations, and we have the following asymptotics for $\mathbb{E}(X_n)$ and $\mathbb{V}(X_n)$.

Let

$$P(s) := \sum_{1 \leq m \leq r} p_m^s.$$

Then the entropy is

$$h := -P'(1) = - \sum_{1 \leq m \leq r} p_m \log p_m.$$

As in the Bernoulli case, we need to distinguish between rational (periodic) and irrational (aperiodic) cases. The former is characterized either by the existence of a $\rho \in \mathbb{R}$ such that $p_m = \rho^{e_m}$, $e_m \in \mathbb{N}$ for $1 \leq m \leq r$, or by the ratios $\frac{\log p_m}{\log p_l} \in \mathbb{Q}$ for all pairs (m, l) .

Theorem 6.2. *The expected value and the variance of X_n (defined in (45)) can asymptotically be approximated by*

$$\begin{aligned}\frac{\mathbb{E}(X_n)}{n} &= \frac{1}{h} + F_1(\log_{1/\rho} n) + o(1), \\ \frac{\mathbb{V}X_n}{n} &= \frac{G(-1)}{h} + F_2(\log_{1/\rho} n) + o(1),\end{aligned}$$

where both $F_1 = F_2 = 0$ in the irrational case and $(\chi_k = \frac{2k\pi i}{\log \rho})$

$$\begin{aligned}F_1(x) &= \frac{1}{h} \sum_{k \in \mathbb{Z} \setminus \{0\}} \chi_k \Gamma(-1 + \chi_k) e^{2k\pi i x}, \\ F_2(x) &= \frac{1}{h} \sum_{k \in \mathbb{Z} \setminus \{0\}} G(-1 + \chi_k) n^{-\chi_k},\end{aligned}$$

in the rational case, where $G = \mathcal{M}[\tilde{g}; s]$ is given in (46) below.

While the dominant term involving the entropy for the expected value is well-known (see [5, 9, 62]), the corresponding term $G(-1)/h$ for the variance is far from being intuitive. On the other hand, if we start with $X_0 = a$ and $X_1 = b$, then

$$\frac{\mathbb{E}(X_n)}{n} = (b - a) + ((r - 1)a + 1) \left(\frac{1}{h} + F_1(\log_{1/\rho} n) \right) + o(1).$$

The function G in the Theorem is described as follows. For $\Re(s) > -2$,

$$\begin{aligned}G(s) &= (s + 1)\Gamma(s) \left(1 - \frac{s^2 + 4s + 8}{2^{s+3}} \right) \\ &\quad + 2 \sum_{j \geq 1} \frac{(-1)^j j(j(j + s + 1) - 1)\Gamma(j + s + 1)P(j + 1)}{(j + 1)!(1 - P(j + 1))} + \Phi_2(s),\end{aligned}\tag{46}$$

where $\Phi_2(s) \equiv 0$ if $p_m = 1/r$ for $1 \leq m \leq r$ (the symmetric case), and

$$\Phi_2(-1 + \chi_k) = \frac{\Gamma(2 + \chi_k)}{2^{2+\chi_k}} - 2 \sum_{j \geq 1} \frac{(-1)^j \Gamma(j + \chi_k + 1) P(j + 1)}{(j - 1)! (1 - P(j + 1))} - \begin{cases} \frac{1}{h} \sum_{j \in \mathbb{Z}} \Gamma(\chi_j + 1) \Gamma(\chi_{k-j} + 1), & \text{in the rational case} \\ 0, & \text{in the irrational case,} \end{cases}$$

in the asymmetric case. Consequently,

$$G(-1 + \chi_k) = \chi_k \Gamma(-1 + \chi_k) \left(1 - \frac{\chi_k + 3}{2^{1+\chi_k}} \right) - 2 \sum_{j \geq 1} \frac{(-1)^j (j + 1 + \chi_k) \Gamma(j + \chi_k) P(j + 1)}{(j - 1)! (j + 1) (1 - P(j + 1))} - \begin{cases} \frac{1}{h} \sum_{j \in \mathbb{Z}} \Gamma(\chi_j + 1) \Gamma(\chi_{k-j} + 1), & \text{in the rational case;} \\ 0, & \text{in the irrational case.} \end{cases}$$

which reduces to (35) and (36) in the Bernoulli model ($r = 2$).

When $p_m = 1/r$ for $1 \leq m \leq r$

$$G(s) = (s + 1) \Gamma(s) \left(1 - \frac{s^2 + 4s + 8}{2^{s+3}} \right) + 2 \sum_{j \geq 1} \frac{(-1)^j j \Gamma(j + 1 + s)}{(j + 1)! (b^j - 1)} (j(j + 1 + s) - 1);$$

compare (31) and (32). Thus the average value of the periodic function is given by

$$\frac{G(-1)}{\log b} = \frac{1}{4 \log b} + \frac{2}{\log b} \sum_{k \geq 1} \frac{(-1)^k (k - 1)}{b^k - 1} = \frac{1}{4 \log b} + \frac{2}{\log b} \sum_{k \geq 1} \frac{1}{(b^k + 1)^2}.$$

This is consistent with the expression derived in [64]

$$\frac{1}{2 \log b} - \frac{1}{(\log b)^2} + \frac{2}{\log b} \sum_{k \geq 1} \frac{1}{b^k + 1} - \frac{4\pi^2}{(\log b)^3} \sum_{k \geq 1} \frac{k}{\sinh \frac{2k\pi^2}{\log b}}.$$

Equating the two expressions leads to the identity

$$\frac{1}{2} - \frac{1}{\log b} + 2 \sum_{k \geq 1} \frac{1}{b^k + 1} = \frac{1}{4} + 2 \sum_{k \geq 1} \frac{1}{(b^k + 1)^2} + \frac{4\pi^2}{(\log b)^2} \sum_{k \geq 1} \frac{k}{\sinh \frac{2k\pi^2}{\log b}},$$

which generalizes (34). Our Fourier series for F_2 is new even in this simple case.

For many other concrete examples, see [3, 55, 79, 80, 83, 103] and the references therein.

7 PATRICIA Tries

In typical random tries, internal nodes at successive levels may have only one descendant (corresponding to the extreme probabilities when binomial distribution assumes 0 and n), resulting in an increase in storage. Indeed, the expected number μ_n of internal nodes under the initial condition $\mu_1 = 0$ is asymptotic to $(h^{-1} + \mathcal{F}[G](r \log_{1/p} n))n$ (see Section 5.1). Thus the expected number of internal nodes with only one child is asymptotic to $(h^{-1} - 1 + \mathcal{F}[G](r \log_{1/p} n))n$. In the symmetric case, the leading constant (neglecting the fluctuation term) is about $1/\log 2 - 1 \approx .4427$, about 44% extra space being needed, and this is the minimum when p varies between 0 and 1. The idea of PATRICIA² tries arose when there was a need to compress such a one-child-in-one-generation pattern; see [73, 84]. When removing all such nodes, the resulting tree has $n - 1$ internal nodes (for n external nodes). See [104] for an analysis connected to unary nodes of random tries, and [5, 15, 62, 69, 95] for other linear shape measures.

Under the same Bernoulli model, we can construct random PATRICIA tries by using the same rule for constructing an ordinary trie but compress all internal nodes with only one descendant. If X_n represents an additive shape parameter in a random PATRICIA trie of size n , then, for $n \geq 2$,

$$X_n \stackrel{d}{=} X_{I'_n} + X_{n-I'_n}^* + T_n, \quad (47)$$

where

$$\mathbb{P}(I'_n = k) = \pi'_{n,k} := \frac{\binom{n}{k} p^k q^{n-k}}{1 - p^n - q^n}, \quad (k = 1, \dots, n-1),$$

and the X_n^* 's are independent copies of X_n . Since we are mainly interested in the variance, we may assume that $X_0 = X_1 = 0$. This then translates into the recurrence for the moment-generating functions (assuming T_n independent of X_n)

$$M_n(y) = \mathbb{E}(e^{T_n y}) \sum_{1 \leq k < n} \pi'_{n,k} M_k(y) M_{n-k}(y) \quad (n \geq 2),$$

with $M_0(y) = M_1(y) = 1$. It follows that the Poisson generating function \tilde{f}_1 of $\mathbb{E}(X_n)$ satisfies the functional equation

$$\tilde{f}_1(z) = \tilde{f}_1(pz) + \tilde{f}_1(qz) + \tilde{g}_1(z) - e^{-qz} \tilde{g}_1(pz) - e^{-pz} \tilde{g}_1(qz), \quad (48)$$

with $\tilde{f}_1(0) = \tilde{f}'_1(0) = 0$, where \tilde{g}_1 represents the Poisson generating function of $\mathbb{E}(T_n)$. For convenience, we also assume $\tilde{g}_1(0) = \tilde{g}'_1(0) = 0$.

The same tools we developed for tries readily apply to (48) and the same asymptotic pattern holds.

Theorem 7.1. *Let $0 < \theta < \pi/2$, $\alpha < 1$ and $\beta \in \mathbb{R}$.*

(a) *If more precisely $\tilde{g}_1 \in \mathcal{I}\mathcal{S}_{\alpha,\beta}$, then*

$$\frac{\mathbb{E}(X_n)}{n} = \frac{G_1(-1)}{h} + \mathcal{F}[G](r \log_{1/p} n) + o(1),$$

where $G_1(s) = \mathcal{M}[\tilde{g}_1(z) - e^{-qz} \tilde{g}_1(pz) - e^{-pz} \tilde{g}_1(qz); s]$.

²PATRICIA is the acronym of “practical algorithm to retrieve information coded in alphanumeric”.

(b) If $\tilde{g}_1 \in \mathcal{I}\mathcal{S}$ and $\tilde{g}_1(z) = cz + O(|z|^\alpha (\log_+ |z|)^\beta)$ uniformly for $|\arg(z)| \leq \theta$, then

$$\frac{\mathbb{E}(X_n)}{n} = \frac{c}{h} \log n + \frac{d}{h} + \frac{p \log^2 p + q \log^2 q}{2h^2} + \mathcal{F}[G_1](r \log_{1/p} n) + o(1),$$

where $G_1(s)$ is the meromorphic continuation of $\mathcal{M}[\tilde{g}_1(z) - e^{-qz} \tilde{g}_1(pz) - e^{-pz} \tilde{g}_1(qz); s]$ and $d = \lim_{s \rightarrow -1} (G_1(s) + c/(s+1))$.

Since the method of proof is the same as that of Theorem 4.1, we omit the details. For the variance of X_n , we have, using the same notations,

$$\tilde{V}_X(z) = \tilde{V}_X(pz) + \tilde{V}_X(qz) + \tilde{V}_T(z) + \tilde{\phi}_0(z) + \tilde{\phi}_1(z) + \tilde{\phi}_2(z),$$

where

$$\begin{aligned} \tilde{\phi}_0(z) &= -e^{-qz} \tilde{g}_2(pz) - e^{-pz} \tilde{g}_2(qz) + 2\tilde{g}_1(z) (e^{-qz} \tilde{g}_1(pz) + e^{-pz} \tilde{g}_1(qz)) \\ &\quad - 2z \tilde{g}'_1(z) (qe^{-qz} \tilde{g}_1(pz) + pe^{-pz} \tilde{g}_1(qz) - pe^{-qz} \tilde{g}'_1(pz) - qe^{-pz} \tilde{g}'_1(qz)) \\ &\quad - z (qe^{-qz} \tilde{g}_1(pz) + pe^{-pz} \tilde{g}_1(qz) - pe^{-qz} \tilde{g}'_1(pz) - qe^{-pz} \tilde{g}'_1(qz))^2 \\ &\quad - (e^{-qz} \tilde{g}_1(pz) + e^{-pz} \tilde{g}_1(qz))^2, \end{aligned}$$

and

$$\begin{aligned} \tilde{\phi}_1(z) &= \tilde{h}_2(z) - 2\tilde{g}_1(z) (\tilde{f}_1(pz) + \tilde{f}_1(qz)) - 2z \tilde{g}'_1(z) (p\tilde{f}'_1(pz) + q\tilde{f}'_1(qz)) \\ &\quad + 2 (e^{-qz} \tilde{g}_1(pz) + e^{-pz} \tilde{g}_1(qz)) (\tilde{f}_1(pz) + \tilde{f}_1(qz)) \\ &\quad - 2z (qe^{-qz} \tilde{g}_1(pz) + pe^{-pz} \tilde{g}_1(qz) - pe^{-qz} \tilde{g}'_1(pz) - qe^{-pz} \tilde{g}'_1(qz)) \\ &\quad \quad \times (p\tilde{f}'_1(pz) + q\tilde{f}'_1(qz)) \\ \tilde{\phi}_2(z) &= pqz (\tilde{f}'_1(pz) - \tilde{f}'_1(qz))^2. \end{aligned}$$

Here \tilde{h}_2 is given by

$$\begin{aligned} \tilde{h}_2(z) &= 2e^{-z} \sum_{n \geq 0} \mathbb{E}(T_n) \sum_{0 \leq j \leq n} \pi_{n,j} (\mathbb{E}(X_j) + \mathbb{E}(X_{n-j})) \frac{z^n}{n!} \\ &\quad - 2e^{-z} \sum_{n \geq 0} (p^n + q^n) \mathbb{E}(T_n) \mathbb{E}(X_n) \frac{z^n}{n!}. \end{aligned}$$

Note that, by Propositions 3.2 and 3.3, if $\tilde{g}_1 \in \mathcal{I}\mathcal{S}$, then $\tilde{f}_1 \in \mathcal{I}\mathcal{S}$, which in turn implies, by Proposition 3.5, that $\tilde{h}_2 \in \mathcal{I}\mathcal{S}$. Consequently, if $\tilde{g}_1 \in \mathcal{I}\mathcal{S}$ and $\tilde{g}_2 \in \mathcal{I}\mathcal{S}$, then both $\tilde{f}_1 \in \mathcal{I}\mathcal{S}$ and $\tilde{f}_2 \in \mathcal{I}\mathcal{S}$. Thus our approach applies to $\mathbb{V}(X_n)$.

Theorem 7.2. Let $0 < \theta < \pi/2$, $\alpha < 1$ and $\beta \in \mathbb{R}$. Assume $\tilde{g}_1, \tilde{g}_2 \in \mathcal{I}\mathcal{S}$ and $\tilde{V}_T(z) = O(|z|^\alpha (\log_+ |z|)^\beta)$ for $|\arg(z)| \leq \theta$.

(a) If $p = q = 1/2$, and $\tilde{g}_1 \in \mathcal{I}\mathcal{S}_{\alpha,\beta}$ or $\tilde{g}_1 \in \mathcal{I}\mathcal{S}_{1,0}$. Then

$$\frac{\mathbb{V}(X_n)}{n} = \frac{1}{\log 2} \sum_{k \in \mathbb{Z}} G(-1 + \chi_k) n^{-\chi_k} + o(1),$$

where $G(s) = \mathcal{M}[\tilde{V}_T(z) + \tilde{\phi}_0(z) + \tilde{\phi}_1(z); s]$.

(b) Assume $p \neq q$.

(i) If $\tilde{g}_1 \in \mathcal{I}\mathcal{S}_{\alpha,\beta}$, then

$$\frac{\mathbb{V}(X_n)}{n} = \frac{G(-1)}{h} + \mathcal{F}[G](r \log_{1/p} n) + o(1),$$

where $G(s) = \Phi_1(s) + \Phi_2(s)$ with $\Phi_1(s) = \mathcal{M}[\tilde{V}_T(z) + \tilde{\phi}_0(z) + \tilde{\phi}_1(z)]$ and $\Phi_2(s)$ is an analytic continuation of $\mathcal{M}[\tilde{\phi}_2; s]$.

(ii) If $\tilde{g}_1(z) = z + O(|z|^\alpha (\log_+ |z|)^\beta)$ uniformly for $|\arg(z)| \leq \theta$. Then

$$\begin{aligned} \frac{\mathbb{V}(X_n)}{n} &= \frac{pq \log^2(p/q)}{h^3} \log n + \frac{d}{h} + \frac{p \log^2 p + q \log^2 q}{2h^2} \\ &\quad + \mathcal{F}[G](r \log_{1/p} n) + o(1). \end{aligned}$$

Here $G(s) = \Phi_1(s) + \Phi_2(s)$ with $\Phi_1(s)$ as above, $\Phi_2(s)$ is a meromorphic continuation of $\mathcal{M}[\tilde{\phi}_2; s]$ and $d = \lim_{s \rightarrow -1} (G(s) + pq \log^2(p/q)/(h^2(s+1)))$.

The proof follows the same arguments as that of Theorem 4.2 and is omitted.

Consider the external path length, which satisfies (47) with $T_n = n$. In this case, we have

$$\tilde{g}_1(z) = z(1 - e^{-z}), \quad \tilde{g}_2(z) = z(1 - e^{-z}) + z^2,$$

and

$$\tilde{V}_T(z) = e^{-z}(z(1 - e^{-z}) + z^2(1 - z)e^{-z}).$$

Also

$$\begin{aligned} \tilde{\phi}_1(z) &= -2zpq \left((zp - 1)e^{-pz} \tilde{f}'_1(pz) + (zq - 1)e^{-qz} \tilde{f}'_1(qz) \right. \\ &\quad \left. + (zp + 1)e^{-qz} \tilde{f}'_1(pz) + (zq + 1)e^{-pz} \tilde{f}'_1(qz) \right) \\ &\quad + 2qze^{-pz} \tilde{f}_1(pz) + 2pze^{-qz} \tilde{f}_1(qz). \end{aligned}$$

Observe that

$$G_1(s) := \mathcal{M}[\tilde{g}_1(z) - e^{-qz} \tilde{g}_1(pz) - e^{-pz} \tilde{g}_1(qz); s] = -\Gamma(s+1) (qp^{-s-1} + pq^{-s-1}).$$

Thus, by Theorem 7.1,

$$\frac{\mathbb{E}(X_n)}{n} = \frac{1}{h} \log n + \frac{\gamma}{h} + \frac{p \log^2 p + q \log^2 q}{2h^2} - 1 + \mathcal{F}[G_1](r \log_{1/p} n) + o(1).$$

Now by Theorem 7.2, the variance satisfies

$$\frac{\mathbb{V}(X_n)}{n} = \frac{G(-1)}{h} + \mathcal{G}[G](r \log_{1/p} n) + o(1),$$

where $G = \Phi_1 + \Phi_2$, as described in Theorem 7.2. Expressions can be derived for G . For brevity, consider only the symmetric case for which we have

$$\begin{aligned} G(s) = \Phi_1(s) &= \Gamma(s+1) \left(2^{s+1}(s+2) - \frac{s^2 + 3s + 6}{4} \right) \\ &\quad + 2^{s+2} \sum_{j \geq 1} \frac{(-1)^j \Gamma(s+j+2)}{(j-1)!(2^j-1)}. \end{aligned}$$

Note that the last series has the alternative form

$$\sum_{j \geq 1} \frac{(-1)^j \Gamma(s + j + 2)}{(j - 1)! (2^j - 1)} = -\Gamma(s + 3) \sum_{j \geq 1} \frac{1}{2^j (1 + 2^{-j})^{3+s}}.$$

Hence, the mean value of the periodic function is given by

$$1 + \frac{3}{4 \log 2} + \frac{2}{\log 2} \sum_{j \geq 1} \frac{1}{2^j (1 + 2^{-j})^2} \approx 0.36132\ 60597\ 81678 \dots$$

which is the same as that obtained in [69] with a different expression (equating our expression with theirs gives the same identity (34)).

8 Conclusions

The prevalent appearance in diverse modeling contexts and high concentration of the binomial distribution make BSPs a distinctive subject full of featured properties and numerous extensions. Periodic oscillation is among the phenomena for which analytic tools proved to be a successful bridge between theory and practical observations. The analytic methodology developed in this paper, based largely on earlier works founded by Flajolet and his coauthors and aiming at clarifying the periodic oscillation of the variance, is itself easily amended for other circumstances, including particularly the case of quadratic shape measures such as the Wiener index (see [44]) or the analysis of partial-match queries (see [42]). The combination of Mellin analysis and analytic de-Poissonization (operated at the more abstract level of admissible functions) proves once again to be powerful tools for unriddling the intrinsic complexity of the asymptotic variance, and provides an efficient mechanical *art of conjecturing* and proving in more general contexts the structure of the variance. More developments will be discussed in a subsequent paper.

References

- [1] ALDOUS, D. Probability distributions on cladograms. In *Random discrete structures (Minneapolis, MN, 1993)*, vol. 76 of *IMA Vol. Math. Appl.* Springer, New York, 1996, pp. 1–18.
- [2] BANDERIER, C., HWANG, H.-K., RAVELOMANANA, V., AND ZACHAROVAS, V. Analysis of an exhaustive search algorithm in random graphs and the $n^{c \log n}$ -asymptotics. Submitted for publication.
- [3] BIGLIERI, E., AND GYÖRFI, L. *Multiple Access Channels: Theory and Practice*. NATO Security Through Science Series. D: Information and Com. Ios PressInc, 2007.
- [4] BLUM, M. G. B., AND FRANÇOIS, O. Minimal clade size and external branch length under the neutral coalescent. *Adv. in Appl. Probab.* 37, 3 (2005), 647–662.
- [5] BOURDON, J., NEBEL, M., AND VALLÉE, B. On the stack-size of general tries. *Theor. Inform. Appl.* 35, 2 (2001), 163–185.

- [6] BRADLEY, R., AND STRENSKI, P. Directed aggregation on the bethe lattice: Scaling, mappings, and universality. *Physical Review B* 31, 7 (1985), 4319.
- [7] CHEN, W.-M., AND HWANG, H.-K. Analysis in distribution of two randomized algorithms for finding the maximum in a broadcast communication model. *J. Algorithms* 46, 2 (2003), 140–177.
- [8] CHRISTOPHI, C. A., AND MAHMOUD, H. M. Distribution of the size of random hash trees, pebbled hash trees and N -trees. *Statist. Probab. Lett.* 53, 3 (2001), 277–282.
- [9] CLÉMENT, J., FLAJOLET, P., AND VALLÉE, B. Dynamical sources in information theory: a general analysis of trie structures. *Algorithmica* 29, 1-2 (2001), 307–369.
- [10] CRISTEA, L.-L., AND PRODINGER, H. Order statistics for the Cantor-Fibonacci distribution. *Aequationes Math.* 73, 1-2 (2007), 78–91.
- [11] DE BRUIJN, N. G., KNUTH, D. E., AND RICE, S. O. The average height of planted plane trees. In *Graph theory and Computing*. Academic Press, New York, 1972, pp. 15–22.
- [12] DE LA BRIANDAIS, R. File searching using variable length keys. In *Papers presented at the Western Joint Computer Conference (March 3-5, 1959)* (1959), ACM, pp. 295–298.
- [13] DEAN, D. S., AND MAJUMDAR, S. N. Phase transition in a generalized Eden growth model on a tree. *J. Stat. Phys.* 124, 6 (2006), 1351–1376.
- [14] DEVROYE, L. *Lecture Notes on Bucket Algorithms*, vol. 6 of *Progress in Computer Science*. Birkhäuser Boston Inc., Boston, MA, 1986.
- [15] DEVROYE, L. Universal asymptotics for random tries and PATRICIA trees. *Algorithmica* 42, 1 (2005), 11–29.
- [16] DRMOTA, M., GITTENBERGER, B., PANHOLZER, A., PRODINGER, H., AND WARD, M. D. On the shape of the fringe of various types of random trees. *Math. Methods Appl. Sci.* 32, 10 (2009), 1207–1245.
- [17] DRMOTA, M., AND SZPANKOWSKI, W. A master theorem for discrete divide and conquer recurrences. In *Proceedings of the Twenty-Second Annual ACM-SIAM Symposium on Discrete Algorithms* (Philadelphia, PA, 2011), SIAM, pp. 342–361.
- [18] EISENBERG, B. On the expectation of the maximum of IID geometric random variables. *Statist. Probab. Lett.* 78, 2 (2008), 135–143.
- [19] ERDŐS, P., HILDEBRAND, A., ODLYZKO, A., PUDAITE, P., AND REZNICK, B. The asymptotic behavior of a family of sequences. *Pacific J. Math.* 126, 2 (1987), 227–241.
- [20] FAGIN, R., NIEVERGELT, J., PIPPENGER, N., AND STRONG, H. R. Extendible hashing - a fast access method for dynamic files. *ACM Trans. Database Syst.* 4, 3 (1979), 315–344.

- [21] FAYOLLE, G., FLAJOLET, P., AND HOFRI, M. On a functional equation arising in the analysis of a protocol for a multi-access broadcast channel. *Adv. in Appl. Probab.* 18, 2 (1986), 441–472.
- [22] FAYOLLE, G., FLAJOLET, P., HOFRI, M., AND JACQUET, P. Analysis of a stack algorithm for random multiple-access communication. *IEEE Trans. Inform. Theory* 31, 2 (1985), 244–254.
- [23] FILL, J. A., MAHMOUD, H. M., AND SZPANKOWSKI, W. On the distribution for the duration of a randomized leader election algorithm. *Ann. Appl. Probab.* 6, 4 (1996), 1260–1283.
- [24] FLAJOLET, P. On the performance evaluation of extendible hashing and trie searching. *Acta Inform.* 20, 4 (1983), 345–369.
- [25] FLAJOLET, P. Approximate counting: a detailed analysis. *BIT* 25, 1 (1985), 113–134.
- [26] FLAJOLET, P. Évaluation de protocoles de communication : aspects mathématiques. In *Le Codage et la Transmission de l'Information : Journée annuelle de la Société Mathématique de France*. Société Mathématique de France, 1988, pp. 1–22.
- [27] FLAJOLET, P. Counting by coin tossings. In *Advances in Computer Science - ASIAN 2004. Higher-Level Decision Making; Proceedings of the 9th Asian Computing Science Conference; Dedicated to Jean-Louis Lassez on the Occasion of His 5th Cycle Birthday*, M. J. Maher, Ed., vol. 3321. Springer, Berlin/Heidelberg, 2004, pp. 1–12.
- [28] FLAJOLET, P., FUSY, É., GANDOUET, O., AND MEUNIER, F. HyperLogLog: the analysis of a near-optimal cardinality estimation algorithm. In *2007 Conference on Analysis of Algorithms, AofA 07*, Discrete Math. Theor. Comput. Sci. Proc., AH. Assoc. Discrete Math. Theor. Comput. Sci., Nancy, 2007, pp. 127–145.
- [29] FLAJOLET, P., GOURDON, X., AND DUMAS, P. Mellin transforms and asymptotics: harmonic sums. *Theoret. Comput. Sci.* 144, 1-2 (1995), 3–58.
- [30] FLAJOLET, P., AND MARTIN, G. N. Probabilistic counting algorithms for data base applications. *J. Comput. System Sci.* 31, 2 (1985), 182–209.
- [31] FLAJOLET, P., PELLETIER, M., AND SORIA, M. On Buffon machines and numbers. In *Proceedings of the Twenty-Second Annual ACM-SIAM Symposium on Discrete Algorithms* (Philadelphia, PA, 2011), SIAM, pp. 172–183.
- [32] FLAJOLET, P., AND PUECH, C. Partial match retrieval of multidimensional data. *J. Assoc. Comput. Mach.* 33, 2 (1986), 371–407.
- [33] FLAJOLET, P., RÉGNIER, M., AND SEDGEWICK, R. Some uses of the Mellin integral transform in the analysis of algorithms. In *Combinatorial algorithms on words (Maratea, 1984)*, vol. 12 of *NATO Adv. Sci. Inst. Ser. F Comput. Systems Sci.* Springer, Berlin, 1985, pp. 241–254.

- [34] FLAJOLET, P., ROUX, M., AND VALLÉE, B. Digital trees and memoryless sources: from arithmetics to analysis. In *21st International Meeting on Probabilistic, Combinatorial, and Asymptotic Methods in the Analysis of Algorithms (AofA'10)*, Discrete Math. Theor. Comput. Sci. Proc., AM. Assoc. Discrete Math. Theor. Comput. Sci., Nancy, 2010, pp. 233–260.
- [35] FLAJOLET, P., AND SAHEB, N. The complexity of generating an exponentially distributed variate. *J. Algorithms* 7, 4 (1986), 463–488.
- [36] FLAJOLET, P., AND SEDGEWICK, R. Mellin transforms and asymptotics: finite differences and Rice’s integrals. *Theoret. Comput. Sci.* 144, 1-2 (1995), 101–124.
- [37] FLAJOLET, P., AND SEDGEWICK, R. *Analytic combinatorics*. Cambridge University Press, Cambridge, 2009.
- [38] FLAJOLET, P., AND SOTTEAU, D. A recursive partitioning process of computer science. In *Proceedings of the Second World Conference on Mathematics at the Service of Man* (Las Palmas, Canary Islands, Spain, 1982), A. Ballester, D. Cardús, and E. Trillas, Eds., Universidad Politécnica de Las Palmas, pp. 25–30.
- [39] FLAJOLET, P., AND STEYAERT, J.-M. A branching process arising in dynamic hashing, trie searching and polynomial factorization. In *Automata, languages and programming (Aarhus, 1982)*, vol. 140 of *Lecture Notes in Comput. Sci.* Springer, Berlin, 1982, pp. 239–251.
- [40] FREDKIN, E. Trie memory. *Commun. ACM* 3 (September 1960), 490–499.
- [41] FREDMAN, M. L., AND KNUTH, D. E. Recurrence relations based on minimization. *J. Math. Anal. Appl.* 48 (1974), 534–559.
- [42] FUCHS, M. The variance for partial match retrievals in k -dimensional bucket digital trees. In *21st International Meeting on Probabilistic, Combinatorial, and Asymptotic Methods in the Analysis of Algorithms (AofA'10)*, Discrete Math. Theor. Comput. Sci. Proc., AM. Assoc. Discrete Math. Theor. Comput. Sci., Nancy, 2010, pp. 261–275.
- [43] FUCHS, M. The subtree size profile of plane-oriented recursive trees. In *ANALCO11—Workshop on Analytic Algorithmics and Combinatorics*. SIAM, Philadelphia, PA, 2011, pp. 85–92.
- [44] FUCHS, M., AND LEE, C.-K. The Wiener index of random digital tries. submitted for publication (2012).
- [45] FUCHS, M., AND PRODINGER, H. Words with a generalized restricted growth property. *Indagationes Mathematicae* (2013), to appear.
- [46] GELENBE, E., NELSON, R., PHILIPS, T., AND TANTAWI, A. An approximation of the processing time for a random graph model of parallel computation. In *Proceedings of 1986 ACM Fall Joint Computer Conference* (Los Alamitos, CA, USA, 1986), ACM '86, IEEE Computer Society Press, pp. 691–697.

- [47] GOODRICH, M. T., AND HIRSCHBERG, D. S. Improved adaptive group testing algorithms with applications to multiple access channels and dead sensor diagnosis. *J. Comb. Optim.* 15, 1 (2008), 95–121.
- [48] GRABNER, P. J., AND PRODINGER, H. Asymptotic analysis of the moments of the Cantor distribution. *Statist. Probab. Lett.* 26, 3 (1996), 243–248.
- [49] GRABNER, P. J., AND PRODINGER, H. Sorting algorithms for broadcast communications: mathematical analysis. *Theoret. Comput. Sci.* 289, 1 (2002), 51–67.
- [50] HAYMAN, W. K. A generalisation of Stirling’s formula. *J. Reine Angew. Math.* 196 (1956), 67–95.
- [51] HILDEBRANDT, P., AND ISBITZ, H. Radix exchange—an internal sorting method for digital computers. *J. ACM* 6, 2 (Apr. 1959), 156–163.
- [52] HUBALEK, F., HWANG, H.-K., LEW, W., MAHMOUD, H., AND PRODINGER, H. A multivariate view of random bucket digital search trees. *J. Algorithms* 44, 1 (2002), 121–158.
- [53] HUSH, D. R., AND WOOD, C. Analysis of tree algorithms for rfid arbitration. In *1998 IEEE International Symposium on Information Theory* (1998), IEEE, p. 107.
- [54] HWANG, H.-K., FUCHS, M., AND ZACHAROVAS, V. Asymptotic variance of random symmetric digital search trees. *Discrete Math. Theor. Comput. Sci.* 12, 2 (2010), 103–165.
- [55] JACQUET, P. The part and try algorithm adapted to free channel access. Tech. Rep. RR-0436, INRIA, Rocquencourt, Aug. 1985.
- [56] JACQUET, P., AND MUHLETHALER, P. Marginal throughput of a stack algorithm for CSMA/CD random length packet communication when the load is over the channel efficiency. Tech. Rep. RR-1275, INRIA, Rocquencourt, Aug. 1990.
- [57] JACQUET, P., AND RÉGNIER, M. Trie partitioning process: limiting distributions. In *CAAP ’86 (Nice, 1986)*, vol. 214 of *Lecture Notes in Comput. Sci.* Springer, Berlin, 1986, pp. 196–210.
- [58] JACQUET, P., AND REGNIER, M. Normal limiting distribution for the size and the external path length of tries. Tech. Rep. RR-0827, INRIA, Rocquencourt, Apr. 1988.
- [59] JACQUET, P., AND RÉGNIER, M. Normal limiting distribution of the size of tries. In *Performance ’87 (Brussels, 1987)*. North-Holland, Amsterdam, 1988, pp. 209–223.
- [60] JACQUET, P., AND SZPANKOWSKI, W. Asymptotic behavior of the Lempel-Ziv parsing scheme and [in] digital search trees. *Theoret. Comput. Sci.* 144, 1-2 (1995), 161–197.
- [61] JACQUET, P., AND SZPANKOWSKI, W. Analytical de-Poissonization and its applications. *Theoret. Comput. Sci.* 201, 1-2 (1998), 1–62.

- [62] JANSON, S. Renewal theory in the analysis of tries and strings. *Theoret. Comput. Sci.* 416 (2012), 33–54.
- [63] JANSON, S., AND SZPANKOWSKI, W. Analysis of an asymmetric leader election algorithm. *Electron. J. Combin.* 4, 1 (1997), Research Paper 17, 16 pp. (electronic).
- [64] JANSSEN, A. J. E. M., AND DE JONG, M. J. Analysis of contention tree algorithms. *IEEE Trans. Inform. Theory* 46, 6 (2000), 2163–2172.
- [65] KAPLAN, M. A., AND GULKO, E. Analytic properties of multiple-access trees. *IEEE Trans. Inform. Theory* 31, 2 (1985), 255–263.
- [66] KEMP, R. The average number of registers needed to evaluate a binary tree optimally. *Acta Inform.* 11, 4 (1978/79), 363–372.
- [67] KIRSCHENHOFER, P., AND PRODINGER, H. *b*-tries: a paradigm for the use of number-theoretic methods in the analysis of algorithms. In *Contributions to General Algebra*, 6. Hölder-Pichler-Tempsky, Vienna, 1988, pp. 141–154.
- [68] KIRSCHENHOFER, P., AND PRODINGER, H. On some applications of formulae of Ramanujan in the analysis of algorithms. *Mathematika* 38, 1 (1991), 14–33.
- [69] KIRSCHENHOFER, P., PRODINGER, H., AND SZPANKOWSKI, W. On the balance property of Patricia tries: external path length viewpoint. *Theoret. Comput. Sci.* 68, 1 (1989), 1–17.
- [70] KIRSCHENHOFER, P., PRODINGER, H., AND SZPANKOWSKI, W. On the variance of the external path length in a symmetric digital trie. *Discrete Appl. Math.* 25, 1-2 (1989), 129–143.
- [71] KIRSCHENHOFER, P., PRODINGER, H., AND SZPANKOWSKI, W. Multidimensional digital searching and some new parameters in tries. *Internat. J. Found. Comput. Sci.* 4, 1 (1993), 69–84.
- [72] KNUTH, D. E. The average time for carry propagation. *Nederl. Akad. Wetensch. Indag. Math.* 40, 2 (1978), 238–242.
- [73] KNUTH, D. E. *The Art of Computer Programming, Volume III, Sorting and Searching*, 2nd ed. Addison-Wesley, 1998.
- [74] LOUCHARD, G., PRODINGER, H., AND WARD, M. D. Number of survivors in the presence of a demon. *Period. Math. Hungar.* 64, 1 (2012), 101–117.
- [75] MADDISON, W. P., AND SLATKIN, M. Null models for the number of evolutionary steps in a character on a phylogenetic tree. *Evolution* (1991), 1184–1197.
- [76] MAHMOUD, H., FLAJOLET, P., JACQUET, P., AND RÉGNIER, M. Analytic variations on bucket selection and sorting. *Acta Inform.* 36, 9-10 (2000), 735–760.
- [77] MAHMOUD, H. M. *Evolution of Random Search Trees*. Wiley-Interscience Series in Discrete Mathematics and Optimization. John Wiley & Sons Inc., New York, 1992.

- [78] MAJUMDAR, S. N. Traveling front solutions to directed diffusion-limited aggregation, digital search trees, and the lempel-ziv data compression algorithm. *Physical Review E* 68, 2 (2003), 026103.
- [79] MASSEY, J. L. Collision-resolution algorithms and random-access communications. In *Multi-User Communication Systems*, G. Longo, Ed., vol. CISM Courses and Lectures. Springer, 1981, pp. 73–137.
- [80] MATHYS, P., AND FLAJOLET, P. Q -ary collision resolution algorithms in random-access systems with free or blocked channel access. *IEEE Trans. Inform. Theory* 31, 2 (1985), 217–243.
- [81] MELLIER, R., MYOUPPO, J. F., AND RAVELOMANANA, V. A non-token-based-distributed mutual exclusion algorithm for single-hop mobile ad hoc networks. In *MWCN 2004* (2004), pp. 287–298.
- [82] MENDELSON, H. Analysis of extendible hashing. *IEEE Trans. Software Engrg.*, 6 (1982), 611–619.
- [83] MOLLE, M. L., AND POLYZOS, G. C. Conflict resolution algorithms and their performance analysis. *Tech. Rep., Dept. CSE, UCSD* (1993).
- [84] MORRISON, D. R. Patricia—practical algorithm to retrieve information coded in alphanumeric. *J. ACM* 15, 4 (1968), 514–534.
- [85] MYOUPPO, J. F., THIMONIER, L., AND RAVELOMANANA, V. Average case analysis-based protocols to initialize packet radio networks. *Wireless Commun. Mobile Comput.* 3, 4 (2003), 539–548.
- [86] NAMBOODIRI, V., AND GAO, L. Energy-aware tag anticollision protocols for rfid systems. *IEEE Trans. Mobile Comput.* 9, 1 (2010), 44–59.
- [87] NEININGER, R., AND RÜSCHENDORF, L. A general limit theorem for recursive algorithms and combinatorial structures. *Ann. Appl. Probab.* 14, 1 (2004), 378–418.
- [88] NGUYEN-THE, M. *Distribution de valuations sur les arbres*. PhD thesis, LIX, Ecole Polytechnique, 2004.
- [89] NICODÈME, P., SALVY, B., AND FLAJOLET, P. Motif statistics. *Theoret. Comput. Sci.* 287, 2 (2002), 593–617.
- [90] PARK, G., HWANG, H.-K., NICODÈME, P., AND SZPANKOWSKI, W. Profiles of tries. *SIAM J. Comput.* 38, 5 (2008/09), 1821–1880.
- [91] POLASEK, W. The Bernoullis and the origin of probability theory: Looking back after 300 years. *Resonance* 5, 8 (2000), 26–42.
- [92] PRODINGER, H. How to select a loser. *Discrete Math.* 120, 1-3 (1993), 149–159.
- [93] RÉGNIER, M., AND JACQUET, P. New results on the size of tries. *IEEE Trans. Inform. Theory* 35, 1 (1989), 203–205.

- [94] RESSLER, E. K. Random list permutations in place. *Inform. Process. Lett.* 43, 5 (1992), 271–275.
- [95] SCHACHINGER, W. On the variance of a class of inductive valuations of data structures for digital search. *Theoret. Comput. Sci.* 144, 1-2 (1995), 251–275.
- [96] SCHACHINGER, W. Limiting distributions for the costs of partial match retrievals in multidimensional tries. *Random Structures Algorithms* 17, 3-4 (2000), 428–459.
- [97] SEDGEWICK, R. Data movement in odd-even merging. *SIAM J. Comput.* 7, 3 (1978), 239–272.
- [98] SHAFER, G. The significance of Jacob Bernoulli’s *Ars Conjectandi* for the philosophy of probability today. *J. Econometrics* 75, 1 (1996), 15–32.
- [99] SHIAU, S.-H., AND YANG, C.-B. A fast initialization algorithm for single-hop wireless networks. *IEICE Transactions* 88-B, 11 (2005), 4285–4292.
- [100] SIMON, K. An improved algorithm for transitive closure on acyclic digraphs. *Theoret. Comput. Sci.* 58, 1-3 (1988), 325–346.
- [101] SZPANKOWSKI, W. Patricia tries again revisited. *J. Assoc. Comput. Mach.* 37, 4 (1990), 691–711.
- [102] SZPANKOWSKI, W. *Average Case Analysis of Algorithms on Sequences*. Wiley-Interscience, New York, 2001. With a foreword by Philippe Flajolet.
- [103] WAGNER, S. On tries, contention trees and their analysis. *Ann. Comb.* 12, 4 (2009), 493–507.
- [104] WAGNER, S. On unary nodes in tries. In *21st International Meeting on Probabilistic, Combinatorial, and Asymptotic Methods in the Analysis of Algorithms (AofA’10)*, Discrete Math. Theor. Comput. Sci. Proc., AM. Assoc. Discrete Math. Theor. Comput. Sci., Nancy, 2010, pp. 577–589.
- [105] YANG, C.-B. Reducing conflict resolution time for solving graph problems in broadcast communications. *Inf. Process. Lett.* 40, 6 (1991), 295–302.