

Transparency condition in the categories of Yetter-Drinfel'd modules over Hopf algebras in braided categories

B. Femić

June 10, 2011

Abstract

We study versions of the categories of Yetter-Drinfel'd modules over a Hopf algebra H in a braided monoidal category \mathcal{C} . Contrarywise to Bespalov's approach, all our structures live in \mathcal{C} . This forces H to be transparent or equivalently to lie in Müger's center $\mathcal{Z}_2(\mathcal{C})$ of \mathcal{C} . We prove that versions of the categories of Yetter-Drinfel'd modules in \mathcal{C} are braided monoidally isomorphic to the categories of (left/right) modules over the Drinfel'd double $D(H) \in \mathcal{C}$ for H finite. We obtain that these categories polarize into two disjoint groups of mutually isomorphic braided monoidal categories. We conclude that if $H \in \mathcal{Z}_2(\mathcal{C})$, then ${}_{D(H)}\mathcal{C}$ embeds as a subcategory into the braided center category $\mathcal{Z}_1({}_H\mathcal{C})$ of the category ${}_H\mathcal{C}$ of left H -modules in \mathcal{C} . For \mathcal{C} braided, rigid and cocomplete and a quasitriangular Hopf algebra H such that $H \in \mathcal{Z}_2(\mathcal{C})$ we prove that the whole center category of ${}_H\mathcal{C}$ is monoidally isomorphic to the category of left modules over $\text{Aut}({}_H\mathcal{C}) \rtimes H$ - the bosonization of the braided Hopf algebra $\text{Aut}({}_H\mathcal{C})$ which is the coend in ${}_H\mathcal{C}$. A family of examples of a transparent Hopf algebras is discussed.

2000 Mathematics Subject Classification: 16T05, 18D10.

Keywords: braided monoidal category, braided Hopf algebra, Yetter-Drinfel'd modules, center category.

1 Introduction

Yetter introduced in [27] “crossed bimodules” generalizing to Hopf algebras the notion of crossed modules over finite groups, which appeared in topology. These new objects are modules and comodules over a Hopf algebra H over a commutative ring with a certain compatibility condition. In [11] they were used to generate solutions to the Yang-Baxter equation and accordingly were called “Yang-Baxter modules”. Yetter's construction and

its variations were studied in [23] where they were termed Yetter-Drinfel'd structures. The initial Yetter's category is denoted by ${}^H_H\mathcal{YD}$.

For a finite-dimensional Hopf algebra H Majid proved that the category ${}_{D'(H)}\mathcal{M}$ of modules over the Drinfel'd double $D'(H) = H \bowtie H^{*op}$ is isomorphic to ${}^H_H\mathcal{YD}$. In [22, Proposition 2.4] the analogous result to the former is proved for the left-right version of the Yetter-Drinfel'd category: ${}_{D(H)}\mathcal{M} \cong {}_H\mathcal{YD}^H$, where $D(H) = (H^{op})^* \bowtie H$.

Another, categorical interpretation of the Yetter-Drinfel'd categories is that they can be seen as the *center* (or the *inner double*) of the category of modules over the Hopf algebra. The center construction (which to any monoidal category assigns a braided monoidal category) is a special case of Pontryagin dual monoidal category, [13]. As observed by Drinfel'd [8] and proved in [15, Example 1.3] and [10, Theorem XIII.5.1] the left (resp. right) center of the category of left modules over H is isomorphic to ${}^H_H\mathcal{YD}$ (resp. ${}_H\mathcal{YD}^H$). For the details on the center construction we refer to [10].

In Radford biproduct Hopf algebra $B \times H$ [20], Majid observed that B is a Hopf algebra in the category ${}^H_H\mathcal{YD}$. If H is quasitriangular, a left H -module B' can be equipped with a left H -comodule structure in such a way that one gets a Yetter-Drinfel'd module. In this particular case, the Hopf algebra $B' \times H$ is named *bosonization* in [17]. The reversed process - recovering a braided Hopf algebra out of an ordinary one - was studied in [17, Section 2] and is called *mutation*.

Yetter-Drinfel'd modules through their equivalence with Hopf bimodules, [24], emerge in Woronowicz's approach to bicovariant differential calculi on quantum groups, [26]. The first order differential calculi over a Hopf algebra H over a field consist of a derivation $d : H \rightarrow \Omega^1(H)$, where $\Omega^1(H)$ is the *bicovariant bimodule* and has a structure of a Hopf bimodule. Another and exotic appearance of left-right Yetter-Drinfel'd modules we find in 3D-topological quantum field theories, [6, Theorem 3.4].

Some of the above-mentioned constructions have been generalized to any braided monoidal category. For a Hopf algebra H in a braided monoidal category \mathcal{C} which admits split idempotents the equivalence of the categories of Hopf bimodules and of Yetter-Drinfel'd modules $\mathcal{YD}(\mathcal{C})^H_H$ was proved in [2]. In the same paper the authors prove that the category of bialgebras in $\mathcal{YD}(\mathcal{C})^H_H$ is isomorphic to the category of admissible pairs in \mathcal{C} . The proof relies on the previously generalized Radford-Majid theorems to the braided case, [1, Theorems 4.1.2 and 4.1.3]. The former result provides a natural and easy description for the Radford-Majid criterion for when a Hopf algebra is a cross product.

In this paper we study categories of Yetter-Drinfel'd modules over a Hopf algebra H in a braided monoidal category \mathcal{C} with a different approach than in [1]. Moreover, we address the question of their isomorphism with the categories of left and right modules over the Drinfel'd double in \mathcal{C} . When studying the monoidal structures of the respective categories, one is tempted to impose the symmetricity of the base category \mathcal{C} as a necessary condition. To avoid this obstacle, Bespalov works in [1] both with \mathcal{C} and with its opposite and co-opposite categories, \mathcal{C}^{op} and \mathcal{C}^{cop} respectively, and with a category $\bar{\mathcal{C}}$. The opposite category of \mathcal{C} has the same objects as \mathcal{C} , but the arrows go in the reversed order. The braiding in \mathcal{C}^{op} is given by $X \otimes Y \xrightarrow{\Phi^{Y,X}} Y \otimes X$, where Φ is the braiding of \mathcal{C} .

The category \mathcal{C}^{cop} has reversed tensor product and the braiding $X \otimes^{cop} Y = Y \otimes X \xrightarrow{\Phi_{Y,X}} X \otimes Y = Y \otimes^{cop} X$. The category $\bar{\mathcal{C}}$ has the same tensor product and its braiding is Φ^{-1} . Contrarywise, in the present paper we work only with the base category \mathcal{C} and investigate which conditions we have to impose in order that the construction works. We find that it is sufficient to require that the braiding Φ of \mathcal{C} fulfills $\Phi_{H,X} = \Phi_{X,H}^{-1}$ for every $X \in \mathcal{C}$. This condition we have encountered also in [7]. It had already appeared in the literature in [4] and [18, Definition 2.9]. In the terminology of the former reference we have that H is *transparent*, while due to the latter H belongs to Müger's center $\mathcal{Z}_2(\mathcal{C}) = \{X \in \mathcal{C} | \Phi_{Y,X}\Phi_{X,Y} = id_{X \otimes Y} \text{ for all } Y \in \mathcal{C}\}$ of the braided monoidal category \mathcal{C} . The notation $\mathcal{Z}_1(\mathcal{C})$ Müger reserved for the center of the monoidal category \mathcal{C} that we mentioned above. If $\Phi_{X,Y} = \Phi_{Y,X}^{-1}$ for some $X, Y \in \mathcal{C}$, we say that $\Phi_{X,Y}$ is *symmetric*.

As a particular case of the bicrossproduct construction (with trivial coactions) in braided monoidal categories, [29], we study the Drinfel'd double $D(H)$ of H in \mathcal{C} . We obtain that $D(H) = (H^{op})^* \bowtie H$ in \mathcal{C} is a bicrossproduct Hopf algebra for finite H , if $\Phi_{H,H}$ is symmetric. Equivalent conditions for when $D(H)$ is (co)commutative are given. We prove that the category of modules over $D(H)$ in \mathcal{C} is isomorphic to that of Yetter-Drinfel'd modules over H in \mathcal{C} if H is transparent. In particular, we get that the two diagrams

$$\begin{array}{ccc}
D(H)\mathcal{C} & \xrightarrow{\quad} & {}^H_H\mathcal{YD}(\mathcal{C}) \\
\downarrow & \boxed{1} & \downarrow \\
{}^H_H\mathcal{YD}(\mathcal{C})^{H^{op}} & \xrightarrow{\quad} & {}^H_H\mathcal{YD}(\mathcal{C})_{H^{cop}} \\
\searrow & & \swarrow \\
& \mathcal{YD}(\mathcal{C})_{H^{cop}}^{H^{op}} &
\end{array}
\quad \text{and} \quad
\begin{array}{ccc}
\mathcal{C}_{D(H)} & \xrightarrow{\quad} & \mathcal{YD}(\mathcal{C})_H^H \\
\downarrow & \boxed{2} & \downarrow \\
{}^{H^{cop}}\mathcal{YD}(\mathcal{C})^H & \xrightarrow{\quad} & {}^{H^{op}}\mathcal{YD}(\mathcal{C})_H \\
\searrow & & \swarrow \\
& {}^{H^{op}}_{H^{cop}}\mathcal{YD}(\mathcal{C}) &
\end{array}$$

commute as arrows of mutually isomorphic braided monoidal categories. Our goal in this paper is not to prove that all the above Yetter-Drinfel'd categories are braided monoidally isomorphic, as it was proved in [1, Corollary 3.5.5] under the previously mentioned suppositions. Rather, we set up a different approach and investigate how far we can get in the study of the above categories.

Bespalov proved in [1, Proposition 3.6.1] that the category of left-left (resp. right-right) Yetter-Drinfel'd modules in \mathcal{C} is braided monoidally isomorphic to a subcategory of the center of the category of left H -modules (resp. right H -comodules). We differentiate the left and the right center category and observe that the mentioned category isomorphism can be extended to the categories in the rectangular diagrams $\langle 1 \rangle$ and $\langle 2 \rangle$ above yielding two polarized groups of mutually isomorphic braided monoidal categories:

$$\begin{array}{ccc}
\mathcal{Z}_l^{\mathcal{C}}({}_H\mathcal{C}) & \xrightarrow{\quad} & \mathcal{Z}_r^{\mathcal{C}}({}^H\mathcal{C}) \\
\downarrow & & \downarrow \\
\mathcal{Z}_r^{\mathcal{C}}({}_H\mathcal{C}) & \xrightarrow{\quad} & \mathcal{Z}_l^{\mathcal{C}}({}^H\mathcal{C})
\end{array}
\quad \text{and} \quad
\begin{array}{ccc}
\mathcal{Z}_r^{\mathcal{C}}(\mathcal{C}_H) & \xrightarrow{\quad} & \mathcal{Z}_l^{\mathcal{C}}(\mathcal{C}^H) \\
\downarrow & & \downarrow \\
\mathcal{Z}_r^{\mathcal{C}}(\mathcal{C}^H) & \xrightarrow{\quad} & \mathcal{Z}_l^{\mathcal{C}}(\mathcal{C}_H).
\end{array}$$

As for the relation between the centers \mathcal{Z}_1 and \mathcal{Z}_2 in the notation of Müger, we obtain in particular that if $H \in \mathcal{Z}_2(\mathcal{C})$, then ${}_{D(H)}\mathcal{C} \hookrightarrow \mathcal{Z}_{1,l}({}_H\mathcal{C})$ (and similarly $\mathcal{C}_{D(H)} \hookrightarrow \mathcal{Z}_{1,r}(\mathcal{C}_H)$).

For the whole center category of a braided, rigid and cocomplete category \mathcal{C} Majid proved $\mathcal{Z}_{1,l}(\mathcal{C}) \cong \mathcal{C}_{\text{Aut}(\mathcal{C})}$ in [14], where $\text{Aut}(\mathcal{C})$ is the coend Hopf algebra in \mathcal{C} . For a quasitriangular Hopf algebra $H \in \mathcal{C}$ [16, Definition 1.3] such that $H \in \mathcal{Z}_2(\mathcal{C})$ we obtain $\mathcal{Z}_{1,l}(\mathcal{C}_H) \cong \mathcal{C}_{H \rtimes \text{Aut}(\mathcal{C}_H)}$ as monoidal categories, where $H \rtimes \text{Aut}(\mathcal{C}_H)$ is the bosonization of the braided Hopf algebra $\text{Aut}(\mathcal{C}_H)$ in \mathcal{C}_H . When $\mathcal{C} = \text{Vec}$ and H is a finite-dimensional quasitriangular Hopf algebra, this recovers the known isomorphism $\mathcal{Z}_l(\mathcal{M}_H) \cong \mathcal{M}_{D'(H)}$. We point out that a similar result to ours was proved in [5] where the authors work with Hopf monads and construct a Drinfel'd double in a fully non-braided setting.

At the end we present a family of transparent Hopf algebras in braided monoidal categories which support our constructions.

The paper is organized as follows. In Section 2 we present preliminaries on some structures in any braided monoidal category \mathcal{C} . In the next section we study the braided monoidal category of left-right Yetter-Drinfel'd modules ${}_H\mathcal{YD}(\mathcal{C})^{H^{op}}$ (assuming that H is transparent). We point out that the categories ${}_H^H\mathcal{YD}(\mathcal{C})$ and $\mathcal{YD}(\mathcal{C})_H^H$ are braided monoidal without any symmetricity conditions on the braiding. Section 4 recalls the bicrossproduct construction (with trivial coactions) in \mathcal{C} . We use it to study the Drinfel'd double $D(H) = (H^{op})^* \bowtie H$ in \mathcal{C} for a finite H , when $\Phi_{H,H}$ is symmetric. Section 5 is devoted to the braided monoidal isomorphism ${}_{D(H)}\mathcal{C} \cong {}_H\mathcal{YD}(\mathcal{C})^{H^{op}}$. In Section 6 we compare different versions of the braided Yetter-Drinfel'd categories in \mathcal{C} , connecting them with the categories of left and right modules over the Drinfel'd double in \mathcal{C} . In the penultimate section we deal with the center construction and relate it to the Yetter-Drinfel'd categories. The last section presents some examples.

Acknowledgements. This work has partially been developed in the Mathematical Institute of the Serbian Academy of Sciences and Arts in Belgrade (Serbia). The author wishes to thank to Facultad de Ciencias de la Universidad de la República in Montevideo for their warm hospitality and provision of the necessary facilities. My gratitude to Yuri Bespalov for clarifying me his proof of [1, Proposition 3.6.1], and to Alain Bruguière for the discussions on the construction of the Drinfel'd double via monads.

2 Preliminaries

We assume the reader is familiar with the theory of braided monoidal categories as well as with the notation of braided diagrams. For the references we recommend [10] and [1]. We recall that a Hopf algebra in a braided monoidal category \mathcal{C} was introduced by Majid in [15]. In the same paper it was proved that the categories of modules and comodules over a bialgebra in \mathcal{C} are monoidal. We only outline some basic conventions. In view of Mac Lane's Coherence Theorem we will assume that our braided monoidal category \mathcal{C} is strict. Our braided diagrams are read from top to bottom, the braiding $\Phi : X \otimes Y \rightarrow Y \otimes X$ and its inverse in \mathcal{C} we denote by:

$$\Phi_{X,Y} = \begin{array}{c} X \ Y \\ \times \\ Y \ X \end{array} \quad \text{and} \quad \Phi_{Y,X}^{-1} = \begin{array}{c} Y \ X \\ \times \\ X \ Y \end{array}$$

For an algebra $A \in \mathcal{C}$ and a coalgebra $C \in \mathcal{C}$ the multiplication in the opposite algebra A^{op} of A and the comultiplication in the co-opposite coalgebra C^{cop} of C we denote by:

$$\nabla_{A^{op}} = \begin{array}{c} A \quad A \\ \text{---} \\ \text{---} \\ \text{---} \\ A \end{array} \quad \text{and} \quad \Delta_{C^{cop}} = \begin{array}{c} C \\ \text{---} \\ \text{---} \\ \text{---} \\ C \quad C \end{array}$$

respectively. The antipode S of a Hopf algebra H in \mathcal{C} is a bialgebra map $S : H \rightarrow H^{op,cop}$. Its compatibility with multiplication and comultiplication is written as:

$$\begin{array}{c} H \quad H \\ \text{---} \\ \text{---} \\ \text{---} \\ \text{---} \\ H \end{array} \text{---} \begin{array}{c} H \quad H \\ \text{---} \\ \text{---} \\ \text{---} \\ \text{---} \\ H \end{array} \quad \text{and} \quad \begin{array}{c} H \\ \text{---} \\ \text{---} \\ \text{---} \\ H \quad H \end{array} \text{---} \begin{array}{c} H \\ \text{---} \\ \text{---} \\ \text{---} \\ H \quad H \end{array}$$

respectively. Moreover, S is the antipode for $H^{op,cop}$. Note that for a bialgebra $B \in \mathcal{C}$, neither B^{op} nor B^{cop} is a bialgebra, unless the braiding Φ fulfills $\Phi_{B,B} = \Phi_{B,B}^{-1}$.

We recall some basic facts.

2.1 A monoidal category \mathcal{C} is called *right closed* if the functor $- \otimes M : \mathcal{C} \rightarrow \mathcal{C}$ has a right adjoint, denoted by $[M, -]$, for all $M \in \mathcal{C}$. For $N \in \mathcal{C}$, the object $[M, N]$ is called *inner hom-object*. The counit of the adjunction evaluated at N is denoted by $ev_{M,N} : [M, N] \otimes M \rightarrow N$. It satisfies the following universal property: *for any morphism $f : T \otimes M \rightarrow N$ there is a unique morphism $g : T \rightarrow [M, N]$ such that $f = ev_{M,N}(g \otimes M)$.* If $f : N \rightarrow N'$ is a morphism in \mathcal{C} , then $[M, f] : [M, N] \rightarrow [M, N']$ is the unique morphism such that $ev_{M,N'}([M, f] \otimes M) = f ev_{M,N}$. The unit of the adjunction $\alpha : N \rightarrow [M, N \otimes M]$ is induced by $ev_{M,N \otimes M}(\alpha \otimes M) = id_{N \otimes M}$. A monoidal category \mathcal{C} is called *left closed* if the functor $M \otimes - : \mathcal{C} \rightarrow \mathcal{C}$ has a right adjoint $\{M, -\}$ for all $M \in \mathcal{C}$. The counit of this adjunction evaluated at $N \in \mathcal{C}$ is denoted by $\bar{ev}_{M,N} : M \otimes \{M, N\} \rightarrow N$ and the unit by $\tilde{\alpha} : N \rightarrow \{M, M \otimes N\}$. It obeys $\bar{ev}_{M,M \otimes N}(M \otimes \tilde{\alpha}) = id_{M \otimes N}$. When \mathcal{C} is braided, there is a natural equivalence of functors $[M, -] \cong \{M, -\}$ and \mathcal{C} is right closed if and only if it is left closed. Throughout we will write $[-, -]$ for both types of inner hom-bifunctors, the difference will be clear from the context. The object $[M, M]$ is an algebra for all $M \in \mathcal{C}$.

2.2 Let P be an object in \mathcal{C} . An object $P^* \in \mathcal{C}$ together with a morphism $e_P : P^* \otimes P \rightarrow I$ is called a *left dual object* for P if there exists a morphism $d_P : I \rightarrow P \otimes P^*$ in \mathcal{C} such that $(P \otimes e_P)(d_P \otimes P) = id_P$ and $(e_P \otimes P^*)(P^* \otimes d_P) = id_{P^*}$. The morphisms e_P and d_P are called *evaluation* and *dual basis*, respectively. In braided diagrams the evaluation e_P and dual basis d_P are denoted by:

$$e_P = \begin{array}{c} P^* \quad P \\ \text{---} \\ \text{---} \\ \text{---} \\ \text{---} \end{array} \quad \text{and} \quad d_P = \begin{array}{c} \text{---} \\ \text{---} \\ \text{---} \\ \text{---} \\ P \quad P^* \end{array}$$

and the two identities they satisfy by:

$$\bigcup_P^P = id_P \quad (2.1)$$

$$\bigcup_{P^*}^{P^*} = id_{P^*}. \quad (2.2)$$

Symmetrically, one defines a right dual object *P for P with morphisms $e'_P : P \otimes {}^*P \rightarrow I$ and $d'_P : I \rightarrow {}^*P \otimes P$. Left and right dual objects are unique up to isomorphism. In a braided monoidal category the left and the right dual for P coincide. The corresponding evaluation and dual basis morphisms are related via:

$$e'_P = e_P \Phi_{P^*, P} \quad (2.3) \quad d'_P = \Phi_{P, P^*}^{-1} d_P \quad (2.4)$$

see e.g. [25, Prop. 2.13, b)] (we take here the opposite sign of the first power of the braiding).

2.3 An object $P \in \mathcal{C}$ is called *right finite*, if $[P, I]$ and $[P, P]$ exist and the morphism $db : P \otimes [P, I] \rightarrow [P, P]$, called the *dual basis morphism* as well, defined via the universal property of $[P, P]$ by $ev_{P, P}(db \otimes P) = P \otimes ev_{P, I}$ is an isomorphism. One may easily prove that *if P is right finite, then $([P, I], e_P = ev)$ is its left dual*. The dual basis morphism is $d_P = db^{-1} \eta_{[P, P]}$, where $\eta_{[P, P]}$ is the unit for the algebra $[P, P]$. A similar claim holds for a left finite object, which is defined similarly as a right finite object. In a braided monoidal category an object is left finite if and only if it is right finite. If P is a finite object, then so is P^* and there is a natural isomorphism $P \cong P^{**}$.

2.4 In the following we collect some facts about duality of Hopf algebras from [25, 2.5, 2.14 and 2.16]. Let \mathcal{C} be a closed braided monoidal category.

- (i) If H is a coalgebra in \mathcal{C} , then $H^* := [H, I]$ is an algebra.
- (ii) If H is a finite algebra in \mathcal{C} , then H^* is a coalgebra.
- (iii) If H is a finite Hopf algebra in \mathcal{C} , then so is H^* .

We give here the structure morphisms. The finiteness condition in ii) and iii) is needed in order to be able to consider $H^* \otimes H^* \cong (H \otimes H)^*$, which allows to define a comultiplication on H^* using the universal property of $[H \otimes H, I]$. The multiplication, comultiplication, antipode S^* , unit and counit of H^* are given by:

$$\begin{array}{c} H^* \quad H^* \quad H \\ \cup \quad \cup \quad \cup \\ \cup \quad \cup \quad \cup \end{array} = \begin{array}{c} H^* \quad H^* \quad H \\ \cup \quad \cup \quad \cup \\ \cup \quad \cup \quad \cup \end{array} \quad (2.5)$$

$$\begin{array}{c} H^* \quad H \quad H \\ \cup \quad \cup \quad \cup \\ \cup \quad \cup \quad \cup \end{array} = \begin{array}{c} H^* \quad H \quad H \\ \cup \quad \cup \quad \cup \\ \cup \quad \cup \quad \cup \end{array} \quad (2.6)$$

$$\begin{array}{c} H^* \quad H \\ \cup \quad \cup \\ \cup \quad \cup \end{array} = \begin{array}{c} H^* \quad H \\ \cup \quad \cup \\ \cup \quad \cup \end{array} \quad (2.7)$$

$$\begin{array}{c} H \\ \cup \\ \cup \end{array} = \begin{array}{c} H \\ \cup \\ \cup \end{array} \quad (2.8)$$

$$\begin{array}{c} H^* \\ \cup \\ \cup \end{array} = \begin{array}{c} H^* \\ \cup \\ \cup \end{array} \quad (2.9)$$

respectively (one uses the universal property of $[H, I]$). It is easy to see that a finite algebra A in \mathcal{C} is commutative if and only if A^* is a cocommutative coalgebra.

For an algebra $A \in \mathcal{C}$ and a coalgebra $C \in \mathcal{C}$ we denote by ${}_A\mathcal{C}$ and \mathcal{C}^C the categories of left A -modules and right C -comodules, respectively. The proof of the following proposition is not difficult. The first statement is proved in [25, Proposition 2.7].

Proposition 2.5 Let $H \in \mathcal{C}$ be a finite coalgebra. If $M \in \mathcal{C}^H$, then $M \in {}_{H^*}\mathcal{C}$ with the structure morphism given in (2.10). If $N \in {}_{H^*}\mathcal{C}$, then $N \in \mathcal{C}^H$ with the structure morphism given in (2.11). These assignments make the categories \mathcal{C}^H and ${}_{H^*}\mathcal{C}$ isomorphic.

$$\begin{array}{c} H^* M \\ \lrcorner \\ M \end{array} = \begin{array}{c} H^* M \\ \lrcorner \\ M \end{array} \quad (2.10) \qquad \begin{array}{c} N \\ \lrcorner \\ N H \end{array} = \begin{array}{c} N \\ \lrcorner \\ N H \end{array} \quad (2.11)$$

Throughout the paper \mathcal{C} will be a braided monoidal category with braiding Φ and $H \in \mathcal{C}$ a Hopf algebra having a bijective antipode.

3 Some braided monoidal categories of Yetter-Drinfel'd modules

A left H -module and left H -comodule $N \in \mathcal{C}$ and a right H -module and right H -comodule $L \in \mathcal{C}$ are called respectively *left-left* and *right-right Yetter-Drinfel'd modules* over H in \mathcal{C} if they obey the compatibility conditions:

$$\begin{array}{c} H \quad N \\ \lrcorner \\ H \quad N \end{array} = \begin{array}{c} H \quad N \\ \lrcorner \\ H \quad N \end{array} \quad (3.1) \qquad \text{and} \qquad \begin{array}{c} L \quad H \\ \lrcorner \\ L \quad H \end{array} = \begin{array}{c} L \quad H \\ \lrcorner \\ L \quad H \end{array} \quad (3.2)$$

respectively. A *left-right Yetter-Drinfel'd module* over H is a left H -module and right H -comodule $M \in \mathcal{C}$ whose H -structures are related via the relation:

$$\begin{array}{c} H \quad M \\ \lrcorner \\ M \quad H \end{array} = \begin{array}{c} H \quad M \\ \lrcorner \\ M \quad H \end{array} \quad (3.3)$$

In all the cases we will shorten the term “Yetter-Drinfel’d module” to *YD-module*. The categories of left-left YD-modules and left H -linear and left H -colinear morphisms in \mathcal{C} (which we denote by ${}^H_H\mathcal{YD}(\mathcal{C})$) and that of right-right YD-modules and right H -linear and right H -colinear morphisms in \mathcal{C} (denoted by $\mathcal{YD}(\mathcal{C})^H_H$) respectively, are known to be braided monoidal categories with braidings:

$$\Phi_{X,Y}^L = \begin{array}{c} X \quad Y \\ \diagdown \quad \diagup \\ \diagup \quad \diagdown \\ Y \quad X \end{array} \quad \text{and} \quad \Phi_{W,Z}^R = \begin{array}{c} W \quad Z \\ \diagup \quad \diagdown \\ \diagdown \quad \diagup \\ Z \quad W \end{array} \quad (3.4)$$

for objects $X, Y \in {}^H_H\mathcal{YD}(\mathcal{C})$ and $W, Z \in \mathcal{YD}(\mathcal{C})^H_H$ respectively, (see e.g. [1]). However, in order that the category of left-right YD-modules be braided monoidal, some symmetricity conditions on the braiding in \mathcal{C} should be assumed, as we will see further below. Like in [1, Thm. 3.4.3] Bespalov has that the category ${}_H\mathcal{YD}(\mathcal{C})^{H^{op}}$ is braided monoidal, but there he considers the tensor product of two left-right YD-modules a right H^{op} -comodule via the codiagonal structure in the category $\bar{\mathcal{C}}$, whereas the H -module structure he considers in \mathcal{C} (as in [1, Lemma 3.3.2]). Thus for two objects M, N of this category, the object $M \otimes N$ has the H -comodule structure:

$$\rho_{M \otimes N} = (M \otimes N \otimes \nabla_{H^{op}})(M \otimes \Phi_{N,H}^{-1} \otimes H)(\rho_M \otimes \rho_N).$$

Bespalov considers $\nabla_{H^{op}} = \nabla \Phi_{H,H}^{-1}$ (instead, we regard here the positive sign of the braiding) in order that H^{op} be a bialgebra in $\bar{\mathcal{C}}$. In the present paper we prefer to consider *all* the structures in \mathcal{C} . Accordingly, we will have that the categories ${}_H\mathcal{YD}(\mathcal{C})^{H^{op}}$ and ${}_{H^{op}}\mathcal{YD}(\mathcal{C})^H$ are braided monoidal if the braiding Φ in \mathcal{C} fulfills $\Phi_{H,X} = \Phi_{X,H}^{-1}$ for every corresponding YD-module $X \in \mathcal{C}$. We will say that $\Phi_{H,X}$ is *symmetric*. As a matter of fact, if $\Phi_{H,H}$ and $\Phi_{H,X}$ are symmetric (indeed H itself is a YD-module over itself), then the upper structure coincides with the usual codiagonal comodule structure on $M \otimes N$ in \mathcal{C} . Nevertheless, we will prove explicitly the claims by our approach as this is the general setting of our work and we will prove also other results in this manner.

Before proving that the category ${}_H\mathcal{YD}(\mathcal{C})^{H^{op}}$ is braided monoidal, we will note some important facts. Observe that:

$$\begin{array}{c} H \\ \circlearrowleft \\ H \end{array} = \begin{array}{c} H \\ \bullet \\ H \end{array} \quad (3.5)$$

since:

From this point on we will assume that the antipode of H is bijective (which is fulfilled for example if H is finite and \mathcal{C} has equalizers, [25, Theorem 4.1]). The sign “+” stands for the antipode whereas “-” stands for the inverse of the antipode. Furthermore, we have that the condition (3.3) is equivalent to:

(3.6)

To prove this assume that (3.3) holds. Then:

Conversely, (3.6) implies:

Remark 3.1 If $\Phi_{H,H}$ is symmetric, (3.5) can be considered with $\Phi_{H,H}$ instead of $\Phi_{H,H}^{-1}$; then one proves that

(versions of the relations (3.3) and (3.6)).

It is important to note that H itself is a YD-module over itself with suitable structures. For example, it is a left-right YD-module with the regular action and the adjoint coaction:

For the other versions of a YD-module (see Section 6) H can be equipped with similar structures - regular (co)actions and adjoint (co)actions.

The last convention before the promised proof is that throughout, by abuse of notation, we will write $\Phi_{H,M}$ is symmetric for all $M \in {}_H\mathcal{YD}(\mathcal{C})^{H^{op}}$, and similarly for other versions of the YD-categories, when strictly speaking we should say for all $M \in \mathcal{C}$. Indeed, via the forgetful functor $\mathcal{U} : {}_H\mathcal{YD}(\mathcal{C})^{H^{op}} \rightarrow \mathcal{C}$ every $M \in {}_H\mathcal{YD}(\mathcal{C})^{H^{op}}$ is an object in \mathcal{C} , and every $N \in \mathcal{C}$ can be equipped with trivial H -(co)module structures to form a YD-module.

Proposition 3.2 Assume that $\Phi_{H,M}$ is symmetric for every left-right YD-module M over H in \mathcal{C} . The category ${}_H\mathcal{YD}(\mathcal{C})^{H^{op}}$ is braided monoidal with braiding and its inverse given by:

$$\Phi_{M,N}^* = \begin{array}{c} M \ N \\ \diagdown \ / \\ \diagup \ \diagdown \\ N \ M \end{array} \quad \text{and} \quad (\Phi_{M,N}^*)^{-1} = \begin{array}{c} N \ M \\ \diagdown \ / \\ \diagup \ \diagdown \\ M \ N \end{array}$$

for $M, N \in {}_H\mathcal{YD}(\mathcal{C})^{H^{op}}$.

Proof. Because of the symmetricity assumption on Φ we will consider the YD-compatibility condition from the above Remark. Let M and N be two left-right YD-modules over H . We consider their tensor product as a left H -module and right H^{op} -comodule with the (co)diagonal structures. We now prove that the YD-compatibility of these H -structures holds for $M \otimes N$:

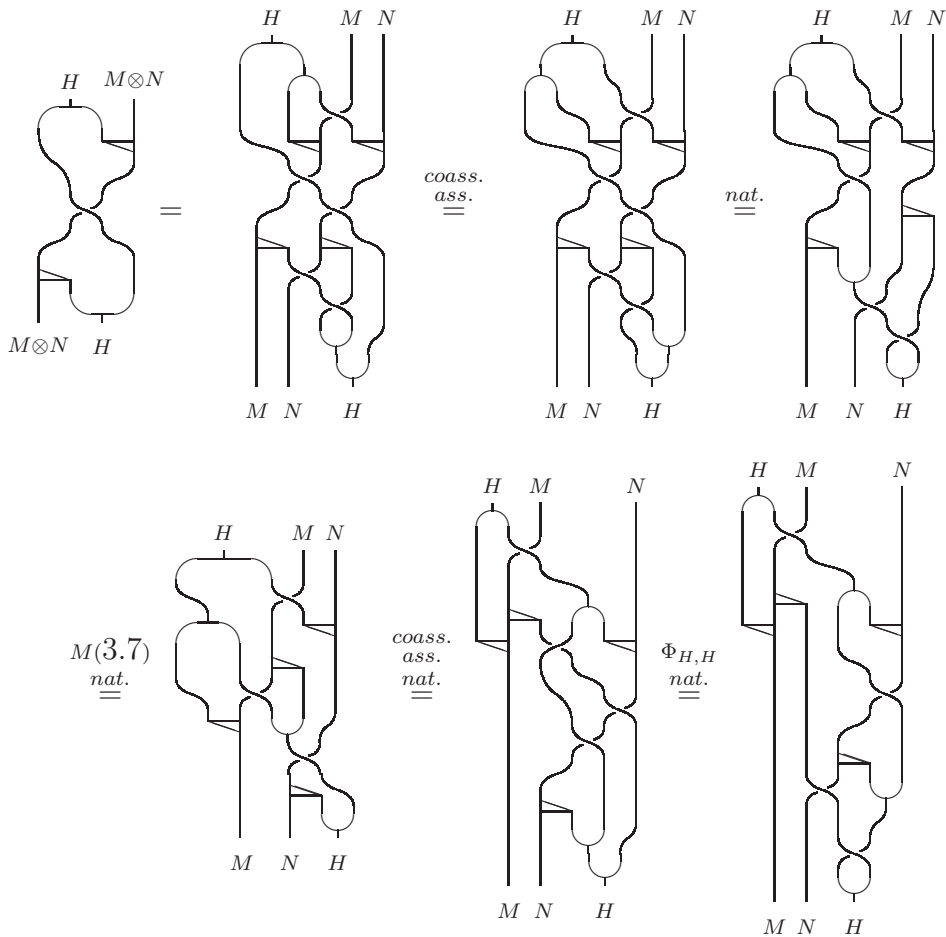

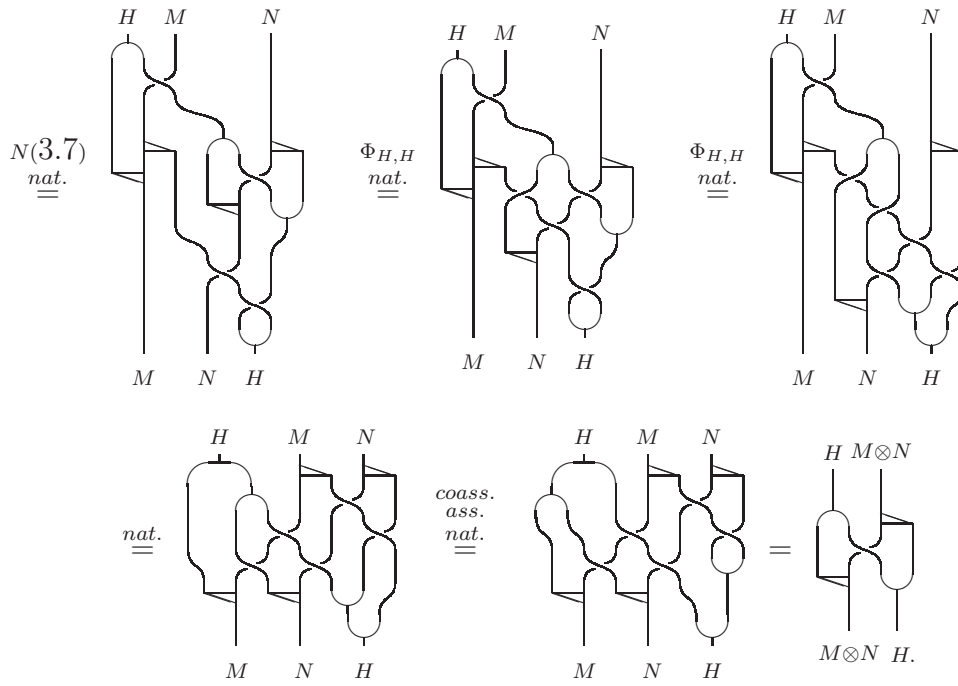

The check that Φ^* satisfies the braiding axioms we leave to the reader. We prove here the H -linearity of Φ^* :

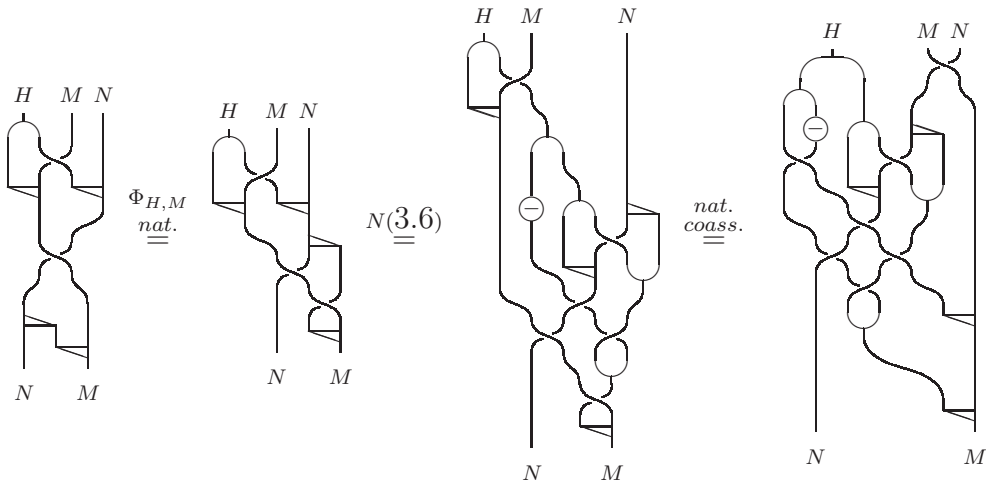

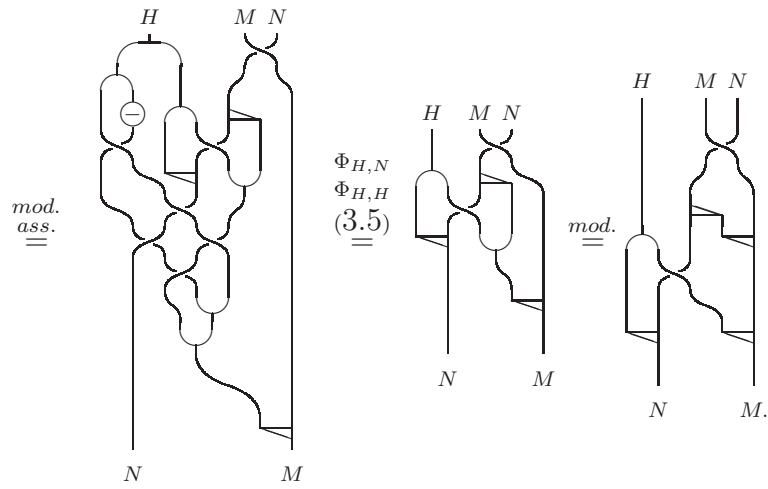

The H^{op} -colinearity of Φ^* follows from:

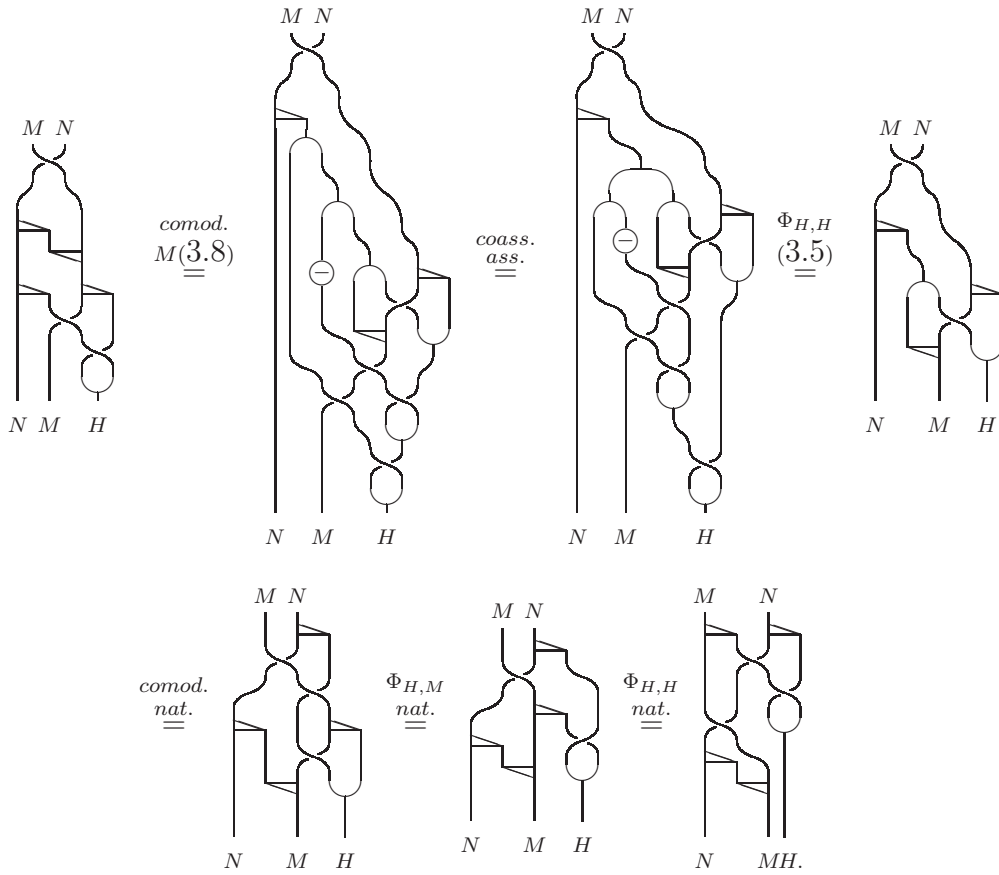

The proof that the inverse of Φ^* is given as in the announcement of the claim is straightforward. \square

Remark 3.3 Note that because of the assumption that $\Phi_{H,M}$ is symmetric, instead of $\Phi^{1+} := \Phi^*$ in Proposition 3.2 we can also consider the braiding:

$$\Phi_{M,N}^{1-} = \begin{array}{c} M \quad N \\ \text{---} \\ \text{---} \\ \text{---} \\ N \quad M. \end{array}$$

Remark 3.4 With the same conditions as in Proposition 3.2 one has that the category ${}_{H^{cop}}\mathcal{YD}(\mathcal{C})^H$ is braided monoidal with braiding and its inverse given by:

$$\Phi_{M,N}^{2+} = \begin{array}{c} M \quad N \\ \text{---} \\ \text{---} \\ \text{---} \\ N \quad M \end{array} \quad \text{and} \quad (\Phi_{M,N}^{2+})^{-1} = \begin{array}{c} N \quad M \\ \text{---} \\ \text{---} \\ \text{---} \\ M \quad N \end{array}$$

for $M, N \in {}_{H^{cop}}\mathcal{YD}(\mathcal{C})^H$. Analogously as in Remark 3.3, the braiding Φ^{2+} can be taken in the form Φ^{2-} . Note that ${}_{H^{cop}}\mathcal{YD}(\mathcal{C})^H$ is not braided by $\Phi^{1\pm}$, since $\Phi^{1\pm}$ is not left H^{cop} -linear even if $\mathcal{C} = \mathit{Vec}$, the category of vector spaces. Thus the identity functor $\text{Id}: {}_H\mathcal{YD}(\mathcal{C})^{H^{op}} \rightarrow {}_{H^{cop}}\mathcal{YD}(\mathcal{C})^H$ is not an isomorphism of braided monoidal categories although it is monoidal.

4 Bicrossproducts in braided monoidal categories

Bicrossproducts in braided monoidal categories (also called cross product bialgebras) were treated in [29, 3]. We recall here bicrossproducts with trivial coactions. Let B and H be bialgebras in \mathcal{C} , where B is a left H -module coalgebra and H is a right B -module coalgebra. Assume further that the following conditions are fulfilled:

$$\begin{array}{c} H \quad B \quad B \\ \text{---} \\ \text{---} \\ \text{---} \\ B \end{array} = \begin{array}{c} H \quad B \quad B \\ \text{---} \\ \text{---} \\ B \end{array} ; \quad \begin{array}{c} H \quad H \quad B \\ \text{---} \\ \text{---} \\ \text{---} \\ H \end{array} = \begin{array}{c} H \quad H \quad B \\ \text{---} \\ \text{---} \\ B \end{array}$$

$$\begin{array}{c} H \quad B \\ \text{---} \\ \text{---} \\ H \quad B \end{array} = \begin{array}{c} H \quad B \\ \text{---} \\ \text{---} \\ H \quad B \end{array} \quad \text{and} \quad \begin{array}{c} H \\ \text{---} \\ B \end{array} = \begin{array}{c} H \\ \bullet \\ \text{---} \\ B \end{array} ; \quad \begin{array}{c} B \\ \text{---} \\ H \end{array} = \begin{array}{c} B \\ \bullet \\ \text{---} \\ H \end{array}$$

Bialgebras B and H described above are called a *matched pair of bialgebras in \mathcal{C}* . We define $B \bowtie H$ as the tensor product $B \otimes H$ endowed with the codiagonal comultiplication, usual unit η and counit ε (that is, $\eta_B \otimes \eta_H$ and $\varepsilon_B \otimes \varepsilon_H$ respectively), and associative multiplication given by:

$$\nabla_{B \bowtie H} = \begin{array}{c} \begin{array}{ccccc} B & H & B & H & \\ \downarrow & \downarrow & \downarrow & \downarrow & \\ \downarrow & \downarrow & \downarrow & \downarrow & \\ \downarrow & \downarrow & \downarrow & \downarrow & \\ B & H & B & H & \end{array} \end{array}$$

In [29, Theorem 1.4] it is proved that $B \bowtie H$ is a bialgebra. Moreover, if both B and H are Hopf algebras, by [29, Theorem 1.5] we know that so is $B \bowtie H$ with the antipode given by:

$$S_{B \bowtie H} = \begin{array}{c} \begin{array}{ccc} B & H & \\ \downarrow & \downarrow & \\ \downarrow & \downarrow & \\ \downarrow & \downarrow & \\ B & H & \end{array} = \begin{array}{c} \begin{array}{ccc} B & H & \\ \downarrow & \downarrow & \\ \downarrow & \downarrow & \\ \downarrow & \downarrow & \\ B & H & \end{array} \end{array}$$

From here it follows:

$$S_{B \bowtie H}(\eta_B \otimes H) = \eta_B \otimes S_H. \tag{4.1}$$

For a module M over $B \bowtie H$ in \mathcal{C} we will consider:

$$\begin{array}{c} \begin{array}{cc} B \bowtie H & M \\ \downarrow & \downarrow \\ \downarrow & \downarrow \\ M & M \end{array} = \begin{array}{c} \begin{array}{ccc} B & H & M \\ \downarrow & \downarrow & \downarrow \\ \downarrow & \downarrow & \downarrow \\ M & M & M \end{array} \end{array} \tag{4.2}$$

Lemma 4.1 *Let B and H be a matched pair of bialgebras. An object M is a module over $B \bowtie H$ in \mathcal{C} if and only if it is an H - and a B -module satisfying the compatibility condition:*

$$\begin{array}{c} \begin{array}{ccc} H & B & M \\ \downarrow & \downarrow & \downarrow \\ \downarrow & \downarrow & \downarrow \\ M & M & M \end{array} = \begin{array}{c} \begin{array}{ccc} H & B & M \\ \downarrow & \downarrow & \downarrow \\ \downarrow & \downarrow & \downarrow \\ M & M & M \end{array} \end{array} \tag{4.3}$$

Proof. An object M is a module over $B \bowtie H$ if and only if:

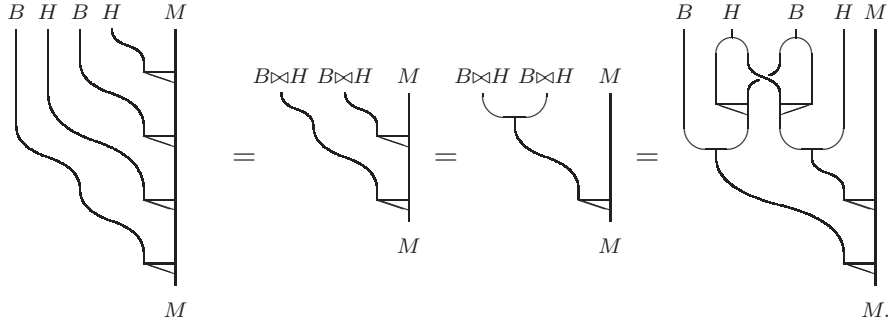

Applying this to $\eta_B \otimes H \otimes B \otimes \eta_H$, we obtain (4.3). For the converse observe that the above equality follows from (4.3) and the H - and B -module properties of M . \square

We now want to consider a particular case of a bicrossproduct - the Drinfel'd double of H . A tedious direct check, which we omit here for practical reasons, shows:

Proposition 4.2 Let $H \in \mathcal{C}$ be a finite Hopf algebra with a bijective antipode and the braiding such that $\Phi_{H,H}$ and Φ_{H,H^*} are symmetric. Then $B \bowtie H$ is a bicrossproduct with $B = (H^{op})^*$ and the actions:

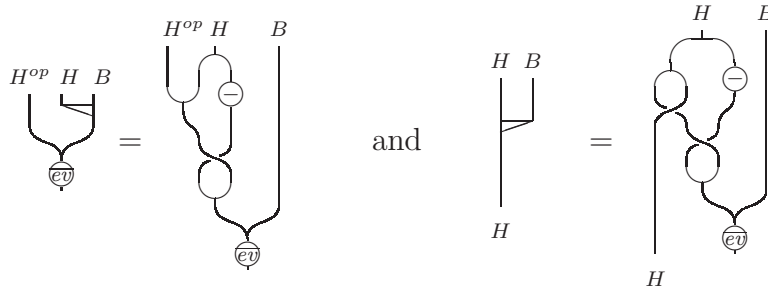

The bialgebra $B \bowtie H$ is called *the Drinfel'd double of H* and is denoted by $D(H)$. Throughout, apart from assuming that our Hopf algebras have a bijective antipode, when we deal with $D(H)$ we will also assume that H is finite. As we mentioned before, the antipode of a finite Hopf algebra is bijective if e.g. \mathcal{C} has equalizers.

Note that B is a bialgebra since $\Phi_{H,H}$ is symmetric (we commented this before 2.1). We only point out that in the proof of the above claim one uses the identity that we next present. Bearing in mind that $B = (H^{op})^*$, we have:

$$\begin{array}{c} B \quad H \quad H \\ \text{[Diagram: two crossings]} \end{array} \stackrel{(2.6)}{=} \begin{array}{c} B \quad H \quad H \\ \text{[Diagram: one crossing]} \end{array} \quad (4.4)$$

Composing this from above (in the braided diagram orientation) with $\Phi_{H \otimes H, B}$ and apply-

ing $\overline{ev} = ev\Phi$ due to (2.3), by naturality we obtain:

$$\begin{array}{c}
 \begin{array}{c} H \ H \ B \\ \diagdown \ \diagup \\ \text{---} \\ \diagup \ \diagdown \\ \text{---} \\ \overline{ev} \end{array} \\
 = \\
 \begin{array}{c} H \ H \ B \\ \diagdown \ \diagup \\ \text{---} \\ \diagup \ \diagdown \\ \text{---} \\ \text{---} \\ \diagdown \ \diagup \\ \text{---} \\ \diagup \ \diagdown \\ \text{---} \end{array} \\
 \stackrel{\Phi_{H,H^*}}{=} \\
 \begin{array}{c} H \ H \ B \\ \diagdown \ \diagup \\ \text{---} \\ \diagup \ \diagdown \\ \text{---} \\ \text{---} \\ \diagdown \ \diagup \\ \text{---} \\ \diagup \ \diagdown \\ \text{---} \end{array} \\
 = \\
 \begin{array}{c} H \ H \ B \\ \diagdown \ \diagup \\ \text{---} \\ \diagup \ \diagdown \\ \text{---} \\ \text{---} \\ \diagdown \ \diagup \\ \text{---} \\ \diagup \ \diagdown \\ \text{---} \\ \overline{ev} \ \overline{ev} \end{array}
 \end{array} \quad (4.5)$$

As a matter of fact the two symmetricity conditions for $\Phi_{H,H}$ and Φ_{H,H^*} in Proposition 4.2 are equivalent (in the next Lemma we add the last condition):

Lemma 4.3 [28, Lemma 1.1] *The following conditions are equivalent:*

1. $\Phi_{H,H}, \Phi_{H,H^*}$ and Φ_{H^*,H^*} are symmetric;
2. $\Phi_{H,H}$ is symmetric;
3. Φ_{H^*,H^*} is symmetric;
4. $(H \otimes ev)(\Phi_{H^*,H} \otimes H) = (ev \otimes H)(H^* \otimes \Phi_{H,H})$;
5. $(H^* \otimes ev)(\Phi_{H^*,H^*} \otimes H) = (ev \otimes H^*)(H^* \otimes \Phi_{H^*,H})$;
6. the conditions 4) and 5) hold true;
7. Φ_{H,H^*} is symmetric.

One proves similarly:

Lemma 4.4 *Let $M \in \mathcal{C}$ be any object. Then $\Phi_{H,M}$ is symmetric if and only if $\Phi_{H^*,M}$ is symmetric.*

Remark 4.5 We remark that $(H^{op})^* \cong (H^*)^{cop}$ as coalgebras:

$$\begin{array}{c}
 \begin{array}{c} (H^{op})^* \ H^{op} \ H^{op} \\ \diagdown \ \diagup \\ \text{---} \\ \diagup \ \diagdown \\ \text{---} \end{array} \\
 = \\
 \begin{array}{c} (H^{op})^* \ H^{op} \ H^{op} \\ \diagdown \ \diagup \\ \text{---} \\ \diagup \ \diagdown \\ \text{---} \end{array} \\
 = \\
 \begin{array}{c} H^* \ H \ H \\ \diagdown \ \diagup \\ \text{---} \\ \diagup \ \diagdown \\ \text{---} \end{array} \\
 = \\
 \begin{array}{c} H^* \ H \ H \\ \diagdown \ \diagup \\ \text{---} \\ \diagup \ \diagdown \\ \text{---} \end{array} \\
 \\
 \stackrel{nat.}{=} \\
 \begin{array}{c} H^* \ H \ H \\ \diagdown \ \diagup \\ \text{---} \\ \diagup \ \diagdown \\ \text{---} \end{array} \\
 \stackrel{nat.}{=} \\
 \begin{array}{c} H^* \ H \ H \\ \diagdown \ \diagup \\ \text{---} \\ \diagup \ \diagdown \\ \text{---} \end{array} \\
 \stackrel{\Phi_{H^*,H^*}}{=} \\
 \begin{array}{c} H^* \ H \ H \\ \diagdown \ \diagup \\ \text{---} \\ \diagup \ \diagdown \\ \text{---} \end{array} \\
 = \\
 \begin{array}{c} (H^*)^{cop} \ H \ H \\ \diagdown \ \diagup \\ \text{---} \\ \diagup \ \diagdown \\ \text{---} \end{array}
 \end{array}$$

The claim follows by the universal property of $H^* \otimes H^* \cong (H \otimes H)^*$. If $\Phi_{H,H}$ is symmetric, then $(H^{op})^*$ and $(H^*)^{cop}$ are bialgebras and they are isomorphic as Hopf algebras.

Remark 4.6 There are several ways to construct a Drinfel'd double. In [3, Prop. 3.6] one can find a construction of a matched pair of bialgebras, and hence a bicrossproduct $H \bowtie A$. With $H = (A^{op})^*$ and the pairing $\langle \cdot, \cdot \rangle = ev$ it is given a different construction than the one in our Proposition 4.2. Taking $A = (H^{cop})^*$ and $\langle \cdot, \cdot \rangle = \overline{ev}$, one obtains a Drinfel'd double of the form $H \bowtie (H^{cop})^* \cong H \bowtie (H^*)^{op}$. The authors proved that if A and H are Hopf algebras where the antipode of A is invertible, then A and H are a matched pair of bialgebras if and only if $\Phi_{A,H}$ is symmetric. In [28, Theorem 3.2] a result similar to our Proposition 4.2 is proved, but the H - and H^{op} -actions are given differently. The quasitriangularity of $D(H)$ we will discuss in the next section.

Developing the right hand-side of the expression (4.3) applied to the Drinfel'd double and using the actions given in Proposition 4.2, yields:

(4.6)

Taking $M = B \bowtie H$ and applying the above equality to $H \otimes B \otimes \eta_{B \bowtie H}$, one gets:

(4.7)

The following result generalizes [21, Proposition 4.6] to the braided case.

Lemma 4.7 *Assume that Φ_{H,H^*} is symmetric. Then the following are equivalent:*

- (i) $D(H)$ is commutative,
- (ii) H and H^* are commutative;
- (iii) H and H^* are cocommutative;
- (iv) $D(H)$ is cocommutative.

Proof. In view of 2.4 it suffices to prove the equivalence of (i) and (ii). We omit to type the whole proof, we only give a sketch of it. First observe that we have identities:

$$\begin{array}{c} H^{op} \quad B \quad B \\ \text{---} \\ \boxed{\overline{ev}} \quad \boxed{\overline{ev}} \\ \text{---} \\ \text{---} \end{array} = \begin{array}{c} H^{op} \quad B \quad B \\ \text{---} \\ \text{---} \\ \text{---} \end{array} \stackrel{\Phi_{H,H^*}}{=} \begin{array}{c} H^{op} \quad B \quad B \\ \text{---} \\ \text{---} \\ \text{---} \end{array} \stackrel{(2.5)}{=} \begin{array}{c} H^{op} \quad B \quad B \\ \text{---} \\ \text{---} \\ \text{---} \end{array} = \begin{array}{c} H^{op} \quad B \quad B \\ \text{---} \\ \text{---} \\ \boxed{\overline{ev}} \end{array} \quad (4.8)$$

and

$$\begin{array}{c} H^{op} \\ \text{---} \\ \text{---} \\ \text{---} \\ H^{op} \end{array} \stackrel{nat.}{=} \begin{array}{c} H^{op} \\ \text{---} \\ \text{---} \\ H^{op} \end{array} = id_{H^{op}} \quad (4.9)$$

Suppose that $D(H)$ is commutative. Using $\overline{ev} = ev\Phi$ and evaluating the product in $D(H)$ at H^{op} , we obtain:

$$\begin{array}{c} H^{op} \quad B \quad B \\ \text{---} \\ \text{---} \\ \text{---} \\ H \end{array} \stackrel{\nabla_{D(H)}(4.9)}{=} \begin{array}{c} H^{op} \quad B \times H \\ \text{---} \\ \boxed{B \times H} \\ \text{---} \\ B \end{array} = \begin{array}{c} H^{op} \quad B \times H \\ \text{---} \\ \boxed{B \times H} \\ \text{---} \\ B \end{array} \stackrel{\nabla_{D(H)}(4.9)}{=} \begin{array}{c} H^{op} \quad B \quad B \\ \text{---} \\ \text{---} \\ \text{---} \\ H \end{array} \quad (4.10)$$

Apply this to $H^{op} \otimes B \otimes \eta_H \otimes B \otimes \eta_H$ and compose the obtained identity with ε_H to obtain:

$$\begin{array}{c} H^{op} \quad B \\ \text{---} \\ \text{---} \\ \text{---} \end{array} = \begin{array}{c} H^{op} \quad B \\ \text{---} \\ \text{---} \\ \text{---} \end{array}$$

By (4.8) one gets that B , and hence H^* , is commutative. Applying (4.10) to $\eta_H \otimes \eta_B \otimes H \otimes \eta_B \otimes H$, one obtains that H is commutative.

Conversely, assuming (ii), using (4.8) and that Φ_{H,H^*} is symmetric, one may prove that (4.10) - which expresses commutativity of $D(H)$ - holds true. \square

5 Yetter-Drinfel'd modules as modules over the Drinfel'd double

Since $D(H)$ is a bialgebra in \mathcal{C} , the category of its left (and right) modules is monoidal. In this and the next section we study the isomorphism between these categories and the appropriate categories of YD-modules. The functors we will consider will act as identity functors on objects and morphisms, we will only have to define the new (co)module structures. Let us regard the pair of functors

$$\mathcal{F} : (H^{op})^* \bowtie_H \mathcal{C} \rightleftarrows {}_H \mathcal{YD}(\mathcal{C})^{H^{op}} : \mathcal{G}.$$

For $M \in (H^{op})^* \bowtie_H \mathcal{C}$ and $K \in {}_H \mathcal{YD}(\mathcal{C})^{H^{op}}$ we define:

$$\begin{array}{c} \mathcal{F}(M) \\ \text{---} \\ \mathcal{F}(M) \quad H \end{array} = \begin{array}{c} M \\ \text{---} \\ M \quad H \end{array} \quad \text{and} \quad \begin{array}{c} H^* \quad \mathcal{G}(K) \\ \text{---} \\ \mathcal{G}(K) \end{array} = \begin{array}{c} H^* \quad K \\ \text{---} \\ K \end{array}$$

Regard $\mathcal{F}(M)$ as a left H -module by the action of $\eta_B \otimes H$ on M , and consider $\mathcal{G}(K) = K$ as a left H -module. By Proposition 2.5 we know that $\mathcal{F}(M)$ is a right H -comodule and $\mathcal{G}(K)$ a left H^* -module.

Assume that $\Phi_{H,H}$ and $\Phi_{H,M}$ are symmetric, where $M \in (H^{op})^* \bowtie_H \mathcal{C}$. Let $B = (H^{op})^*$. We have:

$$\begin{array}{c} \begin{array}{c} B \quad H \quad \mathcal{F}(M) \\ \text{---} \\ \mathcal{F}(M) \end{array} \quad \stackrel{\mathcal{F}}{=} \quad \begin{array}{c} B \quad H \quad M \\ \text{---} \\ M \end{array} \quad \stackrel{(4.4)}{=} \quad \begin{array}{c} B \quad H \quad M \\ \text{---} \\ M \end{array} \quad \stackrel{\Phi_{H,H} \text{ nat. (2.2)}}{=} \quad \begin{array}{c} B \quad H \quad M \\ \text{---} \\ M \end{array} \\ \\ \begin{array}{c} \stackrel{(4.6)}{=} \quad \begin{array}{c} B \quad H \quad M \\ \text{---} \\ M \end{array} \quad \stackrel{\text{nat.}}{=} \quad \begin{array}{c} B \quad H \quad M \\ \text{---} \\ M \end{array} \quad \stackrel{\Phi_{H,B} (2.3)}{=} \quad \begin{array}{c} B \quad H \quad M \\ \text{---} \\ M \end{array} \end{array}$$

On the other hand, it is:

From the universal property of $H^* = [H, I]$ the obtained identity implies that $\mathcal{F}(M)$ obeys (3.7), thus \mathcal{F} is well defined. For the converse assume that moreover $\Phi_{H,K}$ is symmetric for $K \in {}_H\mathcal{YD}(\mathcal{C})^{H^{op}}$. We will need:

Now we compute:

$$\begin{array}{c}
 \begin{array}{c} H \ B \ \mathcal{G}(K) \\ \text{Diagram 1} \\ \mathcal{G}(K) \end{array} \\
 \stackrel{(4.2)}{=} \\
 \begin{array}{c} H \ B \ K \\ \text{Diagram 2} \\ K \end{array} \\
 \stackrel{(5.1)}{=} \\
 \begin{array}{c} H \ B \ K \\ \text{Diagram 3} \\ K \end{array} \\
 \stackrel{\Phi_{H,H}}{=} \\
 \begin{array}{c} H \ B \ K \\ \text{Diagram 4} \\ K \end{array} \\
 \stackrel{\Phi_{H,B}}{=} \\
 \begin{array}{c} H \ B \ K \\ \text{Diagram 5} \\ K \end{array} \\
 \stackrel{\text{nat.}}{=} \\
 \begin{array}{c} H \ B \ K \\ \text{Diagram 6} \\ K \end{array} \\
 \stackrel{\Phi_{H,H}}{=} \\
 \begin{array}{c} H \ B \ K \\ \text{Diagram 7} \\ K \end{array} \\
 \stackrel{\Phi_{H,K} \text{ YD}}{=} \\
 \begin{array}{c} H \ B \ K \\ \text{Diagram 8} \\ K \end{array} \\
 \stackrel{\text{coass. ass.}}{=} \\
 \begin{array}{c} H \ B \ K \\ \text{Diagram 9} \\ K \end{array} \\
 \stackrel{\Phi_{H,H} (3.5)}{=} \\
 \begin{array}{c} H \ B \ K \\ \text{Diagram 10} \\ K \end{array} \\
 \stackrel{\Phi_{H,B} (2.3)}{=} \\
 \begin{array}{c} H \ B \ K \\ \text{Diagram 11} \\ K \end{array} \\
 \stackrel{(4.2)}{=} \\
 \begin{array}{c} H \ B \ \mathcal{G}(K) \\ \text{Diagram 12} \\ \mathcal{G}(K) \end{array}
 \end{array}$$

By (4.3) and (4.6) this proves that $\mathcal{G}(K)$ is a module over $B \rtimes H$. From Proposition 2.5 we then know that \mathcal{F} and \mathcal{G} make an isomorphism of categories. Let us show that \mathcal{F} is a monoidal functor. Take $M, N \in (H^{op})^* \rtimes H \mathcal{C}$, then:

$$\begin{array}{c}
 \begin{array}{c} F(M \otimes N) \\ \text{Diagram 1} \\ F(M \otimes N) \ H \end{array} \\
 = \\
 \begin{array}{c} M \ N \\ \text{Diagram 2} \\ M \ N \ H \end{array} \\
 = \\
 \begin{array}{c} M \ N \\ \text{Diagram 3} \\ M \ N \ H \end{array} \\
 \stackrel{\text{nat.}}{=} \\
 \begin{array}{c} M \ N \\ \text{Diagram 4} \\ M \ N \ H \end{array} \\
 \stackrel{\text{nat.}}{=} \\
 \begin{array}{c} M \ N \\ \text{Diagram 5} \\ M \ N \ H \end{array} \\
 = \\
 \begin{array}{c} F(M) \ F(N) \\ \text{Diagram 6} \\ F(M) \ F(N) \ H^{op} \end{array}
 \end{array}$$

Finally, for $M, N \in (H^{op})^* \bowtie H \mathcal{C}$ consider:

$$\Psi_{M,N} := \begin{array}{c} \begin{array}{c} \text{---} M \quad N \text{---} \\ | \quad | \\ \boxed{D(H)} \quad \boxed{D(H)} \\ | \quad | \\ \text{---} N \quad M \text{---} \end{array} \\ = \\ \begin{array}{c} \text{---} M \quad N \text{---} \\ | \quad | \\ \text{---} N \quad M \text{---} \end{array} \\ \stackrel{\text{nat.}}{=} \\ \begin{array}{c} \text{---} M \quad N \text{---} \\ | \quad | \\ \text{---} N \quad M \text{---} \end{array} \\ \stackrel{\text{nat.}}{=} \\ \begin{array}{c} \text{---} M \quad N \text{---} \\ | \quad | \\ \text{---} N \quad M \text{---} \end{array} \\ \stackrel{\mathcal{F}}{=} \\ \begin{array}{c} \text{---} M \quad N \text{---} \\ | \quad | \\ \text{---} N \quad M \text{---} \end{array} \\ \stackrel{\Phi_{H,M} \text{ nat.}}{=} \\ \begin{array}{c} \text{---} M \quad N \text{---} \\ | \quad | \\ \text{---} N \quad M \text{---} \end{array} \end{array}$$

Note that the right hand-side is $\Phi_{M,N}^{1+}$. Then we have that Ψ becomes the braiding in $(H^{op})^* \bowtie H \mathcal{C}$. Its inverse is given by:

$$\Psi_{M,N}^{-1} \begin{array}{c} \text{---} N \quad M \text{---} \\ | \quad | \\ \ominus \\ | \quad | \\ \text{---} M \quad N \text{---} \end{array}$$

Proposition 5.1 Assume $H \in \mathcal{C}$ is a finite Hopf algebra with a bijective antipode. Suppose that $\Phi_{H,M}$ is symmetric for all $M \in {}_H \mathcal{YD}(\mathcal{C})^{H^{op}}$. The categories ${}_H \mathcal{YD}(\mathcal{C})^{H^{op}}$ and ${}_{D(H)} \mathcal{C}$ are isomorphic as braided monoidal categories.

In [16, Definition 1.2] Majid defined an ‘‘opposite comultiplication’’ Δ^{op} for a bialgebra H . Let $\mathcal{O}(H, \Delta^{op})$ denote the subcategory of those H -modules with respect to which Δ^{op} is an opposite comultiplication. If $\mathcal{R} : I \rightarrow H \otimes H$ is a quasitriangular structure for H , [16, Definition 1.3], then by [16, Proposition 3.2] the subcategory $\mathcal{O}(H, \Delta^{op})$ is braided by

$$M \otimes N \xrightarrow{\mathcal{R} \otimes M \otimes N} H \otimes H \otimes M \otimes N \xrightarrow{H \otimes \Phi_{H,M} \otimes N} H \otimes M \otimes H \otimes N \xrightarrow{\mu_M \otimes \mu_N} M \otimes N \xrightarrow{\Phi_{M,N}} N \otimes M.$$

We denote this composition by $\Phi(\mathcal{R})$. It is straightforward to check that if $\Phi_{H,M}$ is symmetric for all H -modules M in \mathcal{C} , then $\Delta^{op} := \Phi_{H,H} \Delta_H$ is an opposite comultiplication for H with respect to the whole category ${}_H \mathcal{C}$, i.e. $\mathcal{O}(H, \Delta^{op}) = {}_H \mathcal{C}$. The same is true for \mathcal{C}_H . In particular, the above holds for $D(H)$. The morphism:

$$\mathcal{R} := \begin{array}{c} | \quad | \\ \cap \\ | \quad | \\ H^* \quad H \quad H^* \quad H \end{array}$$

is a quasitriangular structure for $D(H)$ and it induces a braiding $\Phi(\mathcal{R})$ on ${}_{D(H)} \mathcal{C}$. Note that it equals to our Ψ from above. As it is the case in the category of modules over a commutative ring and a usual quasitriangular Hopf algebra, the axioms of quasitriangularity of $D(H)$ are equivalent to the two braiding axioms for Ψ , its left $D(H)$ -linearity and invertibility, if $\Phi_{H,M}$ is symmetric for all $M \in {}_{D(H)} \mathcal{C}$.

5.1 Bosonization and an isomorphism of categories

Bespalov proved in [1, Lemma 5.3.1 and Section 5.4] that a left (right) module over a quasitriangular bialgebra (H, \mathcal{R}) can be equipped with a left (right) comodule structure over H so that the subcategory $\mathcal{O}(H, \Delta^{op})$ becomes a full braided subcategory of ${}^H_H\mathcal{YD}(\mathcal{C})$ ($\mathcal{YD}(\mathcal{C})_H^H$). This is a braided version of the classical result from [12].

Assume that H is a quasitriangular Hopf algebra with respect to the whole category \mathcal{C}_H (e.g. if $\Phi_{H,M}$ is symmetric for all $M \in \mathcal{C}_H$). Then \mathcal{C}_H is braided. Let B be a Hopf algebra in \mathcal{C}_H . Equipped with a right H -comodule structure:

$$\rho_B = \begin{array}{c} B \\ | \\ \text{---} \text{---} \text{---} \text{---} \text{---} \text{---} \\ | \\ B \end{array} \begin{array}{c} \mathcal{R} \\ | \\ | \\ | \\ | \\ | \\ | \\ | \\ | \\ H \end{array}$$

B becomes a right-right YD-module. The structure morphisms of B are right H -linear. Since H is quasitriangular, they turn out to be also right H -colinear. We show this for the multiplication:

$$\begin{array}{c} B \ B \\ | \ | \\ \text{---} \text{---} \\ | \ | \\ B \ H \end{array} = \begin{array}{c} B \ B \\ | \ | \\ \text{---} \text{---} \text{---} \text{---} \text{---} \text{---} \\ | \ | \\ B \ H \end{array} \begin{array}{c} \mathcal{R} \\ | \\ | \\ | \\ | \\ | \\ | \\ | \\ | \\ H \end{array} = \begin{array}{c} B \ B \\ | \ | \\ \text{---} \text{---} \text{---} \text{---} \text{---} \text{---} \\ | \ | \\ B \ H \end{array} \begin{array}{c} \mathcal{R} \\ | \\ | \\ | \\ | \\ | \\ | \\ | \\ | \\ H \end{array} \stackrel{\star}{=} \begin{array}{c} B \ B \\ | \ | \\ \text{---} \text{---} \text{---} \text{---} \text{---} \text{---} \\ | \ | \\ B \ H \end{array} \begin{array}{c} \mathcal{R} \\ | \\ | \\ | \\ | \\ | \\ | \\ | \\ | \\ H \end{array} \stackrel{\Phi_{H,B} \text{ nat.}}{=} \begin{array}{c} B \ B \\ | \ | \\ \text{---} \text{---} \text{---} \text{---} \text{---} \text{---} \\ | \ | \\ B \ H \end{array} \begin{array}{c} \mathcal{R} \\ | \\ | \\ | \\ | \\ | \\ | \\ | \\ | \\ H \end{array} = \begin{array}{c} B \ B \\ | \ | \\ \text{---} \text{---} \\ | \ | \\ B \ H \end{array}$$

where at the place \star we applied the quasitriangular axiom $(\Delta^{op} \otimes H)\mathcal{R} = \mathcal{R}_{23}\mathcal{R}_{13}$. Since \mathcal{C}_H is a braided subcategory of $\mathcal{YD}(\mathcal{C})_H^H$, we have that the braiding in \mathcal{C}_H induced by \mathcal{R} (the right hand-side version of $\Phi(\mathcal{R})$) equals Φ^R from (3.4) and B is indeed a Hopf algebra in $\mathcal{YD}(\mathcal{C})_H^H$. By [1, Theorem 4.1.2] the cross product algebra $H \times B$ is then a Hopf algebra in \mathcal{C} , the bosonization of the braided Hopf algebra B . Its multiplication and comultiplication are given by:

$$\begin{array}{c} H \ B \ H \ B \\ | \ | \ | \ | \\ \text{---} \text{---} \text{---} \text{---} \\ | \ | \ | \ | \\ H \ B \end{array} \quad \text{and} \quad \begin{array}{c} H \ B \\ | \ | \\ \text{---} \text{---} \\ | \ | \\ H \ B \end{array}$$

which are the tensor product algebra and coalgebra respectively in the category $\mathcal{YD}(\mathcal{C})_H^H$. The antipode of $H \times B$ is given by $S_{H \times B} := \Phi_{B,H}^R(S_B \otimes S_H)\Phi_{H,B}^R$. Similarly as in Lemma 4.1 one proves that the categories $\mathcal{C}_{H \times B}$ and $(\mathcal{C}_H)_B$ are isomorphic. An object of the latter category is a right H - and a right B -module M satisfying the compatibility condition:

$$\begin{array}{c} M \ B \ H \\ | \ | \ | \\ \text{---} \text{---} \text{---} \text{---} \\ | \ | \ | \\ M \end{array} = \begin{array}{c} M \ B \ H \\ | \ | \ | \\ \text{---} \text{---} \text{---} \text{---} \\ | \ | \ | \\ M \end{array}$$

Moreover, the isomorphism $\mathcal{F} : (\mathcal{C}_H)_B \rightarrow \mathcal{C}_{H \times B}$ is monoidal, since for $M, N \in (\mathcal{C}_H)_B$ it is:

Thus we have proved:

Proposition 5.2 Let H be a quasitriangular Hopf algebra such that $\Phi_{H,M}$ is symmetric for all $M \in \mathcal{C}_H$. Let B be a Hopf algebra in \mathcal{C}_H . Then $H \times B$ is a Hopf algebra in \mathcal{C} and there is a monoidal isomorphism of categories $\mathcal{C}_{H \times B} \cong (\mathcal{C}_H)_B$.

6 Other versions of Yetter-Drinfel'd categories

We start this section by giving equivalent conditions for the left-left and the right-right YD-compatibility conditions and relating the corresponding categories with that of modules over the Drinfel'd double. Subsequently, we will study two versions of left-right, as well as two versions of right-left YD-categories. At the end we will relate all the categories we have studied.

6.1 Left-left and right-right YD-modules as modules over the Drinfel'd double

At the beginning of Section 3 we noted that the categories ${}^H_H\mathcal{YD}(\mathcal{C})$ of left-left YD-modules and $\mathcal{YD}(\mathcal{C})^H_H$, of right-right YD-modules, are braided monoidal categories without any further conditions. However, in order to prove that these categories are isomorphic to that of left (respectively right) $D(H)$ -modules in \mathcal{C} for a finite Hopf algebra H with a bijective antipode, one has to require the same symmetricity conditions on the braiding as in Proposition 5.1. Before supporting this claim, we note that the expressions (3.1) and (3.2) are equivalent to:

(6.1)

and

(6.2)

respectively, if $\Phi_{H,N}$ ($\Phi_{H,L}$) is symmetric for $N \in {}^H_H\mathcal{YD}(\mathcal{C})$ and $L \in \mathcal{YD}(\mathcal{C})^H_H$. The same symmetricity conditions are necessary to prove that ${}^H_H\mathcal{YD}(\mathcal{C})$ and $\mathcal{YD}(\mathcal{C})^H_H$, characterized by (6.1) and (6.2) respectively, are monoidal categories.

Consider the functors $\mathcal{F}_l : {}_{D(H)}\mathcal{C} \rightleftarrows {}^H_H\mathcal{YD}(\mathcal{C}) : \mathcal{G}_l$ defined by

$$\begin{array}{c} \mathcal{F}_l(M) \\ \begin{array}{c} \text{---} \\ \text{---} \\ \text{---} \end{array} \\ H \\ \mathcal{F}_l(M) \end{array} = \begin{array}{c} M \\ \begin{array}{c} \text{---} \\ \text{---} \\ \text{---} \\ \oplus \end{array} \\ H \\ M \end{array} \quad \text{and} \quad \begin{array}{c} H^* \\ \mathcal{G}_l(N) \\ \begin{array}{c} \text{---} \\ \text{---} \\ \text{---} \end{array} \\ \mathcal{G}_l(N) \end{array} = \begin{array}{c} H^* \\ N \\ \begin{array}{c} \text{---} \\ \text{---} \\ \text{---} \\ \ominus \end{array} \\ N \end{array}$$

for $M \in (H^{op})^* \bowtie_H \mathcal{C}$ and $N \in {}^H_H\mathcal{YD}(\mathcal{C})$, where $\mathcal{F}_l(M)$ is a left H -module by the action of $\eta_B \otimes H$ on M , and $\mathcal{G}_l(N) = N$ as a left H -module. Even though one uses (3.1) as the defining relation for the category ${}^H_H\mathcal{YD}(\mathcal{C})$, one has that \mathcal{F}_l and \mathcal{G}_l define an isomorphism of categories if $\Phi_{H,N}$ is symmetric. We show here only that this is a monoidal isomorphism. Observe first:

$$\begin{array}{c} \begin{array}{c} \text{---} \\ \text{---} \\ \text{---} \\ \text{---} \\ \text{---} \end{array} \\ H \\ B \\ B \end{array} = \begin{array}{c} \begin{array}{c} \text{---} \\ \text{---} \\ \text{---} \\ \text{---} \\ \text{---} \\ \text{---} \end{array} \\ H \\ H^* \\ H^* \end{array} \stackrel{(4.4)}{=} \begin{array}{c} \begin{array}{c} \text{---} \\ \text{---} \\ \text{---} \\ \text{---} \\ \text{---} \\ \text{---} \end{array} \\ H \\ H^* \\ H^* \end{array} = \begin{array}{c} \begin{array}{c} \text{---} \\ \text{---} \\ \text{---} \\ \text{---} \\ \text{---} \end{array} \\ H \\ H^* \\ H^* \end{array} \quad (6.3)$$

Now for $M, N \in {}_{D(H)}\mathcal{C}$ we have:

$$\begin{array}{c} \mathcal{F}_l(M \otimes N) \\ \begin{array}{c} \text{---} \\ \text{---} \\ \text{---} \\ \text{---} \\ \text{---} \end{array} \\ H \\ \mathcal{F}_l(M \otimes N) \end{array} = \begin{array}{c} \begin{array}{c} M \\ N \\ \text{---} \\ \oplus \end{array} \\ H \\ M \\ N \end{array} = \begin{array}{c} \begin{array}{c} M \\ N \\ \text{---} \\ \oplus \\ \oplus \end{array} \\ H \\ M \\ N \end{array} \stackrel{(6.3)}{=} \begin{array}{c} \begin{array}{c} M \\ N \\ \text{---} \\ \oplus \\ \oplus \end{array} \\ H \\ M \\ N \end{array} \stackrel{\Phi_{H,H^*}}{=} \begin{array}{c} \begin{array}{c} M \\ N \\ \text{---} \\ \oplus \\ \oplus \end{array} \\ H \\ M \\ N \end{array}$$

$$\stackrel{nat.}{=} \begin{array}{c} \begin{array}{c} M \\ N \\ \text{---} \\ \oplus \\ \oplus \end{array} \\ H \\ M \\ N \end{array} \stackrel{\Phi_{H,M}}{=} \begin{array}{c} \begin{array}{c} M \\ N \\ \text{---} \\ \oplus \\ \oplus \end{array} \\ H \\ M \\ N \end{array} = \begin{array}{c} \mathcal{F}_l(M) \\ \mathcal{F}_l(N) \\ \begin{array}{c} \text{---} \\ \text{---} \\ \text{---} \end{array} \\ H \\ \mathcal{F}_l(M) \mathcal{F}_l(N) \end{array}$$

It is easily shown that the functor $\mathcal{L} : {}^H_H\mathcal{YD}(\mathcal{C}) \rightarrow \mathcal{YD}(\mathcal{C})^H_H$ given by

$$\begin{array}{c} \mathcal{L}(M) \\ \begin{array}{c} \text{---} \\ \text{---} \\ \text{---} \end{array} \\ H \\ \mathcal{L}(M) \end{array} = \begin{array}{c} M \\ H \\ \begin{array}{c} \text{---} \\ \oplus \\ \oplus \end{array} \\ M \end{array} \quad \text{and} \quad \begin{array}{c} \mathcal{L}(M) \\ \begin{array}{c} \text{---} \\ \text{---} \\ \text{---} \end{array} \\ H \\ \mathcal{L}(M) \end{array} = \begin{array}{c} M \\ \begin{array}{c} \text{---} \\ \ominus \\ \ominus \end{array} \\ M \\ H \end{array}$$

for $M, N \in {}^H_H\mathcal{YD}(\mathcal{C})$ is an isomorphism of categories. It is even monoidal if $\Phi_{H,M}$ is symmetric for every $M \in {}^H_H\mathcal{YD}(\mathcal{C})$. We show only the compatibility of the H -module structures on the tensor products:

However, \mathcal{L} does not respect the braidings.

6.2 Left-right and right-left YD-modules

In Section 3 we studied the categories of left-right YD-modules ${}^H\mathcal{YD}(\mathcal{C})^{H^{op}}$ and ${}_{H^{cop}}\mathcal{YD}(\mathcal{C})^H$, Remark 3.4. Symmetrically, we may consider the category ${}^H\mathcal{YD}(\mathcal{C})_H$ of right-left YD-modules. These are right H -modules and left H -comodules which satisfy the compatibility condition (6.4). If $\Phi_{H,H}$ is symmetric, this condition is equivalent to (6.5).

The category ${}^H\mathcal{YD}(\mathcal{C})_{H^{cop}}$ is monoidal if $\Phi_{H,N}$ is symmetric for all $N \in {}^H\mathcal{YD}(\mathcal{C})_{H^{cop}}$. This is a braided monoidal category with braiding:

for $M, N \in {}^H\mathcal{YD}(\mathcal{C})_{H^{cop}}$. Another possibility for the braiding is Φ^{3-} (similarly as in Remark 3.3). Using the fact that $\Phi_{H,H}$ is symmetric, one may show that the functor $\mathcal{A} : {}^H\mathcal{YD}(\mathcal{C})_{H^{cop}} \rightarrow {}^H\mathcal{YD}(\mathcal{C})^{H^{op}}$ given by:

for $M, N \in {}^H\mathcal{YD}(\mathcal{C})_{H^{cop}}$ is an isomorphism of categories. We show that it is monoidal. For the right H -comodule structures we have:

For the left H -module structures we find:

Analogously to the two versions of left-right YD-categories, we have two versions of right-left YD-categories, where the second one is: ${}^{H^{op}}\mathcal{YD}(\mathcal{C})_H$. It is monoidal if $\Phi_{H,M}$ is symmetric for all $M \in {}^{H^{op}}\mathcal{YD}(\mathcal{C})_H$. This is a braided monoidal category with braiding:

$$\Phi_{M,N}^{4+} = \begin{array}{c} M \quad N \\ \diagdown \quad \diagup \\ \diagup \quad \diagdown \\ N \quad M \end{array}$$

for $M, N \in {}^{H^{op}}\mathcal{YD}(\mathcal{C})_H$. As in Remark 3.4 we have that $\Phi^{3\pm}$ is not a braiding for ${}^{H^{op}}\mathcal{YD}(\mathcal{C})_H$.

Let us next examine the relation between the categories ${}_H\mathcal{YD}(\mathcal{C})^{H^{op}}$ and ${}_{H^{cop}}\mathcal{YD}(\mathcal{C})^H$, on the one hand, and ${}^{H^{op}}\mathcal{YD}(\mathcal{C})_H$ and ${}^H\mathcal{YD}(\mathcal{C})_{H^{cop}}$, on the other hand. First of all recall that the corresponding identity functors are not isomorphisms of braided monoidal categories (Remark 3.4). Take $M \in {}_H\mathcal{YD}(\mathcal{C})^H$. The object $\mathcal{H}(M) = M$ with structures:

$$\begin{array}{c} \mathcal{H}(M) \\ \diagdown \quad \diagup \\ \diagup \quad \diagdown \\ \mathcal{H}(M)_H \end{array} = \begin{array}{c} M \\ \diagdown \quad \diagup \\ \diagup \quad \diagdown \\ M \quad H \end{array} \quad \text{and} \quad \begin{array}{c} H \quad \mathcal{H}(M) \\ \diagdown \quad \diagup \\ \diagup \quad \diagdown \\ \mathcal{H}(M) \end{array} = \begin{array}{c} H \quad M \\ \diagdown \quad \diagup \\ \diagup \quad \diagdown \\ M \end{array}$$

is a right H^{cop} -comodule and a left H^{op} -module. This defines a (bijective) functor $\mathcal{H} : {}_H\mathcal{YD}(\mathcal{C})^H \rightarrow {}_{H^{op},cop}\mathcal{YD}(\mathcal{C})^{H^{op},cop}$ (the objects of ${}_{H^{op},cop}\mathcal{YD}(\mathcal{C})^{H^{op},cop}$ are left-right YD-modules over the Hopf algebra $H^{op,cop}$). Indeed,

is equivalent to

The functor \mathcal{H} restricts to monoidal functors $\mathcal{H}_1 : {}_H\mathcal{C} \rightarrow {}_{H^{cop}}\mathcal{C}$ and $\mathcal{H}_2 : \mathcal{C}^H \rightarrow \mathcal{C}^{H^{op}}$. (For $M, M' \in {}_H\mathcal{YD}(\mathcal{C})^H$, the module structures of $\mathcal{H}_i(M \otimes M')$ and $\mathcal{H}_i(M) \otimes \mathcal{H}_i(M')$, for $i = 1$, are compatible since the antipode is a coalgebra anti-morphism and since $\Phi_{H,H}$ is symmetric, while the corresponding comodule structures for $i = 2$ are compatible since the antipode of H is an algebra anti-morphism.) Hence \mathcal{H} induces a monoidal functor \mathcal{H}' from ${}_H\mathcal{YD}(\mathcal{C})^{H^{op}}$ to the category \mathcal{D} with objects in ${}_{H^{op},cop}\mathcal{YD}(\mathcal{C})^{H^{op},cop}$, whose monoidal structure and the braiding are like the ones in ${}_{H^{cop}}\mathcal{YD}(\mathcal{C})^H$. The category \mathcal{D} is shown to be indeed a braided monoidal category, however the functor \mathcal{H}' does not respect the braidings. It is easily seen that $\mathcal{H}(\Phi^{1+}) = \Phi^{1+} \neq \Phi^{2+}$. Thus we will not consider that \mathcal{H}' induces a braided monoidal functor ${}_H\mathcal{YD}(\mathcal{C})^{H^{op}} \rightarrow {}_{H^{cop}}\mathcal{YD}(\mathcal{C})^H$.

In [1, Lemma 3.5.4] it is proved that ${}_H\mathcal{YD}(\mathcal{C})^{H^{op}} \xrightarrow{(\text{Id}, \Omega)} ({}_{H^{cop}}\mathcal{YD}(\mathcal{C})^H)^{cop}$ is an isomorphism of braided monoidal categories, where (Id, Ω) is the extension of the braided monoidal isomorphism functor $\mathcal{C} \rightarrow \mathcal{C}^{cop}$. As announced in the introduction of our paper, we do not make this kind of identifications, we stick to the original category \mathcal{C} .

Similarly, there is a functor $\mathcal{B} : {}^H\mathcal{YD}(\mathcal{C})_H \rightarrow {}^{H^{op},cop}\mathcal{YD}(\mathcal{C})_{H^{op},cop}$ defined via:

$$\begin{array}{c} \mathcal{B}(M) \\ \text{trapezoid} \\ H\mathcal{B}(M) \end{array} = \begin{array}{c} M \\ \ominus \\ \text{trapezoid} \\ H M \end{array} \quad \text{and} \quad \begin{array}{c} \mathcal{B}(M)_H \\ \text{trapezoid} \\ \mathcal{B}(M) \end{array} = \begin{array}{c} M H \\ \oplus \\ \text{trapezoid} \\ M \end{array}$$

for $M \in {}^H\mathcal{YD}(\mathcal{C})_{H^{cop}}$. It induces monoidal functors $\mathcal{B}_1 : {}^H\mathcal{C} \rightarrow {}^{H^{op}}\mathcal{C}$ and $\mathcal{B}_2 : \mathcal{C}_H \rightarrow \mathcal{C}_{H^{cop}}$, but not a braided monoidal functor ${}^H\mathcal{YD}(\mathcal{C})_{H^{cop}} \rightarrow {}^{H^{op}}\mathcal{YD}(\mathcal{C})_H$.

6.3 Comparing all the categories

To sum up the results of this section consider the following diagram:

$$\begin{array}{ccc} D(H)\mathcal{C} & \xrightarrow{\mathcal{F}_l} & {}^H_H\mathcal{YD}(\mathcal{C}) \\ \mathcal{F} \downarrow & \boxed{1} \nearrow \mathcal{F}_1 & \downarrow \mathcal{F}_2 \\ {}^H\mathcal{YD}(\mathcal{C})^{H^{op}} & \xrightarrow{\mathcal{A}^{-1}} & {}^H\mathcal{YD}(\mathcal{C})_{H^{cop}} \end{array} \quad (6.6)$$

We define the functors \mathcal{F}_1 and \mathcal{F}_2 so that the triangles $\langle 1 \rangle$ and $\langle 2 \rangle$ commute. We write out the functor \mathcal{F}_1 explicitly:

$$\begin{array}{c} \mathcal{F}_1(M) \\ \text{trapezoid} \\ \mathcal{F}_1(M)_H \end{array} = \begin{array}{c} M \\ \ominus \\ \text{trapezoid} \\ M H \end{array} \quad \text{with inverse} \quad \begin{array}{c} \mathcal{F}_1^{-1}(N) \\ \text{trapezoid} \\ \mathcal{F}_1^{-1}(N)_H \end{array} = \begin{array}{c} N \\ \oplus \\ \text{trapezoid} \\ H N \end{array}$$

We saw that the functors $\mathcal{F}_l, \mathcal{F}$ and \mathcal{A} are monoidal isomorphisms, so we have four mutually isomorphic monoidal categories. We now compare their braidings. We have:

$$\Phi_{M,N}^L = \begin{array}{c} M N \\ \text{braid} \\ N M \end{array} \stackrel{\mathcal{F}_1^{-1}}{=} \begin{array}{c} M N \\ \oplus \\ \text{braid} \\ N M \end{array} \stackrel{\Phi_{H,M}^{nat.}}{=} \begin{array}{c} M N \\ \oplus \\ \text{braid} \\ N M \end{array} = (\Phi_{N,M}^{1-})^{-1}$$

and

$$\Phi_{M,N}^{3+} = \begin{array}{c} M N \\ \text{braid} \\ N M \end{array} \stackrel{\mathcal{A}^{-1}}{=} \begin{array}{c} M N \\ \oplus \\ \ominus \\ \text{braid} \\ N M \end{array} = \begin{array}{c} M N \\ \text{braid} \\ N M \end{array} \stackrel{nat.}{=} \begin{array}{c} M N \\ \text{braid} \\ N M \end{array} = \Phi_{M,N}^{1+}$$

This proves that the functors $\mathcal{F}_1 : {}^H_H\mathcal{YD}(\mathcal{C}) \rightarrow {}_H\mathcal{YD}(\mathcal{C})^{H^{op}}$ and $\mathcal{A} : {}^H\mathcal{YD}(\mathcal{C})_{H^{cop}} \rightarrow {}_H\mathcal{YD}(\mathcal{C})^{H^{op}}$ are isomorphisms of braided monoidal categories. By Proposition 5.1, $\mathcal{F} : {}_{D(H)}\mathcal{C} \rightarrow {}_H\mathcal{YD}(\mathcal{C})^{H^{op}}$ is also such a functor. Then by commutativity of $\langle 1 \rangle$ and $\langle 2 \rangle$ in (6.6) we have four mutually isomorphic braided monoidal categories.

Symmetrically as in (6.6), we may consider:

$$\begin{array}{ccc}
 \mathcal{C}_{D(H)} & \xrightarrow{\mathcal{S}} & \mathcal{YD}(\mathcal{C})_{H^H} \\
 \downarrow \mathcal{T} & \searrow \mathcal{F}_3 & \downarrow \mathcal{F}_4 \\
 {}_{H^{cop}}\mathcal{YD}(\mathcal{C})^H & \xrightarrow{\mathcal{E}} & {}^{H^{op}}\mathcal{YD}(\mathcal{C})_H
 \end{array}
 \quad \begin{array}{c} \boxed{4} \\ \boxed{3} \end{array}
 \tag{6.7}$$

The functors $\mathcal{S} : \mathcal{C}_{D(H)} \rightarrow \mathcal{YD}(\mathcal{C})_{H^H}$, $\mathcal{T} : \mathcal{C}_{D(H)} \rightarrow {}_{H^{cop}}\mathcal{YD}(\mathcal{C})^H$ and $\mathcal{E} : {}_{H^{cop}}\mathcal{YD}(\mathcal{C})^H \rightarrow {}^{H^{op}}\mathcal{YD}(\mathcal{C})_H$ are given by:

$$\begin{array}{ccc}
 \begin{array}{c} S(M) \\ \text{---} \\ \text{---} \\ \text{---} \\ S(M) \quad H \end{array} = \begin{array}{c} M \\ \text{---} \\ \text{---} \\ \text{---} \\ M \quad H \end{array} \oplus & \text{with} & \begin{array}{c} S^{-1}(N) \quad H^* \\ \text{---} \\ \text{---} \\ \text{---} \\ S^{-1}(N) \end{array} = \begin{array}{c} N \quad H^* \\ \text{---} \\ \text{---} \\ \text{---} \\ N \end{array} \\
 \begin{array}{c} \mathcal{T}(M) \\ \text{---} \\ \text{---} \\ \text{---} \\ \mathcal{T}(M) \quad H \end{array} = \begin{array}{c} M \\ \text{---} \\ \text{---} \\ \text{---} \\ M \quad H \end{array} \oplus ; & & \begin{array}{c} H \quad \mathcal{T}(M) \\ \text{---} \\ \text{---} \\ \text{---} \\ \mathcal{T}(M) \end{array} = \begin{array}{c} H \quad M \\ \text{---} \\ \text{---} \\ \text{---} \\ M \end{array} \ominus
 \end{array}$$

and

$$\begin{array}{ccc}
 \begin{array}{c} \mathcal{E}(K) \\ \text{---} \\ \text{---} \\ \text{---} \\ H \mathcal{E}(K) \end{array} = \begin{array}{c} K \\ \text{---} \\ \text{---} \\ \text{---} \\ H \quad K \end{array} \oplus ; & \begin{array}{c} \mathcal{E}(K) \quad H \\ \text{---} \\ \text{---} \\ \text{---} \\ \mathcal{E}(K) \end{array} = \begin{array}{c} K \quad H \\ \text{---} \\ \text{---} \\ \text{---} \\ K \end{array} \ominus & \text{with} & \begin{array}{c} \mathcal{E}^{-1}(L) \\ \text{---} \\ \text{---} \\ \text{---} \\ H \mathcal{E}^{-1}(L) \end{array} = \begin{array}{c} L \\ \text{---} \\ \text{---} \\ \text{---} \\ L \quad H \end{array} \ominus ; & \begin{array}{c} H \quad \mathcal{E}^{-1}(L) \\ \text{---} \\ \text{---} \\ \text{---} \\ \mathcal{E}^{-1}(L) \end{array} = \begin{array}{c} H \quad L \\ \text{---} \\ \text{---} \\ \text{---} \\ L \end{array} \oplus
 \end{array}$$

(in the definitions of \mathcal{S} and \mathcal{T} the symbols \cap and \cup stand for the morphisms $d' : I \rightarrow H^* \otimes H$ and $e' : H \otimes H^* \rightarrow I$, recall 2.2). The functors \mathcal{F}_3 and \mathcal{F}_4 are defined so that the triangles $\langle 3 \rangle$ and $\langle 4 \rangle$ in (6.7) commute. The proofs that $\mathcal{S}, \mathcal{F}_3$ and \mathcal{E} are monoidal functors are analogous to the corresponding proofs for the functors $\mathcal{F}_l, \mathcal{F}$ and \mathcal{A} , respectively. Then clearly also \mathcal{T} and \mathcal{F}_4 are monoidal. The braiding in $\mathcal{C}_{D(H)}$ is given by:

$$\Psi_{M,N}^R := \begin{array}{c} M \quad N \\ \text{---} \\ \text{---} \\ \text{---} \\ \text{---} \\ \text{---} \\ \text{---} \\ \text{---} \\ \text{---} \\ N \quad M \end{array} = \begin{array}{c} M \quad N \\ \text{---} \\ \text{---} \\ \text{---} \\ \text{---} \\ \text{---} \\ \text{---} \\ \text{---} \\ \text{---} \\ N \quad M \end{array}$$

and we have:

$$\begin{aligned}
\Psi_{M,N}^R &= \begin{array}{c} M \ N \\ | \ | \\ \text{---} \\ | \ | \\ N \ M \end{array} \stackrel{\mathcal{S}^{-1}}{=} \begin{array}{c} M \ N \\ | \ | \\ \text{---} \\ | \ | \\ N \ M \end{array} \stackrel{\mathcal{T}^{-1}}{=} \begin{array}{c} M \ N \\ | \ | \\ \text{---} \\ | \ | \\ N \ M \end{array} \stackrel{\text{nat.}}{=} \begin{array}{c} M \ N \\ | \ | \\ \text{---} \\ | \ | \\ N \ M \end{array} = (\Phi_{N,M}^R)^{-1} \\
\Psi_{M,N}^R &= \begin{array}{c} M \ N \\ | \ | \\ \text{---} \\ | \ | \\ N \ M \end{array} \stackrel{\mathcal{T}^{-1}}{=} \begin{array}{c} M \ N \\ | \ | \\ \text{---} \\ | \ | \\ N \ M \end{array} \stackrel{\Phi_{H,N}}{=} \begin{array}{c} M \ N \\ | \ | \\ \text{---} \\ | \ | \\ N \ M \end{array} = \Phi_{M,N}^{2-}
\end{aligned}$$

and

$$\begin{aligned}
\Phi_{M,N}^{2+} &= \begin{array}{c} M \ N \\ | \ | \\ \text{---} \\ | \ | \\ N \ M \end{array} \stackrel{\mathcal{E}^{-1}}{=} \begin{array}{c} M \ N \\ | \ | \\ \text{---} \\ | \ | \\ N \ M \end{array} \stackrel{\Phi_{H,M}}{\Phi_{H,N}}{=} \begin{array}{c} M \ N \\ | \ | \\ \text{---} \\ | \ | \\ N \ M \end{array} \stackrel{\text{nat.}}{=} \begin{array}{c} M \ N \\ | \ | \\ \text{---} \\ | \ | \\ N \ M \end{array} = \begin{array}{c} M \ N \\ | \ | \\ \text{---} \\ | \ | \\ N \ M \end{array} = \Phi_{M,N}^{4+}.
\end{aligned}$$

(The braiding $\Phi_{M,N}^{2+}$ is the one from Remark 3.4.) This proves that the functors \mathcal{S} , \mathcal{T} and \mathcal{E} respect the braidings.

Note that our result that $\mathcal{E} : {}_{H^{cop}}\mathcal{YD}(\mathcal{C})^H \rightarrow {}^{H^{op}}\mathcal{YD}(\mathcal{C})_H$ is an isomorphisms of braided monoidal categories generalizes [1, Lemma 3.5.2], where the braided monoidal isomorphism functor ${}^{H^{op}}\mathcal{YD}(\mathcal{C})_H \rightarrow ({}_{H^{cop}}\mathcal{YD}(\mathcal{C})^H)^{op,cop}$ is given if \mathcal{C} has right duals. It sends an object from the source category to its dual object.

Finally, let us record that we do not find any braided monoidal functor which would connect the two groups of categories from (6.6) and (6.7). At the end of Subsection 6.2 we showed that a natural candidate \mathcal{H}' for a monoidal functor from ${}_H\mathcal{YD}(\mathcal{C})^{H^{op}}$ to ${}_{H^{cop}}\mathcal{YD}(\mathcal{C})^H$ is not a braided functor. Likewise, at the end of Subsection 6.1 we showed that $\mathcal{L} : {}^H_H\mathcal{YD}(\mathcal{C}) \rightarrow \mathcal{YD}(\mathcal{C})^H_H$ is a monoidal but not a braided functor. In the relation (3.5.1) after [1, Corollary 3.5.5] two (mutually isomorphic) isomorphism functors $\mathcal{G}_1, \mathcal{G}_2 : \mathcal{YD}(\mathcal{C})^H_H \rightarrow {}^H_H\mathcal{YD}(\mathcal{C})$ are given. For $M \in \mathcal{YD}(\mathcal{C})^H_H$ with right module and comodule structure morphisms μ and ρ respectively, the functors \mathcal{G}_1 and \mathcal{G}_2 are defined by $\mathcal{G}_1(M, \nu, \rho) = (M, \mu_1 = \nu\Phi^{-1}(S^{-1} \otimes M), \lambda_1 = (S \otimes M)\Phi\rho)$ and $\mathcal{G}_2(M, \nu, \rho) = (M, \mu_2 = \nu\Phi(S \otimes M), \lambda_2 = (S^{-1} \otimes M)\Phi^{-1}\rho)$, respectively. Here μ_i and λ_i denote the left module and comodule structure morphisms of $\mathcal{G}_i(M) = M$, respectively, for $i = 1, 2$. That these functors are well-defined one can check directly applying (6.2). However, that they are not monoidal we can see even when $\mathcal{C} = Vec$, the category of vector spaces. Let us see

this for \mathcal{G}_1 : $h \triangleright (m \otimes n) = (m \otimes n) \triangleleft S^{-1}(h) = m \triangleleft S^{-1}(h_{(2)}) \otimes n \triangleleft S^{-1}(h_{(1)}) = h_{(2)} \triangleright m \otimes h_{(1)} \triangleright n$, which shows that \mathcal{G}_1 restricts to a monoidal functor $\mathcal{M}_H \rightarrow {}_{H^{cop}}\mathcal{M}$. Moreover, a direct check shows that if $\Phi_{H,M}$ is symmetric for any $M \in \mathcal{YD}(\mathcal{C})_H^H$, the functor \mathcal{G}_1 is a braided monoidal isomorphism $\mathcal{YD}(\mathcal{C})_H^H \rightarrow {}_{H^{cop}}\mathcal{YD}(\mathcal{C})$, where ${}_{H^{cop}}\mathcal{YD}(\mathcal{C})$ is a braided monoidal category with braiding:



Thus, we can complete (6.7), and symmetrically (6.6), into commutative diagrams of isomorphic braided monoidal categories:

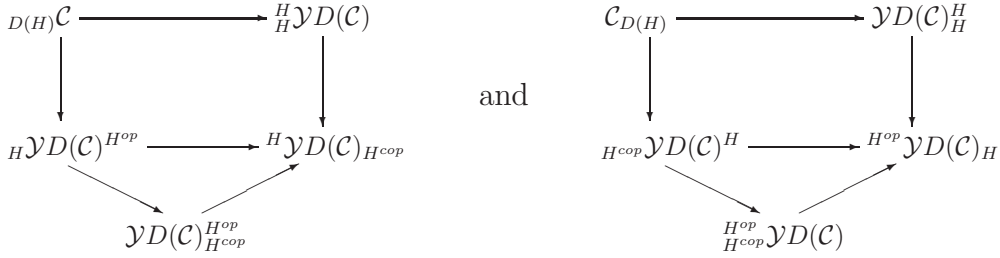

There are further monoidal isomorphisms for YD-categories. In [1, Lemma 3.5.6] there is given a monoidal isomorphism ${}_H\mathcal{YD}(\mathcal{C})^{H^{op}} \rightarrow {}_H\mathcal{YD}(\mathcal{C})_A$, where A is a further bialgebra with a bialgebra pairing $\rho : H \otimes A \rightarrow I$. Here the latter is a monoidal category without any symmetricity conditions, but the former requires some. On the other hand, we checked that there is a monoidal isomorphism ${}_H^H\mathcal{YD}(\mathcal{C}) \rightarrow {}_{H,A^{cop}}\mathcal{YD}(\mathcal{C})$, where the latter does require some symmetricity conditions whereas the former does not. The objects M of ${}_{H,A^{cop}}\mathcal{YD}(\mathcal{C})$ satisfy the condition:

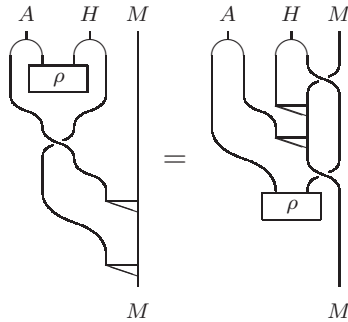

where $\rho : A \otimes H \rightarrow I$ is a bialgebra pairing. This is another example of the appearance that a (braided) monoidal isomorphism functor from a YD-category in \mathcal{C} necessarily requires that the braiding in \mathcal{C} be symmetric between H and any object of the category.

7 Center construction

The center construction for monoidal categories has been introduced independently by Drinfel'd ¹ and Joyal and Street [9]. It consists of assigning a braided monoidal category called *center of \mathcal{C}* to a monoidal category \mathcal{C} . We will differ the left $\mathcal{Z}_l(\mathcal{C})$ and the right $\mathcal{Z}_r(\mathcal{C})$ center of \mathcal{C} . We recall here the definition of the (right) center from [10, Definition XIII.4.1].

Proposition and Definition 7.1 *For a monoidal category \mathcal{C} the objects of $\mathcal{Z}_r(\mathcal{C})$ are pairs $(V, c_{-,V})$ with $V \in \mathcal{C}$, where $c_{-,V}$ is a family of natural isomorphisms $c_{X,V} : X \otimes V \rightarrow V \otimes X$ for $X \in \mathcal{C}$ such that for all $Y \in \mathcal{C}$ it is*

$$c_{X \otimes Y, V} = (c_{X, V} \otimes Y)(X \otimes c_{Y, V}). \quad (7.1)$$

A morphism between $(V, c_{-,V})$ and $(W, c_{-,W})$ is a morphism $f : V \rightarrow W$ in \mathcal{C} such that for all $X \in \mathcal{C}$ it is

$$(f \otimes X)c_{X, V} = c_{X, W}(X \otimes f). \quad (7.2)$$

The identity morphism in \mathcal{C} is the identity morphism in $\mathcal{Z}_r(\mathcal{C})$ and the composition of two morphisms in \mathcal{C} is a morphism in $\mathcal{Z}_r(\mathcal{C})$. Thus $\mathcal{Z}_r(\mathcal{C})$ is a category, called the right center of \mathcal{C} .

From the definition it is clear that $c_{-, -}$ is a transformation natural in both arguments. In [10, Theorem XIII.4.2] it is proved that $\mathcal{Z}_r(\mathcal{C})$ is a braided monoidal category. The unit object is (I, Id) , the tensor product of $(V, c_{-,V})$ and $(W, c_{-,W})$ is $(V \otimes W, c_{-,V \otimes W})$, where $c_{X, V \otimes W} : X \otimes V \otimes W \rightarrow V \otimes W \otimes X$ is a morphism in \mathcal{C} defined for all $X \in \mathcal{C}$ by

$$c_{X, V \otimes W} = (V \otimes c_{X, W})(c_{X, V} \otimes W). \quad (7.3)$$

The braiding in $\mathcal{Z}_r(\mathcal{C})$ is given by:

$$c_{V, W} : (V, c_{-,V}) \otimes (W, c_{-,W}) \rightarrow (W, c_{-,W}) \otimes (V, c_{-,V}).$$

The left center $\mathcal{Z}_l(\mathcal{C})$ of \mathcal{C} is defined analogously – an object in $\mathcal{Z}_l(\mathcal{C})$ has the form $(V, c_{V, -})$ with $V \in \mathcal{C}$.

For a Hopf algebra H over a field the left center of the category of left modules over H is isomorphic to ${}^H_H\mathcal{YD}$ [15, Example 1.3], and the right center of the category of left modules over H is isomorphic to ${}_H\mathcal{YD}^H$ [10, Theorem XIII.5.1]. Generalizing these results to a braided monoidal category \mathcal{C} , Bespalov indicated in [1, Proposition 3.6.1] that ${}^H_H\mathcal{YD}(\mathcal{C})$ is isomorphic as a braided monoidal category to a subcategory $\mathcal{Z}_l^{\mathcal{C}}({}_H\mathcal{C})$ of the (left) center of ${}_H\mathcal{C}$. The condition that the objects $(V, c_{V, -})$ of $\mathcal{Z}_l^{\mathcal{C}}({}_H\mathcal{C})$ fulfill is that for every $X \in \mathcal{C}$ with trivial H -action (via the counit) the morphism $c_{V, X}$ coincides with the braiding $\Phi_{V, X}$ in \mathcal{C} . In other words, with the forgetful functor $\mathcal{U} : {}_H\mathcal{C} \rightarrow \mathcal{C}$ one has that $c_{V, \mathcal{U}(X)} = \Phi_{V, \mathcal{U}(X)}$ for every $X \in {}_H\mathcal{C}$. For completeness we present below the proof for an analogous statement.

¹Private communication to Majid in response to the preprint of [13], February 1990.

Proposition 7.2 The categories $\mathcal{Z}_r^{\mathcal{C}}({}_H\mathcal{C})$ and ${}_H\mathcal{YD}(\mathcal{C})^{Hop}$ are isomorphic as braided monoidal categories.

Proof. First of all, note that for $(V, c_{-,V}) \in \mathcal{Z}_r^{\mathcal{C}}({}_H\mathcal{C})$ we have:

$$c_{H,V} \stackrel{\text{nat.}}{=} \begin{array}{c} H \ V \\ \bullet \ \bullet \\ \boxed{c_{H \otimes H, V}} \\ \downarrow \ \downarrow \\ V \ H \end{array} \stackrel{(7.1)}{=} \begin{array}{c} H \ V \\ \bullet \ \bullet \\ \boxed{c_{H,V}} \\ \downarrow \ \downarrow \\ V \ H \end{array} \stackrel{\text{nat.}}{=} \begin{array}{c} H \ V \\ \bullet \ \bullet \\ \boxed{c_{H,V}} \\ \downarrow \ \downarrow \\ V \ H \end{array} \quad (7.4)$$

The morphism $\rho := c_{H,V}(\eta_H \otimes V) : V \rightarrow V \otimes H$ defines a right H -comodule structure on V :

$$\begin{array}{c} V \\ \downarrow \\ V \ H \end{array} \stackrel{\text{nat.}}{=} \begin{array}{c} V \\ \bullet \\ \boxed{c_{H,V}} \\ \downarrow \ \downarrow \\ V \ H \ H \end{array} \stackrel{(7.1)}{=} \begin{array}{c} V \\ \bullet \ \bullet \\ \boxed{c_{H \otimes H, V}} \\ \downarrow \ \downarrow \\ V \ H \ H \end{array} \stackrel{\text{nat.}}{=} \begin{array}{c} V \\ \bullet \\ \boxed{c_{H,V}} \\ \downarrow \ \downarrow \\ V \ H \ H \end{array} \stackrel{\text{nat.}}{=} \begin{array}{c} V \\ \downarrow \\ V \ H \ H \end{array}$$

The counit property follows from $c_{I,V} = id_V$ (see (7.1)). With this H -comodule and the existing H -module structure V is a left-right YD-module:

$$\begin{array}{c} H \ V \\ \downarrow \ \downarrow \\ V \ H \end{array} \stackrel{(7.4)}{=} \begin{array}{c} H \ V \\ \bullet \ \bullet \\ \boxed{c_{H,V}} \\ \downarrow \ \downarrow \\ V \ H \end{array} \stackrel{c_{H,V} \in {}_H\mathcal{C}}{=} \begin{array}{c} H \ V \\ \downarrow \ \downarrow \\ V \ H \end{array} \stackrel{\text{nat.}}{=} \begin{array}{c} H \ V \\ \bullet \ \bullet \\ \boxed{c_{H,V}} \\ \downarrow \ \downarrow \\ V \ H \end{array} \stackrel{\text{nat.}}{=} \begin{array}{c} H \ V \\ \downarrow \ \downarrow \\ V \ H \end{array}$$

A morphism $f : V \rightarrow W$ in $\mathcal{Z}_r^{\mathcal{C}}({}_H\mathcal{C})$ becomes a morphism of left-right YD-modules – it is right H -colinear because of (7.2). This defines a functor \mathcal{K} from $\mathcal{Z}_r^{\mathcal{C}}({}_H\mathcal{C})$ to the category of left-right YD-modules. We now prove that $\mathcal{K} : \mathcal{Z}_r^{\mathcal{C}}({}_H\mathcal{C}) \rightarrow {}_H\mathcal{YD}(\mathcal{C})^{Hop}$ is monoidal. Let $(V, c_{-,V})$ and $(W, c_{-,W})$ be in $\mathcal{Z}_r^{\mathcal{C}}({}_H\mathcal{C})$. Then we have:

$$\begin{array}{c} \mathcal{K}(V \otimes W) \\ \downarrow \\ \mathcal{K}(V \otimes W) \ H \end{array} \stackrel{(7.3)}{=} \begin{array}{c} V \otimes W \\ \bullet \ \bullet \\ \boxed{c_{H, V \otimes W}} \\ \downarrow \ \downarrow \\ V \otimes W \ H \end{array} \stackrel{(7.4)}{=} \begin{array}{c} V \ W \\ \bullet \ \bullet \\ \boxed{c_{H,V}} \\ \downarrow \ \downarrow \\ V \ W \ H \end{array} \stackrel{\text{nat.}}{=} \begin{array}{c} V \ W \\ \bullet \ \bullet \\ \boxed{c_{H,V}} \ \boxed{c_{H,W}} \\ \downarrow \ \downarrow \\ V \ W \ H \end{array} \stackrel{\text{nat.}}{=} \begin{array}{c} \mathcal{K}(V) \ \mathcal{K}(W) \\ \downarrow \ \downarrow \\ \mathcal{K}(V) \ \mathcal{K}(W) \ H \end{array}$$

If $(V, c_{-,V}) \in \mathcal{Z}_r^{\mathcal{C}}({}_H\mathcal{C})$, then $\Phi_{-,V}^{1+} = c_{-,V}$ because of (7.4). On the other hand, for $M \in {}_H\mathcal{YD}(\mathcal{C})^{Hop}$ its comodule structure morphism is obviously equal to $\Phi_{H,M}^{1+}(\eta_H \otimes M)$. Hence the inverse functor of \mathcal{K} is given by sending a YD-module M into the pair $(M, \Phi_{-,M}^{1+})$. Consequently, \mathcal{K} respects the braiding and this finishes the proof. \square

Similarly, one may prove that the following categories are braided monoidally isomorphic:

$$\mathcal{Z}_l^{\mathcal{C}}({}_H\mathcal{C}) \cong {}_H^H\mathcal{YD}(\mathcal{C}) \cong \mathcal{Z}_r^{\mathcal{C}}({}^H\mathcal{C}), \quad \mathcal{Z}_r^{\mathcal{C}}(\mathcal{C}_H) \cong \mathcal{YD}(\mathcal{C})_H^H \cong \mathcal{Z}_l^{\mathcal{C}}(\mathcal{C}^H)$$

$${}^H\mathcal{YD}(\mathcal{C})_{H^{cop}} \cong \mathcal{Z}_l^{\mathcal{C}}({}^H\mathcal{C}), \quad {}_{H^{cop}}\mathcal{YD}(\mathcal{C})^H \cong \mathcal{Z}_r^{\mathcal{C}}(\mathcal{C}^H), \quad {}^{H^{op}}\mathcal{YD}(\mathcal{C})_H \cong \mathcal{Z}_l^{\mathcal{C}}(\mathcal{C}_H).$$

The above center subcategories are defined analogously to $\mathcal{Z}_r^{\mathcal{C}}({}_H\mathcal{C})$. Adding to this list the categories ${}_{(H^{op})^* \bowtie H}\mathcal{C}$ and $\mathcal{C}_{(H^{op})^* \bowtie H}$, we may identify

$${}_{(H^{op})^* \bowtie H}\mathcal{C} \cong \mathcal{Z}_l^{\mathcal{C}}({}_H\mathcal{C}) \quad \text{and} \quad \mathcal{C}_{(H^{op})^* \bowtie H} \cong \mathcal{Z}_r^{\mathcal{C}}(\mathcal{C}_H) \quad (7.5)$$

having in mind that the corresponding H -module structures remain unchanged by the isomorphism functors. Then due to (6.6) and (6.7) we obtain the following diagrams of isomorphic braided monoidal categories:

$$\begin{array}{ccc} \mathcal{Z}_l^{\mathcal{C}}({}_H\mathcal{C}) & \longrightarrow & \mathcal{Z}_r^{\mathcal{C}}({}^H\mathcal{C}) \\ \downarrow & & \downarrow \\ \mathcal{Z}_r^{\mathcal{C}}({}_H\mathcal{C}) & \longrightarrow & \mathcal{Z}_l^{\mathcal{C}}({}^H\mathcal{C}) \end{array} \quad \text{and} \quad \begin{array}{ccc} \mathcal{Z}_r^{\mathcal{C}}(\mathcal{C}_H) & \longrightarrow & \mathcal{Z}_l^{\mathcal{C}}(\mathcal{C}^H) \\ \downarrow & & \downarrow \\ \mathcal{Z}_r^{\mathcal{C}}(\mathcal{C}^H) & \longrightarrow & \mathcal{Z}_l^{\mathcal{C}}(\mathcal{C}_H) \end{array}$$

7.1 Transparency and Müger's centers \mathcal{Z}_1 and \mathcal{Z}_2

Throughout the paper we have used the condition that $\Phi_{H,M}$ is symmetric for every $M \in \mathcal{C}$. This means that H is *transparent* in \mathcal{C} in terms of [4], or that H belongs to Müger's center $\mathcal{Z}_2(\mathcal{C}) = \{X \in \mathcal{C} \mid \Phi_{Y,X}\Phi_{X,Y} = id_{X \otimes Y} \text{ for all } Y \in \mathcal{C}\}$, [18, Definition 2.9]. Note that due to Lemma 4.4, H is transparent if and only if so is H^* . The center of a monoidal category \mathcal{D} that we studied above is denoted by $\mathcal{Z}_1(\mathcal{D})$ in [18] (neglecting the difference between the left and the right center). Then we may state:

Proposition 7.3 Let H be a finite Hopf algebra with a bijective antipode in a braided monoidal category \mathcal{C} . If $H \in \mathcal{Z}_2(\mathcal{C})$, then there are embeddings of braided monoidal categories:

$${}_H^H\mathcal{YD}(\mathcal{C}) \cong {}_{D(H)}\mathcal{C} \hookrightarrow \mathcal{Z}_{1,l}({}_H\mathcal{C}) \quad \text{and} \quad \mathcal{YD}(\mathcal{C})_H^H \cong \mathcal{C}_{D(H)} \hookrightarrow \mathcal{Z}_{1,r}(\mathcal{C}_H).$$

7.2 The whole center category and the coend

The center category of a monoidal category \mathcal{C} is a particular case of the Pontryagin dual monoidal category introduced by Majid in [13, Section 3]. For \mathcal{C} braided, rigid and

cocomplete from [14, Theorem 3.2] one deduces that there is an isomorphism of monoidal categories:

$$\mathcal{Z}_l(\mathcal{C}) \cong \mathcal{C}_{\text{Aut}(\mathcal{C})} \quad (7.6)$$

where

$$\text{Aut}(\mathcal{C}) \cong \int^{X} X^* \otimes X$$

is the coend in \mathcal{C} . It has a structure of a bialgebra in \mathcal{C} and if \mathcal{C} is rigid, it is a Hopf algebra. As we observed in Section 5, if H is a quasitriangular Hopf algebra such that $\Phi_{H,M}$ is symmetric for all $M \in \mathcal{C}$, i.e. $H \in \mathcal{Z}_2(\mathcal{C})$, then the whole category \mathcal{C}_H is braided. Thus for \mathcal{C} rigid $\text{Aut}(\mathcal{C}_H)$ becomes a Hopf algebra in \mathcal{C}_H and according to Proposition 5.2 the categories $(\mathcal{C}_H)_{\text{Aut}(\mathcal{C}_H)}$ and $\mathcal{C}_{H \rtimes \text{Aut}(\mathcal{C}_H)}$ are monoidally isomorphic. By the identity (7.6) we then have:

Proposition 7.4 Let \mathcal{C} be a rigid braided monoidal category and $H \in \mathcal{C}$ a quasitriangular Hopf algebra such that $H \in \mathcal{Z}_2(\mathcal{C})$. There is a monoidal isomorphism of categories:

$$\mathcal{Z}_l(\mathcal{C}_H) \cong \mathcal{C}_{H \rtimes \text{Aut}(\mathcal{C}_H)}.$$

When $\mathcal{C} = \text{Vec}$ and H is a finite-dimensional quasitriangular Hopf algebra, $\text{Aut}(\mathcal{M}_H) = H^*$ as a vector space with a modified multiplication, [14], and the above yields $\mathcal{Z}_l(\mathcal{M}_H) \cong \mathcal{M}_{D'(H)}$, where $D'(H) = H \bowtie H^{*op}$ is a version of the Drinfel'd double. Symmetrically to (7.6) one has $\mathcal{Z}_r(\mathcal{C}) \cong_{\text{Aut}(\mathcal{C})} \mathcal{C}$. For $H \in \mathcal{Z}_2(\mathcal{C})$ this yields the monoidal isomorphism $\mathcal{Z}_r({}_H\mathcal{C}) \cong_{\text{Aut}({}_H\mathcal{C}) \rtimes H} \mathcal{C}$. Here $\text{Aut}({}_H\mathcal{C}) \rtimes H$ is the bosonization of the braided Hopf algebra $\text{Aut}({}_H\mathcal{C})$ in ${}_H\mathcal{C}$.

Another approach to the center construction of monoidal categories and the Drinfel'd double uses monads [5]. Assume T is a Hopf monad in a rigid monoidal category \mathcal{C} for which the coend $C_T(X) = \int^{Y \in \mathcal{C}} T(Y)^* \otimes X \otimes Y$ exists for every $X \in \mathcal{C}$. The authors construct a quasitriangular Hopf monad \mathbb{D}_T , called *the double of T* , and prove the braided monoidal isomorphism $\mathbb{D}_T\mathcal{C} \cong \mathcal{Z}_l({}_T\mathcal{C})$, [5, Theorem 6.5]. Relying on monads, this construction generalizes the Drinfel'd double to a fully non-braided setting. In the particular case when a Hopf monad is associated to a Hopf algebra H in a rigid braided monoidal category \mathcal{C} , the underlying object of the double \mathbb{D}_H is $H \otimes H^* \otimes \text{Aut}(\mathcal{C})$, assuming that \mathcal{C} admits the coend, e.g. \mathcal{C} is cocomplete. (When $\mathcal{C} = \text{Vec}$, one recovers the usual Drinfel'd double.) In this case one has the braided monoidal isomorphisms ([5, Theorem 8.13]):

$$\mathcal{Z}_l(\mathcal{C}_H) \cong \mathcal{C}_{\mathbb{D}_H} \cong \mathbb{D}_H\mathcal{C} \cong \mathcal{Z}_r({}_H\mathcal{C}). \quad (7.7)$$

To prove the isomorphism between the left and the right hand-side categories one applies identifications with objects in \mathcal{C}^{cop} . Moreover, the isomorphism in the middle is possible since \mathbb{D}_H is quasitriangular. For $H = I$ the trivial Hopf algebra, it is $\mathbb{D}_I = \text{Aut}(\mathcal{C})$ and one recovers (7.6). On the other hand, observe that for $H = I$ the center subcategory becomes $\mathcal{Z}_r^{\mathcal{C}}(I\mathcal{C}) \cong \mathcal{C}$.

We point out that the notions of a quasitriangular structure in [14] and [5] differ. In the latter case an R-matrix for a Hopf algebra $H \in \mathcal{C}$ is a morphism $\mathfrak{r} : C \otimes C \rightarrow H \otimes H$ defined in such a way that H is quasitriangular if and only if the category of H -modules in \mathcal{C} is braided. The R-matrix that Majid uses [16, Definition 1.3] (and which we apply) is a morphism $\mathcal{R} : I \rightarrow H \otimes H$ obtained by straightforward extension of the axioms in the classical case. Its existence implies that the *subcategory* $\mathcal{O}(H, \Delta^{op})$ of the category of H -modules in \mathcal{C} is braided. Though, both constructions recover the classical notion of a quasitriangular structure for the category of vector spaces (in this case the coend is just the field).

8 Particular cases and examples

When a Hopf algebra $H \in \mathcal{C}$ is commutative or/and cocommutative, the symmetricity condition on $\Phi_{H,X}$ for any $X \in \mathcal{C}$ that emerges throughout the paper obtains a certain interpretation.

Proposition 8.1 [7, Proposition 3.12] Let $H \in \mathcal{C}$ be a Hopf algebra.

- (i) The braiding Φ of \mathcal{C} is left H -linear if and only if $\Phi_{H,X} = \Phi_{X,H}^{-1}$ for any $X \in \mathcal{C}$ and H is cocommutative.
- (ii) The braiding Φ of \mathcal{C} is left H -colinear if and only if $\Phi_{H,X} = \Phi_{X,H}^{-1}$ for any $X \in \mathcal{C}$ and H is commutative.

On the other hand, if the braiding Φ of \mathcal{C} is left H -linear, then the category ${}_H\mathcal{C}$ is braided monoidal with the same braiding Φ . Similarly, if Φ is left H -colinear, then the category ${}^H\mathcal{C}$ is braided monoidal with the braiding Φ .

We illustrate the above cases by an example. The following family of Hopf algebras was studied in [19, Section 4]. Let n, m be natural numbers, k a field such that $\text{char}(k) \nmid 2m$ and ω a $2m$ -th primitive root of unity. For $i = 1, \dots, n$ choose $1 \leq d_i < 2m$ odd numbers and set $d^{\leq n} = (d_1, \dots, d_n)$. Then

$$H(m, n, d^{\leq n}) = k\langle g, x_1, \dots, x_n \mid g^{2m} = 1, x_i^2 = 0, gx_i = \omega^{d_i} x_i g, x_i x_j = -x_j x_i \rangle$$

is a Hopf algebra, where g is group-like and x_i is a $(g^m, 1)$ -primitive element, that is, $\Delta(x_i) = 1 \otimes x_i + x_i \otimes g^m$ and $\varepsilon(x_i) = 0$. The antipode is given by $S(g) = g^{-1}$ and $S(x_i) = -x_i g^m$. We proved in [7] that $H(m, n, d^{\leq n})$ decomposes as the Radford biproduct (indeed a bosonization):

$$H(m, n, d^{\leq n}) \cong B \rtimes H(m, n-1, d^{\leq n-1}) \tag{8.1}$$

where the braided Hopf algebra is the exterior algebra $B = K[x_n]/(x_n^2)$. The isomorphism is given by: $G \mapsto 1 \times g, X_i \mapsto 1 \times x_i, X_n \mapsto x_n \times g^m$. We have that B is a module over $H = H(m, n-1, d^{\leq n-1})$ by the action $g \cdot x_n = \omega^{d_n} x_n$ and $x_i \cdot x_n = 0$ for $i = 1, \dots, n-1$.

It becomes a commutative and cocommutative Hopf algebra in ${}_H\mathcal{M}$ with x_n being a primitive element, i.e., $\Delta_B(x_n) = 1 \otimes x_n + x_n \otimes 1$, $\varepsilon_B(x_n) = 0$ and $S_B(x_n) = -x_n$. The Hopf algebra $H(m, n, d^{\leq n})$ is quasitriangular with the family of quasitriangular structures [7, (6.4) on p. 69]:

$$\mathcal{R}_s^n = \frac{1}{2m} \left(\sum_{j,t=0}^{2m-1} \omega^{-jt} g^j \otimes g^{st} \right) \quad (8.2)$$

where $0 \leq s < 2m$ is such that $sd_i \equiv m \pmod{2m}$ for every $i = 1, \dots, n$. Moreover, \mathcal{R}_s^n is triangular if and only if $s = m$. As it is well known ([12]), every left H -module M belongs to ${}^H_H\mathcal{YD}$ with the coaction

$$\lambda(m) = \mathcal{R}^{(2)} \otimes \mathcal{R}^{(1)} m, \quad m \in M \quad (8.3)$$

- we denote $\mathcal{R} = \mathcal{R}_s^{n-1}$ for brevity - and $({}_H\mathcal{M}, \Phi_{\mathcal{R}})$ can be seen as a braided monoidal subcategory of $({}^H_H\mathcal{YD}, \Phi^L)$. Here Φ^L is given by (3.4), that is $\Phi^L(x \otimes y) = x_{[-1]} \cdot y \otimes x_{[0]}$, whereas $\Phi_{\mathcal{R}}$ and its inverse are given by:

$$\Phi_{\mathcal{R}}(x \otimes y) = \mathcal{R}^{(2)} y \otimes \mathcal{R}^{(1)} x; \quad \Phi_{\mathcal{R}}^{-1}(x \otimes y) = \mathcal{R}^{(1)} y \otimes S^{-1}(\mathcal{R}^{(2)}) x. \quad (8.4)$$

Thus B becomes a Hopf algebra in $({}^H_H\mathcal{YD}, \Phi^L)$.

Set $\mathcal{C} = {}^H_H\mathcal{YD}$. Let us now prove that $\Phi_{B,M}^L$ is symmetric for any M in \mathcal{C} . Take $m \in M$ and let us check if $\Phi^L(b \otimes m) = (\Phi^L)^{-1}(b \otimes m)$ (see (8.4) and (8.2)). For $b = 1$ the computation is easier, we compute here the case $b = x_n$. We find:

$$\begin{aligned} \Phi_{\mathcal{R}}(x_n \otimes m) &= \frac{1}{2m} \left(\sum_{j,t=0}^{2m-1} \omega^{-jt} g^{st} \cdot m \otimes g^j \cdot x_n \right) \\ &= \frac{1}{2m} \left(\sum_{j,t=0}^{2m-1} \omega^{-jt} g^{st} \cdot m \otimes \omega^{d_n j} x_n \right) \\ &= \frac{1}{2m} \left(\sum_{t=0}^{2m-1} \left[\sum_{j=0}^{2m-1} (\omega^{d_n - t})^j \right] g^{st} \cdot m \right) \otimes x_n \\ &= g^{sd_n} \cdot m \otimes x_n \end{aligned}$$

(the sum in the bracket in the penultimate expression is different from 0 only for $j = -sd_n \pmod{2m}$, when it equals $2m$). Similarly, it is:

$$\begin{aligned} \Phi_{\mathcal{R}}^{-1}(x_n \otimes m) &= \frac{1}{2m} \left(\sum_{j,t=0}^{2m-1} \omega^{-jt} g^j \cdot m \otimes S^{-1}(g^{st}) \cdot x_n \right) \\ &= \frac{1}{2m} \left(\sum_{j,t=0}^{2m-1} \omega^{-jt} g^j \cdot m \otimes g^{-st} \cdot x_n \right) \\ &= \frac{1}{2m} \left(\sum_{j,t=0}^{2m-1} \omega^{-jt} g^j \cdot m \otimes \omega^{-d_n st} x_n \right) \\ &= \frac{1}{2m} \left(\sum_{j=0}^{2m-1} \left[\sum_{t=0}^{2m-1} (\omega^{-(j+sd_n)})^t \right] g^j \cdot m \right) \otimes x_n \\ &= g^{-sd_n} \cdot m \otimes x_n. \end{aligned}$$

Recall that $sd_i \equiv m \pmod{2m}$ for every $i = 1, \dots, n$. Hence $g^{sd_n} = -1$ and the two expressions we computed above are equal. Thus the wanted symmetricity condition is fulfilled for the described family of Hopf algebras.

This together with the fact that B is both commutative and cocommutative in \mathcal{C} means due to Proposition 8.1 that Φ^L is B -linear and B -colinear. Hence ${}^B\mathcal{C}$ and ${}^B\mathcal{C}$ are braided by Φ^L . Actually, we have more. In (8.1) the quasitriangular structure \mathcal{R} extends from H to $B \rtimes H$. The extension is given by $\overline{\mathcal{R}} = (\iota \otimes \iota)\mathcal{R}$, where $\iota : H \rightarrow B \rtimes H$ is the Hopf algebra embedding. Consequently, the braiding $\Phi_{\mathcal{R}}$ in ${}^H\mathcal{M}$ - which determines simultaneously the braiding in \mathcal{C} - extends to the braiding $\Phi_{\overline{\mathcal{R}}}$ in ${}^{B \rtimes H}\mathcal{M}$ - which determines the braiding in ${}^{B \rtimes H}{}_{B \rtimes H}\mathcal{YD}$. In other words, the braiding in \mathcal{C} extends to the braiding in ${}^{B \rtimes H}{}_{B \rtimes H}\mathcal{YD} \cong {}^B_B\mathcal{YD}(\mathcal{C})$ (extension by trivial B -(co)actions). The latter braided monoidal isomorphism is due to the left version of [1, Proposition 4.2.3].

References

- [1] Y.N. Bespalov, *Crossed Modules and Quantum Groups in Braided Categories*, Appl. Categ. Structures **5/2** (1997), 155-204.
- [2] Y.N. Bespalov, B. Drabant, *Hopf (bi-)modules and crossed modules in braided monoidal categories*, J. Pure Appl. Algebra **123** (1998), 105–129.
- [3] Y.N. Bespalov, B. Drabant, *Cross Product Bialgebras I*, J. Algebra **219** (1999), 466–505.
- [4] A. Bruguières, *Catégories prémodulaires, modularisations et invariants des variétés de dimension 3*, Math. Ann. **316** (2000), 215-236.
- [5] A. Bruguières, A. Virelizier, *The double of a Hopf monad*, ArXiv: 0812.2443 v2 [math.QA].
- [6] L. Crane, D. Yetter *On algebraic structures implicit in topological quantum field theories*, J. Knot Theory Ramifications **157/2** (1999), 125–163
- [7] J. Cuadra, B. Femić, *A sequence to compute the Brauer group of certain quasi-triangular Hopf algebras*. ArXiv: 0809.2517 v2 [math.QA].
- [8] V.G. Drinfel'd, private communication to Majid in response to the preprint of [13], February 1990.
- [9] A. Joyal, R. Street, *Tortile Yang-Baxter operators in tensor categories*, J. Pure Appl. Algebra **71** (1991), 43–51.
- [10] C. Kassel, *Quantum Groups*, Graduate Texts in Mathematics **155**, Springer-Verlag, New York (1995).
- [11] L.A. Lambe, D.E. Radford, *Algebraic aspects of the quantum Yang-Baxter equation*, J. Algebra **154** (1992), 228–288.

- [12] S. Majid, *Doubles of quasitriangular Hopf algebras*, Commun. Algebra **19**/11 (1991), 3061-3073.
- [13] S. Majid, *Representations, duals and quantum doubles of monoidal categories*, Proc. Winter School Geom. Phys., Srni, January 1990, Suppl. Rend. Circ. Mat. Palermo, Ser. II **26** (1991), 197-206.
- [14] S. Majid, *Braided groups and duals of monoidal categories*, Can. Math. Soc. Conf. Proc. **13** (1992), 329-343.
- [15] S. Majid, *Algebras and Hopf algebras in braided categories*, Advances in Hopf algebras (Chicago, IL, 1992), 55–105, Lecture Notes in Pure and Appl. Math. **158**, Dekker, New York, 1994.
- [16] S. Majid, *Transmutation theory and rank for quantum braided groups*, Math. Proc. Camb. Phil. Soc., **113** 1993, 45-70.
- [17] S. Majid, *Crossed Products by Braided Groups and Bosonization*, J. Algebra **163** (1994), 165-190.
- [18] M. Müger, *On the Structure of Modular Categories*, Proc. London Math. Soc. **87**/3 (2003), 291–308.
- [19] A. Nenciu, *Quasitriangular structures for a class of pointed Hopf algebras constructed by Ore extensions*. Comm. Algebra **29** no. 8 (2001), 3419-3432.
- [20] D.E. Radford, *The Structure of Hopf Algebras with a Projection*, J. Algebra **92** (1985), 322-347.
- [21] D.E. Radford, *Minimal quasitriangular Hopf algebras*, J. Algebra **157**/2 (1993), 285-315.
- [22] D.E. Radford, *Solutions to the quantum Yang-Baxter equation and the Drinfel'd double*, J. Algebra **161**(1993), 20-32.
- [23] D.E. Radford, J. Towber, *Yetter-Drinfel'd categories associated to an arbitrary bialgebra*, J. Pure Appl. Algebra **87** (1993), 259-279.
- [24] P. Schauenburg, *Hopf modules and Yetter-Drinfel'd modules*, J. Algebra **169** (1994), 874–890.
- [25] M. Takeuchi, *Finite Hopf algebras in braided tensor categories*, J. Pure Appl. Algebra **138** (1999), 59-82.
- [26] S.L. Woronowicz, *Differential calculus on compact matrix pseudogroups (Quantum Groups)*, Commun. Math. Phys. **122** (1989), 125-170.

- [27] D.N. Yetter, *Quantum groups and representations of monoidal categories*, Math. Proc. Cambridge Philos. Soc. **108** (1990), 261-290.
- [28] S. Zhang, *Duality Theorem and Drinfel'd double in braided tensor categories*, Algebra Colloq. **10/2** (2003), 127-134.
- [29] S. Zhang, H.-X. Chen *Double bicrossproducts in braided tensor categories*, Comm. Algebra **29/1** (2001), 31-66.