

# Composite Strategy for Multicriteria Ranking/Sorting (methodological issues, examples)

Mark Sh. Levin \*

The paper addresses the modular design of composite solving strategies for multicriteria ranking (sorting). Here a “scale of creativity” that is close to creative levels proposed by Altshuller is used as the reference viewpoint: (i) a basic object, (ii) a selected object, (iii) a modified object, and (iv) a designed object (e.g., composition of object components). These levels maybe used in various parts of decision support systems (DSS) (e.g., information, operations, user). The paper focuses on the more creative above-mentioned level (i.e., composition or combinatorial synthesis) for the operational part (i.e., composite solving strategy). This is important for a search/exploration mode of decision making process with usage of various procedures and techniques and analysis/integration of obtained results.

The paper describes methodological issues of decision technology and synthesis of composite strategy for multicriteria ranking. The synthesis of composite strategies is based on “hierarchical morphological multicriteria design” (HMMD) which is based on selection and combination of design alternatives (DAs) (here: local procedures or techniques) while taking into account their quality and quality of their interconnections (IC). A new version of HMMD with interval multiset estimates for DAs is used. The operational environment of DSS COMBI for multicriteria ranking, consisting of a morphology of local procedures or techniques (as design alternatives DAs), is examined as a basic one.

*Keywords:* Decision making technology; Multicriteria ranking; Sorting; Decision support system; System architecture, Problem solving strategies; Combinatorial synthesis; Software engineering; Multiset

## Contents

<b>1</b>	<b>INTRODUCTION</b>	<b>1</b>
<b>2</b>	<b>METHODOLOGICAL ISSUES</b>	<b>3</b>
2.1	Decision Making Framework, Solving Scheme, Problems . . . . .	3
2.2	Multicriteria Ranking (Sorting) . . . . .	5
2.3	Towards Reconfigurable Problem Solving Framework . . . . .	7
2.4	History of DSS COMBI . . . . .	10
2.5	Main Components of DSS . . . . .	12
<b>3</b>	<b>SYNTHESIS OF COMPOSITE STRATEGY</b>	<b>14</b>
3.1	Combinatorial Synthesis with Interval Multiset estimates . . . . .	14
3.2	Example of Composite Strategy . . . . .	16
<b>4</b>	<b>CONCLUSION</b>	<b>17</b>

## 1. INTRODUCTION

In recent years, there has been considerable interest in complex DSS consisting of the data bases (including descriptions of decision making situations), model bases, user interface, and knowledge bases (e.g., [3],[13],[18],[41],[42],[43],[44], [51],[69],[77],[115],[116], [119],[122],[126],[142],[145],[151], [152],[154],[159], [165]). The structures of multicriteria DSS were described in ([6],[8],[13],[30],[42],[44],[52], [68],[72],[92],[116], [151],[159],[161],[165]). Jelassi has proposed five generations of multicriteria DSS ([72],[159]).

\*Mark Sh. Levin: <http://www.mslevin.iitp.ru>; email: [mslevin@acm.org](mailto:mslevin@acm.org)

Main tendencies of decision support technology are presented in ([41],[152],[155]). Saxena investigated computer-aided decision support engineering including six stages methodology for DSS development (problem definition, task analysis, requirements engineering, system design, system prototype, user evaluation and adaptation [152]). Four models for a decision support system are analyzed in [123]: (i) the symbolic DSS, (ii) the expert system, (iii) the holistic DSS, and (iv) the adaptive DSS. Adaptive decision support systems have been examined in ([46],[67]). Howard has described the decision analysis process [68]. An object relational approach for the design of DSS has been proposed by Srinivasan and Sundaram [162]. A special framework to support the design of a DSS for some new decision problem was suggested in [141]. Some contemporary trends are targeted to the following: (a) distributed cooperative DSS (e.g., [19],[54],[155],[174]) (b) spatial DSS (SDDS, i.e., integration of DSS and GIS) (e.g., [29],[133],[140],[144]); (c) multi-agent DSS (e.g., [19],[24],[62],[130]); (d) mobile DSS (e.g., [45],[65],[122],[134]); and (e) Web-based DSS (e.g., [15],[88],[144],[149],[171],[175]). A classification of DSS is described in [137].

Issues of model management have been widely studied and used in DSS engineering (e.g., [5],[16],[17],[18],[25],[30],[35],[59],[66],[71],[113]). The research domain involves various directions, for example: 1. model selection (e.g., [117]), e.g., selection of a package for multi-attribute decision making that is more compatible with the user's needs [53]; 2. usage of model libraries (e.g., [118]); 3. building (construction, composition, integration) of models (e.g., [10],[11],[26],[69],[87]); 4. an object-oriented framework for model management (e.g., [127]); 5. meta-modeling approaches (e.g., [128]); 6. manipulation of composite models (e.g., [57],[90]); 7. knowledge-based model management (e.g., [114]); and 8. applying machine learning to model management (e.g., [156]).

In the field of algorithms/algorithm systems the following interesting trends can be pointed out:

1. Automatic algorithm design as a combinatorial meta-problem [169]. Here typical entries (for algorithm design) are: (i) choice of problem variables, (ii) choice of constraints, and (iii) choice of search method and constraint behavior. The approach realizes a joint design of problem formulation and algorithm.

2. Adaptive algorithms/software (e.g., [121]).

3. Usage of generic library of problem solving methods/algorithms (e.g., [86],[139],[143]).

4. Algorithm portfolio (e.g., [55],[58],[135],[177]).

5. Reconfiguration or self-organizing algorithms (e.g., [64],[176]).

6. Cooperative/hybrid metaheuristics for combinatorial optimization (e.g., [76],[163]).

Some special research projects focus on the design of problem solving environments (e.g., [36],[48],[56]). For example, in [139] a generic two-level library of problem solving is described which consists of two parts for the following: (a) basic task and subtasks problem solvers (task level), (b) problem solving technique (method level). Note special studies are needed for the problem formulation phase (e.g., [39]).

In the field of DSS, planning of decision making processes is a vital part of decision making engineering. In this case, design/building of solving strategies is often under examination: (1) selection and integration of models from a model base (e.g., [35],[59],[77],[115],[168]); (2) intelligent strategies for decision making (e.g., [63]); (3) MCDM techniques selection approaches (e.g., [21],[61],[84],[131]); (4) expert-based hierarchical planning (e.g., [168]); (5) usage of decision making method families and their configuration (e.g., [32],[33],[85]); and (6) visual and interactive support for multicriteria decision making process. (e.g., [164]).

In this paper, an operational part of DSS for multicriteria ranking (sorting) and composition of corresponding composite solving strategies is examined. Usually, planning the decision support process is based on the selection and integration of models from a model base. These procedures use special model knowledge including descriptions of basic submodels and their connections, etc. (e.g., [35], [77], [115], [168]). In general, four "creative levels" can be considered: (i) a basic object, (ii) a selected object, (iii) a modified object, and (iv) a designed composite object (as composition of local elements/components). The levels are close to a "scale of creativity" that has been suggested by G.S. Altshuller (e.g., [4]) The levels may be applied to various parts of DSS (information, operations, user). Here, composition of solving strategies for multicriteria ranking (sorting) from some local techniques or procedures is studied. Our morphological composition approach is close to the strategy-generation table suggested by Howard [68]. Note here issues of creativity in decision making are not considered [78].

The morphological approach for the design/planning of composite solving strategies is based on "hierarchical morphological multicriteria design" (HMMD) which involves a series and/or parallel composition of

the design alternatives (DAs) for data processing while taking into account interconnections (IC) among DAs ([98],[99],[102],[105]). In the case of model management/engineering, DAs correspond to alternative models or algorithms/interactive procedures. HMMD is based on the following assumptions: (1) tree-like structure of a designed system; (2) system effectiveness (excellence) is represented as an aggregation of two parts: effectiveness of subsystems (components), and effectiveness of compatibility among subsystems; (3) monotone criteria (Cr) for DAs; (4) ordinal coordinated priorities of DAs ( $\iota = \overline{1, l}$ , 1 corresponds to the best one); and (5) ordinal coordinated estimates of compatibility for each “neighbor” pair of DAs ( $w = \overline{1, \nu}$ ,  $\nu$  corresponds to the best one). In the case of interval multiset estimates (a generalization of ordinal estimates [106]), qualities of DAs and/or their compatibility are evaluated with usage of this kind of estimates (i.e., a special new type of poset-like scales).

HMMD consists of the following main phases:

**Phase 1.** Top-Down design of tree-like system model including Cr and factors of compatibility.

**Phase 2.** Generation of DAs for leaf nodes of model.

**Phase 3.** Bottom-Up hierarchical selection and composition (iterative): (a) assessment of DAs on Cr, (b) assessment of IC, (c) computing the priorities of DAs, and (d) composing DAs for a higher hierarchical level.

Note that similar approaches have been used in engineering design as combinatorial optimization models and morphological analysis (e.g., [7],[14],[60],[75],[180]).

Our study is based on the experience in the design and implementation of DSS COMBI for multicriteria ranking (joint project of the author and Andrew A. Michailov; 1984...1991) ([93],[99],[110]). This DSS was based on a series-parallel transformation of preference relations ([92],[93],[110]). Operational environment of DSS COMBI includes a morphology of the composite solving strategy for forming/transforming the preference relations, linear orderings, and rankings. DSS COMBI corresponds to DSS generation 4.5 of 5-level classification of Jelassi ([72],[159]). The following is described: (i) methodological issues in decision making technology for multicriteria ranking, (ii) a scheme for designing a series solving strategy.

## 2. METHODOLOGICAL ISSUES

### 2.1. Decision Making Framework, Solving Scheme, Problems

Generally, decision making process is based on the following basic parts (e.g., [99],[102],[157]): (i) alternatives, (ii) criteria and estimates of the alternatives upon the criteria, (iii) preferences over the alternatives, (iv) solving method(s), (v) decision(s), and (vi) specialists (decision maker, support experts). Fig. 1 depicts a basic framework of the decision making process.

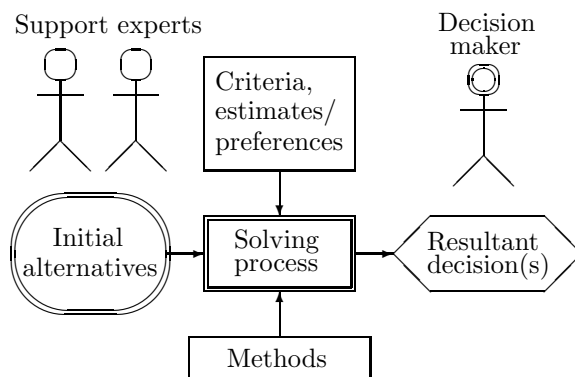

Fig. 1. Basic framework of decision making

H. Simon has suggested a rational decision making based on the choice problem [157]: (i) the identification and listing of all the alternatives, (ii) determination of all the consequences resulting from each of the alternatives, and (iii) the comparison of the accuracy and efficiency of each of these sets of consequences. A modified version of the approach is the following ([92],[102]):

*Stage 1.* Analysis of the examined system/process, extraction of the problem.

*Stage 2.* Problem structuring: (2.1.) generation of alternatives, (2.2.) generation of criteria and scale for each criterion.

*Stage 3.* Obtaining the initial information (estimates of the alternatives, preferences over the alternatives).

*Stage 4.* Solving process to obtain the decision(s).

*Stage 5.* Analysis of the obtained decision(s).

Fig. 2 depicts an extended decision making scheme including some feedback lines.

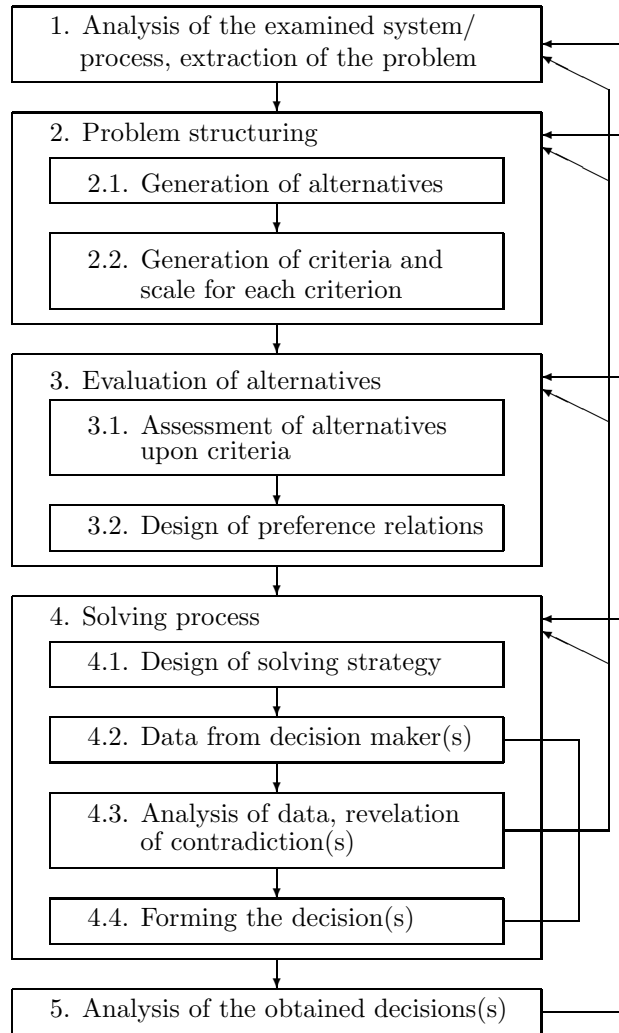

Fig. 2. Extended decision making scheme

Fig. 3 depicts the basic decision making problems ([49],[79],[92],[99],[124],[148]):

(a) choice/selection (e.g., [2],[49],[79],[124],[157],[166]),

(b) linear ordering (e.g., [49],[50],[79],[124]),

(c) sorting/ranking (e.g., [22],[28],[49],[99],[110],[124],[148],[178],[179]), and

(d) clustering/classification (e.g., [27],[70],[124],[125],[179]).

In general, it is reasonable to extend the decision making process by additional management/monitoring and support analysis/learning of user(s) (Fig. 4). This approach was implemented in DSS COMBI ([92],[93],[99],[107],[108],[109],[110],[111]), for example: (i) special hypertext system for learning and support, (ii) analysis and diagnosis of user(s), (iii) library of typical DM problems for various domains, (iv) basic typical solving composite strategies, and (v) possibility for retrieval and analysis of intermediate information/solutions.

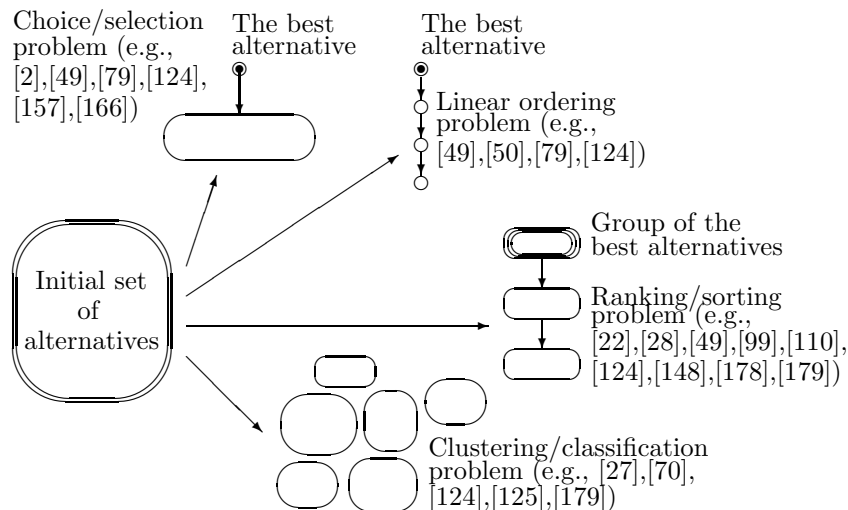

Fig. 3. Basic decision making problems

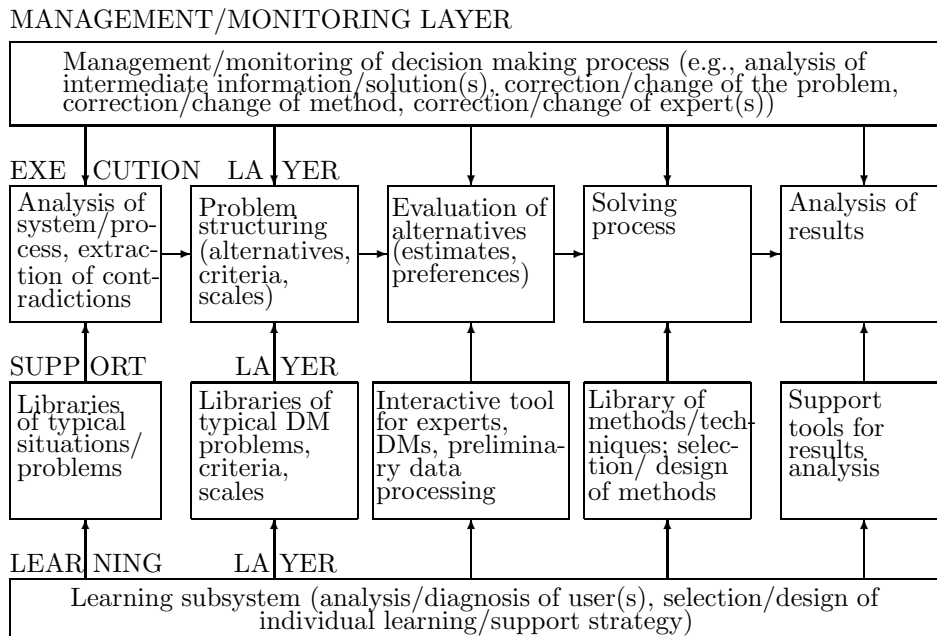

Fig. 4. Extended four-layer architecture of decision making process

## 2.2. Multicriteria Ranking (Sorting)

Let  $A = \{1, \dots, i, \dots, n\}$  be a set of alternatives (items) which are evaluated on criteria  $K = \{1, \dots, j, \dots, d\}$ , and  $z(i, j)$  is an estimate (quantitative, ordinal) of alternative  $i$  on criterion  $j$ . The matrix  $Z = \{z(i, j)\}$  may be mapped into a poset on  $A$ . We search for the following resultant kind of the poset as a partition with ordered subsets (a layered structure):  $B = \{B_1, \dots, B_k, \dots, B_m\}$ ,  $B_{k_1} \cap B_{k_2} = \emptyset$  if  $k_1 \neq k_2$ , and each alternative from  $B_{k_1}$  (layer  $k_1$ ) dominates each alternative from  $B_{k_2}$  (layer  $k_2$ ), if  $k_1 \leq k_2$ . Thus, each alternative has a priority which equals the number of the corresponding layer. This problem is illustrated in Fig. 5. This problem belongs to a class of ill-structured problems by classification of H. Simon [158]. In general, the resultant ordered subsets can have intersections (i.e., the problem can be targeted to obtain interval priorities for the alternatives) (Fig. 6). In this case, the “fuzzy” decision will be denoted by  $\tilde{B}$  (a layered structure with intersection of the layers). Let  $\bar{B}$  be a linear ordering of alternatives.

The basic techniques for the multicriteria ranking (sorting) problems are the following (e.g., [23],[38],[173]): (1) statistical approaches [20]; (2) multi-attribute utility analysis (e.g., [50],[79]); (3) multi-criterion decision making (e.g., [83]); (4) analytic hierarchy process (e.g., [150]); (5) outranking techniques (e.g.,

[12],[148]); (6) knowledge bases (e.g., [112]); (7) neural network (e.g., [170]); (8) logical procedures (e.g., [109]); (9) expert judgment (e.g., [89]); and (10) hybrid techniques (e.g., [47]). In the main, the above-mentioned techniques correspond to one-phase problem solving framework.

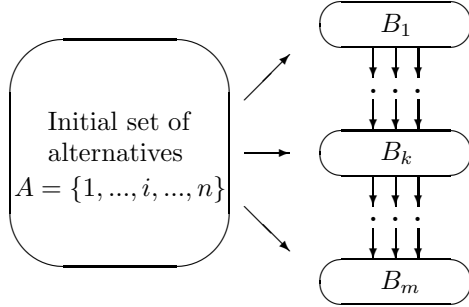

Fig. 5. Multicriteria ranking (sorting)

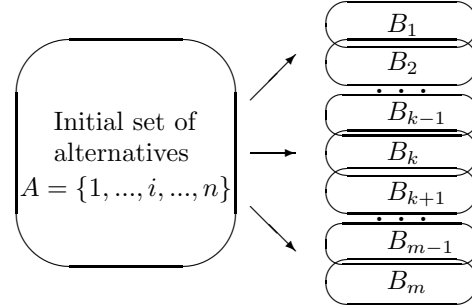

Fig. 6. Ranking with interval priorities

The following numerical example illustrates the examined multicriteria problem.

Let  $A = \{A_1, A_2, A_3, A_4, A_5, A_6, A_7, A_8, A_9\}$  be a set of initial alternatives. The alternatives are evaluated upon 2 criteria  $K = \{K_1, K_2\}$ , an ordinal scale is used for each criterion ( $[0, 1, 2, 3, 4]$  and 4 corresponds to the best level). The ordinal estimates of alternatives are presented in Table 1, a space of estimates is depicted in Fig. 7. Three types of solutions are presented:

- (a) linear ordering  $\bar{B}$  (Fig. 8; e.g., additive utility function is used);
- (b) ranking (sorting, four linear ordered subsets)  $B$  (Fig. 9; e.g., expert judgement is used); and
- (c) “fuzzy” ranking  $\tilde{B}$  (Fig. 10; e.g., expert judgement is used).

Table 2 integrates the obtained priorities of alternatives.

Table 1. Estimates

Alternative	Criteria	
	$K_1$	$K_2$
$A_1$	2	3
$A_2$	2	4
$A_3$	1	3
$A_4$	4	4
$A_5$	1	1
$A_6$	4	3
$A_7$	2	2
$A_8$	0	2
$A_9$	2	1

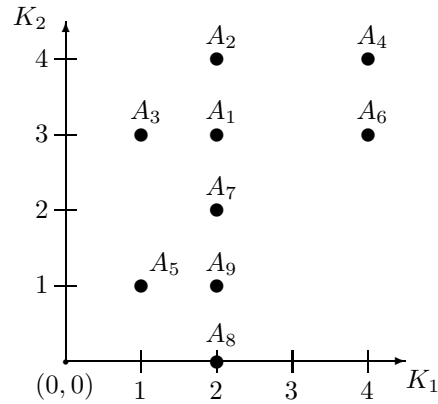

Fig 7. Space of estimates

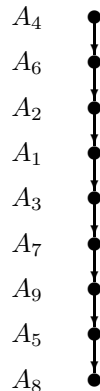

Fig 8. Linear ordering  $\bar{B}$

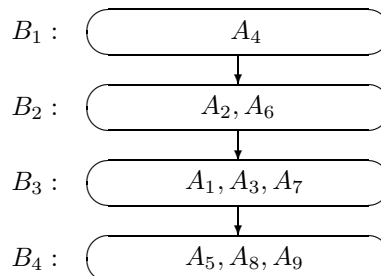

Fig 9. Ranking  $B$

An approach for decision making as series or series-parallel processing (transformation, articulation) of preferences (combinatorial models for decision making) for suggested in [91]. In DSS COMBI, a functional graph has been suggested as impementation of the approach for multicriteria ranking ([93],[99],[110]). The graph was realized as a graphical menu. In this case, the solving strategy is combined from a set of basic operations (local techniques or procedures) (e.g., forming preference relations over the alternatives, forming the intermediate linear ordering of the alternatives, forming the resultant decision structure over the alternatives) (Fig. 11).

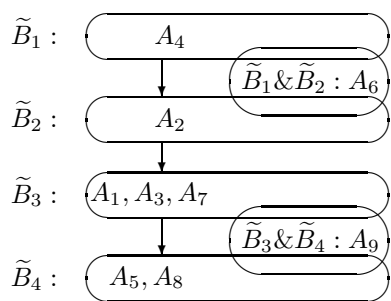

Fig 10. "Fuzzy" ranking  $\tilde{B}$

Table 2. Resultant priorities

Alter-native	Linear ordering	Ranking	"Fuzzy" ranking
$A_1$	4	3	3
$A_2$	3	2	2
$A_3$	5	3	3
$A_4$	1	1	1
$A_5$	8	4	4
$A_6$	2	2	[1, 2]
$A_7$	6	3	3
$A_8$	9	4	4
$A_9$	7	4	[3, 4]

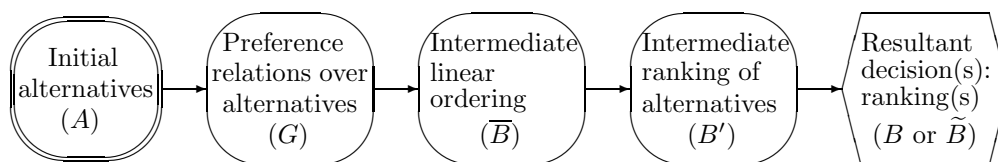

Fig. 11. Decision making as preferences processing ([92],[99],[110])

### 2.3. Towards Reconfigurable Problem Solving Framework

Here a generalized problem solving framework is examined. An algorithm system (e.g., for data processing) is considered as a basic example.

The basic parts of the framework are the following: (a) problem (problem structuring/formulation) (b) algorithm (operational part) (c) data part (obtaining data, elicitation of preferences, ...) (d) human part (preliminary learning, learning based on solving process)

First, a static structure of the algorithm system is analyzed. The following versions the algorithm/algorithm systems can be considered:

1. usage of the basic algorithm(s) (Fig. 12);
2. selection of the best algorithm from an algorithm base (while taking into account an input information) and its usage (Fig. 13);
3. modification of the basic algorithm(s) (while taking into account an input information) and its usage (Fig. 14); and
4. design of the new algorithm(s) (while taking into account an input information) and its usage (Fig. 15).

A simplified hierarchy of solving process components is depicted in Fig. 16.

In general, the following problem solving frameworks can be considered:

1. One-phase framework: problem solving.
2. Two-phase framework: (i) problem structuring/formulation and (ii) problem solving.
3. Three-phase framework: (i) problem structuring/formulation; (ii) problem solving; and (iii) analysis of results.
4. Adaptive three-phase framework with feedback: (a) problem structuring/formulation; (b) problem solving (including analysis of intermediate results and problem reformulation and resolving); (c) analysis of results (including analysis of results and problem reformulation and resolving).

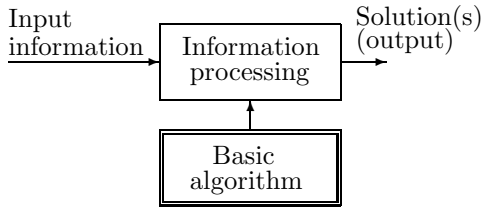

Fig. 12. Usage of a basic algorithm

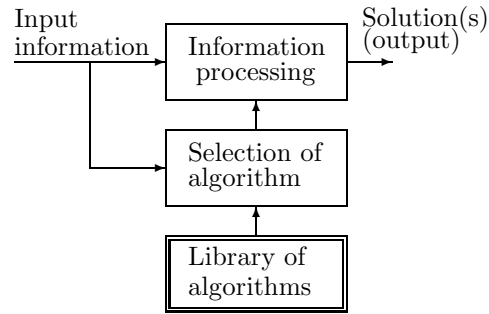

Fig. 13. Usage of a selected algorithm

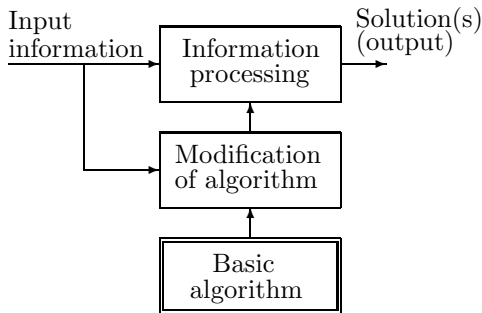

Fig. 14. Modification a basic algorithm

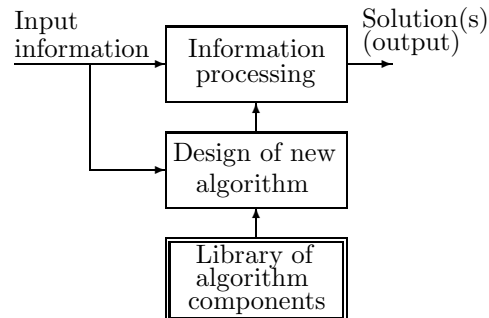

Fig. 15. Design of a new algorithm

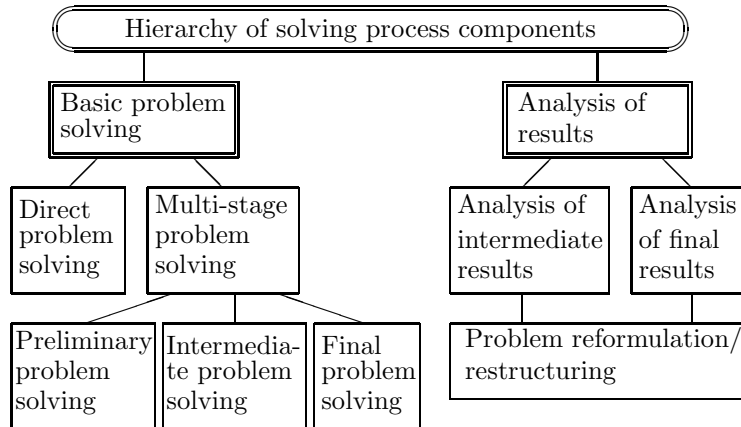

Fig. 16. Problem solving with analysis, reformulation

The following three illustrative examples of multistage solving strategies are presented for set consisting of nine initial alternatives (Table 1): (i) two-stage series ranking strategy with preliminary linear ordering (Fig. 17); (ii) two-stage series ranking strategy with preliminary preferences (Fig. 18); (iii) three-stage series ranking strategy (Fig. 19); and (iv) three-stage series-parallel strategy (with aggregation) (Fig. 20).

Fig. 21 depicts adaptive three-stage framework for problem solving. In addition, it is possible to consider a solving framework in which problem formulation/structuring is executed during the solving process for a preliminary problem.

The stage “Reconfiguration of problem solving process” can be considered as the following: (i) selection of another algorithm (solving scheme) (Fig. 13), (ii) modification of the algorithm (solving scheme) (Fig. 14), (iii) design of a new algorithm (solving scheme) (Fig. 15). Concurrently, information operations (searching/acquisition/usage) can be used (e.g., new/additional preferences, new/additional reference points of intermediate decisions).

In the case of a man-machine procedure, it is possible to examine change or re-organization of an expert team and types (e.g., mode, support procedure(s)) of man-machine interaction.



The stage “Problem reformulation/restructuring” can be considered as the following: (i) change of the initial problem, (ii) modification of the initial problem (e.g., change of the problem parameters, initial data), (iii) building of a new problem framework (i.e., a composite problem).

Fig. 22 depicts an example to illustrate a series process with problem reformulation.

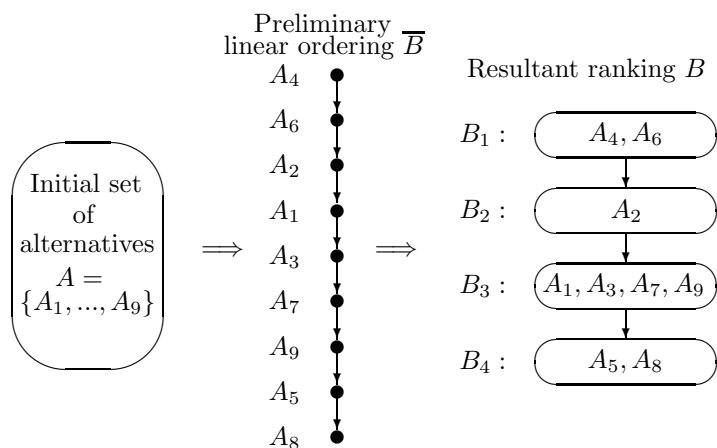

Fig. 17. Two-stage series ranking strategy (with linear ordering)

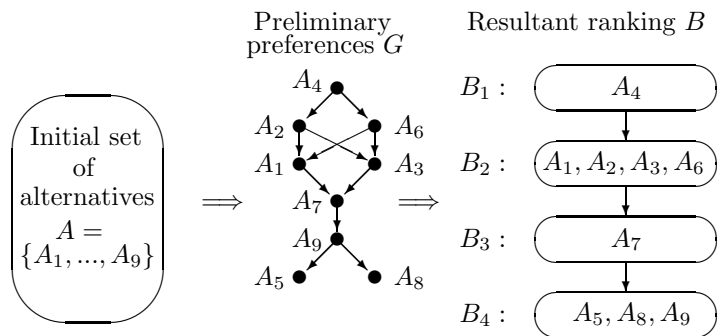

Fig. 18. Two-stage series ranking strategy (with preferences)

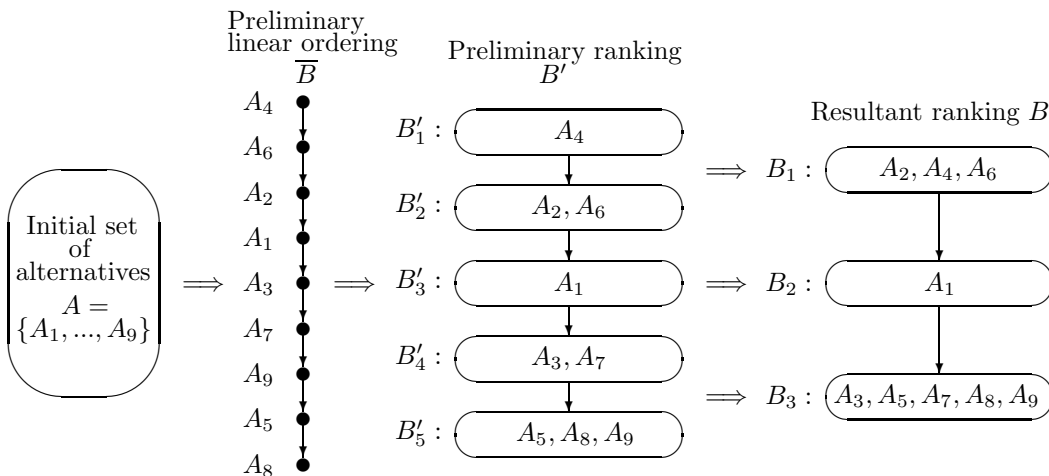

Fig. 19. Three-stage series ranking strategy

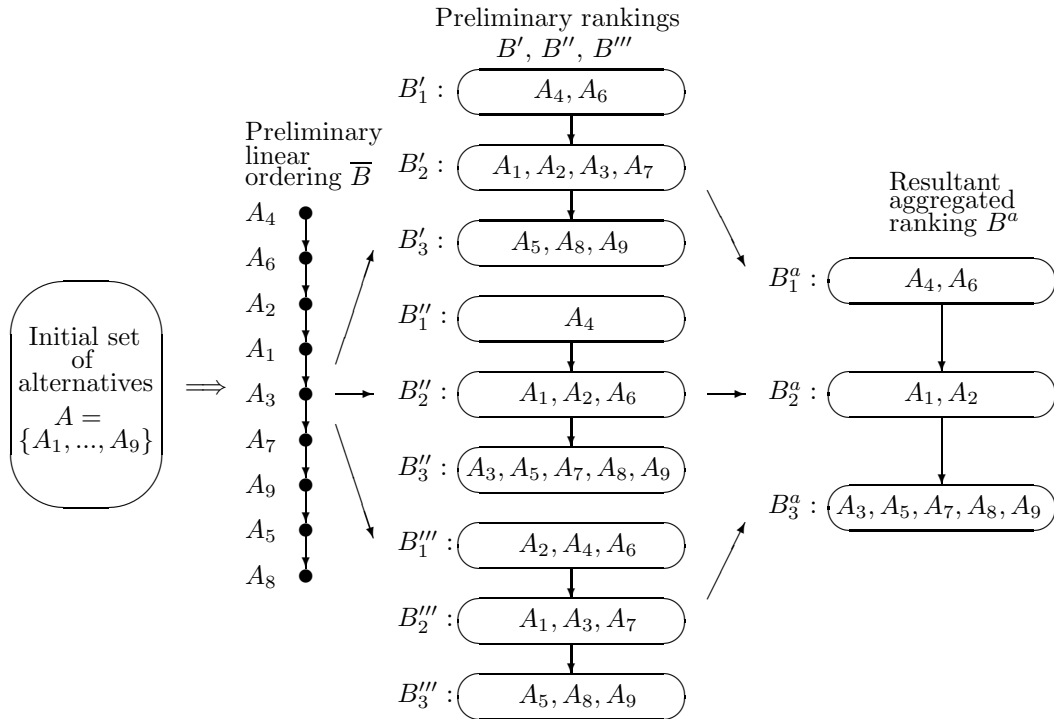

Fig. 20. Three-stage series-parallel ranking strategy (with aggregation)

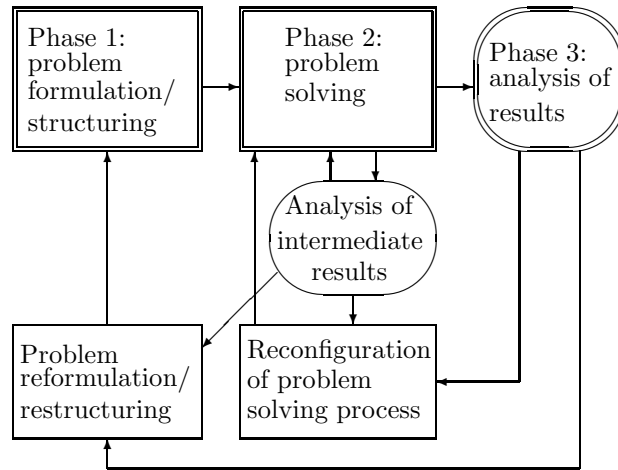

Fig. 21. Problem solving with reconfiguration

**2.4. History of DSS COMBI**

A preliminary version of DSS COMBI was implemented as a set of multicriteria techniques (Fortran, mainframe, methods: several types of utility functions, Electre-like technique). Analysis, comparison and aggregation of results, obtained via different techniques, was widely used. Further, DSS with method composition was designed. DSS COMBI was targeted to three type of resultant decisions (Fig. 23): (a) linear ranking (mainly, an intermediate result)  $\bar{B}$ , (b) multicriteria ranking as sorting (ordinal priorities of alternatives, i.e., a layered structure)  $B$ , and (c) multicriteria ranking as a layered structure with intersection the layers (ordinal priorities of alternatives over an ordinal decision scale)  $\tilde{B}$ .

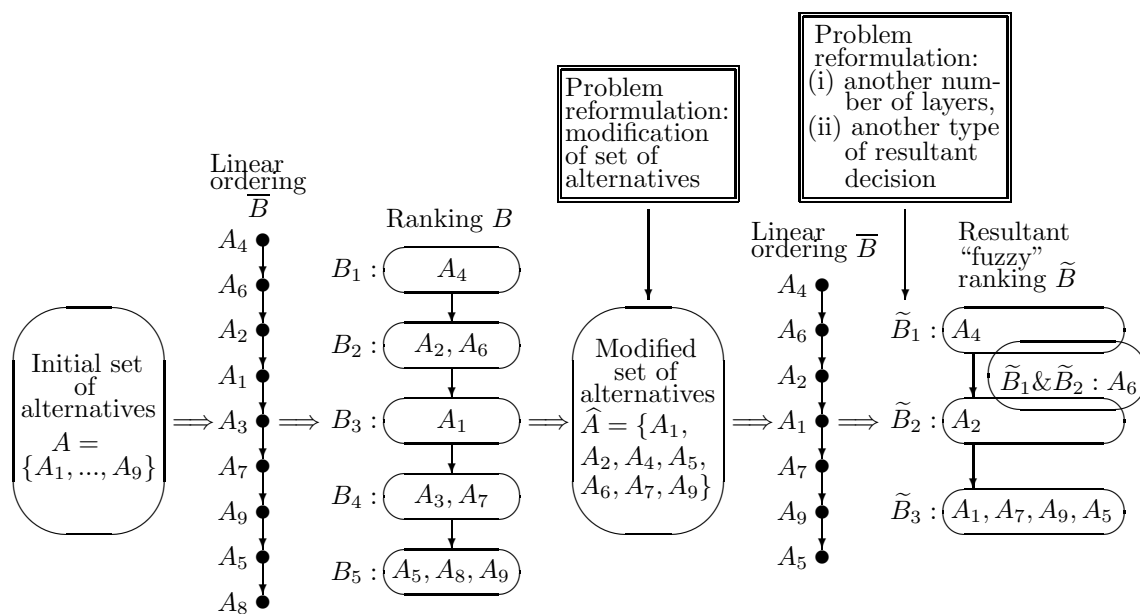

Fig. 22. Series process with problem reformulation

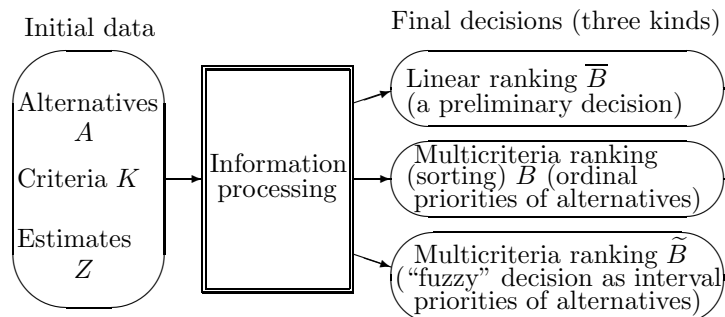

Fig. 23. Solving framework of DSS COMBI ([92],[99],[110])

Table 3 presents a brief description of DSS COMBI generations with method composition ([93],[99],[110]). A functional graph menu was realized in DSS COMBI (since generation 1) (Fig. 24).

Table 3. Generations of DSS COMBI

Generation of DSS COMBI	Type of computer	Type of interface	Domain	Learning	Year	Reference	Presentation at conference	Usage in teaching
0. COMBI (Pascal-based)	Mini-computer	Language-based	Various	None	1987	[107],[108]	None	None
1. COMBI PC (Pascal-based)	PC	Graphical menu	Various	Yes	1988	[92],[110]	SPUDM-89	None
2. COMBI PC (C-based)	PC	Graphical menu	Various	Yes	1989	[93],[94],[99],[110]	MCDM-90 EWHCI-93	[96],[97] [103],[104]
3. COMBI PC (C-based)	PC	Graphical menu	Investment	Yes	1991	[93]	None	None

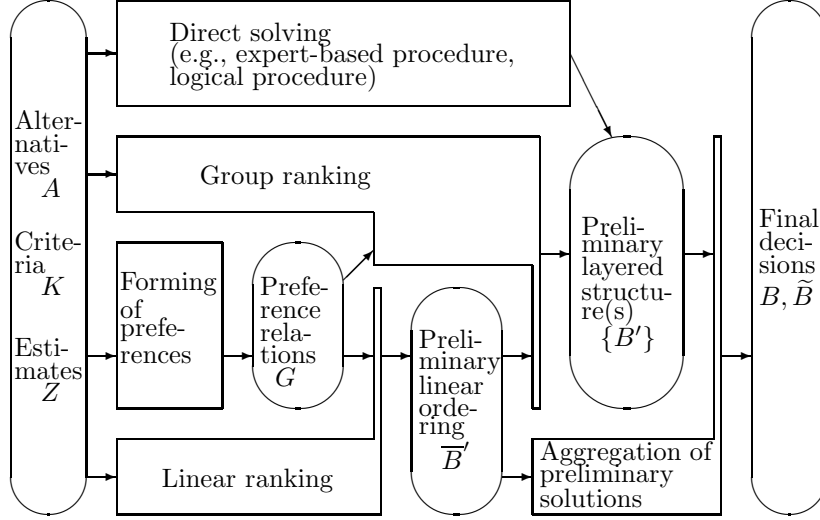

Fig. 24. Structure of functional planar graph menu ([92],[99],[110])

## 2.5. Main Components of DSS

Here, the following DSS parts are considered: 1. information part as data, knowledge; 2. operational part as tools for information processing; and 3. human part as user or group of users (including experts, decision maker, etc.).

Usually information part includes the following: (1) data (alternatives or basic items, criteria, multicriteria estimates of alternatives upon criteria, preference relations); (2) tools for maintaining data (DBMS and interfaces with other commercial DBMSs); (3) support information for learning (e.g., a helper, etc.).

In this paper (as in DSS COMBI), the following series (or series-parallel) framework of information (a preference relation or a matrix) processing is examined ([93], [99], [110]): (1) basic data as alternatives (items) ( $A$ ), criteria ( $K$ ), multicriteria estimates of alternatives upon criteria ( $Z$ ); (2) preference relation of alternatives ( $G$ ); (3) an intermediate linear ordering of alternatives ( $\bar{B}$ ) (4) an preliminary ranking of alternatives as a layered structure(s) ( $B'$ ); and (5) resultant ranking of alternatives as layered structure ( $B$ ) (an ordinal priority for each alternative) or fuzzy ranking ( $\tilde{B}$ ) (with intersection of layers).

The following kinds of basic operations are considered: (i) data processing (series and/or parallel); (ii) data aggregation. In addition, parallelization of the solving process on the basis of various components (alternatives, criteria, techniques, experts) can be used. The solving process may be presented as a hierarchy with the following functional/operational layers ([93], [99], [110]): (1) algorithms and man-machine interactive procedures for data transformation (bottom layer); (2) strategies (step-by-step schemes of data transformation, particularly series-parallel ones); (3) scenarios (complexes of strategies with their analysis and feedback).

Thus, the following alternative series frameworks (composite solving strategies) of information processing are considered (Fig. 11, Fig. 24):

1. Basic series framework:  $E : A \Rightarrow G \Rightarrow \bar{B}' \Rightarrow \{B'\} \Rightarrow B \text{ or } \tilde{B}$ .
2. Compressed series frameworks:
  - 2.1.  $W^1 : A \Rightarrow \{B'\} \Rightarrow B \text{ or } \tilde{B}$ .
  - 2.2.  $W^2 : A \Rightarrow G \Rightarrow \{B'\} \Rightarrow B \text{ or } \tilde{B}$ .
  - 2.3.  $W^3 : A \Rightarrow G \Rightarrow \bar{B}' \Rightarrow B \text{ or } \tilde{B}$ .
  - 2.4.  $W^4 : A \Rightarrow \bar{B}' \Rightarrow \{B'\} \Rightarrow B \text{ or } \tilde{B}$ .
  - 2.5.  $W^5 : A \Rightarrow \bar{B}' \Rightarrow \{B'\} \Rightarrow B \text{ or } \tilde{B}$ .
3. Direct solving process:  $D : A \Rightarrow B \text{ or } \tilde{B}$ .

Thus, the solving process can be considered as the following four-part system (Fig. 25):  $S = H * T * U * X$ , where the following four stages are basic ones: (i) stage  $H$  corresponds to forming a preliminary preference relation  $G$  (over alternatives  $A$ ) (an algorithm or a procedure); (ii) stage  $T$  corresponds to forming a preliminary linear ranking  $\bar{B}$  (an algorithm or a procedure); (iii) stage  $U$

corresponds to forming some preliminary rankings  $\{B\}$  (an algorithm or a procedure); and (iv) stage  $X$  corresponds to aggregation of the preliminary rankings  $\{B\}$  into the resultant decisions  $B$  (or  $\tilde{B}$ ) (an algorithm or a procedure). The following basic local techniques (as processing units) have been used in DSS COMBI ([93], [99], [110]):

**I.** Stage  $H$ : absent ( $H_0$ ), pairwise comparison (a simple expert-based procedure) ( $H_1$ ), dominance by of Pareto-rule ( $H_2$ ) (e.g., [124],[132]), outranking Electre-like technique (a special Electre-based interactive procedure with feedback, designed by M.Sh. Levin [110]) ( $H_3$ ).

**II.** Stage  $T$ : absent ( $T_0$ ), line elements sum of preference matrix ( $T_1$ ), additive utility function (e.g., [50],[79]) ( $T_2$ ).

**III.** Stage  $U$ : absent ( $U_0$ ), step-by-step revelation of *maximal* elements ( $U_1$ ), step-by-step revelation of Pareto-efficient elements (e.g., [124],[132]) ( $U_2$ ), dividing the linear ranking ( $U_3$ ), expert procedure for ranking (expert-based direct solving procedure (e.g., [89]) ( $U_4$ ), direct logical method for ranking (direct solving method based on logical approach, designed by A.A. Mikhailov) ([109],[110]) ( $U_5$ ).

**IV.** Stage  $X$ : absent ( $X_0$ ), simple election-like procedure ( $X_1$ ), aggregation model based on special knapsack-like problem ( $X_2$ ) [99].

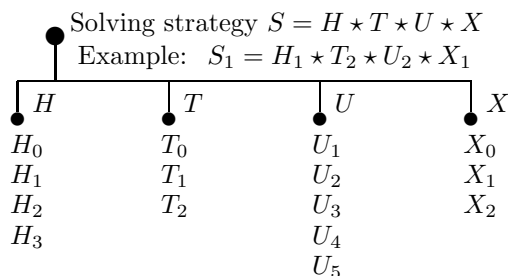

Fig. 25. Morphology of solving strategy

Here the index 0 corresponds to absence of the preprocessing at the stage. Thus, the following examples can be considered (symbol  $\&$  corresponds to parallel integration of processing operations):

(1) a series solving strategy  $S_1 = H_1 \star T_2 \star U_2 \star X_0$ ;

(2) a series-parallel solving strategy:

$$S_2 = (S' \& S'' \& S''') \star X_1 = ((H_3 \star T_1 \star U_1) \& (H_3 \star T_1 \star U_2) \& (H_1 \star T_2 \star U_1)) \star X_1.$$

Parallelization of the solving process is based on three approaches:

(1) concurrent usage of different experts in the same interactive procedure (e.g., in  $U_4$ );

(2) concurrent usage of different methods at the same solving stage (e.g.,  $H_3$ );

(3) concurrent usage of the same method with different parameters at the same solving stage (e.g., in  $U_4$ ).

The design of solving strategies consists of two problems [99]: (a) selection of local techniques and (b) combinatorial synthesis of the selected techniques. The requirements to the composite solving strategies are based on the following: (i) kinds of task and of users; (ii) available resources (e.g., human, computer, time); (iii) features of the decision situation (e.g., kind of uncertainty, required precision and robustness of result). Thus, the following six criteria are examined [99]: (1) required computer resources; (2) required human resources; (3) quality of ranking (robustness, etc.); (4) possibility for data representation; (5) possibility for an analysis of intermediate data; and (6) usability (easy to learn, understanding, etc.).

Two direct solving strategies are as follows: (a) direct expert based ranking (e.g., [89]):  $D_1 = H_4 \star T_5 \star U_4 \star X_0$ ; (b) direct logical method for ranking (suggested and designed by A.A. Mikhailov [110]):  $D'_2 = H_4 \star T_6 \star U_5 \star X_0$  or for the case of several experts: (a)  $D''_2 = H_4 \star T_6 \star U_5 \star X_1$ , (b)  $D'''_2 = H_4 \star T_6 \star U_5 \star X_1$ . In our design approach, the strategies are based on defined top-level compatibility between their components (and zero compatibility between the components of the strategies and other components).

Note, some traditional approaches to build a solving process for decision making are oriented to the selection of the best method (or algorithm, model) (e.g., [8],[61],[131],[156]). A model composition on the basis of a filter space is described in [25]. A non-linear recursive process consisting of four steps is analyzed for multicriteria decision aid in [61].

In general, human part consists of the following: (a) user or group of users (experts, decision makers); (b) techniques for the modeling, diagnostics, selection, and assignment of specialists; (c) subsystem for

user training; (d) user interfaces and tools for their adaptation. In recent years, many authors have been investigated user modeling (e.g., [9],[81],[93],[147]). Issues of adaptation of user interfaces are considered in (e.g., [31],[37],[101],[129],[153]). Graphical interaction in multicriteria decision making is considered in ([74],[82],[120],[138],[167]). The effectiveness of different representations for managerial problem solving has been studied in [160]. Note a special prospective class of graph-based modeling systems for decision making processes has been proposed in ([73],[74],[90]). A hierarchical process of the user interface design for DSS COMBI on the basis of HMMD, and comparing some system versions are described in details in ([94],[99]).

### 3. SYNTHESIS OF COMPOSITE STRATEGY

#### 3.1. Combinatorial Synthesis with Interval Multiset estimates

Interval multiset estimates have been suggested by M.Sh. Levin in [106]. The approach consists in assignment of elements (1, 2, 3, ...) into an ordinal scale [1, 2, ..., l]. As a result, a multi-set based estimate is obtained, where a basis set involves all levels of the ordinal scale:  $\Omega = \{1, 2, \dots, l\}$  (the levels are linear ordered:  $1 \succ 2 \succ 3 \succ \dots$ ) and the assessment problem (for each alternative) consists in selection of a multiset over set  $\Omega$  while taking into account two conditions:

1. cardinality of the selected multiset equals a specified number of elements  $\eta = 1, 2, 3, \dots$  (i.e., multisets of cardinality  $\eta$  are considered);
2. "configuration" of the multiset is the following: the selected elements of  $\Omega$  cover an interval over scale [1, l] (i.e., "interval multiset estimate").

Thus, an estimate  $e$  for an alternative  $A$  is (scale [1, l], position-based form or position form):  $e(A) = (\eta_1, \dots, \eta_l, \dots, \eta_l)$ , where  $\eta_\iota$  corresponds to the number of elements at the level  $\iota$  ( $\iota = \overline{1, l}$ ), or  $e(A) = \{\underbrace{1, \dots, 1}_{\eta_1}, \underbrace{2, \dots, 2}_{\eta_2}, \underbrace{3, \dots, 3}_{\eta_3}, \dots, \underbrace{l, \dots, l}_{\eta_l}\}$ . The number of multisets of cardinality  $\eta$ , with elements taken from a finite set of cardinality  $l$ , is called the "multiset coefficient" or "multiset number" ([80],[172]):  $\mu^{l,\eta} = \frac{l(l+1)(l+2)\dots(l+\eta-1)}{\eta!}$ . This number corresponds to possible estimates (without taking into account interval condition 2). In the case of condition 2, the number of estimates is decreased. Generally, assessment problems based on interval multiset estimates can be denoted as follows:  $P^{l,\eta}$ . A poset-like scale of interval multiset estimates for assessment problem  $P^{3,4}$  is presented in Fig. 26. The assessment problem will be used in our applied numerical examples.

In addition, operations over multiset estimates are used [106]: integration, vector-like proximity, aggregation, and alignment.

Integration of estimates (mainly, for composite systems) is based on summarization of the estimates by components (i.e., positions). Let us consider  $n$  estimates (position form): estimate  $e^1 = (\eta_1^1, \dots, \eta_l^1, \dots, \eta_l^1)$ , . . . , estimate  $e^\kappa = (\eta_1^\kappa, \dots, \eta_l^\kappa, \dots, \eta_l^\kappa)$ , . . . , estimate  $e^n = (\eta_1^n, \dots, \eta_l^n, \dots, \eta_l^n)$ . Then, the integrated estimate is: estimate  $e^I = (\eta_1^I, \dots, \eta_l^I, \dots, \eta_l^I)$ , where  $\eta_l^I = \sum_{\kappa=1}^n \eta_l^\kappa \quad \forall l = \overline{1, l}$ . In fact, the operation  $\uplus$  is used for multiset estimates:  $e^I = e^1 \uplus \dots \uplus e^\kappa \uplus \dots \uplus e^n$ .

Further, vector-like proximity is described. Let  $A_1$  and  $A_2$  be two alternatives with corresponding interval multiset estimates  $e(A_1), e(A_2)$ . Vector-like proximity for the alternatives above is:  $\delta(e(A_1), e(A_2)) = (\delta^-(A_1, A_2), \delta^+(A_1, A_2))$ , where vector components are: (i)  $\delta^-$  is the number of one-step changes: element of quality  $\iota + 1$  into element of quality  $\iota$  ( $\iota = \overline{1, l-1}$ ) (this corresponds to "improvement"); (ii)  $\delta^+$  is the number of one-step changes: element of quality  $\iota$  into element of quality  $\iota + 1$  ( $\iota = \overline{1, l-1}$ ) (this corresponds to "degradation"). It is assumed:  $|\delta(e(A_1), e(A_2))| = |\delta^-(A_1, A_2)| + |\delta^+(A_1, A_2)|$ .

Now let us consider median estimates (aggregation) for the specified set of initial estimates (traditional approach). Let  $E = \{e_1, \dots, e_\kappa, \dots, e_n\}$  be the set of specified estimates (or a corresponding set of specified alternatives), let  $D$  be the set of all possible estimates (or a corresponding set of possible alternatives) ( $E \subseteq D$ ). Thus, the median estimates ("generalized median"  $M^g$  and "set median"  $M^s$ ) are:  $M^g = \arg \min_{M \in D} \sum_{\kappa=1}^n |\delta(M, e_\kappa)|$ ;  $M^s = \arg \min_{M \in E} \sum_{\kappa=1}^n |\delta(M, e_\kappa)|$ .

A brief description of combinatorial synthesis (HMMD) was presented in introduction.

Let  $S$  be a system consisting of  $m$  parts (components):  $R(1), \dots, R(i), \dots, R(m)$ . A set of design alternatives is generated for each system part above.

The problem is:

Find a composite design alternative  $S = S(1) \star \dots \star S(i) \star \dots \star S(m)$  of DAs (one representative design alternative  $S(i)$  for each system component/part  $R(i)$ ,  $i = \overline{1, m}$ ) with non-zero compatibility between design alternatives.

A discrete “space” of the system excellence (a poset) on the basis of the following vector is used:  $N(S) = (w(S); e(S))$ , where  $w(S)$  is the minimum of pairwise compatibility between DAs which correspond to different system components (i.e.,  $\forall R_{j_1}$  and  $R_{j_2}$ ,  $1 \leq j_1 \neq j_2 \leq m$ ) in  $S$ ,  $e(S) = (\eta_1, \dots, \eta_l, \dots, \eta_l)$ , where  $\eta_l$  is the number of DAs of the  $l$ th quality in  $S$ .

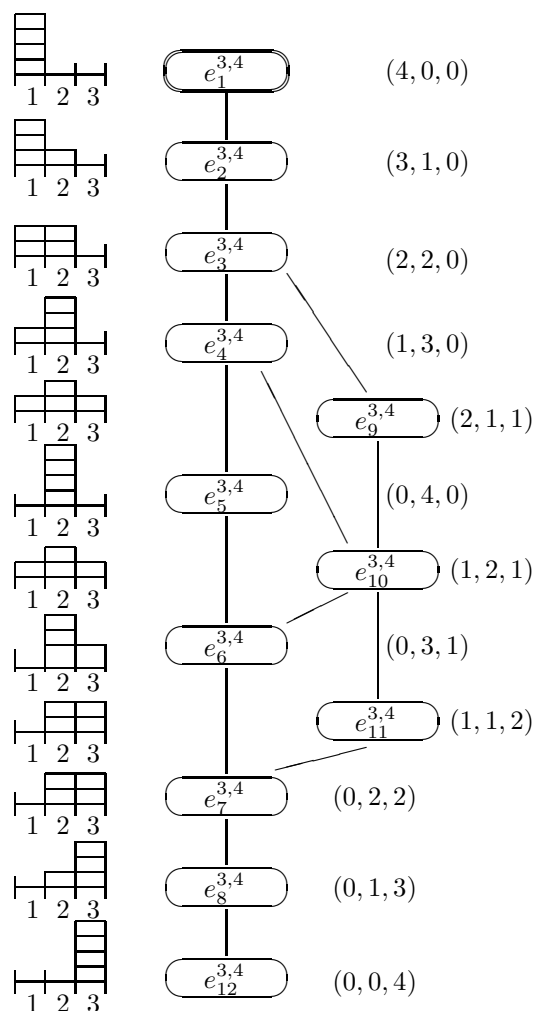

Fig. 26. Scale, estimates ( $P^{3,4}$ ) [106]

Further, the problem is described as follows:

$$\max e(S), \quad \max w(S), \quad s.t. \quad w(S) \geq 1.$$

As a result, we search for composite solutions which are nondominated by  $N(S)$  (i.e., Pareto-efficient). “Maximization” of  $e(S)$  is based on the corresponding poset. The considered combinatorial problem is NP-hard and an enumerative solving scheme is used.

Further, combinatorial synthesis can be based on usage of interval multiset estimates of design alternatives for system parts. For the resultant system  $S = S(1) \star \dots \star S(i) \star \dots \star S(m)$  the same type of the interval multiset estimate is examined: an aggregated estimate (“generalized median”) of corresponding interval multiset estimates of its components (i.e., selected DAs). Thus,  $N(S) = (w(S); e(S))$ , where  $e(S)$

is the “generalized median” of estimates of the solution components. Finally, the modified problem is:

$$\max e(S) = M^g = \arg \min_{M \in D} \sum_{i=1}^m |\delta(M, e(S_i))|, \quad \max w(S), \quad s.t. \quad w(S) \geq 1.$$

Here enumeration methods or heuristics are used ([102],[105],[106]).

The next version of combinatorial synthesis problem will be the following. Let  $w(i, j)$  will be an interval multiset estimate for compatibility between two selected design alternatives  $S_i$  and  $S_j$  in solution  $S$  (the same type of interval multiset estimates is used for the elements and for their compatibility). Then, the problem is:

$$\max e(S) = M^g = \arg \min_{M \in D} \sum_{i=1}^m |\delta(M, e(S_i))| + \sum_{(i,j) \in S} |\delta(M, w(i, j))|,$$

$$s.t. \quad w(S) = w(i, j) \succeq w_0, \quad \forall (i, j) \in S.$$

Here  $w_0$  is a constraint (a bottom bound) for compatibility. Evidently, enumeration methods or heuristics can be used here as well.

### 3.2. Example of Composite Strategy

The four-stage (four-part)) morphological scheme of solving strategy for multicriteria ranking (sorting) to obtain the layered structure  $B$  is presented in Fig. 24:  $S = H \star T \star U \star X$ . Generally, design alternatives (local techniques, DAs) are evaluated upon six criteria [99] and the vector estimates are transformed into interval multiset estimates. In the example, expert judgment was used and illustrative estimates are presented in Table 4 (Fig. 27). Note, the estimates of DAs correspond to a certain applied situation, e.g., professional level of expert(s).

Here the design of series solving strategy is based on the compressed morphology (without aggregation, i.e., without local techniques  $X_1$  and  $X_2$ ) (Fig. 27). Table 5 contains estimates of compatibility.

Finally, the following composite Pareto-efficient DAs are obtained:

- (i)  $S_1 = H_1 \star T_0 \star U_2 \star X_0$ ,  $N(S_1) = (2; 4, 0, 0)$ ; (ii)  $S_2 = H_2 \star T_0 \star U_2 \star X_0$ ,  $N(S_2) = (3; 3, 1, 0)$ ;
- (iii)  $S_3 = H_3 \star T_0 \star U_2 \star X_0$ ,  $N(S_3) = (3; 3, 1, 0)$ ; (iv)  $S_4 = H_0 \star T_0 \star U_5 \star X_0$ ,  $N(S_4) = (3; 3, 1, 0)$ .

Fig. 28 illustrates a space of quality for the obtained solutions.

Table 4. DAs and estimates

DAs	Description	Interval multiset estimate
$H_0$	Absence	–
$H_1$	Pairwise comparison	(4, 0, 0)
$H_2$	Dominance by Pareto-rule	(3, 1, 0)
$H_3$	Outranking technique	(3, 1, 0)
$T_0$	Absence	–
$T_1$	Line elements sum of preference matrix	(1, 2, 1)
$T_2$	Additive utility function	(2, 2, 0)
$U_0$	Absence	–
$U_1$	Step-by-step revelation of maximal elements	(2, 2, 0)
$U_2$	Step-by-step revelation of Pareto efficient elements	(4, 0, 0)
$U_3$	Dividing the linear ranking	(0, 1, 3)
$U_4$	Expert procedure for ranking	(2, 2, 0)
$U_5$	Direct logical method for ranking	(3, 1, 0)
$X_0$	Absence	(0, 4, 0)
$X_1$	Expert procedure for ranking	(3, 1, 0)
$X_2$	Direct logical method for ranking	(4, 0, 0)

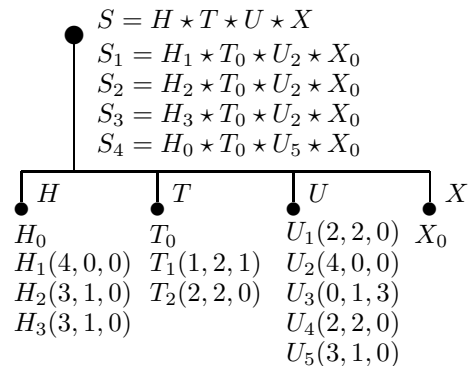

Fig. 27. Morphology of series strategy



Table 5. Compatibility of DAs

	$T_0$	$T_1$	$T_2$	$U_1$	$U_2$	$U_3$	$U_4$	$U_5$	$X_0$
$H_0$	3	3	3	0	0	0	3	3	0
$H_1$	0	1	0	2	2	0	0	0	3
$H_2$	0	1	0	3	3	0	0	0	3
$H_3$	0	1	0	3	3	0	0	0	3
$T_0$				0	0	0	3	3	0
$T_1$				0	0	2	0	0	3
$T_2$				0	0	2	0	0	3
$U_1$									3
$U_2$									3
$U_3$									3
$U_4$									3
$U_5$									3

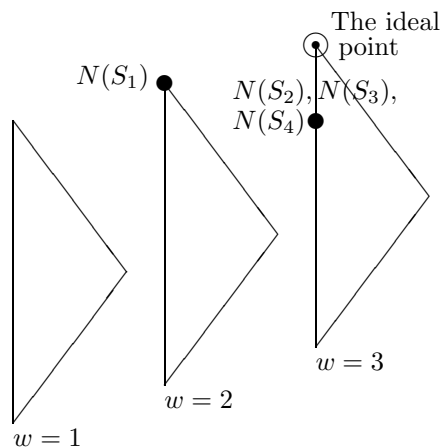

Fig. 28. Space of system quality

#### 4. CONCLUSION

In the paper, a modular approach to solving strategies in DSS for multicriteria ranking (sorting) has been described. First, methodological issues in architectural design of DSS are examined (decision making framework, typical problems, approaches to configuration of solving strategies). Second, combinatorial synthesis for design of series composite strategy for multicriteria ranking (sorting) is presented. The study is based on DSS COMBI for multicriteria ranking (1984...1991). Evidently, an important and prospective direction consists in aggregation (fusion) of preference relations which are obtained from different sources (experts, algorithm / procedures). This leads to series-parallel solving strategies (e.g., [99]). Here it may be reasonable to take into account the following two research directions: (1) routing in And-Or graphs (e.g., [1],[34]); (2) activity nets [40]). In addition, it is reasonable to point out the significance of an extended composite solving framework that involves a preliminary stage for problem formulation, a final stage for analysis of results, and on-line monitoring of the solving process (Fig. 28). Here, the same design approaches may be applied.

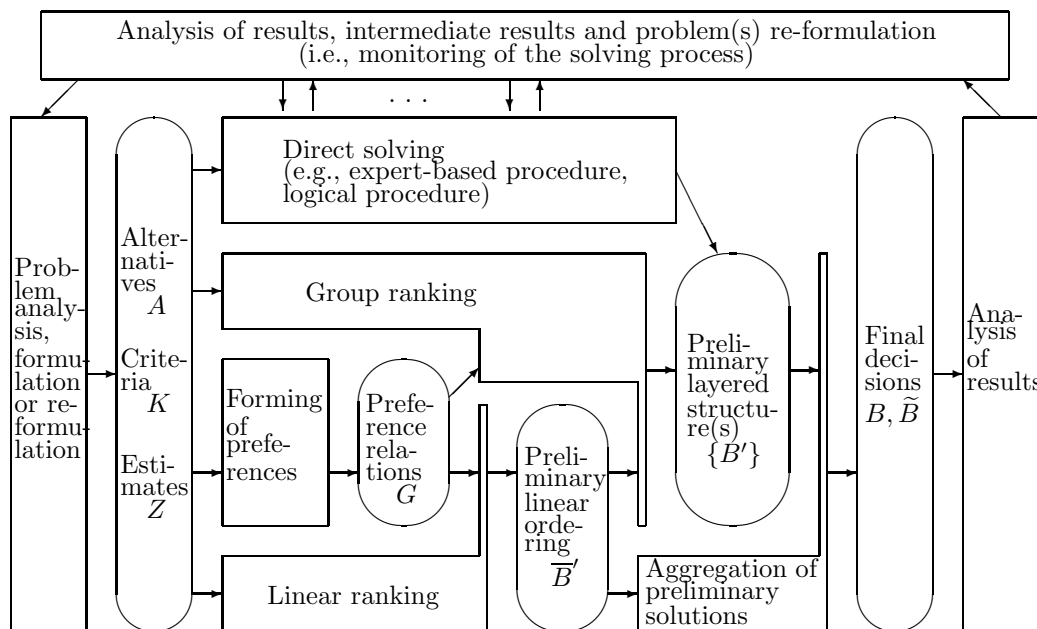

Fig. 28. Extended functional graph

Finally, it is reasonable to emphasize the significance of our approach for teaching of multicriteria analysis and system design (techniques, case studies, applied examples, projects) (e.g., [95],[100],[103],[104]).

## REFERENCES

1. G.M. Adelson-Velsky, A. Gelbukh, E. Levner, On fast path-finding algorithms in AND-OR graphs. *Mathematical Problems in Engineering* 8(4-5) (2002) 283–293.
2. M. Aizerman, F. Aleskerov, *Theory of Choice*. North-Holland, Amsterdam and New York, 1995.
3. M. Alavi, E.A. Joachiminsthaler, Revising DSS implementation research: A meta-analysis of the literature and suggestions for research. *MIS Quarterly*, 16(1) (1992) 95–116.
4. G.S. Altshuller, *Creativity as Exact Science. The Theory of the Solution of Inventive Problems*. Gordon and Breach Science Publishers, London, 1984.
5. L.M. Applegate, B.R. Konsynski, J.F. Nunamaker, Model management systems: designs for decision support. *Decision Support Systems* 2(1) (1986) 81–91.
6. G. Ariav, M.J. Ginzberg, DSS design: A systemic view of decision support. *Comm. of the ACM* 28(10) (1985) 1045–1052.
7. R.U. Ayres, *Technological Forecasting and Long-Time Planning*. McGraw-Hill Book Company, New York, 1969.
8. S. Banerjee, A. Basu, Model type selection in an integrated DSS environment. *Decision Support Systems* 9(1) (1993) 75–89.
9. S. Baron, D.S. Kruser, B.M. Huey (Eds.) *Quantitative Modeling of Human Performance in Complex, Dynamic Systems*. National Academy Press, Washington, D.C., 1990.
10. A. Basu, R.W. Blanning, Metagraphs: A tools for modeling decision support systems. *Manag. Sci.* 40(12) (1994) 1579–1600.
11. A. Basu, R.W. Blanning, Model integration using metagraphs. *Inform. Syst. Res.* 5(3) (1994) 195–218.
12. M. Behzadian, R. Kazemzadeh, A. Albadvi, M. Aghdasi, PROMETHEE: a comprehensive literature review on methodologies and applications. *EJOR* 200(1) (2010) 198–215.
13. P.C. Bell, DSS: Past, present and prospects. *J. of Decision Syst.* 1(2/3) (1992) 127–137.
14. O. Berman, N. Ashrafi, Optimization models for reliability of modular software systems. *IEEE Trans. on Soft. Eng.* 19(11) (1993) 1119–1123.
15. H.K. Bhargava, D.J. Power, D. Sun, Progress in Web-based decision support technologies. *DSS* 43(4) (2007) 1083–1095.
16. M. Binbasioglu, Key features for model building decision support systems. *Eur. J. of Oper. Res.* 82(3) (1995) 422–437.
17. R.W. Blanning, C.W. Holsapple, A.B. Whinston, (Eds.), Special Issue on Model Management Systems. *Decision Support Systems* 9(1) (1993).
18. N. Bolloju, M. Khalifa, E. Turban, Integrating knowledge management into enterprise environment for the next generation decision support. *Decision Support Systems*, 33(2) (2002) 163–178.
19. R. Bose, Intelligent agents framework for developing knowledge-based decision support systems for collaborative organizational processes. *Expert Systems with Applications* 11(3) (1996) 247–261.
20. D.E. Boyce, A. Farni, R. Weischedel, *Optimal Subset Selection: Multiple Regression Interdependence and Optimal Network Algorithms*. Lecture Notes in Economics and Mathematical Systems, Springer-Verlag, Berlin, 1974.
21. W.K.M. Brauers, E.K. Zavadskas, Robustness of MULTIMOORA: A method for multi-objective optimization. *Informatika* 23(1) (2012) 1–25.
22. A. Bregar, J. Gyorkos, M.B. Juric, Interactive aggregation/disaggregation dichotomic sorting procedure for group decision analysis based on the threshold model. *Informatika* 19(2) (2008) 161–190.
23. D.M. Buede, Software review. Overview of MCDA software market, *J. of Multi-Criteria Decision Analysis* 1(1) (1992) 59–61.
24. T. Bui, J. Lee, An agent-based framework for building decision support systems. *DSS* 25(3) (1999) 225–237.
25. K. Chari, Model composition using filter spaces. *Information Systems Research* 13(1) (2002) 15–35.
26. K. Chari, Model composition in a distributed environment. *Decision Support Systems* 35(3) (2003) 399–413.

27. Y. Chen, D.M. Kilgour, K.W. Hipel, Multiple criteria classification with an application in water resources planning, *Computer and Operations Research* 33(11) (2006) 3301–3323.
28. Y. Chen, K.W. Hipel, D.M. Kilgour, Multiple-criteria sorting using case-based distance model with an application in water resources management. *IEEE Trans. SMC, Part A* 37(5) (2007) 680–691.
29. M.D. Crossland, B.E. Wynne, W.C. Perkins, Spatial Decision Support Systems: An overview of technology and a test of efficacy. *DSS* 14(3) (1995) 219–235.
30. P. d'Alessandro, M. Dalla Mora, E. De Santis, Issues in design and architecture of advanced dynamic decision support systems. *Decision Support Systems* 5(4) (1989) 365–377.
31. M. Debevc, D. Donlagic, R. Sveciko, S. Spasovski, and B. Meyer, Flexible user support with adaptive bar. In: *Proc. of Int. Conf. on Human Computer Interaction EWHCI'94*, St. Petersburg, vol. 1, 1994, pp. 129–134.
32. R. Deneckere, A. Iacovelli, E. Kornysheva, C. Souveyet, From method fragment to method services. *Exploiting Modeling Methods for Systems Analysis and Design EMMSAD'08*, Montpellier, France, Electronic preprint, 17 pp., Nov. 2, 2009. <http://arxiv.org/abs/0911.0428> [cs.SE]
33. R. Deneckere, E. Kornysheva, C. Rolland, Method family description and configuration. In: *ICEIS 2011*, vol. 3, (2011) 384–387.
34. E. Dinic, The Fastest Algorithm for the PERT Problem with AND- and OR-nodes. In: *Proc. of Integer Programming and Combinatorial Optimization Conf.*, Univ. of Waterloo Press, (1990), 185–187.
35. D.R. Dolk, B.R. Konsynski, Knowledge representation for model management systems, *IEEE Trans. on Soft. Eng.* 10(6) (1984) 619–628.
36. B. Dominguez-Ballesteros, G. Mitra, C. Lucas, N.-S. Koutsoukis, Modeling and solving environments for mathematical programming (MP): a status review and new directions. *J. of the Oper. Res. Soc.* 53(10) (2002) 1072–1092.
37. B.L. Dos Santos, C.W. Holsapple, A framework for designing adaptive DSS interfaces, *Decision Support Systems* 5(1) (1989) 1–11.
38. J.S. Dyer, P.C. Fishburn, R.E. Steuer, J. Wallenius, S. Zionts, Multiple criteria decision making, multiattribute utility theory: The next ten years. *Manag. Sci.* 38(5) (1992) 645–654.
39. M.A. Eierman, G.C. Philip, The task of problem formulation. *Int. J. of Inform. Technol. and Dec. Making* 2(3) (2003) 353–372.
40. E.S. Elmaghraby, Activity nets: A guided tour through some recent developments. *Eur. J. of Oper. Res.* 82(3) (1995) 383–408.
41. K.J. Engemann, Developments in decision technologies. *Int. J. of Technology, Policy and Management*, 3(3/4) (2003) 225–229.
42. S.B. Eom, S.M. Lee, J.K. Kim, The intellectual structure of decision support systems (1971-1989). *Decision Support Systems* 10(1) (1993) 19–35.
43. S.B. Eom, Decision support systems research: reference disciplines and a cumulative tradition. *Omega* 23(5) (1995) 511–523.
44. S.B. Eom, The intellectual development and structure of decision support systems (1991-1995). *Omega* 26(5) (1998) 639–657.
45. A. Eren, A. Subasi, O. Coslun, A decision support system for telemedicine through the mobile telecommunications platform. *J. of Medical Systems* 32(1) (2008) 31–35.
46. B. Fazlolahi, M.A. Parikh, S. Verma, Adaptive decision support systems. *Decision Support Systems* 20(4) (1997) 297–315.
47. K. Fedra, C. Zhao, L. Winkelbauer, Interactive Multicriteria Decision Support: Combining Rule-based and Numerical Approaches, in: J. Wessels and A.P. Wierzbicki, Eds., *User-Oriented Methodology and Technology of Decision Analysis and Support*, Lecture Notes in Economics and Mathematical Systems, 397, Springer, Vienna, 1993.
48. D. Fensel, E. Motta, Structured development of problem solving methods. *IEEE Trans. KDE* 13(6) (2001) 913–932.
49. J. Figueira, S. Greco, M. Ehrgott (Eds.), *Multicriteria Decision Analysis: State of the Art Surveys*. Kluwer Academic Publishers, Boston, 2005.
50. P.C. Fishburn, *Utility Theory for Decision Making*, Wiley, New York, 1970.
51. G.A. Forgionne, Decision technology system: A vehicle to consolidate decision making support, *Inform. Processing and Manag.* 27(6) (1991) 679–697.

52. G.A. Forgionne, An architecture for the integration of decision making support functionalities. In: M. Mora, G. Frogionne, J.N.D. Gupta, (Eds.), *Decision Making Support Systems. Achivements and Challenges for the New Decades*. Idea Group Publishing, Hershley, 1–19, 2003.
53. S. French, D.-L. Xu, Comparison study of multi-attribute decision analytic software. *J. of Multi-Criteria Decision Anasysis* 13 (2-3) (2005) 65–80.
54. A. Gachet, P.H. Schwiler, A Jini-based software framework for developing distributed cooperative support systems. *Software: Practice and Experience* 33(3) (2003) 221–258.
55. M. Gagliolo, *Online Dynamic Algorithm Portfolios - Miimizing the Computational Cost of Problem Solving*. Ph.D. thesis, Univ. of Lugano, 2010.
56. E. Gallopoulos, E.N. Houstis, J.R. Rice, Workshop on problem-solving environments: findings and recommendtions. *ACM Computing Surveys* 27(2) (1995) 277–279.
57. J. Gerlach, F.-Y. Kuo, An approach to dialog management for presentation and manipulation of composite models in decision support systems. *Decision Support Systems* 6(3) (1990) 227–242.
58. C. Gomes, B. Selman, Algorithm portfolio. *Artif. Intell.* 126(1-2) (2001) 43–62.
59. D. Grosh, R. Agarwal, Model selection and sequencing in decision support systems, *OMEGA* 19(2/3) (1991) 157–167.
60. I.E. Grossmann, Mixed-integer non-linear programming techniques for the synthesis of engineering systems, *Res. in Eng. Des.* 1(2/3) (1990) 205–228.
61. A. Guitouni, J.-M. Martel, Tentitative guidelines to help choosing an appropriative MCDM method. *Eur. J. of Oper. Res.* 109(2) (1998) 501–521.
62. C. Hahn, C. Madrigal-Mora, K. Fischer, A platform-independent metamodel for multiagent shystems. *Autonomous Agents and Multi-Agent Systems* 18(2) 239–266, 2009.
63. T. Hanne, *Intelligent Strategies for Meta Multiple Criteria Decision Making*. Kluwer, Boston, 2001.
64. R. Harbane, M.-C. Heydemann, Efficient reconfiguration algorithms of de Bruijn and Kautz networks into linear arrays. *Theor. Comp. Sci.* 263(1-2) (2001) 173–189.
65. H. van der Heijden, Mobile decision support for in-store purchase decisions. *DSS* 42(2) (2006) 656–663.
66. M. Holocher, R. Michalski, D. Solte, F. Vicuna, MIDA: An open systems architecture for model-oriented integration of data and algorithms. *Decision Support Systems* 20(2) (1997) 135–147.
67. C.W. Holsapple, R. Pakath, V.S. Jacob, J.S. Zaveri, Learning by problem processors. Adaptive decision support systems. *Decision Support Systems* 10(2) (1993) 85–108.
68. R.A. Howard, Decision analysis: practice and promise. *Manag. Science* 34(6) (1988) 679–695.
69. J. Iijima, Automatic model building and solving for optimization software. *Decision Support Systems* 18 (1996) 293–300.
70. A.K. Jain, M.N. Murty, P.J. Flynn, Data Clustering: a Review. *ACM Comput. Surv.* 31(3) (1999) 264–323.
71. M. Jarke, F.J. Rademacher, The AI potential of model management and its central role in decision support. *Decision Support Systems* 4(4) (1988) 387–404.
72. M.T. Jelassi, MCDM: From "Stand-Alone" Methods to Integrated and Intelligent DSS. In: *Proc. of the VII-th Intl. Conf. on Multiple Criteria Decision Making*, vol. 1, 250–259, 1986.
73. C. Jones, An introduction to graph-based modeling systems. Part II: Graph-grammars and the implementation. *ORSA J. of Computing* 3(3) (1991) 180–206.
74. C.V. Jones, User Interface Development and Decision Support Systems, in: C.W. Holsapple and A.B. Whinston, Eds., *Recent Developments in Decision Support Systems*, NATO ASI Serie F 101 Springer, Berlin, 1993.
75. J.C. Jones, *Design Methods*, 2nd ed., New York: J.Wiley & Sons, 1992.
76. I. Jourdan, M. Basseur, E.-G. Talbi, Hybridizing exact methods and metaheuristics: A taxonomy. *EJOR* 199(3) (2009) 620–629.
77. R. Kaula, Integrating decision support systems in organizations: A three-level framework, *Industrial Manag. & Data Syst.* 94(4) (1994) 6–14.
78. R.L. Keeny, Creativity in decision making with value-focused thinking. *Sloan Management Review* (1994) 33–41.
79. R.L. Keeney, H. Raiffa, *Decisions with Multiple Objectives: Preferences and Value Tradeoffs* Wiley, New York, 1976.
80. D.E. Knuth, *The Art of Computer Programming. Vol. 2, Seminumerical Algorithms*. Addison Wesley,

Reading, 1998.

81. A. Kobsa, W. Wahlster, (Eds.), User Models in Dialog Systems. Springer, Berlin, 1989.
82. P. Korhonen, Using harmonious houses for visual pairwise comparison of multiple criteria alternatives. *Decision Support Systems* 7 (1991) 47–54.
83. P. Korhonen, J. Wallenius, S. Zionts, Solving the discrete multiple criteria problem using convex cones, *Manag. Sci.* 30(11) (1984) 1336–1345.
84. E. Kornyshova, C. Salinesi, MCDM techniques selection approaches: State of the art. In: Proc. of the 2007 IEEE Symp. on Computational Intell. in Multicriteria Decision Making MCDM 2007, art. no. 4222978, 22–29, 2007.
85. E. Kornyshova, R. Deneckere, Decision making method family MADISE: Validation within the requirements engineering domain. In: 2012 Sixth Int. Conf. on Research Challenges in Information Science RCIS 2012, Valencia, Spain, 1–10, May 2012.
86. L. Kotthoff, Algorithm selection for combinatorial search problems: A survey. Electronic preprint, 37 pp., Oct. 30, 2012. <http://arxiv.org/abs/1210.7959> [cs.AI]
87. R. Krishnan, PDM: A knowledge-based tool for model construction. *Decision Support Systems* 7(4) (1991) 301–314.
88. O.B. Kwon, Meta web service: building web-based open decision support system based on web services. *Expert Systems with Appl.* 24(4) (2003) 375–389.
89. O.I. Larichev, H.M. Moshkovich, E.M. Furems, Decision support system 'Class'. In: B. Brehmer, H. Jungerman, P. Lourens, G. Sevon (Eds.), *New Direction in Research on Decision Making*. North Holland, Amsterdam, Elsevier, 305-315, 1988.
90. R.M. Lee, Direct manipulation of graph-based decision models. *DSS* 9(4) (1993) 393–411.
91. M.Sh. Levin, Combinatorial models in decision making. In: "Procedures for Evaluation of Multicriteria Objects". Inst. of System Analysis, Moscow, 9 (1984) 35–41 (in Russian).
92. M.Sh. Levin, Application of Combinatorial Models in Computer-Aided Systems. VNIITEMR, Moscow, 1986 (in Russian).
93. M.Sh. Levin, Hierarchical components of human-computer systems. In: L.E. Bass, J. Gornostaev, and C. Unger, (Eds.), *Human-Computer Interaction, Lecture Notes in Computer Science*, 753 Springer, Berlin, 37–52, 1993.
94. M.Sh. Levin, Hierarchical design of user interfaces. In: B. Blumenthal, J. Gornostaev, and C. Unger (Eds.) *Human-Computer Interaction, Lecture Notes in Computer Science*, 876 Springer, Berlin, 140–151, 1994.
95. M.Sh. Levin, The third literacy. *Aut. Doc. & Math. Linguistics* 29(3) (1995) 66–81.
96. M.Sh. Levin, Typical decision making problems in preparation of business plans, *Scientific and Technical Information Processing*, 22(5)(1995) 24–34.
97. M.Sh. Levin, Hierarchical decision making for education in information engineering. In: 7th Annual Conf. of EAEEIE, Oulu, 301–307, 1996.
98. M.Sh. Levin, Hierarchical morphological multicriteria design of decomposable systems. *Concurrent Engineering: Res. and Appl.* 4(2) (1996) 111–117.
99. M.Sh. Levin, *Combinatorial Engineering of Decomposable Systems*. Kluwer, Dordrecht, 1998.
100. M.Sh. Levin, Towards systems engineering education. In: Proc. 15th Eur. Meeting on Cybern. and Syst. Res., Vienna, vol. 1, 257–262, 2000.
101. M.Sh. Levin, Towards combinatorial analysis, adaptation and planning of human-computer interfaces. *Appl. Intell.* 16(3) (2002) 235–247.
102. M.Sh. Levin, *Composite Systems Decisions*. Springer, New York, 2006.
103. M.Sh. Levin, Course "System design: structural approach". In: ASME Int. Design Engineering Technical Conferences and Computers and Information in Engineering Conference, vol. 4a "18th Int. Conf. on design Theory and Methodology DTM", 475–484, 2006.
104. M.Sh. Levin, Course on system design (structural approach). Electronic preprint, 22 pp., Febr. 19, 2011. <http://arxiv.org/abs/1103.3845> [cs.SE]
105. M.Sh. Levin, Morphological methods for design of modular systems (a survey). Electronic preprint, 20 pp., Jan. 9, 2011. <http://arxiv.org/abs/1201.1712> [cs.SE]
106. M.Sh. Levin, Multiset estimates and combinatorial synthesis, Electronic preprint. 30 pp., May 9, 2012. <http://arxiv.org/abs/1205.2046> [cs.SY]

- 107.M.Sh. Levin, A.A. Michailov, Dialogue system for stratification. Proc. of All-Union Inst. for Standardization in Machine-Building (VNIINMASH), Moscow, 57 (1987) 53–59 (in Russian).
- 108.M.Sh. Levin, A.A. Michailov, Building a system for group ranking. In: “Models and Methods of Optimization”, Inst. of System Analysis, Moscow, 11 (1987) 104–114 (in Russian).
- 109.M.Sh. Levin, A.A. Michailov, Logical approach to organization of procedure expert stratification. In: Abstracts of 2nd All-Union School “Applied problems of Control for Macrosystems”. Inst. of System Analysis, Moscow, (1987) 29–31 (in Russian).
- 110.M.Sh. Levin, A.A. Michailov, Technology’s fragments of object set’s stratification. Preprint, Inst. of System Analysis, Moscow, 1988 (in Russian).
- 111.M.Sh. Levin, A.A. Michailov, Dialogue System for Comparison of Multicriteria Objects./ 89.01.0045; 50890000275; 89.03. Description 77p, Specification 3 p.// Information Bulletin ”Algorithms & Software”, Computing Center of Russian Academy of Sciences, 1990, N 1.
- 112.H.L. Li, Solving discrete multicriteria decision problems based on logic-based decision support systems. *DSS* 3(2) (1987) 101–118.
- 113.T.-P. Liang, Integrating model management with data management in decision support systems. *DSS* 1(3) (1985) 221–232.
- 114.T.-P. Liang, Development of a knowledge-based model management system. *Oper. Res.* 36(6) (1988) 849–863.
- 115.J. Liu, Y. Li, J. Liu, T. Huang, A synthetic and intelligent DSS. In: Proc. of Int. Conf. on Syst. Sci. and Eng. (ICSSE’88), Beijing, China, 1988.
- 116.M. Makowski, A.P. Wierzbicki, Architecture of decision support systems. In: A.P. Wierzbicki, M. Makowski, and J. Wessels, (Eds.), *Model-Based Decision Support Methodology with Environmental Applications*, Kluwer, Dordrecht, 2000.
- 117.P. Mangiameli, D. West, R. Rampal, Model selection for medical diagnosis decision support systems. *DSS* 36(3) (2004) 247–259.
- 118.M.V. Manino, B.S. Greenberg, S.N. Hong, Model libraries: Knowledge representation and reasoning, *ORSA J. on Comput.* 2(3) (1990) 287–301.
- 119.G.M. Marakas, *Decision Support Systems in the Twenty First Century*. Prentice Hall, Upper Saddle River, NJ, 1999.
- 120.B. Mareschal, J.-P. Brans, Geometrical representation for MCDA, *Eur. J. of Oper. Res.* 34(1) (1988) 69–77.
- 121.P.K. McKinley, S.M. Sadjadi, E.P. Kasten, B.H.C. Cheng, Composing adaptive software. *IEEE Computer* 37(7) (2004) 56–64.
- 122.W. Michalowski, S. Rubin, R. Slowinski, S. Wilk, Mobile clinical support system for pediatric emergencies. *DSS* 36(2) (2003) 161–176.
- 123.D. Mirchandani, R. Pakath, Four models for a decision support system. *Inform. & Manag.* 35(1) (1999) 31–42.
- 124.B.G. Mirkin, *Group Choice*. Halsted Press, 1979.
- 125.B.G. Mirkin, *Clustering for Data Mining: A Data Recovery Approach*. Chapman & Hall/CRC, New York, 2005.
- 126.M. Mora, G. Frogionne, J.N.D. Gupta, (Eds.), *Decision Making Support Systems. Achievements and Challenges for the New Decades*. Idea Group Publishing, Hershey, 2003.
- 127.W.A. Muhanna, An object-oriented framework for model management and DSS development. *DSS* 9(2) (1993) 217–229.
- 128.W.A. Muhanna, R.A. Pick, Meta-modeling concepts and tools for model management: A systems approach, *Manag. Sci.* 40(9) (1994) 1093–1123.
- 129.A.F. Norcio, J. Stanley, Adaptive human computer interfaces: A literature survey and perspective, *IEEE Trans. on SMC* 19(2) (1989) 399–408.
- 130.S. Ossowski, A. Fernandez, J.M. Serrano, J.L. Perez-de-la-Cruz, M.V. Belmonte, J.Z. Hernandez, A.M. Garcia-Serrano, J.M. Maseda, Designing multiagent decision support systems for traffic management. In: *Applications in Agent Technology in Traffic and Transportation*, Springer, 51–67, 2005.
- 131.V.M. Ozeroy, Choosing the ‘best’ multiple criteria decision-making method. *INFOR* 30(2) (1992) 159–171.
- 132.V. Pareto, *Manual of Political Economy*. (English translation), A. M. Kelley Publishers, New York,

- 1971.
- 133.D.C. Parker, S.M. Manson, M.A. Hoffmann, P. Deadman, Multi-agent systems for the simulation of land-use and land-cover change: A review. *Annals of the Association of American Geographers* 93(2) (2003) 314–337.
- 134.J.J. Perez, F.J. Cabrerizo, E. Herrera-Viedma, A mobile decision support system for dynamic group decision-making problems. *IEEE Trans. SMC, Part A* 40(6) (2010) 1244–1256.
- 135.M. Petrik, S. Zilberstein, Learning parallel portfolios of algorithms. *Ann. Math. Artif. Intell.* 48(1-2) (2006) 85–106.
- 136.J. Piaget, *Biology and Knowledge*, The University of Chicago Press, Chicago, 1971.
- 137.D.J. Power, Specifying an expanded framework for classifying and describing decision support systems. *Communication of the Association for Information Systems* 13 (2004) 258–266.
- 138.W.E. Pracht, Model visualization: graphical support for DSS problem structuring and knowledge organization. *Decision Support Systems* 6(1) (1990) 13–27.
- 139.D.G. Rajpathak, E. Motta, Z. Zdrahal, R. Roy, A generic library of problem solving methods for scheduling applications. *IEEE Trans. KDE* 18(6) (2006) 815–828.
- 140.M. Rao, G. Fan, J. Thomas, G. Cherian, V. Chudiwale, M. Awawdeh, A web-based GIS Decision Support System for managing and planning USDS’s Conservation Reserve Program (CRP). *Environmental Modelling & Planning* 22(9) (2007) 1270–1280.
- 141.Y. Reich, A. Kapeliuk, A framework for organizing the space of decision problems with application to solving subjective, context-dependent problems. *DSS* 41(1) (2005) 1–19.
- 142.R.A. Ribeiro, A.J. Rodrigues, P. Zarate (Eds.). Special Issue “Decision Support Systems: Current Research”, *Eur. J. of Oper. Res.* 145(2) (2003).
- 143.J.R. Rice, The algorithm selection problem. *Advances in Computers* 15(1976) 15–118.
- 144.C. Rinner, Web-based spatial decision support: status and research directions. *J. of Geographic Information and Decision Analysis*, 7(1) (2003) 14-31.
- 145.C. Rosenthal-Sabroux, P. Zarate, (Eds.). Special Issue “Artificial Intelligence Tools for Decision Support Systems”, *Eur. J. of Oper. Res.* 103(2) (1997).
- 146.W.B. Rouse, A note on the nature of creativity in engineering: implications for supporting system design. *Inform. Processing & Manag.* 22(4) (1986) 279–285.
- 147.W.B. Rouse, J.A. Cannon-Bowers, E. Salas, The role of mental models in team performance in complex systems, *IEEE Trans. on Syst., Man and Cybern.* 22(6) (1992) 1296–1308.
- 148.B. Roy, *Multicriteria Methodology for Decision Aiding*, Dordrecht: Kluwer Academic Publishers, 1996.
- 149.K.A. Salewicz, M. Nakayama, Development of a web-based decision support system (DSS) for managing large international rivers. *Global Environmental Change*, 14(Supplement) (2004) 25–37.
- 150.T.L. Saaty, *The Analytic Hierarchy Process*. McGraw-Hill, New York, 1980.
- 151.Y. Sawaragi, Towards interactive and intelligent decision support systems. In: Y. Sawaragi, K. Inoue, and H. Nakaayama, (Eds.), *Toward Interactive and Intelligent Decision Support Systems*. Springer, Berlin, 1–9, 1987.
- 152.K.B.C. Saxena, Computer-aided decision support engineering. In: C.W. Holsapple and A.B. Whinston, (Eds.), *Recent Developments in Decision Support Systems*, NATO ASI Serie F 101, Springer, Berlin, 1993.
- 153.M. Schneider-Hufschmidt, T. Kuhme, and U. Malinowsli, *Adaptive User Interfaces: Principles and Practice*, Elsevier, Amsterdam, 1993.
- 154.F. Seo, I. Nishizaki, A configuration of intelligent decision support systems for strategic use: concepts and demonstrations for group decision making. In: J. Wessels, A.P. Wierzbicki (Eds.), *User-Oriented Methodology and Techniques of Decision Analysis and Support*, *Lecture Notes in Economics and Mathematical Systems*, 397, Springer, Vienna, 1993.
- 155.J.P. Shim, M. Warkentin, J.F. Courtney, D.J. Power, R. Sharda, C. Carlsson, Past, present, and future of decision support technology. *Decision Support Systems* 33(2) (2002) 111–126.
- 156.M.J. Show, P.-L. Tu, P. De, Applying machine learning to model management in decision support systems. *Decision Support Systems* 4(3) (1988) 285–305.
- 157.H.A. Simon, *Administrative Behavior: A Study of Decision-Making Processes in Administrative Organization*. 4rd ed., The Free Press, New York, 1997.

- 158.H.A. Simon, A. Newell, Heuristic problem solving: The next advance in operations research. *Operations Research* 6(1) (1958) 1–10.
- 159.Y. Siskos, A. Spyridakos, Intelligent multicriteria decision support: overview and perspectives. *Eur. J. of Oper. Res.* 113(2) (1999) 236–246.
- 160.J.B. Smelcer, E. Carmel, The effectiveness of different representations for managerial problem solving: comparing tables and maps. *Decision Sci.* 28(2) (1997) 391–420.
- 161.R.H. Sprague, E.D. Carlson, *Building Effective Decision Support Systems*. Prentice Hall, Englewood Cliffs, NJ., 1982.
- 162.A. Srinivasan, D. Sundaram, An object relational approach for the design of decision support systems. *Eur. J. of Oper. Res.* 127(3) (2000) 594–610.
- 163.E. Talbi, *Metaheuristics: From Design To Implementation*. Wiley, 2009.
- 164.H.L. Trinkaus, Th. Hanne, knowCube: a visual and interactive support for multicriteria decision making. *Computers and Operations Research* 32(5) (2005) 1289–1309.
- 165.E. Turban, J. Aronson, *Decision Support Systems and Intelligent Systems*. Prentice Hall, Upper Saddle River, New Jersey, 2001.
- 166.A. Tversky, Elimination by aspects: A theory of choice. *Psychological Review* 79(4) (1972) 281–299.
- 167.R. Vetschera, MCView: An integrated graphical system to support multiattribute decisions. *Decision Support Systems* 11(4) (1994) 363–371.
- 168.A. Vinze, A. Sen, Expert assistance for the decision support process using hierarchical planning. *IEEE Trans. SMC* 21(2) (1991) 390–401.
- 169.M. Wallace, J. Schimpf, Finding the right hybrid algorithm - A combinatorial meta-problem. *Annals of Mathematics and Artificial Intelligence* 34(4) (2002) 259–269.
- 170.J. Wang, B. Malakooti, A feedforward neural network for multiple criteria decision making, *Comput. and Oper. Res.* 19(2) (1992) 151–167.
- 171.Y. Xie, H. Wang, J. Efstathiou, A research framework for Web-based open decision support systems. *Knowledge-Based Systems* 18(7) (2005) 309–319.
- 172.R.R. Yager, On the theory of bags. *Int. J. of General Systems* 13(1) (1986) 23–37.
- 173.E.K. Zavadskas, L. Ustinovichius, F. Peldschus, Development of software for multiple criteria evaluation. *Informatica (LT)* 14(2) (2003) 259–272.
- 174.X.F. Zha, A knowledge intensive multi-agent framework for cooperative/collaborative design modeling and decision support of assemblies. *Knowledge-Based Systems* 15(8) (2002) 493–506.
- 175.S. Zhang, S. Goddard, A software architecture and framework for Web-based distributed decision systems. *DSS* 43(4) (2007) 1133–1150.
- 176.I. Zelinka, Soma - self-organizing migration algorithm. In: *New Optimization Techniques in Engineering*. Springer, 186–217, 2004.
- 177.S. Zilberstein, S.J. Russell, Optimal composition of real-time systems. *Artificial Intelligence* 82(1-2) (1993) 181–213.
- 178.C. Zopounidis, M. Doumpos, PREFDIS: a multicriteria decision support system for sorting decision problems. *Comp. and Oper. Res.* 27(7-8) (2000) 779–797.
- 179.C. Zopounidis, M. Doumpos, Multicriteria classification and sorting methods: A literature review. *Eur. J. of Oper. Res.* 138(2) (2002) 229–246.
- 180.F. Zwicky, *Discovery Invention, Research Through the Morphological Approach*. McMillan, New York, 1969.