

Learning in the Model Space for Fault Diagnosis

Huanhuan Chen, Peter Tiño, Xin Yao, and Ali Rodan *

November 1, 2012

Abstract

The emergence of large scaled sensor networks facilitates the collection of large amounts of real-time data to monitor and control complex engineering systems. However, in many cases the collected data may be incomplete or inconsistent, while the underlying environment may be time-varying or un-formulated. In this paper, we have developed an innovative cognitive fault diagnosis framework that tackles the above challenges. This framework investigates fault diagnosis in the model space instead of in the signal space. Learning in the model space is implemented by fitting a series of models using a series of signal segments selected with a rolling window. By investigating the learning techniques in the fitted model space, faulty models can be discriminated from healthy models using one-class learning algorithm. The framework enables us to construct fault library when unknown faults occur, which can be regarded as cognitive fault isolation. This paper also theoretically investigates how to measure the pairwise distance between two models in the model space and incorporates the model distance into the learning algorithm in the model space. The results on three benchmark applications and one simulated model for the Barcelona water distribution network have confirmed the effectiveness of the proposed framework.

1 Introduction

The smooth operation of complex engineering systems is crucial to the modern society. To ensure reliability, safety and availability of such complex systems, large amounts of real-time data will be collected to detect and diagnose faults as soon as possible. Therefore designing an intelligent real-time system for fault diagnosis has been receiving considerable attention both from industry and academia.

The fault diagnosis procedure can be investigated in the following three steps: (i) fault detection is to determine whether a fault has occurred or not;

*The authors are with The Centre of Excellence for Research in Computational Intelligence and Applications (CERCIA), School of Computer Science, University of Birmingham, Birmingham B15 2TT, United Kingdom, email: {H.Chen, P.Tino, X.Yao, A.A.Rodan}@cs.bham.ac.uk.

(ii) fault isolation aims to determine the type/location of fault; and (iii) fault identification estimates the magnitude or severity of the fault. In some cases, the issues of fault isolation and fault identification are interwoven, since they both determine the type of fault that has occurred.

In recent years, there has been a lot of research in the design and analysis of fault diagnosis schemes for different dynamic systems (for example, [1, 2]). A significant part of the research has focused on linear dynamical systems, where it is possible to obtain rigorous theoretical results. More recently, considerable effort has been devoted to the development of fault diagnosis schemes for nonlinear systems with various kinds of assumptions and fault scenarios [3, 4, 5].

These traditional fault diagnosis approaches rely, to a large degree, on the mathematical model of the “normal” system. If such a mathematical model is available, then fault diagnosis is achieved by comparing actual observations with the prediction of the model. Most autonomous fault diagnosis algorithms are based on this methodology. However, for complex engineering systems operating in unformulated or time-varying environments, such mathematical models may not be accurate or even unavailable at all. Therefore, it is necessary to develop cognitive fault diagnosis methods mainly based on the collected real-time data.

In this contribution we present a novel framework for dealing with fault detection to fault isolation if no, or very limited knowledge is provided about the underlying system. We do not assume that we know the type, the number or the functional form of the faults in advance. The core idea is to transform the signal into a higher dimensional “dynamical feature space” via reservoir computation models and then represent varying aspects of the signal through variation in the linear readout models trained in such dynamical feature spaces. In this way parts of the signal captured in a rolling window will be represented by the reservoir model with the readout mapping fitted in that window.

Dynamic reservoirs of reservoir models have been shown to be ‘generic’ in the sense that they are able to represent a wide variety of dynamical features of the input driven signals, so that given a task at hand only the linear readout on top of reservoir needs to be retrained [6]. Hence in our formulation, the underlying dynamic reservoir will be the *same* throughout the signal - the differences in the signal characteristics at different times will be captured solely by the linear readout models and will be quantified in the function space of readout models.

We assume that for some sufficiently long initial period the system is in a ‘normal/healthy’ regime so that when a fault occurs the readout models characterizing the fault will be sufficiently ‘distinct’ from the normal ones. A variety of novelty/anomaly detection techniques can be used for the purposes of detection of deviations from the ‘normal’. In this contribution we will use one-class support vector machines (OCS) [7] methodology in the readout model space. As new faults occur in time they will be captured by our incremental fault library building algorithm operating in the readout model space.

There have been other learning based approaches on fault detection and diagnosis, e.g. [8, 9, 10, 11]. For example, in [10], when neural network is expanded or the topology of the network is changed to accommodate new faults or unexpected dynamics, the network should be retrained [10]. Later on, Barakat

et al. proposed to use self adaptive growing neural network for faults diagnosis [12]. They applied wavelet decomposition and used the variance and Kurtosis of the decomposed signals as features. In 2009, Yélamos et. al [13] proposed to use support vector machines for fault diagnosis in chemical plants. Crucially, most of the current learning based approaches are formulated in the supervised learning framework, assuming that all fault patterns are known in advance. This can clearly be unrealistic.

The contributions of this paper are as follows: a) we propose a novel learning framework for cognitive fault diagnosis; b) the framework is based on learning in the model space (as opposed to the traditional data space) of readout models operating on the dynamic reservoir feature space representing parts of signals; c) we propose to use incremental one class learning in the readout model space for fault detection/isolation and dynamic fault library building.

The rest of this paper is organized as follows. Section 2 introduces deterministic reservoir computing and the framework of “learning in the model space”, followed by the incremental one class learning algorithm for cognitive fault diagnosis in Section 3. The experimental results and analysis are reported in Section 4. Finally, Section 5 concludes the paper and presents some future work.

2 Deterministic Reservoir Computing and Learning in the Model Space

This section introduces deterministic reservoir model to fit multiple-input and multiple-output (MIMO) signals. Then, we introduce the framework of “learning in the model space” for fault diagnosis.

2.1 Deterministic Reservoir Computing

Reservoir Computing (RC) [6] is a recent class of state space models based on a “fixed” randomly constructed state transition mapping, realized through so-called reservoir and an trainable (usually linear) readout mapping from the reservoir. Popular RC methods include Echo State Networks (ESNs) [14], Liquid State Machines [15] and the back-propagation decorrelation neural network [16].

In this paper, we will focus on Echo State Networks. ESNs are one of the simplest yet effective forms of RC. Generally speaking, ESNs are recurrent neural networks with a non-trainable sparse recurrent part (reservoir) and a simple linear readout. Typically, the reservoir connection weights as well as the input weights are randomly generated, subjected to the “Echo State Property” [14].

The traditional randomized RC is largely driven by a series of randomized model building stages, which could be unstable and hard to understand, especially for fault diagnosis. In this paper, we propose to use the deterministic reservoir algorithm, i.e. simple cycle topology with regular jumps (CRJ) [17], to fit the signals for fault diagnosis, since CRJ can approach any non-linear

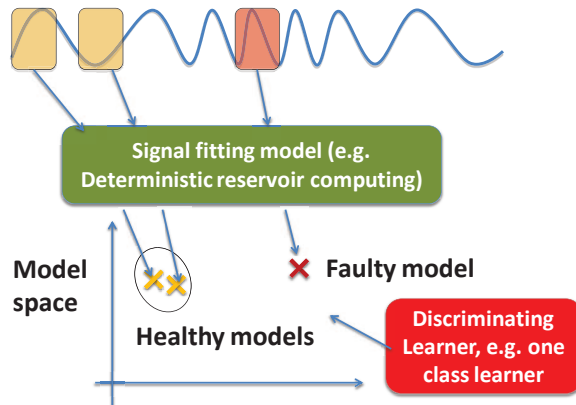

Figure 1: Illustration of “learning in the model space” framework. The first stage is to fit models using the input-output signal, i.e. generate individual points in the model space. The second stage is to discriminate the faulty models from healthy models using discriminating learners.

mapping with arbitrary accuracy. Due to the linear training, the CRJ model can be trained fast and run in real-time.

2.2 Learning in the Model Space

Recently, there is a new trend in the machine learning community to represent ‘local’ data collections through models that capture what we think is important in the data and do machine learning on those models - this can have benefit of more robust and more targeted learning on diverse data collections [18].

The idea of learning in the model space is to use models fitted on parts of data as more stable and parsimonious representations of the data. Learning is then performed directly in the model space, instead of the original data space. Some aspects of the idea of learning in the model space have occurred in different forms in the machine learning community. For example, using generative kernels for classification (e.g. P-kernel [19] or Fisher kernel [20]) can be viewed as a form of learning in a model-induced feature space (see e.g. [21, 22]). Recently, Brodersen et al. [18] used a generative model of brain imaging data to represent fMRI measurements of different subjects to build a SVM-type learner to classify these subjects into aphasic patients or healthy controls.

In this paper, we use “learning in the model space” approach to represent chunks of signals by dynamic models (reservoirs models with linear readout) and perform learning in the models space of readouts. The framework is illustrated in Figure 1.

2.2.1 Distance in the Model Space

There are several ways to generate the model space from the original signal space. One possible way is to identify parameterized models with their parameter vectors and work in the parameter space. This, however, will make the learning highly dependent on the particular model parameterization used. A more satisfying approach is to use parameterization-free notions of distance or similarities between the models.

In the model space, the m -norm distance between models $f_1(\mathbf{x})$ and $f_2(\mathbf{x})$ ($f_1, f_2 : \mathbb{R}^N \rightarrow \mathbb{R}^O$) is defined as follows:

$$L_m(f_1, f_2) = \left(\int_C D_m(f_1(\mathbf{x}), f_2(\mathbf{x})) d\mu(\mathbf{x}) \right)^{1/m},$$

where $D_m(f_1(\mathbf{x}), f_2(\mathbf{x})) = \|f_1(\mathbf{x}) - f_2(\mathbf{x})\|^m$ is a function to measure the difference between $f_1(\mathbf{x})$ and $f_2(\mathbf{x})$, $\mu(x)$ is the probability density function of the input domain \mathbf{x} , and C is the integral range. In this paper, we adopt $m = 2$ and first assume that x is uniformly distributed. Of course, non-uniform $\mu(\mathbf{x})$ can be adopted either by using samples generated from it or by estimating it directly using e.g. Gaussian mixture models.

In the following, we demonstrate the application of the distance definition in the model space for linear readout models. The readout model can be represented by the following equation

$$f(\mathbf{x}) = W\mathbf{x} + \mathbf{a},$$

where $\mathbf{x} = [x_1, \dots, x_N]^T$ is a state vector or basis function, N is the number of input variables in the model, W is the parameters ($O \times N$ matrix) in the model, O is the output dimensionality, and $\mathbf{a} = [a_1, \dots, a_o] \in \mathbb{R}^O$ is the bias vector of output nodes.

Consider two readouts from the *same* reservoir

$$\begin{aligned} f_1(\mathbf{x}) &= W_1\mathbf{x} + \mathbf{a}_1, \\ f_2(\mathbf{x}) &= W_2\mathbf{x} + \mathbf{a}_2. \end{aligned}$$

Since the sigmoid activation function is employed in the domain of the readout, $C \in [-1, 1]^N$. Then,

$$\begin{aligned} &L_2(f_1, f_2) \\ &= \left(\int_C \|f_1(\mathbf{x}) - f_2(\mathbf{x})\|^2 d\mathbf{x} \right)^{1/2} \\ &= \left(\int_C \|(W_1 - W_2)\mathbf{x} + (\mathbf{a}_1 - \mathbf{a}_2)\|^2 d\mathbf{x} \right)^{1/2} \\ &= \left(\int_C \|W\mathbf{x}\|^2 + 2\mathbf{a}^T W\mathbf{x} + \|\mathbf{a}\|^2 d\mathbf{x} \right)^{1/2} \end{aligned}$$

where $W = W_1 - W_2$, and $\mathbf{a} = \mathbf{a}_1 - \mathbf{a}_2$.

Note that for any fixed \mathbf{a} and W

$$\int_C \mathbf{a}^T W \mathbf{x} \, d\mathbf{x} = 0,$$

in the integral range C .

Therefore,

$$\begin{aligned} L_2(f_1, f_2) &= \left(\int_C \|W\mathbf{x}\|^2 + \|\mathbf{a}\|^2 \, d\mathbf{x} \right)^{1/2} \\ &= \left(\int_C \sum_{i=1}^O (\mathbf{w}_i^T \mathbf{x})^2 + \|\mathbf{a}\|^2 \, d\mathbf{x} \right)^{1/2} \\ &= \left(\frac{2^N}{3} \sum_{j=1}^N \sum_{i=1}^O w_{i,j}^2 + 2^N \|\mathbf{a}\|^2 \right)^{1/2} \end{aligned} \quad (1)$$

where \mathbf{w}_i^T is the i -th row of W , $w_{i,j}$ is the (i, j) -th element of W .

Scaling of the squared model distance ($L_2^2(f_1, f_2)$) by 2^{-N} we obtain

$$\frac{1}{3} \sum_{j=1}^N \sum_{i=1}^O w_{i,j}^2 + \|\mathbf{a}\|^2,$$

which differs from the squared Euclidean distance of the readout parameters

$$\sum_{j=1}^N \sum_{i=1}^O w_{i,j}^2 + \|\mathbf{a}\|^2,$$

by the factor $1/3$ applied to the differences in the linear part W of the affine readouts. Hence, more importance is given to the ‘offset’ than ‘orientation’ of the readout mapping.

In the above, we assumed that the distribution of \mathbf{x} is uniform in the integral range C . As mentioned before, in case of non-uniform $\mu(\mathbf{x})$, we can either use samples generate from μ or estimate it analytically using e.g. a Gaussian mixture model.

Assume we have m sampled points \mathbf{x}_i , $i = 1, 2, \dots, m$ from μ . Then

$$\begin{aligned} &L_2(f_1, f_2) \\ &= \left(\int_C \|f_1(\mathbf{x}) - f_2(\mathbf{x})\|^2 \, d\mu(\mathbf{x}) \right)^{1/2} \\ &\approx \left(\frac{1}{m} \sum_{i=1}^m \|f_1(\mathbf{x}_i) - f_2(\mathbf{x}_i)\|^2 \right)^{1/2}. \end{aligned} \quad (2)$$

Alternatively, Gaussian mixture model can be employed to represent μ ,

$$\begin{aligned}\mu(\mathbf{x}) &= \sum_{i=1}^K \alpha_i \mu_i(\mathbf{x}|\eta_i, \Sigma_i), \text{ and} \\ \mu_i(\mathbf{x}|\eta_i, \Sigma_i) &= \frac{\exp\left(-\frac{1}{2}(\mathbf{x} - \eta_i)^T \Sigma_i^{-1}(\mathbf{x} - \eta_i)\right)}{(2\pi)^{N/2} |\Sigma_i|^{1/2}},\end{aligned}$$

where $\sum_{i=1}^K \alpha_i = 1$ and N is the dimensionality of \mathbf{x} .

Then, the distance $L_2(f_1, f_2)$ can be obtained as follows:

$$\begin{aligned}L_2(f_1, f_2) &= \left(\int_C (f_1(\mathbf{x}) - f_2(\mathbf{x}))^2 d\mu(\mathbf{x}) \right)^{1/2}, \\ &= \sum_{i=1}^K \alpha_i \left\{ \begin{aligned} &\text{trace}(W^T W \Sigma_i) + \eta_i^T W^T W \eta_i \\ &+ 2\mathbf{a}^T W \eta_i + \mathbf{a}^T \mathbf{a} \end{aligned} \right\}.\end{aligned}\tag{3}$$

3 Incremental One Class Learning for Cognitive Fault Diagnosis

In fault diagnosis, it should be determined whether a running sub-system/component is in a normal operation condition, or whether a faulty situation is occurring. It is relatively cheap and simple to obtain measurements from a normally working system (although sampling from all possible normal situations might still be expensive). In contrast, sampling from faulty situations requires the system to break down in various ways to obtain faulty measurement examples. The construction of a fault library will therefore be very expensive, or completely impractical. In this section, we focus on this challenge and aim to develop an algorithm that can identify unknown faults and construct a fault library dynamically, which will facilitate fault isolation based on this library.

Based on the ‘‘learning in the model space’’ framework (Figure 1), one class learning [7] will be employed in the model space for fault diagnosis. One-class classification is a special type of classification algorithm. One-class SVMs are to discover a hyperplane that has maximal distance to the origin in the kernel feature space with the given training examples falling beyond the hyperplane [7].

Note that the signal characteristics can change at different positions of the rolling window. That means that the underlying measure μ over reservoir activations \mathbf{x} can change. Consider two readouts f_i and f_j obtained from two rolling window positions i and j . If reservoir activations in positions i and j are considered we would obtain two distances $L_{\mu_i}(f_i, f_j)$ and $L_{\mu_j}(f_i, f_j)$, respectively¹.

¹The measures μ_k will be represented by reservoir activation samples at window position k .

Algorithm 1 Incremental One Class Learning for Cognitive Fault Detection

- 1: **Input:** multiple-input and multiple-output data stream $\mathbf{s}_1, \dots, \mathbf{s}_t, \mathbf{s}_{t+1}, \dots$, where $\mathbf{s}_t = (u_1, \dots, u_V, y_1, \dots, y_O)^T$, V is the number of signal inputs and O is the number of outputs. The data segment $\mathbf{s}_1, \dots, \mathbf{s}_t$ are normal states of the system; parameters (σ and ν) of one-class SVMs; window size m .
 - 2: **Output:** model library lib .
 - 3: **for** each sliding window $(\mathbf{s}_i, \dots, \mathbf{s}_{i+m-1}), 1 \leq i \leq t+1-m$ **do**
 - 4: Fit deterministic reservoir computing model.
 - 5: $drc(\mathbf{s}_i, \dots, \mathbf{s}_{i+m-1}) \rightarrow f_i$
 - 6: **end for**
 - 7: Calculate the pairwise model distance matrix $\mathbf{L}_2(f_i, f_j), 1 \leq i, j \leq t+1-m$ according to Equation (1)
 - 8: Apply one class SVMs: $OCS(\mathbf{L}_2, \sigma, \nu) \rightarrow \Theta_0$ and add Θ_0 in the model library $lib = \{\Theta_0\}$.
 - 9: **for** sliding window $(\mathbf{s}_j, \dots, \mathbf{s}_{j+m-1}), j > t$ **do**
 - 10: $drc(\mathbf{s}_j, \dots, \mathbf{s}_{j+m-1}) \rightarrow f_j$;
 - 11: **if** f_j belongs to a known fault Θ_k in the lib **then**
 - 12: update Θ_k with f_j and empty candidate pool;
 - 13: **else**
 - 14: put f_j in the candidate pool;
 - 15: **end if**
 - 16: **if** size of candidate pool $> 0.5 * m$ **then**
 - 17: build a new model Θ_{k+1} with candidate pool
 - 18: Add Θ_{k+1} to lib and empty candidate pool
 - 19: **end if**
 - 20: **end for**
-

The distance f_i, f_j based on the sampling approach is then

$$\tilde{L}_2(f_i, f_j) = L_{\mu_i}(f_i, f_j) + L_{\mu_j}(f_i, f_j).$$

In this paper, we propose an algorithm that can construct the fault library online. The idea is to use each one-class learner to represent each fault/sub-fault segment by using the “learning in the model space” approach. In the beginning, a normal one-class learner Θ_0 will be constructed based on the normal signal segments. With the rolling window moving forward, we continually apply Θ_0 to judge whether a fault occurs. If a fault is coming, we will train a new one-class-learner Θ_i for fault i . Then, we keep monitoring the signal and determine whether the ongoing signal segment belongs to either normal state or a known fault. If not, a new one-class learner Θ_i will be built and included in the model library. The algorithm is illustrated in Algorithm 1, which includes the following major steps:

1. Normal data preparation by applying deterministic reservoir model drc to the rolling windows (size m) in the first t steps, i.e. the “normal” regime is sequentially induced. (Lines 3-6)

2. Calculate the pairwise model distance matrix $\mathbf{L}_2(f_i, f_j)$ and employ one class SVMs (OCS) to obtain the normal class Θ_0 . (Lines 7-8)

In one class SVMs, Gaussian RBF kernel is employed with the data distance replaced by the *model distance* $L_2(f_i, f_j)$;

$$\phi_\sigma(f_i, f_j) = \exp \{-\sigma \cdot L_2(f_i, f_j)\}.$$

3. With the rolling window moving forward, if a new f_j belongs to an existing model Θ_k ², update the existing Θ_k with this new data f_j and empty candidate pool. Otherwise, put the “point” f_j in the candidate pool. (Lines 9-15)
4. If the number of data points in the candidate pool exceeds half of the window size m , construct a new one-class learner Θ_{k+1} and empty the candidate pool. (Lines 16-18)

In the above algorithm, the assumption is that the system is running normally in the first t steps. Although the window size m should be relatively large (e.g. > 300 time steps) to accurately fit the dynamic models (e.g. deterministic reservoir computing in this paper). The rolling window is moved forward by one time step, which reduces fault detection delays.

4 Experimental Studies

This section presents experimental results in four-“fault”-diagnosis scenarios, which include one synthetic nonlinear auto-regressive moving average (NARMA) system with three different signals, one van der Pol oscillator with three faults imposed, one benchmark three-tank-system with three faults and Barcelona water system with 31 faults. This paper will investigate fault detectability and fault isolationability using a number of approaches.

4.1 Experimental Settings

In our experiments, to evaluate the “learning in the model space” framework for fault diagnosis, a number of approaches have been adopted for comparisons. The approaches include: Hotelling’s T-squared statistic test (T2) [23], a density-based algorithm for discovering clusters in large spatial databases with noise (DBscan) [24], affinity propagation [25] in the model space (AP-Model), affinity propagation in the signal space (AP-Signal), one class SVMs [7] in the model space (OCS-Model), one class SVMs in the signal space (OCS-Signal), autoregressive–moving-average model with exogenous inputs with incremental one-class learner (ARMAX-OCS), reservoir computing with incremental one-class learner (RC-OCS), deterministic reservoir computing with incremental

²If the new point f_j is classified to more than one model by one-class SVMs, count the point in the last model because of sequential correlation.

Table 1: Algorithms and Parameters

Algorithm	Space	Parameters
T2	signal	-
DBscan	model	k number of neighborhood ε neighborhood radius
AP-Model	model	-
AP-Signal	signal	-
OCS-Model	model	σ Gaussian kernel parameter ν the upper bound of outliers
OCS-Signal	signal	σ Gaussian kernel parameter ν the upper bound of outliers
ARMAX-OCS	model	σ Gaussian kernel parameter ν the upper bound of outliers m number of nodes in reservoir (25) p autoregressive terms q moving average terms b exogenous inputs terms
RC-OCS	model	σ Gaussian kernel parameter ν the upper bound of outliers m number of nodes in reservoir (25)
DRC-OCS (sampling)	model	σ Gaussian kernel parameter ν the upper bound of outliers m number of nodes in reservoir (25)
DRC-OCS	model	σ Gaussian kernel parameter ν the upper bound of outliers m number of nodes in reservoir (25)

one-class learner (DRC-OCS) and DRC-OCS (sampling) where the model distance matrix is estimated by sampling method (Equations (2 and (3))). Table 1 summaries all the algorithms employed in this paper.

The signal space is generated by selecting p consecutive points, i.e. $\{\mathbf{s}_t, \dots, \mathbf{s}_{t+p-1}\}$, where $\mathbf{s}_t = (u_1, \dots, u_V, y_1, \dots, y_O)^T$, as a training point by re-arranging these p points to one vector. The order p will be selected in the range $[1, 30]$.

In the following four data sets, we generate 3000 time steps for normal signal and each fault signal, respectively, and employ a rolling window (size 500) to generate a series of data segments, which are employed to train deterministic reservoir model. In each data set, the first 1000 time steps of the signal are normal, i.e. the first 500 models are normal with window size 500.

The parameters of DBscan are optimized by minimizing the number of discovered classes and the false alarm rates using the first 500 normal points. The parameters of ARMAX are selected by minimizing the normalized mean squared error (NMSE) in the first 1000 time steps. The parameters of one class SVMs in OCS-Model, OCS-Signal, ARMAX-OCS, RC-OCS and DRC-OCS will be optimized by 5-fold cross validation using the first 500 data points.

4.2 NARMA System

In NARMA, the current output depends on both the input and the previous output. Generally speaking, it is difficult to model this system due to high non-

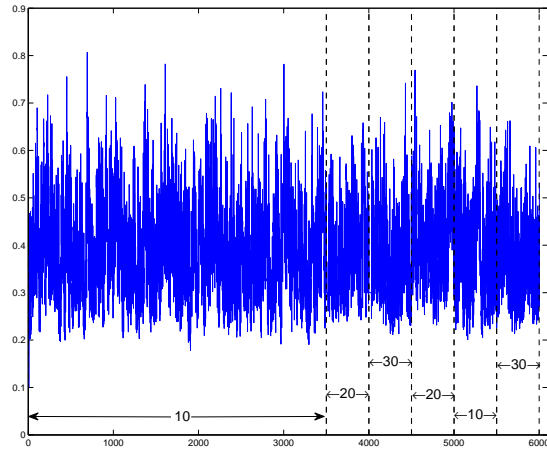

Figure 2: Illustration of three NARMA sequences with different orders (10, 20 and 30).

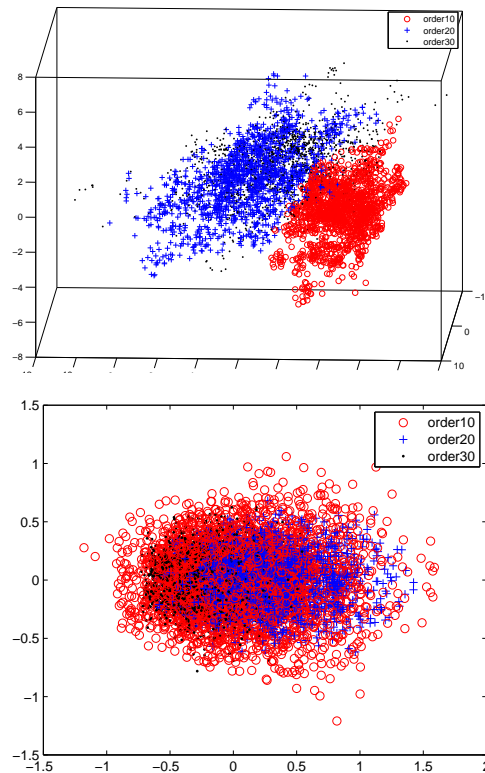

Figure 3: Visualization of the NARMA data set in the model space (top) and signal space ($p = 30$) (bottom) by multi-dimensional scaling (MDS).

linearity and possibly long memory. In this paper, we employed three NARMA time series with orders $O = 10, 20, 30$ that are given by Equations (4), (5) and (6), respectively.

$$\begin{aligned}
y(t+1) &= 0.3y(t) + 0.05y(t) \sum_{i=0}^9 y(t-i) \\
&\quad + 1.5u(t-9)u(t) + 0.1,
\end{aligned} \tag{4}$$

$$\begin{aligned}
y(t+1) &= \tanh(0.3y(t) + 0.05y(t) \sum_{i=0}^{19} y(t-i) \\
&\quad + 1.5u(t-19)u(t) + 0.01) + 0.2,
\end{aligned} \tag{5}$$

$$\begin{aligned}
y(t+1) &= 0.2y(t) + 0.004y(t) \sum_{i=0}^{29} y(t-i) \\
&\quad + 1.5u(t-29)u(t) + 0.201,
\end{aligned} \tag{6}$$

where $y(t)$ is the system output at time t , $u(t)$ is the system input at time t ($u(t)$ is an i.i.d stream generated uniformly in the interval $[0, 0.5]$).

The three sequences are illustrated in Figure 2. The three NARMA sequences look quite similar, and it is very difficult to separate them based on the signal only.

Figure 3 shows MDS analysis³ of the NARMA data set in the model space (top) and in the signal space (bottom). Based on this figure, it is relatively easier to separate different classes in the model space, while most of the data points overlap in the signal space. The figure confirms that the model based representation is able to effectively represent the signals. In Table 3, several supervised classification techniques have been employed to confirm the benefits of using model space based approaches.

4.3 Van der Pol Oscillator

A Van der Pol oscillator [26] has been a subject of extensive research and its discrete-time expressions play an important role in the numerical investigations. Discrete-time Van der Pol oscillator can be obtained as follows

$$\begin{aligned}
y_1(k) &= y_2\Delta t + y_1(k-1), \\
y_2(k) &= y_2(k-1) + y_2(k-1)(1 - y_1(k-1)^2)\Delta t \\
&\quad - y_1(k-1)\Delta t + \epsilon,
\end{aligned}$$

where ϵ is Gaussian white noise with variance 0.01.

Three faults are imposed to the van der Pol oscillator by adding $0.75 \sin(y_1(k-1))\Delta t$, $0.75 \tanh(y_1(k-1))\Delta t$ and $0.75 \cos(y_1(k-1)^2)$ to $y_2(k)$. The van der Pol oscillator and the three faults are illustrated in Figure 4.

³Multidimensional scaling (MDS) aims to preserve the pairwise distance between points, which is suitable to preserve the *model distance* for visualization.

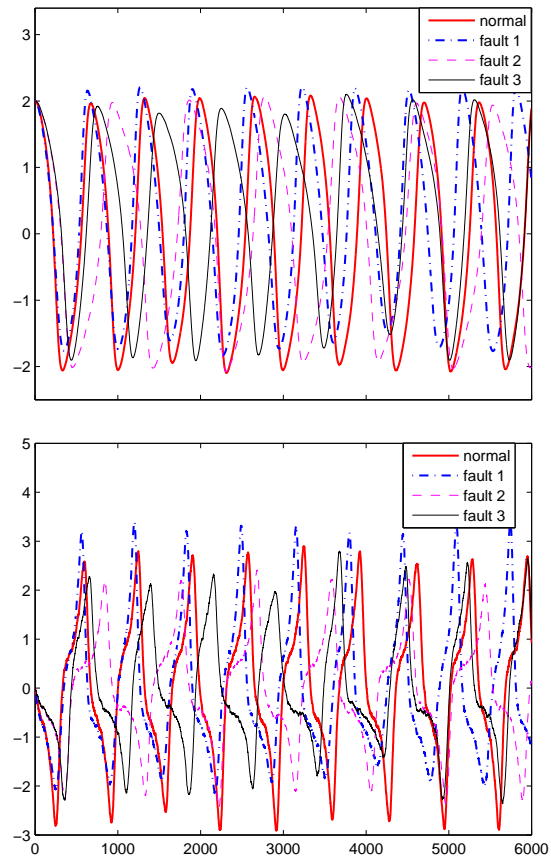

Figure 4: Illustration of Van der Pol oscillator and three different faults. (top: $y_1(k)$, bottom: $y_2(k)$)

4.4 Three Tank System

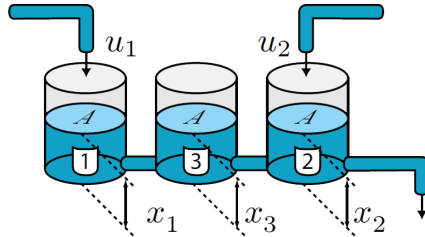

Figure 5: Three tank system [3].

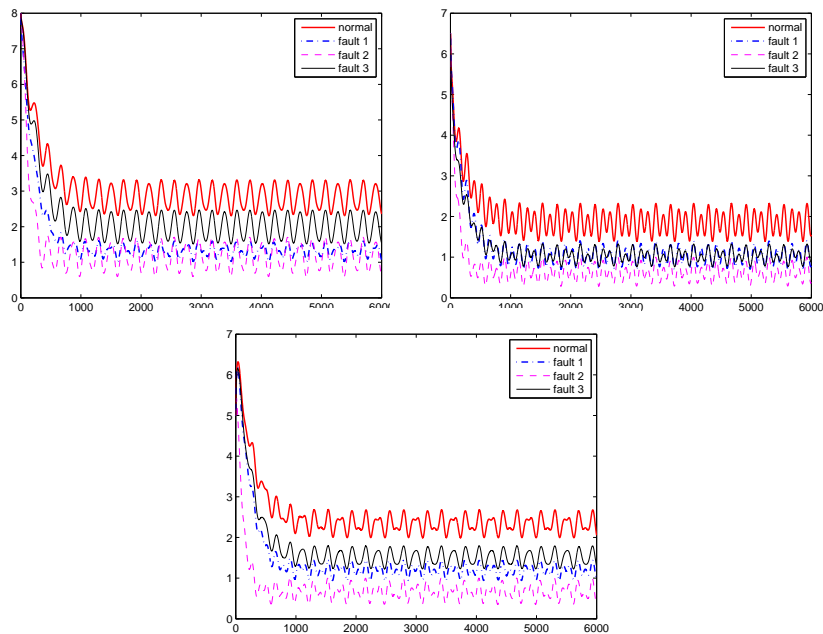

Figure 6: Illustration of levels in three tanks in the three tank system and three different faults. (left: tank 1, middle: tank 2, right: tank 3)

A well-known three-tank problem [3] in Figure 5 is presented to illustrate the effectiveness of the proposed algorithm. The cross-section of these tanks is $A_i = 1m^2$, and there is a cross-section $A_p = 0.1m^2$ at the end of each tank. The outflow rate is c_j , $i, j = 1, \dots, 3$. The level of each tank is denoted by x_i ($0 \leq x_i \leq 10$, $i = 1, \dots, 3$).

The input flows by two pumps are denoted by u_i with the restrictions $0 \leq u_i \leq 1m^3/s$, $i = 1, 2$. In this paper, the inflows are set with $u_1(k) = 0.2 \cos(0.3kT_s) + 0.3$ and $u_2(k) = 0.25 \cos(0.5kT_s) + 0.3$, respectively, and the

initial levels of tanks are 8, 6.5, and 5 meter. In the model, three faults are introduced as follows:

- 1) **Actuator fault in pump 1:** the pump is partially or fully shutdown.
- 2) **Leakage in tank 3:** there is a leak circular hole with unknown radius $0 < \rho_3 < 1$ in the tank bottom.
- 3) **Actuator fault in pump 2:** the fault is same as fault 1 but related to pump number 2.

Figure 6 illustrates the water levels of three tanks in normal and three faulty situations.

4.5 Barcelona Water Distribution Network

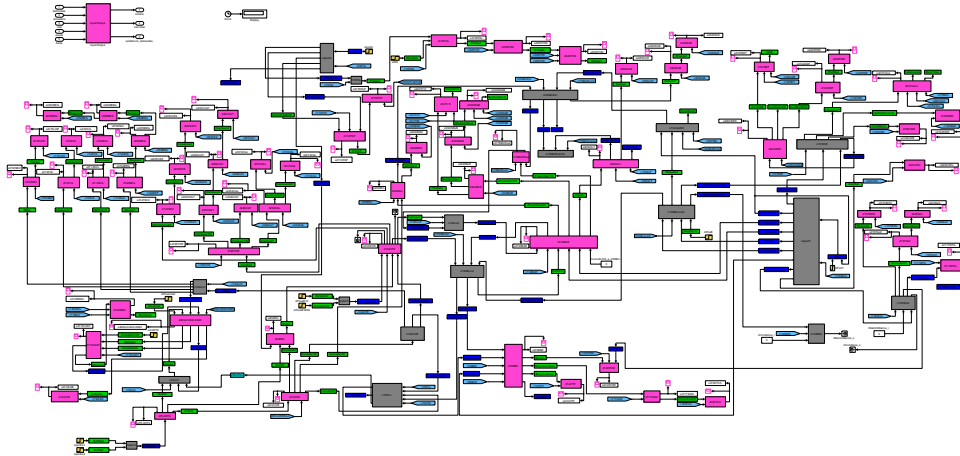

Figure 7: Barcelona Water System Simulator Programmed by MATLAB Simulink [27].

The next application is Barcelona Water Distribution Network (BWDN) [27]. BWDN supplies water to approximately 3 million consumers, distributed in 23 municipalities in a 424 km^2 area. Water can be taken from both surface and underground sources. From these sources, water is supplied to 218 demand sectors through about 4645 km of pipe. The complete transport network has been modeled using 63 storage tanks, 3 surface and 6 underground sources, 79 pumps, 50 valves, 18 nodes and 88 demands.

A detailed simulation model of the BWDN has been developed using MATLAB/Simulink [27] (Figure 7), which has been calibrated and validated using real data. In this simulator, we can manipulate and inject different faults into the system. Studied faults are introduced in the two subsystems of the network shown in Figure 8. In the two subsystems, we introduced 31 faults, which are

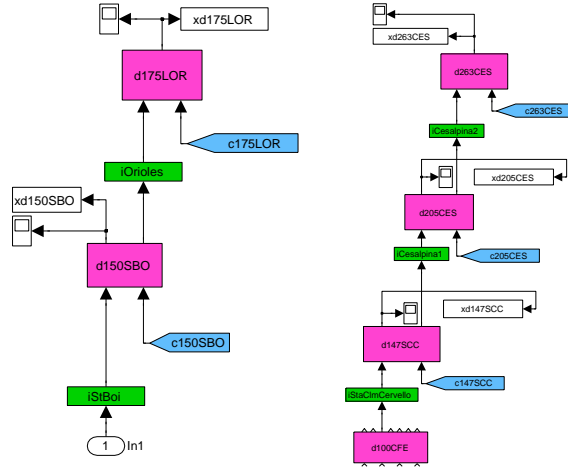

Figure 8: Subsystems of the water network where faults are introduced. iOrioles, iStaCImCervello, iCesalpina1, iCesalpina2 are actuators (controller). c175LOR, c147SCC, c205CES, c263CES are demand (input). d175LOR, d147SCC, d205CES, d263CES are tank level (output).

detailed in Table 2. These faults include actuator faults, actuator sensor faults, demand (input) sensor faults, and tanks (output) sensor faults. Four examples of faulty signals are illustrated in Figure 9.

As there are two subsystems, two deterministic reservoir computing models, each with 25 nodes in the reservoir, have been employed in the proposed framework.

4.6 Comparisons and Evaluations

This section will first report the comparisons of several supervised algorithms applied in the model space and signal space, respectively, and then evaluate those algorithms listed in Table 1 in terms of fault detectability and fault isolationability.

In above section, the model space and signal space have been illustrated by the MDS algorithm. However, due to the high dimensionality, the visualizations might not reveal the real relationship of these data points in the high dimensional space. In order to compare the model space and signal space based approaches, Table 3 reports the comparisons of the representations of model space and signal space using a number of supervised learning algorithms, including classification and regression trees (CART), support vector machines (SVMs), one class support vector machine (OCS), Bagging (100 trees) and Adaboosting (100 trees).

In the signal space approach, the order p will be selected in the range $[1, 30]$ by 5-fold cross validation approach. The parameters of SVMs and one-class

Table 2: Parameterizations of faults. MFD stands for maximum flow/demand.

ID	Faulty Element	Type	Magnitude	ID	Faulty Element	Type	Magnitude
1	iOrioles	1	-25%	17	iStaClnCervello	3	0.01%
2	iOrioles	2	-25%	18	iStaClnCervello	4	0.5%
3	iOrioles	2	-10%	19	iStaClnCervello	5	-
4	iOrioles	3	0.001%	20	iStaClnCervello	6	4
5	iOrioles	3	0.1%	21	iCesalpina1	1	10%
6	iOrioles	4	10%	22	iCesalpina1	2	-15%
7	iOrioles	4	1%	23	iCesalpina1	3	0.01%
8	iOrioles	5	-	24	iCesalpina1	4	0.75%
9	iOrioles	6	2	25	iCesalpina1	5	-
10	c175LOR	1	-20%	26	iCesalpina1	6	0.75
11	c175LOR	2	-15%	27	c263CES	1	30%
12	c175LOR	3	0.01%	28	c263CES	2	-15%
13	c175LOR	4	1%	29	c263CES	3	0.025%
14	c175LOR	5	-	30	c263CES	4	0.5%
15	iStaClnCervello	1	-15%	31	c263CES	5	-
16	iStaClnCervello	2	-7.5%				
Type	Details & Parameter			Type	Details & Parameter		
1	Additive offset (%MFD)			4	Additive drift (%MFD)		
2	Additive incipient offset (%MFD)			5	Abrupt freezing (-)		
3	Noise (variance %MFD)			6	Multiplicative offset (divided by)		

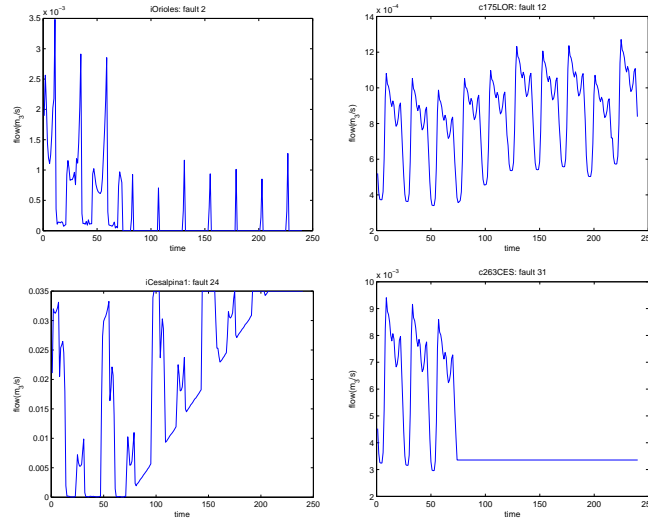

Figure 9: Examples of Faulty Signals

Table 3: Comparisons of model space based approach and signal based approach using supervised learning techniques. The reported results are based on 10 runs of 5-fold cross validation.

Algorithm	NARMA		Van der Pol		Three Tank		Water	
	Model	Signal	Model	Signal	Model	Signal	Model	Signal
CART	0.00(0.00)	0.33(0.01)	0.07(0.01)	0.11(0.01)	0.01(0.00)	0.02(0.00)	0.06(0.01)	0.11(0.00)
SVMs	0.00(0.00)	0.07(0.01)	0.05(0.01)	0.07(0.01)	0.00(0.00)	0.00(0.00)	0.06(0.00)	0.14(0.00)
OCS	0.04(0.01)	0.32(0.01)	0.15(0.01)	0.27(0.01)	0.02(0.01)	0.10(0.01)	0.09(0.01)	0.23(0.00)
Bagging	0.00(0.00)	0.24(0.01)	0.01(0.00)	0.07(0.00)	0.00(0.00)	0.01(0.01)	0.04(0.01)	0.08(0.01)
Boosting	0.00(0.00)	0.33(0.01)	0.15(0.01)	0.22(0.01)	0.01(0.00)	0.04(0.00)	0.07(0.01)	0.16(0.00)

Table 4: Comparisons of several algorithms in terms of fault detection ability, i.e. fault detection rate (FDR) and false alarm rate (FAR).

Algorithm	NARMA		Van der Pol		Three Tank		Barcelona Water	
	FDR	FAR	FDR	FAR	FDR	FAR	FDR	FAR
T2	0.9072	0.1000	0.3009	0.0998	0.2311	0.0999	0.2316	0.1384
DBscan	1	0.0917	0.9146	0.2317	0.8958	0.0683	0.7981	0.1368
OCS-Model	1	0.1102	0.9310	0.0509	0.8521	0.1082	0.9313	0.2683
OCS-Signal	0.7042	0.2097	0.7686	0.2104	0.7521	0.2082	0.4920	0.3796
AP-Model	1	0	1.0000	0.3405	0.8407	0.1128	0.9014	0.2678
AP-Signal	1	0.5427	1.0000	0.7405	0.7155	0.2387	0.8879	0.2458
ARMAX-OCS	0.9882	0.0517	0.8727	0	0.9776	0	0.7369	0.1588
RC-OCS	0.9747	0.0558	0.9762	0.0158	0.8387	0	0.8271	0.1079
DRC-OCS(Sampling)	0.9789	0	0.9804	0	0.9926	0	0.9327	0.0817
DRC-OCS	0.9921	0	0.9818	0	0.9919	0	0.9762	0.0473

Table 5: Comparisons of several algorithms in terms of fault isolation ability.

Algorithm	NARMA (3 classes)				Van der Pol (4 classes)			
	Classes	Precision	Recall	Specificity	Classes	Precision	Recall	Specificity
DBscan	4	0.6690	0.7650	0.8825	10	0.7629	0.6842	0.8018
AP-Model	271	0.9699	0.9698	0.9899	367	0.8778	0.8757	0.9585
ARMAX-OCS	5	0.9354	0.9229	0.9615	2	0.4309	0.4880	0.7868
RC-OCS	3	0.9637	0.9615	0.9808	6	0.9606	0.9583	0.9861
DRC-OCS(Sampling)	3	0.9683	0.9692	0.9914	5	0.9617	0.9726	0.9819
DRC-OCS	3	0.9861	0.9858	0.9929	5	0.9736	0.9731	0.9910
Algorithm	Three Tank (4 classes)				Barcelona Water (32 classes)			
	Classes	Precision	Recall	Specificity	Classes	Precision	Recall	Specificity
DBscan	14	0.8742	0.7561	0.9253	61	0.8019	0.7326	0.8654
AP-Model	272	0.9713	0.9704	0.9901	654	0.9366	0.9428	0.9751
ARMAX-OCS	5	0.9914	0.9923	0.9984	57	0.7826	0.7419	0.8237
RC-OCS	9	0.9182	0.8788	0.9596	44	0.8913	0.8942	0.9263
DRC-OCS(Sampling)	7	0.9940	0.9949	0.9988	39	0.9219	0.9310	0.9513
DRC-OCS	10	0.9931	0.9931	0.9977	48	0.9538	0.9640	0.9871

SVMs are optimized by 5-fold cross validation. The parameters in CART, Bagging and Adaboosting follow the defaults in MATLAB.

The reported results in Table 3 are based on 10 runs of 5-fold cross validation. In Table 3, model space representation usually achieves lower error rate. In some cases, e.g. CART/SVMs in NARMA and SVM/Bagging in three tank system, model space representation can even achieve 100% accuracy. These results are consistent with those MDS visualizations, and confirm the benefits to use model space rather than signal space in fault diagnosis.

In fault diagnosis, the first step is to discriminate faults from normal situations. Table 4 reports fault detection results using a number of algorithms listed in Table 1. The parameters related to DBscan, one-class SVM and ARMAX are optimized by 5-fold cross validation in the normal period. In this table, fault detection rate (FDR) and false alarm rate (FAR) are employed as two metrics.

According to Table 4, model space based algorithms, such as DRC-OCS, RC-OCS, are superior to other algorithms. Since deterministic reservoir is more stable than random reservoir and there is no model assumption in DRC⁴, DRC-OCS is better than RC-OCS and ARMAX-OCS.

Although the sampling method of DRC-OCS could potentially obtain better estimates when the readout parameters are non-uniform, it would require dense sampling points, i.e. large window size m in this case, with increased computational cost. However, due to real-time requirements and computational restrictions, the windows size should be restricted for prompt response to faults. Hence, DRC-OCS (sampling) is often inferior to DRC-OCS.

The statistical-test based algorithm T2 acts as a base line algorithm and it usually has a lower FDR and a fair FAR. DBscan and affinity propagation (AP) are clustering based algorithms. As these clustering algorithms do not make use of the information that the first t steps are normal, these algorithms did not perform well in the four applications.

In time-varying environment, there may be unanticipated fault scenarios that haven't been encountered before. In this paper, we proposed a dynamic fault library construction framework and its application on fault isolation. These results are reported in Table 5.

In Table 5, we first report the true number of classes and the discovered classes (i.e. number of faults plus normal class) using a number of algorithms for each data set⁵. Then, we report the fault isolation performance of these algorithms in terms of precision, recall and specificity.

Since the number of discovered faults does not equal to the true number of faults, we compare each true cluster Λ_i and these discovered clusters and merge those clusters with maximizing overlap with Λ_i to a pseudo-cluster $\tilde{\Lambda}_i$. The performance metrics are obtained by comparing Λ and $\tilde{\Lambda}$.

Based on Table 5, DRC-OCS usually outperforms other algorithms under

⁴ARMAX model assumes the model order and ARMAX-OCS might not perform well on signals with incorrect model assumption.

⁵Due to the assumption that the type of faults are unknown in advance, these compared algorithms always discover more faults than true number of faults by decomposing each true fault to a number of small fault segments.

these three metrics. AP-model performs well on the isolation stage, but it often generates too many sub-faults in the library, e.g. 270 sub-faults verse 2 faults.

In the three “learning in the model space” approaches, i.e. DRC-OCS, RC-OCS and ARMAX-OCS, DRC-OCS is the best and ARMAX-OCS is the most inferior one as it requires the model order selection for different applications. Without prior information for complex applications, it is usually difficult to select the model order. With limited sampling points due to real-time requirement, the sampling method of DRC-OCS is often inferior to DRC-OCS, though it often outperforms other approaches.

Based on the results presented in Table 3, 4 and 5, the proposed approach DRC-OCS achieves the best results and these results also confirmed that “learning in the model space” is an effective framework for fault diagnosis.

5 Conclusion

In this paper, an effective cognitive fault diagnosis framework has been proposed to tackle the challenges in complex engineering systems in time-varying or unformulated environment. Instead of investigating the fault diagnosis in the signal space, this paper introduces “learning in the model space” framework that represents the multiple-input and multiple-output data as a series of models fitted using a rolling window. By investigating the characteristic of these fitted models using learning approach in the model space, we can identify and isolate faults effectively, and dynamically construct a fault library.

This contribution applies deterministic reservoir models to fit the MIMO data, since reservoir models are generic to fit a wide variety of dynamical features of the input driven signals, and the deterministic reservoir models further simplify the model structure and thus improve the fitting performance.

To rigorously investigate these fitted models for fault diagnosis, this paper demonstrates the application of the distance definition in the model space for linear readout models. The model distance differs from the squared Euclidean distance of the readout parameters, indicating that more importance is given to the ‘offset’ than ‘orientation’ of the readout mapping. We also present the estimated forms of model distance by using either sampling methods or a Gaussian mixture model when the domain of readout-parameters is non-uniform.

By replacing the data distance matrix with the *model distance* matrix, one-class SVMs are able to “learn” in the model space to identify normal/abnormal models. To accommodate unknown faults, the algorithm “incremental one class learning in the model space” is proposed to identify and isolate faults, and simultaneously construct the fault library.

To evaluate this proposed framework with other related fault diagnosis approaches, three benchmark systems and one simulated model for Barcelona water system have been employed. The results confirm both the benefits to represent MIMO data in the model space and the effectiveness of “learning in model space” framework.

“Learning in the model space” is an effective framework for complex data

representation and fault diagnosis. Instead of using reservoir models and one class SVMs as fitting and discriminating models, respectively, there should be other effective opinions or combinations for various application systems, which consist of our future work.

Acknowledgment

This work is supported by the European Union Seventh Framework Programme under grant agreement No. INFSO-ICT-270428. This work has benefitted from many discussions with the members of the iSense project team.

References

- [1] J. Chen and R. J. Patton, *Robust model-based fault diagnosis for dynamic systems*. Kluwer Academic Publishers, 1999.
- [2] J. J. Gertler, *Fault Detection and Diagnosis in Engineering Systems*. Marcel Dekker Inc., 1998.
- [3] X. Zhang, M. Polycarpou, and T. Parisini, “A robust detection and isolation scheme for abrupt and incipient faults in nonlinear systems,” *IEEE Transactions on Automatic Control*, vol. 47, no. 4, pp. 576–593, 2002.
- [4] X. Zhang, T. Parisini, and M. Polycarpou, “Sensor bias fault isolation in a class of nonlinear systems,” *IEEE Transactions on Automatic Control*, vol. 50, no. 3, pp. 370–376, 2005.
- [5] X. Yan and C. Edwards, “Nonlinear robust fault reconstruction and estimation using a sliding mode observer,” *Automatica*, vol. 43, no. 9, pp. 1605–1614, 2007.
- [6] M. Lukoševičius and H. Jaeger, “Reservoir computing approaches to recurrent neural network training,” *Computer Science Review*, vol. 3, no. 3, pp. 127–149, 2009.
- [7] B. Schölkopf, J. Platt, J. Shawe-Taylor, A. Smola, and R. Williamson, “Estimating the support of a high-dimensional distribution,” *Neural computation*, vol. 13, no. 7, pp. 1443–1471, 2001.
- [8] A. Vemuri and M. Polycarpou, “Neural-network-based robust fault diagnosis in robotic systems,” *IEEE Transactions on Neural Networks*, vol. 8, no. 6, pp. 1410–1420, 1997.
- [9] V. Palade and C. Bocaniala, *Computational intelligence in fault diagnosis*. Springer Publishing Company, Incorporated, 2010.

- [10] V. Venkatasubramanian, R. Rengaswamy, S. Kavuri, and K. Yin, “A review of process fault detection and diagnosis:: Part iii: Process history based methods,” *Computers & chemical engineering*, vol. 27, no. 3, pp. 327–346, 2003.
- [11] P. Kankar, S. Sharma, and S. Harsha, “Fault diagnosis of ball bearings using machine learning methods,” *Expert Systems with Applications*, vol. 38, no. 3, pp. 1876–1886, 2011.
- [12] M. Barakat, F. Druaux, D. Lefebvre, M. Khalil, and O. Mustapha, “Self adaptive growing neural network classifier for faults detection and diagnosis,” *Neurocomputing*, vol. 74, no. 18, pp. 3865–3876, 2011.
- [13] I. Yélamos, G. Escudero, M. Graells, and L. Puigjaner, “Performance assessment of a novel fault diagnosis system based on support vector machines,” *Computers & Chemical Engineering*, vol. 33, no. 1, pp. 244–255, 2009.
- [14] H. Jaeger, “The echo state approach to analysing and training recurrent neural networks,” German National Research Center for Information Technology, Tech. Rep., 2001.
- [15] W. Maass, T. Natschläger, and H. Markram, “Real-time computing without stable states: A new framework for neural computation based on perturbations,” *Neural computation*, vol. 14, no. 11, pp. 2531–2560, 2002.
- [16] J. J. Steil, “Backpropagation-decorrelation: Online recurrent learning with $o(n)$ complexity,” in *Proceedings of IEEE International Joint Conference on Neural Networks*, vol. 2, 2004, pp. 843–848.
- [17] A. Rodan and P. Tiño, “Simple deterministically constructed cycle reservoirs with regular jumps,” *Neural computation*, 2012, accepted.
- [18] K. Brodersen, T. Schofield, A. Leff, C. Ong, E. Lomakina, J. Buhmann, and K. Stephan, “Generative embedding for model-based classification of fmri data,” *PLoS computational biology*, vol. 7, no. 6, p. e1002079, 2011.
- [19] D. Haussler, “Convolution kernels on discrete structures,” Technical report, UC Santa Cruz, Tech. Rep., 1999.
- [20] T. Jaakkola and D. Haussler, “Exploiting generative models in discriminative classifiers,” *NIPS*, pp. 487–493, 1999.
- [21] T. Jebara, R. Kondor, and A. Howard, “Probability product kernels,” *The Journal of Machine Learning Research*, vol. 5, pp. 819–844, 2004.
- [22] A. Bosch, A. Zisserman, and X. Muoz, “Scene classification using a hybrid generative/discriminative approach,” *IEEE Transactions on Pattern Analysis and Machine Intelligence*, vol. 30, no. 4, pp. 712–727, 2008.

- [23] J. Cho, J. Lee, S. Wook Choi, D. Lee, and I. Lee, “Fault identification for process monitoring using kernel principal component analysis,” *Chemical engineering science*, vol. 60, no. 1, pp. 279–288, 2005.
- [24] M. Ester, H. Kriegel, J. Sander, and X. Xu, “A density-based algorithm for discovering clusters in large spatial databases with noise,” in *Proceedings of the 2nd International Conference on Knowledge Discovery and Data mining*, 1996, pp. 226–231.
- [25] B. Frey and D. Dueck, “Clustering by passing messages between data points,” *Science*, vol. 315, no. 5814, pp. 972–976, 2007.
- [26] D. Kaplan and L. Glass, *Understanding nonlinear dynamics*. Springer, 1995, vol. 19.
- [27] J. Quevedo, V. Puig, G. Cembrano, J. Blanch, J. Aguilar, D. Saporta, G. Benito, M. Hedro, and A. Molina, “Validation and reconstruction of flow meter data in the barcelona water distribution network,” *Control Engineering Practice*, vol. 18, no. 6, pp. 640–651, 2010.