

# Toric Topology

Victor M. Buchstaber

Taras E. Panov

STEKLOV MATHEMATICAL INSTITUTE, RUSSIAN ACADEMY OF SCIENCES,  
GUBKINA STREET 8, 119991 MOSCOW, RUSSIA

*E-mail address:* buchstab@mi.ras.ru

DEPARTMENT OF MATHEMATICS AND MECHANICS, MOSCOW STATE UNIVERSITY,  
LENINSKIE GORY, 119991 MOSCOW, RUSSIA

INSTITUTE FOR INFORMATION TRANSMISSION PROBLEMS, RUSSIAN ACADEMY  
OF SCIENCES, MOSCOW

INSTITUTE OF THEORETICAL AND EXPERIMENTAL PHYSICS, MOSCOW

*E-mail address:* tpanov@mech.math.msu.su

ABSTRACT. Toric topology emerged in the end of the 1990s on the borders of equivariant topology, algebraic and symplectic geometry, combinatorics and commutative algebra. It has quickly grown up into a very active area with many interdisciplinary links and applications, and continues to attract experts from different fields.

The key players in toric topology are moment-angle manifolds, a family of manifolds with torus actions defined in combinatorial terms. Their construction links to combinatorial geometry and algebraic geometry of toric varieties via the related notion of a quasitoric manifold. Discovery of remarkable geometric structures on moment-angle manifolds led to seminal connections with the classical and modern areas of symplectic, Lagrangian and non-Kähler complex geometry. A related categorical construction of moment-angle complexes and their generalisations, polyhedral products, provides a universal framework for many fundamental constructions of homotopical topology. The study of polyhedral products is now evolving into a separate area of homotopy theory, with strong links to other areas of toric topology. A new perspective on torus action has also contributed to the development of classical areas of algebraic topology, such as complex cobordism.

The book contains lots of open problems and is addressed to experts interested in new ideas linking all the subjects involved, as well as to graduate students and young researchers ready to enter into a beautiful new area.

# Contents

Introduction	1
Chapter guide	2
Acknowledgments	5
Chapter 1. Geometry and combinatorics of polytopes	7
1.1. Convex polytopes	7
1.2. Gale duality and Gale diagrams	15
1.3. Face vectors and Dehn–Sommerville relations	20
1.4. Characterising the face vectors of polytopes	25
Polytopes: additional topics	31
1.5. Nestohedra and graph-associahedra	31
1.6. Flagtopes and truncated cubes	44
1.7. Differential algebra of combinatorial polytopes	50
1.8. Families of polytopes and differential equations	55
Chapter 2. Combinatorial structures	61
2.1. Polyhedral fans	62
2.2. Simplicial complexes	65
2.3. Barycentric subdivision and flag complexes	70
2.4. Alexander duality	73
2.5. Classes of triangulated spheres	76
2.6. Triangulated manifolds	81
2.7. Stellar subdivisions and bistellar moves	84
2.8. Simplicial posets and simplicial cell complexes	87
2.9. Cubical complexes	89
Chapter 3. Combinatorial algebra of face rings	97
3.1. Face rings of simplicial complexes	98
3.2. Tor-algebras and Betti numbers	103
3.3. Cohen–Macaulay complexes	111
3.4. Gorenstein complexes and Dehn–Sommerville relations	115
3.5. Face rings of simplicial posets	118
Face rings: additional topics	127
3.6. Cohen–Macaulay simplicial posets	127
3.7. Gorenstein simplicial posets	131
3.8. Generalised Dehn–Sommerville relations	133
Chapter 4. Moment-angle complexes	135
4.1. Basic definitions	137

4.2. Polyhedral products	141
4.3. Homotopical properties	145
4.4. Cell decomposition	149
4.5. Cohomology ring	150
4.6. Bigraded Betti numbers	155
4.7. Coordinate subspace arrangements	162
Moment-angle complexes: additional topics	169
4.8. Free and almost free torus actions on moment-angle complexes	169
4.9. Massey products in the cohomology of moment-angle complexes	175
4.10. Moment-angle complexes from simplicial posets	178
Chapter 5. Toric varieties and manifolds	185
5.1. Classical construction from rational fans	185
5.2. Projective toric varieties and polytopes	189
5.3. Cohomology of toric manifolds	191
5.4. Algebraic quotient construction	194
5.5. Hamiltonian actions and symplectic reduction	201
Chapter 6. Geometric structures on moment-angle manifolds	207
6.1. Intersections of quadrics	207
6.2. Moment-angle manifolds from polytopes	210
6.3. Symplectic reduction and moment maps revisited	215
6.4. Complex structures on intersections of quadrics	218
6.5. Moment-angle manifolds from simplicial fans	221
6.6. Complex structures on moment-angle manifolds	225
6.7. Holomorphic principal bundles and Dolbeault cohomology	229
6.8. Hamiltonian-minimal Lagrangian submanifolds	236
Chapter 7. Half-dimensional torus actions	245
7.1. Locally standard actions and manifolds with corners	246
7.2. Toric manifolds and their quotients	248
7.3. Quasitoric manifolds	249
7.4. Locally standard $T$ -manifolds and torus manifolds	263
7.5. Topological toric manifolds	284
7.6. Relationship between different classes of $T$ -manifolds	288
7.7. Bounded flag manifolds	290
7.8. Bott towers	293
7.9. Weight graphs	308
Chapter 8. Homotopy theory of polyhedral products	321
8.1. Rational homotopy theory of polyhedral products	322
8.2. Wedges of spheres and connected sums of sphere products	328
8.3. Stable decompositions of polyhedral products	333
8.4. Loop spaces, Whitehead and Samelson products	338
8.5. The case of flag complexes	347
Chapter 9. Torus actions and complex cobordism	355
9.1. Toric and quasitoric representatives in complex bordism classes	355
9.2. The universal toric genus	365

9.3. Equivariant genera, rigidity and fibre multiplicativity	372
9.4. Isolated fixed points: localisation formulae	375
9.5. Quasitoric manifolds and genera	382
Appendix A. Commutative and homological algebra	387
A.1. Algebras and modules	387
A.2. Homological theory of graded rings and modules	390
A.3. Regular sequences and Cohen–Macaulay algebras	397
A.4. Formality and Massey products	402
Appendix B. Algebraic topology	407
B.1. Homotopy and homology	407
B.2. Elements of rational homotopy theory	418
B.3. Group actions and equivariant cohomology	420
B.4. Eilenberg–Moore spectral sequences	424
Appendix C. Categorical constructions	427
C.1. Diagrams and model categories	427
C.2. Algebraic model categories	432
C.3. Homotopy limits and colimits	438
Appendix D. Bordism and cobordism	441
D.1. Bordism of manifolds	441
D.2. Thom spaces and cobordism functors	442
D.3. Oriented and complex bordism	445
D.4. Structure results	452
D.5. Ring generators	453
D.6. Invariant stably complex structures	456
Appendix E. Formal group laws and Hirzebruch genera	459
E.1. Elements of the theory of formal group laws	459
E.2. Formal group law of geometric cobordisms	460
E.3. Hirzebruch genera	463
Bibliography	469
Index	483



## Introduction

Traditionally, the study of torus actions on topological spaces has been considered as a classical field of algebraic topology. Specific problems connected with torus actions arise in different areas of mathematics and mathematical physics, which results in permanent interest in the theory, constant source of new applications and penetration of new ideas into topology.

Since the 1970s, algebraic and symplectic viewpoints on torus actions have enriched the subject with new combinatorial ideas and methods, largely based on the convex-geometric concept of polytopes.

The study of algebraic torus actions on algebraic varieties has quickly developed into a much successful branch of algebraic geometry, known as *toric geometry*. It gives a bijection between, on the one hand, *toric varieties*, which are complex algebraic varieties equipped with an action of an algebraic torus with a dense orbit, and on the other hand, *fans*, which are combinatorial objects. The fan allows one to completely translate various algebraic-geometric notions into combinatorics. Projective toric varieties correspond to fans which arise from convex polytopes. A valuable aspect of this theory is that it provides many explicit examples of algebraic varieties, leading to applications in deep subjects such as the singularity theory and mirror symmetry.

In symplectic geometry, since the early 1980s there has been much activity in the field of Hamiltonian group actions on symplectic manifolds. Such an action defines the *moment map* from the manifold to a Euclidean space (more precisely, the dual Lie algebra of the torus) whose image is a convex polytope. If the torus has half the dimension of the manifold the moment map image determines the manifold up to equivariant symplectomorphism. The class of polytopes which can arise as the images of moment maps can be described explicitly, together with an effective procedure of recovering a symplectic manifold from such a polytope. In symplectic geometry, as in algebraic geometry, one translates various geometric constructions into the language of convex polytopes and combinatorics.

There is a tight relationship between the algebraic and the symplectic pictures: a projective embedding of a toric manifold determines a symplectic form and a moment map. The image of the moment map is a convex polytope that is dual to the fan. In both the smooth algebraic-geometric and the symplectic situations, the compact torus action is locally isomorphic to the standard action of  $(S^1)^n$  on  $\mathbb{C}^n$  by rotation of the coordinates. Thus the quotient of the manifold by this action is naturally a manifold with corners, stratified according to the dimension of the stabilisers, and each stratum can be equipped with data that encodes the isotropy torus action along that stratum. Not only does this structure of the quotient provide a powerful means of investigating the action, but some of its subtler combinatorial properties may also be illuminated by a careful study of the equivariant topology

of the manifold. Thus, it should come as no surprise that since the beginning of the 1990s, the ideas and methodology of toric varieties and Hamiltonian torus actions have started penetrating back into algebraic topology.

By 2000, several constructions of topological analogues of toric varieties and symplectic toric manifolds have appeared in the literature, together with different seemingly unrelated realisations of what later has become known as the moment-angle manifolds. We tried to systematise both known and emerging links between torus actions and combinatorics in our 2000 paper [54] in Russian Mathematical Surveys, where the terms ‘moment-angle manifold’ and ‘moment-angle complex’ first appeared. Two years later it grew up into a book ‘Torus Actions and Their Applications in Topology and Combinatorics’ [55] published by the AMS in 2002 (the extended Russian edition [57] appeared in 2004). The title ‘Toric Topology’ coined by our colleague Nigel Ray became official after the 2006 Osaka conference under the same name. Its proceedings volume [150] contained many important contributions to the subject, as well as the introductory survey ‘An invitation to toric topology: vertex four of a remarkable tetrahedron’ by Buchstaber and Ray. The vertices of the ‘toric tetrahedron’ are topology, combinatorics, algebraic and symplectic geometry, and it symbolised much strengthened links between these subjects. With many young researchers entering the subject and conferences held around the world every year, toric topology has definitely grown up into a mature area. Its various aspects are presented in this monograph, with an intention to consolidate the foundations and stimulate further applications.

### Chapter guide

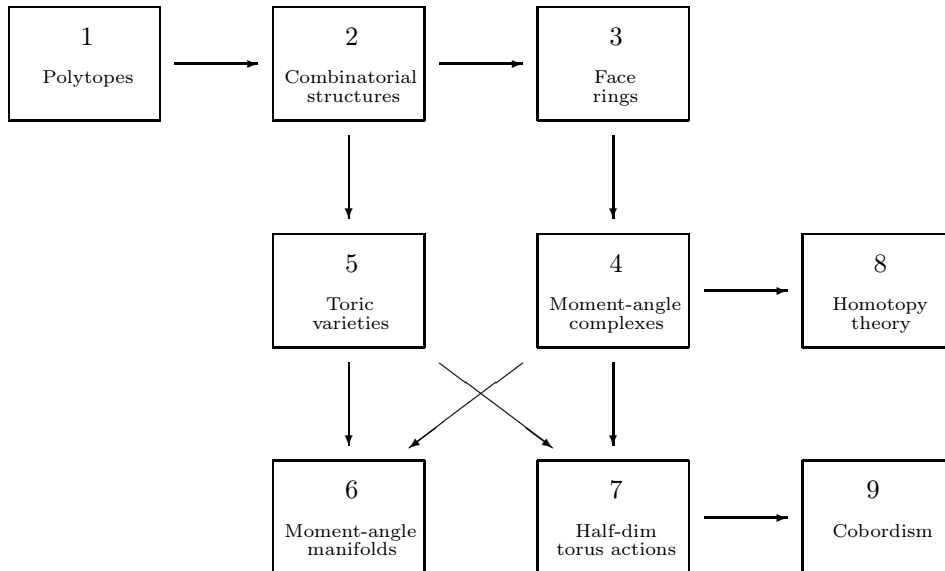

At the heart of toric topology lies a class of torus actions whose orbit spaces are highly structured in combinatorial terms, that is, have lots of orbit types tied together in a nice combinatorial way. We use the generic terms *toric space* and *toric object* to refer to a topological space with a nice torus action, or to a space produced



from a torus action via different standard topological or categorical constructions. Examples of toric spaces include toric varieties, toric and quasitoric manifolds and their generalisations, moment-angle manifolds, moment-angle complexes and their Borel constructions, polyhedral products, complements of coordinate subspace arrangements, intersections of real or Hermitian quadrics, etc.

Each chapter and most sections have their own introductions with more specific information about the contents.

In Chapter 1 we collect background material related to convex polytopes, including basic convex-geometric constructions and the combinatorial theory of face vectors. The famous  $g$ -theorem describing integer sequences that can be the face vectors of simple (or simplicial) polytopes was one of the most striking applications of toric geometry to combinatorics. The concept of Gale duality and Gale diagrams are important tools for the study of moment-angle manifolds via intersections of quadrics. In the additional sections we describe several combinatorial constructions providing families of simple polytopes, including nestohedra, graph associahedra, flagtopes and truncated cubes. The classical series of permutahedra and associahedra (Stasheff polytopes) are particular examples. The construction of nestohedra takes its origin in singularity and representation theory. We develop a differential algebraic formalism which links the generating series of nestohedra to classical partial differential equations. The potential of truncated cubes in toric topology is yet to be fully exploited, as they provide an immense source of explicitly constructed toric spaces.

In Chapter 2 we describe systematically combinatorial structures that appear in the orbit spaces of toric objects. Besides convex polytopes, these include fans, simplicial and cubical complexes, simplicial posets. All these structures are objects of independent interest for combinatorialists, and we emphasised the aspects of their combinatorial theory most relevant to subsequent topological applications.

The subject of Chapter 3 is the algebraic theory of face rings (also known as Stanley–Reisner rings) of simplicial complexes, and their generalisations to simplicial posets. With the appearance of the face rings in the beginning of the 1970s in the work of Reisner and Stanley many combinatorial problems were translated into the language of commutative algebra, which paved the way for their solution using the extensive machinery of algebraic and homological methods. Algebraic tools used for attacking combinatorial problems included regular sequences, Cohen–Macaulay and Gorenstein rings, Tor-algebras, local cohomology, etc. A whole new thriving field appeared on the borders of combinatorics and algebra, which has since become known as *combinatorial commutative algebra*.

Chapter 4 is the first ‘toric’ chapter of the book; it links the combinatorial and algebraic constructions of the previous chapters to the world of toric spaces. The concept of the moment-angle complex  $\mathcal{Z}_{\mathcal{K}}$  is introduced as a functor from the category of simplicial complexes  $\mathcal{K}$  to the category of topological spaces with torus actions and equivariant maps. When  $\mathcal{K}$  is a triangulated manifold, the moment-angle complex  $\mathcal{Z}_{\mathcal{K}}$  consists a free orbit  $\mathcal{Z}_{\emptyset}$  consisting of singular points. Removing this orbit we obtain an open manifold  $\mathcal{Z}_{\mathcal{K}} \setminus \mathcal{Z}_{\emptyset}$ , which satisfies the relative version of Poincaré duality. Combinatorial invariants of simplicial complexes  $\mathcal{K}$  therefore can be described in terms of topological characteristics of the corresponding moment-angle complexes  $\mathcal{Z}_{\mathcal{K}}$ . In particular, the face numbers of  $\mathcal{K}$ , as well as the more subtle *bigraded Betti numbers* of the face ring  $\mathbb{Z}[\mathcal{K}]$  can be expressed in terms of

the cellular cohomology groups of  $\mathcal{Z}_{\mathcal{K}}$ . The integral cohomology ring  $H^*(\mathcal{Z}_{\mathcal{K}})$  is shown to be isomorphic to the Tor-algebra  $\mathrm{Tor}_{\mathbb{Z}[v_1, \dots, v_m]}(\mathbb{Z}[\mathcal{K}], \mathbb{Z})$ . The proof builds upon a construction of a ring model for *cellular* cochains of  $\mathcal{Z}_{\mathcal{K}}$  and the corresponding cellular diagonal approximation, which is functorial with respect to maps of moment-angle complexes induced by simplicial maps of  $\mathcal{K}$ . This functorial property of the cellular diagonal approximation for  $\mathcal{Z}_{\mathcal{K}}$  is quite special, due to the lack of such a construction for general cell complexes. Another result of Chapter 4 is a homotopy equivalence (an equivariant deformation retraction) from the complement  $U(\mathcal{K})$  of the arrangement of coordinate subspaces in  $\mathbb{C}^m$  determined by  $\mathcal{K}$  to the moment-angle complex  $\mathcal{Z}_{\mathcal{K}}$ . Particular cases of this result are known in toric geometry and geometric invariant theory. It opens a new perspective on moment-angle complexes, linking them to the theory of configuration spaces and arrangements.

We tried to make the material of the first four chapters of the book accessible for an undergraduate student, or a reader with a very basic knowledge of algebra and topology. The general algebraic and topological constructions required here are collected in Appendices A and B respectively. More experienced readers may refer to these appendices purely for terminology and notation.

Toric varieties are the subject of Chapter 5. This is an extensive area with vast literature available. We outline the influence of toric geometry on the emergence of toric topology and emphasise combinatorial, topological and symplectic aspects of toric varieties. The construction of moment-angle manifolds via nondegenerate intersections of Hermitian quadrics in  $\mathbb{C}^m$ , motivated by symplectic geometry, is also discussed here. Some basic knowledge of algebraic geometry may be required in Chapter 5. Appropriate references are given in the introduction to the chapter.

Geometry of moment-angle manifolds is studied in Chapter 6. The construction of moment-angle manifolds as the level sets of toric moment maps is taken as the starting point for the systematic study of intersections of Hermitian quadrics via Gale duality. Following a remarkable discovery by Bosio and Meersseman of complex-analytic structures on moment-angle manifolds corresponding to simple polytopes, we proceed by showing that moment-angle manifolds corresponding to a more general class of complete simplicial fans can also be endowed with complex-analytic structures. The resulting family of *non-Kähler* complex manifolds includes the classical series of Hopf and Calabi–Eckmann manifolds. We also describe important invariants of these complex structures, such as the Hodge numbers and Dolbeault cohomology rings, study holomorphic torus principal bundles over toric varieties, and establish collapse results for the relevant spectral sequences. We conclude by exploring the construction of A. E. Mironov providing a vast family of Lagrangian submanifolds with special minimality properties in complex space, complex projective space and other toric varieties. Like many other geometric constructions in this chapter, it builds upon the realisation of the moment-angle manifold as an intersection of quadrics.

In Chapter 7 we discuss several topological constructions of even-dimensional manifolds with an effective action of a torus of half the dimension of the manifold. They can be viewed as topological analogues and generalisations of compact nonsingular toric varieties (or *toric manifolds*). These include *quasitoric manifolds* of Davis and Januszkiewicz, *torus manifolds* of Hattori and Masuda, and *topological toric manifolds* of Ishida, Fukukawa and Masuda. For all these classes of toric objects, the equivariant topology of the action and the combinatorics of the orbit

spaces interact in a nice and peculiar way, leading to a host of results linking topology with combinatorics. We also discuss the relationship with GKM-manifolds (named after Goresky, Kottwitz and MacPherson), another class of toric objects taking its origin in symplectic topology.

Homotopy-theoretical aspects of toric topology are the subject of Chapter 8. This is now a very active area. Homotopy techniques brought to bear on the study of polyhedral products and other toric spaces include model categories, homotopy limits and colimits, higher Whitehead and Samelson products. The required information about categorical methods in topology is collected in Appendix C.

The final Chapter 9 we review applications of toric methods in the classical field of algebraic topology, complex bordism and cobordism. It is a generalised cohomology theory that combines both geometric intuition and elaborated algebraic techniques. The toric viewpoint brings an entirely new perspective on complex bordism theory in both its non-equivariant and equivariant versions.

The later chapters require more specific knowledge of algebraic topology, such as characteristic classes and spectral sequences, for which we recommend respectively the classical book of Milnor and Stasheff [227] and the excellent guide by McCleary [215]. Basic facts and constructions from bordism and cobordism theory are given in Appendix D, while the related techniques of formal group laws and genera are reviewed in Appendix E.

### Acknowledgments

We wish to express our deepest thanks to

- our teacher Sergei Petrovich Novikov for encouragement and support of our research on toric topology;
- our friends and coauthors Mikiya Masuda and Nigel Ray for long and much fruitful collaboration;
- Peter Landweber for most helpful suggestions on improving the text;
- all our colleagues who participated in conferences on toric topology for the insight gained from discussions following talks and presentations.

The work was supported by the Russian Science Foundation (grant no. 14-11-00414). We also thank the Russian Foundation for Basic Research, the President of the Russian Federation Grants Council and Dmitri Zimin's 'Dynasty' foundation for their support of our research related to this monograph.



## Geometry and combinatorics of polytopes

This chapter is an introductory survey of the geometric and combinatorial theory of convex polytopes, with the emphasis on those of its aspects related to the topological applications later in the book. We do not assume any specific knowledge of the reader here. Algebraic definitions (graded rings and algebras) required in the end of this chapter are contained in Section A.1 of the Appendix.

Convex polytopes have been studied since ancient times. Nowadays both combinatorial and geometrical aspects of polytopes are presented in numerous textbooks and monographs. Among them are the classical monograph [139] by Grünbaum and Ziegler's more recent lectures [325]. Face vectors and other combinatorial topics are discussed in books by McMullen–Shephard [221], Brønsted [42], and the survey article [187] by Klee and Kleinschmidt; while Yemelichev–Kovalev–Kravtsov [319] focus on applications to linear programming and optimisation. All these sources may be recommended for the subsequent study of the theory of polytopes, and contain a host of further references.

### 1.1. Convex polytopes

**Definitions and basic constructions.** Let  $\mathbb{R}^n$  be  $n$ -dimensional Euclidean space with the scalar product  $\langle \cdot, \cdot \rangle$ . There are two constructively different ways to define a convex polytope in  $\mathbb{R}^n$ :

DEFINITION 1.1.1. A *convex polytope* is the convex hull  $\text{conv}(\mathbf{v}_1, \dots, \mathbf{v}_q)$  of a finite set of points  $\mathbf{v}_1, \dots, \mathbf{v}_q \in \mathbb{R}^n$ .

DEFINITION 1.1.2. A *convex polyhedron*  $P$  is a nonempty intersection of finitely many half-spaces in some  $\mathbb{R}^n$ :

$$(1.1) \quad P = \{ \mathbf{x} \in \mathbb{R}^n : \langle \mathbf{a}_i, \mathbf{x} \rangle + b_i \geq 0 \quad \text{for } i = 1, \dots, m \},$$

where  $\mathbf{a}_i \in \mathbb{R}^n$  and  $b_i \in \mathbb{R}$ . A *convex polytope* is a bounded convex polyhedron.

All polytopes in this book will be convex. The two definitions above produce the same geometrical object, i.e. a subset of  $\mathbb{R}^n$  is the convex hull of a finite point set if and only if it is a bounded intersection of finitely many half-spaces. This classical fact is proved in many textbooks on polytopes and convex geometry, and it lies at the heart of many applications of polytope theory to linear programming and optimisation, see e.g. [325, Theorem 1.1].

The *dimension* of a polyhedron is the dimension of its affine hull. We often abbreviate a ‘polyhedron of dimension  $n$ ’ to *n-polyhedron*. A *supporting hyperplane* of  $P$  is an affine hyperplane  $H$  which has common points with  $P$  and for which the polyhedron is contained in one of the two closed half-spaces determined by the hyperplane. The intersection  $P \cap H$  with a supporting hyperplane is called a *face* of the polyhedron. Denote by  $\partial P$  and  $\text{int } P = P \setminus \partial P$  the topological

boundary and interior of  $P$  respectively. In the case  $\dim P = n$  the boundary  $\partial P$  is the union of all faces of  $P$ . Each face of an  $n$ -polyhedron ( $n$ -polytope) is itself a polyhedron (polytope) of dimension  $\leq n$ . Zero-dimensional faces are called *vertices*, one-dimensional faces are *edges*, and faces of codimension one are *facets*.

Two polytopes  $P \subset \mathbb{R}^{n_1}$  and  $Q \subset \mathbb{R}^{n_2}$  of the same dimension are said to be *affinely equivalent* (or *affinely isomorphic*) if there is an affine map  $\mathbb{R}^{n_1} \rightarrow \mathbb{R}^{n_2}$  establishing a bijection between the points of the two polytopes. Two polytopes are *combinatorially equivalent* if there is a bijection between their faces preserving the inclusion relation. Note that two affinely isomorphic polytopes are combinatorially equivalent, but the opposite is not true.

The faces of a given polytope  $P$  form a partially ordered set (a *poset*) with respect to inclusion. It is called the *face poset* of  $P$ . Two polytopes are combinatorially equivalent if and only if their face posets are isomorphic.

DEFINITION 1.1.3. A *combinatorial polytope* is a class of combinatorially equivalent polytopes.

Many topological constructions later in this book will depend only on the combinatorial equivalence class of a polytope. Nevertheless, it is always helpful, and sometimes necessary, to keep in mind a particular geometric representative  $P$  rather than thinking in terms of abstract posets. Depending on the context, we shall denote by  $P$ ,  $Q$ , etc., geometric polytopes or their combinatorial equivalent classes (combinatorial polytopes). Whenever we consider both geometric and combinatorial polytopes, we shall use the notation  $P \approx Q$  for combinatorial equivalence.

We refer to (1.1) as a *presentation* of the polyhedron  $P$  by inequalities. These inequalities contain more information than the polyhedron  $P$ , for the following reason. It may happen that some of the inequalities  $\langle \mathbf{a}_i, \mathbf{x} \rangle + b_i \geq 0$  can be removed from the presentation without changing  $P$ ; we refer to such inequalities as *redundant*. A presentation without redundant inequalities is called *irredundant*. An irredundant presentation of a given polyhedron is unique up to multiplication of pairs  $(\mathbf{a}_i, b_i)$  by positive numbers.

EXAMPLE 1.1.4 (simplex and cube). An  $n$ -dimensional *simplex*  $\Delta^n$  is the convex hull of  $n + 1$  points in  $\mathbb{R}^n$  that do not lie on a common affine hyperplane. All faces of an  $n$ -simplex are simplices of dimension  $\leq n$ . Any two  $n$ -simplices are affinely equivalent. Let  $\mathbf{e}_1, \dots, \mathbf{e}_n$  be the standard basis in  $\mathbb{R}^n$ . The  $n$ -simplex  $\text{conv}(\mathbf{0}, \mathbf{e}_1, \dots, \mathbf{e}_n)$  is called *standard*. Equivalently, the standard  $n$ -simplex is specified by the  $n + 1$  inequalities

$$(1.2) \quad x_i \geq 0 \quad \text{for } i = 1, \dots, n, \quad \text{and} \quad -x_1 - \dots - x_n + 1 \geq 0.$$

The *regular*  $n$ -simplex is the convex hull of the endpoints of  $\mathbf{e}_1, \dots, \mathbf{e}_{n+1}$  in  $\mathbb{R}^{n+1}$ .

The *standard*  $n$ -cube is given by

$$(1.3) \quad \mathbb{I}^n = [0, 1]^n = \{(x_1, \dots, x_n) \in \mathbb{R}^n : 0 \leq x_i \leq 1 \quad \text{for } i = 1, \dots, n\}.$$

Equivalently, the standard  $n$ -cube is the convex hull of  $2^n$  points  $(\varepsilon_1, \dots, \varepsilon_n) \in \mathbb{R}^n$ , where  $\varepsilon_i = 0$  or  $1$ . Whenever we work with combinatorial polytopes, we shall refer to any polytope combinatorially equivalent to  $\mathbb{I}^n$  as a *cube*, and denote it by  $I^n$ .

The cube  $\mathbb{I}^n$  has  $2n$  facets. We denote by  $F_k^0$  the facet specified by the equation  $x_k = 0$ , and by  $F_k^1$  that specified by the equation  $x_k = 1$ , for  $1 \leq k \leq n$ .

**Simple and simplicial polytopes. Polarity.** The notion of a *generic* polytope depends on the choice of definition. Below we describe the two possibilities.

A set of  $q > n$  points in  $\mathbb{R}^n$  is in *general position* if no  $n + 1$  of them lie on a common affine hyperplane. Now, assuming Definition 1.1.1, we may say that a polytope is generic if it is the convex hull of a set of generally positioned points. This implies that all faces of the polytope are simplices, i.e. every facet has the minimal number of vertices (namely,  $n$ ). Polytopes with this property are called *simplicial*.

Assuming Definition 1.1.2, a presentation (1.1) is said to be *generic* if  $P$  is nonempty and the hyperplanes defined by the equations  $\langle \mathbf{a}_i, \mathbf{x} \rangle + b_i = 0$  are in general position at any point of  $P$  (that is, for any  $\mathbf{x} \in P$  the normal vectors  $\mathbf{a}_i$  of the hyperplanes containing  $\mathbf{x}$  are linearly independent). If presentation (1.1) is generic, then  $P$  is  $n$ -dimensional. If  $P$  is a polytope, then the existence of a generic presentation implies that  $P$  is *simple*, that is, exactly  $n$  facets meet at each vertex of  $P$ . Each face of a simple polytope is again a simple polytope. Every vertex of a simple polytope has a neighbourhood affinely equivalent to a neighbourhood of  $\mathbf{0}$  in the *positive orthant*  $\mathbb{R}_{\geq}^n$ . It follows that every vertex is contained in exactly  $n$  edges, and each subset of  $k$  edges with a common vertex spans a  $k$ -face.

A generic presentation may contain redundant inequalities, but, for any such inequality, the intersection of the corresponding hyperplane with  $P$  is empty (i.e., the inequality is strict at any  $\mathbf{x} \in P$ ). We set

$$F_i = \{ \mathbf{x} \in P : \langle \mathbf{a}_i, \mathbf{x} \rangle + b_i = 0 \}.$$

If presentation (1.1) is generic, then each  $F_i$  is either a facet of  $P$  or is empty.

The *polar set* of a polyhedron  $P \subset \mathbb{R}^n$  is defined as

$$(1.4) \quad P^* = \{ \mathbf{u} \in \mathbb{R}^n : \langle \mathbf{u}, \mathbf{x} \rangle + 1 \geq 0 \text{ for all } \mathbf{x} \in P \}.$$

The set  $P^*$  is a convex polyhedron with  $\mathbf{0} \in P^*$ .

REMARK.  $P^*$  is naturally a subset in the dual space  $(\mathbb{R}^n)^*$ , but we shall not make this distinction until later on, assuming  $\mathbb{R}^n$  to be Euclidean. Also, in convex geometry the inequality  $\langle \mathbf{u}, \mathbf{x} \rangle \leq 1$  is usually used in the definition of polarity, but the definition above is better suited for applications in toric geometry. These two ways of defining the polar set are taken into each other by the central symmetry.

The following properties are well known in convex geometry:

THEOREM 1.1.5 (see [42, §2.9] or [325, Th. 2.11]).

- (a)  $P^*$  is bounded if and only if  $\mathbf{0} \in \text{int } P$ ;
- (b)  $P \subset (P^*)^*$ , and  $(P^*)^* = P$  if and only if  $\mathbf{0} \in P$ ;
- (c) if a polytope  $Q$  is given as a convex hull,  $Q = \text{conv}(\mathbf{a}_1, \dots, \mathbf{a}_m)$ , then  $Q^*$  is given by inequalities (1.1) with  $b_i = 1$  for  $1 \leq i \leq m$ ; in particular,  $Q^*$  is a convex polyhedron, but not necessarily bounded;
- (d) if a polytope  $P$  is given by inequalities (1.1) with  $b_i = 1$ , then  $P^* = \text{conv}(\mathbf{a}_1, \dots, \mathbf{a}_m)$ ; furthermore,  $\langle \mathbf{a}_i, \mathbf{x} \rangle + 1 \geq 0$  is a redundant inequality if and only if  $\mathbf{a}_i \in \text{conv}(\mathbf{a}_j : j \neq i)$ .

REMARK. A polyhedron  $P$  admits a presentation (1.1) with  $b_i = 1$  if and only if  $\mathbf{0} \in \text{int } P$ . In general,  $(P^*)^* = \text{conv}(P, \mathbf{0})$ .

EXAMPLE 1.1.6. The difference between the situations  $\mathbf{0} \in P$  and  $\mathbf{0} \in \text{int } P$  may be illustrated by the following example. Let  $Q = \text{conv}(\mathbf{0}, \mathbf{e}_1, \mathbf{e}_2)$  be the standard 2-simplex in  $\mathbb{R}^2$ . By Theorem 1.1.5 (c),  $Q^*$  is specified by the three inequalities

$$\langle \mathbf{0}, \mathbf{x} \rangle + 1 \geq 0, \quad \langle \mathbf{e}_1, \mathbf{x} \rangle + 1 \geq 0, \quad \langle \mathbf{e}_2, \mathbf{x} \rangle + 1 \geq 0,$$

of which the first is satisfied for all  $\mathbf{x}$ , so we obtain an unbounded polyhedron. Its dual is  $\text{conv}(\mathbf{0}, \mathbf{e}_1, \mathbf{e}_2)$  by Theorem 1.1.5 (d), giving back the standard 2-simplex.

Any combinatorial polytope  $P$  has a presentation (1.1) with  $b_i = 1$  (take the origin to the interior of  $P$  by a parallel transform, and then divide each of the inequalities in (1.1) by the corresponding  $b_i$ ). Then  $P^*$  is also a polytope with  $\mathbf{0} \in P^*$ , and  $(P^*)^* = P$ . We refer to the combinatorial polytope  $P^*$  as the *dual* of the combinatorial polytope  $P$ . (We shall not introduce a new notation for the dual polytope, keeping in mind that polarity is a convex-geometric notion, while duality of polytopes is combinatorial.)

THEOREM 1.1.7 (see [42, §2.10]). *If  $P$  and  $P^*$  are dual polytopes, then the face poset of  $P^*$  is obtained from the face poset of  $P$  by reversing the inclusion relation.*

As a corollary, we obtain that  $P$  is simple if and only if its dual polytope  $P^*$  is simplicial. Any polygon is both simple and simplicial.

PROPOSITION 1.1.8. *In dimensions  $n \geq 3$  a simplex is the only polytope which is both simple and simplicial.*

PROOF. Let be  $P$  be a polytope which is both simple and simplicial. Choose a vertex  $v \in P$ . Since  $P$  is simple,  $v$  is connected by edges to exactly  $n$  other vertices, say  $v_1, \dots, v_n$ . We claim that there are no other vertices in  $P$ . To prove this it is enough to show that all vertices  $v_1, \dots, v_n$  are pairwise connected by edges, as then every vertex from  $v, v_1, \dots, v_n$  will be connected to the remaining  $n$  vertices. Indeed, take a pair  $v_i, v_j$ . Since  $P$  is simple and  $v$  is connected to both  $v_i$  and  $v_j$ , all these three vertices belong to a 2-face. Since  $P$  is simplicial and  $n \geq 3$ , this face is a 2-simplex, in which  $v_i$  and  $v_j$  are connected by an edge. We conclude that  $P$  has  $n + 1$  vertices, so it is an  $n$ -simplex.  $\square$

The proof above also shows that if all 2-faces of a simple polytope are triangular, then  $P$  is a simplex. A similar property is valid for a cube: if all 2-faces of a simple polytope  $P$  are quadrangular, then  $P$  is a cube (an exercise).

EXAMPLE 1.1.9. The dual of a simplex is again a simplex. To describe the dual of a cube, we consider the cube  $[-1, 1]^n$  (the standard cube (1.3) is not good as  $\mathbf{0}$  is not in its interior). Then the polar set is the convex hull of the endpoints of  $2n$  vectors  $\pm \mathbf{e}_k$ ,  $1 \leq k \leq n$ . It is called the *cross-polytope*. The 3-dimensional cross-polytope is the octahedron.

A combinatorial polytope  $P$  is called *self-dual* if  $P^*$  is combinatorially equivalent to  $P$ . There are many examples of self-dual non-simple polytopes; an infinite family of them is given by  $k$ -gonal pyramids for  $k \geq 4$ . Here is a more interesting *regular* example:

EXAMPLE 1.1.10 (24-cell). Let  $Q$  be the 4-polytope obtained by taking the convex hull of the following 24 points in  $\mathbb{R}^4$ : endpoints of 8 vectors  $\pm \mathbf{e}_i$ ,  $1 \leq i \leq 4$ ,



and 16 points of the form  $(\pm\frac{1}{2}, \pm\frac{1}{2}, \pm\frac{1}{2}, \pm\frac{1}{2})$ . By Theorem 1.1.5 (c), the polar polytope  $Q^*$  is given by the following 24 inequalities:

$$(1.5) \quad \pm x_i + 1 \geq 0 \text{ for } i = 1, \dots, 4, \quad \text{and} \quad \frac{1}{2}(\pm x_1 \pm x_2 \pm x_3 \pm x_4) + 1 \geq 0.$$

Each of these inequalities turns into equality in exactly one of the specified 24 points, so it defines a supporting hyperplane whose intersection with  $Q$  is only one point. This implies that  $Q$  has exactly 24 vertices. The vertices of  $Q^*$  may be determined by applying the ‘elimination process’ to (1.5) (see [325, §1.2]), and as a result we obtain 24 points of the form  $\pm e_i \pm e_j$  for  $1 \leq i < j \leq 4$ . Each supporting hyperplane defined by (1.5) contains exactly 6 vertices of  $Q^*$ , which form an octahedron. So both  $Q$  and  $Q^*$  have 24-vertices and 24 octahedral facets. In fact, both  $Q$  and  $Q^*$  provide examples of a *regular 4-polytope* called a *24-cell*. It is the only regular self-dual polytope different from a simplex. For more details on the 24-cell and other regular polytopes see [85].

### Products, hyperplane cuts and connected sums.

CONSTRUCTION 1.1.11 (Product). The *product*  $P_1 \times P_2$  of two simple polytopes  $P_1$  and  $P_2$  is again a simple polytope. The dual operation on simplicial polytopes can be described as follows. Let  $S_1 \subset \mathbb{R}^{n_1}$  and  $S_2 \subset \mathbb{R}^{n_2}$  be two simplicial polytopes. Assume that both  $S_1$  and  $S_2$  contain 0 in their interiors. Now define

$$S_1 \circ S_2 = \text{conv}(S_1 \times 0 \cup 0 \times S_2) \subset \mathbb{R}^{n_1+n_2}.$$

Then  $S_1 \circ S_2$  is again a simplicial polytope. For any two simple polytopes  $P_1, P_2$  containing 0 in their interiors the following identity holds:

$$P_1^* \circ P_2^* = (P_1 \times P_2)^*.$$

Both operations  $\times$  and  $\circ$  are also defined on combinatorial polytopes; in this case the above formula holds without any restrictions.

CONSTRUCTION 1.1.12 (Hyperplane cuts and face truncations). Assume given a simple polytope (1.1) and a hyperplane  $H = \{\mathbf{x} \in \mathbb{R}^n : \langle \mathbf{a}, \mathbf{x} \rangle + b = 0\}$  that does not contain any vertex of  $P$ . Then the intersections  $P \cap H_{\geq}$  and  $P \cap H_{\leq}$  of  $P$  with either of the halfspaces determined by  $H$  are simple polytopes; we refer to them as *hyperplane cuts* of  $P$ . To see that  $P \cap H_{\geq}$  and  $P \cap H_{\leq}$  are simple we note that their new vertices are transverse intersections of  $H$  with the edges of  $P$ . Since  $P$  is simple, each of those edges is contained in  $n - 1$  facets, so each new vertex of  $P \cap H_{\geq}$  or  $P \cap H_{\leq}$  is contained in exactly  $n$  facets.

If  $H$  separates all vertices of a certain  $i$ -face  $G \subset P$  from the other vertices of  $P$  and  $G \subset H_{\geq}$ , then  $P \cap H_{\geq}$  is combinatorially equivalent to  $G \times \Delta^{n-i}$  (an exercise), and we say that the polytope  $P \cap H_{\leq}$  is obtained from  $P$  by a *face truncation*.

In particular, if the cut off face  $G$  is a vertex, the result is a *vertex truncation* of  $P$ . When the choice of the cut off vertex is clear or irrelevant we use the notation  $\text{vt}(P)$ . We also use the notation  $\text{vt}^k(P)$  for a polytope obtained from  $P$  by a  $k$ -fold iteration of the vertex truncation.

We can describe the face poset of the simple polytope  $\tilde{P}$  obtained by truncating  $P$  at a face  $G \subset P$  as follows. Let  $F_1, \dots, F_m$  be the facets of  $P$ , and assume that  $G = F_{i_1} \cap \dots \cap F_{i_k}$ . The polytope  $\tilde{P}$  has  $m$  facets corresponding to  $F_1, \dots, F_m$  (and obtained from them by truncation), which we denote by the same letters for

simplicity, and a new facet  $F = P \cap H$ . Then we have

$$\begin{aligned} F_{j_1} \cap \cdots \cap F_{j_\ell} &\neq \emptyset \text{ in } \tilde{P} \\ &\iff F_{j_1} \cap \cdots \cap F_{j_\ell} \neq \emptyset \text{ in } P, \text{ and } F_{j_1} \cap \cdots \cap F_{j_\ell} \not\subset G, \\ F \cap F_{j_1} \cap \cdots \cap F_{j_\ell} &\neq \emptyset \text{ in } \tilde{P} \\ &\iff G \cap F_{j_1} \cap \cdots \cap F_{j_\ell} \neq \emptyset \text{ in } P, \text{ and } F_{j_1} \cap \cdots \cap F_{j_\ell} \not\subset G. \end{aligned}$$

Note that  $F_{j_1} \cap \cdots \cap F_{j_\ell} \not\subset G$  if and only if  $\{i_1, \dots, i_k\} \not\subset \{j_1, \dots, j_\ell\}$ .

The two previous construction worked for geometric polytopes. Here is an example of a construction which is more suitable for combinatorial ones.

**CONSTRUCTION 1.1.13** (Connected sum of polytopes). Suppose we are given two simple polytopes  $P$  and  $Q$ , both of dimension  $n$ , with distinguished vertices  $v$  and  $w$  respectively. An informal way to obtain the *connected sum*  $P \#_{v,w} Q$  of  $P$  at  $v$  and  $Q$  at  $w$  is as follows. We cut off  $v$  from  $P$  and  $w$  from  $Q$ ; then, after a projective transformation, we can glue the rest of  $P$  to the rest of  $Q$  along the new simplex facets to obtain  $P \#_{v,w} Q$ . A more formal definition is given below, following [62, §6].

First, we introduce an  $n$ -dimensional polyhedron  $\Gamma$ , which will be used as a template for the construction; it arises by considering the standard  $(n-1)$ -simplex  $\Delta^{n-1}$  in the subspace  $\{\mathbf{x} : x_1 = 0\} \subset \mathbb{R}^n$ , and taking its cartesian product with the first coordinate axis. The facets  $G_r$  of  $\Gamma$  therefore have the form  $\mathbb{R} \times D_r$ , where  $D_r$ ,  $1 \leq r \leq n$ , are the facets of  $\Delta^{n-1}$ . Both  $\Gamma$  and the  $G_r$  are divided into positive and negative halves, determined by the sign of the coordinate  $x_1$ .

We order the facets of  $P$  meeting in  $v$  as  $E_1, \dots, E_n$ , and the facets of  $Q$  meeting in  $w$  as  $F_1, \dots, F_n$ . Denote the complementary sets of facets by  $\mathcal{C}_v$  and  $\mathcal{C}_w$ ; those in  $\mathcal{C}_v$  avoid  $v$ , and those in  $\mathcal{C}_w$  avoid  $w$ .

We now choose projective transformations  $\varphi_P$  and  $\varphi_Q$  of  $\mathbb{R}^n$ , whose purpose is to map  $v$  and  $w$  to the infinity of the  $x_1$  axis. We insist that  $\varphi_P$  embeds  $P$  in  $\Gamma$  so as to satisfy two conditions; firstly, that the hyperplane defining  $E_r$  is identified with the hyperplane defining  $G_r$ , for each  $1 \leq r \leq n$ , and secondly, that the images of the hyperplanes defining  $\mathcal{C}_v$  meet  $\Gamma$  in its negative half. Similarly,  $\varphi_Q$  identifies the hyperplane defining  $F_r$  with that defining  $G_r$ , for each  $1 \leq r \leq n$ , but the images of the hyperplanes defining  $\mathcal{C}_w$  meet  $\Gamma$  in its positive half. We define the *connected sum*  $P \#_{v,w} Q$  of  $P$  at  $v$  and  $Q$  at  $w$  to be the simple  $n$ -polytope determined by the images of the hyperplanes defining  $\mathcal{C}_v$  and  $\mathcal{C}_w$  and hyperplanes defining  $G_r$ ,  $1 \leq r \leq n$ . It is defined only up to combinatorial equivalence; moreover, different choices for either of  $v$  and  $w$ , or either of the orderings for  $E_r$  and  $F_r$ , are likely to affect the combinatorial type. When the choices are clear, or their effect on the result irrelevant, we use the abbreviation  $P \# Q$ .

The related construction of connected sum  $P \# S$  of a simple polytope  $P$  and a simplicial polytope  $S$  is described in [325, Example 8.41].

**EXAMPLE 1.1.14.**

1. If  $P$  is an  $m_1$ -gon and  $Q$  is an  $m_2$ -gon then  $P \# Q$  is an  $(m_1 + m_2 - 2)$ -gon.
2. If  $P$  is an  $n$ -simplex, then  $P \# Q \approx \text{vt}(P)$ .
3. If both  $P$  and  $Q$  are  $n$ -simplices, then  $P \# Q \approx \text{vt}(\Delta^n) \approx \Delta^{n-1} \times \Delta^1$ . The combinatorial type of  $\text{vt}(\Delta^n)$  does not depend on the choice of the cut off vertex. All the vertices of the resulting polytope  $\Delta^{n-1} \times \Delta^1$  are equivalent, therefore, the

combinatorial type of  $\text{vt}^2(\Delta^n) \approx \Delta^n \# \Delta^n \# \Delta^n$  is still independent of the choices. The choice of the cut off vertex becomes significant from the next step, i.e. for  $\text{vt}^3(\Delta^n)$ , see Exercise 1.1.25.

### Neighbourly polytopes.

DEFINITION 1.1.15. A polytope is called *k-neighbourly* if any set of its  $k$  or fewer vertices spans a face. According to Exercise 1.1.26, the only  $n$ -polytope which is more than  $\lfloor \frac{n}{2} \rfloor$ -neighbourly is a simplex. An  $n$ -polytope which is  $\lfloor \frac{n}{2} \rfloor$ -neighbourly is called simply *neighbourly*.

EXAMPLE 1.1.16 (neighbourly 4-polytope). Let  $P = \Delta^2 \times \Delta^2$ , the product of two triangles. Then  $P$  is simple, and it is easy to see that any two facets of  $P$  share a common 2-face. Therefore, any two vertices of  $P^*$  are connected by an edge, so  $P^*$  is a neighbourly simplicial 4-polytope.

More generally, if  $P_1^*$  is  $k_1$ -neighbourly and  $P_2^*$  is  $k_2$ -neighbourly, then  $(P_1 \times P_2)^*$  is  $\min(k_1, k_2)$ -neighbourly. It follows that  $(\Delta^n \times \Delta^n)^*$  and  $(\Delta^n \times \Delta^{n+1})^*$  are neighbourly  $2n$ - and  $(2n + 1)$ -polytopes respectively. The next example gives a neighbourly polytope with an arbitrary number of vertices.

EXAMPLE 1.1.17 (cyclic polytopes). The *moment curve* in  $\mathbb{R}^n$  is given by

$$\mathbf{x}: \mathbb{R} \longrightarrow \mathbb{R}^n, \quad t \mapsto \mathbf{x}(t) = (t, t^2, \dots, t^n) \in \mathbb{R}^n.$$

For any  $m > n$  define the *cyclic polytope*  $C^n(t_1, \dots, t_m)$  as the convex hull of  $m$  distinct points  $\mathbf{x}(t_i)$ ,  $t_1 < t_2 < \dots < t_m$ , on the moment curve.

THEOREM 1.1.18.

- (a)  $C^n(t_1, \dots, t_m)$  is a simplicial  $n$ -polytope;
- (b)  $C^n(t_1, \dots, t_m)$  has exactly  $m$  vertices  $\mathbf{x}(t_i)$ ,  $1 \leq i \leq m$ ;
- (c) the combinatorial type of  $C^n(t_1, \dots, t_m)$  does not depend on the specific choice of parameters  $t_1, \dots, t_m$ ;
- (d)  $C^n(t_1, \dots, t_m)$  is a neighbourly polytope.

PROOF. This proof is taken from [325, Theorem 0.7]. Recall the well-known Vandermonde determinant identity

$$\det \begin{pmatrix} 1 & 1 & \dots & 1 \\ \mathbf{x}(t_0) & \mathbf{x}(t_1) & \dots & \mathbf{x}(t_n) \end{pmatrix} = \begin{vmatrix} 1 & 1 & \dots & 1 \\ t_0 & t_1 & \dots & t_n \\ \vdots & \vdots & \ddots & \vdots \\ t_0^{n-1} & t_1^{n-1} & \dots & t_n^{n-1} \\ t_0^n & t_1^n & \dots & t_n^n \end{vmatrix} = \prod_{0 \leq i < j \leq n} (t_j - t_i).$$

This implies that no  $n + 1$  points on the moment curve belong to a common affine hyperplane, proving (a). Denote  $[m] = \{1, \dots, m\}$ . Properties (b) and (c) follow from the following statement: an  $n$ -element subset  $\omega \subset [m]$  corresponds to the vertex set of a facet of  $C^n(t_1, \dots, t_m)$  if and only if the following ‘Gale’s evenness condition’ is satisfied:

*If elements  $i < j$  are not in  $\omega$ , then the number of elements  $k \in \omega$  between  $i$  and  $j$  is even.*

To prove this we write  $\omega = \{i_1, \dots, i_n\}$  and consider the hyperplane  $H_\omega$  through the corresponding points  $\mathbf{x}(t_{i_s})$ ,  $1 \leq s \leq n$ , on the moment curve. We have

$$H_\omega = \{\mathbf{x} \in \mathbb{R}^n : F_\omega(\mathbf{x}) = 0\},$$

where

$$F_\omega(\mathbf{x}) = \det \begin{pmatrix} 1 & 1 & \dots & 1 \\ \mathbf{x} & \mathbf{x}(t_{i_1}) & \dots & \mathbf{x}(t_{i_n}) \end{pmatrix}.$$

(The latter is exactly the linear function vanishing on the prescribed points.) Now let the point  $\mathbf{x}(t)$  move on the moment curve. Then  $F_\omega(\mathbf{x}(t))$  is a polynomial in  $t$  of degree  $n$ . It has  $n$  different roots  $t_{i_1}, \dots, t_{i_n}$ , and changes sign at each of them. Now  $\omega$  corresponds to the vertex set of a facet if and only if  $F_\omega(\mathbf{x}(t_i))$  has the same sign for all the points  $\mathbf{x}(t_i)$  with  $i \notin \omega$ ; that is, if  $F_\omega(\mathbf{x}(t))$  has an even number of sign changes between  $t = t_i$  and  $t = t_j$ , for  $i < j$  and  $i, j \notin \omega$ . This proves Gale's condition, and statements (b) and (c).

It remains to prove (d). We need to check that any subset  $\tau = \{i_1, \dots, i_k\} \subset [m]$  of cardinality  $k \leq \lfloor \frac{n}{2} \rfloor$  corresponds to the vertex set of a face. Choose some  $\varepsilon > 0$  so that  $t_i < t_i + \varepsilon < t_{i+1}$  for all  $i < m$ , and some  $N > t_m + \varepsilon$ . Define a linear function  $F_\tau(\mathbf{x})$  as

$$\det(\mathbf{x}, \mathbf{x}(t_{i_1}), \mathbf{x}(t_{i_1} + \varepsilon), \dots, \mathbf{x}(t_{i_k}), \mathbf{x}(t_{i_k} + \varepsilon), \mathbf{x}(N + 1), \dots, \mathbf{x}(N + n - 2k)).$$

It vanishes on  $\mathbf{x}(t_i)$  with  $i \in \tau$ . Now  $F_\tau(\mathbf{x}(t))$  is a polynomial in  $t$  of degree  $n$ , and it has  $n$  different roots

$$t_{i_1}, t_{i_1} + \varepsilon, \dots, t_{i_k}, t_{i_k} + \varepsilon, N + 1, \dots, N + n - 2k.$$

If  $i, j \notin \tau$ , then there is an even number of roots between  $t = t_i$  and  $t = t_j$ , because a root  $t = t_l$  always come in a pair with the root  $t = t_l + \varepsilon$ . Thus, the linear function  $F_\tau(\mathbf{x})$  has the same sign on all the points  $\mathbf{x}(t_i)$  with  $i \notin \tau$ . This linear function defines a supporting hyperplane, so  $\tau$  corresponds to the vertex set of a face.  $\square$

We shall denote the combinatorial cyclic  $n$ -polytope with  $m$  vertices by  $C^n(m)$ .

The vertices and edges of a polytope  $P$  determine a graph, which is called the *graph of polytope* and denoted  $\Gamma(P)$ . This graph is *simple*, that is, it has no loops and multiple edges. The following theorem is due to Blind and Mani, see also [325, §3.4] for a simpler proof given by Kalai.

**THEOREM 1.1.19.** *The combinatorial type of a simple polytope  $P$  is determined by its graph  $\Gamma(P)$ . In other words, two simple polytopes are combinatorially equivalent if their graphs are isomorphic.*

This theorem fails for general polytopes: the graph of a neighbourly polytope is isomorphic to that of a simplex with the same number of vertices. In general, simplicial  $n$ -polytopes are determined by their  $\lfloor \frac{n}{2} \rfloor$ -skeleta. General  $n$ -polytopes are determined by their  $(n - 2)$ -skeleta. See [325, §3.4] for more history and references.

### Exercises.

1.1.20. Show that if  $P$  and  $Q$  are  $n$ -polytopes, and the face poset of  $P$  is a subposet of the face poset of  $Q$ , then  $P$  and  $Q$  are combinatorially equivalent.

1.1.21. The polyhedron  $P$  defined by (1.1) has a vertex if and only if the vectors  $\mathbf{a}_1, \dots, \mathbf{a}_m$  span the whole  $\mathbb{R}^n$ .

1.1.22. Show that a simple  $n$ -polytope all of whose 2-faces are quadrangular is combinatorially equivalent to an  $n$ -cube.

1.1.23. Show that any hyperplane cut of  $\Delta^n$  is combinatorially equivalent to a product of two simplices. Conclude that any combinatorial simple  $n$ -polytope with  $n + 2$  facets is combinatorially equivalent (in fact, projectively equivalent) to a product of two simplices.

1.1.24. Let  $P$  be a simple polytope. Show that if a hyperplane  $H$  separates all vertices of a certain  $i$ -face  $G \subset P$  from the other vertices of  $P$  and  $G \subset H_{\geq}$ , then  $P \cap H_{\geq} \approx G \times \Delta^{n-i}$ .

1.1.25. How many combinatorially different polytopes may be obtained as  $\text{vt}^3(\Delta^n)$ ?

1.1.26. Show that if a polytope is  $k$ -neighbourly, then every  $(2k - 1)$ -face is a simplex. Conclude that if an  $n$ -polytope is  $(\lfloor \frac{n}{2} \rfloor + 1)$ -neighbourly, then it is a simplex. Conclude also that a neighbourly  $2k$ -polytope is simplicial. Are there neighbourly non-simplicial polytopes of odd dimension?

1.1.27. Are the polytopes  $(\Delta^n \times \Delta^n)^*$  and  $(\Delta^n \times \Delta^{n+1})^*$  combinatorially equivalent to cyclic polytopes?

## 1.2. Gale duality and Gale diagrams

The following construction realises any polytope (1.1) of dimension  $n$  by the intersection of the orthant

$$(1.6) \quad \mathbb{R}_{\geq}^m = \{(y_1, \dots, y_m) \in \mathbb{R}^m : y_i \geq 0 \text{ for } i = 1, \dots, m\} \subset \mathbb{R}^m$$

with an affine  $n$ -plane.

CONSTRUCTION 1.2.1. Let (1.1) be a presentation of a polyhedron. Consider the linear map  $A: \mathbb{R}^m \rightarrow \mathbb{R}^n$  sending the  $i$ th basis vector  $\mathbf{e}_i$  to  $\mathbf{a}_i$ . It is given by the  $n \times m$ -matrix (which we also denote by  $A$ ) whose columns are the vectors  $\mathbf{a}_i$  written in the standard basis of  $\mathbb{R}^n$ . The dual map  $A^*: \mathbb{R}^n \rightarrow \mathbb{R}^m$  is given by  $\mathbf{x} \mapsto (\langle \mathbf{a}_1, \mathbf{x} \rangle, \dots, \langle \mathbf{a}_m, \mathbf{x} \rangle)$ . Note that  $A$  is of rank  $n$  if and only if the polyhedron  $P$  has a vertex (e.g., when  $P$  is a polytope, see Exercise 1.1.21). Also, let  $\mathbf{b} = (b_1, \dots, b_m)^t \in \mathbb{R}^m$  be the column vector of  $b_i$ s. Then we can write (1.1) as

$$P = P(A, \mathbf{b}) = \{\mathbf{x} \in \mathbb{R}^n : (A^* \mathbf{x} + \mathbf{b})_i \geq 0 \text{ for } i = 1, \dots, m\},$$

where  $\mathbf{x} = (x_1, \dots, x_n)^t$  is the column of coordinates. Consider the affine map

$$i_{A, \mathbf{b}}: \mathbb{R}^n \rightarrow \mathbb{R}^m, \quad i_{A, \mathbf{b}}(\mathbf{x}) = A^* \mathbf{x} + \mathbf{b} = (\langle \mathbf{a}_1, \mathbf{x} \rangle + b_1, \dots, \langle \mathbf{a}_m, \mathbf{x} \rangle + b_m)^t.$$

If  $P$  has a vertex, then the image of  $\mathbb{R}^n$  under  $i_{A, \mathbf{b}}$  is an  $n$ -dimensional affine plane in  $\mathbb{R}^m$ , which we can write by  $m - n$  linear equations:

$$(1.7) \quad \begin{aligned} i_{A, \mathbf{b}}(\mathbb{R}^n) &= \{\mathbf{y} \in \mathbb{R}^m : \mathbf{y} = A^* \mathbf{x} + \mathbf{b} \text{ for some } \mathbf{x} \in \mathbb{R}^n\} \\ &= \{\mathbf{y} \in \mathbb{R}^m : \Gamma \mathbf{y} = \Gamma \mathbf{b}\}, \end{aligned}$$

where  $\Gamma = (\gamma_{jk})$  is an  $(m - n) \times m$ -matrix whose rows form a basis of linear relations between the vectors  $\mathbf{a}_i$ . That is,  $\Gamma$  is of full rank and satisfies the identity  $\Gamma A^* = 0$ .

The polytopes  $P$  and  $i_{A, \mathbf{b}}(P) = \mathbb{R}_{\geq}^m \cap i_{A, \mathbf{b}}(\mathbb{R}^n)$  are affinely equivalent.

EXAMPLE 1.2.2. Consider the standard  $n$ -simplex  $\Delta^n \subset \mathbb{R}^n$ , see (1.2). It is given by (1.1) with  $\mathbf{a}_i = \mathbf{e}_i$  (the  $i$ th standard basis vector) for  $i = 1, \dots, n$  and

$\mathbf{a}_{n+1} = -\mathbf{e}_1 - \cdots - \mathbf{e}_n$ ;  $b_1 = \cdots = b_n = 0$  and  $b_{n+1} = 1$ . We may take  $\Gamma = (1, \dots, 1)$  in Construction 1.2.1. Then  $\Gamma \mathbf{y} = y_1 + \cdots + y_m$ ,  $\Gamma \mathbf{b} = 1$ , and we have

$$i_{A, \mathbf{b}}(\Delta^n) = \{\mathbf{y} \in \mathbb{R}^{n+1} : y_1 + \cdots + y_{n+1} = 1, y_i \geq 0 \text{ for } i = 1, \dots, n\}.$$

This is the regular  $n$ -simplex in  $\mathbb{R}^{n+1}$ .

CONSTRUCTION 1.2.3 (Gale duality). Let  $\mathbf{a}_1, \dots, \mathbf{a}_m$  be a configuration of vectors that span the whole  $\mathbb{R}^n$ . Form an  $(m-n) \times m$ -matrix  $\Gamma = (\gamma_{jk})$  whose rows form a basis in the space of linear relations between the vectors  $\mathbf{a}_i$ . The set of columns  $\gamma_1, \dots, \gamma_m$  of  $\Gamma$  is called a *Gale dual* configuration of  $\mathbf{a}_1, \dots, \mathbf{a}_m$ . The transition from the configuration of vectors  $\mathbf{a}_1, \dots, \mathbf{a}_m$  in  $\mathbb{R}^n$  to the configuration of vectors  $\gamma_1, \dots, \gamma_m$  in  $\mathbb{R}^{m-n}$  is called the (linear) *Gale transform*. Each configuration determines the other uniquely up to isomorphism of its ambient space. In other words, each of the matrices  $A$  and  $\Gamma$  determines the other uniquely up to multiplication by an invertible matrix from the left.

Using the coordinate-free notation, we may think of  $\mathbf{a}_1, \dots, \mathbf{a}_m$  as a set of linear functions on an  $n$ -dimensional space  $W$ . Then we have an exact sequence

$$0 \rightarrow W \xrightarrow{A^*} \mathbb{R}^m \xrightarrow{\Gamma} L \rightarrow 0,$$

where  $A^*$  is given by  $\mathbf{x} \mapsto (\langle \mathbf{a}_1, \mathbf{x} \rangle, \dots, \langle \mathbf{a}_m, \mathbf{x} \rangle)$ , and the map  $\Gamma$  takes  $\mathbf{e}_i$  to  $\gamma_i \in L \cong \mathbb{R}^{m-n}$ . Similarly, in the dual exact sequence

$$0 \rightarrow L^* \xrightarrow{\Gamma^*} \mathbb{R}^m \xrightarrow{A} W^* \rightarrow 0,$$

the map  $A$  takes  $\mathbf{e}_i$  to  $\mathbf{a}_i \in W^* \cong \mathbb{R}^n$ . Therefore, two configurations  $\mathbf{a}_1, \dots, \mathbf{a}_m$  and  $\gamma_1, \dots, \gamma_m$  are Gale dual if they are obtained as the images of the standard basis of  $\mathbb{R}^m$  under the maps  $A$  and  $\Gamma$  in a pair of dual short exact sequences.

Here is an important property of Gale dual configurations:

THEOREM 1.2.4. *Let  $\mathbf{a}_1, \dots, \mathbf{a}_m$  and  $\gamma_1, \dots, \gamma_m$  be Gale dual configurations of vectors in  $\mathbb{R}^n$  and  $\mathbb{R}^{m-n}$  respectively, and let  $I = \{i_1, \dots, i_k\} \subset [m]$ . Then the subset  $\{\mathbf{a}_i : i \in I\}$  is linearly independent if and only if the subset  $\{\gamma_j : j \notin I\}$  spans the whole  $\mathbb{R}^{m-n}$ .*

The proof uses an algebraic lemma:

LEMMA 1.2.5. *Let  $\mathbf{k}$  be a field or  $\mathbb{Z}$ , and assume given a diagram*

$$\begin{array}{ccccccc} & & & & 0 & & \\ & & & & \downarrow & & \\ & & & & U & & \\ & & & & \downarrow i_1 & & \\ 0 & \longrightarrow & R & \xrightarrow{i_2} & S & \xrightarrow{p_2} & T \longrightarrow 0 \\ & & & & \downarrow p_1 & & \\ & & & & V & & \\ & & & & \downarrow & & \\ & & & & 0 & & \end{array}$$

*in which both vertical and horizontal lines are short exact sequences of  $\mathbf{k}$ -vector spaces or free abelian groups. Then  $p_1 i_2$  is surjective (respectively, injective or split injective) if and only if  $p_2 i_1$  is surjective (respectively, injective or split injective).*

PROOF. This is a simple diagram chase. Assume first that  $p_1i_2$  is surjective. Take  $\alpha \in T$ ; we need to cover it by an element in  $U$ . There is  $\beta \in S$  such that  $p_2(\beta) = \alpha$ . If  $\beta \in i_1(U)$ , then we are done. Otherwise set  $\gamma = p_1(\beta) \neq 0$ . Since  $p_1i_2$  is surjective, we can choose  $\delta \in R$  such that  $p_1i_2(\delta) = \gamma$ . Set  $\eta = i_2(\delta) \neq 0$ . Hence,  $p_1(\eta) = p_1(\beta) (= \gamma)$  and there is  $\xi \in U$  such that  $i_1(\xi) = \beta - \eta$ . Then  $p_2i_1(\xi) = p_2(\beta - \eta) = \alpha - p_2i_2(\delta) = \alpha$ . Thus,  $p_2i_1$  is surjective.

Now assume that  $p_1i_2$  is injective. Suppose  $p_2i_1(\alpha) = 0$  for a nonzero  $\alpha \in U$ . Set  $\beta = i_1(\alpha) \neq 0$ . Since  $p_2(\beta) = 0$ , there is a nonzero  $\gamma \in R$  such that  $i_2(\gamma) = \beta$ . Then  $p_1i_2(\gamma) = p_1(\beta) = p_1i_1(\alpha) = 0$ . This contradicts the assumption that  $p_1i_2$  is injective. Thus,  $p_2i_1$  is injective.

Finally, if  $p_1i_2$  is split injective, then its dual map  $i_2^*p_1^*: V^* \rightarrow R^*$  is surjective. Then  $i_1^*p_2^*: T^* \rightarrow U^*$  is also surjective. Thus,  $p_2i_1$  is split injective.  $\square$

PROOF OF THEOREM 1.2.4. Let  $A$  be the  $n \times m$ -matrix with column vectors  $\mathbf{a}_1, \dots, \mathbf{a}_m$ , and let  $\Gamma$  be the  $(m-n) \times m$ -matrix with columns  $\gamma_1, \dots, \gamma_m$ . Denote by  $A_I$  the  $n \times k$ -submatrix formed by the columns  $\{\mathbf{a}_i: i \in I\}$  and denote by  $\Gamma_{\bar{I}}$  the  $(m-n) \times (m-k)$ -submatrix formed by the columns  $\{\gamma_j: j \notin I\}$ . We also consider the corresponding maps  $A_I: \mathbb{R}^k \rightarrow \mathbb{R}^n$  and  $\Gamma_{\bar{I}}: \mathbb{R}^{m-k} \rightarrow \mathbb{R}^{m-n}$ .

Let  $i: \mathbb{R}^k \rightarrow \mathbb{R}^m$  be the inclusion of the coordinate subspace spanned by the vectors  $\mathbf{e}_i, i \in I$ , and let  $p: \mathbb{R}^m \rightarrow \mathbb{R}^{m-k}$  the projection sending every such  $\mathbf{e}_i$  to zero. Then  $A_I = A \cdot i$  and  $\Gamma_{\bar{I}}^* = p \cdot \Gamma^*$ . The vectors  $\{\mathbf{a}_i: i \in I\}$  are linearly independent if and only if  $A_I = A \cdot i$  is injective, and the vectors  $\{\gamma_j: j \notin I\}$  span  $\mathbb{R}^{m-n}$  if and only if  $\Gamma_{\bar{I}}^* = p \cdot \Gamma^*$  is injective. These two conditions are equivalent by Lemma 1.2.5.  $\square$

CONSTRUCTION 1.2.6 (Gale diagram). Let  $P$  be a polytope (1.1) with  $b_i = 1$  and let  $P^* = \text{conv}(\mathbf{a}_1, \dots, \mathbf{a}_m)$  be the polar polytope. Let  $\tilde{A}^* = (A^* \mathbf{1})$  be the  $m \times (n+1)$ -matrix obtained by appending a column of units to  $A^*$ . The matrix  $\tilde{A}^*$  has full rank  $n+1$  (indeed, otherwise there is  $\mathbf{x} \in \mathbb{R}^n$  such that  $\langle \mathbf{a}_i, \mathbf{x} \rangle = 1$  for all  $i$ , and then  $\lambda \mathbf{x}$  is in  $P$  for any  $\lambda \geq 1$ , so that  $P$  is unbounded). A configuration of vectors  $G = (\mathbf{g}_1, \dots, \mathbf{g}_m)$  in  $\mathbb{R}^{m-n-1}$  which is Gale dual to  $\tilde{A}$  is called a *Gale diagram* of  $P^*$ . A Gale diagram  $G = (\mathbf{g}_1, \dots, \mathbf{g}_m)$  of  $P^*$  is therefore determined by the conditions

$$GA^* = 0, \quad \text{rank } G = m - n - 1, \quad \text{and} \quad \sum_{i=1}^m \mathbf{g}_i = \mathbf{0}.$$

The rows of the matrix  $G$  from a basis of affine dependencies between the vectors  $\mathbf{a}_1, \dots, \mathbf{a}_m$ , i.e. a basis in the space of  $\mathbf{y} = (y_1, \dots, y_m)^t$  satisfying

$$y_1 \mathbf{a}_1 + \dots + y_m \mathbf{a}_m = \mathbf{0}, \quad y_1 + \dots + y_m = 0.$$

PROPOSITION 1.2.7. *The polyhedron  $P = P(A, \mathbf{b})$  is bounded if and only if the matrix  $\Gamma = (\gamma_{jk})$  can be chosen so that the affine plane  $i_{A, \mathbf{b}}(\mathbb{R}^n)$  is given by*

$$(1.8) \quad i_{A, \mathbf{b}}(\mathbb{R}^n) = \left\{ \mathbf{y} \in \mathbb{R}^m: \begin{array}{l} \gamma_{11}y_1 + \dots + \gamma_{1m}y_m = c, \\ \gamma_{j1}y_1 + \dots + \gamma_{jm}y_m = 0, \quad 2 \leq j \leq m-n. \end{array} \right\},$$

where  $c > 0$  and  $\gamma_{1k} > 0$  for all  $k$ .

Furthermore, if  $b_i = 1$  in (1.1), then the vectors  $\mathbf{g}_i = (\gamma_{2i}, \dots, \gamma_{m-n,i})^t, i = 1, \dots, m$ , form a Gale diagram of the polar polytope  $P^* = \text{conv}(\mathbf{a}_1, \dots, \mathbf{a}_m)$ .

PROOF. The image  $i_{A,\mathbf{b}}(P)$  is the intersection of the  $n$ -plane  $L = i_{A,\mathbf{b}}(\mathbb{R}^n)$  with  $\mathbb{R}_{\geq}^m$ . It is bounded if and only if  $L_0 \cap \mathbb{R}_{\geq}^m = \{\mathbf{0}\}$ , where  $L_0$  is the  $n$ -plane through  $\mathbf{0}$  parallel to  $L$ . Choose a hyperplane  $H_0$  through  $\mathbf{0}$  such that  $L_0 \subset H_0$  and  $H_0 \cap \mathbb{R}_{\geq}^m = \{\mathbf{0}\}$ . Let  $H$  be the affine hyperplane parallel to  $H_0$  and containing  $L$ . Since  $L \subset H$ , we may take the equation defining  $H$  as the first equation in the system  $\Gamma \mathbf{y} = \Gamma \mathbf{b}$  defining  $L$ . The conditions on  $H_0$  imply that  $H \cap \mathbb{R}_{\geq}^m$  is nonempty and bounded, that is,  $c > 0$  and  $\gamma_{1k} > 0$  for all  $k$ . Now, subtracting the first equation from the other equations of the system  $\Gamma \mathbf{y} = \Gamma \mathbf{b}$  with appropriate coefficients, we achieve that the right hand sides of the last  $m - n - 1$  equations become zero.

To prove the last statement, we observe that in our case

$$\Gamma = \begin{pmatrix} \gamma_{11} & \cdots & \gamma_{1m} \\ \mathbf{g}_1 & \cdots & \mathbf{g}_m \end{pmatrix}.$$

The conditions  $\Gamma A^t = 0$  and  $\text{rank } \Gamma = m - n$  imply that  $G A^t = 0$  and  $\text{rank } G = m - n - 1$ . Finally, by comparing (1.7) with (1.8) we obtain  $\Gamma \mathbf{b} = \begin{pmatrix} c \\ \mathbf{0} \end{pmatrix}$ . Since  $b_i = 1$ , we get  $\sum_{i=1}^m \mathbf{g}_i = \mathbf{0}$ . Thus,  $G = (\mathbf{g}_1, \dots, \mathbf{g}_m)$  is a Gale diagram of  $P^*$ .  $\square$

COROLLARY 1.2.8. *A polyhedron  $P = P(A, \mathbf{b})$  is bounded if and only if the vectors  $\mathbf{a}_1, \dots, \mathbf{a}_m$  satisfy  $\alpha_1 \mathbf{a}_1 + \cdots + \alpha_m \mathbf{a}_m = \mathbf{0}$  for some positive numbers  $\alpha_k$ .*

PROOF. If  $\mathbf{a}_1, \dots, \mathbf{a}_m$  satisfy  $\sum_{k=1}^m \alpha_k \mathbf{a}_k = \mathbf{0}$  with positive  $\alpha_k$ , then we can take  $\sum_{k=1}^m \alpha_k y_k = \sum_{k=1}^m \alpha_k b_k$  as the first equation defining the  $n$ -plane  $i_{A,\mathbf{b}}(\mathbb{R}^n)$  in  $\mathbb{R}^m$ . It follows that  $i_{A,\mathbf{b}}(P)$  is contained in the intersection of the hyperplane  $\sum_{k=1}^m \alpha_k y_k = \sum_{k=1}^m \alpha_k b_k$  with  $\mathbb{R}_{\geq}^m$ , which is bounded since all  $\alpha_k$  are positive. Therefore,  $P$  is bounded.

Conversely, if  $P$  is bounded, then it follows from Proposition 1.2.7 and Gale duality that  $\mathbf{a}_1, \dots, \mathbf{a}_m$  satisfy  $\gamma_{11} \mathbf{a}_1 + \cdots + \gamma_{1m} \mathbf{a}_m = \mathbf{0}$  with  $\gamma_{1k} > 0$ .  $\square$

A Gale diagram of  $P^*$  encodes its combinatorics (and the combinatorics of  $P$ ) completely. We give the corresponding statement in the generic case only:

PROPOSITION 1.2.9. *Assume that (1.1) is a generic presentation with  $b_i = 1$ . Let  $P^* = \text{conv}(\mathbf{a}_1, \dots, \mathbf{a}_m)$  be the polar simplicial polytope and  $G = (\mathbf{g}_1, \dots, \mathbf{g}_m)$  be its Gale diagram. Then the following conditions are equivalent:*

- (a)  $F_{i_1} \cap \cdots \cap F_{i_k} \neq \emptyset$  in  $P = P(A, \mathbf{1})$ ;
- (b)  $\text{conv}(\mathbf{a}_{i_1}, \dots, \mathbf{a}_{i_k})$  is a face of  $P^*$ ;
- (c)  $\mathbf{0} \in \text{conv}(\mathbf{g}_j : j \notin \{i_1, \dots, i_k\})$ .

PROOF. The equivalence (a)  $\Leftrightarrow$  (b) follows from Theorems 1.1.5 and 1.1.7.

(b)  $\Rightarrow$  (c). Let  $\text{conv}(\mathbf{a}_{i_1}, \dots, \mathbf{a}_{i_k})$  be a face of  $P^*$ . We first observe that each of  $\mathbf{a}_{i_1}, \dots, \mathbf{a}_{i_k}$  is a vertex of this face, as otherwise presentation (1.1) is not generic. By definition of a face, there exists a linear function  $\xi$  such that  $\xi(\mathbf{a}_j) = 0$  for  $j \in \{i_1, \dots, i_k\}$  and  $\xi(\mathbf{a}_j) > 0$  otherwise. The condition  $\mathbf{0} \in \text{int } P^*$  implies that  $\xi(\mathbf{0}) > 0$ , and we may assume that  $\xi$  has the form  $\xi(\mathbf{u}) = \langle \mathbf{u}, \mathbf{x} \rangle + 1$  for some  $\mathbf{x} \in \mathbb{R}^n$ . Set  $y_j = \xi(\mathbf{a}_j) = \langle \mathbf{a}_j, \mathbf{x} \rangle + 1$ , i.e.  $\mathbf{y} = A^* \mathbf{x} + \mathbf{1}$ . We have

$$\sum_{j \notin \{i_1, \dots, i_k\}} \mathbf{g}_j y_j = \sum_{j=1}^m \mathbf{g}_j y_j = G \mathbf{y} = G(A^* \mathbf{x} + \mathbf{1}) = G \mathbf{1} = \sum_{j=1}^m \mathbf{g}_j = \mathbf{0},$$

where  $y_j > 0$  for  $j \notin \{i_1, \dots, i_k\}$ . It follows that  $\mathbf{0} \in \text{conv}(\mathbf{g}_j : j \notin \{i_1, \dots, i_k\})$ .



(c) $\Rightarrow$ (b). Let  $\sum_{j \notin \{i_1, \dots, i_k\}} \mathbf{g}_j y_j = \mathbf{0}$  with  $y_j \geq 0$  and at least one  $y_j$  nonzero. This is a linear relation between the vectors  $\mathbf{g}_j$ . The space of such linear relations has basis formed by the columns of the matrix  $\tilde{A}^* = (A^* \mathbf{1})$ . Hence, there exists  $\mathbf{x} \in \mathbb{R}^n$  and  $b \in \mathbb{R}$  such that  $y_j = \langle \mathbf{a}_j, \mathbf{x} \rangle + b$ . The linear function  $\xi(\mathbf{u}) = \langle \mathbf{u}, \mathbf{x} \rangle + b$  takes zero values on  $\mathbf{a}_j$  with  $j \in \{i_1, \dots, i_k\}$  and takes nonnegative values on the other  $\mathbf{a}_j$ . Hence,  $\mathbf{a}_{i_1}, \dots, \mathbf{a}_{i_k}$  is a subset of the vertex set of a face. Since  $P^*$  is simplicial,  $\mathbf{a}_{i_1}, \dots, \mathbf{a}_{i_k}$  is a vertex set of a face.  $\square$

REMARK. We allow redundant inequalities in Proposition (1.2.9). In this case we obtain the equivalences

$$F_i = \emptyset \iff \mathbf{a}_i \in \text{conv}(\mathbf{a}_j : j \neq i) \iff \mathbf{0} \notin \text{conv}(\mathbf{g}_j : j \neq i).$$

A configuration of vectors  $G = (\mathbf{g}_1, \dots, \mathbf{g}_m)$  in  $\mathbb{R}^{m-n-1}$  with the property

$$\mathbf{0} \in \text{conv}(\mathbf{g}_j : j \notin \{i_1, \dots, i_k\}) \iff \text{conv}(\mathbf{a}_{i_1}, \dots, \mathbf{a}_{i_k}) \text{ is a face of } P^*$$

is called a *combinatorial Gale diagram* of  $P^* = \text{conv}(\mathbf{a}_1, \dots, \mathbf{a}_m)$ . For example, a configuration obtained by multiplying each vector in a Gale diagram by a positive number is a combinatorial Gale diagram. Also, the vectors of a combinatorial Gale diagram can be moved as long as the origin does not cross the ‘walls’, i.e. affine hyperplanes spanned by subsets of  $\mathbf{g}_1, \dots, \mathbf{g}_m$ . A combinatorial Gale diagram of  $P^*$  is a Gale diagram of a polytope which is combinatorially equivalent to  $P^*$ .

EXAMPLE 1.2.10.

1. The Gale diagram of  $\Delta^n$  (when  $m = n + 1$ ) consists of  $n + 1$  points  $\mathbf{0}$  in  $\mathbb{R}^0$ , i.e.  $\mathbf{g}_i = \mathbf{0}, i = 1, \dots, m$ .

2. Let  $P = \Delta^{p-1} \times \Delta^{q-1}, p + q = m$ , i.e.  $m = n + 2$ . Then  $P^*$  is a hyperplane cut of a simplex  $\Delta^{m-2}$  by a hyperplane that separates some  $p - 1$  of its vertices from the other  $q - 1$ . A combinatorial Gale diagram of  $P^*$  consists of  $p$  points  $1 \in \mathbb{R}^1$  and  $q$  points  $-1 \in \mathbb{R}^1$ . The cases  $p = 1$  or  $q = 1$  correspond to a presentation of  $\Delta^{m-2}$  with one redundant inequality.

3. A combinatorial Gale diagram of a pentagon ( $m = n + 3$ ) is shown in Fig. 1.1. The property that  $\text{conv}(\mathbf{a}_1, \mathbf{a}_2)$  is a face translates to  $\mathbf{0} \in \text{conv}(\mathbf{g}_3, \mathbf{g}_4, \mathbf{g}_5)$ .

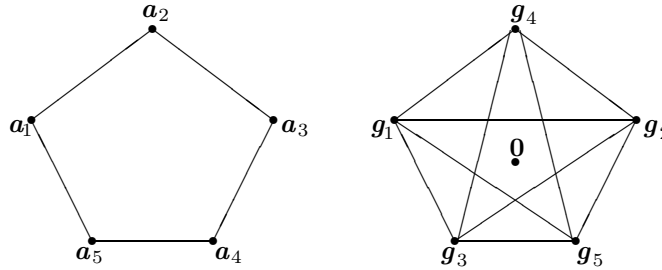

FIGURE 1.1. A pentagon and its Gale diagram.

Gale diagrams provide an efficient tool for studying the combinatorics of higher-dimensional polytopes with few vertices, as in this case a Gale diagram translates the higher-dimensional structure to a low-dimensional one. For example, Gale diagrams are used to classify  $n$ -polytopes with up to  $n + 3$  vertices and to find unusual examples when the number of vertices is  $n + 4$ , see [325, §6.5].

**Exercises.**

1.2.11. Describe combinatorial Gale diagrams of polytopes shown in Fig. 1.2.

**1.3. Face vectors and Dehn–Sommerville relations**

The notion of the  $f$ -vector (or face vector) is a central concept in the combinatorial theory of polytopes. It has been studied since the time of Euler.

DEFINITION 1.3.1. Let  $P$  be a convex  $n$ -polytope. Denote by  $f_i$  the number of  $i$ -dimensional faces of  $P$ . The integer sequence  $\mathbf{f}(P) = (f_0, f_1, \dots, f_n)$  is known as the  $f$ -vector (or the *face vector*) of  $P$ . Note that  $f_n = 1$ . The homogeneous  $F$ -polynomial of  $P$  is defined by

$$F(P)(s, t) = s^n + f_{n-1}s^{n-1}t + \dots + f_1st^{n-1} + f_0t^n.$$

The  $h$ -vector  $\mathbf{h}(P) = (h_0, h_1, \dots, h_n)$  and the  $H$ -polynomial of  $P$  are defined by

$$(1.9) \quad \begin{aligned} h_0s^n + h_1s^{n-1}t + \dots + h_nt^n &= (s-t)^n + f_{n-1}(s-t)^{n-1}t + \dots + f_0t^n, \\ H(P)(s, t) &= h_0s^n + h_1s^{n-1}t + \dots + h_{n-1}st^{n-1} + h_nt^n = F(P)(s-t, t). \end{aligned}$$

The  $g$ -vector of a simple polytope  $P$  is the vector  $\mathbf{g}(P) = (g_0, g_1, \dots, g_{\lfloor n/2 \rfloor})$ , where  $g_0 = 1$  and  $g_i = h_i - h_{i-1}$  for  $i = 1, \dots, \lfloor n/2 \rfloor$ .

EXAMPLE 1.3.2. We have

$$\begin{aligned} F(\Delta^n) &= s^n + \binom{n+1}{1}s^{n-1}t + \binom{n+1}{2}s^{n-2}t^2 + \dots + t^n = \frac{(s+t)^{n+1} - t^{n+1}}{s}, \\ H(\Delta^n) &= s^n + s^{n-1}t + s^{n-2}t^2 + \dots + t^n = \frac{s^{n+1} - t^{n+1}}{s-t}. \end{aligned}$$

Obviously, the  $f$ -vector is a *combinatorial invariant* of a polytope, that is, it depends only on the face poset. This invariant is far from being complete, even for simple polytopes:

EXAMPLE 1.3.3. Two different combinatorial simple polytopes may have same  $f$ -vectors. For instance, let  $P$  be the 3-cube and  $Q$  a simple 3-polytope with 2 triangular, 2 quadrangular and 2 pentagonal facets, see Figure 1.2. (Note that  $Q$  is obtained by truncating a tetrahedron at two vertices, it is also dual to the cyclic polytope  $C^3(6)$  from Definition 1.1.17.) Then  $\mathbf{f}(P) = \mathbf{f}(Q) = (8, 12, 6)$ .

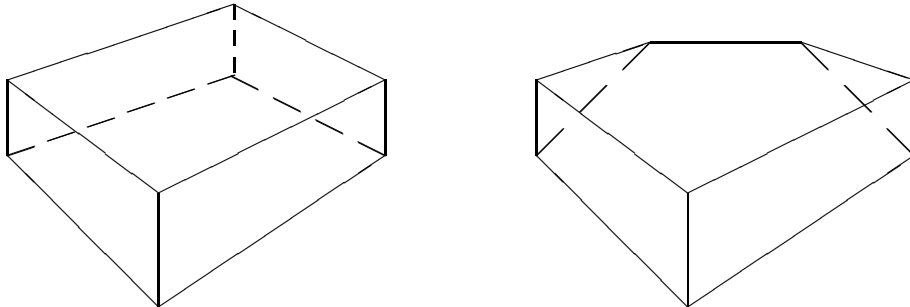

FIGURE 1.2. Two combinatorially non-equivalent simple polytopes with the same  $f$ -vectors.

The  $f$ -vector and the  $h$ -vector contain equivalent combinatorial information, and determine each other by means of linear relations, namely

$$(1.10) \quad h_k = \sum_{i=0}^k (-1)^{k-i} \binom{n-i}{n-k} f_{n-i}, \quad f_k = \sum_{q=k}^n \binom{q}{k} h_{n-q}, \quad \text{for } 0 \leq k \leq n.$$

In particular,  $h_0 = 1$  and  $h_n = f_0 - f_1 + \dots + (-1)^n f_n$ . By the *Euler formula*,

$$(1.11) \quad f_0 - f_1 + \dots + (-1)^n f_n = 1,$$

which is equivalent to  $h_n = h_0$ . This is the first evidence of the fact that many combinatorial relations for the face numbers have much simpler form when written in terms of the  $h$ -vector. Another example of this phenomenon is given by the following generalisation of the Euler formula for simple or simplicial polytopes.

**THEOREM 1.3.4 (Dehn–Sommerville relations).** *The  $h$ -vector of any simple  $n$ -polytope is symmetric, that is,*

$$H(s, t) = H(t, s), \quad \text{or } h_i = h_{n-i} \quad \text{for } 0 \leq i \leq n.$$

The Dehn–Sommerville relations can be proved in many different ways. We present a proof from [42], which can be viewed as a combinatorial version of Morse-theoretic arguments. An alternative proof will be given in Section 1.7.

**PROOF OF THEOREM 1.3.4.** Let  $P \subset \mathbb{R}^n$  be a simple polytope. Choose a generic linear function  $\varphi: \mathbb{R}^n \rightarrow \mathbb{R}$  which distinguishes the vertices of  $P$ . Write  $\varphi(\mathbf{x}) = \langle \boldsymbol{\nu}, \mathbf{x} \rangle$  for some vector  $\boldsymbol{\nu}$  in  $\mathbb{R}^n$ . The assumption on  $\varphi$  implies that  $\boldsymbol{\nu}$  is parallel to no edge of  $P$ . We can view  $\varphi$  as a height function on  $P$  and turn the 1-skeleton of  $P$  into a directed graph by orienting each edge in such a way that  $\varphi$  increases along it, see Figure 1.3. For each vertex  $v$  of  $P$  define the index  $\text{ind}_\nu(v)$  as

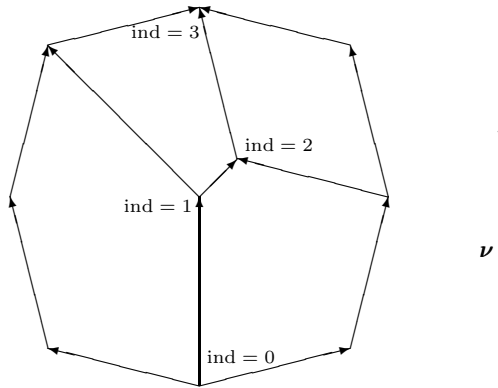

FIGURE 1.3. Orienting the 1-skeleton of  $P$ .

the number of incident edges that point towards  $v$ . Denote the number of vertices of index  $i$  by  $I_\nu(i)$ . We claim that  $I_\nu(i) = h_{n-i}$ . Indeed, each face of  $P$  has a unique top vertex (the maximum of the height function  $\varphi$  restricted to the face) and a unique bottom vertex (the minimum of  $\varphi$ ). Let  $G$  be a  $k$ -face of  $P$ , and  $v_G$  its top vertex. Since  $P$  is simple, there are exactly  $k$  edges of  $G$  meeting at  $v_G$ , whence  $\text{ind}(v_G) \geq k$ . On the other hand, each vertex of index  $q \geq k$  is the top vertex for

exactly  $\binom{q}{k}$  faces of dimension  $k$ . It follows that the number of  $k$ -faces of  $P$  can be calculated as

$$f_k = \sum_{q \geq k} \binom{q}{k} I_\nu(q).$$

Now the second identity from (1.10) shows that  $I_\nu(q) = h_{n-q}$ , as claimed. In particular, the number  $I_\nu(q)$  does not depend on  $\nu$ . At the same time, we have  $\text{ind}_\nu(v) = n - \text{ind}_{-\nu}(v)$  for any vertex  $v$ , which implies that

$$h_{n-q} = I_\nu(q) = I_{-\nu}(n-q) = h_q. \quad \square$$

REMARK. The above proof also shows that the numbers  $h_k = I_\nu(n-k)$  are nonnegative, which is not evident from (1.10). On the other hand, the nonnegativity of the  $h$ -vector translates into certain conditions on the  $f$ -vector. This will be important in the subsequent study of  $f$ -vectors for combinatorial objects more general than simple polytopes.

THEOREM 1.3.5. *The  $f$ -vector of a simple  $n$ -polytope satisfies*

$$(1.12) \quad f_k = \sum_{i=0}^k (-1)^i \binom{n-i}{n-k} f_i, \quad \text{for } 0 \leq k \leq n.$$

PROOF. By the Dehn–Sommerville relations,

$$F(s-t, t) = H(s, t) = H(t, s) = F(t-s, s).$$

By substituting  $u = s-t$  we obtain  $F(u, t) = F(-u, t+u)$ , or

$$\begin{aligned} u^n + f_{n-1}u^{n-1}t + \cdots + f_1ut^{n-1} + f_0u_n \\ = (-u)^n + f_{n-1}(-u)^{n-1}(t+u) + \cdots + f_1(-u)(t+u)^{n-1} + f_0(t+u)^n. \end{aligned}$$

Calculating the coefficient of  $u^k t^{n-k}$  in both sides above yields (1.12).  $\square$

By Theorem 1.1.7, the  $f$ -vector of the dual  $n$ -polytope  $P^*$  satisfies

$$f_i(P^*) = f_{n-1-i}(P), \quad \text{for } 0 \leq i \leq n-1.$$

Then it follows from (1.12) that the  $f$ -vector of a simplicial polytope satisfies the relations  $f_{n-1-k} = \sum_{i=0}^k (-1)^i \binom{n-i}{n-k} f_{n-1-i}$  or, equivalently,

$$f_{q-1} = \sum_{j=q}^n (-1)^{n-j} \binom{j}{q} f_{j-1}, \quad \text{for } 1 \leq q \leq n+1.$$

PROPOSITION 1.3.6. *The  $F$ - and  $H$ -polynomial are multiplicative, i.e.*

$$(1.13) \quad F(P_1 \times P_2) = F(P_1)F(P_2), \quad H(P_1 \times P_2) = H(P_1)H(P_2).$$

for any convex polytopes  $P_1$  and  $P_2$ .

PROOF. Let  $\dim P_1 = n_1$  and  $\dim P_2 = n_2$ . Each  $k$ -face of  $P_1 \times P_2$  is the product of an  $i$ -face of  $P_1$  and a  $(k-i)$ -face of  $P_2$  for some  $i$ , whence

$$(1.14) \quad f_k(P_1 \times P_2) = \sum_{i=0}^{n_1} f_i(P_1) f_{k-i}(P_2), \quad \text{for } 0 \leq k \leq n_1 + n_2.$$

This implies the first identity, and the second follows from (1.9).  $\square$

EXAMPLE 1.3.7. We have  $F(I^n) = (F(\Delta^1))^n$  and  $H(I^n) = (H(\Delta^1))^n$ , i.e.

$$F(I^n) = (s + 2t)^n, \quad H(I^n) = (s + t)^n.$$

We can also express the  $f$ -vector and the  $h$ -vector of the connected sum  $P \# Q$  in terms of those of  $P$  and  $Q$  (the proof is left as an exercise):

PROPOSITION 1.3.8. *Let  $P$  and  $Q$  be simple  $n$ -polytopes. Then*

$$f_0(P \# Q) = f_0(P) + f_0(Q) - 2; \quad h_0(P \# Q) = h_n(P \# Q) = 1;$$

$$f_i(P \# Q) = f_i(P) + f_i(Q) - \binom{n}{i}, \quad \text{for } 1 \leq i \leq n;$$

$$h_i(P \# Q) = h_i(P) + h_i(Q), \quad \text{for } 1 \leq i \leq n - 1.$$

Using the Dehn–Sommerville relations we can show that a simplicial polytope cannot be ‘too neighbourly’ (see Definition 1.1.15) if it is not a simplex.

PROPOSITION 1.3.9. *Let  $S$  be a  $q$ -neighbourly simplicial  $n$ -polytope, and let  $S \neq \Delta^n$ . Then  $q \leq \lfloor \frac{n}{2} \rfloor$ .*

PROOF. Let  $S^*$  be the dual polytope. By Theorem 1.1.7,  $f_{n-i}(S^*) = f_{i-1}(S) = \binom{m}{i}$  for  $1 \leq i \leq q$ , where  $m$  is the number of vertices of  $S$ . From (1.10) we get

$$(1.15) \quad h_k(S^*) = \sum_{i=0}^k (-1)^{k-i} \binom{n-i}{k-i} \binom{m}{i} = \binom{m-n+k-1}{k}, \quad \text{for } k \leq q,$$

The second equality is obtained by calculating the coefficient of  $t^k$  on both sides of

$$\frac{1}{(1+t)^{n-k+1}} (1+t)^m = (1+t)^{m-n+k-1}.$$

If  $S \neq \Delta^n$ , then  $m > n + 1$ , which together with (1.15) gives  $h_0(S^*) < h_1(S^*) < \dots < h_q(S^*)$ . It then follows from the Dehn–Sommerville relations that  $q \leq \lfloor \frac{n}{2} \rfloor$ .  $\square$

Since the  $H$ -polynomial of a simple  $n$ -polytope  $P$  satisfies the identity  $H(P)(s, t) = H(P)(t, s)$ , we can express it in terms of elementary symmetric functions as follows:

$$(1.16) \quad H(P)(s, t) = \sum_{i=0}^{\lfloor n/2 \rfloor} \gamma_i (s+t)^{n-2i} (st)^i.$$

The identity  $h_0 = h_n = 1$  implies that  $\gamma_0 = 1$ .

DEFINITION 1.3.10. The integer sequence  $\gamma(P) = (\gamma_0, \dots, \gamma_{\lfloor n/2 \rfloor})$  is called the  $\gamma$ -vector of  $P$ . We refer to

$$\gamma(P)(\tau) = \gamma_0 + \gamma_1 \tau + \dots + \gamma_{\lfloor n/2 \rfloor} \tau^{\lfloor n/2 \rfloor}$$

as the  $\gamma$ -polynomial of  $P$ .

EXAMPLE 1.3.11. We have  $\gamma(I^1)(\tau) = 1$ . If  $P_m^2$  is an  $m$ -gon, then  $\gamma(P_m^2)(\tau) = 1 + (m-4)\tau$ .

The components of the  $\gamma$ -vector can be expressed via the components of any of the  $f$ -,  $h$ - or  $g$ -vector by means of linear relations, and vice versa. The explicit transition formulae between the  $g$ - and  $\gamma$ -vectors are given by the next lemma.

LEMMA 1.3.12. *Let  $P$  be a simple  $n$ -polytope. Then*

$$g_i = (n - 2i + 1) \sum_{j=0}^i \frac{1}{n - i - j + 1} \binom{n - 2j}{i - j} \gamma_j;$$

$$\gamma_i = (-1)^i \sum_{j=0}^i (-1)^j \binom{n - i - j}{i - j} g_j, \quad 0 \leq i \leq \lfloor \frac{n}{2} \rfloor.$$

PROOF. Using the formulae of Examples 1.3.2 and 1.3.7 we calculate

$$H(P) = \sum_{j=0}^{\lfloor n/2 \rfloor} \gamma_j (st)^j H(I^{n-2j}),$$

$$H(I^q) = \sum_{j=0}^q \binom{q}{j} s^j t^{q-j} = \sum_{k=0}^{\lfloor q/2 \rfloor} c_{k,q} (st)^k H(\Delta^{q-2k}),$$

where  $c_{0,q} = 1$  and  $c_{k,q} = \binom{q}{k} - \binom{q}{k-1} = \frac{q-2k+1}{q-k+1} \binom{q}{k} > 0$  for  $k = 1, \dots, \lfloor \frac{q}{2} \rfloor$ . Hence

$$H(P)(s, t) = \sum_{i=0}^{\lfloor n/2 \rfloor} \left( \sum_{j=0}^i c_{i-j, n-2j} \gamma_j \right) (st)^i H(\Delta^{n-2i}).$$

On the other hand,

$$H(P)(s, t) = \sum_{i=0}^{\lfloor n/2 \rfloor} g_i (st)^i H(\Delta^{n-2i}).$$

Comparing the last two formulae we obtain  $g_i = \sum_{j=0}^i c_{i-j, n-2j} \gamma_j$ , which is equivalent to the first required formula. The second is left as an exercise.  $\square$

PROPOSITION 1.3.13. *Let  $P, Q$  be two simple  $n$ -polytopes, and consider the following four conditions:*

- (a)  $f_i(P) \geq f_i(Q)$  for  $i = 0, 1, \dots, n$ ;
- (b)  $h_i(P) \geq h_i(Q)$  for  $i = 0, 1, \dots, n$ ;
- (c)  $g_i(P) \geq g_i(Q)$  for  $i = 0, 1, \dots, \lfloor \frac{n}{2} \rfloor$ ;
- (d)  $\gamma_i(P) \geq \gamma_i(Q)$  for  $i = 0, 1, \dots, \lfloor \frac{n}{2} \rfloor$ .

Then (d) $\Rightarrow$ (c) $\Rightarrow$ (b) $\Rightarrow$ (a).

PROOF. The first of equations (1.10) implies that the components of  $\mathbf{f}(P)$  are expressed via the components of  $\mathbf{h}(P)$  with positive coefficients, which proves the implication (b) $\Rightarrow$ (a). We have  $h_k = \sum_{i=0}^k g_i$  for  $0 \leq k \leq \lfloor \frac{n}{2} \rfloor$ , which gives the implication (c) $\Rightarrow$ (b). The implication (d) $\Rightarrow$ (c) follows similarly from the first formula of Lemma 1.3.12.  $\square$

The components of the  $f$ -vector of any polytope are nonnegative. The nonnegativity of the components of the  $h$ -vector of a simple polytope follows from their geometric interpretation obtained in the proof of Theorem 1.3.4; the  $h$ -vector of a non-simple polytope may have negative components (e.g. for the octahedron). The nonnegativity of the  $g$ -vector of a simple  $n$ -polytope (that is, the inequalities  $g_i(P) \geq g_i(\Delta^n)$ ) is a much more subtle property; it follows from the  $g$ -theorem discussed in the next section. The  $\gamma$ -vector of a simple polytope may have negative components (e.g. for  $P = \Delta^2$ ); its nonnegativity for special classes of simple

polytopes will be discussed in Section 1.6. The nonnegativity of the  $\gamma$ -vector can be expressed by the inequalities  $\gamma_i(P) \geq \gamma_i(I^n)$ , see Exercise 1.3.17.

**Exercises.**

1.3.14. Show that any 3-polytope has a face with  $\leq 5$  vertices.

1.3.15. Prove Proposition 1.3.8.

1.3.16. Prove the second transition formula of Lemma 1.3.12.

1.3.17. Show that the  $\gamma$ -polynomial is multiplicative, that is,

$$\gamma(P \times Q)(\tau) = \gamma(P)(\tau) \cdot \gamma(Q)(\tau)$$

In particular,  $\gamma(I^n)(\tau) = 1$ , i.e.  $\gamma(I^n) = (1, 0, \dots, 0)$ .

**1.4. Characterising the face vectors of polytopes**

The face numbers are the simplest combinatorial invariants of polytopes, and they arise in many hard problems of combinatorial geometry. One of the most natural and basic questions is to describe all possible face numbers, or, more precisely, determine which integer vectors arise as the  $f$ -vectors of polytopes. In the general case this question is probably intractable (see the end of this section), but a particularly nice answer exists in the case of simple (or, equivalently, simplicial) polytopes. Obviously, the Dehn–Sommerville relations provide a necessary condition. As far as only linear equations are concerned, there are no further restrictions:

PROPOSITION 1.4.1 (Klee [186]). *The Dehn–Sommerville relations are the most general linear equations satisfied by the face numbers of all simple polytopes.*

PROOF. Once again, the use of the  $h$ -vector simplifies the proof significantly. Given a simple polytope  $P$ , we set

$$h(P)(t) = H(P)(1, t) = h_0(P) + h_1(P)t + \dots + h_n(P)t^n.$$

It is enough to prove that the affine hull of the  $h$ -vectors  $(h_0, h_1, \dots, h_n)$  of simple  $n$ -polytopes is an  $\lfloor \frac{n}{2} \rfloor$ -dimensional plane. This can be done by presenting  $\lfloor \frac{n}{2} \rfloor + 1$  simple polytopes with affinely independent  $h$ -vectors. Take  $Q_k = \Delta^k \times \Delta^{n-k}$  for  $0 \leq k \leq \lfloor \frac{n}{2} \rfloor$ . Since  $h(\Delta^k)(t) = 1 + t + \dots + t^k$ , formula (1.13) gives

$$h(Q_k)(t) = \frac{1 - t^{k+1}}{1 - t} \cdot \frac{1 - t^{n-k+1}}{1 - t}.$$

It follows that the lowest degree term in the polynomial  $h(Q_{k+1})(t) - h(Q_k)(t)$  is  $t^{k+1}$ , for  $0 \leq k \leq \lfloor \frac{n}{2} \rfloor - 1$ . Therefore, the vectors  $\mathbf{h}(Q_k)$  are affinely independent for these values of  $k$ .  $\square$

EXAMPLE 1.4.2. Let  $P$  be a simple polytope. Since every vertex is contained in exactly  $n$  edges and each edge connects two vertices, we have a linear relation

$$(1.17) \quad 2f_1 = nf_0.$$

By Proposition 1.4.1 this must be a consequence of the Dehn–Sommerville relations (in fact, it is equation (1.12) for  $k = 1$ .)

Equation (1.17) together with the Euler identity (1.11) shows that the  $f$ -vector of a simple 3-polytope  $P^3$  is completely determined by the number of facets, namely,

$$\mathbf{f}(P^3) = (2f_2 - 4, 3f_2 - 6, f_2, 1).$$

Similarly, the  $f$ -vector of a simplicial 3-polytope  $S^3$  is determined by the number of vertices, namely,

$$\mathbf{f}(S^3) = (f_0, 3f_0 - 6, 2f_0 - 4, 1).$$

REMARK. Euler's formula (1.11) is the only linear relation satisfied by the face vectors of general polytopes. This can be proved similarly to Proposition 1.4.1, by specifying sufficiently many polytopes with affinely independent face vectors.

Apart from the linear equations, the  $f$ -vectors of polytopes satisfy certain inequalities. Here are some of the simplest of them.

EXAMPLE 1.4.3. There are the following obvious lower bounds for the number of vertices and the number of facets of an  $n$ -polytope:

$$f_0 \geq n + 1, \quad f_{n-1} \geq n + 1.$$

Since every pair of vertices is joined by at most one edge, and every pair of facets intersect at most one face of codimension 2, we have the upper bounds

$$f_1 \leq \binom{f_0}{2}, \quad f_{n-2} \leq \binom{f_{n-1}}{2}.$$

If the polytope is simplicial, then there is also the following lower bound for  $f_1$ :

$$f_1 \geq nf_0 - \binom{n+1}{2}.$$

It is much more difficult to prove though, even for 4-polytopes. For simplicial 3-polytopes the inequality above turns into identity.

Historically, the most important inequality-type results preceding the general characterisation of  $f$ -vectors were the *Upper Bound Theorem (UBT)* and the *Lower Bound Theorem (LBT)*. They give respectively an upper and a lower bound for the number of faces in a simplicial polytope with the given number of vertices.

THEOREM 1.4.4 (UBT for simplicial polytopes). *Among all simplicial  $n$ -polytopes  $S$  with  $m$  vertices the cyclic polytope  $C^n(m)$  (Example 1.1.17) has the maximal number of  $i$ -faces for  $1 \leq i \leq n$ . That is, if  $f_0(S) = m$ , then*

$$f_i(S) \leq f_i(C^n(m)) \quad \text{for } i = 1, \dots, n.$$

*Equality is achieved for all  $i$  if and only if  $S$  is a neighbourly polytope.*

The UBT was conjectured by Motzkin and proved by McMullen [217] in 1970. Since  $C^n(m)$  is neighbourly, we have

$$f_i(C^n(m)) = \binom{m}{i+1} \quad \text{for } 0 \leq i \leq \left\lfloor \frac{n}{2} \right\rfloor - 1.$$

Due to the Dehn–Sommerville relations, this determines the full  $f$ -vector of  $C^n(m)$ . The exact values are given by the following lemma.

LEMMA 1.4.5. *The number of  $i$ -faces of the cyclic polytope  $C^n(m)$  (or any neighbourly  $n$ -polytope with  $m$  vertices) is given by*

$$f_i = \sum_{q=0}^{\left\lfloor \frac{n}{2} \right\rfloor} \binom{q}{n-1-i} \binom{m-n+q-1}{q} + \sum_{p=0}^{\left\lfloor \frac{n-1}{2} \right\rfloor} \binom{n-p}{n-1-i} \binom{m-n+p-1}{p}$$

for  $0 \leq i \leq n$ , where we set  $\binom{p}{q} = 0$  for  $p < q$  or  $q < 0$ .



PROOF. We set  $C = C^n(m)$ . Using the second identity from (1.10), the identity  $\lfloor \frac{n}{2} \rfloor + 1 = n - \lfloor \frac{n-1}{2} \rfloor$ , the Dehn–Sommerville relations for  $C^*$ , and (1.15), we calculate

$$\begin{aligned} f_i(C) &= f_{n-1-i}(C^*) = \sum_{q=0}^n \binom{q}{n-1-i} h_{n-q}(C^*) \\ &= \sum_{q=0}^{\lfloor n/2 \rfloor} \binom{q}{n-1-i} h_q(C^*) + \sum_{q=\lfloor n/2 \rfloor+1}^n \binom{q}{n-1-i} h_{n-q}(C^*) \\ &= \sum_{q=0}^{\lfloor n/2 \rfloor} \binom{q}{n-1-i} \binom{m-n+q-1}{q} + \sum_{p=0}^{\lfloor (n-1)/2 \rfloor} \binom{n-p}{n-1-i} \binom{m-n+p-1}{p}. \quad \square \end{aligned}$$

LEMMA 1.4.6. *Assume that the inequalities*

$$h_i(P) \leq \binom{m-n+i-1}{i}, \quad i = 0, \dots, \lfloor \frac{n}{2} \rfloor$$

*hold for the  $h$ -vector of a simple polytope  $P$  with  $m$  facets. Then the dual simplicial polytope  $P^*$  satisfies the UBT inequalities  $f_i(P^*) \leq f_i(C^n(m))$  for  $i = 1, \dots, n$ .*

PROOF. Since  $h_i((C^n(m))^*) = \binom{m-n+i-1}{i}$  for  $i = 0, \dots, \lfloor \frac{n}{2} \rfloor$ , the statement follows from Proposition 1.3.13. Alternatively, replace the last ‘=’ in the calculation from the proof of Lemma 1.4.5 by ‘ $\leq$ ’.  $\square$

This was one of the key observations in McMullen’s original proof [217] of the UBT for simplicial polytopes (the whole proof can also be found in [42, §18] and [325, §8.4]). R. Stanley gave an algebraic argument establishing the inequalities from Lemma 1.4.6, and therefore the UBT, in a much more general setting of *triangulated spheres*. We shall discuss Stanley’s approach and conclude the proof of the UBT in Section 3.3.

REMARK. The UBT holds for all convex polytopes. That is, the cyclic polytope  $C^n(m)$  has the maximal number of  $i$ -faces among all convex  $n$ -polytopes with  $m$  vertices. The argument for this builds on the following observation of Klee and McMullen, which we reproduce from [325, Lemma 8.24].

LEMMA 1.4.7. *By a small perturbation of vertices of an  $n$ -polytope  $P$  one can achieve that the resulting polytope  $P'$  is simplicial, and*

$$f_i(P) \leq f_i(P') \quad \text{for } i = 1, \dots, n-1.$$

DEFINITION 1.4.8. A simplicial  $n$ -polytope  $S$  is called *stacked* if there is a sequence  $S_0, S_1, \dots, S_k = S$  of  $n$ -polytopes such that  $S_0$  is an  $n$ -simplex and  $S_{i+1}$  is obtained from  $S_i$  by adding a pyramid over a facet of  $S_i$  (the vertex of the added pyramid is chosen close enough to its base, so that the whole construction remains convex and simplicial). The polar simple polytopes are those obtained from a simplex by iterating the vertex cut operation of Example 1.1.14.2. These are sometimes called *truncation polytopes*.

The  $f$ -vector of a stacked polytope is easy to calculate (see Exercise 1.4.17).

THEOREM 1.4.9 (LBT for simplicial polytopes). *Among all simplicial  $n$ -polytopes  $S$  with  $m$  vertices a stacked polytope has the minimal number of  $i$ -faces*

for  $2 \leq i \leq n-1$ . That is, if  $f_0(S) = m$ , then

$$\begin{aligned} f_i(S) &\geq \binom{n}{i}m - \binom{n+1}{i+1}i \quad \text{for } i = 1, \dots, n-2; \\ f_{n-1}(S) &\geq (n-1)m - (n+1)(n-2). \end{aligned}$$

For  $n \neq 3$  equality is achieved for all  $i$  if and only if  $S$  is a stacked polytope.

REMARK. For  $n = 3$  the LBT inequalities  $f_1 \geq 3m - 6$  and  $f_2 \geq 2m - 4$  turn into equalities for all simplicial polytopes.

An inductive argument by McMullen, Perles and Walkup [222] reduced the LBT to the case  $i = 1$ , namely, to the inequality  $f_1 \geq nm - \binom{n+1}{2}$ . It was finally proved by Barnette [19], [20]. Barnette's proof of the LBT, with some simplifications, can also be found in [42]. The fact that equality is achieved only for stacked polytopes (if  $n \neq 3$ ) was proved by Billera and Lee [30].

REMARK. Unlike the UBT, little is known about generalisations of the LBT to non-simplicial convex polytopes. Some results in this direction were obtained in [177] along with generalisations of the LBT to triangulated spheres and manifolds, which we also discuss later in this book.

An easy calculation shows that the inequalities  $f_{n-1} \geq n+1$  and  $f_{n-2} \geq nf_{n-1} - \binom{n+1}{2}$  for simple polytopes from Example 1.4.3 can be written in terms of the  $h$ -vector as follows:  $h_0 \leq h_1 \leq h_2$ . Having reduced the whole LBT to the inequality  $h_1 \leq h_2$ , McMullen and Walkup [222] conjectured that the components of the  $h$ -vector 'grow up to the middle', that is the inequalities

$$(1.18) \quad h_0 \leq h_1 \leq \dots \leq h_{\lfloor \frac{n}{2} \rfloor}$$

hold for a simple  $n$ -polytope. It has since become known as the *Generalised Lower Bound Conjecture (GLBC)*.

McMullen also suggested a generalisation to the UBT, whose formulation requires an algebraic digression.

DEFINITION 1.4.10. For any two positive integers  $a, i$  there exists a unique *binomial  $i$ -expansion* of  $a$  of the form

$$a = \binom{a_i}{i} + \binom{a_{i-1}}{i-1} + \dots + \binom{a_j}{j},$$

where  $a_i > a_{i-1} > \dots > a_j \geq j \geq 1$ .

The binomial  $i$ -expansion of  $a$  can be constructed by choosing  $a_i$  as the unique number satisfying  $\binom{a_i}{i} \leq a < \binom{a_i+1}{i}$ , then choosing  $a_{i-1}$ , and so on. One needs only to check that  $a_i > a_{i-1}$ , which is straightforward.

Now define the  $i$ th *pseudopower* of  $a$  as

$$a^{\langle i \rangle} = \binom{a_i+1}{i+1} + \binom{a_{i-1}+1}{i} + \dots + \binom{a_j+1}{j+1}, \quad 0^{\langle i \rangle} = 0.$$

EXAMPLE 1.4.11.

1. For  $a > 0$ ,  $a^{\langle 1 \rangle} = \binom{a+1}{2}$ .

2. If  $i \geq a$  then the binomial expansion has the form

$$a = \binom{i}{i} + \binom{i-1}{i-1} + \dots + \binom{i-a+1}{i-a+1} = 1 + \dots + 1,$$

and therefore  $a^{\langle i \rangle} = a$ .

3. Let  $a = 28$ ,  $i = 4$ . Then

$$28 = \binom{6}{4} + \binom{5}{3} + \binom{3}{2}, \quad 28^{\langle 4 \rangle} = \binom{7}{5} + \binom{6}{4} + \binom{4}{3} = 40.$$

The importance of the binomial expansion and pseudopowers comes from the following fundamental result of combinatorial commutative algebra.

**THEOREM 1.4.12** (Macaulay, Stanley). *The following two conditions are equivalent for a sequence of integers  $(k_0, k_1, k_2, \dots)$ :*

- (a)  $k_0 = 1$  and  $0 \leq k_{i+1} \leq k_i^{\binom{i}{i}}$  for  $i \geq 1$ ;
- (b) *there exists a connected commutative graded algebra  $A = A^0 \oplus A^1 \oplus A^2 \oplus \dots$  over a field  $\mathbf{k}$  such that  $A$  is generated by its degree-one elements and  $\dim_{\mathbf{k}} A^i = k_i$  for  $i \geq 0$ .*

Macaulay's original theorem [202] says that (b) above is equivalent to the existence of a *multicomplex* whose  $h$ -vector is given by  $(k_0, k_1, k_2, \dots)$ . The original proof is long and complicated. The reformulation of Macaulay's condition in terms of pseudopowers, i.e. condition (a), is due to Stanley [293, Theorem 2.2]. Simpler proofs of Theorem 1.4.12 can be found in [79] and [45, §4.2].

**DEFINITION 1.4.13.** A sequence of integers satisfying either of the conditions of Theorem 1.4.12 is called an *M-sequence*. Finite *M*-sequences are *M-vectors*.

Now observe that the number  $\binom{m-n+i-1}{i}$  on the right hand side of the inequality of Lemma 1.4.6 equals the number of degree  $i$  monomials in  $h_1 = m - n$  generators. It follows that the inequalities of Lemma 1.4.6, and therefore the UBT, hold if the  $h$ -vector is an *M*-vector.

In 1970 McMullen [218] combined all known and conjectured information about the  $f$ -vectors, including the Dehn–Sommerville relations and the generalisations to the LBT and UBT discussed above, into a (conjectured) complete characterisation. McMullen's conjecture is now proved, and remains up to the present time perhaps the most impressive achievement of the combinatorial theory of face numbers:

**THEOREM 1.4.14** (*g*-theorem). *An integer vector  $(f_0, f_1, \dots, f_n)$  is the  $f$ -vector of a simple  $n$ -polytope if and only if the corresponding sequence  $(h_0, \dots, h_n)$  determined by (1.9) satisfies the following three conditions:*

- (a)  $h_i = h_{n-i}$  for  $i = 0, 1, \dots, n$  (the Dehn–Sommerville relations);
- (b)  $h_0 \leq h_1 \leq \dots \leq h_{\lfloor \frac{n}{2} \rfloor}$ ;
- (c)  $h_0 = 1, h_{i+1} - h_i \leq (h_i - h_{i-1})^{\binom{i}{i}}$  for  $i = 1, \dots, \lfloor \frac{n}{2} \rfloor - 1$ .

**REMARK.** Condition (b) says that the components of the  $h$ -vector 'grow up to the middle', while (c) gives a restriction on the rate of this growth. Both (b) and (c) can be reformulated by saying that the  $g$ -vector  $(g_0, \dots, g_{\lfloor n/2 \rfloor})$  (see Definition 1.3.1) is an *M*-vector; this explains the name '*g*-theorem'. The fact that the  $g$ -vector is an *M*-vector implies that the  $h$ -vector is also an *M*-vector (see Exercise 1.4.18).

Both necessity and sufficiency parts of the *g*-theorem were proved almost simultaneously (around 1980), although by radically different methods.

The sufficiency part was proved by Billera and Lee [29], [30]. The proof is quite elementary and relies upon a remarkable combinatorial-geometrical construction combining cyclic polytopes (achieving the upper bound for the number of faces) with the operation of 'adding a pyramid' (used to produce polytopes achieving the lower bound). As a result, a simplicial polytope can be produced with any prescribed  $g$ -vector between the minimal and the maximal ones. Another important consequence of the results of [222] and [30] is that the GLBC inequalities (1.18) are the most general linear inequalities satisfied by the  $f$ -vectors of simplicial polytopes.

On the other hand, Stanley's proof [289] of the necessity part of  $g$ -theorem (i.e. that the  $g$ -vector of a simple polytope is an  $M$ -vector) used deep results from algebraic geometry, in particular, the *Hard Lefschetz theorem* for the cohomology of *toric varieties*. We shall give this argument in Section 5.3. After the appearance of Stanley's paper combinatorists had been looking for a more elementary combinatorial proof of his theorem, until in 1993 a first such proof was found by McMullen [219]. It builds upon the notion of the *polytope algebra*, which may be thought of as a combinatorial model for the cohomology algebras of toric varieties. Despite being elementary, it was a complicated proof. Later McMullen simplified his approach in [220]. Yet another elementary proof of the  $g$ -theorem was given by Timorin [307]. It relies on an interpretation of McMullen's polytope algebra as the algebra of differential operators with constant coefficients vanishing on the *volume polynomial* of the polytope.

By duality, the UBT and the LBT provide upper and lower bounds for the number of faces of a simple polytope with the given number of facets. Similarly, the  $g$ -theorem also provides a characterisation for the  $f$ -vectors of simplicial polytopes. During the last three decades some work was done in extending the  $g$ -theorem to objects more general than simplicial (or simple) polytopes, although the most important conjecture here remains open since 1971 (see Section 2.5). There are basically two diverging routes for generalisations of the  $g$ -theorem: towards non-polytopal objects (like triangulations of spheres or manifolds), and towards general convex polytopes which are neither simple nor simplicial. The former requires machinery from combinatorial topology and commutative algebra; we shall discuss the corresponding generalisations in more detail in the next chapters. The generalisations of the  $g$ -theorem to non-simplicial convex polytopes are mostly beyond the scope of this book; they require algebraic geometry techniques such as *intersection homology*, which we only briefly discuss in Section 5.3.

### Exercises.

1.4.15. Prove the following upper bound for the number of  $k$ -faces in a simple  $n$ -polytope  $P$  with  $f_0$  vertices:

$$f_k \leq \frac{1}{k+1} \binom{n}{k} f_0, \quad \text{for } k = 1, \dots, n,$$

where the equality is achieved only for  $P = \Delta^n$ . Observe that this inequality gives a better upper bound for simple polytopes than the UBT.

1.4.16. Prove Lemma 1.4.7.

1.4.17. Show that the numbers of faces of a stacked  $n$ -polytope  $S$  with  $m = f_0$  vertices are given by

$$\begin{aligned} f_i(S) &= \binom{n}{i} m - \binom{n+1}{i+1} i \quad \text{for } 1 \leq i \leq n-2; \\ f_{n-1}(S) &= (n-1)m - (n+1)(n-2). \end{aligned}$$

1.4.18. Let  $\mathbf{h} = (h_0, h_1, \dots, h_n)$  be an integer vector with  $h_0 = 1$  and  $h_i = h_{n-i}$  for  $0 \leq i \leq n$ , and let  $\mathbf{g} = (g_0, g_1, \dots, g_{\lfloor n/2 \rfloor})$  where  $g_0 = 1$ ,  $g_i = h_i - h_{i-1}$  for  $i > 0$ . Show that if  $\mathbf{g}$  is an  $M$ -vector, then  $\mathbf{h}$  is also an  $M$ -vector.

1.4.19. Prove directly that parts (a) and (b) of the  $g$ -theorem imply the LBT, while parts (a) and (c) imply the UBT.

## Polytopes: additional topics

### 1.5. Nestohedra and graph-associahedra

Several constructions of series of simple polytopes with remarkable properties appeared in the beginning of the 1990s under the common name of ‘generalised associahedra’. (The original associahedron, or *Stasheff polytope*, was first introduced in homotopy theory [295].) Nowadays generalised associahedra find numerous applications in algebraic geometry [125], the theory of knot and link invariants [38], representation theory and cluster algebras [116], and the theory of operads and geometric ‘field theories’ originating from quantum physics [296].

Without attempting to overview all aspects of generalised associahedra, we describe one particular construction which uses the Minkowski sum and the combinatorial concept of a *building set*. Our exposition is much influenced by the original works of Feichtner–Sturmfels [110] and Postnikov [265]. The resulting family of polytopes is known as *nestohedra*. Although it does not include all possible generalisations of associahedra, this family is wide enough to contain all classical series, and its construction is elementary enough so that it requires no specific knowledge.

The *Minkowski sum* is a classical geometric construction allowing one to produce new polytopes from known ones, just like the product, hyperplane cut and connected sum described in Section 1.1. However, a Minkowski sum of simple polytopes usually fails to be simple. Interesting examples of polytopes can be obtained by taking Minkowski sums of regular simplices. Simplices in such a Minkowski sum are indexed by a collection  $\mathcal{S}$  of subsets in a finite set. It was shown in [110] and [265] that a Minkowski sum of regular simplices is a simple polytope if  $\mathcal{S}$  satisfies certain combinatorial condition, identifying it as a *building set*. The resulting family of simple polytopes was called *nestohedra* in [266] because of its connection to *nested sets* considered by De Concini and Procesi [91] in the context of subspace arrangements. An example of a building set is provided by the collection of subsets of vertices which span connected subgraphs in a given graph. The corresponding nestohedra are called *graph-associahedra*; they were introduced and studied in the work of Carr and Devadoss [67], and independently in the work of Toledano Laredo [308] under the name *De Concini–Procesi associahedra*. These include the classical series of *permutahedra* and *associahedra*.

**Minkowski sums of simplices.** Recall that the *Minkowski sum* of two subsets  $A, B \subset \mathbb{R}^n$  is defined as

$$A + B = \{\mathbf{x} + \mathbf{y} : \mathbf{x} \in A, \mathbf{y} \in B\}.$$

PROPOSITION 1.5.1. *The Minkowski sum of two polytopes is a polytope. Moreover, if  $P = \text{conv}(\mathbf{v}_1, \dots, \mathbf{v}_k)$  and  $Q = \text{conv}(\mathbf{w}_1, \dots, \mathbf{w}_l)$ , then*

$$P + Q = \text{conv}(\mathbf{v}_1 + \mathbf{w}_1, \dots, \mathbf{v}_i + \mathbf{w}_j, \dots, \mathbf{v}_k + \mathbf{w}_l).$$

PROOF. Follows directly from the definition of Minkowski sum.  $\square$

For every subset  $S \subset [n+1] = \{1, \dots, n+1\}$  consider the regular simplex

$$\Delta_S = \text{conv}(\mathbf{e}_i : i \in S) \subset \mathbb{R}^{n+1}.$$

Let  $\mathcal{F}$  be a collection of nonempty subsets of  $[n+1]$ . We assume that  $\mathcal{F}$  contains all singletons  $\{i\}$ ,  $1 \leq i \leq n+1$ . As usual, denote by  $|\mathcal{F}|$  the number of elements in  $\mathcal{F}$ . Given a subset  $N \subset [n+1]$ , denote by  $\mathcal{F}|_N$  the *restriction* of  $\mathcal{F}$  to  $N$ , i.e.

$$\mathcal{F}|_N = \{S \in \mathcal{F} : S \subset N\}$$

of subsets in  $N$ . A collection  $\mathcal{F}$  is *connected* if  $[n+1]$  cannot be represented as a disjoint union of nonempty subsets  $N_1$  and  $N_2$  such that for every  $S \in \mathcal{F}$  either  $S \subset N_1$  or  $S \subset N_2$ . Obviously, every collection  $\mathcal{F}$  splits into the disjoint union of its *connected components*.

REMARK. In some further considerations we shall allow  $\mathcal{F}$  to contain some subsets of  $[n+1]$  with multiplicities.

Now consider the convex polytope

$$(1.19) \quad P_{\mathcal{F}} = \sum_{S \in \mathcal{F}} \Delta_S \subset \mathbb{R}^{n+1}.$$

The following statement gives some of its basic properties.

PROPOSITION 1.5.2. *Let  $\mathcal{F} = \mathcal{F}_1 \sqcup \dots \sqcup \mathcal{F}_q$  be the decomposition into connected components. Then*

- (a)  $P_{\mathcal{F}} = P_{\mathcal{F}_1} \times \dots \times P_{\mathcal{F}_q}$ ;
- (b)  $\dim P_{\mathcal{F}} = n+1 - q$ .

PROOF. Statement (a) follows from the fact that the polytopes  $P_{\mathcal{F}_i}$  are contained in complementary subspaces for  $1 \leq i \leq q$ , so their Minkowski sum is the product. Because of (a), it is enough to verify (b) for connected  $\mathcal{F}$  only. Then we need to prove that  $\dim P_{\mathcal{F}} = n$ . Observe that  $P_{\mathcal{F}}$  is contained in the hyperplane  $H_{\mathcal{F}} = \{\mathbf{x} \in \mathbb{R}^{n+1} : \sum_{i=1}^{n+1} x_i = |\mathcal{F}|\}$ , and therefore  $\dim P_{\mathcal{F}} \leq n$ . If  $\mathcal{F}$  has a unique maximal element, then this element is  $[n+1]$ , because  $\mathcal{F}$  is connected. Hence,  $P_{\mathcal{F}}$  has an  $n$ -simplex as a Minkowski summand, and therefore  $\dim P_{\mathcal{F}} = n$ . We shall only need this case in the further considerations, so we skip the rest of the proof and leave it as an exercise.  $\square$

We now describe two extreme examples of polytopes  $P_{\mathcal{F}}$ , corresponding to the minimal and the maximal connected collections.

EXAMPLE 1.5.3 (Simplex). Let  $\mathcal{S}$  be the collection consisting of all singletons and the whole set  $[n+1]$ . Then  $P_{\mathcal{S}}$  is the regular  $n$ -simplex  $\Delta_{[n+1]}$  shifted by the vector  $\mathbf{e}_1 + \dots + \mathbf{e}_{n+1}$ .

**Permutahedron.** Let  $\mathcal{C}$  be the *complete* collection, consisting of all subsets in  $[n+1]$ . The polytope  $P_{\mathcal{C}}$  is  $n$ -dimensional by Proposition 1.5.2.

THEOREM 1.5.4.  *$P_{\mathcal{C}}$  can be described as the intersection of the hyperplane*

$$H_{\mathcal{C}} = \left\{ \mathbf{x} \in \mathbb{R}^{n+1} : \sum_{i=1}^{n+1} x_i = 2^{n+1} - 1 \right\}$$

with the halfspaces

$$H_{S, \geq} = \{ \mathbf{x} \in \mathbb{R}^{n+1} : \sum_{i \in S} x_i \geq 2^{|S|} - 1 \}$$

for all proper subsets  $S \subsetneq [n+1]$ . Moreover, every halfspace above is irredundant, i.e. determines a facet  $F_S$  of  $P_{\mathcal{C}}$ , so there are  $|\mathcal{C}| = 2^{n+1} - 2$  facets in total.

PROOF. By definition, every point  $\mathbf{x} = (x_1, \dots, x_{n+1}) \in P_{\mathcal{C}}$  can be written as  $\mathbf{x} = \sum_{S \in \mathcal{C}} \mathbf{x}^S$  where  $\mathbf{x}^S = (x_1^S, \dots, x_{n+1}^S) \in \Delta_S$ . Then

$$\sum_{i=1}^{n+1} x_i = \sum_{S \in \mathcal{C}} \sum_{i=1}^{n+1} x_i^S = \sum_{S \in \mathcal{C}} 1 = |\mathcal{C}| = 2^{n+1} - 1,$$

which implies that  $P_{\mathcal{C}} \subset H_{\mathcal{C}}$ . Similarly,

$$(1.20) \quad \sum_{i \in S} x_i = \sum_{T \in \mathcal{C}} \sum_{i \in S} x_i^T \geq \sum_{T \subset S} \sum_{i \in S} x_i^T = \sum_{T \subset S} 1 = |\mathcal{C}|_S = 2^{|S|} - 1,$$

so  $P_{\mathcal{C}}$  is contained in all subspaces  $H_{S, \geq}$ .

It remains to show that any facet of  $P_{\mathcal{C}}$  has the form  $P_{\mathcal{C}} \cap H_S$ , where  $H_S$  is the bounding hyperplane for  $H_{S, \geq}$ . Since  $P_{\mathcal{C}}$  is a Minkowski sum of simplices, each of its faces  $G$  is a Minkowski sum of faces of these simplices. We therefore may write  $G$  as  $\sum_{S \in \mathcal{C}} \Delta_{T_S}$  where  $T_S \subset S$ . By Proposition 1.5.2, if  $G$  is a facet (i.e.  $\dim G = n - 1$ ), then the collection  $\mathcal{T} = \{T_S\}$  of subsets in  $[n+1]$  has exactly two connected components. (Note that  $\mathcal{T}$  may contain some subsets more than once.) Let  $[n+1] = N_1 \sqcup N_2$  and  $\mathcal{T} = \mathcal{T}|_{N_1} \sqcup \mathcal{T}|_{N_2}$  be the decomposition into components. Then the hyperplane containing the facet  $G$  is defined by each of the two equations

$$(1.21) \quad \sum_{i \in N_1} x_i = |\mathcal{T}|_{N_1}| \quad \text{or} \quad \sum_{i \in N_2} x_i = |\mathcal{T}|_{N_2}|.$$

Since every  $T_S$  is contained in the corresponding  $S$ , we have

$$(1.22) \quad |\mathcal{T}|_{N_1}| \geq |\mathcal{C}|_{N_1}| \quad \text{and} \quad |\mathcal{T}|_{N_2}| \geq |\mathcal{C}|_{N_2}|.$$

We claim that at least one of these inequalities turns into equality. Indeed, assume the converse. By (1.20) the minimum of the linear function  $\sum_{i \in N_1} x_i$  on  $P_{\mathcal{C}}$  is  $|\mathcal{C}|_{N_1}|$ , so there is a point  $\mathbf{x}' \in P_{\mathcal{C}}$  with

$$(1.23) \quad \sum_{i \in N_1} x'_i = |\mathcal{C}|_{N_1}| < |\mathcal{T}|_{N_1}|.$$

Similarly, there is a point  $\mathbf{x}'' \in P_{\mathcal{C}}$  with

$$\sum_{i \in N_2} x''_i = |\mathcal{C}|_{N_2}| < |\mathcal{T}|_{N_2}|.$$

Since  $N_1 \sqcup N_2 = [n+1]$ , the latter inequality is equivalent to  $\sum_{i \in N_1} x''_i > |\mathcal{T}|_{N_1}|$ . This together with (1.23) implies that there are points of  $P_{\mathcal{C}}$  in both open halfspaces determined by the first of the equations (1.21), which contradicts the assumption that  $G$  is a facet. So at least one of (1.22) is an equality, which implies that the hyperplane (1.21) containing  $G$  has the form  $H_S$  (where  $S$  is either  $N_1$  or  $N_2$ ).

It follows that every facet is contained in the hyperplane  $H_S$  for some  $S$ . On the other hand, every subset  $S$  can be taken as  $N_1$  in the construction of the preceding paragraph, which shows that every  $H_S$  contains a facet.  $\square$

Having identified the facets, we may derive the following description of the whole face poset of  $P_C$ .

**PROPOSITION 1.5.5.** *Faces of  $P_C$  of dimension  $k$  are in one-to-one correspondence with ordered partitions of the set  $[n + 1]$  into  $n + 1 - k$  nonempty parts. An inclusion of faces  $G \subset F$  occurs whenever the ordered partition corresponding to  $G$  can be obtained by refining the ordered partition corresponding to  $F$ .*

**PROOF.** This follows from the fact that two facets  $F_{S_1}$  and  $F_{S_2}$  of  $P_C$  have nonempty intersection if and only if  $S_1 \subset S_2$  or  $S_2 \subset S_1$ . We skip the details to avoid repetitive arguments; see Theorem 1.5.13 below for a more general result.  $\square$

**COROLLARY 1.5.6.**

- (a)  $P_C$  is a simple polytope;
- (b) the vertices of  $P_C$  are obtained by all permutations of the coordinates of the point  $(1, 2, 4, \dots, 2^n) \in \mathbb{R}^{n+1}$ .

The polytope whose vertices are obtained by permuting the coordinates of a given point is known as the *permutahedron*; it has been studied by convex geometers since the beginning of the 20th century. More precisely, given a point  $\mathbf{a} = (a_1, \dots, a_{n+1}) \in \mathbb{R}^{n+1}$  with  $a_1 < a_2 < \dots < a_{n+1}$ , define the corresponding permutahedron as

$$Pe^n(\mathbf{a}) = \text{conv}(\sigma(a_1), \dots, \sigma(a_{n+1})): \sigma \in \Sigma_{n+1},$$

where  $\Sigma_{n+1}$  denotes the group of permutations of  $n + 1$  elements. In particular,  $P_C = Pe^n(1, 2, \dots, 2^n)$ . All  $n$ -dimensional permutahedra  $Pe^n(\mathbf{a})$  are combinatorially equivalent; this follows from the following description of their faces:

**THEOREM 1.5.7.**

- (a) Every facet of  $Pe^n(\mathbf{a})$  is the intersection of  $Pe^n(\mathbf{a})$  with the hyperplane

$$H_S = \left\{ \mathbf{x} \in \mathbb{R}^{n+1}: \sum_{i \in S} x_i = a_1 + a_2 + \dots + a_{|S|} \right\}$$

for a proper subset  $S \subsetneq [n + 1]$ .

- (b) The faces of  $Pe^n(\mathbf{a})$  are described in the same way as in Proposition 1.5.5.

**PROOF.** This can be proved by mimicking the proof of Theorem 1.5.4. Another way to proceed is as follows. Every face of  $Pe^n(\mathbf{a})$  is a set of points where a certain linear function  $\varphi_{\mathbf{b}} = (\mathbf{b}, \cdot)$  restricted to the polytope achieves its minimum. We denote this face by  $G_{\mathbf{b}}$ . Then  $\mathbf{b} = (b_1, \dots, b_{n+1})$  defines an ordered partition  $[n + 1] = N_1 \sqcup \dots \sqcup N_k$  according to the sets of equal coordinates of  $\mathbf{b}$ . Namely, if  $b_k = b_l$  then  $k$  and  $l$  are in the same  $N_i$ , while if  $b_k < b_l$  then  $k \in N_i$  and  $l \in N_j$  with  $i < j$ . It can be shown that (a)  $\dim G_{\mathbf{b}} = n + 1 - k$ , and (b) the face  $G_{\mathbf{b}}$  only depends on the ordered partition above and does not depend on the particular values of  $b_k$ . In particular, the vertices of  $Pe^n(\mathbf{a})$  correspond to  $\varphi_{\mathbf{b}}$  where all coordinates of  $\mathbf{b}$  are different, while the facets correspond to  $\varphi_{\mathbf{b}}$  where all coordinates of  $\mathbf{b}$  are either 0 or 1. We leave the details to the reader.  $\square$

We shall denote an  $n$ -dimensional combinatorial permutahedron by  $Pe^n$ . The classical permutahedron corresponds to  $\mathbf{a} = (1, 2, \dots, n + 1)$ . It can also be obtained as a Minkowski sum (1.19) as follows (we leave the proof as an exercise):



PROPOSITION 1.5.8. *Let  $\mathcal{I}$  be the collection of all subsets of cardinality  $\leq 2$  in  $[n+1]$ . Then*

$$P_{\mathcal{I}} = Pe^n(1, 2, \dots, n+1).$$

The polytope  $P_{\mathcal{I}}$  is the Minkowski sum of segments of the form  $\text{conv}(\mathbf{e}_i, \mathbf{e}_j)$  for  $1 \leq i < j \leq n+1$ , shifted by the vector  $\mathbf{e}_1 + \dots + \mathbf{e}_{n+1}$ . Minkowski sums of segments are known as *zonotopes*; this family of polytopes has many remarkable properties [325, §7.3]. However, general zonotopes are rarely simple; the permutahedron is one of the few exceptions.

**Building sets and nestohedra.** We now return to general Minkowski sums (1.19). The next statement gives a description of  $P_{\mathcal{F}}$  in terms of inequalities, and generalises the first part of Theorem 1.5.4.

PROPOSITION 1.5.9 ([110, Proposition 3.12]).  *$P_{\mathcal{F}}$  can be described as the intersection of the hyperplane*

$$H_{\mathcal{F}} = \left\{ \mathbf{x} \in \mathbb{R}^{n+1} : \sum_{i=1}^{n+1} x_i = |\mathcal{F}| \right\}$$

with the halfspaces

$$H_{T, \geq} = \left\{ \mathbf{x} \in \mathbb{R}^{n+1} : \sum_{i \in T} x_i \geq |\mathcal{F}|_T \right\}$$

corresponding to all proper subsets  $T \subsetneq [n+1]$ .

PROOF. Since  $P_{\mathcal{F}}$  is a Minkowski summand in the permutahedron  $P_{\mathcal{C}}$ , it is defined by inequalities of the form  $\sum_{i \in T} x_i \geq b_T$  for some parameters  $b_T$ . The minimum value of the linear function  $\sum_{i \in T} x_i$  on a simplex  $\Delta_S$  equals one if  $S \subset T$ , and equals zero otherwise. Therefore,  $b_T = |\mathcal{F}|_T$ , as needed.  $\square$

It follows that  $P_{\mathcal{F}}$  can be obtained by iteratively cutting the  $n$ -simplex

$$H_{\mathcal{F}} \cap \{ \mathbf{x} : x_i \geq 1 \text{ for } i = 1, \dots, n+1 \}$$

by the hyperplanes  $H_{T, \geq}$  corresponding to subsets  $T$  of cardinality  $\geq 2$ . In the case of the permutahedron, each of these cuts is nontrivial, that is, the corresponding hyperplane is not redundant. In general, the description of  $P_{\mathcal{F}}$  in Proposition 1.5.9 is redundant. The concept of a building set will allow us to achieve an irredundant description of  $P_{\mathcal{F}}$  for certain  $\mathcal{F}$  and therefore describe the face posets. The resulting polytopes  $P_{\mathcal{F}}$  will be simple; furthermore they will be obtained from a simplex by a sequence of face truncations.

DEFINITION 1.5.10. A collection  $\mathcal{B}$  of nonempty subsets of  $[n+1]$  is called a *building set* on  $[n+1]$  if the following two conditions are satisfied:

- (a)  $S', S'' \in \mathcal{B}$  with  $S' \cap S'' \neq \emptyset$  implies  $S' \cup S'' \in \mathcal{B}$ ;
- (b)  $\{i\} \in \mathcal{B}$  for all  $i \in [n+1]$ .

REMARK. The terminology comes from a more general notion of a *building set in a finite lattice*, so that the building set above corresponds to the case of the Boolean lattice  $2^{[n+1]}$ . We do not give the general definition because it requires too much poset terminology. See [110, §3] for the details.

Note that a building set  $\mathcal{B}$  on  $[n+1]$  is *connected* if and only if  $[n+1] \in \mathcal{B}$ . Given  $S \subsetneq [n+1]$  define the *contraction of  $S$  from  $\mathcal{B}$*  as

$$\mathcal{B}/S = \{T \setminus S : T \in \mathcal{B}, T \setminus S \neq \emptyset\} = \{S' \subset [n+1] \setminus S : S' \in \mathcal{B} \text{ or } S' \cup S \in \mathcal{B}\}.$$

The restriction  $\mathcal{B}|_S$  and the contraction  $\mathcal{B}/S$  are building sets on  $S$  and  $[n+1] \setminus S$  respectively. Note that  $\mathcal{B}|_S$  is connected if and only if  $S \in \mathcal{B}$ . If  $\mathcal{B}$  is connected, then  $\mathcal{B}/S$  is also connected for any  $S$ .

We now consider polytopes  $P_{\mathcal{B}}$  (1.19) corresponding to building sets  $\mathcal{B}$ . The following specification of Proposition 1.5.9 gives an irredundant description of  $P_{\mathcal{B}}$  as an intersection of halfspaces.

PROPOSITION 1.5.11 ([110], [265]). *We have*

$$P_{\mathcal{B}} = \left\{ \mathbf{x} \in \mathbb{R}^{n+1} : \sum_{i=1}^{n+1} x_i = |\mathcal{B}|, \sum_{i \in S} x_i \geq |\mathcal{B}|_S \text{ for every } S \in \mathcal{B} \right\}.$$

If  $\mathcal{B}$  is connected, then this representation is irredundant, that is, every hyperplane  $H_S = \{ \mathbf{x} \in \mathbb{R}^{n+1} : \sum_{i \in S} x_i = |\mathcal{B}|_S \}$  with  $S \neq [n+1]$  defines a facet  $F_S$  of  $P_{\mathcal{B}}$  (so that the number of facets of  $P_{\mathcal{B}}$  is  $|\mathcal{B}| - 1$ ).

PROOF. The halfspace  $H_{T, \geq}$  in the presentation of  $P_{\mathcal{B}}$  from Proposition 1.5.9 is irredundant if the intersection of  $P_{\mathcal{B}}$  with the corresponding hyperplane  $H_T$  is a facet. This intersection is a face of  $P_{\mathcal{B}}$  given by

$$P_{\mathcal{B}|_T} + P_{\mathcal{B}/T}$$

(since  $P_{\mathcal{B}|_T}$  and  $P_{\mathcal{B}/T}$  lie in complementary subspaces, their Minkowski sum is actually a product). In order for this face to have codimension one in  $P_{\mathcal{B}}$ , it is necessary, by Proposition 1.5.2, that the collection  $\mathcal{B}|_T$  is connected. This condition is equivalent to  $T \in \mathcal{B}$ . If  $\mathcal{B}$  is connected, then this condition is also sufficient, because then  $\mathcal{B}/T$  is also connected, and  $\dim(P_{\mathcal{B}|_T} + P_{\mathcal{B}/T}) = n - 1$  by Proposition 1.5.2.  $\square$

COROLLARY 1.5.12. *If  $\mathcal{B}$  is a connected building set on  $[n+1]$ , then every facet of  $P_{\mathcal{B}}$  can be written as*

$$P_{\mathcal{B}|_T} \times P_{\mathcal{B}/T}$$

for some  $T \in \mathcal{B} \setminus [n+1]$ .

THEOREM 1.5.13. *The intersection of facets  $F_{S_1} \cap \cdots \cap F_{S_k}$  is nonempty (and therefore is a face of  $P_{\mathcal{B}}$ ) if and only if the following two conditions are satisfied:*

- (a) for any  $i, j$ ,  $1 \leq i < j \leq k$ , either  $S_i \subset S_j$ , or  $S_j \subset S_i$ , or  $S_i \cap S_j = \emptyset$ ;
- (b) if the sets  $S_{i_1}, \dots, S_{i_p}$  are pairwise nonintersecting, then  $S_{i_1} \sqcup \cdots \sqcup S_{i_p} \notin \mathcal{B}$ .

DEFINITION 1.5.14. A subcollection  $\{S_1, \dots, S_k\} \subset \mathcal{B}$  satisfying conditions (a) and (b) of Theorem 1.5.13 is called a *nested set*. Following [266], we refer to polytopes  $P_{\mathcal{B}}$  (1.19) corresponding to building sets  $\mathcal{B}$  as *nestohedra*.

PROOF OF THEOREM 1.5.13. Assume  $F_{S_1} \cap \cdots \cap F_{S_k} \neq \emptyset$ .

If (a) fails, then  $S_i \cup S_j \in \mathcal{B}$ , and for any  $\mathbf{x} \in F_{S_i} \cap F_{S_j}$  we have

$$\sum_{k \in S_i} x_k = |\mathcal{B}|_{S_i}, \quad \sum_{k \in S_j} x_k = |\mathcal{B}|_{S_j}, \quad \sum_{k \in S_i \cup S_j} x_k \geq |\mathcal{B}|_{S_i \cup S_j}.$$

Adding the first two equalities and subtracting the third inequality we obtain

$$\sum_{k \in S_i \cap S_j} x_k \leq |\mathcal{B}|_{S_i} + |\mathcal{B}|_{S_j} - |\mathcal{B}|_{S_i \cup S_j} < |\mathcal{B}|_{S_i} + |\mathcal{B}|_{S_j} - |\mathcal{B}|_{S_i \cup S_j} = |\mathcal{B}|_{S_i \cap S_j}$$

where the second inequality is strict because  $\mathcal{B}|_{S_i} \cup \mathcal{B}|_{S_j} \subsetneq \mathcal{B}|_{S_i \cup S_j}$ . Now the inequality  $\sum_{k \in S_i \cap S_j} x_k < |\mathcal{B}|_{S_i \cap S_j}|$  contradicts Proposition 1.5.9.

If (b) fails, then  $S_{i_1} \sqcup \cdots \sqcup S_{i_p} \in \mathcal{B}$ , and for any  $\mathbf{x} \in F_{S_{i_1}} \cap \cdots \cap F_{S_{i_p}}$  we have

$$\sum_{k \in S_{i_q}} x_k = |\mathcal{B}|_{S_{i_q}}| \quad \text{for } 1 \leq q \leq p, \quad \text{and} \quad \sum_{k \in S_{i_1} \sqcup \cdots \sqcup S_{i_p}} x_k \geq |\mathcal{B}|_{S_{i_1} \sqcup \cdots \sqcup S_{i_p}}|.$$

Subtracting the first  $p$  equalities from the last inequality we obtain

$$|\mathcal{B}|_{S_{i_1}}| + \cdots + |\mathcal{B}|_{S_{i_p}}| \geq |\mathcal{B}|_{S_{i_1} \sqcup \cdots \sqcup S_{i_p}}|.$$

This leads to a contradiction because  $S_{i_1} \sqcup \cdots \sqcup S_{i_p} \in \mathcal{B}$ .

Now assume that both (a) and (b) are satisfied. We need to show that  $F_{S_1} \cap \cdots \cap F_{S_k} \neq \emptyset$ .

We write  $\mathbf{x} = \sum_{T \in \mathcal{B}} x^T$  and note that the inequality  $\sum_{i \in S} x_i \geq |\mathcal{B}|_S|$  defining the facet  $F_S$  turns into equality if and only if  $x_i^T = 0$  for every  $T \in \mathcal{B}$ ,  $T \not\subset S$  and  $i \in S$  (this follows from (1.20)). Hence,

$$(1.24) \quad \mathbf{x} = \sum_{T \in \mathcal{B}} x^T \in F_{S_1} \cap \cdots \cap F_{S_k} \\ \iff x_i^T = 0 \quad \text{whenever } T \in \mathcal{B}, T \not\subset S_j, i \in S_j, \quad \text{for } 1 \leq j \leq k.$$

We therefore need to find  $\mathbf{x}$  whose coordinates satisfy the  $k$  conditions on the right hand side of (1.24). Given  $T \in \mathcal{B}$ , the  $j$ th condition is not void only if  $T \not\subset S_j$  and  $T \cap S_j \neq \emptyset$ . We may assume without the loss of generality that the first  $k'$  conditions in (1.24) are not void, and the rest are void. That is,  $T \not\subset S_j$  and  $T \cap S_j \neq \emptyset$  for  $1 \leq j \leq k'$ , while  $T \subset S_j$  or  $T \cap S_j = \emptyset$  for  $j > k'$ . Then we claim that  $T \setminus (S_1 \cup \cdots \cup S_{k'}) \neq \emptyset$ . Indeed, otherwise choosing among  $S_1, \dots, S_{k'}$  the maximal subsets  $S_{i_1}, \dots, S_{i_p}$  (which are pairwise disjoint by (a)) we obtain  $S_{i_1} \sqcup \cdots \sqcup S_{i_p} = T \cup S_{i_1} \cup \cdots \cup S_{i_p} \in \mathcal{B}$ , which contradicts (b). Now setting  $x_i^T = 1$  for only one  $i \in T \setminus (S_1 \cup \cdots \cup S_{k'})$  and  $x_i^T = 0$  for the rest, we obtain the required point  $\mathbf{x}$  in the intersection  $F_{S_1} \cap \cdots \cap F_{S_k}$ .  $\square$

From the description of the face lattice of nestohedra in Theorem 1.5.13 it is easy to deduce their following main property.

**THEOREM 1.5.15.** *Every nestohedron  $P_{\mathcal{B}}$  is a simple polytope.*

**PROOF.** By Proposition 1.5.2 we may assume that  $\mathcal{B}$  is connected. A collection  $S_1, \dots, S_k$  may satisfy both conditions of Theorem 1.5.13 only if  $k \leq n$ .  $\square$

**EXAMPLE 1.5.16.** If  $\mathcal{B}$  is a connected building set on a 2-element set, then  $P_{\mathcal{B}}$  is an interval  $I^1$ . If  $\mathcal{B}$  is a connected building set on a 3-element set, then  $P_{\mathcal{B}}$  is a polygon, and only  $m$ -gons with  $3 \leq m \leq 6$  arise in this way.

More examples will appear in the next subsections.

Proposition 1.5.11 gives a particular way to obtain a nestohedron  $P_{\mathcal{B}}$  from a simplex by a sequence of hyperplane cuts. The next result shows that these hyperplane cuts can be organised in such a way that we get a sequence of face truncations (see Construction 1.1.12).

Let  $\mathcal{B}_0 \subset \mathcal{B}_1$  be building sets on  $[n+1]$ , and  $S \in \mathcal{B}_1$ . We define a *decomposition of  $S$  into elements of  $\mathcal{B}_0$*  as  $S = S_1 \sqcup \cdots \sqcup S_k$ , where  $S_j$  are pairwise nonintersecting elements of  $\mathcal{B}_0$  and  $k$  is minimal among such disjoint representations of  $S$ . It can be easily seen that this decomposition exists and is unique.

LEMMA 1.5.17. *Let  $\mathcal{B}_0 \subset \mathcal{B}_1$  be connected building sets on  $[n+1]$ . Then  $P_{\mathcal{B}_1}$  is obtained from  $P_{\mathcal{B}_0}$  by a sequence of truncations at faces  $G_i = \bigcap_{j=1}^{k_i} F_{S_j^i}$  corresponding to the decompositions  $S^i = S_1^i \sqcup \cdots \sqcup S_{k_i}^i$  of elements  $S^i \in \mathcal{B}_1 \setminus \mathcal{B}_0$ , numbered in any order that is reverse to inclusion (i.e.  $S^i \supseteq S^{i'} \Rightarrow i \leq i'$ ).*

PROOF. We use induction on the number  $N = |\mathcal{B}_1| - |\mathcal{B}_0|$ . For  $N = 1$ , we have  $\mathcal{B}_1 = \mathcal{B}_0 \cup \{S^1\}$ . We shall show that  $P_{\mathcal{B}_1}$  is obtained from  $P_{\mathcal{B}_0}$  by a single truncation at the face  $G = F_{S_1^1} \cap \cdots \cap F_{S_k^1}$ , where  $S^1 = S_1^1 \sqcup \cdots \sqcup S_k^1$  is the decomposition of  $S^1$  into elements of  $\mathcal{B}_0$ . Let  $\tilde{P}_{\mathcal{B}_0}$  denote the polytope obtained by truncating  $P_{\mathcal{B}_0}$  at  $G$ . Since both  $\tilde{P}_{\mathcal{B}_0}$  and  $P_{\mathcal{B}_1}$  are  $n$ -dimensional polytopes (here we use the assumption that both  $\mathcal{B}_0$  and  $\mathcal{B}_1$  are connected), it is enough to verify that the face poset of  $P_{\mathcal{B}_1}$  is a subposet of the face poset of  $\tilde{P}_{\mathcal{B}_0}$  (see Exercise 1.1.20).

The facets of  $P_{\mathcal{B}_1}$  are  $F_{S^1}$  and  $F_{S_j}$  with  $S_j \in \mathcal{B}_0$ . We first consider a nonempty intersection of the form  $F_{S_1} \cap \cdots \cap F_{S_\ell}$  in  $P_{\mathcal{B}_1}$ , i.e. a nested set  $\{S_1, \dots, S_\ell\}$  of  $\mathcal{B}_1$ , with all  $S_j \in \mathcal{B}_0$ . Then obviously,  $\{S_1, \dots, S_\ell\}$  is a nested set of  $\mathcal{B}_0$ , i.e.  $F_{S_1} \cap \cdots \cap F_{S_\ell} \neq \emptyset$  in  $P_{\mathcal{B}_0}$ . Furthermore, since  $S^1$  is the only element of  $\mathcal{B}_1 \setminus \mathcal{B}_0$ , we have that

$$S_{j_1} \sqcup \cdots \sqcup S_{j_p} \neq S^1 = S_1^1 \sqcup \cdots \sqcup S_k^1$$

for any  $\{j_1, \dots, j_p\} \subset [\ell]$ . The latter condition implies that  $\{S_1^1, \dots, S_k^1\} \not\subset \{S_1, \dots, S_\ell\}$ , i.e.  $F_{S_1^1} \cap \cdots \cap F_{S_k^1} \not\subset G$  in the face poset of  $P_{\mathcal{B}_0}$ . By the description of the face poset of  $\tilde{P}_{\mathcal{B}_0}$  given in Construction 1.1.12, this implies that  $F_{S_1} \cap \cdots \cap F_{S_\ell} \neq \emptyset$  in  $\tilde{P}_{\mathcal{B}_0}$ .

Now we consider a nonempty intersection of the form  $F_{S^1} \cap F_{S_1} \cap \cdots \cap F_{S_\ell}$  in  $P_{\mathcal{B}_1}$ , i.e. a nested set  $\{S^1, S_1, \dots, S_\ell\}$  of  $\mathcal{B}_1$ , with  $S_j \in \mathcal{B}_0$  and  $S^1 \in \mathcal{B}_1 \setminus \mathcal{B}_0$ . We claim that  $\{S_1^1, \dots, S_k^1, S_1, \dots, S_\ell\}$  is a nested set of  $\mathcal{B}_0$ , i.e.  $G \cap F_{S_1^1} \cap \cdots \cap F_{S_\ell} \neq \emptyset$  in  $P_{\mathcal{B}_0}$ . To do this we need to verify (a) and (b) of Theorem 1.5.13.

We need to check condition (a) for pairs of the form  $S_p^1, S_q$ ; for other pairs it is obvious. That is, we need to check that if  $S_p^1 \cap S_q \neq \emptyset$ , then one of  $S_p^1, S_q$  is contained in the other. The condition  $S_p^1 \cap S_q \neq \emptyset$  implies that  $S^1 \cap S_q \neq \emptyset$ . Since  $\{S^1, S_1, \dots, S_\ell\}$  is a nested set of  $\mathcal{B}_1$ , we obtain that  $S_p^1 \subset S^1 \subset S_q$  or  $S_q \subset S^1$ . By the minimality of the decomposition  $S^1 = S_1^1 \sqcup \cdots \sqcup S_k^1$ , the inclusion  $S_q \subset S^1$  implies that  $S_q$  is contained in some  $S_r^1$ , which can be only  $S_p^1$ , since  $S_p^1 \cap S_q \neq \emptyset$ .

To verify condition (b) of Theorem 1.5.13 for  $\{S_1^1, \dots, S_k^1, S_1, \dots, S_\ell\}$ , we consider a subcollection  $\{S_{i_1}^1, \dots, S_{i_p}^1, S_{j_1}, \dots, S_{j_q}\}$  consisting of pairwise nonintersecting subsets. We need to check that its union is not in  $\mathcal{B}_0$ . For obvious reasons, we may assume that  $p > 0$  and  $q > 0$ . Since  $\{S^1, S_1, \dots, S_\ell\}$  is a nested set of  $\mathcal{B}_1$ , we have that either  $S_{j_i} \subset S^1$  or  $S_{j_i} \cap S^1 = \emptyset$  for each  $i = 1, \dots, q$ . Suppose that  $S_{i_1}^1 \sqcup \cdots \sqcup S_{i_p}^1 \sqcup S_{j_1} \sqcup \cdots \sqcup S_{j_q} \in \mathcal{B}_0$ . Then  $S^1 \sqcup S_{j_1} \sqcup \cdots \sqcup S_{j_q} \in \mathcal{B}_1$  by the definition of the building set. If any of  $S_{j_i}$  is disjoint with  $S^1$ , then we get a contradiction with condition (b) for the nested set  $\{S^1, S_1, \dots, S_\ell\}$  of  $\mathcal{B}_1$ . Therefore,  $S_{j_i} \subset S^1$  for  $i = 1, \dots, q$ , so that  $S_{i_1}^1 \sqcup \cdots \sqcup S_{i_p}^1 \sqcup S_{j_1} \sqcup \cdots \sqcup S_{j_q} \subset S^1$ . By the argument of the previous paragraph, for each  $S_{j_i}$  we have that  $S_{j_i} \subset S_r^1$  or  $S_r^1 \subset S_{j_i}$  for some  $r = 1, \dots, k$ . Then it follows from the minimality of the decomposition  $S^1 = S_1^1 \sqcup \cdots \sqcup S_k^1$  and the definition of a building set that  $S_{i_1}^1 \sqcup \cdots \sqcup S_{i_p}^1 \sqcup S_{j_1} \sqcup \cdots \sqcup S_{j_q} = S^1$ , which contradicts the assumption that  $S^1 \notin \mathcal{B}_0$ .

Hence,  $\{S_1^1, \dots, S_k^1, S_1, \dots, S_\ell\}$  is a nested set of  $\mathcal{B}_0$ . Similarly to the case considered in the previous paragraph, we also obtain that  $F_{S_1^1} \cap \cdots \cap F_{S_\ell} \not\subset G$  in

the face poset of  $P_{\mathcal{B}_0}$ . Once again, by the description of the face poset of  $\tilde{P}_{\mathcal{B}_0}$  given in Construction 1.1.12, this implies that  $F_{S^1} \cap F_{S^1} \cap \dots \cap F_{S^\ell} \neq \emptyset$  in  $\tilde{P}_{\mathcal{B}_0}$ .

It follows that the face poset of  $P_{\mathcal{B}_1}$  is indeed contained as a subposet in the face poset of  $\tilde{P}_{\mathcal{B}_0}$ , and thus  $P_{\mathcal{B}_1} = \tilde{P}_{\mathcal{B}_0}$ .

It now remains to finish the induction. Assuming the theorem holds for  $M < N$ , we shall prove it for  $M = N$ . Since  $S^1$  is not contained in any other  $S^i$ , the collection of sets  $\mathcal{B}'_0 = \mathcal{B}_0 \cup \{S^1\}$  is a building set. By the induction assumption,  $P_{\mathcal{B}'_0}$  is obtained from  $P_{\mathcal{B}_0}$  by truncation at the face corresponding to the decomposition of  $S^1$ , and  $P_{\mathcal{B}_1}$  is obtained from  $P_{\mathcal{B}'_0}$  by a sequence of truncations corresponding to the decompositions of  $S^i$  for  $i = 2, \dots, N$ .  $\square$

REMARK. The proof given above only establishes a combinatorial equivalence between  $P_{\mathcal{B}_1}$  and  $\tilde{P}_{\mathcal{B}_0}$ . Since Proposition 1.5.11 gives a geometric presentation of nestohedra by a sequence of hyperplane cuts, it follows easily that the face truncations of  $P_{\mathcal{B}_0}$  giving  $P_{\mathcal{B}_1}$  are also geometric.

THEOREM 1.5.18. *Every nestohedron  $P_{\mathcal{B}}$  corresponding to a connected building set  $\mathcal{B}$  can be obtained from a simplex by a sequence of face truncations.*

PROOF. Assume that  $\mathcal{B}$  is a connected building set on  $[n+1]$ . Then we have  $\mathcal{S} \subset \mathcal{B}$ , where  $\mathcal{S}$  is the connected building set of Example 1.5.3, whose corresponding nestohedron is an  $n$ -simplex. Now apply Lemma 1.5.17.  $\square$

The following construction, suggested by N. Erokhovets, will allow us to show that every nestohedron can be obtained from a connected building set, up to combinatorial equivalence.

CONSTRUCTION 1.5.19 (Substitution of building sets). Let  $\mathcal{B}_1, \dots, \mathcal{B}_{n+1}$  be connected building sets on  $[k_1], \dots, [k_{n+1}]$ . Then, for every connected building set  $\mathcal{B}$  on  $[n+1]$ , we define a connected building set  $\mathcal{B}(\mathcal{B}_1, \dots, \mathcal{B}_{n+1})$  on  $[k_1] \sqcup \dots \sqcup [k_{n+1}] = [k_1 + \dots + k_{n+1}]$ , consisting of elements  $S^i \in \mathcal{B}_i$  and  $\bigsqcup_{i \in S} [k_i]$ , where  $S \in \mathcal{B}$ .

When  $\mathcal{B}_1, \dots, \mathcal{B}_n$  are singletons  $\{1\}, \dots, \{n\}$ , we shall write  $\mathcal{B}(1, 2, \dots, n, \mathcal{B}_{n+1})$  instead of  $\mathcal{B}(\{1\}, \{2\}, \dots, \{n\}, \mathcal{B}_{n+1})$ .

LEMMA 1.5.20. *Let  $\mathcal{B}, \mathcal{B}_1, \dots, \mathcal{B}_{n+1}$  be connected building sets on  $[n+1], [k_1], \dots, [k_{n+1}]$ , and let  $\mathcal{B}' = \mathcal{B}(\mathcal{B}_1, \dots, \mathcal{B}_{n+1})$ . Then  $P_{\mathcal{B}'} \approx P_{\mathcal{B}} \times P_{\mathcal{B}_1} \times \dots \times P_{\mathcal{B}_{n+1}}$ .*

PROOF. Set  $\mathcal{B}'' = \mathcal{B} \sqcup \mathcal{B}_1 \sqcup \dots \sqcup \mathcal{B}_{n+1}$  and define the map  $\varphi: \mathcal{B}'' \rightarrow \mathcal{B}'$  by

$$\varphi(S) = \begin{cases} S & \text{if } S \in \mathcal{B}_i \\ \bigsqcup_{i \in S} [k_i] & \text{if } S \in \mathcal{B}. \end{cases}$$

Then  $\varphi$  generates a bijection between  $\mathcal{B}'' \setminus \mathcal{B}''_{\max}$  and  $\mathcal{B}' \setminus [k_1 + \dots + k_{n+1}]$ , where  $\mathcal{B}''_{\max} = \{[n+1], [k_1], \dots, [k_{n+1}]\}$  denotes the collection of maximal sets of  $\mathcal{B}''$ . Let  $\mathcal{S} \subset \mathcal{B} \setminus [n+1]$  and  $\mathcal{S}_i \subset \mathcal{B}_i \setminus [k_i]$ . Notice that  $\varphi(\mathcal{S}) \cup \bigcup_{i=1}^{n+1} \varphi(\mathcal{S}_i)$  is a nested set of  $\mathcal{B}'$  if and only if  $\mathcal{S}$  is a nested set of  $\mathcal{B}$  and  $\mathcal{S}_i$  is a nested set of  $\mathcal{B}_i$  for all  $i$ . It follows that  $P_{\mathcal{B}'} \approx P_{\mathcal{B}''} = P_{\mathcal{B}} \times P_{\mathcal{B}_1} \times \dots \times P_{\mathcal{B}_{n+1}}$ .  $\square$

EXAMPLE 1.5.21. Assume that each of  $\mathcal{B}, \mathcal{B}_1, \mathcal{B}_2$  is the building set  $\{\{1\}, \{2\}, \{1, 2\}\}$  corresponding to the segment  $\mathbb{I}$ . Let us describe the building set  $\mathcal{B}(\mathcal{B}_1, \mathcal{B}_2)$ . In the building set  $\{\{a\}, \{b\}, \{a, b\}\}$ , we substitute  $a$  by  $\mathcal{B}_1 = \{\{1\}, \{2\}, \{1, 2\}\}$  and  $b$  by  $\mathcal{B}_2 = \{\{3\}, \{4\}, \{3, 4\}\}$ . As a result, we obtain the

connected building set  $\mathcal{B}'$ , consisting of  $\{1\}, \{2\}, \{3\}, \{4\}, \{1, 2\}, \{3, 4\}, [4]$ . Its corresponding nestohedron is obtained by truncating a 3-simplex at two nonadjacent edges; it is combinatorially equivalent to a 3-cube.

The facet correspondence  $\varphi$  between the combinatorial cubes  $P_{\mathcal{B}} \times P_{\mathcal{B}_1} \times P_{\mathcal{B}_2}$  and  $P_{\mathcal{B}'}$  is given by

$$\begin{aligned} \{1\} \in \mathcal{B}_1 &\mapsto \{1\} \in \mathcal{B}', & \{2\} \in \mathcal{B}_1 &\mapsto \{2\} \in \mathcal{B}', \\ \{3\} \in \mathcal{B}_2 &\mapsto \{3\} \in \mathcal{B}', & \{4\} \in \mathcal{B}_2 &\mapsto \{4\} \in \mathcal{B}', \\ \{a\} \in \mathcal{B}_2 &\mapsto \{1, 2\} \in \mathcal{B}', & \{b\} \in \mathcal{B}_2 &\mapsto \{3, 4\} \in \mathcal{B}'. \end{aligned}$$

EXAMPLE 1.5.22. Let  $\mathcal{B} = \{\{1\}, \dots, \{n+1\}, [n+1]\}$  be the building set corresponding to the simplex  $\Delta^n$  and let  $\mathcal{B}_1, \dots, \mathcal{B}_{n+1}$  be arbitrary connected building sets on  $[k_1], \dots, [k_{n+1}]$ . Then

$$\mathcal{B}' = \mathcal{B}(\mathcal{B}_1, \dots, \mathcal{B}_{n+1}) = (\mathcal{B}_1 \sqcup \dots \sqcup \mathcal{B}_{n+1}) \cup [k_1 + \dots + k_{n+1}],$$

and  $P_{\mathcal{B}'} \approx \Delta^n \times P_{\mathcal{B}_1} \times \dots \times P_{\mathcal{B}_{n+1}}$ .

PROPOSITION 1.5.23. *For each nestohedron  $P_{\mathcal{B}}$  there exists a connected building set  $\mathcal{B}'$  such that  $P_{\mathcal{B}} \approx P_{\mathcal{B}'}$ .*

PROOF. Indeed, any building set  $\mathcal{B}$  can be written as  $\mathcal{B}_1 \sqcup \dots \sqcup \mathcal{B}_k$ , where  $\mathcal{B}_i$  are connected building sets on  $[k_i + 1]$ . Define a building set  $\tilde{\mathcal{B}} = \mathcal{B}_1(1, \dots, k_1, \mathcal{B}_2) \sqcup \mathcal{B}_3 \sqcup \dots \sqcup \mathcal{B}_k$ , giving the same combinatorial polytope. We have that  $\tilde{\mathcal{B}}$  is a product (disjoint union) of  $k-1$  connected building sets. Then we apply again a substitution to  $\tilde{\mathcal{B}}$ , and so on. At the end we obtain a connected building set  $\mathcal{B}'$ .  $\square$

### Graph associahedra.

DEFINITION 1.5.24. Let  $\Gamma$  be a graph on the vertex set  $[n+1]$  without loops and multiple edges (a *simple* graph). The *graphical building set*  $\mathcal{B}_{\Gamma}$  consists of all nonempty subsets  $S \subset [n+1]$  such that the graph  $\Gamma|_S$  is connected.

The nestohedron  $P_{\Gamma} = P_{\mathcal{B}_{\Gamma}}$  corresponding to a graphical building set is called a *graph-associahedron* [67].

EXAMPLE 1.5.25 (associahedron). Let  $\Gamma$  be a ‘path’ with  $n$  edges  $\{i, i+1\}$  for  $1 \leq i \leq n$ . Then  $\mathcal{B}_{\Gamma}$  consists of all ‘segments’ of the form  $[i, j] = \{i, i+1, \dots, j\}$  where  $1 \leq i \leq j \leq n+1$ . To describe the face poset of the corresponding polytope  $P_{\Gamma}$  it is convenient to use brackets in a string of  $n+2$  letters  $a_1 a_2 \dots a_{n+2}$ . We associate with a segment  $[i, j]$  a pair of brackets before  $a_i$  and after  $a_{j+1}$ . Using Theorem 1.5.13 it is easy to see that the facets corresponding to  $n$  different segments intersect at a vertex if and only if the corresponding bracketing of  $a_1 a_2 \dots a_{n+2}$  with  $n$  pairs of brackets is correct. In particular, the vertices of  $\mathcal{B}_{\Gamma}$  correspond to all different ways to obtain a product  $a_1 a_2 \dots a_{n+2}$  when multiplication is not associative. The number of vertices is therefore equal to  $\frac{1}{n+2} \binom{2n+2}{n+1}$ , the  $(n+1)$ th *Catalan number*. Two vertices are adjacent if and only if the bracketing corresponding to one vertex can be obtained from the bracketing corresponding to the other vertex by deleting a pair of brackets and inserting, in a unique way, another pair of brackets different from the deleted one. That is, two vertices are adjacent if they correspond to a single application of the associative law. This explains the name *associahedron* for the polytope  $\mathcal{P}_{\Gamma}$  of this example; we shall denote it  $As^n$ .

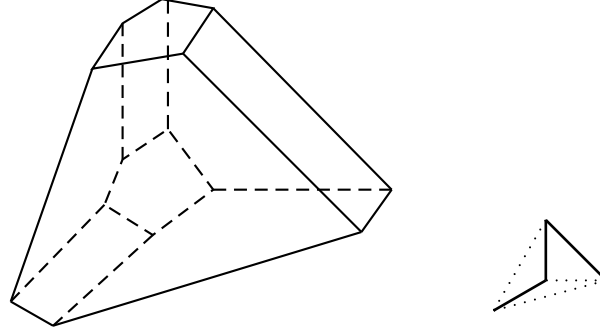

FIGURE 1.4. 3-dimensional associahedron and the corresponding graph.

Proposition 1.5.11 describes the associahedron as the result of consecutive hyperplane cuts of a simplex, see Figure 1.4 for the case  $n = 3$ . It can also be obtained by hyperplane cuts from a cube, as described in the next theorem.

**THEOREM 1.5.26.** *The image of  $As^n$  under a certain affine transformation  $\mathbb{R}^{n+1} \rightarrow \mathbb{R}^n$  is the intersection of the cube*

$$\{\mathbf{y} \in \mathbb{R}^n : 0 \leq y_j \leq j(n+1-j) \text{ for } 1 \leq j \leq n\}$$

with the halfspaces

$$\{\mathbf{y} \in \mathbb{R}^n : y_j - y_k + (j-k)k \geq 0\}$$

for  $1 \leq k < j \leq n$ .

**PROOF.** Proposition 1.5.11 gives the following presentation:

$$(1.25) \quad As^n = \left\{ \mathbf{x} \in \mathbb{R}^{n+1} : \sum_{k=1}^{n+1} x_k = \frac{(n+1)(n+2)}{2}, \right. \\ \left. \sum_{k=i}^j x_k \geq \frac{(j-i+1)(j-i+2)}{2} \text{ for } 1 \leq i \leq j \leq n+1 \right\}.$$

Apply the affine transformation  $\mathbb{R}^{n+1} \rightarrow \mathbb{R}^n$  given by

$$(x_1, \dots, x_{n+1}) \mapsto (z_1, \dots, z_n) \quad \text{where } z_l = \sum_{k=1}^l x_k, \quad \text{for } 1 \leq l \leq n.$$

Now we rewrite the inequalities of (1.25) in the new coordinates  $(z_1, \dots, z_n)$ . The inequalities with  $i = 1$  (corresponding to the facets  $F_S$  with  $\{1\} \in S$ ) become

$$(1.26) \quad z_j \geq \frac{j(j+1)}{2}, \quad \text{for } 1 \leq j \leq n.$$

Inequalities (1.25) with  $j = n+1$  (corresponding to  $F_S$  with  $\{n+1\} \in S$ ) become

$$\frac{(n+1)(n+2)}{2} - z_{i-1} \geq \frac{(n+2-i)(n+3-i)}{2}, \quad \text{for } 2 \leq i \leq n+1,$$

or equivalently,

$$(1.27) \quad z_j \leq (n+2)j - \frac{j(j+1)}{2}, \quad \text{for } 1 \leq j \leq n.$$

The remaining inequalities (1.25) take the form

$$(1.28) \quad z_j - z_{i-1} \geq \frac{(j-i+1)(j-i+2)}{2} \quad \text{for } 1 < i \leq j < n+1.$$

Now the required presentation is obtained from (1.26), (1.27) and (1.28) by applying the shift  $y_j = z_j - \frac{j(j+1)}{2}$  and setting  $k = i - 1$ .  $\square$

EXAMPLE 1.5.27. The case  $n = 3$  of Theorem 1.5.26 is shown in Figure 1.5 (right). We start with a 3-cube (more precisely, a parallelepiped) given by the

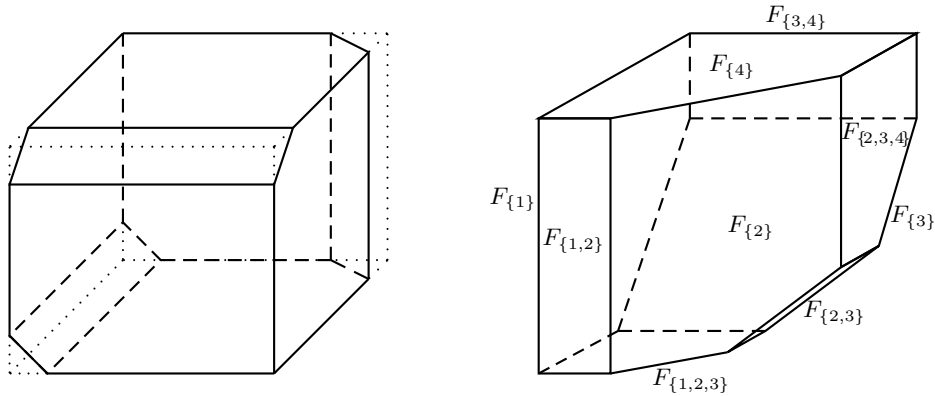

FIGURE 1.5. 3-dimensional associahedron cut from a cube.

inequalities

$$0 \leq y_1 \leq 3, \quad 0 \leq y_2 \leq 4, \quad 0 \leq y_3 \leq 3,$$

and cut it by the three hyperplanes

$$y_2 - y_1 + 1 = 0, \quad y_3 - y_1 + 2 = 0, \quad y_3 - y_2 + 2 = 0.$$

Another way to cut a 3-dimensional combinatorial associahedron from a 3-cube is shown in Figure 1.5 (left); this time we cut three nonadjacent and pairwise orthogonal edges. The two associahedra in Figure 1.5 are not affinely equivalent.

The associahedron  $As^n$  first appeared (as a combinatorial object) in the work of Stasheff [295] as the space of parameters for the higher associativity of the  $(n+2)$ -fold product map in an  $H$ -space. For more information about the associahedra we refer to [125] and [49, Lec. II], where the reader may find other geometric and combinatorial realisations of  $As^n$ .

EXAMPLE 1.5.28 (permutahedron revisited). Let  $\Gamma$  be a complete graph; then  $\mathcal{B}_\Gamma$  is the complete building set  $\mathcal{C}$  and  $P_\Gamma$  is the permutahedron  $Pe^n$ , see Figure 1.6 for the case  $n = 3$ .

EXAMPLE 1.5.29 (cyclohedron). Let  $\Gamma$  be a ‘cycle’ consisting of  $n+1$  edges  $\{i, i+1\}$  for  $1 \leq i \leq n$  and  $\{n+1, 1\}$ . The corresponding  $P_\Gamma$  is known as the *cyclohedron*  $Cy^n$ , or *Bott-Taubes polytope*, see Figure 1.7. It was first introduced in [38] in connection with the study of link invariants.

EXAMPLE 1.5.30 (stellahedron). Let  $\Gamma$  be a ‘star’ consisting of  $n$  edges  $\{i, n+1\}$ ,  $1 \leq i \leq n$ , emanating from the point  $n+1$ . The corresponding  $P_\Gamma$  is known as the *stellahedron*  $St^n$ , see Figure 1.8.



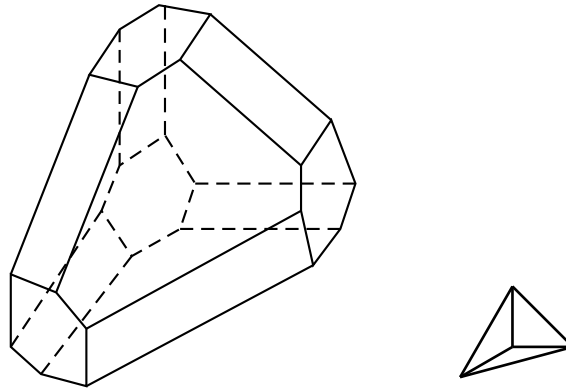

FIGURE 1.6. 3-dimensional permutahedron and the corresponding graph.

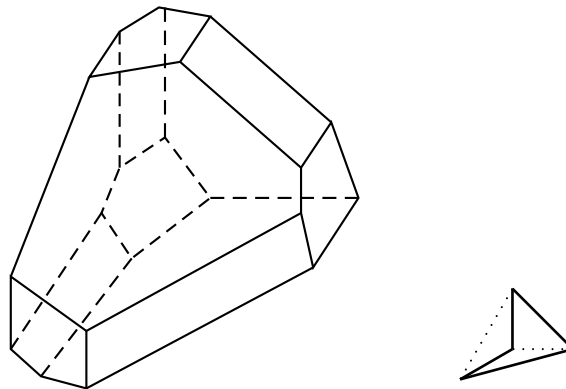

FIGURE 1.7. 3-dimensional cyclohedron and the corresponding graph.

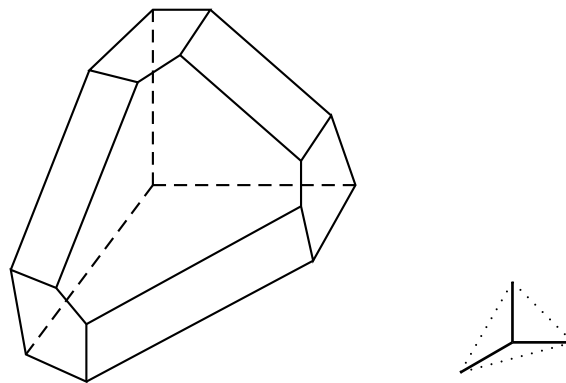

FIGURE 1.8. 3-dimensional stellahedron and the corresponding graph.

**Exercises.**

1.5.31. Every collection  $\mathcal{F}$  of subsets in  $[n + 1]$  may be completed in a unique way to a building set by iteratively adding to  $\mathcal{F}$  the unions  $S_1 \cup S_2$  of intersecting sets ( $S_1 \cap S_2 \neq \emptyset$ ) until the process stops. Denote the resulting building set by  $\widehat{\mathcal{F}}$ . Show that  $\widehat{\mathcal{F}}$  is connected if and only if  $\mathcal{F}$  is connected, and that  $\dim P_{\widehat{\mathcal{F}}} = \dim P_{\mathcal{F}}$  (hint: for a pair of intersecting sets  $S_1, S_2$  compare the polytopes  $\Delta_{S_1} + \Delta_{S_2}$  and  $\Delta_{S_1} + \Delta_{S_2} + \Delta_{S_1 \cup S_2}$ ). Use this fact to complete the proof of Proposition 1.5.2.

1.5.32. Finish the argument in the proof of Proposition 1.5.5.

1.5.33. Complete the details in the proof of Theorem 1.5.7.

1.5.34. Prove Proposition 1.5.8.

1.5.35. Given two building sets  $\mathcal{B}_0 \subset \mathcal{B}_1$ , show that a decomposition  $S = S_1 \sqcup \cdots \sqcup S_k$  of  $S \in \mathcal{B}_1$  into elements  $S_i \in \mathcal{B}_0$  with minimal  $k$  is unique.

1.5.36. A combinatorial polytope obtained from a simplex by a sequence of face truncations is called a *truncated simplex*. Notice that a truncated simplex is a simple polytope. By Theorem 1.5.18, every nestohedron corresponding to a connected nested set is a truncated simplex. Give an example of

- (a) a simple polytope which is not a truncated simplex;
- (b) a truncated simplex which is not a nestohedron;
- (c) a Minkowski sum of simplices  $P_{\mathcal{F}}$  given by (1.19) which is not a truncated simplex.

1.5.37. Consider the following connected building set on  $[4]$ :

$$\mathcal{B} = \{\{1\}, \{2\}, \{3\}, \{4\}, \{1, 2, 3\}, \{2, 3, 4\}, [4]\}.$$

Then  $P_{\mathcal{B}}$  is combinatorially equivalent to the polytope shown in Fig. 1.2, right.

## 1.6. Flagtopes and truncated cubes

DEFINITION 1.6.1. A simple polytope  $P$  is called a *flagtope* (or *flag polytope*) if every collection of its pairwise intersecting facets has a nonempty intersection. (The origins of this terminology will be explained in Section 2.3.)

Flagtopes and flag simplicial complexes (which are the subject of Section 2.3) feature in the well-known *Charney–Davis conjecture* [69] and its generalisation due to Gal [123]. According to the Gal conjecture, the components of the  $\gamma$ -vector of a flagtope are nonnegative.

Gal’s conjecture is important as it connects the combinatorial study of polytopes and sphere triangulations to differential geometry and topology of manifolds. This conjecture has been proved in special cases.

Although not all nestohedra are flagtopes (a simplex is the easiest counterexample), flag nestohedra constitute an important family. In particular, all graph-associahedra (and therefore, the classical series of associahedra and permutahedra) are flagtopes, see Proposition 1.6.6.

As we have seen in Theorem 1.5.26, the associahedron can be obtained by hyperplane cuts from a cube. In this section we give a proof of a much more general and precise result: a nestohedron is a flagtope if and only if it can be obtained from a cube by a sequence of truncations at faces of codimension 2 (we refer to such polytopes as *2-truncated cubes*), see Theorem 1.6.16. This result was proved by Buchstaber and Volodin in [64, Theorem 6.6]. On the other hand, it can be easily

seen that the Gal conjecture is valid for 2-truncated cubes (see Proposition 1.6.12). This observation (formulated in terms of the dual operation of stellar subdivision at an edge) was present in the work of Charney–Davis and later Gal, and used to support their conjectures. As a corollary we obtain that the Gal conjecture holds for all flag nestohedra.

EXAMPLE 1.6.2.

1. The cube  $I^n$  is a flagtope, but the simplex  $\Delta^n$  is not if  $n > 1$ .
2. The product  $P \times Q$  of two flagtopes is a flagtope.
3. The connected sum  $P \# Q$  of two simple  $n$ -polytopes and the vertex truncation  $\text{vt}(P)$  are not flagtopes if  $n > 1$ .

A polytope  $P$  is said to be *triangle-free* if it does not contain a triangular 2-face.

PROPOSITION 1.6.3. *A flagtope is triangle-free.*

PROOF. Assume that a flagtope  $P$  of dimension  $n$  contains a triangular 2-face  $T$  with vertices  $v_1, v_2, v_3$  and edges  $e_1, e_2, e_3$ , where  $v_i$  is opposite to  $e_i$ . Since  $P$  is simple, each  $e_i$  is an intersection of  $n - 1$  facets. Hence, for each  $i = 1, 2, 3$  there is a unique facet, say  $F_i$ , which contains the edge  $e_i$  but not the triangle  $T$ . Also,  $T$  is an intersection of  $n - 2$  facets, and we may assume that  $T = \bigcap_{i=4}^{n+1} F_i$ . Now we observe that  $\bigcap_{i=1, i \neq j}^{n+1} F_i = v_j$  for  $j = 1, 2, 3$ . This implies that the intersection of any pair of facets among  $F_1, \dots, F_{n+1}$  is nonempty. On the other hand,  $\bigcap_{i=1}^{n+1} F_i = \emptyset$  because  $P$  is simple and  $n$ -dimensional. Therefore  $P$  cannot be a flagtope.  $\square$

The converse to Proposition 1.6.3 does not hold in general (see exercises), but it is valid for polytopes with few facets:

THEOREM 1.6.4 ([33]). *If  $P$  is a triangle-free convex  $n$ -polytope then  $f_i(P) \geq f_i(I^n)$  for  $i = 0, \dots, n$ . In particular, such  $P$  has at least  $2n$  facets. Furthermore if  $P$  is simple then*

- (a)  $f_{n-1}(P) = 2n$  implies that  $P = I^n$ ;
- (b)  $f_{n-1}(P) = 2n + 1$  implies that  $P = P_5 \times I^{n-2}$  where  $P_5$  is a pentagon;
- (c)  $f_{n-1}(P) = 2n + 2$  implies that  $P = P_6 \times I^{n-2}$  or  $P = Q \times I^{n-3}$  or  $P = P_5 \times P_5 \times I^{n-4}$  where  $P_6$  is a hexagon and  $Q$  is a 3-polytope obtained by truncating a pentagonal prism at one of its edges forming a pentagonal facet.

COROLLARY 1.6.5. *A triangle-free simple  $n$ -polytope with at most  $2n + 2$  facets is a flagtope.*

Another source of examples of flagtopes is provided by graph-associahedra (see Definition 1.5.24):

PROPOSITION 1.6.6. *Every graph-associahedron  $P_\Gamma$  is a flagtope.*

PROOF. Let  $F_{S_1}, \dots, F_{S_k}$  be a set of facets of  $P_\Gamma$  with nonempty pairwise intersections. We need to check that  $F_{S_1} \cap \dots \cap F_{S_k} \neq \emptyset$ , i.e. that condition (b) of Theorem 1.5.13 is satisfied (condition (a) holds automatically as it depends only on pairwise intersections). Let  $S_{i_1}, \dots, S_{i_p}$  be pairwise nonintersecting sets among  $S_1, \dots, S_k$ ; then  $S_{i_r} \cup S_{i_s} \notin \mathcal{B}_\Gamma$  for  $1 \leq r < s \leq p$  because  $F_{S_{i_r}} \cap F_{S_{i_s}} \neq \emptyset$ . Therefore, all subgraphs  $\Gamma|_{S_{i_r} \cup S_{i_s}}$  are disconnected, which implies that  $\Gamma|_{S_{i_1} \cup \dots \cup S_{i_p}}$  is also disconnected. Thus,  $S_{i_1} \cup \dots \cup S_{i_p} \notin \mathcal{B}_\Gamma$ , and  $F_{S_1} \cap \dots \cap F_{S_k} \neq \emptyset$  by Theorem 1.5.13.  $\square$

The main conjecture about the face numbers of flagtopes uses the notion of the  $\gamma$ -vector  $\gamma(P) = (\gamma_0, \dots, \gamma_{\lfloor n/2 \rfloor})$  (see Definition 1.3.10):

CONJECTURE 1.6.7 (Gal [123]). *A flagtope  $P$  of dimension  $n$  satisfies  $\gamma_i(P) \geq 0$  for  $i = 0, \dots, \lfloor \frac{n}{2} \rfloor$ .*

We shall verify the Gal conjecture for all flag nestohedra. To do this we shall show that any flag nestohedron can be obtained by consecutively truncating a cube at codimension-2 faces.

Our first task is therefore to describe how the  $\gamma$ -vector changes under face truncations. For this it is convenient to use the  $H$ -polynomial given by (1.9), and the  $\gamma$ -polynomial

$$\gamma(P)(\tau) = \gamma_0 + \gamma_1\tau + \dots + \gamma_{\lfloor n/2 \rfloor}\tau^{\lfloor n/2 \rfloor}.$$

PROPOSITION 1.6.8. *Let  $Q$  be the polytope obtained by truncating a simple  $n$ -polytope  $P$  at a  $k$ -dimensional face  $G$ . Then*

- (a)  $H(Q) = H(P)(s, t) + stH(G)H(\Delta^{n-k-2})$ ,
- (b)  $\gamma(Q) = \gamma(P) + \tau\gamma(G)\gamma(\Delta^{n-k-2})$ .

PROOF. The truncation removes  $G$  and creates a face  $G \times \Delta^{n-k-1}$ , so that

$$f_i(Q) = f_i(P) + f_i(G \times \Delta^{n-k-1}) - f_i(G), \quad \text{for } 0 \leq i \leq n.$$

Hence,  $F(Q) = F(P) + tF(G)F(\Delta^{n-k-1}) - t^{n-k}F(G)$ , and

$$\begin{aligned} H(Q) &= H(P) + tH(G)H(\Delta^{n-k-1}) - t^{n-k}H(G) \\ &= H(P) + tH(G) \left( \sum_{i=0}^{n-k-1} s^i t^{n-k-1-i} - t^{n-k-1} \right) \\ &= H(P) + stH(G) \left( \sum_{j=0}^{n-k-2} s^j t^{n-k-2-j} \right) = H(P) + stH(G)H(\Delta^{n-k-2}), \end{aligned}$$

which proves (a). Furthermore,

$$\begin{aligned} \sum_{i=0}^{\lfloor \frac{n}{2} \rfloor} \gamma_i(Q)(st)^i (s+t)^{n-2i} &= H(Q) = \sum_{i=0}^{\lfloor \frac{n}{2} \rfloor} \gamma_i(P)(st)^i (s+t)^{n-2i} \\ &\quad + st \left( \sum_{p=0}^{\lfloor \frac{k}{2} \rfloor} \gamma_p(G)(st)^p (s+t)^{k-2p} \right) \left( \sum_{q=0}^{\lfloor \frac{n-k-2}{2} \rfloor} \gamma_q(\Delta^{n-k-2})(st)^q (s+t)^{n-k-2-2q} \right) \\ &= \sum_{i=0}^{\lfloor \frac{n}{2} \rfloor} \gamma_i(P)(st)^i (s+t)^{n-2i} + \sum_{p=0}^{\lfloor \frac{k}{2} \rfloor} \sum_{q=0}^{\lfloor \frac{n-k-2}{2} \rfloor} \gamma_p(G)\gamma_q(\Delta^{n-k-2})(st)^{p+q+1} (s+t)^{n-2(p+q+1)}. \end{aligned}$$

Hence,  $\gamma_i(Q) = \gamma_i(P) + \sum_{p+q=i-1} \gamma_p(G)\gamma_q(\Delta^{n-k-2})$ , which proves (b).  $\square$

DEFINITION 1.6.9. We refer to a truncation at a codimension-2 face as a *2-truncation*. A combinatorial polytope obtained from a cube by 2-truncations will be called a *2-truncated cube*.

The following corollary is the dual of a result from [123]:

COROLLARY 1.6.10. *Let the polytope  $Q$  be obtained from a simple polytope  $P$  by 2-truncation at a face  $G$ . Then*

- (a)  $H(Q) = H(P) + stH(G)$ ,
- (b)  $\gamma(Q) = \gamma(P) + \tau\gamma(G)$ .

PROPOSITION 1.6.11. *Each face of a 2-truncated cube is a 2-truncated cube.*

PROOF. It is enough to show that if  $P$  is a 2-truncated cube, then all the facets of  $P$  are 2-truncated cubes. The proof is by induction on the number of face truncations. Let the polytope  $Q$  be obtained from a 2-truncated cube  $P$  by 2-truncation at a face  $G$  of codimension 2. Then the new facet is  $G \times I$ , and it is a 2-truncated cube by the induction assumption. Every other facet  $F'$  of the polytope  $Q$  is either a facet of  $P$ , or obtained from a facet  $F''$  of  $P$  by 2-truncation at a face  $G' \subset F''$ .  $\square$

PROPOSITION 1.6.12. *Any 2-truncated cube  $P$  satisfies  $\gamma_i(P) \geq 0$ , i.e. the Gal conjecture holds for 2-truncated cubes.*

PROOF. We proceed by induction on the dimension of  $P$ , using Proposition 1.6.11 and the formula  $\gamma(Q) = \gamma(P) + \tau\gamma(G)$ .  $\square$

Here is a criterion for a nestohedron to be a flagtope.

PROPOSITION 1.6.13 ([64], [266]). *Let  $\mathcal{B}$  be a building set on  $[n+1]$ . Then the nestohedron  $P_{\mathcal{B}}$  is a flagtope if and only if for every element  $S \in \mathcal{B}$  with  $|S| > 1$  there exist elements  $S', S'' \in \mathcal{B}$  such that  $S' \sqcup S'' = S$ .*

PROOF. Suppose  $P_{\mathcal{B}}$  is a flagtope. Consider an element  $S \in \mathcal{B}$ . Then we may write  $S = S_1 \sqcup \dots \sqcup S_k$ , where  $S_1, \dots, S_k \in \mathcal{B} \setminus \{S\}$  and  $k$  is minimal among such decompositions of  $S$ . Then for any subset  $J \subset [k]$  with  $1 < |J| < k$  we have that  $\bigsqcup_{j \in J} S_j \notin \mathcal{B}$ , since otherwise  $k$  can be decreased. If  $k > 2$  then, by Theorem 1.5.13, the facets  $F_{S_1}, \dots, F_{S_k}$  of  $P_{\mathcal{B}}$  intersect pairwise, but have empty common intersection. Therefore,  $k = 2$ .

Suppose for each element  $S \in \mathcal{B}$  with  $|S| > 1$ , there exist elements  $S', S'' \in \mathcal{B}$  such that  $S' \sqcup S'' = S$ . Let  $F_{S_1}, \dots, F_{S_k}$ ,  $k \geq 3$ , be a minimal collection of facets that intersect pairwise but have empty common intersection. We shall lead this to a contradiction by finding a nontrivial subcollection of  $F_{S_1}, \dots, F_{S_k}$  with empty common intersection.

Assume there is a set  $\tilde{S} \in \mathcal{B}|_S$  intersecting more than one  $S_i$ , but not intersecting every  $S_i$ . Then the subcollection of facets  $F_{S_i}$  satisfying  $S_i \cap \tilde{S} \neq \emptyset$  will have empty common intersection, since

$$\bigsqcup_{S_i: S_i \cap \tilde{S} \neq \emptyset} S_i \in \mathcal{B}$$

by definition of a building set.

It remains to find  $\tilde{S} \in \mathcal{B}|_S$  intersecting more than one  $S_i$ , but not intersecting every  $S_i$ . By Theorem 1.5.13,  $S_1 \sqcup \dots \sqcup S_k = S \in \mathcal{B}$ . Therefore, we can write  $S = S' \sqcup S''$ , where  $S', S'' \in \mathcal{B}$ . Let  $S^1$  be that of the sets  $S'$  and  $S''$  which intersects more elements  $S_i$  than the other. Then  $S^1$  intersects more than one  $S_i$ . If  $S^1$  does not intersect all of  $S_i$ , then we are done. Otherwise we write  $S^1 = S'^1 \sqcup S''^1$ , where  $S'^1, S''^1 \in \mathcal{B}$ , and choose as  $S^2$  that of the sets  $S'^1$  and  $S''^1$  which intersects more elements  $S_i$  than the other. If  $S^2$  intersects all the sets  $S_i$ , choose  $S^3$  in the same

way, and so on. Since the cardinality of the sets  $S^1, S^2, S^3, \dots$  strictly decreases, at some point this process stops, and we get that one of the sets  $S^i, S''^i$  intersects more than one  $S_i$ , but does not intersect every  $S_i$ .  $\square$

**PROPOSITION 1.6.14 ([266]).** *Let  $\mathcal{B}$  be a building set on  $[n+1]$  such that  $P_{\mathcal{B}}$  is a flagtope. Then there exists a building set  $\mathcal{B}_0 \subset \mathcal{B}$  such that  $P_{\mathcal{B}_0}$  is a combinatorial cube with  $\dim P_{\mathcal{B}_0} = \dim P_{\mathcal{B}}$ .*

**PROOF.** By Proposition 1.5.2, we need to consider only connected building sets. For  $n = 1$ , the proposition is true. Assuming that the assertion holds for  $m < n$ , we shall prove it for  $m = n$ . By Proposition 1.6.13, we have  $[n+1] = S' \sqcup S''$ , where  $S', S'' \in \mathcal{B}$ . By the induction assumption, the building sets  $\mathcal{B}|_{S'}$  and  $\mathcal{B}|_{S''}$  have subsets  $\mathcal{B}'_0$  and  $\mathcal{B}''_0$  whose corresponding nestohedra are cubes. The building set  $\mathcal{B}_0 = (\mathcal{B}'_0 \sqcup \mathcal{B}''_0) \cup [n+1]$  is the desired one (see Example 1.5.22).  $\square$

It now follows from Lemma 1.5.17 that a flag nestohedron can be obtained from a cube by a sequence of face truncations. The following lemma shows that there is a sequence consisting only of codimension-2 face truncations:

**LEMMA 1.6.15.** *Let  $\mathcal{B}_1 \subset \mathcal{B}_2$  be connected building sets on  $[n+1]$  whose corresponding nestohedra  $P_{\mathcal{B}_1}$  and  $P_{\mathcal{B}_2}$  are flagtopes. Then*

- (a)  $P_{\mathcal{B}_2}$  is obtained from  $P_{\mathcal{B}_1}$  by a sequence of 2-truncations;
- (b)  $\gamma_i(P_{\mathcal{B}_1}) \leq \gamma_i(P_{\mathcal{B}_2})$  for  $i = 0, 1, \dots, [n/2]$ .

Furthermore, if  $\mathcal{B}_1 \neq \mathcal{B}_2$ , then the inequality above is strict for some  $i$ .

**PROOF.** Let  $S$  be a minimal (by inclusion) element of  $\mathcal{B}_2 \setminus \mathcal{B}_1$ . We set  $\mathcal{B}' = \widehat{\mathcal{B}_1 \cup \{S\}}$  to be the minimal (by inclusion) building set containing  $\mathcal{B}_1 \cup \{S\}$ . By Proposition 1.6.13, there exist  $S', S'' \in \mathcal{B}_2$  such that  $S' \sqcup S'' = S$ . It follows from the choice of  $S$  that  $S', S'' \in \mathcal{B}_1$ . It is easy to show that  $\mathcal{B}'$  is the collection of sets  $\mathcal{B}_1 \cup \{T = T' \sqcup T'' : T', T'' \in \mathcal{B}_1, S' \subset T', S'' \subset T''\}$ . Hence, the decomposition of any element of  $\mathcal{B}' \setminus \mathcal{B}_1$  consists of two elements. Therefore, by Lemma 1.5.17, the nestohedron  $P_{\mathcal{B}'}$  is obtained from  $P_{\mathcal{B}_1}$  by a sequence of 2-truncations.

Since  $\mathcal{B}_1 \subsetneq \mathcal{B}' \subset \mathcal{B}_2$ , we can finish the proof of (a) by induction on the number of elements in  $\mathcal{B}_2 \setminus \mathcal{B}_1$ . Statement (b) follows from Corollary 1.6.10.  $\square$

Finally we can prove the main result of this section, giving a characterisation of flag nestohedra:

**THEOREM 1.6.16 ([64]).** *A nestohedron  $P_{\mathcal{B}}$  is a flagtope if and only if it is a 2-truncated cube.*

*More precisely, if  $P_{\mathcal{B}}$  is a flagtope, then there exists a sequence of building sets  $\mathcal{B}_0 \subset \mathcal{B}_1 \subset \dots \subset \mathcal{B}_N = \mathcal{B}$ , where  $P_{\mathcal{B}_0}$  is a combinatorial cube,  $\mathcal{B}_i = \mathcal{B}_{i-1} \cup \{S_i\}$ , and  $P_{\mathcal{B}_i}$  is obtained from  $P_{\mathcal{B}_{i-1}}$  by 2-truncation at the face  $F_{S_{j_1}} \cap F_{S_{j_2}} \subset P_{\mathcal{B}_{i-1}}$ , where  $S_i = S_{j_1} \sqcup S_{j_2}$ , and  $S_{j_1}, S_{j_2} \in \mathcal{B}_{i-1}$ .*

**PROOF.** By Proposition 1.5.23, we need to consider only connected building sets. The ‘only if’ statement follows from Proposition 1.6.14 and Lemma 1.6.15. To prove the ‘if’ statement we need to check that a polytope obtained from a flagtope by a 2-truncation is a flagtope. This is left as an exercise.  $\square$

Together with Proposition 1.6.12, Theorem 1.6.16 implies

**COROLLARY 1.6.17.** *The Gal conjecture holds for all flag nestohedra  $P_{\mathcal{B}}$ , i.e.  $\gamma_i(P_{\mathcal{B}}) \geq 0$ .*

**EXAMPLE 1.6.18.** Let us see how Theorem 1.6.16 works in the case of the 3-dimensional associahedron. The building set corresponding to  $As^3$  is given by

$$\mathcal{B} = \{\{1\}, \{2\}, \{3\}, \{4\}, \{1, 2\}, \{2, 3\}, \{3, 4\}, \{1, 2, 3\}, \{2, 3, 4\}, \{1, 2, 3, 4\}\}$$

(see Fig. 1.5, right). In order to obtain  $As^3$  from  $I^3$  by 2-truncations, we have to specify a building set  $\mathcal{B}_0 \subset \mathcal{B}$ , such that  $P_{\mathcal{B}_0} \approx I^3$ , and to order the elements of  $\mathcal{B} \setminus \mathcal{B}_0$  in such a way that adding a new element to the building set corresponds to a 2-truncation.

First let  $\mathcal{B}_0$  consist of  $\{i\}, \{1, 2\}, \{3, 4\}, [4]$ . The associahedron  $P_{\mathcal{B}}$  is then obtained from  $P_{\mathcal{B}_0} \approx I^3$  by consecutive truncation at the faces  $F_{\{1,2\}} \cap F_{\{3\}}, F_{\{2\}} \cap F_{\{3,4\}}, F_{\{2\}} \cap F_{\{3\}}$  in this order. (Warning:  $P_{\mathcal{B}_0}$  is *not* the rectangular parallelepiped, it is a tetrahedron with two opposite edges truncated. However the three 2-truncations of  $P_{\mathcal{B}_0}$  described here and the three 2-truncations of the rectangular parallelepiped described in Example 1.5.27 give the same (up to affine equivalence) polytope  $As^3$  shown in Fig. 1.5, right.)

Another option is to let  $\mathcal{B}_0$  consist of  $\{i\}, \{1, 2\}, \{1, 2, 3\}, [4]$ . Then  $P_{\mathcal{B}_0}$  is obtained from a tetrahedron by truncating a vertex and then truncating an edge which contained this vertex; we have that  $P_{\mathcal{B}_0} \approx I^3$ . To obtain the associahedron  $P_{\mathcal{B}}$  from  $P_{\mathcal{B}_0}$  we first truncate the face  $F_{\{2\}} \cap F_{\{3\}}$  of  $P_{\mathcal{B}_0} \approx I^3$  and get the new facet  $F_{\{2,3\}}$ . Then we truncate the faces  $F_{\{2,3\}} \cap F_{\{4\}}$  and  $F_{\{3\}} \cap F_{\{4\}}$ .

### Exercises.

1.6.19. In a flagtope, a collection of pairwise intersecting faces (of any dimension) has a nonempty intersection.

1.6.20. A face of a flagtope is a flagtope. This generalises Proposition 1.6.3.

1.6.21. Give an example of a triangle-free simple  $n$ -polytope with  $2n + 3$  facets which is not a flagtope.

1.6.22. Give an example of a non-flag simple polytope  $P$  with  $\gamma_i(P) \geq 0$ .

1.6.23. A polytope obtained from a flagtope by a 2-truncation is a flagtope.

1.6.24 ([64, Theorem 9.1]). The face vectors of  $n$ -dimensional flag nestohedra  $P_{\mathcal{B}}$  satisfy

- (a)  $\gamma_i(I^n) \leq \gamma_i(P_{\mathcal{B}}) \leq \gamma_i(Pe^n)$  for  $i = 0, 1, \dots, [n/2]$ ;
- (b)  $g_i(I^n) \leq g_i(P_{\mathcal{B}}) \leq g_i(Pe^n)$  for  $i = 0, 1, \dots, [n/2]$ ;
- (c)  $h_i(I^n) \leq h_i(P_{\mathcal{B}}) \leq h_i(Pe^n)$  for  $i = 0, 1, \dots, n$ ;
- (d)  $f_i(I^n) \leq f_i(P_{\mathcal{B}}) \leq f_i(Pe^n)$  for  $i = 0, 1, \dots, n$ .

Furthermore, the lower bounds are achieved only for  $P_{\mathcal{B}} = I^n$  and the upper bounds are achieved only for  $P_{\mathcal{B}} = Pe^n$ . (Hint: to prove (a) use Lemma 1.6.15. The other inequalities follow from Proposition 1.3.13.)

1.6.25 ([64, Theorem 9.2]). The face vectors of graph associahedra  $P_{\Gamma}$  corresponding to connected graphs  $\Gamma$  on  $[n + 1]$  satisfy

- (a)  $\gamma_i(As^n) \leq \gamma_i(P_{\Gamma}) \leq \gamma_i(Pe^n)$  for  $i = 0, 1, \dots, [n/2]$ ;
- (b)  $g_i(As^n) \leq g_i(P_{\Gamma}) \leq g_i(Pe^n)$  for  $i = 0, 1, \dots, [n/2]$ ;
- (c)  $h_i(As^n) \leq h_i(P_{\Gamma}) \leq h_i(Pe^n)$  for  $i = 0, 1, \dots, n$ ;

(d)  $f_i(As^n) \leq f_i(P_\Gamma) \leq f_i(Pe^n)$  for  $i = 0, 1, \dots, n$ .

Furthermore, the lower bounds are achieved only for  $P_B = As^n$  and the upper bounds are achieved only for  $P_B = Pe^n$ .

### 1.7. Differential algebra of combinatorial polytopes

Here we develop a differential-algebraic formalism that will allow us to analyse the combinatorics of families of polytopes and their face numbers from the viewpoint of differential equations. All polytopes in this section are combinatorial.

**Ring of polytopes.** Denote by  $\mathfrak{P}^{2n}$  the free abelian group generated by all combinatorial  $n$ -polytopes. The group  $\mathfrak{P}^{2n}$  is infinitely generated for  $n > 1$ , and it splits into a direct sum of finitely generated components as follows:

$$\mathfrak{P}^{2n} = \bigoplus_{m \geq n+1} \mathfrak{P}^{2n, 2(m-n)}$$

where  $\mathfrak{P}^{2n, 2(m-n)}$  is the group generated by  $n$ -polytopes with  $m$  facets. (The fact that there are finitely many combinatorial polytopes with a given number of facets is left as an exercise.)

DEFINITION 1.7.1. The product of polytopes turns the direct sum

$$\mathfrak{P} = \bigoplus_{n \geq 0} \mathfrak{P}^{2n} = \mathfrak{P}^0 + \bigoplus_{m \geq 2} \bigoplus_{n=1}^{m-1} \mathfrak{P}^{2n, 2(m-n)}$$

into a bigraded commutative ring, the *ring of polytopes*. The unit is  $P^0$ , a point.

Simple polytopes generate a bigraded subring of  $\mathfrak{P}$ , which we denote by  $\mathfrak{S}$ .

A polytope is *indecomposable* if it cannot be represented as a product of two other polytopes of positive dimension.

PROPOSITION 1.7.2 ([50, Proposition 2.22]).  $\mathfrak{P}$  is a polynomial ring generated by indecomposable combinatorial polytopes.

PROOF. We need to show that any polytope  $P$  of positive dimension can be represented as a product of indecomposable polytopes,  $P = P_1 \times \dots \times P_k$ , and this representation is unique up to reordering the factors. The existence of such a decomposition is clear. Now assume that  $P_1 \times \dots \times P_k \approx Q_1 \times \dots \times Q_s$ . Fix a vertex  $v = v_1 \times \dots \times v_k = w_1 \times \dots \times w_s$ , where  $v_i \in P_i$  and  $w_j \in Q_j$ . The faces of the form  $v_1 \times \dots \times P_i \times \dots \times v_k$  and  $w_1 \times \dots \times Q_j \times \dots \times w_s$  are maximal indecomposable faces of  $P$  containing the vertex  $v$ , and therefore they bijectively correspond to each other under the combinatorial equivalence. It follows that  $k = s$  and  $P_i \approx Q_i$  for  $i = 1, \dots, k$  up to a permutation of factors.

Since  $\mathfrak{P}$  is a free abelian group generated by combinatorial polytopes, and each polytope can be uniquely represented by a monomial in indecomposable polytopes, it follows that  $\mathfrak{P}$  is a polynomial ring on indecomposable polytopes.  $\square$

Given  $P \in \mathfrak{P}^{2n}$ , denote by  $dP \in \mathfrak{P}^{2(n-1)}$  the sum of all facets of  $P$  in the ring  $\mathfrak{P}$ . The following lemma is straightforward.

LEMMA 1.7.3.  $d: \mathfrak{P} \rightarrow \mathfrak{P}$  is a linear operator of degree  $-2$  satisfying the identity

$$d(P_1 P_2) = (dP_1) P_2 + P_1 (dP_2).$$

Therefore,  $\mathfrak{P}$  is a differential ring, and  $\mathfrak{S}$  is its differential subring.



EXAMPLE 1.7.4. We have

$$dI^n = n(dI)I^{n-1} = 2nI^{n-1}, \quad \text{and} \quad d\Delta^n = (n+1)\Delta^{n-1}.$$

**Face-polynomials revisited.** By Proposition 1.3.6, the  $F$ -polynomial and the  $H$ -polynomial define ring homomorphisms

$$F: \mathfrak{P} \longrightarrow \mathbb{Z}[s, t], \quad H: \mathfrak{P} \longrightarrow \mathbb{Z}[s, t],$$

which send  $P \in \mathfrak{P}$  to  $F(P)(s, t)$  and  $H(P)(s, t)$  respectively.

THEOREM 1.7.5. *For any simple polytope  $P$  we have*

$$(1.29) \quad F(dP) = \frac{\partial}{\partial t} F(P).$$

PROOF. Assume that  $P$  is a simple  $n$ -polytope with facets  $P_1, \dots, P_m$ . Then

$$F(dP) = \sum_{i=1}^m F(P_i) = \sum_{i=1}^m \sum_{k=0}^{n-1} f_k(P_i) s^k t^{n-1-k}.$$

On the other hand,

$$\frac{\partial}{\partial t} F(P) = \sum_{k=0}^{n-1} (n-k) f_k(P) s^k t^{n-1-k}.$$

Comparing the coefficients in the two sums above we reduce (1.29) to

$$(1.30) \quad \sum_{i=1}^m f_k(P_i) = (n-k) f_k(P).$$

Since  $P$  is simple, every  $k$ -face is contained in exactly  $n-k$  facets, so it is counted  $n-k$  times on the left hand side of the above identity.  $\square$

COROLLARY 1.7.6. *Let  $P_1$  and  $P_2$  be two simple  $n$ -polytopes such that  $dP_1 = dP_2$  in  $\mathfrak{S}$ . Then  $F(P_1) = F(P_2)$ .*

PROOF. Indeed,  $F(dP_1) = F(dP_2)$  implies that  $\frac{\partial F(P_1)}{\partial t} = \frac{\partial F(P_2)}{\partial t}$ . Using that  $F(P)(s, 0) = s^n$  we obtain  $F(P_1) = F(P_2)$ .  $\square$

PROPOSITION 1.7.7. *Let  $\tilde{F}: \mathfrak{S} \rightarrow \mathbb{Z}[s, t]$  be a linear map such that*

$$\tilde{F}(dP) = \frac{\partial}{\partial t} \tilde{F}(P) \quad \text{and} \quad \tilde{F}(P)|_{t=0} = s^n.$$

*Then  $\tilde{F}(P) = F(P)$ .*

PROOF. We have  $\tilde{F}(P^0) = 1 = F(P^0)$ . Assume by induction the statement is true in dimensions  $\leq n-1$ , and let  $P$  be a simple  $n$ -polytope. Then  $\tilde{F}(dP)(s, t) = F(dP)(s, t)$ . It follows that  $\frac{\partial}{\partial t} \tilde{F}(P) = \frac{\partial}{\partial t} F(P)$ . Therefore,  $\tilde{F}(P)(s, t) = F(P)(s, t) + C(s)$ . Setting  $t = 0$ , we obtain  $s^n = s^n + C(s)$ , whence  $C(s) = 0$ .  $\square$

Theorem 1.7.5 also allows us to reduce the Dehn–Sommerville relations (1.12) to the Euler formula:

THEOREM 1.7.8. *The following identity holds for any simple  $n$ -polytope  $P$ :*

$$(1.31) \quad F(P)(s, t) = F(P)(-s, s+t).$$

PROOF. We have  $F(P^0)(s, t) = 1 = F(P^0)(-s, s + t)$ . Assume by induction the identity holds in dimensions  $\leq n - 1$ . Then for a given  $P$  of dimension  $n$  we have  $F(dP)(s, t) = F(dP)(-s, s + t)$ . Therefore,  $\frac{\partial}{\partial t}F(P)(s, t) = \frac{\partial}{\partial t}F(P)(-s, s + t)$  and  $F(P)(s, t) - F(P)(-s, s + t) = C(s)$ . By Euler's formula (1.11),

$$F(-s, s) = (f_0 - f_1 + \cdots + (-1)^n f_n) s^n = s^n.$$

Therefore,  $C(s) = F(P)(s, 0) - F(P)(-s, s) = 0$ .  $\square$

EXAMPLE 1.7.9. For a simple 3-polytope  $P^3$  with  $m = f_2$  facets we have  $f_1 = 3(m - 2)$ ,  $f_0 = 2(m - 2)$ . Assume that all facets are  $k$ -gons, so  $dP^3 = mP_k^2$ . Then by Theorem 1.7.5,

$$m(s^2 + kst + kt^2) = \frac{\partial}{\partial t}(s^3 + ms^2t + 3(m - 2)st^2 + 2(m - 2)t^3),$$

which implies  $m(6 - k) = 12$ . It follows that the pair  $(k, m)$  may only take values  $(3, 4)$ ,  $(4, 6)$  and  $(5, 12)$  corresponding to a simplex, cube and dodecahedron.

For general polytopes the difference  $\delta = Fd - \frac{\partial}{\partial t}F$  measures the failure of identity (1.29).

A polytope is said to be  $k$ -simple (for  $k \geq 0$ ) if each of its  $k$ -faces is an intersection of exactly  $n - k$  facets. For example, a simple polytope is 0-simple, while 1-simple polytopes are also known as *simple in edges*. Every  $n$ -polytope is  $(n - 1)$ - and  $(n - 2)$ -simple.

A polytope is  $k$ -simplicial if each of its  $k$ -dimensional faces is a simplex. A simplicial  $n$ -polytope is  $(n - 1)$ -simplicial, and every polytope is 1-simplicial. By polarity, if an  $n$ -polytope  $P$  is  $k$ -simple, then  $P^*$  is  $(n - 1 - k)$ -simplicial.

THEOREM 1.7.10. *Let  $P \in \mathfrak{P}$ . Then the following identity holds:*

$$F(dP) = \frac{\partial}{\partial t}F(P) + \delta(P),$$

where  $\delta: \mathfrak{P} \rightarrow \mathbb{Z}[s, t]$  is an  $F$ -derivation, i.e. it is linear and satisfies the identity

$$\delta(P_1P_2) = \delta(P_1)F(P_2) + F(P_1)\delta(P_2).$$

Moreover, if  $P$  is an  $n$ -polytope, then  $\delta(P) = \delta_2 s^{n-3}t^2 + \cdots + \delta_{n-1}t^{n-1}$  and  $\delta_i \geq 0$  for  $2 \leq i \leq n - 1$ . Also,  $P$  is  $k$ -simple if and only if  $\delta_{n-1-k} = 0$ ; in this case  $\delta_i = 0$  for  $2 \leq i \leq n - 1 - k$ .

PROOF. The fact that  $\delta = Fd - \frac{\partial}{\partial t}F$  is an  $F$ -derivation is verified by a direct computation. By (1.30) the coefficient of  $s^k t^{n-1-k}$  in  $\delta(P)$  is given by

$$\delta_{n-1-k} = \sum_{i=1}^m f_k(P_i) - (n - k)f_k(P).$$

It vanishes for  $k = n - 1$  and  $k = n - 2$  (as each codimension-two face of  $P$  is contained in exactly two facets). Also,  $\delta_{n-1-k}$  is non-negative because every  $k$ -face is contained in at least  $n - k$  facets. Finally, if  $P$  is  $k$ -simple, then every  $j$ -face is contained in exactly  $n - j$  facets for  $j \geq k$ , so  $\delta_{n-1-j}$  vanishes for  $j \geq k$ .  $\square$

EXAMPLE 1.7.11. Let  $P$  be a simple  $n$ -polytope, and  $P^*$  the dual simplicial polytope. Since the face poset of  $P^*$  is the opposite to the face poset of  $P$ ,

$$F(P^*)(s, t) = s^n + t \frac{F(P)(t, s) - t^n}{s} = s^n + \sum_{k=0}^{n-1} f_k(P) s^{n-1-k} t^{k+1}.$$

We have  $dP^* = f_0(P)\Delta^{n-1}$ , therefore,

$$\delta(P^*) = f_0(P) \frac{(s+t)^n - t^n}{s} - \frac{\partial}{\partial t} \sum_{k=0}^n f_k(P) s^{n-1-k} t^{k+1}.$$

The coefficient of  $s^{n-1-k} t^k$  on the right hand side above is given by

$$\delta_k(P^*) = \binom{n}{k} f_0(P) - (k+1)f_k(P), \quad \text{for } 1 \leq k \leq n.$$

This is non-negative by Theorem 1.7.10 or by Exercise 1.4.15.

The following properties of  $H(P)$  follow from the corresponding properties of  $F(P)$  established above and the identity  $H(P)(s, t) = F(P)(s - t, t)$ .

**THEOREM 1.7.12.**

- (a) *The ring homomorphism  $H: \mathfrak{B} \rightarrow \mathbb{Z}[s, t]$  satisfies  $H(P)|_{t=0} = s^n$ . The restriction of  $H$  to the subring  $\mathfrak{S}$  of simple polytopes satisfies the equation*

$$H(dP) = \partial H(P)$$

where  $\partial = \frac{\partial}{\partial s} + \frac{\partial}{\partial t}$ .

- (b) *The image of  $H$  is generated by  $H(\Delta^1) = s + t$  and  $H(\Delta^2) = s^2 + st + t^2$ .*  
(c) *If  $\tilde{H}: \mathfrak{S} \rightarrow \mathbb{Z}[s, t]$  is a linear map satisfying  $\tilde{H}(dP) = \partial \tilde{H}(P)$  and  $\tilde{H}(P)|_{t=0} = s^n$  for any simple  $n$ -polytope  $P$ , then  $\tilde{H}(P) = H(P)$ .*

**Ring of building sets.** Let  $\mathcal{B}_1$  and  $\mathcal{B}_2$  be building sets on  $[n_1]$  and  $[n_2]$  respectively. A map  $f: \mathcal{B}_1 \rightarrow \mathcal{B}_2$  of building sets is a map  $f: [n_1] \rightarrow [n_2]$  satisfying  $f^{-1}(S) \in \mathcal{B}_1$  for every  $S \in \mathcal{B}_2$ . Two building sets  $\mathcal{B}_1$  and  $\mathcal{B}_2$  are said to be *equivalent*, if there exist maps  $f: \mathcal{B}_1 \rightarrow \mathcal{B}_2$  and  $g: \mathcal{B}_2 \rightarrow \mathcal{B}_1$  of building sets such that the compositions  $f \circ g$  and  $g \circ f$  are the identity maps.

The *product* of  $\mathcal{B}_1$  and  $\mathcal{B}_2$  is the building set  $\mathcal{B}_1 \cdot \mathcal{B}_2$  on  $[n_1 + n_2]$  induced by appending the interval  $[n_2]$  to the interval  $[n_1]$ .

**EXAMPLE 1.7.13.** The collection  $\mathcal{S}$  of Example 1.5.3 and the complete collection  $\mathcal{C}$  are both connected building sets on  $[n + 1]$ . They are initial and terminal connected building sets respectively, since for every connected building set  $\mathcal{B}$  on  $[n + 1]$  there are maps  $\mathcal{C} \rightarrow \mathcal{B} \rightarrow \mathcal{S}$  of building sets induced by the identity map on  $[n + 1]$ .

**DEFINITION 1.7.14.** Denote by  $\mathfrak{B}^{2n}$  the free abelian group generated by the equivalence classes of building sets on  $[k]$  for  $k \leq n + 1$ . Since  $\mathcal{B}_1 \cdot \mathcal{B}_2$  is equivalent to  $\mathcal{B}_2 \cdot \mathcal{B}_1$ , the product turns  $\mathfrak{B} = \bigoplus_{n \geq 0} \mathfrak{B}^{2n}$  into a commutative associative ring.

Given a connected building set  $\mathcal{B}$  on  $[n + 1]$ , define

$$(1.32) \quad d\mathcal{B} = \sum_{S \in \mathcal{B} \setminus [n+1]} \mathcal{B}|_S \cdot \mathcal{B}/S$$

where the sum is taken in the ring  $\mathfrak{B}$ . Since  $\mathfrak{B}$  is generated by connected building sets, we may extend  $d$  to a linear map  $d: \mathfrak{B} \rightarrow \mathfrak{B}$  using the Leibniz formula

$$(1.33) \quad d(\mathcal{B}_1 \cdot \mathcal{B}_2) = (d\mathcal{B}_1) \cdot \mathcal{B}_2 + \mathcal{B}_1 \cdot (d\mathcal{B}_2).$$

We therefore get a derivation of  $\mathfrak{B}$ .

PROPOSITION 1.7.15. *The map  $\mathcal{B} \mapsto P_{\mathcal{B}}$  induces a differential ring homomorphism  $\beta: \mathfrak{B} \rightarrow \mathfrak{P}$ . Its image is a graded subring with unit in  $\mathfrak{P}$  multiplicatively generated by nestohedra  $P_{\mathcal{B}}$  corresponding to connected building sets  $\mathcal{B}$ .*

PROOF. The fact that  $\beta$  is a ring homomorphism is obvious. It follows from Corollary 1.5.12 and (1.33) that  $\beta$  commutes with the differentials. Every building set consisting only of singletons is mapped to  $P^0$  which represents a unit in  $\mathfrak{P}$ . Finally, it follows from Proposition 1.5.2 (a) that the image  $\beta(\mathfrak{B})$  is generated by  $P_{\mathcal{B}}$  with connected  $\mathcal{B}$ .  $\square$

REMARK. The ring  $\mathfrak{B}$  does not have unit, and the map  $\beta$  is not injective.

Given a subset  $S \subset [n+1]$ , denote by  $\Gamma|_S$  the restriction of  $\Gamma$  to the vertex set  $S$ , and denote by  $\Gamma/S$  the graph with the vertex set  $[n+1] \setminus S$  having an edge between two vertices  $i$  and  $j$  whenever they are path connected in  $\Gamma_{S \cup \{i,j\}}$ .

PROPOSITION 1.7.16. *For a connected graph  $\Gamma$  on  $n+1$  vertices, we have*

$$dP_{\Gamma} = \sum_{\substack{S \subsetneq [n+1] \\ \Gamma|_S \text{ is connected}}} P(\Gamma|_S) \times P(\Gamma/S).$$

PROOF. Follows directly from (1.32).  $\square$

EXAMPLE 1.7.17. We have the following formulae for the differentials of the four graph-associahedra defined in Section 1.5:

$$\begin{aligned} dAs^n &= \sum_{i+j=n-1} (i+2)As^i \times As^j; \\ dPe^n &= \sum_{i+j=n-1} \binom{n+1}{i+1} Pe^i \times Pe^j; \\ dCy^n &= (n+1) \sum_{i+j=n-1} As^i \times Cy^j; \\ dSt^n &= n \cdot St^{n-1} + \sum_{i=0}^{n-1} \binom{n}{i} St^i \times Pe^{n-i-1}. \end{aligned}$$

For example (see Figs. 1.4–1.8),

$$\begin{aligned} dAs^3 &= 2As^0 \times As^2 + 3As^1 \times As^1 + 4As^2 \times As^0; \\ dPe^3 &= 4Pe^0 \times Pe^2 + 6Pe^1 \times Pe^1 + 4Pe^2 \times Pe^0; \\ dCy^3 &= 4(As^0 \times Cy^2 + As^1 \times Cy^1 + As^2 \times Cy^0); \\ dSt^3 &= 3St^2 + St^0 \times Pe^2 + 3St^1 \times Pe^1 + 3St^2 \times Pe^0. \end{aligned}$$

### Exercises.

1.7.18. Show that there are finitely many combinatorial polytopes with a given number of facets.

1.7.19. Show that  $\delta = Fd - \frac{\partial}{\partial t}F$  is an  $F$ -derivation.

### 1.8. Families of polytopes and differential equations

In this section, using the language of generating series, we interpret the formulae for the differential of nestohedra and graph-associahedra as certain partial differential equations. These differential equations encode the combinatorial information of the face structure of nestohedra. This exposition builds upon the results of [51] and [48].

Denote by  $\mathfrak{P}[q]$  the polynomial ring in an indeterminate  $q$  with coefficients in  $\mathfrak{P}$ .

PROPOSITION 1.8.1. *Let*

$$Q: \mathfrak{P} \rightarrow \mathfrak{P}[q], \quad P \mapsto Q(P; q)$$

be a linear map such that

$$Q(dP; q) = \frac{\partial}{\partial q} Q(P; q) \quad \text{and} \quad Q(P; 0) = P$$

for any polytope  $P$ . Then

$$Q(P; q) = \sum_{k=0}^n (d^k P) \frac{q^k}{k!}.$$

PROOF. Use induction by dimension, as in the proof of Proposition 1.7.7.  $\square$

Now assume given a sequence  $\mathcal{P} = \{P^n, n \geq 0\}$  of polytopes, one in each dimension. We define its *generating series* as the formal power series

$$\mathcal{P}(x) = \sum_{n \geq 0} \lambda_n P^n x^{n+n_0}$$

in  $\mathfrak{P} \otimes \mathbb{Q}[[x]]$ . The parameter  $n_0$  and the coefficients  $\lambda_n$  will be chosen depending on a particular sequence  $\mathcal{P}$ . Using the transformation  $Q$  of the previous proposition we may define the following 2-parameter extension of the generating series:

$$(1.34) \quad \mathcal{P}(q, x) = \sum_{n \geq 0} \lambda_n Q(P^n; q) x^{n+n_0}.$$

We have  $\mathcal{P}(0, x) = \mathcal{P}(x)$ .

We consider the following generating series of the six sequences of nestohedra:

$$(1.35) \quad \begin{aligned} \Delta(x) &= \sum_{n \geq 0} \Delta^n \frac{x^{n+1}}{(n+1)!}; & I(x) &= \sum_{n \geq 0} I^n \frac{x^n}{n!}; \\ As(x) &= \sum_{n \geq 0} As^n x^{n+2}; & Pe(x) &= \sum_{n \geq 0} Pe^n \frac{x^{n+1}}{(n+1)!}; \\ Cy(x) &= \sum_{n \geq 0} Cy^n \frac{x^{n+1}}{n+1}; & St(x) &= \sum_{n \geq 0} St^n \frac{x^n}{n!}. \end{aligned}$$

LEMMA 1.8.2. *The differentials of the generating series above are given by*

$$\begin{aligned} d\Delta(x) &= x\Delta(x); & dI(x) &= 2xI(x); \\ dAs(x) &= As(x) \frac{d}{dx} As(x); & dPe(x) &= Pe^2(x); \\ dCy(x) &= As(x) \frac{d}{dx} Cy(x); & dSt(x) &= (x + Pe(x))St(x). \end{aligned}$$

PROOF. This follows from the formulae of Examples 1.7.4 and 1.7.17.  $\square$

THEOREM 1.8.3. *The two-parameter extensions of the generating series (1.35) satisfy the following partial differential equations:*

$$\begin{aligned} \frac{\partial}{\partial q} \Delta(q, x) &= x\Delta(q, x); & \frac{\partial}{\partial q} I(q, x) &= 2xI(q, x); \\ \frac{\partial}{\partial q} As(q, x) &= As(q, x) \frac{\partial}{\partial x} As(q, x); & \frac{\partial}{\partial q} Pe(q, x) &= Pe^2(q, x); \\ \frac{\partial}{\partial q} Cy(q, x) &= As(q, x) \frac{\partial}{\partial x} Cy(q, x); & \frac{\partial}{\partial q} St(q, x) &= (x + Pe(q, x))St(q, x). \end{aligned}$$

PROOF. A direct calculation using formulae (1.34) and (1.35).  $\square$

REMARK. The role of the parameters  $\lambda_n$  in (1.34) can be illustrated as follows. If we replace the first series  $\Delta(x)$  of (1.35) by

$$\widehat{\Delta}(x) = \sum_{n \geq 0} \Delta^n \frac{x^{n+1}}{n+1},$$

then the first equations of Lemma 1.8.2 and Theorem 1.8.3 take the form

$$d\widehat{\Delta}(x) = x^2 \frac{d}{dx} \widehat{\Delta}(x), \quad \frac{\partial}{\partial q} \widehat{\Delta}(q, x) = x^2 \frac{d}{dx} \widehat{\Delta}(q, x).$$

Four of the equations of Theorem 1.8.3, namely those corresponding to the series  $\Delta$ ,  $I$ ,  $Pe$  and  $St$ , are ordinary differential equations. Their solutions are completely determined by the initial data  $\mathcal{P}(0, x) = \mathcal{P}(x)$  and are given by the explicit formulae

$$\begin{aligned} \Delta(q, x) &= \Delta(x)e^{qx}; & I(q, x) &= I(x)e^{2qx}; \\ Pe(q, x) &= \frac{Pe(x)}{1 - qPe(x)}; & St(q, x) &= St(x) \frac{e^{qx}}{1 - qPe(x)}. \end{aligned}$$

The equation for  $U = As(q, x)$  has the form  $U_q = UU_x$ . This classical quasilinear partial differential equation was considered by E. Hopf, and therefore became known as the *Hopf equation*.

THEOREM 1.8.4.

(a) *The series  $As(q, x)$  is given by the solution of the functional equation (equation on characteristics)*

$$(1.36) \quad As(q, x) = As(x + qAs(q, x)),$$

where  $As(x) = As(0, x)$ .

(b) *The series  $Cy(q, x)$  is given by the solution of*

$$(1.37) \quad Cy(q, x) = Cy(x + qAs(q, x)),$$

where  $Cy(x) = Cy(0, x)$ .

PROOF. Set  $U = As(q, x)$  and  $As_x = \frac{d}{dx} As(x)$ . If  $U$  is a solution to (1.36), then we obtain by differentiating

$$U_q = (U + qU_q)As_x, \quad U_x = (1 + qU_x)As_x.$$

Therefore,  $(1 - qAs_x)U_q = UAs_x$  and  $(1 - qAs_x)U_x = As_x$ , which implies that  $U$  satisfies the Hopf equation  $U_q = UU_x$ . Its solution with the initial condition  $U(0, x) = As(x)$  is unique by the general theory of quasilinear equations (in our case the uniqueness can be also verified using standard arguments with power series).

Similarly, by differentiating (1.37) we obtain for  $V = Cy(q, x)$ :

$$V_q = (U + qU_q)Cy_x, \quad V_x = (1 + qU_x)Cy_x.$$

Using that  $U_q = UU_x$  we rewrite the first equation above as  $V_q = U(1 + qU_x)Cy_x$ , which implies  $V_q = UV_x$  as claimed. This is exactly the equation for  $V = Cy(q, x)$  given by Theorem 1.8.3, and its solution with  $V(0, x) = Cy(x)$  is unique.  $\square$

We can also use Lemma 1.8.2 to calculate the face-polynomials  $F(s, t)$  of graph-associahedra. Let  $\mathcal{P}(x)$  be one of the generating series (1.35), and set

$$F_{\mathcal{P}} = F(\mathcal{P}(x)) = \sum_{n \geq 0} \lambda^n x^{n+n_0} \sum_{k=0}^n f_k(P^n) s^k t^{n-k}.$$

We refer to  $F_{\mathcal{P}} = F_{\mathcal{P}}(s, t; x)$  as the *generating series of face-polynomials*; it is a series in  $x$  whose coefficients are polynomials in  $s$  and  $t$ .

**THEOREM 1.8.5.** *The generating series of face-polynomials corresponding to (1.35) satisfy the following differential equations, with the initial conditions given in the second column:*

$$\begin{aligned} \frac{\partial}{\partial t} F_{\Delta} &= xF_{\Delta}, & F_{\Delta}(s, 0; x) &= \frac{e^{sx} - 1}{s}; \\ \frac{\partial}{\partial t} F_I &= 2xF_I, & F_I(s, 0; x) &= e^{sx}; \\ \frac{\partial}{\partial t} F_{As} &= F_{As} \frac{\partial}{\partial x} F_{As}, & F_{As}(s, 0; x) &= \frac{x^2}{1 - sx}; \\ \frac{\partial}{\partial t} F_{Pe} &= F_{Pe}^2, & F_{Pe}(s, 0; x) &= \frac{e^{sx} - 1}{s}; \\ \frac{\partial}{\partial t} F_{Cy} &= F_{As} \frac{\partial}{\partial x} F_{Cy}, & F_{Cy}(s, 0; x) &= -\frac{\ln(1 - sx)}{s}; \\ \frac{\partial}{\partial t} F_{St} &= (x + F_{Pe})F_{St}, & F_{St}(s, 0; x) &= e^{sx}. \end{aligned}$$

**PROOF.** The differential equations are obtained by applying  $F$  to the equations of Lemma 1.8.2 and using the fact that  $F(dP) = \frac{\partial}{\partial t} F(P)$ . The initial conditions follow by substituting  $s^n$  for  $P^n$  in (1.35) and calculating the resulting series.  $\square$

Again, the four equations for the series  $F_{\Delta}$ ,  $F_I$ ,  $F_{Pe}$  and  $F_{St}$  are ordinary differential equations. Their solutions are completely determined by the initial data; the explicit formulae are left as exercises. The remaining two partial differential equations for the series  $F_{As}$  and  $F_{Cy}$  can be explicitly solved as follows.

**THEOREM 1.8.6.**

(a) *The series  $U = F_{As}$  satisfies the quadratic equation*

$$(1.38) \quad t(s + t)U^2 + (2tx + sx - 1)U + x^2 = 0.$$

*The initial condition  $F_{As}(s, 0; x) = \frac{x^2}{1 - sx}$  determines its solution uniquely.*

(b) The series  $F_{C_y}$  is given by

$$F_{C_y} = -\frac{1}{s} \ln(1 - s(x + tF_{A_s})).$$

PROOF. (a) By analogy with (1.36) we show that  $U = F_{A_s}$  satisfies

$$U = \varphi(x + tU),$$

where  $\varphi(x) = F_{A_s}(s, 0; x) = \frac{x^2}{1-sx}$ . It is equivalent to (1.38).

(b) We have that  $V = F_{C_y}$  is given by the solution to  $V_t = UV_x$ . By analogy with (1.37) we show that it is given by

$$V = \psi(x + tU),$$

where  $U = F_{A_s}$  and  $\psi(x) = F_{C_y}(s, 0; x) = -\frac{\ln(1-sx)}{s}$ . □

As a corollary, we shall derive a formula for the number of  $k$ -faces in  $As^n$ , which equals the number of bracketing of a word of  $n+2$  letters with  $n-k$  pairs of brackets. These numbers were first calculated by Cayley in 1891:

**THEOREM 1.8.7.** *The number of  $k$ -dimensional faces in an  $n$ -dimensional as-sociahedron is given by*

$$f_k(As^n) = \frac{1}{n+2} \binom{n}{k} \binom{2n-k+2}{n+1}.$$

PROOF. We use the fact that  $F_{A_s}$  satisfies the Hopf equation, whose solutions may be obtained using conservation laws. Let

$$U(t, x) = \sum_{k \geq 0} U_k(x) t^k$$

be the solution of the Cauchy problem for the Hopf equation:

$$(1.39) \quad U_t = UU_x, \quad U(0, x) = \varphi(x).$$

This equation has the following conservation laws

$$\left( \frac{U^k}{k} \right)_t = \left( \frac{U^{k+1}}{k+1} \right)_x, \quad \text{for } k \geq 1.$$

Hence,

$$\frac{d^k}{dt^k} U = \frac{d^{k-1}}{dt^{k-1}} \left( \frac{U^2}{2} \right)_x = \frac{d^{k-2}}{dt^{k-2}} \left( \frac{U^3}{3} \right)_{xx} = \dots = \frac{d^k}{dx^k} \left( \frac{U^{k+1}}{k+1} \right), \quad \text{for } k \geq 1.$$

Evaluating at  $t = 0$  we obtain

$$\frac{d^k}{dt^k} U \Big|_{t=0} = k! U_k(x) = \frac{d^k}{dx^k} \left( \frac{U_0^{k+1}(x)}{k+1} \right).$$

Therefore,

$$U_k(x) = \frac{1}{(k+1)!} \frac{d^k}{dx^k} \varphi^{k+1}(x).$$

By Theorem 1.8.5 the function

$$(1.40) \quad U = F_{A_s}(s, t; x) = \sum_{n \geq 0} \sum_{k=0}^n f_{n-k}(As^n) s^{n-k} t^k x^{n+2}$$



satisfies the Hopf equation (1.39) with the initial function  $\varphi(s; x) = \frac{x^2}{1-sx}$ . We therefore calculate

$$\begin{aligned} U_k(s; x) &= \frac{1}{(k+1)!} \frac{d^k}{dx^k} \left( \frac{x^{2(k+1)}}{(1-sx)^{k+1}} \right) \\ &= \frac{1}{(k+1)!} \frac{d^k}{dx^k} \left( x^{2(k+1)} \sum_{l \geq 0} \binom{l+k}{l} s^l x^l \right) \\ &= \frac{1}{(k+1)!} \sum_{l \geq 0} \binom{l+k}{k} \frac{(2k+l+2)!}{(k+l+2)!} s^l x^{k+l+2} \\ &= \sum_{n \geq k} \frac{1}{n+2} \binom{n}{k} \binom{n+k+2}{n+1} s^{n-k} x^{n+2}. \end{aligned}$$

On the other hand, it follows from (1.40) that

$$U_k(s; x) = \sum_{n \geq k} f_{n-k}(As^n) s^{n-k} x^{n+2}.$$

Comparing the last two formulae we obtain

$$f_{n-k}(As^n) = \frac{1}{n+2} \binom{n}{k} \binom{n+k+2}{n+1},$$

which is equivalent to the required formula.  $\square$

### Exercises.

1.8.8. By solving the first two differential equations of Theorem 1.8.5 show that the generating series for the  $F$ -polynomials of simplices and cubes are given by

$$\begin{aligned} F_{\Delta}(s, t; x) &= \sum_{n \geq 0} F(\Delta^n) \frac{x^{n+1}}{(n+1)!} = e^{tx} \frac{e^{sx} - 1}{s}, \\ F_I(s, t; x) &= \sum_{n \geq 0} F(I^n) \frac{x^n}{n!} = e^{tx} e^{(s+t)x}. \end{aligned}$$

Compare this with the formulae for  $F(\Delta^n)$  and  $F(I^n)$ .

1.8.9. Show by solving the corresponding differential equations from Theorem 1.8.5 that the generating series for the face-polynomials of permutahedra and stellahedra are given by

$$\begin{aligned} F_{Pe}(s, t; x) &= \sum_{n \geq 0} F(Pe^n) \frac{x^{n+1}}{(n+1)!} = \frac{e^{sx} - 1}{s - t(e^{sx} - 1)}, \\ F_{St}(s, t; x) &= \sum_{n \geq 0} F(St^n) \frac{x^n}{n!} = \frac{se^{(s+t)x}}{s - t(e^{sx} - 1)}. \end{aligned}$$

Compute the face-polynomials  $F(Pe^n)$  and  $F(St^n)$  and the face numbers explicitly.

1.8.10. Define the generating series  $H_{\mathcal{P}}(s, t; x)$  of  $H$ -polynomials by analogy with the generating series of face-polynomials. Deduce the following formulae for

sequences of nestohedra:

$$\begin{aligned}
 H_{\Delta}(s, t; x) &= \sum_{n \geq 0} H(\Delta^n) \frac{x^{n+1}}{(n+1)!} = \frac{e^{sx} - e^{tx}}{s-t}, \\
 H_I(s, t; x) &= \sum_{n \geq 0} H(I^n) \frac{x^n}{n!} = e^{(s+t)x}, \\
 H_{Pe}(s, t; x) &= \sum_{n \geq 0} H(Pe^n) \frac{x^{n+1}}{(n+1)!} = \frac{e^{sx} - e^{tx}}{se^{tx} - te^{sx}}, \\
 H_{St}(s, t; x) &= \sum_{n \geq 0} H(St^n) \frac{x^n}{n!} = \frac{(s-t)e^{(s+t)x}}{se^{tx} - te^{sx}}.
 \end{aligned}$$

1.8.11. The series  $Y = H_{As}(s, t; x) = \sum_{n \geq 0} H(As^n)x^{n+2}$  satisfies the quadratic equation

$$Y = (x + sY)(x + tY).$$

The initial condition  $H_{As}(s, 0; x) = \frac{x^2}{1-sx}$  determines its solution uniquely.

1.8.12. The components of the  $h$ -vector of  $As^n$  are given by

$$h_k = \frac{1}{n+1} \binom{n+1}{k} \binom{n+1}{k+1}, \quad 0 \leq k \leq n.$$

## Combinatorial structures

The face poset of a convex polytope is a classical example of a combinatorial structure underlying a decomposition of a geometric object. With the development of combinatorial topology several new combinatorial structures emerged, such as simplicial and cubical complexes, simplicial posets and other types of regular cellular (or CW) complexes. Many of these structures have eventually become objects of independent study in geometric combinatorics.

A simplicial complex is the abstract combinatorial structure behind a simplicial subdivision (or *triangulation*) of a topological space. Triangulations were first introduced by Poincaré and provide a rigorous and convenient tool for studying topological invariants of smooth manifolds by combinatorial methods. The notion of a *nerve* of a covering of a topological space, introduced by Alexandroff, provides another source of examples of simplicial complexes.

The study of triangulations stimulated the development of first combinatorial and then algebraic topology in the first half of the XXth century. With the appearance of cellular complexes algebraic tools gradually replaced the combinatorial ones in mainstream topology. Simplicial complexes still play a pivotal role in *PL* (piecewise linear) topology, however nowadays the main source of interest in them is in discrete and computational geometry. One reason for that is the emergence of computers, since simplicial complexes provide the most effective way to translate geometric and topological structures into machine language.

We therefore may distinguish two different views on the role of simplicial complexes and triangulations. In topology, simplicial complexes and their different derivatives such as singular chains and simplicial sets are used as technical tools to study the topology of the underlying space. Most combinatorial invariants of nerves or triangulations (such as the number of faces of a given dimension) do not have meaning in topology, as they do not reflect any topological feature of the underlying space. Topologists therefore tend not to distinguish between simplicial complexes that have the same underlying topology. For instance, refining a triangulation (such as passing to the barycentric subdivision) changes the combinatorics drastically, but does not affect the underlying topology. On the other hand, in combinatorial geometry the combinatorics of a simplicial complex is what really matters, while the underlying topology is often simple or irrelevant.

In toric topology the combinatorist's point of view on triangulations and similar decompositions is enriched by elaborate topological techniques. Combinatorial invariants of triangulations therefore can be analysed by topological methods, and at the same time combinatorial structures such as simplicial complexes or posets become a source of examples of topological spaces and manifolds with nice features and lots of symmetry, e.g. bearing a torus action. The combinatorial structures are the subject of this chapter; the associated topological objects will come later.

Here we assume only minimal knowledge of topology. The reader may also check Appendix B for the definition of simplicial homology groups, etc.

### 2.1. Polyhedral fans

Like convex polytopes, polyhedral fans encode both geometrical and combinatorial information. The geometry of fans is poorer than that of convex polytopes, but this geometry is still a part of the structure of a fan, which distinguishes fans from the purely combinatorial objects considered later in this chapter.

Although fans were considered in convex geometry independently, the main source of interest to them is in the theory of *toric varieties*, which are classified by rational fans. Toric varieties are the subject of Chapter 5, and here we describe the terminology and constructions related to fans.

DEFINITION 2.1.1. A set of vectors  $\mathbf{a}_1, \dots, \mathbf{a}_k \in \mathbb{R}^n$  defines a *convex polyhedral cone*, or simply *cone*,

$$\sigma = \mathbb{R}_{\geq} \langle \mathbf{a}_1, \dots, \mathbf{a}_k \rangle = \{ \mu_1 \mathbf{a}_1 + \dots + \mu_k \mathbf{a}_k : \mu_i \in \mathbb{R}_{\geq} \}.$$

Here  $\mathbf{a}_1, \dots, \mathbf{a}_k$  are referred to as *generating vectors* (or *generators*) of  $\sigma$ . A *minimal* set of generators of a cone is defined up to multiplication of vectors by positive constants. A cone is *rational* if its generators can be chosen from the integer lattice  $\mathbb{Z}^n \subset \mathbb{R}^n$ . If  $\sigma$  is a rational cone, then its generators  $\mathbf{a}_1, \dots, \mathbf{a}_k$  are usually chosen to be *primitive*, i.e. each  $\mathbf{a}_i$  is the smallest lattice vector in the ray defined by it.

A cone is *strongly convex* if it does not contain a line. A cone is *simplicial* if it is generated by a part of basis of  $\mathbb{R}^n$ , and is *regular* if it is generated by a part of basis of  $\mathbb{Z}^n$ . (Regular cones play a special role in the theory of toric varieties, see Chapter 5.)

A cone is also an (unbounded) intersection of finitely many halfspaces in  $\mathbb{R}^n$ , so it is a convex polyhedron in the sense of Definition 1.1.2. We therefore may define face of a cone in the same way as we did for polytopes, as intersections of  $\sigma$  with supporting hyperplanes. We can only consider supporting hyperplanes containing  $\mathbf{0}$ ; such a hyperplane is defined by a linear function  $\mathbf{u}$  and will be denoted by  $\mathbf{u}^\perp$ . A *face*  $\tau$  of a cone  $\sigma$  is therefore an intersection of  $\sigma$  with a supporting hyperplane  $\mathbf{u}^\perp$ , i.e.  $\tau = \sigma \cap \mathbf{u}^\perp$ . Every face of a cone is itself a cone. If  $\sigma \neq \mathbb{R}^n$ , then  $\sigma$  has the smallest face  $\sigma \cap (-\sigma)$ ; it is a vertex  $\mathbf{0}$  if and only if  $\sigma$  strongly convex. A minimal generator set of a cone consists of nonzero vectors along its edges.

A *fan* is a finite collection  $\Sigma = \{\sigma_1, \dots, \sigma_s\}$  of strongly convex cones in some  $\mathbb{R}^n$  such that every face of a cone in  $\Sigma$  belongs to  $\Sigma$  and the intersection of any two cones in  $\Sigma$  is a face of each. A fan  $\Sigma$  is *rational* (respectively, *simplicial*, *regular*) if every cone in  $\Sigma$  is rational (respectively, simplicial, regular). A fan  $\Sigma = \{\sigma_1, \dots, \sigma_s\}$  is called *complete* if  $\sigma_1 \cup \dots \cup \sigma_s = \mathbb{R}^n$ .

Given a cone  $\sigma \subset \mathbb{R}^n$ , define its *dual* as

$$(2.1) \quad \sigma^\vee = \{ \mathbf{x} \in \mathbb{R}^n : \langle \mathbf{u}, \mathbf{x} \rangle \geq 0 \text{ for all } \mathbf{u} \in \sigma \}.$$

(Note the difference with the definition of the polar set of a polyhedron, see (1.4).) Observe that if  $\mathbf{u} \in \sigma^\vee$ , then  $\mathbf{u}^\perp$  is a supporting hyperplane of  $\sigma$ . It can be shown that  $\sigma^\vee$  is indeed a cone,  $(\sigma^\vee)^\vee = \sigma$ , and  $\sigma^\vee$  is strongly convex if and only if  $\dim \sigma = n$ .

Cones in a fan can be separated by hyperplanes (or linear functions):

LEMMA 2.1.2 (Separation Lemma). *Let  $\sigma$  and  $\sigma'$  be two cones whose intersection  $\tau$  is a face of each. Then there exists  $\mathbf{u} \in \sigma^\vee \cap (-\sigma')^\vee$  such that*

$$\tau = \sigma \cap \mathbf{u}^\perp = \sigma' \cap \mathbf{u}^\perp.$$

*In other words, a supporting hyperplane defining  $\tau$  can be chosen so as to separate  $\sigma$  and  $\sigma'$ .*

PROOF. We only sketch a proof; the details can be found, e.g. in [122, §1.2]. The fact that  $\sigma$  and  $\sigma'$  intersect in a face implies that the cone  $\xi = \sigma - \sigma' = \sigma + (-\sigma')$  is not the whole space. Let  $\mathbf{u}^\perp$  be a supporting hyperplane defining the smallest face of  $\xi$ , that is,

$$\xi \cap \mathbf{u}^\perp = \xi \cap (-\xi) = (\sigma - \sigma') \cap (\sigma' - \sigma).$$

We claim that this  $\mathbf{u}$  has the required properties. Indeed,  $\sigma \subset \xi$  implies  $\mathbf{u} \in \sigma^\vee$ , and  $\tau \subset \xi \cap (-\xi)$  implies  $\tau \subset \sigma \cap \mathbf{u}^\perp$ . Conversely, if  $\mathbf{x} \in \sigma \cap \mathbf{u}^\perp$ , then  $\mathbf{x}$  is in  $\sigma' - \sigma$ , so that  $\mathbf{x} = \mathbf{y}' - \mathbf{y}$  for  $\mathbf{y}' \in \sigma'$ ,  $\mathbf{y} \in \sigma$ . Then  $\mathbf{x} + \mathbf{y} \in \sigma \cap \sigma' = \tau$ , which implies that both  $\mathbf{x}$  and  $\mathbf{y}$  are in  $\tau$ . Hence  $\sigma \cap \mathbf{u}^\perp = \tau$ , and the same argument for  $-\mathbf{u}$  shows that  $\mathbf{u} \in (-\sigma')^\vee$  and  $\sigma' \cap \mathbf{u}^\perp = \tau$ .  $\square$

Miraculously, the convex-geometrical separation property above will translate into topological separation (Hausdorffness) of algebraic varieties and topological spaces constructed from fans in the latter chapters.

The next construction assigns a complete fan to every convex polytope.

CONSTRUCTION 2.1.3 (Normal fan). Let  $P$  be a polytope (1.1) with  $m$  facets  $F_1, \dots, F_m$  and normal vectors  $\mathbf{a}_1, \dots, \mathbf{a}_m$ . Given a face  $Q \subset P$  define the cone

$$(2.2) \quad \sigma_Q = \{\mathbf{u} \in \mathbb{R}^n : \langle \mathbf{u}, \mathbf{x}' \rangle \leq \langle \mathbf{u}, \mathbf{x} \rangle \text{ for all } \mathbf{x}' \in Q \text{ and } \mathbf{x} \in P\}.$$

The dual cone  $\sigma_Q^\vee$  is generated by vectors  $\mathbf{x} - \mathbf{x}'$  where  $\mathbf{x} \in P$  and  $\mathbf{x}' \in Q$ . In other words,  $\sigma_Q^\vee$  is the ‘‘polyhedral angle’’ at the face  $Q$  consisting of all vectors pointing from points of  $Q$  to points of  $P$ .

We say that a vector  $\mathbf{a}_i$  is *normal* to the face  $Q$  if  $Q \subset F_i$ . The cone  $\sigma_Q$  is generated by those  $\mathbf{a}_i$  which are normal to  $Q$  (this is an exercise). Then

$$\Sigma_P = \{\sigma_Q : Q \text{ is a face of } P\}$$

is a complete fan  $\Sigma_P$  in  $\mathbb{R}^n$  (this is another exercise), which is denoted by  $\Sigma_P$  and is referred to as the *normal fan* of the polytope  $P$ . If  $\mathbf{0}$  is contained in the interior of  $P$  then  $\Sigma_P$  may be also described as the set of cones over the faces of the polar polytope  $P^*$  (yet another exercise).

It is clear from the above descriptions that the normal fan  $\Sigma_P$  is simplicial if and only if  $P$  is simple. In this case the definition of  $\Sigma_P$  may be simplified: the cones of  $\Sigma_P$  are generated by those sets  $\{\mathbf{a}_{i_1}, \dots, \mathbf{a}_{i_k}\}$  for which the intersection  $F_{i_1} \cap \dots \cap F_{i_k}$  is nonempty.

If all vertices of  $P$  are in the lattice  $\mathbb{Z}^n$  then the normal fan  $\Sigma_P$  is rational, but the converse is not true. Polytopes whose normal fans are regular are called *Delzant* (this name comes from a symplectic geometry construction discussed in Section 5.5). Therefore,  $P$  is a Delzant polytope if and only if for every vertex  $\mathbf{x} \in P$  the normal vectors to the facets meeting at  $\mathbf{x}$  can be chosen to form a basis of  $\mathbb{Z}^n$ . In this definition one may replace ‘normal vectors to the facets meeting at  $\mathbf{x}$ ’ by ‘vectors along the edges meeting at  $\mathbf{x}$ ’. A Delzant polytope is necessarily simple.

The normal fan  $\Sigma_P$  of a polytope  $P$  contains the information about the normals to the facets (the generators  $\mathbf{a}_i$  of the edges of  $\Sigma_P$ ) and the combinatorial structure of  $P$  (which sets of vectors  $\mathbf{a}_i$  span a cone of  $\Sigma_P$  is determined by which facets intersect at a face), however the scalars  $b_i$  in (1.1) are lost. Not any complete fan can be obtained by ‘forgetting the numbers  $b_i$ ’ from a presentation of a polytope by inequalities, i.e. not any complete fan is a normal fan. This fails even for regular fans, as is shown by the next example, which is taken from [122].

EXAMPLE 2.1.4. Consider the complete three-dimensional fan  $\Sigma$  with 7 edges generated by the vectors  $\mathbf{a}_1 = \mathbf{e}_1$ ,  $\mathbf{a}_2 = \mathbf{e}_2$ ,  $\mathbf{a}_3 = \mathbf{e}_3$ ,  $\mathbf{a}_4 = -\mathbf{e}_1 - \mathbf{e}_2 - \mathbf{e}_3$ ,  $\mathbf{a}_5 = -\mathbf{e}_1 - \mathbf{e}_2$ ,  $\mathbf{a}_6 = -\mathbf{e}_2 - \mathbf{e}_3$ ,  $\mathbf{a}_7 = -\mathbf{e}_1 - \mathbf{e}_3$ , and 10 three-dimensional cones with vertex  $\mathbf{0}$  over the faces of the triangulated boundary of the tetrahedron shown in Fig. 2.1. It is easy to verify that  $\Sigma$  is regular.

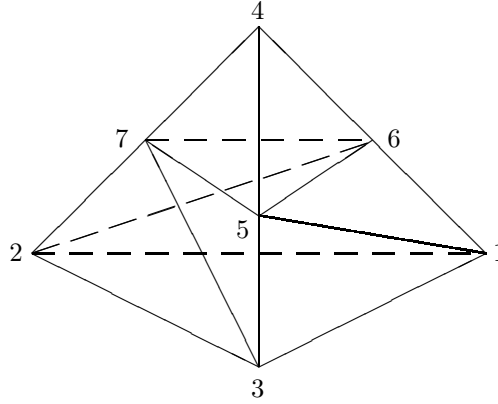

FIGURE 2.1. Complete regular fan not coming from a polytope.

Assume that  $\Sigma = \Sigma_P$  is the normal fan of a polytope  $P$ . Consider the function  $\psi: \mathbb{R}^n \rightarrow \mathbb{R}$  given by

$$\psi(\mathbf{u}) = \min_{\mathbf{x} \in P} \langle \mathbf{u}, \mathbf{x} \rangle = \min_{\mathbf{v} \in V(P)} \langle \mathbf{u}, \mathbf{v} \rangle,$$

where  $V(P)$  is the set of vertices of  $P$ . This function is continuous and its restriction to every 3-dimensional cone of  $\Sigma_P$  is linear. Indeed, 3-dimensional cones  $\sigma_{\mathbf{v}}$  correspond to vertices  $\mathbf{v} \in V(P)$ , and we have  $\psi(\mathbf{u}) = \langle \mathbf{u}, \mathbf{v} \rangle$  for  $\mathbf{u} \in \sigma_{\mathbf{v}}$  by definition (2.2) of  $\sigma_{\mathbf{v}}$ .

Now consider the two 3-dimensional cones of  $\Sigma_P$  generated by the triples  $\mathbf{a}_1, \mathbf{a}_3, \mathbf{a}_5$  and  $\mathbf{a}_1, \mathbf{a}_5, \mathbf{a}_6$ , and let  $\mathbf{v}$  and  $\mathbf{v}'$  be the corresponding vertices of  $P$ . Then  $\psi(\mathbf{a}_1) = \langle \mathbf{a}_1, \mathbf{v} \rangle$ ,  $\psi(\mathbf{a}_3) = \langle \mathbf{a}_3, \mathbf{v} \rangle$ ,  $\psi(\mathbf{a}_5) = \langle \mathbf{a}_5, \mathbf{v} \rangle$ ,  $\psi(\mathbf{a}_6) = \langle \mathbf{a}_6, \mathbf{v}' \rangle$ , hence,

$$\psi(\mathbf{a}_1) + \psi(\mathbf{a}_5) - \psi(\mathbf{a}_3) = \langle \mathbf{a}_1 + \mathbf{a}_5 - \mathbf{a}_3, \mathbf{v} \rangle = \langle \mathbf{a}_6, \mathbf{v} \rangle > \langle \mathbf{a}_6, \mathbf{v}' \rangle = \psi(\mathbf{a}_6).$$

Therefore,

$$\psi(\mathbf{a}_1) + \psi(\mathbf{a}_5) > \psi(\mathbf{a}_3) + \psi(\mathbf{a}_6).$$

Similarly,

$$\psi(\mathbf{a}_2) + \psi(\mathbf{a}_6) > \psi(\mathbf{a}_1) + \psi(\mathbf{a}_7),$$

$$\psi(\mathbf{a}_3) + \psi(\mathbf{a}_7) > \psi(\mathbf{a}_2) + \psi(\mathbf{a}_5).$$

Adding the last three inequalities together we get a contradiction.

**Exercises.**

2.1.5. Let  $\sigma$  be a cone in  $\mathbb{R}^n$ . Show that  $\sigma^\vee$  is also a cone,  $(\sigma^\vee)^\vee = \sigma$ , and  $\sigma^\vee$  is strongly convex if and only if  $\dim \sigma = n$ .

2.1.6. The cone  $\sigma_Q$  given by (2.2) is generated by those vectors among  $\mathbf{a}_1, \dots, \mathbf{a}_m$  which are normal to  $Q$ .

2.1.7. The set  $\{\sigma_Q : Q \text{ is a face of } P\}$  is a complete fan in  $\mathbb{R}^n$ .

2.1.8. If  $\mathbf{0}$  is contained in the interior of  $P$  then  $\Sigma_P$  consists of cones over the faces of the polar polytope  $P^*$ .

2.1.9. Let  $P$  be a convex polytope (not necessarily simple). Does the collection of cones generated by the sets  $\{\mathbf{a}_{i_1}, \dots, \mathbf{a}_{i_k}\}$  of normal vectors for which  $F_{i_1} \cap \dots \cap F_{i_k} \neq \emptyset$  form a fan?

**2.2. Simplicial complexes**

A simplex is the convex hull of a set of affinely independent points in  $\mathbb{R}^n$ .

DEFINITION 2.2.1. A *geometric simplicial complex* in  $\mathbb{R}^n$  is a collection  $\mathcal{P}$  of simplices of arbitrary dimension such that every face of a simplex in  $\mathcal{P}$  belongs to  $\mathcal{P}$  and the intersection of any two simplices in  $\mathcal{P}$  is either empty or a face of each.

To make the exposition more streamlined and without creating much ambiguity we shall not distinguish between the collection  $\mathcal{P}$  (which is an abstract set of simplices) and the union of its simplices (which is a subset in  $\mathbb{R}^n$ ). In  $PL$  (piecewise linear) topology the latter union is usually referred to as ‘the *polyhedron* of  $\mathcal{P}$ ’. Although we have already reserved the term ‘polyhedron’ for a finite intersection of halfspaces (1.1), we shall also occasionally use it in the  $PL$  topological sense (when it creates no ambiguity).

A *face* of  $\mathcal{P}$  is a face of any of its simplices. The dimension of  $\mathcal{P}$  is the maximal dimension of its faces.

If we know the set of vertices of  $\mathcal{P}$  in  $\mathbb{R}^n$  then we may recover the whole  $\mathcal{P}$  by specifying which subsets of vertices span simplices. This observation leads to the following definition.

DEFINITION 2.2.2. An *abstract simplicial complex* on a set  $\mathcal{V}$  is a collection  $\mathcal{K}$  of subsets  $I \subset \mathcal{V}$  such that if  $I \in \mathcal{K}$  then any subset of  $I$  also belongs to  $\mathcal{K}$ . We always assume that the empty set  $\emptyset$  belongs to  $\mathcal{K}$ . We refer to  $I \in \mathcal{K}$  as an (abstract) *simplex* of  $\mathcal{K}$ .

One-element simplices are called *vertices* of  $\mathcal{K}$ . If  $\mathcal{K}$  contains all one-element subsets of  $\mathcal{V}$ , then we say that  $\mathcal{K}$  is a simplicial complex *on the vertex set*  $\mathcal{V}$ .

It is sometimes convenient to consider simplicial complexes  $\mathcal{K}$  whose vertex sets are proper subsets of  $\mathcal{V}$ . In this case we refer to a one-element subset of  $\mathcal{V}$  which is not a vertex of  $\mathcal{K}$  as a *ghost vertex*.

The *dimension* of a simplex  $I \in \mathcal{K}$  is  $\dim I = |I| - 1$ , where  $|I|$  denotes the number of elements in  $I$ . The dimension of  $\mathcal{K}$  is the maximal dimension of its simplices. A simplicial complex  $\mathcal{K}$  is *pure* if all its maximal simplices have the same dimension. A subcollection  $\mathcal{K}' \subset \mathcal{K}$  which is itself a simplicial complex is called a *subcomplex* of  $\mathcal{K}$ .

A geometric simplicial complex  $\mathcal{P}$  is said to be a *geometric realisation* of an abstract simplicial complex  $\mathcal{K}$  on a set  $\mathcal{V}$  if there is a bijection between  $\mathcal{V}$  and the vertex set of  $\mathcal{P}$  which maps abstract simplices of  $\mathcal{K}$  to vertex sets of faces of  $\mathcal{P}$ .

Both geometric and abstract simplicial complexes will be assumed to be *finite*, unless we explicitly specify otherwise. In most constructions we identify the set  $\mathcal{V}$  with the index set  $[m] = \{1, \dots, m\}$  and consider abstract simplicial complexes on  $[m]$ . An identification of  $\mathcal{V}$  with  $[m]$  fixes an order of vertices, although this order will be irrelevant in most cases. We drop the parentheses in the notation of one-element subsets  $\{i\} \subset [m]$ , so that  $i \in \mathcal{K}$  means that  $\{i\}$  is a vertex of  $\mathcal{K}$ , and  $i \notin \mathcal{K}$  means that  $\{i\}$  is a ghost vertex.

We shall use the common notation  $\Delta^{m-1}$  for any of the following three objects: an  $(m-1)$ -simplex (a convex polytope), the geometric simplicial complex consisting of all faces in an  $(m-1)$ -simplex, and the abstract simplicial complex consisting of all subsets of  $[m]$ .

**CONSTRUCTION 2.2.3.** Every abstract simplicial complex  $\mathcal{K}$  on  $[m]$  can be realised geometrically in  $\mathbb{R}^m$  as follows. Let  $e_1, \dots, e_m$  be the standard basis in  $\mathbb{R}^m$ , and for each  $I \subset [m]$  denote by  $\Delta^I$  the convex hull of points  $e_i$  with  $i \in I$ . Then

$$\bigcup_{I \in \mathcal{K}} \Delta^I \subset \mathbb{R}^m$$

is a geometric realisation of  $\mathcal{K}$ .

The above construction is just a geometrical interpretation of the fact that any simplicial complex on  $[m]$  is a subcomplex of the simplex  $\Delta^{m-1}$ . Also, by a classical result [263], a  $d$ -dimensional abstract simplicial complex admits a geometric realisation in  $\mathbb{R}^{2d+1}$ .

**EXAMPLE 2.2.4.** The boundary of a simplicial  $n$ -polytope is a simplicial complex of dimension  $n-1$ . For a simple polytope  $P$ , we shall denote by  $\mathcal{K}_P$  the boundary complex  $\partial P^*$  of the dual polytope. It coincides with the nerve of the covering of  $\partial P$  by the facets. That is, the vertices of  $\mathcal{K}_P$  are the facets of  $P$ , and a set of vertices spans a simplex whenever the intersection of the corresponding facets is nonempty. We refer to  $\mathcal{K}_P$  as the *nerve complex* of  $P$ .

**DEFINITION 2.2.5.** The *f-vector* of an  $(n-1)$ -dimensional simplicial complex  $\mathcal{K}$  is  $\mathbf{f}(\mathcal{K}) = (f_0, f_1, \dots, f_{n-1})$ , where  $f_i$  is the number of  $i$ -dimensional simplices in  $\mathcal{K}$ . We also set  $f_{-1} = 1$ ; to justify this convention one can assign dimension  $-1$  to the empty simplex. The *h-vector*  $\mathbf{h}(\mathcal{K}) = (h_0, h_1, \dots, h_n)$  is defined by the identity

$$(2.3) \quad h_0 s^n + h_1 s^{n-1} + \dots + h_n = (s-1)^n + f_0 (s-1)^{n-1} + \dots + f_{n-1}.$$

(Warning: this is not the identity obtained by substituting  $t = 1$  in (1.9).) The *g-vector*  $\mathbf{g}(\mathcal{K}) = (g_0, g_1, \dots, g_{\lfloor n/2 \rfloor})$  is defined by  $g_0 = 1$  and  $g_i = h_i - h_{i-1}$  for  $i = 1, \dots, \lfloor n/2 \rfloor$ .

**REMARK.** If  $\mathcal{K} = \mathcal{K}_P$  is the nerve complex of a simple polytope  $P$ , then  $\mathbf{f}(\mathcal{K}) = \mathbf{f}(P^*)$  and  $\mathbf{h}(\mathcal{K}) = \mathbf{h}(P)$ . This our notational convention may look artificial, but it seems to be the best possible way to treat the face vectors of both polytopes and simplicial complexes consistently.

**DEFINITION 2.2.6.** Let  $\mathcal{K}_1, \mathcal{K}_2$  be simplicial complexes on the sets  $[m_1], [m_2]$  respectively, and  $\mathcal{P}_1, \mathcal{P}_2$  their geometric realisations. A map  $\varphi: [m_1] \rightarrow [m_2]$  induces a *simplicial map* between  $\mathcal{K}_1$  and  $\mathcal{K}_2$  if  $\varphi(I) \in \mathcal{K}_2$  for any  $I \in \mathcal{K}_1$ . A simplicial map  $\varphi$  is said to be *nondegenerate* if  $|\varphi(I)| = |I|$  for any  $I \in \mathcal{K}_1$ . On the geometric level,



a simplicial map extends linearly on the faces of  $\mathcal{P}_1$  to a map  $\mathcal{P}_1 \rightarrow \mathcal{P}_2$ , which we continue to denote by  $\varphi$ . A *simplicial isomorphism* is a simplicial map for which there exists a simplicial inverse.

There is an obvious isomorphism between any two geometric realisations of an abstract simplicial complex  $\mathcal{K}$ . We therefore shall use the common notation  $|\mathcal{K}|$  for any geometric realisation of  $\mathcal{K}$ . Whenever it is safe, we shall not distinguish between abstract simplicial complexes and their geometric realisations. For example, we shall say ‘simplicial complex  $\mathcal{K}$  is homeomorphic to  $X$ ’ instead of ‘the geometric realisation of  $\mathcal{K}$  is homeomorphic to  $X$ ’.

We shall refer to a simplicial complex homeomorphic to a topological space  $X$  as a *triangulation of  $X$* , or a *simplicial subdivision of  $X$* .

A *subdivision* of a geometric simplicial complex  $\mathcal{P}$  is a geometric simplicial complex  $\mathcal{P}'$  such that each simplex of  $\mathcal{P}'$  is contained in a simplex of  $\mathcal{P}$  and each simplex of  $\mathcal{P}$  is a union of finitely many simplices of  $\mathcal{P}'$ . A *PL map*  $\varphi: \mathcal{P}_1 \rightarrow \mathcal{P}_2$  is a simplicial map from a subdivision of  $\mathcal{P}_1$  to a subdivision of  $\mathcal{P}_2$ . A *PL homeomorphism* is a *PL map* for which there exists a *PL inverse*. In other words, two simplicial complexes are *PL homeomorphic* if there is a simplicial complex isomorphic to a subdivision of each of them.

REMARK. For a topological approach to *PL maps* (where a *PL map* is defined between spaces rather than their triangulations) we refer to standard sources on *PL topology*, such as [165] and [277].

EXAMPLE 2.2.7.

1. If  $P$  is a simple  $n$ -polytope then the nerve complex  $\mathcal{K}_P$  (see Example 2.2.4) is a triangulation of an  $(n - 1)$ -dimensional sphere  $S^{n-1}$ .

2. Let  $\Sigma$  be a simplicial fan in  $\mathbb{R}^n$  with  $m$  edges generated by vectors  $\mathbf{a}_1, \dots, \mathbf{a}_m$ . Its *underlying simplicial complex* is defined by

$$\mathcal{K}_\Sigma = \{\{i_1, \dots, i_k\} \subset [m] : \mathbf{a}_{i_1}, \dots, \mathbf{a}_{i_k} \text{ span a cone of } \Sigma\}.$$

Informally,  $\mathcal{K}_\Sigma$  may be viewed as the intersection of  $\Sigma$  with a unit sphere. The fan  $\Sigma$  is complete if and only if  $\mathcal{K}_\Sigma$  is a triangulation of  $S^{n-1}$ . If  $\Sigma$  is a normal fan of a simple  $n$ -polytope  $P$ , then  $\mathcal{K}_\Sigma = \mathcal{K}_P$ .

CONSTRUCTION 2.2.8 (join). Let  $\mathcal{K}_1$  and  $\mathcal{K}_2$  be simplicial complexes on sets  $\mathcal{V}_1$  and  $\mathcal{V}_2$  respectively. The *join* of  $\mathcal{K}_1$  and  $\mathcal{K}_2$  is the simplicial complex

$$\mathcal{K}_1 * \mathcal{K}_2 = \{I \subset \mathcal{V}_1 \sqcup \mathcal{V}_2 : I = I_1 \cup I_2, I_1 \in \mathcal{K}_1, I_2 \in \mathcal{K}_2\}$$

on the set  $\mathcal{V}_1 \sqcup \mathcal{V}_2$ . The join operation is associative by inspection.

EXAMPLE 2.2.9.

1. If  $\mathcal{K}_1 = \Delta^{m_1-1}$ ,  $\mathcal{K}_2 = \Delta^{m_2-1}$ , then  $\mathcal{K}_1 * \mathcal{K}_2 = \Delta^{m_1+m_2-1}$ .

2. The simplicial complex  $\Delta^0 * \mathcal{K}$  (the join of  $\mathcal{K}$  and a point) is called the *cone* over  $\mathcal{K}$  and denoted  $\text{cone } \mathcal{K}$ .

3. Let  $S^0$  be a pair of disjoint points (a 0-sphere). Then  $S^0 * \mathcal{K}$  is called the *suspension* of  $\mathcal{K}$  and denoted  $\Sigma\mathcal{K}$ . Geometric realisations of cone  $\mathcal{K}$  and  $\Sigma\mathcal{K}$  are the topological cone and suspension over  $|\mathcal{K}|$  respectively.

4. Let  $P_1$  and  $P_2$  be simple polytopes. Then

$$\mathcal{K}_{P_1 \times P_2} = \mathcal{K}_{P_1} * \mathcal{K}_{P_2}.$$

(see Construction 1.1.11).

CONSTRUCTION 2.2.10. The fact that the product of two simplices is not a simplex makes triangulations of products of spaces more subtle. There is the following canonical way to triangulate the product of two simplicial complexes whose vertices are ordered. Let  $\mathcal{K}_1$  and  $\mathcal{K}_2$  be simplicial complexes on  $[m_1]$  and  $[m_2]$  respectively (this is one of the few constructions where the order of vertices is important: here it is an additional structure). We construct a simplicial complex  $\mathcal{K}_1 \tilde{\times} \mathcal{K}_2$  on  $[m_1] \times [m_2]$  as follows. By definition, simplices of  $\mathcal{K}_1 \tilde{\times} \mathcal{K}_2$  are those subsets in products  $I_1 \times I_2$  of  $I_1 \in \mathcal{K}_1$  and  $I_2 \in \mathcal{K}_2$  which establish non-decreasing relations between  $I_1$  and  $I_2$ . More formally,

$$\mathcal{K}_1 \tilde{\times} \mathcal{K}_2 = \{I \subset I_1 \times I_2 : I_1 \in \mathcal{K}_1, I_2 \in \mathcal{K}_2, \\ \text{and } i \leq i' \text{ implies } j \leq j' \text{ for any two pairs } (i, j), (i', j') \in I\}.$$

We leave it as an exercise to check that  $|\mathcal{K}_1 \tilde{\times} \mathcal{K}_2|$  defines a triangulation of  $|\mathcal{K}_1| \times |\mathcal{K}_2|$ . Note that  $\mathcal{K}_1 \tilde{\times} \mathcal{K}_2 \neq \mathcal{K}_2 \tilde{\times} \mathcal{K}_1$  in general. Note also that if  $\mathcal{K}_1 = \mathcal{K}_2 = \mathcal{K}$ , then the diagonal is naturally a subcomplex in the triangulation of  $|\mathcal{K}| \times |\mathcal{K}|$ .

CONSTRUCTION 2.2.11 (connected sum of simplicial complexes). Let  $\mathcal{K}_1$  and  $\mathcal{K}_2$  be two pure  $d$ -dimensional simplicial complexes on sets  $\mathcal{V}_1$  and  $\mathcal{V}_2$  respectively, where  $|\mathcal{V}_1| = m_1$ ,  $|\mathcal{V}_2| = m_2$ . Choose two maximal simplices  $I_1 \in \mathcal{K}_1$ ,  $I_2 \in \mathcal{K}_2$  and fix an identification of  $I_1$  with  $I_2$ . Let  $\mathcal{V}_1 \cup_I \mathcal{V}_2$  be the union of  $\mathcal{V}_1$  and  $\mathcal{V}_2$  in which  $I_1$  is identified with  $I_2$ , and denote by  $I$  the subset created by the identification. We have  $|\mathcal{V}_1 \cup_I \mathcal{V}_2| = m_1 + m_2 - d - 1$ . Both  $\mathcal{K}_1$  and  $\mathcal{K}_2$  now can be viewed as simplicial complexes on the set  $\mathcal{V}_1 \cup_I \mathcal{V}_2$ . We define the *connected sum* of  $\mathcal{K}_1$  and  $\mathcal{K}_2$  at  $I_1$  and  $I_2$  as the simplicial complex

$$\mathcal{K}_1 \#_{I_1, I_2} \mathcal{K}_2 = (\mathcal{K}_1 \cup \mathcal{K}_2) \setminus \{I\}$$

on the set  $\mathcal{V}_1 \cup_I \mathcal{V}_2$ . When the choices are clear, or their effect on the result irrelevant, we use the abbreviation  $\mathcal{K}_1 \# \mathcal{K}_2$ . Geometrically, the connected sum of  $|\mathcal{K}_1|$  and  $|\mathcal{K}_2|$  is produced by attaching  $|\mathcal{K}_1|$  to  $|\mathcal{K}_2|$  along  $I_1$  and  $I_2$  and then removing the face  $I$  obtained by the identification.

EXAMPLE 2.2.12. Connected sum of simple polytopes defined in Construction 1.1.13 is dual to the operation described above. Namely, if  $P$  and  $Q$  are two simple  $n$ -polytopes, then

$$\mathcal{K}_P \# \mathcal{K}_Q = \mathcal{K}_{P \# Q}.$$

DEFINITION 2.2.13. Let  $\mathcal{K}$  be a simplicial complex on a set  $\mathcal{V}$ . The *link* and the *star* of a simplex  $I \in \mathcal{K}$  are the subcomplexes

$$\text{lk}_{\mathcal{K}} I = \{J \in \mathcal{K} : I \cup J \in \mathcal{K}, I \cap J = \emptyset\}; \\ \text{st}_{\mathcal{K}} I = \{J \in \mathcal{K} : I \cup J \in \mathcal{K}\}.$$

We also define the subcomplex

$$\partial \text{st}_{\mathcal{K}} I = \{J \in \mathcal{K} : I \cup J \in \mathcal{K}, I \not\subset J\}.$$

Then we have a sequence of inclusions

$$\text{lk}_{\mathcal{K}} I \subset \partial \text{st}_{\mathcal{K}} I \subset \text{st}_{\mathcal{K}} I.$$

For any vertex  $v \in \mathcal{K}$ , the subcomplex  $\text{st}_{\mathcal{K}} v$  is the cone over  $\text{lk}_{\mathcal{K}} v = \partial \text{st}_{\mathcal{K}} v$ . Also,  $|\text{st}_{\mathcal{K}} v|$  is the union of all faces of  $|\mathcal{K}|$  that contain  $v$ . We omit the subscript  $\mathcal{K}$  in the notation of link and star whenever the ambient simplicial complex is clear.

The links of simplices determine the topological structure of the space  $|\mathcal{K}|$  near any of its points. In particular, the following proposition describes the ‘local cohomology’ of  $|\mathcal{K}|$ .

PROPOSITION 2.2.14. *Let  $x$  be an interior point of a simplex  $I \in \mathcal{K}$ . Then*

$$H^i(|\mathcal{K}|, |\mathcal{K}| \setminus x) \cong \tilde{H}^{i-|I|}(\text{lk } I),$$

where  $H^i(X, A)$  denotes the  $i$ th relative singular cohomology group of a pair  $A \subset X$ , and  $\tilde{H}^i(\mathcal{K})$  denotes the  $i$ th reduced simplicial cohomology group of  $\mathcal{K}$ .

PROOF. We have

$$\begin{aligned} H^i(|\mathcal{K}|, |\mathcal{K}| \setminus x) &\cong H^i(\text{st } I, (\text{st } I) \setminus x) \cong H^i(\text{st } I, (\partial I) * (\text{lk } I)) \cong \\ &\cong \tilde{H}^{i-1}((\partial I) * (\text{lk } I)) \cong \tilde{H}^{i-|I|}(\text{lk } I). \end{aligned}$$

Here the first isomorphism follows from the excision property, the second uses the fact that  $(\partial I) * (\text{lk } I)$  is a deformation retract of  $(\text{st } I) \setminus x$ , the third follows from the homology sequence of pair, and the fourth is by the suspension isomorphism.  $\square$

Given a subcomplex  $\mathcal{L} \subset \mathcal{K}$ , define the *closed combinatorial neighbourhood* of  $\mathcal{L}$  in  $\mathcal{K}$  by

$$U_{\mathcal{K}}(\mathcal{L}) = \bigcup_{I \in \mathcal{L}} \text{st}_{\mathcal{K}} I.$$

That is,  $U_{\mathcal{K}}(\mathcal{L})$  consists of all simplices of  $\mathcal{K}$ , together with all their faces, having some simplex of  $\mathcal{L}$  as a face. Define also the *open combinatorial neighbourhood*  $\overset{\circ}{U}_{\mathcal{K}}(\mathcal{L})$  of  $|\mathcal{L}|$  in  $|\mathcal{K}|$  as the union of relative interiors of simplices of  $|\mathcal{K}|$  having some simplex of  $|\mathcal{L}|$  as a face.

DEFINITION 2.2.15. Given a subset  $I \subset \mathcal{V}$ , define the corresponding *full subcomplex* of  $\mathcal{K}$  (or the *restriction* of  $\mathcal{K}$  to  $I$ ) as

$$(2.4) \quad \mathcal{K}_I = \{J \in \mathcal{K} : J \subset I\}.$$

Set  $\text{core } \mathcal{V} = \{v \in \mathcal{V} : \text{st } v \neq \mathcal{K}\}$ . The *core* of  $\mathcal{K}$  is the subcomplex  $\text{core } \mathcal{K} = \mathcal{K}_{\text{core } \mathcal{V}}$ . Then we may write  $\mathcal{K} = \text{core}(\mathcal{K}) * \Delta^{s-1}$ , where  $\Delta^{s-1}$  is the simplex on the set  $\mathcal{V} \setminus \text{core } \mathcal{V}$ .

EXAMPLE 2.2.16.

1.  $\text{lk}_{\mathcal{K}} \emptyset = \mathcal{K}$ .
2. Let  $K = \partial \Delta^3$  be the boundary of the tetrahedron on four vertices 1, 2, 3, 4, and  $I = \{1, 2\}$ . Then  $\text{lk } I$  consists of two disjoint points 3 and 4.
3. Let  $\mathcal{K}$  be the cone over  $\mathcal{L}$  with vertex  $v$ . Then  $\text{lk } v = \mathcal{L}$ ,  $\text{st } v = \mathcal{K}$ , and  $\text{core } \mathcal{K} = \text{core } \mathcal{L}$ .

### Exercises.

2.2.17. Assume that  $\mathcal{K}_1$  is realised geometrically in  $\mathbb{R}^{n_1}$  and  $\mathcal{K}_2$  in  $\mathbb{R}^{n_2}$ . Construct a realisation of the join  $\mathcal{K}_1 * \mathcal{K}_2$  in  $\mathbb{R}^{n_1+n_2+1}$ .

2.2.18. Show that  $|\mathcal{K}_1 \tilde{\times} \mathcal{K}_2|$  is a triangulation of  $|\mathcal{K}_1| \times |\mathcal{K}_2|$ .

2.2.19. Let  $\mathcal{K}$  be a pure simplicial complex. Then  $\text{lk } I$  is pure of dimension  $\dim \mathcal{K} - |I|$  for any  $I \in \mathcal{K}$ .

### 2.3. Barycentric subdivision and flag complexes

DEFINITION 2.3.1. The *barycentric subdivision* of an abstract simplicial complex  $\mathcal{K}$  is the simplicial complex  $\mathcal{K}'$  defined as follows. The vertex set of  $\mathcal{K}'$  is the set  $\{I \in \mathcal{K}, I \neq \emptyset\}$  of nonempty simplices of  $\mathcal{K}$ . Simplices of  $\mathcal{K}'$  are chains of embedded simplices of  $\mathcal{K}$ . That is,  $\{I_1, \dots, I_r\} \in \mathcal{K}'$  if and only if  $I_1 \subset I_2 \subset \dots \subset I_r$  in  $\mathcal{K}$  (after possible reordering) and  $I_1 \neq \emptyset$ .

The *barycentre* of a geometric simplex in  $\mathbb{R}^d$  with vertices  $\mathbf{v}_1, \dots, \mathbf{v}_{d+1}$  is the point  $\frac{1}{d+1}(\mathbf{v}_1 + \dots + \mathbf{v}_{d+1})$ . A geometric realisation of  $\mathcal{K}'$  may be obtained by mapping every vertex of  $\mathcal{K}'$  to the barycentre of the corresponding simplex of  $|\mathcal{K}|$ ; simplices of  $|\mathcal{K}'|$  are therefore spanned by the sets of barycentres of chains of embedded simplices of  $|\mathcal{K}|$ .

EXAMPLE 2.3.2. For any  $(n-1)$ -dimensional simplicial complex  $\mathcal{K}$  on  $[m]$ , there is a nondegenerate simplicial map  $\mathcal{K}' \rightarrow \Delta^{n-1}$  defined on the vertices by  $I \mapsto |I|$  for  $I \in \mathcal{K}$ , where  $|I|$  denotes the cardinality of  $I$ . Here  $I$  is viewed as a vertex of  $\mathcal{K}'$  and  $|I|$  as a vertex of  $\Delta^{n-1}$ .

EXAMPLE 2.3.3. Let  $\mathcal{K}$  be a simplicial complex on a set  $\mathcal{V}$ , and assume we are given a choice function  $c: \mathcal{K} \rightarrow \mathcal{V}$  assigning to each simplex  $I \in \mathcal{K}$  one of its vertices. For instance, if  $\mathcal{V} = [m]$  we can define  $c(I)$  as the minimal element of  $I$ . For every such  $f$  there is a canonical simplicial map  $\varphi_c: \mathcal{K}' \rightarrow \mathcal{K}$  constructed as follows. We define  $\varphi_c$  on the vertices of  $\mathcal{K}'$  by  $\varphi_c(I) = c(I)$  and then extend it to simplices of  $\mathcal{K}'$  by the formula

$$\varphi_c(I_1 \subset I_2 \subset \dots \subset I_r) = \{c(I_1), c(I_2), \dots, c(I_r)\}.$$

The right hand side is a subset of  $I_r$ , and therefore it is a simplex of  $\mathcal{K}$ .

We shall need explicit formulae for the transformation of the  $f$ - and  $h$ -vectors under the barycentric subdivision. Introduce the matrix

$$B = (b_{ij}), \quad 0 \leq i, j \leq n-1; \quad b_{ij} = \sum_{k=0}^i (-1)^k \binom{i+1}{k} (i-k+1)^{j+1}.$$

It can be shown that  $b_{ij} = 0$  for  $i > j$  and  $b_{ii} = (i+1)!$ , so that  $B$  is a nonsingular upper triangular matrix.

LEMMA 2.3.4. *Let  $\mathcal{K}'$  be the barycentric subdivision of an  $(n-1)$ -dimensional simplicial complex  $\mathcal{K}$ . Then the  $f$ -vectors of  $\mathcal{K}$  and  $\mathcal{K}'$  are related by the identity*

$$f_i(\mathcal{K}') = \sum_{j=i}^{n-1} b_{ij} f_j(\mathcal{K}), \quad 0 \leq i \leq n-1,$$

that is,  $\mathbf{f}^t(\mathcal{K}') = B\mathbf{f}^t(\mathcal{K})$  where  $\mathbf{f}^t(\mathcal{K})$  is the column vector with entries  $f_i(\mathcal{K})$ .

PROOF. Consider the barycentric subdivision of a  $j$ -simplex  $\Delta^j$ , and let  $b'_{ij}$  be the number of its  $i$ -simplices which lie inside  $\Delta^j$ , i.e. not contained in  $\partial\Delta^j$ . Then we have  $f_i(\mathcal{K}') = \sum_{j=i}^{n-1} b'_{ij} f_j(\mathcal{K})$ . It remains to show that  $b_{ij} = b'_{ij}$ . Indeed, it is easy to see that the numbers  $b'_{ij}$  satisfy the following recurrence relation:

$$b'_{ij} = (j+1)b'_{i-1, j-1} + \binom{j+1}{2} b'_{i-1, j-2} + \dots + \binom{j+1}{j-i+1} b'_{i-1, i-1}.$$

It follows by induction that  $b'_{ij}$  is given by the same formula as  $b_{ij}$ .  $\square$

Now introduce the matrix

$$D = (d_{pq}), \quad 0 \leq p, q \leq n; \quad d_{pq} = \sum_{k=0}^p (-1)^k \binom{n+1}{k} (p-k)^q (p-k+1)^{n-q},$$

where we set  $0^0 = 1$ .

LEMMA 2.3.5. *The  $h$ -vectors of  $\mathcal{K}$  and  $\mathcal{K}'$  are related by the identity:*

$$h_p(\mathcal{K}') = \sum_{q=0}^n d_{pq} h_q(\mathcal{K}), \quad 0 \leq p \leq n,$$

that is,  $\mathbf{h}^t(\mathcal{K}') = D\mathbf{h}^t(\mathcal{K})$ . Moreover, the matrix  $D$  is nonsingular.

PROOF. The formula for  $h_p(\mathcal{K}')$  is established by a routine check using Lemma 2.3.4, relations (2.3) and identities for the binomial coefficients. If we add the component  $f_{-1} = 1$  to the  $f$ -vector and change the matrix  $B$  appropriately, then we obtain  $D = C^{-1}BC$ , where  $C$  is the transition matrix from the  $h$ -vector to the  $f$ -vector (its explicit form can be obtained easily from relations (2.3)). This implies the nonsingularity of  $D$ .  $\square$

DEFINITION 2.3.6. Let  $\mathcal{P}$  be a poset (partially ordered set) with strict order relation  $<$ . Its *order complex*  $\text{ord}(\mathcal{P})$  is the collection of all totally ordered chains  $x_1 < x_2 < \cdots < x_k$  (or *flags*),  $x_i \in \mathcal{P}$ . Clearly,  $\text{ord}(\mathcal{P})$  is a simplicial complex.

The following proposition is clear from the definition.

PROPOSITION 2.3.7. *Let  $\mathcal{K}$  be a simplicial complex, viewed as the poset of its simplices with respect to inclusion. Then  $\text{ord}(\mathcal{K} \setminus \emptyset)$  is the barycentric subdivision  $\mathcal{K}'$ . The order complex of  $\mathcal{K}$  (with the empty simplex included) is  $\text{cone}(\mathcal{K}')$ .*

This observation may be used to define the barycentric subdivision of other combinatorial objects. For example, let  $Q$  be a convex polytope, and  $\mathcal{Q}$  the poset of its proper faces. Then  $\text{ord}(\mathcal{Q})$  is a simplicial complex; moreover, it is the boundary complex of a simplicial polytope  $Q'$  (an exercise), called the *barycentric subdivision* of  $Q$ . The vertices of  $Q'$  correspond to the barycentres of proper faces of  $Q$ .

PROPOSITION 2.3.8. *Let  $P$  be a simple polytope and let  $\mathcal{K} = \mathcal{K}_P$  be its nerve complex. Given a facet  $F \subset P$ , let  $v$  be the corresponding vertex of  $\mathcal{K}$ . Then  $\text{st}_{\mathcal{K}} v$  is a triangulation of  $F$ .*

PROOF. We identify  $\partial P$  with  $\mathcal{K}'$  by mapping the barycentre of each proper face of  $P$  to the corresponding vertex of  $\mathcal{K}'$ . Under this identification,  $F$  is mapped to the union of simplices of  $\mathcal{K}'$  corresponding to chains  $G_1 \subset \cdots \subset G_k = F$  of faces of  $P$  ending at  $F$ . This union is exactly the star of  $v$  in  $\mathcal{K}'$ .  $\square$

DEFINITION 2.3.9. A simplicial complex  $\mathcal{K}$  is called a *flag complex* if any set of vertices of  $\mathcal{K}$  which are pairwise connected by edges spans a simplex.

A flag complex is therefore completely determined by its 1-skeleton, which is a simple graph. Given such a graph  $\Gamma$ , we may reconstruct the flag complex  $\mathcal{K}_\Gamma$ , whose simplices are the vertex sets of complete subgraphs (or *cliques*) of  $\Gamma$ .

Flag complexes may be characterised in terms of their missing faces. A *missing face* of  $\mathcal{K}$  is a subset  $I \subset [m]$  such that  $I \notin \mathcal{K}$ , but every proper subset of  $I$  is a simplex of  $\mathcal{K}$ . Then  $\mathcal{K}$  is flag if and only if each of its missing faces has two vertices.

Therefore,  $P$  is a flag simple  $n$ -polytope if and only if any set of its facets whose pairwise intersections are nonempty intersect at a face.

EXAMPLE 2.3.10.

1. The order complex of a poset is a flag complex.
2. A simple polytope  $P$  is a flag polytope (see Definition 1.6.1) if and only if its nerve complex  $\mathcal{K}_P$  is a flag complex.
3. The boundary of a 5-gon is a flag complex, but it is not the order complex of a poset.
4. The boundary of a  $d$ -simplex is not flag for  $d > 1$ .
5. The join  $\mathcal{K}_1 * \mathcal{K}_2$  of two flag complexes (see Construction 2.2.8) is flag (an exercise). Therefore, the product  $P \times Q$  of two flag simple polytopes is flag.
6. The connected sum  $\mathcal{K}_1 \# \mathcal{K}_2$  of two  $d$ -dimensional complexes (see Construction 2.2.11) is not flag if  $d > 1$ .

Since the  $h$ -vector of a sphere triangulation is symmetric, the  $\gamma$ -vector  $\gamma(\mathcal{K}) = (\gamma_0, \gamma_1, \dots, \gamma_{\lfloor n/2 \rfloor})$  of an  $(n-1)$ -dimensional sphere triangulation  $\mathcal{K}$  can be defined by the equation

$$(2.5) \quad \sum_{i=0}^n h_i s^i t^{n-i} = \sum_{i=0}^{\lfloor n/2 \rfloor} \gamma_i (s+t)^{n-2i} (st)^i.$$

CONJECTURE 2.3.11 (Gal [123]). *Let  $\mathcal{K}$  be a flag triangulation of an  $(n-1)$ -sphere. Then  $\gamma_i(\mathcal{K}) \geq 0$  for  $i = 0, \dots, \lfloor \frac{n}{2} \rfloor$ .*

Substituting  $n = 2q$ ,  $s = 1$  and  $t = -1$  into (2.5) we obtain

$$\sum_{i=0}^{2q} (-1)^i h_i = (-1)^q \gamma_q.$$

The top inequality  $\gamma_q \geq 0$  from the Gal conjecture therefore implies the following:

CONJECTURE 2.3.12 (Charney–Davis [69]). *The inequality*

$$(-1)^q \sum_{i=0}^{2q} (-1)^i h_i(\mathcal{K}) \geq 0$$

*holds for any flag triangulation  $\mathcal{K}$  of a  $(2q-1)$ -sphere.*

The Charney–Davis conjecture is a discrete analogue of the well-known *Hopf conjecture* of differential geometry, which states that the Euler characteristic  $\chi$  of a closed nonpositively curved Riemannian manifold  $M^{2q}$  satisfies the inequality  $(-1)^q \chi \geq 0$ . Due to a theorem of Gromov [136], a piecewise Euclidean cubical complex satisfies the discrete analogue of the nonpositive curvature condition, the so-called *CAT(0) inequality*, if and only if the links of all vertices are flag complexes. As was observed in [69], the Hopf conjecture for piecewise Euclidean cubical manifolds translates into Conjecture 2.3.12.

The Hopf and Charney–Davis conjectures are valid for  $q = 1, 2$ . In [123] the Gal conjecture was verified for  $n \leq 5$ .

### Exercises.

2.3.13. Show that the matrix  $B$  of Lemma 2.3.4 satisfies  $b_{ij} = 0$  for  $i > j$  and  $b_{ii} = (i+1)!$ .

2.3.14. Prove the formula for  $h_p(\mathcal{K}')$  of Lemma 2.3.5.

2.3.15. Show that the order complex of the poset of proper faces of a polytope is the boundary complex of a simplicial polytope. (Hint: use stellar subdivisions, see Section 2.7 and the exercises there.)

2.3.16. The join of two flag complexes is flag.

2.3.17. Links of simplices in a flag complex are flag.

## 2.4. Alexander duality

For any simplicial complex, a dual complex may be defined on the same set. This duality has many important combinatorial and topological consequences.

DEFINITION 2.4.1 (dual complex). Let  $\mathcal{K}$  be a simplicial complex on  $[m]$  and  $\mathcal{K} \neq \Delta^{m-1}$ . Define

$$\widehat{\mathcal{K}} = \{I \subset [m] : [m] \setminus I \notin \mathcal{K}\}.$$

Then  $\widehat{\mathcal{K}}$  is also a simplicial complex on  $[m]$ , which we refer to as the *Alexander dual* of  $\mathcal{K}$ . Obviously, the dual of  $\widehat{\mathcal{K}}$  is  $\mathcal{K}$ .

CONSTRUCTION 2.4.2. The barycentric subdivisions of both  $\mathcal{K}$  and  $\widehat{\mathcal{K}}$  can be realised as subcomplexes in the barycentric subdivision of the boundary of the standard simplex on the set  $[m]$  in the following way.

A face of  $(\partial\Delta^{m-1})'$  corresponds to a chain  $I_1 \subset \cdots \subset I_r$  of included subsets in  $[m]$  with  $I_1 \neq \emptyset$  and  $I_r \neq [m]$ . We denote this face by  $\Delta_{I_1 \subset \cdots \subset I_r}$ . (For example,  $\Delta_{\{i\}}$  is the  $i$ th vertex of  $\Delta^{m-1}$  regarded as a vertex of  $(\partial\Delta^{m-1})'$ .) Then

$$(2.6) \quad G(\mathcal{K}) = \bigcup_{I_1 \subset \cdots \subset I_r, I_r \in \mathcal{K}} \Delta_{I_1 \subset \cdots \subset I_r}$$

is a geometric realisation of  $\mathcal{K}'$ . Denote  $\widehat{i} = [m] \setminus \{i\}$  and, more generally,  $\widehat{I} = [m] \setminus I$  for any subset  $I \subset [m]$ . Define the following subcomplex in  $(\partial\Delta^{m-1})'$ :

$$D(\mathcal{K}) = \bigcup_{I_1 \subset \cdots \subset I_r, \widehat{I}_r \notin \mathcal{K}} \Delta_{\widehat{I}_r \subset \cdots \subset \widehat{I}_1}.$$

PROPOSITION 2.4.3. For any simplicial complex  $\mathcal{K} \neq \Delta^{m-1}$  on the set  $[m]$ ,  $D(\mathcal{K})$  is a geometric realisation of the barycentric subdivision of the dual complex:

$$(2.7) \quad D(\mathcal{K}) = |\widehat{\mathcal{K}}'|.$$

Moreover, the open combinatorial neighbourhood of complex (2.6) realising  $\mathcal{K}'$  in  $(\partial\Delta^{m-1})'$  coincides with the complement of the complex  $D(\mathcal{K})$  realising  $\widehat{\mathcal{K}}'$ :

$$\overset{\circ}{U}_{(\partial\Delta^{m-1})'}(|\mathcal{K}'|) = (\partial\Delta^{m-1})' \setminus |\widehat{\mathcal{K}}'|.$$

In particular,  $|\mathcal{K}'|$  is a deformation retract of the complement to  $|\widehat{\mathcal{K}}'|$  in  $(\partial\Delta^{m-1})'$ .

PROOF. We map a vertex  $\{i\}$  of  $\widehat{\mathcal{K}}$  to the vertex  $\widehat{i} = \Delta_{\widehat{i}}$  of  $(\partial\Delta^{m-1})'$ , and map the barycentre of a face  $I \in \widehat{\mathcal{K}}$  to the vertex  $\Delta_{\widehat{I}}$ . Then the whole complex  $\widehat{\mathcal{K}}'$  is mapped to the subcomplex

$$\bigcup_{I_1 \subset \cdots \subset I_r, I_r \in \widehat{\mathcal{K}}} \Delta_{\widehat{I}_r \subset \cdots \subset \widehat{I}_1},$$

which is the same as  $D(\mathcal{K})$ . The second statement is left as an exercise.  $\square$

EXAMPLE 2.4.4. Let  $\mathcal{K}$  be the boundary of a 4-gon with vertices 1, 2, 3, 4 (see Fig. 2.2). Then  $\widehat{\mathcal{K}}$  consists of two disjoint segments. The picture shows both  $\mathcal{K}'$  and  $\widehat{\mathcal{K}}'$  as subcomplexes in  $(\partial\Delta^3)'$ .

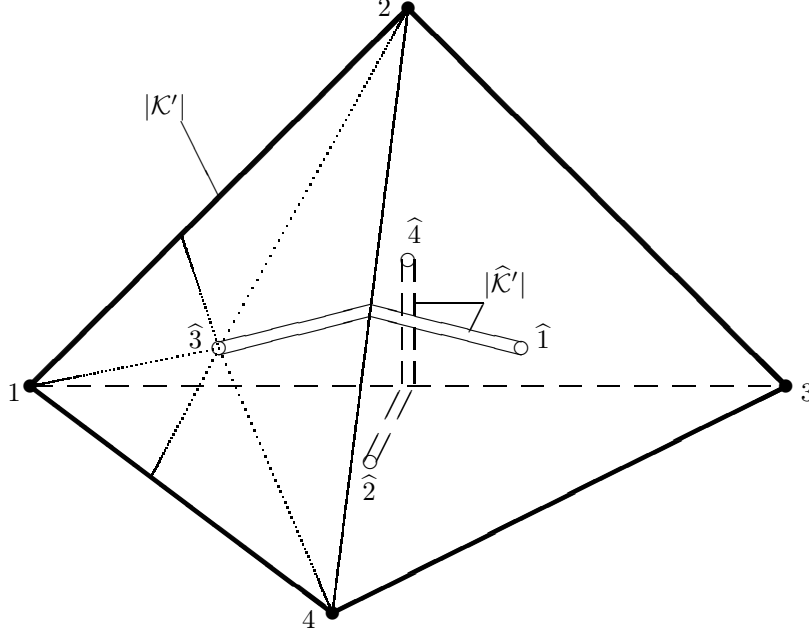

FIGURE 2.2. Dual complex and Alexander duality.

THEOREM 2.4.5 (Combinatorial Alexander duality). *For any simplicial complex  $\mathcal{K} \neq \Delta^{m-1}$  on the set  $[m]$  there is an isomorphism*

$$\widetilde{H}^j(\mathcal{K}) \cong \widetilde{H}_{m-3-j}(\widehat{\mathcal{K}}), \quad \text{for } -1 \leq j \leq m-2,$$

where  $\widetilde{H}_k(\cdot)$  and  $\widetilde{H}^k(\cdot)$  denote the  $k$ th reduced simplicial homology and cohomology group (with integer coefficients) respectively. Here we assume that  $\widetilde{H}_{-1}(\emptyset) = \widetilde{H}^{-1}(\emptyset) = \mathbb{Z}$ .

PROOF. Since  $(\partial\Delta^{m-1})'$  is homeomorphic to  $S^{m-2}$ , the Alexander duality theorem [151, Theorem 3.44] and Proposition 2.4.3 imply that

$$\begin{aligned} \widetilde{H}^j(\mathcal{K}) &= \widetilde{H}^j(\mathring{U}_{(\partial\Delta^{m-1})'}(|\mathcal{K}'|)) = \widetilde{H}^j((\partial\Delta^{m-1})' \setminus |\widehat{\mathcal{K}}'|) \\ &= \widetilde{H}^j(S^{m-2} \setminus |\widehat{\mathcal{K}}|) \cong \widetilde{H}_{m-3-j}(\widehat{\mathcal{K}}). \quad \square \end{aligned}$$

A more direct topological proof is outlined in Exercise 2.4.10. Theorem 2.4.5 can be also proved in a purely combinatorial way, see [32]. There is also a proof within ‘combinatorial commutative algebra’ (which is the subject of Chapter 3), see Exercise 3.2.15 or [225, Theorem 5.6].

The duality between  $\mathcal{K}$  and  $\widehat{\mathcal{K}}$  extends to a duality between full subcomplexes of  $\mathcal{K}$  and links of simplices in  $\widehat{\mathcal{K}}$ :



COROLLARY 2.4.6. *Let  $\mathcal{K} \neq \Delta^{m-1}$  be a simplicial complex on  $[m]$  and  $I \notin \mathcal{K}$ , that is,  $\widehat{I} \in \widehat{\mathcal{K}}$ . Then there is an isomorphism*

$$\widetilde{H}^j(\mathcal{K}_I) \cong \widetilde{H}_{|I|-3-j}(\text{lk}_{\widehat{\mathcal{K}}} \widehat{I}), \quad \text{for } -1 \leq j \leq |I| - 2.$$

PROOF. We apply Theorem 2.4.5 to the complex  $\mathcal{K}_I$ , viewed as a simplicial complex on the set  $I$  of  $|I|$  elements. It follows from the definition that the dual complex is  $\text{lk}_{\widehat{\mathcal{K}}} \widehat{I}$ , which also can be viewed as a simplicial complex on the set  $I$ .  $\square$

EXAMPLE 2.4.7. Let  $\mathcal{K}$  be the boundary of a pentagon. Then  $\widehat{\mathcal{K}}$  is a Möbius band triangulated as shown on Fig. 2.3. Note that this  $\widehat{\mathcal{K}}$  can be realised as a subcomplex in  $\partial\Delta^4$ , and therefore it can be realised in  $\mathbb{R}^3$  as a subcomplex in the Schlegel diagram of  $\Delta^4$ , see Construction 2.5.2.

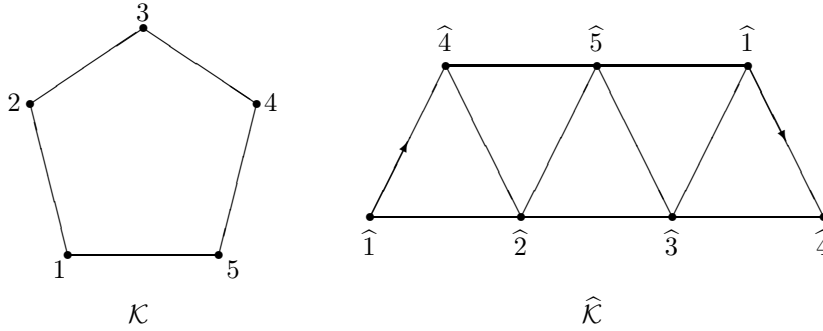

FIGURE 2.3. The boundary of a pentagon and its dual complex.

Adding a ghost vertex to  $\mathcal{K}$  results in suspending  $\widehat{\mathcal{K}}$ , up to homotopy. The precise statement is as follows (the proof is clear and is omitted).

PROPOSITION 2.4.8. *Let  $\mathcal{K}$  be a simplicial complex on  $[m]$  and  $\mathcal{K}^\circ$  be the complex on  $[m+1]$  obtained by adding one ghost vertex  $\circ = m+1$  to  $\mathcal{K}$ . Then the maximal simplices of  $\widehat{\mathcal{K}}^\circ$  are  $[m]$  and  $I \cup \circ$  for  $I \in \widehat{\mathcal{K}}$ , that is,*

$$\widehat{\mathcal{K}}^\circ = \Delta^{m-1} \cup_{\widehat{\mathcal{K}}} \text{cone } \widehat{\mathcal{K}}.$$

*In particular,  $\widehat{\mathcal{K}}^\circ$  is homotopy equivalent to the suspension  $\Sigma\widehat{\mathcal{K}}$ .*

**Exercises.**

2.4.9. Show that

$$\overset{\circ}{U}_{(\partial\Delta^{m-1})'}(|\mathcal{K}'|) = (\partial\Delta^{m-1})' \setminus |\widehat{\mathcal{K}}'|.$$

2.4.10. Complete the details in the following direct proof of combinatorial Alexander duality (Theorem 2.4.5).

There is a simplicial map

$$\varphi: (\partial\Delta^{m-1})' \rightarrow \mathcal{K}' * \widehat{\mathcal{K}}'$$

which is constructed as follows. We identify  $|\mathcal{K}'|$  with  $G(\mathcal{K})$  and  $|\widehat{\mathcal{K}}'|$  with  $D(\mathcal{K})$ , see (2.6) and (2.7). The vertex sets of these two subcomplexes split the vertex set of  $(\partial\Delta^{m-1})'$  into two nonintersecting subsets. Therefore,  $\varphi$  is uniquely determined

on the vertices. Check that  $\varphi$  is indeed a simplicial map. It induces a map of simplicial cochains

$$\varphi^* : C^j(\mathcal{K}') \otimes C^{m-3-j}(\widehat{\mathcal{K}}') \rightarrow C^{m-2}((\partial\Delta^{m-1})'),$$

or, equivalently,

$$C^j(\mathcal{K}') \rightarrow C_{m-3-j}(\widehat{\mathcal{K}}') \otimes C^{m-2}((\partial\Delta^{m-1})').$$

By evaluating on the fundamental cycle of  $(\partial\Delta^{m-1})'$  in  $C_{m-2}$  and passing to simplicial (co)homology, we obtain the required isomorphism

$$H^j(\mathcal{K}) \xrightarrow{\cong} H_{m-3-j}(\widehat{\mathcal{K}}).$$

## 2.5. Classes of triangulated spheres

Boundary complexes of simplicial polytopes form an important albeit restricted class of triangulated spheres. In this section we review several other classes of triangulated spheres and related complexes, and discuss their role in topology, geometry and combinatorics.

**DEFINITION 2.5.1.** A *triangulated sphere* (also known as a *sphere triangulation* or *simplicial sphere*) of dimension  $d$  is a simplicial complex  $\mathcal{K}$  homeomorphic to a  $d$ -sphere  $S^d$ . A *PL sphere* is a triangulated sphere  $\mathcal{K}$  which is *PL* homeomorphic to the boundary of a simplex (equivalently, there exists a subdivision of  $\mathcal{K}$  isomorphic to a subdivision of the boundary of a simplex).

**REMARK.** A *PL* sphere is not the same as a ‘*PL* manifold homeomorphic to a sphere’, but rather a ‘*PL* manifold which is *PL* homeomorphic to the *standard* sphere’, where the *standard PL* structure on a sphere is defined by triangulating it as the boundary of a simplex. Nevertheless, the two notions coincide in dimensions other than 4, see the discussion in the next section.

In small dimensions, triangulated spheres can be effectively visualised using *Schlegel diagrams* and their generalisations, which we describe below.

**DEFINITION 2.5.2.** By analogy with the notion of a geometric simplicial complex, we define a *polyhedral complex* as a collection  $\mathcal{C}$  of convex polytopes in a space  $\mathbb{R}^n$  such that every face of a polytope in  $\mathcal{C}$  belongs to  $\mathcal{C}$  and the intersection of any two polytopes in  $\mathcal{C}$  is either empty or a face of each. Two polyhedral complexes  $\mathcal{C}_1$  and  $\mathcal{C}_2$  are said to be *combinatorially equivalent* if there is a one-to-one correspondence between their polytopes respecting the inclusion of faces.

The boundary  $\partial P$  of a convex polytope  $P$  is a polyhedral complex. Another important polyhedral complex associated with  $P$  can be constructed as follows. Choose a facet  $F$  of  $P$  and a point  $p \notin P$  ‘close enough’ to  $F$  so that any segment connecting  $p$  to a point in  $P \setminus F$  intersects the relative interior of  $F$  (see Fig. 2.4 for the case  $P = I^3$ ). Now project the complex  $\partial P$  onto  $F$  from the point  $p$ . The projection images of faces of  $P$  different from  $F$  form a polyhedral complex  $\mathcal{C}$  subdividing  $F$ . We refer to  $\mathcal{C}$ , and also to any polyhedral complex combinatorially equivalent to it, as a *Schlegel diagram* of the polytope  $P$ .

An *n*-*diagram* is a polyhedral complex  $\mathcal{C}$  consisting of *n*-polytopes and their faces and satisfying the following conditions:

- (a) the union of all polytopes in  $\mathcal{C}$  is an *n*-polytope  $Q$ ;

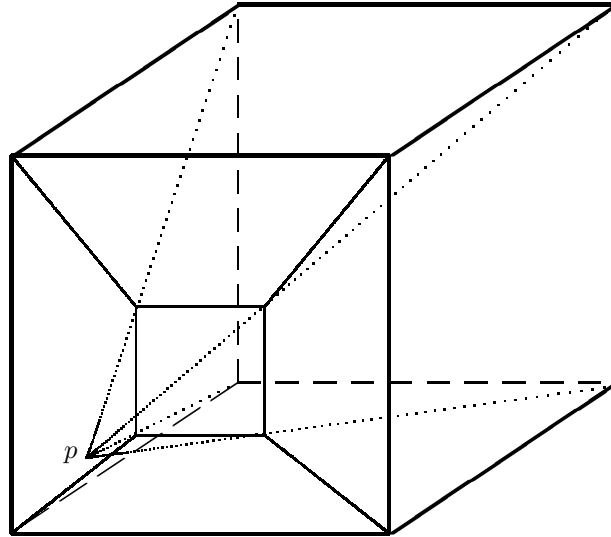
FIGURE 2.4. Schlegel diagram of  $I^3$ .

- (b) every nonempty intersection of a polytope from  $\mathcal{C}$  with the boundary of  $Q$  belongs to  $\mathcal{C}$ .

We refer to  $Q$  as the *base* of the  $n$ -diagram  $\mathcal{C}$ . An  $n$ -diagram is *simplicial* if it consists of simplices and its base is a simplex.

By definition, a Schlegel diagram of an  $n$ -polytope is an  $(n - 1)$ -diagram.

**PROPOSITION 2.5.3.** *Let  $\mathcal{C}$  be a simplicial  $(n - 1)$ -diagram with base  $Q$ . Then  $\mathcal{C} \cup_{\partial Q} Q$  is an  $(n - 1)$ -dimensional PL sphere.*

**PROOF.** We need to construct a simplicial complex which is a subdivision of both  $\mathcal{C} \cup_{\partial Q} Q$  and  $\partial \Delta^n$ . This can be done as follows. Replace one of the facets of  $\partial \Delta^n$  by the diagram  $\mathcal{C}$ . The resulting simplicial complex  $\mathcal{K}$  is a subdivision of  $\partial \Delta^n$ . On the other hand,  $\mathcal{K}$  is isomorphic to the subdivision of  $\mathcal{C} \cup_{\partial Q} Q$  obtained by replacing  $Q$  by a Schlegel diagram of  $\Delta^n$ .  $\square$

**COROLLARY 2.5.4.** *The boundary of a simplicial  $n$ -polytope is an  $(n - 1)$ -dimensional PL sphere.*

In dimensions  $n \leq 3$  every  $(n - 1)$ -diagram is a Schlegel diagram of an  $n$ -polytope. Indeed, for  $n \leq 2$  this is obvious, and for  $n = 3$  this is one of equivalent formulations of the well-known *Steinitz Theorem* (see [325, Theorem 5.8]). The first example of a 3-diagram which is not a Schlegel diagram of a 4-polytope was found by Grünbaum ([139, §11.5], see also [140]) as a correction of Brückner's result of 1909 on the classification of simplicial 4-polytopes with 8 vertices. Another example was found by Barnette [18]. We describe Barnette's example below. For the original example of Grünbaum, see Exercise 2.5.15.

**CONSTRUCTION 2.5.5** (Barnette's 3-diagram). Here a certain simplicial 3-diagram  $\mathcal{C}$  will be constructed. Consider the octahedron  $Q$  obtained by twisting the top face  $(abc)$  of a triangular prism (Fig. 2.5 (a)) slightly so that the vertices  $a, b, c, d, e$  and  $f$  are in general position. Assume that the edges  $(bd)$ ,  $(ce)$  and

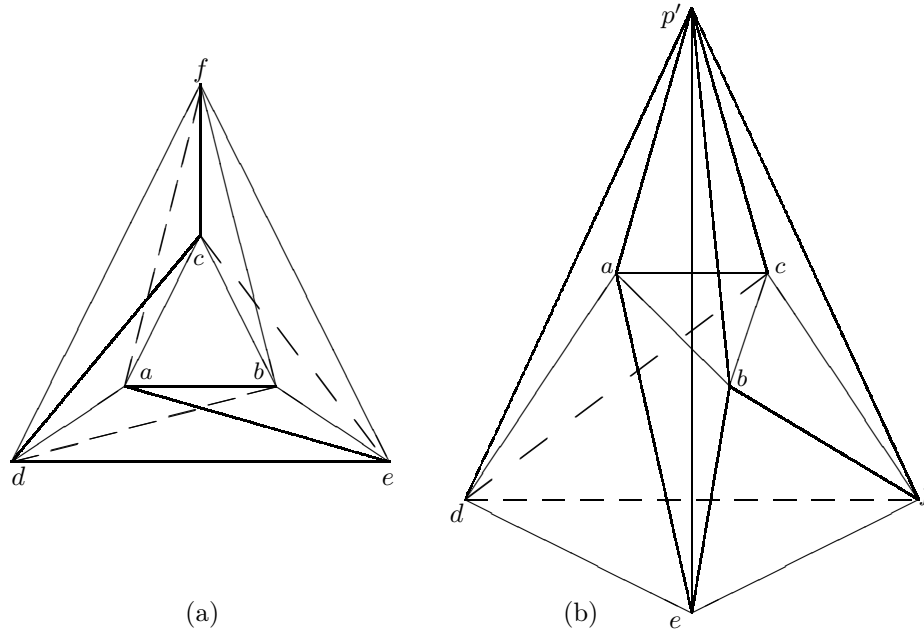

FIGURE 2.5. Barnette's 3-diagram.

( $af$ ) lie inside  $Q$ . The tetrahedra ( $abde$ ), ( $bcef$ ) and ( $acdf$ ) will be included in the complex  $\mathcal{C}$ . Each of these tetrahedra has two faces which lie inside  $Q$ . These 6 triangles together with ( $abc$ ) and ( $def$ ) form a triangulated 2-sphere inside  $Q$ , which we denote by  $\mathcal{S}$ . Now place a point  $p$  inside  $\mathcal{S}$  so that the line segments from  $p$  to the vertices of  $\mathcal{S}$  lie inside  $\mathcal{S}$ . We add to  $\mathcal{C}$  the eight tetrahedra obtained by taking cones with vertex  $p$  over the faces of  $\mathcal{S}$  (namely, the tetrahedra ( $pabc$ ), ( $pdef$ ), ( $pabd$ ), ( $pbed$ ), ( $pbce$ ), ( $pcef$ ), ( $pacf$ ) and ( $padf$ )). Note that  $\mathcal{S} = \text{lk } p$ . Applying a projective transformation if necessary, we may assume that there is a point  $p'$  outside the octahedron  $Q$  with the property that the segments joining  $p'$  with the vertices of  $Q$  lie outside  $Q$  (see Fig. 2.5 (b)). Finally, we add to  $\mathcal{C}$  the tetrahedra obtained by taking cones with vertex  $p'$  over the faces of  $Q$  other than the face ( $def$ ) (there are 7 such tetrahedra: ( $p'abc$ ), ( $p'abe$ ), ( $p'ade$ ), ( $p'acd$ ), ( $p'cdf$ ), ( $p'bcf$ ) and ( $p'bef$ )). The union of all tetrahedra in  $\mathcal{C}$  is the tetrahedron ( $p'def$ ); hence,  $\mathcal{C}$  is a simplicial 3-diagram. It has 8 vertices and 18 tetrahedra.

**PROPOSITION 2.5.6.** *The 3-diagram  $\mathcal{C}$  from the previous construction is not a Schlegel diagram.*

**PROOF.** Suppose there is a polytope  $P$  whose Schlegel diagram is  $\mathcal{C}$ . Since  $P$  is simplicial, we may assume that its vertices are in general position. We label the vertices of  $P$  with the same letters as the corresponding vertices in  $\mathcal{C}$ . Consider the complex  $\mathcal{S} = \text{lk } p$ . Let  $P'$  be the convex hull of all vertices of  $P$  other than  $p$ . Then  $P'$  is still a simplicial polytope, and  $\mathcal{S}$  is a subcomplex in  $\partial P'$ . In the complex  $\partial P'$  the sphere  $\mathcal{S}$  is filled with tetrahedra whose vertices belong to  $\mathcal{S}$ . Then at least one edge of one of these tetrahedra lies inside  $\mathcal{S}$ . However, any two vertices of  $\mathcal{S}$  which are not joined by an edge on  $\mathcal{S}$  are joined by an edge of  $\mathcal{C}$  lying outside  $\mathcal{S}$ . Since the polytope  $P'$  cannot contain a double edge we have reached a contradiction.  $\square$

Now we can introduce two more classes of triangulated spheres.

**DEFINITION 2.5.7.** A *polytopal sphere* is a triangulated sphere isomorphic to the boundary complex of a simplicial polytope.

A *starshaped sphere* is a triangulated sphere isomorphic to the underlying complex of a complete simplicial fan. Equivalently, a triangulated sphere  $\mathcal{K}$  of dimension  $n - 1$  is starshaped if there is a geometric realisation of  $\mathcal{K}$  in  $\mathbb{R}^n$  and a point  $p \in \mathbb{R}^n$  with the property that each ray emanating from  $p$  meets  $|\mathcal{K}|$  in exactly one point. The set of points such  $p \in \mathbb{R}^n$  is called the *kernel* of  $|\mathcal{K}|$ .

**EXAMPLE 2.5.8.** The triangulated 3-sphere coming from Barnette's 3-diagram is known as the *Barnette sphere*. It is starshaped. Indeed, in the construction of Barnette's 3-diagram we have the octahedron  $Q \subset \mathbb{R}^3$  and a vertex  $p'$  outside  $Q$  such that  $\text{lk } p' = \partial Q$ . If we choose the vertex  $p'$  in  $\mathbb{R}^4 \setminus \mathbb{R}^3$ , then the Barnette sphere can be realised in  $\mathbb{R}^4$  as the boundary complex of the pyramid with vertex  $p'$  and base  $Q$  (subdivided as described in Construction 2.5.5). This realisation is obviously starshaped.

We therefore have the following hierarchy of triangulations:

$$(2.8) \quad \begin{array}{ccccccc} \text{polytopal} & & \text{starshaped} & & PL & & \text{triangulated} \\ \text{spheres} & \subset & \text{spheres} & \subset & \text{spheres} & \subset & \text{spheres} \end{array}$$

Here the first inclusion follows from the construction of the normal fan (Construction 2.1.3), and the second is left as an exercise.

In dimension 2 any triangulated sphere is polytopal (this is another corollary of the Steinitz theorem). Also, by the result of Mani [205], any triangulated  $d$ -dimensional sphere with up to  $d + 4$  vertices is polytopal. However, in general all inclusions above are strict.

The first inclusion in (2.8) is strict already in dimension 3, as is seen from Example 2.5.8. There are 39 combinatorially different triangulations of a 3-sphere with 8 vertices, among which exactly two are nonpolytopal (namely, the Barnette and Brückner spheres); this classification was completed by Barnette [21].

The second inclusion in (2.8) is also strict in dimension 3. The first example of a nonstarshaped sphere triangulation was found by Ewald and Schulz [109]. We sketch this example below, following [108, Theorem 5.5].

**EXAMPLE 2.5.9 (Nonstarshaped sphere triangulation).** We use the fact, observed by Barnette, that not every tetrahedron in Barnette's 3-diagram can be chosen as the base of a 3-diagram of the Barnette sphere (see Exercise 2.5.16). For instance, the tetrahedron  $(abcd)$  cannot be chosen as the base.

Now let  $\mathcal{K}$  be a connected sum of two copies of the Barnette sphere along the tetrahedra  $(abcd)$  (the identification of vertices in the two tetrahedra is irrelevant). Assume that  $\mathcal{K}$  has a starshaped realisation in  $\mathbb{R}^4$ . The hyperplane  $H$  through the points  $a, b, c, d$  splits  $|\mathcal{K}|$  into two parts  $|\mathcal{K}_1|$  and  $|\mathcal{K}_2|$ . Since the kernel of  $|\mathcal{K}|$  is an open set, it contains a point  $p$  not lying in  $H$ . Then by projecting either  $|\mathcal{K}_1|$  or  $|\mathcal{K}_2|$  onto  $H$  from  $p$ , we obtain a 3-diagram of the Barnette sphere with base  $(abcd)$ . This is a contradiction.

The fact that  $\mathcal{K}$  is a *PL* sphere is an exercise.

The third inclusion in (2.8) is the subtlest one. It is known that in dimension 3 any triangulated sphere is *PL*. In dimension 4 the corresponding question is open,

but starting from dimension 5 there exist *non-PL* sphere triangulations. See the discussion in the next section and Example 2.6.3.

Many important open problems of combinatorial geometry arise from analysing the relationships between different classes of sphere triangulations. We end this section by discussing some of these problems.

In connection with the condition of realisability of a triangulated  $(n-1)$ -sphere in  $\mathbb{R}^n$  in the definition of a starshaped sphere, we note that the existence of such a realisation is open in general:

PROBLEM 2.5.10. Does every *PL*  $(n-1)$ -sphere admit a geometric realisation in an  $n$ -dimensional space?

The  $g$ -theorem (Theorem 1.4.14) gives a complete characterisation of integral vectors arising as the  $f$ -vectors of polytopal spheres. It is therefore natural to ask whether the  $g$ -theorem extends to all sphere triangulations. This question was posed by McMullen [218] as an extension of his conjecture for simplicial polytopes. Since 1980, when McMullen's conjecture for simplicial polytopes was proved by Billera, Lee, and Stanley, its generalisation to spheres has been regarded as the main open problem in the theory of  $f$ -vectors:

PROBLEM 2.5.11 ( $g$ -conjecture for triangulated spheres). Does Theorem 1.4.14 hold for triangulated spheres?

The  $g$ -conjecture is open even for starshaped spheres. Note that only the necessity of the conditions in the  $g$ -theorem (that is, the fact that every  $g$ -vector is an  $M$ -vector) has to be verified for triangulated spheres. If correct, the  $g$ -conjecture would imply a complete characterisation of  $f$ -vectors of triangulated spheres.

The Dehn–Sommerville relations (condition (a) in Theorem 1.4.14) hold for arbitrary sphere triangulations (see Corollary 3.4.7 below). The  $f$ -vectors of triangulated spheres also satisfy the UBT and LBT inequalities given in Theorems 1.4.4 and 1.4.9 respectively. The proof of the Lower Bound Theorem for simplicial polytopes given by Barnette in [20] extends to all triangulated spheres (see also [177]). In particular, this implies the second GLBC inequality  $h_1 \leq h_2$ , see (1.18). The Upper Bound Theorem for triangulated spheres was proved by Stanley [288] (we shall give his argument in Section 3.3). This implies that the  $g$ -conjecture is true for triangulated spheres of dimension  $\leq 4$ . The third GLBC inequality  $h_2 \leq h_3$  (for spheres of dimension  $\geq 5$ ) is open.

Many attempts to prove the  $g$ -conjecture were made after 1980. Though unsuccessful, these attempts resulted in some very interesting reformulations of the  $g$ -conjecture. The results of Pachner [253] reduce the  $g$ -conjecture (for *PL* spheres) to some properties of *bistellar moves*; see the discussion after Theorem 2.7.3 below.

The lack of progress in proving the  $g$ -conjecture motivated Björner and Lutz to launch a computer-aided search for counterexamples [31]. Though their bistellar flip algorithm and BISTELLAR software produced many remarkable results on triangulations of manifolds, no counterexamples to the  $g$ -conjecture were found. More information on the  $g$ -conjecture and related questions may be found in [293] and [325, Lecture 8].

We may extend the hierarchy (2.8) by considering polyhedral complexes homeomorphic to spheres (the so-called *polyhedral spheres*) instead of triangulated spheres. There are obvious analogues of polytopal and *PL* spheres in this generality. However, unlike the case of triangulations, the two definitions of a starshaped sphere

(namely, the one using fans and the one using the kernel points) no longer produce the same classes of objects, see [108, §III.5] for the corresponding examples. One of the most notorious and long standing problems is to find a proper higher dimensional analogue to the Steinitz theorem. This theorem characterises graphs of 3-dimensional polytopes, and one of its equivalent formulations is that every polyhedral 2-sphere is polytopal. In higher dimensions, identification of the class of polytopal spheres inside all polyhedral spheres is known as the *Steinitz problem*:

**PROBLEM 2.5.12 (Steinitz Problem).** Find necessary and sufficient conditions for a polyhedral decomposition of a sphere to be combinatorially equivalent to the boundary complex of a convex polytope.

This is far from being solved even in the case of triangulated spheres. For more information on the relationships between different classes of polyhedral spheres and complexes see the above cited book of Ewald [108] and the survey article by Klee and Kleinschmidt [187].

### Exercises.

2.5.13. Show that  $\mathcal{K}$  is the underlying complex of a complete simplicial fan if and only if there is a geometric realisation of  $\mathcal{K}$  in  $\mathbb{R}^n$  and a point  $p \in \mathbb{R}^n$  with the property that each ray emanating from  $p$  meets  $|\mathcal{K}|$  in exactly one point.

2.5.14. Prove that every starshaped sphere is a *PL* sphere.

2.5.15 (Brückner sphere). The *Brückner sphere* is obtained by replacing two tetrahedra  $(abc)$  and  $(p'abc)$  in the Barnette sphere by three tetrahedra  $(pp'ab)$ ,  $(pp'ac)$  and  $(pp'bc)$  (this is an example of a bistellar 1-move considered in Section 2.7). Show that the Brückner sphere is starshaped but not polytopal. Note that the 1-skeleton of the Brückner sphere is a complete graph (that is, the Brückner sphere is a *neighbourly* triangulation, see Definition 1.1.15).

2.5.16. Show that the tetrahedron  $(abcd)$  in Barnette's 3-diagram (Construction 2.5.5) cannot be chosen as the base of a 3-diagram of the Barnette sphere. Which tetrahedra can be chosen as the base?

2.5.17. The connected sum of two *PL* spheres is a *PL* sphere.

## 2.6. Triangulated manifolds

Piecewise linear topology experienced an intensive development during the second half of the 20th century, thanks to the efforts of many topologists. Surgery theory for simply connected manifolds of dimension  $\geq 5$  originated from the early work of Milnor, Kervaire, Browder, Novikov and Wall, culminated in the proof of the topological invariance of rational Pontryagin classes given by Novikov in 1965, and was further developed in the work of Lashof, Rothenberg, Sullivan, Kirby, Siebenmann, and others. It led to a better understanding of the place of *PL* manifolds between the topological and smooth categories. Without attempting to overview the current state of the subject, which is generally beyond the scope of this book, we include several important results on the triangulation of topological manifolds, with a particular emphasis on various nonexamples. We also provide references for further reading.

All manifolds here are compact, connected and closed, unless otherwise stated.

DEFINITION 2.6.1. A *triangulated manifold* (or *simplicial manifold*) is a simplicial complex  $\mathcal{K}$  whose geometric realisation  $|\mathcal{K}|$  is a topological manifold.

A *PL manifold* is a simplicial complex  $\mathcal{K}$  of dimension  $d$  such that  $\text{lk } I$  is a *PL sphere* of dimension  $d - |I|$  for every nonempty simplex  $I \in \mathcal{K}$ .

Every *PL manifold*  $|\mathcal{K}|$  of dimension  $d$  is a triangulated manifold: it has an atlas whose change of coordinates functions are piecewise linear. Indeed, for each vertex  $v \in |\mathcal{K}|$  the  $(d - 1)$ -dimensional *PL sphere*  $\text{lk } v$  bounds an open neighbourhood  $U_v$  which is homeomorphic to an open  $d$ -ball. Since any point of  $|\mathcal{K}|$  is contained in  $U_v$  for some  $v$ , this defines an atlas for  $|\mathcal{K}|$ .

REMARK. The term ‘*PL manifold*’ is often used for a manifold with a *PL atlas*, while its particular triangulation with the property above is referred to as a *combinatorial manifold*. We shall not distinguish between these two notions.

Does every triangulation of a topological manifold yield a simplicial complex which is a *PL manifold*? The answer is ‘no’, and the question itself ascends to a famous conjecture of the dawn of topology, known as the *Hauptvermutung*, which is German for ‘main conjecture’. Below we briefly review the current status of this conjecture, referring to the survey article [274] by Ranicki for a much more detailed historical account and more references.

In the early days of topology all of the known topological invariants were defined in combinatorial terms, and it was very important to find out whether the topology of a triangulated space fully determines the combinatorial equivalence class of the triangulation (in the sense of Definition 2.2.6). In the modern terminology, the *Hauptvermutung* states that any two homeomorphic simplicial complexes are combinatorially equivalent (*PL homeomorphic*). This is valid in dimensions  $\leq 3$ ; the result is due to Rado (1926) for 2-manifolds, Papakyriakopoulos (1943) for 2-complexes, Moise (1953) for 3-manifolds, and E. Brown (1963) for 3-complexes [43]; see [233] for a detailed exposition. The first examples of complexes disproving the *Hauptvermutung* in dimensions  $\geq 6$  were found by Milnor in the early 1960s. However, the *manifold Hauptvermutung*, namely the question of whether two homeomorphic triangulated manifolds are combinatorially equivalent, remained open until the end of the 1960s. The first counterexamples were found by Siebenmann in 1969, and relied heavily on the topological surgery theory. The ‘double suspension theorem’, which we state as Theorem 2.6.2 below, appeared around 1975 and provided much more explicit counterexamples to the manifold *Hauptvermutung*.

A *d-dimensional homology sphere* (or simply *homology d-sphere*) is a topological  $d$ -manifold whose integral homology groups are isomorphic to those of a  $d$ -sphere  $S^d$ .

THEOREM 2.6.2 (Edwards, Cannon). *The double suspension of any homology d-sphere is homeomorphic to  $S^{d+2}$ .*

This theorem was proved for most double suspensions and all triple suspensions by Edwards [103]; the general case was done by Cannon [65]. One of its most important consequences is the existence of non-*PL triangulations* of 5-spheres, which also disproves the manifold *Hauptvermutung* in dimensions  $\geq 5$ .

EXAMPLE 2.6.3 (non-*PL triangulated 5-sphere*). Let  $M$  be a triangulated homology 3-sphere which is not homeomorphic to  $S^3$ . An example of such  $M$  is provided by the *Poincaré sphere*. It is the homogeneous space  $SO(3)/A_5$ , where the alternating group  $A_5$  is represented in  $\mathbb{R}^3$  as the group of self-transformations



of a dodecahedron. A particular symmetric triangulation of the Poincaré sphere is given in [31]. By Theorem 2.6.2, the double suspension  $\Sigma^2 M$  is homeomorphic to  $S^5$  (and, more generally,  $\Sigma^k M$  is homeomorphic to  $S^{k+3}$  for  $k \geq 2$ ). However,  $\Sigma^2 M$  cannot be a *PL* sphere, since  $M$  appears as the link of a 1-simplex in  $\Sigma^2 M$ .

Also, according to a result of Björner and Lutz [31], for any  $d \geq 5$  there is a non-*PL* triangulation of  $S^d$  with  $d + 13$  vertices.

Theorem 2.6.2 led to progress in the following ‘manifold recognition problem’: given a simplicial complex, how one can decide whether its geometric realisation is a topological manifold? In higher dimensions there is the following result, which can be viewed as a generalisation of the double suspension theorem.

**THEOREM 2.6.4** (Edwards [104]). *For  $d \geq 5$  the realisation of a simplicial complex  $\mathcal{K}$  is a topological manifold of dimension  $d$  if and only if  $\text{lk} I$  has the homology of a  $(d - |I|)$ -sphere for each nonempty simplex  $I \in \mathcal{K}$ , and  $\text{lk} v$  is simply connected for each vertex  $v$  of  $\mathcal{K}$ .*

**REMARK.** From the algorithmic point of view, the homology of links is easily computable, but their simply connectedness seems to be undecidable. There is a related result of Novikov [318, Appendix] that a triangulated 5-sphere cannot be algorithmically recognised. On the other hand, the algorithmic recognition problem for a triangulated 3-sphere has a positive solution, with the first algorithm provided by Rubinstein [278]. See detailed exposition in Matveev’s book [213], which also contains a proof that all 3-dimensional *Haken manifolds* can be recognised and fully classified algorithmically.

With the discovery of exotic smooth structures on 7-spheres by Milnor and the disproof of the Hauptvermutung it had become important to understand better the relationship between *PL* and smooth structures on topological manifolds. Since a *PL* structure implies the existence of a particular sort of triangulation, the related question of whether a topological manifold admits *any* triangulation (not necessarily *PL*) had also become important.

Triangulations of 2-manifolds have been known from the early days of topology. A proof that any 3-manifold can be triangulated was obtained independently by Moise and Bing in the end of 1950s (the proof can be found in [233]). Since the link of a vertex in a triangulated 3-sphere is a 2-sphere, and a 2-sphere is always *PL*, all topological 3-manifolds are *PL*.

A smooth manifold of any dimension has a *PL* triangulation by a theorem of Whitney (a proof can be found in [235]). Moreover, in dimensions  $\leq 3$  every topological manifold has a unique smooth structure, see [233] for a proof. All these considerations show that in dimensions up to 3 the categories of topological, *PL* and smooth manifolds are equivalent.

The situation in dimension 4 is quite different. There exist topological 4-manifolds that do not admit a *PL* triangulation. An example is provided by Freedman’s fake  $\mathbb{C}P^2$  [118, §8.3, §10.1], a topological manifold which is homeomorphic, but not diffeomorphic to the complex projective plane  $\mathbb{C}P^2$ . This example also shows that the Hauptvermutung is false in dimension 4. Even worse, some topological 4-manifolds do not admit any triangulation; an example is the topological 4-manifold with the intersection form  $E_8$ , see [3].

In dimension 4 the categories of  $PL$  and smooth manifolds agree, that is, there is exactly one smooth structure on every  $PL$  manifold. However, the classification of  $PL$  (or equivalently, smooth) structures is wide open even for the simplest topological manifolds. The most notable problem here is the following.

PROBLEM 2.6.5. Is a  $PL$  (or smooth) structure on a 4-sphere unique?

In dimensions  $\geq 5$  the  $PL$  structure on a topological sphere is unique (that is, a  $PL$  manifold which is homeomorphic to a sphere is a  $PL$  sphere).

For the discussion of the classification of  $PL$  structures on topological manifolds we refer to Ranicki's survey [274], the original essay [185] by Kirby and Siebenmann, and a more recent survey by Rudyak [279].

### 2.7. Stellar subdivisions and bistellar moves

By a theorem of Alexander, a common subdivision of two  $PL$  homeomorphic  $PL$  manifolds can be obtained by iterating operations from a very simple and explicit list, known as *stellar subdivisions*. An even more concrete iterative description of  $PL$  homeomorphisms was obtained by Pachner [252], who introduced the notion of *bistellar moves* (in other terminology, *bistellar flips* or *bistellar operations*), generalising the 2- and 3-dimensional *flips* from low-dimensional topology. These operations allow us to decompose a  $PL$  homeomorphism into a sequence of simple 'moves' and thus provide a very convenient way to compute and handle topological invariants of  $PL$  manifolds. Starting from a given  $PL$  triangulation, bistellar operations may be used to construct new triangulations with some good properties, such as ones that are symmetric or have a small number of vertices. On the other hand, bistellar moves can be used to produce some nasty triangulations if we start from a non- $PL$  triangulation. Both approaches were used in the work of Björner–Lutz [31] and Lutz [200] to find many interesting triangulations of low-dimensional manifolds. In our exposition of bistellar moves we follow the terminology of [200].

Bistellar moves also provide a combinatorial interpretation for algebraic *flop* operations for projective *toric varieties* and for certain surgery operations on moment-angle complexes and torus manifolds. Finally, bistellar moves may be used to define a metric on the space of  $PL$  triangulations of a given  $PL$  manifold, see [238].

DEFINITION 2.7.1 (stellar subdivisions and bistellar moves). Let  $I \in \mathcal{K}$  be a nonempty simplex of a simplicial complex  $\mathcal{K}$ . The *stellar subdivision* of  $\mathcal{K}$  at  $I$  is obtained by replacing the star of  $I$  by the cone over its boundary:

$$ss_I \mathcal{K} = (\mathcal{K} \setminus st_{\mathcal{K}} I) \cup (\text{cone } \partial st_{\mathcal{K}} I).$$

If  $\dim I = 0$  then  $ss_I \mathcal{K} = \mathcal{K}$ . Otherwise the complex  $ss_I \mathcal{K}$  acquires an additional vertex (the vertex of the cone) whose link is  $\partial st_{\mathcal{K}} I$ . Two possible stellar subdivisions of a 2-dimensional complex are shown in Fig. 2.6.

Now let  $\mathcal{K}$  be a triangulated manifold of dimension  $d$ . Assume that  $I \in \mathcal{K}$  is a  $(d - j)$ -face such that the simplicial complex  $lk_{\mathcal{K}} I$  is the boundary of a  $j$ -simplex  $J$  which is not a face of  $\mathcal{K}$ . Then the operation  $bm_I$  on  $\mathcal{K}$  defined by

$$bm_I \mathcal{K} = (\mathcal{K} \setminus (I * \partial J)) \cup (\partial I * J)$$

is called a *bistellar  $j$ -move*. Since  $I * \partial J = st_{\mathcal{K}} I$  and  $\partial I * J = st_{\tilde{\mathcal{K}}} J$ , where  $\tilde{\mathcal{K}} = bm_I \mathcal{K}$ , the bistellar  $j$ -move is the composition of a stellar subdivision at  $I$  and the inverse stellar subdivision at  $J$ , which explains the term. In particular,

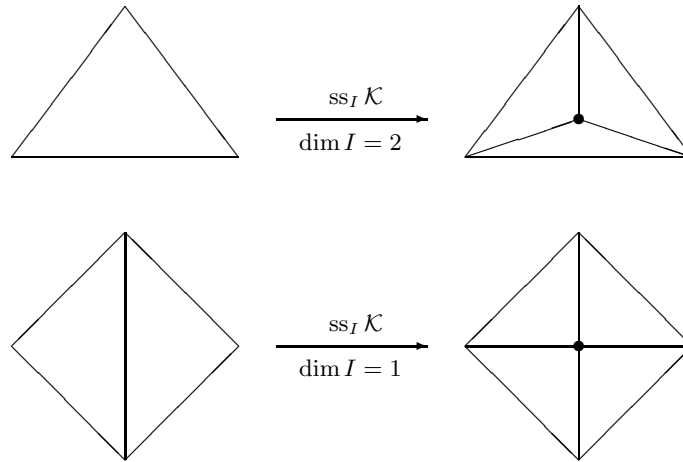

FIGURE 2.6. Stellar subdivisions at a 2-simplex and at an edge.

the stellar subdivision  $ss_I \mathcal{K}$  is a common subdivision of  $\mathcal{K}$  and  $\tilde{\mathcal{K}}$ , so that  $\mathcal{K}$  and  $\tilde{\mathcal{K}}$  are combinatorially equivalent. Note that a 0-move is the stellar subdivision at a maximal simplex (we assume that the boundary of a 0-simplex is empty).

Bistellar  $j$ -moves with  $i \geq \lfloor \frac{d}{2} \rfloor$  are also called *reverse  $(d - j)$ -moves*. A 0-move adds a new vertex to the triangulation, a  $d$ -move (reverse 0-move) deletes a vertex, and all other bistellar moves do not change the number of vertices. The bistellar moves in dimension 2 and 3 are shown in Figures 2.7 and 2.8. The bistellar 1-move in dimension 3 replaces two tetrahedra with a common face by 3 tetrahedra with a common edge.

Two simplicial complexes are said to be *bistellarly equivalent* if one can be transformed to another by a finite sequence of bistellar moves.

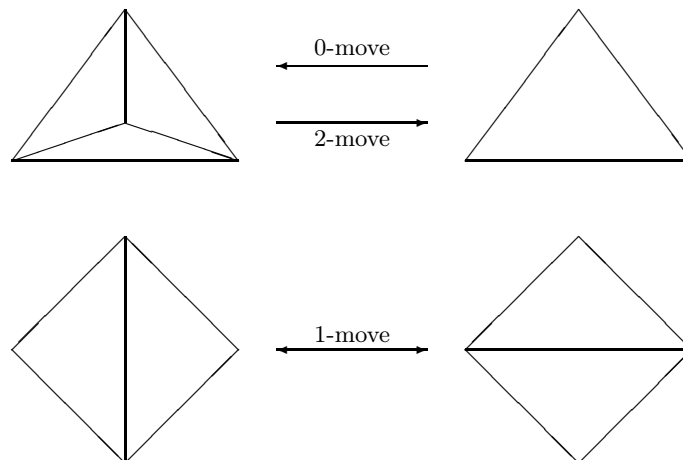
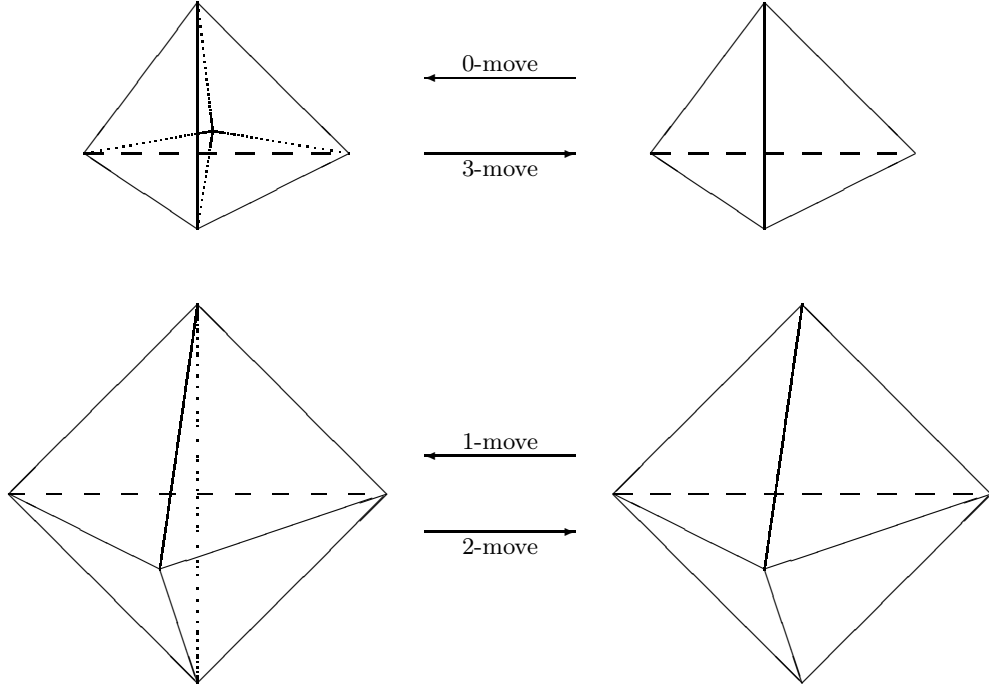

FIGURE 2.7. Bistellar moves for  $q = 2$ .

FIGURE 2.8. Bistellar moves for  $q = 3$ .

We have seen that bistellar equivalence implies  $PL$  homeomorphism. The following result shows that for  $PL$  manifolds the converse is also true.

**THEOREM 2.7.2** (Pachner [252, Theorem 1], [253, (5.5)]). *Two  $PL$  manifolds are bistellarly equivalent if and only if they are  $PL$  homeomorphic.*

The behaviour of the face numbers of a triangulation under bistellar moves is easily controlled. It can be most effectively described in terms of the  $g$ -vector,  $g_i(\mathcal{K}) = h_i(\mathcal{K}) - h_{i-1}(\mathcal{K})$ ,  $0 < i \leq \lfloor \frac{d}{2} \rfloor$ :

**THEOREM 2.7.3** (Pachner [252]). *If a triangulated  $d$ -manifold  $\tilde{\mathcal{K}}$  is obtained from  $\mathcal{K}$  by a bistellar  $k$ -move,  $0 \leq k \leq \lfloor \frac{d-1}{2} \rfloor$ , then*

$$g_{k+1}(\tilde{\mathcal{K}}) = g_{k+1}(\mathcal{K}) + 1;$$

$$g_i(\tilde{\mathcal{K}}) = g_i(\mathcal{K}) \quad \text{for all } i \neq k + 1.$$

*Furthermore, if  $d$  is even and  $\tilde{\mathcal{K}}$  is obtained from  $\mathcal{K}$  by a bistellar  $\lfloor \frac{d}{2} \rfloor$ -move, then*

$$g_i(\tilde{\mathcal{K}}) = g_i(\mathcal{K}) \quad \text{for all } i.$$

This theorem allows us to interpret the inequalities from the  $g$ -conjecture for  $PL$  spheres (see Theorem 1.4.14) in terms of the numbers of bistellar  $k$ -moves needed to transform a given  $PL$  sphere to the boundary of a simplex. For instance, the inequality  $h_1 \leq h_2$ ,  $n \geq 4$ , is equivalent to the statement that the number of 1-moves in the sequence of bistellar moves taking a given  $(n-1)$ -dimensional  $PL$  sphere to the boundary of an  $n$ -simplex is less than or equal to the number of reverse 1-moves. (Note that the  $g$ -vector of  $\partial\Delta^n$  is  $(1, 0, \dots, 0)$ .)

REMARK. There is also a generalisation of Theorem 2.7.2 to  $PL$  manifolds with boundary, see [253, (6.3)].

In the case of polytopal sphere triangulations a stellar subdivision is related to another familiar operation:

PROPOSITION 2.7.4. *Assume given a simple polytope  $P$  and a proper face  $G \subset P$ . Let  $P^*$  be the dual simplicial polytope,  $\mathcal{K}_P = \partial P^*$  its nerve complex, and  $J \subset P^*$  the face dual to  $G$ . Then the stellar subdivision  $\text{ss}_J \mathcal{K}_P$  is the nerve complex of the polytope  $\tilde{P}$  obtained by the face truncation at  $G$ .*

PROOF. This follows directly by comparing the face poset of  $\tilde{P}$ , described in Construction 1.1.12, with that of  $\text{ss}_J \mathcal{K}_P$ .  $\square$

### Exercises.

2.7.5. The barycentric subdivision of  $\mathcal{K}$  can be obtained as a sequence of stellar subdivisions at all faces  $I \in \mathcal{K}$ , starting from the maximal ones.

2.7.6. Deduce formulae for the transformation of the  $f$ -,  $h$ - and  $g$ -vector of  $\mathcal{K}$  under a stellar subdivision. Deduce similar formulae for a bistellar move (the case of the  $g$ -vector is Theorem 2.7.3).

## 2.8. Simplicial posets and simplicial cell complexes

Simplicial posets describe the combinatorial structures underlying ‘generalised simplicial complexes’ whose faces are still simplices, but two faces are allowed to intersect in any subcomplex of their boundary, rather than just in a single face. These are also known as ‘ideal triangulations’ in low-dimensional topology, or as ‘simplicial cell complexes’.

DEFINITION 2.8.1. A poset (partially ordered set)  $\mathcal{S}$  with order relation  $\leq$  is called *simplicial* if it has an initial element  $\hat{0}$  and for each  $\sigma \in \mathcal{S}$  the lower segment

$$[\hat{0}, \sigma] = \{\tau \in \mathcal{S} : \hat{0} \leq \tau \leq \sigma\}$$

is the face poset of a simplex. (The latter poset is also known as a *Boolean lattice*, and simplicial posets are sometimes called *Boolean posets*.) We assume all our posets to be finite. The *rank function*  $|\cdot|$  on  $\mathcal{S}$  is defined by setting  $|\sigma| = k$  if  $[\hat{0}, \sigma]$  is the face poset of a  $(k - 1)$ -dimensional simplex. The rank of  $\mathcal{S}$  is the maximum of ranks of its elements, and the *dimension* of  $\mathcal{S}$  is its rank minus one. A *vertex* of  $\mathcal{S}$  is an element of rank one. We assume that  $\mathcal{S}$  has  $m$  vertices, denote the vertex set by  $V(\mathcal{S})$ , and usually identify it with  $[m] = \{1, \dots, m\}$ . Similarly, we denote by  $V(\sigma)$  the vertex set of  $\sigma$ , that is the set of  $i$  with  $i \leq \sigma$ .

The face poset of a simplicial complex is a simplicial poset, but there are many simplicial posets that do not arise in this way (see Example 2.8.2 below). We identify a simplicial complex with its face poset, thereby regarding simplicial complexes as particular cases of simplicial posets.

To each  $\sigma \in \mathcal{S}$  we assign a geometric simplex  $\Delta^\sigma$  whose face poset is  $[\hat{0}, \sigma]$ , and glue these geometric simplices together according to the order relation in  $\mathcal{S}$ . As a result we get a regular cell complex in which the closure of each cell is identified with a simplex preserving the face structure, and all attaching and characteristic maps are inclusions (see [151, Appendix] for the terminology of cell complexes).

We call it the *simplicial cell complex* associated with  $\mathcal{S}$  and denote its underlying space by  $|\mathcal{S}|$ .

In the case when  $\mathcal{S}$  is (the face poset of) a simplicial complex  $\mathcal{K}$  the space  $|\mathcal{S}|$  is the geometric realisation  $|\mathcal{K}|$ .

REMARK. Using a more formal categorical language, we consider the *face category*  $(\mathcal{S})$  whose objects are elements  $\sigma \in \mathcal{S}$  and there is a morphism from  $\sigma$  to  $\tau$  whenever  $\sigma \leq \tau$ . Define a diagram (covariant functor)  $\Delta^{\mathcal{S}}$  from  $(\mathcal{S})$  to topological spaces by sending  $\sigma \in \mathcal{S}$  to the geometric simplex  $\Delta^{\sigma}$  and sending every morphism  $\sigma \leq \tau$  to the inclusion  $\Delta^{\sigma} \hookrightarrow \Delta^{\tau}$ . Then we may write

$$|\mathcal{S}| = \operatorname{colim} \Delta^{\mathcal{S}},$$

where the colimit (or direct limit) is taken in the category of topological spaces. This is the first example of colimit construction over the face category  $(\mathcal{S})$ . Many other examples of this sort will appear later.

In most circumstances we shall not distinguish between simplicial posets and simplicial cell complexes. We shall also sometimes refer to elements  $\sigma \in \mathcal{S}$  as *simplices* or *faces* of  $\mathcal{S}$ .

EXAMPLE 2.8.2. Consider the simplicial cell complex obtained by attaching two  $d$ -dimensional simplices along their boundaries. Its corresponding simplicial poset is not the face poset of a simplicial complex if  $d > 0$ .

Three cellular subdivisions of a circle are shown in Fig. 2.9. The first is not a simplicial cell complex. The second is a simplicial cell complex, but not a simplicial complex (it corresponds to  $d = 1$  in the previous paragraph). The third one is a simplicial complex.

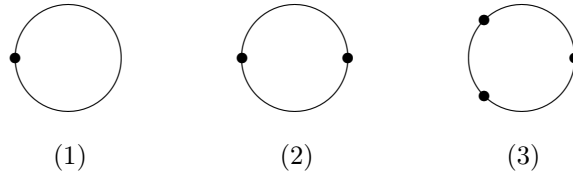

FIGURE 2.9. Cellular subdivisions of a circle.

CONSTRUCTION 2.8.3 (folding a simplicial poset onto a simplicial complex). For every simplicial poset  $\mathcal{S}$  there is the associated simplicial complex  $\mathcal{K}_{\mathcal{S}}$  on the same vertex set  $V(\mathcal{S})$ , whose simplices are sets  $V(\sigma)$ ,  $\sigma \in \mathcal{S}$ . There is a *folding map* of simplicial posets

$$(2.9) \quad \mathcal{S} \longrightarrow \mathcal{K}_{\mathcal{S}}, \quad \sigma \mapsto V(\sigma).$$

It is identical on the vertices, and every simplex in  $\mathcal{K}_{\mathcal{S}}$  gets covered by a finite number of simplices of  $\mathcal{S}$ .

For any two elements  $\sigma, \tau \in \mathcal{S}$ , denote by  $\sigma \vee \tau$  the set of their least common upper bounds (*joins*), and denote by  $\sigma \wedge \tau$  the set of their greatest common lower bounds (*meets*). Since  $\mathcal{S}$  is a simplicial poset,  $\sigma \wedge \tau$  consists of a single element whenever  $\sigma \vee \tau$  is nonempty. It is easy to observe that  $\mathcal{S}$  is a simplicial complex

if and only if for any  $\sigma, \tau \in \mathcal{S}$  the set  $\sigma \vee \tau$  is either empty or consists of a single element. In this case  $\mathcal{S}$  coincides with  $\mathcal{K}_{\mathcal{S}}$ .

Applying barycentric subdivision to every simplex  $\sigma \in \mathcal{S}$  we obtain a new simplicial cell complex  $\mathcal{S}'$ , called the *barycentric subdivision* of  $\mathcal{S}$ . From Proposition 2.3.7 it is clear that  $\mathcal{S}'$  can be identified with the (geometric realisation of the) order complex  $\text{ord}(\mathcal{S} \setminus \hat{0})$ . We therefore obtain the following.

**PROPOSITION 2.8.4.** *The barycentric subdivision  $\mathcal{S}'$  of a simplicial cell complex is a simplicial complex.*

### Exercises.

2.8.5. Show that the following conditions are equivalent for a simplicial poset  $\mathcal{S}$ :

- (a)  $\mathcal{S}$  is (the face poset of) a simplicial complex;
- (b) for any  $\sigma, \tau \in \mathcal{S}$  the set  $\sigma \wedge \tau$  consists of a single element;
- (c) for any  $\sigma, \tau \in \mathcal{S}$  the set  $\sigma \vee \tau$  is either empty or consists of a single element.

## 2.9. Cubical complexes

At some stage of the development of combinatorial topology, cubical complexes were considered as an alternative to triangulations, a new way to study topological invariants combinatorially. Their nice feature is that the product of cubes is again a cube, which makes subdivisions of products easier and leads to a more straightforward definition of the multiplication in cohomology. Later it turned out, however, that the cubical (co)homology itself is not particularly advantageous in comparison with the simplicial one. Currently combinatorial geometry is the main field of applications of cubical complexes; moreover, subdivisions into cubes sometimes are very helpful in various geometrical and topological considerations. In this section we collect the necessary definitions and notation, and then proceed to describe some important cubical decompositions of simple polytopes and simplicial complexes.

**Definitions and examples.** As in the case of simplicial complexes, a cubical complex can be defined either abstractly (as a poset) or geometrically (as a cell complex).

**DEFINITION 2.9.1.** An *abstract cubical complex* is a finite poset  $(\mathcal{C}, \subset)$  containing an initial element  $\emptyset$  and satisfying the following two conditions:

- (a) for every element  $G \in \mathcal{C}$  the segment  $[\emptyset, G]$  is isomorphic to the face poset of a cube;
- (b) for every two elements  $G_1, G_2 \in \mathcal{C}$  there is a unique meet (greatest lower bound).

Elements  $G \in \mathcal{C}$  are *faces* of the cubical complex. If  $[\emptyset, G]$  is the face poset of the  $k$ -cube  $\mathbb{I}^k$ , then the face  $G$  is of  *$k$ -dimensional*. The dimension of  $\mathcal{C}$  is the maximal dimension of its faces. The meet of any two faces  $G_1, G_2$  is also called their *intersection* and denoted  $G_1 \cap G_2$ .

A  *$d$ -dimensional topological cube* is a  $d$ -ball with a face structure defined by a homeomorphism with the standard cube  $\mathbb{I}^d$ . A *face* of a topological  $d$ -cube is thus the homeomorphic image of a face of  $\mathbb{I}^d$ .

**DEFINITION 2.9.2.** A *topological cubical complex* is a set  $\mathcal{U}$  of topological cubes of arbitrary dimensions which are all embedded in the same space  $\mathbb{R}^n$  and satisfy the following conditions:

- (a) every face of a cube in  $\mathcal{U}$  belongs to  $\mathcal{U}$ ;
- (b) The intersection of any two cubes in  $\mathcal{U}$  is a face of each.

Every abstract cubical complex  $\mathcal{C}$  has a *geometric realisation*, a topological cubical complex  $\mathcal{U}$  whose faces form a poset isomorphic to  $\mathcal{C}$ . Such  $\mathcal{U}$  can be constructed by taking a disjoint union of topological cubes corresponding to all segments  $[\emptyset, G] \subset \mathcal{C}$  and identifying faces according to the poset relation.

From now on we shall not distinguish between abstract cubical complexes and their geometric realisations.

By analogy with simplicial complexes, define the *f-vector* of a cubical complex  $\mathcal{C}$  by  $\mathbf{f}(\mathcal{C}) = (f_0, f_1, \dots)$  where  $f_i$  is the number of  $i$ -dimensional faces. There are also notions of  $h$ - and  $g$ -vectors, and cubical analogues of the UBC, LBC and  $g$ -conjecture. See [2], [13] and [294] for more details and references.

The difference between Definition 2.9.2 of a geometric cubical complex and Definition 2.2.1 of a geometric simplicial complex is that we realise abstract cubes by topological complexes rather than polytopes. This difference is substantial: if we replace topological cubes by combinatorial ones (i.e. by convex polytopes combinatorially equivalent to a cube) in Definition 2.9.2, then we obtain the definition of a *polyhedral cubical complex*. Although this notion is also important in combinatorial geometry, not every abstract cubical complex can be realised by a polyhedral complex, as shown by the next example.

EXAMPLE 2.9.3. Consider the decomposition of a Möbius strip into 3 squares shown in Fig. 2.10.

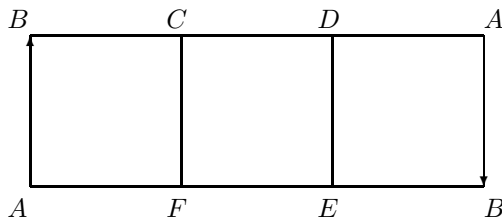

FIGURE 2.10. Cubical complex which does not admit a polyhedral realisation.

PROPOSITION 2.9.4. *The topological cubical complex shown in Fig. 2.10 does not admit a polyhedral cubical realisation.*

PROOF. Assume that such a realisation exists. Then since  $ABED$  is a convex 4-gon, the points  $A$  and  $D$  are in the same halfplane with respect to the line  $BE$ , and therefore  $A$  and  $D$  are in the same halfspace defined by the plane  $BCE$ . Similarly, since  $ABCF$  is a convex 4-gon, the points  $A$  and  $F$  are in the same halfspace with respect to  $BCE$ . Hence,  $D$  and  $F$  are also in the same halfspace with respect to  $BCE$ . On the other hand, since  $CDEF$  is a convex 4-gon, the points  $D$  and  $F$  must be in different subspaces with respect to  $BCE$ . A contradiction.  $\square$

The example above shows that, unlike the case of simplicial complexes, the theory of abstract cubical complexes cannot be described by using only convex-geometric considerations. Another simple manifestation of this is the fact that not



every cubical complex may be realised as a subcomplex in a standard cube, in contrast to simplicial complexes which are always embeddable in a standard simplex. The boundary of a triangle is the simplest example of a cubical complex not embeddable in a cube. It is also not embeddable into the standard cubical lattice in  $\mathbb{R}^n$  (for any  $n$ ). On the other hand, every cubical complex admits a cubical subdivision which is embeddable in a standard cube, as shown in the next subsection. Without subdivision the question of embeddability in a standard cube or cubical lattice is nontrivial. The importance of studying cubical maps (in particular, cubical embeddings) of 2-dimensional cubical complexes to the cubical lattice in  $\mathbb{R}^3$  was pointed out by S. Novikov in connection with the *3-dimensional Ising model*. In [97] necessary and sufficient conditions were obtained for a cubical complex to admit a cubical map to the standard lattice.

### Cubical subdivisions of simple polytopes and simplicial complexes.

The particular constructions of cubical complexes given here will be important in the definition of moment-angle complexes. Neither of these constructions is particularly new, but they are probably not well recorded in the literature (see however the references at the end of the section).

Any face of  $\mathbb{I}^m$  has the form

$$C_{J \subset I} = \{(y_1, \dots, y_m) \in \mathbb{I}^m : y_j = 0 \text{ for } j \in J, \quad y_j = 1 \text{ for } j \notin I\}$$

where  $J \subset I$  is a pair of embedded (possibly empty) subsets of  $[m]$ . We also set

$$(2.10) \quad C_I = C_{\emptyset \subset I} = \{(y_1, \dots, y_m) \in \mathbb{I}^m : y_j = 1 \text{ for } j \notin I\}$$

to simplify the notation.

**CONSTRUCTION 2.9.5** (canonical triangulation of  $\mathbb{I}^m$ ). Denote by  $\Delta = \Delta^{m-1}$  the simplex on  $[m]$ . We assign to a subset  $I = \{i_1, \dots, i_k\} \subset [m]$  the vertex  $v_I = C_{I \subset I}$  of  $\mathbb{I}^m$ . That is,  $v_I = (\varepsilon_1, \dots, \varepsilon_m)$  where  $\varepsilon_i = 0$  if  $i \in I$  and  $\varepsilon_i = 1$  otherwise. Regarding each  $I$  as a vertex of the barycentric subdivision of  $\Delta$ , we can extend the correspondence  $I \mapsto v_I$  to a piecewise linear embedding  $i_c: \Delta' \rightarrow \mathbb{I}^m$ . Under this embedding the vertices of  $\Delta$  are mapped to the vertices of  $\mathbb{I}^m$  with exactly one zero coordinate, and the barycentre of  $\Delta$  is mapped to  $(0, \dots, 0) \in \mathbb{I}^m$  (see Fig. 2.11). The image  $i_c(\Delta')$  is the union of  $m$  facets of  $\mathbb{I}^m$  meeting at the vertex  $(0, \dots, 0)$ . For each pair  $I \subset J$ , all simplices of  $\Delta'$  of the form  $I = I_1 \subset I_2 \subset \dots \subset I_k = J$  are mapped to the same face  $C_{I \subset J}$  of  $\mathbb{I}^m$ . The map  $i_c: \Delta' \rightarrow \mathbb{I}^m$  extends to  $\text{cone}(\Delta')$  by mapping the cone vertex to  $(1, \dots, 1) \in \mathbb{I}^m$ . The image of the resulting map  $\text{cone}(i_c)$  is the whole cube  $\mathbb{I}^m$ . Thus,  $\text{cone}(i_c): \text{cone}(\Delta') \rightarrow \mathbb{I}^m$  is a *PL* homeomorphism which is linear on simplices of  $\text{cone}(\Delta')$ . This defines a canonical triangulation of  $\mathbb{I}^m$ , the ‘triangulation along the main diagonal’.

The subdivisions which appear above can be summarised as follows:

**PROPOSITION 2.9.6.** *The PL map  $\text{cone}(i_c): \text{cone}(\Delta') \rightarrow \mathbb{I}^m$  gives rise to*

- (a) *a cubical subdivision of  $\Delta^{m-1}$  isomorphic to “half of the boundary of  $\mathbb{I}^m$ ” (the union of facets of  $\mathbb{I}^m$  containing the zero vertex);*
- (b) *a cubical subdivision of  $\text{cone} \Delta^{m-1}$  (which is  $\Delta^m$ ) isomorphic to  $\mathbb{I}^m$ ;*
- (c) *a simplicial subdivision of  $\mathbb{I}^m$  isomorphic to  $\text{cone}((\Delta^{m-1})')$ .*

**CONSTRUCTION 2.9.7** (cubical subdivision of a simple polytope). Let  $P$  be a simple  $n$ -polytope with  $m$  facets  $F_1, \dots, F_m$ . We shall construct a piecewise linear

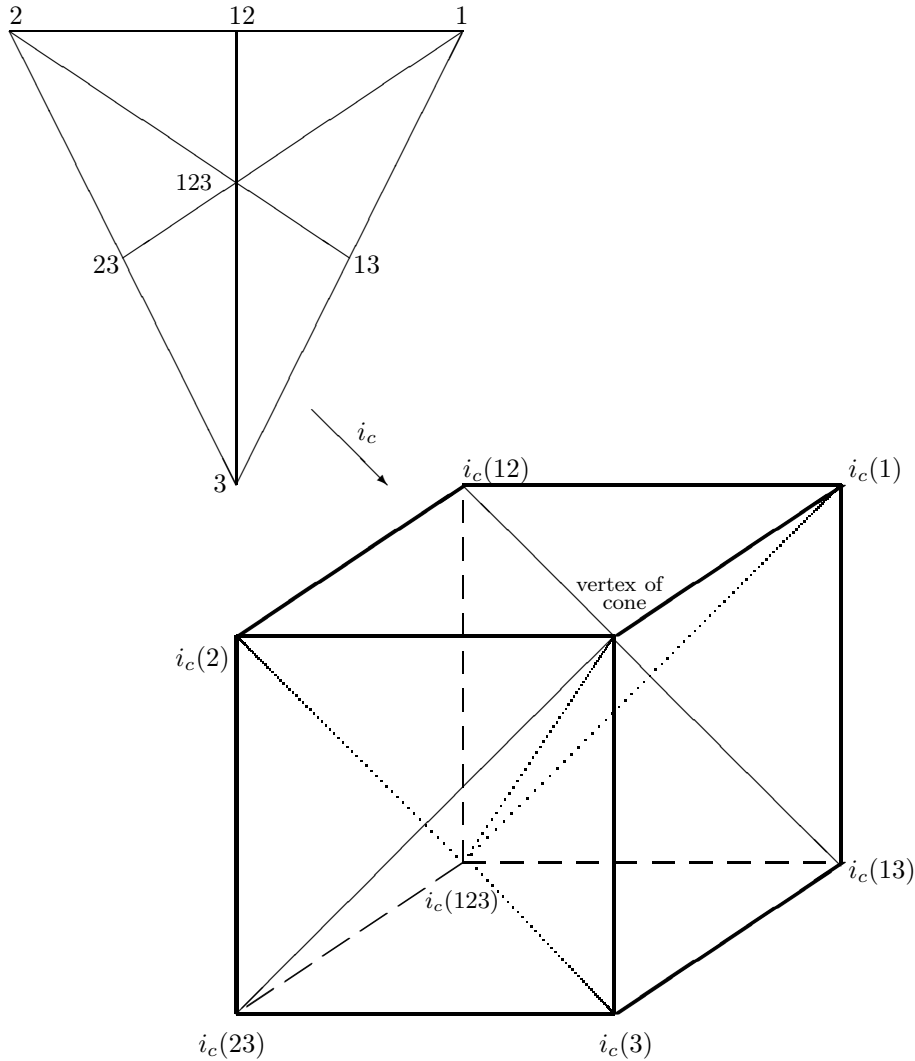
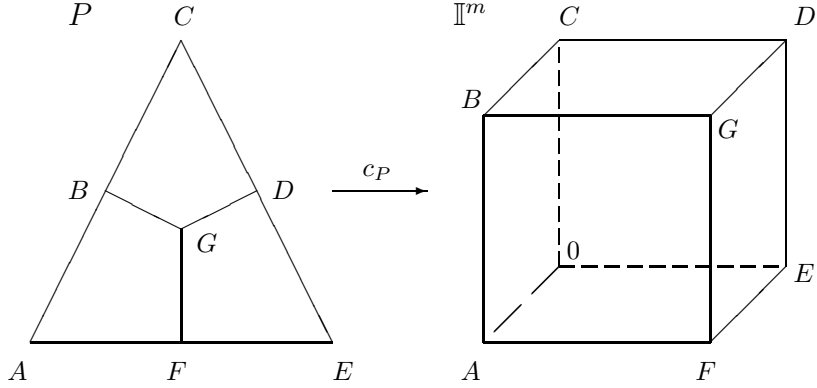

FIGURE 2.11. Taking cone over the barycentric subdivision of simplex defines a triangulation of the cube.

embedding of  $P$  into the standard cube  $\mathbb{I}^m$ , thereby inducing a cubical subdivision  $\mathcal{C}(P)$  of  $P$  by the preimages of faces of  $\mathbb{I}^m$ .

Denote by  $\mathcal{S}$  the set of barycentres of faces of  $P$ , including the vertices and the barycentre of the whole polytope. This will be the vertex set of  $\mathcal{C}(P)$ . Every  $(n-k)$ -face  $G$  of  $P$  is an intersection of  $k$  facets:  $G = F_{i_1} \cap \cdots \cap F_{i_k}$ . We map the barycentre of  $G$  to the vertex  $(\varepsilon_1, \dots, \varepsilon_m) \in \mathbb{I}^m$ , where  $\varepsilon_i = 0$  if  $i \in \{i_1, \dots, i_k\}$  and  $\varepsilon_i = 1$  otherwise. The resulting map  $\mathcal{S} \rightarrow \mathbb{I}^m$  can be extended linearly on the simplices of the barycentric subdivision of  $P$  to an embedding  $c_P: P \rightarrow \mathbb{I}^m$ . The case  $n = 2$ ,  $m = 3$  is shown in Fig. 2.12.

FIGURE 2.12. Embedding  $c_P: P \rightarrow \mathbb{I}^m$  for  $n = 2$ ,  $m = 3$ .

The image  $c_P(P) \subset \mathbb{I}^m$  is the union of all faces  $C_{J \subset I}$  such that  $\bigcap_{i \in I} F_i \neq \emptyset$ . For such  $C_{J \subset I}$ , the preimage  $c_P^{-1}(C_{J \subset I})$  is declared to be a face of the cubical complex  $\mathcal{C}(P)$ . The vertex set of  $c_P^{-1}(C_{J \subset I})$  is the subset of  $\mathcal{S}$  consisting of barycentres of all faces between the faces  $G$  and  $H$  of  $P$ , where  $G = \bigcap_{j \in J} F_j$  and  $H = \bigcap_{i \in I} F_i$ . Therefore, faces of  $\mathcal{C}(P)$  correspond to pairs of embedded faces  $G \supset H$  of  $P$ , and we denote them by  $C_{G \supset H}$ . In particular, maximal ( $n$ -dimensional) faces of  $\mathcal{C}(P)$  correspond to pairs  $G = P$ ,  $H = v$ , where  $v$  is a vertex of  $P$ . For these maximal faces we use the abbreviated notation  $C_v = C_{P \supset v}$ .

For every vertex  $v = F_{i_1} \cap \cdots \cap F_{i_n} \in P$  with  $I_v = \{i_1, \dots, i_n\}$  we have

$$(2.11) \quad c_P(C_v) = C_{I_v} = \{(y_1, \dots, y_m) \in \mathbb{I}^m : y_j = 1 \text{ whenever } v \notin F_j\}.$$

We therefore obtain:

**PROPOSITION 2.9.8.** *A simple polytope  $P$  with  $m$  facets admits a cubical decomposition whose maximal faces  $C_v$  correspond to the vertices  $v \in P$ . The resulting cubical complex  $\mathcal{C}(P)$  embeds canonically into  $\mathbb{I}^m$ , as described by (2.11).*

**LEMMA 2.9.9.** *The number of  $k$ -faces of the cubical complex  $\mathcal{C}(P)$  is given by*

$$f_k(\mathcal{C}(P)) = \sum_{i=0}^{n-k} \binom{n-i}{k} f_i(P), \quad \text{for } 0 \leq k \leq n.$$

**PROOF.** The formula follows from the fact that the  $k$ -faces of  $\mathcal{C}(P)$  are in one-to-one correspondence with the pairs  $G^{i+k} \supset H^i$  of faces of  $P$ .  $\square$

**CONSTRUCTION 2.9.10** (cubical subdivision of a simplicial complex). Let  $\mathcal{K}$  be a simplicial complex on  $[m]$ . Then  $\mathcal{K}$  is naturally a subcomplex of  $\Delta^{m-1}$  and its barycentric subdivision  $\mathcal{K}'$  is a subcomplex of  $(\Delta^{m-1})'$ . Restricting the  $PL$  map from Construction 2.9.5 to  $\mathcal{K}'$ , we obtain the embedding  $i_c|_{\mathcal{K}'}: |\mathcal{K}'| \rightarrow \mathbb{I}^m$ . Its image is a cubical subcomplex in  $\mathbb{I}^m$ , which we denote  $\text{cub}(\mathcal{K})$ . Then  $\text{cub}(\mathcal{K})$  is the union of faces  $C_{I \subset J} \subset \mathbb{I}^m$  over all pairs  $I \subset J$  of nonempty simplices of  $\mathcal{K}$ :

$$(2.12) \quad \text{cub}(\mathcal{K}) = \bigcup_{\emptyset \neq I \subset J \in \mathcal{K}} C_{I \subset J} \subset \mathbb{I}^m.$$

CONSTRUCTION 2.9.11. Since  $\text{cone}(\mathcal{K}')$  is a subcomplex of  $\text{cone}((\Delta^{m-1})')$ , Construction 2.9.5 also provides a *PL* embedding

$$\text{cone}(i_c)|_{\text{cone}(\mathcal{K}')} : |\text{cone}(\mathcal{K}')| \rightarrow \mathbb{I}^m.$$

The image of this embedding is an  $n$ -dimensional cubical subcomplex of  $\mathbb{I}^m$ , which we denote  $\text{cc}(\mathcal{K})$ . It is easy to see that

$$(2.13) \quad \text{cc}(\mathcal{K}) = \bigcup_{I \subset J \in \mathcal{K}} C_{I \subset J} = \bigcup_{J \in \mathcal{K}} C_J.$$

REMARK. If  $i \in [m]$  is not a vertex of  $\mathcal{K}$  (a ghost vertex), then  $\text{cc}(\mathcal{K})$  is contained in the facet  $\{y_i = 1\}$  of  $\mathbb{I}^m$ .

Here is a summary of the two previous constructions.

PROPOSITION 2.9.12. *For any simplicial complex  $\mathcal{K}$  on the set  $[m]$ , there is a *PL* embedding of  $|\mathcal{K}|$  into  $\mathbb{I}^m$  linear on the simplices of  $\mathcal{K}'$ . The image of this embedding is the cubical subcomplex (2.12). Moreover, there is a *PL* embedding of  $|\text{cone } \mathcal{K}|$  into  $\mathbb{I}^m$  linear on the simplices of  $\text{cone}(\mathcal{K}')$ , whose image is the cubical subcomplex (2.13).*

A cubical complex  $\mathcal{C}'$  is called a *cubical subdivision* of a cubical complex  $\mathcal{C}$  if each face of  $\mathcal{C}'$  is contained in a face of  $\mathcal{C}$ , and each face of  $\mathcal{C}$  is a union of finitely many faces of  $\mathcal{C}'$ .

PROPOSITION 2.9.13. *For every cubical complex  $\mathcal{C}$  with  $q$  vertices, there exists a cubical subdivision that is embeddable as a subcomplex in  $\mathbb{I}^q$ .*

PROOF. We first construct a simplicial complex  $\mathcal{K}_{\mathcal{C}}$  which subdivides the cubical complex  $\mathcal{C}$  and has the same vertices. This can be done by induction on the skeleta of  $\mathcal{C}$ , by extending the triangulation from the  $k$ -dimensional skeleton to the interiors of  $(k+1)$ -dimensional faces using a generic convex function  $f: \mathbb{R}^k \rightarrow \mathbb{R}$ , see [325, §5.1] (note that the 1-skeleton of  $\mathcal{C}$  is already a simplicial complex). Then applying Construction 2.9.10 to  $\mathcal{K}_{\mathcal{C}}$  we get cubical complex  $\text{cub}(\mathcal{K}_{\mathcal{C}})$  that subdivides  $\mathcal{K}_{\mathcal{C}}$  and therefore  $\mathcal{C}$ . It is embeddable into  $\mathbb{I}^q$  by Proposition 2.9.12.  $\square$

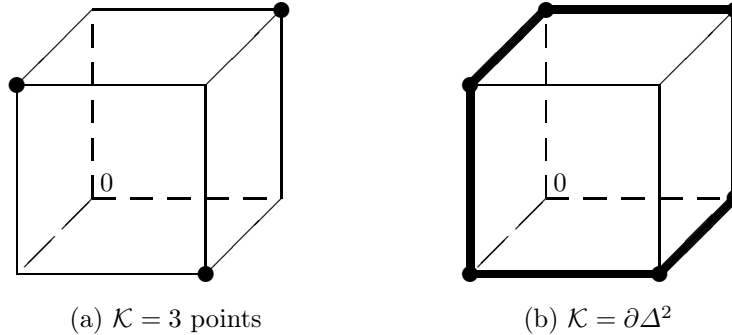
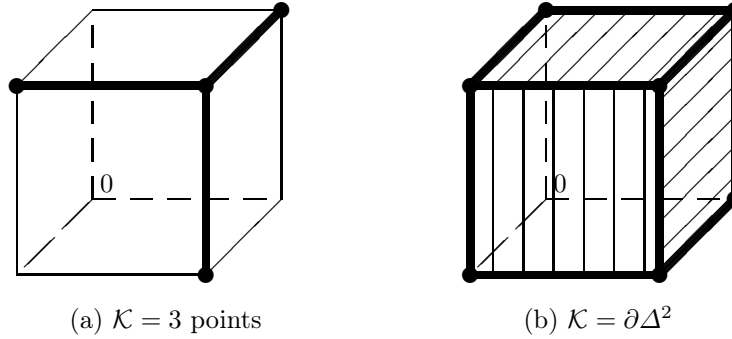

FIGURE 2.13. Cubical complex  $\text{cub}(\mathcal{K})$ .

EXAMPLE 2.9.14. The cubical complexes  $\text{cub}(\mathcal{K})$  and  $\text{cc}(\mathcal{K})$  when  $\mathcal{K}$  is a disjoint union of 3 vertices or the boundary of a triangle are shown in Figs. 2.13–2.14.

FIGURE 2.14. Cubical complex  $cc(\mathcal{K})$ .

REMARK. Let  $P$  be a simple  $n$ -polytope, and let  $\mathcal{K}_P$  be its nerve complex. Then  $cc(\mathcal{K}_P) = c_P(P)$ , i.e.  $cc(\mathcal{K}_P)$  coincides with the cubical complex  $\mathcal{C}(P)$  from Construction 2.9.7.

Different versions of Construction 2.9.11 can be found in [13, p. 299]. A similar construction was also considered in [90, p. 434]. Finally, a version of cubical subcomplex  $\text{cub}(\mathcal{K}) \subset \mathbb{I}^m$  appeared in [97] in connection with the problems described in the end of the previous subsection.

#### Exercises.

2.9.15. Show that the triangulation of  $\mathbb{I}^m$  from Construction 2.9.5 coincides with the triangulation of the product of  $m$  one-dimensional simplices from Construction 2.2.10.

f

## Combinatorial algebra of face rings

In this chapter we collect the wealth of algebraic notions and constructions related to face rings. Our choice of material and notation was guided by the topological applications in the later chapters of the book. (This explains the unusual for algebraists even grading in the polynomial rings and their homogeneous quotients, and also the nonpositive homological grading in free resolutions and Tor.) In the first sections we review standard results and constructions of combinatorial commutative algebra, including the Tor-algebras and algebraic Betti numbers of face rings, Cohen–Macaulay and Gorenstein complexes. The later sections contain some more recent developments, including the face rings of simplicial posets, different characterisations of Cohen–Macaulay and Gorenstein simplicial posets in terms of their face rings and  $h$ -vectors, and generalisations of the Dehn–Sommerville relations. Although all these algebraic and combinatorial results have a strong topological flavour and were indeed originally motivated by topological constructions, we have tried to keep this chapter mostly algebraic and do not require much topological knowledge from the reader here.

The preliminary algebraic material of a more general sort, not directly or exclusively related to the face rings (such as resolutions and the functor Tor, and Cohen–Macaulay rings) is collected in Appendix A.

Alongside the monograph by Stanley [293], an extensive survey of Cohen–Macaulay rings by Bruns and Herzog [45] and a more recent monograph [225] by Miller and Sturmfels may be recommended for a deeper study of algebraic methods in combinatorics.

We use the common notation  $\mathbf{k}$  for the ground ring, which is always assumed to be the ring  $\mathbb{Z}$  of integers or a field. The former is preferable for topological applications, but the latter is more common in the algebraic literature. We shall often refer to  $\mathbf{k}$ -modules as ‘ $\mathbf{k}$ -vector spaces’; in the case  $\mathbf{k} = \mathbb{Z}$  the latter means ‘abelian groups’.

We assume graded commutativity instead of commutativity; algebras commutative in the standard sense will be those whose nontrivial graded components appear only in even degrees. In particular, the polynomial algebra  $\mathbf{k}[v_1, \dots, v_m]$ , which we often abbreviate to  $\mathbf{k}[m]$ , has  $\deg v_i = 2$ . The exterior algebra  $\Lambda[u_1, \dots, u_m]$  has  $\deg u_i = 1$ . Given a subset  $I = \{i_1, \dots, i_k\} \subset [m]$  we denote by  $v_I$  the square-free monomial  $v_{i_1} \cdots v_{i_k}$  in  $\mathbf{k}[m]$ . We also denote by  $u_I$  the exterior monomial  $u_{i_1} \cdots u_{i_k}$  where  $i_1 < \cdots < i_k$ .

### 3.1. Face rings of simplicial complexes

DEFINITION 3.1.1. The *face ring* (or the *Stanley–Reisner ring*) of a simplicial complex  $\mathcal{K}$  on the set  $[m]$  is the quotient graded ring

$$\mathbf{k}[\mathcal{K}] = \mathbf{k}[v_1, \dots, v_m] / \mathcal{I}_{\mathcal{K}},$$

where  $\mathcal{I}_{\mathcal{K}} = (v_I : I \notin \mathcal{K})$  is the ideal generated by those monomials  $v_I$  for which  $I$  is not a simplex of  $\mathcal{K}$ . The ideal  $\mathcal{I}_{\mathcal{K}}$  is known as the *Stanley–Reisner ideal* of  $\mathcal{K}$ .

EXAMPLE 3.1.2.

1. Let  $\mathcal{K}$  be the 2-dimensional simplicial complex shown in Fig. 3.1. Then

$$\mathcal{I}_{\mathcal{K}} = (v_1 v_5, v_3 v_4, v_1 v_2 v_3, v_2 v_4 v_5).$$

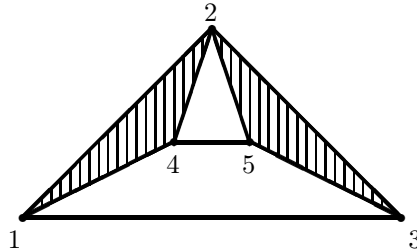

FIGURE 3.1.

2. The face ring  $\mathbf{k}[\mathcal{K}]$  is a *quadratic algebra* (that is, the ideal  $\mathcal{I}_{\mathcal{K}}$  is generated by quadratic monomials) if and only if  $\mathcal{K}$  is a *flag complex* (an exercise).

3. Let  $\mathcal{K}_1 * \mathcal{K}_2$  be the join of  $\mathcal{K}_1$  and  $\mathcal{K}_2$  (see Construction 2.2.8). Then

$$\mathbf{k}[\mathcal{K}_1 * \mathcal{K}_2] = \mathbf{k}[\mathcal{K}_1] \otimes \mathbf{k}[\mathcal{K}_2].$$

Here and below  $\otimes$  denotes the tensor product over  $\mathbf{k}$ .

We note that  $\mathcal{I}_{\mathcal{K}}$  is a *monomial ideal*, and it has a basis consisting of square-free monomials  $v_I$  corresponding to the missing faces of  $\mathcal{K}$ .

PROPOSITION 3.1.3. *Every square-free monomial ideal  $\mathcal{I}$  in the polynomial ring is the Stanley–Reisner ideal of a simplicial complex  $\mathcal{K}$ .*

PROOF. We set

$$\mathcal{K} = \{I \subset [m] : v_I \notin \mathcal{I}\}.$$

Then  $\mathcal{K}$  is a simplicial complex and  $\mathcal{I} = \mathcal{I}_{\mathcal{K}}$ . □

Let  $P$  be a simple  $n$ -polytope and let  $\mathcal{K}_P$  be its nerve complex (see Example 2.2.4). We define the *face ring*  $\mathbf{k}[P]$  as the face ring of  $\mathcal{K}_P$ . Explicitly,

$$\mathbf{k}[P] = \mathbf{k}[v_1, \dots, v_m] / \mathcal{I}_P,$$

where  $\mathcal{I}_P$  is the ideal generated by those square-free monomials  $v_{i_1} v_{i_2} \cdots v_{i_s}$  whose corresponding facets intersect trivially,  $F_{i_1} \cap \cdots \cap F_{i_s} = \emptyset$ .



EXAMPLE 3.1.4.

1. Let  $P$  be an  $n$ -simplex (viewed as a simple polytope). Then

$$\mathbf{k}[P] = \mathbf{k}[v_1, \dots, v_{n+1}] / (v_1 v_2 \cdots v_{n+1}).$$

2. Let  $P$  be a 3-cube  $I^3$ . Then

$$\mathbf{k}[P] = \mathbf{k}[v_1, v_2, \dots, v_6] / (v_1 v_4, v_2 v_5, v_3 v_6).$$

3. Let  $P$  be an  $m$ -gon,  $m \geq 4$ . Then

$$\mathcal{I}_P = (v_i v_j : i - j \neq 0, \pm 1 \pmod{m}).$$

4. Given two simple polytopes  $P_1$  and  $P_2$ , we have

$$\mathbf{k}[P_1 \times P_2] = \mathbf{k}[P_1] \otimes \mathbf{k}[P_2].$$

PROPOSITION 3.1.5. *Let  $\varphi: \mathcal{K} \rightarrow \mathcal{L}$  be a simplicial map between simplicial complexes  $\mathcal{K}$  and  $\mathcal{L}$  on the vertex sets  $[m]$  and  $[l]$  respectively. Define the map  $\varphi^*: \mathbf{k}[w_1, \dots, w_l] \rightarrow \mathbf{k}[v_1, \dots, v_m]$  by*

$$\varphi^*(w_j) = \sum_{i \in \varphi^{-1}(j)} v_i.$$

*Then  $\varphi^*$  descends to a homomorphism  $\mathbf{k}[\mathcal{L}] \rightarrow \mathbf{k}[\mathcal{K}]$ , which we continue to denote  $\varphi^*$ .*

PROOF. We only need to check that  $\varphi^*(\mathcal{I}_{\mathcal{L}}) \subset \mathcal{I}_{\mathcal{K}}$ . Suppose  $J = \{j_1, \dots, j_s\} \subset [l]$  is not a simplex of  $\mathcal{L}$ . We have

$$\varphi^*(w_{j_1} \cdots w_{j_s}) = \sum_{i_1 \in \varphi^{-1}(j_1), \dots, i_s \in \varphi^{-1}(j_s)} v_{i_1} \cdots v_{i_s}.$$

We claim that the right hand side above belongs to  $\mathcal{I}_{\mathcal{K}}$ , i.e. for any monomial  $v_{i_1} \cdots v_{i_s}$  in the right hand side the set  $I = \{i_1, \dots, i_s\}$  is not a simplex of  $\mathcal{K}$ . Indeed, otherwise we would have  $\varphi(I) = J \in \mathcal{L}$  by the definition of a simplicial map, which contradicts the assumption.  $\square$

EXAMPLE 3.1.6. The face ring of the barycentric subdivision  $\mathcal{K}'$  of  $\mathcal{K}$  is

$$\mathbf{k}[\mathcal{K}'] = \mathbf{k}[b_I : I \in \mathcal{K} \setminus \{\emptyset\}] / \mathcal{I}_{\mathcal{K}'},$$

where  $b_I$  is the polynomial generator of degree 2 corresponding to a nonempty simplex  $I \in \mathcal{K}$ , and  $\mathcal{I}_{\mathcal{K}'}$  is generated by quadratic monomials  $b_I b_J$  for which  $I \not\subset J$  and  $J \not\subset I$ . The simplicial map  $\nabla: \mathcal{K}' \rightarrow \mathcal{K}$  from Example 2.3.3 induces a map  $\nabla^*$  of the face ring, given on the generators  $v_j \in \mathbf{k}[\mathcal{K}]$  by

$$\nabla^*(v_j) = \sum_{I \in \mathcal{K}: \min I = j} b_I.$$

EXAMPLE 3.1.7. The nondegenerate map  $\mathcal{K}' \rightarrow \Delta^{n-1}$  from Example 2.3.2 induces the following map of the corresponding face rings:

$$\begin{aligned} \mathbf{k}[v_1, \dots, v_n] &\longrightarrow \mathbf{k}[\mathcal{K}'] \\ v_i &\longmapsto \sum_{|I|=i} b_I. \end{aligned}$$

This defines a canonical  $\mathbf{k}[v_1, \dots, v_n]$ -module structure on  $\mathbf{k}[\mathcal{K}']$ .

An important tool arising from the functoriality of the face ring is the restriction homomorphism. For any simplex  $I \in \mathcal{K}$ , the corresponding full subcomplex  $\mathcal{K}_I$  is  $\Delta^{|I|-1}$  and  $\mathbf{k}[\mathcal{K}_I]$  is the polynomial ring  $\mathbf{k}[v_i : i \in I]$  on  $|I|$  generators. The inclusion  $\mathcal{K}_I \subset \mathcal{K}$  induces the *restriction homomorphism*

$$s_I : \mathbf{k}[\mathcal{K}] \rightarrow \mathbf{k}[v_i : i \in I],$$

which maps  $v_i$  to zero whenever  $i \notin I$ .

The following simple proposition will be used in several algebraic and topological arguments of the later chapters.

PROPOSITION 3.1.8. *The direct sum*

$$s = \bigoplus_{I \in \mathcal{K}} s_I : \mathbf{k}[\mathcal{K}] \longrightarrow \bigoplus_{I \in \mathcal{K}} \mathbf{k}[v_i : i \in I]$$

of all restriction maps is a monomorphism.

PROOF. Consider the composite map

$$\mathbf{k}[v_1, \dots, v_m] \xrightarrow{p} \mathbf{k}[\mathcal{K}] \xrightarrow{s} \bigoplus_{I \in \mathcal{K}} \mathbf{k}[v_i : i \in I]$$

where  $p$  is the quotient projection. Suppose  $sp(Q) = 0$  where  $Q = Q(v_1, \dots, v_m)$  is a polynomial. Then for any monomial  $v_{i_1}^{\alpha_1} \cdots v_{i_k}^{\alpha_k}$  which enters  $Q$  with a nonzero coefficient we have  $I = \{i_1, \dots, i_k\} \notin \mathcal{K}$  (as otherwise the  $I$ th component of the image under  $sp$  is nonzero). Hence  $p(Q) = 0$  and  $s$  is injective.  $\square$

PROPOSITION 3.1.9. *The face ring  $\mathbf{k}[\mathcal{K}]$  has the  $\mathbf{k}$ -vector space basis consisting of monomials  $v_{j_1}^{\alpha_1} \cdots v_{j_k}^{\alpha_k}$  where  $\alpha_i > 0$  and  $\{j_1, \dots, j_k\} \in \mathcal{K}$ .*

PROOF. Indeed, the polynomial algebra  $\mathbf{k}[m]$  has the  $\mathbf{k}$ -vector space basis consisting of all monomials  $v_{j_1}^{\alpha_1} \cdots v_{j_k}^{\alpha_k}$ , and such a monomial maps to zero under the projection  $\mathbf{k}[m] \rightarrow \mathbf{k}[\mathcal{K}]$  precisely when  $\{j_1, \dots, j_k\} \notin \mathcal{K}$ .  $\square$

Recall that the Poincaré series of a nonnegatively graded  $\mathbf{k}$ -vector space  $V = \bigoplus_{i=0}^{\infty} V^i$  is given by  $F(V; \lambda) = \sum_{i=0}^{\infty} (\dim_{\mathbf{k}} V^i) \lambda^i$ . Since  $\mathbf{k}[\mathcal{K}]$  is graded by even integers, its Poincaré series is even.

THEOREM 3.1.10 (Stanley). *Let  $\mathcal{K}$  be an  $(n-1)$ -dimensional simplicial complex with  $f$ -vector  $(f_0, \dots, f_{n-1})$  and  $h$ -vector  $(h_0, \dots, h_n)$ . Then the Poincaré series of the face ring  $\mathbf{k}[\mathcal{K}]$  is*

$$F(\mathbf{k}[\mathcal{K}]; \lambda) = \sum_{k=0}^n f_{k-1} \left( \frac{\lambda^2}{1-\lambda^2} \right)^k = \frac{h_0 + h_1 \lambda^2 + \cdots + h_n \lambda^{2n}}{(1-\lambda^2)^n}.$$

PROOF. By Proposition 3.1.9, a  $(k-1)$ -dimensional simplex  $\{i_1, \dots, i_k\} \in \mathcal{K}$  contributes a summand  $\frac{\lambda^{2k}}{(1-\lambda^2)^k}$  to the Poincaré series of  $\mathcal{K}$  (this summand is just the Poincaré series of the subspace generated by monomials  $v_{i_1}^{\alpha_1} \cdots v_{i_k}^{\alpha_k}$  with positive exponents  $\alpha_i$ ). This proves the first identity, and the second follows from (2.3).  $\square$

EXAMPLE 3.1.11.

1. Let  $\mathcal{K} = \Delta^{n-1}$ . Then  $f_i = \binom{n}{i+1}$  for  $-1 \leq i \leq n-1$ ,  $h_0 = 1$  and  $h_i = 0$  for  $i > 0$ . Since every subset of  $[n]$  is a simplex of  $\Delta^{n-1}$ , we have  $\mathbf{k}[\Delta^{n-1}] = \mathbf{k}[v_1, \dots, v_n]$  and  $F(\mathbf{k}[\Delta^{n-1}]; \lambda) = (1-\lambda^2)^{-n}$ .

2. Let  $\mathcal{K} = \partial\Delta^n$  be the boundary of an  $n$ -simplex. Then  $h_i = 1$  for  $0 \leq i \leq n$ , and  $\mathbf{k}[\partial\Delta^n] = \mathbf{k}[v_1, \dots, v_{n+1}]/(v_1 v_2 \cdots v_{n+1})$ . By Theorem 3.1.10,

$$F(\mathbf{k}[\partial\Delta^n]; \lambda) = \frac{1 + \lambda^2 + \cdots + \lambda^{2n}}{(1 - \lambda^2)^n}.$$

The affine algebraic variety corresponding to the commutative finitely generated  $\mathbf{k}$ -algebra  $\mathbf{k}[\mathcal{K}] = \mathbf{k}[m]/\mathcal{I}_{\mathcal{K}}$  (i.e. the set of common zeros of elements of  $\mathcal{I}_{\mathcal{K}}$ , viewed as algebraic functions on  $\mathbf{k}^m$ ) can be easily identified as follows.

PROPOSITION 3.1.12. *The affine variety corresponding to  $\mathbf{k}[\mathcal{K}]$  is given by*

$$X(\mathcal{K}) = \bigcup_{I \in \mathcal{K}} S_I,$$

where  $S_I = \mathbf{k}\langle \mathbf{e}_i : i \in I \rangle$  is the coordinate subspace in  $\mathbf{k}^m$  spanned by the set of standard basis vectors corresponding to  $I$ .

PROOF. The statement obviously holds in the case  $\mathcal{K} = \Delta^{m-1}$ . So we assume  $\mathcal{K} \neq \Delta^{m-1}$ . We shall use the following notation from Section 2.4:  $\widehat{I} = [m] \setminus I$ , the complement of  $I \subset [m]$ , and  $\widehat{\mathcal{K}} = \{\widehat{I} \in [m] : I \notin \mathcal{K}\}$ , the dual complex of  $\mathcal{K}$ . Given a point  $\mathbf{z} = (z_1, \dots, z_m) \in \mathbf{k}^m$ , we denote by

$$\omega(\mathbf{z}) = \{i : z_i = 0\} \subset [m],$$

the set of zero coordinates of  $\mathbf{z}$ .

By the definition of the algebraic variety  $X(\mathcal{K})$  corresponding to  $\mathbf{k}[\mathcal{K}]$ ,

$$\begin{aligned} X(\mathcal{K}) &= \bigcap_{J \notin \mathcal{K}} \bigcup_{j \in J} \{\mathbf{z} : z_j = 0\} = \bigcap_{J \notin \mathcal{K}} \{\mathbf{z} : \omega(\mathbf{z}) \cap J \neq \emptyset\} \\ &= \bigcap_{\widehat{J} \in \widehat{\mathcal{K}}} \{\mathbf{z} : \omega(\mathbf{z}) \not\subset \widehat{J}\} = \{\mathbf{z} : \omega(\mathbf{z}) \notin \widehat{\mathcal{K}}\}. \end{aligned}$$

On the other hand,

$$\begin{aligned} \bigcup_{I \in \mathcal{K}} S_I &= \bigcup_{I \in \mathcal{K}} \bigcap_{j \in \widehat{I}} \{\mathbf{z} : z_j = 0\} = \bigcup_{I \in \mathcal{K}} \{\mathbf{z} : \widehat{I} \subset \omega(\mathbf{z})\} \\ &= \bigcup_{\widehat{I} \notin \widehat{\mathcal{K}}} \{\mathbf{z} : \omega(\mathbf{z}) \supset \widehat{I}\} = \{\mathbf{z} : \omega(\mathbf{z}) \notin \widehat{\mathcal{K}}\}. \end{aligned}$$

The required identity follows by comparing the two formulae above.  $\square$

REMARK. The variety  $X(\mathcal{K})$  is an example of an *arrangement of coordinate subspaces*, which will be studied further in Section 4.7.

We finish this section with a result showing that the face ring determines its underlying simplicial complex:

THEOREM 3.1.13 (Bruns–Gubeladze [44]). *Let  $\mathbf{k}$  be a field, and  $\mathcal{K}_1$  and  $\mathcal{K}_2$  be two simplicial complexes on the vertex sets  $[m_1]$  and  $[m_2]$  respectively. Suppose  $\mathbf{k}[\mathcal{K}_1]$  and  $\mathbf{k}[\mathcal{K}_2]$  are isomorphic as  $\mathbf{k}$ -algebras. Then there exists a bijective map  $[m_1] \rightarrow [m_2]$  which induces an isomorphism between  $\mathcal{K}_1$  and  $\mathcal{K}_2$ .*

PROOF. Let  $f: \mathbf{k}[\mathcal{K}_1] \rightarrow \mathbf{k}[\mathcal{K}_2]$  be an isomorphism of  $\mathbf{k}$ -algebras. An easy argument shows that we can assume that  $f$  is a graded isomorphism (an exercise, or see [44, p. 316]).

Since  $f$  is graded, by restriction to the linear components we observe that  $m_1 = m_2$  and that  $f$  is induced by a linear isomorphism  $F: \mathbf{k}[m_1] \rightarrow \mathbf{k}[m_2]$ . This is described by the commutative diagram

$$\begin{array}{ccc} \mathbf{k}[v_1, \dots, v_{m_1}] & \xrightarrow{F} & \mathbf{k}[v_1, \dots, v_{m_2}] \\ \downarrow & & \downarrow \\ \mathbf{k}[\mathcal{K}_1] & \xrightarrow{f} & \mathbf{k}[\mathcal{K}_2] \end{array}$$

By passing to the associated affine varieties, we observe that the isomorphism  $f^*: X(\mathcal{K}_2) \rightarrow X(\mathcal{K}_1)$  is the restriction of the  $\mathbf{k}$ -linear isomorphism  $F^*: \mathbf{k}^{m_2} \rightarrow \mathbf{k}^{m_1}$ . This is described by the commutative diagram

$$\begin{array}{ccc} \mathbf{k}^{m_2} & \xrightarrow{F^*} & \mathbf{k}^{m_1} \\ \uparrow & & \uparrow \\ X(\mathcal{K}_2) & \xrightarrow{f^*} & X(\mathcal{K}_1) \end{array}$$

The isomorphism  $f^*$  establishes a bijective correspondence

$$\Phi: \{\text{maximal faces of } \mathcal{K}_2\} \rightarrow \{\text{maximal faces of } \mathcal{K}_1\}$$

which is defined by the formula  $f^*(S_I) = S_{\Phi(I)}$ , where  $I$  is a maximal face of  $\mathcal{K}_2$ . It is also clear that  $|\Phi(I)| = |I| = \dim S_I$ .

We denote by  $\mathcal{P}_1$  the intersection poset of the subspaces  $S_I$ ,  $I \in \mathcal{K}_1$ , with respect to inclusion (i.e. the elements of  $\mathcal{P}_1$  are nonempty intersections  $S_{I_1} \cap \dots \cap S_{I_k}$  with  $I_j \in \mathcal{K}_1$ ). The poset  $\mathcal{P}_1$  can be also viewed as the intersection poset of the maximal faces of  $\mathcal{K}_1$ . We define the poset  $\mathcal{P}_2$  corresponding to  $\mathcal{K}_2$  similarly. The correspondence  $\Phi$  obviously extends to an isomorphism of posets  $\Phi: \mathcal{P}_2 \rightarrow \mathcal{P}_1$ , which preserves the dimension of spaces (or the number of elements in the intersections of maximal faces).

Now introduce the following equivalence relation on the vertex sets  $[m_1]$  and  $[m_2]$ : for  $i_1, i_2 \in [m_1]$  (or  $j_1, j_2 \in [m_2]$ ) we put  $i_1 \sim i_2$  if and only if the two sets of maximal faces  $\mathcal{K}_1$  containing  $i_1$  and  $i_2$  respectively coincide (and similarly for  $j_1$  and  $j_2$ ). The equivalence classes in  $[m_1]$  are the minimal (with respect to inclusion) nonempty intersections of maximal faces of  $\mathcal{K}_1$ , and similarly for  $[m_2]$ . Since  $\Phi$  is an isomorphism of posets, the two systems of equivalence classes are in natural bijective correspondence, and the corresponding equivalence classes have the same numbers of elements. This gives rise to the bijective map  $\varphi: [m_2] \rightarrow [m_1]$  which satisfies the condition that  $i \in I$  if and only if  $\varphi(i) \in \Phi(I)$ , where  $i \in [m_2]$  and  $I \in \mathcal{K}_2$  is a maximal face. Since any face of a simplicial complex is contained in a maximal face, we obtain that  $\psi = \varphi^{-1}: [m_1] \rightarrow [m_2]$  is the required map.  $\square$

### Exercises.

3.1.14. Show that the Stanley–Reisner ideal  $\mathcal{I}_{\mathcal{K}}$  is generated by quadratic monomials if and only if  $\mathcal{K}$  is a flag complex.

3.1.15 (see [261, (4.7)]). Let  $\text{CAT}(\mathcal{K})$  be the face category of  $\mathcal{K}$  (objects are simplices, morphisms are inclusions),  $\text{CAT}^{op}(\mathcal{K})$  the opposite category (in which the morphisms are reverted), and  $\text{CGA}$  the category of commutative graded algebras. (See Appendix C.1 for basics of categories and diagrams.) Consider the diagram

$$\begin{aligned} \mathbf{k}[\cdot]^{\mathcal{K}}: \text{CAT}^{op}(\mathcal{K}) &\longrightarrow \text{CGA}, \\ I &\longmapsto \mathbf{k}[v_i: i \in I] \end{aligned}$$

whose value on a morphism  $I \subset J$  is the surjection  $\mathbf{k}[v_j: j \in J] \rightarrow \mathbf{k}[v_i: i \in I]$  sending each  $v_j$  with  $j \notin I$  to zero. Show that

$$\mathbf{k}[\mathcal{K}] = \lim \mathbf{k}[\cdot]^{\mathcal{K}}$$

where the limit is taken in the category  $\text{CGA}$ .

3.1.16. If  $\mathbf{k}[\mathcal{K}_1]$  and  $\mathbf{k}[\mathcal{K}_2]$  are isomorphic as  $\mathbf{k}$ -algebras, then there is also a graded isomorphism  $\mathbf{k}[\mathcal{K}_1] \rightarrow \mathbf{k}[\mathcal{K}_2]$ . (Hint: Show first that  $\mathbf{k}[\mathcal{K}_1]$  and  $\mathbf{k}[\mathcal{K}_2]$  are isomorphic as augmented  $\mathbf{k}$ -algebras, and then pass to the associated graded algebras with respect to the augmentation ideals.)

### 3.2. Tor-algebras and Betti numbers

The algebraic Betti numbers of the face ring  $\mathbf{k}[\mathcal{K}]$  are the dimensions of the Tor-groups of  $\mathbf{k}[\mathcal{K}]$  viewed as a module over the polynomial ring. These basic homological invariants of a simplicial complex  $\mathcal{K}$  appear to be of great importance both for combinatorial commutative algebra and toric topology.

The face ring  $\mathbf{k}[\mathcal{K}]$  acquires a canonical  $\mathbf{k}[m]$ -module structure via the quotient projection  $\mathbf{k}[m] \rightarrow \mathbf{k}[\mathcal{K}]$ . We therefore may consider the corresponding Tor-modules (see Appendix, Section A.2):

$$\text{Tor}_{\mathbf{k}[v_1, \dots, v_m]}(\mathbf{k}[\mathcal{K}], \mathbf{k}) = \bigoplus_{i, j \geq 0} \text{Tor}_{\mathbf{k}[v_1, \dots, v_m]}^{-i, 2j}(\mathbf{k}[\mathcal{K}], \mathbf{k}).$$

From Lemma A.2.10 we obtain that  $\text{Tor}_{\mathbf{k}[m]}(\mathbf{k}[\mathcal{K}], \mathbf{k})$  is a bigraded algebra in a natural way, and there is the following isomorphism of bigraded algebras:

$$\text{Tor}_{\mathbf{k}[v_1, \dots, v_m]}(\mathbf{k}[\mathcal{K}], \mathbf{k}) \cong H[\Lambda[u_1, \dots, u_m] \otimes \mathbf{k}[\mathcal{K}], d],$$

where the bigrading and differential on the right hand side are given by

$$(3.1) \quad \begin{aligned} \text{bideg } u_i &= (-1, 2), & \text{bideg } v_i &= (0, 2), \\ du_i &= v_i, & dv_i &= 0. \end{aligned}$$

DEFINITION 3.2.1. We refer to  $\text{Tor}_{\mathbf{k}[v_1, \dots, v_m]}(\mathbf{k}[\mathcal{K}], \mathbf{k})$  as the *Tor-algebra* of a simplicial complex  $\mathcal{K}$ .

The *bigraded Betti numbers* of  $\mathbf{k}[\mathcal{K}]$  are defined by

$$(3.2) \quad \beta^{-i, 2j}(\mathbf{k}[\mathcal{K}]) = \dim_{\mathbf{k}} \text{Tor}_{\mathbf{k}[v_1, \dots, v_m]}^{-i, 2j}(\mathbf{k}[\mathcal{K}], \mathbf{k}), \quad \text{for } i, j \geq 0.$$

We also set

$$\beta^{-i}(\mathbf{k}[\mathcal{K}]) = \dim_{\mathbf{k}} \text{Tor}_{\mathbf{k}[v_1, \dots, v_m]}^{-i}(\mathbf{k}[\mathcal{K}], \mathbf{k}) = \sum_j \beta^{-i, 2j}(\mathbf{k}[\mathcal{K}]).$$

The Tor-algebra has the following functorial property:

PROPOSITION 3.2.2. *A simplicial map  $\varphi: \mathcal{K} \rightarrow \mathcal{L}$  between simplicial complexes on the sets  $[m]$  and  $[l]$  respectively induces a homomorphism*

$$\varphi_{\text{Tor}}^*: \text{Tor}_{\mathbf{k}[w_1, \dots, w_l]}(\mathbf{k}[\mathcal{L}], \mathbf{k}) \rightarrow \text{Tor}_{\mathbf{k}[v_1, \dots, v_m]}(\mathbf{k}[\mathcal{K}], \mathbf{k})$$

of the corresponding Tor-algebras.

PROOF. This follows from Proposition 3.1.5 and Theorem A.2.5 (b).  $\square$

Consider the minimal resolution  $(R_{\min}, d)$  of the  $\mathbf{k}[m]$ -module  $\mathbf{k}[\mathcal{K}]$  (see Construction A.2.2). Then  $R_{\min}^0 \cong 1 \cdot \mathbf{k}[m]$  is a free module with one generator of degree 0. The basis of  $R_{\min}^{-1}$  is a minimal generator set for  $\mathcal{I}_{\mathcal{K}}$ , and these minimal generators correspond to the missing faces of  $\mathcal{K}$ . Given a missing face  $\{i_1, \dots, i_k\} \subset [m]$ , denote by  $r_{i_1, \dots, i_k}$  the corresponding generator of  $R_{\min}^{-1}$ . Then the map  $d: R_{\min}^{-1} \rightarrow R_{\min}^0$  takes  $r_{i_1, \dots, i_k}$  to  $v_{i_1} \dots v_{i_k}$ . By Proposition A.2.6,  $\beta^{-1, 2j}(\mathbf{k}[\mathcal{K}])$  is equal to the number of missing faces with  $j$  elements.

EXAMPLE 3.2.3. Let  $\mathcal{K} = \begin{array}{|c|} \hline 4 \quad \square \quad 3 \\ \hline 1 \quad \square \quad 2 \end{array}$ , the boundary of a 4-gon. Then

$$\mathbf{k}[\mathcal{K}] \cong \mathbf{k}[v_1, \dots, v_4]/(v_1v_3, v_2v_4).$$

Let us construct a minimal resolution of  $\mathbf{k}[\mathcal{K}]$ . The module  $R_{\min}^0$  has one generator 1 (of degree 0). The module  $R_{\min}^{-1}$  has two generators  $r_{13}$  and  $r_{24}$  of degree 4, and the differential  $d: R_{\min}^{-1} \rightarrow R_{\min}^0$  takes  $r_{13}$  to  $v_1v_3$  and  $r_{24}$  to  $v_2v_4$ . The kernel  $R_{\min}^{-1} \rightarrow R_{\min}^0$  is generated by one element  $v_2v_4r_{13} - v_1v_3r_{24}$ . Hence,  $R_{\min}^{-2}$  has one generator of degree 8, which we denote by  $a$ , and the map  $d: R_{\min}^{-2} \rightarrow R_{\min}^{-1}$  is injective and takes  $a$  to  $v_2v_4r_{13} - v_1v_3r_{24}$ . Thus, the minimal resolution is

$$0 \longrightarrow R_{\min}^{-2} \longrightarrow R_{\min}^{-1} \longrightarrow R_{\min}^0 \longrightarrow M \longrightarrow 0,$$

where  $\text{rank } R_{\min}^0 = \beta^{0,0}(\mathbf{k}[\mathcal{K}]) = 1$ ,  $\text{rank } R_{\min}^{-1} = \beta^{-1,4}(\mathbf{k}[\mathcal{K}]) = 2$ ,  $\text{rank } R_{\min}^{-2} = \beta^{-2,8}(\mathbf{k}[\mathcal{K}]) = 1$ .

The following fundamental result of Hochster reduces the calculation of the Betti numbers  $\beta^{-i, 2j}(\mathbf{k}[\mathcal{K}])$  to the calculation of reduced simplicial cohomology of full subcomplexes in  $\mathcal{K}$ .

THEOREM 3.2.4 (Hochster [162]). *We have*

$$\text{Tor}_{\mathbf{k}[v_1, \dots, v_m]}^{-i, 2j}(\mathbf{k}[\mathcal{K}], \mathbf{k}) = \bigoplus_{J \subset [m]: |J|=j} \tilde{H}^{j-i-1}(\mathcal{K}_J; \mathbf{k}),$$

where  $\mathcal{K}_J$  is the full subcomplex of  $\mathcal{K}$  obtained by restricting to  $J \subset [m]$ . We assume  $\tilde{H}^{-1}(\mathcal{K}_{\emptyset}; \mathbf{k}) = \mathbf{k}$  above.

We shall give a proof of Hochster's formula following [257]. The idea is to first reduce the Koszul algebra  $(\Lambda[u_1, \dots, u_m] \otimes \mathbf{k}[\mathcal{K}], d)$  to a certain finite dimensional quotient  $R^*(\mathcal{K})$ , without changing the cohomology, and then identify  $R^*(\mathcal{K})$  with the sum of simplicial cochain complexes of all full subcomplexes in  $\mathcal{K}$ . The algebra  $R^*(\mathcal{K})$  will also be used in the cohomological calculations for moment-angle complexes in Chapter 4.

We use simplified notation  $u_J v_I$  for a monomial  $u_J \otimes v_I$  in the Koszul algebra  $\Lambda[u_1, \dots, u_m] \otimes \mathbf{k}[\mathcal{K}]$ .

CONSTRUCTION 3.2.5. We introduce the quotient algebra

$$R^*(\mathcal{K}) = \Lambda[u_1, \dots, u_m] \otimes \mathbf{k}[\mathcal{K}] / (v_i^2 = u_i v_i = 0, 1 \leq i \leq m).$$

Since the ideal generated by  $v_i^2$  and  $u_i v_i$  is homogeneous and invariant with respect to the differential (since  $d(u_i v_i) = 0$  and  $d(v_i^2) = 0$ ), we obtain that  $R^*(\mathcal{K})$  has differential and bigrading (3.1). We also have the quotient projection

$$\varrho: \Lambda[u_1, \dots, u_m] \otimes \mathbf{k}[\mathcal{K}] \rightarrow R^*(\mathcal{K}).$$

By definition, the algebra  $R^*(\mathcal{K})$  has a  $\mathbf{k}$ -vector space basis consisting of monomials  $u_J v_I$  where  $J \subset [m]$ ,  $I \in \mathcal{K}$  and  $J \cap I = \emptyset$ . Therefore,

$$(3.3) \quad \dim_{\mathbf{k}} R^{-p, 2q} = f_{q-p-1} \binom{m-q+p}{p},$$

where  $(f_0, f_1, \dots, f_{n-1})$  is the  $f$ -vector of  $\mathcal{K}$  and  $f_{-1} = 1$ . We have a  $\mathbf{k}$ -linear map

$$\iota: R^*(\mathcal{K}) \rightarrow \Lambda[u_1, \dots, u_m] \otimes \mathbf{k}[\mathcal{K}]$$

sending each  $u_J v_I$  identically. The map  $\iota$  commutes with the differentials, and therefore defines a homomorphism of bigraded differential  $\mathbf{k}$ -vector spaces satisfying the relation  $\varrho \cdot \iota = \text{id}$ . Note that  $\iota$  is not a map of algebras.

LEMMA 3.2.6. *The projection homomorphism  $\varrho: \Lambda[u_1, \dots, u_m] \otimes \mathbf{k}[\mathcal{K}] \rightarrow R^*(\mathcal{K})$  induces an isomorphism in cohomology.*

PROOF. The argument is similar to that used for the Koszul resolution (see Construction A.2.4). We shall construct a cochain homotopy between the maps  $\text{id}$  and  $\iota \cdot \varrho$  from  $\Lambda[u_1, \dots, u_m] \otimes \mathbf{k}[\mathcal{K}]$  to itself, that is, a map  $s$  satisfying the identity

$$(3.4) \quad ds + sd = \text{id} - \iota \cdot \varrho.$$

We first consider the case  $\mathcal{K} = \Delta^{m-1}$ . Then  $\Lambda[u_1, \dots, u_m] \otimes \mathbf{k}[\Delta^{m-1}]$  is the Koszul resolution (A.5), which will be denoted by

$$(3.5) \quad E = E_m = \Lambda[u_1, \dots, u_m] \otimes \mathbf{k}[v_1, \dots, v_m],$$

and the algebra  $R^*(\Delta^{m-1})$  is isomorphic to

$$(3.6) \quad (\Lambda[u] \otimes \mathbf{k}[v] / (v^2, uv))^{\otimes m}.$$

For  $m = 1$ , we define the map  $s_1: E_1^{0,*} = \mathbf{k}[v] \rightarrow E_1^{-1,*}$  by the formula

$$s_1(a_0 + a_1 v + \dots + a_j v^j) = u(a_2 v + a_3 v^2 + \dots + a_j v^{j-1}).$$

We need to check identity (3.4) for  $x = a_0 + a_1 v + \dots + a_j v^j \in E_1^{0,*}$  and for  $ux \in E_1^{-1,*}$ , as each element of  $E_1$  is the sum of elements of these two types. In the first case we have  $ds_1 x = x - a_0 - a_1 v = x - \iota \varrho x$ , and  $s_1 dx = 0$ . In the second case, i.e. for  $ux \in E_1^{-1,*}$ , we have  $ds_1(ux) = 0$ , and  $s_1 d(ux) = ux - a_0 u = ux - \iota \varrho(ux)$ . In both cases (3.4) holds.

Now we may assume by induction that a cochain homotopy  $s_m: E_m \rightarrow E_m$  has been already constructed for  $m = k - 1$ . Since  $E_k = E_{k-1} \otimes E_1$ ,  $\varrho_k = \varrho_{k-1} \otimes \varrho_1$  and  $\iota_k = \iota_{k-1} \otimes \iota_1$ , a direct calculation shows that the map

$$(3.7) \quad s_k = s_{k-1} \otimes \text{id} + \iota_{k-1} \varrho_{k-1} \otimes s_1$$

is a cochain homotopy between  $\text{id}$  and  $\iota_k \varrho_k$ , which finishes the proof for  $\mathcal{K} = \Delta^{m-1}$ .

In the case of arbitrary  $\mathcal{K}$  the algebras  $\Lambda[u_1, \dots, u_m] \otimes \mathbf{k}[\mathcal{K}]$  and  $R^*(\mathcal{K})$  are obtained by factorising (3.5) and (3.6) respectively by the ideal  $\mathcal{I}_{\mathcal{K}}$  in  $\Lambda[u_1, \dots, u_m] \otimes \mathbf{k}[m]$ . Observe that  $\mathcal{I}_{\mathcal{K}}$  is generated by  $v_I$  with  $I \notin \mathcal{K}$  as an ideal, and it has

a  $\mathbf{k}$ -vector space basis of monomials  $u_J v_{i_1}^{\alpha_1} \cdots v_{i_k}^{\alpha_k}$  with  $I = \{i_1, \dots, i_k\} \notin \mathcal{K}$  and  $\alpha_i > 0$ . We need to check that

$$d(\mathcal{I}_{\mathcal{K}}) \subset \mathcal{I}_{\mathcal{K}}, \quad \iota \varrho(\mathcal{I}_{\mathcal{K}}) \subset \mathcal{I}_{\mathcal{K}}, \quad s(\mathcal{I}_{\mathcal{K}}) \subset \mathcal{I}_{\mathcal{K}}.$$

The first inclusion is obvious: since  $d$  is a derivation, we only need to check that  $dv_I \in \mathcal{I}_{\mathcal{K}}$  for  $I \notin \mathcal{K}$ , but  $dv_I = 0$ . The second inclusion is also clear, since

$$\iota \varrho(u_J v_{i_1}^{\alpha_1} \cdots v_{i_k}^{\alpha_k}) = \begin{cases} u_J v_{i_1} \cdots v_{i_k}, & \text{if } \alpha_i = 1 \text{ and } J \cap \{i_1, \dots, i_k\} = \emptyset; \\ 0, & \text{otherwise.} \end{cases}$$

It remains to check the third inclusion. By expanding the inductive formula (3.7) we obtain

$$s_m = s_1 \otimes \text{id} \otimes \cdots \otimes \text{id} + \iota_1 \varrho_1 \otimes s_1 \otimes \text{id} \otimes \cdots \otimes \text{id} + \iota_1 \varrho_1 \otimes \cdots \otimes \iota_1 \varrho_1 \otimes s_1.$$

It follows that

$$s_m(u_J v_{i_1}^{\alpha_1} \cdots v_{i_k}^{\alpha_k}) = \sum_{p: \alpha_p > 1} \pm u_J u_{i_p} v_{i_1}^{\alpha_1} \cdots v_{i_p}^{\alpha_p - 1} \cdots v_{i_k}^{\alpha_k}.$$

Therefore,  $s(\mathcal{I}_{\mathcal{K}}) \subset \mathcal{I}_{\mathcal{K}}$ , and identity (3.4) holds in  $\Lambda[u_1, \dots, u_m] \otimes \mathbf{k}[\mathcal{K}]$ .  $\square$

As an immediate consequence of Lemma 3.2.6 we obtain

**COROLLARY 3.2.7.** *We have that  $\beta^{-i, 2j}(\mathbf{k}[\mathcal{K}]) = 0$  if  $i > m$  or  $j > m$ .*

**PROOF.** Indeed,  $R^{-i, 2j}(\mathcal{K}) = 0$  if either  $i$  or  $j$  is greater than  $m$ .  $\square$

Now, in order to prove Theorem 3.2.4, we need to show that the cohomology of  $R^*(\mathcal{K})$  is isomorphic to the direct sum of the reduced cohomology of the full subcomplexes on the right hand side of Hochster's formula. We shall see that this is true even without passing to cohomology, i.e.  $R^*(\mathcal{K})$  is isomorphic to  $\bigoplus_{I \subset [m]} C^*(\mathcal{K}_I)$ , with the appropriate shift in dimensions, where  $C^*$  denotes the simplicial cochain groups. To do this, it is convenient to refine the grading in  $\mathbf{k}[\mathcal{K}]$  as follows.

**CONSTRUCTION 3.2.8** (multigraded structure in face rings and Tor-algebras). A *multigrading* (more precisely, an  $\mathbb{N}^m$ -grading) is defined in  $\mathbf{k}[v_1, \dots, v_m]$  by setting

$$\text{mdeg } v_1^{i_1} \cdots v_m^{i_m} = (2i_1, \dots, 2i_m).$$

Since  $\mathbf{k}[\mathcal{K}]$  is the quotient of the polynomial ring by a monomial ideal, it inherits the multigrading. We may assume that all free modules in the resolution (A.2) are multigraded and the differentials preserve the multidegree. Then the algebra  $\text{Tor}_{\mathbf{k}[m]}(\mathbf{k}[\mathcal{K}], \mathbf{k})$  acquires the canonical  $\mathbb{Z} \oplus \mathbb{N}^m$ -grading, i.e.

$$\text{Tor}_{\mathbf{k}[v_1, \dots, v_m]}(\mathbf{k}[\mathcal{K}], \mathbf{k}) = \bigoplus_{i \geq 0, \mathbf{a} \in \mathbb{N}^m} \text{Tor}_{\mathbf{k}[v_1, \dots, v_m]}^{-i, 2\mathbf{a}}(\mathbf{k}[\mathcal{K}], \mathbf{k}).$$

The differential algebra  $R^*(\mathcal{K})$  also acquires a  $\mathbb{Z} \oplus \mathbb{N}^m$ -grading, and Lemma 3.2.6 implies that

$$(3.8) \quad \text{Tor}_{\mathbf{k}[v_1, \dots, v_m]}^{-i, 2\mathbf{a}}(\mathbf{k}[\mathcal{K}], \mathbf{k}) \cong H^{-i, 2\mathbf{a}}(R^*(\mathcal{K}), d).$$

We may view a subset  $J \subset [m]$  as a  $(0, 1)$ -vector in  $\mathbb{N}^m$  whose  $j$ th coordinate is 1 if  $j \in J$  and is 0 otherwise. Then there is the following multigraded version of Hochster's formula:



THEOREM 3.2.9. *For any subset  $J \subset [m]$  we have*

$$\mathrm{Tor}_{\mathbf{k}[v_1, \dots, v_m]}^{-i, 2J}(\mathbf{k}[\mathcal{K}], \mathbf{k}) \cong \widetilde{H}^{|J|-i-1}(\mathcal{K}_J),$$

and  $\mathrm{Tor}_{\mathbf{k}[m]}^{-i, 2\mathbf{a}}(\mathbf{k}[\mathcal{K}], \mathbf{k}) = 0$  if  $\mathbf{a}$  is not a  $(0, 1)$ -vector.

PROOF OF THEOREM 3.2.4 AND THEOREM 3.2.9. Let  $C^q(\mathcal{K}_J)$  denote the  $q$ th simplicial cochain group with coefficients in  $\mathbf{k}$ . Denote by  $\alpha_L \in C^{p-1}(\mathcal{K}_J)$  the basis cochain corresponding to an oriented simplex  $L = (l_1, \dots, l_p) \in \mathcal{K}_J$ ; it takes value 1 on  $L$  and vanishes on all other simplices. Now we define a  $\mathbf{k}$ -linear map

$$(3.9) \quad \begin{aligned} f: C^{p-1}(\mathcal{K}_J) &\longrightarrow R^{p-|J|, 2J}(\mathcal{K}), \\ \alpha_L &\longmapsto \varepsilon(L, J) u_{J \setminus L} v_L, \end{aligned}$$

where  $\varepsilon(L, J)$  is the sign defined by

$$\varepsilon(L, J) = \prod_{j \in L} \varepsilon(j, J),$$

and  $\varepsilon(j, J) = (-1)^{r-1}$  if  $j$  is the  $r$ th element of the set  $J \subset [m]$ , written in increasing order. Obviously,  $f$  is an isomorphism of  $\mathbf{k}$ -vector spaces, and a direct check shows that it commutes with the differentials. Indeed, we have

$$\begin{aligned} f(d\alpha_L) &= f\left(\sum_{j \in J \setminus L, j \cup L \in \mathcal{K}_J} \varepsilon(j, j \cup L) \alpha_{j \cup L}\right) \\ &= \sum_{j \in J \setminus L} \varepsilon(j \cup L, J) \varepsilon(j, j \cup L) u_{J \setminus (j \cup L)} v_{j \cup L} \end{aligned}$$

(note that  $v_{j \cup L} \in \mathbf{k}[\mathcal{K}]$ , and hence it is zero unless  $j \cup L \in \mathcal{K}_J$ ). On the other hand,

$$df(\alpha_L) = \sum_{j \in J \setminus L} \varepsilon(L, J) \varepsilon(j, J \setminus L) u_{J \setminus (j \cup L)} v_{j \cup L}.$$

By the definition of  $\varepsilon(L, J)$ ,

$$\varepsilon(j \cup L, J) \varepsilon(j, j \cup L) = \varepsilon(L, J) \varepsilon(j, J) \varepsilon(j, j \cup L) = \varepsilon(L, J) \varepsilon(j, J \setminus L),$$

which implies that  $f(d\alpha_L) = df(\alpha_L)$ . Therefore,  $f$  together with the map  $\mathbf{k} \rightarrow R^{-|J|, 2J}(\mathcal{K})$ ,  $1 \mapsto u_J$ , defines an isomorphism of cochain complexes

$$\begin{array}{ccccccccccc} 0 & \rightarrow & \mathbf{k} & \xrightarrow{d} & C^0(\mathcal{K}_J) & \xrightarrow{d} & \dots & \xrightarrow{d} & C^{p-1}(\mathcal{K}_J) & \xrightarrow{d} & \dots \\ & & \downarrow \cong & & \downarrow \cong & & & & \downarrow \cong & & \\ 0 & \rightarrow & R^{-|J|, 2J}(\mathcal{K}) & \xrightarrow{d} & R^{1-|J|, 2J}(\mathcal{K}) & \xrightarrow{d} & \dots & \xrightarrow{d} & R^{p-|J|, 2J}(\mathcal{K}) & \xrightarrow{d} & \dots \end{array}$$

Then it follows from (3.8) that

$$\widetilde{H}^{p-1}(\mathcal{K}_J) \cong \mathrm{Tor}_{\mathbf{k}[v_1, \dots, v_m]}^{p-|J|, 2J}(\mathbf{k}[\mathcal{K}], \mathbf{k}),$$

which is equivalent to the first isomorphism of Theorem 3.2.9. Since  $R^{-i, 2\mathbf{a}}(\mathcal{K}) = 0$  if  $\mathbf{a}$  is not a  $(0, 1)$ -vector,  $\mathrm{Tor}_{\mathbf{k}[m]}^{-i, 2\mathbf{a}}(\mathbf{k}[\mathcal{K}], \mathbf{k})$  vanishes for such  $\mathbf{a}$ .  $\square$

Since  $\mathrm{Tor}_{\mathbf{k}[m]}(\mathbf{k}[\mathcal{K}], \mathbf{k})$  is an algebra, the isomorphisms of Theorem 3.2.4 turn the direct sum

$$(3.10) \quad \bigoplus_{\substack{p \geq 0 \\ J \subset [m]}} \widetilde{H}^{p-1}(\mathcal{K}_J)$$

into a (multigraded)  $\mathbf{k}$ -algebra. Consider the product in the simplicial cochains of full subcomplexes given by

$$(3.11) \quad \begin{aligned} \mu: C^{p-1}(\mathcal{K}_I) \otimes C^{q-1}(\mathcal{K}_J) &\longrightarrow C^{p+q-1}(\mathcal{K}_{I \sqcup J}), \\ \alpha_L \otimes \alpha_M &\longmapsto \begin{cases} \alpha_{L \sqcup M}, & \text{if } I \cap J = \emptyset; \\ 0, & \text{otherwise.} \end{cases} \end{aligned}$$

Here  $\alpha_{L \sqcup M} \in C^{p+q-1}(\mathcal{K}_{I \sqcup J})$  denotes the basis simplicial cochain corresponding to  $L \sqcup M$  if the latter is a simplex of  $\mathcal{K}_{I \sqcup J}$  and zero otherwise. If  $I \cap J = \emptyset$ , then  $\mathcal{K}_{I \sqcup J}$  is a subcomplex in the join  $\mathcal{K}_I * \mathcal{K}_J$ , and the above product is the restriction to  $\mathcal{K}_{I \sqcup J}$  of the standard exterior product

$$C^{p-1}(\mathcal{K}_I) \otimes C^{q-1}(\mathcal{K}_J) \longrightarrow C^{p+q-1}(\mathcal{K}_I * \mathcal{K}_J).$$

PROPOSITION 3.2.10. *The product in the direct sum  $\bigoplus_{p \geq 0, J \subset [m]} \tilde{H}^{p-1}(\mathcal{K}_J)$  induced by the isomorphisms from Hochster's theorem coincides up to a sign with the product given by (3.11).*

PROOF. This is a direct calculation. We use the isomorphism  $f$  given by (3.9):

$$\alpha_L \cdot \alpha_M = f^{-1}(f(\alpha_L) \cdot f(\alpha_M)) = f^{-1}(\varepsilon(L, I) u_{I \setminus L} v_L \varepsilon(M, J) u_{J \setminus M} v_M)$$

If  $I \cap J \neq \emptyset$ , then the product  $u_{I \setminus L} v_L u_{J \setminus M} v_M$  is zero in  $R^*(\mathcal{K})$ . Otherwise we have that  $u_{I \setminus L} v_L u_{J \setminus M} v_M = \zeta u_{(I \cup J) \setminus (L \cup M)} v_{L \cup M}$ , where  $\zeta = \prod_{k \in I \setminus L} \varepsilon(k, k \cup J \setminus M)$ , and we can continue the above identity as

$$\alpha_L \cdot \alpha_M = \varepsilon(L, I) \varepsilon(M, J) \zeta \varepsilon(L \cup M, I \cup J) \alpha_{L \sqcup M}.$$

Note that this calculation also gives the explicit value for the correcting sign, but we shall not need this.  $\square$

Let  $P$  be a simple polytope. The multigraded components of  $\text{Tor}_{\mathbf{k}[m]}(\mathbf{k}[P], \mathbf{k})$  can be expressed directly in terms of  $P$  as follows. Let  $\{F_1, \dots, F_m\}$  be the set of facets of  $P$ . Given  $I \subset [m]$ , we define the following subset of the boundary of  $P$ :

$$P_I = \bigcup_{i \in I} F_i.$$

PROPOSITION 3.2.11. *For any subset  $J \subset [m]$  we have*

$$\text{Tor}_{\mathbf{k}[v_1, \dots, v_m]}^{-i, 2J}(\mathbf{k}[P], \mathbf{k}) \cong \tilde{H}^{|J| - i - 1}(P_J),$$

and  $\text{Tor}_{\mathbf{k}[m]}^{-i, 2\mathbf{a}}(\mathbf{k}[P], \mathbf{k}) = 0$  if  $\mathbf{a}$  is not a  $(0, 1)$ -vector.

PROOF. Let  $\mathcal{K} = \mathcal{K}_P$  be the nerve complex of  $P$ . Then the statement follows from Theorem 3.2.9 and the fact that  $\mathcal{K}_J$  is a deformation retract of  $P_J$ . The latter is because  $P$  is simple, and therefore,  $P_J = \bigcup_{i \in J} F_i = \bigcup_{i \in J} \text{st}_{\mathcal{K}'}\{i\}$  (by Proposition 2.3.8), which is the combinatorial neighbourhood of  $(\mathcal{K}_J)'$  in  $\mathcal{K}'$ .  $\square$

For a description of the multiplication in  $\text{Tor}_{\mathbf{k}[m]}(\mathbf{k}[P], \mathbf{k})$  in terms of  $P$ , see Exercise 3.2.14.

EXAMPLE 3.2.12.

1. Let  $P$  be a 4-gon, so that  $\mathcal{K}_P = \begin{matrix} 4 & \square & 3 \\ & 1 & 2 \end{matrix}$ , as in Example 3.2.3. This time we calculate the Betti numbers  $\beta^{-i,2^j}(\mathbf{k}[P])$  using Hochster's formula. We have

$$\begin{aligned} \beta^{0,0}(\mathbf{k}[P]) &= \dim \tilde{H}^{-1}(\emptyset) = 1 && 1 \\ \beta^{-1,4}(\mathbf{k}[P]) &= \dim \tilde{H}^0(P_{\{1,3\}}) \oplus \tilde{H}^0(P_{\{2,4\}}) = 2 && u_1 v_3, u_2 v_4 \\ \beta^{-2,8}(\mathbf{k}[P]) &= \dim \tilde{H}^1(P_{\{1,2,3,4\}}) = 1 && u_1 u_2 v_3 v_4 \end{aligned}$$

where in the right column we include cocycles in the Koszul algebra  $\Lambda[u_1, \dots, u_m] \otimes \mathbf{k}[P]$  representing generators of the corresponding cohomology groups. All other Betti numbers are zero. We have a nontrivial product  $[u_1 v_3] \cdot [u_2 v_4] = [u_1 u_2 v_3 v_4]$ ; all other products of positive-dimensional classes are zero. Note that in this example all Tor-groups have bases represented by monomials in the Koszul algebra. This is not the case in general, as is shown by the next example.

2. Now let  $\mathcal{K} = 1 \bullet \rightarrow 2 \ 3 \bullet \rightarrow 4$  be the union of two segments. Then the generator of

$$\text{Tor}_{\mathbf{k}[v_1, \dots, v_4]}^{-3,8}(\mathbf{k}[\mathcal{K}], \mathbf{k}) \cong \tilde{H}^0(\mathcal{K}_{\{1,2,3,4\}}; \mathbf{k}) \cong \mathbf{k}$$

is represented by the cocycle  $u_1 u_2 u_3 v_4 - u_1 u_2 u_4 v_3$  in the Koszul algebra, and it cannot be represented by a monomial.

3. Let us calculate the Betti numbers (both bigraded and multigraded) of  $\mathbf{k}[\mathcal{K}]$  for the complex shown in Fig. 3.1, using Hochster's formula. We have

$$\begin{aligned} \beta^{0,0} &= \dim \tilde{H}^0(\emptyset) = 1, \\ \beta^{-1,4} &= \beta^{-1,(2,0,0,0,2)} + \beta^{-1,(0,0,2,2,0)} = \dim \tilde{H}^0(\mathcal{K}_{\{1,5\}}) \oplus \tilde{H}^0(\mathcal{K}_{\{3,4\}}) = 2, \\ \beta^{-1,6} &= \beta^{-1,(2,2,2,0,0)} + \beta^{-1,(0,2,0,2,2)} = \dim \tilde{H}^1(\mathcal{K}_{\{1,2,3\}}) \oplus \tilde{H}^1(\mathcal{K}_{\{2,4,5\}}) = 2, \\ \beta^{-2,8} &= \beta^{-2,(0,2,2,2,2)} + \beta^{-2,(2,0,2,2,2)} + \dots + \beta^{-2,(2,2,2,2,0)} \\ &= \dim \tilde{H}^1(\mathcal{K}_{\{2,3,4,5\}}) \oplus \dots \oplus \tilde{H}^1(\mathcal{K}_{\{1,2,3,4\}}) = 5, \\ \beta^{-3,10} &= \beta^{-3,(2,2,2,2,2)} = \dim \tilde{H}^1(\mathcal{K}_{\{1,2,3,4,5\}}) = 2. \end{aligned}$$

All other Betti numbers are zero.

4. Let  $\mathcal{K}$  be a triangulation of the real projective plane  $\mathbb{R}P^2$  with  $m$  vertices (the minimal example has  $m = 6$ , see Fig. 3.2, where the vertices with the same labels are identified, and the boundary edges are identified according to the orientation shown). Then, by Hochster's formula,

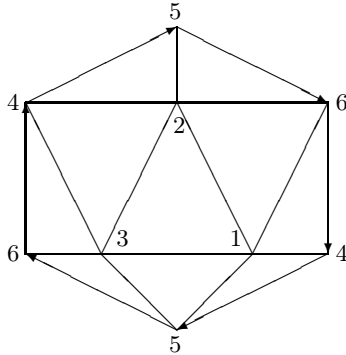

FIGURE 3.2. 6-vertex triangulation of  $\mathbb{R}P^2$ .

$$\mathrm{Tor}_{\mathbf{k}[v_1, \dots, v_m]}^{3-m, 2m}(\mathbf{k}[\mathcal{K}], \mathbf{k}) = \tilde{H}^2(\mathcal{K}_{[m]}; \mathbf{k}) = \tilde{H}^2(\mathbb{R}P^2; \mathbf{k}) = 0$$

if the characteristic of  $\mathbf{k}$  is not 2. On the other hand,

$$\mathrm{Tor}_{\mathbb{Z}_2[v_1, \dots, v_m]}^{3-m, 2m}(\mathbb{Z}_2[\mathcal{K}], \mathbb{Z}_2) = \tilde{H}^2(\mathcal{K}_{[m]}; \mathbb{Z}_2) = \tilde{H}^2(\mathbb{R}P^2; \mathbb{Z}_2) = \mathbb{Z}_2.$$

This example shows that the Tor-groups of  $\mathbf{k}[\mathcal{K}]$ , and even the algebraic Betti numbers, depend on  $\mathbf{k}$ . A similar example shows that  $\mathrm{Tor}_{\mathbb{Z}[m]}(\mathbb{Z}[\mathcal{K}], \mathbb{Z})$  may have an arbitrary amount of additive torsion. (This is a well-known fact for the usual cohomology of spaces, and so we may take  $\mathcal{K}$  to be a triangulation of a space with the appropriate torsion in cohomology.)

### Exercises.

3.2.13. Let  $P$  be a pentagon. Calculate the bigraded Betti numbers of  $\mathbf{k}[P]$  and the multiplication in  $\mathrm{Tor}_{\mathbf{k}[m]}(\mathbf{k}[P], \mathbf{k})$

- (a) using algebra  $R^*(\mathcal{K}_P)$  and Lemma 3.2.6;
- (b) using Hochster's theorem and Proposition 3.2.10,

and compare the results.

3.2.14. Use Proposition 3.2.11 and the isomorphism

$$\tilde{H}^{|J|-i-1}(P_J) \cong H^{|J|-i}(P, P_J)$$

to show that the multiplication induced from  $\mathrm{Tor}_{\mathbf{k}[m]}(\mathbf{k}[P], \mathbf{k})$  in the direct sum

$$\bigoplus_{\substack{p \geq 0 \\ J \subset [m]}} H^p(P, P_J)$$

comes from the standard exterior multiplication

$$H^p(P, P_I) \otimes H^q(P, P_J) \longrightarrow H^{p+q}(P, P_I \cup P_J)$$

when  $I \cap J = \emptyset$  and is zero otherwise.

3.2.15. Complete the details in the following algebraic proof of the Alexander duality (Theorem 2.4.5); this argument goes back to the original work of Hochster [162]:

1. Choose  $J \notin \mathcal{K}$ , that is,  $\hat{J} = [m] \setminus J \in \hat{\mathcal{K}}$ , and show that for any  $L = \{l_1, \dots, l_q\} \subset J$ ,

$$J \setminus L \notin \mathcal{K} \iff L \in \mathrm{lk}_{\hat{\mathcal{K}}} \hat{J}.$$

2. Consider the Koszul algebra

$$S(\mathcal{K}) = [\Lambda[u_1, \dots, u_m] \otimes \mathcal{I}_{\mathcal{K}}, d]$$

of the Stanley–Reisner ideal  $\mathcal{I}_{\mathcal{K}}$  (see Lemma A.2.10 and the remark after it), and show that its multigraded component  $S^{-q, 2J}(\mathcal{K})$  has a  $\mathbf{k}$ -basis consisting of monomials  $u_L v_{J \setminus L}$  where  $L \in \mathrm{lk}_{\hat{\mathcal{K}}} \hat{J}$ .

3. Consider the  $\mathbf{k}$ -vector space isomorphism

$$g: C_{q-1}(\mathrm{lk}_{\hat{\mathcal{K}}} \hat{J}) \longrightarrow S^{-q, 2J}(\mathcal{K}),$$

$$[L] \mapsto u_L v_{J \setminus L},$$

where  $[L] \in C_{q-1}(\mathrm{lk}_{\hat{\mathcal{K}}} \hat{J})$  is the basis simplicial chain corresponding to  $L$ . Show that  $g$  commutes with the differentials, and therefore defines an isomorphism of chain complexes (in analogy with (3.9), but with no correction sign).

4. Deduce that

$$\widetilde{H}_{q-1}(\mathrm{lk}_{\widehat{\mathcal{K}}} \widehat{J}) \cong \mathrm{Tor}_{\mathbf{k}[m]}^{-q, 2J}(\mathcal{I}_{\mathcal{K}}, \mathbf{k}) \cong \mathrm{Tor}_{\mathbf{k}[m]}^{-q-1, 2J}(\mathbf{k}[\mathcal{K}], \mathbf{k}) \cong \widetilde{H}^{|J|-q-2}(\mathcal{K}_J),$$

where the first isomorphism is obtained by passing to homology in step 3, the second follows from the long exact sequence of Theorem A.2.5 (e), and the third is Theorem 3.2.4. It remains to note that the resulting isomorphism is equivalent to that of Corollary 2.4.6.

### 3.3. Cohen–Macaulay complexes

It is usually quite difficult to determine whether a given ring is Cohen–Macaulay (see Appendix, Section A.3). One of the key results of combinatorial commutative algebra, the *Reisner Theorem*, gives an effective criterion for the Cohen–Macaulayness of face rings, in terms of simplicial cohomology of  $\mathcal{K}$ . A reformulation of Reisner’s criterion, due to Munkres and Stanley, tells us that the Cohen–Macaulayness of the face ring  $\mathbf{k}[\mathcal{K}]$  is a topological property of  $\mathcal{K}$ , i.e. it depends only on the topology of the realisation  $|\mathcal{K}|$ . These results have many important applications in both combinatorial commutative algebra and toric topology.

Here we assume that  $\mathbf{k}$  is a field, unless otherwise stated. If  $\mathcal{K}$  is of dimension  $n - 1$ , then the Krull dimension of  $\mathbf{k}[\mathcal{K}]$  is  $n$  (an exercise). We start with the following combinatorial description of homogeneous systems of parameters (hsop’s) in  $\mathbf{k}[\mathcal{K}]$  in terms of the restriction homomorphisms  $s_I: \mathbf{k}[\mathcal{K}] \rightarrow \mathbf{k}[v_i: i \in I]$  (see Proposition 3.1.8).

LEMMA 3.3.1. *Let  $\mathcal{K}$  be a simplicial complex of dimension  $n - 1$ . A sequence of homogeneous elements  $\mathbf{t} = (t_1, \dots, t_n)$  of the face ring  $\mathbf{k}[\mathcal{K}]$  is a homogeneous system of parameters if and only if*

$$\dim_{\mathbf{k}}(\mathbf{k}[v_i: i \in I]/s_I(\mathbf{t})) < \infty$$

for each simplex  $I \in \mathcal{K}$ , where  $s_I(\mathbf{t})$  is the image of the sequence  $\mathbf{t}$  under the restriction map  $s_I$ .

PROOF. Assume that  $\mathbf{t}$  is an hsop. By applying the right exact functor  $\otimes_{\mathbf{k}[\mathbf{t}]}$  to the epimorphism  $s_I: \mathbf{k}[\mathcal{K}] \rightarrow \mathbf{k}[v_i: i \in I]$  we obtain that  $\mathbf{k}[\mathcal{K}]/\mathbf{t} \rightarrow \mathbf{k}[v_i: i \in I]/s_I(\mathbf{t})$  is also an epimorphism. Hence,

$$\dim_{\mathbf{k}}(\mathbf{k}[v_i: i \in I]/s_I(\mathbf{t})) \leq \dim_{\mathbf{k}}(\mathbf{k}[\mathcal{K}]/\mathbf{t}) < \infty.$$

For the opposite statement, assume that

$$\dim_{\mathbf{k}} \bigoplus_{I \in \mathcal{K}} \mathbf{k}[v_i: i \in I]/s_I(\mathbf{t}) < \infty.$$

Consider the short exact sequence of  $\mathbf{k}[\mathbf{t}]$ -modules

$$0 \longrightarrow \mathbf{k}[\mathcal{K}] \xrightarrow{\oplus s_I} \bigoplus_{I \in \mathcal{K}} \mathbf{k}[v_i: i \in I] \longrightarrow Q \longrightarrow 0,$$

where  $Q$  is the quotient module, and the following fragment of the corresponding long exact sequence for  $\mathrm{Tor}$  (Theorem A.2.5 (e)):

$$\cdots \longrightarrow \mathrm{Tor}_{\mathbf{k}[\mathbf{t}]}^{-1}(Q, \mathbf{k}) \longrightarrow \mathbf{k}[\mathcal{K}]/\mathbf{t} \longrightarrow \bigoplus_{I \in \mathcal{K}} \mathbf{k}[v_i: i \in I]/s_I(\mathbf{t}) \longrightarrow \cdots$$

Since  $\bigoplus_{I \in \mathcal{K}} \mathbf{k}[v_i : i \in I]$  is a finitely generated  $\mathbf{k}[\mathbf{t}]$ -module, its quotient  $Q$  is also finitely generated. Hence  $\dim_{\mathbf{k}} \operatorname{Tor}_{\mathbf{k}[\mathbf{t}]}^{-1}(Q, \mathbf{k}) < \infty$  (see Proposition A.2.6), and, by the exact sequence above,  $\dim_{\mathbf{k}}(\mathbf{k}[\mathcal{K}]/\mathbf{t}) < \infty$ . Therefore,  $\mathbf{t}$  is an lsop in  $\mathbf{k}[\mathcal{K}]$ .  $\square$

Recall that we refer to a sequence  $\mathbf{t} = (t_1, \dots, t_n) \in \mathbf{k}[\mathcal{K}]$  as linear if  $\deg t_i = 2$  for all  $i$ . We may write a linear sequence as

$$(3.12) \quad t_i = \lambda_{i1}v_1 + \dots + \lambda_{im}v_m, \quad \text{for } 1 \leq i \leq n.$$

Here is a simple characterisation of lsops in a face ring (see Definition A.3.9):

**LEMMA 3.3.2.** *A linear sequence  $\mathbf{t} = (t_1, \dots, t_n) \in \mathbf{k}[\mathcal{K}]$ ,  $\dim \mathcal{K} = n - 1$ , is an lsop if and only if the restriction  $s_I(\mathbf{t})$  to each simplex of  $I \in \mathcal{K}$  generates the polynomial algebra  $\mathbf{k}[v_i : i \in I]$  (i.e. the rank of the  $n \times |I|$  matrix  $\Lambda_I = (\lambda_{ij})$ ,  $1 \leq i \leq n$ ,  $j \in I$ , is equal to  $|I|$ ).*

**PROOF.** Indeed, if  $\mathbf{t}$  is linear, then the conditions  $\dim_{\mathbf{k}} \mathbf{k}[v_i : i \in I]/s_I(\mathbf{t}) < \infty$  and  $\mathbf{k}[v_i : i \in I]/s_I(\mathbf{t}) \cong \mathbf{k}$  are equivalent. The latter means that  $s_I(\mathbf{t})$  generates  $\mathbf{k}[v_i : i \in I]$  as a  $\mathbf{k}$ -algebra.  $\square$

Note that it is enough to verify the conditions of Lemmata 3.3.1 and 3.3.2 only for maximal simplices  $I \in \mathcal{K}$ .

**DEFINITION 3.3.3.** A linear sequence  $\mathbf{t} = (t_1, \dots, t_n) \in \mathbb{Z}[\mathcal{K}]$  is referred to as a *integral lsop* if its reduction modulo  $p$  is an lsop in  $\mathbb{Z}_p[\mathcal{K}]$  for any prime  $p$ . Equivalently,  $\mathbf{t}$  is an integral lsop if  $n = \dim \mathcal{K} + 1$  and the restriction  $s_I(\mathbf{t})$  to each simplex  $I \in \mathcal{K}$  generates the polynomial ring  $\mathbb{Z}[v_i : i \in I]$  (the equivalence of these two conditions is an exercise).

Although the rational face ring  $\mathbb{Q}[\mathcal{K}]$  always admit an lsop by Theorem A.3.10, an lsop in  $\mathbb{Z}_p[\mathcal{K}]$  for a prime  $p$  (or an integral lsop in  $\mathbb{Z}[\mathcal{K}]$ ) may fail to exist, as is shown by the next example.

**EXAMPLE 3.3.4.**

1. Let  $\mathcal{K}$  be a simplicial complex of dimension  $n - 1$  on  $m \geq 2^n$  vertices whose 1-skeleton is a complete graph. Then the face ring  $\mathbb{Z}_2[\mathcal{K}]$  does not admit an lsop. Indeed, assume that (3.12) is an lsop. Then, by Corollary 3.3.2, each column vector of the  $n \times m$ -matrix  $(\lambda_{ij})$  is nonzero, and all column vectors are pairwise different (since each pair of vertices of  $\mathcal{K}$  spans an edge). This is a contradiction, since the number of different nonzero vectors in  $\mathbb{Z}_2^n$  is  $2^n - 1$ . By considering the reduction modulo 2 we obtain that  $\mathbb{Z}[\mathcal{K}]$  also does not admit an integral lsop.

2. There are also simple polytopes  $P$  whose face rings  $\mathbf{k}[P]$  do not admit an lsop over  $\mathbb{Z}_2$  or  $\mathbb{Z}$ . Indeed, let  $P$  be the dual of a 2-neighbourly simplicial  $n$ -polytope (e.g., a cyclic polytope of dimension  $n \geq 4$ , see Example 1.1.17) with  $m \geq 2^n$  vertices. Then the 1-skeleton of  $\mathcal{K}_P$  is a complete graph, and therefore  $\mathbb{Z}[P] = \mathbb{Z}[\mathcal{K}_P]$  does not admit an lsop. This example is taken from [90].

By considering the reduction modulo 2 we observe that the ring  $\mathbb{Z}[\mathcal{K}]$  for  $\mathcal{K}$  from the previous example also does not admit an integral lsop. Existence of integral lsop's in the face rings  $\mathbb{Z}[\mathcal{K}]$  is a very subtle question of great importance for toric topology; it will be discussed in more detail in Section 4.8.

**DEFINITION 3.3.5.**  $\mathcal{K}$  is a *Cohen–Macaulay complex over a field  $\mathbf{k}$*  if  $\mathbf{k}[\mathcal{K}]$  is a Cohen–Macaulay algebra. We say that  $\mathcal{K}$  is a *Cohen–Macaulay complex over  $\mathbb{Z}$* , or

simply a *Cohen–Macaulay complex*, if  $\mathbf{k}[\mathcal{K}]$  is a Cohen–Macaulay algebra for  $\mathbf{k} = \mathbb{Q}$  and any finite field.

REMARK. We shall often consider  $\mathbf{k}[\mathcal{K}]$  as a  $\mathbf{k}[m]$ -module rather than a  $\mathbf{k}$ -algebra. However, this does not affect regular sequences and the Cohen–Macaulay property: it is an easy exercise to show that a sequence  $\mathbf{t} \subset \mathbf{k}[m]$  is  $\mathbf{k}[m]$ -regular for  $\mathbf{k}[\mathcal{K}]$  as a  $\mathbf{k}[m]$ -module if and only the image of  $\mathbf{t}$  in  $\mathbf{k}[\mathcal{K}]$  is  $\mathbf{k}[\mathcal{K}]$ -regular. In particular,  $\mathbf{k}[\mathcal{K}]$  is a Cohen–Macaulay algebra if and only if it is a Cohen–Macaulay  $\mathbf{k}[m]$ -module. We shall therefore not distinguish between these two notions.

EXAMPLE 3.3.6. Let  $\mathcal{K} = \partial\Delta^2$ . Then  $\mathbf{k}[\mathcal{K}] = \mathbf{k}[v_1, v_2, v_3]/(v_1v_2v_3)$  and the Krull dimension is  $\dim \mathbf{k}[\mathcal{K}] = 2$ . The elements  $v_1, v_2 \in \mathbf{k}[\mathcal{K}]$  are algebraically independent, but do not form an lsop, since  $\mathbf{k}[\mathcal{K}]/(v_1, v_2) \cong \mathbf{k}[v_3]$  and  $\dim(\mathbf{k}[\mathcal{K}]/(v_1, v_2)) = 1$ . On the other hand, the elements  $t_1 = v_1 - v_3, t_2 = v_2 - v_3$  form an lsop, since  $\mathbf{k}[\mathcal{K}]/(t_1, t_2) \cong \mathbf{k}[t]/t^3$ . It is easy to see that  $\mathbf{k}[\mathcal{K}]$  is a free  $\mathbf{k}[t_1, t_2]$ -module on the basis  $\{1, v_1, v_1^2\}$ . Therefore,  $\mathbf{k}[\mathcal{K}]$  is a Cohen–Macaulay ring and  $(t_1, t_2)$  is a regular sequence.

Cohen–Macaulay complexes can be characterised homologically as follows:

PROPOSITION 3.3.7. *The following conditions are equivalent for a simplicial complex  $\mathcal{K}$  of dimension  $n - 1$  with  $m$  vertices:*

- (a)  $\mathcal{K}$  is Cohen–Macaulay over a field  $\mathbf{k}$ ;
- (b)  $\beta^{-i}(\mathbf{k}[\mathcal{K}]) = 0$  for  $i > m - n$  and  $\beta^{-(m-n)}(\mathbf{k}[\mathcal{K}]) \neq 0$ .

PROOF. By definition, condition (a) is that  $\text{depth } \mathbf{k}[\mathcal{K}] = n$ . Condition (b) is equivalent to the equality  $\text{pdim } \mathbf{k}[\mathcal{K}] = m - n$ , by Corollary A.2.7. Since  $\text{depth } \mathbf{k}[m] = m$ , the two conditions are equivalent by Theorem A.3.8.  $\square$

EXAMPLE 3.3.8. Let  $\mathcal{K}$  be the 6-vertex triangulation of  $\mathbb{R}P^2$ , see Example 3.2.12.4 and Figure 3.2. Then  $m - n = 3$ , and, by Theorem 3.2.4,

$$\beta^{-4}(\mathbb{Z}_2[\mathcal{K}]) = \dim_{\mathbb{Z}_2} \tilde{H}^1(\mathbb{R}P^2; \mathbb{Z}_2) = 1,$$

so  $\mathcal{K}$  is not Cohen–Macaulay over  $\mathbb{Z}_2$ . On the other hand, a similar calculation shows that if the characteristic of  $\mathbf{k}$  is not 2, then  $\beta^{-i}(\mathbf{k}[\mathcal{K}]) = 0$  for  $i > 3$  and  $\beta^{-3}(\mathbf{k}[\mathcal{K}]) = 6$ , i.e.  $\mathcal{K}$  is Cohen–Macaulay over such fields.

PROPOSITION 3.3.9 (Stanley). *If  $\mathcal{K}$  is a Cohen–Macaulay complex of dimension  $n - 1$ , then  $\mathbf{h}(\mathcal{K}) = (h_0, \dots, h_n)$  is an  $M$ -vector (see Definition 1.4.13).*

PROOF. Let  $\mathcal{K}$  be Cohen–Macaulay, and let  $\mathbf{t} = (t_1, \dots, t_n)$  be an lsop in  $\mathbf{k}[\mathcal{K}]$ , where  $\mathbf{k}$  is a field of zero characteristic. Then, by Proposition A.3.14,

$$F(\mathbf{k}[\mathcal{K}], \lambda) = \frac{F(\mathbf{k}[\mathcal{K}]/\mathbf{t}; \lambda)}{(1 - \lambda^2)^n}.$$

On the other hand, the Poincaré series of  $\mathbf{k}[\mathcal{K}]$  is given by Theorem 3.1.10, which implies that

$$F(\mathbf{k}[\mathcal{K}]/\mathbf{t}; \lambda) = h_0 + h_1\lambda^2 + \dots + h_n\lambda^{2n}.$$

Now,  $A = \mathbf{k}[\mathcal{K}]/\mathbf{t}$  is a graded algebra generated by its degree-two elements and  $\dim_{\mathbf{k}} A^{2i} = h_i$ , so  $(h_0, \dots, h_n)$  is an  $M$ -vector by definition.  $\square$

REMARK. According to a result of Stanley [293, Theorem II.3.3], if  $(h_0, \dots, h_n)$  is an  $M$ -vector, then there exists an  $(n-1)$ -dimensional Cohen–Macaulay complex  $\mathcal{K}$  such that  $h_i(\mathcal{K}) = h_i$ . Together with Proposition 3.3.9, this gives a complete characterisation of face vectors of Cohen–Macaulay complexes.

The following fundamental result gives a combinatorial characterisation of Cohen–Macaulay complexes:

THEOREM 3.3.10 (Reisner [276]). *Let  $\mathbf{k} = \mathbb{Z}$  or a field. A simplicial complex  $\mathcal{K}$  is Cohen–Macaulay over  $\mathbf{k}$  if and only if for any simplex  $I \in \mathcal{K}$  (including  $I = \emptyset$ ) and  $i < \dim(\text{lk } I)$ , we have  $\tilde{H}_i(\text{lk } I; \mathbf{k}) = 0$ .*

The proof can be found in many texts on combinatorial commutative algebra, see e.g. [293, §II.4] or [225, Chapter 13]. It is not very hard, but uses the notion of *local cohomology*, which is beyond the scope of this book.

The following reformulation of Reisner’s Theorem shows that the Cohen–Macaulayness is a topological property of a simplicial complex.

PROPOSITION 3.3.11 (Munkres, Stanley). *A simplicial complex  $\mathcal{K}$  is Cohen–Macaulay over  $\mathbf{k}$  if and only if for any point  $x \in |\mathcal{K}|$ , we have*

$$H_i(|\mathcal{K}|, |\mathcal{K}| \setminus x; \mathbf{k}) = \tilde{H}_i(\mathcal{K}; \mathbf{k}) = 0 \quad \text{for } i < \dim \mathcal{K}.$$

PROOF. Let  $I \in \mathcal{K}$ . If  $I = \emptyset$ , then  $\tilde{H}_i(\mathcal{K}; \mathbf{k}) = \tilde{H}_i(\text{lk } I; \mathbf{k})$ . If  $I \neq \emptyset$ , then

$$(3.13) \quad H_i(|\mathcal{K}|, |\mathcal{K}| \setminus x; \mathbf{k}) = \tilde{H}_{i-|I|}(\text{lk } I; \mathbf{k})$$

for any  $x$  in the interior of  $I$ , by Proposition 2.2.14.

If  $\mathcal{K}$  is Cohen–Macaulay, then it is pure (Exercise 3.3.20) and therefore  $\text{lk } I$  is pure of dimension  $\dim \mathcal{K} - |I|$  (Exercise 2.2.19). Hence,  $i < \dim \mathcal{K}$  implies that  $i - |I| < \dim \text{lk } I$  and  $H_i(|\mathcal{K}|, |\mathcal{K}| \setminus x; \mathbf{k}) = 0$  by (3.13) and Theorem 3.3.10.

On the other hand, if  $H_i(|\mathcal{K}|, |\mathcal{K}| \setminus x; \mathbf{k}) = 0$  for  $i < \dim \mathcal{K}$ , then  $\tilde{H}_j(\text{lk } I; \mathbf{k}) = H_{j+|I|}(|\mathcal{K}|, |\mathcal{K}| \setminus x; \mathbf{k}) = 0$  for  $j < \dim \text{lk } I$ , since  $j + |I| < \dim \text{lk } I + |I| \leq \dim \mathcal{K}$ . Thus,  $\mathcal{K}$  is Cohen–Macaulay by Theorem 3.3.10.  $\square$

COROLLARY 3.3.12. *If a triangulation of a space  $X$  is a Cohen–Macaulay complex, then any other triangulation of  $X$  is Cohen–Macaulay as well.*

COROLLARY 3.3.13. *Any triangulated sphere is a Cohen–Macaulay complex.*

In particular, the  $h$ -vector of a triangulated sphere is an  $M$ -vector. This fact was used by Stanley in his generalisation of the UBT (Theorem 1.4.4) to arbitrary sphere triangulations:

THEOREM 3.3.14 (UBT for spheres). *For any triangulated  $(n-1)$ -dimensional sphere  $\mathcal{K}$  with  $m$  vertices, the  $h$ -vector  $(h_0, h_1, \dots, h_n)$  satisfies the inequalities*

$$h_i(\mathcal{K}) \leq \binom{m-n+i-1}{i}.$$

Therefore, the UBT holds for triangulated spheres, that is,

$$f_i(\mathcal{K}) \leq f_i(C^n(m)) \quad \text{for } i = 1, \dots, n-1.$$

PROOF. Let  $A = \mathbf{k}[\mathcal{K}]/\mathfrak{t}$  be the algebra from the proof of Proposition 3.3.9, so that  $\dim_{\mathbf{k}} A^{2i} = h_i$ . In particular,  $\dim_{\mathbf{k}} A^2 = h_1 = m - n$ . Since  $A$  is generated by  $A^2$ , the number  $h_i$  cannot exceed the number of monomials of degree  $i$  in  $m - n$  generators, i.e.  $h_i \leq \binom{m-n+i-1}{i}$ . The rest follows from Lemma 1.4.6.  $\square$



**Exercises.**

3.3.15. If  $\mathcal{K}$  is a simplicial complex of dimension  $n - 1$ , then  $\dim \mathbf{k}[\mathcal{K}] = n$ .

3.3.16. Let  $\mathbf{t}$  be an lsop in  $\mathbf{k}[\mathcal{K}]$ . Then the  $\mathbf{k}$ -vector space  $\mathbf{k}[\mathcal{K}]/\mathbf{t}$  is generated by monomials  $v_I$  for  $I \in \mathcal{K}$ . (Hint: prove that  $v_i v_I = 0$  in  $\mathbf{k}[\mathcal{K}]/\mathbf{t}$  for any  $i \in [m]$  and for any *maximal* simplex  $I \in \mathcal{K}$ , and then use Proposition 3.1.9).

3.3.17. A sequence  $\mathbf{t} \subset \mathbf{k}[m]$  is  $\mathbf{k}[m]$ -regular for  $\mathbf{k}[\mathcal{K}]$  as a  $\mathbf{k}[m]$ -module if and only the image of  $\mathbf{t}$  in  $\mathbf{k}[\mathcal{K}]$  is  $\mathbf{k}[\mathcal{K}]$ -regular.

3.3.18. Let  $\mathbf{t} = (t_1, \dots, t_n) \subset \mathbb{Z}[\mathcal{K}]$  be a linear sequence,  $\dim \mathcal{K} = n - 1$ . The following conditions are equivalent:

- (a) the reduction of  $\mathbf{t}$  modulo  $p$  is an lsop in  $\mathbb{Z}_p[\mathcal{K}]$  for any prime  $p$ ;
- (b) the restriction  $s_I(\mathbf{t})$  to each simplex  $I \in \mathcal{K}$  generates the polynomial ring  $\mathbb{Z}[v_i : i \in I]$ ;
- (c) for each  $I \in \mathcal{K}$  the columns of the  $n \times |I|$  matrix  $(\lambda_{ij})$ ,  $1 \leq i \leq n$ ,  $j \in I$ , generate the integer lattice  $\mathbb{Z}^{|I|}$ .

3.3.19. A finitely generated commutative  $\mathbf{k}$ -algebra is called a *complete intersection algebra* if it is the quotient of a polynomial algebra by a regular sequence. Observe that a complete intersection algebra is Cohen–Macaulay. Show that a face ring  $\mathbf{k}[\mathcal{K}]$  is a complete intersection algebra if and only if it is isomorphic to the quotient of the form

$$\mathbf{k}[v_1, \dots, v_m] / (v_1 v_2 \cdots v_{k_1}, v_{k_1+1} v_{k_1+2} \cdots v_{k_1+k_2}, \dots, v_{k_1+\cdots+k_{p-1}+1} \cdots v_{k_1+\cdots+k_p}).$$

This is equivalent to  $\mathcal{K}$  being decomposable into a join of the form

$$\partial \Delta^{k_1-1} * \partial \Delta^{k_2-1} * \dots * \partial \Delta^{k_p-1} * \Delta^{m-s-1},$$

where  $s = k_1 + \cdots + k_p$  and the join factor  $\Delta^{m-s-1}$  is void if  $s = m$ .

3.3.20. A Cohen–Macaulay complex is pure. (Hint: given a maximal simplex  $J \in \mathcal{K}$ , consider the ideal  $\mathcal{I}_J = (v_i : i \notin J)$  in  $\mathbf{k}[m]$ , and show that

$$\text{depth } \mathbf{k}[\mathcal{K}] \leq \dim(\mathbf{k}[m]/\mathcal{I}_J) = \dim \mathbf{k}[v_j : j \in J] = |J|.)$$

**3.4. Gorenstein complexes and Dehn–Sommerville relations**

Gorenstein rings are a class of Cohen–Macaulay rings with a special duality property. As in the case of Cohen–Macaulayness, simplicial complexes whose face rings are Gorenstein play an important role in combinatorial commutative algebra. In a sense, non-acyclic Gorenstein complexes provide a ‘best possible algebraic approximation’ to sphere triangulations. We review here the most important aspects of Gorenstein complexes. The proofs of the main results of this section, in particular Theorems 3.4.2 and 3.4.4, require considerably more commutative algebraic techniques than those from the previous sections. We refer the reader to [45, Chapter 3] for the general theory of Gorenstein rings and the missing proofs.

We recall from Proposition 3.3.7 that nonzero Betti numbers of a Cohen–Macaulay complex  $\mathcal{K}$  of dimension  $n - 1$  with  $m$  vertices appear up to homological degree  $-(m - n)$ , and  $\beta^{-(m-n)}(\mathbf{k}[\mathcal{K}]) \neq 0$ .

**DEFINITION 3.4.1.** A Cohen–Macaulay complex  $\mathcal{K}$  of dimension  $n - 1$  with  $m$  vertices is called *Gorenstein* (over a field  $\mathbf{k}$ ) if  $\beta^{-(m-n)}(\mathbf{k}[\mathcal{K}]) = 1$ , that is, if

$\mathrm{Tor}_{\mathbf{k}[m]}^{-(m-n)}(\mathbf{k}[\mathcal{K}], \mathbf{k}) \cong \mathbf{k}$ . Furthermore,  $\mathcal{K}$  is *Gorenstein\** if  $\mathcal{K}$  is Gorenstein and  $\mathcal{K} = \mathrm{core} \mathcal{K}$  (see Definition 2.2.15).

Since  $\mathcal{K} = \mathrm{core}(\mathcal{K}) * \Delta^{s-1}$  for some  $s$ , we have  $\mathbf{k}[\mathcal{K}] = \mathbf{k}[\mathrm{core}(\mathcal{K})] \otimes \mathbf{k}[s]$ . Then Lemma A.3.5 implies that

$$\mathrm{Tor}_{\mathbf{k}[m]}^{-i}(\mathbf{k}[\mathcal{K}], \mathbf{k}) \cong \mathrm{Tor}_{\mathbf{k}[m-s]}^{-i}(\mathbf{k}[\mathrm{core} \mathcal{K}], \mathbf{k}).$$

Therefore,  $\mathcal{K}$  is Gorenstein if and only if  $\mathrm{core} \mathcal{K}$  is Gorenstein\*.

As in the case of Cohen–Macaulay complexes, Gorenstein\* complexes can be characterised topologically as follows.

**THEOREM 3.4.2** ([293, §II.5] or [45, Theorem 5.6.1]). *The following conditions are equivalent:*

- (a)  $\mathcal{K}$  is a Gorenstein\* complex over  $\mathbf{k}$ ;
- (b) for any simplex  $I \in \mathcal{K}$  (including  $I = \emptyset$ ) the subcomplex  $\mathrm{lk} I$  has homology of a sphere of dimension  $\dim(\mathrm{lk} I)$ ;
- (c) for any  $x \in |\mathcal{K}|$ ,

$$H^i(|\mathcal{K}|, |\mathcal{K}| \setminus x; \mathbf{k}) = \tilde{H}^i(\mathcal{K}; \mathbf{k}) = \begin{cases} \mathbf{k} & \text{if } i = \dim \mathcal{K}; \\ 0 & \text{otherwise.} \end{cases}$$

In topology, polyhedra  $|\mathcal{K}|$  satisfying the conditions of the previous theorem are sometimes called *generalised homology spheres* (‘generalised’ because a homology sphere is usually assumed to be a manifold). In particular, triangulated spheres are Gorenstein\* complexes. Triangulated manifolds are not Gorenstein\* or even Cohen–Macaulay in general (*Buchsbaum complexes* provide a proper algebraic approximation to triangulated manifolds, see [293, § II.8]). Nevertheless, the Tor-algebra of a Gorenstein\* complex behaves like the cohomology algebra of a manifold: it satisfies *Poincaré duality*. This fundamental result was proved by Avramov and Golod for Noetherian local rings; here we state the graded version of their theorem in the case of face rings.

**DEFINITION 3.4.3.** A graded commutative connected  $\mathbf{k}$ -algebra  $A$  is called a *Poincaré algebra* if it is finite dimensional over  $\mathbf{k}$ , i.e.  $A = \bigoplus_{i=0}^d A^i$ , and the  $\mathbf{k}$ -linear maps

$$\begin{aligned} A^i &\rightarrow \mathrm{Hom}_{\mathbf{k}}(A^{d-i}, A^d), \\ a &\mapsto \varphi_a, \quad \text{where } \varphi_a(b) = ab \end{aligned}$$

are isomorphisms for  $0 \leq i \leq d$ . The classical example of a Poincaré algebra is the cohomology algebra of a manifold.

**THEOREM 3.4.4** (Avramov–Golod, [45, Theorem 3.4.5]). *A simplicial complex  $\mathcal{K}$  is Gorenstein\* if and only if the algebra  $T = \bigoplus_{i=0}^d T^i$ , where  $T^i = \mathrm{Tor}_{\mathbf{k}[m]}^{-i}(\mathbf{k}[\mathcal{K}], \mathbf{k})$  and  $d = \max\{j : \mathrm{Tor}_{\mathbf{k}[m]}^{-j}(\mathbf{k}[\mathcal{K}], \mathbf{k}) \neq 0\}$ , is a Poincaré algebra.*

**COROLLARY 3.4.5.** *Let  $\mathcal{K}$  be a Gorenstein\* complex of dimension  $n - 1$  on the set  $[m]$ . Then the Betti numbers and the Poincaré series of the Tor groups satisfy*

$$\begin{aligned} \beta^{-i, 2j}(\mathbf{k}[\mathcal{K}]) &= \beta^{-(m-n)+i, 2(m-j)}(\mathbf{k}[\mathcal{K}]), \quad 0 \leq i \leq m - n, \quad 0 \leq j \leq m, \\ F(\mathrm{Tor}_{\mathbf{k}[m]}^{-i}(\mathbf{k}[\mathcal{K}], \mathbf{k}); \lambda) &= \lambda^{2m} F(\mathrm{Tor}_{\mathbf{k}[m]}^{-(m-n)+i}(\mathbf{k}[\mathcal{K}], \mathbf{k}); \frac{1}{\lambda}). \end{aligned}$$

PROOF. Theorems 3.2.4 and 3.4.2 imply that

$$\beta^{-(m-n)}(\mathbf{k}[\mathcal{K}]) = \beta^{-(m-n), 2m}(\mathbf{k}[\mathcal{K}]) = 1.$$

We therefore have  $d = m - n$  and  $T^d = \mathrm{Tor}_{\mathbf{k}[m]}^{-(m-n), 2m}(\mathbf{k}[\mathcal{K}], \mathbf{k}) \cong \mathbf{k}$  in the notation of Theorem 3.4.4. Since the multiplication in the Tor-algebra preserves the bigrading, the isomorphisms  $T^i \xrightarrow{\cong} \mathrm{Hom}_{\mathbf{k}}(T^{m-n-i}, T^{m-n})$  from the definition of a Poincaré algebra can be refined to isomorphisms

$$T^{i, 2j} \xrightarrow{\cong} \mathrm{Hom}_{\mathbf{k}}(T^{m-n-i, 2(m-j)}, T^{m-n, 2m}),$$

where  $T^{m-n, 2m} \cong \mathbf{k}$ . This implies the first identity, and the second is a direct corollary.  $\square$

As a further corollary we obtain the following symmetry property for the Poincaré series of the face ring:

COROLLARY 3.4.6. *If  $\mathcal{K}$  is Gorenstein\* of dimension  $n - 1$ , then*

$$F(\mathbf{k}[\mathcal{K}], \lambda) = (-1)^n F(\mathbf{k}[\mathcal{K}], \frac{1}{\lambda}).$$

PROOF. We apply Proposition A.2.1 to the minimal resolution of the  $\mathbf{k}[m]$ -module  $\mathbf{k}[\mathcal{K}]$ . Note that  $F(\mathbf{k}[m]; \lambda) = (1 - \lambda^2)^{-m}$ . It follows from the formula for the Poincaré series from Proposition A.2.1 and Proposition A.2.6 that

$$F(\mathbf{k}[\mathcal{K}]; \lambda) = (1 - \lambda^2)^{-m} \sum_{i=0}^{m-n} (-1)^i F(\mathrm{Tor}_{\mathbf{k}[m]}^{-i}(\mathbf{k}[\mathcal{K}], \mathbf{k}); \lambda).$$

Using Corollary 3.4.5, we calculate

$$\begin{aligned} F(\mathbf{k}[\mathcal{K}]; \lambda) &= (1 - \lambda^2)^{-m} \sum_{i=0}^{m-n} (-1)^i \lambda^{2m} F(\mathrm{Tor}_{\mathbf{k}[m]}^{-(m-n)+i}(\mathbf{k}[\mathcal{K}], \mathbf{k}); \frac{1}{\lambda}) = \\ &= (1 - (\frac{1}{\lambda})^2)^{-m} (-1)^m \sum_{j=0}^{m-n} (-1)^{m-n-j} F(\mathrm{Tor}_{\mathbf{k}[m]}^{-j}(\mathbf{k}[\mathcal{K}], \mathbf{k}); \frac{1}{\lambda}) = \\ &= (-1)^n F(\mathbf{k}[\mathcal{K}]; \frac{1}{\lambda}). \quad \square \end{aligned}$$

COROLLARY 3.4.7. *The Dehn–Sommerville relations  $h_i = h_{n-i}$  hold for any Gorenstein\* complex of dimension  $n - 1$  (in particular, for any triangulation of an  $(n - 1)$ -sphere).*

PROOF. This follows from the explicit form of the Poincaré series for  $\mathbf{k}[\mathcal{K}]$  (Theorem 3.1.10) and the previous corollary.  $\square$

The Dehn–Sommerville relations may be further generalised to wider classes of complexes and posets; we give some of these generalisations in Section 3.8 below.

Unlike the situation with Cohen–Macaulay complexes, a characterisation of  $h$ -vectors (or, equivalently,  $f$ -vectors) of Gorenstein complexes is not known:

PROBLEM 3.4.8 (Stanley). Characterise the  $h$ -vectors of Gorenstein complexes.

If the  $g$ -conjecture (i.e. the inequalities of Theorem 1.4.14 (b) and (c)) holds for Gorenstein complexes, then this would imply a solution to the above problem.

**Exercises.**

3.4.9. A Gorenstein complex  $\mathcal{K}$  is Gorenstein\* if and only if it is *non-acyclic* (i.e.  $\tilde{H}^*(\mathcal{K}; \mathbf{k}) \neq 0$ ).

3.4.10 ([293, Theorem II.5.1]). Show that  $\mathcal{K}$  is Gorenstein\* if and only if the following three conditions are satisfied:

- (a)  $\mathcal{K}$  is Cohen–Macaulay;
- (b) every  $(n - 2)$ -dimensional simplex is contained in exactly two  $(n - 1)$ -dimensional simplices;
- (c)  $\chi(\mathcal{K}) = \chi(S^{n-1})$ , where  $\chi(\cdot)$  denotes the Euler characteristic.

3.4.11. Let  $\mathcal{K}$  be a Gorenstein\* complex of dimension  $n - 1$  on  $[m]$ . Show that

$$\tilde{H}^k(\mathcal{K}_J) \cong \tilde{H}^{n-2-k}(\mathcal{K}_{\hat{J}})$$

for any  $J \subset [m]$ , where  $\hat{J} = [m] \setminus J$ . This is known as *Alexander duality for non-acyclic Gorenstein complexes*.

**3.5. Face rings of simplicial posets**

The whole theory of face rings may be extended to simplicial posets (defined in Section 2.8), thereby leading to new important classes of rings in combinatorial commutative algebra and applications in toric topology.

The *face ring*  $\mathbf{k}[\mathcal{S}]$  of a simplicial poset  $\mathcal{S}$  was introduced by Stanley [292] as a quotient of a certain graded polynomial ring by a homogeneous ideal determined by the poset relation in  $\mathcal{S}$ . The rings  $\mathbf{k}[\mathcal{S}]$  have remarkable algebraic and homological properties, albeit they are much more complicated than the Stanley–Reisner face rings  $\mathbf{k}[\mathcal{K}]$ . Unlike  $\mathbf{k}[\mathcal{K}]$ , the ring  $\mathbf{k}[\mathcal{S}]$  is not generated in the lowest positive degree. Face rings of simplicial posets were further studied by Duval [101] and Maeda–Masuda–Panov [209], [204], among others. *Cohen–Macaulay* and *Gorenstein\** face rings are particularly important; both properties are topological, that is, depend only on the topological type of the geometric realisation  $|\mathcal{S}|$ .

As usual, we shall not distinguish between simplicial posets  $\mathcal{S}$  and their geometric realisations (simplicial cell complexes)  $|\mathcal{S}|$ . Given two elements  $\sigma, \tau \in \mathcal{S}$ , we denote by  $\sigma \vee \tau$  the set of their joins, and denote by  $\sigma \wedge \tau$  the set of their meets. Whenever either of these sets consists of a single element, we use the same notation for this particular element of  $\mathcal{S}$ .

To make clear the idea behind the definition of the face ring of a simplicial poset, we first consider the case when  $\mathcal{S}$  is a simplicial complex  $\mathcal{K}$ . Then  $\sigma \wedge \tau$  consists of a single element (possibly  $\emptyset$ ), and  $\sigma \vee \tau$  is either empty or consists of a single element. We consider the graded polynomial ring  $\mathbf{k}[v_\sigma : \sigma \in \mathcal{K}]$  with one generator  $v_\sigma$  of degree  $\deg v_\sigma = 2|\sigma|$  for each simplex  $\sigma \in \mathcal{K}$ . The following proposition provides an alternative presentation of the face ring  $\mathbf{k}[\mathcal{K}]$ , with a larger set of generators:

PROPOSITION 3.5.1. *There is a canonical isomorphism of graded rings*

$$\mathbf{k}[\mathcal{K}] \cong \mathbf{k}[v_\sigma : \sigma \in \mathcal{K}] / \mathcal{I}'_{\mathcal{K}},$$

where  $\mathcal{I}'_{\mathcal{K}}$  is the ideal generated by the element  $v_\emptyset - 1$  and all elements of the form

$$v_\sigma v_\tau - v_{\sigma \wedge \tau} v_{\sigma \vee \tau}.$$

Here we set  $v_{\sigma \vee \tau} = 0$  whenever  $\sigma \vee \tau$  is empty.

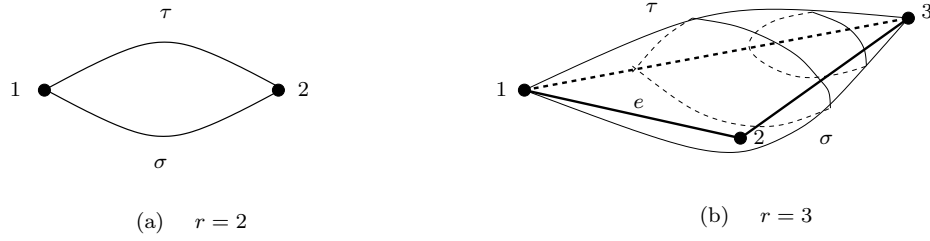

FIGURE 3.3. Simplicial cell complexes.

PROOF. The isomorphism is established by the map taking  $v_\sigma$  to  $\prod_{i \in \sigma} v_i$ . The rest is left as an exercise.  $\square$

Now let  $\mathcal{S}$  be an arbitrary simplicial poset with the vertex set  $V(\mathcal{S}) = [m]$ . In this case both  $\sigma \vee \tau$  and  $\sigma \wedge \tau$  may consist of more than one element, but  $\sigma \wedge \tau$  consists of a single element whenever  $\sigma \vee \tau$  is nonempty.

We consider the graded polynomial ring  $\mathbf{k}[v_\sigma : \sigma \in \mathcal{S}]$  with one generator  $v_\sigma$  of degree  $\deg v_\sigma = 2|\sigma|$  for every element  $\sigma \in \mathcal{S}$ .

DEFINITION 3.5.2 ([292]). The *face ring* of a simplicial poset  $\mathcal{S}$  is the quotient

$$\mathbf{k}[\mathcal{S}] = \mathbf{k}[v_\sigma : \sigma \in \mathcal{S}] / \mathcal{I}_{\mathcal{S}},$$

where  $\mathcal{I}_{\mathcal{S}}$  is the ideal generated by the elements  $v_{\hat{0}} - 1$  and

$$(3.14) \quad v_\sigma v_\tau - v_{\sigma \wedge \tau} \cdot \sum_{\eta \in \sigma \vee \tau} v_\eta.$$

The sum over the empty set is zero, so we have  $v_\sigma v_\tau = 0$  in  $\mathbf{k}[\mathcal{S}]$  if  $\sigma \vee \tau$  is empty.

The grading may be refined to an  $\mathbb{N}^m$ -grading by setting  $m\deg v_\sigma = 2V(\sigma)$ . Here  $V(\sigma) \subset [m]$  is the vertex set of  $\sigma$ , and we identify subsets of  $[m]$  with  $\{0, 1\}$ -vectors in  $\{0, 1\}^m \subset \mathbb{N}^m$  as usual. In particular,  $m\deg v_i = 2\mathbf{e}_i$ .

EXAMPLE 3.5.3.

1. The simplicial cell complex shown in Fig. 3.3 (a) is obtained by gluing two segments along their boundaries and has rank 2. The vertices are 1, 2 and we denote the 1-dimensional simplices by  $\sigma$  and  $\tau$ . Then the face ring  $\mathbf{k}[\mathcal{S}]$  is the quotient of the graded polynomial ring

$$\mathbf{k}[v_1, v_2, v_\sigma, v_\tau], \quad \deg v_1 = \deg v_2 = 2, \quad \deg v_\sigma = \deg v_\tau = 4$$

by the two relations

$$v_1 v_2 = v_\sigma + v_\tau, \quad v_\sigma v_\tau = 0.$$

2. The simplicial cell complex in Fig. 3.3 (b) is obtained by gluing two triangles along their boundaries and has rank 3. The vertices are 1, 2, 3 and we denote the 1-dimensional simplices (edges) by  $e$ ,  $f$  and  $g$ , and the 2-dimensional simplices by  $\sigma$  and  $\tau$ . The face ring  $\mathbf{k}[\mathcal{S}]$  is isomorphic to the quotient of the polynomial ring

$$\mathbf{k}[v_1, v_2, v_3, v_\sigma, v_\tau], \quad \deg v_1 = \deg v_2 = \deg v_3 = 2, \quad \deg v_\sigma = \deg v_\tau = 6$$

by the two relations

$$v_1 v_2 v_3 = v_\sigma + v_\tau, \quad v_\sigma v_\tau = 0.$$

The generators corresponding to the edges can be excluded because of the relations  $v_e = v_1 v_2$ ,  $v_f = v_2 v_3$  and  $v_g = v_1 v_3$ .

REMARK. The ideal  $\mathcal{I}_{\mathcal{S}}$  is generated by *straightening relations* (3.14); these relations allow us to express the product of any pair of generators via products of generators corresponding to pairs of ordered elements of the poset. This can be restated by saying that  $\mathbf{k}[\mathcal{S}]$  is an example of an *algebra with straightening law* (ASL for short, also known as a *Hodge algebra*). Lemma 3.5.4 and Theorem 3.5.7 below reflect algebraic properties of ASL's, and may be restated in this generality. For more on the theory of ASL's see [293, § III.6] and [45, Chapter 7].

A monomial  $v_{\sigma_1}^{i_1} v_{\sigma_2}^{i_2} \cdots v_{\sigma_k}^{i_k} \in \mathbf{k}[v_{\sigma} : \sigma \in \mathcal{S}]$  is *standard* if  $\sigma_1 < \sigma_2 < \cdots < \sigma_k$ .

LEMMA 3.5.4. *Any element of  $\mathbf{k}[\mathcal{S}]$  can be written as a linear combination of standard monomials.*

PROOF. It is enough to prove the statement for elements of  $\mathbf{k}[\mathcal{S}]$  represented by monomials in generators  $v_{\sigma}$ . We write such a monomial as  $a = v_{\tau_1} v_{\tau_2} \cdots v_{\tau_k}$  where some of the  $\tau_i$  may coincide. We need to show that any such monomial can be expressed as a sum of monomials  $\sum v_{\sigma_1} \cdots v_{\sigma_l}$  with  $\sigma_1 \leq \cdots \leq \sigma_l$ . We may assume by induction that  $\tau_2 \leq \cdots \leq \tau_k$ . Using relation (3.14) we can replace  $a$  by

$$v_{\tau_1 \wedge \tau_2} \left( \sum_{\rho \in \tau_1 \vee \tau_2} v_{\rho} \right) v_{\tau_3} \cdots v_{\tau_k}.$$

Now the first two factors in each summand above correspond to ordered elements of  $\mathcal{S}$ . We proceed by replacing the products  $v_{\rho} v_{\tau_3}$  by  $v_{\rho \wedge \tau_3} (\sum_{\pi \in \rho \vee \tau_3} v_{\pi})$ . Since  $\tau_1 \wedge \tau_2 \leq \rho \wedge \tau_3$ , now the first three factors in each monomial are in order. Continuing this process, we obtain in the end a sum of monomials corresponding to totally ordered sets of elements of  $\mathcal{S}$ .  $\square$

We refer to the presentation from Lemma 3.5.4 as a *standard representation* of an element  $a \in \mathbf{k}[\mathcal{S}]$ .

Given  $\sigma \in \mathcal{S}$ , we define the corresponding *restriction homomorphism* as

$$s_{\sigma} : \mathbf{k}[\mathcal{S}] \rightarrow \mathbf{k}[\mathcal{S}] / (v_{\tau} : \tau \not\leq \sigma).$$

The following result is straightforward.

PROPOSITION 3.5.5. *Let  $|\sigma| = k$  with  $V(\sigma) = \{i_1, \dots, i_k\}$ . Then the image of the homomorphism  $s_{\sigma}$  is the polynomial ring  $\mathbf{k}[v_{i_1}, \dots, v_{i_k}]$ .*

The next result generalises Proposition 3.1.8 to simplicial posets.

THEOREM 3.5.6. *The direct sum*

$$s = \bigoplus_{\sigma \in \mathcal{S}} s_{\sigma} : \mathbf{k}[\mathcal{S}] \longrightarrow \bigoplus_{\sigma \in \mathcal{S}} \mathbf{k}[v_i : i \in V(\sigma)]$$

*of all restriction maps is a monomorphism.*

PROOF. Take a nonzero element  $a \in \mathbf{k}[\mathcal{S}]$  and write its standard representation. Fix a standard monomial  $v_{\sigma_1}^{i_1} \cdots v_{\sigma_k}^{i_k}$  which enters into this decomposition with a nonzero coefficient. Allowing some of the exponents  $i_j$  to be zero, we may assume that  $\sigma_k$  is a maximal element in  $\mathcal{S}$  and  $|\sigma_j| = j$  for  $1 \leq j \leq k$ . We shall prove that  $s_{\sigma_k}(a) \neq 0$ . Identify  $s_{\sigma_k}(\mathbf{k}[\mathcal{S}])$  with the polynomial ring  $\mathbf{k}[t_1, \dots, t_k]$  (so that  $t_j = v_{i_j}$  in the notation of Proposition 3.5.5). Then  $s_{\sigma_k}(v_{\sigma_k}) = t_1 \cdots t_k$ , and we may assume without loss of generality that  $s_{\sigma_k}(v_{\sigma_j}) = t_1 \cdots t_j$  for  $1 \leq j \leq k$ . Hence,

$$s_{\sigma_k}(v_{\sigma_1}^{i_1} \cdots v_{\sigma_k}^{i_k}) = t_1^{i_1} (t_1 t_2)^{i_2} \cdots (t_1 \cdots t_k)^{i_k}.$$

If we prove that no other monomial  $v_{\tau_1}^{j_1} \cdots v_{\tau_m}^{j_m}$  is mapped by  $s_{\sigma_k}$  to the same element of  $\mathbf{k}[t_1, \dots, t_k]$ , then this would imply that  $s_{\sigma_k}(a) \neq 0$ . Note that

$$s_{\sigma_k}(v_{\tau_1}^{j_1} \cdots v_{\tau_m}^{j_m}) = 0 \quad \text{if } \tau_i \not\leq \sigma_k \text{ for some } i \text{ with } j_i \neq 0,$$

so that we may assume that  $m = k$ . Now suppose that

$$(3.15) \quad s_{\sigma_k}(v_{\sigma_1}^{i_1} \cdots v_{\sigma_k}^{i_k}) = s_{\sigma_k}(v_{\tau_1}^{j_1} \cdots v_{\tau_k}^{j_k}).$$

We shall prove that  $v_{\sigma_1}^{i_1} \cdots v_{\sigma_k}^{i_k} = v_{\tau_1}^{j_1} \cdots v_{\tau_k}^{j_k}$ . We may assume by induction that the ‘tails’ of these monomial coincide, that is, there is some  $q$ ,  $1 \leq q \leq k$ , such that  $i_p = j_p$  and  $\sigma_p = \tau_p$  for  $i_p \neq 0$  whenever  $p > q$ . We shall prove that  $i_q = j_q$  and  $\sigma_q = \tau_q$  if  $i_q \neq 0$ . We obtain from (3.15) that

$$\begin{aligned} s_{\sigma_k}(v_{\sigma_1}^{i_1} \cdots v_{\sigma_q}^{i_q})(t_1 \cdots t_{q+1})^{i_{q+1}} \cdots (t_1 \cdots t_k)^{i_k} &= \\ &= s_{\sigma_k}(v_{\tau_1}^{j_1} \cdots v_{\tau_q}^{j_q})(t_1 \cdots t_{q+1})^{j_{q+1}} \cdots (t_1 \cdots t_k)^{j_k}, \end{aligned}$$

hence,  $s_{\sigma_k}(v_{\sigma_1}^{i_1} \cdots v_{\sigma_q}^{i_q}) = s_{\sigma_k}(v_{\tau_1}^{j_1} \cdots v_{\tau_q}^{j_q})$ . Let  $j_l$  be the last nonzero exponent in  $v_{\tau_1}^{j_1} \cdots v_{\tau_q}^{j_q}$  (i.e.  $j_{l+1} = \cdots = j_q = 0$ ). Then we also have  $i_{l+1} = \cdots = i_q = 0$ , as otherwise  $s_{\sigma_k}(v_{\sigma_1}^{i_1} \cdots v_{\sigma_q}^{i_q})$  is divisible by  $t_1 \cdots t_{l+1}$ , while  $s_{\sigma_k}(v_{\tau_1}^{j_1} \cdots v_{\tau_q}^{j_q})$  is not. We also have  $i_l = j_l$  and  $\sigma_l = \tau_l$ , since  $i_l$  is the maximal power of the monomial  $t_1 \cdots t_l$  which divides  $s_{\sigma_k}(v_{\sigma_1}^{i_1} \cdots v_{\sigma_q}^{i_q})$ . We conclude by induction that  $v_{\sigma_1}^{i_1} \cdots v_{\sigma_k}^{i_k} = v_{\tau_1}^{j_1} \cdots v_{\tau_k}^{j_k}$ , and  $s_{\sigma_k}(a) \neq 0$ .  $\square$

REMARK. The proof above also shows that the map  $s = \bigoplus_{\sigma} s_{\sigma}$  in Theorem 3.5.6 can be defined as the sum over only the maximal elements  $\sigma \in \mathcal{S}$ .

THEOREM 3.5.7. *The standard representation of an element  $a \in \mathbf{k}[\mathcal{S}]$  is unique. In other words, the standard monomials  $v_{\sigma_1}^{i_1} \cdots v_{\sigma_k}^{i_k}$  form a  $\mathbf{k}$ -basis of  $\mathbf{k}[\mathcal{S}]$ .*

PROOF. This follows directly from Lemma 3.5.4 and Theorem 3.5.6.  $\square$

Lemma 3.3.1, which describes  $\text{hsop}$ ’s in the face rings of simplicial complexes, can be readily extended to simplicial posets (the same proof based on the properties of the restriction map  $s$  works):

LEMMA 3.5.8. *Let  $\mathcal{S}$  be a simplicial poset of rank  $n$ . A sequence of homogeneous elements  $\mathbf{t} = (t_1, \dots, t_n)$  of  $\mathbf{k}[\mathcal{S}]$  is a homogeneous system of parameters if and only*

$$\dim_{\mathbf{k}}(\mathbf{k}[v_i : i \in V(\sigma)]/s_{\sigma}(\mathbf{t})) < \infty$$

for each element  $\sigma \in \mathcal{S}$ .

The  $f$ -vector of a simplicial poset  $\mathcal{S}$  is  $\mathbf{f}(\mathcal{S}) = (f_0, \dots, f_{n-1})$ , where  $n - 1 = \dim \mathcal{S}$  and  $f_i$  is the number of elements of rank  $i + 1$  (i.e. the number of faces of dimension  $i$  in the simplicial cell complex). We also set  $f_{-1} = 1$ . The  $h$ -vector  $\mathbf{h}(\mathcal{S}) = (h_0, \dots, h_n)$  is then defined by (2.3).

The Poincaré series of the face ring  $\mathbf{k}[\mathcal{S}]$  has exactly the same form as in the case of simplicial complexes:

THEOREM 3.5.9. *We have*

$$F(\mathbf{k}[\mathcal{S}]; \lambda) = \sum_{k=0}^n \frac{f_{k-1} \lambda^{2k}}{(1 - \lambda^2)^k} = \frac{h_0 + h_1 \lambda^2 + \cdots + h_n \lambda^{2n}}{(1 - \lambda^2)^n}.$$

PROOF. By Theorem 3.5.7, we need to calculate the Poincaré series of the  $\mathbf{k}$ -vector space generated by the monomials  $v_{\sigma_1}^{i_1} \cdots v_{\sigma_k}^{i_k}$  with  $\sigma_1 < \cdots < \sigma_k$ . For every  $\sigma \in \mathcal{S}$  denote by  $\mathcal{M}_\sigma$  the set of such monomials with  $\sigma_k = \sigma$  and  $i_k > 0$ . Let  $|\sigma| = k$ ; consider the restriction homomorphism  $s_\sigma$  to the polynomial ring  $\mathbf{k}[t_1, \dots, t_k]$ . Then  $s_\sigma(\mathcal{M}_\sigma)$  is the set of monomials in  $\mathbf{k}[t_1, \dots, t_k]$  which are divisible by  $t_1 \cdots t_k$ . Therefore, the Poincaré series of the subspace generated by the set  $\mathcal{M}_\sigma$  is  $\frac{\lambda^{2k}}{(1-\lambda^2)^k}$ . Now, to finish the proof of the first identity we note that  $\mathcal{S}$  is the union  $\bigcup_{\sigma \in \mathcal{S}} \mathcal{M}_\sigma$  of the nonintersecting subsets  $\mathcal{M}_\sigma$ . The second identity follows from (2.3).  $\square$

As we have seen in Exercise 3.1.15, the face ring  $\mathbf{k}[\mathcal{K}]$  of a simplicial complex can be realised as the limit of a diagram of polynomial algebras over  $\text{CAT}^{op}(\mathcal{K})$ . A similar description exists for the face ring  $\mathbf{k}[\mathcal{S}]$ :

CONSTRUCTION 3.5.10 ( $\mathbf{k}[\mathcal{S}]$  as a limit). We consider the diagram  $\mathbf{k}[\cdot]^\mathcal{S}$  similar to that of Exercise 3.1.15:

$$\begin{aligned} \mathbf{k}[\cdot]^\mathcal{S}: \text{CAT}^{op}(\mathcal{S}) &\longrightarrow \text{CGA}, \\ \sigma &\longmapsto \mathbf{k}[v_i: i \in V(\sigma)], \end{aligned}$$

whose value on a morphism  $\sigma \leq \tau$  is the surjection

$$\mathbf{k}[v_i: i \in V(\tau)] \rightarrow \mathbf{k}[v_i: i \in V(\sigma)]$$

sending each  $v_i$  with  $i \notin V(\sigma)$  to zero.

LEMMA 3.5.11. *We have*

$$\mathbf{k}[\mathcal{S}] = \lim \mathbf{k}[\cdot]^\mathcal{S}$$

where the limit is taken in the category CGA.

PROOF. We set up a total order on the elements of  $\mathcal{S}$  so that the rank function does not decrease, and proceed by induction. We therefore may assume the statement is proved for a simplicial poset  $\mathcal{T}$ , and need to prove it for  $\mathcal{S}$  which is obtained from  $\mathcal{T}$  by adding one element  $\sigma$ . Then  $\mathcal{S}_{<\sigma} = \{\tau \in \mathcal{S}: \tau < \sigma\}$  is the face poset of the boundary of the simplex  $\Delta^\sigma$ . Geometrically, we may think of  $|\mathcal{S}|$  as obtained from  $|\mathcal{T}|$  by attaching one simplex  $\Delta^\sigma$  along its boundary (if  $|\sigma| = 1$ , then  $\Delta^\sigma$  is a single point, so  $|\mathcal{S}|$  is a disjoint union of  $|\mathcal{T}|$  and a point). We therefore need to prove that the following is a pullback diagram:

$$(3.16) \quad \begin{array}{ccc} \mathbf{k}[\mathcal{S}] & \longrightarrow & \mathbf{k}[\mathcal{S}_{\leq \sigma}] \\ \downarrow & & \downarrow \\ \mathbf{k}[\mathcal{T}] & \longrightarrow & \mathbf{k}[\mathcal{S}_{< \sigma}]. \end{array}$$

Here the vertical arrows map  $v_\sigma$  to 0, while the horizontal ones map  $v_\tau$  to 0 for  $\tau \not\leq \sigma$ . Denote by  $A$  the pullback of (3.16) with  $\mathbf{k}[\mathcal{S}]$  dropped. We need to show that the natural map  $\mathbf{k}[\mathcal{S}] \rightarrow A$  is an isomorphism.

Since the limits in CGA are created in the underlying category of graded  $\mathbf{k}$ -vector spaces, the space of  $A$  is the direct sum of  $\mathbf{k}[\mathcal{T}]$  and  $\mathbf{k}[\mathcal{S}_{\leq \sigma}]$  with the pieces  $\mathbf{k}[\mathcal{S}_{< \sigma}]$  identified in both spaces. In other words,

$$(3.17) \quad A = T \oplus \mathbf{k}[\mathcal{S}_{< \sigma}] \oplus S,$$

where  $T$  is the complement to  $\mathbf{k}[\mathcal{S}_{< \sigma}]$  in  $\mathbf{k}[\mathcal{T}]$ , and  $S$  is the complement to  $\mathbf{k}[\mathcal{S}_{< \sigma}]$  in  $\mathbf{k}[\mathcal{S}_{\leq \sigma}]$ . By Theorem 3.5.7, the space  $\mathbf{k}[\mathcal{S}_{< \sigma}]$  has basis of standard monomials



$v_{\tau_1}^{j_1} v_{\tau_2}^{j_2} \cdots v_{\tau_k}^{j_k}$  with  $\tau_k < \sigma$ . Similarly,  $S$  has basis of those monomials with  $\tau_k = \sigma$  and  $j_k > 0$ , while  $T$  has basis of those monomials with  $\tau_k \not\leq \sigma$  and  $j_k > 0$ . Yet another application of Theorem 3.5.7 gives a decomposition of  $\mathbf{k}[\mathcal{S}]$  identical to (3.17): a standard basis monomial  $v_{\tau_1}^{j_1} v_{\tau_2}^{j_2} \cdots v_{\tau_k}^{j_k}$  with  $j_k > 0$  has either  $\tau_k \not\leq \sigma$ , or  $\tau_k < \sigma$ , or  $\tau_k = \sigma$ . These three possibilities map to  $T$ ,  $\mathbf{k}[\mathcal{S}_{<\sigma}]$  and  $S$  respectively. It follows that  $\mathbf{k}[\mathcal{S}] \rightarrow A$  is an isomorphism of  $\mathbf{k}$ -vector spaces. Since it is an algebra map, it is also an isomorphism of algebras, thus finishing the proof.  $\square$

The description of  $\mathbf{k}[\mathcal{S}]$  as a limit has the following important corollary, describing the functorial properties of the face rings and generalising Proposition 3.1.5.

**PROPOSITION 3.5.12.** *Let  $f: \mathcal{S} \rightarrow \mathcal{T}$  be a rank-preserving map of simplicial posets. Define a homomorphism*

$$f^*: \mathbf{k}[w_\tau: \tau \in \mathcal{T}] \rightarrow \mathbf{k}[v_\sigma: \sigma \in \mathcal{S}], \quad f^*(w_\tau) = \sum_{\sigma \in f^{-1}(\tau), |\sigma|=|\tau|} v_\sigma.$$

*Then  $f^*$  descends to a ring homomorphism  $\mathbf{k}[\mathcal{T}] \rightarrow \mathbf{k}[\mathcal{S}]$ , which we continue to denote by  $f^*$ .*

**PROOF.** The poset map  $f$  gives rise to a functor  $f: \text{CAT}^{op}(\mathcal{S}) \rightarrow \text{CAT}^{op}(\mathcal{T})$  and therefore to a natural transformation

$$f^*: [\text{CAT}^{op}(\mathcal{T}), \text{CGA}] \rightarrow [\text{CAT}^{op}(\mathcal{S}), \text{CGA}],$$

where  $[\text{CAT}^{op}(\mathcal{S}), \text{CGA}]$  denotes the functors from  $\text{CAT}^{op}(\mathcal{S})$  to  $\text{CGA}$ . It is easy to see that  $f^* \mathbf{k}[\cdot]_{\mathcal{T}} = \mathbf{k}[\cdot]_{\mathcal{S}}$  in the notation of Construction 3.5.10, so we have the induced map of limits  $f^*: \mathbf{k}[\mathcal{T}] \rightarrow \mathbf{k}[\mathcal{S}]$ . We also have that  $f^*(w_\tau) = \sum_{\sigma \in f^{-1}(\tau)} v_\sigma$  by the construction of  $\text{lim}$  in  $\text{CGA}$ .  $\square$

**EXAMPLE 3.5.13.** The folding map (2.9) induces a monomorphism  $\mathbf{k}[\mathcal{K}_{\mathcal{S}}] \rightarrow \mathbf{k}[\mathcal{S}]$ , which embeds  $\mathbf{k}[\mathcal{K}_{\mathcal{S}}]$  in  $\mathbf{k}[\mathcal{S}]$  as the subring generated by the elements  $v_i$ .

**REMARK.** An attempt to prove Proposition 3.5.12 directly from the definition, by showing that  $f^*(\mathcal{I}_{\mathcal{T}}) \subset \mathcal{I}_{\mathcal{S}}$ , runs into a complicated combinatorial analysis of the poset structure. This is an example of a situation where the use of an abstract categorical description of  $\mathbf{k}[\mathcal{S}]$  proves to be beneficial.

Let  $\mathbf{k}[m] = \mathbf{k}[v_1, \dots, v_m]$  be the polynomial algebra on  $m$  generators of degree 2 corresponding to the vertices of  $\mathcal{S}$ . The face ring  $\mathbf{k}[\mathcal{S}]$  acquires a  $\mathbf{k}[m]$ -algebra structure via the map  $\mathbf{k}[m] \rightarrow \mathbf{k}[\mathcal{S}]$  sending each  $v_i$  identically. (Unlike the case of simplicial complexes, this map is generally not surjective.) We thereby obtain a  $\mathbb{Z} \oplus \mathbb{N}^m$ -graded Tor-algebra of  $\mathbf{k}[\mathcal{S}]$ :

$$\text{Tor}_{\mathbf{k}[v_1, \dots, v_m]}(\mathbf{k}[\mathcal{S}], \mathbf{k}) = \bigoplus_{i \geq 0, \mathbf{a} \in \mathbb{N}^m} \text{Tor}_{\mathbf{k}[v_1, \dots, v_m]}^{-i, 2\mathbf{a}}(\mathbf{k}[\mathcal{S}], \mathbf{k}),$$

by analogy with Construction 3.2.8 for simplicial complexes.

We finish this section by stating a generalisation of Hochster's theorem to simplicial posets, and deriving some of its corollaries.

**THEOREM 3.5.14** (Duval [101], see also [199]). *For any subset  $J \subset [m]$  we have*

$$\text{Tor}_{\mathbf{k}[v_1, \dots, v_m]}^{-i, 2J}(\mathbf{k}[\mathcal{S}], \mathbf{k}) \cong \widetilde{H}^{|J|-i-1}(|\mathcal{S}_J|; \mathbf{k}),$$

*where  $\mathcal{S}_J$  the subposet of  $\mathcal{S}$  consisting of those  $\sigma$  for which  $V(\sigma) \subset J$ . Also,  $\text{Tor}_{\mathbf{k}[m]}^{-i, 2\mathbf{a}}(\mathbf{k}[\mathcal{S}], \mathbf{k}) = 0$  if  $\mathbf{a}$  is not a  $(0, 1)$ -vector.*

PROOF. The argument follows the lines of the proof of Theorem 3.2.9. We define the quotient differential graded algebra

$$R^*(\mathcal{S}) = \Lambda[u_1, \dots, u_m] \otimes \mathbf{k}[\mathcal{S}] / \mathcal{I}_R$$

where  $\mathcal{I}_R$  is the ideal generated by the elements

$$u_i v_\sigma \quad \text{with } i \in V(\sigma), \quad \text{and} \quad v_\sigma v_\tau \quad \text{with } \sigma \wedge \tau \neq \hat{0}.$$

Note that the latter condition is equivalent to  $V(\sigma) \cap V(\tau) \neq \emptyset$ .

Then we need to prove the analogue of Lemma 3.2.6, that is, to show that the quotient projection

$$\varrho: \Lambda[u_1, \dots, u_m] \otimes \mathbf{k}[\mathcal{S}] \rightarrow R^*(\mathcal{S})$$

induces an isomorphism in cohomology. This can be done by providing the appropriate chain homotopy, as in the proof of Lemma 3.2.6, but the formulae will be more complicated. Alternatively, we can use a topological argument, see the proof of Theorem 4.10.6 below.

Let  $\mathcal{C}^{p-1}(|\mathcal{S}_J|)$  denote the  $(p-1)$ th cellular cochain group of  $|\mathcal{S}_J|$  with coefficients in  $\mathbf{k}$ . It has a basis of cochains  $\alpha_\sigma$  corresponding to elements  $\sigma \in \mathcal{S}_J$  with  $|\sigma| = p$ . We define a  $\mathbf{k}$ -linear map

$$f: \mathcal{C}^{p-1}(|\mathcal{S}_J|) \longrightarrow R^{p-|J|, 2J}(\mathcal{S}), \quad \alpha_\sigma \longmapsto \varepsilon(V(\sigma), J) u_{J \setminus V(\sigma)} v_\sigma,$$

where  $\varepsilon(V(\sigma), J)$  is the sign from the proof of Theorem 3.2.9. This map is an isomorphism of cochain complexes; the details are left to the reader. Therefore,

$$\tilde{H}^{p-1}(|\mathcal{S}_J|) \cong \mathrm{Tor}_{\mathbf{k}[v_1, \dots, v_m]}^{p-|J|, 2J}(\mathbf{k}[\mathcal{S}], \mathbf{k}),$$

which is equivalent to the first required isomorphism. Since  $R^{-i, 2\mathbf{a}}(\mathcal{S}) = 0$  if  $\mathbf{a}$  is not a  $(0, 1)$ -vector,  $\mathrm{Tor}_{\mathbf{k}[m]}^{-i, 2\mathbf{a}}(\mathbf{k}[\mathcal{K}], \mathbf{k})$  vanishes for such  $\mathbf{a}$ .  $\square$

We define the *multigraded algebraic Betti numbers* of  $\mathbf{k}[\mathcal{S}]$  as

$$\beta^{-i, 2\mathbf{a}}(\mathbf{k}[\mathcal{S}]) = \dim_{\mathbf{k}} \mathrm{Tor}_{\mathbf{k}[v_1, \dots, v_m]}^{-i, 2\mathbf{a}}(\mathbf{k}[\mathcal{S}], \mathbf{k}),$$

for  $0 \leq i \leq m$ ,  $\mathbf{a} \in \mathbb{N}^m$ . We also set

$$\beta^{-i}(\mathbf{k}[\mathcal{S}]) = \dim_{\mathbf{k}} \mathrm{Tor}_{\mathbf{k}[v_1, \dots, v_m]}^{-i}(\mathbf{k}[\mathcal{S}], \mathbf{k}) = \sum_{\mathbf{a} \in \mathbb{N}^m} \beta^{-i, 2\mathbf{a}}(\mathbf{k}[\mathcal{S}]).$$

EXAMPLE 3.5.15. Let  $\mathcal{S}$  be the simplicial poset of Example 3.5.3.1. By Theorem 3.5.14,  $\beta^{0, (0,0)}(\mathbf{k}[\mathcal{S}]) = \beta^{0, (2,2)}(\mathbf{k}[\mathcal{S}]) = 1$ , and the other Betti numbers are zero. This implies that  $\mathbf{k}[\mathcal{S}]$  is a free  $\mathbf{k}[v_1, v_2]$ -module with two generators, 1 and  $v_\sigma$ , of degree 0 and 4 respectively.

Note that unlike the case of simplicial complexes,  $\beta^0(\mathbf{k}[\mathcal{S}])$  may be larger than 1. In fact, the following proposition follows easily from Theorem 3.5.14.

PROPOSITION 3.5.16. *The number of generators of  $\mathbf{k}[\mathcal{S}]$  as a  $\mathbf{k}[m]$ -module equals*

$$\beta^0(\mathbf{k}[\mathcal{S}]) = \sum_{J \subset [m]} \dim \tilde{H}^{|J|-1}(|\mathcal{S}_J|).$$

**Exercises.**

3.5.17. Finish the proof of Proposition 3.5.1.

3.5.18. Fill in the details in the proof of Theorem 3.5.14.

3.5.19. Calculate the multigraded Betti numbers for the simplicial poset of Example 3.5.3.2.



## Face rings: additional topics

### 3.6. Cohen–Macaulay simplicial posets

Assume given a property  $A$  of simplicial complexes. Then we can extend this property to posets by postulating that a poset  $\mathcal{P}$  has the property  $A$  if the order complex  $\text{ord}(\mathcal{P})$  (see Definition 2.3.6) has the property  $A$ . In particular, Cohen–Macaulay and Gorenstein posets can be defined in this way. Simplicial posets  $\mathcal{S}$  are of particular interest to us; in this case the order complex is identified with the barycentric subdivision  $\mathcal{S}'$  (to be precise, with the cone over the barycentric subdivision, as we include the empty simplex, but this difference is inessential for the definitions to follow).

**DEFINITION 3.6.1.** A simplicial poset  $\mathcal{S}$  is *Cohen–Macaulay* (over  $\mathbf{k}$ ) if its barycentric subdivision  $\mathcal{S}'$  is a Cohen–Macaulay simplicial complex.

By definition,  $\mathcal{S}$  is a Cohen–Macaulay simplicial poset if and only if the face ring  $\mathbf{k}[\mathcal{S}']$  is Cohen–Macaulay. Since the face ring is also defined for the face poset  $\mathcal{S}$  itself (and not only for its barycentric subdivision), it is perfectly natural to ask whether the class of Cohen–Macaulay simplicial posets admits an intrinsic description in terms of their face rings  $\mathbf{k}[\mathcal{S}]$ . One would achieve such a description by proving that the ring  $\mathbf{k}[\mathcal{S}']$  is Cohen–Macaulay if and only if the ring  $\mathbf{k}[\mathcal{S}]$  is Cohen–Macaulay. The ‘if’ part follows from the general theory of ASL’s, see [292, Corollary 3.7]. The ‘only if’ part was proved in [204]; the proof uses the decomposition of the barycentric subdivision into a sequence of stellar subdivisions and then goes on to show that the Cohen–Macaulay property is preserved under stellar subdivisions. We include this characterisation of Cohen–Macaulay simplicial posets in terms of their face rings in Theorem 3.6.7 below.

Since many of the constructions in this section are geometric, we often talk about simplicial cell complexes rather than simplicial posets. We say that a simplicial subdivision of a simplicial cell complex  $\mathcal{S}$  is *regular* if it is a simplicial complex. For instance, the barycentric subdivision is regular. Since the Cohen–Macaulayness of a simplicial complex is a topological property (see Proposition 3.3.11), we have the following statement.

**PROPOSITION 3.6.2.** *The following conditions are equivalent:*

- (a) *the barycentric subdivision of a simplicial cell complex  $\mathcal{S}$  is a Cohen–Macaulay complex;*
- (b) *any regular subdivision of  $\mathcal{S}$  is a Cohen–Macaulay complex;*
- (c) *a regular subdivision of  $\mathcal{S}$  is a Cohen–Macaulay complex.*

As a further corollary we obtain that Proposition 3.3.11 itself extends to simplicial cell complexes, i.e. the property of a simplicial cell complex to be Cohen–Macaulay is also topological.

By analogy with Definition 2.2.13, we define the *star* and the *link* of  $\sigma \in \mathcal{S}$  as the following subcomplexes:

$$\begin{aligned} \text{st}_{\mathcal{S}} \sigma &= \{\tau \in \mathcal{S} : \sigma \vee \tau \text{ is nonempty}\}; \\ \text{lk}_{\mathcal{S}} \sigma &= \{\tau \in \mathcal{S} : \sigma \vee \tau \text{ is nonempty, and } \tau \wedge \sigma = \hat{0}\}. \end{aligned}$$

REMARK. If  $\mathcal{S}$  is a simplicial complex, then the poset  $\text{lk}_{\mathcal{S}} \sigma$  is isomorphic to the open semi-interval

$$\mathcal{S}_{>\sigma} = \{\rho \in \mathcal{S} : \rho > \sigma\},$$

and  $|\text{st}_{\mathcal{S}} \sigma| \cong \Delta^{\sigma} * |\text{lk}_{\mathcal{S}} \sigma|$ , where  $*$  denotes the join. However, none of these isomorphisms holds for general  $\mathcal{S}$ , see Example 3.6.5 below.

Because of this remark, we cannot simply extend the definition of stellar subdivisions (Definition 2.7.1) to simplicial cell complexes. Instead, we define the *stellar subdivision*  $\text{ss}_{\sigma} \mathcal{S}$  of  $\mathcal{S}$  at  $\sigma$  as the simplicial cell complex obtained by stellarly subdividing each face containing  $\sigma$  in a compatible way.

PROPOSITION 3.6.3. *The barycentric subdivision  $\mathcal{S}'$  can be obtained as a sequence of stellar subdivisions, one at each face  $\sigma \in \mathcal{S}$ , starting from the maximal faces. Moreover, each stellar subdivision in the sequence is applied to a face whose star is a simplicial complex.*

PROOF. Assume  $\dim \mathcal{S} = n - 1$ . We start by applying to  $\mathcal{S}$  stellar subdivisions at all  $(n - 1)$ -dimensional faces. Denote the resulting complex by  $\mathcal{S}_1$ . The  $(n - 2)$ -faces of  $\mathcal{S}_1$  are of two types: the “old” ones, remaining from  $\mathcal{S}$ , and the “new” ones, appearing as the result of the stellar subdivisions. Then we take stellar subdivisions of  $\mathcal{S}_1$  at all “old”  $(n - 2)$ -faces, and denote the result by  $\mathcal{S}_2$ . Next we apply to  $\mathcal{S}_2$  stellar subdivisions at all  $(n - 3)$ -faces remaining from  $\mathcal{S}$ . Proceeding in this way, at the end we get  $\mathcal{S}_{n-1} = \mathcal{S}'$ . To prove the second statement, consider two subsequent complexes  $\mathcal{R}$  and  $\tilde{\mathcal{R}}$  in the sequence, so that  $\tilde{\mathcal{R}}$  is obtained from  $\mathcal{R}$  by a single stellar subdivision at some  $\sigma \in \mathcal{S}$ . Then  $\text{st}_{\mathcal{R}} \sigma$  is isomorphic to  $\Delta^{\sigma} * (\mathcal{S}_{>\sigma})'$  and therefore it is a simplicial complex.  $\square$

We proceed with two lemmata necessary to prove our main result.

LEMMA 3.6.4. *Let  $\mathcal{S}$  be a simplicial poset of rank  $n$  with vertex set  $V(\mathcal{S}) = [m]$ , and assume that the first  $k$  vertices span a face  $\sigma$ . Assume further that  $\text{st}_{\mathcal{S}} \sigma$  is a simplicial complex, and let  $\tilde{\mathcal{S}}$  be the stellar subdivision of  $\mathcal{S}$  at  $\sigma$ . Let  $v$  denote the degree-two generator of  $\mathbf{k}[\tilde{\mathcal{S}}]$  corresponding to the added vertex. Then there exists a unique homomorphism  $\beta : \mathbf{k}[\mathcal{S}] \rightarrow \mathbf{k}[\tilde{\mathcal{S}}]$  such that*

$$\begin{aligned} v_{\tau} &\mapsto v_{\tau} && \text{for } \tau \notin \text{st}_{\mathcal{S}} \sigma; \\ v_i &\mapsto v + v_i, && \text{for } i = 1, \dots, k; \\ v_i &\mapsto v_i, && \text{for } i = k + 1, \dots, m. \end{aligned}$$

Moreover,  $\beta$  is injective, and if  $\mathbf{t}$  is an hsop in  $\mathbf{k}[\mathcal{S}]$ , then  $\beta(\mathbf{t})$  is an hsop in  $\mathbf{k}[\tilde{\mathcal{S}}]$ .

PROOF. In order to define the map  $\beta$  we first need to specify the images of  $v_{\tau}$  for all  $\tau \in \text{st}_{\mathcal{S}} \sigma$ . Choose such a  $v_{\tau}$  and let  $V(\tau) = \{i_1, \dots, i_{\ell}\}$  be its vertex set. Then we have the following identity in the ring  $\mathbf{k}[\mathcal{S}] = \mathbf{k}[v_{\tau} : \tau \in \mathcal{S}]/\mathcal{I}_{\mathcal{S}}$ :

$$(3.18) \quad v_{i_1} \cdots v_{i_{\ell}} = v_{\tau} + \sum_{\eta: V(\eta)=V(\tau), \eta \neq \tau} v_{\eta}.$$

For any  $v_\eta$  in the latter sum we have  $\eta \notin \text{st}_S \sigma$ , since  $\text{st}_S \sigma$  is a simplicial complex, in which any set of vertices spans at most one face. Since  $\beta$  is already defined on the product on the left hand side and on the sum on the right hand side above, this determines  $\beta(v_\tau)$  uniquely.

We therefore obtain a map of polynomial algebras  $\mathbf{k}[v_\tau : \tau \in \mathcal{S}] \rightarrow \mathbf{k}[v_\tau : \tau \in \tilde{\mathcal{S}}]$  (which we denote by the same letter  $\beta$  for a moment), and need to check that it descends to a map of face rings,  $\mathbf{k}[\mathcal{S}] \rightarrow \mathbf{k}[\tilde{\mathcal{S}}]$ . In other words, we need to verify that  $\beta(\mathcal{I}_S) \subset \mathcal{I}_{\tilde{\mathcal{S}}}$ .

It is clear from the definition of  $\beta$  that we have the commutative diagram

$$\begin{array}{ccccc} \mathbf{k}[v_\tau : \tau \in \mathcal{S}] & \xrightarrow{p} & \mathbf{k}[\mathcal{S}] & \xrightarrow{s} & \bigoplus_{\tau \in \mathcal{S}} \mathbf{k}[v_i : i \in V(\tau)] \\ \downarrow \beta & & \downarrow \beta & & \downarrow s(\beta) \\ \mathbf{k}[v_\tau : \tau \in \tilde{\mathcal{S}}] & \xrightarrow{\tilde{p}} & \mathbf{k}[\tilde{\mathcal{S}}] & \xrightarrow{\tilde{s}} & \bigoplus_{\tau \in \tilde{\mathcal{S}}} \mathbf{k}[v_i : i \in V(\tau)], \end{array}$$

in which the middle vertical map is not yet defined. Here by  $s$  and  $\tilde{s}$  we denote the restriction maps from Theorem 3.5.6, and  $s(\beta)$  is the map induced by  $\beta$  on the direct sum of polynomial algebras. Now let  $x \in \mathcal{I}_S$ , i.e.  $p(x) = 0$ . Then, by the commutativity of the diagram,  $\tilde{s}\tilde{p}\beta(x) = 0$ . Since  $\tilde{s}$  is injective, we have  $\tilde{p}\beta(x) = 0$ . Hence,  $\beta(x) \in \mathcal{I}_{\tilde{\mathcal{S}}}$ , which implies that the middle vertical map is well defined.

The last statement also follows from the commutative diagram above. The map  $s(\beta)$  sends each direct summand of its domain isomorphically to at least one summand of its range, and therefore it is injective. Thus,  $\beta: \mathbf{k}[\mathcal{S}] \rightarrow \mathbf{k}[\tilde{\mathcal{S}}]$  is also injective. The statement about hso's then follows Lemma 3.5.8.  $\square$

REMARK. If we defined the map  $\beta$  by sending each  $v_i$  identically, then it would still give rise to a ring homomorphism  $\mathbf{k}[\mathcal{S}] \rightarrow \mathbf{k}[\tilde{\mathcal{S}}]$ , but the latter would not be injective (for example, it would map  $v_\sigma \in \mathbf{k}[\mathcal{S}]$  to zero).

EXAMPLE 3.6.5. The assumption on  $\text{st}_S \sigma$  in Lemma 3.6.4 is not always satisfied. For example, if  $\mathcal{S}$  is obtained by identifying two 2-simplices along their boundaries, and  $\sigma$  is any edge, then  $\text{st}_S \sigma = \mathcal{S}$ , which is not a simplicial complex.

Note also that if  $\text{st}_S \sigma$  is not a simplicial complex, then the map  $\beta: \mathbf{k}[\mathcal{S}] \rightarrow \mathbf{k}[\tilde{\mathcal{S}}]$  is not determined uniquely by the conditions specified in Lemma 3.6.4 (we cannot determine the images of  $v_\tau$  with  $\tau \in \text{st}_S \sigma$ ). Nevertheless, it is still possible to define the map  $\beta: \mathbf{k}[\mathcal{S}] \rightarrow \mathbf{k}[\tilde{\mathcal{S}}]$  for an arbitrary simplicial poset  $\mathcal{S}$ , see Section 7.9.

LEMMA 3.6.6. *Assume that  $\mathbf{k}[\mathcal{S}]$  is a Cohen–Macaulay ring, and let  $\tilde{\mathcal{S}}$  be a stellar subdivision of  $\mathcal{S}$  at  $\sigma$  such that  $\text{st}_S \sigma$  is a simplicial complex. Then  $\mathbf{k}[\tilde{\mathcal{S}}]$  is a Cohen–Macaulay ring.*

PROOF. We first prove that  $\text{st}_S \sigma$  is a Cohen–Macaulay complex. Since  $\text{st}_S \sigma = \Delta^\sigma * \text{lk}_S \sigma$ , it is enough to verify that  $\text{lk}_S \sigma$  is Cohen–Macaulay. This follows from Reisner’s Theorem (Theorem 3.3.10) and the fact that simplicial cohomology of  $\text{lk}_S \sigma$  is a direct summand in local cohomology of  $\mathbf{k}[\mathcal{S}]$  (see [293, Theorem II.4.1] or [45, Theorem 5.3.8]).

Choose an hso  $\mathbf{t} = (t_1, \dots, t_n)$  in  $\mathbf{k}[\mathcal{S}]$  and set  $\tilde{\mathbf{t}} = \beta(\mathbf{t})$ . Let

$$p: \mathbf{k}[\mathcal{S}] \rightarrow \mathbf{k}[\mathcal{S}]/(v_\tau : \tau \notin \text{st}_S \sigma) = \mathbf{k}[\text{st}_S \sigma]$$

be the quotient projection. Set  $R = \ker p$ . Similarly, set

$$\tilde{R} = \ker(\tilde{p}: \mathbf{k}[\tilde{\mathcal{S}}] \rightarrow \mathbf{k}[\text{st}_{\tilde{\mathcal{S}}} v]),$$

where  $v$  is the new vertex added in the process of stellar subdivision. Since the simplicial cell complexes  $\mathcal{S}$  and  $\tilde{\mathcal{S}}$  do not differ on the complements of  $\text{st}_{\mathcal{S}} \sigma$  and  $\text{st}_{\tilde{\mathcal{S}}} v$  respectively, the map  $\beta$  restricts to the identity isomorphism  $R \rightarrow \tilde{R}$ . We therefore have the following commutative diagram with exact rows:

$$\begin{array}{ccccccc} 0 & \longrightarrow & R & \longrightarrow & \mathbf{k}[\mathcal{S}] & \xrightarrow{p} & \mathbf{k}[\text{st}_{\mathcal{S}} \sigma] \longrightarrow 0 \\ & & \downarrow \cong & & \downarrow \beta & & \downarrow \\ 0 & \longrightarrow & \tilde{R} & \longrightarrow & \mathbf{k}[\tilde{\mathcal{S}}] & \xrightarrow{\tilde{p}} & \mathbf{k}[\text{st}_{\tilde{\mathcal{S}}} v] \longrightarrow 0, \end{array}$$

Applying the functors  $\otimes_{\mathbf{k}[\mathfrak{t}]} \mathbf{k}$  and  $\otimes_{\mathbf{k}[\tilde{\mathfrak{t}}]} \mathbf{k}$  to the diagram above, we get a map between the long exact sequences for  $\text{Tor}$ . Consider the following fragment:

$$\begin{array}{ccccccc} \text{Tor}_{\mathbf{k}[\mathfrak{t}]}^{-2}(\mathbf{k}[\text{st}_{\mathcal{S}} \sigma], \mathbf{k}) & \xrightarrow{f} & \text{Tor}_{\mathbf{k}[\mathfrak{t}]}^{-1}(R, \mathbf{k}) & \rightarrow & \text{Tor}_{\mathbf{k}[\mathfrak{t}]}^{-1}(\mathbf{k}[\mathcal{S}], \mathbf{k}) & \rightarrow & \text{Tor}_{\mathbf{k}[\mathfrak{t}]}^{-1}(\mathbf{k}[\text{st}_{\mathcal{S}} \sigma], \mathbf{k}) \\ & & \downarrow \cong & & \downarrow & & \downarrow \\ \text{Tor}_{\mathbf{k}[\tilde{\mathfrak{t}}]}^{-2}(\mathbf{k}[\text{st}_{\tilde{\mathcal{S}}} v], \mathbf{k}) & \xrightarrow{\tilde{f}} & \text{Tor}_{\mathbf{k}[\tilde{\mathfrak{t}}]}^{-1}(\tilde{R}, \mathbf{k}) & \rightarrow & \text{Tor}_{\mathbf{k}[\tilde{\mathfrak{t}}]}^{-1}(\mathbf{k}[\tilde{\mathcal{S}}], \mathbf{k}) & \rightarrow & \text{Tor}_{\mathbf{k}[\tilde{\mathfrak{t}}]}^{-1}(\mathbf{k}[\text{st}_{\tilde{\mathcal{S}}} v], \mathbf{k}). \end{array}$$

Since  $\mathbf{k}[\mathcal{S}]$  is Cohen–Macaulay,  $\text{Tor}_{\mathbf{k}[\mathfrak{t}]}^{-1}(\mathbf{k}[\mathcal{S}], \mathbf{k}) = 0$  and the map  $f$  is surjective. Then  $\tilde{f}$  is also surjective. Since  $\text{st}_{\mathcal{S}} \sigma$  is a Cohen–Macaulay simplicial complex and  $|\text{st}_{\mathcal{S}} \sigma| \cong |\text{st}_{\tilde{\mathcal{S}}} v|$ , Proposition 3.3.11 implies that  $\mathbf{k}[\text{st}_{\tilde{\mathcal{S}}} v]$  is Cohen–Macaulay. Therefore,  $\text{Tor}_{\mathbf{k}[\tilde{\mathfrak{t}}]}^{-1}(\mathbf{k}[\text{st}_{\tilde{\mathcal{S}}} v], \mathbf{k}) = 0$ . Since  $\tilde{f}$  is surjective, we also have  $\text{Tor}_{\mathbf{k}[\tilde{\mathfrak{t}}]}^{-1}(\mathbf{k}[\tilde{\mathcal{S}}], \mathbf{k}) = 0$ . Hence  $\mathbf{k}[\tilde{\mathcal{S}}]$  is free as a  $\mathbf{k}[\tilde{\mathfrak{t}}]$ -module (see [203, Lemma VII.6.2]) and thereby is Cohen–Macaulay.  $\square$

Now we can prove the main result of this section:

**THEOREM 3.6.7.** *A simplicial poset  $\mathcal{S}$  is Cohen–Macaulay if and only if the face ring  $\mathbf{k}[\mathcal{S}]$  is Cohen–Macaulay.*

**PROOF.** The fact that the face ring of a Cohen–Macaulay simplicial poset  $\mathcal{S}$  is Cohen–Macaulay is proved in [292, Corollary 3.7] (see also [293, § III.6]) using the theory of ASL’s.

Assume now that  $\mathbf{k}[\mathcal{S}]$  is a Cohen–Macaulay ring. Since the barycentric subdivision  $\mathcal{S}'$  is obtained by a sequence of stellar subdivisions, subsequent application of Lemma 3.6.6 shows that  $\mathbf{k}[\mathcal{S}']$  is also Cohen–Macaulay. Thus,  $\mathcal{S}'$  is a Cohen–Macaulay poset.  $\square$

We end this section by giving Stanley’s characterisation of  $h$ -vectors of Cohen–Macaulay simplicial posets.

**THEOREM 3.6.8 (Stanley).** *The integer vector  $\mathbf{h} = (h_0, h_1, \dots, h_n)$  is the  $h$ -vector of a Cohen–Macaulay simplicial poset if and only if  $h_0 = 1$  and  $h_i \geq 0$ .*

**PROOF.** Let  $\mathbf{h} = \mathbf{h}(\mathcal{S})$  for a Cohen–Macaulay simplicial poset  $\mathcal{S}$ . The condition  $h_0 = 1$  follows from the definition of the  $h$ -vector, see (2.3). Let  $\mathbf{k}$  be a field of zero characteristic, and  $\mathfrak{t} = (t_1, \dots, t_n)$  an lsoip in  $\mathbf{k}[\mathcal{S}]$  (since  $\mathbf{k}[\mathcal{S}]$  is not generated by linear elements, the existence of an lsoip is not automatic and is left as an exercise;



alternatively, see [292, Lemma 3.9]). Comparing the formula for the Poincaré series from Proposition A.3.14 with that of Theorem 3.5.9, we obtain

$$F(\mathbf{k}[\mathcal{S}]/\mathbf{t}; \lambda) = h_0 + h_1\lambda^2 + \cdots + h_n\lambda^{2n}.$$

Hence,  $h_i \geq 0$ , as needed.

Now we construct a Cohen–Macaulay simplicial cell complex  $\mathcal{S}$  with any given  $h$ -vector such that  $h_0 = 1$  and  $h_i \geq 0$ . First note that  $\mathbf{h}(\Delta^{n-1}) = (1, 0, \dots, 0)$  and  $\Delta^{n-1}$  is a Cohen–Macaulay simplicial (cell) complex. Now, given an  $(n-1)$ -dimensional Cohen–Macaulay simplicial cell complex  $\mathcal{S}$  with the  $h$ -vector  $(h_0, \dots, h_n)$ , it suffices to construct, for any  $k = 1, \dots, n$ , a new Cohen–Macaulay simplicial cell complex  $\mathcal{S}_k$  with the  $h$ -vector given by

$$(3.19) \quad \mathbf{h}(\mathcal{S}_k) = (h_0, \dots, h_{k-1}, h_k + 1, h_{k+1}, \dots, h_n).$$

To do this, we choose an  $(n-1)$ -face of  $\mathcal{S}$ , and in this face choose some  $k$  faces of dimension  $n-2$ . Then add to  $\mathcal{S}$  a new  $(n-1)$ -simplex by attaching it along some  $k$  faces of dimension  $n-2$  to the chosen  $k$  faces of  $\mathcal{S}$ . A direct check shows that the  $h$ -vector of the resulting simplicial cell complex  $\mathcal{S}_k$  is given by (3.19). The fact that  $\mathcal{S}_k$  is Cohen–Macaulay follows directly from Proposition 3.3.11.  $\square$

Note that this characterisation is substantially simpler than that for simplicial complexes (see Propositions 3.3.9 and the remark after it).

### Exercises.

3.6.9. The map of face rings  $\mathbf{k}[\mathcal{S}] \rightarrow \mathbf{k}[\tilde{\mathcal{S}}]$  of Lemma 3.6.4 is not induced by any poset map  $\tilde{\mathcal{S}} \rightarrow \mathcal{S}$ .

3.6.10. Let  $\tilde{\mathcal{S}}$  be a stellar subdivision of  $\mathcal{S}$  at  $\sigma$  such that  $\text{st}_{\mathcal{S}} \sigma$  is a simplicial complex. Show that the ring  $\mathbf{k}[\mathcal{S}]$  is Cohen–Macaulay if and only if  $\mathbf{k}[\tilde{\mathcal{S}}]$  is Cohen–Macaulay, i.e. the converse of Lemma 3.6.6 holds.

3.6.11. If  $\mathbf{k}$  is of characteristic zero, then  $\mathbf{k}[\mathcal{S}]$  admits an lsop.

## 3.7. Gorenstein simplicial posets

Gorenstein simplicial posets arise in toric topology as the combinatorial structures associated to the orbit quotients of *torus manifolds*, which are the subject of Chapter 7. It was exactly this particular feature of Gorenstein simplicial posets which allowed Masuda [207] to complete the characterisation of their  $h$ -vectors, conjectured by Stanley in [292]. We include Masuda’s result here as Theorem 3.7.4.

**DEFINITION 3.7.1.** A simplicial poset  $\mathcal{S}$  is *Gorenstein* (respectively, *Gorenstein\**) if its barycentric subdivision  $\mathcal{S}'$  is a Gorenstein (respectively, Gorenstein\*) simplicial complex.

Like Cohen–Macaulayness, the property of a simplicial poset  $\mathcal{S}$  being Gorenstein\* depends only on the topology of the realisation  $|\mathcal{S}|$  (this follows from Theorem 3.4.2). In particular, simplicial cell subdivisions of spheres are Gorenstein\*.

The problem of characterisation of  $h$ -vectors of Gorenstein\* simplicial posets is more subtle than the corresponding question in the Cohen–Macaulay case. (Although this problem is much easier for simplicial posets than for simplicial complexes, see the discussion of the  $g$ -conjecture in Sections 2.5 and 3.4.)

**THEOREM 3.7.2.** *Let  $\mathbf{h}(\mathcal{S}) = (h_0, h_1, \dots, h_n)$  be the  $h$ -vector of a Gorenstein\* simplicial poset of rank  $n$ . Then  $h_0 = 1$ ,  $h_i \geq 0$  and  $h_i = h_{n-i}$  for any  $i$ .*

**PROOF.** The inequalities  $h_i \geq 0$  follow from the fact that  $\mathcal{S}$  is Cohen–Macaulay (Theorem 3.6.8). The identities  $h_i = h_{n-i}$  will follow from the expression of the  $h$ -vector of the barycentric subdivision  $\mathcal{S}'$  via  $\mathbf{h}(\mathcal{S})$  and from the Dehn–Sommerville relations for the Gorenstein\* simplicial complex  $\mathcal{S}'$ . Indeed, repeating the argument from Lemmata 2.3.4 and 2.3.5 we obtain the identity  $\mathbf{h}(\mathcal{S}') = D\mathbf{h}(\mathcal{S})$ , in which the vector  $\mathbf{h}(\mathcal{S}')$  is symmetric, i.e. satisfies the Dehn–Sommerville relations. It can be checked directly using some identities for binomial coefficients that the operator  $D$  (and its inverse) takes symmetric vectors to symmetric ones (which is equivalent to the identity  $d_{pq} = d_{n+1-p, n+1-q}$ ). This calculation can be avoided by using the following argument. The Dehn–Sommerville relations specify a linear subspace  $W$  of dimension  $k = \lfloor \frac{n}{2} \rfloor + 1$  in the space  $\mathbb{R}^{n+1}$  with coordinates  $h_0, \dots, h_n$ . We need to check that this subspace is  $D$ -invariant. To do this it suffices to choose a basis  $\mathbf{e}_1, \dots, \mathbf{e}_k$  in  $W$  and check that  $D\mathbf{e}_i \in W$  for all  $i$ . There is a basis in  $W$  consisting of  $h$ -vectors of simplicial spheres (and even simplicial polytopes, see the proof of Proposition 1.4.1). Since the barycentric subdivision of a simplicial sphere is a simplicial sphere, the vectors  $D\mathbf{e}_i$ ,  $1 \leq i \leq k$ , are also symmetric, and  $W$  is a  $D$ -invariant subspace. Thus, the vector  $\mathbf{h}(\mathcal{S}) = D^{-1}\mathbf{h}(\mathcal{S}')$  satisfies the Dehn–Sommerville relations.  $\square$

**THEOREM 3.7.3** ([292, Theorem 4.3]). *Let  $\mathbf{h} = (h_0, h_1, \dots, h_n)$  be an integer vector with  $h_0 = 1$ ,  $h_i \geq 0$  and  $h_i = h_{n-i}$ . Any of the following (mutually exclusive) conditions are sufficient for the existence of a Gorenstein\* simplicial poset of rank  $n$  and  $h$ -vector  $\mathbf{h}(\mathcal{S}) = \mathbf{h}$ :*

- (a)  $n$  is odd;
- (b)  $n$  is even and  $h_{n/2}$  is even;
- (c)  $n$  is even,  $h_{n/2}$  is odd, and  $h_i > 0$  for all  $i$ .

**PROOF.** We start with the following two basic examples of  $(n-1)$ -dimensional simplicial cell complexes of dimension:  $\partial\Delta^n$ , with  $h$ -vector  $\mathbf{h}(\partial\Delta^n) = (1, 1, \dots, 1)$ ; and  $\mathcal{S}_n$ , the simplicial cell complex obtained by identifying two  $(n-1)$ -simplices along their boundaries, with  $\mathbf{h}(\mathcal{S}_n) = (1, 0, \dots, 0, 1)$ . By applying the standard operations of join and connected sum (Constructions 2.2.8 and 2.2.11) to these two complexes we can obtain a simplicial cell complex with any prescribed  $h$ -vector satisfying the conditions of the theorem. Indeed, for  $k \neq n-k$  we have

$$\mathbf{h}(\mathcal{S}_k * \mathcal{S}_{n-k}) = (1, 0, \dots, 0, 1, 0, \dots, 0, 1, 0, \dots, 0, 1),$$

where  $h_k = h_{n-k} = 1$ , and the other entries are zero. Also, for  $n = 2k$  we have

$$\mathbf{h}(\mathcal{S}_k * \mathcal{S}_k) = (1, 0, \dots, 0, 2, 0, \dots, 0, 1),$$

where  $h_k = 2$ . Now, by taking connected sum of the appropriate number of complexes  $\partial\Delta^n$ ,  $\mathcal{S}_n$  and  $\mathcal{S}_k * \mathcal{S}_{n-k}$  and using the identity

$$h_i(\mathcal{S} \# \tilde{\mathcal{S}}) = h_i(\mathcal{S}) + h_i(\tilde{\mathcal{S}}) \quad \text{for } 1 \leq i \leq n-1,$$

(see Example 1.3.8, which is valid for any two pure  $(n-1)$ -dimensional simplicial cell complexes), we obtain any required  $h$ -vector.  $\square$

The subtlest part of the characterisation of  $h$ -vectors of Gorenstein\* simplicial posets is the following result, which was proved by Masuda:

**THEOREM 3.7.4 ([207]).** *Let  $\mathbf{h}(\mathcal{S}) = (h_0, h_1, \dots, h_n)$  be the  $h$ -vector of a Gorenstein\* simplicial poset  $\mathcal{S}$  of even rank  $n$ , and let  $h_i = 0$  for some  $i$ . Then the number  $h_{n/2}$  is even.*

Note that the evenness of  $h_{n/2}$  is equivalent to the evenness of the number of facets  $f_{n-1} = \sum_{i=0}^n h_i$ . The idea behind Masuda’s proof of Theorem 3.7.4 lies within the topological theory of torus manifolds, which is the subject of Section 7.4.

We combine the results of Theorems 3.7.2, 3.7.3 and 3.7.4 in the following characterisation result for the  $h$ -vectors of Gorenstein\* simplicial posets.

**THEOREM 3.7.5.** *An integer vector  $\mathbf{h} = (h_0, h_1, \dots, h_n)$  is the  $h$ -vector of a Gorenstein\* simplicial poset of rank  $n$  (or a simplicial cell subdivision of an  $(n-1)$ -sphere) if and only if the following conditions are satisfied:*

- (a)  $h_0 = 1$  and  $h_i \geq 0$ ;
- (b)  $h_i = h_{n-i}$  for all  $i$ ;
- (c) either  $h_i > 0$  for all  $i$  or  $\sum_{i=0}^n h_i$  is even.

### 3.8. Generalised Dehn–Sommerville relations

In this section we obtain some further generalisations of the Dehn–Sommerville relations, in particular, to arbitrary triangulated manifolds.

Let  $\mathcal{S}$  be a simplicial poset of rank  $n$ . Given  $\sigma \in \mathcal{S}$ , consider the closed upper semi-interval  $\mathcal{S}_{\geq \sigma} = \{\tau \in \mathcal{S} : \tau \geq \sigma\}$  with the induced rank function, and set

$$(3.20) \quad \chi(\mathcal{S}_{\geq \sigma}) = \sum_{\tau \geq \sigma} (-1)^{|\tau|-1}.$$

A simplicial poset  $\mathcal{S}$  of rank  $n$  satisfying  $\chi(\mathcal{S}_{\geq \sigma}) = (-1)^{n-1}$  for all  $\sigma \in \mathcal{S}$  is called *Eulerian*. According to a result of [290, (3.40)], the Dehn–Sommerville relations  $h_i = h_{n-i}$  hold for Eulerian posets. This can be generalised as follows.

**THEOREM 3.8.1** (see [204, Theorem 9.1]). *The following identity holds for the  $h$ -vector  $\mathbf{h}(\mathcal{S}) = (h_0, \dots, h_n)$  of a simplicial poset  $\mathcal{S}$  of rank  $n$ :*

$$\sum_{i=0}^n (h_{n-i} - h_i) t^i = \sum_{\sigma \in \mathcal{S}} \left( 1 + (-1)^n \chi(\mathcal{S}_{\geq \sigma}) \right) (t-1)^{n-|\sigma|}.$$

*In particular, if  $\mathcal{S}$  is Eulerian, then  $h_i = h_{n-i}$ .*

**PROOF.** We have

$$(3.21) \quad \begin{aligned} \sum_{i=0}^n h_i t^i &= t^n \sum_{i=0}^n h_i \left(\frac{1}{t}\right)^{n-i} = t^n \sum_{i=0}^n f_{i-1} \left(\frac{1-t}{t}\right)^{n-i} \\ &= \sum_{i=0}^n f_{i-1} t^i (1-t)^{n-i} = \sum_{\tau \in \mathcal{S}} t^{|\tau|} (1-t)^{n-|\tau|} \\ &= \sum_{\tau \in \mathcal{S}} \sum_{\sigma \leq \tau} (t-1)^{|\tau|-|\sigma|} (1-t)^{n-|\tau|} = \sum_{\tau \in \mathcal{S}} \sum_{\sigma \leq \tau} (-1)^{n-|\tau|} (t-1)^{n-|\sigma|} \\ &= \sum_{\sigma \in \mathcal{S}} (t-1)^{n-|\sigma|} \sum_{\tau \geq \sigma} (-1)^{n-|\tau|} = \sum_{\sigma \in \mathcal{S}} (t-1)^{n-|\sigma|} (-1)^{n-1} \chi(\mathcal{S}_{\geq \sigma}), \end{aligned}$$

where the fifth identity follows from the binomial expansion of the right hand side of the identity  $t^{|\tau|} = ((t-1) + 1)^{|\tau|}$  and the fact that  $[\hat{0}, \tau] = \{\sigma \in \mathcal{S} : \sigma \leq \tau\}$  is a Boolean lattice of rank  $|\tau|$ .

On the other hand, we have

$$(3.22) \quad \sum_{i=0}^n h_{n-i} t^i = \sum_{i=0}^n h_i t^{n-i} = \sum_{i=0}^n f_{i-1} (t-1)^{n-i} = \sum_{\sigma \in \mathcal{S}} (t-1)^{n-|\sigma|}.$$

Subtracting (3.21) from (3.22) we obtain the required identity.  $\square$

As a corollary we obtain a generalisation of the Dehn–Sommerville relations to triangulated manifolds. This formula appeared in [293, p. 74] (the orientability assumption there can be removed by passing to the orientation double cover, see also [54, Corollary 4.5.4]):

**THEOREM 3.8.2.** *Let  $\mathcal{K}$  be a triangulation of a closed  $(n-1)$ -dimensional manifold. Then the  $h$ -vector  $\mathbf{h}(\mathcal{K}) = (h_0, \dots, h_n)$  satisfies the identities*

$$h_{n-i} - h_i = (-1)^i \binom{n}{i} (\chi(\mathcal{K}) - \chi(S^{n-1})), \quad 0 \leq i \leq n.$$

Here  $\chi(\mathcal{K}) = f_0 - f_1 + \dots + (-1)^{n-1} f_{n-1} = 1 + (-1)^{n-1} h_n$  is the Euler characteristic of  $\mathcal{K}$  and  $\chi(S^{n-1}) = 1 + (-1)^{n-1}$ .

**PROOF.** Viewing  $\mathcal{K}$  as a simplicial poset, we calculate

$$\begin{aligned} \chi(\mathcal{K}_{\geq \sigma}) &= \sum_{\tau > \sigma} (-1)^{|\tau|-1} + (-1)^{|\sigma|-1} = (-1)^{|\sigma|} \left( \sum_{\tau > \sigma} (-1)^{|\tau|-|\sigma|-1} - 1 \right) \\ &= (-1)^{|\sigma|} \left( \sum_{\emptyset \neq \rho \in \text{lk}_{\mathcal{K}} \sigma} (-1)^{|\rho|-1} - 1 \right) = (-1)^{|\sigma|} (\chi(\text{lk}_{\mathcal{K}} \sigma) - 1). \end{aligned}$$

Here we have used the fact that the poset of nonempty faces of  $\text{lk}_{\mathcal{K}} \sigma$  is isomorphic to  $\mathcal{S}_{> \sigma}$ , with the rank function shifted by  $|\sigma|$ . Now since  $\mathcal{K}$  is a triangulated  $(n-1)$ -dimensional manifold, the link of a nonempty face  $\sigma \in \mathcal{K}$  has the homology of a sphere of dimension  $(n-|\sigma|-1)$ . Hence,  $\chi(\text{lk}_{\mathcal{K}} \sigma) = 1 + (-1)^{n-|\sigma|-1}$ , and therefore  $\chi(\mathcal{K}_{\geq \sigma}) = (-1)^{n-1}$  for  $\sigma \neq \emptyset$ . Also,  $\text{lk}_{\mathcal{K}} \emptyset = \mathcal{K}$ . Now using the identity of Theorem 3.8.1 we calculate

$$\sum_{i=0}^n (h_{n-i} - h_i) t^i = (1 + (-1)^n (\chi(\mathcal{K}) - 1)) (t-1)^n = (-1)^n (\chi(\mathcal{K}) - \chi(S^{n-1})) (t-1)^n.$$

The required identity follows by comparing the coefficients of  $t^i$ .  $\square$

For other generalisations of Dehn–Sommerville relations see [27] and [138].

### Exercises.

3.8.3. The identity of Theorem 3.8.2 holds for simplicial posets.

## Moment-angle complexes

This is the first genuinely ‘toric’ chapter of this book; it links the combinatorial and algebraic constructions of the previous chapters to the world of toric spaces.

The term ‘moment-angle complex’ refers to a decomposition of a certain toric space  $\mathcal{Z}_{\mathcal{K}}$  into products of polydiscs and tori parametrised by simplices in a given simplicial complex  $\mathcal{K}$ . The underlying space  $\mathcal{Z}_{\mathcal{K}}$  features in several important algebraic, symplectic and topological constructions of torus actions, which are the subject of the next three chapters. The decomposition of  $\mathcal{Z}_{\mathcal{K}}$  as the ‘moment-angle complex’, which first appeared in [52], [53], provided an effective topological instrument for studying these spaces.

The basic building block in the ‘moment-angle’ decomposition of  $\mathcal{Z}_{\mathcal{K}}$  is the pair  $(D^2, S^1)$  of a unit disc and circle, and the whole construction can be extended naturally to arbitrary pairs of spaces  $(X, A)$ . The resulting complex  $(X, A)^{\mathcal{K}}$  is now known as the ‘polyhedral product space’ over a simplicial complex  $\mathcal{K}$ ; this terminology was suggested by William Browder, cf. [14]. Many spaces important for toric topology admit polyhedral product decompositions.

It has soon become clear that the construction of the moment-angle complex  $\mathcal{Z}_{\mathcal{K}}$  and its generalisation  $(X, A)^{\mathcal{K}}$  is of truly universal nature, and has remarkable functorial properties. The most basic of these is that the construction of  $\mathcal{Z}_{\mathcal{K}}$  establishes a functor from simplicial complexes and simplicial maps to spaces with torus actions and equivariant maps. If  $\mathcal{K}$  is a simplicial subdivision of a sphere (a triangulated sphere), then  $\mathcal{Z}_{\mathcal{K}}$  is a manifold, and most important geometric examples of  $\mathcal{Z}_{\mathcal{K}}$  arise in this way. In the case when  $A$  is a point, the polyhedral product  $(X, pt)^{\mathcal{K}}$  interpolates between the  $m$ -fold wedge, or bouquet, of  $X$  (corresponding to  $m$  discrete points as  $\mathcal{K}$ ) and the  $m$ -fold product of  $X$  (corresponding to the full simplex as  $\mathcal{K}$ ). Parallel to the topological and geometric study of moment-angle complexes  $\mathcal{Z}_{\mathcal{K}}$  and related toric spaces, a homotopy-theoretic study of polyhedral products  $(X, A)^{\mathcal{K}}$  has now gained its own momentum. Basic homotopy properties of moment-angle complexes are given in Section 4.3, while more advanced homotopy-theoretic aspects of toric topology are the subject of Chapter 8.

The key result of this chapter is the calculation of the integral cohomology ring of  $\mathcal{Z}_{\mathcal{K}}$ , carried out in Section 4.5. The ring  $H^*(\mathcal{Z}_{\mathcal{K}})$  is shown to be isomorphic to the Tor-algebra  $\text{Tor}_{\mathbb{Z}[v_1, \dots, v_m]}(\mathbb{Z}[\mathcal{K}], \mathbb{Z})$ , where  $\mathbb{Z}[\mathcal{K}]$  is the face ring of  $\mathcal{K}$ . The canonical bigraded structure in the Tor groups thereby acquires a geometric interpretation in terms of the bigraded cell decomposition of  $\mathcal{Z}_{\mathcal{K}}$ . The calculation of  $H^*(\mathcal{Z}_{\mathcal{K}})$  builds upon a construction of a ring model for *cellular* cochains of  $\mathcal{Z}_{\mathcal{K}}$  and the corresponding cellular diagonal approximation, which is functorial with respect to maps of moment-angle complexes induced by simplicial maps of  $\mathcal{K}$ . This functorial property of the cellular diagonal approximation for  $\mathcal{Z}_{\mathcal{K}}$  is quite special, due to the lack of such a construction for general cell complexes.

The construction of the moment-angle complex therefore brings the methods of equivariant topology to bear on the study of combinatorics of simplicial complexes, and gives a new geometric dimension to combinatorial commutative algebra. In particular, homological invariants of face rings, such as Tor-algebras or algebraic Betti numbers, can be now interpreted geometrically in terms of cohomology of moment-angle complexes. This link is explored further in Sections 4.6 and 4.10.

Another important aspect of the theory of moment-angle complexes is their connection to coordinate subspace arrangements and their complements. As we have already seen in Proposition 3.1.12, coordinate subspace arrangements arise as affine varieties corresponding to face rings. Their complements have played an important role in toric geometry and singularity theory, and, more recently, in the theory of linkages and robotic motion planning. Arrangements of coordinate subspaces in  $\mathbb{C}^m$  correspond bijectively to simplicial complexes  $\mathcal{K}$  on the set  $[m]$ , and the complement of such an arrangement deformation retracts onto the corresponding moment-angle complex  $\mathcal{Z}_{\mathcal{K}}$ . In particular, the moment-angle complex and the complement of the arrangement have the same homotopy type. We therefore may use the results on moment-angle complexes to obtain a description of the cohomology groups and cup product structure of a coordinate subspace arrangement complement. The formula obtained for the cohomology groups is related to the general formula of Goresky–MacPherson [130] by means of Alexander duality.

The material of this chapter, with the exception of ‘Additional topics’, is mainly a freshened and modernised exposition of the results obtained by the authors and their collaborators in [53], [55], [24], [257].

Spaces with torus actions, or *toric spaces*, will be the main players throughout the rest of this book. (See Appendix B.3 for the key concepts of the theory of group actions on topological spaces.) The most basic example of a toric space is the complex  $m$ -dimensional space  $\mathbb{C}^m$ , on which the *standard torus*

$$\mathbb{T}^m = \{ \mathbf{t} = (t_1, \dots, t_m) \in \mathbb{C}^m : |t_i| = 1 \text{ for } i = 1, \dots, m \}$$

acts coordinatewise. That is, the action is given by

$$\begin{aligned} \mathbb{T}^m \times \mathbb{C}^m &\longrightarrow \mathbb{C}^m, \\ (t_1, \dots, t_m) \cdot (z_1, \dots, z_m) &= (t_1 z_1, \dots, t_m z_m). \end{aligned}$$

The quotient  $\mathbb{C}^m / \mathbb{T}^m$  of this action is the *positive orthant*

$$\mathbb{R}_{\geq}^m = \{ (y_1, \dots, y_m) \in \mathbb{R}^m : y_i \geq 0 \text{ for } i = 1, \dots, m \},$$

with the quotient projection given by

$$\begin{aligned} \mu: \mathbb{C}^m &\longrightarrow \mathbb{R}_{\geq}^m, \\ (z_1, \dots, z_m) &\longmapsto (|z_1|^2, \dots, |z_m|^2) \end{aligned}$$

(or by  $(z_1, \dots, z_m) \longmapsto (|z_1|, \dots, |z_m|)$ , but the former is usually more preferable).

We shall use the blackboard bold capital  $\mathbb{T}$  in the notation for the standard torus  $\mathbb{T}^m$  only, and use italic  $T^m$  to denote an abstract  $m$ -torus, i.e. a compact abelian Lie group isomorphic to a product of  $m$  circles. We shall also denote the standard unit circle by  $\mathbb{S}$  or  $\mathbb{T}$  occasionally, to distinguish it from an abstract circle  $S^1$ .

All homology and cohomology groups in this chapter are with integer coefficients, unless another coefficient group is explicitly specified.

### 4.1. Basic definitions

**Moment-angle complex**  $\mathcal{Z}_{\mathcal{K}}$ . We consider the unit polydisc in the  $m$ -dimensional complex space  $\mathbb{C}^m$ :

$$\mathbb{D}^m = \{(z_1, \dots, z_m) \in \mathbb{C}^m : |z_i|^2 \leq 1 \text{ for } i = 1, \dots, m\}.$$

The polydisc  $\mathbb{D}^m$  is a  $\mathbb{T}^m$ -invariant subspace of  $\mathbb{C}^m$ , and the quotient  $\mathbb{D}^m/\mathbb{T}^m$  is identified with the standard unit cube  $\mathbb{I}^m \subset \mathbb{R}_{\geq 0}^m$ .

**CONSTRUCTION 4.1.1 (moment-angle complex)**. Let  $\mathcal{K}$  be a simplicial complex on the set  $[m]$ . We recall the cubical subcomplex  $\text{cc}(\mathcal{K})$  in  $\mathbb{I}^m$  from Construction 2.9.11, which subdivides cone  $\mathcal{K}$ . The *moment-angle complex*  $\mathcal{Z}_{\mathcal{K}}$  corresponding to  $\mathcal{K}$  is defined from the pullback square

$$\begin{array}{ccc} \mathcal{Z}_{\mathcal{K}} & \hookrightarrow & \mathbb{D}^m \\ \downarrow & & \downarrow \mu \\ \text{cc}(\mathcal{K}) & \hookrightarrow & \mathbb{I}^m \end{array}$$

Explicitly,  $\mathcal{Z}_{\mathcal{K}} = \mu^{-1}(\text{cc}(\mathcal{K}))$ . By construction,  $\mathcal{Z}_{\mathcal{K}}$  is a  $\mathbb{T}^m$ -invariant subspace in the polydisc  $\mathbb{D}^m$ , and the quotient  $\mathcal{Z}_{\mathcal{K}}/\mathbb{T}^m$  is homeomorphic to  $|\text{cone } \mathcal{K}|$ .

Using the decomposition  $\text{cc}(\mathcal{K}) = \bigcup_{I \in \mathcal{K}} C_I$  into faces, see (2.10), it follows that

$$(4.1) \quad \mathcal{Z}_{\mathcal{K}} = \bigcup_{I \in \mathcal{K}} B_I,$$

where

$$B_I = \mu^{-1}(C_I) = \{(z_1, \dots, z_m) \in \mathbb{D}^m : |z_j|^2 = 1 \text{ for } j \notin I\},$$

and the union in (4.1) is understood as the union of subsets inside the polydisc  $\mathbb{D}^m$ . Note that  $B_I$  is a product of  $|I|$  discs and  $m - |I|$  circles. Following our notational tradition, we denote a topological 2-disc (the underlying space of  $\mathbb{D}$ ) by  $D^2$ . Then we may rewrite (4.1) as the following decomposition of  $\mathcal{Z}_{\mathcal{K}}$  into products of discs and circles:

$$(4.2) \quad \mathcal{Z}_{\mathcal{K}} = \bigcup_{I \in \mathcal{K}} \left( \prod_{i \in I} D^2 \times \prod_{i \notin I} S^1 \right),$$

From now on we shall denote the space  $B_I$  by  $(D^2, S^1)^I$ . Obviously, the union in (4.1) or (4.2) can be taken over the maximal simplices  $I \in \mathcal{K}$  only.

Using the categorical language, we may consider the face category  $\text{CAT}(\mathcal{K})$ , and define the functor (or diagram, see Appendix C.1)

$$(4.3) \quad \begin{aligned} \mathcal{D}_{\mathcal{K}}(D^2, S^1) : \text{CAT}(\mathcal{K}) &\longrightarrow \text{TOP}, \\ I &\longmapsto B_I = (D^2, S^1)^I, \end{aligned}$$

which maps the morphism  $I \subset J$  of  $\text{CAT}(\mathcal{K})$  to the inclusion of spaces  $(D^2, S^1)^I \subset (D^2, S^1)^J$ . Then we have

$$\mathcal{Z}_{\mathcal{K}} = \text{colim}_{I \in \mathcal{K}} \mathcal{D}_{\mathcal{K}}(D^2, S^1) = \text{colim}_{I \in \mathcal{K}} (D^2, S^1)^I.$$

**EXAMPLE 4.1.2.**

1. Let  $\mathcal{K} = \Delta^{m-1}$  be the full simplex. Then  $\text{cc}(\mathcal{K}) = \mathbb{I}^m$  and  $\mathcal{Z}_{\mathcal{K}} = \mathbb{D}^m$ .

2. Let  $\mathcal{K}$  be a simplicial complex on  $[m]$ , and let  $\mathcal{K}^\circ$  be the complex on  $[m+1]$  obtained by adding one ghost vertex  $\circ = \{m+1\}$  to  $\mathcal{K}$ . Then the cubical complex  $\text{cc}(\mathcal{K}^\circ)$  is contained in the facet  $\{y_{m+1} = 1\}$  of the cube  $\mathbb{I}^{m+1}$ , and

$$\mathcal{Z}_{\mathcal{K}^\circ} = \mathcal{Z}_{\mathcal{K}} \times S^1.$$

In particular, if  $\mathcal{K}$  is the ‘empty’ simplicial complex on  $[m]$ , consisting of the empty simplex  $\emptyset$  only, then  $\text{cc}(\mathcal{K})$  is the vertex  $(1, \dots, 1) \in \mathbb{I}^m$  and  $\mathcal{Z}_{\mathcal{K}} = \mu^{-1}(1, \dots, 1) = \mathbb{T}^m$  is the standard  $m$ -torus.

For arbitrary  $\mathcal{K}$  on  $[m]$ , the moment-angle complex  $\mathcal{Z}_{\mathcal{K}}$  contains the  $m$ -torus  $\mathbb{T}^m$  (corresponding to  $\mathcal{K} = \emptyset$ ) and is contained in the polydisc  $\mathbb{D}^m$  (corresponding to  $\mathcal{K} = \Delta^{m-1}$ ).

3. Let  $\mathcal{K}$  be the complex consisting of two disjoint points. Then

$$\mathcal{Z}_{\mathcal{K}} = (D^2 \times S^1) \cup (S^1 \times D^2) = \partial(D^2 \times D^2) \cong S^3,$$

the standard decomposition of a 3-sphere into the union of two solid tori.

4. More generally, if  $\mathcal{K} = \partial\Delta^{m-1}$  (the boundary of a simplex), then

$$\begin{aligned} \mathcal{Z}_{\mathcal{K}} &= (D^2 \times \cdots \times D^2 \times S^1) \cup (D^2 \times \cdots \times S^1 \times D^2) \cup \cdots \cup (S^1 \times \cdots \times D^2 \times D^2) \\ &= \partial((D^2)^m) \cong S^{2m-1}. \end{aligned}$$

5. Let  $\mathcal{K} = \square_3^2$ , the boundary of a 4-gon. Then we have four maximal simplices  $\{1, 3\}$ ,  $\{2, 3\}$ ,  $\{1, 4\}$  and  $\{2, 4\}$ , and

$$\begin{aligned} \mathcal{Z}_{\mathcal{K}} &= (D^2 \times S^1 \times D^2 \times S^1) \cup (S^1 \times D^2 \times D^2 \times S^1) \\ &\quad \cup (D^2 \times S^1 \times S^1 \times D^2) \cup (S^1 \times D^2 \times S^1 \times D^2) \\ &= ((D^2 \times S^1) \cup (S^1 \times D^2)) \times D^2 \times S^1 \cup ((D^2 \times S^1) \cup (S^1 \times D^2)) \times S^1 \times D^2 \\ &= ((D^2 \times S^1) \cup (S^1 \times D^2)) \times ((D^2 \times S^1) \cup (S^1 \times D^2)) \cong S^3 \times S^3. \end{aligned}$$

In the last example,  $\mathcal{K}$  is the join of  $\{1, 2\}$  and  $\{3, 4\}$ . More generally,

PROPOSITION 4.1.3. *Let  $\mathcal{K} = \mathcal{K}_1 * \mathcal{K}_2$ ; then*

$$\mathcal{Z}_{\mathcal{K}} = \mathcal{Z}_{\mathcal{K}_1} \times \mathcal{Z}_{\mathcal{K}_2}.$$

PROOF. By the definition of join (Construction 2.2.8), we have

$$\begin{aligned} \mathcal{Z}_{\mathcal{K}_1 * \mathcal{K}_2} &= \bigcup_{I_1 \in \mathcal{K}_1, I_2 \in \mathcal{K}_2} (D^2, S^1)^{I_1 \sqcup I_2} = \bigcup_{I_1 \in \mathcal{K}_1, I_2 \in \mathcal{K}_2} (D^2, S^1)^{I_1} \times (D^2, S^1)^{I_2} \\ &= \left( \bigcup_{I_1 \in \mathcal{K}_1} (D^2, S^1)^{I_1} \right) \times \left( \bigcup_{I_2 \in \mathcal{K}_2} (D^2, S^1)^{I_2} \right) = \mathcal{Z}_{\mathcal{K}_1} \times \mathcal{Z}_{\mathcal{K}_2}. \quad \square \end{aligned}$$

The topological structure of  $\mathcal{Z}_{\mathcal{K}}$  is quite complicated even for simplicial complexes  $\mathcal{K}$  with few vertices. Several different techniques will be developed to describe the topology of  $\mathcal{Z}_{\mathcal{K}}$ ; this is one of the main subjects of the book. To get an idea on how  $\mathcal{Z}_{\mathcal{K}}$  may look like we included Exercises 4.2.9 and 4.2.10, in which the topological structure of  $\mathcal{Z}_{\mathcal{K}}$  is more complicated than in the examples above, but which are still accessible by relatively elementary topological methods. As we shall see below, the cohomology of  $\mathcal{Z}_{\mathcal{K}}$  may have an arbitrary torsion (Corollary 4.5.9), as well as Massey products (Section 4.9).

Moment-angle complexes corresponding to triangulated spheres and manifolds are of particular interest:



**THEOREM 4.1.4.** *Let  $\mathcal{K}$  be a triangulation of an  $(n-1)$ -dimensional sphere with  $m$  vertices. Then  $\mathcal{Z}_{\mathcal{K}}$  is a (closed) topological manifold of dimension  $m+n$ .*

*If  $\mathcal{K}$  is a triangulated manifold, then  $\mathcal{Z}_{\mathcal{K}} \setminus \mu^{-1}(1, \dots, 1)$  is an (open) non-compact manifold. Here  $(1, \dots, 1) \in \mathbb{I}^m$  is the cone vertex, and  $\mu^{-1}(1, \dots, 1) = \mathbb{T}^m$ .*

**PROOF.** We first construct a decomposition of the polyhedron  $|\text{cone}(\mathcal{K}')|$  into ‘faces’ similar to the faces of a simple polytope (in fact, in the case of the nerve complex  $\mathcal{K} = \mathcal{K}_P$ , our faces will be exactly the faces of  $P$ ). The vertices  $i \in \mathcal{K}$  are also vertices of the barycentric subdivision  $\mathcal{K}'$ , and we set

$$(4.4) \quad F_i = \text{st}_{\mathcal{K}'}\{i\}, \quad 1 \leq i \leq m,$$

(i.e.  $F_i$  is the star of the  $i$ th vertex of  $\mathcal{K}$  in the barycentric subdivision  $\mathcal{K}'$ ). We refer to  $F_i$  as *facets* of our face decomposition, and define a face of codimension  $k$  as a nonempty intersection of a set of  $k$  facets. In particular, the vertices of our face decomposition are the barycentres of  $(n-1)$ -dimensional simplices of  $\mathcal{K}$ . Such a barycentre  $b$  corresponds to a maximal simplex  $I = \{i_1, \dots, i_n\}$  of  $\mathcal{K}$ , and we denote by  $U_I$  the open subset in  $|\text{cone}(\mathcal{K}')|$  obtained by removing all faces not containing  $b$ . We observe that any point of  $|\text{cone}(\mathcal{K}')|$  is contained in  $U_I$  for some  $I \in \mathcal{K}$ .

Under the map  $\text{cone}(i_c): |\text{cone}(\mathcal{K}')| \rightarrow \mathbb{I}^m$  of Construction 2.9.11 the facet  $F_i$  is mapped to the intersection of  $\text{cc}(\mathcal{K})$  with the  $i$ th coordinate plane  $y_i = 0$ . Therefore, the image of  $U_I$  under the map  $\text{cone}(i_c)$  is given by

$$(4.5) \quad W_I = \text{cone}(i_c)(U_I) = \{(y_1, \dots, y_m) \in \text{cc}(\mathcal{K}) : y_i \neq 0 \text{ for } i \notin I\}.$$

Assume now that  $\mathcal{K}$  is a triangulated sphere. Then  $|\text{cone}(\mathcal{K}')|$  is homeomorphic to an  $n$ -dimensional disc  $D^n$ , and each  $U_I$  is homeomorphic to an open subset in  $\mathbb{R}_{\geq}^n$  preserving the dimension of faces. (This means that  $|\text{cone}(\mathcal{K}')|$  is a *manifold with corners*, see Section 7.1). By identifying  $|\text{cone}(\mathcal{K}')|$  with  $\text{cc}(\mathcal{K})$  and further identifying  $\text{cc}(\mathcal{K})$  with the quotient  $\mathcal{Z}_{\mathcal{K}}/\mathbb{T}^m$ , we obtain that each point of  $\mathcal{Z}_{\mathcal{K}}$  has a neighbourhood of the form  $\mu^{-1}(W_I)$ . It follows from (4.5) that the latter is homeomorphic to an open subset in  $\mu_n^{-1}(\mathbb{R}_{\geq}^n) \times T^{m-n} = \mathbb{C}^n \times T^{m-n}$ , where  $\mathbb{R}^n$  is the coordinate  $n$ -plane corresponding to  $i_1, \dots, i_n$ , the map  $\mu_n: \mathbb{C}^n \rightarrow \mathbb{R}_{\geq}^n$  is the restriction of  $\mu: \mathbb{C}^m \rightarrow \mathbb{R}_{\geq}^m$  to the corresponding coordinate plane in  $\mathbb{C}^m$ , and the torus  $T^{m-n}$  sits in the complementary coordinate  $(m-n)$ -plane in  $\mathbb{C}^m$ . An open subset in  $\mathbb{C}^n \times T^{m-n}$  with  $n \geq 1$  can be regarded as an open subset in  $\mathbb{R}^{m+n}$ , and therefore  $\mathcal{Z}_{\mathcal{K}}$  is an  $(m+n)$ -dimensional manifold.

If  $\mathcal{K}$  is a triangulated manifold, then  $|\text{cone}(\mathcal{K}')|$  is not a manifold because of the singularity at the cone vertex  $v$ . However, by removing this vertex we obtain a (non-compact) manifold whose boundary is  $|\mathcal{K}|$ . Using the face decomposition defined by (4.4) we obtain that  $|\text{cone}(\mathcal{K}')| \setminus v$  is locally homeomorphic to  $\mathbb{R}_{\geq}^n$  preserving the dimension of faces (i.e.  $|\text{cone}(\mathcal{K}')| \setminus v$  is a non-compact manifold with corners). Under the identification of  $|\text{cone}(\mathcal{K}')|$  with  $\text{cc}(\mathcal{K})$  the vertex of the cone is mapped to the vertex  $(1, \dots, 1) \in \mathbb{I}^m$ , and  $\mu^{-1}(1, \dots, 1) = \mathbb{T}^m$ . Therefore,

$$\mu^{-1}(\text{cc}(\mathcal{K}) \setminus (1, \dots, 1)) = \mathcal{Z}_{\mathcal{K}} \setminus \mu^{-1}(1, \dots, 1)$$

is an  $(m+n)$ -dimensional non-compact manifold.  $\square$

**REMARK.** A pair of spaces  $(X, A)$  where  $A$  is a compact subset in  $X$  is called a *Lefschetz pair* if  $X \setminus A$  is an open (non-compact) manifold. We therefore obtain that  $(\mathcal{Z}_{\mathcal{K}}, \mu^{-1}(1, \dots, 1))$  is a Lefschetz pair whenever  $\mathcal{K}$  is a triangulated manifold.

We therefore refer to moment-angle complexes  $\mathcal{Z}_{\mathcal{K}}$  corresponding to triangulated spheres as *moment-angle manifolds*. *Polytopal* moment-angle manifolds  $\mathcal{Z}_{\mathcal{K}_P}$ , corresponding to the nerve complexes  $\mathcal{K}_P$  of simple polytopes (see Example 2.2.4), are particularly important. As we shall see in Chapter 6, polytopal moment-angle manifolds are smooth. A smooth structure also exists on moment-angle manifolds  $\mathcal{Z}_{\mathcal{K}}$  corresponding to starshaped spheres  $\mathcal{K}$  (i.e. underlying complexes of complete simplicial fans, see Section 2.5). In general, the smoothness of  $\mathcal{Z}_{\mathcal{K}}$  is open.

The geometry of moment-angle manifolds is nice and rich; it is the subject of Chapter 6.

**Real moment-angle complex  $\mathcal{R}_{\mathcal{K}}$ .** The construction of the moment-angle complex  $\mathcal{Z}_{\mathcal{K}}$  has a real analogue, in which the complex space  $\mathbb{C}^m$  is replaced by the real space  $\mathbb{R}^m$ , the complex polydisc  $\mathbb{D}^m$  is replaced by the ‘big’ cube

$$[-1, 1]^m = \{(u_1, \dots, u_m) \in \mathbb{R}^m : |u_i| \leq 1 \text{ for } i = 1, \dots, m\},$$

the standard torus  $\mathbb{T}^m$  is replaced by the ‘real torus’  $\mathbb{Z}_2^m$  (the product of  $m$  copies of the group  $\mathbb{Z}_2 = \{-1, 1\}$ ), and the pair  $(D^2, S^1)$  is replaced by  $(D^1, S^0)$ , where  $S^0$  (a pair of points) is the boundary of the segment  $D^1$ . The group  $(\mathbb{Z}_2)^m$  acts on the big cube  $[-1, 1]^m$  coordinatewise, with quotient the standard ‘small’ cube  $\mathbb{I}^m$ . The quotient projection  $[-1, 1]^m \rightarrow \mathbb{I}^m$  may be described by the map

$$\rho: (u_1, \dots, u_m) \mapsto (u_1^2, \dots, u_m^2).$$

CONSTRUCTION 4.1.5 (real moment-angle complex). Given a simplicial complex  $\mathcal{K}$  on  $[m]$ , define the *real moment-angle complex*  $\mathcal{R}_{\mathcal{K}}$  from the pullback square

$$\begin{array}{ccc} \mathcal{R}_{\mathcal{K}} & \hookrightarrow & [-1, 1]^m \\ \downarrow & & \downarrow \rho \\ \text{cc}(\mathcal{K}) & \hookrightarrow & \mathbb{I}^m \end{array}$$

Explicitly,  $\mathcal{R}_{\mathcal{K}} = \rho^{-1}(\text{cc}(\mathcal{K}))$ . By construction,  $\mathcal{R}_{\mathcal{K}}$  is a  $\mathbb{Z}_2^m$ -invariant subspace in the ‘big’ cube  $[-1, 1]^m$ , and the quotient  $\mathcal{R}_{\mathcal{K}}/\mathbb{Z}_2^m$  is homeomorphic to  $|\text{cone } \mathcal{K}|$ .

$\mathcal{R}_{\mathcal{K}}$  is a cubical subcomplex in  $[-1, 1]^m$  obtained by reflecting the subcomplex  $\text{cc}(\mathcal{K}) \subset \mathbb{I}^m = [0, 1]^m$  at all  $m$  coordinate hyperplanes of  $\mathbb{R}^m$ . If  $\mathcal{K} = \mathcal{K}_P$  is the nerve complex of a simple polytope  $P$ , then  $\text{cc}(\mathcal{K}_P)$  can be viewed as a cubical subdivision of  $P$  embedded piecewise linearly into  $\mathbb{R}_{\geq 0}^m$  (see Construction 2.9.7). In this case  $\mathcal{R}_{\mathcal{K}_P}$  is obtained by reflecting the image of  $P$  at all coordinate planes.

By analogy with (4.2), we have

$$\mathcal{R}_{\mathcal{K}} = \bigcup_{I \in \mathcal{K}} \left( \prod_{i \in I} D^1 \times \prod_{i \notin I} S^0 \right).$$

EXAMPLE 4.1.6.

1. Let  $\mathcal{K} = \partial \Delta^{m-1}$  be the boundary of the standard simplex. Then  $\mathcal{R}_{\mathcal{K}} \cong S^{m-1}$  is the boundary of the cube  $[-1, 1]^m$ . For  $m = 3$  this complex is obtained by reflecting the complex shown in Fig. 2.14 (b) at all 3 coordinate planes of  $\mathbb{R}^3$ .

2. Let  $\mathcal{K}$  consist of  $m$  disjoint points. Then  $\mathcal{R}_{\mathcal{K}}$  is the 1-dimensional skeleton (graph) of the cube  $[-1, 1]^m$ . For  $m = 3$  this complex is obtained by reflecting the complex shown in Fig. 2.14 (a) at all 3 coordinate planes of  $\mathbb{R}^3$ .

3. More generally, let  $\mathcal{K} = \text{sk}^i \Delta^{m-1}$  be the  $i$ -dimensional skeleton of  $\Delta^{m-1}$  (i.e. the set of all faces of  $\Delta^{m-1}$  of dimension  $\leq i$ ). Then  $\mathcal{R}_{\mathcal{K}}$  is the  $(i+1)$ -dimensional skeleton of the cube  $[-1, 1]^m$ .

The following analogue of Theorem 4.1.4 holds, and is proved similarly:

**THEOREM 4.1.7.** *Let  $\mathcal{K}$  be a triangulation of an  $(n-1)$ -dimensional sphere with  $m$  vertices. Then  $\mathcal{R}_{\mathcal{K}}$  is a (closed) topological manifold of dimension  $n$ .*

*If  $\mathcal{K}$  is a triangulated manifold, then  $\mathcal{R}_{\mathcal{K}} \setminus \rho^{-1}(1, \dots, 1)$  is an (open) non-compact manifold, where  $\rho^{-1}(1, \dots, 1) = \{-1, 1\}^m$ .*

The real moment-angle complexes corresponding to polygons can be identified easily (compare Exercise 4.2.10):

**PROPOSITION 4.1.8.** *Let  $\mathcal{K}$  be the boundary of an  $m$ -gon. Then  $\mathcal{R}_{\mathcal{K}}$  is homeomorphic to an oriented surface  $S_g$  of genus  $g = 1 + (m-4)2^{m-3}$ .*

**PROOF.** We observe that the manifold  $\mathcal{R}_{\mathcal{K}}$  is orientable (an exercise). Since it is 2-dimensional, its topological type is determined by the Euler characteristic. Now  $\mathcal{R}_{\mathcal{K}}$  is obtained by reflecting the  $m$ -gon embedded into  $\mathbb{R}_{\geq}^m$  at  $m$  coordinate hyperplanes, so that  $\mathcal{R}_{\mathcal{K}}$  is patched from  $2^m$  polygons, meeting by 4 at each vertex. Therefore, the number of vertices is  $m2^{m-2}$ , the number of edges is  $m2^{m-1}$ , and the Euler characteristic is

$$\chi(\mathcal{R}_{\mathcal{K}}) = 2^{m-2}(4 - m) = 2 - 2g.$$

The result follows.  $\square$

## 4.2. Polyhedral products

Decomposition (4.2) of  $\mathcal{Z}_{\mathcal{K}}$  which uses the disc and circle  $(D^2, S^1)$  is readily generalised to arbitrary pairs of spaces:

**CONSTRUCTION 4.2.1** (polyhedral product). Let  $\mathcal{K}$  be a simplicial complex on  $[m]$  and

$$(\mathbf{X}, \mathbf{A}) = \{(X_1, A_1), \dots, (X_m, A_m)\}$$

be a collection of  $m$  pairs of spaces,  $A_i \subset X_i$ . For each simplex  $I \in [m]$  we set

$$(4.6) \quad (\mathbf{X}, \mathbf{A})^I = \{(x_1, \dots, x_m) \in \prod_{j=1}^m X_j : x_j \in A_j \text{ for } j \notin I\}$$

and define the *polyhedral product* of  $(\mathbf{X}, \mathbf{A})$  corresponding to  $\mathcal{K}$  by

$$(\mathbf{X}, \mathbf{A})^{\mathcal{K}} = \bigcup_{I \in \mathcal{K}} (\mathbf{X}, \mathbf{A})^I = \bigcup_{I \in \mathcal{K}} \left( \prod_{i \in I} X_i \times \prod_{i \notin I} A_i \right).$$

Using the categorical language, we can define the  $\text{CAT}(\mathcal{K})$ -diagram

$$(4.7) \quad \begin{aligned} \mathcal{D}_{\mathcal{K}}(\mathbf{X}, \mathbf{A}) : \text{CAT}(\mathcal{K}) &\longrightarrow \text{TOP}, \\ I &\longmapsto (\mathbf{X}, \mathbf{A})^I, \end{aligned}$$

which maps the morphism  $I \subset J$  of  $\text{CAT}(\mathcal{K})$  to the inclusion of spaces  $(\mathbf{X}, \mathbf{A})^I \subset (\mathbf{X}, \mathbf{A})^J$ . Then we have

$$(\mathbf{X}, \mathbf{A})^{\mathcal{K}} = \text{colim } \mathcal{D}_{\mathcal{K}}(\mathbf{X}, \mathbf{A}) = \text{colim}_{I \in \mathcal{K}} (\mathbf{X}, \mathbf{A})^I.$$

In the case when all the pairs  $(X_i, A_i)$  are the same, i.e.  $X_i = X$  and  $A_i = A$  for  $i = 1, \dots, m$ , we use the notation  $(X, A)^\mathcal{K}$  for  $(\mathbf{X}, \mathbf{A})^\mathcal{K}$ . Also, if each  $X_i$  is a pointed space and  $A_i = pt$ , then we use the abbreviated notation  $\mathbf{X}^\mathcal{K}$  for  $(\mathbf{X}, pt)^\mathcal{K}$ , and  $X^\mathcal{K}$  for  $(X, pt)^\mathcal{K}$ .

REMARK. The decomposition of  $\mathcal{Z}_\mathcal{K}$  into a union of products of discs and circles first appeared in [52] (in the polytopal case) and in [54] (in general). The term ‘moment-angle complex’ for  $\mathcal{Z}_\mathcal{K} = (D^2, S^1)^\mathcal{K}$  was also introduced in [54], where several other examples of polyhedral products  $(X, A)^\mathcal{K}$  were considered. The definition of  $(X, A)^\mathcal{K}$  for an arbitrary pair of spaces  $(X, A)$  was suggested to the authors by N. Strickland (in a private communication, and also in an unpublished note) as a general framework for the constructions of [54]; it was also included in the final version of [54] and in [55]. Further generalisations of  $(X, A)^\mathcal{K}$  to a set of pairs of spaces  $(\mathbf{X}, \mathbf{A})$  were studied in the work of Grbić and Theriault [133], as well as Bahri, Bendersky, Cohen and Gitler [14], where the term ‘polyhedral product’ was introduced (following a suggestion of W. Browder). Since 2000, the terms ‘generalised moment-angle complex’, ‘ $\mathcal{K}$ -product’ and ‘partial product space’ have been also used to refer to the spaces  $(X, A)^\mathcal{K}$ .

Recall that a *map of pairs*  $(X, A) \rightarrow (X', A')$  is a commutative diagram

$$(4.8) \quad \begin{array}{ccc} A & \hookrightarrow & X \\ \downarrow & & \downarrow \\ A' & \hookrightarrow & X'. \end{array}$$

We refer to  $(X, A)$  as a *monoid pair* if  $X$  is a topological monoid (a space with a continuous associative multiplication and unit), and  $A$  is a submonoid. A *map of monoid pairs* is a map of pairs in which all maps in (4.8) are homomorphisms.

If  $(X, A)$  is a monoid pair, then a set map  $\varphi: [l] \rightarrow [m]$  induces a map

$$(4.9) \quad \psi: \prod_{i=1}^l X \rightarrow \prod_{i=1}^m X, \quad (x_1, \dots, x_l) \mapsto (y_1, \dots, y_m),$$

where

$$y_j = \prod_{i \in \varphi^{-1}(j)} x_i, \quad \text{for } j = 1, \dots, m,$$

and we set  $y_j = 1$  if  $\varphi^{-1}(j) = \emptyset$ .

PROPOSITION 4.2.2. *If  $(X, A)$  is a monoid pair, then  $(X, A)^\mathcal{K}$  is an invariant subspace of  $\prod_{i=1}^m X$  with respect to the coordinatewise action of  $\prod_{i=1}^m A$  on  $\prod_{i=1}^m X$ .*

PROOF. Indeed,  $(X, A)^I \subset \prod_{i=1}^m X$  is an invariant subset for each  $I \in \mathcal{K}$ .  $\square$

The following proposition describes the functorial properties of the polyhedral product in its  $\mathcal{K}$  and  $(\mathbf{X}, \mathbf{A})$  arguments.

PROPOSITION 4.2.3.

- (a) *A set of maps of pairs  $(\mathbf{X}, \mathbf{A}) \rightarrow (\mathbf{X}', \mathbf{A}')$  induces a map of polyhedral products  $(\mathbf{X}, \mathbf{A})^\mathcal{K} \rightarrow (\mathbf{X}', \mathbf{A}')^\mathcal{K}$ . If two sets of maps  $(\mathbf{X}, \mathbf{A}) \rightarrow (\mathbf{X}', \mathbf{A}')$  are componentwise homotopic, then the induced maps  $(\mathbf{X}, \mathbf{A})^\mathcal{K} \rightarrow (\mathbf{X}', \mathbf{A}')^\mathcal{K}$  are also homotopic.*
- (b) *An inclusion of a simplicial subcomplex  $\mathcal{L} \hookrightarrow \mathcal{K}$  induces an inclusion of polyhedral products  $(\mathbf{X}, \mathbf{A})^\mathcal{L} \hookrightarrow (\mathbf{X}, \mathbf{A})^\mathcal{K}$ .*

- (c) If  $(X, A)$  is a monoid pair, then for any simplicial map  $\varphi: \mathcal{L} \rightarrow \mathcal{K}$  of simplicial complexes on the sets  $[l]$  and  $[m]$  respectively, the map (4.9) restricts to a map of polyhedral products  $\varphi_{\mathcal{Z}}: (X, A)^{\mathcal{L}} \rightarrow (X, A)^{\mathcal{K}}$ .
- (d) If  $(X, A)$  is a commutative monoid pair, then the restriction

$$\psi|_A: \prod_{i=1}^l A \rightarrow \prod_{i=1}^m A$$

of (4.9) is a homomorphism, and the induced map  $\varphi_{\mathcal{Z}}: (X, A)^{\mathcal{L}} \rightarrow (X, A)^{\mathcal{K}}$  is  $\psi|_A$ -equivariant, i.e.

$$\varphi_{\mathcal{Z}}(\mathbf{a} \cdot \mathbf{x}) = \psi|_A(\mathbf{a}) \cdot \varphi_{\mathcal{Z}}(\mathbf{x})$$

for all  $\mathbf{a} = (a_1, \dots, a_l) \in \prod_{i=1}^l A$  and  $\mathbf{x} = (x_1, \dots, x_l) \in (X, A)^{\mathcal{L}}$ .

PROOF. For (a), we observe that a set of maps  $(\mathbf{X}, \mathbf{A}) \rightarrow (\mathbf{X}', \mathbf{A}')$  induces a map  $(\mathbf{X}, \mathbf{A})^I \rightarrow (\mathbf{X}', \mathbf{A}')^I$  for each  $I \in \mathcal{K}$ , and these maps corresponding to different  $I, J \in \mathcal{K}$  are compatible on the intersection  $(\mathbf{X}, \mathbf{A})^I \cap (\mathbf{X}, \mathbf{A})^J = (\mathbf{X}, \mathbf{A})^{I \cap J}$ . We therefore obtain a map  $(\mathbf{X}, \mathbf{A})^{\mathcal{K}} \rightarrow (\mathbf{X}', \mathbf{A}')^{\mathcal{K}}$ . A componentwise homotopy between two maps  $(\mathbf{X}, \mathbf{A}) \rightarrow (\mathbf{X}', \mathbf{A}')$  can be thought of as a map of pairs  $(\mathbf{X} \times \mathbb{I}, \mathbf{A} \times \mathbb{I}) \rightarrow (\mathbf{X}', \mathbf{A}')$ , where  $\mathbf{X} \times \mathbb{I}$  consists of spaces  $X_i \times \mathbb{I}$ . It therefore induces a map of polyhedral products

$$(\mathbf{X} \times \mathbb{I}, \mathbf{A} \times \mathbb{I})^{\mathcal{K}} \rightarrow (\mathbf{X}', \mathbf{A}')^{\mathcal{K}}$$

where  $(\mathbf{X} \times \mathbb{I}, \mathbf{A} \times \mathbb{I})^{\mathcal{K}} \cong (\mathbf{X}, \mathbf{A})^{\mathcal{K}} \times (\mathbb{I}, \mathbb{I})^{\mathcal{K}} = (\mathbf{X}, \mathbf{A})^{\mathcal{K}} \times \mathbb{I}^m$ . By restricting the resulting map  $(\mathbf{X}, \mathbf{A})^{\mathcal{K}} \times \mathbb{I}^m \rightarrow (\mathbf{X}', \mathbf{A}')^{\mathcal{K}}$  to the diagonal of the cube  $\mathbb{I}^m$  we obtain a homotopy between the two induced maps  $(\mathbf{X}, \mathbf{A})^{\mathcal{K}} \rightarrow (\mathbf{X}', \mathbf{A}')^{\mathcal{K}}$ .

To prove (b) we just observe that if  $\mathcal{L}$  is a subcomplex of  $\mathcal{K}$ , then for each  $I \in \mathcal{L}$  we have  $(\mathbf{X}, \mathbf{A})^I \subset \mathcal{Z}_{\mathcal{K}}$ .

To prove (c) we observe that for any subset  $I \subset [m]$  we have  $\psi((X, A)^I) \subset (X, A)^{\varphi(I)}$ . Let  $I \in \mathcal{L}$ , so that  $(X, A)^I \subset (X, A)^{\mathcal{L}}$ . Since  $\varphi$  is a simplicial map, we have  $\varphi(I) \in \mathcal{K}$  and  $(X, A)^{\varphi(I)} \subset (X, A)^{\mathcal{K}}$ . Therefore, the map  $\psi$  restricts to a map of polyhedral products  $(X, A)^{\mathcal{L}} \rightarrow (X, A)^{\mathcal{K}}$ .

Statement (d) is proved by a direct calculation:

$$\begin{aligned} \varphi_{\mathcal{Z}}(\mathbf{a} \cdot \mathbf{x}) &= \varphi_{\mathcal{Z}}(a_1 x_1, \dots, a_l x_l) = \left( \prod_{i \in \varphi^{-1}(1)} a_i x_i, \dots, \prod_{i \in \varphi^{-1}(m)} a_i x_i \right) \\ &= \left( \prod_{i \in \varphi^{-1}(1)} a_i \prod_{i \in \varphi^{-1}(1)} x_i, \dots, \prod_{i \in \varphi^{-1}(m)} a_i \prod_{i \in \varphi^{-1}(m)} x_i \right) \\ &= \left( \prod_{i \in \varphi^{-1}(1)} a_i, \dots, \prod_{i \in \varphi^{-1}(m)} a_i \right) \cdot \left( \prod_{i \in \varphi^{-1}(1)} x_i, \dots, \prod_{i \in \varphi^{-1}(m)} x_i \right) \\ &= \psi|_A(\mathbf{a}) \cdot \varphi_{\mathcal{Z}}(\mathbf{x}). \end{aligned}$$

Note that we have used the commutativity of  $X$  in the third identity.  $\square$

We state the most important particular case of Proposition 4.2.3 separately:

PROPOSITION 4.2.4. *A simplicial map  $\mathcal{L} \rightarrow \mathcal{K}$  of simplicial complexes on the sets  $[l]$  and  $[m]$  gives rise to a map of moment-angle complexes  $\mathcal{Z}_{\mathcal{L}} \rightarrow \mathcal{Z}_{\mathcal{K}}$  which is equivariant with respect to the induced homomorphism of tori  $\mathbb{T}^l \rightarrow \mathbb{T}^m$ .*

The polyhedral product construction behaves nicely with respect to the join operation (the proof is exactly the same as that of Proposition 4.1.3):

PROPOSITION 4.2.5. *We have that*

$$(\mathbf{X}, \mathbf{A})^{\mathcal{K}_1 * \mathcal{K}_2} = (\mathbf{X}, \mathbf{A})^{\mathcal{K}_1} \times (\mathbf{X}, \mathbf{A})^{\mathcal{K}_2}.$$

EXAMPLE 4.2.6.

1. The moment-angle complex  $\mathcal{Z}_{\mathcal{K}}$  is the polyhedral product  $(D^2, S^1)^{\mathcal{K}}$  (when considered abstractly) or  $(\mathbb{D}, \mathbb{S})^{\mathcal{K}}$  (when viewed as a subcomplex in  $\mathbb{D}^m$ ).

2. For the cubical complex of (2.13) we have

$$\text{cc}(\mathcal{K}) = (I^1, 1)^{\mathcal{K}},$$

where  $I^1 = [0, 1]$  is the unit interval and 1 is its edge. The quotient map  $\mathcal{Z}_{\mathcal{K}} \rightarrow |\text{cone } \mathcal{K}|$  is the map of polyhedral products  $(D^2, S^1)^{\mathcal{K}} \rightarrow (I^1, 1)^{\mathcal{K}}$  induced by the map of pairs  $(D^2, S^1) \rightarrow (I^1, 1)$ , which is the quotient map by the  $S^1$ -action.

3. For the real moment-angle complex we have

$$\mathcal{R}_{\mathcal{K}} = (D^1, S^0)^{\mathcal{K}},$$

Where  $D^1 = [-1, 1]$  is a 1-disc, and  $S^0 = \{-1, 1\}$  is its boundary.

4. If  $\mathcal{K}$  consists of  $m$  disjoint points and  $A_i = pt$ , then

$$(\mathbf{X}, pt)^{\mathcal{K}} = \mathbf{X}^{\mathcal{K}} = X_1 \vee X_2 \vee \cdots \vee X_m$$

is the *wedge* (or *bouquet*) of the  $X_i$ 's.

5. More generally, consider the sequence of inclusions of skeleta

$$\text{sk}^0 \Delta^{m-1} \subset \cdots \subset \text{sk}^{m-2} \Delta^{m-1} \subset \text{sk}^{m-1} \Delta^{m-1} = \Delta^{m-1}.$$

It gives rise to a filtration in the product  $X_1 \times X_2 \times \cdots \times X_m$ :

$$\begin{array}{ccccccc} \mathbf{X}^{\text{sk}^0 \Delta^{m-1}} & \subset & \cdots & \subset & \mathbf{X}^{\text{sk}^{m-2} \Delta^{m-1}} & \subset & \mathbf{X}^{\text{sk}^{m-1} \Delta^{m-1}} \\ \parallel & & & & \parallel & & \parallel \\ X_1 \vee X_2 \vee \cdots \vee X_m & & & & \mathbf{X}^{\partial \Delta^{m-1}} & & X_1 \times X_2 \times \cdots \times X_m \end{array}$$

Its second-to-last term,  $\mathbf{X}^{\partial \Delta^{m-1}}$  is known to topologists as the *fat wedge* of the  $X_i$ 's. Explicitly, the fat wedge of a sequence of pointed spaces  $X_1, \dots, X_m$  is

$$(X_1 \times \cdots \times X_{m-1} \times pt) \cup (X_1 \times \cdots \times pt \times X_m) \cup \cdots \cup (pt \times \cdots \times X_{m-1} \times X_m),$$

where the union is taken inside the product  $X_1 \times X_2 \times \cdots \times X_m$ .

The filtration above was considered by G. Porter [264], who obtained a decomposition of its loop spaces into a wedge in the case when each  $X_i$  is a suspension, generalising the *Hilton–Milnor Theorem*. We shall consider this decomposition in more detail in Section 8.3.

### Exercises.

4.2.7. Show that if  $\mathcal{K}$  is a triangulated sphere, then the manifold  $\mathcal{R}_{\mathcal{K}}$  is orientable. (Hint: use the fact that  $\mathcal{R}_{\mathcal{K}}$  is obtained by reflecting the  $n$ -ball  $|\text{cone } \mathcal{K}|$  at all  $m$  coordinate hyperplanes of  $\mathbb{R}^m$  to extend the orientation from  $|\text{cone } \mathcal{K}|$  to the whole of  $\mathcal{R}_{\mathcal{K}}$ .)

4.2.8. Show that if  $\mathcal{K} = \text{sk}^i \Delta^{m-1}$ , then  $\mathcal{R}_{\mathcal{K}}$  is homotopy equivalent to a wedge of  $(i+1)$ -dimensional spheres (see Example 4.1.6.3). The number of spheres is given by  $\sum_{k=i+2}^m \binom{m}{k} \binom{k-1}{i+1}$ .

4.2.9. Let  $\mathcal{K}$  be the complex consisting of three disjoint points. Show that  $\mathcal{Z}_{\mathcal{K}}$  is homotopy equivalent to the following wedge (bouquet) of spheres:

$$\mathcal{Z}_{\mathcal{K}} \cong S^3 \vee S^3 \vee S^3 \vee S^4 \vee S^4.$$

(Hint: compare the case  $m = 3, i = 0$  of the previous exercise; it may also help to look at the realisation of  $\mathcal{Z}_{\mathcal{K}}$  as the complement of a coordinate subspace arrangement (up to homotopy), see Section 4.7.)

4.2.10. Let  $\mathcal{K}$  be the boundary of a 5-gon. Show that the manifold  $\mathcal{Z}_{\mathcal{K}}$  is homeomorphic to  $(S^3 \times S^4)^{\#5}$ , a connected sum of 5 copies of  $S^3 \times S^4$ . (This may be a difficult one; the general statement is given in Theorem 4.6.12 below. The reader may return to this exercise after reading Section 6.2, see Exercise 6.2.15.)

4.2.11. If  $\mathcal{K}$  is a triangulation of an  $(n-1)$ -sphere with  $m$  vertices, then for any  $k > 0$  the polyhedral product  $(D^k, S^{k-1})^{\mathcal{K}}$  is a manifold of dimension  $m(k-1) + n$ .

4.2.12. More generally, if  $(M, \partial M)$  is a manifold with boundary and  $\mathcal{K}$  is a triangulated sphere, then  $(M, \partial M)^{\mathcal{K}}$  is a manifold (without boundary). If  $(M, \partial M)$  is a  $PL$  manifold, and  $\mathcal{K}$  is a  $PL$  sphere, then the manifold  $(M, \partial M)^{\mathcal{K}}$  is also  $PL$ .

4.2.13. Let  $\mathcal{K}_I$  be the full subcomplex corresponding to  $I \subset [m]$ . Then  $\mathcal{Z}_{\mathcal{K}_I}$  is a retract of  $\mathcal{Z}_{\mathcal{K}}$ .

### 4.3. Homotopical properties

Two key observations of this section constitute the basis for the subsequent applications of the commutative algebra apparatus of Chapter 3 to toric topology. First, the cohomology of the polyhedral product space of the form  $(\mathbb{C}P^\infty)^{\mathcal{K}} = (\mathbb{C}P^\infty, pt)^{\mathcal{K}}$  is isomorphic to the face ring  $\mathbb{Z}[\mathcal{K}]$  (Proposition 4.3.1). Second, the moment-angle complex  $\mathcal{Z}_{\mathcal{K}} = (D^2, S^1)^{\mathcal{K}}$  is the homotopy fibre of the canonical inclusion  $(\mathbb{C}P^\infty)^{\mathcal{K}} \hookrightarrow (\mathbb{C}P^\infty, \mathbb{C}P^\infty)^{\mathcal{K}} = (\mathbb{C}P^\infty)^m$  (Theorem 4.3.2).

The classifying space  $BS^1$  of the circle  $S^1$  is the infinite-dimensional complex projective space  $\mathbb{C}P^\infty$ . The classifying space  $BT^m$  of the  $m$ -torus  $T^m$  is the product  $(\mathbb{C}P^\infty)^m$  of  $m$  copies of  $\mathbb{C}P^\infty$ . The universal principal  $S^1$ -bundle is the infinite Hopf bundle  $S^\infty \rightarrow \mathbb{C}P^\infty$  (the direct limit of Hopf bundles  $S^{2k+1} \rightarrow \mathbb{C}P^k$ ), so the total space  $ET^m$  of the universal principal  $T^m$ -bundle over  $BT^m$  can be identified with the  $m$ -fold product of the infinite-dimensional sphere  $S^\infty$ .

The integral cohomology ring of  $BT^m$  is isomorphic to the polynomial ring  $\mathbb{Z}[v_1, \dots, v_m]$ ,  $\deg v_i = 2$  (this explains our choice of grading). The space  $BT^m$  has the canonical cell decomposition, in which each factor  $\mathbb{C}P^\infty$  has one cell in every even dimension. The polyhedral product

$$(\mathbb{C}P^\infty)^{\mathcal{K}} = \bigcup_{I \in \mathcal{K}} (\mathbb{C}P^\infty, pt)^I$$

is a cellular subcomplex in  $BT^m = (\mathbb{C}P^\infty)^m$ .

**PROPOSITION 4.3.1.** *The cohomology ring of  $(\mathbb{C}P^\infty)^{\mathcal{K}}$  is isomorphic to the face ring  $\mathbb{Z}[\mathcal{K}]$ . The inclusion of a cellular subcomplex*

$$i: (\mathbb{C}P^\infty)^{\mathcal{K}} \hookrightarrow (\mathbb{C}P^\infty)^m$$

*induces the quotient projection in cohomology:*

$$i^*: \mathbb{Z}[v_1, \dots, v_m] \rightarrow \mathbb{Z}[v_1, \dots, v_m]/\mathcal{I}_{\mathcal{K}} = \mathbb{Z}[\mathcal{K}].$$

PROOF. Since  $(\mathbb{C}P^\infty)^m$  has only even-dimensional cells and  $(\mathbb{C}P^\infty)^\mathcal{K}$  is a cellular subcomplex, the cohomology of both spaces coincides with their cellular cochains. Let  $D_j^{2k}$  denote the  $2k$ -dimensional cell in the  $j$ th factor of  $(\mathbb{C}P^\infty)^m$ . The cellular cochain group  $\mathcal{C}^*((\mathbb{C}P^\infty)^m)$  has basis of cochains  $(D_{j_1}^{2k_1} \cdots D_{j_p}^{2k_p})^*$  dual to the products of cells  $D_{j_1}^{2k_1} \times \cdots \times D_{j_p}^{2k_p}$ . The cochain map

$$\mathcal{C}^*((\mathbb{C}P^\infty)^m) \rightarrow \mathcal{C}^*((\mathbb{C}P^\infty)^\mathcal{K})$$

induced by the inclusion  $(\mathbb{C}P^\infty)^\mathcal{K} \hookrightarrow (\mathbb{C}P^\infty)^m$  is an epimorphism with kernel generated by those cochains  $(D_{j_1}^{2k_1} \cdots D_{j_p}^{2k_p})^*$  for which  $\{j_1, \dots, j_p\} \notin \mathcal{K}$ . Under the identification of  $\mathcal{C}^*((\mathbb{C}P^\infty)^m)$  with  $\mathbb{Z}[v_1, \dots, v_m]$ , a cochain  $(D_{j_1}^{2k_1} \cdots D_{j_p}^{2k_p})^*$  is mapped to the monomial  $v_{j_1}^{k_1} \cdots v_{j_p}^{k_p}$ . Therefore,  $\mathcal{C}^*((\mathbb{C}P^\infty)^\mathcal{K})$  is identified with the quotient of  $\mathbb{Z}[v_1, \dots, v_m]$  by the subgroup generated by all monomials  $v_{j_1}^{k_1} \cdots v_{j_p}^{k_p}$  with  $\{j_1, \dots, j_p\} \notin \mathcal{K}$ . By Proposition 3.1.9, this quotient is exactly  $\mathbb{Z}[\mathcal{K}]$ .  $\square$

We consider the Borel construction  $ET^m \times_{T^m} \mathcal{Z}_\mathcal{K}$  for the  $T^m$ -space  $\mathcal{Z}_\mathcal{K}$  (see Appendix B.3).

THEOREM 4.3.2. *The inclusion  $i: (\mathbb{C}P^\infty)^\mathcal{K} \hookrightarrow (\mathbb{C}P^\infty)^m$  is decomposed into a composition of a homotopy equivalence*

$$h: (\mathbb{C}P^\infty)^\mathcal{K} \xrightarrow{\cong} ET^m \times_{T^m} \mathcal{Z}_\mathcal{K}$$

and the fibration  $p: ET^m \times_{T^m} \mathcal{Z}_\mathcal{K} \rightarrow BT^m = (\mathbb{C}P^\infty)^m$  with fibre  $\mathcal{Z}_\mathcal{K}$ .

In particular, the moment-angle complex  $\mathcal{Z}_\mathcal{K}$  is the homotopy fibre of the canonical inclusion  $i: (\mathbb{C}P^\infty)^\mathcal{K} \hookrightarrow (\mathbb{C}P^\infty)^m$ .

PROOF. We use functoriality and homotopy invariance of the polyhedral product construction (Proposition 4.2.3). We have  $\mathcal{Z}_\mathcal{K} = \bigcup_{I \in \mathcal{K}} (D^2, S^1)^I$ , see (4.1), and each subset  $(D^2, S^1)^I$  is  $T^m$ -invariant. We therefore obtain the following decomposition of the Borel construction as a polyhedral product:

$$\begin{aligned} ET^m \times_{T^m} \mathcal{Z}_\mathcal{K} &= \bigcup_{I \in \mathcal{K}} (ET^m \times_{T^m} (D^2, S^1)^I) = \bigcup_{I \in \mathcal{K}} (S^\infty \times_{S^1} D^2, S^\infty \times_{S^1} S^1)^I \\ &= (S^\infty \times_{S^1} D^2, S^\infty \times_{S^1} S^1)^\mathcal{K}, \end{aligned}$$

where  $S^\infty = ET^1 = ES^1$ .

Now consider the commutative diagram

$$(4.10) \quad \begin{array}{ccccc} pt & \longrightarrow & S^\infty \times_{S^1} S^1 & \longrightarrow & pt \\ \downarrow & & \downarrow & & \downarrow \\ \mathbb{C}P^\infty & \xrightarrow{j} & S^\infty \times_{S^1} D^2 & \xrightarrow{f} & \mathbb{C}P^\infty, \end{array}$$

where  $j$  is the inclusion of the zero section in a disc bundle (note that  $\mathbb{C}P^\infty = S^\infty/S^1$ ), and  $f$  is the projection map from the bundle to its Thom space,

$$f: S^\infty \times_{S^1} D^2 \rightarrow (S^\infty \times_{S^1} D^2)/(S^\infty \times_{S^1} S^1) \cong \mathbb{C}P^\infty.$$

Since  $S^\infty \times_{S^1} S^1 = S^\infty$  and  $D^2$  are contractible, the composite maps  $f \circ j$  and  $j \circ f$  are homotopic to the identity. It follows that we have a homotopy equivalence of



pairs  $(\mathbb{C}P^\infty, pt) \rightarrow (S^\infty \times_{S^1} D^2, S^\infty \times_{S^1} S^1)$  which induces a homotopy equivalence of polyhedral products

$$h: (\mathbb{C}P^\infty)^\mathcal{K} \rightarrow (S^\infty \times_{S^1} D^2, S^\infty \times_{S^1} S^1)^\mathcal{K} = ET^m \times_{T^m} \mathcal{Z}_\mathcal{K}.$$

In order to establish the factorisation  $i = p \circ h$  we consider the diagram

$$\begin{array}{ccccc} pt & \longrightarrow & S^\infty \times_{S^1} S^1 & \longrightarrow & \mathbb{C}P^\infty \\ \downarrow & & \downarrow & & \parallel \\ \mathbb{C}P^\infty & \xrightarrow{j} & S^\infty \times_{S^1} D^2 & \xrightarrow{g} & \mathbb{C}P^\infty, \end{array}$$

where  $g$  is the projection of the disc bundle onto its base (note that this map is different from the map  $f$  above). By passing to the induced maps of polyhedral products we obtain the factorisation of

$$i: (\mathbb{C}P^\infty)^\mathcal{K} \xrightarrow{h} (S^\infty \times_{S^1} D^2, S^\infty \times_{S^1} S^1)^\mathcal{K} \xrightarrow{p} (\mathbb{C}P^\infty, \mathbb{C}P^\infty)^\mathcal{K}$$

into the composition of  $h$  and  $p$ .  $\square$

The following statement is originally due to Davis and Januszkiewicz [90, Theorem 4.8] (they used a different model for  $\mathcal{Z}_\mathcal{K}$ , which will be discussed in Section 6.2).

**COROLLARY 4.3.3.** *The equivariant cohomology ring of the moment-angle complex  $\mathcal{Z}_\mathcal{K}$  is isomorphic to the face ring of  $\mathcal{K}$ :*

$$H_{T^m}^*(\mathcal{Z}_\mathcal{K}) \cong \mathbb{Z}[\mathcal{K}].$$

*In equivariant cohomology, the projection  $p: ET^m \times_{T^m} \mathcal{Z}_\mathcal{K} \rightarrow BT^m$  induces the quotient projection*

$$p^*: \mathbb{Z}[v_1, \dots, v_m] \rightarrow \mathbb{Z}[\mathcal{K}] = \mathbb{Z}[v_1, \dots, v_m]/\mathcal{I}_\mathcal{K}.$$

**PROOF.** This follows from Theorem 4.3.2 and Proposition 4.3.1.  $\square$

In view of this result, the Borel construction  $ET^m \times_{T^m} \mathcal{Z}_\mathcal{K}$  is often called the *Davis–Januszkiewicz space* and denoted by  $DJ(\mathcal{K})$ . According to Theorem 4.3.2 it is modelled (up to homotopy) on the polyhedral product  $(\mathbb{C}P^\infty)^\mathcal{K}$ .

**EXAMPLE 4.3.4.** Let  $\mathcal{K}$  be the complex consisting of two disjoint points. Then  $\mathcal{Z}_\mathcal{K} \cong S^3$  and  $(\mathbb{C}P^\infty)^\mathcal{K} = \mathbb{C}P^\infty \vee \mathbb{C}P^\infty$  (a wedge of two copies of  $\mathbb{C}P^\infty$ ). The Borel construction  $ET^2 \times_{T^2} \mathcal{Z}_\mathcal{K}$  can be identified with the total space of the sphere bundle  $S(\eta \times \eta)$  associated with the product of two universal (Hopf) complex line bundles  $\eta$  over  $BT^1 = \mathbb{C}P^\infty$ . By Theorem 4.3.2, the space  $ET^2 \times_{T^2} \mathcal{Z}_\mathcal{K}$  is homotopy equivalent to  $\mathbb{C}P^\infty \vee \mathbb{C}P^\infty$ , and the bundle projection  $S(\eta \times \eta) \rightarrow \mathbb{C}P^\infty \times \mathbb{C}P^\infty$  induces the quotient projection  $\mathbb{Z}[v_1, v_2] \rightarrow \mathbb{Z}[v_1, v_2]/(v_1 v_2)$  in cohomology.

We have the following basic information about the homotopy groups of  $\mathcal{Z}_\mathcal{K}$ :

**PROPOSITION 4.3.5.**

- (a) *If  $\mathcal{K}$  is a simplicial complex on the vertex set  $[m]$  (i.e. there are no ghost vertices), then the moment-angle complex  $\mathcal{Z}_\mathcal{K}$  is 2-connected (i.e.  $\pi_1(\mathcal{Z}_\mathcal{K}) = \pi_2(\mathcal{Z}_\mathcal{K}) = 0$ ), and*

$$\pi_i(\mathcal{Z}_\mathcal{K}) = \pi_i((\mathbb{C}P^\infty)^\mathcal{K}) \quad \text{for } i \geq 3.$$

- (b) *If  $\mathcal{K}$  is a  $q$ -neighbourly simplicial complex, then  $\pi_i(\mathcal{Z}_\mathcal{K}) = 0$  for  $i < 2q + 1$ . Furthermore,  $\pi_{2q+1}(\mathcal{Z}_\mathcal{K})$  is a free abelian group of rank equal to the number of  $(q + 1)$ -element missing faces of  $\mathcal{K}$ .*

PROOF. We observe that  $(\mathbb{C}P^\infty)^m$  is the Eilenberg–Mac Lane space  $K(\mathbb{Z}^m, 2)$ , and the 3-dimensional skeleton of  $(\mathbb{C}P^\infty)^\mathcal{K}$  coincides with the 3-skeleton of  $(\mathbb{C}P^\infty)^m$ . If  $\mathcal{K}$  is  $q$ -neighbourly, then the  $(2q+1)$ -skeletons of  $(\mathbb{C}P^\infty)^\mathcal{K}$  and  $(\mathbb{C}P^\infty)^m$  agree. Now both statements follow from the exact homotopy sequence of the map  $(\mathbb{C}P^\infty)^\mathcal{K} \rightarrow (\mathbb{C}P^\infty)^m$  with homotopy fibre  $\mathcal{Z}_\mathcal{K}$ .  $\square$

EXAMPLE 4.3.6. Let  $\mathcal{K} = \text{sk}_1 \Delta^3$  (a complete graph on 4 vertices). Then  $\mathcal{K}$  is 2-neighbourly and has 4 missing triangles, so  $\mathcal{Z}_\mathcal{K}$  is 4-connected and  $\pi_5(\mathcal{Z}_\mathcal{K}) = \mathbb{Z}^4$ .

### Exercises.

4.3.7. By analogy with Proposition 4.3.1, show that

$$H^*((\mathbb{R}P^\infty)^\mathcal{K}, \mathbb{Z}_2) \cong \mathbb{Z}_2[v_1, \dots, v_m] / (v_{i_1} \cdots v_{i_k} : \{i_1, \dots, i_k\} \notin \mathcal{K}), \quad \deg v_i = 1.$$

4.3.8. Consider a sequence of pointed odd-dimensional spheres

$$\mathbf{S} = (S^{2p_1-1}, \dots, S^{2p_m-1}).$$

Show that there is an isomorphism of rings

$$H^*((\mathbf{S})^\mathcal{K}) \cong \Lambda[u_1, \dots, u_m] / (u_{i_1} \cdots u_{i_k} : \{i_1, \dots, i_k\} \notin \mathcal{K}), \quad \deg u_i = 2p_i - 1.$$

This ring is known as the *exterior face ring* of  $\mathcal{K}$ . In the case  $p_1 = \cdots = p_m = 1$  we obtain  $(\mathbf{S})^\mathcal{K} = (S^1)^\mathcal{K}$ , which is a cell subcomplex in the torus  $T^m$ .

For a more general statement describing the cohomology of the polyhedral product  $\mathbf{X}^\mathcal{K}$ , see Theorem 8.3.7.

4.3.9 ([95, Lemma 2.3.1]). Assume given commutative diagrams

$$\begin{array}{ccccc} F'_i & \longrightarrow & E'_i & \longrightarrow & B_i \\ \downarrow & & \downarrow & & \parallel \\ F_i & \longrightarrow & E_i & \longrightarrow & B_i \end{array}$$

of cell complexes where the horizontal arrows are fibrations and the vertical arrows are inclusions of cell subcomplexes, for  $i = 1, \dots, m$ . Denote by  $(\mathbf{F}, \mathbf{F}')$ ,  $(\mathbf{E}, \mathbf{E}')$  and  $(\mathbf{B}, \mathbf{B})$  the corresponding sequences of pairs. Show that there is a fibration of polyhedral products

$$(\mathbf{F}, \mathbf{F}')^\mathcal{K} \rightarrow (\mathbf{E}, \mathbf{E}')^\mathcal{K} \rightarrow (\mathbf{B}, \mathbf{B})^\mathcal{K}$$

where  $(\mathbf{B}, \mathbf{B})^\mathcal{K} = B_1 \times \cdots \times B_m$ .

4.3.10. Use the previous exercise, the path-loop fibration  $\Omega X \rightarrow PX \rightarrow X$  and homotopy invariance of the polyhedral product (Proposition 4.2.3) to show that the homotopy fibre of the inclusion  $\mathbf{X}^\mathcal{K} \rightarrow \mathbf{X}^m$  is  $(PX, \Omega X)^\mathcal{K}$  or, equivalently,  $(\text{cone } \Omega X, \Omega X)^\mathcal{K}$ . That is, construct a homotopy fibration

$$(PX, \Omega X)^\mathcal{K} \rightarrow (\mathbf{X}, pt)^\mathcal{K} \rightarrow (\mathbf{X}, \mathbf{X})^\mathcal{K}.$$

When  $X_i = \mathbb{C}P^\infty$  we obtain the homotopy fibration  $\mathcal{Z}_\mathcal{K} \rightarrow (\mathbb{C}P^\infty)^\mathcal{K} \rightarrow (\mathbb{C}P^\infty)^m$  of Theorem 4.3.2.

4.3.11. When  $\mathcal{K}$  is a pair of points and  $\mathbf{X} = (X_1, X_2)$ , show that  $(PX, \Omega X)^\mathcal{K}$  is homotopy equivalent to  $\Sigma \Omega X_1 \wedge \Omega X_2$ . Deduce *Ganea's Theorem* identifying the homotopy fibre of the inclusion  $X_1 \vee X_2 \rightarrow X_1 \times X_2$  with  $\Sigma \Omega X_1 \wedge \Omega X_2$ .

4.3.12. In the setting of Example 4.3.4, consider the diagonal circle  $S^1_d \subset T^2$ . Show that it acts freely on  $\mathcal{Z}_{\mathcal{K}} \cong S^3$ . Deduce that the Borel construction  $ET^2 \times_{T^2} \mathcal{Z}_{\mathcal{K}}$  is homotopy equivalent to  $ES^1 \times_{S^1} \mathbb{C}P^1$ , where  $\mathbb{C}P^1 = S^3/S^1_d$  with  $S^1$ -action given by  $t \cdot [z_0 : z_1] = [z_0 : tz_1]$ . It follows that  $ES^1 \times_{S^1} \mathbb{C}P^1 \simeq \mathbb{C}P^\infty \vee \mathbb{C}P^\infty$ . Show that  $ES^1 \times_{S^1} \mathbb{C}P^1$  can be identified with the complex projectivisation  $\mathbb{C}P(\eta \oplus \bar{\eta})$ , where  $\eta$  is the tautological line bundle over  $\mathbb{C}P^\infty$  and  $\bar{\eta}$  is its complex conjugate. What can be said about the complex projectivisation  $\mathbb{C}P(\eta \oplus \eta)$ ?

### 4.4. Cell decomposition

We consider the following decomposition of the disc  $\mathbb{D}$  into 3 cells: the point  $1 \in \mathbb{D}$  is the 0-cell; the complement to 1 in the boundary circle is the 1-cell, which we denote by  $T$ ; and the interior of  $\mathbb{D}$  is the 2-cell, which we denote by  $D$ . By taking product we obtain a cellular decomposition of  $\mathbb{D}^m$  whose cells are parametrised by pairs of subsets  $J, I \subset [m]$  with  $J \cap I = \emptyset$ : the set  $J$  parametrises the  $T$ -cells in

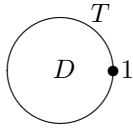

the product and  $I$  parametrises the  $D$ -cells. We denote the cell of  $\mathbb{D}^m$  corresponding to a pair  $J, I$  by  $\varkappa(J, I)$ ; it is a product of  $|J|$  cells of  $T$ -type and  $|I|$  cells of  $D$ -type (the positions in  $[m] \setminus I \cup J$  are filled by 0-cells). Then  $\mathcal{Z}_{\mathcal{K}}$  embeds as a cellular subcomplex in  $\mathbb{D}^m$ ; we have  $\varkappa(J, I) \subset \mathcal{Z}_{\mathcal{K}}$  whenever  $I \in \mathcal{K}$ .

Let  $\mathcal{C}^*(\mathcal{Z}_{\mathcal{K}})$  be the cellular cochains of  $\mathcal{Z}_{\mathcal{K}}$ . It has a basis of cochains  $\varkappa(J, I)^*$  dual to the corresponding cells. We introduce the bigrading by setting

$$\text{bideg } \varkappa(J, I)^* = (-|J|, 2|I| + 2|J|),$$

so that  $\text{bideg } D = (0, 2)$ ,  $\text{bideg } T = (-1, 2)$  and  $\text{bideg } 1 = (0, 0)$ . Since the cellular differential preserves the second grading, the complex  $\mathcal{C}^*(\mathcal{Z}_{\mathcal{K}})$  splits into the sum of its components with fixed second degree:

$$(4.11) \quad \mathcal{C}^*(\mathcal{Z}_{\mathcal{K}}) = \bigoplus_{q=0}^m \mathcal{C}^{*,2q}(\mathcal{Z}_{\mathcal{K}}).$$

The cohomology of the moment-angle complex therefore acquires an additional grading, and we define the *bigraded Betti numbers* of  $\mathcal{Z}_{\mathcal{K}}$  by

$$(4.12) \quad b^{-p,2q}(\mathcal{Z}_{\mathcal{K}}) = \text{rank } H^{-p,2q}(\mathcal{Z}_{\mathcal{K}}), \quad \text{for } 1 \leq p, q \leq m.$$

The ordinary Betti numbers of  $\mathcal{Z}_{\mathcal{K}}$  therefore satisfy

$$(4.13) \quad b^k(\mathcal{Z}_{\mathcal{K}}) = \sum_{-p+2q=k} b^{-p,2q}(\mathcal{Z}_{\mathcal{K}}).$$

The map of the moment-angle complexes  $\mathcal{Z}_{\mathcal{K}} \rightarrow \mathcal{Z}_{\mathcal{L}}$  induced by a simplicial map  $\mathcal{K} \rightarrow \mathcal{L}$  (see Proposition 4.2.4) is clearly a cellular map. We therefore obtain

**PROPOSITION 4.4.1.** *The correspondence  $\mathcal{K} \mapsto \mathcal{Z}_{\mathcal{K}}$  gives rise to a functor from the category of simplicial complexes and simplicial maps to the category of cell complexes with torus actions and equivariant maps. It also induces a natural transformation between the functor of simplicial cochains of  $\mathcal{K}$  and the functor of cellular cochains of  $\mathcal{Z}_{\mathcal{K}}$ .*

The map  $\mathcal{Z}_{\mathcal{K}} \rightarrow \mathcal{Z}_{\mathcal{L}}$  induced by a simplicial map  $\mathcal{K} \rightarrow \mathcal{L}$  preserves the cellular bigrading, so that the bigraded cohomology groups are also functorial.

### 4.5. Cohomology ring

The main result of this section, Theorem 4.5.4, establishes an isomorphism between the integral cohomology ring of the moment-angle complex  $\mathcal{Z}_{\mathcal{K}}$  and the Tor-algebra of the simplicial complex  $\mathcal{K}$ . This result was first proved in [53] for field coefficients using the Eilenberg–Moore spectral sequence of the fibration  $\mathcal{Z}_{\mathcal{K}} \rightarrow (\mathbb{C}P^\infty)^{\mathcal{K}} \rightarrow (\mathbb{C}P^\infty)^m$ . The proof given here is taken from [24] and [57]; it establishes the isomorphism over the integers and works with the cellular cochains.

One of the key steps in the proof is the construction of a cellular approximation of the diagonal map  $\Delta: \mathcal{Z}_{\mathcal{K}} \rightarrow \mathcal{Z}_{\mathcal{K}} \times \mathcal{Z}_{\mathcal{K}}$  which is functorial with respect to maps of moment-angle complexes induced by simplicial maps. The resulting cellular cochain algebra is isomorphic to the algebra  $R^*(\mathcal{K})$  from Construction 3.2.5 (obtained by factorising the Koszul algebra of the face ring  $\mathbb{Z}[\mathcal{K}]$  by an acyclic ideal); its cohomology is isomorphic to the Tor-algebra of  $\mathcal{K}$ .

Another proof of Theorem 4.5.4 was given by Franz [117].

**Algebraic model for cellular cochains.** We recall the algebra  $R^*(\mathcal{K})$  from Construction 3.2.5:

$$R^*(\mathcal{K}) = \Lambda[u_1, \dots, u_m] \otimes \mathbb{Z}[\mathcal{K}] / (v_i^2 = u_i v_i = 0, 1 \leq i \leq m),$$

with the bigrading and differential given by

$$\text{bideg } u_i = (-1, 2), \quad \text{bideg } v_i = (0, 2), \quad du_i = v_i, \quad dv_i = 0.$$

The algebra  $R^*(\mathcal{K})$  has finite rank as an abelian group, with a basis of monomials  $u_J v_I$  where  $J \subset [m]$ ,  $I \in \mathcal{K}$  and  $J \cap I = \emptyset$ .

Comparing the differential graded module structures in  $R^*(\mathcal{K})$  and  $\mathcal{C}^*(\mathcal{Z}_{\mathcal{K}})$  we observe that they coincide, as described in the following statement:

LEMMA 4.5.1. *The map*

$$g: R^*(\mathcal{K}) \rightarrow \mathcal{C}^*(\mathcal{Z}_{\mathcal{K}}), \quad u_J v_I \mapsto \varkappa(J, I)^*,$$

*is an isomorphism of cochain complexes. Hence, there is an additive isomorphism*

$$H[R^*(\mathcal{K})] \cong H^*(\mathcal{Z}_{\mathcal{K}}).$$

PROOF. Since  $g$  arises from a bijective correspondence between bases of  $R^*(\mathcal{K})$  and  $\mathcal{C}^*(\mathcal{Z}_{\mathcal{K}})$ , it is an isomorphism of bigraded modules (or groups). It also clearly commutes with the differentials:

$$\delta g(u_i) = \delta(T_i^*) = D_i^* = g(v_i) = g(du_i), \quad \delta g(v_i) = \delta(D_i^*) = 0 = g(dv_i),$$

where  $T_i$  denotes the cell  $\varkappa(\{i\}, \emptyset)$ , and  $D_i = \varkappa(\emptyset, \{i\})$ .  $\square$

Having identified the algebra  $R^*(\mathcal{K})$  with the cellular cochains of the moment-angle complex, we can give a topological interpretation to the quasi-isomorphism of Lemma 3.2.6. To do this we shall identify the Koszul algebra  $\Lambda[u_1, \dots, u_m] \otimes \mathbb{Z}[\mathcal{K}]$  with the cellular cochains of a space homotopy equivalent to  $\mathcal{Z}_{\mathcal{K}}$ .

The infinite-dimensional sphere  $S^\infty$  is the direct limit (union) of standardly embedded odd-dimensional spheres. Each odd sphere  $S^{2k+1}$  can be obtained from  $S^{2k-1}$  by attaching two cells of dimensions  $2k$  and  $2k+1$ :

$$S^{2k+1} \cong (S^{2k-1} \cup_f D^{2k}) \cup_g D^{2k+1}.$$

Here the map  $f: \partial D^{2k} \rightarrow S^{2k-1}$  is the identity (and has degree 1), and the map  $g: \partial D^{2k+1} = S^{2k} \rightarrow D^{2k}$  is the projection of the standard sphere onto its equatorial

plane (and has degree 0). This implies that  $S^\infty$  is contractible and has a cell decomposition with one cell in each dimension; the boundary of an even cell is the closure of an odd cell, and the boundary of an odd cell is zero. The 2-dimensional skeleton of this cell decomposition is the disc  $D^2$  decomposed into three cells as described in Section 4.4. The cellular cochain complex of  $S^\infty$  can be identified with the Koszul algebra

$$\Lambda[u] \otimes \mathbb{Z}[v], \quad \deg u = 1, \deg v = 2, \quad du = v, dv = 0.$$

The functoriality of the polyhedral product (Proposition 4.2.3 (a)) implies that there is the following deformation retraction onto a cellular subcomplex:

$$\mathcal{Z}_{\mathcal{K}} = (D^2, S^1)^{\mathcal{K}} \hookrightarrow (S^\infty, S^1)^{\mathcal{K}} \longrightarrow (D^2, S^1)^{\mathcal{K}}.$$

Furthermore, the cellular cochains of the polyhedral product  $(S^\infty, S^1)^{\mathcal{K}}$  are identified with the Koszul algebra  $\Lambda[u_1, \dots, u_m] \otimes \mathbb{Z}[\mathcal{K}]$ , in the same way as  $\mathcal{C}^*(\mathcal{Z}_{\mathcal{K}})$  is identified with  $R^*(\mathcal{K})$ . Since  $\mathcal{Z}_{\mathcal{K}} \subset (S^\infty, S^1)^{\mathcal{K}}$  is a deformation retract, the corresponding cellular cochain map

$$\Lambda[u_1, \dots, u_m] \otimes \mathbb{Z}[\mathcal{K}] = \mathcal{C}^*((S^\infty, S^1)^{\mathcal{K}}) \longrightarrow \mathcal{C}^*(\mathcal{Z}_{\mathcal{K}}) = R^*(\mathcal{K})$$

induces an isomorphism in cohomology. The above map is a homomorphism of algebras, so it is a quasi-isomorphism. In fact, the cochain homotopy map constructed in the proof of Lemma 3.2.6 is nothing but the cellular cochain map induced by the homotopy above.

**Cellular diagonal approximation.** Here we establish the cohomology ring isomorphism in Lemma 4.5.1. The difficulty of working with cellular cochains is that they do not admit a functorial associative multiplication. The diagonal map used in the definition of the cohomology product is not cellular, and a cellular approximation cannot be made functorial with respect to arbitrary cellular maps. Here we construct a canonical cellular diagonal approximation  $\tilde{\Delta}: \mathcal{Z}_{\mathcal{K}} \rightarrow \mathcal{Z}_{\mathcal{K}} \times \mathcal{Z}_{\mathcal{K}}$  which is functorial with respect to maps of  $\mathcal{Z}_{\mathcal{K}}$  induced by simplicial maps of  $\mathcal{K}$ , and show that the resulting product in the cellular cochains of  $\mathcal{Z}_{\mathcal{K}}$  coincides with the product in  $R^*(\mathcal{K})$ .

The product in the cohomology of a cell complex  $X$  is defined as follows (see [248], [151]). Consider the composite map of cellular cochain complexes

$$(4.14) \quad \mathcal{C}^*(X) \otimes \mathcal{C}^*(X) \xrightarrow{\times} \mathcal{C}^*(X \times X) \xrightarrow{\tilde{\Delta}^*} \mathcal{C}^*(X).$$

Here the map  $\times$  sends a cellular cochain  $c_1 \otimes c_2 \in \mathcal{C}^{q_1}(X) \otimes \mathcal{C}^{q_2}(X)$  to the cochain  $c_1 \times c_2 \in \mathcal{C}^{q_1+q_2}(X \times X)$ , whose value on a cell  $e_1 \times e_2 \in X \times X$  is  $(-1)^{q_1 q_2} c_1(e_1) c_2(e_2)$ . The map  $\tilde{\Delta}^*$  is induced by a cellular map  $\tilde{\Delta}$  (a cellular *diagonal approximation*) homotopic to the diagonal  $\Delta: X \rightarrow X \times X$ . In cohomology, map (4.14) induces a multiplication  $H^*(X) \otimes H^*(X) \rightarrow H^*(X)$  which does not depend on a choice of cellular approximation and is functorial. However, map (4.14) itself is not functorial because the choice of a cellular approximation is not canonical.

Nevertheless, in the case  $X = \mathcal{Z}_{\mathcal{K}}$  we can use the following construction.

**CONSTRUCTION 4.5.2** (cellular approximation for  $\Delta: \mathcal{Z}_{\mathcal{K}} \rightarrow \mathcal{Z}_{\mathcal{K}} \times \mathcal{Z}_{\mathcal{K}}$ ). Consider the map  $\tilde{\Delta}: \mathbb{D} \rightarrow \mathbb{D} \times \mathbb{D}$  given in the polar coordinates  $z = \rho e^{i\varphi} \in \mathbb{D}$ ,  $0 \leq \rho \leq 1$ ,  $0 \leq \varphi < 2\pi$ , by the formula

$$(4.15) \quad \rho e^{i\varphi} \mapsto \begin{cases} (1 - \rho + \rho e^{2i\varphi}, 1) & \text{for } 0 \leq \varphi \leq \pi, \\ (1, 1 - \rho + \rho e^{2i\varphi}) & \text{for } \pi \leq \varphi < 2\pi. \end{cases}$$

It is easy to see that this is a cellular map homotopic to the diagonal  $\Delta: \mathbb{D} \rightarrow \mathbb{D} \times \mathbb{D}$ , and its restriction to the boundary circle  $\mathbb{S}$  is a diagonal approximation for  $\mathbb{S}$ , as described by the following diagram:

$$(4.16) \quad \begin{array}{ccc} \mathbb{S} & \longrightarrow & \mathbb{D} \\ \tilde{\Delta} \downarrow & & \downarrow \tilde{\Delta} \\ \mathbb{S} \times \mathbb{S} & \longrightarrow & \mathbb{D} \times \mathbb{D} \end{array}$$

(explicit formulae for the homotopies involved can be found in Exercise 4.5.11). Taking the  $m$ -fold product we obtain a cellular approximation  $\tilde{\Delta}: \mathbb{D}^m \rightarrow \mathbb{D}^m \times \mathbb{D}^m$ . Applying Proposition 4.2.3 (a) to the map of pairs  $\tilde{\Delta}: (\mathbb{D}, \mathbb{S}) \rightarrow (\mathbb{D} \times \mathbb{D}, \mathbb{S} \times \mathbb{S})$  and observing that  $(\mathbb{D} \times \mathbb{D}, \mathbb{S} \times \mathbb{S})^{\mathcal{K}} \cong \mathcal{Z}_{\mathcal{K}} \times \mathcal{Z}_{\mathcal{K}}$ , we obtain that  $\tilde{\Delta}: \mathbb{D}^m \rightarrow \mathbb{D}^m \times \mathbb{D}^m$  restricts to a cellular approximation of the diagonal map of  $\mathcal{Z}_{\mathcal{K}}$ , as described in the following diagram:

$$\begin{array}{ccc} \mathcal{Z}_{\mathcal{K}} & \longrightarrow & \mathbb{D}^m \\ \tilde{\Delta} \downarrow & & \downarrow \tilde{\Delta} \\ \mathcal{Z}_{\mathcal{K}} \times \mathcal{Z}_{\mathcal{K}} & \longrightarrow & \mathbb{D}^m \times \mathbb{D}^m. \end{array}$$

Finally, applying Proposition 4.2.3 (c) to diagram (4.16) we obtain that the approximation  $\tilde{\Delta}$  is functorial with respect to the maps of moment-angle-complexes  $\mathcal{Z}_{\mathcal{K}} \rightarrow \mathcal{Z}_{\mathcal{L}}$  induced by simplicial maps  $\mathcal{K} \rightarrow \mathcal{L}$ .

LEMMA 4.5.3. *The cellular cochain algebra  $\mathcal{C}^*(\mathcal{Z}_{\mathcal{K}})$  with the product defined via the diagonal approximation  $\tilde{\Delta}: \mathcal{Z}_{\mathcal{K}} \rightarrow \mathcal{Z}_{\mathcal{K}} \times \mathcal{Z}_{\mathcal{K}}$  and map (4.14) is isomorphic to the algebra  $R^*(\mathcal{K})$ . We therefore have an isomorphism of cohomology rings*

$$H[R^*(\mathcal{K})] \cong H^*(\mathcal{Z}_{\mathcal{K}}).$$

PROOF. We first consider the case  $\mathcal{K} = \Delta^0$ , i.e.  $\mathcal{Z}_{\mathcal{K}} = \mathbb{D}$ . The cellular cochain complex has basis of cochains  $1 \in \mathcal{C}^0(\mathbb{D})$ ,  $T^* \in \mathcal{C}^1(\mathbb{D})$  and  $D^* \in \mathcal{C}^2(\mathbb{D})$  dual to the cells introduced in Section 4.4. The multiplication defined by (4.14) in  $\mathcal{C}^*(\mathbb{D})$  is trivial, so we have a ring isomorphism

$$R^*(\Delta^0) = \Lambda[u] \otimes \mathbb{Z}[v]/(v^2 = uv = 0) \longrightarrow \mathcal{C}^*(\mathbb{D}).$$

Taking an  $m$ -fold tensor product we obtain a ring isomorphism for  $\mathcal{K} = \Delta^{m-1}$ :  
 $f: R^*(\Delta^{m-1}) = \Lambda[u_1, \dots, u_m] \otimes \mathbb{Z}[v_1, \dots, v_m]/(v_i^2 = u_i v_i = 0) \longrightarrow \mathcal{C}^*(\mathbb{D}^m).$

Now for arbitrary  $\mathcal{K}$  we have an inclusion  $\mathcal{Z}_{\mathcal{K}} \subset \mathbb{D}^m = \mathcal{Z}_{\Delta^{m-1}}$  of a cellular subcomplex and the corresponding ring homomorphism  $q: \mathcal{C}^*(\mathbb{D}^m) \rightarrow \mathcal{C}^*(\mathcal{Z}_{\mathcal{K}})$ . Consider the commutative diagram

$$\begin{array}{ccc} R^*(\Delta^{m-1}) & \xrightarrow{f} & \mathcal{C}^*(\mathbb{D}^m) \\ p \downarrow & & \downarrow q \\ R^*(\mathcal{K}) & \xrightarrow{g} & \mathcal{C}^*(\mathcal{Z}_{\mathcal{K}}). \end{array}$$

Here the maps  $p$ ,  $f$  and  $q$  are ring homomorphisms, and  $g$  is an isomorphism of groups by Lemma 4.5.1. We claim that  $g$  is also a ring isomorphism. Indeed, take  $\alpha, \beta \in R^*(\mathcal{K})$ . Since  $p$  is onto, we have  $\alpha = p(\alpha')$  and  $\beta = p(\beta')$ . Then

$$g(\alpha\beta) = gp(\alpha'\beta') = qf(\alpha'\beta') = qf(\alpha')qf(\beta') = gp(\alpha')gp(\beta') = g(\alpha)g(\beta),$$

as claimed. Thus,  $g$  is a ring isomorphism.  $\square$

**Main result.** By combining the results of Lemmata A.2.10, 3.2.6 and 4.5.3 we obtain the main result of this section:

THEOREM 4.5.4. *There are isomorphisms, functorial in  $\mathcal{K}$ , of bigraded algebras*

$$\begin{aligned} H^{*,*}(\mathcal{Z}_{\mathcal{K}}) &\cong \mathrm{Tor}_{\mathbb{Z}[v_1, \dots, v_m]}(\mathbb{Z}[\mathcal{K}], \mathbb{Z}) \\ &\cong H(\Lambda[u_1, \dots, u_m] \otimes \mathbb{Z}[\mathcal{K}], d), \end{aligned}$$

where the bigrading and the differential on the right hand side are defined by

$$\mathrm{bideg} u_i = (-1, 2), \quad \mathrm{bideg} v_i = (0, 2), \quad du_i = v_i, \quad dv_i = 0.$$

The algebraic Betti numbers (3.2) of the face ring  $\mathbb{Z}[\mathcal{K}]$  therefore acquire a topological interpretation as the bigraded Betti numbers (4.12) of the moment-angle complex  $\mathcal{Z}_{\mathcal{K}}$ .

Now we combine results of Propositions 3.1.5, 3.2.2 and 4.4.1, Corollary 4.3.3 and Theorem 4.5.4 in the following statement describing the functorial properties of the correspondence  $\mathcal{K} \mapsto \mathcal{Z}_{\mathcal{K}}$ .

PROPOSITION 4.5.5. *Consider the following functors:*

- (a)  $\mathcal{Z}$ , the covariant functor  $\mathcal{K} \mapsto \mathcal{Z}_{\mathcal{K}}$  from the category of finite simplicial complexes and simplicial maps to the category of spaces with torus actions and equivariant maps (the moment-angle complex functor);
- (b)  $\mathbf{k}[\cdot]$ , the contravariant functor  $\mathcal{K} \mapsto \mathbf{k}[\mathcal{K}]$  from simplicial complexes to graded  $\mathbf{k}$ -algebras (the face ring functor);
- (c) Tor-*alg*, the contravariant functor

$$\mathcal{K} \mapsto \mathrm{Tor}_{\mathbf{k}[v_1, \dots, v_m]}(\mathbf{k}[\mathcal{K}], \mathbf{k})$$

from simplicial complexes to bigraded  $\mathbf{k}$ -algebras (the Tor-algebra functor; it is the composition of  $\mathbf{k}[\cdot]$  and  $\mathrm{Tor}_{\mathbf{k}[v_1, \dots, v_m]}(\cdot, \mathbf{k})$ );

- (d)  $H_T^*$ , the contravariant functor  $X \mapsto H_T^*(X; \mathbf{k})$  from spaces with torus actions to  $\mathbf{k}$ -algebras (the equivariant cohomology functor);
- (e)  $H^*$ , the contravariant functor  $X \mapsto H^*(X; \mathbf{k})$  from spaces to  $\mathbf{k}$ -algebras (the ordinary cohomology functor).

Then we have the following identities:

$$H_T^* \circ \mathcal{Z} = \mathbf{k}[\cdot], \quad H^* \circ \mathcal{Z} = \mathrm{Tor}\text{-alg}.$$

The second identity implies that for any simplicial map  $\varphi: \mathcal{K} \rightarrow \mathcal{L}$  the corresponding cohomology map

$$\varphi_{\mathcal{Z}}^*: H^*(\mathcal{Z}_{\mathcal{L}}) \rightarrow H^*(\mathcal{Z}_{\mathcal{K}})$$

coincides with the induced homomorphism of Tor-algebras  $\varphi_{\mathrm{Tor}}^*$  from Proposition 3.2.2. In particular, the map  $\varphi$  gives rise to a map

$$H^{-q, 2p}(\mathcal{Z}_{\mathcal{L}}) \rightarrow H^{-q, 2p}(\mathcal{Z}_{\mathcal{K}})$$

of bigraded cohomology.

In the case of Cohen–Macaulay complexes  $\mathcal{K}$  (see Section 3.3) we have the following version of Theorem 4.5.4.

PROPOSITION 4.5.6. *Let  $\mathcal{K}$  be an  $(n-1)$ -dimensional Cohen–Macaulay complex, and let  $\mathfrak{t}$  be an *hsop* in  $\mathbf{k}[\mathcal{K}]$ . Then we have the following isomorphism of algebras:*

$$H^*(\mathcal{Z}_{\mathcal{K}}; \mathbf{k}) \cong \mathrm{Tor}_{\mathbf{k}[v_1, \dots, v_m]/\mathfrak{t}}(\mathbf{k}[\mathcal{K}]/\mathfrak{t}, \mathbf{k}).$$

PROOF. This follows from Theorem 4.5.4 and Lemma A.3.5.  $\square$

Note that the algebra  $\mathbf{k}[\mathcal{K}]/\mathfrak{t}$  is finite-dimensional as a  $\mathbf{k}$ -vector space, unlike  $\mathbf{k}[\mathcal{K}]$ . In some circumstances this observation allows us to calculate the cohomology of  $\mathcal{Z}_{\mathcal{K}}$  more effectively.

**Description of the product in terms of full subcomplexes.** The Hochster formula (Theorem 3.2.4) for the components of the Tor-algebra can be used to obtain an alternative description of the product structure in  $H^*(\mathcal{Z}_{\mathcal{K}})$ .

We recall from Section 3.2 that the bigraded structure in the Tor-algebra is refined to a multigrading, and the multigraded components of Tor can be calculated in terms of the full subcomplexes of  $\mathcal{K}$ :

$$\mathrm{Tor}_{\mathbb{Z}[v_1, \dots, v_m]}^{-i, 2J}(\mathbb{Z}[\mathcal{K}], \mathbb{Z}) \cong \tilde{H}^{|J|-i-1}(\mathcal{K}_J),$$

where  $J \subset [m]$ , see Theorem 3.2.9. Furthermore, the product in the Tor-algebra defines a product in the direct sum  $\bigoplus_{p \geq 0, J \subset [m]} \tilde{H}^{p-1}(\mathcal{K}_J)$  given by (3.11).

The bigraded structure in the cellular cochain complex of  $\mathcal{Z}_{\mathcal{K}}$  defined in Section 4.4 can be also refined to a multigrading (a  $\mathbb{Z} \oplus \mathbb{Z}^m$ -grading):

$$\mathcal{C}^*(\mathcal{Z}_{\mathcal{K}}) = \bigoplus_{J \subset [m]} \mathcal{C}^{*, 2J}(\mathcal{Z}_{\mathcal{K}}),$$

where  $\mathcal{C}^{*, 2J}(\mathcal{Z}_{\mathcal{K}})$  is the subcomplex spanned by the cochains  $\varkappa(J \setminus I, I)^*$  with  $I \subset J$  and  $I \in \mathcal{K}$ . The bigraded cohomology groups are decomposed as follows:

$$H^{-i, 2j}(\mathcal{Z}_{\mathcal{K}}) = \bigoplus_{J \subset [m]: |J|=j} H^{-i, 2J}(\mathcal{Z}_{\mathcal{K}}),$$

where  $H^{-i, 2J}(\mathcal{Z}_{\mathcal{K}}) = H^{-i}[\mathcal{C}^{*, 2J}(\mathcal{Z}_{\mathcal{K}})]$ .

THEOREM 4.5.7 (Baskakov [22]). *There are isomorphisms*

$$\tilde{H}^{p-1}(\mathcal{K}_J) \xrightarrow{\cong} H^{p-|J|, 2J}(\mathcal{Z}_{\mathcal{K}}),$$

which are functorial with respect to simplicial maps and induce a ring isomorphism

$$h: \sum_{J \subset [m]} \tilde{H}^*(\mathcal{K}_J) \xrightarrow{\cong} H^*(\mathcal{Z}_{\mathcal{K}}).$$

PROOF. The statement about the additive isomorphisms follows from Theorems 3.2.9 and 4.5.4. In explicit terms, the cohomology isomorphisms are induced by the cochain isomorphisms given by

$$\begin{aligned} \mathcal{C}^{p-1}(\mathcal{K}_J) &\longrightarrow \mathcal{C}^{p-|J|, 2J}(\mathcal{Z}_{\mathcal{K}}), \\ \alpha_L &\longmapsto \varepsilon(L, J) \varkappa(J \setminus L, L)^* \end{aligned}$$

similar to (3.9), where  $\alpha_L \in \mathcal{C}^{p-1}(\mathcal{K}_J)$  is the cochain dual to a simplex  $L \in \mathcal{K}_J$ .

The ring isomorphism follows from Proposition 3.2.10 and Theorem 4.5.4.  $\square$

We summarise the results above in the following description of the cohomology groups and the product structure of  $H^*(\mathcal{Z}_{\mathcal{K}})$  in terms of full subcomplexes of  $\mathcal{K}$ :

THEOREM 4.5.8. *There are isomorphisms of groups*

$$H^{-i, 2j}(\mathcal{Z}_{\mathcal{K}}) \cong \bigoplus_{J \subset [m]: |J|=j} \tilde{H}^{j-i-1}(\mathcal{K}_J), \quad H^\ell(\mathcal{Z}_{\mathcal{K}}) \cong \bigoplus_{J \subset [m]} \tilde{H}^{\ell-|J|-1}(\mathcal{K}_J).$$



These isomorphisms sum up into a ring isomorphism

$$H^*(\mathcal{Z}_{\mathcal{K}}) \cong \bigoplus_{J \subset [m]} \tilde{H}^*(\mathcal{K}_J),$$

where the ring structure on the right hand side is given by the canonical maps

$$H^{k-|I|-1}(\mathcal{K}_I) \otimes H^{\ell-|J|-1}(\mathcal{K}_J) \rightarrow H^{k+\ell-|I|-|J|-1}(\mathcal{K}_{I \cup J})$$

which are induced by simplicial maps  $\mathcal{K}_{I \cup J} \rightarrow \mathcal{K}_I * \mathcal{K}_J$  for  $I \cap J = \emptyset$  and zero otherwise.

It follows that the cohomology of  $\mathcal{Z}_{\mathcal{K}}$  may have arbitrary torsion:

**COROLLARY 4.5.9.** *Any finite abelian group can appear as a summand in a cohomology group of  $H^*(\mathcal{Z}_{\mathcal{K}})$  for some  $\mathcal{K}$ .*

**PROOF.** It follows from the Theorem 4.5.8 that  $\tilde{H}^*(\mathcal{K})$  is a direct summand in  $H^*(\mathcal{Z}_{\mathcal{K}})$  (with appropriate shifts in dimension). Therefore, we can take  $\mathcal{K}$  whose simplicial cohomology contains the appropriate torsion.  $\square$

### Exercises.

4.5.10. Let  $\mathbb{S}$  be the standard unit circle decomposed into two cells, where the 0-cell is the unit. The map

$$\tilde{\Delta}: \mathbb{S} \rightarrow \mathbb{S} \times \mathbb{S}, \quad e^{i\varphi} \mapsto \begin{cases} (e^{2i\varphi}, 1) & \text{for } 0 \leq \varphi \leq \pi, \\ (1, e^{2i\varphi}) & \text{for } \pi \leq \varphi < 2\pi \end{cases}$$

is a cellular diagonal approximation. It is obtained by restricting map (4.15) to the boundary circle ( $\rho = 1$ ). A homotopy  $F_t$  between the diagonal  $\Delta: \mathbb{S} \rightarrow \mathbb{S} \times \mathbb{S}$  ( $t = 0$ ) and its cellular approximation  $\tilde{\Delta}$  ( $t = 1$ ) is given by

$$F_t: \mathbb{S} \rightarrow \mathbb{S} \times \mathbb{S}, \quad e^{i\varphi} \mapsto \begin{cases} (e^{i(1+t)\varphi}, e^{i(1-t)\varphi}) & \text{for } 0 \leq \varphi \leq \pi, \\ (e^{i(1-t)\varphi+2\pi it}, e^{i(1+t)\varphi-2\pi it}) & \text{for } \pi \leq \varphi < 2\pi. \end{cases}$$

4.5.11. Show that the formula

$$\rho e^{i\varphi} \mapsto \begin{cases} ((1-\rho)t + \rho e^{i(1+t)\varphi}, (1-\rho)t + \rho e^{i(1-t)\varphi}) & \text{for } 0 \leq \varphi \leq \pi, \\ ((1-\rho)t + \rho e^{i(1-t)\varphi+2\pi it}, (1-\rho)t + \rho e^{i(1+t)\varphi-2\pi it}) & \text{for } \pi \leq \varphi < 2\pi. \end{cases}$$

defines a homotopy  $G_t: \mathbb{D} \rightarrow \mathbb{D} \times \mathbb{D}$  between the diagonal  $\Delta: \mathbb{D} \rightarrow \mathbb{D} \times \mathbb{D}$  ( $t = 0$ ) and its approximation  $\tilde{\Delta}$  (4.16) ( $t = 1$ ). For  $\rho = 1$  the homotopy  $G_t$  restricts to the homotopy  $F_t$  of the previous exercise.

## 4.6. Bigraded Betti numbers

Here we describe the main properties of the bigraded Betti numbers (4.12) of moment-angle complexes and give some examples of explicit calculations.

**LEMMA 4.6.1.** *Let  $\mathcal{K}$  be a simplicial complex of dimension  $n - 1$  with  $f_0 = m$  vertices and  $f_1$  edges, so that  $\dim \mathcal{Z}_{\mathcal{K}} = m + n$ . We have*

- (a)  $b^{0,0}(\mathcal{Z}_{\mathcal{K}}) = b^0(\mathcal{Z}_{\mathcal{K}}) = 1$  and  $b^{0,2q}(\mathcal{Z}_{\mathcal{K}}) = 0$  for  $q \neq 0$ ;
- (b)  $b^{-p,2q} = 0$  for  $q > m$  or  $p > q$ ;
- (c)  $b^1(\mathcal{Z}_{\mathcal{K}}) = b^2(\mathcal{Z}_{\mathcal{K}}) = 0$ ;
- (d)  $b^3(\mathcal{Z}_{\mathcal{K}}) = b^{-1,4}(\mathcal{Z}_{\mathcal{K}}) = \binom{m}{2} - f_1$ ;
- (e)  $b^{-p,2q}(\mathcal{Z}_{\mathcal{K}}) = 0$  for  $p \geq q > 0$  or  $q - p > n$ ;

$$(f) \quad b^{m+n}(\mathcal{Z}_{\mathcal{K}}) = b^{-(m-n), 2m}(\mathcal{Z}_{\mathcal{K}}) = \text{rank } \tilde{H}^{n-1}(\mathcal{K}).$$

PROOF. We consider the algebra  $R^*(\mathcal{K})$  whose cohomology is  $H^*(\mathcal{Z}_{\mathcal{K}})$ . Recall that  $R^*(\mathcal{K})$  has additive basis of monomials  $u_J v_I$  with  $I \in \mathcal{K}$  and  $I \cap J = \emptyset$ . Since  $\text{bideg } v_i = (0, 2)$ ,  $\text{bideg } u_j = (-1, 2)$ , the bigraded component  $R^{-p, 2q}(\mathcal{K})$  has basis of monomials  $u_J v_I$  with  $|I| = q - p$  and  $|J| = p$ . In particular,  $R^{-p, 2q}(\mathcal{K}) = 0$  for  $q > m$  or  $p > q$ , which implies (b). To prove (a) we observe that  $R^{0,0}(\mathcal{K}) = \mathbf{k}$  and each  $v_I \in R^{0,2q}(\mathcal{K})$  with  $q > 0$  is a coboundary, hence,  $H^{0,2q}(\mathcal{Z}_{\mathcal{K}}) = 0$  for  $q > 0$ .

Now we prove (e). Let  $u_J v_I \in R^{-p, 2q}(\mathcal{K})$ ; then  $|I| = q - p$  and  $I \in \mathcal{K}$ . Since a simplex of  $\mathcal{K}$  has at most  $n$  vertices,  $R^{-p, 2q}(\mathcal{K}) = 0$  for  $q - p > n$ . We have  $b^{-p, 2q}(\mathcal{Z}_{\mathcal{K}}) = 0$  for  $p > q$  by (b) so we need only to check that  $b^{-q, 2q}(\mathcal{Z}_{\mathcal{K}}) = 0$  for  $q > 0$ . The group  $R^{-q, 2q}(\mathcal{K})$  has basis of monomials  $u_J$  with  $|J| = q$ . Since  $d(u_i) = v_i$ , there are no nonzero cocycles in  $R^{-q, 2q}(\mathcal{K})$  for  $q > 0$ , hence,  $H^{-q, 2q}(\mathcal{Z}_{\mathcal{K}}) = 0$ .

Statement (c) follows from (e) and (4.13).

We also have  $H^3(\mathcal{Z}_{\mathcal{K}}) = H^{-1,4}(\mathcal{Z}_{\mathcal{K}})$ , by (e). There is a basis in  $R^{-1,4}(\mathcal{K})$  consisting of monomials  $u_j v_i$  with  $i \neq j$ . We have  $d(u_j v_i) = v_i v_j$  and  $d(u_i u_j) = u_j v_i - u_i v_j$ . Hence,  $u_j v_i$  is a cocycle if and only if  $\{i, j\} \notin \mathcal{K}$ ; in this case the two cocycles  $u_j v_i$  and  $u_i v_j$  represent the same cohomology class. This proves (d).

It remains to prove (f). The total degree of a monomial  $u_J v_I \in R^*(\mathcal{K})$  is  $2|I| + |J|$ , and there are constraints  $|I| + |J| \leq m$  and  $|I| \leq n$ . Therefore, the maximum of the total degree is achieved for  $|I| = n$  and  $|J| = m - n$ . This proves the first identity of (f), and the second follows from Theorem 4.5.8.  $\square$

Lemma 4.6.1 shows that nonzero bigraded Betti numbers  $b^{r, 2q}(\mathcal{Z}_{\mathcal{K}})$  with  $r \neq 0$  appear only in the strip bounded by the lines  $r = -1$ ,  $q = m$ ,  $r + q = 1$  and  $r + q = n$  in the second quadrant, see Fig. 4.1 (a).

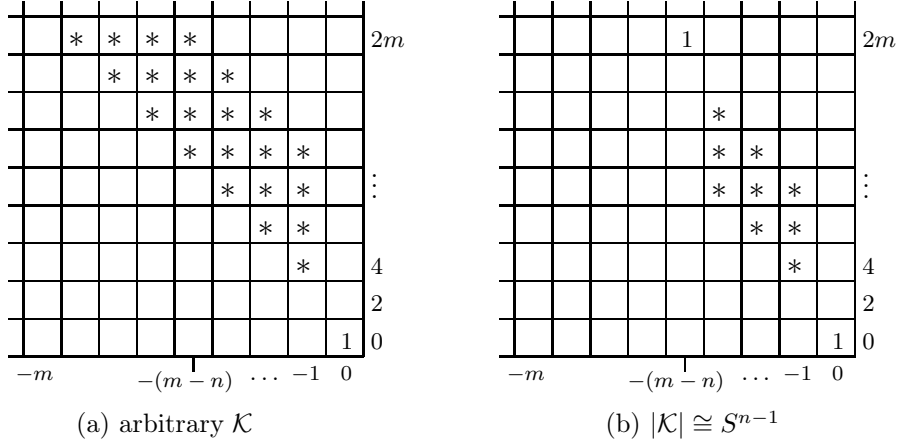

FIGURE 4.1. Possible locations on nonzero  $b^{-p, 2q}(\mathcal{Z}_{\mathcal{K}})$  (marked by \*).

The next result allows us to express the numbers of faces of  $\mathcal{K}$  (i.e. its  $f$ - and  $h$ -vectors) via the bigraded Betti numbers. We consider the Euler characteristics of the complexes  $\mathcal{C}^{*, 2q}(\mathcal{Z}_{\mathcal{K}})$  (see (4.11)),

$$(4.17) \quad \chi_q(\mathcal{Z}_{\mathcal{K}}) = \sum_{p=0}^m (-1)^p \text{rank } \mathcal{C}^{-p, 2q}(\mathcal{Z}_{\mathcal{K}}) = \sum_{p=0}^m (-1)^p b^{-p, 2q}(\mathcal{Z}_{\mathcal{K}})$$

and define the generating series

$$\chi(\mathcal{Z}_{\mathcal{K}}; t) = \sum_{q=0}^m \chi_q(\mathcal{Z}_{\mathcal{K}}) t^{2q}.$$

**THEOREM 4.6.2.** *The following identity holds for an  $(n-1)$ -dimensional simplicial complex  $\mathcal{K}$  with  $m$  vertices:*

$$\chi(\mathcal{Z}_{\mathcal{K}}; t) = (1-t^2)^{m-n} (h_0 + h_1 t^2 + \cdots + h_n t^{2n}).$$

Here  $(h_0, h_1, \dots, h_n)$  is the  $h$ -vector of  $\mathcal{K}$ .

**PROOF.** The bigraded component  $\mathcal{C}^{-p, 2q}(\mathcal{Z}_{\mathcal{K}})$  has basis of cellular cochains  $\varkappa(J, I)^*$  with  $I \in \mathcal{K}$ ,  $|I| = q - p$  and  $|J| = p$ . Therefore,  $\text{rank } \mathcal{C}^{-p, 2q}(\mathcal{Z}_{\mathcal{K}}) = f_{q-p-1} \binom{m-q+p}{p}$ , where  $(f_0, f_1, \dots, f_{n-1})$  is the  $f$ -vector of  $\mathcal{K}$  and  $f_{-1} = 1$ . By substituting this into (4.17) we obtain

$$\chi_q(\mathcal{Z}_{\mathcal{K}}) = \sum_{j=0}^m (-1)^{q-j} f_{j-1} \binom{m-j}{q-j}.$$

Then

$$(4.18) \quad \chi(\mathcal{Z}_{\mathcal{K}}; t) = \sum_{q=0}^m \sum_{j=0}^m t^{2j} t^{2(q-j)} (-1)^{q-j} f_{j-1} \binom{m-j}{q-j} \\ = \sum_{j=0}^m f_{j-1} t^{2j} (1-t^2)^{m-j} = (1-t^2)^m \sum_{j=0}^n f_{j-1} (t^{-2} - 1)^{-j}.$$

Set  $h(t) = h_0 + h_1 t + \cdots + h_n t^n$ . Then it follows from (2.3) that

$$t^n h(t^{-1}) = (t-1)^n \sum_{j=0}^n f_{j-1} (t-1)^{-j}.$$

By substituting  $t^{-2}$  for  $t$  in the identity above we finally rewrite (4.18) as

$$\frac{\chi(\mathcal{Z}_{\mathcal{K}}; t)}{(1-t^2)^m} = \frac{t^{-2n} h(t^2)}{(t^{-2} - 1)^n} = \frac{h(t^2)}{(1-t^2)^n},$$

which is equivalent to the required identity.  $\square$

**COROLLARY 4.6.3.** *If  $\mathcal{K} \neq \Delta^{m-1}$ , then the Euler characteristic of  $\mathcal{Z}_{\mathcal{K}}$  is zero.*

**PROOF.** We have

$$\chi(\mathcal{Z}_{\mathcal{K}}) = \sum_{p, q=0}^m (-1)^{-p+2q} b^{-p, 2q}(\mathcal{Z}_{\mathcal{K}}) = \sum_{q=0}^m \chi_q(\mathcal{Z}_{\mathcal{K}}) = \chi(\mathcal{Z}_{\mathcal{K}}; 1) = 0$$

by Theorem 4.6.2 (note that  $\mathcal{K} \neq \Delta^{m-1}$  implies that  $m > n$ ).  $\square$

We proceed by describing the properties of bigraded Betti numbers for particular classes of simplicial complexes.

**DEFINITION 4.6.4.** A finite simplicial complex  $\mathcal{K}$  is called a  $d$ -dimensional *pseudomanifold* if the following three conditions are satisfied:

- (a) all maximal simplices of  $\mathcal{K}$  have dimension  $d$  (i.e.  $\mathcal{K}$  is pure  $d$ -dimensional);
- (b) each  $(d-1)$ -simplex of  $\mathcal{K}$  is the face of exactly two  $d$ -simplices of  $\mathcal{K}$ .

- (c) if  $I$  and  $I'$  are  $d$ -simplices of  $\mathcal{K}$ , then there is a sequence  $I = I_1, I_2, \dots, I_k = I'$  of  $d$ -simplices of  $\mathcal{K}$  such that  $I_j$  and  $I_{j+1}$  have a common  $(d-1)$ -face for  $1 \leq i \leq k-1$ .

If  $\mathcal{K}$  is a  $d$ -dimensional pseudomanifold, then either  $H_d(\mathcal{K}) \cong \mathbb{Z}$  or 0 (an exercise). In the former case the pseudomanifold  $\mathcal{K}$  is called *orientable*.

LEMMA 4.6.5. *Let  $\mathcal{K}$  be an orientable pseudomanifold of dimension  $n-1$  with  $m$  vertices. Then*

$$H^{m+n}(\mathcal{Z}_{\mathcal{K}}) = \tilde{H}^{n-1}(\mathcal{K}) \cong \mathbb{Z}.$$

*Under the isomorphism  $H^*(\mathcal{Z}_{\mathcal{K}}) \cong H[R^*(\mathcal{K})]$ , the group above is generated by the class of any monomial  $u_J v_I \in R^*(\mathcal{K})$  of bidegree  $-(m-n), 2m$  such that  $I \in \mathcal{K}$  and  $J = [m] \setminus I$ .*

PROOF. The isomorphism of groups follows from Theorem 4.5.8 and the fact that  $\mathcal{K}$  is orientable. We have  $H^{m+n}(\mathcal{Z}_{\mathcal{K}}) = H^{-(m-n), 2m}(\mathcal{Z}_{\mathcal{K}})$ . The group  $R^{-(m-n), 2m}(\mathcal{K})$  has basis of monomials  $u_J v_I$  with  $I \in \mathcal{K}$ ,  $|I| = n$  and  $J = [m] \setminus I$ . Each of these monomials is a cocycle. Let  $I, I'$  be two  $(n-1)$ -simplices of  $\mathcal{K}$  having a common  $(n-2)$ -face. Consider the corresponding cocycles  $u_J v_I$  and  $u_{J'} v_{I'}$  (where  $J = [m] \setminus I$ ,  $J' = [m] \setminus I'$ ):

$$\begin{aligned} u_J v_I &= u_{j_1} u_{j_2} \cdots u_{j_{m-n}} v_{i_1} \cdots v_{i_{n-1}} v_{i_n}, \\ u_{J'} v_{I'} &= u_{i_n} u_{j_2} \cdots u_{j_{m-n}} v_{i_1} \cdots v_{i_{n-1}} v_{j_1}. \end{aligned}$$

Since  $\mathcal{K}$  is a pseudomanifold, the  $(n-2)$ -face  $\{i_1, \dots, i_{n-1}\}$  is contained in exactly two  $(n-1)$ -faces, namely  $I = \{i_1, \dots, i_{n-1}, i_n\}$  and  $I' = \{i_1, \dots, i_{n-1}, j_1\}$ . Therefore we have the following identity in  $R^*(\mathcal{K})$

$$\begin{aligned} d(u_{i_n} u_{j_1} u_{j_2} \cdots u_{j_{m-n}} v_{i_1} \cdots v_{i_{n-1}}) &= \\ &= u_{j_1} u_{j_2} \cdots u_{j_{m-n}} v_{i_1} \cdots v_{i_{n-1}} v_{i_n} - u_{i_n} u_{j_2} \cdots u_{j_{m-n}} v_{i_1} \cdots v_{i_{n-1}} v_{j_1} \end{aligned}$$

Hence,  $[u_J v_I] = [u_{J'} v_{I'}]$  (as cohomology classes). Property (c) from the definition of a pseudomanifold implies that all monomials  $u_J v_I \in R^{-(m-n), 2m}(\mathcal{K})$  represent the same cohomology class up to sign. The isomorphism (3.9) takes  $u_J v_I$  to  $\pm \alpha_I \in C^{n-1}(\mathcal{K})$ , which represents a generator of  $\tilde{H}^{n-1}(\mathcal{K}) \cong \mathbb{Z}$  (see Exercise 4.6.17).  $\square$

REMARK. If  $\mathcal{K}$  is a non-orientable pseudomanifold, then the same argument shows that any monomial  $u_J v_I \in R^*(\mathcal{K})$  as above represents the generator of  $H^{m+n}(\mathcal{Z}_{\mathcal{K}}) = H^{n-1}(\mathcal{K}) \cong \mathbb{Z}_2$ .

PROPOSITION 4.6.6. *Let  $\mathcal{K}$  be a triangulated sphere of dimension  $n-1$ . Then Poincaré duality for the moment-angle manifold  $\mathcal{Z}_{\mathcal{K}}$  respects the bigrading in cohomology. In particular,*

$$b^{-p, 2q}(\mathcal{Z}_{\mathcal{K}}) = b^{-(m-n)+p, 2(m-q)}(\mathcal{Z}_{\mathcal{K}}) \quad \text{for } 0 \leq p \leq m-n, 0 \leq q \leq m.$$

PROOF. The Poincaré duality maps (see Definition 3.4.3) are defined via the cohomology multiplication in  $H^*(\mathcal{Z}_{\mathcal{K}})$ , which respects the bigrading. We have  $\dim \mathcal{Z}_{\mathcal{K}} = m+n$ , and

$$H^{m+n}(\mathcal{Z}_{\mathcal{K}}) = \text{Tor}_{\mathbb{Z}[v_1, \dots, v_m]}^{-(m-n), 2m}(\mathbb{Z}[\mathcal{K}], \mathbb{Z}) \cong \mathbb{Z},$$

by Lemma 4.6.5. This implies the required identity for the Betti numbers.  $\square$

COROLLARY 4.6.7. *Let  $\mathcal{K}$  be a triangulated  $(n-1)$ -sphere and  $\mathcal{Z}_{\mathcal{K}}$  the corresponding moment-angle manifold,  $\dim \mathcal{Z}_{\mathcal{K}} = m+n$ . Then*

- (a)  $b^{-p,2q}(\mathcal{Z}_{\mathcal{K}}) = 0$  for  $p \geq m-n$ , with the only exception  $b^{-(m-n),2m} = 1$ ;
- (b)  $b^{-p,2q}(\mathcal{Z}_{\mathcal{K}}) = 0$  for  $q-p \geq n$ , with the only exception  $b^{-(m-n),2m} = 1$ .

It follows that if  $|\mathcal{K}| \cong S^{n-1}$ , then nonzero bigraded Betti numbers  $b^{r,2q}(\mathcal{Z}_{\mathcal{K}})$ , except  $b^{0,0}(\mathcal{Z}_{\mathcal{K}})$  and  $b^{-(m-n),2m}(\mathcal{Z}_{\mathcal{K}})$ , appear only in the strip bounded by the lines  $r = -(m-n-1)$ ,  $r = -1$ ,  $r+q = 1$  and  $r+q = n-1$  in the second quadrant, see Fig. 4.1 (b).

A space  $X$  is called a *Poincaré duality space* (over  $\mathbf{k}$ ) if  $H^*(X; \mathbf{k})$  is a Poincaré algebra (see Definition 3.4.3). We have the following characterisation of moment-angle complexes with Poincaré duality, extending the result of Corollary 4.6.6.

THEOREM 4.6.8.  *$\mathcal{Z}_{\mathcal{K}}$  is a Poincaré duality space over a field  $\mathbf{k}$  if and only if  $\mathcal{K}$  is a Gorenstein complex over  $\mathbf{k}$ .*

PROOF. Assume that  $\mathcal{K}$  is a Gorenstein complex. Consider the algebra  $T$  defined in Theorem 3.4.4, i.e.  $T = \bigoplus_{i=0}^d T^i$ , where  $T^i = \text{Tor}_{\mathbf{k}[m]}^{-i}(\mathbf{k}[\mathcal{K}], \mathbf{k})$  and  $d = \max\{j: \text{Tor}_{\mathbf{k}[m]}^{-j}(\mathbf{k}[\mathcal{K}], \mathbf{k}) \neq 0\}$ . Since  $T$  is Poincaré algebra,  $\mathbf{k} \cong T^0 \cong \text{Hom}_{\mathbf{k}}(T^d, T^d)$ , which implies that  $T^d \cong \mathbf{k}$ . Since  $T$  has a bigrading, we obtain  $T^d = T^{d,2q}$  for some  $q \geq 0$ . Since the multiplication in  $T$  respects the bigrading, the isomorphisms  $T^i \xrightarrow{\cong} \text{Hom}_{\mathbf{k}}(T^{d-i}, T^d)$  from the definition of a Poincaré algebra split into isomorphisms

$$T^{i,2j} \xrightarrow{\cong} \text{Hom}_{\mathbf{k}}(T^{d-i,2(q-j)}, T^{d,2q}).$$

Let  $H^k = H^k(\mathcal{Z}_{\mathcal{K}}; \mathbf{k})$  and  $H = \bigoplus_{k=0}^r H^k$ ; then  $H^k = \bigoplus_{i+2j=k} T^{i,2j}$  and  $r = d+2q$ . Therefore, we have the isomorphisms

$$H^k = \bigoplus_{i+2j=k} T^{i,2j} \xrightarrow{\cong} \bigoplus_{i+2j=k} \text{Hom}_{\mathbf{k}}(T^{d-i,2(q-j)}, T^{d,2q}) = \text{Hom}_{\mathbf{k}}(H^{r-k}, H^r),$$

which imply that  $H$  is a Poincaré algebra.

Now assume that  $H = \bigoplus_{k=0}^r H^k$  is a Poincaré algebra. Then

$$\mathbf{k} \cong H^r = \text{Tor}_{\mathbf{k}[v_1, \dots, v_m]}^{-d, 2q}(\mathbf{k}[\mathcal{K}], \mathbf{k}) = T^{d, 2q}$$

for some  $d, q \geq 0$ . Since the multiplication in the cohomology of  $\mathcal{Z}_{\mathcal{K}}$  respects the bigrading, the isomorphisms  $H^k \xrightarrow{\cong} \text{Hom}_{\mathbf{k}}(H^{r-k}, H^r)$  split into isomorphisms

$$H^{-i, 2j} = T^{i, 2j} \xrightarrow{\cong} \text{Hom}_{\mathbf{k}}(T^{d-i, 2(q-j)}, T^{d, 2q}),$$

which in their turn define the isomorphisms

$$T^i = \bigoplus_j T^{i, 2j} \xrightarrow{\cong} \bigoplus_j \text{Hom}_{\mathbf{k}}(T^{d-i, 2(q-j)}, T^d) = \text{Hom}_{\mathbf{k}}(T^{d-i}, T^d).$$

Thus,  $T$  is a Poincaré algebra.  $\square$

REMARK. We do not assume that  $r = \max\{k: H^k(\mathcal{Z}_{\mathcal{K}}; \mathbf{k}) \neq 0\}$  is equal to  $\dim \mathcal{Z}_{\mathcal{K}} = m+n$  in Theorem 4.6.8. It follows from the proof above that  $\mathcal{Z}_{\mathcal{K}}$  is a Poincaré duality space with  $r = \dim \mathcal{Z}_{\mathcal{K}}$  if and only if  $\mathcal{K}$  is a Gorenstein\* complex.

Here are some explicit examples of calculations of  $H^*(\mathcal{Z}_{\mathcal{K}})$  using Theorem 4.5.4.

EXAMPLE 4.6.9. Let  $\mathcal{K} = \partial\Delta^{m-1}$ . Then

$$\mathbb{Z}[\mathcal{K}] = \mathbb{Z}[v_1, \dots, v_m]/(v_1 \cdots v_m).$$

The cocycle  $u_1 v_2 v_3 \cdots v_m \in \Lambda[u_1, \dots, u_m] \otimes \mathbb{Z}[\mathcal{K}]$  of bidegree  $(-1, 2m)$  represents a generator of the top degree cohomology group of  $\mathcal{Z}_{\mathcal{K}} \cong S^{2m-1}$ .

EXAMPLE 4.6.10. Let  $\mathcal{K}$  be the boundary of 5-gon. We have  $\dim \mathcal{Z}_{\mathcal{K}} = 7$ . We enumerate the vertices of  $\mathcal{K}$  clockwise. The face ring of  $\mathcal{K}$  is given in Example 3.1.4.3. The group  $H^3(\mathcal{Z}_{\mathcal{K}})$  has 5 generators corresponding to the diagonals of the 5-gon; these generators are represented by the cocycles  $u_i v_{i+2} \in \mathbb{Z}[\mathcal{K}] \otimes \Lambda[u_1, \dots, u_5]$ ,  $1 \leq i \leq 5$  (the summation of indices is modulo 5). A direct calculation shows that  $H^4(\mathcal{Z}_{\mathcal{K}})$  also has 5 generators, represented by the cocycles  $u_j u_{j+1} v_{j+3}$ ,  $1 \leq j \leq 5$ . The Betti vector of  $\mathcal{Z}_{\mathcal{K}}$  is therefore given by

$$(b^0(\mathcal{Z}_{\mathcal{K}}), b^1(\mathcal{Z}_{\mathcal{K}}), \dots, b^7(\mathcal{Z}_{\mathcal{K}})) = (1, 0, 0, 5, 5, 0, 0, 1).$$

By Lemma 4.6.5, the product of cocycles  $u_i v_{i+2}$  and  $u_j u_{j+1} v_{j+3}$  represents a generator of  $H^7(\mathcal{Z}_{\mathcal{K}})$  if and only if all the indices  $i, i+2, j, j+1, j+3$  are different. Hence, for each cohomology class  $[u_i v_{i+2}] \in H^3(\mathcal{Z}_{\mathcal{K}})$  there is a unique class  $[u_j u_{j+1} v_{j+3}] \in H^4(\mathcal{Z}_{\mathcal{K}})$  such that the product  $[u_i v_{i+2}] \cdot [u_j u_{j+1} v_{j+3}]$  is nonzero. These calculations are summarised by the cohomology ring isomorphism

$$H^*(\mathcal{Z}_{\mathcal{K}}) \cong H^*((S^3 \times S^4)^{\#5}),$$

in accordance with Exercise 4.2.10.

EXAMPLE 4.6.11. Now we calculate the Betti numbers and the cohomology product for  $\mathcal{Z}_{\mathcal{K}}$  in the case when  $\mathcal{K}$  is a boundary of an  $m$ -gon with  $m \geq 4$ .

It follows from Corollary 4.6.7 that the only nonzero bigraded Betti numbers of  $\mathcal{Z}_{\mathcal{K}}$  are  $b^{-(p-1), 2p}$  for  $2 \leq p \leq m-2$  and  $b^{0,0}(\mathcal{Z}_{\mathcal{K}}) = b^{-(m-2), 2m}(\mathcal{Z}_{\mathcal{K}}) = 1$ . The ordinary Betti numbers are therefore given by

$$b^0(\mathcal{Z}_{\mathcal{K}}) = b^{m+2}(\mathcal{Z}_{\mathcal{K}}) = 1, \quad b^k(\mathcal{Z}_{\mathcal{K}}) = b^{-(k-2), 2(k-1)}(\mathcal{Z}_{\mathcal{K}}) \quad \text{for } 3 \leq k \leq m-1.$$

To calculate  $b^{-(k-2), 2(k-1)}(\mathcal{Z}_{\mathcal{K}})$  for  $3 \leq k \leq m-1$  we use the algebra  $R^*(\mathcal{K})$  of Construction 3.2.5. We have

$$(4.19) \quad b^{-(k-2), 2(k-1)}(\mathcal{Z}_{\mathcal{K}}) = \text{rank } H^{-(k-2), 2(k-1)}(R^*, d) = \\ \text{rank ker}[d: R^{-(k-2), 2(k-1)} \rightarrow R^{-(k-3), 2(k-1)}] - \text{rank } dR^{-(k-1), 2(k-1)}.$$

Since  $H^{-(k-1), 2(k-1)}(\mathcal{Z}_{\mathcal{K}}) = 0$  for  $k > 1$ , the differential  $d$  from  $R^{-(k-1), 2(k-1)}$  is monomorphic, and

$$\text{rank } dR^{-(k-1), 2(k-1)} = \text{rank } R^{-(k-1), 2(k-1)}.$$

Similarly, since  $H^{-(k-3), 2(k-1)}(\mathcal{Z}_{\mathcal{K}}) = 0$  for  $k \leq m$ , the differential from  $R^{-(k-2), 2(k-1)}$  is epimorphic, and

$$\text{rank ker}[d: R^{-(k-2), 2(k-1)} \rightarrow R^{-(k-3), 2(k-1)}] \\ = \text{rank } R^{-(k-2), 2(k-1)} - \text{rank } R^{-(k-3), 2(k-1)}.$$

Substituting the above two expressions into (4.19) and using formula (3.3) for the dimensions of  $R^{-p,2q}$ , we calculate

$$\begin{aligned} b^k(\mathcal{Z}_{\mathcal{K}}) &= b^{-(k-2),2(k-1)}(\mathcal{Z}_{\mathcal{K}}) \\ &= \text{rank } R^{-(k-2),2(k-1)} - \text{rank } R^{-(k-3),2(k-1)} - \text{rank } R^{-(k-1),2(k-1)} \\ &= m \binom{m-1}{k-2} - m \binom{m-2}{k-3} - \binom{m}{k-1} \\ &= (k-2) \binom{m-2}{k-1} + (m-k) \binom{m-2}{m-k+1} \quad \text{for } 3 \leq k \leq m-1. \end{aligned}$$

Note that the cohomology of  $\mathcal{Z}_{\mathcal{K}}$  does not have torsion in this example (this follows from Theorem 4.5.8).

The product of any three classes of positive degree in  $H^*(\mathcal{Z}_{\mathcal{K}})$  is zero (i.e. the *cohomology product length* of  $\mathcal{Z}_{\mathcal{K}}$  is 2). Indeed, if  $\alpha_i \in H^{-(p_i-1),2p_i}(\mathcal{Z}_{\mathcal{K}})$  for  $i = 1, 2, 3$ , then

$$\alpha_1 \alpha_2 \alpha_3 \in H^{-(p_1+p_2+p_3-3),2(p_1+p_2+p_3)}(\mathcal{Z}_{\mathcal{K}}),$$

which is zero by Lemma 4.6.1 (e) (note that  $n = 2$  in this example). Hence all nontrivial products in  $H^*(\mathcal{Z}_{\mathcal{K}})$  arise from Poincaré duality.

The above calculations of the Betti numbers together with the observations about the cohomology product can be summarised by saying that  $\mathcal{Z}_{\mathcal{K}}$  cohomologically looks like a connected sum of sphere products, namely,

$$(4.20) \quad H^*(\mathcal{Z}_{\mathcal{K}}) \cong H^* \left( \#_{k=3}^{m-1} (S^k \times S^{m+2-k}) \#^{(k-2)} \binom{m-2}{k-1} \right),$$

as rings.

According to a result of McGavran [216], the cohomology isomorphism of (4.20) is induced by a homeomorphism of manifolds. This is true even in a more general situation, when  $\mathcal{K}$  is the boundary of a stacked polytope (see Definition 1.4.8):

**THEOREM 4.6.12** ([216], [36, Theorem 6.3]). *Let  $\mathcal{K}$  be the boundary of a stacked polytope of dimension  $n$  with  $m > n + 1$  vertices. Then the corresponding moment-angle manifold is homeomorphic to a connected sum of sphere products,*

$$\mathcal{Z}_{\mathcal{K}} \cong \#_{k=3}^{m-n+1} (S^k \times S^{m+n-k}) \#^{(k-2)} \binom{m-n}{k-1}.$$

For  $n = 2$  we obtain a homeomorphism of manifolds underlying the isomorphism (4.20) (note that any 2-polytope is stacked).

The bigraded Betti numbers for stacked polytopes can also be calculated:

**THEOREM 4.6.13** ([303], [72], [195]). *Let  $\mathcal{K}$  be as in Theorem 4.6.12 and  $n \geq 3$ . Then the nonzero bigraded Betti numbers of  $\mathcal{Z}_{\mathcal{K}}$  are given by*

$$\begin{aligned} b^{0,0}(\mathcal{Z}_{\mathcal{K}}) &= b^{-(m-n),2m}(\mathcal{Z}_{\mathcal{K}}) = 1, \\ b^{-i,2(i+1)}(\mathcal{Z}_{\mathcal{K}}) &= i \binom{m-n}{i+1} \quad \text{for } 1 \leq i \leq m-n-1, \\ b^{-i,2(i+n-1)}(\mathcal{Z}_{\mathcal{K}}) &= (m-n-i) \binom{m-n}{m-n+1-i} \quad \text{for } 1 \leq i \leq m-n-1. \end{aligned}$$

### Exercises.

4.6.14. A triangulated manifold  $\mathcal{K}$  is a pseudomanifold.

4.6.15. If  $\mathcal{K}$  is a  $d$ -dimensional pseudomanifold, then either  $H_d(\mathcal{K}) \cong \mathbb{Z}$  or  $H_d(\mathcal{K}) \cong 0$ . What happens for homology and cohomology with coefficients in a field  $\mathbf{k}$ ?

4.6.16. If  $\mathcal{K}$  is an orientable  $d$ -dimensional pseudomanifold (i.e.  $H_d(\mathcal{K}) \cong \mathbb{Z}$ ) then  $H^d(\mathcal{K}) \cong \mathbb{Z}$ , and if  $\mathcal{K}$  is non-orientable then  $H^d(\mathcal{K}) \cong \mathbb{Z}_2$ . What happens for cohomology with coefficients in a field  $\mathbf{k}$ ?

4.6.17. Let  $\mathcal{K}$  be an orientable  $d$ -dimensional pseudomanifold. The homology group  $H_d(\mathcal{K}) \cong \mathbb{Z}$  is generated by the class of simplicial chain  $\langle \mathcal{K} \rangle = \sum_{I \in \mathcal{K}, \dim I = d} I$  where the  $d$ -simplices  $I \in \mathcal{K}$  are oriented properly (the *fundamental homology class* of  $\mathcal{K}$ ). The cohomology group  $H^d(\mathcal{K}) \cong \mathbb{Z}$  is generated by the class of any cochain  $\alpha_I$  taking value 1 on an oriented  $d$ -simplex  $I \in \mathcal{K}$  and vanishing on all other simplices.

4.6.18. Calculate  $H^*(\mathcal{Z}_{\mathcal{K}})$  where  $\mathcal{K}$  is the boundary of a pentagon using Theorem 4.5.8 and the description of the cohomology product given in Proposition 3.2.10 (or Exercise 3.2.14).

#### 4.7. Coordinate subspace arrangements

Here we establish a homotopy equivalence between the moment-angle complex  $\mathcal{Z}_{\mathcal{K}}$  and the complement of the arrangement of coordinate subspaces in  $\mathbb{C}^m$  corresponding to a simplicial complex  $\mathcal{K}$ . As a corollary we obtain an explicit description of the cohomology ring of a coordinate subspace arrangement complement. In some cases, knowing the cohomology ring allows us to identify the homotopy type of arrangement complements.

Coordinate subspace arrangements already appeared in Section 3.1 as affine algebraic varieties corresponding to face rings (see Proposition 3.1.12). Here we consider these arrangements from the general point of view.

A *coordinate subspace* in  $\mathbb{C}^m$  can be given as

$$(4.21) \quad L_I = \{(z_1, \dots, z_m) \in \mathbb{C}^m : z_{i_1} = \dots = z_{i_k} = 0\},$$

where  $I = \{i_1, \dots, i_k\}$  is a subset of  $[m]$ .

CONSTRUCTION 4.7.1. We assign to a simplicial complex  $\mathcal{K}$  the arrangement of complex coordinate subspaces (or *coordinate subspace arrangement*) given by

$$\mathcal{A}(\mathcal{K}) = \{L_I : I \notin \mathcal{K}\}.$$

We denote by  $U(\mathcal{K})$  the complement to  $\mathcal{A}(\mathcal{K})$  in  $\mathbb{C}^m$ , that is,

$$(4.22) \quad U(\mathcal{K}) = \mathbb{C}^m \setminus \bigcup_{I \notin \mathcal{K}} L_I.$$

Observe that if  $\mathcal{K}' \subset \mathcal{K}$  is a subcomplex, then  $U(\mathcal{K}') \subset U(\mathcal{K})$ .

PROPOSITION 4.7.2. *The assignment  $\mathcal{K} \mapsto U(\mathcal{K})$  defines a bijective inclusion-preserving correspondence between simplicial complexes on the set  $[m]$  and complements of coordinate subspace arrangements in  $\mathbb{C}^m$ .*

PROOF. We need to reconstruct a simplicial complex from the complement and check that it indeed defines the inverse correspondence. Let  $\mathcal{A}$  be a coordinate subspace arrangement in  $\mathbb{C}^m$ , and let  $U$  be its complement. Set

$$\mathcal{K}(U) = \{I \subset [m] : L_I \cap U \neq \emptyset\}.$$

It is easy to see that  $\mathcal{K}(U)$  is a simplicial complex satisfying  $U(\mathcal{K}(U)) = U$  and  $\mathcal{K}(U(\mathcal{K})) = \mathcal{K}$ .  $\square$



If  $\{i\}$  is a ghost vertex of  $\mathcal{K}$ , then the coordinate subspace arrangement  $\mathcal{A}(\mathcal{K})$  contains the hyperplane  $\{z_i = 0\}$ . The arrangement  $\mathcal{A}(\mathcal{K})$  does not contain hyperplanes if and only if the vertex set of  $\mathcal{K}$  is the whole  $[m]$ .

The complement  $U(\mathcal{K})$  is an example of a polyhedral product space (see Construction 4.2.1), as is shown by the next proposition.

PROPOSITION 4.7.3.  $U(\mathcal{K}) = (\mathbb{C}, \mathbb{C}^\times)^\mathcal{K}$ .

PROOF. Given a point  $\mathbf{z} = (z_1, \dots, z_m) \in \mathbb{C}^m$ , consider its zero set  $\omega(\mathbf{z}) = \{i \in [m] : z_i = 0\} \subset [m]$ . We have

$$\begin{aligned} U(\mathcal{K}) &= \mathbb{C}^m \setminus \bigcup_{I \notin \mathcal{K}} L_I = \mathbb{C}^m \setminus \bigcup_{I \notin \mathcal{K}} \{\mathbf{z} : \omega(\mathbf{z}) \supset I\} = \mathbb{C}^m \setminus \bigcup_{I \notin \mathcal{K}} \{\mathbf{z} : \omega(\mathbf{z}) = I\} \\ &= \bigcup_{I \in \mathcal{K}} \{\mathbf{z} : \omega(\mathbf{z}) = I\} = \bigcup_{I \in \mathcal{K}} \{\mathbf{z} : \omega(\mathbf{z}) \subset I\} = \bigcup_{I \in \mathcal{K}} (\mathbb{C}, \mathbb{C}^\times)^I = (\mathbb{C}, \mathbb{C}^\times)^\mathcal{K}. \quad \square \end{aligned}$$

EXAMPLE 4.7.4.

1. If  $\mathcal{K} = \Delta^{m-1}$ , then  $U(\mathcal{K}) = \mathbb{C}^m$ .
2. If  $\mathcal{K} = \partial\Delta^{m-1}$ , then  $U(\mathcal{K}) = \mathbb{C}^m \setminus \{0\}$ .
3. Let  $\mathcal{K}$  be the discrete complex with  $m$  vertices. Then

$$U(\mathcal{K}) = \mathbb{C}^m \setminus \bigcup_{1 \leq i < j \leq m} \{z_i = z_j = 0\}$$

is the complement to all coordinate subspaces of codimension two.

4. More generally, if  $\mathcal{K}$  is the  $i$ -dimensional skeleton of  $\Delta^{m-1}$ , then  $U(\mathcal{K})$  is the complement to all coordinate subspaces of codimension  $i + 2$ .

Since each coordinate subspace is invariant under the standard action of  $\mathbb{T}^m$  on  $\mathbb{C}^m$ , the complement  $U(\mathcal{K})$  is also a  $\mathbb{T}^m$ -invariant subset in  $\mathbb{C}^m$ .

A *deformation retraction* of a space  $X$  onto a subspace  $A$  is a homotopy  $F_t: X \rightarrow X$ ,  $t \in \mathbb{I}$ , such that  $F_0 = \text{id}$  (the identity map),  $F_1(X) = A$  and  $F_t|_A = \text{id}$  for all  $t$ . The term ‘deformation retraction’ is often used only for the last map  $f = F_1: X \rightarrow A$ ; this map is a homotopy equivalence.

THEOREM 4.7.5. *The moment-angle complex  $\mathcal{Z}_\mathcal{K}$  is a  $\mathbb{T}^m$ -invariant subspace of  $U(\mathcal{K})$ , and there is a  $\mathbb{T}^m$ -equivariant deformation retraction*

$$\mathcal{Z}_\mathcal{K} \hookrightarrow U(\mathcal{K}) \xrightarrow{\simeq} \mathcal{Z}_\mathcal{K}.$$

PROOF. We have  $\mathcal{Z}_\mathcal{K} = (\mathbb{D}, \mathbb{S})^\mathcal{K} \subset (\mathbb{C}, \mathbb{C}^\times)^\mathcal{K} = U(\mathcal{K})$  by the functoriality of the polyhedral product, so the moment-angle complex  $\mathcal{Z}_\mathcal{K}$  is indeed contained in the complement  $U(\mathcal{K})$  as a  $\mathbb{T}^m$ -invariant subset.

The deformation retraction  $U(\mathcal{K}) \rightarrow \mathcal{Z}_\mathcal{K}$  will be constructed by induction. We remove simplices from  $\Delta^{m-1}$  until we obtain  $\mathcal{K}$ , in such a way that we get a simplicial complex at each intermediate step.

The base of induction is clear: if  $\mathcal{K} = \Delta^{m-1}$ , then  $U(\mathcal{K}) = \mathbb{C}^m$ ,  $\mathcal{Z}_\mathcal{K} = \mathbb{D}^m$ , and the retraction  $\mathbb{C}^m \rightarrow \mathbb{D}^m$  is evident.

The orbit space  $\mathcal{Z}_\mathcal{K}/\mathbb{T}^m$  is the cubical complex  $\text{cc}(\mathcal{K}) = (\mathbb{I}, 1)^\mathcal{K}$  (see Construction 2.9.11). The orbit space  $U(\mathcal{K})/\mathbb{T}^m$  can be identified with

$$U(\mathcal{K})_{\geq} = U(\mathcal{K}) \cap \mathbb{R}_{\geq}^m = (\mathbb{R}_{\geq}, \mathbb{R}_{>})^\mathcal{K}$$

where  $\mathbb{R}_{\geq}^m$  is viewed as a subset in  $\mathbb{C}^m$ .

We shall first construct a deformation retraction  $r: U(\mathcal{K})_{\geq} \rightarrow \text{cc}(\mathcal{K})$  of orbit spaces, and then cover it by a deformation retraction  $\tilde{r}: U(\mathcal{K}) \rightarrow \mathcal{Z}_{\mathcal{K}}$ .

Now assume that  $\mathcal{K}$  is obtained from a simplicial complex  $\mathcal{K}'$  by removing one maximal simplex  $J = \{j_1, \dots, j_k\}$ , i.e.  $\mathcal{K} \cup J = \mathcal{K}'$ . Then the cubical complex  $\text{cc}(\mathcal{K}')$  is obtained from  $\text{cc}(\mathcal{K})$  by adding a single  $k$ -dimensional face  $C_J = (\mathbb{I}, 1)^J$ . We also have  $U(\mathcal{K}) = U(\mathcal{K}') \setminus L_J$ , so that

$$U(\mathcal{K})_{\geq} = U(\mathcal{K}')_{\geq} \setminus \{\mathbf{y}: y_{j_1} = \dots = y_{j_k} = 0\}.$$

We may assume by induction that there is a deformation retraction  $r': U(\mathcal{K}')_{\geq} \rightarrow \text{cc}(\mathcal{K}')$  such that  $\omega(r'(\mathbf{y})) = \omega(\mathbf{y})$ , where  $\omega(\mathbf{y})$  is the set of zero coordinates of  $\mathbf{y}$ . In particular,  $r'$  restricts to a deformation retraction

$$r': U(\mathcal{K}')_{\geq} \setminus \{\mathbf{y}: y_{j_1} = \dots = y_{j_k} = 0\} \longrightarrow \text{cc}(\mathcal{K}') \setminus \mathbf{y}_J$$

where  $\mathbf{y}_J$  is the point with coordinates  $y_{j_1} = \dots = y_{j_k} = 0$  and  $y_j = 1$  for  $j \notin J$ .

Since  $J \notin \mathcal{K}$ , we have  $\mathbf{y}_J \notin \text{cc}(\mathcal{K})$ . On the other hand,  $\mathbf{y}_J$  belongs to the extra face  $C_J = (\mathbb{I}, 1)^J$  of  $\text{cc}(\mathcal{K}')$ . We therefore may apply the deformation retraction  $r_J$  shown in Fig. 4.2 on the face  $C_J$ , with centre at  $\mathbf{y}_J$ . In coordinates, a homotopy  $F_t$

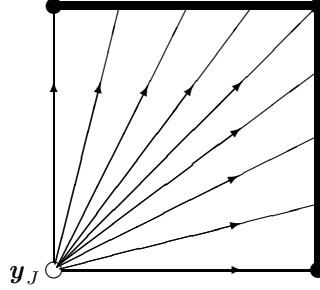

FIGURE 4.2. Retraction  $r_J: \text{cc}(\mathcal{K}') \setminus \mathbf{y}_J \rightarrow \text{cc}(\mathcal{K})$ .

between the identity map  $\text{cc}(\mathcal{K}') \setminus \mathbf{y}_J \rightarrow \text{cc}(\mathcal{K}') \setminus \mathbf{y}_J$  (for  $t = 0$ ) and the retraction  $r_J: \text{cc}(\mathcal{K}') \setminus \mathbf{y}_J \rightarrow \text{cc}(\mathcal{K})$  (for  $t = 1$ ) is given by

$$\begin{aligned} F_t: \text{cc}(\mathcal{K}') \setminus \mathbf{y}_J &\longrightarrow \text{cc}(\mathcal{K}') \setminus \mathbf{y}_J, \\ (y_1, \dots, y_m, t) &\longmapsto (y_1 + t\alpha_1 y_1, \dots, y_m + t\alpha_m y_m) \end{aligned}$$

where

$$\alpha_i = \begin{cases} \frac{1 - \max_{j \in J} y_j}{\max_{j \in J} y_j}, & \text{if } i \in J, \\ 0, & \text{if } i \notin J, \end{cases} \quad \text{for } 1 \leq i \leq m.$$

We observe that  $\omega(F_t(\mathbf{y})) = \omega(\mathbf{y})$  for any  $t$  and  $\mathbf{y} \in \text{cc}(\mathcal{K}')$ . Now, the composition

$$(4.23) \quad r: U(\mathcal{K})_{\geq} = U(\mathcal{K}')_{\geq} \setminus \{\mathbf{y}: y_{j_1} = \dots = y_{j_k} = 0\} \xrightarrow{r'} \text{cc}(\mathcal{K}') \setminus \mathbf{y}_J \xrightarrow{r_J} \text{cc}(\mathcal{K})$$

is a deformation retraction, and it satisfies  $\omega(r(\mathbf{y})) = \omega(\mathbf{y})$  as this is true for  $r_J$  and  $r'$ . The inductive step is now complete. The required retraction  $\tilde{r}: U(\mathcal{K}) \rightarrow \mathcal{Z}_{\mathcal{K}}$

covers  $r$  as shown in the following commutative diagram:

$$\begin{array}{ccccc} \mathcal{Z}_{\mathcal{K}} & \hookrightarrow & U(\mathcal{K}) & \xrightarrow{\tilde{r}} & \mathcal{Z}_{\mathcal{K}} \\ \downarrow \mu & & \downarrow \mu & & \downarrow \mu \\ \text{cc}(\mathcal{K}) & \hookrightarrow & U_{\geq}(\mathcal{K}) & \xrightarrow{r} & \text{cc}(\mathcal{K}) \end{array}$$

Explicitly,  $\tilde{r}$  is decomposed inductively in a way similar to (4.23),

$$\tilde{r}: U(\mathcal{K}) = U(\mathcal{K}') \setminus L_J \xrightarrow{\tilde{r}'} \mathcal{Z}_{\mathcal{K}'} \setminus \mu^{-1}(\mathbf{y}_J) \xrightarrow{\tilde{r}_J} \mathcal{Z}_{\mathcal{K}},$$

where  $\mu^{-1}(\mathbf{y}_J) = \prod_{j \in J} \{0\} \times \prod_{j \notin J} \mathbb{S}$ , and  $\tilde{r}_J$  is given in coordinates  $(z_1, \dots, z_m) = (\sqrt{y_1}e^{i\varphi_1}, \dots, \sqrt{y_m}e^{i\varphi_m})$  by

$$(\sqrt{y_1}e^{i\varphi_1}, \dots, \sqrt{y_m}e^{i\varphi_m}) \mapsto (\sqrt{y_1 + \alpha_1 y_1}e^{i\varphi_1}, \dots, \sqrt{y_m + \alpha_m y_m}e^{i\varphi_m})$$

with  $\alpha_i$  as above.  $\square$

Since  $U(\mathcal{K})$  and  $\mathcal{Z}_{\mathcal{K}}$  are homotopy equivalent, we can use the results on the cohomology of  $\mathcal{Z}_{\mathcal{K}}$  (such as Theorems 4.5.4 and 4.5.8) to describe the cohomology rings of coordinate subspace arrangement complements. The additive isomorphism  $H^k(U(\mathcal{K})) \cong \bigoplus_{-i+2j=k} \text{Tor}_{\mathbf{k}[v_1, \dots, v_m]}^{-i, 2j}(\mathbf{k}[\mathcal{K}], \mathbf{k})$  has been also proved in [124].

EXAMPLE 4.7.6. Let  $\mathcal{K}$  be the set of  $m$  disjoint points. Then  $\mathcal{Z}_{\mathcal{K}}$  is homotopy equivalent to the complement  $U(\mathcal{K})$  of Example 4.7.4.3, and

$$\mathbb{Z}[\mathcal{K}] = \mathbb{Z}[v_1, \dots, v_m]/(v_i v_j, i \neq j).$$

The subspace of cocycles in  $R^*(\mathcal{K})$  has basis of monomials

$$u_{i_1} u_{i_2} \cdots u_{i_{k-1}} v_{i_k} \quad \text{with } i_p \neq i_q \text{ for } p \neq q.$$

Since the total degree of  $u_{i_1} u_{i_2} \cdots u_{i_{k-1}} v_{i_k}$  is  $k+1$ , the space of cocycles of degree  $k+1$  has dimension  $m \binom{m-1}{k-1}$ . The subspace of coboundaries of degree  $k+1$  is spanned by the elements of the form

$$d(u_{i_1} \cdots u_{i_k})$$

and has dimension  $\binom{m}{k}$ . Therefore,

$$\text{rank } H^0(U(\mathcal{K})) = 1,$$

$$\text{rank } H^1(U(\mathcal{K})) = H^2(U(\mathcal{K})) = 0,$$

$$\text{rank } H^{k+1}(U(\mathcal{K})) = m \binom{m-1}{k-1} - \binom{m}{k} = (k-1) \binom{m}{k}, \quad \text{for } 2 \leq k \leq m,$$

and the multiplication in the cohomology of  $U(\mathcal{K})$  is trivial.

The calculation of the previous example shows that if  $\mathcal{K}$  is the set of  $m$  points, then there is a cohomology ring isomorphism

$$(4.24) \quad H^*(U(\mathcal{K})) \cong H^* \left( \bigvee_{k=2}^m (S^{k+1})^{\vee(k-1)} \binom{m}{k} \right),$$

where  $X^{\vee k}$  denotes the  $k$ -fold wedge of a space  $X$ . This cohomology isomorphism is induced by a homotopy equivalence, as is shown by the following result.

THEOREM 4.7.7 ([132], [133, Corollary 9.5]). *Let  $\mathcal{K}$  be the  $i$ -dimensional skeleton of the simplex  $\Delta^{m-1}$ , so that  $U(\mathcal{K})$  is the complement to all coordinate planes of codimension  $i+2$  in  $\mathbb{C}^m$ . Then  $U(\mathcal{K})$  is homotopy equivalent to a wedge of spheres:*

$$U(\mathcal{K}) \simeq \bigvee_{k=i+2}^m (S^{i+k+1})^{\vee \binom{m}{k} \binom{k-1}{i+1}}.$$

The proof uses the homotopy fibration  $\mathcal{Z}_{\mathcal{K}} \rightarrow (\mathbb{C}P^\infty)^{\mathcal{K}} \rightarrow (\mathbb{C}P^\infty)^m$  (see Theorem 4.3.2); it will be further discussed in Section 8.2. For  $i = 0$  we obtain the homotopy equivalence behind cohomology isomorphism (4.24).

Real coordinate subspace arrangements

$$U_{\mathbb{R}}(\mathcal{K}) = (\mathbb{R}, \mathbb{R}^\times)^{\mathcal{K}}$$

in  $\mathbb{R}^m$  are defined and treated similarly; there are real analogues of all results and constructions of this section. (The real version of Theorem 4.7.7 is much simpler: see Exercise 4.2.8).

A coordinate subspace can be given either by setting some coordinates to zero, as in (4.21), or as the linear span of a subset of the standard basis  $e_1, \dots, e_m$ . The latter approach leads to an alternative way of parametrising complements of coordinate subspace arrangements by simplicial complexes, which is related to the former one by Alexander duality.

Given a subset  $I \subset [m]$  we set  $S_I = \mathbb{C}\langle e_i : i \in I \rangle$  (the  $\mathbb{C}$ -span of the basis vectors corresponding to  $I$ ), and use the notation  $\hat{I} = [m] \setminus I$  and  $\hat{\mathcal{K}} = \{\hat{I} \subset [m] : I \notin \mathcal{K}\}$  from Construction 2.4.1. Then the coordinate subspace arrangement corresponding to a simplicial complex  $\mathcal{K}$  can be written in the following two ways:

$$\mathcal{A}(\mathcal{K}) = \{L_I : I \notin \mathcal{K}\} = \{S_{\hat{I}} : \hat{I} \in \hat{\mathcal{K}}\}.$$

Using Alexander duality we can reformulate the description of the cohomology of  $U(\mathcal{K})$  in terms of full subcomplexes of  $\mathcal{K}$  (Theorem 4.5.8) as follows.

PROPOSITION 4.7.8. *There are isomorphisms*

$$\tilde{H}^q(U(\mathcal{K})) \cong \bigoplus_{\hat{I} \in \hat{\mathcal{K}}} \tilde{H}_{2m-2|\hat{I}|-q-2}(\mathrm{lk}_{\hat{\mathcal{K}}} \hat{I}).$$

PROOF. By Theorems 4.7.5 and 4.5.8,

$$H^q(U(\mathcal{K})) \cong \bigoplus_{I \subset [m]} \tilde{H}^{q-|I|-1}(\mathcal{K}_I).$$

Nonempty simplices  $I \in \mathcal{K}$  do not contribute to the sum above, since the corresponding subcomplexes  $\mathcal{K}_I$  are contractible. Since  $\tilde{H}^{-1}(\emptyset) = \mathbb{Z}$ , the empty simplex contributes  $\mathbb{Z}$  to  $H^0(U(\mathcal{K}))$ . Therefore, we can rewrite the isomorphism above as

$$\tilde{H}^q(U(\mathcal{K})) \cong \bigoplus_{I \notin \mathcal{K}} \tilde{H}^{q-|I|-1}(\mathcal{K}_I).$$

Using Alexander duality (Proposition 2.4.6) we calculate

$$\tilde{H}^{q-|I|-1}(\mathcal{K}_I) \cong \tilde{H}_{|I|-3-q+|I|+1}(\mathrm{lk}_{\hat{\mathcal{K}}} \hat{I}) = \tilde{H}_{2m-2|\hat{I}|-q-2}(\mathrm{lk}_{\hat{\mathcal{K}}} \hat{I}),$$

where  $\hat{I} = [m] \setminus I$  is a simplex of  $\hat{\mathcal{K}}$ . □

Proposition 4.7.8 is a particular case of the well-known *Goresky–MacPherson formula* [130, Chapter III], which calculates the (co)homology groups of the complement of an arrangement of affine subspaces in terms of its *intersection poset*. In the case of coordinate subspace arrangements  $\mathcal{A}(\mathcal{K})$  the intersection poset is the face poset of the dual complex  $\widehat{\mathcal{K}}$ . For more on the relationships between general affine subspace arrangements and moment-angle complexes see [55, Chapter 8].

**Exercises.**

4.7.9. The affine algebraic variety  $X(\mathcal{K})$  corresponding to the face ring  $\mathbb{C}[\mathcal{K}]$  (see Proposition 3.1.12) and the coordinate subspace arrangement  $\mathcal{A}(\mathcal{K})$  of Construction 4.7.1 are related by the identity  $X(\widehat{\mathcal{K}}) = \mathcal{A}(\mathcal{K})$ , where  $\widehat{\mathcal{K}} = \{I \subset [m] : [m] \setminus I \notin \mathcal{K}\}$  is the Alexander dual complex.

4.7.10. Show directly that the complement to the 3 coordinate lines in  $\mathbb{C}^3$  is homotopy equivalent to the wedge of spheres  $S^3 \vee S^3 \vee S^3 \vee S^4 \vee S^4$ ; this corresponds to  $m = 3$  in (4.24).

4.7.11. Show directly (without referring to Theorem 4.7.5 and Proposition 4.3.5) that the complement  $U(\mathcal{K})$  is 2-connected if  $\mathcal{K}$  does not have ghost vertices, and that  $U(\mathcal{K})$  is  $2q$ -connected if  $\mathcal{K}$  is  $q$ -neighbourly.



## Moment-angle complexes: additional topics

### 4.8. Free and almost free torus actions on moment-angle complexes

Here consider free and almost free actions of toric subgroups  $T^k \subset \mathbb{T}^m$  on  $\mathcal{Z}_{\mathcal{K}}$ . As usual,  $\mathcal{K}$  is an  $(n-1)$ -dimensional simplicial complex on  $[m]$ , and  $\mathcal{Z}_{\mathcal{K}}$  is the corresponding moment-angle complex.

We start with a simple characterisation of the isotropy subgroups of the standard  $\mathbb{T}^m$ -action on  $\mathcal{Z}_{\mathcal{K}}$ . For each  $I \subset [m]$  we consider the coordinate subtorus

$$\mathbb{T}^I = \{(t_1, \dots, t_m) \in \mathbb{T}^m : t_j = 1 \text{ for } j \notin I\} = \prod_{i \in I} \mathbb{T} \subset \mathbb{T}^m$$

(note that  $\mathbb{T}^I = (\mathbb{T}, 1)^I$  in the notation of Construction 4.2.1).

**PROPOSITION 4.8.1.** *Let  $\mathbf{z} \in \mathcal{Z}_{\mathcal{K}}$ , and set  $\omega(\mathbf{z}) = \{i \in [m] : z_i = 0\} \in \mathcal{K}$ . Then the isotropy subgroup of  $\mathbf{z}$  with respect to the  $\mathbb{T}^m$ -action is  $\mathbb{T}^{\omega(\mathbf{z})}$ . Furthermore, each coordinate subtorus  $\mathbb{T}^I$  for  $I \in \mathcal{K}$  is the isotropy subgroup for a point  $\mathbf{z} \in \mathcal{Z}_{\mathcal{K}}$ .*

**PROOF.** An element  $\mathbf{t} = (t_1, \dots, t_m) \in \mathbb{T}^m$  fixes  $\mathbf{z}$  if and only if  $t_i = 1$  whenever  $z_i \neq 0$ , which is equivalent to that  $\mathbf{t} \in \mathbb{T}^{\omega(\mathbf{z})}$ . The last statement is also clear:  $\mathbb{T}^I$  is the isotropy subgroup for any  $\mathbf{z} \in (\mathbb{D}, \mathbb{S})^I \subset \mathcal{Z}_{\mathcal{K}}$  with  $\omega(\mathbf{z}) = I$ .  $\square$

Recall that an action of a group on a topological space is *almost free* if all isotropy subgroups are finite.

**DEFINITION 4.8.2.** We define the *free toral rank* of  $\mathcal{Z}_{\mathcal{K}}$ , denoted  $\text{ftr } \mathcal{Z}_{\mathcal{K}}$ , as the maximal dimension of toric subgroups  $T^k \subset \mathbb{T}^m$  acting on  $\mathcal{Z}_{\mathcal{K}}$  freely. Similarly, the *almost free toral rank* of  $\mathcal{Z}_{\mathcal{K}}$ , denoted  $\text{atr } \mathcal{Z}_{\mathcal{K}}$ , is the maximal dimension of toric subgroups  $T^k \subset \mathbb{T}^m$  acting on  $\mathcal{Z}_{\mathcal{K}}$  almost freely.

**PROPOSITION 4.8.3.** *Let  $\mathcal{K}$  be a simplicial complex of dimension  $n-1$  on  $m$  vertices and  $\mathcal{K} \neq \Delta^{m-1}$ . The toral ranks of  $\mathcal{Z}_{\mathcal{K}}$  satisfy the following inequalities:*

$$1 \leq \text{ftr } \mathcal{Z}_{\mathcal{K}} \leq \text{atr } \mathcal{Z}_{\mathcal{K}} \leq m - n.$$

**PROOF.** By Proposition 4.8.1, isotropy subgroups for the  $\mathbb{T}^m$ -action on  $\mathcal{Z}_{\mathcal{K}}$  are coordinate subgroups of the form  $\mathbb{T}^I$ . The diagonal circle in  $\mathbb{T}^m$  intersects each of these coordinate subgroups trivially (since  $I \neq [m]$ ), and therefore acts freely on  $\mathcal{Z}_{\mathcal{K}}$ . This proves the first inequality. The second is obvious. To prove the third one, assume that  $T^k \subset \mathbb{T}^m$  acts almost freely on  $\mathcal{Z}_{\mathcal{K}}$ . Then the intersection of  $T^k$  with every  $\mathbb{T}^m$ -isotropy subgroup  $\mathbb{T}^I$  is a finite group. Choose a maximal simplex  $I \in \mathcal{K}$ ,  $|I| = n$ . Then  $\mathbb{T}^I \cap T^k$  can be finite only if  $k \leq m - n$ .  $\square$

The map  $\mathbb{R}^m \rightarrow \mathbb{T}^m$ ,  $(\varphi_1, \dots, \varphi_m) \mapsto (e^{2\pi i \varphi_1}, \dots, e^{2\pi i \varphi_m})$ , identifies  $\mathbb{T}^m$  with the quotient  $\mathbb{R}^m / \mathbb{Z}^m$ . Subtori  $T^k \subset \mathbb{T}^m$  of dimension  $k$  bijectively correspond to unimodular sublattices  $L \subset \mathbb{Z}^m$  of rank  $k$  (a sublattice is *unimodular* if it is a direct

summand in  $\mathbb{Z}^m$ ). The inclusion  $T^k \subset \mathbb{T}^m$  can be viewed as  $L_{\mathbb{R}}/L \subset \mathbb{R}^m/\mathbb{Z}^m$ , where  $L_{\mathbb{R}}$  is the  $k$ -dimensional subspace in  $\mathbb{R}^m$  spanned by  $L$ .

Choosing a basis in  $L$  we obtain an integer  $m \times k$ -matrix  $S = (s_{ij})$ ,  $1 \leq i \leq m$ ,  $1 \leq j \leq k$ , so that  $L$  is identified with the image of  $S: \mathbb{Z}^k \rightarrow \mathbb{Z}^m$ . The  $k$ -torus  $T^k$  is the image of the corresponding monomorphism of tori  $\mathbb{T}^k \rightarrow \mathbb{T}^m$ , namely,

$$(4.25) \quad T^k = \left\{ \left( e^{2\pi i(s_{11}\psi_1 + \dots + s_{1k}\psi_k)}, \dots, e^{2\pi i(s_{m1}\psi_1 + \dots + s_{mk}\psi_k)} \right) \right\} \subset \mathbb{T}^m,$$

where  $(\psi_1, \dots, \psi_k) \in \mathbb{R}^k$ . Since  $L$  is unimodular, the columns of  $S$  form a part of basis of the lattice  $\mathbb{Z}^m$ .

LEMMA 4.8.4. *Let  $T^k$  be a  $k$ -dimensional subtorus in  $\mathbb{T}^m$  and let  $L$  be the corresponding unimodular sublattice of rank  $k$  in  $\mathbb{Z}^m$ . Let  $S = (s_{ij})$ ,  $1 \leq i \leq m$ ,  $1 \leq j \leq k$ , be a matrix defining  $L$ , so that  $T^k$  is given by (4.25).*

- (a) *The torus  $T^k$  acts on  $\mathcal{Z}_{\mathcal{K}}$  almost freely if and only if for each  $I \in \mathcal{K}$  the intersection of subspaces  $L_{\mathbb{R}}$  and  $\mathbb{R}^I$  in  $\mathbb{R}^m$  is zero. Equivalently, the  $(m - |I|) \times k$ -matrix  $S_{\hat{I}}$  obtained by deleting from  $S$  the rows with numbers  $i \in I$  has rank  $k$ .*
- (b) *The torus  $T^k$  acts on  $\mathcal{Z}_{\mathcal{K}}$  freely if and only if for each  $I \in \mathcal{K}$  the sublattice spanned by  $L$  and  $\mathbb{Z}^I$  in  $\mathbb{Z}^m$  is unimodular of rank  $k + |I|$ . Equivalently, the columns of the  $(m - |I|) \times k$ -matrix  $S_{\hat{I}}$  form a part of basis of  $\mathbb{Z}^{m-|I|}$ .*

PROOF. We prove (a) first. By Proposition 4.8.1, the  $T^k$ -action on  $\mathcal{Z}_{\mathcal{K}}$  is almost free if and only if the intersection  $T^k \cap \mathbb{T}^I \subset \mathbb{T}^m$  is finite for each  $I \in \mathcal{K}$ . This intersection can be identified with the kernel of the map  $f: T^k \times \mathbb{T}^I \rightarrow \mathbb{T}^m$  (the product of the inclusion maps  $T^k \rightarrow \mathbb{T}^m$  and  $\mathbb{T}^I \rightarrow \mathbb{T}^m$ ). This kernel is finite if and only if the corresponding map of real spaces  $L_{\mathbb{R}} \times \mathbb{R}^I \rightarrow \mathbb{R}^m$  is injective, which is equivalent to that  $L_{\mathbb{R}} \cap \mathbb{R}^I = \{0\}$ . Let  $I = \{i_1, \dots, i_p\}$ , then the matrix of  $f$  has the form  $(S|e_{i_1}| \dots |e_{i_p})$ , where  $e_i$  is the  $i$ th standard basis column vector. Clearly, this matrix has rank  $k + |I|$  if and only if the matrix  $S_{\hat{I}}$  has rank  $k$ .

Now we prove (b). The  $T^k$ -action on  $\mathcal{Z}_{\mathcal{K}}$  is free if and only if the kernel of  $f: T^k \times \mathbb{T}^I \rightarrow \mathbb{T}^m$  is trivial for each  $I \in \mathcal{K}$ , i.e.  $T^k \times \mathbb{T}^I$  embeds as a subtorus. This is equivalent to the conditions stated in (b).  $\square$

Let  $\mathbf{t} = (t_1, \dots, t_n) \in \mathbb{Z}[\mathcal{K}]$  be a linear sequence given by

$$(4.26) \quad t_i = \lambda_{i1}v_1 + \dots + \lambda_{im}v_m, \quad \text{for } 1 \leq i \leq n.$$

We consider the integer  $n \times m$ -matrix  $\Lambda = (\lambda_{ij})$ ,  $1 \leq i \leq n$ ,  $1 \leq j \leq m$ . It defines a homomorphism of lattices  $\Lambda: \mathbb{Z}^m \rightarrow \mathbb{Z}^n$  and a homomorphism of tori  $\Lambda: \mathbb{T}^m \rightarrow \mathbb{T}^n$ .

THEOREM 4.8.5. *The following conditions are equivalent:*

- (a) *the sequence  $(t_1, \dots, t_n)$  given by (4.26) is an lsop in the rational face ring  $\mathbb{Q}[\mathcal{K}]$ ;*
- (b) *the kernel  $T_{\Lambda} = \text{Ker}(\Lambda: \mathbb{T}^m \rightarrow \mathbb{T}^n)$  is a product of an  $(m - n)$ -torus and a finite group, and  $T_{\Lambda}$  acts almost freely on  $\mathcal{Z}_{\mathcal{K}}$ .*



PROOF. We first observe that under any of conditions (a) or (b) the rational map  $\Lambda: \mathbb{Q}^m \rightarrow \mathbb{Q}^n$  is surjective. For each simplex  $I \in \mathcal{K}$  we consider the diagram

$$\begin{array}{ccccccc}
 & & & 0 & & & \\
 & & & \downarrow & & & \\
 & & & \mathbb{Q}^{m-n} & & & \\
 & & & \downarrow i_1 & & & \\
 0 & \longrightarrow & \mathbb{Q}^{|I|} & \xrightarrow{i_2} & \mathbb{Q}^m & \xrightarrow{p_2} & \mathbb{Q}^{m-|I|} \longrightarrow 0 \\
 & & & & \downarrow \Lambda & & \\
 & & & & \mathbb{Q}^n & & \\
 & & & & \downarrow & & \\
 & & & & 0 & & 
 \end{array}$$

where  $i_2$  is the inclusion of the coordinate subspace  $\mathbb{Q}^I \rightarrow \mathbb{Q}^m$ . The map  $\Lambda i_2$  is given by the  $n \times |I|$  matrix  $\Lambda_I = (\lambda_{ij})$ ,  $1 \leq i \leq n$ ,  $j \in I$ . By Lemma 3.3.2, the sequence  $(t_1, \dots, t_n)$  is a rational lsop if and only if the rank of  $\Lambda_I$  is  $|I|$  for each  $I \in \mathcal{K}$ . Hence condition (a) of the theorem is equivalent to the injectivity of the map  $\Lambda i_2$  for each  $I \in \mathcal{K}$ .

On the other hand, by Lemma 4.8.4 (a), the action of the  $(m-n)$ -torus  $T_\Lambda$  on  $\mathcal{Z}_\mathcal{K}$  is almost free if and only if  $i_1(\mathbb{Q}^{m-n}) \cap \mathbb{Q}^I = \{0\}$  for each  $I \in \mathcal{K}$ . The latter condition is equivalent to that  $i_1(\mathbb{Q}^{m-n}) \cap \text{Ker } p_2 = \{0\}$ , i.e. that  $p_2 i_1$  is injective. Hence condition (b) of the theorem is equivalent to the injectivity of the map  $p_2 i_1$  for each  $I \in \mathcal{K}$ . Now the theorem follows from Lemma 1.2.5.  $\square$

The almost free toral rank of  $\mathcal{Z}_\mathcal{K}$  can now be easily determined:

COROLLARY 4.8.6. *We have  $\text{atr } \mathcal{Z}_\mathcal{K} = m - n$ , i.e. for each simplicial complex  $\mathcal{K}$  of dimension  $(n-1)$  on  $[m]$  there is an  $(m-n)$ -dimensional subtorus in  $\mathbb{T}^m$  acting on  $\mathcal{Z}_\mathcal{K}$  almost freely.*

PROOF. Choose a rational lsop in  $\mathbb{Q}[\mathcal{K}]$  by Theorem A.3.10, and multiply it by a common denominator to get an integral sequence (4.26). It is still an lsop in  $\mathbb{Q}[\mathcal{K}]$  (but it may fail to be an lsop in  $\mathbb{Z}[\mathcal{K}]$ ), and therefore the  $(m-n)$ -torus  $T_\Lambda$  acts on  $\mathcal{Z}_\mathcal{K}$  almost freely by Theorem 4.8.5.  $\square$

There is an analogue of Theorem 4.8.5 for free torus actions:

THEOREM 4.8.7. *The following conditions are equivalent:*

- (a) *the sequence  $(t_1, \dots, t_n)$  given by (4.26) is an lsop in  $\mathbb{Z}[\mathcal{K}]$ ;*
- (b)  *$T_\Lambda = \text{Ker}(\Lambda: \mathbb{T}^m \rightarrow \mathbb{T}^n)$  is an  $(m-n)$ -torus acting freely on  $\mathcal{Z}_\mathcal{K}$ .*

PROOF. The argument is the same as in the proof of Theorem 4.8.5: Lemma 1.2.5 is now applied to the diagram of integral lattices instead of rational vector spaces.  $\square$

Nevertheless, there is no analogue of Corollary 4.8.6 for free torus actions, as integral lsop's may fail to exist. Indeed, the free toral rank of  $\mathcal{Z}_\mathcal{K}$  where  $\mathcal{K}$  is the boundary of a cyclic  $n$ -polytope with  $m \geq 2^n$  vertices is strictly less than  $m-n$ , as shown by Example 3.3.4. The free toral rank of  $\mathcal{Z}_\mathcal{K}$  is a combinatorial characteristic of  $\mathcal{K}$ , also known as the *Buchstaber invariant*. Its determination is a very subtle problem; see [107] and [120] for some partial results in this direction.

There is the following important conjecture of equivariant topology and rational homotopy theory concerning almost free torus action.

CONJECTURE 4.8.8 (Toral Rank Conjecture, Halperin [148]). *Assume that a torus  $T^k$  acts almost freely on a finite-dimensional topological space  $X$ . Then*

$$\dim H^*(X; \mathbb{Q}) \geq 2^k,$$

*i.e. the total dimension of the cohomology of  $X$  is at least that of the torus  $T^k$ .*

The Toral Rank Conjecture is valid for  $k \leq 3$  and is open in general. See [269] and [312] for the discussion of the current status of this conjecture.

In the case of moment-angle complexes we have the following result:

THEOREM 4.8.9 ([66], [311]). *Let  $\mathcal{K}$  be a simplicial complex of dimension  $n-1$  with  $m$  vertices, and let  $\mathcal{Z}_{\mathcal{K}}$  be the corresponding moment-angle complex. Then*

$$\text{rank } H^*(\mathcal{Z}_{\mathcal{K}}) = \sum_{k=0}^{m+n} \text{rank } H^k(\mathcal{Z}_{\mathcal{K}}) \geq 2^{m-n}.$$

The proof of this theorem given in [311] uses a construction of independent interest and a couple of technical lemmata. We include this proof below.

COROLLARY 4.8.10. *The Toral Rank Conjecture is valid for subtori  $T^k \subset \mathbb{T}^m$  acting almost freely on  $\mathcal{Z}_{\mathcal{K}}$ .*

The following is a particular case of the so-called *simplicial wedge construction* [268]. It has been brought into toric topology by the work [15].

CONSTRUCTION 4.8.11 (Simplicial doubling). Let  $\mathcal{K}$  be a simplicial complex on the vertex set  $[m]$ . The *double* of  $\mathcal{K}$  is the simplicial complex  $\mathcal{D}(\mathcal{K})$  on the vertex set  $[2m] = \{1, 1', 2, 2', \dots, m, m'\}$  whose missing faces (minimal non-faces) are  $\{i_1, i'_1, \dots, i_k, i'_k\}$  where  $\{i_1, \dots, i_k\}$  is a missing face of  $\mathcal{K}$ . In other words,  $\mathcal{D}(\mathcal{K})$  is determined by its face ring given by

$$\mathbf{k}[\mathcal{D}(\mathcal{K})] = \mathbf{k}[v_1, v_{1'}, \dots, v_m, v_{m'}] / (\{v_{i_1} v_{i'_1} \cdots v_{i_k} v_{i'_k} : \{i_1, \dots, i_k\} \notin \mathcal{K}\}).$$

EXAMPLE 4.8.12.

1. If  $\mathcal{K} = \Delta^{m-1}$  (the full simplex on  $m$  vertices), then  $\mathcal{D}(\mathcal{K}) = \Delta^{2m-1}$ .
2. If  $\mathcal{K} = \partial\Delta^{m-1}$ , then  $\mathcal{D}(\mathcal{K}) = \partial\Delta^{2m-1}$ .

The doubling construction interacts nicely with the polyhedral product:

THEOREM 4.8.13. *Let  $(X, A)$  be a pair of spaces, let  $\mathcal{K}$  be a simplicial complex on  $[m]$  and  $\mathcal{D}(\mathcal{K})$  its double. Then*

$$(X, A)^{\mathcal{D}(\mathcal{K})} = (X \times X, X \times A \cup A \times X)^{\mathcal{K}}.$$

PROOF. Set  $(Y, B) = (X \times X, X \times A \cup A \times X)$ . Given a point  $\mathbf{y} = (y_1, \dots, y_m) \in Y^m$ , we set

$$\omega_Y(\mathbf{y}) = \{i \in [m] : y_i \notin B\} \subset [m].$$

Similarly, given  $\mathbf{x} = (x_1, x_{1'}, \dots, x_m, x_{m'}) \in X^{2m}$ , we set

$$\omega_X(\mathbf{x}) = \{j \in \{1, 1', \dots, m, m'\} : x_j \notin A\} \subset \{1, 1', \dots, m, m'\}.$$

We identify  $\mathbf{y}$  with  $\mathbf{x}$  by the formula  $(y_1, \dots, y_m) = ((x_1, x_{1'}), \dots, (x_m, x_{m'})) \in Y^m = X^{2m}$ . It follows from the definition of the polyhedral product that  $\mathbf{y} \notin$

$(Y, B)^\mathcal{K}$  if and only if  $\omega_Y(\mathbf{y}) \notin \mathcal{K}$ . The latter is equivalent to the condition  $\omega_X(\mathbf{x}) \notin \mathcal{D}(\mathcal{K})$ , since if  $\omega_Y(\mathbf{y}) = \{i_1, \dots, i_k\}$  then  $\omega_X(\mathbf{x}) \supset \{i_1, i'_1, \dots, i_k, i'_k\}$ . Therefore,

$$\mathbf{y} \notin (Y, B)^\mathcal{K} \iff \mathbf{x} \notin (X, A)^{\mathcal{D}(\mathcal{K})},$$

which implies that  $(X, A)^{\mathcal{D}(\mathcal{K})} = (Y, B)^\mathcal{K}$ .  $\square$

REMARK. The simplicial wedge [268], [15] is a generalisation of the doubling construction, in which the  $i$ th vertex of  $\mathcal{K}$  is replaced by a  $j_i$ -tuple of vertices, for some vector  $\mathbf{j} = (j_1, \dots, j_m)$  of natural numbers. The double corresponds to  $\mathbf{j} = (2, \dots, 2)$ . There is an analogue of Theorem 4.8.13 in this setting, see [15, §7].

As an important consequence of Theorem 4.8.13 we obtain the following relationship between the moment-angle complex  $\mathcal{Z}_\mathcal{K}$  and its real analogue  $\mathcal{R}_\mathcal{K}$ :

COROLLARY 4.8.14. *We have  $\mathcal{Z}_\mathcal{K} \cong \mathcal{R}_{\mathcal{D}(\mathcal{K})}$ .*

PROOF. Apply Theorem 4.8.13 to the pair  $(X, A) = (D^1, S^0)$ , observing that  $(D^1 \times D^1, D^1 \times S^0 \cup S^0 \times D^1) \cong (D^2, S^1)$ .  $\square$

LEMMA 4.8.15. *Let  $(X, A)$  be a pair of cell complexes such that  $A$  has a collar neighbourhood  $U(A)$  in  $X$  (i.e. there is a homeomorphism of pairs  $(U(A), A) \cong (A \times [0, 1), A \times \{0\})$ ). Let  $Y = X_1 \cup_A X_2$  be the space obtained by attaching two copies of  $X$  along  $A$ . Then*

$$\text{rank } H^*(Y) \geq \text{rank } H^*(A).$$

PROOF. The assumption on  $(X, A)$  implies that we can apply the Mayer–Vietoris sequence to the decomposition  $Y = X_1 \cup_A X_2$ :

$$\dots \xrightarrow{\beta_{k-1}} H^{k-1}(A) \xrightarrow{\delta_{k-1}} H^k(Y) \xrightarrow{\alpha_k} H^k(X_1) \oplus H^k(X_2) \xrightarrow{\beta_k} H^k(A) \rightarrow \dots$$

The map  $\beta_k$  is  $i_1^* \oplus (-i_2^*)$ , where  $i_1: A \rightarrow X_1$  and  $i_2: A \rightarrow X_2$  are the inclusions. Since  $X_1 = X_2 = X$ , and the inclusions  $i_1$  and  $i_2$  coincide, we have  $\text{rank Ker } \beta_k \geq \text{rank } H^k(X)$  and  $\text{rank Im } \beta_k \leq \text{rank } H^k(X)$ . Using these inequalities we calculate

$$\begin{aligned} \text{rank } H^k(Y) &= \text{rank Ker } \alpha_k + \text{rank Im } \alpha_k = \text{rank Im } \delta_{k-1} + \text{rank Ker } \beta_k \\ &\geq \text{rank } H^{k-1}(A) - \text{rank Im } \beta_{k-1} + \text{rank } H^k(X) \\ &\geq \text{rank } H^{k-1}(A) - \text{rank } H^{k-1}(X) + \text{rank } H^k(X). \end{aligned}$$

The required inequality is obtained by summing up over  $k$ .  $\square$

THEOREM 4.8.16. *Let  $\mathcal{K}$  be a simplicial complex of dimension  $n - 1$  with  $m$  vertices, and let  $\mathcal{R}_\mathcal{K}$  be the corresponding real moment-angle complex. Then*

$$\text{rank } H^*(\mathcal{R}_\mathcal{K}) \geq 2^{m-n'} \geq 2^{m-n},$$

where  $n'$  is the minimum of the cardinality of maximal simplices of  $\mathcal{K}$  (so that  $n' = n = \dim \mathcal{K} + 1$  if and only if  $\mathcal{K}$  is pure).

PROOFS OF THEOREMS 4.8.9 AND 4.8.16. We first prove the inequality for  $\mathcal{R}_\mathcal{K}$ , by induction on the number of vertices  $m$ . For  $m = 1$  the statement is clear. We embed  $\mathcal{R}_\mathcal{K}$  as a subcomplex in the ‘big’ cube  $[-1, 1]^m$  (see Construction 4.1.5) with coordinates  $\mathbf{u} = (u_1, \dots, u_m)$ ,  $-1 \leq u_i \leq 1$ . Assume that the first vertex

of  $\mathcal{K}$  belongs to an  $(n' - 1)$ -dimensional maximal simplex of  $\mathcal{K}$ , and consider the following subspaces of  $\mathcal{R}_{\mathcal{K}}$ :

$$\begin{aligned} X_+ &= \{\mathbf{u} \in \mathcal{R}_{\mathcal{K}} : u_1 \geq 0\}, & X_- &= \{\mathbf{u} \in \mathcal{R}_{\mathcal{K}} : u_1 \leq 0\}, \\ A &= X_+ \cap X_- = \{\mathbf{u} \in \mathcal{R}_{\mathcal{K}} : u_1 = 0\}. \end{aligned}$$

Applying Lemma 4.8.15 to the decomposition  $\mathcal{R}_{\mathcal{K}} = X_+ \cup_A X_-$  we obtain

$$\text{rank } H^*(\mathcal{R}_{\mathcal{K}}) \geq \text{rank } H^*(A).$$

On the other hand,  $A$  is the disjoint union of  $2^{m-m_1-1}$  copies of  $\mathcal{R}_{\text{lk}_{\mathcal{K}}\{1\}}$ , where  $m_1$  is the number of vertices of  $\text{lk}_{\mathcal{K}}\{1\}$ . Since  $\{1\}$  is a vertex of a maximal simplex of  $\mathcal{K}$  of minimal cardinality  $n'$ , the minimal cardinality of maximal simplices in  $\text{lk}_{\mathcal{K}}\{1\}$  is  $n'_1 = n' - 1$ . Now using the inductive hypothesis we obtain

$$\text{rank } H^*(A) = 2^{m-m_1-1} \text{rank } H^*(\mathcal{R}_{\text{lk}_{\mathcal{K}}\{1\}}) \geq 2^{m-m_1-1} 2^{m_1-n'_1} = 2^{m-n'}.$$

Theorem 4.8.16 is therefore proved.

To prove Theorem 4.8.9 we use the fact that  $\mathcal{Z}_{\mathcal{K}} \cong \mathcal{R}_{\mathcal{D}(\mathcal{K})}$ , and observe that the numbers  $m - n$  (and  $m - n'$ ) for  $\mathcal{K}$  and  $\mathcal{D}(\mathcal{K})$  coincide.  $\square$

Using Theorems 4.5.4 and 4.5.8 we may reformulate Theorem 4.8.9 in both algebraic and combinatorial terms:

**THEOREM 4.8.17.** *Let  $\mathcal{K}$  be a simplicial complex of dimension  $n - 1$  with  $m$  vertices, and let  $\mathbf{k}$  be a field. Then*

$$\dim \text{Tor}_{\mathbf{k}[v_1, \dots, v_m]}(\mathbf{k}[\mathcal{K}], \mathbf{k}) = \sum_{J \subset [m], k \geq 0} \dim \tilde{H}^{k-|J|-1}(\mathcal{K}_J; \mathbf{k}) \geq 2^{m-n}.$$

As a corollary we obtain that the weak Horrocks Conjecture (Conjecture A.2.12) holds for a particular class of rings:

**COROLLARY 4.8.18.** *Let  $\mathcal{K}$  be a Cohen–Macaulay simplicial complex (over a field  $\mathbf{k}$ ) of dimension  $n - 1$  with  $m$  vertices. Let  $\mathbf{t} = (t_1, \dots, t_n)$  be an lsoip in  $\mathbf{k}[\mathcal{K}]$ , so that  $\mathbf{k}[m]/\mathbf{t} \cong \mathbf{k}[w_1, \dots, w_{m-n}]$  and  $\dim \mathbf{k}[\mathcal{K}]/\mathbf{t} < \infty$ . Then*

$$\dim \text{Tor}_{\mathbf{k}[w_1, \dots, w_{m-n}]}(\mathbf{k}[\mathcal{K}]/\mathbf{t}, \mathbf{k}) \geq 2^{m-n},$$

*i.e. the weak Horrocks Conjecture holds for the rings  $\mathbf{k}[\mathcal{K}]/\mathbf{t}$ .*

**PROOF.** This follows from the previous theorem and Proposition 4.5.6.  $\square$

### Exercises.

4.8.19. Show that  $\text{ftr } \mathcal{Z}_{\mathcal{K}} = 1$  if and only if  $\mathcal{K} = \partial\Delta^{m-1}$ .

4.8.20. The Toral Rank Conjecture fails if  $\dim X = \infty$ .

4.8.21. Show that the doubling operation respects the join, that is,  $\mathcal{D}(\mathcal{K} * \mathcal{L}) = \mathcal{D}(\mathcal{K}) * \mathcal{D}(\mathcal{L})$ .

4.8.22. Assume that  $\mathcal{K}$  is the boundary complex of a simplicial  $n$ -polytope  $Q \subset \mathbb{R}^n$  with  $m$  vertices  $v_1, \dots, v_m$ . Then  $\mathcal{D}(\mathcal{K})$  is the boundary of a simplicial polytope  $\mathcal{D}(Q)$  of dimension  $m + n$  with  $2m$  vertices, which can be obtained in the following way. We embed  $\mathbb{R}^n$  as the coordinate subspace in  $\mathbb{R}^{m+n}$  on the last  $n$  coordinates. For each vertex  $v_i \in Q \subset \mathbb{R}^n$  take the line  $l_i \subset \mathbb{R}^{m+n}$  through  $v_i$  parallel to the  $i$ th coordinate line of  $\mathbb{R}^{m+n}$ , for  $1 \leq i \leq m$ . Then replace each  $v_i$  by a pair of points

$v'_i, v''_i \in l_i$  such that  $v_i$  the centre of the segment with the vertices  $v'_i, v''_i$ . Then the boundary of

$$\mathcal{D}(Q) = \text{conv}(v'_1, v''_1, \dots, v'_m, v''_m) \subset \mathbb{R}^{m+n}$$

is  $\mathcal{D}(\mathcal{K})$ .

4.8.23. There is the following generalisation of Theorem 4.8.13. Let

$$(\mathbf{X}, \mathbf{A}) = \{(X_1, A_1), (X_{1'}, A_{1'}), \dots, (X_m, A_m), (X_{m'}, A_{m'})\}$$

be a set of  $2m$  pairs of spaces. Define a new set  $(\mathbf{Y}, \mathbf{B}) = \{(Y_1, B_1), \dots, (Y_m, B_m)\}$  of  $m$  pairs, where

$$(Y_i, B_i) = (X_i \times X_{i'}, X_i \times A_{i'} \cup A_i \times X_{i'}).$$

Then

$$(\mathbf{X}, \mathbf{A})^{\mathcal{D}(\mathcal{K})} \cong (\mathbf{Y}, \mathbf{B})^{\mathcal{K}}.$$

Further generalisations can be found in [15, §7].

4.8.24. The inequality  $\text{rank } H^*(\mathcal{R}_{\mathcal{K}}) \geq 2^{m-n}$  of Theorem 4.8.16 (or the inequality  $\text{rank } H^*(\mathcal{Z}_{\mathcal{K}}) \geq 2^{m-n}$ ) turns into identity if and only if

$$\mathcal{K} = \partial\Delta^{k_1-1} * \partial\Delta^{k_2-1} * \dots * \partial\Delta^{k_p-1} * \Delta^{m-s-1},$$

where  $s = k_1 + \dots + k_p$  and the join factor  $\Delta^{m-s-1}$  is void if  $s = m$  (compare Exercise 3.3.19). In this case both  $\mathcal{R}_{\mathcal{K}}$  and  $\mathcal{Z}_{\mathcal{K}}$  are products of spheres and a disc.

#### 4.9. Massey products in the cohomology of moment-angle complexes

Here we address the question of existence of nontrivial triple Massey products in the Koszul complex

$$(\Lambda[u_1, \dots, u_m] \otimes \mathbb{Z}[\mathcal{K}], d)$$

of the face ring, and therefore in the cohomology of  $\mathcal{Z}_{\mathcal{K}}$ . The general definition of Massey products in the cohomology of a differential graded algebra is reviewed in Section A.4 of the Appendix. A geometrical approach to constructing nontrivial triple Massey products in the Koszul complex of the face ring was developed by Baskakov in [23] as an extension of the cohomology calculation in Theorem 4.5.7. It is well-known that non-trivial higher Massey products obstruct the *formality* of a differential graded algebra, which in our case leads to a family of nonformal moment-angle manifolds  $\mathcal{Z}_{\mathcal{K}}$  (see Section B.2 for the background material).

CONSTRUCTION 4.9.1 (Baskakov [23]). Let  $\mathcal{K}_i$  be a triangulation of a sphere  $S^{n_i-1}$  with  $|V_i| = m_i$  vertices,  $i = 1, 2, 3$ . Set  $m = m_1 + m_2 + m_3$ ,  $n = n_1 + n_2 + n_3$ ,

$$\mathcal{K} = \mathcal{K}_1 * \mathcal{K}_2 * \mathcal{K}_3, \quad \mathcal{Z}_{\mathcal{K}} = \mathcal{Z}_{\mathcal{K}_1} \times \mathcal{Z}_{\mathcal{K}_2} \times \mathcal{Z}_{\mathcal{K}_3}.$$

Then  $\mathcal{K}$  is a triangulation of  $S^{n-1}$  and therefore  $\mathcal{Z}_{\mathcal{K}}$  is an  $(m+n)$ -manifold.

We choose maximal simplices  $I_1 \in \mathcal{K}_1$ ,  $I'_2, I''_2 \in \mathcal{K}_2$  such that  $I'_2 \cap I''_2 = \emptyset$ , and  $I_3 \in \mathcal{K}_3$ . Set

$$\tilde{\mathcal{K}} = \text{ss}_{I_1 \cup I'_2}(\text{ss}_{I''_2 \cup I_3} \mathcal{K}),$$

where  $\text{ss}_I$  denotes the stellar subdivision at  $I$ , see Definition 2.7.1. Then  $\tilde{\mathcal{K}}$  is a triangulation of  $S^{n-1}$  with  $m+2$  vertices. Take generators

$$\beta_i \in \tilde{H}^{n_i-1}(\tilde{\mathcal{K}}_{V_i}) \cong \tilde{H}^{n_i-1}(S^{n_i-1}), \quad \text{for } i = 1, 2, 3,$$

where  $\tilde{\mathcal{K}}_{V_i}$  is the restriction of  $\tilde{\mathcal{K}}$  to the vertex set of  $\mathcal{K}_i$ , and set

$$\alpha_i = h(\beta_i) \in H^{n_i-m_i, 2m_i}(\mathcal{Z}_{\tilde{\mathcal{K}}}) \subset H^{m_i+n_i}(\mathcal{Z}_{\tilde{\mathcal{K}}}),$$

where  $h$  is the isomorphism of Theorem 4.5.7. Then

$$\beta_1\beta_2 \in \tilde{H}^{n_1+n_2-1}(\tilde{\mathcal{K}}_{V_1 \sqcup V_2}) \cong \tilde{H}^{n_1+n_2-1}(S^{n_1+n_2-1} \setminus pt = 0,$$

hence  $\alpha_1\alpha_2 = h(\beta_1\beta_2) = 0$ , and similarly  $\alpha_2\alpha_3 = 0$ . Therefore, the triple Massey product  $\langle \alpha_1, \alpha_2, \alpha_3 \rangle \subset H^{m+n-1}(\mathcal{Z}_{\tilde{\mathcal{K}}})$  is defined. By definition, it is the set of cohomology classes represented by the cocycles  $(-1)^{\deg a_1+1}a_1f + ea_3$  where  $a_i$  is a cocycle representing  $\alpha_i$ , and  $e, f$  are cochains satisfying  $de = a_1a_2, df = a_2a_3$ .

For the simplest example of this series, take  $\mathcal{K}_i = S^0$  (two points), so that  $\mathcal{K}$  is the boundary of an octahedron, and  $\tilde{\mathcal{K}}$  is obtained by applying stellar subdivisions at two skew edges. We shall consider this example in more detail below.

Recall that a Massey product is *trivial* if it contains zero.

**THEOREM 4.9.2.** *The above defined triple Massey product*

$$\langle \alpha_1, \alpha_2, \alpha_3 \rangle \subset H^{m+n-1}(\mathcal{Z}_{\tilde{\mathcal{K}}})$$

*is nontrivial.*

**PROOF.** Consider the subcomplex of  $\tilde{\mathcal{K}}$  consisting of the two new vertices added to  $\mathcal{K}$  in the process of stellar subdivision. By Proposition 4.2.3 (b), the inclusion of this subcomplex induces an embedding of a 3-dimensional sphere  $S^3 \hookrightarrow \mathcal{Z}_{\tilde{\mathcal{K}}}$ . Since the two new vertices are not joined by an edge in  $\mathcal{Z}_{\tilde{\mathcal{K}}}$ , the embedded 3-sphere defines a non-trivial class  $x \in H_3(\mathcal{Z}_{\tilde{\mathcal{K}}})$ . Its Poincaré dual cohomology class in  $H^{m+n-1}(\mathcal{Z}_{\tilde{\mathcal{K}}})$  is contained in the Massey product  $\langle \alpha_1, \alpha_2, \alpha_3 \rangle$ . We need only to check that this element cannot be turned into zero by adding elements from the indeterminacy of the Massey product, i.e. from the subspace

$$\alpha_1 \cdot H^{m_2+m_3+n_2+n_3-1}(\mathcal{Z}_{\tilde{\mathcal{K}}}) + \alpha_3 \cdot H^{m_1+m_2+n_1+n_2-1}(\mathcal{Z}_{\tilde{\mathcal{K}}}).$$

To do this we use the multigraded structure in  $H^*(\mathcal{Z}_{\tilde{\mathcal{K}}})$ . The multigraded components of the group  $H^{m_2+m_3+n_2+n_3-1}(\mathcal{Z}_{\tilde{\mathcal{K}}})$  different from the component determined by the full subcomplex  $\tilde{\mathcal{K}}_{V_2 \sqcup V_3}$  do not affect the nontriviality of the Massey product, while the multigraded component corresponding to  $\tilde{\mathcal{K}}_{V_2 \sqcup V_3}$  is zero since  $\tilde{\mathcal{K}}_{V_2 \sqcup V_3} \cong S^{n_2+n_3-1} \setminus pt$  is contractible. The group  $H^{m_1+m_2+n_1+n_2-1}(\mathcal{Z}_{\tilde{\mathcal{K}}})$  is considered similarly. It follows that the Massey product contains a unique nonzero element in its multigraded component and therefore it is nontrivial.  $\square$

**COROLLARY 4.9.3.** *Let  $\tilde{\mathcal{K}}$  be a triangulated sphere obtained from another sphere  $\mathcal{K}$  by applying two stellar subdivisions as described above. Then the corresponding 2-connected moment-angle manifold  $\mathcal{Z}_{\tilde{\mathcal{K}}}$  is non-formal.*

In the proof of Theorem 4.9.2 the nontriviality of the Massey product is established geometrically. A parallel argument may be carried out algebraically using the Koszul complex or its quotient algebra  $R^*(\mathcal{K})$ , as illustrated in the next example. To be precise, the nonformality of a manifold  $\mathcal{Z}_{\mathcal{K}}$  is equivalent to the nonformality of its *singular* cochain algebra  $C^*(\mathcal{Z}_{\mathcal{K}}; \mathbb{Q})$  (or Sullivan's algebra  $A_{PL}(\mathcal{Z}_{\mathcal{K}})$ ), while the rational Koszul complex or the algebra  $R^*(\mathcal{K}) \otimes \mathbb{Q}$  are quasi-isomorphic to the *cellular* cochain algebra  $\mathcal{C}^*(\mathcal{Z}_{\mathcal{K}}; \mathbb{Q})$ . However, this difference is irrelevant: it can be easily seen that the existence of a nontrivial triple Massey product for the cellular cochain algebra  $\mathcal{C}^*(\mathcal{Z}_{\mathcal{K}}; \mathbb{Q})$  implies that  $\mathcal{Z}_{\mathcal{K}}$  is nonformal (an exercise, or see [95, Proposition 5.6.1]).

EXAMPLE 4.9.4. We consider the simplest case of Construction 4.9.1, when  $\tilde{\mathcal{K}}$  is obtained from the boundary of an octahedron by applying stellar subdivisions at two skew edges. Then  $\tilde{\mathcal{K}} = \mathcal{K}_P$  is the nerve complex of a simple 3-polytope  $P$  obtained by truncating a cube at two edges as shown in Figure 4.3. The face ring is given by

$$\mathbb{Z}[\mathcal{K}_P] = \mathbb{Z}[v_1, \dots, v_6, w_1, w_2] / \mathcal{I}_{\mathcal{K}_P},$$

where  $v_i, i = 1, \dots, 6$ , are the generators coming from the facets of the cube and  $w_1, w_2$  are the generators corresponding to the two new facets, and

$$\mathcal{I}_{\mathcal{K}_P} = (v_1v_2, v_3v_4, v_5v_6, w_1w_2, v_1v_3, v_4v_5, w_1v_3, w_1v_6, w_2v_2, w_2v_4).$$

We denote the corresponding exterior generators of  $R^*(\mathcal{K}_P)$  by  $u_1, \dots, u_6, t_1, t_2$ ;

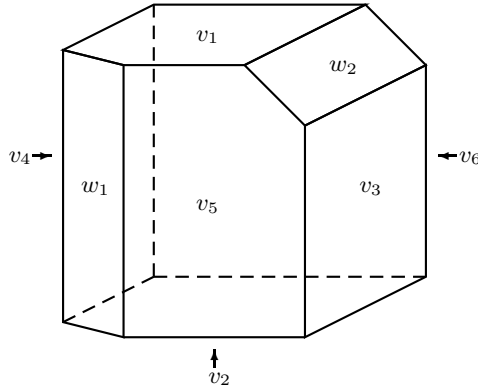

FIGURE 4.3.

they satisfy  $du_i = v_i$  and  $dt_i = w_i$ . Consider the cocycles

$$a = v_1u_2, \quad b = v_3u_4, \quad c = v_5u_6$$

and the corresponding cohomology classes  $\alpha, \beta, \gamma \in H^{-1,4}[R^*(\mathcal{K})]$ . The equations

$$ab = de, \quad bc = df$$

have a solution  $e = 0, f = v_5u_3u_4u_6$ , so the triple Massey product  $\langle \alpha, \beta, \gamma \rangle \in H^{-4,12}[R^*(\mathcal{K})]$  is defined. This Massey product is represented by the cocycle

$$af + ec = v_1v_5u_2u_3u_4u_6$$

and is nontrivial. The differential graded algebra  $R^*(\mathcal{K}_P)$  and the 11-dimensional manifold  $\mathcal{Z}_{\mathcal{K}_P}$  are not formal.

REMARK. We can truncate the polytope  $P$  from the previous example at another edge to obtain a 3-dimensional associahedron  $As^3$ , shown in Figure 1.5 (left). By considering similar nontrivial Massey products (now there will be three of them, corresponding to each pair of cut off edges) we deduce that the 12-dimensional moment-angle manifold corresponding to  $As^3$  is also nonformal.

In view of Theorem 4.9.2, the question arises of describing the class of simplicial complexes  $\mathcal{K}$  for which the algebra  $R^*(\mathcal{K})$  (equivalently, the Koszul algebra  $(\Lambda[u_1, \dots, u_m] \otimes \mathbb{Z}[\mathcal{K}], d)$ ) is formal. For example, this is the case if  $\mathcal{K}$  is the boundary of a polytope or, more generally, if  $\mathcal{K}$  is of the form described in Theorem 4.6.12.

Triple Massey products in the cohomology of  $\mathcal{Z}_{\mathcal{K}}$  were further studied in the work of Denham and Suciu [95]. According to [95, Theorem 6.1.1], there exists a nontrivial triple Massey product of 3-dimensional cohomology classes  $\alpha, \beta, \gamma \in H^3(\mathcal{Z}_{\mathcal{K}})$  if and only if the 1-skeleton of  $\mathcal{K}$  contains an induced subgraph isomorphic to one of the five explicitly described ‘obstruction’ graphs. In [95, Example 8.5.1] there is also constructed an example of  $\mathcal{K}$  for which the corresponding  $\mathcal{Z}_{\mathcal{K}}$  has an *indecomposable* triple Massey product in the cohomology (a triple Massey product is indecomposable if it does not contain a cohomology class that can be written as a product of two cohomology classes of positive dimension).

To conclude this section, we mention that the algebraic study of Massey products in the cohomology of Koszul complexes has a long history. It goes back to the work of Golod [128], who studied the Poincaré series of  $\mathrm{Tor}_R(\mathbf{k}, \mathbf{k})$  for a Nötherian local ring  $R$ . The main result of Golod is a calculation of the Poincaré series for the class of rings whose Koszul complexes have all Massey products vanishing (including the cohomology multiplication). Such rings were called *Golod* in the monograph [147] of Gulliksen and Levin, where the reader can find a detailed exposition of Golod’s theorem together with several further applications.

**DEFINITION 4.9.5.** We refer to a simplicial complex  $\mathcal{K}$  as *Golod* (over a ring  $\mathbf{k}$ ) if its face ring  $\mathbf{k}[\mathcal{K}]$  has the Golod property, i.e. if the multiplication and all higher Massey products in  $\mathrm{Tor}_{\mathbf{k}[v_1, \dots, v_m]}(\mathbf{k}[\mathcal{K}], \mathbf{k}) = H(\Lambda[u_1, \dots, u_m] \otimes \mathbf{k}[\mathcal{K}], d)$  are trivial.

Golod complexes were studied in [157], where several combinatorial criteria for Golodness were given. The appearance of moment-angle complexes added a topological dimension to the whole study. In particular, Theorem 4.5.4 implies that  $\mathcal{K}$  is Golod whenever  $\mathcal{Z}_{\mathcal{K}}$  is homotopy equivalent to a wedge of spheres. This observation was used in [133, Theorems 9.1, 11.2] to produce new classes of Golod simplicial complexes, including skeleta of simplices considered in Theorem 4.7.7, and, more generally, all *shifted* complexes. For all such  $\mathcal{K}$  the corresponding moment-angle complex  $\mathcal{Z}_{\mathcal{K}}$  is homotopy equivalent to a wedge of spheres. There are examples of Golod complexes  $\mathcal{K}$  for which  $\mathcal{Z}_{\mathcal{K}}$  is *not* homotopy equivalent to a wedge of spheres (see Exercise 4.9.7 and [131, Example 3.3]). More explicit series of Golod complexes were constructed by Seyed Fakhari and Welker in [284].

By a result of Berglund and Jöllenbek [28, Theorem 5.1], the face ring  $\mathbf{k}[\mathcal{K}]$  is Golod if and only if the multiplication in  $\mathrm{Tor}_{\mathbf{k}[v_1, \dots, v_m]}(\mathbf{k}[\mathcal{K}], \mathbf{k})$  is trivial (i.e. triviality of the cup-product implies that all higher Massey products are also trivial).

More details on the relationship between the Golod property for  $\mathcal{K}$  and the homotopy theory of moment-angle complexes  $\mathcal{Z}_{\mathcal{K}}$  can be found in [133], [131], as well as in Section 8.5.

### Exercises.

4.9.6. If the cellular cochain algebra  $\mathcal{C}^*(\mathcal{Z}_{\mathcal{K}}; \mathbb{Q})$  carries a nontrivial triple Massey product, then  $\mathcal{Z}_{\mathcal{K}}$  is nonformal.

4.9.7. Let  $\mathcal{K}$  be the triangulation of  $\mathbb{R}P^2$  from Example 3.2.12.4. Then  $\mathcal{K}$  is a Golod complex, but  $\mathcal{Z}_{\mathcal{K}}$  is not homotopy equivalent to a wedge of spheres.

## 4.10. Moment-angle complexes from simplicial posets

Simplicial posets  $\mathcal{S}$  generalise naturally abstract simplicial complexes (see Section 2.8). Algebraic properties of their face rings  $\mathbf{k}[\mathcal{S}]$  were discussed in Section 3.5.



Following the categorical description of the moment-angle complex  $\mathcal{Z}_{\mathcal{K}}$  outlined in the end of Construction 4.1.1, it is easy to extend the definition of  $\mathcal{Z}_{\mathcal{K}}$  to simplicial posets. The resulting space  $\mathcal{Z}_{\mathcal{S}}$  carries a torus action, and its equivariant and ordinary cohomology is expressed in terms of the face ring  $\mathbb{Z}[\mathcal{S}]$  in the same way as for the standard moment-angle complexes  $\mathcal{Z}_{\mathcal{K}}$ . Simplicial posets and associated moment-angle complexes therefore provide a broader context for studying the link between torus actions and combinatorial commutative algebra. These developments are originally due to Lü and Panov [199].

Let  $\mathcal{S}$  be a finite simplicial poset with the vertex set  $V(\mathcal{S}) = [m]$ .

CONSTRUCTION 4.10.1 (moment-angle complex). We consider the face category  $\text{CAT}(\mathcal{S})$  whose objects are elements  $\sigma \in \mathcal{S}$  and there is a morphism from  $\sigma$  to  $\tau$  whenever  $\sigma \leq \tau$ . For each element  $\sigma \in \mathcal{S}$  we define the following subset in the standard unit polydisc  $\mathbb{D}^m \subset \mathbb{C}^m$ :

$$(D^2, S^1)^\sigma = \{(z_1, \dots, z_m) \in \mathbb{D}^m : |z_j|^2 = 1 \text{ for } j \notin \sigma\}.$$

Then  $(D^2, S^1)^\sigma$  is homeomorphic to a product of  $|\sigma|$  discs and  $m - |\sigma|$  circles. We have an inclusion  $(D^2, S^1)^\tau \subset (D^2, S^1)^\sigma$  whenever  $\tau \leq \sigma$ . Now define a diagram

$$\begin{aligned} \mathcal{D}_{\mathcal{S}}(D^2, S^1) : \text{CAT}(\mathcal{S}) &\longrightarrow \text{TOP}, \\ \sigma &\longmapsto (D^2, S^1)^\sigma, \end{aligned}$$

which maps a morphism  $\sigma \leq \tau$  of  $\text{CAT}(\mathcal{S})$  to the inclusion  $(D^2, S^1)^\sigma \subset (D^2, S^1)^\tau$  (see Appendix C.1 for the definition of diagrams and their colimits).

We define the *moment-angle complex* corresponding to  $\mathcal{S}$  by

$$\mathcal{Z}_{\mathcal{S}} = \text{colim}_{\sigma \in \mathcal{S}} \mathcal{D}_{\mathcal{S}}(D^2, S^1) = \text{colim}_{\sigma \in \mathcal{S}} (D^2, S^1)^\sigma.$$

The space  $\mathcal{Z}_{\mathcal{S}}$  is therefore glued from the blocks  $(D^2, S^1)^\sigma$  according to the poset relation in  $\mathcal{S}$ . When  $\mathcal{S}$  is (the face poset of) a simplicial complex  $\mathcal{K}$  it becomes the standard moment-angle complex  $\mathcal{Z}_{\mathcal{K}}$ .

Since every subset  $(D^2, S^1)^\sigma \subset \mathbb{D}^m$  is invariant with respect to the coordinate-wise action of the  $m$ -torus  $\mathbb{T}^m$ , the moment-angle complex  $\mathcal{Z}_{\mathcal{S}}$  acquires a  $\mathbb{T}^m$ -action.

This definition extends to a set  $(\mathbf{X}, \mathbf{A})$  of  $m$  pairs of spaces (see Construction 4.2.1), so we define the *polyhedral product* of  $(\mathbf{X}, \mathbf{A})$  corresponding to  $\mathcal{S}$  by

$$(\mathbf{X}, \mathbf{A})^{\mathcal{S}} = \text{colim}_{\sigma \in \mathcal{S}} \mathcal{D}_{\mathcal{S}}(\mathbf{X}, \mathbf{A}) = \text{colim}_{\sigma \in \mathcal{S}} (\mathbf{X}, \mathbf{A})^\sigma.$$

The construction of the polyhedral product  $(\mathbf{X}, \mathbf{A})^{\mathcal{S}}$  is functorial in all arguments: there are straightforward analogues of Propositions 4.2.3 and 4.2.4, which are proved in a similar way.

EXAMPLE 4.10.2. Let  $\mathcal{S}$  be the simplicial poset of Fig. 3.3 (a). Then  $\mathcal{Z}_{\mathcal{S}}$  is obtained by gluing two copies of  $D^2 \times D^2$  along their boundary  $S^3 = D^2 \times S^1 \cup S^1 \times D^2$ . Therefore,  $\mathcal{Z}_{\mathcal{S}} \cong S^4$ . Here,  $\mathcal{K}_{\mathcal{S}} = \Delta^1$  (a segment), and the moment-angle complex map induced by the map  $\mathcal{S} \rightarrow \mathcal{K}_{\mathcal{S}}$  (2.9) folds  $S^4$  onto  $D^4$ . Similarly, if  $\mathcal{S}$  is of Fig. 3.3 (b), then  $\mathcal{Z}_{\mathcal{S}} \cong S^6$ . Note that even-dimensional spheres do not appear as moment-angle complexes  $\mathcal{Z}_{\mathcal{K}}$  for simplicial complexes  $\mathcal{K}$ .

The *join* of simplicial posets  $\mathcal{S}_1$  and  $\mathcal{S}_2$  is the simplicial poset  $\mathcal{S}_1 * \mathcal{S}_2$  whose elements are pairs  $(\sigma_1, \sigma_2)$ , with  $(\sigma_1, \sigma_2) \leq (\tau_1, \tau_2)$  whenever  $\sigma_1 \leq \tau_1$  in  $\mathcal{S}_1$  and  $\sigma_2 \leq \tau_2$  in  $\mathcal{S}_2$ . The following properties of  $\mathcal{Z}_{\mathcal{S}}$  are similar to those of  $\mathcal{Z}_{\mathcal{K}}$ .

THEOREM 4.10.3.

- (a)  $\mathcal{Z}_{\mathcal{S}_1 * \mathcal{S}_2} \cong \mathcal{Z}_{\mathcal{S}_1} \times \mathcal{Z}_{\mathcal{S}_2}$ ;
- (b) the quotient  $\mathcal{Z}_{\mathcal{S}}/\mathbb{T}^m$  is homeomorphic to the cone over  $|\mathcal{S}|$ ;
- (c) if  $|\mathcal{S}| \cong S^{n-1}$ , then  $\mathcal{Z}_{\mathcal{S}}$  is a manifold of dimension  $m + n$ .

PROOF. Statements (a) and (b) are proved in the same way as the corresponding statements for simplicial complexes, see Section 4.1. To prove (c) we use the ‘dual’ decomposition of the boundary of the  $n$ -ball cone  $|\mathcal{S}|$  into faces, in the same way as in the proof of Theorem 4.1.4.  $\square$

CONSTRUCTION 4.10.4 (cell decomposition). We proceed by analogy with the construction of Section 4.4. The disc  $\mathbb{D}$  is decomposed into 3 cells: the point  $1 \in \mathbb{D}$  is the 0-cell; the complement to 1 in the boundary circle is the 1-cell, which we denote  $T$ ; and the interior of  $\mathbb{D}$  is the 2-cell, which we denote  $D$ . The polydisc  $\mathbb{D}^m$  then acquires the product cell decomposition, with each  $(D^2, S^1)^\sigma \subset (D^2, S^1)^\tau$  being an inclusion of cellular subcomplexes for  $\sigma \leq \tau$ . We therefore obtain a cell decomposition of  $\mathcal{Z}_{\mathcal{S}}$  (although this time it is not a subcomplex in  $\mathbb{D}^m$  in general!). Each cell in  $\mathcal{Z}_{\mathcal{S}}$  is determined by an element  $\sigma \in \mathcal{S}$  and a subset  $\omega \in V(\mathcal{S})$  with  $V(\sigma) \cap \omega = \emptyset$ . Such a cell is a product of  $|\sigma|$  cells of  $D$ -type,  $|\omega|$  cells of  $T$ -type and the rest of 1-type. We denote this cell by  $\kappa(\omega, \sigma)$ .

The resulting cellular cochain complex  $\mathcal{C}^*(\mathcal{Z}_{\mathcal{S}})$  has an additive basis consisting of cochains  $\kappa(\omega, \sigma)^*$  dual to the corresponding cells. We introduce a  $\mathbb{Z} \oplus \mathbb{Z}^m$ -grading on the cochains by setting

$$\text{mdeg } \kappa(\omega, \sigma)^* = (-|\omega|, 2V(\sigma) + 2\omega),$$

where we think of both  $V(\sigma)$  and  $\omega$  as vectors in  $\{0, 1\}^m \subset \mathbb{Z}^m$ . The cellular differential preserves the  $\mathbb{Z}^m$ -part of the multigrading, so we obtain a decomposition

$$\mathcal{C}^*(\mathcal{Z}_{\mathcal{S}}) = \bigoplus_{\mathbf{a} \in \mathbb{Z}^m} \mathcal{C}^{*, 2\mathbf{a}}(\mathcal{Z}_{\mathcal{K}})$$

into a sum of subcomplexes. The only nontrivial subcomplexes are those for which  $\mathbf{a}$  is in  $\{0, 1\}^m$ . The cellular cohomology of  $\mathcal{Z}_{\mathcal{S}}$  thereby acquires a multigrading, and we define the *multigraded Betti numbers*  $b^{-i, 2\mathbf{a}}(\mathcal{Z}_{\mathcal{S}})$  by

$$b^{-i, 2\mathbf{a}}(\mathcal{Z}_{\mathcal{S}}) = \text{rank } H^{-i, 2\mathbf{a}}(\mathcal{Z}_{\mathcal{S}}), \quad \text{for } 1 \leq i \leq m, \mathbf{a} \in \mathbb{Z}^m.$$

For the ordinary Betti numbers we have  $b^k(\mathcal{Z}_{\mathcal{S}}) = \sum_{-i+2|\mathbf{a}|=k} b^{-i, 2\mathbf{a}}(\mathcal{Z}_{\mathcal{S}})$ .

The map of moment-angle complexes  $\mathcal{Z}_{\mathcal{S}_1} \rightarrow \mathcal{Z}_{\mathcal{S}_2}$  induced by a simplicial poset map  $\mathcal{S}_1 \rightarrow \mathcal{S}_2$  is clearly a cellular map, and therefore the cellular cohomology is functorial with respect to such maps.

We now recall from Section 3.5 that the face ring  $\mathbb{Z}[\mathcal{S}]$  is a  $\mathbb{Z}^m$ -graded  $\mathbb{Z}[v_1, \dots, v_m]$ -module via the map sending each  $v_i$  identically, and we have the  $\mathbb{Z} \oplus \mathbb{Z}^m$ -graded Tor-algebra of  $\mathbb{Z}[\mathcal{S}]$ :

$$\text{Tor}_{\mathbb{Z}[v_1, \dots, v_m]}(\mathbb{Z}[\mathcal{S}], \mathbb{Z}) = \bigoplus_{i \geq 0, \mathbf{a} \in \mathbb{N}^m} \text{Tor}_{\mathbb{Z}[v_1, \dots, v_m]}^{-i, 2\mathbf{a}}(\mathbb{Z}[\mathcal{S}], \mathbb{Z}).$$

THEOREM 4.10.5. *There is a graded ring isomorphism*

$$H^*(\mathcal{Z}_{\mathcal{S}}) \cong \text{Tor}_{\mathbb{Z}[v_1, \dots, v_m]}(\mathbb{Z}[\mathcal{S}], \mathbb{Z})$$

whose graded components are given by the group isomorphisms

$$(4.27) \quad H^p(\mathcal{Z}_S) \cong \bigoplus_{-i+2|\mathbf{a}|=p} \mathrm{Tor}_{\mathbb{Z}[v_1, \dots, v_m]}^{-i, 2\mathbf{a}}(\mathbb{Z}[\mathcal{S}], \mathbb{Z})$$

in each degree  $p$ . Here  $|\mathbf{a}| = j_1 + \dots + j_m$  for  $\mathbf{a} = (j_1, \dots, j_m)$ .

Using the Koszul complex we restate the above theorem as follows:

**THEOREM 4.10.6.** *There is a graded ring isomorphism*

$$H^*(\mathcal{Z}_S) \cong H(\Lambda[u_1, \dots, u_m] \otimes \mathbb{Z}[\mathcal{S}], d),$$

where the  $\mathbb{Z} \oplus \mathbb{Z}^m$ -grading and the differential on the right hand side are defined by

$$\mathrm{mdeg} u_i = (-1, 2\mathbf{e}_i), \quad \mathrm{mdeg} v_\sigma = (0, 2V(\sigma)), \quad du_i = v_i, \quad dv_\sigma = 0,$$

and  $\mathbf{e}_i \in \mathbb{Z}^m$  is the  $i$ th basis vector, for  $i = 1, \dots, m$ .

**PROOF.** The proof follows the lines of the proof of Theorem 4.5.4, but the analogues of Lemmata 3.2.6 and 4.5.3 are proved in a different way.

We first set up the quotient differential graded ring

$$R^*(\mathcal{S}) = \Lambda[u_1, \dots, u_m] \otimes \mathbb{Z}[\mathcal{S}] / \mathcal{I}_R$$

where  $\mathcal{I}_R$  is the ideal generated by the elements

$$u_i v_\sigma \quad \text{with } i \in V(\sigma), \quad \text{and} \quad v_\sigma v_\tau \quad \text{with } \sigma \wedge \tau \neq \hat{0}.$$

Note that the latter condition is equivalent to  $V(\sigma) \cap V(\tau) \neq \emptyset$ . The ring  $R^*(\mathcal{S})$  will serve as an algebraic model for the cellular cochains of  $\mathcal{Z}_S$ .

We need to prove an analogue of Lemma 3.2.6, i.e. show that the quotient map

$$\varrho: \Lambda[u_1, \dots, u_m] \otimes \mathbb{Z}[\mathcal{S}] \rightarrow R^*(\mathcal{S})$$

induces an isomorphism in cohomology. Instead of constructing a chain homotopy directly, we shall identify both  $R^*(\mathcal{S})$  and  $\Lambda[u_1, \dots, u_m] \otimes \mathbb{Z}[\mathcal{S}]$  with the cellular cochains of homotopy equivalent spaces.

Theorem 3.5.7 implies that  $R^*(\mathcal{S})$  has basis of monomials  $u_\omega v_\sigma$  where  $\omega \subset V(\mathcal{S})$ ,  $\sigma \in \mathcal{S}$ ,  $\omega \cap V(\sigma) = \emptyset$ , and  $u_\omega = u_{i_1} \dots u_{i_k}$  for  $\omega = \{i_1, \dots, i_k\}$ . In particular,  $R^*(\mathcal{S})$  is a free abelian group of finite rank. The map

$$(4.28) \quad g: R^*(\mathcal{S}) \rightarrow \mathcal{C}^*(\mathcal{Z}_S), \quad u_\omega v_\sigma \mapsto \kappa(\omega, \sigma)^*$$

is an isomorphism of cochain complexes. Indeed, the additive bases of the two groups are in one-to-one correspondence, and the differential in  $R^*(\mathcal{S})$  acts (in the case  $|\omega| = 1$  and  $i \notin V(\sigma)$ ) as

$$d(u_i v_\sigma) = v_i v_\sigma = \sum_{\eta \in iV\sigma} v_\eta.$$

This is exactly how the cellular differential in  $\mathcal{C}^*(\mathcal{Z}_S)$  acts on  $\kappa(i, \sigma)^*$ . The case of arbitrary  $\omega$  is treated similarly. It follows that we have an isomorphism of cohomology groups  $H^j[R^*(\mathcal{S})] \cong H^j(\mathcal{Z}_S)$  for all  $j$ .

The differential algebra  $(\Lambda[u_1, \dots, u_m] \otimes \mathbb{Z}[\mathcal{S}], d)$  also may be identified with the cellular cochains of a certain space. Namely, consider the polyhedral product  $(S^\infty, S^1)^S$ . Then we show in the same way as in Subsection 4.5 that there is an isomorphism of cochain complexes

$$g': \Lambda[u_1, \dots, u_m] \otimes \mathbb{Z}[\mathcal{S}] \rightarrow \mathcal{C}^*((S^\infty, S^1)^S).$$

Furthermore, the standard functoriality arguments give a deformation retraction

$$\mathcal{Z}_{\mathcal{S}} = (D^2, S^1)^{\mathcal{S}} \hookrightarrow (S^{\infty}, S^1)^{\mathcal{S}} \longrightarrow (D^2, S^1)^{\mathcal{S}}$$

onto a cellular subcomplex. Hence the cochain map  $\mathcal{C}^*((S^{\infty}, S^1)^{\mathcal{S}}) \rightarrow \mathcal{C}^*(\mathcal{Z}_{\mathcal{S}})$  corresponding to the inclusion  $\mathcal{Z}_{\mathcal{S}} \hookrightarrow (S^{\infty}, S^1)^{\mathcal{S}}$  induces an isomorphism in cohomology.

Summarising the above observations we obtain the commutative square

$$(4.29) \quad \begin{array}{ccc} \Lambda[u_1, \dots, u_m] \otimes \mathbb{Z}[\mathcal{S}] & \xrightarrow{g'} & \mathcal{C}^*((S^{\infty}, S^1)^{\mathcal{S}}) \\ e \downarrow & & \downarrow \\ R^*(\mathcal{S}) & \xrightarrow{g} & \mathcal{C}^*(\mathcal{Z}_{\mathcal{S}}) \end{array}$$

in which the horizontal arrows are isomorphisms of cochain complexes, and the right vertical arrow induces an isomorphism in cohomology. It follows that the left arrow also induces an isomorphism in cohomology, as claimed.

The additive isomorphism of (4.27) now follows from (4.29). To establish the ring isomorphism we need to analyse the multiplication of cellular cochains.

We consider the diagonal approximation map  $\tilde{\Delta}: \mathbb{D}^m \rightarrow \mathbb{D}^m \times \mathbb{D}^m$  given on each coordinate by (4.15). It restricts to a map  $(D^2, S^1)^{\sigma} \rightarrow (D^2, S^1)^{\sigma} \times (D^2, S^1)^{\sigma}$  for every  $\sigma \in \mathcal{S}$  and gives rise to a map of diagrams

$$\mathcal{D}_{\mathcal{S}}(D^2, S^1) \rightarrow \mathcal{D}_{\mathcal{S}}(D^2, S^1) \times \mathcal{D}_{\mathcal{S}}(D^2, S^1).$$

By definition, the colimit of the latter is  $\mathcal{Z}_{\mathcal{S} * \mathcal{S}}$ , which is identified with  $\mathcal{Z}_{\mathcal{S}} \times \mathcal{Z}_{\mathcal{S}}$ . We therefore obtain a cellular approximation  $\tilde{\Delta}: \mathcal{Z}_{\mathcal{S}} \rightarrow \mathcal{Z}_{\mathcal{S}} \times \mathcal{Z}_{\mathcal{S}}$  for the diagonal map of  $\mathcal{Z}_{\mathcal{S}}$ . It induces a ring structure on the cellular cochains via the composition

$$\mathcal{C}^*(\mathcal{Z}_{\mathcal{S}}) \otimes \mathcal{C}^*(\mathcal{Z}_{\mathcal{S}}) \xrightarrow{\times} \mathcal{C}^*(\mathcal{Z}_{\mathcal{S}} \times \mathcal{Z}_{\mathcal{S}}) \xrightarrow{\tilde{\Delta}^*} \mathcal{C}^*(\mathcal{Z}_{\mathcal{S}}).$$

We claim that, with this multiplication in  $\mathcal{C}^*(\mathcal{Z}_{\mathcal{S}})$ , the map (4.28) becomes a ring isomorphism. To see this we first observe that since (4.28) is a linear map, it is enough to consider the product of two generators  $u_{\omega}v_{\sigma}$  and  $u_{\psi}v_{\tau}$ . If any two of the subsets  $\omega$ ,  $V(\sigma)$ ,  $\psi$  and  $V(\tau)$  have nonempty intersection, then  $u_{\omega}v_{\sigma} \cdot u_{\psi}v_{\tau} = 0$  in  $R^*(\mathcal{S})$ . Otherwise (if all four subsets are disjoint) we have

$$(4.30) \quad g(u_{\omega}v_{\sigma} \cdot u_{\psi}v_{\tau}) = g(u_{\omega \sqcup \psi} \cdot \sum_{\eta \in \sigma \vee \tau} v_{\eta}) = \sum_{\eta \in \sigma \vee \tau} \kappa(\omega \sqcup \psi, \eta)^*.$$

We also observe that for any cell  $\kappa(\chi, \eta)$  of  $\mathcal{Z}_{\mathcal{S}}$  (with  $\chi \cap V(\eta) = \emptyset$ ) we have

$$\tilde{\Delta}\kappa(\chi, \eta) = \sum_{\substack{\omega \sqcup \psi = \chi \\ \sigma \vee \tau \ni \eta}} \kappa(\omega, \sigma) \times \kappa(\psi, \tau).$$

Therefore,

$$\begin{aligned} g(u_{\omega}v_{\sigma}) \cdot g(u_{\psi}v_{\tau}) &= \kappa(\omega, \sigma)^* \cdot \kappa(\psi, \tau)^* \\ &= \tilde{\Delta}^*(\kappa(\omega, \sigma) \times \kappa(\psi, \tau))^* = \sum_{\eta \in \sigma \vee \tau} \kappa(\omega \sqcup \psi, \eta)^*. \end{aligned}$$

Comparing this with (4.30) we deduce that (4.28) is a ring map.  $\square$

REMARK. Using the monoid structure on  $\mathbb{D}$  as in Proposition 4.2.4 one easily sees that the construction of  $\mathcal{Z}_{\mathcal{S}}$  is functorial with respect to maps of simplicial posets. This together with Proposition 3.5.12 makes the isomorphism of Theorem 4.10.5 functorial.

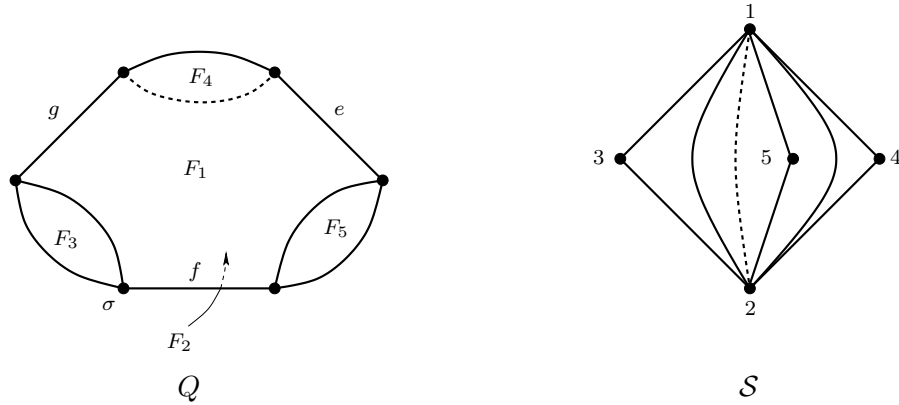

FIGURE 4.4. ‘Ball with corners’  $Q$  dual to the simplicial poset  $\mathcal{S}$ .

Using Hochster’s formula for simplicial posets (Theorem 3.5.14) we can calculate the cohomology of  $\mathcal{Z}_{\mathcal{S}}$  via the cohomology of full subposets  $\mathcal{S}_J \subset \mathcal{S}$ . Here is an example of calculation using this method.

EXAMPLE 4.10.7. Let  $\mathcal{S}$  be the simplicial poset shown on Fig. 4.4 (right). It has  $m = 5$  vertices, 9 edges and 6 triangular faces. The dual 3-dimensional ‘ball with corners’  $Q$  (see the proof of Theorem 4.10.3) is shown in Figure 4.4 (left). We denote its facets  $F_1, \dots, F_5$ , edges  $e, f, g$  and the vertex  $\sigma = F_3 \cap f$  as shown. The corresponding moment-angle complex  $\mathcal{Z}_{\mathcal{S}}$  is an 8-dimensional manifold.

The face ring  $\mathbb{Z}[\mathcal{S}]$  is the quotient of the polynomial ring

$$\mathbb{Z}[\mathcal{S}] = \mathbb{Z}[v_1, \dots, v_5, v_e, v_f, v_g], \quad \deg v_i = 2, \quad \deg v_e = \deg v_f = \deg v_g = 4$$

by the relations

$$\begin{aligned} v_1 v_2 &= v_e + v_f + v_g, \\ v_3 v_4 &= v_3 v_5 = v_4 v_5 = v_3 v_e = v_4 v_f = v_5 v_g = v_e v_f = v_e v_g = v_e v_f = 0. \end{aligned}$$

The other generators and relations in the original presentation of  $\mathbb{Z}[\mathcal{S}]$  can be derived from the above; e.g.,  $v_{\sigma} = v_3 v_f$ .

Given  $J \subset [m]$  we define the following subset in the boundary of  $Q$ :

$$Q_J = \bigcup_{j \in J} F_j \subset Q.$$

By analogy with Proposition 3.2.11 we prove that

$$(4.31) \quad H^{-i, 2J}(\mathcal{Z}_{\mathcal{S}}) \cong \tilde{H}^{|J|-i-1}(Q_J).$$

Using this formula we calculate the nontrivial cohomology groups of  $\mathcal{Z}_S$  as follows:

$$\begin{array}{ll}
H^{0,(0,0,0,0)}(\mathcal{Z}_S) = \tilde{H}^{-1}(\emptyset) = \mathbb{Z} & 1 \\
H^{-1,(0,0,2,2,0)}(\mathcal{Z}_S) = \tilde{H}^0(F_3 \cup F_4) = \mathbb{Z} & u_3v_4 \\
H^{-1,(0,0,2,0,2)}(\mathcal{Z}_S) = \tilde{H}^0(F_3 \cup F_5) = \mathbb{Z} & u_5v_3 \\
H^{-1,(0,0,0,2,2)}(\mathcal{Z}_S) = \tilde{H}^0(F_4 \cup F_5) = \mathbb{Z} & u_4v_5 \\
H^{-2,(0,0,2,2,2)}(\mathcal{Z}_S) = \tilde{H}^0(F_3 \cup F_4 \cup F_5) = \mathbb{Z} \oplus \mathbb{Z} & u_5u_3v_4, u_5u_4v_3 \\
H^{0,(2,2,0,0,0)}(\mathcal{Z}_S) = \tilde{H}^1(F_1 \cup F_2) = \mathbb{Z} \oplus \mathbb{Z} & v_e, v_f \\
H^{-1,(2,2,2,0,0)}(\mathcal{Z}_S) = \tilde{H}^1(F_1 \cup F_2 \cup F_3) = \mathbb{Z} & u_3v_e \\
H^{-1,(2,2,0,2,0)}(\mathcal{Z}_S) = \tilde{H}^1(F_1 \cup F_2 \cup F_4) = \mathbb{Z} & u_4v_f \\
H^{-1,(2,2,0,0,2)}(\mathcal{Z}_S) = \tilde{H}^1(F_1 \cup F_2 \cup F_5) = \mathbb{Z} & u_5v_g \\
H^{-2,(2,2,2,2,2)}(\mathcal{Z}_S) = \tilde{H}^2(F_1 \cup \dots \cup F_5) = \mathbb{Z} & u_5u_4v_3v_f = u_5u_4v_\sigma
\end{array}$$

It follows that the ordinary (1-graded) Betti numbers of  $\mathcal{Z}_S$  are given by the sequence  $(1, 0, 0, 3, 4, 3, 0, 0, 1)$ . In the right column of the table above we include the cocycles in the differential graded ring  $\Lambda[u_1, \dots, u_5] \otimes \mathbb{Z}[\mathcal{S}]$  representing generators of the corresponding cohomology group. This allows us to determine the ring structure in  $H^*(\mathcal{Z}_S)$ . For example,

$$[u_5u_3v_4] \cdot [v_f] = [u_5u_3v_4v_f] = 0 = [u_5u_4v_3] \cdot [v_e].$$

On the other hand,

$$\begin{aligned}
[u_5u_3v_4] \cdot [v_e] &= -[u_3u_5v_4v_e] = -[u_3u_4v_5v_e] \\
&= [u_3u_4v_5v_f] = [u_5u_4v_3v_f] = [u_5u_4v_3] \cdot [v_f].
\end{aligned}$$

Here we have used the relations  $d(u_3u_4u_5v_e) = u_3u_4v_5v_e - u_3u_5v_4v_e$  and  $d(u_1u_3u_4v_2v_5) = u_3u_4v_5v_e + u_3u_4v_5v_f$ . All nontrivial products come from Poincaré duality. These calculations are summarised by the cohomology ring isomorphism

$$H^*(\mathcal{Z}_S) \cong H^*((S^3 \times S^5)^{\#3} \# (S^4 \times S^4)^{\#2})$$

where the manifold on the right hand side is the connected sum of three copies of  $S^3 \times S^5$  and two copies of  $S^4 \times S^4$ . We expect that the isomorphism above is induced by a homeomorphism.

### Exercises.

4.10.8. Generalise Proposition 4.3.1 to simplicial posets, i.e. establish a ring isomorphism  $H^*((\mathbb{C}P^\infty, pt)^S) \cong \mathbb{Z}[\mathcal{S}]$ .

4.10.9. Construct a homotopy equivalence

$$h: (\mathbb{C}P^\infty, pt)^S \xrightarrow{\simeq} E\mathbb{T}^m \times_{\mathbb{T}^m} \mathcal{Z}_S$$

by extending the argument of Theorem 4.3.2, and deduce that  $H_{\mathbb{T}^m}^*(\mathcal{Z}_S) \cong \mathbb{Z}[\mathcal{S}]$ .

## Toric varieties and manifolds

A toric variety is an algebraic variety on which an *algebraic torus*  $(\mathbb{C}^\times)^n$  acts with a dense (Zariski open) orbit. An algebraic torus contains a (compact) torus  $T^n$ , so toric varieties are toric spaces in our usual sense. Toric varieties are described by combinatorial-geometric objects, rational fans (see Section 2.1), and the combinatorics of the fan determines the orbit structure of the torus action.

Toric varieties were introduced in 1970 in the pioneering work of Demazure on *Cremona group*. The geometry of toric varieties, or *toric geometry*, very quickly became one of the most fascinating topics in algebraic geometry and found applications in many other mathematical sciences, sometimes distant from each other. We have already mentioned the proof for the necessity part of the  $g$ -theorem for simplicial polytopes given by Stanley. Other remarkable applications include counting lattice points and volumes of lattice polytopes; relations with Newton polytopes and the number of solutions of a system of algebraic equations (after Khovanskii and Kushnirenko); discriminants, resultants and hypergeometric functions (after Gelfand, Kapranov and Zelevinsky); reflexive polytopes and mirror symmetry for Calabi–Yau toric hypersurfaces and complete intersections (after Batyrev). Standard references on toric geometry include Danilov’s survey [86] and books by Oda [250], Fulton [122] and Ewald [108]. The most recent exhaustive account by Cox, Little and Schenck [84] covers many new applications, including those mentioned above. Without attempting to give another review of toric geometry, in this chapter we collect the basic definitions and constructions, and emphasise topological and combinatorial aspects of toric varieties.

We review the three main approaches to toric varieties in the appropriate sections: the ‘classical’ construction via fans, the ‘algebraic quotient’ construction, and the ‘symplectic reduction’ construction. The intersection of Hermitian quadrics appearing in the symplectic construction of toric varieties links toric geometry to moment-angle complexes. This link will be developed further in the next chapter.

A basic knowledge of algebraic geometry would much help the reader of this chapter, although it is not absolutely necessary.

### 5.1. Classical construction from rational fans

An *algebraic torus* is a commutative complex algebraic group isomorphic to a product  $(\mathbb{C}^\times)^n$  of copies of the multiplicative group  $\mathbb{C}^\times = \mathbb{C} \setminus \{0\}$ . It contains a compact torus  $T^n$  as a Lie (but not algebraic) subgroup.

We shall often identify an algebraic torus with the standard model  $(\mathbb{C}^\times)^n$ .

**DEFINITION 5.1.1.** A *toric variety* is a normal complex algebraic variety  $V$  containing an algebraic torus  $(\mathbb{C}^\times)^n$  as a Zariski open subset in such a way that the natural action of  $(\mathbb{C}^\times)^n$  on itself extends to an action on  $V$ .

It follows that  $(\mathbb{C}^\times)^n$  acts on  $V$  with a dense orbit. Toric varieties originally appeared as equivariant compactifications of an algebraic torus, although non-compact (e.g., affine) examples are now of equal importance.

EXAMPLE 5.1.2. The algebraic torus  $(\mathbb{C}^\times)^n$  and the affine space  $\mathbb{C}^n$  are the simplest examples of toric varieties. A compact example is given by the projective space  $\mathbb{C}P^n$  on which the torus acts in homogeneous coordinates as follows:

$$(t_1, \dots, t_n) \cdot (z_0 : z_1 : \dots : z_n) = (z_0 : t_1 z_1 : \dots : t_n z_n).$$

Algebraic geometry of toric varieties is translated completely into the language of combinatorial and convex geometry. Namely, there is a bijective correspondence between rational fans in  $n$ -dimensional space (see Section 2.1) and complex  $n$ -dimensional toric varieties. Under this correspondence,

$$\begin{aligned} \text{cones} &\longleftrightarrow \text{affine varieties} \\ \text{complete fans} &\longleftrightarrow \text{compact (complete) varieties} \\ \text{normal fans of polytopes} &\longleftrightarrow \text{projective varieties} \\ \text{regular fans} &\longleftrightarrow \text{nonsingular varieties} \\ \text{simplicial fans} &\longleftrightarrow \text{orbifolds} \end{aligned}$$

We review this construction below; the details can be found in the sources mentioned above. Following the algebraic tradition, we use the coordinate-free notation.

We fix a lattice  $N$  of rank  $n$  (isomorphic to  $\mathbb{Z}^n$ ), and denote by  $N_{\mathbb{R}}$  its ambient  $n$ -dimensional real vector space  $N \otimes_{\mathbb{Z}} \mathbb{R} \cong \mathbb{R}^n$ . Define the algebraic torus  $\mathbb{C}_N^\times = N \otimes_{\mathbb{Z}} \mathbb{C}^\times \cong (\mathbb{C}^\times)^n$ . All cones and fans in this chapter are rational.

CONSTRUCTION 5.1.3. We first describe how to assign an affine toric variety to a cone  $\sigma \subset N_{\mathbb{R}}$ . Consider the dual cone  $\sigma^\vee \subset N_{\mathbb{R}}^*$  (see (2.1)) and denote by

$$S_\sigma = \sigma^\vee \cap N^*$$

the set of its lattice points. Then  $S_\sigma$  is a finitely generated semigroup (with respect to addition). Let  $A_\sigma = \mathbb{C}[S_\sigma]$  be the semigroup ring of  $S_\sigma$ . It is a commutative finitely generated  $\mathbb{C}$ -algebra, with a  $\mathbb{C}$ -vector space basis  $\{\chi^{\mathbf{u}} : \mathbf{u} \in S_\sigma\}$ . The multiplication in  $A_\sigma$  is defined via the addition in  $S_\sigma$ :

$$\chi^{\mathbf{u}} \cdot \chi^{\mathbf{u}'} = \chi^{\mathbf{u} + \mathbf{u}'},$$

so  $\chi^0$  is the unit. The *affine toric variety*  $V_\sigma$  corresponding to  $\sigma$  is the affine algebraic variety corresponding to  $A_\sigma$ :

$$V_\sigma = \text{Spec}(A_\sigma), \quad A_\sigma = \mathbb{C}[V_\sigma].$$

By choosing a multiplicative generator set in  $A_\sigma$  we represent it as a quotient

$$A_\sigma = \mathbb{C}[x_1, \dots, x_r] / \mathcal{I};$$

then the variety  $V_\sigma$  is the common zero set of polynomials from the ideal  $\mathcal{I}$ . Each point of  $V_\sigma$  corresponds to a semigroup homomorphism  $\text{Hom}_{\text{sg}}(S_\sigma, \mathbb{C}_m)$ , where  $\mathbb{C}_m = \mathbb{C}^\times \cup \{0\}$  is the multiplicative semigroup of complex numbers.

Now if  $\tau$  is a face of  $\sigma$ , then  $\sigma^\vee \subset \tau^\vee$ , and the inclusion of semigroup algebras  $\mathbb{C}[S_\sigma] \rightarrow \mathbb{C}[S_\tau]$  induces a morphism  $V_\tau \rightarrow V_\sigma$ , which is an inclusion of a Zariski open subset. This allows us to glue the affine varieties  $V_\sigma$  corresponding to all cones  $\sigma$  in a fan  $\Sigma$  into an algebraic variety  $V_\Sigma$ , referred to as the *toric variety* corresponding



to the fan  $\Sigma$ . More formally,  $V_\Sigma$  may be defined as the *colimit* of algebraic varieties  $V_\sigma$  over the partially ordered set of cones of  $\Sigma$ :

$$V_\Sigma = \operatorname{colim}_{\sigma \in \Sigma} V_\sigma.$$

Here is the crucial point: the fact that the cones  $\sigma$  patch into a fan  $\Sigma$  guarantees that the variety  $V_\Sigma$  obtained by gluing the pieces  $V_\sigma$  is Hausdorff in the usual topology. In algebraic geometry, the Hausdorffness is replaced by the related notion of separatedness: a variety  $V$  is *separated* if the image of the diagonal map  $\Delta: V \rightarrow V \times V$  is Zariski closed. A separated variety is Hausdorff in the usual topology.

LEMMA 5.1.4. *If a collection of cones  $\{\sigma\}$  forms a fan  $\Sigma$ , then the variety  $V_\Sigma = \operatorname{colim}_{\sigma \in \Sigma} V_\sigma$  is separated.*

PROOF. Using the separatedness criterion of [285, Ch. V, §4.3] (see also [86, Proposition 5.4]), it is enough to verify the following: if cones  $\sigma$  and  $\sigma'$  intersect in a common face  $\tau$ , then the diagonal map  $V_\tau \rightarrow V_\sigma \times V_{\sigma'}$  is a closed embedding. This is equivalent to the assertion that the natural homomorphism  $A_\sigma \otimes A_{\sigma'} \rightarrow A_\tau$  is surjective. To prove this, we use Separation Lemma (Lemma 2.1.2). According to it, there is a linear function  $\mathbf{u}$  which is nonnegative on  $\sigma$ , nonpositive on  $\sigma'$  and the intersection of the hyperplane  $\mathbf{u}^\perp$  with  $\sigma$  is  $\tau$ . Now take  $\mathbf{u}' \in \tau^\vee$ , i.e.  $\mathbf{u}'$  is nonnegative on  $\tau$ . Then there is an integer  $k \geq 0$  such that  $\mathbf{u}' + k\mathbf{u}$  is nonnegative on  $\sigma$ , i.e.  $\mathbf{u}' + k\mathbf{u} \in \sigma^\vee$ . Then  $\mathbf{u}' = (\mathbf{u}' + k\mathbf{u}) + (-k\mathbf{u}) \in \sigma^\vee + \sigma'^\vee$ . It follows that  $S_\sigma \oplus S_{\sigma'} \rightarrow S_\tau$  is surjective map of vector spaces (or semigroups), hence  $A_\sigma \otimes A_{\sigma'} \rightarrow A_\tau$  is a surjective homomorphism.  $\square$

We shall consider only separated varieties in what follows.

The variety  $V_\sigma$  carries an algebraic action of the torus  $\mathbb{C}_N^\times = N \otimes_{\mathbb{Z}} \mathbb{C}^\times$

$$(5.1) \quad \mathbb{C}_N^\times \times V_\sigma \rightarrow V_\sigma, \quad (\mathbf{t}, x) \mapsto \mathbf{t} \cdot x$$

which is defined as follows. A point  $\mathbf{t} \in \mathbb{C}_N^\times$  is determined by a group homomorphism  $N^* \rightarrow \mathbb{C}^\times$ . In coordinates, the homomorphism  $\mathbb{Z}^n \cong N^* \rightarrow \mathbb{C}^\times$  corresponding to  $\mathbf{t} = (t_1, \dots, t_n)$  is given by

$$\mathbf{u} = (u_1, \dots, u_n) \mapsto \mathbf{t}(\mathbf{u}) = (t_1^{u_1} \dots t_n^{u_n}).$$

A point  $x \in V_\sigma$  corresponds to a semigroup homomorphism  $S_\sigma \rightarrow \mathbb{C}_m$ . Then we define  $\mathbf{t} \cdot x$  as the point in  $V_\sigma$  corresponding to the semigroup homomorphism  $S_\sigma \rightarrow \mathbb{C}_m$  given by

$$\mathbf{u} \mapsto \mathbf{t}(\mathbf{u})x(\mathbf{u}).$$

The homomorphism of algebras  $A_\sigma \rightarrow A_\sigma \otimes \mathbb{C}[N^*]$  dual to the action (5.1) maps  $\chi^\mathbf{u}$  to  $\chi^\mathbf{u} \otimes \chi^\mathbf{u}$  for  $\mathbf{u} \in S_\sigma$ . If  $\sigma = \{\mathbf{0}\}$ , then we obtain the multiplication in the algebraic group  $\mathbb{C}_N^\times$ . The actions on the varieties  $V_\sigma$  are compatible with the inclusions of open sets  $V_\tau \rightarrow V_\sigma$  corresponding to the inclusions of faces  $\tau \subset \sigma$ . Therefore, for each fan  $\Sigma$  we obtain a  $\mathbb{C}_N^\times$ -action on the variety  $V_\Sigma$ , which extends the  $\mathbb{C}_N^\times$ -action on itself.

EXAMPLE 5.1.5. Let  $N = \mathbb{Z}^n$  and let  $\sigma$  be the cone spanned by the first  $k$  basis vectors  $\mathbf{e}_1, \dots, \mathbf{e}_k$ , where  $0 \leq k \leq n$ . The semigroup  $S_\sigma = \sigma^\vee \cap N^*$  is generated by the dual elements  $\mathbf{e}_1^*, \dots, \mathbf{e}_k^*$  and  $\pm \mathbf{e}_{k+1}^*, \dots, \pm \mathbf{e}_n^*$ . Therefore,

$$A_\sigma \cong \mathbb{C}[x_1, \dots, x_k, x_{k+1}, x_{k+1}^{-1}, \dots, x_n, x_n^{-1}],$$

where we set  $x_i = \chi^{e_i^*}$ . It follows that the corresponding affine variety is

$$V_\sigma \cong \mathbb{C} \times \cdots \times \mathbb{C} \times \mathbb{C}^\times \times \cdots \times \mathbb{C}^\times = \mathbb{C}^k \times (\mathbb{C}^\times)^{n-k}.$$

In particular, for  $k = n$  we obtain an  $n$ -dimensional affine space, and for  $k = 0$  (i.e.  $\sigma = \{0\}$ ) we obtain the algebraic torus  $(\mathbb{C}^\times)^n$ .

EXAMPLE 5.1.6. Let  $\sigma \subset \mathbb{R}^2$  be the cone generated by the vectors  $e_2$  and  $2e_1 - e_2$  (note that these two vectors do not span  $\mathbb{Z}^2$ , so this cone is not regular). The dual cone  $\sigma^\vee$  is generated by  $e_1^*$  and  $e_1^* + 2e_2^*$ . The semigroup  $S_\sigma$  is generated by  $e_1^*$ ,  $e_1^* + e_2^*$  and  $e_1^* + 2e_2^*$ , with one relation among them. Therefore,

$$A_\sigma = \mathbb{C}[x, xy, xy^2] \cong \mathbb{C}[u, v, w]/(v^2 - uw)$$

and  $V_\sigma$  is a quadratic cone (a singular variety).

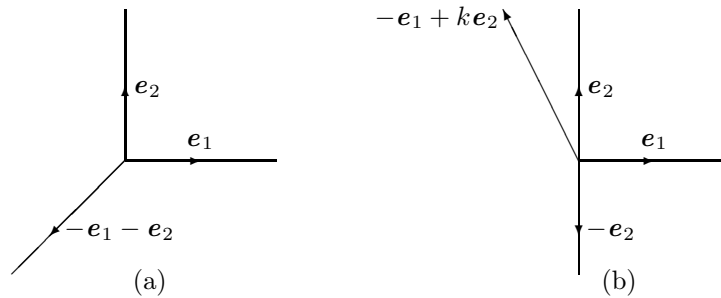

FIGURE 5.1. Complete fans in  $\mathbb{R}^2$

EXAMPLE 5.1.7. Let  $\Sigma$  be the complete fan in  $\mathbb{R}^2$  with the following three maximal cones: the cone  $\sigma_0$  generated by  $e_1$  and  $e_2$ , the cone  $\sigma_1$  generated by  $e_2$  and  $-e_1 - e_2$ , and the cone  $\sigma_2$  generated by  $-e_1 - e_2$  and  $e_1$ , see Fig. 5.1 (a). Then each affine variety  $V_{\sigma_i}$  is isomorphic to  $\mathbb{C}^2$ , with coordinates  $(x, y)$  for  $\sigma_0$ ,  $(x^{-1}, x^{-1}y)$  for  $\sigma_1$ , and  $(y^{-1}, xy^{-1})$  for  $\sigma_2$ . These three affine charts glue together into the complex projective plane  $V_\Sigma = \mathbb{C}P^2$  in the standard way: if  $(z_0 : z_1 : z_2)$  are the homogeneous coordinates in  $\mathbb{C}P^2$ , then we have  $x = z_1/z_0$  and  $y = z_2/z_0$ .

EXAMPLE 5.1.8. Fix  $k \in \mathbb{Z}$  and consider the complete fan in  $\mathbb{R}^2$  with the four two-dimensional cones generated by the pairs of vectors  $(e_1, e_2)$ ,  $(e_1, -e_2)$ ,  $(-e_1 + ke_2, -e_2)$  and  $(-e_1 + ke_2, e_2)$ , see Fig 5.1 (b). It can be shown that the corresponding toric variety  $F_k$  is the projectivisation  $\mathbb{C}P(\underline{\mathbb{C}} \oplus \mathcal{O}(k))$  of the sum of a trivial line bundle  $\underline{\mathbb{C}}$  and the  $k$ th power  $\mathcal{O}(k) = \gamma^{\otimes k}$  of the canonical line bundle  $\gamma$  over  $\mathbb{C}P^1$  (an exercise). These 2-dimensional complex varieties  $F_k$  are known as *Hirzebruch surfaces*.

EXAMPLE 5.1.9. Let  $\mathcal{K}$  be a simplicial complex on  $[m]$ . The complement  $U(\mathcal{K})$  of the coordinate subspace arrangement corresponding to  $\mathcal{K}$  (see (4.22)) is a  $(\mathbb{C}^\times)^m$ -invariant subset in  $\mathbb{C}^m$ , and therefore it is a nonsingular toric variety. This variety is not affine in general; it is quasiprojective (the complement to a Zariski closed subset in an affine variety).

The fan  $\Sigma_{\mathcal{K}}$  corresponding to  $U(\mathcal{K})$  consists of the cones  $\sigma_I \subset \mathbb{R}^m$  generated by the basis vectors  $e_{i_1}, \dots, e_{i_k}$ , for all simplices  $I = \{i_1, \dots, i_k\} \in \mathcal{K}$ . The affine toric variety corresponding to  $\sigma_I$  is  $(\mathbb{C}, \mathbb{C}^\times)^I$ , and the affine cover of  $U(\mathcal{K})$  is its polyhedral product decomposition  $U(\mathcal{K}) = \bigcup_{I \in \mathcal{K}} (\mathbb{C}, \mathbb{C}^\times)^I$  given by Proposition 4.7.3.

The inclusion poset of closures of  $\mathbb{C}_N^\times$ -orbits of  $V_\Sigma$  is isomorphic to the reversed inclusion poset of faces of  $\Sigma$ . That is,  $k$ -dimensional cones of  $\Sigma$  correspond to codimension- $k$  orbits of the algebraic torus action on  $V_\Sigma$ . In particular,  $n$ -dimensional cones correspond to fixed points, and the apex (the zero cone) corresponds to the dense orbit. Furthermore, if a subcollection of cones of  $\Sigma$  forms a fan  $\Sigma'$ , then the toric variety  $V_{\Sigma'}$  is embedded into  $V_\Sigma$  as a Zariski open subset.

We recall from Section 2.1 that a fan is called simplicial (respectively, regular) if each of its cones is generated by a part of basis of the space  $N_\mathbb{R}$  (respectively, of the lattice  $N$ ), and a fan is called complete if the union of its cones is the whole  $N_\mathbb{R}$ .

A toric variety  $V_\Sigma$  is compact (in usual topology) if and only if the fan  $\Sigma$  is complete. If  $\Sigma$  is a simplicial fan, then  $V_\Sigma$  is an *orbifold*, that is, it is locally isomorphic to a quotient of  $\mathbb{C}^n$  by a finite group action. A toric variety  $V_\Sigma$  is nonsingular (smooth) if and only if the fan  $\Sigma$  is regular.

### Exercises.

5.1.10. Let  $\Sigma$  be the ‘multifan’ in  $\mathbb{R}^1$  consisting of two identical 1-dimensional cones generated by  $e_1$  and a 0-dimensional cone  $\mathbf{0}$ . Describe the algebraic variety  $V_\Sigma$  obtained by gluing the affine varieties corresponding to this ‘multifan’ and show that  $V_\Sigma$  is not separated (or non-Hausdorff in the usual topology).

5.1.11. Describe the toric variety corresponding to the fan with 3 one-dimensional cones generated by the vectors  $e_1$ ,  $e_2$  and  $-e_1 - e_2$ .

5.1.12. Show that the toric variety of Example 5.1.8 is isomorphic to the Hirzebruch surface  $F_k = \mathbb{C}P(\underline{\mathbb{C}} \oplus \mathcal{O}(k))$ .

5.1.13. Show that the Hirzebruch surface  $F_k$  is homeomorphic to  $S^2 \times S^2$  for even  $k$  and is homeomorphic to  $\mathbb{C}P^2 \# \overline{\mathbb{C}P^2}$  for odd  $k$ , where  $\#$  denotes the connected sum, and  $\overline{\mathbb{C}P^2}$  is  $\mathbb{C}P^2$  with the orientation reversed.

## 5.2. Projective toric varieties and polytopes

CONSTRUCTION 5.2.1 (projective toric varieties). Let  $P$  be a convex polytope with vertices in the dual lattice  $N^*$  (a *lattice polytope*), and let  $\Sigma_P$  be the normal fan of  $P$  (see Construction 2.1.3). Since  $P \subset N_\mathbb{R}^*$ , the fan  $\Sigma_P$  belongs to the space  $N_\mathbb{R}$ . It has a maximal cone  $\sigma_v$  for each vertex  $v \in P$ . The dual cone  $\sigma_v^*$  is the ‘vertex cone’ at  $v$ , generated by all vectors pointing from  $v$  to other points of  $P$ .

Define the toric variety  $V_P = V_{\Sigma_P}$ . Since the normal fan  $\Sigma_P$  does not depend on the linear size of the polytope, we may assume that for each vertex  $v$  the semigroup  $S_{\sigma_v}$  is generated by the lattice points of the polytope (this can always be achieved by replacing  $P$  by  $kP$  with sufficiently large  $k$ ). Since  $N^*$  is the lattice of characters of the algebraic torus  $\mathbb{C}_N^\times = N \otimes_\mathbb{Z} \mathbb{C}^\times$  (that is,  $N^* = \text{Hom}_\mathbb{Z}(\mathbb{C}_N^\times, \mathbb{C}^\times)$ ), the lattice points of the polytope  $P \subset N^*$  define an embedding

$$i_P: \mathbb{C}_N^\times \rightarrow (\mathbb{C}^\times)^{|N^* \cap P|},$$

where  $|N^* \cap P|$  is the number of lattice points in  $P$ .

PROPOSITION 5.2.2 (see [84, §2.2] or [122, §3.4]). *The toric variety  $V_P$  is identified with the projective closure  $i_P(\mathbb{C}_N^\times) \subset \mathbb{C}P^{|N^* \cap P|}$ .*

It follows that toric varieties arising from polytopes are projective, i.e. can be defined by a set of homogeneous equations in a projective space. The converse is

also true: the fan corresponding to a projective toric variety is the normal fan of a lattice polytope.

The polytope  $P$  carries more geometric information than the normal fan  $\Sigma_P$ : different lattice polytopes with the same normal fan  $\Sigma$  correspond to different projective embeddings of the toric variety  $V_\Sigma$ .

Nonsingular projective toric varieties correspond to lattice polytopes  $P$  which are simple and Delzant (that is, for each vertex  $v$ , the normal vectors of facets meeting at  $v$  form a basis of the lattice  $N$ ).

Constructions of Chapter 1 provide explicit series of Delzant polytopes and therefore nonsingular projective toric varieties. Basic examples include simplices and cubes in all dimensions. The product of two Delzant polytopes is obviously Delzant. If  $P$  is a Delzant polytope, then its face truncation  $P \cap H_{\geq}$  (Construction 1.1.12) by an appropriately chosen hyperplane  $H$  is also Delzant (an exercise). All nestohedra (in particular, permutahedra and associahedra) admit Delzant realisations. This fact, first observed in [265, Proposition 7.10], can be proved either by using the sequence of face truncations described in Lemma 1.5.17 or directly from the presentation of nestohedra given in Proposition 1.5.11.

EXAMPLE 5.2.3. The fan  $\Sigma$  described in Example 2.1.4 is regular, but cannot be obtained as the normal fan of a simple polytope. The corresponding 3-dimensional toric variety  $V_\Sigma$  is compact and nonsingular, but not projective.

We note that although the fan  $\Sigma$  from the previous example cannot be realised *geometrically* as the fan over the faces of a simplicial polytope (or, equivalently, as the normal fan of a simple polytope), its underlying simplicial complex  $\mathcal{K}_\Sigma$  is nevertheless *combinatorially* equivalent to the boundary complex of a simplicial polytope (namely, an octahedron with a pyramid over one of its facets, see Fig. 2.1). In other words, using the terminology of Section 2.5, the starshaped sphere triangulation  $\mathcal{K}_\Sigma$  is polytopal (in the combinatorial sense).

There are, of course, nonpolytopal starshaped spheres, such as the Barnette sphere  $\mathcal{K}$  (see Example 2.5.8). It is easy to see that a simplicial fan realising the Barnette sphere can be chosen rational. However, to realise a nonpolytopal sphere by a *regular* fan turned out to be a more difficult task. This question has been finally settled by Suyama [299]; his example is obtained by subdividing a simplicial fan realising the Barnette sphere. This is also important for the study of *quasitoric manifolds* and other topological generalisations of toric varieties discussed in Chapter 7.

We observe that each combinatorial simple polytope admits a convex realisation as a lattice polytope. Indeed by a small perturbation of the defining inequalities in (1.1) we can make all of them rational (that is, with rational  $\mathbf{a}_i$  and  $b_i$ ). Such a perturbation does not change the combinatorial type, as the half-spaces defined by the inequalities are in general position. As a result, we obtain a simple polytope  $P'$  of the same combinatorial type with rational vertex coordinates. To get a lattice polytope (say, with vertices in the standard lattice  $\mathbb{Z}^n$ ) we just take the magnified polytope  $kP'$  for appropriate  $k \in \mathbb{Z}$ . Similarly, by perturbing the vertices instead of the hyperplanes, we can obtain a lattice realisation for an arbitrary simplicial polytope (and we can obtain a rational fan realisation of any starshaped sphere triangulation). However, this argument does not work for convex polytopes which are neither simple nor simplicial. In fact, there are exist *nonrational* combinatorial

polytopes, which cannot be realised with rational vertex coordinates, see [325, Example 6.21] and the discussion there.

Toric geometry, even in its topological part, does not translate to a purely combinatorial study of fans and polytopes: the underlying convex geometry is what really matters. This is illustrated by the simple observation that different realisations of a combinatorial polytope by lattice polytopes often produce different (even topologically) toric varieties:

EXAMPLE 5.2.4. The complete regular fan  $\Sigma_k$  corresponding to the Hirzebruch surface  $F_k$  (see Fig. 5.1 (b)) is the normal fan of a lattice quadrilateral (trapezoid), e.g. given by

$$P_k = \{(x_1, x_2) \in \mathbb{R}^2 : x_1 \geq 0, x_2 \geq 0, -x_1 + kx_2 \geq -1, -x_2 \geq -1\}.$$

The polytopes  $P_k$  corresponding to different  $k$  are combinatorially equivalent (as they are all quadrilaterals), but the topology of the corresponding toric varieties  $F_k$  is different for even and odd  $k$  (see Exercise 5.1.13).

Furthermore, there exist combinatorial simple polytopes that do not admit any lattice realisation  $P$  with smooth  $V_P$ :

EXAMPLE 5.2.5 ([90, 1.22]). Let  $P$  be the dual of a 2-neighbourly simplicial  $n$ -polytope (e.g., a cyclic polytope of dimension  $n \geq 4$ , see Example 1.1.17) with  $m \geq 2^n$  vertices. Then for any lattice realisation of  $P$  the corresponding normal fan  $\Sigma_P$  is not regular, and the toric variety  $V_P$  is singular. Indeed, assume that the normal fan  $\Sigma_P$  is regular. Since the 1-skeleton of  $\mathcal{K}_P$  is a complete graph, each pair of primitive generators  $\mathbf{a}_i, \mathbf{a}_j$  of one-dimensional cones of  $\Sigma_P$  is a part of basis of  $\mathbb{Z}^n$ , and therefore  $\mathbf{a}_i$  and  $\mathbf{a}_j$  must be different modulo 2. This is a contradiction, since the number of different nonzero vectors in  $\mathbb{Z}_2^n$  is  $2^n - 1$ .

### Exercises.

5.2.6. Let  $P$  be a Delzant polytope and  $G \subset P$  a face. Show that a hyperplane  $H$  truncating  $G$  from  $P$  in Construction 1.1.12 can be chosen so that the truncated polytope  $P \cap H_{\geq}$  is Delzant.

5.2.7. The presentation of a nestohedron  $P_{\mathcal{B}}$  from Proposition 1.5.11 is Delzant.

5.2.8. Describe explicitly a rational fan realising the Barnette sphere by writing down its primitive integral generator vectors.

5.2.9. Write down a system of homogeneous equations defining each Hirzebruch surface in a projective space. (Hint: use Construction 5.2.1.)

## 5.3. Cohomology of toric manifolds

A *toric manifold* is a smooth compact toric variety. (Compactness will be always understood in the sense of usual topology; it corresponds to algebraic geometer's notion of *completeness*.) Toric manifolds  $V_{\Sigma}$  correspond to complete regular fans  $\Sigma$ . *Projective toric manifolds*  $V_P$  correspond to lattice polytopes  $P$  whose normal fans are regular.

The cohomology of a toric manifold  $V_{\Sigma}$  can be calculated effectively from the fan  $\Sigma$ . The Betti numbers are determined by the combinatorics of  $\Sigma$  only, while the ring structure of  $H^*(V_{\Sigma})$  depends on the geometric data. The required combinatorial ingredients are the  $h$ -vector  $\mathbf{h}(\mathcal{K}_{\Sigma}) = (h_0, h_1, \dots, h_n)$  (see Definition 2.2.5) of

the underlying simplicial complex  $\mathcal{K}_\Sigma$  and its face ring  $\mathbb{Z}[\mathcal{K}_\Sigma]$  (Definition 3.1.1). The geometric data consists of the primitive generators  $\mathbf{a}_1, \dots, \mathbf{a}_m$  of one-dimensional cones (edges) of  $\Sigma$ .

**THEOREM 5.3.1 (Danilov–Jurkiewicz).** *Let  $V_\Sigma$  be the toric manifold corresponding to a complete regular fan  $\Sigma$  in  $N_{\mathbb{R}}$ . The cohomology ring of  $V_\Sigma$  is given by*

$$H^*(V_\Sigma) \cong \mathbb{Z}[v_1, \dots, v_m]/\mathcal{I},$$

where  $v_1, \dots, v_m \in H^2(V_\Sigma)$  are the cohomology classes dual the invariant divisors corresponding to the one-dimensional cones of  $\Sigma$ , and  $\mathcal{I}$  is the ideal generated by elements of the following two types:

- (a)  $v_{i_1} \cdots v_{i_k}$  with  $\{i_1, \dots, i_k\} \notin \mathcal{K}_\Sigma$  (the Stanley–Reisner relations);
- (b)  $\sum_{i=1}^m \langle \mathbf{a}_j, \mathbf{u} \rangle v_i$ , for any  $\mathbf{u} \in N^*$ .

The homology groups of  $V_\Sigma$  vanish in odd dimensions, and are free abelian in even dimensions, with ranks given by

$$b_{2i}(V_\Sigma) = h_i(\mathcal{K}_\Sigma),$$

where  $h_i(\mathcal{K}_\Sigma)$ ,  $i = 0, 1, \dots, n$ , are the components of the  $h$ -vector of  $\mathcal{K}_\Sigma$ .

This theorem was proved by Jurkiewicz for projective toric manifolds and by Danilov [86, Theorem 10.8] in the general case. We shall give a topological proof of a more general result in Section 7.4 (see Theorem 7.4.35).

To obtain an explicit presentation of the ring  $H^*(V_\Sigma)$  we choose a basis of  $N$  and write the vectors  $\mathbf{a}_j$  in coordinates:  $\mathbf{a}_j = (a_{j1}, \dots, a_{jn})^t$ ,  $1 \leq j \leq m$ . Then the ideal  $\mathcal{J}_\Sigma$  is generated by the  $n$  linear forms

$$t_i = a_{1i}v_1 + \cdots + a_{mi}v_m \in \mathbb{Z}[v_1, \dots, v_m], \quad 1 \leq i \leq n.$$

By Lemma 3.3.2, the sequence  $t_1, \dots, t_n$  is an lsoip in the Cohen–Macaulay ring  $\mathbb{Z}[\mathcal{K}_\Sigma]$ , so it is a regular sequence. Hence,  $\mathbb{Z}[\mathcal{K}_\Sigma]$  is a free  $\mathbb{Z}[t_1, \dots, t_n]$ -module, and statement (a) of Theorem 5.3.1 follows from (b) and Theorem 3.1.10.

**REMARK.** Theorem 5.3.1 remains valid for complete simplicial fans and corresponding toric orbifolds if the integer coefficients are replaced by the rationals [86]. The integral cohomology of toric orbifolds often has torsion, and the ring structure is subtle even in the simplest case of weighted projective spaces [181], [17].

It follows from Theorem 5.3.1 that the cohomology ring of  $V_\Sigma$  is generated by two-dimensional classes. This is the first property to check if one wishes to determine whether a given algebraic variety or smooth manifold has a structure of a toric manifold. For instance, this rules out flag varieties and Grassmanians different from projective spaces. Another important property of toric manifolds is that the *Chow ring* of  $V_\Sigma$  coincides with its integer cohomology ring [122, § 5.1].

Assume now that  $\Sigma = \Sigma_P$  is the normal fan of a lattice polytope  $P = P(\mathbf{A}, \mathbf{b})$  given by (1.1). Let  $V_P$  be the corresponding projective toric variety, see Construction 5.2.1. In the notation of Theorem 5.3.1, the linear combination  $D_P = b_1D_1 + \cdots + b_mD_m$  is an *ample divisor* on  $V_P$  (see, e.g., [84, Proposition 6.1.10]). This means that, when  $k$  is sufficiently large,  $kD_P$  is a hyperplane section divisor for a projective embedding  $V_P \subset \mathbb{C}P^r$ . In fact, the space of sections  $H^0(V_P, kD_P)$  of (the line bundle corresponding to)  $kD_P$  has basis corresponding to the lattice points in  $kP$ . One may take  $k$  so that  $kP$  has ‘enough lattice points’ to get an

embedding of  $V_P$  into the projectivisation of  $H^0(V_P, kD_P)$ ; this is exactly the embedding described in Construction 5.2.1. Let  $\omega = b_1v_1 + \cdots + b_mv_m \in H^2(V_P; \mathbb{C})$  be the complex cohomology class of  $D_P$ .

**THEOREM 5.3.2** (Hard Lefschetz Theorem for toric orbifolds). *Let  $P$  be a lattice simple polytope (1.1), let  $V_P$  be the corresponding projective toric variety, and let  $\omega = b_1v_1 + \cdots + b_mv_m \in H^2(V_P; \mathbb{C})$  be the class defined above. Then the maps*

$$H^{n-i}(V_P; \mathbb{C}) \xrightarrow{\omega^i} H^{n+i}(V_P; \mathbb{C})$$

are isomorphisms for all  $i = 1, \dots, n$ .

If  $V_P$  is smooth, then it is Kähler, and  $\omega$  is the class of the Kähler 2-form.

The proof of the Hard Lefschetz Theorem is well beyond the scope of this book. In fact, it is a corollary of a more general version of Hard Lefschetz Theorem for the (middle perversity) *intersection cohomology*, which is valid for all projective varieties (not necessary orbifolds). See the discussion in [122, §5.2] or [84, §12.6].

Now we are ready to give Stanley's argument for the 'only if' part of the  $g$ -theorem for simple polytopes:

**PROOF OF THE NECESSITY PART OF THEOREM 1.4.14.** We need to establish conditions (a)–(c) for a combinatorial simple polytope. Realise it by a lattice polytope  $P \subset \mathbb{R}^n$  as described in the previous section. Let  $V_P$  be the corresponding toric variety. Part (a) is already proved (Theorem 1.3.4). It follows from Theorem 5.3.2 that the multiplication by  $\omega \in H^2(V_P; \mathbb{Q})$  is a monomorphism  $H^{2i-2}(V_P; \mathbb{Q}) \rightarrow H^{2i}(V_P; \mathbb{Q})$  for  $i \leq \lfloor \frac{n}{2} \rfloor$ . This together with part (a) of Theorem 5.3.1 gives that  $h_{i-1} \leq h_i$  for  $0 \leq i \leq \lfloor \frac{n}{2} \rfloor$ , thus proving (b). To prove (c), define the graded commutative  $\mathbb{Q}$ -algebra  $A = H^*(V_P; \mathbb{Q})/(\omega)$ , where  $(\omega)$  is the ideal generated by  $\omega$ . Then  $A^0 = \mathbb{Q}$ ,  $A^{2i} = H^{2i}(V_P; \mathbb{Q})/(\omega \cdot H^{2i-2}(V_P; \mathbb{Q}))$  for  $1 \leq i \leq \lfloor \frac{n}{2} \rfloor$ , and  $A$  is generated by degree-two elements (since so is  $H^*(V_P; \mathbb{Q})$ ). It follows from Theorem 1.4.12 that the numbers  $\dim A^{2i} = h_i - h_{i-1}$ ,  $0 \leq i \leq \lfloor \frac{n}{2} \rfloor$ , are the components of an  $M$ -vector, thus proving (c) and the whole theorem.  $\square$

**REMARK.** The Dehn–Sommerville equations now can be interpreted as Poincaré duality for  $V_P$ . (Even though  $V_P$  may be not smooth, the rational cohomology algebra of a toric orbifold satisfies Poincaré duality.)

The Hard Lefschetz Theorem holds for projective varieties only. Therefore, Stanley's argument cannot be generalised to nonpolytopal spheres. However, the cohomology of toric varieties can be used to prove statements generalising the  $g$ -theorem in a different direction, namely, to the case of general (not necessarily simple or simplicial) convex polytopes. So suppose  $P$  is a convex lattice  $n$ -polytope, and  $V_P$  is the corresponding projective toric variety. If  $P$  is not simple then  $V_P$  has worse than orbifold-type singularities and its ordinary cohomology behaves badly. The Betti numbers of  $V_P$  are not determined by the combinatorial type of  $P$  and do not satisfy Poincaré duality. On the other hand, the dimensions  $\hat{h}_i = \dim IH_{2i}(V_P)$  of the intersection homology groups of  $V_P$  are combinatorial invariants of  $P$  (see the description in [291] or [84, §12.5]). The vector

$$\hat{h}(P) = (\hat{h}_0, \hat{h}_1, \dots, \hat{h}_n)$$

is called the *intersection  $h$ -vector*, or the *toric  $h$ -vector* of  $P$ . If  $P$  is simple, then the toric  $h$ -vector coincides with the standard  $h$ -vector, but in general  $\hat{h}(P)$  is

not determined by the face numbers of  $P$ . The toric  $h$ -vector satisfies the ‘Dehn–Sommerville equations’  $\widehat{h}_i = \widehat{h}_{n-i}$ , and the Hard Lefschetz Theorem for intersection cohomology shows that it also satisfies the GLBC inequalities:

$$\widehat{h}_0 \leq \widehat{h}_1 \leq \cdots \leq \widehat{h}_{\lfloor \frac{n}{2} \rfloor}.$$

In the case when  $P$  cannot be realised by a lattice polytope (i.e., when  $P$  is non-rational), the toric  $h$ -vector can still be defined combinatorially, but the GLBC inequalities require a separate proof. Partial results in this direction were obtained by several people, before the Hard Lefschetz Theorem for nonrational polytopes was eventually proved in the work of Karu [179]. This result also gives a purely combinatorial proof of the Hard Lefschetz Theorem for projective toric varieties.

### Exercises.

5.3.3. Show that the complex Grassmanian  $\text{Gr}_k(\mathbb{C}^n)$  ( $k$ -planes in  $\mathbb{C}^n$ ) with  $1 < k < n - 1$  does not support an algebraic torus action turning it into a toric variety.

## 5.4. Algebraic quotient construction

Along with the classical construction of toric varieties from fans, described in Section 5.1, there is an alternative way to define a toric variety: as the quotient of a Zariski open subset in  $\mathbb{C}^m$  (more precisely, the complement of a coordinate subspace arrangement) by an action of an abelian algebraic group (a product of an algebraic torus and a finite group). Different versions of this construction, which we refer to as simply the ‘quotient construction’, have appeared in the work of several authors since the early 1990s. In our exposition we mainly follow the work of Cox [83] (and also its modernised exposition in [84, Chapter 5]); more historical remarks can be also found in these sources.

**Quotients in algebraic geometry.** Taking quotients of algebraic varieties by algebraic group actions is tricky for both topological and algebraic reasons. First, as algebraic groups are non-compact (as algebraic tori), their orbits may be not closed, and the quotients may be non-Hausdorff. Second, even if the quotient is Hausdorff as a topological space, it may fail to be an algebraic variety. This may be remedied to some extent by the notion of the categorical quotient.

Let  $X$  be an algebraic variety with an action of an affine algebraic group  $G$ . An algebraic variety  $Y$  is called a *categorical quotient* of  $X$  by the action of  $G$  if there exists a morphism  $\pi: X \rightarrow Y$  which is constant on  $G$ -orbits of  $X$  and has the following universal property: for any morphism  $\varphi: X \rightarrow Z$  which is constant on  $G$ -orbits, there is a unique morphism  $\widehat{\varphi}: Y \rightarrow Z$  such that  $\widehat{\varphi} \circ \pi = \varphi$ . This is described by the diagram

$$\begin{array}{ccc} X & \xrightarrow{\varphi} & Z \\ & \searrow \pi & \nearrow \widehat{\varphi} \\ & Y & \end{array}$$

A categorical quotient  $Y$  is unique up to isomorphism, and we denote it by  $X//G$ .

Assume first that  $X = \text{Spec } A$  is an affine variety, where  $A = \mathbb{C}[X]$  is the algebra of regular functions on  $X$ . Let  $\mathbb{C}[X]^G$  be the subalgebra of  $G$ -invariant functions (i.e. such functions  $f$  that  $f(gx) = f(x)$  for any  $g \in G$  and  $x \in X$ ).



If  $G$  is an algebraic torus (or any *reductive* affine algebraic group), then  $\mathbb{C}[X]^G$  is finitely generated. The corresponding affine variety  $\text{Spec } \mathbb{C}[X]^G$  is the categorical quotient  $X//G$ . The quotient morphism  $\pi: X \rightarrow X//G$  is dual to the inclusion of algebras  $\mathbb{C}[X]^G \rightarrow \mathbb{C}[X]$ . The morphism  $\pi$  is surjective and induces a one-to-one correspondence between points of  $X//G$  and *closed*  $G$ -orbits of  $X$  (i.e.  $\pi^{-1}(x)$  contains a unique closed  $G$ -orbit for any  $x \in X//G$ , see [84, Proposition 5.0.7]).

Therefore, if all  $G$ -orbits of an affine variety  $X$  are closed, then the categorical quotient  $X//G$  is identified as a topological space with the ordinary ‘topological’ quotient  $X/G$ . Quotients of this type are called *geometric* and also denoted by  $X/G$ .

EXAMPLE 5.4.1. Let  $\mathbb{C}^\times$  act on  $\mathbb{C} = \text{Spec}(\mathbb{C}[z])$  by scalar multiplication. There are two orbits: the closed orbit  $0$  and the open orbit  $\mathbb{C}^\times$ . The topological quotient  $\mathbb{C}/\mathbb{C}^\times$  is a non-Hausdorff two-point space.

On the other hand, the categorical quotient  $\mathbb{C}/\mathbb{C}^\times = \text{Spec}(\mathbb{C}[z]^{\mathbb{C}^\times})$  is a point, since any  $\mathbb{C}^\times$ -invariant polynomial is constant (and there is only one closed orbit).

Similarly, if  $\mathbb{C}^\times$  acts on  $\mathbb{C}^n = \text{Spec}(\mathbb{C}[z_1, \dots, z_n])$  diagonally, then an invariant polynomial satisfies  $f(\lambda z_1, \dots, \lambda z_n) = f(z_1, \dots, z_n)$  for all  $\lambda \in \mathbb{C}^\times$ . Such a polynomial must be constant, hence  $\mathbb{C}^n//\mathbb{C}^\times$  is a point.

In good cases categorical quotients of general (non-affine) varieties  $X$  may be constructed by ‘gluing from affine pieces’ as follows. Assume that  $G$  acts on  $X$  and  $\pi: X \rightarrow Y$  is a morphism of varieties that is constant on  $G$ -orbits. If  $Y$  has an open affine cover  $Y = \bigcup_\alpha V_\alpha$  such that  $\pi^{-1}(V_\alpha)$  is affine and  $V_\alpha$  is the categorical quotient (that is,  $\pi|_{\pi^{-1}(V_\alpha)}: \pi^{-1}(V_\alpha) \rightarrow V_\alpha$  is the morphism dual to the inclusion of algebras  $\mathbb{C}[\pi^{-1}(V_\alpha)]^G \rightarrow \mathbb{C}[V_\alpha]$ ), then  $Y$  is the categorical quotient  $X//G$ .

EXAMPLE 5.4.2. Let  $\mathbb{C}^\times$  act on  $\mathbb{C}^2 \setminus \{\mathbf{0}\}$  diagonally, where  $\mathbb{C}^2 = \text{Spec}(\mathbb{C}[z_0, z_1])$ . We have an open affine cover  $\mathbb{C}^2 \setminus \{\mathbf{0}\} = U_0 \cup U_1$ , where

$$\begin{aligned} U_0 &= \mathbb{C}^2 \setminus \{z_0 = 0\} = \mathbb{C}^\times \times \mathbb{C} = \text{Spec}(\mathbb{C}[z_0^{\pm 1}, z_1]), \\ U_1 &= \mathbb{C}^2 \setminus \{z_1 = 0\} = \mathbb{C} \times \mathbb{C}^\times = \text{Spec}(\mathbb{C}[z_0, z_1^{\pm 1}]), \\ U_0 \cap U_1 &= \mathbb{C}^2 \setminus \{z_0 z_1 = 0\} = \mathbb{C}^\times \times \mathbb{C}^\times = \text{Spec}(\mathbb{C}[z_0^{\pm 1}, z_1^{\pm 1}]). \end{aligned}$$

The algebras of  $\mathbb{C}^\times$ -invariant functions are

$$\mathbb{C}[z_0^{\pm 1}, z_1]^{\mathbb{C}^\times} = \mathbb{C}[z_1/z_0], \quad \mathbb{C}[z_0, z_1^{\pm 1}]^{\mathbb{C}^\times} = \mathbb{C}[z_0/z_1], \quad \mathbb{C}[z_0^{\pm 1}, z_1^{\pm 1}]^{\mathbb{C}^\times} = \mathbb{C}[(z_1/z_0)^{\pm 1}].$$

It follows that  $V_0 = U_0//\mathbb{C}^\times \cong \mathbb{C}$  and  $V_1 = U_1//\mathbb{C}^\times \cong \mathbb{C}$  glue together along  $V_0 \cap V_1 = (U_0 \cap U_1)//\mathbb{C}^\times \cong \mathbb{C}^\times$  in the standard way to produce  $\mathbb{C}P^1$ . All  $\mathbb{C}^\times$ -orbits are closed in  $\mathbb{C}^2 \setminus \{\mathbf{0}\}$ , hence  $\mathbb{C}P^1 = (\mathbb{C}^2 \setminus \{\mathbf{0}\})/\mathbb{C}^\times$  is the geometric quotient.

Similarly,  $\mathbb{C}P^n = (\mathbb{C}^{n+1} \setminus \{\mathbf{0}\})/\mathbb{C}^\times$  for the diagonal action of  $\mathbb{C}^\times$ .

EXAMPLE 5.4.3. Now we let  $\mathbb{C}^\times$  act on  $\mathbb{C}^2 \setminus \{\mathbf{0}\}$  by  $\lambda \cdot (z_0, z_1) = (\lambda z_0, \lambda^{-1} z_1)$ . Using the same affine cover of  $\mathbb{C}^2 \setminus \{\mathbf{0}\}$  as in the previous example, we obtain the following algebras of  $\mathbb{C}^\times$ -invariant functions:

$$\mathbb{C}[z_0^{\pm 1}, z_1]^{\mathbb{C}^\times} = \mathbb{C}[z_0 z_1], \quad \mathbb{C}[z_0, z_1^{\pm 1}]^{\mathbb{C}^\times} = \mathbb{C}[z_0 z_1], \quad \mathbb{C}[z_0^{\pm 1}, z_1^{\pm 1}]^{\mathbb{C}^\times} = \mathbb{C}[(z_0 z_1)^{\pm 1}].$$

This time gluing together  $V_0$  and  $V_1$  along  $V_0 \cap V_1 \cong \mathbb{C}^\times$  gives the variety obtained from two copies of  $\mathbb{C}$  by identifying all nonzero points. This variety is nonseparated (the two zeros do not have nonintersecting neighbourhoods in the usual topology). Since we only consider separated varieties, this is not a categorical quotient.

A toric variety  $V_\Sigma$  will be described as the quotient of the ‘total space’  $U(\Sigma)$  by an action of a commutative algebraic group  $G$ . We now proceed to describe  $G$  and  $U(\Sigma)$ .

**The total space  $U(\Sigma)$  and the acting group  $G$ .** Let  $\Sigma$  be a rational fan in the  $n$ -dimensional space  $N_{\mathbb{R}}$  with  $m$  one-dimensional cones generated by primitive vectors  $\mathbf{a}_1, \dots, \mathbf{a}_m$ . We shall assume that the linear span of  $\mathbf{a}_1, \dots, \mathbf{a}_m$  is the whole  $N_{\mathbb{R}}$ . (Equivalently, the toric variety  $V_\Sigma$  does not have torus factors, i.e. cannot be written as  $V_\Sigma = V_{\Sigma'} \times \mathbb{C}^\times$ . For the general case see [84, §5.1].)

We consider the map of lattices  $A: \mathbb{Z}^m \rightarrow N$  sending the  $i$ th basis vector of  $\mathbb{Z}^m$  to  $\mathbf{a}_i \in N$ . Our assumption implies that the corresponding map of algebraic tori,

$$A \otimes_{\mathbb{Z}} \mathbb{C}^\times : (\mathbb{C}^\times)^m \rightarrow \mathbb{C}_N^\times$$

is surjective.

Define the group  $G = G(\Sigma)$  as the kernel of the map  $A \otimes_{\mathbb{Z}} \mathbb{C}^\times$ , which we denote by  $\exp A$ . We therefore have an exact sequence of groups

$$(5.2) \quad 1 \longrightarrow G \longrightarrow (\mathbb{C}^\times)^m \xrightarrow{\exp A} \mathbb{C}_N^\times \longrightarrow 1.$$

Explicitly,  $G$  is given by

$$(5.3) \quad G = \{(z_1, \dots, z_m) \in (\mathbb{C}^\times)^m : \prod_{i=1}^m z_i^{\langle \mathbf{a}_i, \mathbf{u} \rangle} = 1 \text{ for any } \mathbf{u} \in N^*\}.$$

The group  $G$  is isomorphic to a product of  $(\mathbb{C}^\times)^{m-n}$  and a finite abelian group. If  $\Sigma$  is a regular fan with at least one  $n$ -dimensional cone, then  $G \cong (\mathbb{C}^\times)^{m-n}$ .

Given a cone  $\sigma \in \Sigma$ , we set  $g(\sigma) = \{i_1, \dots, i_k\} \subset [m]$  if  $\sigma$  is generated by  $\mathbf{a}_{i_1}, \dots, \mathbf{a}_{i_k}$ , and consider the monomial  $z^{\hat{\sigma}} = \prod_{j \notin g(\sigma)} z_j$ . The quasiaffine variety

$$U(\Sigma) = \mathbb{C}^m \setminus \{\mathbf{z} \in \mathbb{C}^m : z^{\hat{\sigma}} = 0 \text{ for all } \sigma \in \Sigma\}$$

has the affine cover

$$(5.4) \quad U(\Sigma) = \bigcup_{\sigma \in \Sigma} U(\sigma).$$

by affine varieties

$$U(\sigma) = \{\mathbf{z} \in \mathbb{C}^m : z^{\hat{\sigma}} \neq 0\} = \{\mathbf{z} \in \mathbb{C}^m : z_j \neq 0 \text{ for } j \notin g(\sigma)\} = (\mathbb{C}, \mathbb{C}^\times)^{g(\sigma)}.$$

Here we used the notation of Construction 4.2.1, so that  $U(\sigma) \cong \mathbb{C}^k \times (\mathbb{C}^\times)^{m-k}$ . Each subset  $U(\sigma) \subset \mathbb{C}^m$  is invariant under the coordinatewise action of  $(\mathbb{C}^\times)^m$  on  $\mathbb{C}^m$ , so that  $U(\Sigma)$  is also invariant.

By definition,  $U(\Sigma)$  is the complement of a union of coordinate subspaces, so we know from Proposition 4.7.2 that it has the form

$$(5.5) \quad U(\mathcal{K}) = \mathbb{C}^m \setminus \bigcup_{\{i_1, \dots, i_k\} \notin \mathcal{K}} \{\mathbf{z} \in \mathbb{C}^m : z_{i_1} = \dots = z_{i_k} = 0\} = \mathcal{Z}_{\mathcal{K}}(\mathbb{C}, \mathbb{C}^\times)$$

for some simplicial complex  $\mathcal{K}$  on  $[m]$ . What is this simplicial complex?

The answer is suggested by decomposition (5.4). We define the simplicial complex  $\mathcal{K}_\Sigma$  generated by all subsets  $g(\sigma) \subset [m]$ :

$$\mathcal{K}_\Sigma = \{I : I \subset g(\sigma) \text{ for some } \sigma \in \Sigma\}.$$

If  $\Sigma$  is a simplicial fan, then each  $I \subset g(\sigma)$  is  $g(\tau)$  for some  $\tau \in \Sigma$ , and we obtain the ‘underlying complex’ of  $\Sigma$  defined in Example 2.2.7. In particular, if  $\Sigma$  is simplicial

and complete, then  $\mathcal{K}_\Sigma$  is a triangulation of  $S^{n-1}$ ; and if  $\Sigma$  is a normal fan of a simple polytope, then  $\mathcal{K}_\Sigma$  is the boundary complex of the dual simplicial polytope. If  $\Sigma$  is the normal fan of a non-simple polytope  $P$  (i.e. the fan over the faces of the polar polytope  $P^*$ ), then  $\mathcal{K}_\Sigma$  is obtained by replacing each face of  $P^*$  by a simplex with the same set of vertices; such a simplicial complex is not pure in general.

PROPOSITION 5.4.4. *We have  $U(\Sigma) = U(\mathcal{K}_\Sigma)$ .*

PROOF. We have  $(\mathbb{C}, \mathbb{C}^\times)^I \subset (\mathbb{C}, \mathbb{C}^\times)^{g(\sigma)}$  whenever  $I \subset g(\sigma)$ , hence,

$$U(\Sigma) = \bigcup_{\sigma \in \Sigma} U(\sigma) = \bigcup_{\sigma \in \Sigma} (\mathbb{C}, \mathbb{C}^\times)^{g(\sigma)} = \bigcup_{\sigma \in \Sigma, I \subset g(\sigma)} (\mathbb{C}, \mathbb{C}^\times)^I = \bigcup_{I \in \mathcal{K}_\Sigma} (\mathbb{C}, \mathbb{C}^\times)^I = U(\mathcal{K}_\Sigma).$$

□

We observe that the subset  $U(\Sigma) \subset \mathbb{C}^m$  depends only on the combinatorial structure of the fan  $\Sigma$ , while the subgroup  $G \subset (\mathbb{C}^\times)^m$  depends on the geometric data, namely, the primitive generators of one-dimensional cones.

**Toric variety as a quotient.** Since  $U(\Sigma) \subset \mathbb{C}^m$  is invariant under the coordinatewise action of  $(\mathbb{C}^\times)^m$ , we obtain a  $G$ -action on  $U(\Sigma)$  by restriction.

THEOREM 5.4.5 (Cox [83, Theorem 2.1]). *Assume that the linear span of one-dimensional cones of  $\Sigma$  is the whole space  $N_{\mathbb{R}}$ .*

- (a) *The toric variety  $V_\Sigma$  is naturally isomorphic to the categorical quotient  $U(\Sigma)//G$ .*
- (b)  *$V_\Sigma$  is the geometric quotient  $U(\Sigma)/G$  if and only if the fan  $\Sigma$  is simplicial.*

PROOF. We first prove that the affine variety  $V_\sigma$  corresponding to a cone  $\sigma \in \Sigma$  is the categorical quotient  $U(\sigma)//G$ . The algebra of regular functions  $\mathbb{C}[U(\sigma)]$  is isomorphic to  $\mathbb{C}[z_i, z_j^{-1} : 1 \leq i \leq m, j \notin g(\sigma)]$  and is generated by Laurent monomials  $\prod_{i=1}^m z_i^{k_i}$  with  $k_i \geq 0$  for  $i \in g(\sigma)$ .

It follows easily from (5.3) that a monomial  $\prod_{i=1}^m z_i^{k_i}$  is invariant under the  $G$ -action on  $U(\sigma)$  if and only if it has the form  $\prod_{i=1}^m z_i^{\langle \mathbf{u}, \mathbf{a}_i \rangle}$  for some  $\mathbf{u} \in N^*$ .

Conditions  $\langle \mathbf{u}, \mathbf{a}_i \rangle \geq 0$  for  $i \in g(\sigma)$  specify the dual cone  $\sigma^\vee \subset N_{\mathbb{R}}^*$ , see (2.1). Hence the invariant subalgebra  $\mathbb{C}[U(\sigma)]^G$  is isomorphic to  $\mathbb{C}[\sigma^\vee \cap N^*] = A_\sigma = \mathbb{C}[V_\sigma]$  (the isomorphism is given by  $\prod_{i=1}^m y_i^{\langle \mathbf{u}, \mathbf{a}_i \rangle} \mapsto \chi^{\mathbf{u}}$ ). Thus,  $U(\sigma)//G \cong V_\sigma$ .

The next step is to glue the isomorphisms  $U(\sigma)//G \cong V_\sigma$  together into an isomorphism  $U(\Sigma)//G \cong V_\Sigma$ . To do this we need to check that the isomorphisms  $\mathbb{C}[U(\sigma)]^G \rightarrow \mathbb{C}[V_\sigma]$  are compatible when we pass to the faces of  $\sigma$ . In other words, for each face  $\tau \subset \sigma$  we need to establish the commutativity of the diagram

$$(5.6) \quad \begin{array}{ccc} \mathbb{C}[U(\sigma)]^G & \longrightarrow & \mathbb{C}[U(\tau)]^G \\ \cong \downarrow & & \downarrow \cong \\ \mathbb{C}[V_\sigma] & \longrightarrow & \mathbb{C}[V_\tau]. \end{array}$$

By the definition of a face, we have  $\tau = \sigma \cap \mathbf{u}^\perp$  for some  $\mathbf{u} \in \sigma^\vee \cap N^*$ , where  $\mathbf{u}^\perp$  denotes the hyperplane in  $N_{\mathbb{R}}$  normal to  $\mathbf{u}$ . Consider the monomial  $\mathbf{z}(\mathbf{u}) = \prod_{i=1}^m z_i^{\langle \mathbf{u}, \mathbf{a}_i \rangle}$ . Since  $\tau = \sigma \cap \mathbf{u}^\perp$ , the monomial  $\mathbf{z}(\mathbf{u})$  has positive exponent of  $z_i$  for  $i \in g(\sigma) \setminus g(\tau)$  and zero exponent of  $z_j$  for  $j \in g(\tau)$ . It follows that the algebra  $\mathbb{C}[U(\tau)]$  is the localisation of  $\mathbb{C}[U(\sigma)]$  by the ideal generated by  $\mathbf{z}(\mathbf{u})$ , i.e.  $\mathbb{C}[U(\tau)] = \mathbb{C}[U(\sigma)]_{\mathbf{z}(\mathbf{u})}$ . Since  $\mathbf{z}(\mathbf{u})$  is a  $G$ -invariant monomial, the localisation

commutes with passing to invariant subalgebras, i.e.  $\mathbb{C}[U(\tau)]^G = \mathbb{C}[U(\sigma)]_{\mathbf{z}(\mathbf{u})}^G$ . Similarly,  $\mathbb{C}[V_\tau] = A_\tau = (A_\sigma)_{\chi^{\mathbf{u}}}$ . Diagram (5.6) then takes the form

$$\begin{array}{ccc} \mathbb{C}[U(\sigma)]^G & \longrightarrow & \mathbb{C}[U(\sigma)]_{\mathbf{z}(\mathbf{u})}^G \\ \cong \downarrow & & \downarrow \cong \\ \mathbb{C}[V_\sigma] & \longrightarrow & \mathbb{C}[V_\sigma]_{\chi^{\mathbf{u}}}, \end{array}$$

where the vertical arrows are localisation maps. It is obviously commutative.

Now using the affine cover (5.4) and the compatibility of the isomorphisms on affine varieties we obtain the isomorphism  $U(\Sigma)//G \cong V_\Sigma = \bigcup_{\sigma \in \Sigma} V_\sigma$ . Statement (a) is therefore proved.

To verify (b) we need to check that all orbits of the  $G$ -action on  $U(\Sigma)$  are closed if and only if the fan  $\Sigma$  is simplicial.

Assume  $\Sigma$  is simplicial, and consider any  $G$ -orbit  $G\mathbf{z}$ ,  $\mathbf{z} \in U(\Sigma)$ . We shall prove that  $G\mathbf{z}$  is closed in the usual topology, which is sufficient since the closures of orbits in the usual and Zariski topologies coincide. We need to check that whenever a sequence  $\{\mathbf{w}^{(k)} : k = 1, 2, \dots\}$  of points of  $G\mathbf{z}$  has a limit  $\mathbf{w} \in U(\Sigma)$ , this limit is in  $G\mathbf{z}$ . Write  $\mathbf{w}^{(k)} = \mathbf{g}^{(k)}\mathbf{z}$  with  $\mathbf{g}^{(k)} \in G$ . Then it is enough to show that a subsequence of  $\{\mathbf{g}^{(k)}\}$  converges to a point  $\mathbf{g} \in G$ , as in this case  $\lim_{k \rightarrow \infty} \mathbf{w}^{(k)} = \mathbf{g}\mathbf{z} \in G\mathbf{z}$ . We write

$$\mathbf{g}^{(k)} = (g_1^{(k)}, \dots, g_m^{(k)}) = (e^{\alpha_1^{(k)} + i\beta_1^{(k)}}, \dots, e^{\alpha_m^{(k)} + i\beta_m^{(k)}}) \in G \subset (\mathbb{C}^\times)^m$$

where  $g_j^{(k)} \in \mathbb{C}^\times$  and  $\alpha_j^{(k)}, \beta_j^{(k)} \in \mathbb{R}$ . Since  $e^{i\beta_j^{(k)}} \in \mathbb{S}$  and the circle is compact, we may assume by passing to a subsequence that the sequence  $\{e^{i\beta_j^{(k)}}\}$  has a limit  $e^{i\beta_j}$  as  $k \rightarrow \infty$  for each  $j = 1, \dots, m$ . It remains to consider the sequences  $\{e^{\alpha_j^{(k)}}\}$ .

By passing to a subsequence we may assume that each sequence  $\{\alpha_j^{(k)}\}$ ,  $j = 1, \dots, m$ , has a finite or infinite limit (including  $\pm\infty$ ). Let

$$I_+ = \{j : \alpha_j^{(k)} \rightarrow +\infty\} \subset [m], \quad I_- = \{j : \alpha_j^{(k)} \rightarrow -\infty\} \subset [m].$$

Since the sequence  $\{\mathbf{w}^{(k)} = \mathbf{g}^{(k)}\mathbf{z}\}$  is converging to  $\mathbf{w} = (w_1, \dots, w_m) \in U(\Sigma)$ , we have  $z_j = 0$  for  $j \in I_+$  and  $w_j = 0$  for  $j \in I_-$ . Then it follows from the decomposition  $U(\Sigma) = \bigcup_{I \in \mathcal{K}_\Sigma} (\mathbb{C}, \mathbb{C}^\times)^I$  that  $I_+$  and  $I_-$  are simplices of  $\mathcal{K}_\Sigma$ . Let  $\sigma_+, \sigma_-$  be the corresponding cones of  $\Sigma$  (here we use the fact that  $\Sigma$  is simplicial). Then  $\sigma_+ \cap \sigma_- = \{\mathbf{0}\}$  by definition of a fan. By Lemma 2.1.2, there is a linear function  $\mathbf{u} \in N^*$  such that  $\langle \mathbf{u}, \mathbf{a} \rangle > 0$  for any nonzero  $\mathbf{a} \in \sigma_+$ , and  $\langle \mathbf{u}, \mathbf{a} \rangle < 0$  for any nonzero  $\mathbf{a} \in \sigma_-$ . Now, since  $\mathbf{g}^{(k)} \in G$ , it follows from (5.3) that

$$(5.7) \quad \sum_{j=1}^m \alpha_j^{(k)} \langle \mathbf{u}, \mathbf{a}_j \rangle = 0.$$

This implies that both  $I_+$  and  $I_-$  are empty, as otherwise the sum above tends to infinity. Thus, each sequence  $\{\alpha_j^{(k)}\}$  has a finite limit  $\alpha_j$ , and a subsequence of  $\{\mathbf{g}^{(k)}\}$  converges to  $(e^{\alpha_1 + i\beta_1}, \dots, e^{\alpha_m + i\beta_m})$ . Passing to the limit in (5.7) and in the similar equation for  $\beta_j^{(k)}$  as  $k \rightarrow \infty$  we obtain that  $(e^{\alpha_1 + i\beta_1}, \dots, e^{\alpha_m + i\beta_m}) \in G$ .

The fact that the  $G$ -action on  $U(\Sigma)$  with non-simplicial  $\Sigma$  has non-closed orbits is left as an exercise (alternatively, see [83, §2] or [84, Theorem 5.1.11]).  $\square$

The quotient torus  $\mathbb{C}_N^\times = (\mathbb{C}^\times)^m / G$  acts on  $V_\Sigma = U(\Sigma)//G$  with a dense orbit.

REMARK. Observe that  $U(\Sigma)$  is itself a toric variety by Example 5.1.9. The map  $A: \mathbb{R}^m \rightarrow N_{\mathbb{R}}$ ,  $\mathbf{e}_i \mapsto \mathbf{a}_i$ , projects the fan  $\Sigma_{\mathcal{K}}$  corresponding to  $U(\Sigma)$  to the fan  $\Sigma$  corresponding to  $V_{\Sigma}$ . This projection defines a morphism of toric varieties  $U(\Sigma) \rightarrow V_{\Sigma}$ , which is exactly the quotient described above. Both fans  $\Sigma_{\mathcal{K}}$  and  $\Sigma$  have the same underlying simplicial complex  $\mathcal{K}$ .

Another way to see that the orbits of the  $G$ -action on  $U(\Sigma)$  are closed is to use the almost freeness of this action (see Exercise 5.4.14):

PROPOSITION 5.4.6.

- (a) *If  $\Sigma$  is a simplicial fan, then the  $G$ -action on  $U(\Sigma)$  is almost free (i.e., all stabiliser subgroups are finite);*
- (b) *If  $\Sigma$  is regular, then the  $G$ -action on  $U(\Sigma)$  is free.*

PROOF. The stabiliser of a point  $\mathbf{z} \in \mathbb{C}^m$  under the action of  $(\mathbb{C}^{\times})^m$  is

$$(\mathbb{C}^{\times})^{\omega(\mathbf{z})} = \{(t_1, \dots, t_m) \in (\mathbb{C}^{\times})^m : t_i = 1 \text{ if } z_i \neq 0\},$$

where  $\omega(\mathbf{z})$  be the set of zero coordinates of  $\mathbf{z}$ . The stabiliser of  $\mathbf{z}$  under the  $G$ -action is  $G_{\mathbf{z}} = (\mathbb{C}^{\times})^{\omega(\mathbf{z})} \cap G$ . Since  $G$  is the kernel of the map  $\exp A: (\mathbb{C}^{\times})^m \rightarrow \mathbb{C}_N^{\times}$  induced by the map of lattices  $A: \mathbb{Z}^m \rightarrow N$ , the subgroup  $G_{\mathbf{z}}$  is the kernel of the composite map

$$(5.8) \quad (\mathbb{C}^{\times})^{\omega(\mathbf{z})} \hookrightarrow (\mathbb{C}^{\times})^m \xrightarrow{\exp A} \mathbb{C}_N^{\times}.$$

This homomorphism of tori is induced by the map of lattices  $\mathbb{Z}^{\omega(\mathbf{z})} \rightarrow \mathbb{Z}^m \rightarrow N$ , where  $\mathbb{Z}^{\omega(\mathbf{z})} \rightarrow \mathbb{Z}^m$  is the inclusion of a coordinate sublattice.

Now let  $\Sigma$  be a simplicial fan and  $\mathbf{z} \in U(\Sigma)$ . Then  $\omega(\mathbf{z}) = g(\sigma)$  for a cone  $\sigma \in \Sigma$ . Therefore, the set of primitive generators  $\{\mathbf{a}_i : i \in \omega(\mathbf{z})\}$  is linearly independent. Hence, the map  $\mathbb{Z}^{\omega(\mathbf{z})} \rightarrow \mathbb{Z}^m \rightarrow N$  taking  $\mathbf{e}_i$  to  $\mathbf{a}_i$  is a monomorphism, which implies that the kernel of (5.8) is a finite group.

If the fan  $\Sigma$  is regular, then  $\{\mathbf{a}_i : i \in \omega(\mathbf{z})\}$  is a part of basis of  $N$ . In this case (5.8) is a monomorphism and  $G_{\mathbf{z}} = \{1\}$ .  $\square$

REMARK. The closedness of orbits is a necessary condition for the topological quotient  $U(\Sigma)/G$  to be Hausdorff (Exercise B.3.4). The proof of Theorem 5.4.5 (b) above uses Separation Lemma (Lemma 2.1.2); this is another example of situation when convex-geometric separation translates into Hausdorffness.

We may consider the following more general setup. Let  $\mathbf{a}_1, \dots, \mathbf{a}_m$  be a set of primitive vectors in  $N$ , and let  $\mathcal{K}$  be a simplicial complex on  $[m]$ . Assume further that for any  $I \in \mathcal{K}$  the set of vectors  $\{\mathbf{a}_i : i \in I\}$  is linearly independent. The latter set spans a simplicial cone, which we denote by  $\sigma_I$ . The data  $\{\mathcal{K}, \mathbf{a}_1, \dots, \mathbf{a}_m\}$  defines the coordinate subspace arrangement complement  $U(\mathcal{K}) \subset \mathbb{C}^m$  and the group  $G$  (5.3). Furthermore, the action of  $G$  on  $U(\mathcal{K})$  is almost free (and it is free if all cones  $\sigma_I$  are regular; this is proved in the same way as Proposition 5.4.6). However, the quotient  $U(\mathcal{K})/G$  is Hausdorff precisely when the cones  $\{\sigma_I : I \in \mathcal{K}\}$  form a fan  $\Sigma$  (see [6, Proposition II.3.1.6] and use the previous remark). In this case  $\mathcal{K} = \mathcal{K}_{\Sigma}$  and  $U(\mathcal{K}) = U(\Sigma)$ .

To see that the quotient  $U(\Sigma)/G$  is Hausdorff in the case when  $\Sigma$  is a simplicial fan, it is not necessary to use the algebraic criterion of separatedness as in the proof of Lemma 5.1.4. Instead, we may modify the argument for the closedness of orbits in the proof of Theorem 5.4.5 and show that action of  $G$  on  $U(\Sigma)$  is *proper* (Exercise 5.4.15), which guarantees that  $U(\Sigma)/G$  is Hausdorff (Exercise 5.4.16).

EXAMPLE 5.4.7. Let  $V_\sigma$  be the affine toric variety corresponding to an  $n$ -dimensional simplicial cone  $\sigma$ . We may write  $V_\sigma = V_\Sigma$  where  $\Sigma$  is the simplicial fan consisting of all faces of  $\sigma$ . Then  $m = n$ ,  $U(\Sigma) = \mathbb{C}^n$ , and  $A: \mathbb{Z}^n \rightarrow N$  is the monomorphism onto the full rank sublattice generated by  $\mathbf{a}_1, \dots, \mathbf{a}_n$ . Therefore,  $G$  is a finite group and  $V_\sigma = \mathbb{C}^n/G = \text{Spec } \mathbb{C}[z_1, \dots, z_n]^G$ .

In particular, if we consider the cone  $\sigma$  generated by  $2\mathbf{e}_1 - \mathbf{e}_2$  and  $\mathbf{e}_2$  in  $\mathbb{R}^2$  (see Example 5.1.6), then  $G$  is  $\mathbb{Z}_2$  embedded as  $\{(1, 1), (-1, -1)\}$  in  $(\mathbb{C}^\times)^2$ . The quotient construction realises the quadratic cone  $V_\sigma = \text{Spec } \mathbb{C}[z_1, z_2]^G = \text{Spec } \mathbb{C}[z_1^2, z_1 z_2, z_2^2]$  as a quotient of  $\mathbb{C}^2$  by  $\mathbb{Z}_2$ .

EXAMPLE 5.4.8. Consider the complete fan of Example 5.1.7. Then

$$U(\Sigma) = \mathbb{C}^3 \setminus \{z_1 = z_2 = z_3 = 0\} = \mathbb{C}^3 \setminus \{\mathbf{0}\}$$

The subgroup  $G$  defined by (5.2) is the diagonal  $\mathbb{C}^\times$  in  $(\mathbb{C}^\times)^3$ . We therefore obtain  $V_\Sigma = U(\Sigma)/G = \mathbb{C}P^2$ .

EXAMPLE 5.4.9. Consider the fan  $\Sigma$  in  $\mathbb{R}^2$  with three one-dimensional cones generated by the vectors  $\mathbf{e}_1$ ,  $\mathbf{e}_2$  and  $-\mathbf{e}_1 - \mathbf{e}_2$ . This fan is not complete, but its one-dimensional cones generate  $\mathbb{R}^2$ , so we may apply Theorem 5.4.5. The simplicial complex  $\mathcal{K}_\Sigma$  consists of 3 disjoint points. The space  $U(\Sigma) = U(\mathcal{K}_\Sigma)$  is therefore the complement to 3 coordinate lines in  $\mathbb{C}^3$ :

$$U(\Sigma) = \mathbb{C}^3 \setminus (\{z_1 = z_2 = 0\} \cup \{z_1 = z_3 = 0\} \cup \{z_2 = z_3 = 0\})$$

The group  $G$  is the diagonal  $\mathbb{C}^\times$  in  $(\mathbb{C}^\times)^3$ . Hence  $V_\Sigma = U(\Sigma)/G$  is a quasiprojective variety obtained by removing three points from  $\mathbb{C}P^2$ .

### Exercises.

5.4.10. The one-dimensional cones of a fan  $\Sigma \subset N_\mathbb{R}$  span  $N_\mathbb{R}$  if and only if the toric variety  $V_\Sigma$  does not have  $\mathbb{C}^\times$ -factors.

5.4.11. If  $\Sigma$  is a regular fan of full dimension, then  $G \cong (\mathbb{C}^\times)^{m-n}$ .

5.4.12. A  $G$ -invariant monomial has the form  $\prod_{i=1}^m z_i^{\langle \mathbf{u}, \mathbf{a}_i \rangle}$  for some  $\mathbf{u} \in N^*$ .

5.4.13. If the fan  $\Sigma$  is non-simplicial, then there exists a non-closed orbit of the  $G$ -action on  $U(\Sigma)$ .

5.4.14. Assume that the action of an algebraic group  $G$  on an algebraic variety  $X$  is almost free. Show that then all  $G$ -orbits are Zariski closed.

5.4.15. A  $G$ -action on  $X$  is called *proper* if the map  $G \times X \rightarrow X \times X$ ,  $(g, x) \mapsto (gx, x)$  is proper, i.e. the preimage of a compact subset is compact. Modify the argument in the proof of Theorem 5.4.5 (b) to show that the  $G$ -action on  $U(\Sigma)$  is proper whenever  $\Sigma$  is simplicial. (Hint: show that if sequences  $\{\mathbf{z}^{(k)}\}$  and  $\{\mathbf{g}^{(k)} \mathbf{z}^{(k)}\}$  have limits in  $U(\Sigma)$ , then a subsequence of  $\{\mathbf{g}^{(k)}\}$  has a limit in  $G$ .)

5.4.16. Show that the quotient  $X/G$  of a locally compact Hausdorff space (e.g. a manifold)  $X$  by a proper  $G$ -action is Hausdorff. Deduce that the quotient  $U(\Sigma)/G$  corresponding to a simplicial fan  $\Sigma$  is Hausdorff. This gives an alternative topological proof of Lemma 5.1.4 (separatedness of toric varieties) in the simplicial case.

5.4.17. Let  $\Sigma$  be a regular fan whose one-dimensional cones span  $N_\mathbb{R}$ . Observe that  $U(\Sigma)$  is 2-connected (see Exercise 4.7.11). Show by considering the exact homotopy sequence of the principal  $G$ -bundle  $U(\Sigma) \rightarrow V_\Sigma$  that the nonsingular

toric variety  $V_\Sigma$  is simply connected, and  $H_2(V_\Sigma; \mathbb{Z})$  is naturally identified with the kernel of the map  $A: \mathbb{Z}^m \rightarrow N$ . Hence  $H^2(V_\Sigma; \mathbb{Z}) = \mathbb{Z}^m / N^*$ , which coincides with the *Picard group* of  $V_\Sigma$ , see [122, §3.4].

### 5.5. Hamiltonian actions and symplectic reduction

Here we describe projective toric manifolds as *symplectic quotients* of Hamiltonian torus actions on  $\mathbb{C}^m$ . This approach may be viewed as a symplectic geometry version of the algebraic quotient construction from the previous section, although historically the symplectic construction preceded the algebraic one [11], [141].

**Symplectic reduction.** We briefly review the background material on symplectic geometry, referring the reader to monographs by Audin [11], Guillemin [141] and Guillemin–Ginzburg–Karshon [142] for further details.

A *symplectic manifold* is a pair  $(W, \omega)$  consisting of a smooth manifold  $W$  and a closed differential 2-form  $\omega$  which is nondegenerate at each point. The dimension of a symplectic manifold  $W$  is necessarily even.

Assume now that a (compact) torus  $T$  acts on  $W$  preserving the symplectic form  $\omega$ . We denote the Lie algebra of the torus  $T$  by  $\mathfrak{t}$  (since  $T$  is commutative, its Lie algebra is trivial, but the construction can be generalised to noncommutative Lie groups). Given an element  $\mathfrak{v} \in \mathfrak{t}$ , we denote by  $X_{\mathfrak{v}}$  the corresponding  $T$ -invariant vector field on  $W$ . The torus action is called *Hamiltonian* if the 1-form  $\omega(X_{\mathfrak{v}}, \cdot)$  is exact for any  $\mathfrak{v} \in \mathfrak{t}$ . In other words, an action is Hamiltonian if for any  $\mathfrak{v} \in \mathfrak{t}$  there exist a function  $H_{\mathfrak{v}}$  on  $W$  (called a *Hamiltonian*) satisfying the condition

$$\omega(X_{\mathfrak{v}}, Y) = dH_{\mathfrak{v}}(Y)$$

for any vector field  $Y$  on  $W$ . The function  $H_{\mathfrak{v}}$  is defined up to addition of a constant. Choose a basis  $\{e_i\}$  in  $\mathfrak{t}$  and the corresponding Hamiltonians  $\{H_{e_i}\}$ . Then the *moment map*

$$\mu: W \rightarrow \mathfrak{t}^*, \quad (x, e_i) \mapsto H_{e_i}(x)$$

(where  $x \in W$ ) is defined. Observe that changing the Hamiltonians  $H_{e_i}$  by constants results in shifting the image of  $\mu$  by a vector in  $\mathfrak{t}^*$ . According to a theorem of Atiyah [8] and Guillemin–Sternberg [143], the image  $\mu(W)$  of the moment map is convex, and if  $W$  is compact then  $\mu(W)$  is a convex polytope in  $\mathfrak{t}^*$ .

EXAMPLE 5.5.1. The most basic example is  $W = \mathbb{C}^m$  with symplectic form

$$\omega = i \sum_{k=1}^m dz_k \wedge d\bar{z}_k = 2 \sum_{k=1}^m dx_k \wedge dy_k,$$

where  $z_k = x_k + iy_k$ . The coordinatewise action of the torus  $\mathbb{T}^m$  on  $\mathbb{C}^m$  is Hamiltonian. The moment map  $\mu: \mathbb{C}^m \rightarrow \mathbb{R}^m$  is given by  $\mu(z_1, \dots, z_m) = (|z_1|^2, \dots, |z_m|^2)$  (an exercise). The image of the moment map  $\mu$  is the positive orthant  $\mathbb{R}_{\geq}^m$ .

CONSTRUCTION 5.5.2 (symplectic reduction). Assume given a Hamiltonian action of a torus  $T$  on a symplectic manifold  $W$ . Assume further that the moment map  $\mu: W \rightarrow \mathfrak{t}^*$  is *proper*, i.e.  $\mu^{-1}(V)$  is compact for any compact subset  $V \subset \mathfrak{t}^*$  (this is always the case if  $W$  itself is compact). Let  $\mathfrak{u} \in \mathfrak{t}^*$  be a *regular value* of the moment map, i.e. the differential  $\mathcal{T}_x W \rightarrow \mathfrak{t}^*$  is surjective for all  $x \in \mu^{-1}(\mathfrak{u})$ . Then the level set  $\mu^{-1}(\mathfrak{u})$  is a smooth compact  $T$ -invariant submanifold in  $W$ . Furthermore, the  $T$ -action on  $\mu^{-1}(\mathfrak{u})$  is almost free (an exercise).

Assume now that the  $T$ -action on  $\mu^{-1}(\mathbf{u})$  is free. The restriction of the symplectic form  $\omega$  to  $\mu^{-1}(\mathbf{u})$  may be degenerate. However, the quotient manifold  $\mu^{-1}(\mathbf{u})/T$  is endowed with a unique symplectic form  $\omega'$  such that

$$p^*\omega' = i^*\omega,$$

where  $i: \mu^{-1}(\mathbf{u}) \rightarrow W$  is the inclusion and  $p: \mu^{-1}(\mathbf{u}) \rightarrow \mu^{-1}(\mathbf{u})/T$  the projection.

We therefore obtain a new symplectic manifold  $(\mu^{-1}(\mathbf{u})/T, \omega')$  which is referred to as the *symplectic reduction*, or the *symplectic quotient* of  $(W, \omega)$  by  $T$ .

The construction of symplectic reduction works also under milder assumptions on the action (see [100] and more references there), but the generality described here will be enough for our purposes.

**The toric case.** The algebraic quotient construction describes a toric manifold  $V_\Sigma$  as a quotient of a noncompact set  $U(\Sigma)$  by a noncompact group  $G$ . Using symplectic reduction, the projective toric manifold  $V_P$  corresponding to a simple lattice polytope  $P$  can be obtained as the quotient of a compact submanifold  $\mathcal{Z}_P \subset U(\Sigma_P)$  by a free action of a compact torus.

Let  $\Sigma$  be a complete regular fan in  $N_{\mathbb{R}} \cong \mathbb{R}^n$  with  $m$  one-dimensional cones generated by  $\mathbf{a}_1, \dots, \mathbf{a}_m$ . Consider the exact sequence of maximal compact subgroups (tori) corresponding to exact sequence of algebraic tori (5.2):

$$(5.9) \quad 1 \longrightarrow K \longrightarrow \mathbb{T}^m \xrightarrow{\exp A} T_N \longrightarrow 1,$$

where  $T_N = N \otimes_{\mathbb{Z}} \mathbb{S} \cong \mathbb{T}^n$ ,  $\exp A: \mathbb{T}^m \rightarrow T_N$  is the map of tori corresponding to the map of lattices  $A: \mathbb{Z}^m \rightarrow N$ ,  $\mathbf{e}_i \mapsto \mathbf{a}_i$ , and  $K = \text{Ker } A$ . The group  $K$  is isomorphic to  $\mathbb{T}^{m-n}$  because  $\Sigma$  is complete and regular.

We let  $K \subset \mathbb{T}^m$  act on  $\mathbb{C}^m$  by restriction of the coordinatewise action of  $\mathbb{T}^m$ . This  $K$ -action on  $\mathbb{C}^m$  is also Hamiltonian, and the corresponding moment map is given by the composition

$$(5.10) \quad \mu_\Sigma: \mathbb{C}^m \xrightarrow{\mu} \mathbb{R}^m \longrightarrow \mathfrak{k}^*,$$

where  $\mathbb{R}^m \rightarrow \mathfrak{k}^*$  is the map of dual Lie algebras corresponding to the inclusion  $K \rightarrow \mathbb{T}^m$ . By choosing a basis in the weight lattice  $L \subset \mathfrak{k}^*$  of the  $(m-n)$ -torus  $K$  we write the linear map  $\mathbb{R}^m \rightarrow \mathfrak{k}^*$  by an integer  $(m-n) \times m$ -matrix  $\Gamma = (\gamma_{jk})$ . Moment map (5.10) is then given by

$$(z_1, \dots, z_m) \mapsto \left( \sum_{k=1}^m \gamma_{1k} |z_k|^2, \dots, \sum_{k=1}^m \gamma_{m-n,k} |z_k|^2 \right),$$

and its level set  $\mu_\Sigma^{-1}(\delta)$  corresponding to a value  $\delta = (\delta_1, \dots, \delta_{m-n}) \in \mathfrak{k}^*$  is the intersection of  $m-n$  Hermitian quadrics in  $\mathbb{C}^m$ :

$$(5.11) \quad \sum_{k=1}^m \gamma_{jk} |z_k|^2 = \delta_j \quad \text{for } j = 1, \dots, m-n.$$

To apply the symplectic reduction we need to identify the regular values of the moment map  $\mu_\Sigma$ . We recall from Section 2.1 that a polytope (1.1) is called Delzant if its normal fan is regular. If  $\Sigma = \Sigma_P$  is the normal fan of a Delzant polytope  $P$ , then the  $(m-n) \times m$ -matrix  $\Gamma$  above is the one considered in Construction 1.2.1. Namely, the rows of  $\Gamma$  form a basis of linear dependencies between the vectors  $\mathbf{a}_i$ .



Given a polytope (1.1), we denote by  $\mathcal{Z}_P$  the intersection of quadrics (5.11) corresponding to  $\delta = \Gamma \mathbf{b}_P$ , where  $\mathbf{b}_P = (b_1, \dots, b_m)^t$ :

$$(5.12) \quad \mathcal{Z}_P = \mu_\Sigma^{-1}(\Gamma \mathbf{b}_P) = \left\{ \mathbf{z} \in \mathbb{C}^m : \sum_{k=1}^m \gamma_{jk} (|z_k|^2 - b_k) = 0 \text{ for } j = 1, \dots, m-n \right\}.$$

PROPOSITION 5.5.3. *Assume that  $\Sigma = \Sigma_P$  is the normal fan of a Delzant polytope  $P$  given by (1.1). Then  $\delta = \Gamma \mathbf{b}_P$  is a regular value of the moment map  $\mu_\Sigma$ .*

PROOF. We only sketch the proof here; a more general statement will be proved as Theorem 6.3.1 in the next chapter. We need to check that this intersection is nondegenerate at each point  $\mathbf{z} \in \mathcal{Z}_P$ , i.e. that  $\mathcal{Z}_P$  is a smooth submanifold in  $\mathbb{C}^m$ . This means that the  $m - n$  gradient vectors of the left hand sides of quadratic equations (5.11) are linearly independent at each  $\mathbf{z} \in \mathcal{Z}_P$ . This can be shown to be equivalent to that the polytope  $P$  defined by (1.1) is simple.  $\square$

As we shall see in Section 6.2, the manifold  $\mathcal{Z}_P$  is  $\mathbb{T}^m$ -equivariantly homeomorphic to the moment-angle manifold  $\mathcal{Z}_{\mathcal{K}_P}$  (where  $\mathcal{K}_P$  is the nerve complex of  $P$ , or the underlying simplicial complex of the normal fan  $\Sigma_P$ ). Furthermore, we have  $\mathcal{Z}_P \subset U(\Sigma_P)$ . (The reader may either wait until Chapter 6, or view these two statements as exercises.)

We therefore may consider the symplectic quotient of  $\mathbb{C}^m$  by  $K \cong \mathbb{T}^{m-n}$ , the  $2n$ -dimensional symplectic manifold  $\mu_\Sigma^{-1}(\Gamma \mathbf{b}_P)/K = \mathcal{Z}_P/K$ .

THEOREM 5.5.4. *Let  $P$  be a lattice Delzant polytope with the normal fan  $\Sigma_P$ , and let  $V_P$  be the corresponding projective toric manifold. The inclusion  $\mathcal{Z}_P \subset U(\Sigma_P)$  induces a diffeomorphism*

$$\mathcal{Z}_P/K \xrightarrow{\cong} U(\Sigma_P)/G = V_P.$$

Therefore, any projective toric manifold  $V_P$  is obtained as the symplectic quotient of  $\mathbb{C}^m$  by an action of a torus  $K \cong \mathbb{T}^{m-n}$ .

PROOF. We sketch the proof given in [11, Prop. VI.3.1.1]; a different proof of a more general statement will be given in Section 6.6.

Consider the function

$$f: \mathbb{C}^m \rightarrow \mathbb{R}, \quad f(\mathbf{z}) = \|\mu_\Sigma(\mathbf{z}) - \Gamma \mathbf{b}_P\|^2.$$

It is nonnegative and minimal on the set  $\mathcal{Z}_P = \mu_\Sigma^{-1}(\Gamma \mathbf{b}_P)$ . The only critical points of  $f$  in  $U(\Sigma_P)$  are  $\mathbf{z} \in \mathcal{Z}_P$ . Hence, for any  $\mathbf{z} \in U(\Sigma_P)$ , the gradient trajectory descending from  $\mathbf{z}$  will reach a point in  $\mathcal{Z}_P$ . Furthermore, any gradient trajectory is contained in a  $G$ -orbit. We therefore obtain that each  $G$ -orbit of  $U(\Sigma_P)$  intersects  $\mathcal{Z}_P$ . Finally, it can be shown that each  $G$ -orbit intersects  $\mathcal{Z}_P$  at a unique  $K$ -orbit, i.e. for each  $\mathbf{z} \in \mathcal{Z}_P$  we have that

$$G \cdot \mathbf{z} \cap \mathcal{Z}_P = K \cdot \mathbf{z}.$$

The statement follows.  $\square$

The toric manifold  $V_P$  therefore acquires a symplectic structure as the symplectic quotient  $\mu_\Sigma^{-1}(\Gamma \mathbf{b}_P)/K$ . On the other hand, the projective embedding of  $V_P$  defined by the lattice polytope  $P$  provides a symplectic form on  $V_P$  by restriction of the standard symplectic form on the complex projective space. It can be shown [141, Appendix 2] that the diffeomorphism from Theorem 5.5.4 preserves

the cohomology class of the symplectic form, or equivalently, the two symplectic structures on  $V_P$  are  $T_N$ -equivariantly symplectomorphic.

The symplectic quotient  $\mu_{\Sigma}^{-1}(\Gamma \mathbf{b}_P)/K$  has a residual action of the quotient  $n$ -torus  $T_N = \mathbb{T}^m/K$ , which is obviously Hamiltonian. This action is identified, via Theorem 5.5.4, with the action of the maximal compact subgroup  $T_N \subset \mathbb{C}_N^{\times}$  on the toric variety  $V_P$ . We denote by  $\mu_V: V_P \rightarrow \mathfrak{t}_N^*$  the moment map for the Hamiltonian action of  $T_N$  on  $V_P$ , where  $\mathfrak{t}_N \cong \mathbb{R}^n$  is the Lie algebra of  $T_N$ . It follows from (5.9) that  $\mathfrak{t}_N^*$  embeds in  $\mathbb{R}^m$  by the map  $A^*$ .

**PROPOSITION 5.5.5.** *The image of the moment map  $\mu_V: V_P \rightarrow \mathfrak{t}_N^*$  is the polytope  $P$ , up to translation.*

**PROOF.** Let  $\omega$  be the standard symplectic form on  $\mathbb{C}^m$  and  $\mu: \mathbb{C}^m \rightarrow \mathbb{R}^m$  the moment map for the standard action of  $\mathbb{T}^m$  (see Example 5.5.1). Let  $p: \mathcal{Z}_P \rightarrow V_P$  be the quotient projection by the action of  $K$ , and let  $i: \mathcal{Z}_P \rightarrow \mathbb{C}^m$  be the inclusion, so that the symplectic form  $\omega'$  on  $V_P$  satisfies  $p^*\omega' = i^*\omega$ . Let  $H_{\mathbf{e}_i}: \mathbb{C}^m \rightarrow \mathbb{R}$  be the Hamiltonian of the  $\mathbb{T}^m$ -action on  $\mathbb{C}^m$  corresponding to the  $i$ th basis vector  $\mathbf{e}_i$  (explicitly,  $H_{\mathbf{e}_i}(\mathbf{z}) = |z_i|^2$ ), and let  $H_{\mathbf{a}_i}: V_P \rightarrow \mathbb{R}$  be the Hamiltonian of the  $T_N$ -action on  $V_P$  corresponding to  $\mathbf{a}_i \in \mathfrak{t}_N$ . Denote by  $X_{\mathbf{e}_i}$  the vector field on  $\mathcal{Z}_P$  generated by  $\mathbf{e}_i$ , and denote by  $Y_{\mathbf{a}_i}$  the vector field on  $V_P$  generated by  $\mathbf{a}_i$ . Observe that  $p_*X_{\mathbf{e}_i} = Y_{\mathbf{a}_i}$ . For any vector field  $Z$  on  $\mathcal{Z}_P$  we have

$$\begin{aligned} dH_{\mathbf{e}_i}(Z) &= i^*\omega(X_{\mathbf{e}_i}, Z) = p^*\omega'(X_{\mathbf{e}_i}, Z) \\ &= \omega'(Y_{\mathbf{a}_i}, p_*Z) = dH_{\mathbf{a}_i}(p_*Z) = d(p^*H_{\mathbf{a}_i})(Z), \end{aligned}$$

hence  $H_{\mathbf{e}_i} = p^*H_{\mathbf{a}_i}$  or  $H_{\mathbf{e}_i}(\mathbf{z}) = H_{\mathbf{a}_i}(p(\mathbf{z}))$  up to constant. By definition of the moment map this implies that  $\mu_V(V_P) \subset \mathfrak{t}_N^* \subset \mathbb{R}^m$  is identified with  $\mu(\mathcal{Z}_P) \subset \mathbb{R}^m$  up to shift by a vector in  $\mathbb{R}^m$ . The inclusion  $\mathfrak{t}_N^* \subset \mathbb{R}^m$  is the map  $A^*$ , and  $\mu(\mathcal{Z}_P) = i_{A, \mathbf{b}}(P) = A^*(P) + \mathbf{b}$  by definition of  $\mathcal{Z}_P$ , see (1.7) and (5.12). We therefore obtain that there exists  $\mathbf{c} \in \mathbb{R}^m$  such that

$$A^*(\mu_V(V_P)) + \mathbf{c} = A^*(P) + \mathbf{b},$$

i.e.  $A^*(\mu_V(V_P))$  and  $A^*(P)$  differ by  $\mathbf{b} - \mathbf{c} \in A^*(\mathfrak{t}_N^*)$ . Since  $A^*$  is monomorphic, the result follows.  $\square$

The symplectic quotient  $V_P = \mu_{\Sigma}^{-1}(\Gamma \mathbf{b}_P)/K$  with the Hamiltonian action of the  $n$ -torus  $\mathbb{T}^m/K$  is called the *Hamiltonian toric manifold* corresponding to a Delzant polytope  $P$ .

According to the theorem of Delzant [93], any  $2n$ -dimensional compact connected symplectic manifold  $W$  with an effective Hamiltonian action of an  $n$ -torus  $T$  is equivariantly symplectomorphic to a Hamiltonian toric manifold  $V_P$ , where  $P$  is the image of the moment map  $\mu: W \rightarrow \mathfrak{t}^*$  (whence the name ‘Delzant polytope’).

**REMARK.** There is a canonical lattice in the dual Lie algebra  $\mathfrak{t}^*$  (the weight lattice of the torus  $T$ ), and the moment polytope  $P = \mu(W) \subset \mathfrak{t}^*$  satisfies the Delzant condition with respect to this lattice.

**EXAMPLE 5.5.6.** Let  $P = \Delta^n$  be the standard simplex (see Example 1.2.2). The cones of the normal fan  $\Sigma_P$  are spanned by the proper subsets of the set of  $n + 1$  vectors  $\{\mathbf{e}_1, \dots, \mathbf{e}_n, -\mathbf{e}_1 - \dots - \mathbf{e}_n\}$ . The groups  $G \cong \mathbb{C}^{\times}$  and  $K \cong \mathbb{S}^1$  are the diagonal subgroups in  $(\mathbb{C}^{\times})^{n+1}$  and  $\mathbb{T}^{n+1}$  respectively, and  $U(\Sigma_P) = \mathbb{C}^{n+1} \setminus \{0\}$ . The matrix  $\Gamma$  is a row of  $n + 1$  units. The moment map (5.10) is given by

$\mu_{\Sigma}(z_1, \dots, z_{n+1}) = |z_1|^2 + \dots + |z_{n+1}|^2$ . Since  $\Gamma b_P = 1$ , the manifold  $\mathcal{Z}_P = \mu_P^{-1}(1)$  is the unit sphere  $\mathbb{S}^{2n+1} \subset \mathbb{C}^{n+1}$ , and  $\mathbb{S}^{2n+1}/K \cong (\mathbb{C}^{n+1} \setminus \{0\})/G = V_P$  is the complex projective space  $\mathbb{C}P^n$ .

**Exercises.**

5.5.7. The moment map  $\mu: \mathbb{C}^m \rightarrow \mathbb{R}^m$  for the coordinatewise action of  $\mathbb{T}^m$  on  $\mathbb{C}^m$  is given by  $\mu(z_1, \dots, z_m) = (|z_1|^2, \dots, |z_m|^2)$ .

5.5.8. The  $T$ -action on  $\mu^{-1}(\mathbf{u})$  is almost free.

5.5.9. The level set  $\mathcal{Z}_P = \mu_{\Sigma}^{-1}(\Gamma b_P)$  is  $\mathbb{T}^m$ -equivariantly homeomorphic to the moment-angle manifold  $\mathcal{Z}_{\mathcal{K}_P}$ .

5.5.10. Show that  $\mathcal{Z}_P \subset U(\Sigma_P)$ .



## Geometric structures on moment-angle manifolds

In this chapter we study the geometry of moment-angle manifolds, in its convex, complex-analytic, symplectic and Lagrangian aspects.

As we have seen in Theorem 4.1.4, the moment-angle complex  $\mathcal{Z}_{\mathcal{K}}$  corresponding to a triangulated sphere  $\mathcal{K}$  is a topological manifold. Moment-angle manifolds corresponding to simplicial polytopes or, more generally, complete simplicial fans, are smooth. In the polytopal case a smooth structure arises from the realisation of  $\mathcal{Z}_{\mathcal{K}}$  by a nonsingular (transverse) intersection of Hermitian quadrics in  $\mathbb{C}^m$ , similar to a level set of the moment map in the construction of symplectic quotients (see Section 5.5). The relationship between polytopes and systems of quadrics is described in terms of Gale duality (see Sections 6.1 and 6.2).

Another way to give  $\mathcal{Z}_{\mathcal{K}}$  a smooth structure is to realise it as the quotient of an open subset in  $\mathbb{C}^m$  (the complement  $U(\mathcal{K})$  of the coordinate subspace arrangement defined by  $\mathcal{K}$ ) by an action of the multiplicative group  $\mathbb{R}_{>}^{m-n}$ . As in the case of the quotient construction of toric varieties (Section 5.4), the quotient of a non-compact manifold  $U(\mathcal{K})$  by the action of a non-compact group  $\mathbb{R}_{>}^{m-n}$  is Hausdorff precisely when  $\mathcal{K}$  is the underlying complex of a simplicial fan.

If  $m - n = 2\ell$  is even, then the action of the real group  $\mathbb{R}_{>}^{m-n}$  on  $U(\mathcal{K})$  can be turned into a holomorphic action of a complex (but not algebraic) group isomorphic to  $\mathbb{C}^{\ell}$ . In this way the moment-angle manifold  $\mathcal{Z}_{\mathcal{K}} \cong U(\mathcal{K})/\mathbb{C}^{\ell}$  acquires a complex-analytic structure. The resulting family of non-Kähler complex manifolds generalises the well-known series as of Hopf and Calabi–Eckmann manifolds [70], as well as LVM-manifolds (a class of complex structures on nonsingular intersections of Hermitian quadrics arising in holomorphic dynamics as transverse sets to certain complex foliations [198], [223]).

The intersections of Hermitian quadrics defining polytopal moment-angle manifolds can be also used to construct new families of Lagrangian submanifolds in  $\mathbb{C}^m$ ,  $\mathbb{C}P^m$  and toric varieties.

Particularly interesting examples of geometric structures (nonsingular intersections of quadrics, polytopal moment-angle manifolds, non-Kähler LVM-manifolds, Hamiltonian-minimal Lagrangian submanifolds) arise from Delzant polytopes. These polytopes are abundant in toric topology (see Section 5.2).

### 6.1. Intersections of quadrics

Here we describe the correspondence between convex polyhedra and intersections of quadrics. It will be used in the next section to define a smooth structure on moment-angle manifolds coming from polytopes.

**From polyhedra to quadrics.** The following construction originally appeared in [55, Construction 3.1.8] (see also [58, §3]):

CONSTRUCTION 6.1.1. Consider a presentation of a convex polyhedron

$$(6.1) \quad P = P(A, \mathbf{b}) = \{ \mathbf{x} \in \mathbb{R}^n : \langle \mathbf{a}_i, \mathbf{x} \rangle + b_i \geq 0 \text{ for } i = 1, \dots, m \}.$$

Assume that  $\mathbf{a}_1, \dots, \mathbf{a}_m$  span  $\mathbb{R}^n$  (i.e.,  $P$  has a vertex) and recall the map

$$i_{A, \mathbf{b}}: \mathbb{R}^n \rightarrow \mathbb{R}^m, \quad i_{A, \mathbf{b}}(\mathbf{x}) = A^* \mathbf{x} + \mathbf{b} = (\langle \mathbf{a}_1, \mathbf{x} \rangle + b_1, \dots, \langle \mathbf{a}_m, \mathbf{x} \rangle + b_m)^t$$

(see Construction 1.2.1). It embeds  $P$  into  $\mathbb{R}_{\geq}^m$ . We define the space  $\mathcal{Z}_{A, \mathbf{b}}$  from the commutative diagram

$$(6.2) \quad \begin{array}{ccc} \mathcal{Z}_{A, \mathbf{b}} & \xrightarrow{i_{\mathcal{Z}}} & \mathbb{C}^m \\ \downarrow & & \downarrow \mu \\ P & \xrightarrow{i_{A, \mathbf{b}}} & \mathbb{R}_{\geq}^m \end{array}$$

where  $\mu(z_1, \dots, z_m) = (|z_1|^2, \dots, |z_m|^2)$ . The torus  $\mathbb{T}^m$  acts on  $\mathcal{Z}_{A, \mathbf{b}}$  with quotient  $P$ , and  $i_{\mathcal{Z}}$  is a  $\mathbb{T}^m$ -equivariant embedding.

By replacing  $y_k$  by  $|z_k|^2$  in the equations defining the affine plane  $i_{A, \mathbf{b}}(\mathbb{R}^n)$  (see (1.7)) we obtain that  $\mathcal{Z}_{A, \mathbf{b}}$  embeds into  $\mathbb{C}^m$  as the set of common zeros of  $m - n$  quadratic equations (*Hermitian quadrics*):

$$(6.3) \quad i_{\mathcal{Z}}(\mathcal{Z}_{A, \mathbf{b}}) = \left\{ \mathbf{z} \in \mathbb{C}^m : \sum_{k=1}^m \gamma_{jk} |z_k|^2 = \sum_{k=1}^m \gamma_{jk} b_k, \text{ for } 1 \leq j \leq m - n \right\}.$$

The following property of the space  $\mathcal{Z}_{A, \mathbf{b}}$  follows easily from its construction.

PROPOSITION 6.1.2. *Given a point  $z \in \mathcal{Z}_{A, \mathbf{b}}$ , the  $j$ th coordinate of  $i_{\mathcal{Z}}(z) \in \mathbb{C}^m$  vanishes if and only if  $z$  projects onto a point  $\mathbf{x} \in P$  such that  $\mathbf{x} \in F_j$ .*

THEOREM 6.1.3. *The following conditions are equivalent:*

- (a) *presentation (6.1) determined by the data  $(A, \mathbf{b})$  is generic;*
- (b) *the intersection of quadrics in (6.3) is nonempty and nonsingular, so that  $\mathcal{Z}_{A, \mathbf{b}}$  is a smooth manifold of dimension  $m + n$ .*

Furthermore, under these conditions the embedding  $i_{\mathcal{Z}}: \mathcal{Z}_{A, \mathbf{b}} \rightarrow \mathbb{C}^m$  has  $\mathbb{T}^m$ -equivariantly framed normal bundle; a trivialisation is defined by a choice of matrix  $\Gamma = (\gamma_{jk})$  in (1.7).

PROOF. For simplicity we identify the space  $\mathcal{Z}_{A, \mathbf{b}}$  with its embedded image  $i_{\mathcal{Z}}(\mathcal{Z}_{A, \mathbf{b}}) \subset \mathbb{C}^m$ . We calculate the gradients of the  $m - n$  quadrics in (6.3) at a point  $\mathbf{z} = (x_1, y_1, \dots, x_m, y_m) \in \mathcal{Z}_{A, \mathbf{b}}$ , where  $z_k = x_k + iy_k$ :

$$(6.4) \quad 2(\gamma_{j1}x_1, \gamma_{j1}y_1, \dots, \gamma_{jm}x_m, \gamma_{jm}y_m), \quad 1 \leq j \leq m - n.$$

These gradients form the rows of the  $(m - n) \times 2m$  matrix  $2\Gamma\Delta$ , where

$$\Delta = \begin{pmatrix} x_1 & y_1 & \dots & 0 & 0 \\ \vdots & \vdots & \ddots & \vdots & \vdots \\ 0 & 0 & \dots & x_m & y_m \end{pmatrix}.$$

Let  $I = \{i_1, \dots, i_k\} = \{i: z_i = 0\}$  be the set of zero coordinates of  $\mathbf{z}$ . Then the rank of the gradient matrix  $2\Gamma\Delta$  at  $\mathbf{z}$  is equal to the rank of the  $(m - n) \times (m - k)$  matrix  $F_{\hat{I}}$  obtained by deleting the columns  $i_1, \dots, i_k$  from  $\Gamma$ .

Now let (6.1) be a generic presentation. By Proposition 6.1.2, a point  $\mathbf{z}$  with  $z_{i_1} = \dots = z_{i_k} = 0$  projects to a point in  $F_{i_1} \cap \dots \cap F_{i_k} \neq \emptyset$ . Hence the vectors

$\mathbf{a}_{i_1}, \dots, \mathbf{a}_{i_k}$  are linearly independent. By Theorem 1.2.4, the rank of  $I_{\hat{\Gamma}}$  is  $m - n$ . Therefore, the intersection of quadrics (6.3) is nonsingular.

On the other hand, if (6.1) is not generic, then there is a point  $\mathbf{z} \in \mathcal{Z}_{A, \mathbf{b}}$  such that the vectors  $\{\mathbf{a}_{i_1}, \dots, \mathbf{a}_{i_k} : z_{i_1} = \dots = z_{i_k} = 0\}$  are linearly dependent. By Theorem 1.2.4, the columns of the corresponding matrix  $I_{\hat{\Gamma}}$  do not span  $\mathbb{R}^{m-n}$ , so its rank is less than  $m - n$  and the intersection of quadrics (6.3) is degenerate at  $\mathbf{z}$ .

The last statement follows from the fact that  $\mathcal{Z}_{A, \mathbf{b}}$  is a nonsingular intersection of quadratic surfaces, each of which is  $\mathbb{T}^m$ -invariant.  $\square$

**From quadrics to polyhedra.** This time we start with an intersection of  $m - n$  Hermitian quadrics in  $\mathbb{C}^m$ :

$$(6.5) \quad \mathcal{Z}_{\Gamma, \delta} = \left\{ \mathbf{z} = (z_1, \dots, z_m) \in \mathbb{C}^m : \sum_{k=1}^m \gamma_{jk} |z_k|^2 = \delta_j, \quad \text{for } 1 \leq j \leq m - n \right\}.$$

The coefficients of quadrics form an  $(m - n) \times m$ -matrix  $\Gamma = (\gamma_{jk})$ , and we denote its column vectors by  $\gamma_1, \dots, \gamma_m$ . We also consider the column vector of the right hand sides,  $\delta = (\delta_1, \dots, \delta_{m-n})^t \in \mathbb{R}^{m-n}$ .

These intersections of quadrics are considered up to *linear equivalence*, which corresponds to applying a nondegenerate linear transformation of  $\mathbb{R}^{m-n}$  to  $\Gamma$  and  $\delta$ . Obviously, such a linear equivalence does not change the set  $\mathcal{Z}_{\Gamma, \delta}$ .

We denote by  $\mathbb{R}_{\geq} \langle \gamma_1, \dots, \gamma_m \rangle$  the cone generated by the vectors  $\gamma_1, \dots, \gamma_m$  (i.e., the set of linear combinations of these vectors with nonnegative coefficients).

A version of the following proposition appeared in [197], and the proof below is a modification of the argument in [36, Lemma 0.3]. It allows us to determine the nondegeneracy of an intersection of quadrics directly from the data  $(\Gamma, \delta)$ :

**PROPOSITION 6.1.4.** *The intersection of quadrics  $\mathcal{Z}_{\Gamma, \delta}$  given by (6.5) is nonempty and nonsingular if and only if the following two conditions are satisfied:*

- (a)  $\delta \in \mathbb{R}_{\geq} \langle \gamma_1, \dots, \gamma_m \rangle$ ;
- (b) if  $\delta \in \mathbb{R}_{\geq} \langle \gamma_{i_1}, \dots, \gamma_{i_k} \rangle$ , then  $k \geq m - n$ .

*Under these conditions,  $\mathcal{Z}_{\Gamma, \delta}$  is a smooth submanifold in  $\mathbb{C}^m$  of dimension  $m + n$ , and the vectors  $\gamma_1, \dots, \gamma_m$  span  $\mathbb{R}^{m-n}$ .*

**PROOF.** First assume that (a) and (b) are satisfied. Then (a) implies that  $\mathcal{Z}_{\Gamma, \delta} \neq \emptyset$ . Let  $\mathbf{z} \in \mathcal{Z}_{\Gamma, \delta}$ . Then the rank of the matrix of gradients of (6.5) at  $\mathbf{z}$  is equal to  $\text{rk}\{\gamma_k : z_k \neq 0\}$ . Since  $\mathbf{z} \in \mathcal{Z}_{\Gamma, \delta}$ , the vector  $\delta$  is in the cone generated by those  $\gamma_k$  for which  $z_k \neq 0$ . By the Carathéodory Theorem (see [325, §1.6]),  $\delta$  belongs to the cone generated by some  $m - n$  of these vectors, that is,  $\delta \in \mathbb{R}_{\geq} \langle \gamma_{k_1}, \dots, \gamma_{k_{m-n}} \rangle$ , where  $z_{k_i} \neq 0$  for  $i = 1, \dots, m - n$ . Moreover, the vectors  $\gamma_{k_1}, \dots, \gamma_{k_{m-n}}$  are linearly independent (otherwise, again by the Carathéodory Theorem, we obtain a contradiction with (b)). This implies that the  $m - n$  gradients of quadrics in (6.5) are linearly independent at  $\mathbf{z}$ , and therefore  $\mathcal{Z}_{\Gamma, \delta}$  is smooth and  $(m + n)$ -dimensional.

To prove the other implication we observe that if (b) fails, that is,  $\delta$  is in the cone generated by some  $m - n - 1$  vectors of  $\gamma_1, \dots, \gamma_m$ , then there is a point  $\mathbf{z} \in \mathcal{Z}_{\Gamma, \delta}$  with at least  $n + 1$  zero coordinates. The gradients of quadrics in (6.5) cannot be linearly independent at such  $\mathbf{z}$ .  $\square$

The torus  $\mathbb{T}^m$  acts on  $\mathcal{Z}_{\Gamma, \delta}$ , and the quotient  $\mathcal{Z}_{\Gamma, \delta}/\mathbb{T}^m$  is identified with the set of nonnegative solutions of the system of  $m - n$  linear equations

$$(6.6) \quad \sum_{k=1}^m \gamma_k y_k = \delta.$$

This set can be described as a convex polyhedron  $P(A, \mathbf{b})$  given by (6.1), where  $(b_1, \dots, b_m)$  is any solution of (6.6) and the vectors  $\mathbf{a}_1, \dots, \mathbf{a}_m \in \mathbb{R}^n$  form the transpose of a basis of solutions of the homogeneous system  $\sum_{k=1}^m \gamma_k y_k = \mathbf{0}$ . We refer to  $P(A, \mathbf{b})$  as the *associated polyhedron* of the intersection of quadrics  $\mathcal{Z}_{\Gamma, \delta}$ . If the vectors  $\gamma_1, \dots, \gamma_m$  span  $\mathbb{R}^{m-n}$ , then  $\mathbf{a}_1, \dots, \mathbf{a}_m$  span  $\mathbb{R}^n$ . In this case the two vector configurations are Gale dual.

We summarise the results and constructions of this section as follows:

**THEOREM 6.1.5.** *A presentation of a polyhedron*

$$P = P(A, \mathbf{b}) = \{ \mathbf{x} \in \mathbb{R}^n : \langle \mathbf{a}_i, \mathbf{x} \rangle + b_i \geq 0 \text{ for } i = 1, \dots, m \}$$

(with  $\mathbf{a}_1, \dots, \mathbf{a}_m$  spanning  $\mathbb{R}^n$ ) defines an intersection of Hermitian quadrics

$$\mathcal{Z}_{\Gamma, \delta} = \left\{ \mathbf{z} = (z_1, \dots, z_m) \in \mathbb{C}^m : \sum_{k=1}^m \gamma_{jk} |z_k|^2 = \delta_j \text{ for } j = 1, \dots, m - n \right\}.$$

(with  $\gamma_1, \dots, \gamma_m$  spanning  $\mathbb{R}^{m-n}$ ) uniquely up to a linear isomorphism of  $\mathbb{R}^{m-n}$ , and an intersection of quadrics  $\mathcal{Z}_{\Gamma, \delta}$  defines a presentation  $P(A, \mathbf{b})$  uniquely up to an isomorphism of  $\mathbb{R}^n$ .

The systems of vectors  $\mathbf{a}_1, \dots, \mathbf{a}_m \in \mathbb{R}^n$  and  $\gamma_1, \dots, \gamma_m \in \mathbb{R}^{m-n}$  are Gale dual, and the vectors  $\mathbf{b} \in \mathbb{R}^m$  and  $\delta \in \mathbb{R}^{m-n}$  are related by the identity  $\delta = \Gamma \mathbf{b}$ .

The intersection of quadrics  $\mathcal{Z}_{\Gamma, \delta}$  is nonempty and nonsingular if and only if the presentation  $P(A, \mathbf{b})$  is generic.

**EXAMPLE 6.1.6** ( $m = n + 1$ : one quadric). If presentation (6.1) is generic and  $P$  is bounded, then  $m \geq n + 1$ . The case  $m = n + 1$  corresponds to a simplex. If  $P = P(A, \mathbf{b})$  is the standard simplex (see Example 1.2.2) we obtain

$$\mathcal{Z}_{A, \mathbf{b}} = \mathbb{S}^{2n+1} = \{ \mathbf{z} \in \mathbb{C}^{n+1} : |z_1|^2 + \dots + |z_{n+1}|^2 = 1 \}.$$

More generally, a presentation (6.1) with  $m = n + 1$  and  $\mathbf{a}_1, \dots, \mathbf{a}_n$  spanning  $\mathbb{R}^n$  can be taken by an isomorphism of  $\mathbb{R}^n$  to the form

$$P = \{ \mathbf{x} \in \mathbb{R}^n : x_i + b_i \geq 0 \text{ for } i = 1, \dots, n, \text{ and } -c_1 x_1 - \dots - c_n x_n + b_{n+1} \geq 0 \}.$$

We therefore have  $\Gamma = (c_1 \cdots c_n \ 1)$ , and  $\mathcal{Z}_{A, \mathbf{b}}$  is given by the single equation

$$c_1 |z_1|^2 + \dots + c_n |z_n|^2 + |z_{n+1}|^2 = c_1 b_1 + \dots + c_n b_n + b_{n+1}.$$

If the presentation is generic and bounded, then  $\mathcal{Z}_{A, \mathbf{b}}$  is nonempty, nonsingular and bounded by Theorem 6.1.3. This implies that all  $c_i$  and the right hand side above are positive, and  $\mathcal{Z}_{A, \mathbf{b}}$  is an ellipsoid.

## 6.2. Moment-angle manifolds from polytopes

In this section we identify the polytopal moment-angle manifold  $\mathcal{Z}_{\mathcal{K}_P}$  (the moment-angle complex corresponding to the nerve complex  $\mathcal{K}_P$  of a simple polytope  $P$ ) with the intersections of quadrics  $\mathcal{Z}_{A, \mathbf{b}}$  (6.3).

A  $\mathbb{T}^m$ -equivariant homeomorphism  $\mathcal{Z}_{\mathcal{K}_P} \cong \mathcal{Z}_{A, \mathbf{b}}$  will be established using the following construction of an identification space, which goes back to the work of



Vinberg [313] on Coxeter groups and was presented in the form described below in the work of Davis and Januszkiewicz [90]. This was the first construction of what later became known as the moment-angle manifold.

CONSTRUCTION 6.2.1. Let  $[m] = \{1, \dots, m\}$  be the standard  $m$ -element set. For each  $I \subset [m]$  we consider the coordinate subtorus

$$\mathbb{T}^I = \{(t_1, \dots, t_m) \in \mathbb{T}^m : t_j = 1 \text{ for } j \notin I\} \subset \mathbb{T}^m.$$

In particular,  $\mathbb{T}^\emptyset$  is the trivial subgroup  $\{1\} \subset \mathbb{T}^m$ .

Define the map  $\mathbb{R}_{\geq} \times \mathbb{T} \rightarrow \mathbb{C}$  by  $(y, t) \mapsto yt$ . Taking product we obtain a map  $\mathbb{R}_{\geq}^m \times \mathbb{T}^m \rightarrow \mathbb{C}^m$ . The preimage of a point  $\mathbf{z} \in \mathbb{C}^m$  under this map is  $\mathbf{y} \times \mathbb{T}^{\omega(\mathbf{z})}$ , where  $y_i = |z_i|$  for  $1 \leq i \leq m$  and  $\omega(\mathbf{z}) = \{i : z_i = 0\} \subset [m]$  is the set of zero coordinates of  $\mathbf{z}$ . Therefore,  $\mathbb{C}^m$  can be identified with the quotient space

$$(6.7) \quad \mathbb{R}_{\geq}^m \times \mathbb{T}^m / \sim \quad \text{where } (\mathbf{y}, \mathbf{t}_1) \sim (\mathbf{y}, \mathbf{t}_2) \text{ if } \mathbf{t}_1^{-1} \mathbf{t}_2 \in \mathbb{T}^{\omega(\mathbf{y})}.$$

Given  $\mathbf{x} \in P$ , set  $I_{\mathbf{x}} = \{i \in [m] : \mathbf{x} \in F_i\}$  (the set of facets containing  $\mathbf{x}$ ).

PROPOSITION 6.2.2. *The space  $\mathcal{Z}_{A, \mathbf{b}}$  given by intersection of quadrics (6.3) corresponding to a presentation  $P = P(A, \mathbf{b})$  is  $\mathbb{T}^m$ -equivariantly homeomorphic to the quotient*

$$P \times \mathbb{T}^m / \sim \quad \text{where } (\mathbf{x}, \mathbf{t}_1) \sim (\mathbf{x}, \mathbf{t}_2) \text{ if } \mathbf{t}_1^{-1} \mathbf{t}_2 \in \mathbb{T}^{I_{\mathbf{x}}}.$$

PROOF. Using (6.2), we identify the space  $\mathcal{Z}_{A, \mathbf{b}}$  with  $i_{A, \mathbf{b}}(P) \times \mathbb{T}^m / \sim$ , where  $\sim$  is the equivalence relation from (6.7). A point  $\mathbf{x} \in P$  is mapped by  $i_{A, \mathbf{b}}$  to  $\mathbf{y} \in \mathbb{R}_{\geq}^m$  with  $I_{\mathbf{x}} = \omega(\mathbf{y})$ .  $\square$

An important corollary of this construction is that the topological type of the intersection of quadrics  $\mathcal{Z}_{A, \mathbf{b}}$  depends only on the combinatorics of  $P$ :

PROPOSITION 6.2.3. *Assume given two generic presentations:*

$$P = \{\mathbf{x} \in \mathbb{R}^n : (A^* \mathbf{x} + \mathbf{b})_i \geq 0\} \quad \text{and} \quad P' = \{\mathbf{x} \in \mathbb{R}^n : (A'^* \mathbf{x} + \mathbf{b}')_i \geq 0\}$$

*such that  $P$  and  $P'$  are combinatorially equivalent simple polytopes.*

- (a) *If both presentations are irredundant, then the corresponding manifolds  $\mathcal{Z}_{A, \mathbf{b}}$  and  $\mathcal{Z}_{A', \mathbf{b}'}$  are  $\mathbb{T}^m$ -equivariantly homeomorphic.*
- (b) *If the second presentation is obtained from the first one by adding  $k$  redundant inequalities, then  $\mathcal{Z}_{A', \mathbf{b}'}$  is homeomorphic to a product of  $\mathcal{Z}_{A, \mathbf{b}}$  and a  $k$ -torus  $T^k$ .*

PROOF. (a) By Proposition 6.2.2, we have  $\mathcal{Z}_{A, \mathbf{b}} \cong P \times \mathbb{T}^m / \sim$  and  $\mathcal{Z}_{A', \mathbf{b}'} \cong P' \times \mathbb{T}^m / \sim$ . If both presentations are irredundant, then any  $F_i$  is a facet of  $P$ , and the equivalence relation  $\sim$  depends on the face structure of  $P$  only. Therefore, any homeomorphism  $P \rightarrow P'$  preserving the face structure extends to a  $\mathbb{T}^m$ -homeomorphism  $P \times \mathbb{T}^m / \sim \rightarrow P' \times \mathbb{T}^m / \sim$ .

(b) Suppose the first presentation has  $m$  inequalities, and the second has  $m'$  inequalities, so that  $m' - m = k$ . Let  $J \subset [m']$  be the subset corresponding to the added redundant inequalities; we may assume that  $J = \{m+1, \dots, m'\}$ . Since  $F_j = \emptyset$  for any  $j \in J$ , we have  $I_{\mathbf{x}} \cap J = \emptyset$  for any  $\mathbf{x} \in P'$ . Therefore, the equivalence relation  $\sim$  does not affect the factor  $\mathbb{T}^J \subset \mathbb{T}^{m'}$ , and we have

$$\mathcal{Z}_{A', \mathbf{b}'} \cong P' \times \mathbb{T}^{m'} / \sim \cong (P \times \mathbb{T}^m / \sim) \times \mathbb{T}^J \cong \mathcal{Z}_{A, \mathbf{b}} \times T^k. \quad \square$$

REMARK. A  $\mathbb{T}^m$ -homeomorphism in Proposition 6.2.3 (a) can be replaced by a  $\mathbb{T}^m$ -diffeomorphism (with respect to the smooth structures of Theorem 6.1.3), but the proof is more technical. It follows from the fact that two simple polytopes are combinatorially equivalent if and only if they are diffeomorphic as ‘smooth manifolds with corners’. For an alternative argument, see [36, Corollary 4.7].

Statement (a) remains valid without assuming that the presentation is generic or bounded, although  $\mathcal{Z}_{A,\mathbf{b}}$  is not a manifold in this case.

Now we recall the moment-angle manifold  $\mathcal{Z}_{\mathcal{K}_P}$  corresponding to the nerve complex  $\mathcal{K}_P$  of a simple polytope  $P$  (see Section 4.1 and Example 2.2.4). Observe that in our formalism, redundant inequalities in a presentation of  $P$  correspond to ghost vertices of  $\mathcal{K}_P$ .

THEOREM 6.2.4. *Let (6.1) be a generic bounded presentation, so that  $P = P(A, \mathbf{b})$  is a simple  $n$ -polytope. The moment-angle manifold  $\mathcal{Z}_{\mathcal{K}_P}$  is  $\mathbb{T}^m$ -equivariantly homeomorphic to the intersection of quadrics  $\mathcal{Z}_{A,\mathbf{b}}$  given by (6.3).*

PROOF. Recall from Construction 4.1.1 that the moment-angle complex  $\mathcal{Z}_{\mathcal{K}_P}$  is defined from a diagram similar to (6.2), in which the bottom map is replaced by the piecewise linear embedding  $c_P: P \rightarrow \mathbb{I}^m$  from Construction 2.9.7:

$$(6.8) \quad \begin{array}{ccc} \mathcal{Z}_{\mathcal{K}_P} & \longrightarrow & \mathbb{D}^m \\ \downarrow & & \downarrow \mu \\ P & \xrightarrow{c_P} & \mathbb{I}^m \end{array}$$

As we have seen in Proposition 6.2.2, the intersection of quadrics  $\mathcal{Z}_{A,\mathbf{b}}$  is  $\mathbb{T}^m$ -homeomorphic to the identification space

$$P \times \mathbb{T}^m / \sim \quad \text{where } (\mathbf{x}, \mathbf{t}_1) \sim (\mathbf{x}, \mathbf{t}_2) \text{ if } \mathbf{t}_1^{-1} \mathbf{t}_2 \in \mathbb{T}^{I_{\mathbf{x}}}.$$

By restricting the equivalence relation (6.7) to  $\mathbb{D}^m \subset \mathbb{C}^m$  we obtain that

$$\mathbb{D}^m \cong \mathbb{I}^m \times \mathbb{T}^m / \sim \quad \text{where } (\mathbf{y}, \mathbf{t}_1) \sim (\mathbf{y}, \mathbf{t}_2) \text{ if } \mathbf{t}_1^{-1} \mathbf{t}_2 \in \mathbb{T}^{\omega(\mathbf{y})}.$$

As in the proof of Proposition 6.2.2, the space  $\mathcal{Z}_{\mathcal{K}_P}$  is identified with  $c_P(P) \times \mathbb{T}^m / \sim$ . A point  $\mathbf{x} \in P$  is mapped by  $c_P$  to  $\mathbf{y} \in \mathbb{I}^m$  with  $I_{\mathbf{x}} = \omega(\mathbf{y}) = \{i \in [m]: \mathbf{x} \in F_i\}$ . We therefore obtain that both  $\mathcal{Z}_{\mathcal{K}_P}$  and  $\mathcal{Z}_{A,\mathbf{b}}$  are  $\mathbb{T}^m$ -homeomorphic to  $P \times \mathbb{T}^m / \sim$ .  $\square$

COROLLARY 6.2.5. *The moment-angle manifold  $\mathcal{Z}_{\mathcal{K}_P}$  corresponding to the nerve complex  $\mathcal{K}_P$  of a simple polytope  $P$  has a smooth structure in which the  $\mathbb{T}^m$ -action is smooth.*

DEFINITION 6.2.6. Given a bounded generic presentation (6.1) defining a simple polytope  $P$ , we shall use the common notation  $\mathcal{Z}_P$  for both the moment-angle manifold  $\mathcal{Z}_{\mathcal{K}_P}$  and the intersection of quadrics (6.3). We refer to  $\mathcal{Z}_P$  as a *polytopal moment-angle manifold*. We endow  $\mathcal{Z}_P$  with the smooth structure coming from the nonsingular intersection of quadrics.

REMARK. As it is shown in [36, Corollary 4.7] a  $\mathbb{T}^m$ -invariant smooth structure on  $\mathcal{Z}_P$  is unique. If the condition of the invariance under the torus action is dropped, then a smooth structure on  $\mathcal{Z}_P$  is not unique, as is shown by examples of odd-dimensional spheres and products of spheres. It would be interesting to relate exotic smooth structures with the construction of moment-angle complexes.

REMARK. If the polytope  $P = P(A, \mathbf{b})$  is not simple, then moment-angle complex  $\mathcal{Z}_{\mathcal{K}_P}$  corresponding to the nerve complex  $\mathcal{K}_P$  is not homeomorphic to the (singular) intersection of quadrics  $\mathcal{Z}_{A, \mathbf{b}}$ . However, the two spaces are homotopy equivalent (see [12]).

An intersection of quadrics representing  $\mathcal{Z}_P$  can be chosen more canonically:

PROPOSITION 6.2.7. *The moment-angle manifold  $\mathcal{Z}_P$  is  $\mathbb{T}^m$ -equivariantly diffeomorphic to a nonsingular intersection of quadrics of the following form:*

$$(6.9) \quad \left\{ \begin{array}{l} \mathbf{z} \in \mathbb{C}^m : \quad \sum_{k=1}^m |z_k|^2 = 1, \\ \sum_{k=1}^m \mathbf{g}_k |z_k|^2 = \mathbf{0}, \end{array} \right\}$$

where  $(\mathbf{g}_1, \dots, \mathbf{g}_m) \subset \mathbb{R}^{m-n-1}$  is a combinatorial Gale diagram of  $P^*$ .

PROOF. It follows from Proposition 1.2.7 that  $\mathcal{Z}_P$  is given by

$$\left\{ \begin{array}{l} \mathbf{z} \in \mathbb{C}^m : \quad \gamma_{11}|z_1|^2 + \dots + \gamma_{1m}|z_m|^2 = c, \\ \mathbf{g}_1|z_1|^2 + \dots + \mathbf{g}_m|z_m|^2 = \mathbf{0}, \end{array} \right\}$$

where  $\gamma_{1k}$  and  $c$  are positive. Divide the first equation by  $c$ , and then replace each  $z_k$  by  $\sqrt{\frac{c}{\gamma_{1k}}}z_k$ . As a result, each  $\mathbf{g}_k$  is multiplied by a positive number, so that  $(\mathbf{g}_1, \dots, \mathbf{g}_m)$  remains to be a combinatorial Gale diagram for  $P^*$ .  $\square$

By adapting Proposition 6.1.4 to the special case of quadrics (6.9), we obtain

PROPOSITION 6.2.8. *The intersection of quadrics given by (6.9) is nonempty nonsingular if and only if the following two conditions are satisfied:*

- (a)  $\mathbf{0} \in \text{conv}(\mathbf{g}_1, \dots, \mathbf{g}_m)$ ;
- (b) if  $\mathbf{0} \in \text{conv}(\mathbf{g}_{i_1}, \dots, \mathbf{g}_{i_k})$ , then  $k \geq m - n$ .

Following [36], we refer to a nonsingular intersection (6.9) of  $m - n - 1$  homogeneous quadrics with a unit sphere in  $\mathbb{C}^m$  as a *link*. We therefore obtain that the class of links coincides with the class of polytopal moment-angle manifolds.

As we have seen in Example 6.1.6, the moment-angle manifold corresponding to an  $n$ -simplex is diffeomorphic to a sphere  $S^{2n+1}$ . This is also the link of an empty system of homogeneous quadrics, corresponding to the case  $m = n + 1$ .

EXAMPLE 6.2.9 ( $m = n + 2$ : two quadrics). A polytope  $P$  defined by  $m = n + 2$  inequalities either is combinatorially equivalent to a product of two simplices (when there are no redundant inequalities), or is a simplex (when one inequality is redundant). In the case  $m = n + 2$  the link (6.9) has the form

$$\left\{ \begin{array}{l} \mathbf{z} \in \mathbb{C}^m : \quad |z_1|^2 + \dots + |z_m|^2 = 1, \\ \mathbf{g}_1|z_1|^2 + \dots + \mathbf{g}_m|z_m|^2 = \mathbf{0}, \end{array} \right\}$$

where  $g_k \in \mathbb{R}$ . Condition (b) of Proposition 6.2.8 implies that all  $g_i$  are nonzero; assume that there are  $p$  positive and  $q = m - p$  negative numbers among them. Then condition (a) implies that  $p > 0$  and  $q > 0$ . Therefore, the link is the intersection of the cone over a product of two ellipsoids of dimensions  $2p - 1$  and  $2q - 1$  (given by the second quadric) with a unit sphere of dimension  $2m - 1$  (given by the first quadric). Such a link is diffeomorphic to  $S^{2p-1} \times S^{2q-1}$ . The case  $p = 1$  or  $q = 1$  corresponds to one redundant inequality. In the irredundant case ( $P$  is a product  $\Delta^{p-1} \times \Delta^{q-1}$ ,  $p, q > 1$ ) we obtain that  $\mathcal{Z}_P \cong S^{2p-1} \times S^{2q-1}$ .

The case of three quadrics was resolved by Lopez de Medrano [197] in 1989. Here is a reformulation of his result in terms of moment-angle manifolds:

**THEOREM 6.2.10.** *Let  $\mathcal{Z}_P$  be the moment-angle manifold given by a nonempty and nodedgenerate intersection of three quadrics (6.9), i.e.  $m = n + 3$ . Then  $\mathcal{Z}_P$  is diffeomorphic to a product of three odd-dimensional spheres or to a connected sum of products of spheres with two spheres in each product.*

The proof of this theorem uses Gale duality, surgery theory and the  $h$ -cobordism Theorem. The original statement of [197] contained some restrictions on the types of quadrics, which later were lifted in [127]. The moment-angle manifold  $\mathcal{Z}_P$  is diffeomorphic to a product of three odd-dimensional spheres precisely when  $P$  is combinatorially equivalent to a product of three simplices. In all other cases, the manifold  $\mathcal{Z}_P$  given by three quadrics is diffeomorphic to a connected sum of the form  $\#_{k=3}^{m-2} (S^k \times S^{2m-3-k})^{\#q_k}$ . The numbers  $q_k$  of products  $S^k \times S^{2m-3-k}$  in the connected sum can be described explicitly in terms of the planar Gale diagram of the associated  $n$ -polytope  $P$  with  $m = n + 3$  facets.

Theorem 4.6.12 together with Theorem 6.2.10 and the previous examples gives a description of the topology of moment-angle manifolds  $\mathcal{Z}_P$  corresponding to the following classes of simple  $n$ -polytopes  $P$ : dual stacked polytopes (including polygons), polytopes with  $m \leq n + 3$  facets, and products of them. More examples of polytopes  $P$  whose corresponding manifolds  $\mathcal{Z}_P$  are diffeomorphic to a connected sum of sphere products were described in [127] (these include some dual cyclic polytopes). In general, the topology of moment-angle manifolds is much more complicated than in these series of examples (see Section 4.9 where examples of  $\mathcal{Z}_P$  with nontrivial Massey products were constructed). On the other hand, no other explicit topological types of moment-angle manifolds  $\mathcal{Z}_P$  are known. Furthermore, the following question remains open:

**PROBLEM 6.2.11.** Does there exist a moment-angle manifold  $\mathcal{Z}_P$  decomposable into nontrivial connected sum where one of the summands is diffeomorphic to a product of more than two spheres.

Here is an example illustrating how the structure of the moment-angle manifold  $\mathcal{Z}_P$  changes when one truncates  $P$  at a vertex:

**EXAMPLE 6.2.12.** Consider the following presentation of a polygon:

$$P = \{(x_1, x_2) \in \mathbb{R}^2 : x_1 \geq 0, x_2 \geq 0, \\ -x_1 + 1 + \delta \geq 0, -x_2 + 1 + \varepsilon \geq 0, -x_1 - x_2 + 1 \geq 0\},$$

where  $\delta, \varepsilon$  are parameters. First we fix some small positive  $\delta$  and vary  $\varepsilon$ . If  $\varepsilon$  is positive, then we get a presentation of a triangle with two redundant inequalities. The corresponding moment-angle manifold is diffeomorphic to  $S^5 \times S^1 \times S^1$ . If  $\varepsilon$  is negative, then we get a presentation of a quadrangle with one redundant inequality. The corresponding manifold is diffeomorphic to  $S^3 \times S^3 \times S^1$ . We see that when the hyperplane  $-x_2 + 1 + \varepsilon = 0$  crosses the vertex of the triangle, the corresponding moment-angle manifold  $\mathcal{Z}_P$  undergoes a surgery turning  $S^5 \times S^1 \times S^1$  to  $S^3 \times S^3 \times S^1$ . Now if we fix some small negative  $\varepsilon$  and decrease  $\delta$  so that the hyperplane  $-x_1 + 1 + \delta = 0$  crosses the vertex of the quadrangle, then the manifold  $\mathcal{Z}_P$  undergoes a more complicated surgery turning the product  $S^3 \times S^3 \times S^1$  to the connected sum  $(S^3 \times S^4)^{\#5}$  (corresponding to the case  $n = 2, m = 5$  in Theorem 4.6.12).

On the dual language of Gale diagrams, the surgeries described above happen when the origin crosses the “walls” inside the pentagonal Gale diagram corresponding to a presentation of a 2-polytope with 5 inequalities (see Figure 1.1). For more information about surgeries of moment-angle manifolds and their relation to “wall crossing”, see [55, §6.4], [36] and [127].

### Exercises.

6.2.13. Let  $G \subset P$  be a face of codimension  $k$  in a simple  $n$ -polytope  $P$ , let  $\mathcal{Z}_P$  be the corresponding moment-angle manifold with the quotient projection  $p: \mathcal{Z}_P \rightarrow P$ . Show that  $p^{-1}(G)$  is a smooth submanifold of  $\mathcal{Z}_P$  of codimension  $2k$ . Furthermore,  $p^{-1}(G)$  is diffeomorphic to  $\mathcal{Z}_G \times T^\ell$ , where  $\mathcal{Z}_G$  is the moment-angle manifold corresponding to  $G$  and  $\ell$  is the number of facets of  $P$  not containing  $G$ .

6.2.14. Let  $P = \text{vt}(I^3)$  be the polytope obtained by truncating a 3-cube at a vertex (see Construction 1.1.12). Write down intersection of quadrics (6.9) defining the corresponding 10-dimensional moment-angle manifold  $\mathcal{Z}_P$ . Use Theorem 4.5.4 or Theorem 4.5.7 to describe the cohomology ring  $H^*(\mathcal{Z}_P)$ . Deduce that  $\mathcal{Z}_P$  cannot be diffeomorphic to a connected sum of sphere products (cf. [36, Example 11.5]).

6.2.15. Write down the quadratic equations defining the moment-angle manifolds  $S^5 \times S^1 \times S^1$ ,  $S^3 \times S^3 \times S^1$  and  $(S^3 \times S^4)^{\#5}$  from Example 6.2.12, and describe explicitly the surgeries between them.

### 6.3. Symplectic reduction and moment maps revisited

As we have seen in Section 5.5, particular examples of polytopal moment-angle manifolds  $\mathcal{Z}_P$  appear as level sets for the moment maps used in the construction of Hamiltonian toric manifolds. In this case, the left hand sides of the equations in (6.3) are quadratic Hamiltonians of a torus action on  $\mathbb{C}^m$ . Here we investigate the relationship between symplectic quotients of  $\mathbb{C}^m$  and intersections of quadrics more thoroughly. As a corollary, we obtain that any symplectic quotient of  $\mathbb{C}^m$  by a torus action is a Hamiltonian toric manifold.

We want to study symplectic quotients of  $\mathbb{C}^m$  by torus subgroups  $T \subset \mathbb{T}^m$ . Such a subgroup of dimension  $m - n$  has the form

$$(6.10) \quad T_\Gamma = \{ (e^{2\pi i \langle \gamma_1, \varphi \rangle}, \dots, e^{2\pi i \langle \gamma_m, \varphi \rangle}) \in \mathbb{T}^m \},$$

where  $\varphi \in \mathbb{R}^{m-n}$  is an  $(m - n)$ -dimensional parameter, and  $\Gamma = (\gamma_1, \dots, \gamma_m)$  is a set of  $m$  vectors in  $\mathbb{R}^{m-n}$ . In order for  $T_\Gamma$  to be a torus, the configuration of vectors  $\gamma_1, \dots, \gamma_m$  must be *rational*, i.e. their integer span  $L = \mathbb{Z} \langle \gamma_1, \dots, \gamma_m \rangle$  must be a full rank discrete subgroup (a *lattice*) in  $\mathbb{R}^{m-n}$ . The lattice  $L$  is identified canonically with  $\text{Hom}(T_\Gamma, \mathbb{S}^1)$  and is called the *weight lattice* of torus (6.10). Let

$$L^* = \{ \lambda^* \in \mathbb{R}^{m-n} : \langle \lambda^*, \lambda \rangle \in \mathbb{Z} \text{ for all } \lambda \in L \}$$

be the dual lattice. We shall represent elements of  $T_\Gamma$  by  $\varphi \in \mathbb{R}^{m-n}$  occasionally, so that  $T_\Gamma$  is identified with the quotient  $\mathbb{R}^{m-n}/L^*$ .

The restricted action of  $T_\Gamma \subset \mathbb{T}^m$  on  $\mathbb{C}^m$  is obviously Hamiltonian, and the corresponding moment map is the composition

$$(6.11) \quad \mu_\Gamma: \mathbb{C}^m \xrightarrow{\mu} \mathbb{R}^m \longrightarrow \mathfrak{t}_\Gamma^*,$$

where  $\mathbb{R}^m \rightarrow \mathfrak{t}_\Gamma^*$  is the map of the dual Lie algebras corresponding to  $T_\Gamma \rightarrow \mathbb{T}^m$ . The map  $\mathbb{R}^m \rightarrow \mathfrak{t}_\Gamma^*$  takes the  $k$ th basis vector  $e_k \in \mathbb{R}^m$  to  $\gamma_k \in \mathfrak{t}_\Gamma^*$ . By identifying

$\mathfrak{t}_\Gamma^*$  with  $\mathbb{R}^{m-n}$  we write the map  $\mathbb{R}^m \rightarrow \mathfrak{t}_\Gamma^*$  by the matrix  $\Gamma = (\gamma_{jk})$ , where  $\gamma_{jk}$  is the  $j$ th coordinate of  $\gamma_k$ . The moment map (6.11) is then given by

$$(z_1, \dots, z_m) \mapsto \left( \sum_{k=1}^m \gamma_{1k} |z_k|^2, \dots, \sum_{k=1}^m \gamma_{m-n,k} |z_k|^2 \right).$$

Its level set  $\mu_\Gamma^{-1}(\delta)$  corresponding to a value  $\delta = (\delta_1, \dots, \delta_{m-n})^t \in \mathfrak{t}_\Gamma^*$  is exactly the intersection of quadrics  $\mathcal{Z}_{\Gamma, \delta}$  given by (6.5).

To apply symplectic reduction we need to identify when the moment map  $\mu_\Gamma$  is proper, find its regular values  $\delta$ , and finally identify when the action of  $T_\Gamma$  on  $\mu_\Gamma^{-1}(\delta) = \mathcal{Z}_{\Gamma, \delta}$  is free. In Theorem 6.3.1 below, all these conditions are expressed in terms of the polyhedron  $P$  associated with  $\mathcal{Z}_{\Gamma, \delta}$  as described in Section 6.1.

It follows from Gale duality that  $\gamma_1, \dots, \gamma_m$  span a lattice  $L$  in  $\mathbb{R}^{m-n}$  if and only if the dual configuration  $\mathbf{a}_1, \dots, \mathbf{a}_m$  spans a lattice  $N = \mathbb{Z}\langle \mathbf{a}_1, \dots, \mathbf{a}_m \rangle$  in  $\mathbb{R}^n$ . We refer to a presentation (6.1) as *rational* if  $\mathbb{Z}\langle \mathbf{a}_1, \dots, \mathbf{a}_m \rangle$  is a lattice.

A polyhedron  $P$  is called *Delzant* if it has a vertex and there is a rational presentation (6.1) such that for any vertex  $\mathbf{x} \in P$  the vectors  $\mathbf{a}_i$  normal to the facets meeting at  $\mathbf{x}$  form a basis of the lattice  $N = \mathbb{Z}\langle \mathbf{a}_1, \dots, \mathbf{a}_m \rangle$ . In the case when  $P$  is bounded and irredundant we obtain the definition used before: a polytope  $P$  is Delzant when its normal fan is regular.

Now let  $\delta \in \mathfrak{t}_\Gamma$  be a value of the moment map  $\mu_\Gamma: \mathbb{C}^m \rightarrow \mathfrak{t}_\Gamma^*$ , and  $\mu_\Gamma^{-1}(\delta) = \mathcal{Z}_{\Gamma, \delta}$  the corresponding level set, which is an intersection of quadrics (6.5). We associate with  $\mathcal{Z}_{\Gamma, \delta}$  a presentation (6.1) as described in Section 6.1 (see Theorem 6.1.5).

**THEOREM 6.3.1.** *Let  $T_\Gamma \subset \mathbb{T}^m$  be a torus subgroup (6.10), determined by a rational configuration of vectors  $\gamma_1, \dots, \gamma_m$ .*

- (a) *The moment map  $\mu_\Gamma: \mathbb{C}^m \rightarrow \mathfrak{t}_\Gamma^*$  is proper if and only if its level set  $\mu_\Gamma^{-1}(\delta)$  is bounded for some (and then for any) value  $\delta \in \mathfrak{t}_\Gamma^*$ . Equivalently, the map  $\mu_\Gamma$  is proper if and only if the Gale dual configuration  $\mathbf{a}_1, \dots, \mathbf{a}_m$  satisfies  $\alpha_1 \mathbf{a}_1 + \dots + \alpha_m \mathbf{a}_m = \mathbf{0}$  for some positive numbers  $\alpha_k$ .*
- (b)  *$\delta \in \mathfrak{t}_\Gamma^*$  is a regular value of  $\mu_\Gamma$  if and only if the intersection of quadrics  $\mu_\Gamma^{-1}(\delta) = \mathcal{Z}_{\Gamma, \delta}$  is nonempty and nonsingular. Equivalently,  $\delta$  is a regular value if and only if the associated presentation  $P = P(\mathbf{A}, \mathbf{b})$  is generic.*
- (c) *The action of  $T_\Gamma$  on  $\mu_\Gamma^{-1}(\delta) = \mathcal{Z}_{\Gamma, \delta}$  is free if and only if the associated polyhedron  $P$  is Delzant.*

**PROOF.** (a) If  $\mu_\Gamma$  is proper then  $\mu_\Gamma^{-1}(\delta) \subset \mathfrak{t}_\Gamma^*$  is compact, so it is bounded.

Now assume that  $\mu_\Gamma^{-1}(\delta) = \mathcal{Z}_{\Gamma, \delta}$  is bounded for some  $\delta$ . Then the associated polyhedron  $P$  is also bounded. By Corollary 1.2.8, this is equivalent to vanishing of a positive linear combination of  $\mathbf{a}_1, \dots, \mathbf{a}_m$ . This condition is independent of  $\delta$ , and we conclude that  $\mu_\Gamma^{-1}(\delta)$  is bounded for any  $\delta$ . Let  $X \subset \mathfrak{t}_\Gamma^*$  be a compact subset. Since  $\mu_\Gamma^{-1}(X)$  is closed, it is compact whenever it is bounded. By Proposition 1.2.7 we may assume that, for any  $\delta \in X$ , the first quadric defining  $\mu_\Gamma^{-1}(\delta) = \mathcal{Z}_{\Gamma, \delta}$  is given by  $\gamma_{11}|z_1|^2 + \dots + \gamma_{1m}|z_m|^2 = \delta_1$  with  $\gamma_{1k} > 0$ . Let  $c = \max_{\delta \in X} \delta_1$ . Then  $\mu_\Gamma^{-1}(X)$  is contained in the bounded set

$$\{\mathbf{z} \in \mathbb{C}^m : \gamma_{11}|z_1|^2 + \dots + \gamma_{1m}|z_m|^2 \leq c\}$$

and is therefore bounded. Hence  $\mu_\Gamma^{-1}(X)$  is compact, and  $\mu_\Gamma$  is proper.

(b) The first statement is the definition of a regular value. The equivalent statement is already proved as Theorem 6.1.3.

(c) We first need to identify the stabilisers of the  $T_\Gamma$ -action on  $\mu_\Gamma^{-1}(\delta)$ . Although the fact that these stabilisers are finite for a regular value  $\delta$  follows from the general construction of symplectic reduction, we can prove this directly.

Given a point  $\mathbf{z} = (z_1, \dots, z_m) \in \mathcal{Z}_{\Gamma, \delta}$ , we define the sublattice

$$L_{\mathbf{z}} = \mathbb{Z}\langle \gamma_i : z_i \neq 0 \rangle \subset L = \mathbb{Z}\langle \gamma_1, \dots, \gamma_m \rangle.$$

LEMMA 6.3.2. *The stabiliser subgroup of  $\mathbf{z} \in \mathcal{Z}_{\Gamma, \delta}$  under the action of  $T_\Gamma$  is given by  $L_{\mathbf{z}}^*/L^*$ . Furthermore, if  $\mathcal{Z}_{\Gamma, \delta}$  is nonsingular, then all these stabilisers are finite, i.e. the action of  $T_\Gamma$  on  $\mathcal{Z}_{\Gamma, \delta}$  is almost free.*

PROOF. An element  $(e^{2\pi i\langle \gamma_1, \varphi \rangle}, \dots, e^{2\pi i\langle \gamma_m, \varphi \rangle}) \in T_\Gamma$  fixes a point  $\mathbf{z} \in \mathcal{Z}_\Gamma$  if and only if  $e^{2\pi i\langle \gamma_k, \varphi \rangle} = 1$  whenever  $z_k \neq 0$ . In other words,  $\varphi \in T_\Gamma$  fixes  $\mathbf{z}$  if and only if  $\langle \gamma_k, \varphi \rangle \in \mathbb{Z}$  whenever  $z_k \neq 0$ . The latter means that  $\varphi \in L_{\mathbf{z}}^*$ . Since  $\varphi \in L^*$  maps to  $1 \in T_\Gamma$ , the stabiliser of  $\mathbf{z}$  is  $L_{\mathbf{z}}^*/L^*$ .

Assume now that  $\mathcal{Z}_{\Gamma, \delta}$  is nonsingular. In order to see that  $L_{\mathbf{z}}^*/L^*$  is finite we need to check that the sublattice  $L_{\mathbf{z}} = \mathbb{Z}\langle \gamma_i : z_i \neq 0 \rangle \subset L$  has full rank  $m - n$ . Indeed,  $\text{rk}\{\gamma_i : z_i \neq 0\}$  is the rank of the matrix of gradients of quadrics in (6.5) at  $\mathbf{z}$ . Since  $\mathcal{Z}_{\Gamma, \delta}$  is nonsingular, this rank is  $m - n$ , as needed.  $\square$

Now we can finish the proof of Theorem 6.3.1 (c). Assume that  $P$  is Delzant. By Lemma 6.3.2, the  $T_\Gamma$ -action on  $\mathcal{Z}_{\Gamma, \delta}$  is free if and only if  $L_{\mathbf{z}} = L$  for any  $\mathbf{z} \in \mathcal{Z}_{\Gamma, \delta}$ . Let  $i: \mathbb{Z}^k \rightarrow \mathbb{Z}^m$  be the inclusion of the coordinate sublattice spanned by those  $\mathbf{e}_i$  for which  $z_i = 0$ , and let  $p: \mathbb{Z}^m \rightarrow \mathbb{Z}^{m-k}$  be the projection sending every such  $\mathbf{e}_i$  to zero. We also have the maps of lattices

$$\Gamma^*: L^* \rightarrow \mathbb{Z}^m, \mathbf{l} \mapsto (\langle \gamma_1, \mathbf{l} \rangle, \dots, \langle \gamma_m, \mathbf{l} \rangle), \quad \text{and} \quad A: \mathbb{Z}^m \rightarrow N, \mathbf{e}_k \mapsto \mathbf{a}_k.$$

Consider the diagram

$$(6.12) \quad \begin{array}{ccccccc} & & & 0 & & & \\ & & & \downarrow & & & \\ & & & L^* & & & \\ & & & \downarrow \Gamma^* & & & \\ 0 & \longrightarrow & \mathbb{Z}^k & \xrightarrow{i} & \mathbb{Z}^m & \xrightarrow{p} & \mathbb{Z}^{m-k} \longrightarrow 0 \\ & & & & \downarrow A & & \\ & & & & N & & \\ & & & & \downarrow & & \\ & & & & 0 & & \end{array}$$

in which the vertical and horizontal sequences are exact. Then the Delzant condition is equivalent to that the composition  $A \cdot i$  is split injective. The condition  $L_{\mathbf{z}} = L$  is equivalent to that  $\Gamma \cdot p^*$  is surjective, or  $p \cdot \Gamma^*$  is split injective. These two conditions are equivalent by Lemma 1.2.5.  $\square$

In the case of polytopes we obtain the following version of Proposition 5.5.3:

COROLLARY 6.3.3. *Let  $P = P(A, \mathbf{b})$  be a Delzant polytope,  $\Gamma = (\gamma_1, \dots, \gamma_m)$  the Gale dual configuration, and  $\mathcal{Z}_P$  the corresponding moment-angle manifold. Then*

- (a)  $\delta = \Gamma \mathbf{b}$  is a regular value of the moment map  $\mu_\Gamma: \mathbb{C}^m \rightarrow \mathfrak{t}_\Gamma^*$  for the Hamiltonian action of  $T_\Gamma \subset \mathbb{T}^m$  on  $\mathbb{C}^m$ ;
- (b)  $\mathcal{Z}_P$  is the regular level set  $\mu_\Gamma^{-1}(\Gamma \mathbf{b})$ ;

(c) *the action of  $T_\Gamma$  on  $\mathcal{Z}_P$  is free.*

In Section 5.5 we defined the Hamiltonian toric manifold  $V_P$  corresponding to a Delzant polytope  $P$  as the symplectic quotient of  $\mathbb{C}^m$  by the torus subgroup  $K \subset \mathbb{T}^m$  determined by the normal fan of  $P$ . By comparing the vertical exact sequence in (6.12) with (5.9) we obtain that  $K = T_\Gamma$ , and the quotient  $n$ -torus  $\mathbb{T}^m/T_\Gamma$  acting on  $V_P = \mathcal{Z}_P/T_\Gamma$  is  $T_N = N \otimes_{\mathbb{Z}} \mathbb{S} = \mathbb{R}^n/N$ .

**COROLLARY 6.3.4.** *Any symplectic quotient of  $\mathbb{C}^m$  by a torus subgroup  $T \subset \mathbb{T}^m$  is a Hamiltonian toric manifold.*

**EXAMPLE 6.3.5.** Consider the case  $m - n = 1$ , i.e.  $T_\Gamma$  is 1-dimensional, and  $\gamma_k \in \mathbb{R}$ . By Theorem 6.3.1 (a), the moment map  $\mu_\Gamma$  is proper whenever

$$\mu_\Gamma^{-1}(\delta) = \{z \in \mathbb{C}^m : \gamma_1|z_1|^2 + \cdots + \gamma_m|z_m|^2 = \delta\}$$

is bounded for any  $\delta \in \mathbb{R}$ . By Theorem 6.3.1 (b),  $\delta$  is a regular value whenever the quadratic hypersurface  $\gamma_1|z_1|^2 + \cdots + \gamma_m|z_m|^2 = \delta$  is nonempty and nonsingular. These two conditions together imply that the hypersurface is an ellipsoid, and the associated polyhedron is an  $n$ -simplex (see Example 6.1.6). By Lemma 6.3.2, the  $T_\Gamma$ -action on  $\mu_\Gamma^{-1}(\delta)$  is free if and only if  $L_z = L$  for any  $z \in \mu_\Gamma^{-1}(\delta)$ . This means that each  $\gamma_k$  generates the same lattice as the whole set  $\gamma_1, \dots, \gamma_m$ , which implies that  $\gamma_1 = \cdots = \gamma_m$ . The Gale dual configuration satisfies  $\mathbf{a}_1 + \cdots + \mathbf{a}_m = \mathbf{0}$ . Then  $T_\Gamma$  is the diagonal circle in  $\mathbb{T}^m$ , the hypersurface  $\mu_\Gamma^{-1}(\delta) = \mathcal{Z}_P$  is a sphere, and the associated polytope  $P$  is the standard simplex up to shift and magnification by a positive factor  $\delta$ . The Hamiltonian toric manifold  $V_P = \mathcal{Z}_P/T_\Gamma$  is the complex projective space  $\mathbb{C}P^n$ .

#### 6.4. Complex structures on intersections of quadrics

Bosio and Meersseman [36] identified polytopal moment-angle manifolds  $\mathcal{Z}_P$  with a class of non-Kähler complex-analytic manifolds introduced in the works of Lopez de Medrano, Verjovsky and Meersseman (*LVM-manifolds*). This was the starting point in the subsequent study of the complex geometry of moment-angle manifolds. We review the construction of LVM-manifolds and its connection to polytopal moment-angle manifolds here.

The initial data of the construction of an LVM-manifold is a link of a homogeneous system of quadrics similar to (6.9), but with *complex* coefficients:

$$(6.13) \quad \mathcal{L} = \left\{ z \in \mathbb{C}^m : \begin{array}{l} \sum_{k=1}^m |z_k|^2 = 1, \\ \sum_{k=1}^m \zeta_k |z_k|^2 = \mathbf{0} \end{array} \right\},$$

where  $\zeta_k \in \mathbb{C}^s$ . We can obviously turn this link into the form (6.9) by identifying  $\mathbb{C}^s$  with  $\mathbb{R}^{2s}$  in the standard way, so that each  $\zeta_k$  becomes  $\mathbf{g}_k \in \mathbb{R}^{m-n-1}$  with  $n = m - 2s - 1$ . We assume that the link is nonsingular, i.e. the system of complex vectors  $(\zeta_1, \dots, \zeta_m)$  (or the corresponding system of real vectors  $(\mathbf{g}_1, \dots, \mathbf{g}_m)$ ) satisfies the conditions (a) and (b) of Proposition 6.2.8.

Now define the manifold  $\mathcal{N}$  as the projectivisation of the intersection of homogeneous quadrics in (6.13):

$$(6.14) \quad \mathcal{N} = \{z \in \mathbb{C}P^{m-1} : \zeta_1|z_1|^2 + \cdots + \zeta_m|z_m|^2 = \mathbf{0}\}, \quad \zeta_k \in \mathbb{C}^s.$$

We therefore have a principal  $S^1$ -bundle  $\mathcal{L} \rightarrow \mathcal{N}$ .



THEOREM 6.4.1 (Meersseman [223]). *The manifold  $\mathcal{N}$  has a holomorphic atlas describing it as a compact complex manifold of complex dimension  $m - 1 - s$ .*

SKETCH OF PROOF. Consider a holomorphic action of  $\mathbb{C}^s$  on  $\mathbb{C}^m$  given by

$$(6.15) \quad \begin{aligned} \mathbb{C}^s \times \mathbb{C}^m &\longrightarrow \mathbb{C}^m \\ (\mathbf{w}, \mathbf{z}) &\mapsto (z_1 e^{\langle \zeta_1, \mathbf{w} \rangle}, \dots, z_m e^{\langle \zeta_m, \mathbf{w} \rangle}), \end{aligned}$$

where  $\mathbf{w} = (w_1, \dots, w_s) \in \mathbb{C}^s$ , and  $\langle \zeta_k, \mathbf{w} \rangle = \zeta_{1k} w_1 + \dots + \zeta_{sk} w_s$ .

Let  $\mathcal{K}$  be the simplicial complex consisting of zero-sets of points of the link  $\mathcal{L}$ :

$$\mathcal{K} = \{\omega(\mathbf{z}) : \mathbf{z} \in \mathcal{L}\}.$$

Observe that  $\mathcal{K} = \mathcal{K}_P$ , where  $P$  is the simple polytope associated with the link  $\mathcal{L}$ . Let  $U = U(\mathcal{K})$  be the corresponding subspace arrangement complement given by (4.7.4). Note that Proposition 1.2.9 implies that  $U$  can be also defined as

$$U = \{(z_1, \dots, z_m) \in \mathbb{C}^m : \mathbf{0} \in \text{conv}(\zeta_j : z_j \neq 0)\}.$$

An argument similar to the proof of Lemma 6.3.2 shows that the restriction of the action (6.15) to  $U \subset \mathbb{C}^m$  is free. Also, this restricted action of  $\mathbb{C}^s$  on  $U$  is proper (we shall prove this in more general context in Theorem 6.6.3 below), so the quotient  $U/\mathbb{C}^s$  is Hausdorff. Using a holomorphic atlas transverse to the orbits of the free action of  $\mathbb{C}^s$  on the complex manifold  $U$  we obtain that the quotient  $U/\mathbb{C}^s$  has a structure of a complex manifold.

On the other hand, it can be shown that the function  $|z_1|^2 + \dots + |z_m|^2$  (the square of the distance to the origin in  $\mathbb{C}^m$ ) has a unique minimum when restricted to an orbit of the free action of  $\mathbb{C}^s$  on  $U$ . The set of these minima (i.e. the set of points closest to the origin in each orbit) can be described as

$$\mathcal{T} = \{\mathbf{z} \in \mathbb{C}^m \setminus \{\mathbf{0}\} : \zeta_1 |z_1|^2 + \dots + \zeta_m |z_m|^2 = \mathbf{0}\}.$$

It follows that the quotient  $U/\mathbb{C}^s$  can be identified with  $\mathcal{T}$ , and therefore  $\mathcal{T}$  acquires a structure of a complex manifold of dimension  $m - s$ .

By projectivising the construction we identify  $\mathcal{N}$  with the quotient of a complement of coordinate subspace arrangement in  $\mathbb{C}P^{m-1}$  (the projectivisation of  $U$ ) by a holomorphic action of  $\mathbb{C}^s$ . In this way  $\mathcal{N}$  becomes a compact complex manifold.  $\square$

The manifold  $\mathcal{N}$  with the complex structure of Theorem 6.4.1 is referred to as an *LVM-manifold*. These manifolds were described by Meersseman [223] as a generalisation of the construction of Lopez de Medrano and Verjovsky [198].

REMARK. The embedding of  $\mathcal{T}$  in  $\mathbb{C}^m$  and of  $\mathcal{N}$  in  $\mathbb{C}P^{m-1}$  given by (6.14) is not holomorphic.

A polytopal moment-angle manifold  $\mathcal{Z}_P$  is diffeomorphic to a link (6.9), which can be turned into a complex link (6.13) whenever  $m + n$  is odd. It follows that the quotient  $\mathcal{Z}_P/S^1$  of an odd-dimensional moment-angle manifold has a complex-analytic structure as an LVM-manifold. By adding redundant inequalities and using the  $S^1$ -bundle  $\mathcal{L} \rightarrow \mathcal{N}$ , Bosio–Meersseman observed that  $\mathcal{Z}_P$  or  $\mathcal{Z}_P \times S^1$  has a structure of an LVM-manifold, depending on whether  $m + n$  is even or odd.

We first summarise the effects that a redundant inequality in (6.1) has on different spaces appeared above:

PROPOSITION 6.4.2. *Assume that (6.1) is a generic presentation. The following conditions are equivalent:*

- (a)  $\langle \mathbf{a}_i, \mathbf{x} \rangle + b_i \geq 0$  is a redundant inequality in (6.1) (i.e.  $F_i = \emptyset$ );
- (b)  $\mathcal{Z}_P \subset \{\mathbf{z} \in \mathbb{C}^m : z_i \neq 0\}$ ;
- (c)  $\{i\}$  is a ghost vertex of  $\mathcal{K}_P$ ;
- (d)  $U(\mathcal{K}_P)$  has a factor  $\mathbb{C}^\times$  on the  $i$ th coordinate;
- (e)  $\mathbf{0} \notin \text{conv}(\mathbf{g}_k : k \neq i)$ .

PROOF. The equivalence of the first four conditions follows directly from the definitions. The equivalence (a) $\Leftrightarrow$ (e) follows from Proposition 1.2.9.  $\square$

THEOREM 6.4.3 ([36]). Let  $\mathcal{Z}_P$  be the moment angle manifold corresponding to an  $n$ -dimensional simple polytope (6.1) defined by  $m$  inequalities.

- (a) If  $m+n$  is even then  $\mathcal{Z}_P$  has a complex structure as an LVM-manifold.
- (b) If  $m+n$  is odd then  $\mathcal{Z}_P \times S^1$  has a complex structure as an LVM-manifold.

PROOF. (a) We add one redundant inequality of the form  $1 \geq 0$  to (6.1), and denote the resulting manifold of (6.2) by  $\mathcal{Z}'_P$ . We have  $\mathcal{Z}'_P \cong \mathcal{Z}_P \times S^1$ . By Proposition 6.2.7,  $\mathcal{Z}_P$  is diffeomorphic to a link given by (6.9). Then  $\mathcal{Z}'_P$  is given by the intersection of quadrics

$$\left\{ \begin{array}{l} \mathbf{z} \in \mathbb{C}^{m+1}: \quad |z_1|^2 + \cdots + |z_m|^2 = 1, \\ \mathbf{g}_1|z_1|^2 + \cdots + \mathbf{g}_m|z_m|^2 = \mathbf{0}, \\ |z_{m+1}|^2 = 1, \end{array} \right\}$$

which is diffeomorphic to the link given by

$$\left\{ \begin{array}{l} \mathbf{z} \in \mathbb{C}^{m+1}: \quad |z_1|^2 + \cdots + |z_m|^2 + |z_{m+1}|^2 = 1, \\ \mathbf{g}_1|z_1|^2 + \cdots + \mathbf{g}_m|z_m|^2 = \mathbf{0}, \\ |z_1|^2 + \cdots + |z_m|^2 - |z_{m+1}|^2 = 0. \end{array} \right\}$$

If we denote by  $\Gamma^* = (\mathbf{g}_1 \dots \mathbf{g}_m)$  the  $(m-n-1) \times m$ -matrix of coefficients of the homogeneous quadrics for  $\mathcal{Z}_P$ , then the corresponding matrix for  $\mathcal{Z}'_P$  is

$$\Gamma^{*'} = \begin{pmatrix} \mathbf{g}_1 & \cdots & \mathbf{g}_m & \mathbf{0} \\ 1 & \cdots & 1 & -1 \end{pmatrix}.$$

Its height  $m-n$  is even, so that we may think of its  $k$ th column as a complex vector  $\zeta_k$  (by identifying  $\mathbb{R}^{m-n}$  with  $\mathbb{C}^{\frac{m-n}{2}}$ ), for  $k = 1, \dots, m+1$ . Now define

$$(6.16) \quad \mathcal{N}' = \{\mathbf{z} \in \mathbb{C}P^m : \zeta_1|z_1|^2 + \cdots + \zeta_{m+1}|z_{m+1}|^2 = \mathbf{0}\}.$$

Then  $\mathcal{N}'$  has a complex structure as an LVM-manifold by Theorem 6.4.1. On the other hand,

$$\mathcal{N}' \cong \mathcal{Z}'_P/S^1 = (\mathcal{Z}_P \times S^1)/S^1 \cong \mathcal{Z}_P,$$

so that  $\mathcal{Z}_P$  also acquires a complex structure.

(b) The proof here is similar, but we have to add two redundant inequalities  $1 \geq 0$  to (6.1). Then  $\mathcal{Z}'_P \cong \mathcal{Z}_P \times S^1 \times S^1$  is given by

$$\left\{ \begin{array}{l} \mathbf{z} \in \mathbb{C}^{m+2}: \quad |z_1|^2 + \cdots + |z_m|^2 + |z_{m+1}|^2 + |z_{m+2}|^2 = 1, \\ \mathbf{g}_1|z_1|^2 + \cdots + \mathbf{g}_m|z_m|^2 = \mathbf{0}, \\ |z_1|^2 + \cdots + |z_m|^2 - |z_{m+1}|^2 = 0, \\ |z_1|^2 + \cdots + |z_m|^2 - |z_{m+2}|^2 = 0. \end{array} \right\}$$

The matrix of coefficients of the homogeneous quadrics is therefore

$$\Gamma^{*'} = \begin{pmatrix} \mathbf{g}_1 & \cdots & \mathbf{g}_m & 0 & 0 \\ 1 & \cdots & 1 & -1 & 0 \\ 1 & \cdots & 1 & 0 & -1 \end{pmatrix}.$$

We think of its columns as a set of  $m+2$  complex vectors  $\zeta_1, \dots, \zeta_{m+2}$ , and define

$$(6.17) \quad \mathcal{N}' = \{ \mathbf{z} \in \mathbb{C}P^{m+1} : \zeta_1 |z_1|^2 + \cdots + \zeta_{m+2} |z_{m+2}|^2 = \mathbf{0} \}.$$

Then  $\mathcal{N}'$  has a complex structure as an LVM-manifold. On the other hand,

$$\mathcal{N}' \cong \mathcal{Z}'_P / S^1 = (\mathcal{Z}_P \times S^1 \times S^1) / S^1 \cong \mathcal{Z}_P \times S^1,$$

and therefore  $\mathcal{Z}_P \times S^1$  has a complex structure.  $\square$

In the next two sections we describe a more direct method of endowing  $\mathcal{Z}_P$  with a complex structure, without referring to projectivised quadrics and LVM-manifolds. This approach, developed in [262], works not only in the polytopal case, but also for the moment-angle manifolds  $\mathcal{Z}_{\mathcal{K}}$  corresponding to underlying complexes  $\mathcal{K}$  of complete simplicial fans.

### 6.5. Moment-angle manifolds from simplicial fans

Let  $\mathcal{K} = \mathcal{K}_{\Sigma}$  be the underlying complex of a complete simplicial fan  $\Sigma$ , and  $U(\mathcal{K})$  the complement of the coordinate subspace arrangement (4.7.4) defined by  $\mathcal{K}$ . Here we shall identify the moment-angle manifold  $\mathcal{Z}_{\mathcal{K}}$  with the quotient of  $U(\mathcal{K})$  by a smooth action of a non-compact group isomorphic to  $\mathbb{R}^{m-n}$ , thereby defining a smooth structure on  $\mathcal{Z}_{\mathcal{K}}$ . A modification of this construction will be used in the next section to endow  $\mathcal{Z}_{\mathcal{K}}$  with a complex structure.

Let  $\Sigma$  be a simplicial fan in  $N_{\mathbb{R}} \cong \mathbb{R}^n$  with generators  $\mathbf{a}_1, \dots, \mathbf{a}_m$ . Recall that the underlying simplicial complex  $\mathcal{K} = \mathcal{K}_{\Sigma}$  is the collection of subsets  $I \subset [m]$  such that  $\{\mathbf{a}_i : i \in I\}$  spans a cone of  $\Sigma$ .

A simplicial fan  $\Sigma$  is therefore determined by two pieces of data:

- a simplicial complex  $\mathcal{K}$  on  $[m]$ ;
- a configuration of vectors  $\mathbf{a}_1, \dots, \mathbf{a}_m$  in  $\mathbb{R}^n$  such that for any simplex  $I \in \mathcal{K}$  the subset  $\{\mathbf{a}_i : i \in I\}$  is linearly independent.

Then for each  $I \in \mathcal{K}$  we can define the simplicial cone  $\sigma_I$  spanned by  $\mathbf{a}_i$  with  $i \in I$ . The ‘bunch of cones’  $\{\sigma_I : I \in \mathcal{K}\}$  patches into a fan  $\Sigma$  whenever any two cones  $\sigma_I$  and  $\sigma_J$  intersect in a common face (which has to be  $\sigma_{I \cap J}$ ). Equivalently, the relative interiors of cones  $\sigma_I$  are pairwise non-intersecting. Under this condition, we say that the data  $\{\mathcal{K}; \mathbf{a}_1, \dots, \mathbf{a}_m\}$  define a fan  $\Sigma$ .

We do allow ghost vertices in  $\mathcal{K}$ ; they do not affect the fan  $\Sigma$ . The vector  $\mathbf{a}_i$  corresponding to a ghost vertex  $\{i\}$  can be zero as it does not correspond to a one-dimensional cone of  $\Sigma$ . This formalism will be important for the construction of a complex structure on  $\mathcal{Z}_{\mathcal{K}}$ ; it was also used in [25] under the name *triangulated vector configurations*.

CONSTRUCTION 6.5.1. For a set of vectors  $\mathbf{a}_1, \dots, \mathbf{a}_m$ , consider the linear map

$$(6.18) \quad A: \mathbb{R}^m \rightarrow N_{\mathbb{R}}, \quad \mathbf{e}_i \mapsto \mathbf{a}_i,$$

where  $\mathbf{e}_1, \dots, \mathbf{e}_m$  is the standard basis of  $\mathbb{R}^m$ . Let

$$\mathbb{R}_{>}^m = \{(y_1, \dots, y_m) \in \mathbb{R}^m : y_i > 0\}$$

be the multiplicative group of  $m$ -tuples of positive real numbers, and define

$$(6.19) \quad \begin{aligned} R &= \exp(\text{Ker } A) = \{(e^{y_1}, \dots, e^{y_m}) : (y_1, \dots, y_m) \in \text{Ker } A\} \\ &= \{(t_1, \dots, t_m) \in \mathbb{R}_{>}^m : \prod_{i=1}^m t_i^{\langle \mathbf{a}_i, \mathbf{u} \rangle} = 1 \text{ for all } \mathbf{u} \in N_{\mathbb{R}}^*\}. \end{aligned}$$

We let  $\mathbb{R}_{>}^m$  act on the complement  $U(\mathcal{K}) \subset \mathbb{C}^m$  by coordinatewise multiplications and consider the restricted action of the subgroup  $R \subset \mathbb{R}_{>}^m$ . Recall that a  $G$ -action on a space  $X$  is *proper* if the *group action map*  $h: G \times X \rightarrow X \times X$ ,  $(g, x) \mapsto (gx, x)$  is proper (the preimage of a compact subset is compact).

**THEOREM 6.5.2 ([262]).** *Assume given data  $\{\mathcal{K}; \mathbf{a}_1, \dots, \mathbf{a}_m\}$  satisfying the conditions above. Then*

- (a) *the group  $R \cong \mathbb{R}^{m-n}$  given by (6.19) acts on  $U(\mathcal{K})$  freely;*
- (b) *if the data  $\{\mathcal{K}; \mathbf{a}_1, \dots, \mathbf{a}_m\}$  define a simplicial fan  $\Sigma$ , then  $R$  acts on  $U(\mathcal{K})$  properly, so the quotient  $U(\mathcal{K})/R$  is a smooth Hausdorff  $(m+n)$ -dimensional manifold;*
- (c) *if the fan  $\Sigma$  is complete, then  $U(\mathcal{K})/R$  is homeomorphic to the moment-angle manifold  $\mathcal{Z}_{\mathcal{K}}$ .*

Therefore,  $\mathcal{Z}_{\mathcal{K}}$  can be smoothed whenever  $\mathcal{K} = \mathcal{K}_{\Sigma}$  for a complete simplicial fan  $\Sigma$ .

**PROOF.** Statement (a) is proved in the same way as Proposition 5.4.6. Indeed, a point  $\mathbf{z} \in U(\mathcal{K})$  has a nontrivial stabiliser with respect to the action of  $\mathbb{R}_{>}^m$  only if some of its coordinates vanish. These  $\mathbb{R}_{>}^m$ -stabilisers are of the form  $(\mathbb{R}_{>}, 1)^I$ , see (4.6), for some  $I \in \mathcal{K}$ . The restriction of  $\exp A$  to any such  $(\mathbb{R}_{>}, 1)^I$  is an injection. Therefore,  $R = \exp(\text{Ker } A)$  intersects any  $\mathbb{R}_{>}^m$ -stabilisers only at the unit, which implies that the  $R$ -action on  $U(\mathcal{K})$  is free.

Let us prove (b) (compare the proof of Theorem 5.4.5 (b) and Exercise 5.4.15). Consider the map

$$h: R \times U(\mathcal{K}) \rightarrow U(\mathcal{K}) \times U(\mathcal{K}), \quad (\mathbf{g}, \mathbf{z}) \mapsto (\mathbf{r}\mathbf{z}, \mathbf{z}),$$

for  $\mathbf{r} \in R$ ,  $\mathbf{z} \in U(\mathcal{K})$ . Let  $V \subset U(\mathcal{K}) \times U(\mathcal{K})$  be a compact subset; we need to show that  $h^{-1}(V)$  is compact. Since  $R \times U(\mathcal{K})$  is metrisable, it suffices to check that any infinite sequence  $\{(\mathbf{r}^{(k)}, \mathbf{z}^{(k)}) : k = 1, 2, \dots\}$  of points in  $h^{-1}(V)$  contains a converging subsequence. Since  $V \subset U(\mathcal{K}) \times U(\mathcal{K})$  is compact, by passing to a subsequence we may assume that the sequence

$$\{h(\mathbf{r}^{(k)}, \mathbf{z}^{(k)})\} = \{(\mathbf{r}^{(k)}\mathbf{z}^{(k)}, \mathbf{z}^{(k)})\}$$

has a limit in  $U(\mathcal{K}) \times U(\mathcal{K})$ . We set  $\mathbf{w}^{(k)} = \mathbf{r}^{(k)}\mathbf{z}^{(k)}$ , and assume that

$$\{\mathbf{w}^{(k)}\} \rightarrow \mathbf{w} = (w_1, \dots, w_m), \quad \{\mathbf{z}^{(k)}\} \rightarrow \mathbf{z} = (z_1, \dots, z_m)$$

for some  $\mathbf{w}, \mathbf{z} \in U(\mathcal{K})$ . We need to show that a subsequence of  $\{\mathbf{r}^{(k)}\}$  has limit in  $R$ . We write

$$\mathbf{r}^{(k)} = (g_1^{(k)}, \dots, g_m^{(k)}) = (e^{\alpha_1^{(k)}}, \dots, e^{\alpha_m^{(k)}}) \in R \subset \mathbb{R}_{>}^m,$$

$\alpha_j^{(k)} \in \mathbb{R}$ . By passing to a subsequence we may assume that each sequence  $\{\alpha_j^{(k)}\}$ ,  $j = 1, \dots, m$ , has a finite or infinite limit (including  $\pm\infty$ ). Let

$$I_+ = \{j : \alpha_j^{(k)} \rightarrow +\infty\} \subset [m], \quad I_- = \{j : \alpha_j^{(k)} \rightarrow -\infty\} \subset [m].$$

Since the sequences  $\{\mathbf{z}^{(k)}\}$ ,  $\{\mathbf{w}^{(k)} = \mathbf{r}^{(k)} \mathbf{z}^{(k)}\}$  converge to  $\mathbf{z}$ ,  $\mathbf{w} \in U(\mathcal{K})$  respectively, we have  $z_j = 0$  for  $j \in I_+$  and  $w_j = 0$  for  $j \in I_-$ . Then it follows from the decomposition  $U(\mathcal{K}) = \bigcup_{I \in \mathcal{K}} (\mathbb{C}, \mathbb{C}^\times)^I$  that  $I_+$  and  $I_-$  are simplices of  $\mathcal{K}$ . Let  $\sigma_+, \sigma_-$  be the corresponding cones of the simplicial fan  $\Sigma$ . Then  $\sigma_+ \cap \sigma_- = \{\mathbf{0}\}$  by definition of a fan. By Lemma 2.1.2, there exists a linear function  $\mathbf{u} \in N_{\mathbb{R}}^*$  such that  $\langle \mathbf{u}, \mathbf{a} \rangle > 0$  for any nonzero  $\mathbf{a} \in \sigma_+$ , and  $\langle \mathbf{u}, \mathbf{a} \rangle < 0$  for any nonzero  $\mathbf{a} \in \sigma_-$ . Since  $\mathbf{r}^{(k)} \in R$ , it follows from (6.19) that

$$(6.20) \quad \sum_{j=1}^m \alpha_j^{(k)} \langle \mathbf{u}, \mathbf{a}_j \rangle = 0.$$

This implies that both  $I_+$  and  $I_-$  are empty, as otherwise the latter sum tends to infinity. Thus, each sequence  $\{\alpha_j^{(k)}\}$  has a finite limit  $\alpha_j$ , and a subsequence of  $\{\mathbf{r}^{(k)}\}$  converges to  $(e^{\alpha_1}, \dots, e^{\alpha_m})$ . Passing to the limit in (6.20) we obtain that  $(e^{\alpha_1}, \dots, e^{\alpha_m}) \in R$ . This proves the properness of the action. Since the Lie group  $R$  acts smoothly, freely and properly on the smooth manifold  $U(\mathcal{K})$ , the orbit space  $U(\mathcal{K})/R$  is Hausdorff and smooth by the standard result [193, Theorem 9.16].

In the case of complete fan it is possible to construct a smooth atlas on  $U(\mathcal{K})/R$  explicitly. To do this, it is convenient to pre-factorise everything by the action of  $\mathbb{T}^m$ , as in the proof of Theorem 4.7.5. We have

$$U(\mathcal{K})/\mathbb{T}^m = (\mathbb{R}_{\geq}, \mathbb{R}_{>})^{\mathcal{K}} = \bigcup_{I \in \mathcal{K}} (\mathbb{R}_{\geq}, \mathbb{R}_{>})^I.$$

Since the fan  $\Sigma$  is complete, we may take the union above only over  $n$ -element simplices  $I = \{i_1, \dots, i_n\} \in \mathcal{K}$ . Consider one such simplex  $I$ ; the generators of the corresponding  $n$ -dimensional cone  $\sigma \in \Sigma$  are  $\mathbf{a}_{i_1}, \dots, \mathbf{a}_{i_n}$ . Let  $\mathbf{u}_1, \dots, \mathbf{u}_n$  be the dual basis of  $N_{\mathbb{R}}^*$  (which is a generator set of the dual cone  $\sigma^\vee$ ). Then we have  $\langle \mathbf{a}_{i_k}, \mathbf{u}_j \rangle = \delta_{kj}$ . Now consider the map

$$p_I: (\mathbb{R}_{\geq}, \mathbb{R}_{>})^I \rightarrow \mathbb{R}_{\geq}^n \\ (y_1, \dots, y_m) \mapsto \left( \prod_{i=1}^m y_i^{\langle \mathbf{a}_i, \mathbf{u}_1 \rangle}, \dots, \prod_{i=1}^m y_i^{\langle \mathbf{a}_i, \mathbf{u}_n \rangle} \right),$$

where we set  $0^0 = 1$ . Note that zero does not occur with a negative exponent in the right hand side, hence  $p_I$  is well defined as a continuous map. Each  $(\mathbb{R}_{\geq}, \mathbb{R}_{>})^I$  is  $R$ -invariant, and it follows from (6.19) that  $p_I$  induces an injective map

$$q_I: (\mathbb{R}_{\geq}, \mathbb{R}_{>})^I/R \rightarrow \mathbb{R}_{\geq}^n.$$

This map is also surjective since every  $(x_1, \dots, x_n) \in \mathbb{R}_{\geq}^n$  is covered by  $(y_1, \dots, y_m)$  where  $y_{i_j} = x_j$  for  $1 \leq j \leq n$  and  $y_k = 1$  for  $k \notin \{i_1, \dots, i_n\}$ . Hence,  $q_I$  is a homeomorphism. It is covered by a  $\mathbb{T}^m$ -equivariant homeomorphism

$$\bar{q}_I: (\mathbb{C}, \mathbb{C}^\times)^I/R \rightarrow \mathbb{C}^n \times \mathbb{T}^{m-n},$$

where  $\mathbb{C}^n$  is identified with the quotient  $\mathbb{R}_{\geq}^n \times \mathbb{T}^n / \sim$ , see (6.7). Since  $U(\mathcal{K})/R$  is covered by open subsets  $(\mathbb{C}, \mathbb{C}^\times)^I/R$ , and  $\mathbb{C}^n \times \mathbb{T}^{m-n}$  embeds as an open subset in  $\mathbb{R}^{m+n}$ , the set of homeomorphisms  $\{\bar{q}_I: I \in \mathcal{K}\}$  provides an atlas for  $U(\mathcal{K})/R$ . The change of coordinates transformations  $\bar{q}_j \bar{q}_I^{-1}: \mathbb{C}^n \times \mathbb{T}^{m-n} \rightarrow \mathbb{C}^n \times \mathbb{T}^{m-n}$  are smooth by inspection; thus  $U(\mathcal{K})/R$  is a smooth manifold.

REMARK. The set of homeomorphisms  $\{q_I: (\mathbb{R}_{\geq}, \mathbb{R}_{>})^I/R \rightarrow \mathbb{R}_{\geq}^n\}$  defines an atlas for the smooth manifold with corners  $\mathcal{Z}_{\mathcal{K}}/\mathbb{T}^m$ . If  $\mathcal{K} = \mathcal{K}_P$  for a simple polytope  $P$ , then this smooth structure with corners coincides with that of  $P$ .

It remains to prove statement (c), that is, identify  $U(\mathcal{K})/R$  with  $\mathcal{Z}_{\mathcal{K}}$ . If  $X$  is a Hausdorff locally compact space with a proper  $G$ -action, and  $Y \subset X$  a compact subspace which intersects every  $G$ -orbit at a single point, then  $Y$  is homeomorphic to the orbit space  $X/G$ . Therefore, we need to verify that each  $R$ -orbit intersects  $\mathcal{Z}_{\mathcal{K}} \subset U(\mathcal{K})$  at a single point. We first prove that the  $R$ -orbit of any  $\mathbf{y} \in U(\mathcal{K})/\mathbb{T}^m = (\mathbb{R}_{\geq}, \mathbb{R}_{>})^{\mathcal{K}}$  intersects  $\mathcal{Z}_{\mathcal{K}}/\mathbb{T}^m$  at a single point. For this we use the cubical decomposition  $\text{cc}(\mathcal{K}) = (\mathbb{I}, 1)^{\mathcal{K}}$  of  $\mathcal{Z}_{\mathcal{K}}/\mathbb{T}^m$ , see Example 4.2.6.2.

Assume first that  $\mathbf{y} \in \mathbb{R}_{>}^m$ . The  $R$ -action on  $\mathbb{R}_{>}^m$  is obtained by exponentiating the linear action of  $\text{Ker } A$  on  $\mathbb{R}^m$ . Consider the subset  $(\mathbb{R}_{\leq}, 0)^{\mathcal{K}} \subset \mathbb{R}^m$ , where  $\mathbb{R}_{\leq}$  denotes the set of nonpositive reals. It is taken by the exponential map  $\exp: \mathbb{R}^m \rightarrow \mathbb{R}_{>}^m$  homeomorphically onto  $\text{cc}^{\circ}(\mathcal{K}) = ((0, 1], 1)^{\mathcal{K}} \subset \mathbb{R}_{>}^m$ , where  $(0, 1]$  is denotes the semi-interval  $\{y \in \mathbb{R}: 0 < y \leq 1\}$ . The map

$$(6.21) \quad A: (\mathbb{R}_{\leq}, 0)^{\mathcal{K}} \rightarrow N_{\mathbb{R}}$$

takes every  $(\mathbb{R}_{\leq}, 0)^I$  to  $-\sigma$ , where  $\sigma \in \Sigma$  is the cone corresponding to  $I \in \mathcal{K}$ . Since  $\Sigma$  is complete, map (6.21) is one-to-one.

The orbit of  $\mathbf{y}$  under the action of  $R$  consists of points  $\mathbf{w} \in \mathbb{R}_{>}^m$  such that  $\exp A\mathbf{w} = \exp A\mathbf{y}$ . Since  $A\mathbf{y} \in N_{\mathbb{R}}$  and map (6.21) is one-to-one, there is a unique point  $\mathbf{y}' \in (\mathbb{R}_{\leq}, 0)^{\mathcal{K}}$  such that  $A\mathbf{y}' = A\mathbf{y}$ . Since  $\exp A\mathbf{y}' \subset \text{cc}^{\circ}(\mathcal{K})$ , the  $R$ -orbit of  $\mathbf{y}$  intersects  $\text{cc}^{\circ}(\mathcal{K})$  and therefore  $\text{cc}(\mathcal{K})$  at a unique point.

Now let  $\mathbf{y} \in (\mathbb{R}_{\geq}, \mathbb{R}_{>})^{\mathcal{K}}$  be an arbitrary point. Let  $\omega(\mathbf{y}) \in \mathcal{K}$  be the set of zero coordinates of  $\mathbf{y}$ , and let  $\sigma \in \Sigma$  be the cone corresponding to  $\omega(\mathbf{y})$ . The cones containing  $\sigma$  constitute a fan  $\text{st } \sigma$  (called the *star* of  $\sigma$ ) in the quotient space  $N_{\mathbb{R}}/\mathbb{R}\langle \mathbf{a}_i: i \in \omega(\mathbf{y}) \rangle$ . The underlying simplicial complex of  $\text{st } \sigma$  is the link  $\text{lk}_{\mathcal{K}} \omega(\mathbf{y})$  of  $\omega(\mathbf{y})$  in  $\mathcal{K}$ . Now observe that the action of  $R$  on the set

$$\{(y_1, \dots, y_m) \in (\mathbb{R}_{\geq}, \mathbb{R}_{>})^{\mathcal{K}}: y_i = 0 \text{ for } i \in \omega(\mathbf{y})\} \cong (\mathbb{R}_{\geq}, \mathbb{R}_{>})^{\text{lk}_{\mathcal{K}} \omega(\mathbf{y})}$$

coincides with the action of the group  $R_{\text{st } \sigma}$  (defined by the fan  $\text{st } \sigma$ ). Now we can repeat the above arguments for the complete fan  $\text{st } \sigma$  and the action of  $R_{\text{st } \sigma}$  on  $(\mathbb{R}_{\geq}, \mathbb{R}_{>})^{\text{lk}_{\mathcal{K}} \omega(\mathbf{y})}$ . As a result, we obtain that every  $R$ -orbit intersects  $\text{cc}(\mathcal{K})$  at a unique point.

To finish the proof of (c) we consider the commutative diagram

$$\begin{array}{ccc} \mathcal{Z}_{\mathcal{K}} & \longrightarrow & U(\mathcal{K}) \\ \downarrow & & \downarrow \pi \\ \text{cc}(\mathcal{K}) & \longrightarrow & (\mathbb{R}_{\geq}, \mathbb{R}_{>})^{\mathcal{K}} \end{array}$$

where the horizontal arrows are embeddings and the vertical ones are projections onto the quotients of  $\mathbb{T}^m$ -actions. Note that the projection  $\pi$  commutes with the  $R$ -actions on  $U(\mathcal{K})$  and  $(\mathbb{R}_{\geq}, \mathbb{R}_{>})^{\mathcal{K}}$ , and the subgroups  $R$  and  $\mathbb{T}^m$  of  $(\mathbb{C}^{\times})^m$  intersect trivially. It follows that every  $R$ -orbit intersects the full preimage  $\pi^{-1}(\text{cc}(\mathcal{K})) = \mathcal{Z}_{\mathcal{K}}$  at a unique point. Indeed, assume that  $\mathbf{z}$  and  $\mathbf{r}\mathbf{z}$  are in  $\mathcal{Z}_{\mathcal{K}}$  for some  $\mathbf{z} \in U(\mathcal{K})$  and  $\mathbf{r} \in R$ . Then  $\pi(\mathbf{z})$  and  $\pi(\mathbf{r}\mathbf{z}) = \mathbf{r}\pi(\mathbf{z})$  are in  $\text{cc}(\mathcal{K})$ , which implies that  $\pi(\mathbf{z}) = \pi(\mathbf{r}\mathbf{z})$ . Hence,  $\mathbf{z} = \mathbf{t}\mathbf{r}\mathbf{z}$  for some  $\mathbf{t} \in \mathbb{T}^m$ . We may assume that  $\mathbf{z} \in (\mathbb{C}^{\times})^m$ , so that the action of both  $R$  and  $\mathbb{T}^m$  is free (otherwise consider the action on  $U(\text{lk}_{\mathcal{K}} \omega(\mathbf{z}))$ ). It follows that  $\mathbf{t}\mathbf{r} = \mathbf{1}$ , which implies that  $\mathbf{r} = \mathbf{1}$ , since  $R \cap \mathbb{T}^m = \{\mathbf{1}\}$ .  $\square$

We do not know if Theorem 6.5.2 generalises to other sphere triangulations:

**PROBLEM 6.5.3.** Describe the class of sphere triangulations  $\mathcal{K}$  for which the moment-angle manifold  $\mathcal{Z}_{\mathcal{K}}$  admits a smooth structure.

**REMARK.** Even if  $\mathcal{Z}_{\mathcal{K}}$  admits a smooth structure for some simplicial complexes  $\mathcal{K}$  not arising from fans, such a structure does not come from a quotient  $U(\mathcal{K})/R$  determined by data  $\{\mathcal{K}; \mathbf{a}_1, \dots, \mathbf{a}_m\}$ . Like in the toric case (see Section 5.4), the  $R$ -action on  $U(\mathcal{K})$  is proper and the quotient  $U(\mathcal{K})/R$  is Hausdorff *precisely when*  $\{\mathcal{K}; \mathbf{a}_1, \dots, \mathbf{a}_m\}$  defines a fan, i.e. the simplicial cones generated by any two subsets  $\{\mathbf{a}_i : i \in I\}$  and  $\{\mathbf{a}_j : j \in J\}$  with  $I, J \in \mathcal{K}$  can be separated by a hyperplane. This observation is originally due to Bosio [35], see also [6, §II.3] and [25].

### 6.6. Complex structures on moment-angle manifolds

Let  $\mathcal{Z}_{\mathcal{K}}$  be the moment-angle manifold corresponding to a complete simplicial fan  $\Sigma$  defined by data  $\{\mathcal{K}; \mathbf{a}_1, \dots, \mathbf{a}_m\}$ . We assume that the dimension  $m + n$  of  $\mathcal{Z}_{\mathcal{K}}$  is even, and set  $m - n = 2\ell$ . This can always be achieved by adding a ghost vertex with any corresponding vector to our data  $\{\mathcal{K}; \mathbf{a}_1, \dots, \mathbf{a}_m\}$ ; topologically this results in multiplying  $\mathcal{Z}_{\mathcal{K}}$  by a circle. Here we show that  $\mathcal{Z}_{\mathcal{K}}$  admits a structure of a complex manifold. The idea is to replace the action of  $R \cong \mathbb{R}^{m-n}$  on  $U(\mathcal{K})$  (whose quotient is  $\mathcal{Z}_{\mathcal{K}}$ ) by a holomorphic action of  $\mathbb{C}^{\frac{m-n}{2}}$  on the same space.

We identify  $\mathbb{C}^m$  (as a real vector space) with  $\mathbb{R}^{2m}$  using the map

$$(z_1, \dots, z_m) \mapsto (x_1, y_1, \dots, x_m, y_m),$$

where  $z_k = x_k + iy_k$ , and consider the  $\mathbb{R}$ -linear map

$$\operatorname{Re}: \mathbb{C}^m \rightarrow \mathbb{R}^m, \quad (z_1, \dots, z_m) \mapsto (x_1, \dots, x_m).$$

In order to obtain a complex structure on the quotient  $\mathcal{Z}_{\mathcal{K}} \cong U(\mathcal{K})/R$  we replace the action of  $R$  by the action of a holomorphic subgroup  $C \subset (\mathbb{C}^\times)^m$  by means of the following construction.

**CONSTRUCTION 6.6.1.** Let  $\mathbf{a}_1, \dots, \mathbf{a}_m$  be a configuration of vectors that span  $N_{\mathbb{R}} \cong \mathbb{R}^n$ , and assume that  $m - n = 2\ell$ . Some of the  $\mathbf{a}_i$ 's may be zero. Recall the map  $A: \mathbb{R}^m \rightarrow N_{\mathbb{R}}$ ,  $\mathbf{e}_i \mapsto \mathbf{a}_i$ .

We choose a complex  $\ell$ -dimensional subspace in  $\mathbb{C}^m$  which projects isomorphically onto the real  $(m - n)$ -dimensional subspace  $\operatorname{Ker} A \subset \mathbb{R}^m$ . More precisely, let  $\mathfrak{c} \cong \mathbb{C}^\ell$ , and choose a linear map  $\Psi: \mathfrak{c} \rightarrow \mathbb{C}^m$  satisfying the two conditions:

- (a) the composite map  $\mathfrak{c} \xrightarrow{\Psi} \mathbb{C}^m \xrightarrow{\operatorname{Re}} \mathbb{R}^m$  is a monomorphism;
- (b) the composite map  $\mathfrak{c} \xrightarrow{\Psi} \mathbb{C}^m \xrightarrow{\operatorname{Re}} \mathbb{R}^m \xrightarrow{A} N_{\mathbb{R}}$  is zero.

These two conditions are equivalent to the following:

- (a')  $\Psi(\mathfrak{c}) \cap \overline{\Psi(\mathfrak{c})} = \{\mathbf{0}\}$ ;
- (b')  $\Psi(\mathfrak{c}) \subset \operatorname{Ker}(A_{\mathbb{C}}: \mathbb{C}^m \rightarrow N_{\mathbb{C}})$ ,

where  $\overline{\Psi(\mathfrak{c})}$  is the complex conjugate space and  $A_{\mathbb{C}}: \mathbb{C}^m \rightarrow N_{\mathbb{C}}$  is the complexification of the real map  $A: \mathbb{R}^m \rightarrow N_{\mathbb{R}}$ . Consider the following commutative diagram:

$$(6.22) \quad \begin{array}{ccccccc} \mathfrak{c} & \xrightarrow{\Psi} & \mathbb{C}^m & \xrightarrow{\operatorname{Re}} & \mathbb{R}^m & \xrightarrow{A} & N_{\mathbb{R}} \\ & & \downarrow \exp & & \downarrow \exp & & \\ & & (\mathbb{C}^\times)^m & \xrightarrow{|\cdot|} & \mathbb{R}_{>}^m & & \end{array}$$

where the vertical arrows are the componentwise exponential maps, and  $|\cdot|$  denotes the map  $(z_1, \dots, z_m) \mapsto (|z_1|, \dots, |z_m|)$ . Now set

$$(6.23) \quad C_\Psi = \exp \Psi(\mathfrak{c}) = \{ (e^{\langle \psi_1, \mathbf{w} \rangle}, \dots, e^{\langle \psi_m, \mathbf{w} \rangle}) \in (\mathbb{C}^\times)^m \}$$

where  $\mathbf{w} \in \mathfrak{c}$  and  $\psi_k \in \mathfrak{c}^*$  is given by the  $k$ th coordinate projection  $\mathfrak{c} \xrightarrow{\Psi} \mathbb{C}^m \rightarrow \mathbb{C}$ . Then  $C_\Psi \cong \mathbb{C}^\ell$  is a complex-analytic (but not algebraic) subgroup in  $(\mathbb{C}^\times)^m$ , and therefore there is a holomorphic action of  $C_\Psi$  on  $\mathbb{C}^m$  and  $U(\mathcal{K})$  by restriction.

EXAMPLE 6.6.2. Let  $\mathbf{a}_1, \dots, \mathbf{a}_m$  be the configuration of  $m = 2\ell$  zero vectors. We supplement it by the empty simplicial complex  $\mathcal{K}$  on  $[m]$  (with  $m$  ghost vertices), so that the data  $\{\mathcal{K}; \mathbf{a}_1, \dots, \mathbf{a}_m\}$  define a complete fan in 0-dimensional space. Then  $A: \mathbb{R}^m \rightarrow \mathbb{R}^0$  is a zero map, and condition (b) of Construction 6.6.1 is void. Condition (a) means that  $\mathfrak{c} \xrightarrow{\Psi} \mathbb{C}^{2\ell} \xrightarrow{\text{Re}} \mathbb{R}^{2\ell}$  is an isomorphism of real spaces.

Consider the quotient  $(\mathbb{C}^\times)^m / C_\Psi$  (note that  $U(\mathcal{K}) = (\mathbb{C}^\times)^m$  in our case). The exponential map  $\mathbb{C}^m \rightarrow (\mathbb{C}^\times)^m$  identifies  $(\mathbb{C}^\times)^m$  with the quotient of  $\mathbb{C}^m$  by the imaginary lattice  $\Gamma = \mathbb{Z}\langle 2\pi i \mathbf{e}_1, \dots, 2\pi i \mathbf{e}_m \rangle$ . Condition (a) implies that the projection  $p: \mathbb{C}^m \rightarrow \mathbb{C}^m / \Psi(\mathfrak{c})$  is nondegenerate on the imaginary subspace of  $\mathbb{C}^m$ . In particular,  $p(\Gamma)$  is a lattice of rank  $m = 2\ell$  in  $\mathbb{C}^m / \Psi(\mathfrak{c}) \cong \mathbb{C}^\ell$ . Therefore,

$$(\mathbb{C}^\times)^m / C_\Psi \cong (\mathbb{C}^m / \Gamma) / \Psi(\mathfrak{c}) = (\mathbb{C}^m / \Psi(\mathfrak{c})) / p(\Gamma) \cong \mathbb{C}^\ell / p(\Gamma)$$

is a complex compact  $\ell$ -dimensional torus.

Any complex torus can be obtained in this way. Indeed, let  $\Psi: \mathfrak{c} \rightarrow \mathbb{C}^m$  be given by an  $2\ell \times \ell$ -matrix  $\begin{pmatrix} -B \\ I \end{pmatrix}$  where  $I$  is the unit matrix and  $B$  is a square matrix of size  $\ell$ . Then  $p: \mathbb{C}^m \rightarrow \mathbb{C}^m / \Psi(\mathfrak{c})$  is given by the matrix  $(IB)$  in appropriate bases, and  $(\mathbb{C}^\times)^m / C_\Psi$  is isomorphic to the quotient of  $\mathbb{C}^\ell$  by the lattice  $\mathbb{Z}\langle \mathbf{e}_1, \dots, \mathbf{e}_\ell, \mathbf{b}_1, \dots, \mathbf{b}_\ell \rangle$ , where  $\mathbf{b}_k$  is the  $k$ th column of  $B$ . (Condition (b) implies that the imaginary part of  $B$  is nondegenerate.)

For example, if  $\ell = 1$ , then  $\Psi: \mathbb{C} \rightarrow \mathbb{C}^2$  is given by  $w \mapsto (\beta w, w)$  for some  $\beta \in \mathbb{C}$ , so that subgroup (6.23) is

$$C_\Psi = \{ (e^{\beta w}, e^w) \} \subset (\mathbb{C}^\times)^2.$$

Condition (a) implies that  $\beta \notin \mathbb{R}$ . Then  $\exp \Psi: \mathbb{C} \rightarrow (\mathbb{C}^\times)^2$  is an embedding, and

$$(\mathbb{C}^\times)^2 / C_\Psi \cong \mathbb{C} / (\mathbb{Z} \oplus \beta \mathbb{Z}) = T_{\mathbb{C}}^1(\beta)$$

is a complex 1-dimensional torus with lattice parameter  $\beta \in \mathbb{C}$ .

THEOREM 6.6.3 ([262]). *Assume that data  $\{\mathcal{K}; \mathbf{a}_1, \dots, \mathbf{a}_m\}$  define a complete fan  $\Sigma$  in  $N_{\mathbb{R}} \cong \mathbb{R}^n$ , and  $m - n = 2\ell$ . Let  $C_\Psi \cong \mathbb{C}^\ell$  be the group given by (6.23). Then*

- (a) *the holomorphic action of  $C_\Psi$  on  $U(\mathcal{K})$  is free and proper, and the quotient  $U(\mathcal{K}) / C_\Psi$  has a structure of a compact complex manifold;*
- (b)  *$U(\mathcal{K}) / C_\Psi$  is diffeomorphic to the moment-angle manifold  $\mathcal{Z}_{\mathcal{K}}$ .*

*Therefore,  $\mathcal{Z}_{\mathcal{K}}$  has a complex structure, in which each element of  $\mathbb{T}^m$  acts by a holomorphic transformation.*

REMARK. A result similar to Theorem 6.6.3 was obtained by Tambour [301]. The approach of Tambour was somewhat different; he constructed complex structures on manifolds  $\mathcal{Z}_{\mathcal{K}}$  arising from *rationally* starshaped spheres  $\mathcal{K}$  (underlying



complexes of complete rational simplicial fans) by relating them to a class of generalised LVM-manifolds described by Bosio in [35].

**PROOF OF THEOREM 6.6.3.** We first prove statement (a). The stabilisers of the  $(\mathbb{C}^\times)^m$ -action on  $U(\mathcal{K})$  are of the form  $(\mathbb{C}^\times, 1)^I$  for  $I \in \mathcal{K}$ . In order to show that  $C_\Psi \subset (\mathbb{C}^\times)^m$  acts freely we need to check that  $C_\Psi$  has trivial intersection with any stabiliser of the  $(\mathbb{C}^\times)^m$ -action. Since  $C_\Psi$  embeds into  $\mathbb{R}_>^m$  by (6.22), it is enough to check that the image of  $C_\Psi$  in  $\mathbb{R}_>^m$  intersects the image of  $(\mathbb{C}^\times, 1)^I$  in  $\mathbb{R}_>^m$  trivially. The former image is  $R$  and the latter image is  $(\mathbb{R}_>, 1)^I$ ; the triviality of their intersection follows from Theorem 6.5.2 (a).

Now we prove the properness of this action. Consider the projection  $\pi: U(\mathcal{K}) \rightarrow (\mathbb{R}_\geq, \mathbb{R}_>)^{\mathcal{K}}$  onto the quotient of the  $\mathbb{T}^m$ -action, and the commutative square

$$\begin{array}{ccc} C_\Psi \times U(\mathcal{K}) & \xrightarrow{h_{\mathbb{C}}} & U(\mathcal{K}) \times U(\mathcal{K}) \\ \downarrow f \times \pi & & \downarrow \pi \times \pi \\ R \times (\mathbb{R}_\geq, \mathbb{R}_>)^{\mathcal{K}} & \xrightarrow{h_{\mathbb{R}}} & (\mathbb{R}_\geq, \mathbb{R}_>)^{\mathcal{K}} \times (\mathbb{R}_\geq, \mathbb{R}_>)^{\mathcal{K}} \end{array}$$

where  $h_{\mathbb{C}}$  and  $h_{\mathbb{R}}$  denote the group action maps, and  $f: C_\Psi \rightarrow R$  is the isomorphism given by the restriction of  $|\cdot|: (\mathbb{C}^\times)^m \rightarrow \mathbb{R}_>^m$ . The preimage  $h_{\mathbb{C}}^{-1}(V)$  of a compact subset  $V \in U(\mathcal{K}) \times U(\mathcal{K})$  is a closed subset in  $W = (f \times \pi)^{-1} \circ h_{\mathbb{R}}^{-1} \circ (\pi \times \pi)(V)$ . The image  $(\pi \times \pi)(V)$  is compact, the action of  $R$  on  $(\mathbb{R}_\geq, \mathbb{R}_>)^{\mathcal{K}}$  is proper by Theorem 6.5.2 (b), and the map  $f \times \pi$  is proper as the quotient projection for a compact group action. Hence,  $W$  is a compact subset in  $C_\Psi \times U(\mathcal{K})$ , and  $h_{\mathbb{C}}^{-1}(V)$  is compact as a closed subset in  $W$ .

The group  $C_\Psi \cong \mathbb{C}^l$  acts holomorphically, freely and properly on the complex manifold  $U(\mathcal{K})$ , therefore the quotient manifold  $U(\mathcal{K})/C_\Psi$  has a complex structure.

As in the proof of Theorem 6.5.2, it is possible to describe a holomorphic atlas of  $U(\mathcal{K})/C_\Psi$ . Since the action of  $C_\Psi$  on the quotient  $U(\mathcal{K})/\mathbb{T}^m = (\mathbb{R}_\geq, \mathbb{R}_>)^{\mathcal{K}}$  coincides with the action of  $R$  on the same space, the quotient of  $U(\mathcal{K})/C_\Psi$  by the action of  $\mathbb{T}^m$  has exactly the same structure of a smooth manifold with corners as the quotient of  $U(\mathcal{K})/R$  by  $\mathbb{T}^m$  (see the proof of Theorem 6.5.2). This structure is determined by the atlas  $\{q_I: (\mathbb{R}_\geq, \mathbb{R}_>)^I/R \rightarrow \mathbb{R}_\geq^I\}$ , which lifts to a covering of  $U(\mathcal{K})/C_\Psi$  by the open subsets  $(\mathbb{C}, \mathbb{C}^\times)^I/C_\Psi$ . For any  $I \in \mathcal{K}$ , the subset  $(\mathbb{C}, \mathbb{T})^I \subset (\mathbb{C}, \mathbb{C}^\times)^I$  intersects each orbit of the  $C_\Psi$ -action on  $(\mathbb{C}, \mathbb{C}^\times)^I$  transversely at a single point. Therefore, every  $(\mathbb{C}, \mathbb{C}^\times)^I/C_\Psi \cong (\mathbb{C}, \mathbb{T})^I$  acquires a structure of a complex manifold. Since  $(\mathbb{C}, \mathbb{C}^\times)^I \cong \mathbb{C}^n \times (\mathbb{C}^\times)^{m-n}$ , and the action of  $C_\Psi$  on the  $(\mathbb{C}^\times)^{m-n}$  factor is free, the complex manifold  $(\mathbb{C}, \mathbb{C}^\times)^I/C_\Psi$  is the total space of a holomorphic  $\mathbb{C}^n$ -bundle over the complex torus  $(\mathbb{C}^\times)^{m-n}/C_\Psi$  (see Example 6.6.2). Writing trivialisations of these  $\mathbb{C}^n$ -bundles for every  $I$ , we obtain a holomorphic atlas for  $U(\mathcal{K})/C_\Psi$ .

The proof of statement (b) follows the lines of the proof of Theorem 6.5.2 (b). We need to show that each  $C_\Psi$ -orbit intersects  $\mathcal{Z}_{\mathcal{K}} \subset U(\mathcal{K})$  at a single point. First we show that the  $C_\Psi$ -orbit of any point in  $U(\mathcal{K})/\mathbb{T}^m$  intersects  $\mathcal{Z}_{\mathcal{K}}/\mathbb{T}^m = \text{cc}(\mathcal{K})$  at a single point; this follows from the fact that the actions of  $C_\Psi$  and  $R$  coincide on  $U(\mathcal{K})/\mathbb{T}^m$ . Then we show that each  $C_\Psi$ -orbit intersects the preimage  $\pi^{-1}(\text{cc}(\mathcal{K}))$  at a single point, using the fact that  $C_\Psi$  and  $\mathbb{T}^m$  have trivial intersection in  $(\mathbb{C}^\times)^m$ .  $\square$

**EXAMPLE 6.6.4 (Hopf manifold).** Let  $\mathbf{a}_1, \dots, \mathbf{a}_{n+1}$  be a set of vectors which span  $N_{\mathbb{R}} \cong \mathbb{R}^n$  and satisfy a linear relation  $\lambda_1 \mathbf{a}_1 + \dots + \lambda_{n+1} \mathbf{a}_{n+1} = \mathbf{0}$  with all  $\lambda_k > 0$ . Let  $\Sigma$  be the complete simplicial fan in  $N_{\mathbb{R}}$  whose cones are generated by

all proper subsets of  $\mathbf{a}_1, \dots, \mathbf{a}_{n+1}$ . To make  $m - n$  even we add one more ghost vector  $\mathbf{a}_{n+2}$ . Hence  $m = n + 2$ ,  $\ell = 1$ , and we have one more linear relation  $\mu_1 \mathbf{a}_1 + \dots + \mu_{n+1} \mathbf{a}_{n+1} + \mathbf{a}_{n+2} = \mathbf{0}$  with  $\mu_k \in \mathbb{R}$ . The subspace  $\text{Ker } A \subset \mathbb{R}^{n+2}$  is spanned by  $(\lambda_1, \dots, \lambda_{n+1}, 0)$  and  $(\mu_1, \dots, \mu_{n+1}, 1)$ .

Then  $\mathcal{K} = \mathcal{K}_\Sigma$  is the boundary of an  $n$ -dimensional simplex with  $n + 1$  vertices and one ghost vertex,  $\mathcal{Z}_\mathcal{K} \cong S^{2n+1} \times S^1$ , and  $U(\mathcal{K}) = (\mathbb{C}^{n+1} \setminus \{\mathbf{0}\}) \times \mathbb{C}^\times$ .

Conditions (a) and (b) of Construction 6.6.1 imply that  $C_\Psi$  is a 1-dimensional subgroup in  $(\mathbb{C}^\times)^m$  given in appropriate coordinates by

$$C_\Psi = \{(e^{\zeta_1 w}, \dots, e^{\zeta_{n+1} w}, e^w) : w \in \mathbb{C}\} \subset (\mathbb{C}^\times)^m,$$

where  $\zeta_k = \mu_k + \alpha \lambda_k$  for some  $\alpha \in \mathbb{C} \setminus \mathbb{R}$ . By changing the basis of  $\text{Ker } A$  if necessary, we may assume that  $\alpha = i$ . The moment-angle manifold  $\mathcal{Z}_\mathcal{K} \cong S^{2n+1} \times S^1$  acquires a complex structure as the quotient  $U(\mathcal{K})/C_\Psi$ :

$$\begin{aligned} & (\mathbb{C}^{n+1} \setminus \{\mathbf{0}\}) \times \mathbb{C}^\times / \{(z_1, \dots, z_{n+1}, t) \sim (e^{\zeta_1 w} z_1, \dots, e^{\zeta_{n+1} w} z_{n+1}, e^w t)\} \\ & \cong (\mathbb{C}^{n+1} \setminus \{\mathbf{0}\}) / \{(z_1, \dots, z_{n+1}) \sim (e^{2\pi i \zeta_1} z_1, \dots, e^{2\pi i \zeta_{n+1}} z_{n+1})\}, \end{aligned}$$

where  $\mathbf{z} \in \mathbb{C}^{n+1} \setminus \{\mathbf{0}\}$ ,  $t \in \mathbb{C}^\times$ . The latter is the quotient of  $\mathbb{C}^{n+1} \setminus \{\mathbf{0}\}$  by a diagonalisable action of  $\mathbb{Z}$ . It is known as a *Hopf manifold*. For  $n = 0$  we obtain the complex torus of Example 6.6.2.

Theorem 6.6.3 can be generalised to the quotients of  $\mathcal{Z}_\mathcal{K}$  by freely acting subgroups  $H \subset \mathbb{T}^m$ , or *partial quotients* of  $\mathcal{Z}_\mathcal{K}$  in the sense of [55, §7.5]. These include both toric manifolds and LVM-manifolds:

**CONSTRUCTION 6.6.5.** Let  $\Sigma$  be a complete simplicial fan in  $N_\mathbb{R}$  defined by data  $\{\mathcal{K}; \mathbf{a}_1, \dots, \mathbf{a}_m\}$ , and let  $H \subset \mathbb{T}^m$  be a subgroup which acts freely on the corresponding moment-angle manifold  $\mathcal{Z}_\mathcal{K}$ . Then  $H$  is a product of a torus and a finite group, and  $h = \dim H \leq m - n$  by Proposition 5.4.6 ( $H$  must intersect trivially with an  $n$ -dimensional coordinate subtorus in  $\mathbb{T}^m$ ). Under an additional assumption on  $H$ , we shall define a holomorphic subgroup  $D$  in  $(\mathbb{C}^\times)^m$  and introduce a complex structure on  $\mathcal{Z}_\mathcal{K}/H$  by identifying it with the quotient  $U(\mathcal{K})/D$ .

The additional assumption is the compatibility with the fan data. Recall the map  $A: \mathbb{R}^m \rightarrow N_\mathbb{R}$ ,  $\mathbf{e}_i \mapsto \mathbf{a}_i$ , and let  $\mathfrak{h} \subset \mathbb{R}^m$  be the Lie algebra of  $H \subset \mathbb{T}^m$ . We assume that  $\mathfrak{h} \subset \text{Ker } A$ . We also assume that  $2\ell = m - n - h$  is even (this can be satisfied by adding a zero vector to  $\mathbf{a}_1, \dots, \mathbf{a}_m$ ). Let  $T = \mathbb{T}^m/H$  be the quotient torus,  $\mathfrak{t}$  its Lie algebra, and  $\rho: \mathbb{R}^m \rightarrow \mathfrak{t}$  the map of Lie algebras corresponding to the quotient projection  $\mathbb{T}^m \rightarrow T$ .

Let  $\mathfrak{c} \cong \mathbb{C}^\ell$ , and choose a linear map  $\Omega: \mathfrak{c} \rightarrow \mathbb{C}^m$  satisfying the two conditions:

- (a) the composite map  $\mathfrak{c} \xrightarrow{\Omega} \mathbb{C}^m \xrightarrow{\text{Re}} \mathbb{R}^m \xrightarrow{\rho} \mathfrak{t}$  is a monomorphism;
- (b) the composite map  $\mathfrak{c} \xrightarrow{\Omega} \mathbb{C}^m \xrightarrow{\text{Re}} \mathbb{R}^m \xrightarrow{A} N_\mathbb{R}$  is zero.

Equivalently, choose a complex subspace  $\mathfrak{c} \subset \mathfrak{t}_\mathbb{C}$  such that the composite map  $\mathfrak{c} \rightarrow \mathfrak{t}_\mathbb{C} \xrightarrow{\text{Re}} \mathfrak{t}$  is a monomorphism.

As in Construction 6.6.1,  $\exp \Omega(\mathfrak{c}) \subset (\mathbb{C}^\times)^m$  is a holomorphic subgroup isomorphic to  $\mathbb{C}^\ell$ . Let  $H_\mathbb{C} \subset (\mathbb{C}^\times)^m$  be the complexification of  $H$  (it is a product of  $(\mathbb{C}^\times)^h$  and a finite group). It follows from (a) that the subgroups  $H_\mathbb{C}$  and  $\exp \Omega(\mathfrak{c})$  intersect trivially in  $(\mathbb{C}^\times)^m$ . We can define a complex  $(h + \ell)$ -dimensional subgroup

$$(6.24) \quad D_{H, \Omega} = H_\mathbb{C} \times \exp \Omega(\mathfrak{c}) \subset (\mathbb{C}^\times)^m.$$

THEOREM 6.6.6 ([262, Theorem 3.7]). *Let  $\Sigma$ ,  $\mathcal{K}$  and  $D_{H,\Omega}$  be as above. Then*

- (a) *the holomorphic action of the group  $D_{H,\Omega}$  on  $U(\mathcal{K})$  is free and proper, and the quotient  $U(\mathcal{K})/D_{H,\Omega}$  has a structure of a compact complex manifold of complex dimension  $m - h - \ell$ ;*
- (b) *there is a diffeomorphism between  $U(\mathcal{K})/D_{H,\Omega}$  and  $\mathcal{Z}_{\mathcal{K}}/H$  defining a complex structure on the quotient  $\mathcal{Z}_{\mathcal{K}}/H$ , in which each element of  $T = \mathbb{T}^m/H$  acts by a holomorphic transformation.*

The proof is similar to that of Theorem 6.6.3 and is omitted.

EXAMPLE 6.6.7.

1. If  $H$  is trivial ( $h = 0$ ) then we obtain Theorem 6.6.3.
2. Let  $H$  be the diagonal circle in  $\mathbb{T}^m$ . The condition  $\mathfrak{h} \subset \text{Ker } A_{\mathbb{R}}$  implies that the vectors  $\mathbf{a}_1, \dots, \mathbf{a}_m$  sum up to zero, which can always be achieved by rescaling them (as  $\Sigma$  is a complete fan). As the result, we obtain a complex structure on the quotient  $\mathcal{Z}_{\mathcal{K}}/S^1$  by the diagonal circle in  $\mathbb{T}^m$ , provided that  $m - n$  is odd. In the polytopal case  $\mathcal{K} = \mathcal{K}_P$ , the quotient  $\mathcal{Z}_{\mathcal{K}}/S^1$  embeds into  $\mathbb{C}^m \setminus \{\mathbf{0}\}/\mathbb{C}^{\times} = \mathbb{C}P^{m-1}$  as an intersection of homogeneous quadrics (6.14), and the complex structure on  $\mathcal{Z}_{\mathcal{K}}/S^1$  coincides with that of an LVM-manifold, see Section 6.4.
3. Let  $h = \dim H = m - n$ . Then  $\mathfrak{h} = \text{Ker } A$ . Since  $\mathfrak{h}$  is the Lie algebra of a torus, the  $(m - n)$ -dimensional subspace  $\text{Ker } A \subset \mathbb{R}^m$  is rational. By Gale duality, this implies that the fan  $\Sigma$  is also rational. We have  $\ell = 0$ ,  $D_{H,\Omega} = H_{\mathbb{C}} \cong (\mathbb{C}^{\times})^{m-n}$  and  $U(\mathcal{K})/H_{\mathbb{C}} = \mathcal{Z}_{\mathcal{K}}/H$  is the toric variety corresponding to  $\Sigma$ .

An effective action of  $T^k$  on an  $m$ -dimensional manifold  $M$  is called *maximal* if there exists a point  $x \in M$  whose stabiliser has dimension  $m - k$ ; the two extreme cases are the free action of a torus on itself and the half-dimensional torus action on a toric manifold. As it is shown by Ishida [169], any compact complex manifold with a maximal effective holomorphic action of a torus is biholomorphic to a quotient  $\mathcal{Z}_{\mathcal{K}}/H$  of a moment-angle manifold with a complex structure described by Theorem 6.6.6. The argument of [169] recovering a fan  $\Sigma$  from a maximal holomorphic torus action builds up on the works [170] and [171], where the result was proved in particular cases. The main result of [171] provides a purely complex-analytic description of toric manifolds  $V_{\Sigma}$ :

THEOREM 6.6.8 ([171, Theorem 1]). *Let  $M$  be a compact connected complex manifold of complex dimension  $n$ , equipped with an effective action of  $T^n$  by holomorphic transformations. If the action has fixed points, then there exists a complete regular fan  $\Sigma$  and a  $T^n$ -equivariant biholomorphism of  $V_{\Sigma}$  with  $M$ .*

### 6.7. Holomorphic principal bundles and Dolbeault cohomology

In the case of rational simplicial normal fans  $\Sigma_P$  a construction of Meersseman–Verjovsky [224] identifies the corresponding projective toric variety  $V_P$  as the base of a holomorphic principal *Seifert fibration*, whose total space is the moment-angle manifold  $\mathcal{Z}_P$  equipped with a complex structure of an LVM-manifold, and fibre is a compact complex torus of complex dimension  $\ell = \frac{m-n}{2}$ . (Seifert fibrations are generalisations of holomorphic fibre bundles to the case when the base is an orbifold.) If  $V_P$  is a projective toric manifold, then there is a holomorphic free action of a complex  $\ell$ -dimensional torus  $T_{\mathbb{C}}^{\ell}$  on  $\mathcal{Z}_P$  with quotient  $V_P$ .

Using the construction of a complex structure on  $\mathcal{Z}_{\mathcal{K}}$  described in the previous section, in [262] holomorphic (Seifert) fibrations with total space  $\mathcal{Z}_{\mathcal{K}}$  were defined

for arbitrary complete rational simplicial fans  $\Sigma$ . By an application of the Borel spectral sequence to the holomorphic fibration  $\mathcal{Z}_{\mathcal{K}} \rightarrow V_{\Sigma}$ , the Dolbeault cohomology of  $\mathcal{Z}_{\mathcal{K}}$  can be described and some Hodge numbers can be calculated explicitly.

Here we make additional assumption that the set of integral linear combinations of the vectors  $\mathbf{a}_1, \dots, \mathbf{a}_m$  is a full-rank lattice (a discrete subgroup isomorphic to  $\mathbb{Z}^n$ ) in  $N_{\mathbb{R}} \cong \mathbb{R}^n$ . We denote this lattice by  $N_{\mathbb{Z}}$  or simply  $N$ . This assumption implies that the complete simplicial fan  $\Sigma$  defined by the data  $\{\mathcal{K}; \mathbf{a}_1, \dots, \mathbf{a}_m\}$  is rational. We also continue assuming that  $m - n$  is even and setting  $\ell = \frac{m-n}{2}$ .

Because of our rationality assumption, the algebraic group  $G$  is defined by (5.3). Furthermore, since we defined  $N$  as the lattice generated by  $\mathbf{a}_1, \dots, \mathbf{a}_m$ , the group  $G$  is isomorphic to  $(\mathbb{C}^{\times})^{2\ell}$  (i.e. there are no finite factors). We also observe that  $C_{\Psi}$  lies in  $G$  as an  $\ell$ -dimensional complex subgroup. This follows from condition (b') of Construction 6.6.1.

The quotient construction (Section 5.4) identifies the toric variety  $V_{\Sigma}$  with  $U(\mathcal{K})/G$ , provided that  $\mathbf{a}_1, \dots, \mathbf{a}_m$  are *primitive* generators of the edges of  $\Sigma$ . In our data  $\{\mathcal{K}; \mathbf{a}_1, \dots, \mathbf{a}_m\}$ , the vectors  $\mathbf{a}_1, \dots, \mathbf{a}_m$  are not necessarily primitive in the lattice  $N$  generated by them. Nevertheless, the quotient  $U(\mathcal{K})/G$  is still isomorphic to  $V_{\Sigma}$ , see [6, Ch. II, Proposition 3.1.7]. Indeed, let  $\mathbf{a}'_i \in N$  be the primitive generator along  $\mathbf{a}_i$ , so that  $\mathbf{a}_i = r_i \mathbf{a}'_i$  for some positive integer  $r_i$ . Then we have a finite branched covering

$$U(\mathcal{K}) \rightarrow U(\mathcal{K}), \quad (z_1, \dots, z_m) \mapsto (z_1^{r_1}, \dots, z_m^{r_m}),$$

which maps the group  $G$  defined by  $\mathbf{a}_1, \dots, \mathbf{a}_m$  to the group  $G'$  defined by  $\mathbf{a}'_1, \dots, \mathbf{a}'_m$ , see (5.3). We therefore obtain a covering  $U(\mathcal{K})/G \rightarrow U(\mathcal{K})/G'$  of the toric variety  $V_{\Sigma} \cong U(\mathcal{K})/G \cong U(\mathcal{K})/G'$  over itself. Having this in mind, we can relate the quotients  $V_{\Sigma} \cong U(\mathcal{K})/G$  and  $\mathcal{Z}_{\mathcal{K}} \cong U(\mathcal{K})/C_{\Psi}$  as follows:

**PROPOSITION 6.7.1.** *Assume that data  $\{\mathcal{K}; \mathbf{a}_1, \dots, \mathbf{a}_m\}$  define a complete simplicial rational fan  $\Sigma$ , and let  $G$  and  $C_{\Psi}$  be the groups defined by (5.3) and (6.23).*

- (a) *The toric variety  $V_{\Sigma}$  is identified, as a topological space, with the quotient of  $\mathcal{Z}_{\mathcal{K}}$  by the holomorphic action of the complex compact torus  $G/C_{\Psi}$ .*
- (b) *If the fan  $\Sigma$  is regular, then  $V_{\Sigma}$  is the base of a holomorphic principal bundle with total space  $\mathcal{Z}_{\mathcal{K}}$  and fibre the complex compact torus  $G/C_{\Psi}$ .*

**PROOF.** To prove (a) we just observe that

$$V_{\Sigma} = U(\mathcal{K})/G = (U(\mathcal{K})/C_{\Psi})/(G/C_{\Psi}) \cong \mathcal{Z}_{\mathcal{K}}/(G/C_{\Psi}),$$

where we used Theorem 6.6.3. The quotient  $G/C_{\Psi}$  is a compact complex  $\ell$ -torus by Example 6.6.2. To prove (b) we observe that the holomorphic action of  $G$  on  $U(\mathcal{K})$  is free by Proposition 5.4.6, and the same is true for the action of  $G/C_{\Psi}$  on  $\mathcal{Z}_{\mathcal{K}}$ . A holomorphic free action of the torus  $G/C_{\Psi}$  gives rise to a principal bundle.  $\square$

**REMARK.** As in the projective situation of [224], if the fan  $\Sigma$  is not regular, then the quotient projection  $\mathcal{Z}_{\mathcal{K}} \rightarrow V_{\Sigma}$  of Proposition 6.7.1 (a) is a holomorphic principal *Seifert fibration* for an appropriate orbifold structure on  $V_{\Sigma}$ .

Let  $M$  be a complex  $n$ -dimensional manifold. The space  $\Omega_{\mathbb{C}}^*(M)$  of complex differential forms on  $M$  decomposes into a direct sum of the subspaces of  $(p, q)$ -forms,  $\Omega_{\mathbb{C}}^*(M) = \bigoplus_{0 \leq p, q \leq n} \Omega^{p, q}(M)$ , and there is the *Dolbeault differential*  $\bar{\partial}: \Omega^{p, q}(M) \rightarrow \Omega^{p, q+1}(M)$ . The dimensions  $h^{p, q}(M)$  of the Dolbeault cohomology

groups  $H_{\bar{\partial}}^{p,q}(M)$ ,  $0 \leq p, q \leq n$ , are known as the *Hodge numbers* of  $M$ . They are important invariants of the complex structure of  $M$ .

The Dolbeault cohomology of a compact complex  $\ell$ -torus  $T_{\mathbb{C}}^{\ell}$  is isomorphic to an exterior algebra on  $2\ell$  generators:

$$(6.25) \quad H_{\bar{\partial}}^{*,*}(T_{\mathbb{C}}^{\ell}) \cong \Lambda[\xi_1, \dots, \xi_{\ell}, \eta_1, \dots, \eta_{\ell}],$$

where  $\xi_1, \dots, \xi_{\ell} \in H_{\bar{\partial}}^{1,0}(T_{\mathbb{C}}^{\ell})$  are the classes of basis holomorphic 1-forms, and  $\eta_1, \dots, \eta_{\ell} \in H_{\bar{\partial}}^{0,1}(T_{\mathbb{C}}^{\ell})$  are the classes of basis antiholomorphic 1-forms. In particular, the Hodge numbers are given by  $h^{p,q}(T_{\mathbb{C}}^{\ell}) = \binom{\ell}{p} \binom{\ell}{q}$ .

The de Rham cohomology of a toric manifold  $V_{\Sigma}$  admits a Hodge decomposition with only nontrivial components of bidegree  $(p, p)$ ,  $0 \leq p \leq n$  [86, §12]. This together with Theorem 5.3.1 gives the following description of the Dolbeault cohomology:

$$(6.26) \quad H_{\bar{\partial}}^{*,*}(V_{\Sigma}) \cong \mathbb{C}[v_1, \dots, v_m]/(\mathcal{I}_{\mathcal{K}} + \mathcal{J}_{\Sigma}),$$

where  $v_i \in H_{\bar{\partial}}^{1,1}(V_{\Sigma})$  are the cohomology classes corresponding to torus-invariant divisors (one for each one-dimensional cone of  $\Sigma$ ), the ideal  $\mathcal{I}_{\mathcal{K}}$  is generated by the monomials  $v_{i_1} \cdots v_{i_k}$  for which  $\mathbf{a}_{i_1}, \dots, \mathbf{a}_{i_k}$  do not span a cone of  $\Sigma$  (the Stanley–Reisner ideal of  $\mathcal{K}$ ), and  $\mathcal{J}_{\Sigma}$  is generated by the linear forms  $\sum_{j=1}^m \langle \mathbf{a}_j, \mathbf{u} \rangle v_j$ ,  $\mathbf{u} \in N^*$ . For the Hodge numbers,  $h^{p,p}(V_{\Sigma}) = h_p$ , where  $(h_0, h_1, \dots, h_n)$  is the  $h$ -vector of  $\mathcal{K}$ , and  $h^{p,q}(V_{\Sigma}) = 0$  for  $p \neq q$ .

**THEOREM 6.7.2 ([262]).** *Assume that data  $\{\mathcal{K}; \mathbf{a}_1, \dots, \mathbf{a}_m\}$  define a complete rational regular fan  $\Sigma$  in  $N_{\mathbb{R}} \cong \mathbb{R}^n$ ,  $m - n = 2\ell$ , and let  $\mathcal{Z}_{\mathcal{K}}$  be the corresponding moment-angle manifold with a complex structure defined by Theorem 6.6.3. Then the Dolbeault cohomology algebra  $H_{\bar{\partial}}^{*,*}(\mathcal{Z}_{\mathcal{K}})$  is isomorphic to the cohomology of the differential bigraded algebra*

$$(6.27) \quad [\Lambda[\xi_1, \dots, \xi_{\ell}, \eta_1, \dots, \eta_{\ell}] \otimes H_{\bar{\partial}}^{*,*}(V_{\Sigma}), d]$$

with differential  $d$  of bidegree  $(0, 1)$  defined on the generators as follows:

$$dv_i = d\eta_j = 0, \quad d\xi_j = c(\xi_j), \quad 1 \leq i \leq m, \quad 1 \leq j \leq \ell,$$

where  $c: H_{\bar{\partial}}^{1,0}(T_{\mathbb{C}}^{\ell}) \rightarrow H^2(V_{\Sigma}, \mathbb{C}) = H_{\bar{\partial}}^{1,1}(V_{\Sigma})$  is the first Chern class map of the principal  $T_{\mathbb{C}}^{\ell}$ -bundle  $\mathcal{Z}_{\mathcal{K}} \rightarrow V_{\Sigma}$ .

**PROOF.** We use the notion of a minimal Dolbeault model of a complex manifold [113, §4.3]. Let  $[B, d_B]$  be such a model for  $V_{\Sigma}$ , i.e.  $[B, d_B]$  is a minimal commutative bigraded differential algebra together with a quasi-isomorphism  $f: B^{*,*} \rightarrow \Omega^{*,*}(V_{\Sigma})$ . Consider the differential bigraded algebra

$$(6.28) \quad [\Lambda[\xi_1, \dots, \xi_{\ell}, \eta_1, \dots, \eta_{\ell}] \otimes B, d], \quad \text{where} \\ d|_B = d_B, \quad d(\xi_i) = c(\xi_i) \in B^{1,1} = H_{\bar{\partial}}^{1,1}(V_{\Sigma}), \quad d(\eta_i) = 0.$$

By [113, Corollary 4.66], this is a model for the Dolbeault cohomology algebra of the total space  $\mathcal{Z}_{\mathcal{K}}$  of the principal  $T_{\mathbb{C}}^{\ell}$ -bundle  $\mathcal{Z}_{\mathcal{K}} \rightarrow V_{\Sigma}$ , provided that  $V_{\Sigma}$  is strictly formal. Recall from [113, Definition 4.58] that a complex manifold  $M$  is *strictly formal* if there exists a differential bigraded algebra  $[Z, \delta]$  together with

quasi-isomorphisms

$$\begin{array}{ccc} [\Omega^{*,*}, \bar{\partial}] & \xleftarrow{\cong} & [Z, \delta] & \xrightarrow{\cong} & [\Omega^*, d_{\text{DR}}] \\ & & \downarrow \cong & & \\ & & [H_{\bar{\partial}}^{*,*}(M), 0] & & \end{array}$$

linking together the de Rham algebra, the Dolbeault algebra and the Dolbeault cohomology.

According to [260, Corollary 7.2], the toric manifold  $V_{\Sigma}$  is formal in the usual (de Rham) sense. Also, the above mentioned Hodge decomposition of [86, §12] implies that  $V_{\Sigma}$  satisfies the  $\partial\bar{\partial}$ -lemma [113, Lemma 4.24]. Therefore  $V_{\Sigma}$  is strictly formal by the same argument as [113, Theorem 4.59], and (6.28) is a model for its Dolbeault cohomology.

The usual formality of  $V_{\Sigma}$  implies the existence of a quasi-isomorphism  $\varphi_B: B \rightarrow H_{\bar{\partial}}^{*,*}(V_{\Sigma})$ , which extends to a quasi-isomorphism

$$\text{id} \otimes \varphi_B: [\Lambda[\xi_1, \dots, \xi_{\ell}, \eta_1, \dots, \eta_{\ell}] \otimes B, d] \rightarrow [\Lambda[\xi_1, \dots, \xi_{\ell}, \eta_1, \dots, \eta_{\ell}] \otimes H_{\bar{\partial}}^{*,*}(V_{\Sigma}), d]$$

by [112, Lemma 14.2]. Thus, the differential algebra  $[\Lambda[\xi_1, \dots, \xi_{\ell}, \eta_1, \dots, \eta_{\ell}] \otimes H_{\bar{\partial}}^{*,*}(V_{\Sigma}), d]$  provides a model for the Dolbeault cohomology of  $\mathcal{Z}_{\mathcal{K}}$ , as claimed.  $\square$

REMARK. If  $V_{\Sigma}$  is projective, then it is Kähler; in this case the model of Theorem 6.7.2 coincides with the model for the Dolbeault cohomology of the total space of a holomorphic torus principal bundle over a Kähler manifold [113, Theorem 4.65].

The first Chern class map  $c$  from Theorem 6.7.2 can be described explicitly in terms of the map  $\Psi$  defining the complex structure on  $\mathcal{Z}_{\mathcal{K}}$ . We recall the map  $A_{\mathbb{C}}: \mathbb{C}^m \rightarrow N_{\mathbb{C}}$ ,  $\mathbf{e}_i \mapsto \mathbf{a}_i$  and the Gale dual  $(m-n) \times m$ -matrix  $\Gamma = (\gamma_{jk})$  whose rows form a basis of linear relations between  $\mathbf{a}_1, \dots, \mathbf{a}_m$ . By Construction 6.6.1,  $\text{Im } \Psi \subset \text{Ker } A_{\mathbb{C}}$ . Denote by  $\text{Ann } U$  the annihilator of a linear subspace  $U \subset \mathbb{C}^m$ , i.e. the subspace of linear functions on  $\mathbb{C}^m$  vanishing on  $U$ .

LEMMA 6.7.3. *Let  $k$  be the number of zero vectors among  $\mathbf{a}_1, \dots, \mathbf{a}_m$ . The first Chern class map*

$$c: H_{\bar{\partial}}^{1,0}(T_{\mathbb{C}}^{\ell}) \rightarrow H^2(V_{\Sigma}, \mathbb{C}) = H_{\bar{\partial}}^{1,1}(V_{\Sigma})$$

*of the principal  $T_{\mathbb{C}}^{\ell}$ -bundle  $\mathcal{Z}_{\mathcal{K}} \rightarrow V_{\Sigma}$  is given by the composition*

$$\text{Ann Im } \Psi / \text{Ann Ker } A_{\mathbb{C}} \xrightarrow{i} \mathbb{C}^m / \text{Ann Ker } A_{\mathbb{C}} \xrightarrow{p} \mathbb{C}^{m-k} / \text{Ann Ker } A_{\mathbb{C}}$$

*where  $i$  is the inclusion and  $p$  is the projection forgetting the coordinates in  $\mathbb{C}^m$  corresponding to zero vectors.*

*Explicitly, the map  $c$  is given on the generators of  $H_{\bar{\partial}}^{1,0}(T_{\mathbb{C}}^{\ell})$  by*

$$c(\xi_j) = \mu_{j1}v_1 + \dots + \mu_{jm}v_m, \quad 1 \leq j \leq \ell,$$

*where  $M = (\mu_{jk})$  is an  $\ell \times m$ -matrix satisfying the two conditions:*

- (a)  $\Gamma M^t: \mathbb{C}^{\ell} \rightarrow \mathbb{C}^{2\ell}$  is a monomorphism;
- (b)  $M\Psi = 0$ .

PROOF. Let  $A_{\mathbb{C}}^*: N_{\mathbb{C}}^* \rightarrow \mathbb{C}^m$ ,  $\mathbf{u} \mapsto (\langle \mathbf{a}_1, \mathbf{u} \rangle, \dots, \langle \mathbf{a}_m, \mathbf{u} \rangle)$ , be the dual map. We have  $H^1(T_{\mathbb{C}}^{\ell}; \mathbb{C}) = (\text{Ker } A_{\mathbb{C}})^* = \mathbb{C}^m / \text{Im } A_{\mathbb{C}}^*$  and  $H^2(V_{\Sigma}; \mathbb{C}) = \mathbb{C}^{m-k} / \text{Im } A_{\mathbb{C}}^*$ . The first Chern class map  $c: H^1(T_{\mathbb{C}}^{\ell}; \mathbb{C}) \rightarrow H^2(V_{\Sigma}; \mathbb{C})$  (the transgression) is then given by  $p: \mathbb{C}^m / \text{Im } A_{\mathbb{C}}^* \rightarrow \mathbb{C}^{m-k} / \text{Im } A_{\mathbb{C}}^*$ . In order to separate the holomorphic part of  $c$

we need to identify the subspace of holomorphic differentials  $H_{\bar{\partial}}^{1,0}(T_{\mathbb{C}}^{\ell}) \cong \mathbb{C}^{\ell}$  inside the space of all 1-forms  $H^1(T_{\mathbb{C}}^{\ell}; \mathbb{C}) \cong \mathbb{C}^{2\ell}$ . Since

$$T_{\mathbb{C}}^{\ell} = G/C_{\Psi} = (\text{Ker exp } A_{\mathbb{C}})/(\text{exp Im } \Psi),$$

holomorphic differentials on  $T_{\mathbb{C}}^{\ell}$  correspond to  $\mathbb{C}$ -linear functions on  $\text{Ker } A_{\mathbb{C}}$  which vanish on  $\text{Im } \Psi$ . The space of functions on  $\text{Ker } A_{\mathbb{C}}$  is  $\mathbb{C}^m / \text{Im } A_{\mathbb{C}}^* = \mathbb{C}^m / \text{Ann Ker } A_{\mathbb{C}}$ , and the functions vanishing on  $\text{Im } \Psi$  form the subspace  $\text{Ann Im } \Psi / \text{Ann Ker } A_{\mathbb{C}}$ . Condition (b) says exactly that the linear functions on  $\mathbb{C}^m$  corresponding to the rows of  $M$  vanish on  $\text{Im } \Psi$ . Condition (a) says that the rows of  $M$  constitute a basis in the complement of  $\text{Ann Ker } A_{\mathbb{C}}$  in  $\text{Ann Im } \Psi$ .  $\square$

It is interesting to compare Theorem 6.7.2 with the following description of the de Rham cohomology of  $\mathcal{Z}_{\mathcal{K}}$ :

**THEOREM 6.7.4.** *Let  $\mathcal{Z}_{\mathcal{K}}$  and  $V_{\Sigma}$  be as in Theorem 6.7.2. The de Rham cohomology  $H^*(\mathcal{Z}_{\mathcal{K}})$  is isomorphic to the cohomology of the differential graded algebra*

$$[\Lambda[u_1, \dots, u_{m-n}] \otimes H^*(V_{\Sigma}), d],$$

with  $\deg u_j = 1$ ,  $\deg v_i = 2$ , and differential  $d$  defined on the generators as

$$dv_i = 0, \quad du_j = \gamma_{j1}v_1 + \dots + \gamma_{jm}v_m, \quad 1 \leq j \leq m-n.$$

**PROOF.** The de Rham cohomology of the manifold  $\mathcal{Z}_{\mathcal{K}}$  is isomorphic to its cellular cohomology (with coefficients in  $\mathbb{R}$ ). By Theorem 4.5.4,

$$H^*(\mathcal{Z}_{\mathcal{K}}) \cong \text{Tor}_{\mathbb{R}[v_1, \dots, v_m]}(\mathbb{R}[\mathcal{K}], \mathbb{R})$$

Since  $\Sigma$  is a complete fan,  $\mathcal{K} = \mathcal{K}_{\Sigma}$  is a sphere triangulation, and therefore the face ring  $\mathbb{R}[\mathcal{K}] = \mathbb{R}[v_1, \dots, v_m]/\mathcal{I}_{\mathcal{K}}$  is Cohen–Macaulay by Corollary 3.3.13. The ideal  $\mathcal{J}_{\Sigma}$  is generated by a regular sequence, so we obtain by Lemma A.3.5,

$$\text{Tor}_{\mathbb{R}[v_1, \dots, v_m]}(\mathbb{R}[\mathcal{K}], \mathbb{R}) \cong \text{Tor}_{\mathbb{R}[v_1, \dots, v_m]/\mathcal{J}_{\Sigma}}(\mathbb{R}[\mathcal{K}]/\mathcal{J}_{\Sigma}, \mathbb{R}).$$

Since  $\mathbb{R}[v_1, \dots, v_m]/\mathcal{J}_{\Sigma}$  is a polynomial ring in  $m-n$  variables, Lemma A.2.10 implies that the Tor-algebra above is isomorphic to

$$H[\Lambda[u_1, \dots, u_{m-n}] \otimes \mathbb{R}[\mathcal{K}]/\mathcal{J}_{\Sigma}, d] \cong H[\Lambda[u_1, \dots, u_{m-n}] \otimes H^*(V_{\Sigma}), d]$$

where the explicit form of the differential  $d$  follows from the definition of the Gale dual configuration  $\Gamma = (\gamma_1, \dots, \gamma_m)$ .  $\square$

There are two classical spectral sequences for the Dolbeault cohomology. First, the *Borel spectral sequence* [34] of a holomorphic bundle  $E \rightarrow B$  with a compact Kähler fibre  $F$ , which has  $E_2 = H_{\bar{\partial}}(B) \otimes H_{\bar{\partial}}(F)$  and converges to  $H_{\bar{\partial}}(E)$ . Second, the *Frölicher spectral sequence* [135, §3.5], whose  $E_1$ -term is the Dolbeault cohomology of a complex manifold  $M$  and which converges to the de Rham cohomology of  $M$ . Theorem 6.7.2 implies a collapse result for these spectral sequences:

**COROLLARY 6.7.5.**

- (a) *The Borel spectral sequence of the holomorphic principal bundle  $\mathcal{Z}_{\mathcal{K}} \rightarrow V_{\Sigma}$  collapses at the  $E_3$ -term, i.e.  $E_3 = E_{\infty}$ ;*
- (b) *the Frölicher spectral sequence of  $\mathcal{Z}_{\mathcal{K}}$  collapses at the  $E_2$ -term.*

PROOF. To prove (a) we just observe that the differential algebra (6.27) is the  $E_2$ -term of the Borel spectral sequence, and its cohomology is the  $E_3$ -term.

By comparing the Dolbeault and de Rham cohomology algebras of  $\mathcal{Z}_{\mathcal{K}}$  given by Theorems 6.7.2 and 6.7.4 we observe that the elements  $\eta_1, \dots, \eta_\ell \in E_1^{0,1}$  cannot survive in the  $E_\infty$ -term of the Frölicher spectral sequence. The only possible non-trivial differential on them is  $d_1: E_1^{0,1} \rightarrow E_1^{1,1}$ . By Theorem 6.7.4, the cohomology algebra of  $[E_1, d_1]$  is exactly the de Rham cohomology of  $\mathcal{Z}_{\mathcal{K}}$ , proving (b).  $\square$

Theorem 6.7.4 can also be interpreted as a collapse result for the Leray–Serre spectral sequence of the principal  $T^{m-n}$ -bundle  $\mathcal{Z}_{\mathcal{K}} \rightarrow V_\Sigma$ .

In order to proceed with calculation of Hodge numbers, we need the following bounds for the dimension of  $\text{Ker } c$  in Lemma 6.7.3:

LEMMA 6.7.6. *Let  $k$  be the number of zero vectors among  $\mathbf{a}_1, \dots, \mathbf{a}_m$ . Then*

$$k - \ell \leq \dim_{\mathbb{C}} \text{Ker}(c: H_{\bar{\partial}}^{1,0}(T_{\mathbb{C}}^\ell) \rightarrow H_{\bar{\partial}}^{1,1}(V_\Sigma)) \leq \frac{k}{2}.$$

*In particular, if  $k \leq 1$  then  $c$  is monomorphism.*

PROOF. Consider the commutative diagram

$$\begin{array}{ccccc} \text{Ann Im } \Psi / \text{Ann Ker } A_{\mathbb{C}} & \xrightarrow{i} & \mathbb{C}^m / \text{Ann Ker } A_{\mathbb{C}} & \xrightarrow{p} & \mathbb{C}^{m-k} / \text{Ann Ker } A_{\mathbb{C}} \\ \downarrow \cong & & \downarrow \text{Re} & & \downarrow \text{Re} \\ \mathbb{R}^{m-n} & \xlongequal{\quad} & \mathbb{R}^{m-n} & \xrightarrow{p'} & \mathbb{R}^{m-n-k}. \end{array}$$

The composition  $\text{Re} \circ i$  is an  $\mathbb{R}$ -linear isomorphism, as it has the form  $H_{\bar{\partial}}^{1,0}(T_{\mathbb{C}}^\ell) \rightarrow H^1(T_{\mathbb{C}}^\ell, \mathbb{C}) \rightarrow H^1(T_{\mathbb{C}}^\ell, \mathbb{R})$ , and any real-valued function on the lattice  $\Gamma$  defining the torus  $T_{\mathbb{C}}^\ell = \mathbb{C}^\ell / \Gamma$  is the real part of the restriction to  $\Gamma$  of a  $\mathbb{C}$ -linear function on  $\mathbb{C}^\ell$ .

Since the diagram above is commutative, the kernel of  $c = p \circ i$  has real dimension at most  $k$ , which implies the upper bound on its complex dimension. For the lower bound,  $\dim_{\mathbb{C}} \text{Ker } c \geq \dim H_{\bar{\partial}}^{1,0}(T_{\mathbb{C}}^\ell) - \dim H_{\bar{\partial}}^{1,1}(V_\Sigma) = \ell - (2\ell - k) = k - \ell$ .  $\square$

THEOREM 6.7.7. *Let  $\mathcal{Z}_{\mathcal{K}}$  be as in Theorem 6.7.2, and let  $k$  be the number of zero vectors among  $\mathbf{a}_1, \dots, \mathbf{a}_m$ . Then the Hodge numbers  $h^{p,q} = h^{p,q}(\mathcal{Z}_{\mathcal{K}})$  satisfy*

- (a)  $\binom{k-\ell}{p} \leq h^{p,0} \leq \binom{[k/2]}{p}$  for  $p \geq 0$ ; in particular,  $h^{p,0} = 0$  for  $p > 0$  if  $k \leq 1$ ;
- (b)  $h^{0,q} = \binom{\ell}{q}$  for  $q \geq 0$ ;
- (c)  $h^{1,q} = (\ell - k) \binom{\ell}{q-1} + h^{1,0} \binom{\ell+1}{q}$  for  $q \geq 1$ ;
- (d)  $\frac{\ell(3\ell+1)}{2} - h_2(\mathcal{K}) - \ell k + (\ell + 1)h^{2,0} \leq h^{2,1} \leq \frac{\ell(3\ell+1)}{2} - \ell k + (\ell + 1)h^{2,0}$ .

PROOF. Let  $A^{p,q}$  denote the bidegree  $(p, q)$  component of the differential algebra from Theorem 6.7.2, and let  $Z^{p,q} \subset A^{p,q}$  denote the subspace of cocycles. Then  $d^{1,0}: A^{1,0} \rightarrow Z^{1,1}$  coincides with the map  $c$ , and the required bounds for  $h^{1,0} = \dim \text{Ker } d^{1,0}$  are already established in Lemma 6.7.6. Since  $h^{p,0} = \dim \text{Ker } d^{p,0}$ , and  $\text{Ker } d^{p,0}$  is the  $p$ th exterior power of the space  $\text{Ker } d^{1,0}$ , statement (a) follows.

The differential is trivial on  $A^{0,q}$ , hence  $h^{0,q} = \dim A^{0,q}$ , proving (b).

The space  $Z^{1,1}$  is spanned by the cocycles  $v_i$  and  $\xi_i \eta_j$  with  $\xi_i \in \text{Ker } d^{1,0}$ . Hence  $\dim Z^{1,1} = 2\ell - k + h^{1,0}\ell$ . Also,  $\dim d(A^{1,0}) = \ell - h^{1,0}$ , therefore,  $h^{1,1} = \ell - k + h^{1,0}(\ell + 1)$ . Similarly,  $\dim Z^{1,q} = (2\ell - k) \binom{\ell}{q-1} + h^{1,0} \binom{\ell}{q}$  (with basis of  $v_i \eta_{j_1} \cdots \eta_{j_{q-1}}$  and  $\xi_i \eta_{j_1} \cdots \eta_{j_q}$  where  $\xi_i \in \text{Ker } d^{1,0}$ ,  $j_1 < \cdots < j_q$ ), and  $d: A^{1,q-1} \rightarrow Z^{1,q}$  hits a subspace of dimension  $(\ell - h^{1,0}) \binom{\ell}{q-1}$ . This proves (c).



We have  $A^{2,1} = U \oplus W$ , where  $U$  has basis of monomials  $\xi_i v_j$  and  $W$  has basis of monomials  $\xi_i \xi_j \eta_k$ . Therefore,

$$(6.29) \quad h^{2,1} = \dim U - \dim dU + \dim W - \dim dW - \dim dA^{2,0}.$$

Now  $\dim U = \ell(2\ell - k)$ ,  $0 \leq \dim dU \leq h_2(\mathcal{K})$  (since  $dU \subset H_{\bar{\partial}}^{2,2}(V_{\Sigma})$ ),  $\dim W - \dim dW = \dim \text{Ker } d|_W = \ell h^{2,0}$ , and  $\dim dA^{2,0} = \binom{\ell}{2} - h^{2,0}$ . By substituting all this into (6.29) we obtain the inequalities of (d).  $\square$

REMARK. At most one ghost vertex needs to be added to  $\mathcal{K}$  to make  $\dim \mathcal{Z}_{\mathcal{K}} = m + n$  even. Since  $h^{p,0}(\mathcal{Z}_{\mathcal{K}}) = 0$  when  $k \leq 1$ , the manifold  $\mathcal{Z}_{\mathcal{K}}$  does not have holomorphic forms of any degree in this case.

If  $\mathcal{Z}_{\mathcal{K}}$  is a torus (so that  $\mathcal{K}$  is empty), then  $m = k = 2\ell$ , and  $h^{1,0}(\mathcal{Z}_{\mathcal{K}}) = h^{0,1}(\mathcal{Z}_{\mathcal{K}}) = \ell$ . Otherwise Theorem 6.7.7 implies that  $h^{1,0}(\mathcal{Z}_{\mathcal{K}}) < h^{0,1}(\mathcal{Z}_{\mathcal{K}})$ , and therefore  $\mathcal{Z}_{\mathcal{K}}$  is not Kähler.

EXAMPLE 6.7.8. Let  $\mathcal{Z}_{\mathcal{K}} \cong S^1 \times S^{2n+1}$  be a Hopf manifold of Example 6.6.4. Our rationality assumption is that  $\mathbf{a}_1, \dots, \mathbf{a}_{n+2}$  span an  $n$ -dimensional lattice  $N$  in  $N_{\mathbb{R}} \cong \mathbb{R}^n$ ; in particular, the fan  $\Sigma$  defined by the proper subsets of  $\mathbf{a}_1, \dots, \mathbf{a}_{n+1}$  is rational. We assume further that  $\Sigma$  is regular (this is equivalent to the condition  $\mathbf{a}_1 + \dots + \mathbf{a}_{n+1} = \mathbf{0}$ ), so that  $\Sigma$  is the normal fan of a Delzant  $n$ -dimensional simplex  $\Delta^n$ . We have  $V_{\Sigma} = \mathbb{C}P^n$ , and (6.26) describes its cohomology as the quotient of  $\mathbb{C}[v_1, \dots, v_{n+2}]$  by the two ideals:  $\mathcal{I}$  generated by  $v_1 \cdots v_{n+1}$  and  $v_{n+2}$ , and  $\mathcal{J}$  generated by  $v_1 - v_{n+1}, \dots, v_n - v_{n+1}$ . The differential algebra of Theorem 6.7.2 is therefore given by  $[\Lambda[\xi, \eta] \otimes \mathbb{C}[t]/t^{n+1}, d]$ , with  $dt = d\eta = 0$  and  $d\xi = t$  for a proper choice of  $t$ . The nontrivial cohomology classes are represented by the cocycles  $1, \eta, \xi t^n$  and  $\xi \eta t^n$ , which gives the following nonzero Hodge numbers of  $\mathcal{Z}_{\mathcal{K}}$ :  $h^{0,0} = h^{0,1} = h^{n+1,n} = h^{n+1,n+1} = 1$ . Observe that the Dolbeault cohomology and Hodge numbers do not depend on a choice of complex structure (the map  $\Psi$ ).

EXAMPLE 6.7.9 (Calabi–Eckmann manifold). Let  $\{\mathcal{K}; \mathbf{a}_1, \dots, \mathbf{a}_{n+2}\}$  be the data defining the normal fan of the product  $P = \Delta^p \times \Delta^q$  of two Delzant simplices with  $p + q = n$ ,  $1 \leq p \leq q \leq n - 1$ . That is,  $\mathbf{a}_1, \dots, \mathbf{a}_p, \mathbf{a}_{p+2}, \dots, \mathbf{a}_{n+1}$  is a basis of lattice  $N$  and there are two relations  $\mathbf{a}_1 + \dots + \mathbf{a}_{p+1} = \mathbf{0}$  and  $\mathbf{a}_{p+2} + \dots + \mathbf{a}_{n+2} = \mathbf{0}$ . The corresponding toric variety  $V_{\Sigma}$  is  $\mathbb{C}P^p \times \mathbb{C}P^q$  and its cohomology ring is isomorphic to  $\mathbb{C}[x, y]/(x^{p+1}, y^{q+1})$ . Consider the map

$$\Psi: \mathbb{C} \rightarrow \mathbb{C}^{n+2}, \quad w \mapsto (w, \dots, w, \alpha w, \dots, \alpha w),$$

where  $\alpha \in \mathbb{C} \setminus \mathbb{R}$  and  $\alpha w$  appears  $q + 1$  times. The map  $\Psi$  satisfies the conditions of Construction 6.6.1. The resulting complex structure on  $\mathcal{Z}_P \cong S^{2p+1} \times S^{2q+1}$  is that of a *Calabi–Eckmann manifold*. We denote complex manifolds obtained in this way by  $\mathcal{CE}(p, q)$  (the complex structure depends on the choice of  $\Psi$ , but we do not reflect this in the notation). Each manifold  $\mathcal{CE}(p, q)$  is the total space of a holomorphic principal bundle over  $\mathbb{C}P^p \times \mathbb{C}P^q$  with fibre the complex 1-torus  $\mathbb{C}/(\mathbb{Z} \oplus \alpha\mathbb{Z})$ .

Theorem 6.7.2 and Lemma 6.7.3 provide the following description of the Dolbeault cohomology of  $\mathcal{CE}(p, q)$ :

$$H_{\bar{\partial}}^{*,*}(\mathcal{CE}(p, q)) \cong H[\Lambda[\xi, \eta] \otimes \mathbb{C}[x, y]/(x^{p+1}, y^{q+1}), d],$$

where  $dx = dy = d\eta = 0$  and  $d\xi = x - y$  for an appropriate choice of  $x, y$ . We therefore obtain

$$(6.30) \quad H_{\bar{\partial}}^{*,*}(\mathcal{CE}(p, q)) \cong \Lambda[\omega, \eta] \otimes \mathbb{C}[x]/(x^{p+1}),$$

where  $\omega \in H_{\bar{\partial}}^{q+1,q}(\mathcal{CE}(p,q))$  is the cohomology class of the cocycle  $\xi \frac{x^{q+1}-y^{q+1}}{x-y}$ . This calculation is originally due to [34, §9]. We note that the Dolbeault cohomology of a Calabi–Eckmann manifold depends only on  $p, q$  and does not depend on the complex parameter  $\alpha$  (or the map  $\Psi$ ).

EXAMPLE 6.7.10. Now let  $P = \Delta^1 \times \Delta^1 \times \Delta^2 \times \Delta^2$ . Then the moment-angle manifold  $\mathcal{Z}_P$  has two structures of a product of Calabi–Eckmann manifolds, namely,  $\mathcal{CE}(1,1) \times \mathcal{CE}(2,2)$  and  $\mathcal{CE}(1,2) \times \mathcal{CE}(1,2)$ . Using isomorphism (6.30) we observe that these two complex manifolds have different Hodge numbers:  $h^{2,1} = 1$  in the first case and  $h^{2,1} = 0$  in the second. This shows that the choice of the map  $\Psi$  affects not only the complex structure of  $\mathcal{Z}_K$ , but also its Hodge numbers, unlike the previous examples of complex tori, Hopf and Calabi–Eckmann manifolds. Certainly it is not highly surprising from the complex-analytic point of view.

### 6.8. Hamiltonian-minimal Lagrangian submanifolds

In this last section we apply the accumulated knowledge on topology of moment-angle manifolds in a somewhat different area, Lagrangian geometry. Systems of real quadrics, which we used in Sections 6.1 and 6.2 to define moment-angle manifolds, also give rise to a family of Hamiltonian-minimal Lagrangian submanifolds in a complex space or more general toric varieties.

Hamiltonian minimality ( $H$ -minimality for short) for Lagrangian submanifolds is a symplectic analogue of minimality in Riemannian geometry. A Lagrangian immersion is called  $H$ -minimal if the variations of its volume along all Hamiltonian vector fields are zero. This notion was introduced in the work of Y.-G. Oh [251] in connection with the celebrated *Arnold conjecture* on the number of fixed points of a Hamiltonian symplectomorphism. The simplest example of an  $H$ -minimal Lagrangian submanifold is the coordinate torus [251]  $S_{r_1}^1 \times \cdots \times S_{r_m}^1 \subset \mathbb{C}^m$ , where  $S_{r_k}^1$  denotes the circle of radius  $r_k > 0$  in the  $k$ th coordinate subspace of  $\mathbb{C}^m$ . More examples of  $H$ -minimal Lagrangian submanifolds in a complex space were constructed in the works [68], [156], [5], among others.

In [229] Mironov suggested a general construction of  $H$ -minimal Lagrangian immersions  $N \looparrowright \mathbb{C}^m$  from intersections of real quadrics. These systems of quadrics are the same as those we used to define moment-angle manifolds, and therefore one can apply toric methods for analysing the topological structure of  $N$ . In [230] an effective criterion was obtained for  $N \looparrowright \mathbb{C}^m$  to be an embedding: the polytope corresponding to the intersection of quadrics must be Delzant. As a consequence, any Delzant polytope gives rise to an  $H$ -minimal Lagrangian submanifold  $N \subset \mathbb{C}^m$ . As in the case of moment-angle manifolds, the topology of  $N$  is quite complicated even for low-dimensional polytopes: for example, a Delzant 5-gon gives rise to a manifold  $N$  which is the total space of a bundle over a 3-torus with fibre a surface of genus 5. Furthermore, by combining Mironov’s construction with symplectic reduction, a new family of  $H$ -minimal Lagrangian submanifolds in of toric varieties was defined in [231]. This family includes many previously constructed explicit examples in  $\mathbb{C}^m$  and  $\mathbb{C}P^{m-1}$ .

**Preliminaries.** Let  $(M, \omega)$  be a symplectic manifold of dimension  $2n$ . An immersion  $i: N \looparrowright M$  of an  $n$ -dimensional manifold  $N$  is called *Lagrangian* if  $i^*(\omega) = 0$ . If  $i$  is an embedding, then  $i(N)$  is a *Lagrangian submanifold* of  $M$ . A vector field  $X$  on  $M$  is *Hamiltonian* if the 1-form  $\omega(X, \cdot)$  is exact.

Now assume that  $M$  is Kähler, so that it has compatible Riemannian metric and symplectic structure. A Lagrangian immersion  $i: N \looparrowright M$  is called *Hamiltonian minimal* (*H-minimal*) if the variations of the volume of  $i(N)$  along all Hamiltonian vector fields with compact support are zero, that is,

$$\frac{d}{dt} \text{vol}(i_t(N)) \Big|_{t=0} = 0,$$

where  $i_t(N)$  is a deformation of  $i(N)$  along a Hamiltonian vector field,  $i_0(N) = i(N)$ , and  $\text{vol}(i_t(N))$  is the volume of the deformed part of  $i_t(N)$ . An immersion  $i$  is *minimal* if the variations of the volume of  $i(N)$  along *all* vector fields are zero.

Our basic example is  $M = \mathbb{C}^m$  with the Hermitian metric  $2 \sum_{k=1}^m d\bar{z}_k \otimes dz_k$ . Its imaginary part is the symplectic form of Example 5.5.1. In the end we consider a more general case when  $M$  is a toric manifold.

**The construction.** We consider an intersection of quadrics similar to (6.5), but in the real space:

$$(6.31) \quad \mathcal{R} = \left\{ \mathbf{u} = (u_1, \dots, u_m) \in \mathbb{R}^m : \sum_{k=1}^m \gamma_{jk} u_k^2 = \delta_j, \text{ for } 1 \leq j \leq m-n \right\}.$$

We assume the nondegeneracy and rationality conditions on the coefficient vectors  $\gamma_i = (\gamma_{1i}, \dots, \gamma_{m-n,i})^t \in \mathbb{R}^{m-n}$ ,  $i = 1, \dots, m$ :

- (a)  $\delta \in \mathbb{R}_{\geq} \langle \gamma_1, \dots, \gamma_m \rangle$ ;
- (b) if  $\delta \in \mathbb{R}_{\geq} \langle \gamma_{i_1}, \dots, \gamma_{i_k} \rangle$ , then  $k \geq m-n$ ;
- (c) the vectors  $\gamma_1, \dots, \gamma_m$  generate a lattice  $L \cong \mathbb{Z}^{m-n}$  in  $\mathbb{R}^{m-n}$ .

These conditions guarantee that  $\mathcal{R}$  is a smooth  $n$ -dimensional submanifold in  $\mathbb{R}^m$  (by the argument of Proposition 6.1.4) and that

$$T_\Gamma = \left\{ (e^{2\pi i \langle \gamma_1, \varphi \rangle}, \dots, e^{2\pi i \langle \gamma_m, \varphi \rangle}) \in \mathbb{T}^m \right\}$$

is an  $(m-n)$ -dimensional torus subgroup in  $\mathbb{T}^m$ . We identify the torus  $T_\Gamma$  with  $\mathbb{R}^{m-n}/L^*$  and represent its elements by  $\varphi \in \mathbb{R}^{m-n}$ . We also define

$$D_\Gamma = \frac{1}{2} L^*/L^* \cong (\mathbb{Z}_2)^{m-n}.$$

Note that  $D_\Gamma$  embeds canonically as a subgroup in  $T_\Gamma$ .

Now we view the intersection  $\mathcal{R}$  as a subset in the intersection  $\mathcal{Z}$  or Hermitian quadrics given by (6.5), or as a subset in the whole space  $\mathbb{C}^m$ . Then we ‘spread’  $\mathcal{R}$  by the action of  $T_\Gamma$ , that is, consider the set of  $T_\Gamma$ -orbits through  $\mathcal{R}$ . More precisely, we consider the map

$$j: \mathcal{R} \times T_\Gamma \longrightarrow \mathbb{C}^m, \\ (\mathbf{u}, \varphi) \mapsto \mathbf{u} \cdot \varphi = (u_1 e^{2\pi i \langle \gamma_1, \varphi \rangle}, \dots, u_m e^{2\pi i \langle \gamma_m, \varphi \rangle})$$

and observe that  $j(\mathcal{R} \times T_\Gamma) \subset \mathcal{Z}$ . We let  $D_\Gamma$  act on  $\mathcal{R} \times T_\Gamma$  diagonally; this action is free, since it is free on the second factor. The quotient

$$N = \mathcal{R} \times_{D_\Gamma} T_\Gamma$$

is an  $m$ -dimensional manifold.

For any  $\mathbf{u} = (u_1, \dots, u_m) \in \mathcal{R}$ , we have the sublattice

$$L_{\mathbf{u}} = \mathbb{Z} \langle \gamma_k : u_k \neq 0 \rangle \subset L = \mathbb{Z} \langle \gamma_1, \dots, \gamma_m \rangle.$$

The set of  $T_\Gamma$ -orbits through  $\mathcal{R}$  is an immersion of  $N$ :

LEMMA 6.8.1.

- (a) *The map  $j: \mathcal{R} \times T_\Gamma \rightarrow \mathbb{C}^m$  induces an immersion  $i: N \looparrowright \mathbb{C}^m$ .*
- (b) *The immersion  $i$  is an embedding if and only if  $L_{\mathbf{u}} = L$  for any  $\mathbf{u} \in \mathcal{R}$ .*

PROOF. Take  $\mathbf{u} \in \mathcal{R}$ ,  $\varphi \in T_\Gamma$  and  $g \in D_\Gamma$ . We have  $\mathbf{u} \cdot g \in \mathcal{R}$ , and  $j(\mathbf{u} \cdot g, g\varphi) = \mathbf{u} \cdot g^2\varphi = \mathbf{u} \cdot \varphi = j(\mathbf{u}, \varphi)$ . Hence, the map  $j$  is constant on  $D_\Gamma$ -orbits, and therefore induces a map of the quotient  $N = (\mathcal{R} \times T_\Gamma)/D_\Gamma$ , which we denote by  $i$ .

Assume that  $j(\mathbf{u}, \varphi) = j(\mathbf{u}', \varphi')$ . Then  $L_{\mathbf{u}} = L_{\mathbf{u}'}$  and

$$(6.32) \quad u_k e^{2\pi i \langle \gamma_k, \varphi \rangle} = u'_k e^{2\pi i \langle \gamma_k, \varphi' \rangle} \quad \text{for } k = 1, \dots, m.$$

Since both  $u_k$  and  $u'_k$  are real, this implies that  $e^{2\pi i \langle \gamma_k, \varphi - \varphi' \rangle} = \pm 1$  whenever  $u_k \neq 0$ , or, equivalently,  $\varphi - \varphi' \in \frac{1}{2}L_{\mathbf{u}}^*/L^*$ . In other words, (6.32) implies that  $\mathbf{u}' = \mathbf{u} \cdot g$  and  $\varphi' = g\varphi$  for some  $g \in \frac{1}{2}L_{\mathbf{u}}^*/L^*$ . The latter is a finite group by Lemma 6.3.2; hence the preimage of any point of  $\mathbb{C}^m$  under  $j$  consists of a finite number of points. If  $L_{\mathbf{u}} = L$ , then  $\frac{1}{2}L_{\mathbf{u}}^*/L^* = \frac{1}{2}L^*/L^* = D_\Gamma$ ; hence  $(\mathbf{u}, \varphi)$  and  $(\mathbf{u}', \varphi')$  represent the same point in  $N$ . Statement (b) follows; to prove (a), it remains to observe that we have  $L_{\mathbf{u}} = L$  for generic  $\mathbf{u}$  (with all coordinates nonzero).  $\square$

THEOREM 6.8.2 ([229, Theorem 1]). *The immersion  $i: N \looparrowright \mathbb{C}^m$  is  $H$ -minimal Lagrangian. Moreover, if  $\sum_{k=1}^m \gamma_k = 0$ , then  $i$  is a minimal Lagrangian immersion.*

PROOF. We only prove that  $i$  is a Lagrangian immersion here. Let

$$(\mathbf{x}, \varphi) \mapsto \mathbf{z}(\mathbf{x}, \varphi) = \left( u_1(\mathbf{x})e^{2\pi i \langle \gamma_1, \varphi \rangle}, \dots, u_m(\mathbf{x})e^{2\pi i \langle \gamma_m, \varphi \rangle} \right)$$

be a local coordinate system on  $N = \mathcal{R} \times_{D_\Gamma} T_\Gamma$ , where  $\mathbf{x} = (x_1, \dots, x_n) \in \mathbb{R}^n$  and  $\varphi = (\varphi_1, \dots, \varphi_{m-n}) \in \mathbb{R}^{m-n}$ . Let  $\langle \xi, \eta \rangle_{\mathbb{C}} = \sum_{i=1}^m \bar{\xi}_i \eta_i = \langle \xi, \eta \rangle + i\omega(\xi, \eta)$  be the Hermitian scalar product of  $\xi, \eta \in \mathbb{C}^m$ . Then

$$\left\langle \frac{\partial \mathbf{z}}{\partial x_k}, \frac{\partial \mathbf{z}}{\partial \varphi_j} \right\rangle_{\mathbb{C}} = 2\pi i \left( \gamma_{j1} u_1 \frac{\partial u_1}{\partial x_k} + \dots + \gamma_{jm} u_m \frac{\partial u_m}{\partial x_k} \right) = 0$$

where the second identity follows by differentiating the quadrics equations (6.31). Also,  $\langle \frac{\partial \mathbf{z}}{\partial x_k}, \frac{\partial \mathbf{z}}{\partial x_j} \rangle_{\mathbb{C}} \in \mathbb{R}$  and  $\langle \frac{\partial \mathbf{z}}{\partial \varphi_k}, \frac{\partial \mathbf{z}}{\partial \varphi_j} \rangle_{\mathbb{C}} \in \mathbb{R}$ . It follows that

$$\omega\left(\frac{\partial \mathbf{z}}{\partial x_k}, \frac{\partial \mathbf{z}}{\partial \varphi_j}\right) = \omega\left(\frac{\partial \mathbf{z}}{\partial x_k}, \frac{\partial \mathbf{z}}{\partial x_j}\right) = \omega\left(\frac{\partial \mathbf{z}}{\partial \varphi_k}, \frac{\partial \mathbf{z}}{\partial \varphi_j}\right) = 0,$$

i.e. the restriction of the symplectic form to the tangent space of  $N$  is zero.  $\square$

REMARK. The identity  $\sum_{k=1}^m \gamma_k = 0$  can not hold for a compact  $\mathcal{R}$  (or  $N$ ).

We recall from Theorem 6.1.5 that a nonsingular intersection of quadrics (6.5) or (6.31) defines a simple polyhedron (1.1), and  $\mathcal{Z}$  is identified with the moment-angle manifold  $\mathcal{Z}_P$ . Now we can summarise the results of the previous sections in the following criterion for  $i: N \rightarrow \mathbb{C}^m$  to be an embedding:

THEOREM 6.8.3. *Let  $\mathcal{Z}$  and  $\mathcal{R}$  be the intersections of Hermitian and real quadrics defined by (6.5) and (6.31), respectively, satisfying conditions (a)–(c) above. Let  $P$  be the associated simple polyhedron, and  $N = \mathcal{R} \times_{D_\Gamma} T_\Gamma$ . The following conditions are equivalent:*

- (a)  *$i: N \rightarrow \mathbb{C}^m$  is an embedding of an  $H$ -minimal Lagrangian submanifold;*
- (b)  *$L_{\mathbf{u}} = L$  for any  $\mathbf{u} \in \mathcal{R}$ ;*
- (c) *the torus  $T_\Gamma$  acts freely on the moment-angle manifold  $\mathcal{Z} = \mathcal{Z}_P$ ;*

(d)  $P$  is a Delzant polyhedron.

PROOF. Equivalence (a)  $\Leftrightarrow$  (b) follows from Lemma 6.8.1 and Theorem 6.8.2. Equivalence (b)  $\Leftrightarrow$  (c) is Lemma 6.3.2, and (c)  $\Leftrightarrow$  (d) is Theorem 6.3.1 (c).  $\square$

**Topology of Lagrangian submanifolds  $N \subset \mathbb{C}^m$ .** We start by reviewing three simple properties linking the topological structure of  $N$  to that of the intersections of quadrics  $\mathcal{Z}$  and  $\mathcal{R}$ .

PROPOSITION 6.8.4.

- (a) The immersion of  $N$  in  $\mathbb{C}^m$  factors as  $N \looparrowright \mathcal{Z} \hookrightarrow \mathbb{C}^m$ ;
- (b)  $N$  is the total space of a bundle over the torus  $T^{m-n}$  with fibre  $\mathcal{R}$ ;
- (c) if  $N \rightarrow \mathbb{C}^m$  is an embedding, then  $N$  is the total space of a principal  $T^{m-n}$ -bundle over the  $n$ -dimensional manifold  $\mathcal{R}/D_\Gamma$ .

PROOF. Statement (a) is clear. Since  $D_\Gamma$  acts freely on  $T_\Gamma$ , the projection  $N = \mathcal{R} \times_{D_\Gamma} T_\Gamma \rightarrow T_\Gamma/D_\Gamma$  onto the second factor is a fibre bundle with fibre  $\mathcal{R}$ . Then (b) follows from the fact that  $T_\Gamma/D_\Gamma \cong T^{m-n}$ .

If  $N \rightarrow \mathbb{C}^m$  is an embedding, then  $T_\Gamma$  acts freely on  $\mathcal{Z}$  by Theorem 6.8.3 and the action of  $D_\Gamma$  on  $\mathcal{R}$  is also free. Therefore, the projection  $N = \mathcal{R} \times_{D_\Gamma} T_\Gamma \rightarrow \mathcal{R}/D_\Gamma$  onto the first factor is a principal  $T_\Gamma$ -bundle, which proves (c).  $\square$

REMARK. The quotient  $\mathcal{R}/D_\Gamma$  is a *real toric variety*, or a *small cover*, over the corresponding polytope  $P$ , see [90] and [55].

EXAMPLE 6.8.5 (one quadric). Suppose that  $\mathcal{R}$  is given by a single equation

$$(6.33) \quad \gamma_1 u_1^2 + \cdots + \gamma_m u_m^2 = \delta$$

in  $\mathbb{R}^m$ . We assume that  $\mathcal{R}$  is compact, so that  $\gamma_i$  and  $\delta$  are positive reals,  $\mathcal{R} \cong S^{m-1}$ , and the corresponding polytope  $P$  is an  $n$ -simplex  $\Delta^n$ . Then  $N \cong S^{m-1} \times_{\mathbb{Z}_2} S^1$ , where the generator of  $\mathbb{Z}_2$  acts by the standard free involution on  $S^1$  and by a certain involution  $\tau$  on  $S^{m-1}$ . The topological type of  $N$  depends on  $\tau$ . Namely,

$$N \cong \begin{cases} S^{m-1} \times S^1 & \text{if } \tau \text{ preserves the orientation of } S^{m-1}, \\ \mathcal{K}^m & \text{if } \tau \text{ reverses the orientation of } S^{m-1}, \end{cases}$$

where  $\mathcal{K}^m$  is known as the  $m$ -dimensional Klein bottle.

PROPOSITION 6.8.6. *Let  $m - n = 1$  (one quadric). We obtain an  $H$ -minimal Lagrangian embedding of  $N \cong S^{m-1} \times_{\mathbb{Z}_2} S^1$  in  $\mathbb{C}^m$  if and only if  $\gamma_1 = \cdots = \gamma_m$  in (6.33). In this case, the topological type of  $N = N(m)$  depends only on the parity of  $m$  and is given by*

$$\begin{aligned} N(m) &\cong S^{m-1} \times S^1 && \text{if } m \text{ is even,} \\ N(m) &\cong \mathcal{K}^m && \text{if } m \text{ is odd.} \end{aligned}$$

PROOF. Since there exists  $\mathbf{u} \in \mathcal{R}$  with only one nonzero coordinate, Theorem 6.8.3 implies that  $N$  embeds in  $\mathbb{C}^m$  if only if  $\gamma_i$  generates the same lattice as the whole set  $\gamma_1, \dots, \gamma_m$  for each  $i$ . Therefore,  $\gamma_1 = \cdots = \gamma_m$ . In this case  $D_\Gamma \cong \mathbb{Z}_2$  acts by the standard antipodal involution on  $S^{m-1}$ , which preserves orientation if  $m$  is even and reverses orientation otherwise.  $\square$

Both examples of  $H$ -minimal Lagrangian embeddings given by Proposition 6.8.6 are well known. The Klein bottle  $\mathcal{K}^m$  with even  $m$  does not admit Lagrangian embeddings in  $\mathbb{C}^m$  (see [242] and [286]).

EXAMPLE 6.8.7 (two quadrics). In the case  $m - n = 2$ , the topology of  $\mathcal{R}$  and  $N$  can be described completely by analysing the action of the two commuting involutions on the intersection of quadrics. We consider the compact case here.

Using Proposition 1.2.7, we write  $\mathcal{R}$  in the form

$$(6.34) \quad \begin{aligned} \gamma_{11}u_1^2 + \cdots + \gamma_{1m}u_m^2 &= c, \\ \gamma_{21}u_1^2 + \cdots + \gamma_{2m}u_m^2 &= 0, \end{aligned}$$

where  $c > 0$  and  $\gamma_{1i} > 0$  for all  $i$ .

PROPOSITION 6.8.8. *There is a number  $p$ ,  $0 < p < m$ , such that  $\gamma_{2i} > 0$  for  $i = 1, \dots, p$  and  $\gamma_{2i} < 0$  for  $i = p + 1, \dots, m$  in (6.34), possibly after reordering the coordinates  $u_1, \dots, u_m$ . The corresponding manifold  $\mathcal{R} = \mathcal{R}(p, q)$ , where  $q = m - p$ , is diffeomorphic to  $S^{p-1} \times S^{q-1}$ . Its associated polytope  $P$  either coincides with  $\Delta^{m-2}$  (if one of the inequalities in (1.1) is redundant) or is combinatorially equivalent to the product  $\Delta^{p-1} \times \Delta^{q-1}$  (if there are no redundant inequalities).*

PROOF. We observe that  $\gamma_{2i} \neq 0$  for all  $i$  in (6.34), as  $\gamma_{2i} = 0$  implies that the vector  $\delta = \begin{pmatrix} c \\ 0 \end{pmatrix}$  is in the cone generated by one  $\gamma_i$ , which contradicts Proposition 6.1.4 (b). By reordering the coordinates, we can achieve that the first  $p$  of  $\gamma_{2i}$  are positive and the rest are negative. Then  $1 < p < m$ , because otherwise (6.34) is empty. Now, (6.34) is the intersection of the cone over the product of two ellipsoids of dimensions  $p - 1$  and  $q - 1$  (given by the second quadric) with an  $(m - 1)$ -dimensional ellipsoid (given by the first quadric). Therefore,  $\mathcal{R}(p, q) \cong S^{p-1} \times S^{q-1}$ . The statement about the polytope follows from the combinatorial fact that a simple  $n$ -polytope with up to  $n + 2$  facets is combinatorially equivalent to a product of simplices; the case of one redundant inequality corresponds to  $p = 1$  or  $q = 1$ .  $\square$

An element  $\varphi \in D_\Gamma = \frac{1}{2}L^*/L^* \cong \mathbb{Z}_2 \times \mathbb{Z}_2$  acts on  $\mathcal{R}(p, q)$  by

$$(u_1, \dots, u_m) \mapsto (\varepsilon_1(\varphi)u_1, \dots, \varepsilon_m(\varphi)u_m),$$

where  $\varepsilon_k(\varphi) = e^{2\pi i \langle \gamma_k, \varphi \rangle} = \pm 1$  for  $1 \leq k \leq m$ .

LEMMA 6.8.9. *Suppose that  $D_\Gamma$  acts on  $\mathcal{R}(p, q)$  freely and  $\varepsilon_i(\varphi) = 1$  for some  $i$ ,  $1 \leq i \leq p$ , and  $\varphi \in D_\Gamma$ . Then  $\varepsilon_l(\varphi) = -1$  for all  $l$  with  $p + 1 \leq l \leq m$ .*

PROOF. Assume the opposite, that is,  $\varepsilon_i(\varphi) = 1$  for some  $1 \leq i \leq p$  and  $\varepsilon_j(\varphi) = 1$  for some  $p + 1 \leq j \leq m$ . Then  $\gamma_{2i} > 0$  and  $\gamma_{2j} < 0$  in (6.34), so we can choose  $\mathbf{u} \in \mathcal{R}(p, q)$  whose only nonzero coordinates are  $u_i$  and  $u_j$ . The element  $\varphi \in D_\Gamma$  fixes this  $\mathbf{u}$ , leading to contradiction.  $\square$

LEMMA 6.8.10. *Suppose  $D_\Gamma$  acts on  $\mathcal{R}(p, q)$  freely. Then there exist two generating involutions  $\varphi_1, \varphi_2 \in D_\Gamma \cong \mathbb{Z}_2 \times \mathbb{Z}_2$  whose action on  $\mathcal{R}(p, q)$  is described by either (a) or (b) below, possibly after reordering the coordinates:*

- (a)  $\varphi_1: (u_1, \dots, u_m) \mapsto (u_1, \dots, u_k, -u_{k+1}, \dots, -u_p, -u_{p+1}, \dots, -u_m),$   
 $\varphi_2: (u_1, \dots, u_m) \mapsto (-u_1, \dots, -u_k, u_{k+1}, \dots, u_p, -u_{p+1}, \dots, -u_m);$
- (b)  $\varphi_1: (u_1, \dots, u_m) \mapsto (-u_1, \dots, -u_p, u_{p+1}, \dots, u_{p+l}, -u_{p+l+1}, \dots, -u_m),$   
 $\varphi_2: (u_1, \dots, u_m) \mapsto (-u_1, \dots, -u_p, -u_{p+1}, \dots, -u_{p+l}, u_{p+l+1}, \dots, u_m);$

here  $0 \leq k \leq p$  and  $0 \leq l \leq q$ .

PROOF. By Lemma 6.8.9, for each of the three nonzero elements  $\varphi \in D_\Gamma$ , we have either  $\varepsilon_i(\varphi) = -1$  for  $1 \leq i \leq p$  or  $\varepsilon_i(\varphi) = -1$  for  $p+1 \leq i \leq m$ . Therefore, we may choose two different nonzero elements  $\varphi_1, \varphi_2 \in D_\Gamma$  such that either  $\varepsilon_i(\varphi_j) = -1$  for  $j = 1, 2$  and  $p+1 \leq i \leq m$ , or  $\varepsilon_i(\varphi_j) = -1$  for  $j = 1, 2$  and  $1 \leq i \leq p$ . This corresponds to the cases (a) and (b) above, respectively. In the former case, after reordering the coordinates, we may assume that  $\varphi_1$  acts as in (a). Then  $\varphi_2$  also acts as in (a), since otherwise the composition  $\varphi_1 \cdot \varphi_2$  cannot act freely by Lemma 6.8.9. The second case is treated similarly.  $\square$

Each of the actions of  $D_\Gamma$  described in Lemma 6.8.10 can be realised by a particular intersection of quadrics (6.34). For example, the system of quadrics

$$(6.35) \quad \begin{aligned} 2u_1^2 + \cdots + 2u_k^2 + u_{k+1}^2 + \cdots + u_p^2 + u_{p+1}^2 + \cdots + u_m^2 &= 3, \\ u_1^2 + \cdots + u_k^2 + 2u_{k+1}^2 + \cdots + 2u_p^2 - u_{p+1}^2 - \cdots - u_m^2 &= 0 \end{aligned}$$

gives the first action of Lemma 6.8.10; the second action is realised similarly. Note that the lattice  $L$  corresponding to (6.35) is a sublattice of index 3 in  $\mathbb{Z}^2$ . We can rewrite (6.35) as

$$(6.36) \quad \begin{aligned} u_1^2 + \cdots + u_k^2 + u_{k+1}^2 + \cdots + u_p^2 &= 1, \\ u_1^2 + \cdots + u_k^2 &+ u_{p+1}^2 + \cdots + u_m^2 = 2, \end{aligned}$$

in which case  $L = \mathbb{Z}^2$ . The action of the two involutions  $\psi_1, \psi_2 \in D_\Gamma = \frac{1}{2}\mathbb{Z}^2/\mathbb{Z}^2$  corresponding to the standard basis vectors of  $\frac{1}{2}\mathbb{Z}^2$  is given by

$$(6.37) \quad \begin{aligned} \psi_1: (u_1, \dots, u_m) &\mapsto (-u_1, \dots, -u_k, -u_{k+1}, \dots, -u_p, u_{p+1}, \dots, u_m), \\ \psi_2: (u_1, \dots, u_m) &\mapsto (-u_1, \dots, -u_k, u_{k+1}, \dots, u_p, -u_{p+1}, \dots, -u_m). \end{aligned}$$

We denote the manifold  $N$  corresponding to (6.36) by  $N_k(p, q)$ . We have

$$(6.38) \quad N_k(p, q) \cong (S^{p-1} \times S^{q-1}) \times_{\mathbb{Z}_2 \times \mathbb{Z}_2} (S^1 \times S^1),$$

where the action of the two involutions on  $S^{p-1} \times S^{q-1}$  is given by  $\psi_1, \psi_2$  above. Note that  $\psi_1$  acts trivially on  $S^{q-1}$  and acts antipodally on  $S^{p-1}$ . Therefore,

$$N_k(p, q) \cong N(p) \times_{\mathbb{Z}_2} (S^{q-1} \times S^1),$$

where  $N(p)$  is the manifold from Proposition 6.8.6. If  $k = 0$  then the second involution  $\psi_2$  acts trivially on  $N(p)$ , and  $N_0(p, q)$  coincides with the product  $N(p) \times N(q)$  of the two manifolds from Example 6.8.5. In general, the projection

$$N_k(p, q) \rightarrow S^{q-1} \times_{\mathbb{Z}_2} S^1 = N(q)$$

describes  $N_k(p, q)$  as the total space of a fibration over  $N(q)$  with fibre  $N(p)$ .

We summarise the above facts and observations in the following topological classification result for compact  $H$ -minimal Lagrangian submanifolds  $N \subset \mathbb{C}^m$  obtained from intersections of two quadrics.

**THEOREM 6.8.11.** *Let  $N \rightarrow \mathbb{C}^m$  be the embedding of the  $H$ -minimal Lagrangian submanifold corresponding to a compact intersection of two quadrics. Then  $N$  is diffeomorphic to some  $N_k(p, q)$  given by (6.38), where  $p + q = m$ ,  $0 < p < m$  and  $0 \leq k \leq p$ . Moreover, every such triple  $(k, p, q)$  can be realised by  $N$ .*

In the case of up to two quadrics considered above, the topology of  $\mathcal{R}$  is relatively simple, and in order to analyse the topology of  $N$ , one only needs to describe the action of involutions on  $\mathcal{R}$ . When the number of quadrics is more than two, the topology of  $\mathcal{R}$  becomes an issue as well.

EXAMPLE 6.8.12 (three quadrics). In the case  $m - n = 3$ , the topology of compact manifolds  $\mathcal{R}$  and  $\mathcal{Z}$  was fully described in [197, Theorem 2]. Each of these manifolds is diffeomorphic to a product of three spheres or to a connected sum of products of spheres with two spheres in each product.

Note that, for  $m - n = 3$ , the manifolds  $\mathcal{R}$  (or  $\mathcal{Z}$ ) can be distinguished topologically by looking at the planar Gale diagrams of the corresponding simple polytopes  $P$  (see Section 1.2). This chimes with the classification of simple  $n$ -polytopes with  $n + 3$  facets, well-known in combinatorial geometry [325, §6.5].

The smallest polytope with  $m - n = 3$  is a pentagon. It has many Delzant realisations, for instance,

$$P = \{(x_1, x_2) \in \mathbb{R}^2: x_1 \geq 0, x_2 \geq 0, -x_1 + 2 \geq 0, -x_2 + 2 \geq 0, -x_1 - x_2 + 3 \geq 0\}.$$

In this case,  $\mathcal{R}$  is an oriented surface of genus 5 (see Proposition 4.1.8), and the moment-angle manifold  $\mathcal{Z}$  is diffeomorphic to a connected sum of 5 copies of  $S^3 \times S^4$ .

We therefore obtain an  $H$ -minimal Lagrangian submanifold  $N \subset \mathbb{C}^5$ , which is the total space of a bundle over  $T^3$  with fibre a surface of genus 5.

Now assume that the polytope  $P$  associated with intersection of quadrics (6.31) is a polygon (i.e.,  $n = 2$ ). If there are no redundant inequalities, then  $P$  is an  $m$ -gon and  $\mathcal{R}$  is an orientable surface  $S_g$  of genus  $g = 1 + 2^{m-3}(m-4)$  by Proposition 4.1.8. If there are  $k$  redundant inequalities, then  $P$  is an  $(m-k)$ -gon. In this case  $\mathcal{R} \cong \mathcal{R}' \times (S^0)^k$ , where  $\mathcal{R}'$  corresponds to an  $(m-k)$ -gon without redundant inequalities. That is,  $\mathcal{R}$  is a disjoint union of  $2^k$  surfaces of genus  $1 + 2^{m-k-3}(m-k-4)$ .

The corresponding  $H$ -minimal submanifold  $N \subset \mathbb{C}^m$  is the total space of a bundle over  $T^{m-2}$  with fibre  $S_g$ . This is an aspherical manifold for  $m \geq 4$ .

**Generalisation to toric manifolds.** Consider two sets of quadrics:

$$\begin{aligned} \mathcal{Z}_\Gamma &= \left\{ \mathbf{z} \in \mathbb{C}^m : \sum_{k=1}^m \gamma_k |z_k|^2 = \mathbf{c} \right\}, \quad \gamma_k, \mathbf{c} \in \mathbb{R}^{m-n}; \\ \mathcal{Z}_\Delta &= \left\{ \mathbf{z} \in \mathbb{C}^m : \sum_{k=1}^m \delta_k |z_k|^2 = \mathbf{d} \right\}, \quad \delta_k, \mathbf{d} \in \mathbb{R}^{m-\ell}; \end{aligned}$$

such that  $\mathcal{Z}_\Gamma$ ,  $\mathcal{Z}_\Delta$  and  $\mathcal{Z}_\Gamma \cap \mathcal{Z}_\Delta$  satisfy the nondegeneracy and rationality conditions (a)–(c) from the beginning of this section. Assume also that the polyhedra corresponding to  $\mathcal{Z}_\Gamma$ ,  $\mathcal{Z}_\Delta$  and  $\mathcal{Z}_\Gamma \cap \mathcal{Z}_\Delta$  are Delzant.

The idea is to use the first set of quadrics to produce a toric manifold  $V$  via symplectic reduction (as described in Section 5.5), and then use the second set of quadrics to define an  $H$ -minimal Lagrangian submanifold in  $V$ .

CONSTRUCTION 6.8.13. Define the real intersections of quadrics  $\mathcal{R}_\Gamma$ ,  $\mathcal{R}_\Delta$ , the tori  $T_\Gamma \cong \mathbb{T}^{m-n}$ ,  $T_\Delta \cong \mathbb{T}^{m-\ell}$ , and the groups  $D_\Gamma \cong \mathbb{Z}_2^{m-n}$ ,  $D_\Delta \cong \mathbb{Z}_2^{m-\ell}$  as before.

We consider the toric variety  $V$  obtained as the symplectic quotient of  $\mathbb{C}^m$  by the torus corresponding to the first set of quadrics:  $V = \mathcal{Z}_\Gamma / T_\Gamma$ . It is a Kähler manifold of real dimension  $2n$ . The quotient  $\mathcal{R}_\Gamma / D_\Gamma$  is the set of real points of  $V$  (the fixed point set of the complex conjugation, or the real toric manifold); it has dimension  $n$ . Consider the subset of  $\mathcal{R}_\Gamma / D_\Gamma$  defined by the second set of quadrics:

$$\mathcal{S} = (\mathcal{R}_\Gamma \cap \mathcal{R}_\Delta) / D_\Gamma,$$

we have  $\dim \mathcal{S} = n + \ell - m$ . Finally, define the  $n$ -dimensional submanifold of  $V$ :

$$N = \mathcal{S} \times_{D_\Delta} T_\Delta.$$



**THEOREM 6.8.14.**  *$N$  is an  $H$ -minimal Lagrangian submanifold in the toric manifold  $V$ .*

**PROOF.** Let  $\widehat{V}$  be the symplectic quotient of  $V$  by the torus corresponding to the second set of quadrics, that is,  $\widehat{V} = (V \cap \mathcal{Z}_\Delta)/T_\Delta = (\mathcal{Z}_\Gamma \cap \mathcal{Z}_\Delta)/(T_\Gamma \times T_\Delta)$ . It is a toric manifold of real dimension  $2(n + \ell - m)$ . The submanifold of real points

$$\widehat{N} = N/T_\Delta = (\mathcal{R}_\Gamma \cap \mathcal{R}_\Delta)/(D_\Gamma \times D_\Delta) \hookrightarrow (\mathcal{Z}_\Gamma \cap \mathcal{Z}_\Delta)/(T_\Gamma \times T_\Delta) = \widehat{V}$$

is the fixed point set of the complex conjugation, hence it is a totally geodesic submanifold. In particular,  $\widehat{N}$  is a minimal submanifold in  $\widehat{V}$ . According to [99, Corollary 2.7],  $N$  is an  $H$ -minimal submanifold in  $V$ .  $\square$

**EXAMPLE 6.8.15.**

1. If  $m - \ell = 0$ , i.e.  $\mathcal{Z}_\Delta = \emptyset$ , then  $V = \mathbb{C}^m$  and we obtain the original construction of  $H$ -minimal Lagrangian submanifolds  $N$  in  $\mathbb{C}^m$ .

2. If  $m - n = 0$ , i.e.  $\mathcal{Z}_\Gamma = \emptyset$ , then  $N$  is set of real points of  $V$ . It is minimal (totally geodesic).

3. If  $m - \ell = 1$ , i.e.  $\mathcal{Z}_\Delta \cong S^{2m-1}$ , then we get  $H$ -minimal Lagrangian submanifolds in  $V = \mathbb{C}P^{m-1}$ . This includes the families of projective examples constructed in [228], [201] and [232].



## Half-dimensional torus actions

In this chapter we study several topological generalisations of toric varieties. All of them are smooth manifolds with an action of a compact torus, the so-called *T-manifolds*. Most of the results here concern the case when the dimension of the acting torus is half the dimension of the manifold.

A compact nonsingular toric variety (or toric manifold)  $V_\Sigma$  of real dimension  $2n$  has an action of  $n$ -dimensional torus  $T^n$  obtained by restricting the action of the algebraic torus  $(\mathbb{C}^\times)^n$ . The action of  $T^n$  on  $V_\Sigma$  is *locally standard*, that is, it locally looks like the standard coordinatewise action of  $T^n$  on  $\mathbb{C}^n$  (more precise definitions are given below). If the variety  $V_\Sigma$  is projective, then the quotient  $V_\Sigma/T^n$  can be identified with a simple convex  $n$ -polytope  $P$  via the moment map. In general, the quotient  $V_\Sigma/T^n$  may be not a polytope, even combinatorially, but it still has a face structure of a manifold with corners, which is dual to the face structure of the simplicial fan  $\Sigma$ . In particular, the fixed points of the  $T^n$ -action on  $V_\Sigma$  correspond to the vertices of the quotient  $V_\Sigma/T^n$ . These basic properties of the torus action can be taken as the starting point for several different topological generalisations of toric manifolds.

A *quasitoric manifold* is a  $2n$ -dimensional manifold  $M$  with a locally standard action of  $T^n$  such that the quotient  $M/T^n$  can be identified with a simple  $n$ -polytope  $P$ . This class of manifolds was introduced in the seminal paper [90] of Davis and Januszkiewicz. They showed, among other things, that the cohomology ring structure of a quasitoric manifold is exactly the same as that of a toric manifold (see Theorem 5.3.1). Quasitoric manifolds have been studied intensively since the second half of 1990s, and the work [53] summarised these early developments and emphasised the role of moment-angle manifolds  $\mathcal{Z}_P$ .

Around the same time, an alternative way to generalise toric varieties was developed in the works of Masuda [206] and Hattori–Masuda [153], which led to a wider class of *torus manifolds*. Along with the usual conditions on the  $T^n$ -action such as smoothness and effectiveness, the crucial point in the definition of a torus manifold is the non-emptiness of the fixed point set. Torus manifolds also admit a combinatorial treatment similar to that of classic toric varieties in terms of fans and polytopes. Namely, torus manifolds may be described by *multi-fans* and *multi-polytopes*; a multi-fan is a collection of cones parametrised by a simplicial complex, where some cones may overlap unlike in the usual fan. The cohomology ring of a torus manifold has a more complicated structure than that of a (quasi)toric manifold; in particular, it is no longer generated by two-dimensional classes. Face rings of simplicial posets (as described in Section 3.5) arise naturally in this context.

Another interesting generalisation of toric manifolds was suggested in the work [170] of Ishida, Fukukawa and Masuda under the name *topological toric manifolds*. The idea is to consider not only the actions of a compact torus, but rather two

commuting actions of  $T^n$  and  $\mathbb{R}_{>}^n$ , which patch together to a *smooth*  $(\mathbb{C}^\times)^n$ -action on a manifold. This smooth  $(\mathbb{C}^\times)^n$ -action is what replaces the algebraic  $(\mathbb{C}^\times)^n$ -action on a toric manifold. The resulting class of manifolds, when properly defined, turns out to be both wide and tractable, and admits a combinatorial description in terms of (generalised) fans in a way similar to toric varieties. The topological characteristics of topological toric manifolds, including their integral cohomology rings and characteristic classes, also have much similarity with those of toric manifolds.

In Section 7.1 we discuss the notion of a locally standard torus action and related combinatorics of orbits; it features in many subsequent generalisations of toric manifolds. Section 7.2 is a brief account of topological properties of the (compact) torus action on toric manifolds, these properties are taken as the base for subsequent topological generalisations. Sections 7.3, 7.4 and 7.5 describe the classes of quasitoric manifolds, torus manifolds and topological toric manifolds, respectively. Section 7.4 can be also viewed as an account on topological properties of locally standard  $T^n$ -manifolds, because the existence of a fixed point (required in the definition of a torus manifold) often comes as a consequence of other topological restrictions on the locally standard  $T^n$ -manifold  $M$ ; for example, a fixed point automatically exists when the odd-degree cohomology of  $M$  vanishes. Similarly, a torus manifold  $M$  with  $H^{odd}(M) = 0$  is necessarily locally standard. In Section 7.6 we describe the relationship between the different classes of half-dimensional torus actions. In Section 7.7 we discuss an important class of examples of projective toric manifolds obtained as spaces of bounded flags in a complex space. These manifolds illustrate nicely many previous constructions with toric and quasitoric manifolds, they will also feature in the last chapter on toric cobordism. Another class of examples, Bott towers, is the subject of Section 7.8. The study of Bott towers has become an important part of toric topology, and many interesting open questions arise here. In the last Section 7.9 we explore connections with another active area, the theory of GKM-manifolds and GKM-graphs, and also study blow-ups of  $T$ -manifolds and their related combinatorial objects. As usual, more specific introductory remarks are available at the beginning of each section.

### 7.1. Locally standard actions and manifolds with corners

We have collected here background material on locally standard  $T^n$ - and  $\mathbb{Z}_2^n$ -actions and combinatorial structures on their orbit spaces. The latter include the notions of *manifolds with faces* and *manifolds with corners*, which have been studied in differential topology since 1960s in the works of Jänich [175], Bredon [41], Davis [88], Davis–Januszkiewicz [90], Izmitiev [174], among others.

As usual, we denote by  $\mathbb{Z}_2$  (respectively, by  $\mathbb{S}$  or  $\mathbb{T}$ ) the multiplicative group of real (respectively, complex) numbers of absolute value one. In this section we denote by  $G$  one of the groups  $\mathbb{Z}_2$  or  $\mathbb{S} = \mathbb{T}$ , and denote by  $\mathbb{F}$  its ambient field  $\mathbb{R}$  or  $\mathbb{C}$  respectively. We refer to the coordinatewise action of  $G^n$  on  $\mathbb{F}^n$  given by

$$(g_1, \dots, g_n) \cdot (z_1, \dots, z_n) = (g_1 z_1, \dots, g_n z_n)$$

as the *standard action* or *standard representation*.

**DEFINITION 7.1.1.** Let  $M$  be a manifold with an action of  $G^n$ . A *standard chart* on  $M$  is a triple  $(U, f, \psi)$ , where  $U \subset M$  is a  $G^n$ -invariant open subset,  $\psi$  is an automorphism of  $G^n$ , and  $f$  is a  $\psi$ -equivariant homeomorphism  $f: U \rightarrow W$  onto a  $G^n$ -invariant open subset  $W \subset \mathbb{F}^n$ . (Recall from Appendix B.3 that the latter

means that  $f(\mathbf{t} \cdot y) = \psi(\mathbf{t})f(y)$  for all  $\mathbf{t} \in G^n$ ,  $y \in U$ .) A  $G^n$ -action on  $M$  is said to be *locally standard* if  $M$  has a standard atlas, i.e. if any point of  $M$  belongs to a standard chart.

The dimension of a manifold with a locally standard  $G^n$ -action is  $n$  if  $G = \mathbb{Z}_2$  and  $2n$  if  $G = \mathbb{T}$ . The orbit space of the standard  $G^n$ -action on  $\mathbb{F}^n$  is the orthant

$$\mathbb{R}_{\geq}^n = \{\mathbf{x} = (x_1, \dots, x_n) \in \mathbb{R}^n : x_i \geq 0 \text{ for } i = 1, \dots, n\}.$$

Therefore, the orbit space of a locally standard action is locally modelled by  $\mathbb{R}_{\geq}^n$ . There are two slightly different ways to formalise this property, depending on whether we work in the topological or smooth category.

**DEFINITION 7.1.2.** A *manifold with faces* (of dimension  $n$ ) is a topological manifold  $Q$  with boundary  $\partial Q$  together with a covering of  $\partial Q$  by closed connected subsets  $\{F_i\}_{i \in \mathcal{S}}$ , called *facets*, satisfying the following properties:

- (a) any facet  $F_i$  is an  $(n-1)$ -dimensional submanifold (with boundary) of  $\partial Q$ ;
- (b) for any finite subset  $I \subset \mathcal{S}$ , the intersection  $\bigcap_{i \in I} F_i$  is either empty or a disjoint union of submanifolds of codimension  $|I|$ ; in the latter case we refer to a connected component of the intersection  $\bigcap_{i \in I} F_i$  as a *face* of  $Q$ ;
- (c) for any point  $q \in Q$ , there exist an open neighbourhood  $U \ni q$  and a homeomorphism  $\varphi: U \rightarrow W$  onto an open subset  $W \subset \mathbb{R}_{\geq}^n$  such that

$$\varphi^{-1}(W \cap \{x_j = 0\}) = U \cap F_i$$

for some  $i \in \mathcal{S}$ .

Observe that the set  $\mathcal{S}$  has to be countable, hence the set of faces in a manifold with faces  $Q$  is also countable. If  $Q$  is compact, then both these sets are finite.

The orthant  $\mathbb{R}_{\geq}^n$  itself has the canonical structure of a manifold with faces; each face has the form  $\mathbb{R}_{\geq}^I$  for  $I \subset [n]$ , where  $\mathbb{R}_{\geq}^I = \{\mathbf{x} \in \mathbb{R}_{\geq}^n : x_j = 0 \text{ for } j \notin I\}$ . The *codimension*  $c(\mathbf{x})$  of point  $\mathbf{x} \in \mathbb{R}_{\geq}^n$  is the number of zero coordinates of  $\mathbf{x}$ . A point of  $Q$  has *codimension*  $k$  if it belongs to a face of codimension  $k$  and does not belong to a face of codimension  $k+1$ .

**DEFINITION 7.1.3.** A *manifold with corners* (of dimension  $n$ ) is a topological manifold  $Q$  with boundary together with an atlas  $\{U_i, \varphi_i\}$  consisting of homeomorphisms  $\varphi_i: U_i \rightarrow W_i$  onto open subsets  $W_i \subset \mathbb{R}_{\geq}^n$  such that  $\varphi_i \varphi_j^{-1}: \varphi_j(U_i \cap U_j) \rightarrow \varphi_i(U_i \cap U_j)$  is a diffeomorphism for all  $i, j$ . (A homeomorphism between open subsets in  $\mathbb{R}_{\geq}^n$  is called a *diffeomorphism* if it can be obtained by restriction of a diffeomorphism of open subsets in  $\mathbb{R}^n$ .)

For any  $q \in Q$ , its codimension  $c(q)$  is well defined. An *open face* of  $Q$  of codimension  $k$  is a connected component of  $c^{-1}(k)$ . A *closed face* (or simply *face*) of  $Q$  is the closure of an open face. A *facet* is a face of codimension 1.

A manifold with corners  $Q$  is said to be *nice* if the covering of  $Q$  by its facets satisfies condition (c) of Definition 7.1.2 (conditions (a) and (b) are satisfied automatically). Equivalently, a manifold with corners is nice if and only if each of its faces of codimension 2 is contained in exactly 2 facets (an exercise).

**REMARK.** Our definitions of faces differ from those of [88] and [174]; the reason is that we want our faces to be connected.

EXAMPLE 7.1.4.

1. The 2-disc with a single ‘corner point’ on its boundary is a manifold with corners which is not nice. All other examples in this list will be nice.

2. A smooth manifold  $Q$  with boundary is a manifold with corners, whose facets are connected components of  $\partial Q$ , and there are no other faces.

3. A direct product of manifolds with corners is a manifold with corners. In particular, a product of smooth manifolds with boundary is a manifold with corners.

4. Let  $P$  be a simple polytope. For each vertex  $v \in P$  we denote by  $U_v$  the open subset in  $P$  obtained by removing all faces of  $P$  that do not contain  $v$ . The subset  $U_v$  is affinely isomorphic to a neighbourhood of zero in  $\mathbb{R}_{\geq}^n$ . Therefore  $P$  is a compact manifold with corners, with atlas  $\{U_v\}$ .

The orbit space  $Q = M/G^n$  of a locally standard action is a manifold with faces. As we shall see in Proposition 7.4.13, if the action is smooth, then  $Q$  is a nice manifold with corners.

### Exercises.

7.1.5. A manifold with corners  $Q$  is nice if and only if any face of codimension two is contained in exactly two facets.

7.1.6. Two simple polytopes are diffeomorphic as manifolds with corners if and only if they are combinatorially equivalent (see [89] for a more general statement).

## 7.2. Toric manifolds and their quotients

By way of motivation, here we take a closer look at the action of the (compact) torus  $T_N \cong T^n$  on a toric manifold  $V_\Sigma$ . The topological properties of the quotient projection  $\pi: V_\Sigma \rightarrow V_\Sigma/T_N$  will be taken as the starting point for subsequent topological generalisations of toric manifolds.

We first recall from Sections 5.5 and 6.3 that a projective (or Hamiltonian) toric manifold  $V_P$  can be identified with the symplectic quotient of  $\mathbb{C}^m$  by an action of  $K \cong T^{m-n}$ , i.e. with the quotient manifold  $\mathcal{Z}_P/K$  where  $\mathcal{Z}_P$  is the moment-angle manifold corresponding to  $P$ . Therefore the quotient of  $V_P$  by the action of the  $n$ -torus  $T_N = \mathbb{T}^m/K$  coincides with the quotient of  $\mathcal{Z}_P$  by  $\mathbb{T}^m$ . Both quotients are identified with the Delzant polytope  $P$ ; in fact, the moment map  $\mu_V: V_P \rightarrow P$  is the quotient projection (see Proposition 5.5.5). In the non-projective smooth case, there is no moment map, and there is no canonical way to identify the quotient  $V_\Sigma/T_N$  with a convex polytope. However, there is a face decomposition (stratification) of  $V_\Sigma/T_N$  according to orbit types, and this face structure is very similar to that of a simple polytope.

Following Davis–Januszkiewicz [90], we can describe a projective toric manifold  $V_P$  as an identification space similar to (6.7).

As usual, for each  $I \subset [m]$  we denote by  $\mathbb{T}^I = \prod_{i \in I} \mathbb{T}$  the corresponding coordinate subgroup in  $\mathbb{T}^m$ . Given  $\mathbf{x} \in P$ , set  $I_{\mathbf{x}} = \{i \in [m]: \mathbf{x} \in F_i\}$  (the set of facets containing  $\mathbf{x}$ ). We recall the map  $A: \mathbb{R}^m \rightarrow N_{\mathbb{R}}$ ,  $\mathbf{e}_i \mapsto \mathbf{a}_i$ , and its exponential  $\exp A: \mathbb{T}^m \rightarrow T_N$ . For each  $\mathbf{x} \in P$  define the subtorus  $T_{\mathbf{x}} = (\exp A)(\mathbb{T}^{I_{\mathbf{x}}}) \subset T_N$ . If  $\mathbf{x}$  is a vertex then  $T_{\mathbf{x}} = T_N$ , and if  $\mathbf{x}$  is an interior point of  $P$  then  $T_{\mathbf{x}} = \{1\}$ .

PROPOSITION 7.2.1. *A projective toric manifold  $V_P$  is  $T_N$ -equivariantly homeomorphic to the quotient*

$$(7.1) \quad P \times T_N / \approx \quad \text{where } (\mathbf{x}, t_1) \approx (\mathbf{x}, t_2) \text{ if } t_1^{-1}t_2 \in T_{\mathbf{x}}.$$

PROOF. Using Proposition 6.2.2, we obtain

$$V_P = \mathcal{Z}_P/K = (P \times (\mathbb{T}^m/K))/\sim = (P \times (\exp A)(\mathbb{T}^m))/\sim = P \times T_N/\approx. \quad \square$$

The projection  $\pi: V_P = P \times T_N/\approx \rightarrow P$  is the quotient map for the  $T_N$ -action, and its fibre  $\pi^{-1}(\mathbf{x}) = T_{\mathbf{x}}$  is the stabiliser of the  $T_N$ -orbit corresponding to  $\mathbf{x}$ . The  $T_N$ -action on  $V_P$  is therefore free over the interior of the polytope, vertices of the polytope correspond to fixed points, and points in the relative interior of a codimension- $k$  face correspond to orbits with the same  $k$ -dimensional stabiliser.

CONSTRUCTION 7.2.2. Let  $\Sigma$  be a simplicial fan and  $V_\Sigma$  the corresponding toric variety. Consider the affine cover  $\{V_\sigma: \sigma \in \Sigma\}$  (see Construction 5.1.3). The quotient  $(V_\sigma)_{\geq} = V_\sigma/T_N$  can be identified with the set of semigroup homomorphisms from  $S_\sigma$  to the semigroup  $\mathbb{R}_{\geq}$  of nonnegative real numbers:

$$V_\sigma/T_N = \text{Hom}_{\text{sg}}(S_\sigma, \mathbb{R}_{\geq}), \quad \sigma \in \Sigma$$

(the details of this construction can be found in [122, §4.1]).

If the fan  $\Sigma$  is regular, then  $V_\sigma \cong \mathbb{C}^k \times (\mathbb{C}^\times)^{n-k}$  where  $k = \dim \sigma$ , see Example 5.1.5. It follows easily that the  $T_N$ -action on a nonsingular toric variety  $V_\Sigma$  is locally standard, and the cover  $\{V_\sigma: \sigma \in \Sigma\}$  provides an atlas of standard charts (see Section 7.1). Furthermore,  $(V_\sigma)_{\geq} \cong \mathbb{R}_{\geq}^k \times \mathbb{R}^{n-k}$  and the orbit space  $Q = V_\Sigma/T_N$  is a manifold with corners, with atlas  $\{(V_\sigma)_{\geq}: \sigma \in \Sigma\}$ .

In the singular case the varieties  $V_\sigma$  may be not isomorphic to  $\mathbb{C}^k \times (\mathbb{C}^\times)^{n-k}$  and the  $T_N$ -action on  $V_\Sigma$  may fail to be locally standard. Nevertheless, the cover  $\{(V_\sigma)_{\geq}: \sigma \in \Sigma\}$  defines a structure of a manifold with faces on  $Q = V_\Sigma/T_N$ .

If  $\Sigma$  is a complete simplicial fan, then the face decomposition of the manifold with corners  $Q = V_\Sigma/T_N$  is Poincaré dual to the sphere triangulation defined by the simplicial complex  $\mathcal{K}_\Sigma$ . There is also a projection  $Q \times T_N \rightarrow V_\Sigma$  defining a homeomorphism  $V_\Sigma \cong Q \times T_N/\approx$ , by analogy with (7.1).

We finish by summarising the observations of this section as follows:

PROPOSITION 7.2.3.

- (a) *The action of the torus  $T_N$  on a nonsingular toric variety  $V_\Sigma$  is locally standard.*
- (b) *If  $V_P$  is a projective toric manifold then the quotient  $V_P/T_N$  is diffeomorphic to the simple polytope  $P$  as a manifold with corners.*

If a toric manifold  $V_\Sigma$  is not projective, then the manifold with corners  $Q = V_\Sigma/T_N$  may be not homeomorphic to a simple polytope (see Section 7.6).

### 7.3. Quasitoric manifolds

Quasitoric manifolds were introduced by Davis and Januszkiewicz as a topological alternative to (nonsingular projective) toric varieties. Originally, the term ‘toric manifolds’ was used in [90] to describe this class of manifolds, but later it was replaced by ‘quasitoric’, as ‘toric manifold’ is often used by algebraic and symplectic geometers as a synonym for ‘non-singular complete toric variety’.

Any quasitoric manifold over  $P$  can be obtained as a quotient of the moment-angle manifold  $\mathcal{Z}_P$  by a freely acting subtorus. This can be viewed as a topological version of the symplectic quotient construction of projective toric manifolds (see Section 5.5). As a result we obtain a canonical smooth structure on a quasitoric manifold, in which the torus action is smooth.

Unlike toric manifolds, quasitoric manifolds are not complex varieties in general, and they may even not admit an almost complex structure. However, an equivariant stably complex structure always exists on a quasitoric manifold  $M$  and is defined canonically by the underlying combinatorial data. These structures will be used in Chapter 9 to define quasitoric representatives in complex cobordism classes.

**Definition and basic constructions.**

DEFINITION 7.3.1. Let  $P$  be a combinatorial simple polytope of dimension  $n$ . A *quasitoric manifold* over  $P$  is a smooth  $2n$ -dimensional manifold  $M$  with a smooth action of the torus  $T^n$  satisfying the two conditions:

- (a) the action is locally standard (see Definition 7.1.1);
- (b) there is a continuous projection  $\pi: M \rightarrow P$  whose fibres are  $T^n$ -orbits.

Property (a) implies that the quotient  $M/P$  is a manifold with corners, and property (b) implies that the quotient is homeomorphic, as a manifold with corners, to the simple polytope  $P$ .

It follows from the definition that the projection  $\pi: M \rightarrow P$  maps a  $k$ -dimensional orbit of the  $T^n$ -action to a point in the relative interior of a  $k$ -dimensional face of  $P$ . In particular, the action is free over the interior of the polytope, while vertices of  $P$  correspond to fixed points of the torus action on  $M$ .

PROPOSITION 7.3.2. *A nonsingular projective toric variety  $V_P$  is a quasitoric manifold over  $P$ .*

PROOF. This follows from Proposition 7.2.3. □

EXAMPLE 7.3.3. The complex projective space  $\mathbb{C}P^n$  with the action of  $T^n \subset (\mathbb{C}^\times)^n$  described in Example 5.1.2 is a quasitoric manifold over the simplex  $\Delta^n$ . The projection  $\pi: \mathbb{C}P^n \rightarrow \Delta^n$  is given by

$$(z_0 : z_1 : \cdots : z_n) \mapsto \frac{1}{\sum_{i=0}^n |z_i|^2} (|z_1|^2, \dots, |z_n|^2).$$

REMARK. For any 2- or 3-dimensional polytope  $P$  there exists a quasitoric manifold over  $P$ . For  $n \geq 4$ , there exist  $n$ -dimensional polytopes which do not arise as quotients of quasitoric manifolds. (See Exercises 7.3.29 and 7.3.30.)

Let  $\mathcal{F} = \{F_1, \dots, F_m\}$  be the set of facets of  $P$ . Consider the preimages

$$M_j = \pi^{-1}(F_j), \quad 1 \leq j \leq m.$$

Points in the relative interior of a facet  $F_j$  correspond to orbits with the same one-dimensional stabiliser subgroup, which we denote by  $T_{F_j}$ . It follows that  $M_j$  is a connected component of the fixed point set of the circle subgroup  $T_{F_j} \subset T^n$ . This implies that  $M_j$  is a  $T^n$ -invariant submanifold of codimension 2 in  $M$ , and  $M_j$  is a quasitoric manifold over  $F_j$  with the action of the quotient torus  $T^n/T_{F_j} \cong T^{n-1}$ . Following [90], we refer to  $M_j$  as the *characteristic submanifold* corresponding to the  $j$ th face  $F_j \subset P$ . The mapping

$$(7.2) \quad \lambda: F_j \mapsto T_{F_j}, \quad 1 \leq j \leq m,$$

is called the *characteristic function* of the quasitoric manifold  $M$ .

Now let  $G$  be a codimension- $k$  face of  $P$ . We can write it as an intersection of  $k$  facets:  $G = F_{j_1} \cap \cdots \cap F_{j_k}$ . Then  $M_G = \pi^{-1}(G)$  is a  $T^n$ -invariant submanifold of codimension  $2k$  in  $M$ , and  $M_G$  is fixed under each circle subgroup  $T(F_{j_p})$ ,  $1 \leq p \leq k$ .



By considering any vertex  $v \in G$  and using the local standardness of the  $T^n$ -action on  $M$  near  $v$ , we observe that the characteristic submanifolds  $M_{j_1}, \dots, M_{j_k}$  intersect transversely at the submanifold  $M_G$ , and the map

$$T_{F_{j_1}} \times \cdots \times T_{F_{j_k}} \rightarrow T^n$$

is a monomorphism onto the  $k$ -dimensional stabiliser of  $M_G$ . The mapping

$$G \mapsto \text{the stabiliser of } M_G$$

extends the characteristic function (7.2) to a map from the face poset of  $P$  to the poset of torus subgroups in  $T^n$ .

**DEFINITION 7.3.4.** Let  $P$  be a combinatorial  $n$ -dimensional simple polytope and let  $\lambda$  be a map from the set of facets of  $P$  to the set of circle subgroups of the torus  $T^n$ . We refer to  $(P, \lambda)$  as a *characteristic pair* if the map  $\lambda(F_{j_1}) \times \cdots \times \lambda(F_{j_k}) \rightarrow T^n$  is a monomorphism whenever  $F_{j_1} \cap \cdots \cap F_{j_k} \neq \emptyset$ .

If  $(P, \lambda)$  is a characteristic pair, then the map  $\lambda$  extends to the face poset of  $P$ , and we have a torus subgroup  $T_G = \lambda(G) \subset T^n$  for each face  $G \subset P$ .

As we shall see below, a quasitoric manifold can be reconstructed from its characteristic pair  $(P, \lambda)$  up to a weakly  $T$ -equivariant homeomorphism.

**CONSTRUCTION 7.3.5** (canonical model  $M(P, \lambda)$ ). Assume given a characteristic pair  $(P, \lambda)$ . For any point  $x \in P$ , we denote by  $G(x)$  the smallest face containing  $x$ . By analogy with (7.1), we define the identification space

$$M(P, \lambda) = P \times T^n / \sim \quad \text{where } (x, t_1) \sim (x, t_2) \text{ if } t_1^{-1}t_2 \in \lambda(G(x)).$$

The free action of  $T^n$  on  $P \times T^n$  descends to an action on  $P \times T^n / \sim$ . This action is free over the interior of the polytope (since no identifications are made over  $\text{int } P$ ), and the fixed points correspond to the vertices. The space  $P \times T^n / \sim$  is covered by the open subsets  $U_v \times T^n / \sim$ , indexed by the vertices  $v \in P$  (see Example 7.1.4.4), and each  $U_v \times T^n / \sim$  is equivariantly homeomorphic to  $\mathbb{C}^n = \mathbb{R}_{\geq 0}^n \times T^n / \sim$ . This implies that the canonical model  $M(P, \lambda)$  is a (topological) manifold with a locally standard  $T^n$ -action and quotient  $P$ . As we shall see from Definition 7.3.13,  $M(P, \lambda)$  has a canonical smooth structure, so it is a quasitoric manifold over  $P$ .

**PROPOSITION 7.3.6** ([90, Lemma 1.4]). *There exists a weakly  $T^n$ -equivariant homeomorphism*

$$M(P, \lambda) = P \times T^n / \sim \rightarrow M$$

*covering the identity map on  $P$ .*

**PROOF.** One first constructs a weakly  $T^n$ -equivariant map  $f: P \times T^n \rightarrow M$  such that  $f$  maps  $x \times T^n$  onto  $\pi^{-1}(x)$  for any point  $x \in P$ . Such a map  $f$  induces a weakly  $T^n$ -equivariant map  $\widehat{f}: M(P, \lambda) = P \times T^n / \sim \rightarrow M$  covering the identity on  $P$ . Furthermore, the map  $\widehat{f}$  is one-to-one on  $T^n$ -orbits, so it is a homeomorphism.

It remains to construct a map  $f: P \times T^n \rightarrow M$ . The argument of Davis–Januszkiewicz which we present here actually works for a more general class of locally standard  $T^n$ -manifolds  $M$ . There is the manifold with boundary  $\widetilde{M}$  obtained by consecutive blowing up the singular strata of  $M$  consisting of non-principal  $T^n$ -orbits. The  $T^n$ -action on  $\widetilde{M}$  is free and  $\widetilde{M}$  is equivariantly diffeomorphic to the complement in  $M$  of the union of tubular neighbourhoods of the singular strata (the latter are characteristic submanifolds  $M_j$  in our case). There is the following

canonical inductive procedure for constructing  $\widetilde{M}$  from  $M$ . One begins by removing a minimal stratum (a fixed point in our case) from  $M$  and replacing it by the sphere bundle of its normal bundle. One continues in this fashion, blowing up minimal strata, until only top stratum is left. There is the canonical projection from the union of sphere bundles to the union of their base spaces (i.e. to the union of singular strata of  $M$ ). Using the construction of [87, p. 344] one extends this projection to a map  $\widetilde{M} \rightarrow M$  which is the identity over top stratum. Now if  $M$  is locally standard, then the quotient  $\widetilde{M}/T^n$  is canonically identified with  $M/T^n$ . In our particular case the latter is a simple polytope  $P$ . Since  $P$  is acyclic together with all its faces, the resulting principal  $T^n$ -bundle  $\widetilde{\pi}: \widetilde{M} \rightarrow P$  is trivial. Therefore, there is an equivariant diffeomorphism  $\widetilde{f}: P \times T^n \rightarrow \widetilde{M}$  inducing the identity on  $P$ . Composing  $\widetilde{f}$  with the collapse map  $\widetilde{M} \rightarrow M$ , we obtain the map  $f$ .  $\square$

REMARK. Note that existence a map  $f: P \times T^n \rightarrow M$  in the proof above is equivalent to existence of a section  $s: P \rightarrow M$  of the quotient projection  $\pi: M \rightarrow P$ . Indeed, given a section  $s$ , one defines  $f(x, t) = t \cdot s(x)$  for  $x \in P$  and  $t \in T^n$ . Conversely, given a map  $f$ , one defines a section by  $s(x) = f(x, 1)$ .

It may seem that constructing a section  $s: P \rightarrow M$  is an easier task than constructing a map  $f$ , taking into account that  $P$  is contractible. However, this comes out to be subtle; it would be interesting to find a more explicit way to construct a section  $s$ .

DEFINITION 7.3.7 (equivalences). Quasitoric manifolds  $M_1$  and  $M_2$  over the same polytope  $P$  are said to be *equivalent over  $P$*  if there exists a weak  $T^n$ -equivariant homeomorphism  $f: M_1 \rightarrow M_2$  covering the identity map on  $P$ .

Two characteristic pairs  $(P, \lambda_1)$  and  $(P, \lambda_2)$  are said to be *equivalent* if there exists an automorphism  $\psi: T^n \rightarrow T^n$  such that  $\lambda_2 = \psi \cdot \lambda_1$ .

PROPOSITION 7.3.8 ([90, Proposition 1.8]). *There is a one-to-one correspondence between equivalence classes of quasitoric manifolds and characteristic pairs. In particular, for any quasitoric manifold  $M$  over  $P$  with characteristic function  $\lambda$ , there is a homeomorphism  $M \cong M(P, \lambda)$ .*

PROOF. Obviously, if two quasitoric manifolds are equivalent over  $P$ , then their characteristic pairs are also equivalent. To establish the other implication, it is enough to show that a quasitoric manifold  $M$  is equivalent to the canonical model  $M(P, \lambda)$ . This follows from Proposition 7.3.6.  $\square$

**Omniorientations and combinatorial quasitoric data.** Here we elaborate on the combinatorial description of quasitoric manifolds  $M$ . Characteristic pairs  $(P, \lambda)$  are replaced by more naturally defined *combinatorial quasitoric pairs*  $(P, \Lambda)$  consisting of an oriented simple polytope and an integer matrix of special type. Compared with the characteristic pair, the pair  $(P, \Lambda)$  carries some additional information, which is equivalent to a choice of orientation for the manifold  $M$  and its characteristic submanifolds. The terminology and constructions described here were introduced in [62] and [58].

DEFINITION 7.3.9. An *omniorientation* of a quasitoric manifold  $M$  consists of a choice of orientation for  $M$  and each characteristic submanifold  $M_j$ ,  $1 \leq j \leq m$ .

In general, an omniorientation on  $M$  cannot be chosen canonically. However, if  $M$  admits a  $T^n$ -invariant almost complex structure (see Definition D.6.1), then

a choice of such structure provides canonical orientations for  $M$  and the invariant submanifolds  $M_j$ . We therefore obtain an omniorientation *associated* with the invariant almost complex structure. In the case when  $M$  has an invariant almost complex structure (for example, when  $M$  is a toric manifold), we always choose the associated omniorientation. Otherwise we choose an omniorientation arbitrarily.

The stabiliser  $T_{F_j}$  of a characteristic submanifold  $M_j \subset M$  can be written as

$$(7.3) \quad T_{F_j} = \{ (e^{2\pi i \lambda_{1j} \varphi}, \dots, e^{2\pi i \lambda_{nj} \varphi}) \in \mathbb{T}^n \},$$

where  $\varphi \in \mathbb{R}$  и  $\lambda_j = (\lambda_{1j}, \dots, \lambda_{nj})^t \in \mathbb{Z}^n$  is a primitive vector. (In the coordinate-free notation used in Chapter 5, the vector  $\lambda_j$  belongs to the lattice  $N$  of one-parameter subgroups of the torus.) This vector is determined by the subgroup  $T_{F_j}$  up to sign. A choice of this sign (and therefore an unambiguous choice of the vector) defines a parametrisation of the circle subgroup  $T_{F_j}$ .

An omniorientation of  $M$  provides a canonical way to choose the vectors  $\lambda_j$ . Indeed, the action of a parametrised circle  $T_{M_j} \subset \mathbb{T}^n$  defines an orientation in the normal bundle  $\nu_j$  of the embedding  $M_j \subset M$ . An omniorientation also defines an orientation on  $\nu_j$  by means of the following decomposition of the tangent bundle:

$$\mathcal{T}M|_{M_j} = \mathcal{T}M_j \oplus \nu_j.$$

Now we choose the direction of the primitive vector  $\lambda_j$  so that these two orientations coincide.

Having fixed an omniorientation, we can extend correspondence (7.2) to a map of lattices

$$\Lambda: \mathbb{Z}^m \rightarrow \mathbb{Z}^n, \quad e_j \mapsto \lambda_j,$$

which we refer to as a *directed* characteristic function. A characteristic function is assumed to be directed whenever an omniorientation is chosen.

We can think of a directed characteristic function as an integer  $n \times m$ -matrix  $\Lambda$  with the following property: if the intersection of facets  $F_{j_1}, \dots, F_{j_k}$  is nonempty, then the vectors  $\lambda_{j_1}, \dots, \lambda_{j_k}$  form a part of basis of the lattice  $\mathbb{Z}^n$ . We refer to such matrices as *characteristic*. In particular, we can write any vertex  $v \in P$  as an intersection of  $n$  facets:  $v = F_{j_1} \cap \dots \cap F_{j_n}$ , and consider the maximal minor  $\Lambda_v = \Lambda_{j_1, \dots, j_n}$  formed by the columns  $j_1, \dots, j_n$  of matrix  $\Lambda$ . Then

$$(7.4) \quad \det \Lambda_v = \pm 1.$$

Since  $M \cong M(P, \lambda) = P \times T^n / \sim$ , and no identifications are made over the interior of  $P$ , a choice of an orientation for  $M$  is equivalent to a choice of an orientation for the polytope  $P$  (once we assume that the torus  $T^n$  is oriented canonically).

**DEFINITION 7.3.10.** Let  $P$  be an oriented combinatorial simple  $n$ -polytope with  $m$  facets, and let  $\Lambda$  be an integer  $n \times m$ -matrix satisfying condition (7.4) for any vertex  $v \in P$ . Then  $(P, \Lambda)$  is called a *combinatorial quasitoric pair*.

An *equivalence* of omnioriented quasitoric manifolds is assumed to preserve the omniorientation; in this case the automorphism  $\psi: T^n \rightarrow T^n$  in Definition 7.3.7 is orientation-preserving. Similarly, two combinatorial quasitoric pairs  $(P, \Lambda_1)$  and  $(P, \Lambda_2)$  are said to be *equivalent* if the orientation of  $P$  coincide and there exists a square integer matrix  $\Psi$  with determinant 1 such that  $\Lambda_2 = \Psi \cdot \Lambda_1$ .

We can summarise the observations above in the following refined version of Proposition 7.3.8:

PROPOSITION 7.3.11. *There is a one-to-one correspondence between equivalence classes of omnioriented quasitoric manifolds and combinatorial quasitoric pairs.*

We shall denote the omnioriented quasitoric manifold corresponding to a combinatorial quasitoric pair  $(P, \Lambda)$  by  $M(P, \Lambda)$ .

Let  $\text{chf}(P)$  denote the set of directed characteristic functions  $\lambda$  for  $P$ . The group  $GL(n, \mathbb{Z})$  of automorphisms of the torus  $T^n$  acts on the set  $\text{chf}(P)$  from the left. Proposition 7.3.11 establishes a one-two-one correspondence

$$(7.5) \quad GL(n, \mathbb{Z}) \backslash \text{chf}(P) \longleftrightarrow \{\text{equivalence classes of omnioriented } M \text{ over } P\}.$$

If the facets of  $P$  are ordered in such a way that the first  $n$  of them meet at a vertex  $v$ , i.e.  $F_1 \cap \cdots \cap F_n = v$ , then each coset from  $GL(n, \mathbb{Z}) \backslash \text{chf}(P)$  contains a unique directed characteristic function given by a matrix of the form

$$(7.6) \quad \Lambda = (I \mid \Lambda_\star) = \begin{pmatrix} 1 & 0 & \cdots & 0 & \lambda_{1,n+1} & \cdots & \lambda_{1,m} \\ 0 & 1 & \cdots & 0 & \lambda_{2,n+1} & \cdots & \lambda_{2,m} \\ \vdots & \vdots & \ddots & \vdots & \vdots & \ddots & \vdots \\ 0 & 0 & \cdots & 1 & \lambda_{n,n+1} & \cdots & \lambda_{n,m} \end{pmatrix}$$

where where  $I$  is the unit matrix and  $\Lambda_\star$  is an  $n \times (m - n)$ -matrix. We refer to (7.6) as a *refined* characteristic matrix, and to  $\Lambda_\star$  as its *refined submatrix*. If a characteristic matrix is given in a non-refined form  $\Lambda = (A \mid B)$ , where  $A$  has size  $n \times n$ , then its refined representative is given by  $(I \mid A^{-1}B)$ .

**Smooth and stably complex structures.** Let  $(P, \Lambda)$  be a combinatorial quasitoric pair. The matrix  $\Lambda$  defines an epimorphism of tori  $\exp \Lambda: \mathbb{T}^m \rightarrow \mathbb{T}^n$ , whose kernel we denote by  $K = K(\Lambda)$ . Condition (7.4) implies that  $K \cong \mathbb{T}^{m-n}$ . We therefore have an exact sequence of tori similar to (5.9). Also, there is the moment-angle manifold  $\mathcal{Z}_P$  corresponding to the polytope  $P$  (see Section 6.2).

PROPOSITION 7.3.12. *The group  $K(\Lambda) \cong \mathbb{T}^{m-n}$  acts freely and smoothly on  $\mathcal{Z}_P$ . There is a  $T^n$ -equivariant homeomorphism*

$$\mathcal{Z}_P / K(\Lambda) \xrightarrow{\cong} M(P, \Lambda)$$

*between the quotient  $\mathcal{Z}_P / K(\Lambda)$  and the canonical model  $M(P, \Lambda)$ .*

PROOF. The fact that  $K$  acts freely on  $\mathcal{Z}_P$  is proved in the same way as Proposition 5.4.6 (a) and Theorem 6.5.2 (a). The stabiliser of a point  $z \in \mathcal{Z}_P$  with respect to the  $\mathbb{T}^m$ -action is a coordinate subtorus  $\mathbb{T}^I$  for some  $I \in \mathcal{K}_P$ . Namely, if  $z \in \mathcal{Z}_P$  projects to  $x \in P$ , then  $I = I_x = \{i \in [m] : x \in F_i\}$ . Condition (7.4) implies that the restriction of the homomorphism  $\exp \Lambda: \mathbb{T}^m \rightarrow \mathbb{T}^n$  to any such subtorus  $\mathbb{T}^I$  is injective, and therefore the kernel  $K$  intersects each  $\mathbb{T}^I$ ,  $I \in \mathcal{K}_P$ , trivially. Hence  $K$  acts freely on  $\mathcal{Z}_P$ , and the quotient  $\mathcal{Z}_P / K$  is a  $2n$ -dimensional manifold with an action of the torus  $\mathbb{T}^m / K \cong \mathbb{T}^n$ .

To prove the second statement, we identify  $\mathcal{Z}_P$  with the quotient  $P \times \mathbb{T}^m / \sim$ , see Section 6.2. Then the projection  $\mathcal{Z}_P \rightarrow \mathcal{Z}_P / K$  is identified with the projection

$$\mathcal{Z}_P = P \times \mathbb{T}^m / \sim \rightarrow P \times \mathbb{T}^n / \sim,$$

induced by the homomorphism  $\exp \Lambda: \mathbb{T}^m \rightarrow \mathbb{T}^n$ . By Construction 7.3.5, the quotient  $P \times \mathbb{T}^n / \sim$  is the canonical quasitoric manifold  $M(P, \Lambda)$ .  $\square$

DEFINITION 7.3.13. Using Proposition 7.3.12 we obtain a smooth structure on the canonical model  $M(P, \Lambda)$  as the quotient of the smooth manifold  $\mathcal{Z}_P$  by the smooth action of  $K(\Lambda)$ , with the induced smooth action of the  $n$ -torus  $\mathbb{T}^m/K(\Lambda)$ . We refer to this smooth structure on  $M(P, \Lambda)$  and on any quasitoric manifold equivalent to it as *canonical*.

Now let  $p: \mathcal{Z}_P \rightarrow P$  be the projection, and consider the submanifolds  $p^{-1}(F_i) \subset \mathcal{Z}_P$  corresponding to facets  $F_i$  of  $P$  (see Exercise 6.2.13). The submanifold  $p^{-1}(F_i)$  is fixed by the  $i$ th coordinate subcircle in  $\mathbb{T}^m$ . Denote by  $\mathbb{C}_i$  the space of the 1-dimensional complex representation of the torus  $\mathbb{T}^m$  induced from the standard representation in  $\mathbb{C}^m$  by the projection  $\mathbb{C}^m \rightarrow \mathbb{C}_i$  onto the  $i$ th coordinate. Let  $\mathcal{Z}_P \times \mathbb{C}_i \rightarrow \mathcal{Z}_P$  be the trivial complex line bundle; we view it as an equivariant  $\mathbb{T}^m$ -bundle with diagonal action of  $\mathbb{T}^m$ . Then the restriction of the bundle  $\mathcal{Z}_P \times \mathbb{C}_i \rightarrow \mathcal{Z}_P$  to the invariant submanifold  $p^{-1}(F_i)$  is  $\mathbb{T}^m$ -isomorphic to the normal bundle of the embedding  $p^{-1}(F_i) \subset \mathcal{Z}_P$ . By taking quotient with respect to the diagonal action of  $K = K(\Lambda)$  we obtain a  $T^n$ -equivariant complex line bundle

$$(7.7) \quad \rho_i: \mathcal{Z}_P \times_K \mathbb{C}_i \rightarrow \mathcal{Z}_P/K = M(P, \Lambda)$$

over the quasitoric manifold  $M = M(P, \Lambda)$ . The restriction of the bundle  $\rho_i$  to the characteristic submanifold  $p^{-1}(F_i)/K = M_i$  is isomorphic to the normal bundle of  $M_i \subset M$  (an exercise). The resulting complex structure on this normal bundle is the one defined by the omniorientation of  $M(P, \Lambda)$ .

THEOREM 7.3.14 ([90, Theorem 6.6]). *There is the following isomorphism of real  $T^n$ -bundles over  $M = M(P, \Lambda)$ :*

$$(7.8) \quad \mathcal{T}M \oplus \underline{\mathbb{R}}^{2(m-n)} \cong \rho_1 \oplus \cdots \oplus \rho_m;$$

here  $\underline{\mathbb{R}}^{2(m-n)}$  denotes the trivial real  $2(m-n)$ -dimensional  $T^n$ -bundle over  $M$ .

PROOF. The proof given here differs from that of [90]: we use the equivariant framing of  $\mathcal{Z}_P$  coming from its realisation by an intersection of quadrics, see Section 6.2. Let  $i_{\mathcal{Z}}: \mathcal{Z}_P \rightarrow \mathbb{C}^m$  be the  $\mathbb{T}^m$ -equivariant embedding, see (6.2). We have a  $\mathbb{T}^m$ -equivariant decomposition

$$(7.9) \quad \mathcal{T}\mathcal{Z}_P \oplus \nu(i_{\mathcal{Z}}) = \mathcal{Z}_P \times \mathbb{C}^m$$

obtained by restricting the tangent bundle  $\mathcal{T}\mathbb{C}^m$  to  $\mathcal{Z}_P$ . The normal bundle  $\nu(i_{\mathcal{Z}})$  is  $\mathbb{T}^m$ -equivariantly trivial by Theorem 6.1.3, and  $\mathcal{Z}_P \times \mathbb{C}^m$  is isomorphic, as a  $\mathbb{T}^m$ -bundle, to the sum of line bundles  $\mathcal{Z}_P \times \mathbb{C}_i$ ,  $1 \leq i \leq m$ . Further, we have

$$(7.10) \quad \mathcal{T}\mathcal{Z}_P = q^*(\mathcal{T}M) \oplus \xi,$$

where  $\xi$  is the tangent bundle along the fibres of the principal  $K$ -bundle  $q: \mathcal{Z}_P \rightarrow \mathcal{Z}_P/K = M$ , see [300, Corollary 6.2]. The bundle  $\xi$  is induced by the projection  $q$  from the vector bundle over  $M$  associated with the principal bundle  $\mathcal{Z}_P \rightarrow M$  through the adjoint representation of the Lie group  $K$ ; since  $K$  is abelian, this bundle is trivial. Taking quotient of identity (7.9) by the action of  $K$  and using (7.10), we obtain a decomposition

$$(7.11) \quad \mathcal{T}M \oplus (\xi/K) \oplus (\nu(i_{\mathcal{Z}})/K) \cong \mathcal{Z}_P \times_K \mathbb{C}^m.$$

As we have seen above, both  $\xi$  and  $\nu(i_{\mathcal{Z}})$  are trivial  $\mathbb{T}^m$ -bundles, so that  $(\xi/K) \oplus (\nu(i_{\mathcal{Z}})/K) \cong \underline{\mathbb{R}}^{2(m-n)}$ . Also,  $\mathcal{Z}_P \times_K \mathbb{C}^m \cong \rho_1 \oplus \cdots \oplus \rho_m$  as  $T^n$ -bundles.  $\square$

The isomorphism of Theorem 7.3.14 gives us an isomorphism of the stable tangent bundle of  $M$  with a complex vector bundle: this is the setup for a stably complex structure (see Definition D.6.1).

**COROLLARY 7.3.15.** *An omnioriented quasitoric manifold  $M$  has a canonical  $T^n$ -invariant stably complex structure  $c_{\mathcal{T}}$  defined by the isomorphism of (7.8).*

The corresponding bordism classes  $[M] \in \Omega_{2n}^U$  will be studied in Section 9.5.

**EXAMPLE 7.3.16.** Let us see which stably complex structures we can obtain from different omniorientations on the simplest quasitoric manifold  $S^2$  over the segment  $I^1$  using Theorem 7.3.14. The standard complex structure of  $\mathbb{C}P^1$  has the characteristic matrix  $(1 \ -1)$ . The group  $K$  is the diagonal circle  $\{(t, t)\} \subset \mathbb{T}^2$ , and (7.11) becomes the standard decomposition

$$\mathcal{T}\mathbb{C}P^1 \oplus \underline{\mathbb{C}} \cong S^3 \times_K \mathbb{C}^2 = \bar{\eta} \oplus \bar{\eta},$$

where  $\eta$  is the tautological and  $\bar{\eta}$  is the canonical line bundle, see Exercise B.3.6.

On the other hand, there is an omniorientation of  $S^2$  corresponding to the characteristic matrix  $(1 \ 1)$ . Then  $K = \{(t^{-1}, t)\} \subset \mathbb{T}^2$ , and (7.11) becomes

$$\mathcal{T}S^2 \oplus \underline{\mathbb{R}}^2 \cong S^3 \times_K \mathbb{C}^2 = \eta \oplus \bar{\eta},$$

which is the trivial stably complex structure on  $S^2$  (see Example D.3.1).

**Weights and signs at fixed points.** Any fixed point  $v$  of the  $T^n$ -action on a quasitoric manifold  $M$  is isolated. It can be obtained as an intersection  $M_{j_1} \cap \cdots \cap M_{j_n}$  of  $n$  characteristic submanifolds and corresponds to a vertex  $F_{j_1} \cap \cdots \cap F_{j_n}$  of the polytope  $P$ . Therefore, the tangent space to  $M$  at  $v$  decomposes into the sum of normal spaces to  $M_{j_k}$  for  $1 \leq k \leq n$ :

$$(7.12) \quad \mathcal{T}_v M = (\rho_{j_1} \oplus \cdots \oplus \rho_{j_n})|_v.$$

We use this decomposition to identify  $\mathcal{T}_v M$  with  $\mathbb{C}^n$ ; then the tangent space to  $M_{j_k}$  is given in the corresponding coordinates  $(z_1, \dots, z_n)$  by the equation  $z_k = 0$ . The representation of the torus  $T^n$  in the tangent space  $\mathcal{T}_v M \cong \mathbb{C}^n$  is determined by its set of *weights*  $\mathbf{w}_k(v) \in \mathbb{Z}^n$ ,  $1 \leq k \leq n$ . Namely, for  $\mathbf{t} = (e^{2\pi i \varphi_1}, \dots, e^{2\pi i \varphi_n}) \in T^n$  and  $\mathbf{z} = (z_1, \dots, z_n) \in \mathcal{T}_v M$ , we have

$$\mathbf{t} \cdot \mathbf{z} = (e^{2\pi i \langle \mathbf{w}_1(v), \varphi \rangle} z_1, \dots, e^{2\pi i \langle \mathbf{w}_n(v), \varphi \rangle} z_n),$$

where  $\varphi = (\varphi_1, \dots, \varphi_n) \in \mathbb{R}^n$ . The weights can be found from the combinatorial quasitoric pair  $(P, A)$  using the following statement:

**PROPOSITION 7.3.17.** *Let  $M = M(P, A)$  be a quasitoric manifold. The weights  $\mathbf{w}_1(v), \dots, \mathbf{w}_n(v)$  of the tangent representation of  $T^n$  at a fixed point  $v = M_{j_1} \cap \cdots \cap M_{j_n}$  are given by the columns of the square matrix  $W_v$  satisfying the identity*

$$W_v^t A_v = I.$$

*In other words,  $\{\mathbf{w}_1(v), \dots, \mathbf{w}_n(v)\}$  is the lattice basis conjugate to  $\{\lambda_{j_1}, \dots, \lambda_{j_n}\}$ .*

**PROOF.** First, note that the local standardness of the action implies that  $\{\mathbf{w}_1(v), \dots, \mathbf{w}_n(v)\}$  is a lattice basis. (The fact that  $\{\lambda_{j_1}, \dots, \lambda_{j_n}\}$  is a lattice basis is expressed by identity (7.4).)

Since the one-parameter subgroup  $T_{F_{j_k}} \subset T^n$  (see (7.3)) fixes the hyperplane  $z_k = 0$  tangent to  $M_{j_k}$ , we obtain that  $\langle \mathbf{w}_i(v), \lambda_{j_k} \rangle = 0$  for  $i \neq k$ . Therefore,  $W_v^t A_v$

is a diagonal matrix. Now, the columns of both  $W_v$  and  $A_v$  are lattice bases, which implies  $\langle \mathbf{w}_k(v), \lambda_{j_k} \rangle = \pm 1$  for  $1 \leq k \leq n$ .

On the other hand, the complex structure on the line bundle  $\rho_{j_k}$  comes from the orientation induced by the action of the one-parameter subgroup of  $T^n$  corresponding to the vector  $\lambda_{j_k}$ . Hence  $\langle \mathbf{w}_k(v), \lambda_{j_k} \rangle > 0$  for  $1 \leq k \leq n$ .  $\square$

The signs of the fixed points defined by the  $T^n$ -invariant stably complex structure on  $M$  (see Definition D.6.2) can be calculated in terms of the combinatorial quasitoric pair  $(P, A)$  as follows:

LEMMA 7.3.18. *Let  $v = M_{j_1} \cap \cdots \cap M_{j_n}$  be a fixed point.*

- (a) *In terms of decomposition (7.12), we have  $\sigma(v) = 1$  if the orientation of the space  $\mathcal{T}_v M$  determined by the orientation of  $M$  coincides with the orientation of the space  $(\rho_{j_1} \oplus \cdots \oplus \rho_{j_n})|_v$  determined by the orientation of the line bundles  $\rho_{j_k}$ ,  $1 \leq k \leq n$ . Otherwise,  $\sigma(v) = -1$ .*
- (b) *In terms of the combinatorial quasitoric pair  $(P, A)$ , we have*

$$\sigma(v) = \text{sign}(\det(\lambda_{j_1}, \dots, \lambda_{j_n}) \det(\mathbf{a}_{j_1}, \dots, \mathbf{a}_{j_n})),$$

where  $\mathbf{a}_{j_1}, \dots, \mathbf{a}_{j_n}$  are inward-pointing normals to the facets  $F_{j_1}, \dots, F_{j_n}$ .

PROOF. To prove (a), we note that the complex line bundle  $\rho_i$  is trivial over the complement to  $M_i$  in  $M$ . Therefore, the nontrivial part of the  $T^n$ -representation  $(\rho_1 \oplus \cdots \oplus \rho_m)|_v$  is exactly  $(\rho_{j_1} \oplus \cdots \oplus \rho_{j_n})|_v$ . This implies that the composite map in Definition D.6.2 is given by

$$(7.13) \quad \mathcal{T}_v M \rightarrow (\rho_{j_1} \oplus \cdots \oplus \rho_{j_n})|_v.$$

To prove (b), we write map (7.13) in coordinates. To do this, we identify  $\mathbb{C}^m$  with  $\mathbb{R}^{2m}$  by mapping a point  $(z_1, \dots, z_m) \in \mathbb{C}^m$  to  $(x_1, \dots, x_m, y_1, \dots, y_m) \in \mathbb{R}^{2m}$ , where  $z_k = x_k + iy_k$ . Using decomposition (7.11), we obtain that the map

$$\mathcal{T}_v M \rightarrow \mathcal{T}_v M \oplus \mathbb{R}^{2(m-n)} \xrightarrow{c\mathcal{T}} (\rho_1 \oplus \cdots \oplus \rho_m)|_v \cong \mathbb{R}^{2m}$$

from Definition D.6.2 is given by the  $2m \times 2n$ -matrix

$$\begin{pmatrix} A^t & \mathbf{0} \\ \mathbf{0} & A^t \end{pmatrix}$$

where  $A$  denotes the  $n \times m$ -matrix with columns vectors  $\mathbf{a}_i$  defined by presentation (1.1) of the polytope  $P$ . Map (7.13) is obtained by restricting to the submatrices of  $A^t$  and  $A^t$  formed by rows with numbers  $j_1, \dots, j_n$ , which implies the required formula for the sign.  $\square$

EXAMPLE 7.3.19. Let  $V_P$  be the projective toric manifold corresponding to a simple lattice polytope  $P$  given by (1.1). Then  $\lambda_i = \mathbf{a}_i$  for  $1 \leq i \leq m$ . Proposition 7.3.17 implies that the weights  $\mathbf{w}_1(v), \dots, \mathbf{w}_n(v)$  of the tangent representation of the torus at a fixed point  $v \in V_P$  are the primitive vectors along the edges of  $P$  pointing out of  $v$ . Furthermore, Lemma 7.3.18 implies that  $\sigma(v) = 1$  for all  $v$ .

For a general quasitoric manifold, the weights  $\mathbf{w}_1(v), \dots, \mathbf{w}_n(v)$  are not vectors along edges. However, by Proposition 7.3.17, there is a natural one-to-one correspondence

$$(7.14) \quad \{\text{oriented edges of } P\} \\ \leftrightarrow \{\text{weights of the tangential } T^n\text{-representations at fixed points}\}.$$

Under this correspondence, an edge  $e$  coming out of a vertex  $v = F_{j_1} \cap \cdots \cap F_{j_n} \in P$  maps to  $\mathbf{w}_k(v)$ , where  $F_{j_k}$  is the unique facet containing  $v$  and not containing  $e$  and  $\mathbf{w}_k(v)$  is the  $k$ th vector of the conjugate basis of  $\lambda_{j_1}, \dots, \lambda_{j_n}$ .

LEMMA 7.3.20. *Let  $\mathbf{e}_1, \dots, \mathbf{e}_n$  be vectors along the edges coming out of a vertex  $v \in P$ , and let  $\mathbf{w}_1(v), \dots, \mathbf{w}_n(v)$  be the corresponding weights. Then there is the following formula for the sign of the vertex:*

$$\sigma(v) = \text{sign}(\det(\mathbf{w}_1(v), \dots, \mathbf{w}_n(v)) \det(\mathbf{e}_1, \dots, \mathbf{e}_n)).$$

PROOF. This follows from Lemma 7.3.18 and the fact that  $\{\mathbf{w}_1(v), \dots, \mathbf{w}_n(v)\}$  is the conjugate basis of  $\{\lambda_{j_1}, \dots, \lambda_{j_n}\}$ , while the vectors  $\{\mathbf{e}_1, \dots, \mathbf{e}_n\}$  can be scaled so that they form the conjugate basis of  $\{\mathbf{a}_{j_1}, \dots, \mathbf{a}_{j_n}\}$ .  $\square$

REMARK. Formulae of Lemmata 7.3.18 and 7.3.20 can be rephrased as the following practical rule for calculation of signs, which will be used below. Write the vectors  $\lambda_{j_1}, \dots, \lambda_{j_n}$  (respectively,  $\mathbf{w}_1(v), \dots, \mathbf{w}_n(v)$ ) into a square matrix in the order given by the orientation of  $P$ , that is, in such a way that inward-pointing normals of the corresponding facets (respectively, vectors along the corresponding edges) form a positive basis of  $\mathbb{R}^n$ . Then the determinant of this matrix is  $\sigma(v)$ . In other words, assuming that the weights  $\mathbf{w}_1(v), \dots, \mathbf{w}_n(v)$  are ordered so that vectors along their corresponding edges form a positive basis, we can rewrite the formula of Lemma 7.3.20 as

$$(7.15) \quad \sigma(v) = \det(\mathbf{w}_1(v), \dots, \mathbf{w}_n(v)).$$

EXAMPLE 7.3.21. The complex projective plane  $\mathbb{C}P^2$  has the standard stably complex structure coming from the bundle isomorphism

$$\mathcal{T}(\mathbb{C}P^2) \oplus \underline{\mathbb{C}} \cong \bar{\eta} \oplus \bar{\eta} \oplus \bar{\eta},$$

where  $\eta$  is the tautological line bundle. The orientation is determined by the complex structure. The toric manifold  $\mathbb{C}P^2$  corresponds to the lattice 2-simplex  $\Delta^2$  with vertices  $(0, 0)$ ,  $(1, 0)$  and  $(0, 1)$ . The column vectors  $\lambda_1, \lambda_2, \lambda_3$  of the matrix  $A$  are the primitive inward-pointing normals to the facets (i.e. they coincide with the vectors  $\mathbf{a}_1, \mathbf{a}_2, \mathbf{a}_3$  for the standard presentation of  $\Delta^2$ ). The weights of the tangential  $T^2$ -representation at a fixed point are the primitive vectors along the edges coming out of the corresponding vertex. This is shown in Fig. 7.1. We have  $\sigma(v_1) = \sigma(v_2) = \sigma(v_3) = 1$ .

EXAMPLE 7.3.22. Now consider  $\mathbb{C}P^2$  with the omniorientation defined by the three vectors  $\lambda_1, \lambda_2, \lambda_3$  in Fig. 7.2. This omniorientation differs from the previous one by the sign of  $\lambda_3$ . The stably complex structure is defined by the isomorphism

$$\mathcal{T}(\mathbb{C}P^2) \oplus \underline{\mathbb{R}}^2 \cong \bar{\eta} \oplus \bar{\eta} \oplus \eta.$$

Using formula (7.15), we calculate

$$\sigma(v_1) = \begin{vmatrix} 1 & 0 \\ 0 & 1 \end{vmatrix} = 1, \quad \sigma(v_2) = \begin{vmatrix} -1 & 1 \\ 1 & 0 \end{vmatrix} = -1, \quad \sigma(v_3) = \begin{vmatrix} 0 & 1 \\ 1 & -1 \end{vmatrix} = -1.$$

If the omniorientation of  $M$  comes from a  $T^n$ -invariant almost complex structure, then all signs of fixed points are positive because the two orientation in (7.12) coincide. As we shall see below in this section, the top Chern number of the stably complex structure of an omnioriented quasitoric manifold  $M$  is equal to the sum



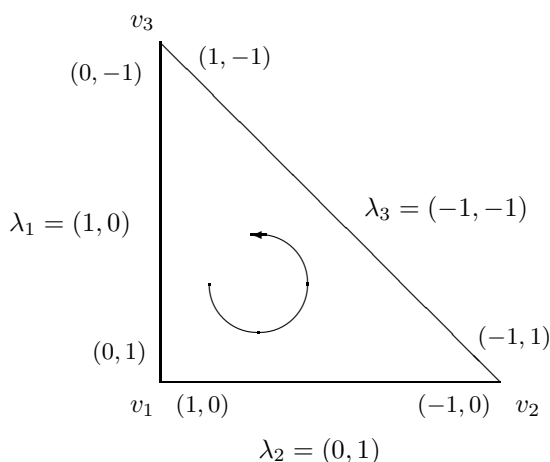

FIGURE 7.1.  $\mathcal{T}(\mathbb{C}P^2) \oplus \mathbb{C} \cong \bar{\eta} \oplus \bar{\eta} \oplus \bar{\eta}$

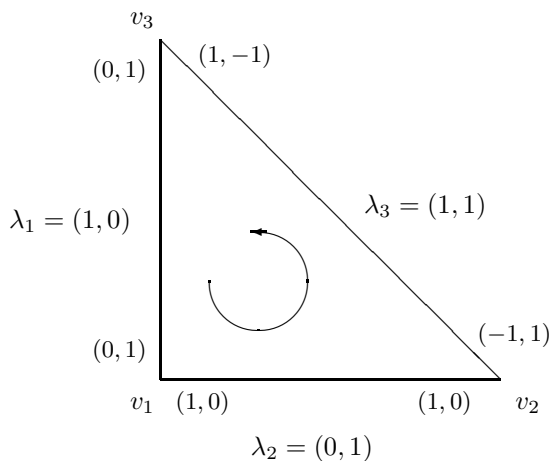

FIGURE 7.2.  $\mathcal{T}(\mathbb{C}P^2) \oplus \mathbb{C} \cong \bar{\eta} \oplus \bar{\eta} \oplus \eta$

of signs of fixed points:  $c_n[M] = \sum_{v \in M} \sigma(v)$ . On the other hand, the Euler characteristic  $\chi(M)$  is equal to the number of fixed points. Therefore, the positivity of all signs is equivalent to the condition  $c_n[M] = \chi(M)$ . According to the classical result of Thomas [306], this condition is sufficient for a stably complex manifold  $M$  to be almost complex. The following result of Kustarev shows that this almost complex structure can be made  $T^n$ -invariant:

**THEOREM 7.3.23 ([190]).** *A quasitoric manifold  $M$  admits a  $T^n$ -invariant almost complex structure if and only if it admits an omniorientation in which all signs of fixed points are positive.*

Theorem 7.3.23 allows one to construct an invariantly almost complex quasitoric manifold which is not toric (see Exercise 7.3.34 below). Such an almost

complex structure cannot be integrable. Indeed, according to the result of Ishida–Karshon [171] (Theorem 6.6.8, see also [172]), a quasitoric manifold with an invariant complex structure is biholomorphic to a compact toric variety.

**Cohomology ring and characteristic classes.** The cohomology ring  $H^*(M)$  of a quasitoric manifold  $M$  has the same structure as the cohomology ring of a nonsingular compact toric variety (see Theorem 5.3.1). In particular, the ring  $H^*(M)$  is generated by two-dimensional classes  $v_i$  dual to the characteristic submanifolds (or equivalently, by the first Chern classes of line bundles  $\rho_i$  from Theorem 7.3.14). The elements  $v_i$  satisfy two types of relations: monomial relations coming from the face ring of the polytope  $P$  and linear relations coming from the characteristic matrix  $A$ .

Let  $M = M(P, A)$  be an omnioriented quasitoric manifold, and let  $\pi: M \rightarrow P$  be the projection onto the orbit space. We start by describing a canonical cell decomposition of  $M$  with only even-dimensional cells. It was first constructed by Khovanskii [183] for toric manifolds.

**CONSTRUCTION 7.3.24.** Recall the ‘Morse-theoretic’ arguments used in the proof of the Dehn–Sommerville relations (Theorem 1.3.4). There we turned the 1-skeleton of  $P$  into an oriented graph and defined the index  $\text{ind}(v)$  of a vertex  $v \in P$  as the number of incoming edges. The incoming edges of  $v$  span a face  $G_v$  of dimension  $\text{ind}(v)$ . Denote by  $\widehat{G}_v$  the subset obtained by removing from  $G_v$  all faces not containing  $v$ . Then  $\widehat{G}_v$  is homeomorphic to  $\mathbb{R}_{\geq \text{ind}(v)}$  and is contained in the open set  $U_v \subset P$  from Example 7.1.4.4. The preimage  $e_v = \pi^{-1}\widehat{G}_v$  is homeomorphic to  $\mathbb{C}^{\text{ind}(v)}$  and the union of subsets  $e_v \subset M$  over all vertices  $v \in P$  defines a cell decomposition of  $M$ . Observe that all cells have even dimension, and the closure of the cell  $e_v$  is the quasitoric submanifold  $\pi^{-1}(G_v) \subset M$ .

**PROPOSITION 7.3.25.** *The homology groups of a quasitoric manifold  $M = M(P, A)$  vanish in odd dimensions, and therefore are free abelian in even dimensions. Their ranks (Betti numbers) are given by*

$$b_{2i}(M) = h_i(P),$$

where  $h_i(P)$ ,  $i = 0, 1, \dots, n$ , are the components of the  $h$ -vector of  $P$ .

**PROOF.** The rank of  $H_{2i}(M; \mathbb{Z})$  is equal to the number of  $2i$ -dimensional cells in the above cell decomposition. This number is equal to the number of vertices of index  $i$ , which is  $h_i(P)$  by the argument from the proof of Theorem 1.3.4.  $\square$

Now consider the face ring  $\mathbb{Z}[P]$  (see Section 3.1) and define its elements

$$(7.16) \quad t_i = \lambda_{i1}v_1 + \cdots + \lambda_{im}v_m \in \mathbb{Z}[P], \quad 1 \leq i \leq n,$$

corresponding to the rows of the characteristic matrix  $A$ .

**LEMMA 7.3.26.** *The elements  $t_1, \dots, t_n$  form a linear regular sequence (an lsop) in the ring  $\mathbb{Z}[P]$ . Conversely, any lsop (7.16) in the ring  $\mathbb{Z}[P]$  defines a combinatorial quasitoric pair  $(P, A)$ .*

**PROOF.** Since  $\mathbb{Z}[P]$  is a Cohen–Macaulay ring (Corollary 3.3.13), any lsop is a regular sequence by Proposition A.3.12. So it is enough to show that  $t_1, \dots, t_n$  is an lsop. Condition (7.4) implies that for any vertex  $v = F_{j_1} \cap \cdots \cap F_{j_n}$  the restrictions of the elements  $t_1, \dots, t_n$  form a basis in the linear part of the polynomial ring  $\mathbb{Z}[v_{j_1}, \dots, v_{j_n}]$ . By Lemma 3.3.1, this condition specifies lsop’s in the ring  $\mathbb{Z}[P]$ .  $\square$

THEOREM 7.3.27 ([90]). *Let  $M = M(P, \Lambda)$  be a quasitoric manifold with  $\Lambda = (\lambda_{ij})$ ,  $1 \leq i \leq n$ ,  $1 \leq j \leq m$ . The cohomology of  $M$  is given by*

$$H^*(M) = \mathbb{Z}[v_1, \dots, v_m]/\mathcal{I},$$

where  $v_i \in H^2(M)$  is the class dual to the characteristic submanifold  $M_i$ , and  $\mathcal{I}$  is the ideal generated by elements of the following two types:

- (a)  $v_{i_1} \cdots v_{i_k}$  whenever  $M_{i_1} \cap \cdots \cap M_{i_k} = \emptyset$  (the Stanley–Reisner relations);
- (b) the linear forms  $t_i = \lambda_{i1}v_1 + \cdots + \lambda_{im}v_m$ ,  $1 \leq i \leq n$ .

In other words,  $H^*(M)$  is the quotient of the face ring  $\mathbb{Z}[P]$  by the ideal generated by linear forms (7.16). We shall prove a more general result, covering both Theorem 5.3.1 and Theorem 7.3.27, in the next section (see Theorem 7.4.35).

If the matrix  $\Lambda$  has refined form (7.6), then the linear relations between the cohomology classes can be written as

$$(7.17) \quad v_i = -\lambda_{i,n+1}v_{n+1} - \cdots - \lambda_{i,m}v_m, \quad 1 \leq i \leq n.$$

It follows that the classes  $v_{n+1}, \dots, v_m$  multiplicatively generate the ring  $H^*(M)$ .

If the cohomology ring of a manifold is not generated by two-dimensional classes, then the manifold does not support a torus action turning it into a quasitoric manifold. For example, complex Grassmanians (except complex projective spaces) are not quasitoric.

REMARK. The structure of the cohomology ring of  $M$  given in Theorem 7.3.27 allows one to describe  $H^*(M)$  as a module over the Steenrod algebra. Furthermore, the ring  $E^*(M)$  can be described easily for any complex-oriented cohomology theory  $E^*$ . We shall give such a description for the complex cobordism ring  $\Omega_U^*(M)$  and the action of the Landweber–Novikov algebra in Chapter 9.

The Chern classes of the stably complex structure on  $M$  (see Corollary 7.3.15) can be also described easily:

THEOREM 7.3.28. *Let  $(M, c_{\mathcal{T}})$  be a quasitoric manifold with the canonical stably complex structure defined by an omniorientation. Then, in the notation of Theorem 7.3.27, we have the following expression for the total Chern class:*

$$c(M) = 1 + c_1(M) + \cdots + c_n(M) = (1 + v_1) \cdots (1 + v_m) \in H^*(M).$$

The homology class dual to  $c_k(M) \in H^{2k}(M)$  is represented by the sum of the submanifolds  $\pi^{-1}(G) \subset M$  corresponding to all  $(n - k)$ -dimensional faces  $G \subset P$ .

PROOF. The first statement holds since the stably complex structure on  $M$  is defined by the isomorphism with the complex bundle  $\rho_1 \oplus \cdots \oplus \rho_m$ , and  $c(\rho_i) = 1 + v_i$ ,  $1 \leq i \leq m$ . To prove the second statement, note that

$$c_k(M) = \sum_{1 \leq j_1 < \cdots < j_k \leq m} v_{j_1} \cdots v_{j_k} \in H^{2k}(M).$$

Here summands  $v_{j_1} \cdots v_{j_k}$  for which  $F_{j_1} \cap \cdots \cap F_{j_k} = \emptyset$  are zero by Theorem 7.3.27, and the remaining summands are dual to the submanifolds  $\pi^{-1}(G)$ , where  $G = F_{j_1} \cap \cdots \cap F_{j_k}$  is a  $(n - k)$ -dimensional face.  $\square$

**Exercises.**

7.3.29. For any 2- or 3-dimensional simple polytope  $P$ , there exists a quasitoric manifold over  $P$ . (Hint: use the model  $M(P, \lambda)$  and the 4-colour Theorem, cf. [90].)

7.3.30. Let  $P$  be the dual of a 2-neighbourly (e.g., cyclic) simplicial polytope of dimension  $n \geq 4$  with  $m \geq 2^n$  vertices. Then there is no quasitoric manifold over  $P$ . (Hint: use the argument from Example 3.3.4.)

7.3.31. Let  $M = M(P, \lambda)$  be a quasitoric manifold and  $\rho_i$  the complex line bundle over  $M$  defined by (7.7). Show that the restriction of  $\rho_i$  to the characteristic submanifold  $M_i$  is isomorphic to the normal bundle of  $M_i$ , and the restriction of  $\rho_i$  to the complement  $M \setminus M_i$  is trivial.

7.3.32. Calculate the signs of the fixed points for the two omniorientations on  $S^2$  in Example 7.3.16 and compare this with the sign calculation from Example D.6.3.

7.3.33. Let  $M$  be a quasitoric manifold over an  $n$ -polytope  $P$  and let  $\mathcal{Z}_P$  be the corresponding moment-angle manifold. Show that the Borel constructions  $ET^n \times_{T^n} M$  and  $ET^m \times_{T^m} \mathcal{Z}_P$  are homotopy equivalent. Deduce that the equivariant cohomology  $H_{T^n}^*(M)$  is isomorphic to the face ring  $\mathbb{Z}[P]$ .

7.3.34. Let  $(P, \lambda)$  be the quasitoric pair shown in Fig. 7.3. Show that the corresponding quasitoric manifold  $M(P, \lambda)$  admits a  $T^2$ -invariant almost complex structure, but is not homeomorphic to a toric variety. (Hint: read Section 9.5.)

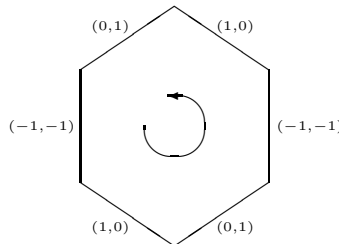

FIGURE 7.3. A quasitoric manifold over a hexagon.

7.3.35. The complex Grassmanian  $Gr_k(\mathbb{C}^n)$  of  $k$ -planes in  $\mathbb{C}^n$  with  $2 \leq k \leq n-2$  does not support a torus action turning it into a (quasi)toric manifold.

7.3.36. Let  $M$  be an omnioriented quasitoric manifold over a polytope  $P$ . Let  $x = F_{i_1} \cap \cdots \cap F_{i_n}$  be a vertex of  $P$  written as an intersection of  $n$  facets; it corresponds to fixed point  $x$  of  $M$ . Show that

$$\langle v_{i_1} v_{i_2} \cdots v_{i_n}, [M] \rangle = \sigma(x),$$

where  $v_i \in H^2(M)$  is the generator corresponding to  $F_i$  (see Theorem 7.3.27),  $[M] \in H_{2n}(M)$  is the fundamental homology class of the oriented manifold  $M$ , and  $\sigma(x)$  is the sign of  $x$  (see Lemma 7.3.18).

7.3.37. The top Chern number of  $M$  is given by  $\langle c_n(M), [M] \rangle = \sum_{v \in P} \sigma(v)$  where the sum is taken over all vertices  $v$  of  $P$ . (Hint: use Theorem 7.3.28.)

7.3.38. Show that if  $M$  is a toric manifold, then  $c_1(M) \neq 0$ . Given an example of an omnioriented quasitoric manifold  $M$  with  $c_1(M) = 0$ .

#### 7.4. Locally standard $T$ -manifolds and torus manifolds

In this section we consider two closely related classes of half-dimensional torus actions on even-dimensional manifolds.

**DEFINITION 7.4.1.** A *locally standard  $T$ -manifold* is a smooth connected closed orientable  $2n$ -dimensional manifold  $M$  with a locally standard action of an  $n$ -dimensional torus  $T = T^n$ .

The orbit space  $Q = M/T$  of a locally standard  $T$ -manifold is a manifold with corners, but, unlike the case of quasitoric manifolds, it may fail to be a simple polytope. For example, a free smooth  $T$ -action with  $\dim M = 2 \dim T$  is locally standard, but the quotient  $Q$  does not have faces at all. The richer is the combinatorics of  $Q$ , the more information about the topology of  $M$  can be retrieved from this combinatorics. The easiest way to make the combinatorics of the orbit space  $Q$  ‘rich enough’ is to require the existence of  $T$ -fixed points, or 0-faces of  $Q$ ; then the local standardness condition would also imply the existence of faces of all dimensions between 0 and  $n$ . We therefore come to the following definition:

**DEFINITION 7.4.2.** A *torus manifold* is a smooth connected closed orientable  $2n$ -dimensional manifold  $M$  with an effective smooth action of an  $n$ -torus  $T$  such that the fixed point set  $M^T$  is nonempty.

Since  $M$  is connected, the  $T$ -action is effective and  $\dim M = 2 \dim T$ , it follows that the fixed point set  $M^T$  is isolated. Indeed, the tangential  $T^n$ -representation at a fixed point is faithful (Exercise B.3.8), which implies that this normal space has dimension at least  $2n$ . Furthermore,  $M^T$  is finite because  $M$  is compact. So the last condition in the definition above only excludes the possibility when the number of fixed points is zero.

Torus manifolds were introduced and studied in the works [206], [153], [154] of Hattori and Masuda. Homological aspects of this study which we present here were developed in [209] and [204].

The classes of locally standard  $T$ -manifolds and torus manifolds contain both toric and quasitoric manifolds in their intersection (see Section 7.6). Quasitoric manifolds are examples with the most regular structure of the orbit space: a simple polytope is contractible as a topological space, and the topology of the manifold is described fully in terms of the combinatorics of faces. In general, the topology of a locally standard  $T$ -manifold depends not only on the combinatorics of the orbit space, but also on its topology. However, even orbit spaces with trivial topology may have combinatorics more complicated than that of a polytope. Examples are simplicial posets reviewed in Sections 2.8 and 3.5.

Even in the case of toric manifolds, we have encountered with combinatorial structures more general than simple polytopes. As we have seen in Section 7.2, the orbit space  $Q = V/T$  of a nonsingular compact toric variety  $V$  is a manifold with corners in which all faces, including  $Q$  itself, are acyclic, and all nonempty intersections of faces are connected. We refer to such a manifold with corners as a *homology polytope*. It is a genuine polytope when the toric manifold is projective, but in general  $Q$  may be not combinatorially equivalent to a convex polytope (see the discussion in Section 7.6). As a result, the class of quasitoric manifolds does not include all nonsingular compact toric varieties (toric manifolds), which is not very convenient. At the same time, one could expect that all topological properties

characterising quasitoric manifolds also hold in a more general situation when the orbit space is a homology (rather than combinatorial) polytope. This is indeed the case, as is seen by the results of this section.

The cohomology ring of a locally standard  $T$ -manifold  $M$  is generated by its degree-two elements if and only if the orbit space  $Q$  is a homology polytope (Theorem 7.4.41). In this case, the cohomology ring has the structure familiar from toric geometry:  $H^*(M)$  is isomorphic to the quotient of the face ring of the orbit space  $Q$  by an ideal generated by certain linear forms.

More generally, we consider  $T$ -manifolds  $M$  whose cohomology vanishes in odd dimensions. Such a  $T$ -manifold necessarily has a fixed point (Lemma 7.4.4), and is locally standard whenever  $\dim M = 2 \dim T$  (Theorem 7.4.14). Therefore, under the condition  $H^{odd}(M) = 0$ , the classes of locally standard  $T$ -manifolds and torus manifolds coincide. In this case, the equivariant cohomology of  $M$  is a free finitely generated module over the  $T$ -equivariant cohomology of point, i.e. over the polynomial ring  $H^*(BT) \cong \mathbb{Z}[t_1, \dots, t_n]$ . In other words,  $H_T^*(M)$  is a Cohen–Macaulay ring. The orbit space of a  $T$ -manifold with vanishing odd-degree cohomology is not necessarily a homology polytope, as is seen from a simple example of a half-dimensional torus action on an even-dimensional sphere (Example 7.4.11). There is a more general notion of a *face-acyclic* manifold with corners  $Q$ , in which all faces are acyclic, but the intersections of faces are not necessarily connected. It turns out that the odd-degree cohomology of a  $T$ -manifold  $M$  vanishes if and only if the orbit space  $Q$  is face-acyclic (Theorem 7.4.46). The equivariant cohomology of such  $M$  is isomorphic to the face ring of the simplicial poset of faces of  $Q$  (this ring may no longer be generated in degree two, see Section 3.5).

The proofs use several results from the theory of *GKM-manifolds* and related *GKM-graphs*, whose foundations were laid in the work [129] of Goresky, Kottwitz and MacPherson. Relationship between this theory and torus manifolds is explored further in Section 7.9.

**Preliminaries: cohomology and fixed points.** Here we obtain some preliminary results about torus actions, without assuming that the action is locally standard. In this subsection  $M$  is a closed connected smooth orientable manifold equipped with an effective smooth action of a torus  $T$  of arbitrary dimension.

We denote by  $M^T$  the set of  $T$ -fixed points of  $M$ , which is a disjoint union of finitely many connected submanifolds.

LEMMA 7.4.3. *There exists a circle subgroup  $S \subset T$  such that  $M^S = M^T$ .*

PROOF. According to the standard result [41, Theorem IV.10.5], there is only a finite number of orbit types of the  $T$ -action on  $M$ , i.e. only finitely many subgroups of  $T$  appear as the stabilisers of the action. We have  $M^S = M^T$  whenever  $S$  is not contained in any proper stabiliser subgroup  $G \subset T$ . This condition is obviously satisfied for a generic circle  $S \subset T$ .  $\square$

LEMMA 7.4.4. *If  $H^{odd}(M; \mathbb{Q}) = 0$ , then  $M$  has a  $T$ -fixed point.*

PROOF. Choose a generic circle  $S \subset T$  satisfying  $M^S = M^T$  (see Lemma 7.4.3). If  $M$  does not have  $T$ -fixed points, then it also does not have  $S$ -fixed points, which implies that the Euler characteristic  $\chi(M)$  is zero. On the other hand, if  $H^{odd}(M; \mathbb{Q}) = 0$ , then  $\chi(M) > 0$ : a contradiction.  $\square$

The inclusion  $M^T \rightarrow M$  induces the *restriction map* in equivariant cohomology:

$$(7.18) \quad r: H_T^*(M) \rightarrow H_T^*(M^T) = H^*(BT) \otimes H^*(M^T).$$

The equivariant cohomology  $H_T^*(M)$  is a  $H^*(BT)$ -module. We denote by  $H^+(BT)$  the positive-degree part of  $H^*(BT)$ . We shall need the following version of the ‘localisation theorem’:

**THEOREM 7.4.5.** *The restriction map  $r: H_T^*(M) \rightarrow H_T^*(M^T)$  becomes an isomorphism when localised at  $H^+(BT)$ .*

For the proof, see [164, p. 40] or [144, Theorem 11.44].

**COROLLARY 7.4.6.** *The kernel of the restriction map  $r: H_T^*(M) \rightarrow H_T^*(M^T)$  is a  $H^*(BT)$ -torsion module.*

Since  $H^*(BT) \cong \mathbb{Z}[t_1, \dots, t_n]$ , we obtain that  $H_T^*(M)$  is a free  $H^*(BT)$ -module if and only if  $H_T^*(M)$  is a Cohen–Macaulay ring (note that the  $H^*(BT)$ -module  $H_T^*(M)$  is finitely generated, as  $M$  is compact). The next statement gives a topological characterisation of  $T$ -manifolds with this property:

**LEMMA 7.4.7.** *Assume that  $M^T$  is finite. Then  $H_T^*(M)$  is a free  $H^*(BT)$ -module if and only if  $H^{odd}(M) = 0$ . In this case,  $H_T^*(M) \cong H^*(BT) \otimes H^*(M)$  as  $H^*(BT)$ -modules.*

**PROOF.** Assume that  $H^{odd}(M) = 0$ . Then  $H^*(M)$  is torsion-free (an exercise) and the Serre spectral sequence of the bundle  $\rho: ET \times_T M \rightarrow BT$  collapses at  $E_2$ . It follows that  $H_T^*(M) = H^*(ET \times_T M)$  is isomorphic (as a  $H^*(BT)$ -module) to the tensor product  $H^*(BT) \otimes H^*(M)$ , and therefore it is a free  $H^*(BT)$ -module.

Assume now that  $H_T^*(M)$  is a free  $H^*(BT)$ -module. Consider the Eilenberg–Moore spectral sequence of the bundle  $\rho: ET \times_T M \rightarrow BT$  (see Corollary B.4.4). It converges to  $H^*(M)$  and has

$$E_2^{*,*} = \text{Tor}_{H^*(BT)}^{*,*}(H_T^*(M), \mathbb{Z}).$$

Since  $H_T^*(M)$  is a free  $H^*(BT)$ -module,

$$\begin{aligned} \text{Tor}_{H^*(BT)}^{*,*}(H_T^*(M), \mathbb{Z}) &= \text{Tor}_{H^*(BT)}^{0,*}(H_T^*(M), \mathbb{Z}) = H_T^*(M) \otimes_{H^*(BT)} \mathbb{Z} \\ &= H_T^*(M) / (\rho^*(H^+(BT))). \end{aligned}$$

Hence  $E_2^{0,*} = H_T^*(M) / (\rho^*(H^+(BT)))$  and  $E_2^{-p,*} = 0$  for  $p > 0$ . It follows that the spectral sequence collapses at  $E_2$ , and

$$(7.19) \quad H^*(M) = H_T^*(M) / (\rho^*(H^+(BT))).$$

Since  $H_T^*(M)$  is a free  $H^*(BT)$ -module, the restriction map (7.18) is a monomorphism (see Corollary 7.4.6). As  $M^T$  is finite,  $H_T^*(M^T)$  is a sum of polynomial rings, hence  $H_T^{odd}(M) = 0$ . This together with (7.19) implies  $H^{odd}(M) = 0$ .  $\square$

We shall be interested in the two special classes of  $T$ -manifolds  $M$ : those with vanishing odd-degree cohomology, and those with cohomology generated by the degree-two classes. Both these cohomological properties are inherited by the fixed point set  $M^H$  with respect to the action of any torus subgroup  $H \subset T$ . This fact is proved in the next two lemmata; it enables us to use inductive arguments.

**LEMMA 7.4.8.** *Let  $H$  be a torus subgroup of  $T$ , and let  $N$  be a connected component of  $M^H$ . If  $H^{odd}(M) = 0$ , then  $H^{odd}(N) = 0$ .*

PROOF. Choose a generic circle subgroup  $S \subset H$  with  $M^S = M^H$ , as in Lemma 7.4.3. Let  $G \subset S$  be a subgroup of prime order  $p$ . The action of  $G$  on  $H^*(M)$  is trivial, because  $G$  is contained in a connected group  $S$ . By [41, Theorem VII.2.2],  $\dim H^{odd}(M^G; \mathbb{Z}_p) \leq \dim H^{odd}(M; \mathbb{Z}_p)$ . Hence  $H^{odd}(M^G; \mathbb{Z}_p) = 0$ . Repeating the same argument for the set  $M^G$  with the induced action of the quotient group  $S/G$  (which is again a circle), we conclude that  $H^{odd}(M^K; \mathbb{Z}_p) = 0$  for any  $p$ -subgroup  $K$  of  $S$ . However,  $M^K = M^S = M^H$  if the order of  $K$  is sufficiently large, so we obtain  $H^{odd}(M^H; \mathbb{Z}_p) = 0$ . Since  $p$  is an arbitrary prime, we conclude that  $H^{odd}(M^H) = 0$ .  $\square$

LEMMA 7.4.9. *Let  $M, H, N$  be as in Lemma 7.4.8. If the ring  $H^*(M)$  is generated by its degree-two part, then the restriction map  $H^*(M) \rightarrow H^*(N)$  is surjective; in particular, the ring  $H^*(N)$  is also generated by its degree-two part.*

PROOF. It suffices to prove that the restriction map  $H^*(M; \mathbb{Z}_p) \rightarrow H^*(N; \mathbb{Z}_p)$  is surjective for any prime  $p$ , because  $H^{odd}(N) = 0$  by Lemma 7.4.8.

The argument below is similar to that used in [41, Theorem VII.3.1]. As in the proof of Lemma 7.4.8, let  $S \subset H$  be a generic circle with  $M^S = M^H$  and let  $G \subset S$  be a subgroup of prime order  $p$ . By [41, Theorem VII.1.5], the restriction map  $H_G^k(M; \mathbb{Z}_p) \rightarrow H_G^k(M^G; \mathbb{Z}_p)$  is an isomorphism for sufficiently large  $k$ . Hence, for any connected component  $N'$  of  $M^G$ , the restriction  $r: H_G^k(M; \mathbb{Z}_p) \rightarrow H_G^k(N'; \mathbb{Z}_p)$  is surjective when  $k$  is large. Now consider the commutative diagram

$$\begin{array}{ccc} H_G^*(M; \mathbb{Z}_p) & \xrightarrow{r} & H_G^*(N'; \mathbb{Z}_p) \cong H^*(BG; \mathbb{Z}_p) \otimes H^*(N'; \mathbb{Z}_p) \\ \downarrow & & \downarrow \\ H^*(M; \mathbb{Z}_p) & \xrightarrow{s} & H^*(N'; \mathbb{Z}_p) \end{array}$$

Choose a basis  $v_1, \dots, v_d \in H^2(M; \mathbb{Z}_p)$ ; then these elements multiplicatively generate  $H^*(M; \mathbb{Z}_p)$ . Since  $H^{odd}(M; \mathbb{Z}_p) = H^{odd}(M^G; \mathbb{Z}_p) = 0$  and  $\chi(M) = \chi(M^T) = \chi(M^G)$ , it follows that  $\sum_i \dim H^i(M; \mathbb{Z}_p) = \sum_i \dim H^i(M^G; \mathbb{Z}_p)$ . By [41, Theorem VII.1.6], the Serre spectral sequence of the bundle  $EG \times_G M \rightarrow BG$  collapses at  $E_2$ . Therefore, the vertical map  $H_G^*(M; \mathbb{Z}_p) \rightarrow H^*(M; \mathbb{Z}_p)$  in the above diagram is surjective. Let  $\xi_j \in H_G^2(M; \mathbb{Z}_p)$  be a lift of  $v_j$ , and  $w_j = s(v_j)$ . Let  $t$  be a generator of  $H^2(BG; \mathbb{Z}_p) \cong \mathbb{Z}_p$ . We have  $H^1(N'; \mathbb{Z}_p) = 0$  by Lemma 7.4.8, which together with the commutativity of the diagram above implies  $r(\xi_j) = \alpha_j t + w_j$  for some  $\alpha_j \in \mathbb{Z}_p$ . Now let  $a \in H^*(N'; \mathbb{Z}_p)$  be an arbitrary element. Then  $t^\ell a$  is in the image of  $r$  when  $\ell$  is large, i.e. there exists a polynomial  $P(\xi_1, \dots, \xi_d)$  such that

$$r(P(\xi_1, \dots, \xi_d)) = t^\ell a.$$

On the other hand,

$$r(P(\xi_1, \dots, \xi_d)) = P(\alpha_1 t + w_1, \dots, \alpha_d t + w_d) = \sum_{k \geq 0} t^k Q_k(w_1, \dots, w_d)$$

for some polynomials  $Q_k$ . Therefore,  $a = Q_\ell(w_1, \dots, w_d)$ , the restriction map  $H^*(M; \mathbb{Z}_p) \rightarrow H^*(N'; \mathbb{Z}_p)$  is surjective, and  $H^*(N'; \mathbb{Z}_p)$  is generated by the degree-two elements  $w_1, \dots, w_d$ .

Now we can repeat the same argument for  $N'$  with the induced action of  $S/G$ , which is again a circle. We conclude that the restriction map  $H^*(M; \mathbb{Z}_p) \rightarrow H^*(N'; \mathbb{Z}_p)$  is surjective for any  $p$ -subgroup  $K$  of  $S$  and any connected component  $N'$  of  $M^K$ . Now, if the order of  $K$  is sufficiently large, then  $M^K = M^S = M^H$



and hence  $N' = N$ . It follows that the restriction map  $H^*(M; \mathbb{Z}_p) \rightarrow H^*(N; \mathbb{Z}_p)$  is surjective for any connected component  $N$  of  $M^H$  and for arbitrary prime  $p$ .  $\square$

**Characteristic submanifolds.** From now on we assume that  $M$  is a torus manifold, i.e.  $M$  is closed, connected, smooth and orientable,  $\dim M = 2 \dim T = 2n$ , the  $T$ -action is smooth and effective and  $M^T \neq \emptyset$ .

A closed connected codimension-two submanifold of  $M$  is called *characteristic* if it is fixed pointwise by a circle subgroup  $S \subset T$ . Since  $M^T \neq \emptyset$ , there exists at least one characteristic submanifold (an exercise). Furthermore, any fixed point is contained in an intersection of some  $n$  characteristic submanifolds.

There are finitely many characteristic submanifolds in  $M$ , and we shall denote them by  $M_i$ ,  $1 \leq i \leq m$ . The intersection of any  $k \leq n$  characteristic submanifolds is either empty or a (possibly disconnected) submanifold of codimension  $2k$  fixed pointwise by a  $k$ -dimensional subtorus of  $T$ . In particular, the intersection of any  $n$  characteristic submanifolds consists of finitely many  $T$ -fixed points.

Since  $M$  is orientable, each  $M_i$  is also orientable (since it is fixed by a circle action). We say that  $M$  is *omnioriented* if an orientation is specified for  $M$  and for each characteristic submanifold  $M_i$ . There are  $2^{m+1}$  choices of omniorientations on  $M$ . In what follows we shall always assume  $M$  to be omnioriented. This allows us to view the circle fixing  $M_i$  as an element in the integer lattice  $\text{Hom}(\mathbb{S}, T) \cong \mathbb{Z}^n$ .

Since both  $M$  and  $M_i$  are oriented, the equivariant Gysin homomorphism  $H_T^*(M_i) \rightarrow H_T^{*+2}(M)$  is defined (see Section B.3). Denote by  $\tau_i \in H_T^2(M)$  the image of  $1 \in H_T^0(M_i)$  under this homomorphism. The restriction of  $\tau_i$  to  $H_T^2(M_i)$  is the equivariant Euler class  $e^T(\nu_i)$  of the normal bundle  $\nu_i = \nu(M_i \subset M)$ .

**PROPOSITION 7.4.10.** *Let  $\lambda_i \in H_2(BT)$  be the element corresponding to the circle subgroup fixing  $M_i$  via the identification  $H_2(BT) = \text{Hom}(\mathbb{S}, T)$ .*

- (a) *Let  $v$  be a  $T$ -fixed point of  $M$ , and assume that  $v$  is contained in the intersection  $M_{i_1} \cap \dots \cap M_{i_n}$ . Then the corresponding elements  $\lambda_{i_1}, \dots, \lambda_{i_n}$  form a basis of  $H_2(BT) \cong \mathbb{Z}^n$ . This basis is conjugate to the set of weights  $\mathbf{w}_1(v), \dots, \mathbf{w}_n(v)$  of the tangential  $T$ -representation at  $v$ .*
- (b) *Let  $\rho: ET \times_T M \rightarrow BT$  be the projection. For any  $t \in H^2(BT)$ ,*

$$\rho^*(t) = \sum_{i=1}^m \langle t, \lambda_i \rangle \tau_i \quad \text{modulo } H^*(BT)\text{-torsion.}$$

**PROOF.** Since the action is effective and  $M$  is connected, the tangential  $T$ -representation at  $v$  is faithful, so the set of weights  $\{\mathbf{w}_1(v), \dots, \mathbf{w}_n(v)\}$  is a basis of  $\text{Hom}(T, \mathbb{S}) = H^2(BT)$ . The proof of (a) is the same as that of Proposition 7.3.17.

By Theorem 7.4.5, the restriction map (7.18) is an isomorphism after localisation at  $H^+(BT)$ . Therefore, to prove (b), we can apply the map  $r$  to the both sides of the identity in question and verify the resulting identity in  $H^*(BT) \otimes H^*(M^T)$ . We may write  $r = \bigoplus_v r_v$ , where  $r_v: H_T^*(M) \rightarrow H^*(BT)$  is the map induced by the inclusion of the fixed point  $v \rightarrow M$ . We have  $r_v(\rho^*(t)) = t$  and

$$r_v \left( \sum_{i=1}^m \langle t, \lambda_i \rangle \tau_i \right) = \sum_{k=1}^n \langle t, \lambda_{i_k} \rangle e^T(\nu_{i_k})|_v = \sum_{k=1}^n \langle t, \lambda_{i_k} \rangle \mathbf{w}_k(v) = t,$$

where the last identity holds because  $\lambda_{i_1}, \dots, \lambda_{i_n}$  and  $\mathbf{w}_1(v), \dots, \mathbf{w}_n(v)$  are conjugate bases.  $\square$

Here is an example of a locally standard torus manifold, which is not quasitoric:

EXAMPLE 7.4.11. Consider the unit  $2n$ -sphere in  $\mathbb{C}^n \times \mathbb{R}$ :

$$S^{2n} = \{(z_1, \dots, z_n, y) \in \mathbb{C}^n \times \mathbb{R} : |z_1|^2 + \dots + |z_n|^2 + y^2 = 1\}.$$

Define a  $T$ -action by the formula

$$(t_1, \dots, t_n) \cdot (z_1, \dots, z_n, y) = (t_1 z_1, \dots, t_n z_n, y).$$

There are two fixed points  $(0, \dots, 0, \pm 1)$  and  $n$  characteristic submanifolds given by  $\{z_1 = 0\}, \dots, \{z_n = 0\}$ . The intersection of any  $k$  characteristic submanifolds is connected if  $k \leq n - 1$ , and consists of two disjoint fixed points if  $k = n > 1$ .

Unlike quasitoric manifolds, some intersections of characteristic submanifolds are disconnected in the example above. The cohomology ring of a quasitoric manifold is generated in degree two (Theorem 7.3.27). The next lemma shows that this is exactly the condition that guarantees the connectedness of intersections of characteristic submanifolds.

LEMMA 7.4.12. *Suppose that  $H^*(M)$  is generated in degree two. Then all nonempty multiple intersections of characteristic submanifolds are connected and have cohomology generated in degree two.*

PROOF. By Lemma 7.4.9, the cohomology  $H^*(M_i)$  is generated by the degree-two part and the restriction map  $H^*(M) \rightarrow H^*(M_i)$  is surjective for any characteristic submanifold  $M_i$ . Then it follows from Lemma 7.4.7 that the restriction map  $H_T^*(M) \rightarrow H_T^*(M_i)$  in equivariant cohomology is also surjective.

Now we prove that multiple intersections are connected. Suppose that  $M_{i_1} \cap \dots \cap M_{i_k} \neq \emptyset$ ,  $1 < k \leq n$ , and let  $N$  be a connected component of this intersection. Since  $N$  is fixed by a subtorus, it contains a  $T$ -fixed point by Lemmata 7.4.4 and 7.4.8. For each  $i \in \{i_1, \dots, i_k\}$ , there are embeddings  $\varphi_i: N \rightarrow M_i$ ,  $\psi_i: M_i \rightarrow M$ , and the corresponding equivariant Gysin homomorphisms:

$$H_T^0(N) \xrightarrow{\varphi_{i!}} H_T^{2k-2}(M_i) \xrightarrow{\psi_{i!}} H_T^{2k}(M).$$

The map  $\psi_i^*: H_T^*(M) \rightarrow H_T^*(M_i)$  is surjective, so we obtain  $\varphi_{i!}(1) = \psi_i^*(u)$  for some  $u \in H_T^{2k-2}(M)$ . Now we calculate

$$(\psi_i \circ \varphi_i)_!(1) = \psi_{i!}(\varphi_{i!}(1)) = \psi_{i!}(\psi_i^*(u)) = \psi_{i!}(1)u = \tau_i u.$$

Hence  $(\psi_i \circ \varphi_i)_!(1)$  is divisible by  $\tau_i$ , for each  $i \in \{i_1, \dots, i_k\}$ . By [206, Proposition 3.4] (see also Theorem 7.4.33 below), the degree- $2k$  part of  $H_T^*(M)$  is additively generated by monomials  $\tau_{j_1}^{k_1} \dots \tau_{j_p}^{k_p}$  such that  $M_{j_1} \cap \dots \cap M_{j_p} \neq \emptyset$  and  $k_1 + \dots + k_p = k$ . It follows that  $(\psi_i \circ \varphi_i)_!(1)$  is a nonzero integral multiple of  $\tau_{i_1} \dots \tau_{i_k} \in H_T^{2k}(M)$ . By the definition of Gysin homomorphism,  $(\psi_i \circ \varphi_i)_!(1)$  maps to zero under the restriction map  $H_T^*(M) \rightarrow H_T^*(x)$  for any point  $x \in (M \setminus N)^T$ . On the other hand, the image of  $\tau_{i_1} \dots \tau_{i_k}$  under the map  $H_T^*(M) \rightarrow H_T^*(x)$  is nonzero for any  $T$ -fixed point  $x \in M_{i_1} \cap \dots \cap M_{i_k}$ . Thus,  $N$  is the only connected component of the latter intersection. The fact that  $H^*(N)$  is generated by its degree-two part follows from Lemma 7.4.9.  $\square$

**Orbit quotients and manifolds with corners.** Let  $Q = M/T$  be the orbit space of a locally standard  $T$ -manifold  $M$ , and let  $\pi: M \rightarrow Q$  be the quotient projection. Then  $Q$  is a manifold with corners (see Definition 7.1.3). The facets of  $Q$  are the projections of the characteristic submanifolds:  $F_i = \pi(M_i)$ ,  $1 \leq i \leq m$ . Faces of  $Q$  are connected components of intersections of facets (note that these intersections may be disconnected, as in Example 7.4.11). For convenience, we regard  $Q$  itself as a face; all other faces are called *proper*.

If  $H^{\text{odd}}(M) = 0$ , then each face has a vertex by Lemmata 7.4.8 and 7.4.4. Moreover, if  $H^*(M)$  is generated in degree two, then all intersections of facets are connected by Lemma 7.4.12.

**PROPOSITION 7.4.13.** *The orbit space  $Q$  of a locally standard  $T$ -manifold is a nice manifold with corners.*

**PROOF.** We need to show that any face  $G$  of codimension  $k$  in  $Q$  is an intersection of exactly  $k$  facets. Let  $q$  be a point in the interior of  $G$ , and let  $x \in \pi^{-1}(q)$ . Let  $z_1, \dots, z_n$  be the coordinates in a locally standard chart containing  $x$ . The point  $x$  has exactly  $k$  of these coordinates vanishing, assume that these are  $z_1, \dots, z_k$ . Then, for any  $i = 1, \dots, k$ , the equation  $z_i = 0$  specifies the tangent space at  $x$  to a characteristic submanifold of  $M$ . Therefore,  $x$  is contained in exactly  $k$  characteristic submanifolds. Each characteristic submanifold is projected onto a facet of  $Q$ , so that  $G$  is contained in exactly  $k$  facets.  $\square$

**THEOREM 7.4.14.** *A torus manifold  $M$  with  $H^{\text{odd}}(M) = 0$  is locally standard.*

**PROOF.** We first show that there are no nontrivial finite stabilisers for the  $T$ -action on  $M$ . Assume the opposite, i.e. there is a point  $x \in M$  with finite nontrivial stabiliser  $T_x$ . Then  $T_x$  contains a nontrivial cyclic subgroup  $G$  of prime order  $p$ . Let  $N$  be the connected component of  $M^G$  containing  $x$ . Since  $N$  contains  $x$  and  $T_x$  is finite, the principal (i.e. the smallest) stabiliser of the induced  $T$ -action on  $N$  is finite. As in the proof of Lemma 7.4.8, it follows from [41, Theorem VII.2.2] that  $H^{\text{odd}}(N; \mathbb{Z}_p) = 0$ . In particular, the Euler characteristic of  $N$  is non-zero, hence  $N$  has a  $T$ -fixed point, say  $y$ . The tangential  $T$ -representation  $\mathcal{T}_y M$  at  $y$  is faithful,  $\dim M = 2 \dim T$  and  $\mathcal{T}_y N$  is a proper  $T$ -subrepresentation of  $\mathcal{T}_y M$ . It follows that there is a nontrivial subtorus  $T' \subset T$  which fixes  $\mathcal{T}_y N$  and does not fix the complement of  $\mathcal{T}_y N$  in  $\mathcal{T}_y M$ . Then  $T'$  is the principal stabiliser of  $N$ , which contradicts the above observation that the principal stabiliser of  $N$  is finite.

If the stabiliser  $T_x$  is trivial,  $M$  is obviously locally standard near  $x$ . Suppose that  $T_x$  is non-trivial. Then it cannot be finite, i.e.  $\dim T_x > 0$ . Let  $H$  be the identity component of  $T_x$ , and  $N$  the connected component of  $M^H$  containing  $x$ . By Lemmata 7.4.8 and 7.4.4,  $N$  has a  $T$ -fixed point, say  $y$ . Looking at the tangential representation at  $y$ , we observe that the induced action of  $T/H$  on  $N$  is effective. By the previous argument, no point of  $N$  has a nontrivial finite stabiliser for the induced action of  $T/H$ , which implies that  $T_x = H$ . Now  $x$  and  $y$  are both in the same connected submanifold  $N$  fixed pointwise by  $T_x$ , hence the  $T_x$ -representation  $\mathcal{T}_x M$  agrees with the restriction of the tangential  $T$ -representation  $\mathcal{T}_y M$  to  $T_x$ . This implies that  $M$  is locally standard near  $x$ .  $\square$

Recall that a space  $X$  is *acyclic* if  $\tilde{H}_i(X) = 0$  for any  $i$ .

DEFINITION 7.4.15. We say that a manifold with corners  $Q$  is *face-acyclic* if  $Q$  and all its faces are acyclic. We call  $Q$  a *homology polytope* if it is face-acyclic and all nonempty multiple intersections of facets are connected.

A simple polytope is a homology polytope. Here is an example that does not arise in this way:

EXAMPLE 7.4.16. The torus manifold  $S^{2n}$  with the  $T$ -action from Example 7.4.11 is locally standard, and the map

$$(z_1, \dots, z_n, y) \rightarrow (|z_1|, \dots, |z_n|, y)$$

induces a face preserving homeomorphism from the orbit space  $S^{2n}/T$  to the space

$$\{(x_1, \dots, x_n, y) \in \mathbb{R}^{n+1} : x_1^2 + \dots + x_n^2 + y^2 = 1, x_1 \geq 0, \dots, x_n \geq 0\}.$$

This manifold with corners is face-acyclic, but is not a homology polytope if  $n > 1$ .

Proposition 7.4.10 allows us to define a characteristic map for locally standard torus manifolds:

$$(7.20) \quad \begin{aligned} \lambda: \{F_1, \dots, F_m\} &\rightarrow H_2(BT) = \text{Hom}(\mathbb{S}, T) \cong \mathbb{Z}^n, \\ F_i &\mapsto \lambda_i. \end{aligned}$$

Given a point  $q \in Q$ , consider the smallest face  $G(q)$  containing  $q$ . This face is a connected component of an intersection of facets  $F_{i_1} \cap \dots \cap F_{i_k}$ . We define the subtorus  $T(q) \subset T$  generated by the circle subgroups corresponding to  $\lambda(F_{i_1}), \dots, \lambda(F_{i_k})$ , and the identification space

$$(7.21) \quad M(Q, \lambda) = Q \times T / \sim \quad \text{where } (x, t_1) \sim (x, t_2) \text{ if } t_1^{-1}t_2 \in T(q).$$

It is easy to see that  $M(Q, \lambda)$  is a closed manifold with a  $T$ -action. Here is a straightforward generalisation of [90, Lemma 1.4] (see Proposition 7.3.6):

PROPOSITION 7.4.17. *Let  $M$  be a locally standard torus manifold with orbit space  $Q$ , and let  $\lambda$  be the map defined by (7.20). If  $Q$  is face-acyclic, then there is a weakly  $T$ -equivariant homeomorphism*

$$M(Q, \lambda) \rightarrow M$$

*covering the identity on  $Q$ .*

REMARK. Instead of face-acyclicity, one can only require that the second cohomology group of each face of  $Q$  vanishes, as this is the condition implying the triviality of torus principal bundles obtained after blowing up the singular strata of lower dimension.

**Face rings of manifolds with corners.** Let  $Q$  be a nice manifold with corners. The set of faces of  $Q$  containing a given face is isomorphic to the poset of faces of a simplex. In other words, the faces of  $Q$  form a simplicial poset  $\mathcal{S}$  (see Definition 2.8.1) with respect to the reverse inclusion. The initial element  $\hat{0}$  of this poset is  $Q$ . We refer to this simplicial poset  $\mathcal{S}$  as the *dual* of  $Q$ ; this duality extends the combinatorial duality between simple polytopes and their boundary sphere triangulations. The dual poset  $\mathcal{S}$  is the poset of faces of a simplicial complex  $\mathcal{K}$  if and only if all nonempty multiple intersections of facets of  $Q$  are connected. In this case,  $\mathcal{K}$  is the nerve of the covering of  $\partial Q$  by facets.

EXAMPLE 7.4.18. Consider the three structures of a manifold with corners on a disc  $D^2$ , shown in Fig. 7.4. The manifold with corners shown on the left is not nice. The middle one is nice and is face-acyclic, but is not a homology polytope. The right one is homeomorphic to a 2-simplex, so it is a homology polytope. Compare this with simplicial posets from Example 2.8.2.

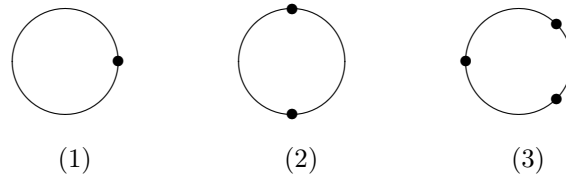

FIGURE 7.4. 2-disc as a manifold with corners.

EXAMPLE 7.4.19. Let  $Q = S^{2n}/T$  be the orbit space of the torus manifold  $S^{2n}$ , see Examples 7.4.11 and 7.4.16 (the case  $n = 2$  is shown in Fig. 7.4 (2)). Here we have  $n$  facets, the intersection of any  $k$  facets is connected if  $k \leq n - 1$ , but the intersection of  $n$  facets consists of two points. The dual simplicial cell complex is obtained by gluing two  $(n - 1)$ -simplices along their boundaries.

We can define the face ring of the orbit space  $Q$  as the face ring of the dual simplicial poset (see Definition 3.5.2). However, for reader's convenience, we give the definition and state the main properties directly in terms of the combinatorics of faces of  $Q$ . The proofs of the statements in this subsection are obtained by obvious dualisation of the corresponding statements in Section 3.5.

The intersection of two faces  $G, H$  in a manifold with corners can be disconnected. We consider  $G \cap H$  as a set of its connected components and use the notation  $E \in G \cap H$  for connected components  $E$  of this intersection. If  $G \cap H \neq \emptyset$ , then there exists a unique minimal face  $G \vee H$  containing both  $G$  and  $H$ .

DEFINITION 7.4.20. The *face ring* of a nice manifold with corners  $Q$  is the quotient

$$\mathbb{Z}[Q] = \mathbb{Z}[v_G : G \text{ a face}] / \mathcal{I}_Q,$$

where  $\mathcal{I}_Q$  is the ideal generated by  $v_Q - 1$  and all elements of the form

$$v_G v_H - v_{G \vee H} \cdot \sum_{E \in G \cap H} v_E.$$

In particular, if  $G \cap H = \emptyset$ , then  $v_G v_H = 0$  in  $\mathbb{Z}[Q]$ .

The grading is given by  $\deg v_G = 2 \operatorname{codim} G$ .

EXAMPLE 7.4.21. Consider the torus action on  $S^{2n}$  from Examples 7.4.11 and 7.4.16 and let  $n = 2$ . Then  $Q$  is a 2-disc with two 0-faces, say  $p$  and  $q$ , and two 1-faces, say  $G$  and  $H$ . Then

$$\mathbb{Z}[Q] = \mathbb{Z}[v_G, v_H, v_p, v_q] / (v_G v_H = v_p + v_q, v_p v_q = 0),$$

where  $\deg v_G = \deg v_H = 2$ ,  $\deg v_p = \deg v_q = 4$ . This is the same ring as the one described in Example 3.5.3.1, but written in the dual notation.

Here is a dualisation of Theorem 3.5.7:

**THEOREM 7.4.22.** *Any element  $a \in \mathbb{Z}[Q]$  can be written uniquely as an integral linear combination of monomials  $v_{G_1}^{i_1} v_{G_2}^{i_2} \cdots v_{G_n}^{i_n}$  corresponding to chains of faces  $G_1 \supset G_2 \supset \cdots \supset G_n$  of  $Q$ .*

Given a vertex  $v \in Q$ , define the restriction map

$$s_v: \mathbb{Z}[Q] \rightarrow \mathbb{Z}[Q]/(v_G: G \not\ni v).$$

The ring  $\mathbb{Z}[Q]/(v_G: G \not\ni v)$  is identified with the polynomial ring  $\mathbb{Z}[v_{F_{i_1}}, \dots, v_{F_{i_n}}]$  on  $n$  degree-two generators corresponding to the facets  $F_{i_1}, \dots, F_{i_n}$  containing  $v$ .

**THEOREM 7.4.23.** *Assume that each face of  $Q$  has a vertex. Then the sum  $s = \bigoplus_v s_v$  of the restriction maps over all vertices  $v \in Q$  is a monomorphism from  $\mathbb{Z}[Q]$  to a direct sum of polynomial rings.*

**Equivariant cohomology.** Here we construct a natural homomorphism from the face ring  $\mathbb{Z}[Q]$  to the equivariant cohomology ring  $H_T^*(M)$  of a locally standard torus manifold modulo  $H^*(BT)$ -torsion. Then we obtain conditions under which this homomorphism is monic and epic; in particular, we show that  $\mathbb{Z}[Q] \rightarrow H_T^*(M)$  is an isomorphism when  $H^{odd}(M) = 0$ .

Since the fixed point set  $M^T$  is finite, the restriction map (7.18) defines a map

$$(7.22) \quad r = \bigoplus_{v \in M^T} r_v: H_T^*(M) \rightarrow H_T^*(M^T) = \bigoplus_{v \in M^T} H^*(BT)$$

to a direct sum of polynomial rings. Its kernel is a  $H^*(BT)$ -torsion by Corollary 7.4.6, and  $r$  is a monomorphism when  $H^{odd}(M) = 0$ .

The 1-skeleton of  $Q$  is an  $n$ -valent graph. We identify  $M^T$  with the vertices of  $Q$  and denote by  $E(Q)$  the set of oriented edges. Given an element  $e \in E(Q)$ , denote the initial point and the terminal point of  $e$  by  $i(e)$  and  $t(e)$ , respectively. Then  $M_e = \pi^{-1}(e)$  is a 2-sphere fixed pointwise by a codimension-one subtorus in  $T$ , and it contains two  $T$ -fixed points  $i(e)$  and  $t(e)$ . The 2-dimensional subspace  $\mathcal{T}_{i(e)} M_e \subset \mathcal{T}_{i(e)} M$  is an irreducible component of the tangential  $T$ -representation  $\mathcal{T}_{i(e)} M$ . The same is true for the other point  $t(e)$ , and the  $T$ -representations  $\mathcal{T}_{i(e)} M$  and  $\mathcal{T}_{t(e)} M$  are isomorphic. There is a unique characteristic submanifold, say  $M_i$ , intersecting  $M_e$  at  $i(e)$  transversely. The omniorientation defines an orientation for the normal bundle  $\nu_i$  of  $M_i$  and, therefore, an orientation of  $\mathcal{T}_{i(e)} M_e$ . We therefore can view the representation  $\mathcal{T}_{i(e)} M_e$  as an element of  $\text{Hom}(T, \mathbb{S}) = H^2(BT)$ , and denote this element by  $\alpha(e)$ .

Let  $e^T(\nu_i) \in H_T^2(M_i)$  be the Euler class of the normal bundle, and denote its restriction to a fixed point  $v \in M_i^T$  by  $e^T(\nu_i)|_v \in H_T^2(v) = H^2(BT)$ . Then

$$(7.23) \quad e^T(\nu_i)|_v = \alpha(e),$$

where  $e$  is the unique edge such that  $i(e) = v$  and  $e \notin F_i = \pi(M_i)$ . Using the terminology of [146], we refer to the map

$$\alpha: E(Q) \rightarrow H^2(BT), \quad e \mapsto \alpha(e),$$

as an *axial function*.

**LEMMA 7.4.24.** *The axial function  $\alpha$  has the following properties:*

- (a)  $\alpha(\bar{e}) = \pm\alpha(e)$  for any  $e \in E(Q)$ , where  $\bar{e}$  denotes  $e$  with the opposite orientation;
- (b) for any vertex  $v$ , the set  $\alpha_v = \{\alpha(e): i(e) = v\}$  is a basis of  $H^2(BT)$ ;

(c) for  $e \in E(Q)$ , we have  $\alpha_{i(e)} = \alpha_{t(e)} \pmod{\alpha(e)}$ .

PROOF. Property (a) follows from the fact that  $\mathcal{T}_{i(e)}M_e$  and  $\mathcal{T}_{t(e)}M_e$  are isomorphic as real  $T$ -representations, and (b) holds since the  $T$ -representation  $\mathcal{T}_{i(e)}M$  is faithful. Let  $T_e$  be the codimension-one subtorus fixing  $M_e$ . Then the  $T_e$ -representations  $\mathcal{T}_{i(e)}M$  and  $\mathcal{T}_{t(e)}M$  are isomorphic, since the points  $i(e)$  and  $t(e)$  are contained in the same connected component  $M_e$  of  $M^{T_e}$ . This implies (c).  $\square$

REMARK. The original definition of an axial function in [146] requires the property  $\alpha(\bar{e}) = -\alpha(e)$ , but we allow  $\alpha(\bar{e}) = \alpha(e)$ . For example,  $\alpha(\bar{e}) = \alpha(e)$  for the  $T^2$ -action on  $S^4$  from Example 7.4.11.

LEMMA 7.4.25. *Given  $\eta \in H_T^*(M)$  and  $e \in E(Q)$ , the difference  $r_{i(e)}(\eta) - r_{t(e)}(\eta)$  is divisible by  $\alpha(e)$ .*

PROOF. Consider the commutative diagram of restrictions

$$\begin{array}{ccc} H_T^*(M) & \longrightarrow & H_T^*(i(e)) \oplus H_T^*(t(e)) = H^*(BT) \oplus H^*(BT) \\ \downarrow & & \downarrow \\ H_{T_e}^*(M_e) & \longrightarrow & H_{T_e}^*(i(e)) \oplus H_{T_e}^*(t(e)) = H^*(BT_e) \oplus H^*(BT_e) \end{array}$$

Since  $H_{T_e}^*(M_e) = H^*(BT_e) \otimes H^*(M_e)$ , the two components of the image of  $\eta$  in  $H^*(BT_e) \oplus H^*(BT_e)$  above coincide. Then it follows from the commutativity of the diagram that the restrictions of  $r_{i(e)}(\eta)$  and  $r_{t(e)}(\eta)$  to  $H^*(BT_e)$  coincide. Now the result follows from the fact that the kernel of the restriction map  $H^*(BT) \rightarrow H^*(BT_e)$  is the ideal generated by  $\alpha(e)$ .  $\square$

The preimage  $M_G = \pi^{-1}(G)$  of a codimension- $k$  face  $G \subset Q$  is a closed  $T$ -invariant submanifold of  $M$ . It is a connected component of an intersection of  $k$  characteristic submanifolds. The omniorientation defines an orientation of  $M_G$  and the equivariant Gysin homomorphism  $H_T^0(M_G) \rightarrow H_T^{2k}(M)$ . Let  $\tau_G$  denote the image of 1 under this homomorphism; it is called the *Thom class* of  $M_G$ . The restriction of  $\tau_G \in H_T^{2k}(M)$  to  $H_T^{2k}(M_G)$  is the equivariant Euler class of the normal bundle  $\nu(M_G \subset M)$ , and  $r_v(\tau_G) = 0$  for  $v \notin (M_G)^T$ . It follows from (7.23) that

$$(7.24) \quad r_v(\tau_G) = \begin{cases} \prod_{i(e)=v, e \notin G} \alpha(e) & \text{if } v \in (M_G)^T; \\ 0 & \text{otherwise.} \end{cases}$$

Define the quotient ring

$$\widehat{H}_T^*(M) = H_T^*(M)/H^*(BT)\text{-torsion.}$$

The restriction map  $r$  from (7.22) induces a monomorphism  $\widehat{H}_T^*(M) \rightarrow H_T^*(M^T)$ , which we continue to denote by  $r$ . In particular,  $\tau_G = 0$  in  $\widehat{H}_T^*(M)$  if  $M_G$  has no  $T$ -fixed points. The next lemma shows that the face ring relations from Definition 7.4.20 hold in  $\widehat{H}_T^*(M)$  with  $v_G$  replaced by  $\tau_G$ .

LEMMA 7.4.26. *For any two faces  $G$  and  $H$  of  $Q$ , the relation*

$$\tau_G \tau_H = \tau_{G \vee H} \cdot \sum_{E \in G \cap H} \tau_E$$

holds in  $\widehat{H}_T^*(M)$ .

PROOF. Since the map  $r: \widehat{H}_T^*(M) \rightarrow H_T^*(M^T)$  is injective, it suffices to show that  $r_v$  maps both sides of the identity to the same element, for any  $v \in M^T$ .

Let  $v \in M^T$ . Given a face  $G \ni v$ , set

$$N_v(G) = \{e \in E(Q) : i(e) = v, e \not\subset G\},$$

which may be thought of as the set of directions transverse to  $G$  at  $v$ . Then we can rewrite (7.24) as follows:

$$(7.25) \quad r_v(\tau_G) = \prod_{e \in N_v(G)} \alpha(e),$$

where the right hand side is understood to be 1 if  $N_v(G) = \emptyset$  and to be 0 if  $v \notin G$ . Assume that  $v \notin G \cap H$ ; then either  $v \notin G$  or  $v \notin H$ , and  $v \notin E$  for any  $E \in G \cap H$ . Hence both sides of the identity from the lemma map to zero by  $r_v$ . Assume that  $v \in G \cap H$ ; then

$$N_v(G) \cup N_v(H) = N_v(G \vee H) \cup N_v(E),$$

where  $E$  is the connected component of the intersection  $G \cap H$  containing  $v$ , and  $v \notin E'$  for any other  $E' \in G \cap H$ . This together with (7.25) implies that both sides of the identity map to the same element by  $r_v$ .  $\square$

Lemma 7.4.26 implies that the map

$$\begin{aligned} \mathbb{Z}[v_G : G \text{ a face}] &\rightarrow H_T^*(M), \\ v_G &\mapsto \tau_G \end{aligned}$$

induces a homomorphism

$$(7.26) \quad \varphi: \mathbb{Z}[Q] \rightarrow \widehat{H}_T^*(M).$$

LEMMA 7.4.27. *The homomorphism  $\varphi$  is injective if any face of  $Q$  has a vertex.*

PROOF. We have  $s = r \circ \varphi$ , where  $s$  is the algebraic restriction map from Lemma 7.4.23. Since  $s$  is injective,  $\varphi$  is also injective.  $\square$

The next theorem, which is a particular case of one of the main results of [129], says that when  $H^{\text{odd}}(M) = 0$ , the condition from Lemma 7.4.25 specifies precisely the image of the equivariant cohomology under the restriction map:

THEOREM 7.4.28 ([129], see also [144, Chapter 11]). *Let  $M$  be a torus manifold with  $H^{\text{odd}}(M) = 0$ . Assume given an element  $\eta_v \in H^*(BT)$  for each  $v \in M^T$ . Then  $\{\eta_v\} \in \bigoplus_{v \in M^T} H^*(BT)$  belongs to the image of the restriction map  $r$  in (7.22) if and only if  $\eta_{i(e)} - \eta_{t(e)}$  is divisible by  $\alpha(e)$  for any  $e \in E(Q)$ .*

COROLLARY 7.4.29. *If  $H^{\text{odd}}(M) = 0$ , then the 1-skeleton of any face of  $Q$  (including  $Q$  itself) is connected.*

PROOF. By Theorem 7.4.28,  $\{\eta_v\} \in \bigoplus_{v \in M^T} H^0(BT)$  belongs to  $r(H_T^0(M))$  if  $\eta_v$  is a locally constant function on the 1-skeleton of  $Q$ . On the other hand, since  $M$  is connected, the image  $r(H_T^0(M))$  is isomorphic to  $\mathbb{Z}$ . Hence the 1-skeleton of  $Q$  is connected. Similarly, the 1-skeleton of any face  $G$  of  $Q$  is connected, because  $M_G = \pi^{-1}(G)$  is also a torus manifold with  $H^{\text{odd}}(M_G) = 0$  (see Lemma 7.4.8).  $\square$

REMARK. Connectedness of 1-skeletons of faces of  $Q$  can be proven without referring to Theorem 7.4.28, see the remark after Theorem 7.4.46.



For a face  $G \subset Q$ , we denote by  $I(G)$  the ideal in  $H^*(BT)$  generated by all elements  $\alpha(e)$  with  $e \in G$ .

LEMMA 7.4.30. *Suppose that the 1-skeleton of a face  $G$  is connected. Given  $\eta \in H_T^*(M)$ , if  $r_v(\eta) \notin I(G)$  for some vertex  $v \in G$ , then  $r_w(\eta) \notin I(G)$  for any vertex  $w \in G$ .*

PROOF. Suppose  $r_w(\eta) \in I(G)$  for some vertex  $w \in G$ . Then  $r_u(\eta) \in I(G)$  for any vertex  $u \in G$  joined with  $w$  by an edge  $f \subset G$ , because  $r_w(\eta) - r_u(\eta)$  is divisible by  $\alpha(f)$  by Lemma 7.4.25. Since the 1-skeleton of  $G$  is connected,  $r_w(\eta) \in I(G)$  for any vertex  $w \in G$ , which contradicts the assumption.  $\square$

LEMMA 7.4.31. *If each face of  $Q$  has connected 1-skeleton, then  $\widehat{H}_T^*(M)$  is generated by the elements  $\tau_G$  as an  $H^*(BT)$ -module.*

PROOF. Let  $\eta \in H_T^+(M)$  be a nonzero element. Set

$$Z(\eta) = \{v \in M^T : r_v(\eta) = 0\}.$$

Take  $v \notin Z(\eta)$ . Then  $r_v(\eta) \in H^*(BT)$  is nonzero and we can express it as a polynomial in  $\{\alpha(e) : i(e) = v\}$ , as the latter is a basis of  $H^2(BT)$ . Let

$$(7.27) \quad \prod_{i(e)=v} \alpha(e)^{n_e}, \quad n_e \geq 0$$

be a monomial entering  $r_v(\eta)$  with a nonzero coefficient. Let  $G$  be the face spanned by the edges  $e$  with  $n_e = 0$ . Then  $r_v(\eta) \notin I(G)$  since  $r_v(\eta)$  contains monomial (7.27). Hence  $r_w(\eta) \notin I(G)$  (in particular,  $r_w(\eta) \neq 0$ ) for any vertex  $w \in G$ , by Lemma 7.4.30.

On the other hand, it follows from (7.24) that monomial (7.27) can be written as  $r_v(u_G \tau_G)$  with some  $u_G \in H^*(BT)$ . Set  $\eta' = \eta - u_G \tau_G \in H_T^*(M)$ . We have  $r_w(\tau_G) = 0$  for any  $w \notin G$ , which implies  $r_w(\eta') = r_w(\eta)$  for  $w \notin G$ . At the same time,  $r_u(\eta) \neq 0$  for  $u \in G$  (see above). It follows that  $Z(\eta') \supset Z(\eta)$ . The number of monomials in  $r_v(\eta')$  is less than that in  $r_v(\eta)$ . Therefore, by subtracting from  $\eta$  a linear combination of elements  $\tau_G$  with coefficients in  $H^*(BT)$ , we obtain an element  $\lambda$  such that  $Z(\lambda)$  contains  $Z(\eta)$  as a proper subset. By iterating this procedure, we end up at an element whose restriction to every vertex is zero. Since the restriction map  $r : \widehat{H}_T^*(M) \rightarrow H_T^*(M^T)$  is injective, the result follows.  $\square$

THEOREM 7.4.32. *Let  $M$  be a locally standard torus manifold with orbit space  $Q$ . If each face of  $Q$  has connected 1-skeleton and contains a vertex, then the monomorphism  $\varphi : \mathbb{Z}[Q] \rightarrow \widehat{H}_T^*(M)$  of (7.26) is an isomorphism.*

PROOF. The homomorphism  $\varphi$  is injective by Lemma 7.4.27. To prove that  $\varphi$  is surjective it suffices to show that  $\widehat{H}_T^*(M)$  is generated by the elements  $\tau_G$  as a ring. By Proposition 7.4.10, the group  $\widehat{H}_T^2(M)$  is generated by the elements  $\tau_{F_i}$  corresponding to the facets  $F_i$ . (Note: the notation  $\tau_i$  is used for  $\tau_{F_i}$  in Proposition 7.4.10.) In particular, any element in  $H^2(BT) \subset \widehat{H}_T^*(M)$  can be written as a linear combination of the elements  $\tau_{F_i}$ . Hence any element in  $H^*(BT)$  is a polynomial in  $\tau_{F_i}$ . The rest follows from Lemma 7.4.31.  $\square$

As a corollary we obtain a complete description of the equivariant cohomology in the case  $H^{odd}(M) = 0$ :

**THEOREM 7.4.33** ([209, Corollary 7.6]). *Let  $M$  be a locally standard  $T$ -manifold with  $H^{odd}(M) = 0$ . Then the equivariant cohomology  $H_T^*(M)$  is isomorphic to the face ring  $\mathbb{Z}[Q]$  of the manifold with corners  $Q = M/T$ .*

**PROOF.** Indeed, if  $H^{odd}(M) = 0$ , then  $M$  is a torus manifold by Lemma 7.4.4. Furthermore,  $H_T^*(M)$  is a free  $H^*(BT)$ -module by Lemma 7.4.7, i.e.  $\widehat{H}_T^*(M) = H_T^*(M)$ . The result follows from Theorem 7.4.32.  $\square$

The condition  $H^{odd}(M) = 0$  can be interpreted in terms of the simplicial poset  $\mathcal{S}$  dual to  $Q$  as follows:

**LEMMA 7.4.34.** *Let  $M$  be a torus manifold with quotient  $Q$ , and  $\mathcal{S}$  be the face poset of  $Q$ . Then  $H^{odd}(M) = 0$  if and only if the following conditions are satisfied:*

- (a) *the ring  $H_T^*(M)$  is isomorphic to  $\mathbb{Z}[\mathcal{S}] (= \mathbb{Z}[Q])$ ;*
- (b)  *$\mathbb{Z}[\mathcal{S}]$  is a Cohen–Macaulay ring.*

*Furthermore, the ring  $H^*(M)$  is generated in degree two if and only if  $\mathcal{S}$  is (the face poset of) a simplicial complex in addition to the above two conditions.*

**PROOF.** If  $H^{odd}(M) = 0$ , then  $H_T^*(M) \cong \mathbb{Z}[Q]$  by Theorem 7.4.33, and  $\mathbb{Z}[\mathcal{S}]$  is a Cohen–Macaulay ring by Lemma 7.4.7.

Now we prove that  $H^{odd}(M) = 0$  under conditions (a) and (b). The composite

$$H^*(BT) \xrightarrow{\rho^*} H_T^*(M) \xrightarrow{r} \bigoplus_{v \in M^T} H^*(BT).$$

is the diagonal map. By Lemma 3.5.8, this implies that  $\rho^*(t_1), \dots, \rho^*(t_n)$  is an lsop. Since  $H_T^*(M)$  is a Cohen–Macaulay ring, any lsop is a regular sequence (Proposition A.3.12). It follows that  $H_T^*(M)$  is a free  $H^*(BT)$ -module and hence  $H^{odd}(M) = 0$ , by Lemma 7.4.7.

It remains to prove the last statement. Assume that  $H^*(M)$  is generated in degree two. By Lemma 7.4.12, all non-empty multiple intersections of facets are connected. Then  $\mathcal{S}$  is the nerve of the covering of  $\partial Q$  by facets.

Assume that  $\mathcal{S}$  is a simplicial complex. Then  $\mathbb{Z}[\mathcal{S}]$  is generated in degree two. Furthermore,  $H_T^*(M) \cong \mathbb{Z}[\mathcal{S}]$  is a free  $H^*(BT)$ -module by the first part of the theorem, whence  $H^*(M)$  is a quotient ring of  $H_T^*(M)$ . It follows that  $H^*(M)$  is also generated by its degree-two part.  $\square$

**Ordinary cohomology.** We can now describe the ordinary cohomology of a locally standard  $T$ -manifold (or torus manifold) with  $H^{odd}(M) = 0$ . This result generalises the corresponding statements for toric and quasitoric manifolds (Theorems 5.3.1 and 7.3.27):

**THEOREM 7.4.35.** *Let  $M$  be a locally standard  $T$ -manifold with  $H^{odd}(M) = 0$ , and let  $Q = M/T$  be the orbit space. Then there is a ring isomorphism*

$$H^*(M) \cong \mathbb{Z}[v_G : G \text{ a face of } Q]/\mathcal{I},$$

where  $\mathcal{I}$  is the ideal generated by elements of the following two types:

- (a)  $v_G v_H - v_{G \vee H} \sum_{E \in G \cap H} v_E$ ;
- (b)  $\sum_{i=1}^m \langle t, \lambda_i \rangle v_{F_i}$ , for  $t \in H^2(BT)$ .

Here  $F_i$  are the facets of  $Q$ ,  $i = 1, \dots, m$ , and the element  $\lambda_i \in H_2(BT)$  corresponds to the circle subgroup fixing the characteristic submanifold  $M_i = \pi^{-1}(F_i)$ .

The Betti numbers are given by the formula

$$\text{rank } H^{2i}(M) = h_i, \quad 0 \leq i \leq n,$$

where  $h_i$  denote the components of the  $h$ -vector of the dual simplicial poset  $\mathcal{S}$ .

PROOF. Since the Serre spectral sequence of the bundle  $\rho: ET \times_T M \rightarrow BT$  collapses at  $E_2$ , the map  $H_T^*(M) \rightarrow H^*(M)$  is surjective and its kernel is the ideal generated by all elements  $\rho^*(t)$ ,  $t \in H^2(BT)$ . Therefore, the statement about the cohomology ring follows from Proposition 7.4.10 and Theorem 7.4.33.

By Lemma 7.4.7,  $H_T^*(M) \cong H^*(BT) \otimes H^*(M)$  as  $H^*(BT)$ -modules, so we have the following formula for the Poincaré series:

$$F(H_T^*(M); \lambda) = \frac{\sum_{i=0}^n \text{rank } H^{2i}(M) \lambda^{2i}}{(1 - \lambda^2)^n}.$$

On the other hand, the Poincaré series of the face ring  $\mathbb{Z}[Q]$  is given by Theorem 3.5.9, and the two series coincide by Theorem 7.4.33. This implies the statement about the Betti numbers.  $\square$

EXAMPLE 7.4.36. The equivariant cohomology ring of the torus manifold  $S^4$  from Example 7.4.21 is isomorphic to the ring  $\mathbb{Z}[Q]$  described there. The ordinary cohomology ring is obtained by taking quotient by the ideal generated by  $v_G$  and  $v_H$ .

**Torus manifolds over homology polytopes.** Using the previous results on the equivariant and ordinary cohomology of torus manifolds with  $H^{odd}(M) = 0$ , we can now proceed to describing the relationship between the cohomology of  $M$  and the cohomology of its orbit space  $Q$ . Here we prove Theorem 7.4.41, which gives a cohomological characterisation of  $T$ -manifolds whose orbit spaces are homology polytopes. In the next subsection we prove that  $Q$  is face-acyclic if and only if  $H^{odd}(M) = 0$ .

LEMMA 7.4.37. *If  $H^{odd}(M) = 0$ , then  $H^1(Q) = 0$ .*

PROOF. We use the Leray spectral sequence of the projection map  $ET \times_T M \rightarrow M/T = Q$  onto the second factor. It has  $E_2^{p,q} = H^p(M/T; \mathcal{H}^q)$  where  $\mathcal{H}^q$  is the sheaf with stalk  $H^q(BT_x)$  over a point  $x \in M/T$ , and the spectral sequence converges to  $H_T^*(M)$ . Since the  $T$ -action on  $M$  is locally standard, the isotropy group  $T_x$  at  $x \in M$  is a subtorus; so  $H^{odd}(BT_x) = 0$ . Hence  $\mathcal{H}^{odd} = 0$ , in particular,  $\mathcal{H}^1 = 0$ . Moreover,  $\mathcal{H}^0 = \mathbb{Z}$  (the constant sheaf). Therefore, we have  $E_2^{0,1} = 0$  and  $E_2^{1,0} = H^1(M/T)$ , whence  $H^1(M/T) \cong H_T^1(M)$ . On the other hand, since  $H^{odd}(M) = 0$  by assumption,  $H_T^*(M)$  is a free  $H^*(BT)$ -module. Therefore,  $H_T^{odd}(M) = 0$  by the universal coefficient theorem. In particular,  $H_T^1(M) = 0$ .  $\square$

LEMMA 7.4.38. *If either*

- (1)  $Q$  is a homology polytope, or
- (2)  $H^*(M)$  is generated by its degree-two part,

*then the dual poset  $\mathcal{S}$  of  $Q$  is (the face poset of) a Gorenstein\* simplicial complex.*

PROOF. Under any of the assumptions (1) or (2), all nonempty multiple intersections of facets of  $Q$  are connected, so  $\mathcal{S}$  is the face poset of the nerve simplicial complex  $\mathcal{K}$  of the covering of  $\partial Q$ . For simplicity, we identify  $\mathcal{S}$  with  $\mathcal{K}$ .

We first prove that  $\mathcal{S}$  is Gorenstein\* under assumption (1). According to Theorem 3.4.2, it is enough to show that the link  $\text{lk } \sigma$  of any simplex  $\sigma \in \mathcal{K}$ , has homology of a sphere of dimension  $\dim \text{lk } \sigma = n - 2 - \dim \sigma$ . If  $\sigma = \emptyset$  then  $\text{lk } \sigma$  is  $\mathcal{K}$  itself, and it has homology of an  $(n - 1)$ -sphere, since  $Q$  is a homology polytope. If  $\sigma \neq \emptyset$  then  $\text{lk } \sigma$  is the nerve of a face of  $Q$ . Since any face of  $Q$  is again a homology polytope,  $\text{lk } \sigma$  has homology of a sphere of dimension  $\dim \text{lk } \sigma$ .

Now we prove that  $\mathcal{K}$  is Gorenstein\* under assumption (2). By Exercise 3.4.10, it is enough to show that

- (a)  $\mathcal{K}$  is Cohen–Macaulay;
- (b) every  $(n - 2)$ -dimensional simplex is contained in exactly two  $(n - 1)$ -dimensional simplices;
- (c)  $\chi(\mathcal{K}) = \chi(S^{n-1})$ .

Condition (a) follows from Lemma 7.4.34. By definition, every  $k$ -dimensional simplex of  $\mathcal{K}$  corresponds to a set of  $k + 1$  characteristic submanifolds with nonempty intersection. By Lemma 7.4.12, the intersection of any  $n$  characteristic submanifolds is either empty or consists of a single  $T$ -fixed point. This means that  $(n - 1)$ -simplices of  $\mathcal{K}$  are in one-to-one correspondence with  $T$ -fixed points of  $M$ . Now, each  $(n - 2)$ -simplex of  $\mathcal{K}$  corresponds to a non-empty intersection of  $n - 1$  characteristic submanifolds of  $M$ . The latter intersection is connected by Lemma 7.4.12, so it is a 2-sphere. Every 2-sphere contains exactly two  $T$ -fixed points, which implies (b). Finally, (c) is just the equation  $h_0 = h_n$ , which is valid as  $h_n = \text{rank } H^{2n}(M) = 1$ .  $\square$

Consider the order complex  $\text{ord}(\mathcal{S})$  (see Definition 2.3.6) and denote by  $C$  its geometric realisation. Then  $C$  is the cone over  $|\mathcal{S}|$ . The space  $C$  has a face structure, as in the proof of Theorem 4.1.4. Namely, for each simplex  $\sigma \in \text{ord}(\mathcal{S})$  we denote by  $C_\sigma$  the geometric realisation of the simplicial complex  $\text{st } \sigma = \{\tau \in \text{ord}(\mathcal{S}) : \sigma \subset \tau\}$ . If  $\sigma$  has dimension  $(k - 1)$ , then we say that  $C_\sigma$  is a codimension- $k$  face of  $C$ . Each facet  $C_i$  (a face of codimension one) is the star of a vertex of  $\text{ord}(\mathcal{S})$ , as in (4.4). A face of codimension  $k$  is a connected component of an intersection of  $k$  facets. Since any face is a cone, it is acyclic.

Although the face posets of  $C$  and  $Q$  coincide, the spaces themselves are different: faces  $C_\sigma$  are defined abstractly and they are contractible (being cones), but faces of  $Q$  may be not contractible even when  $Q$  is a homology polytope. Nevertheless, we can define the characteristic map  $\lambda$  for the face structure of  $C$  by (7.20), and define a  $T$ -space

$$M(C, \lambda) = C \times T / \sim$$

by analogy with (7.21). Since  $C$  may be not a manifold with corners, the space  $M(C, \lambda)$  is not a manifold in general. By a straightforward generalisation of Proposition 7.3.12, the space  $M(C, \lambda)$  can be identified with the quotient  $\mathcal{Z}_\mathcal{S}/K$  of the moment-angle complex corresponding to  $\mathcal{S}$  (see Section 4.10) by a freely acting torus of dimension  $(m - n)$ .

**PROPOSITION 7.4.39.** *We have  $H_T^*(M(C, \lambda)) \cong \mathbb{Z}[\mathcal{S}]$ .*

**PROOF.** We have  $H_{\mathbb{T}^m}^*(\mathcal{Z}_\mathcal{S}) \cong \mathbb{Z}[\mathcal{S}]$  by Exercise 4.10.9. Now,  $H_{\mathbb{T}^m}^*(\mathcal{Z}_\mathcal{S}) \cong H_T^*(M(C, \lambda))$ , because  $M(C, \lambda) \cong \mathcal{Z}_\mathcal{S}/K$  and  $T = \mathbb{T}^m/K$ .  $\square$

PROPOSITION 7.4.40. *There is a face-preserving map  $Q \rightarrow C$ , which is covered by a  $T$ -equivariant map*

$$\Phi: M(Q, \lambda) \rightarrow M(C, \lambda).$$

PROOF. The map  $Q \rightarrow C$  is constructed inductively; we start with a bijection between vertices, and then extend the map to faces of higher dimension. Each face of  $C$  is a cone, there are no obstructions to such extensions. Since the map  $Q \rightarrow C$  preserves the face structure, it is covered by a  $T$ -equivariant map

$$M(Q, \lambda) = T \times Q / \sim \longrightarrow T \times C / \sim = M(C, \lambda). \quad \square$$

Now we can prove the main result of this subsection:

THEOREM 7.4.41 ([209]). *The cohomology of a locally standard  $T$ -manifold  $M$  is generated in degree two if and only if the orbit space  $Q$  is a homology polytope.*

PROOF. Assume that  $Q$  is a homology polytope. Then  $M$  is homeomorphic to the canonical model  $M(Q, \lambda)$  (Lemma 7.4.17), and we can view the map  $\Phi$  from Proposition 7.4.40 as a map  $M \rightarrow M(C, \lambda)$ . For simplicity, we denote  $M(C, \lambda)$  by  $M_C$  in this proof. Let  $M_{C,i} = \pi^{-1}(C_i)$ ,  $1 \leq i \leq m$ , be the ‘characteristic’ subspaces of  $M_C$ . We also denote by  $\partial C$  the union of all facets  $C_i$  of  $C$ ; topologically,  $\partial C$  is the simplicial cell complex  $|\mathcal{S}|$ . The  $T$ -action is free on  $M_C \setminus \cup_i M_{C,i}$  and on  $M \setminus \cup_i M_i$ , so we have

$$H_T^*(M_C, \cup_i M_{C,i}) \cong H^*(C, \partial C), \quad H_T^*(M, \cup_i M_i) \cong H^*(Q, \partial Q).$$

Therefore, the map  $\Phi$  induces a map between exact sequences

$$(7.28) \quad \begin{array}{ccccccc} \longrightarrow & H^*(C, \partial C) & \longrightarrow & H_T^*(M_C) & \longrightarrow & H_T^*(\cup_i M_{C,i}) & \longrightarrow \\ & \downarrow & & \downarrow \Phi^* & & \downarrow & \\ \longrightarrow & H^*(Q, \partial Q) & \longrightarrow & H_T^*(M) & \longrightarrow & H_T^*(\cup_i M_i) & \longrightarrow \end{array}$$

Each  $M_i$  itself is a torus manifold with quotient homology polytope  $F_i$ . Using induction and the Mayer–Vietoris sequence, we may assume that the map  $H_T^*(\cup_i M_{C,i}) \rightarrow H_T^*(\cup_i M_i)$  above is an isomorphism. By Lemma 7.4.38,  $\partial C \cong |\mathcal{S}|$  has homology of an  $(n-1)$ -sphere. Hence  $H^*(C, \partial C) \cong H^*(D^n, S^{n-1})$ , because  $C$  is the cone over  $\partial C$ . We also have  $H^*(Q, \partial Q) \cong H^*(D^n, S^{n-1})$ , because  $Q$  is a homology polytope. Using these isomorphisms, we see from the construction of the map  $\Phi$  that the induced map  $H^*(C, \partial C) \rightarrow H^*(Q, \partial Q)$  is the identity on  $H^*(D^n, S^{n-1})$ . By applying the 5-lemma to (7.28) we obtain that  $\Phi^*: H_T^*(M_C) \rightarrow H_T^*(M)$  is an isomorphism. This together with Proposition 7.4.39 implies  $H_T^*(M) \cong \mathbb{Z}[\mathcal{S}]$ . The ring  $\mathbb{Z}[\mathcal{S}]$  is Cohen–Macaulay by Lemma 7.4.38. Therefore, all conditions of Lemma 7.4.34 are satisfied, and  $H^*(M)$  is generated by its degree-two part.

Assume now that  $H^*(M)$  is generated in degree two. Since all nonempty intersections of characteristic submanifolds are connected and their cohomology rings are generated in degree two (Lemma 7.4.12), we may assume by induction that all proper faces of  $Q$  are homology polytopes. In particular, the proper faces are acyclic, whence  $H^*(\partial Q) \cong H^*(\partial C)$ , because both  $\partial Q$  and  $\partial C$  have acyclic coverings with the same nerve  $\mathcal{S}$ . This together with Lemma 7.4.38 implies

$$(7.29) \quad H^*(\partial Q) \cong H^*(S^{n-1}).$$

We need to show that  $Q$  itself is acyclic. We first prove the following:

CLAIM.  $H^2(Q) = 0$ .

PROOF. The claim is trivial for  $n = 1$ . If  $n = 2$  then  $Q$  is a surface with boundary, hence  $H^2(Q) = 0$ . Now assume  $n \geq 3$ . We consider the equivariant cohomology exact sequence of pair  $(M, \cup_i M_i)$  (the bottom row of (7.28)). All the maps in the exact sequence are  $H^*(BT)$ -module maps. By Lemma 7.4.7,  $H_T^*(M)$  is a free  $H^*(BT)$ -module. On the other hand,  $H^*(Q, \partial Q)$  is finitely generated over  $\mathbb{Z}$ , so it is a torsion  $H^*(BT)$ -module. It follows that the whole sequence splits into short exact sequences:

$$(7.30) \quad 0 \rightarrow H_T^k(M) \rightarrow H_T^k(\cup_i M_i) \rightarrow H^{k+1}(Q, \partial Q) \rightarrow 0$$

By setting  $k = 1$  we obtain

$$H_T^1(\cup_i M_i) \cong H^2(Q, \partial Q).$$

The same argument as in Lemma 7.4.37 shows that

$$H_T^1(\cup_i M_i) = H^1((\cup_i M_i)/T) = H^1(\partial Q).$$

By considering the projection  $(ET \times M)/T \rightarrow M/T = Q$  we conclude that the coboundary map  $H^1(\partial Q) \rightarrow H^2(Q, \partial Q)$  is an isomorphism. Therefore, we get the following fragment of the exact sequence of pair:

$$0 \rightarrow H^2(Q) \rightarrow H^2(\partial Q) \rightarrow H^3(Q, \partial Q).$$

By (7.29),  $H^2(\partial Q) \cong H^2(S^{n-1})$ , whence  $H^2(Q) = 0$  for  $n \geq 4$ . If  $n = 3$ , the coboundary map  $H^2(\partial Q) \rightarrow H^3(Q, \partial Q)$  above is an isomorphism because  $Q$  is orientable by Lemma 7.4.37, whence  $H^2(Q) = 0$  again.  $\square$

Now we resume the proof of the theorem. We obtain a  $T$ -homeomorphism  $M \rightarrow M(Q, \lambda)$  (because  $H^2(Q) = 0$  and all proper faces are acyclic by the inductive assumption, see the remark after Proposition 7.4.17), and therefore a  $T$ -map  $\Phi: M \rightarrow M_C$ , as in the proof of the ‘if’ part of the theorem. We consider diagram (7.28) again. Using induction and a Mayer–Vietoris argument, we may assume that  $H_T^*(\cup_i M_{C,i}) \rightarrow H_T^*(\cup_i M_i)$  is an isomorphism. By Lemma 7.4.38,  $H^*(C, \partial C) \cong H^*(D^n, S^{n-1})$ . The map  $Q \rightarrow C$  used in the construction of  $\Phi$  induces a map

$$(7.31) \quad H^*(D^n, S^{n-1}) \cong H^*(C, \partial C) \rightarrow H^*(Q, \partial Q),$$

which is an isomorphism in dimension  $n$ . Applying the 5-lemma (Exercise A.1.3) to (7.28), we obtain that  $\Phi^*: H_T^*(M_C) \rightarrow H_T^*(M)$  is injective. Theorem 7.4.33 and Proposition 7.4.39 imply that  $H_T^*(M) \cong \mathbb{Z}[Q] \cong H_T^*(M_C)$ , and all graded components of these rings are finitely generated. The same argument works with any field coefficients, so that  $\Phi^*: H_T^*(M_C) \rightarrow H_T^*(M)$  is actually an isomorphism. By applying the 5-lemma again to diagram (7.28), we obtain that (7.31) is an isomorphism, i.e.  $H^*(Q, \partial Q) \cong H^*(D^n, S^{n-1})$ . This together with (7.29) implies that  $Q$  is acyclic.  $\square$

Theorem 7.4.41 shows that if the cohomology ring of a locally standard  $T$ -manifold is generated in degree two, then the combinatorics of the orbit space  $Q$  is fully determined by its nerve simplicial complex. The following result gives a characterisation of simplicial complexes arising in this way.

PROPOSITION 7.4.42. *A simplicial complex  $\mathcal{K}$  can be the nerve of a locally standard  $T$ -manifold with cohomology generated in degree two if and only if  $\mathcal{K}$  is Gorenstein\* and  $\mathbb{Z}[\mathcal{K}]$  admits an lsop.*

PROOF. If  $H^*(M)$  is generated in degree two, then  $\mathcal{K}$  is Gorenstein\* by Lemma 7.4.38. In particular,  $\mathbb{Z}[\mathcal{K}]$  is a Cohen–Macaulay ring. Furthermore,  $H_T^*(M) \cong \mathbb{Z}[\mathcal{K}]$  by Theorem 7.4.33. Since  $H_T^*(M) \cong H^*(BT) \otimes H^*(M)$  as a  $H^*(BT)$ -module, the ring  $\mathbb{Z}[\mathcal{K}]$  admits an lsop.

Now assume that  $\mathbb{Z}[\mathcal{K}]$  is Gorenstein\* and admits an lsop. By [88, Theorem 12.2], there exists a homology polytope  $Q$  with nerve  $\mathcal{K}$ . Since  $\mathbb{Z}[\mathcal{K}]$  admits an lsop, any element  $t \in H^2(BT)$  can be written as

$$t = \sum_{i=1}^m \lambda_i(t)v_i$$

with  $\lambda_i(t) \in \mathbb{Z}$ . Clearly,  $\lambda_i(t)$  is linear in  $t$ , so that we can view  $\lambda_i$  as an element of the dual lattice  $H_2(BT)$  (see Proposition 7.4.10). Now define a map  $\lambda$  (7.20) which sends  $F_i$  to  $\lambda_i$ . Then  $M = M(Q, \lambda)$  (see (7.21)) is a locally standard  $T$ -manifold, and its cohomology is generated in degree two by Theorem 7.4.41.  $\square$

**Torus manifolds over face-acyclic manifolds with corners.** Here we prove the second main result on the cohomology of  $T$ -manifolds, Theorem 7.4.46. It states that the orbit space  $Q$  of a locally standard  $T$ -manifold  $M$  is face-acyclic if and only if  $H^{odd}(M) = 0$ . The proof is by reduction to Theorem 7.4.41 on  $T$ -manifolds over homology polytopes; it relies upon the operation of blow-up and the algebraic results of Section 3.6.

As before,  $M$  is a locally standard  $T$ -manifold with orbit projection  $\pi: M \rightarrow Q$ .

CONSTRUCTION 7.4.43 (Blow-up of a  $T$ -manifold). Let  $M_G = \pi^{-1}(G)$  be the submanifold corresponding to a face  $G \subset Q$ , and  $\nu_G = \nu(M_G \subset M)$  the normal bundle. Since  $M_G$  is a transverse intersection of characteristic submanifolds,  $\nu_G$  is the Whitney sum of their normal bundles. The omniorientation on  $M$  makes  $\nu_G$  into a complex  $T$ -bundle.

Consider the  $T$ -bundle  $\nu_G \oplus \mathbb{C}$ , where the  $T$ -action on the trivial summand  $\mathbb{C}$  is trivial. The projectivisation  $\mathbb{C}P(\nu_G \oplus \mathbb{C})$  is a locally standard  $T$ -manifold containing  $M_G$ , and there are invariant neighbourhoods of  $M_G$  in  $M$  and of  $M_G$  in  $\mathbb{C}P(\nu_G \oplus \mathbb{C})$  which are  $T$ -diffeomorphic. After removing these invariant neighbourhoods of  $M_G$  from  $M$  and  $\mathbb{C}P(\nu_G \oplus \mathbb{C})$  and reversing orientation on the latter, we can identify the resulting  $T$ -manifolds along their boundaries. As a result, we obtain a locally standard  $T$ -manifold  $\widetilde{M}$ , which is called the *blow-up* of  $M$  at  $M_G$ .

If  $G$  is a vertex, then  $\widetilde{M}$  is diffeomorphic to the connected sum  $M \# \overline{\mathbb{C}P}^n$ .

There is a blow-down map  $\widetilde{M} \rightarrow M$ , which collapses the total space  $\mathbb{C}P(\nu_G \oplus \mathbb{C})$  onto  $M_G$  and is the identity on the remaining part of  $\widetilde{M}$ .

The orbit space  $\widetilde{Q}$  of  $\widetilde{M}$  is obtained by truncating  $Q$  at the face  $G$ . As a result,  $\widetilde{Q}$  acquires a new facet, which we denote by  $\widetilde{G}$ . The simplicial cell complex dual to  $\widetilde{Q}$  is obtained from the dual of  $Q$  by applying a stellar subdivision at the face dual to  $G$  (see Definition 2.7.1).

LEMMA 7.4.44.  *$\widetilde{Q}$  is face-acyclic if and only if  $Q$  is face-acyclic.*

PROOF. All new faces appearing as the result of truncating  $Q$  at  $G$  are contained in the facet  $\widetilde{G} \subset \widetilde{Q}$ . The blow-down map  $\widetilde{M} \rightarrow M$  induces the projection

$\tilde{Q} \rightarrow Q$  collapsing  $\tilde{G}$  onto  $G$ . The face  $G$  is a deformation retract of  $\tilde{G}$  (combinatorially,  $\tilde{G}$  is a product of  $G$  and a simplex). Hence  $G$  is acyclic if and only if  $\tilde{G}$  is acyclic. Similarly, any other new face  $\tilde{Q}$  deformation retracts onto a face of  $Q$ . Furthermore, the map  $\tilde{Q} \rightarrow Q$  is also a deformation retraction.  $\square$

LEMMA 7.4.45.  $H^{odd}(\tilde{M}) = 0$  if and only if  $H^{odd}(M) = 0$ .

PROOF. Assume that  $H^{odd}(M) = 0$ . By Lemma 7.4.8,  $H^{odd}(M_G) = 0$ . The facial submanifold  $M_G \subset M$  is blown up to a codimension-two submanifold  $\tilde{M}_{\tilde{G}} \cong \mathbb{C}P(\nu_G)$ . The cohomology of the projectivisation of a complex vector bundle over  $M_G$  is a free  $H^*(M_G)$ -module on even-dimensional generators (see, e.g. [297, Chapter V]). Therefore,  $H^{odd}(\tilde{M}_{\tilde{G}}) = 0$ .

The blow-down map  $\tilde{M} \rightarrow M$  induces a map between exact sequences of pairs

$$\begin{array}{ccccccc} H^{k-1}(M_G) & \longrightarrow & H^k(M, M_G) & \longrightarrow & H^k(M) & \longrightarrow & H^k(M_G) \\ \downarrow & & \downarrow \cong & & \downarrow & & \downarrow \\ H^{k-1}(\tilde{M}_{\tilde{G}}) & \longrightarrow & H^k(\tilde{M}, \tilde{M}_{\tilde{G}}) & \longrightarrow & H^k(\tilde{M}) & \longrightarrow & H^k(\tilde{M}_{\tilde{G}}) \end{array}$$

where the second vertical arrow is an isomorphism by excision. Assume that  $k$  is odd. Since  $H^k(M) = 0$ , the map  $H^{k-1}(M_G) \rightarrow H^k(M, M_G)$  is onto. Therefore,  $H^{k-1}(\tilde{M}_{\tilde{G}}) \rightarrow H^k(\tilde{M}, \tilde{M}_{\tilde{G}})$  is onto. Since  $H^k(\tilde{M}_{\tilde{G}}) = 0$ , this implies  $H^k(\tilde{M}) = 0$ .

To prove the opposite statement, we use the algebraic results from Section 3.6. Assume  $H^{odd}(\tilde{M}) = 0$ . Let  $\mathcal{S}$  be the dual simplicial poset of  $Q$ , and let  $\tilde{\mathcal{S}}$  be the dual poset of  $\tilde{Q}$ . Then  $\tilde{\mathcal{S}}$  is obtained from  $\mathcal{S}$  by stellar subdivision at the face dual to  $G$ . By Lemma 7.4.34,  $\mathbb{Z}[\tilde{\mathcal{S}}]$  is a Cohen–Macaulay ring. We claim that  $\mathbb{Z}[\mathcal{S}]$  is also Cohen–Macaulay (i.e. the converse of Lemma 3.6.6 holds). Indeed, Theorem 3.6.7 implies that  $\tilde{\mathcal{S}}$  is a Cohen–Macaulay simplicial poset. Let  $\mathcal{K}$  be a simplicial complex which is a common subdivision of simplicial cell complexes  $\tilde{\mathcal{S}}$  and  $\mathcal{S}$  (for example, we may take  $\mathcal{K}$  to be the barycentric subdivision of  $\tilde{\mathcal{S}}$ ). Then  $\mathcal{K}$  is a Cohen–Macaulay complex by Corollary 3.6.2, hence  $\mathcal{S}$  is a Cohen–Macaulay simplicial poset. Another application of Theorem 3.6.7 gives that  $\mathbb{Z}[\mathcal{S}]$  is a Cohen–Macaulay ring. Finally, Lemma 7.4.34 implies that  $H^{odd}(M) = 0$ .  $\square$

Now we can prove our final result:

THEOREM 7.4.46 ([209]). *The odd-degree cohomology of a locally standard  $T$ -manifold  $M$  vanishes if and only if the orbit space  $Q$  is face-acyclic.*

PROOF. The idea is to reduce to Theorem 7.4.41 by blowing up sufficiently many facial submanifolds. If the orbit space of  $M$  is face-acyclic, then it becomes a homology polytope after sufficiently many blow-ups.

Let  $\mathcal{S}$  be the simplicial poset dual to  $Q$ . Since the barycentric subdivision is a sequence of stellar subdivisions (Proposition 3.6.3), by applying appropriate blow-ups we get a torus manifold  $M'$  with orbit space  $Q'$  such that the face poset of  $Q'$  is the barycentric subdivision of the face poset of  $Q$ . The collapse map  $M' \rightarrow M$  is a composition of blow-down maps:

$$(7.32) \quad M = M_0 \longleftarrow M_1 \longleftarrow \cdots \longleftarrow M_k = M'.$$

Assume that  $H^{odd}(M) = 0$ . Then  $M$  is locally standard by Theorem 7.4.14. By applying Lemma 7.4.45 successively, we get  $H^{odd}(M') = 0$ . By construction, all



intersections of faces of  $Q'$  are connected, so  $H^*(M')$  is generated in degree two by Lemma 7.4.34 and  $Q'$  is a homology polytope by Theorem 7.4.41. In particular,  $Q'$  is face-acyclic. Finally, by applying Lemma 7.4.44 successively, we conclude that  $Q$  is also face-acyclic.

Assume now that  $Q$  is face-acyclic. By applying Lemma 7.4.44 successively, we obtain that  $Q'$  is also face-acyclic. On the other hand,  $\mathcal{S}'$  is a simplicial complex, hence  $Q'$  is a homology polytope. By Theorem 7.4.41,  $H^{odd}(M') = 0$ . By applying lemma 7.4.45 successively, we finally conclude that  $H^{odd}(M) = 0$ .  $\square$

REMARK. As one can easily observe, the argument in the “only if” part of the above theorem is independent of Theorem 7.4.28 and Theorem 7.4.33. Now, given that  $Q$  is face-acyclic, one readily deduces that the 1-skeleton of  $Q$  is connected. Indeed, otherwise the smallest face containing vertices from two different connected components of the 1-skeleton would be a manifold with at least two boundary components and thereby non-acyclic. Thus, our reference to Theorem 7.4.28 was actually irrelevant, although it made the argument more straightforward.

### Exercises.

7.4.47. If  $M$  is orientable and  $H^{odd}(M) = 0$ , then  $H^*(M)$  is torsion-free.

7.4.48. Any torus manifold  $M$  has at least two characteristic submanifolds.

7.4.49. Any  $T$ -fixed point of a torus  $2n$ -manifold  $M$  is contained in an intersection of  $n$  characteristic submanifolds.

7.4.50. Each face of a face-acyclic manifold with corners has a vertex.

7.4.51. The equivariant Chern class of torus manifold  $M$  with an invariant stably complex structure is given by

$$c^T(M) = \prod_{i=1}^m (1 + \tau_i) \quad \text{modulo } H^*(BT)\text{-torsion}$$

where  $\tau_i \in H_T^2(M)$  is the Thom class defined before Proposition 7.4.10. (Hint: use Corollary 7.4.6, see [206, Theorem 3.1].)

7.4.52. Let  $M$  be a torus manifold of dimension  $2n$  with  $H^{odd}(M; \mathbb{Z}_2) = 0$  and let  $G \subset T$  denote the discrete subgroup isomorphic to  $\mathbb{Z}_2^n$ . Show that the  $G$ -equivariant Stiefel–Whitney class of  $M$  is given by

$$w^G(M) = \prod_{i=1}^m (1 + \tau_i),$$

where  $\tau_i \in H_G^2(M; \mathbb{Z}_2)$  is the mod-2 Thom class.

7.4.53. Prove the following particular case of Theorem 3.7.4. Let  $\mathcal{S}$  be a Gorenstein\* simplicial poset such that there exists a torus manifold  $M$  with  $H^{odd}(M) = 0$  and orbit space  $Q$  whose dual poset is  $\mathcal{S}$ . Let  $\mathbf{h}(\mathcal{S}) = (h_0, h_1, \dots, h_n)$  be the  $h$ -vector. Assume that  $n$  is even and  $h_i = 0$  for some  $i$ . Then  $h_{n/2}$  is even. (Hint: use the previous exercise, see [209, Theorem 10.1]. An algebraic version of this argument was used in [207] to prove Theorem 3.7.4 completely.)

### 7.5. Topological toric manifolds

Recall that a toric manifold is a smooth complete (compact) algebraic variety with an effective algebraic action of an algebraic torus  $(\mathbb{C}^\times)^n$  having an open dense orbit. More constructively, toric varieties can be defined via the fan-variety correspondence; this gives a covering of the variety by invariant affine charts, which in the smooth complete case are algebraic representation spaces of  $(\mathbb{C}^\times)^n$ .

The idea behind Ishida, Fukukawa and Masuda's generalisation of toric manifolds is to combine topological versions of these two definitions of toric varieties:

**DEFINITION 7.5.1 ([170]).** A *topological toric manifold* is a closed smooth manifold  $X$  of dimension  $2n$  with an effective *smooth* action of  $(\mathbb{C}^\times)^n$  having an open dense orbit and covered by finitely many invariant open subsets each equivariantly diffeomorphic to a smooth representation space of  $(\mathbb{C}^\times)^n$ .

As is pointed out in [170], keeping only the first part of the definition (i.e. a smooth  $(\mathbb{C}^\times)^n$ -action with a dense orbit) leads to a vast and untractable class of objects; therefore it is important to include the covering by equivariant charts.

In this section we review the main properties of topological toric manifolds, and outline the construction of the correspondence between topological toric manifolds and generalised fans, called *topological fans*. We mainly follow the notation and terminology of [170]. The details of proofs can be found in the original paper.

The effectiveness of the  $(\mathbb{C}^\times)^n$ -action on a topological toric manifold  $X$  implies that the smooth representation of  $(\mathbb{C}^\times)^n$  modelling each invariant chart of  $X$  is faithful. A faithful smooth real  $2n$ -dimensional representation of  $(\mathbb{C}^\times)^n$  is isomorphic to a direct sum of complex one-dimensional representations.

To get a hold on smooth representations of  $(\mathbb{C}^\times)^n$ , we consider the case  $n = 1$  first. Since  $GL(1, \mathbb{C}) = \mathbb{C}^\times$ , a smooth representation of  $\mathbb{C}^\times$  in  $\mathbb{C}$  can be viewed as a smooth endomorphism of  $\mathbb{C}^\times$ . Such an endomorphism has the form

$$z \mapsto z^\mu = |z|^{b+ic} \left( \frac{z}{|z|} \right)^a \quad \text{with } \mu = (b + ic, a) \in \mathbb{C} \times \mathbb{Z}.$$

The representation given by  $z \rightarrow z^\mu$  is algebraic if and only if  $c = 0$  and  $b = a$ .

Composition of smooth endomorphisms of  $\mathbb{C}^\times$  defines a (noncommutative) product on  $\mathbb{C} \times \mathbb{Z}$ , given by

$$(z^{\mu_1})^{\mu_2} = z^{\mu_2\mu_1}, \quad \mu_2\mu_1 = (b_1b_2 + i(b_1c_2 + c_1a_2), a_1a_2).$$

This product becomes the matrix product if we represent  $\mu$  by  $2 \times 2$ -matrices:

$$\begin{pmatrix} b_2 & 0 \\ c_2 & a_2 \end{pmatrix} \begin{pmatrix} b_1 & 0 \\ c_1 & a_1 \end{pmatrix} = \begin{pmatrix} b_2b_1 & 0 \\ c_2b_1 + a_2c_1 & a_2a_1 \end{pmatrix}.$$

Let  $\mathcal{R}$  be the ring consisting of elements of  $\mathbb{C} \times \mathbb{Z}$  with componentwise addition and multiplication defined above. The ring  $\mathcal{R}$  is therefore isomorphic to the ring  $\text{Hom}_{\text{sm}}(\mathbb{C}^\times, \mathbb{C}^\times)$  of smooth endomorphisms of  $\mathbb{C}^\times$ .

Given  $\alpha = (\alpha^1, \dots, \alpha^n) \in \mathcal{R}^n$  and  $\beta = (\beta^1, \dots, \beta^n) \in \mathcal{R}^n$ , define smooth homomorphisms  $\chi^\alpha \in \text{Hom}((\mathbb{C}^\times)^n, \mathbb{C}^\times)$  and  $\lambda_\beta \in \text{Hom}(\mathbb{C}^\times, (\mathbb{C}^\times)^n)$  by

$$\chi^\alpha(z_1, \dots, z_n) = \prod_{k=1}^n z_k^{\alpha^k}, \quad \lambda_\beta(z) = (z^{\beta^1}, \dots, z^{\beta^n}),$$

and also define

$$\langle \alpha, \beta \rangle = \sum_{k=1}^n \alpha^k \beta^k \in \mathcal{R}.$$

The following properties are checked easily:

- (a)  $\chi^\alpha(\lambda_\beta(z)) = z^{\langle \alpha, \beta \rangle}$ ;
- (b)  $\lambda_\beta(\chi^\alpha(z_1, \dots, z_n)) = \left( \prod_{k=1}^n z_k^{\beta^1 \alpha^k}, \dots, \prod_{k=1}^n z_k^{\beta^n \alpha^k} \right)$ .

Given  $\alpha_1, \dots, \alpha_n \in \mathcal{R}^n$ , define the endomorphism  $\bigoplus_{i=1}^n \chi^{\alpha_i}$  of  $(\mathbb{C}^\times)^n$  by

$$\left( \bigoplus_{i=1}^n \chi^{\alpha_i} \right) (z_1, \dots, z_n) = (\chi^{\alpha_1}(z_1, \dots, z_n), \dots, \chi^{\alpha_n}(z_1, \dots, z_n)).$$

**PROPOSITION 7.5.2.** *Any smooth representation of  $(\mathbb{C}^\times)^n$  in  $\mathbb{C}^n$  has the form  $\bigoplus_{i=1}^n \chi^{\alpha_i}$  with  $\alpha_i \in \mathcal{R}^n$ . This representation is faithful if and only if the  $n \times n$ -matrix formed by the coordinates of  $\alpha_i$  has an inverse in  $\text{Mat}_n(\mathcal{R})$ .*

A faithful representation of  $(\mathbb{C}^\times)^n$  in  $\mathbb{C}^n$  has a unique fixed point  $\mathbf{0}$ , hence the fixed point set  $X^{(\mathbb{C}^\times)^n}$  of a topological toric manifold is finite.

A closed connected submanifold of real codimension two in a topological toric manifold  $X$  is called *characteristic* if it is fixed pointwise by a subgroup isomorphic to  $\mathbb{C}^\times$ . There are finitely many characteristic submanifolds in  $X$ , and we denote them by  $X_1, \dots, X_m$ .

It can be easily seen that a topological toric manifold  $X$  is simply connected ([170, Proposition 3.2]). In particular,  $X$  is orientable. For each characteristic submanifold  $X_j$ , the normal bundle  $\nu_j = \nu(X_j \subset X)$  is orientable as a  $(\mathbb{C}^\times)$ -equivariant bundle. Therefore,  $X_j$  itself is also orientable. A choice of an orientation for each  $X_j$  together with an orientation of  $X$  is called an *omniorientation* on  $X$ . Topological toric manifolds are assumed to be omnioriented below.

**LEMMA 7.5.3** ([170, Lemma 3.3]). *For each characteristic submanifold  $X_j$ , there is a unique  $\beta_j(X) \in \mathcal{R}^n$  such that the subgroup  $\lambda_{\beta_j(X)}(\mathbb{C}^\times) \subset (\mathbb{C}^\times)^n$  fixes  $X_j$  pointwise and  $\lambda_{\beta_j(X)}(z)_* \xi = z\xi$  for any  $z \in \mathbb{C}^\times, \xi \in \nu_i$ , where  $\lambda_{\beta_j(X)}(z)_*$  denotes the differential of  $\lambda_{\beta_j(X)}(z)$ .*

Characteristic submanifolds of  $X$  intersect transversely. Furthermore, multiple intersections of characteristic submanifolds are all connected (as in the case of quasitoric manifolds, and unlike general torus manifolds), see [170, Lemma 3.6]. In particular, any fixed point  $v \subset X^{(\mathbb{C}^\times)^n}$  is an intersection of an  $n$ -tuple  $X_{j_1}, \dots, X_{j_n}$  of characteristic submanifolds, so we have an isomorphism of real  $(\mathbb{C}^\times)^n$ -representation spaces

$$\mathcal{T}_v X \cong (\nu_{j_1} \oplus \dots \oplus \nu_{j_n})|_v.$$

The omniorientation of  $X$  defines orientations for the left and right hand side of the identity above. These two orientations may be different, so the sign of  $v$  is defined (compare Lemma 7.3.18 (a)).

The element  $\beta_j(X)$  defined in Lemma 7.5.3 can be written as

$$(7.33) \quad \beta_j(X) = (\mathbf{b}_j(X) + i\mathbf{c}_j(X), \mathbf{a}_j(X)) \in \mathbb{C}^n \times \mathbb{Z}^n.$$

Here is an analogue of Proposition 7.3.17 for topological toric manifolds:

LEMMA 7.5.4 ([170, Lemma 3.4]). *Let  $v = X_{j_1} \cap \cdots \cap X_{j_n}$  be a fixed point of  $X$ . Then  $\{\mathbf{b}_{j_1}(X), \dots, \mathbf{b}_{j_n}(X)\}$  and  $\{\mathbf{a}_{j_1}(X), \dots, \mathbf{a}_{j_n}(X)\}$  are bases of  $\mathbb{R}^n$  and  $\mathbb{Z}^n$  respectively.*

*The complex  $\mathbb{C}^\times$ -representation space  $(\nu_{j_1} \oplus \cdots \oplus \nu_{j_n})|_v$  is isomorphic to  $\bigoplus_{k=1}^n \chi^{\alpha_k^{(v)}}$ , where  $\{\alpha_1^{(v)}, \dots, \alpha_n^{(v)}\}$  is the dual set of  $\{\beta_{j_1}(X), \dots, \beta_{j_n}(X)\}$ , defined uniquely by the condition*

$$\langle \alpha_k^{(v)}, \beta_{j_\ell}(X) \rangle = \delta_{k\ell}$$

(here  $\delta_{k\ell}$  denotes the Kronecker delta).

Define the simplicial complex  $\mathcal{K}(X)$  on  $[m]$  whose simplices correspond to nonempty intersections of characteristic submanifolds:

$$\mathcal{K}(X) = \{I = \{i_1, \dots, i_k\} \in [m]: X_{i_1} \cap \cdots \cap X_{i_k} \neq \emptyset\}.$$

When  $X$  is a toric manifold, we have  $\mathbf{b}_j(X) = \mathbf{a}_j(X)$  and  $\mathbf{c}_j(X) = \mathbf{0}$  in (7.33), and the primitive vector  $\mathbf{a}_j(X)$  corresponds to the 1-parameter algebraic subgroup of  $(\mathbb{C}^\times)^n$  fixing the divisor  $X_j$ . Furthermore, the data  $\{\mathcal{K}(X); \mathbf{a}_1(X), \dots, \mathbf{a}_m(X)\}$  define a complete simplicial regular fan (see Section 6.5). Now let us see what kind of combinatorial structure replaces a fan in the case of topological toric manifolds.

Given  $I \in \mathcal{K}(X)$ , let  $\sigma_I = \mathbb{R}_{\geq} \langle \mathbf{b}_i : i \in I \rangle$  denote the cone spanned by the vectors  $\mathbf{b}_i \in \mathbb{R}^n$  with  $i \in I$ . By Lemma 7.5.4,  $\sigma_I$  is a simplicial cone of dimension  $|I|$ .

LEMMA 7.5.5 ([170, Lemma 3.7]).  $\bigcup_{I \in \mathcal{K}(X)} \sigma_I = \mathbb{R}^n$  and  $\sigma_I \cap \sigma_J = \sigma_{I \cap J}$ . *In other words, the data  $\{\mathcal{K}(X); \mathbf{b}_1(X), \dots, \mathbf{b}_m(X)\}$  define a complete simplicial fan.*

DEFINITION 7.5.6. Let  $\mathcal{K}$  be a simplicial complex on  $[m]$ , and let

$$\beta_j = (\mathbf{b}_j + i\mathbf{c}_j, \mathbf{a}_j) \in \mathbb{C}^n \times \mathbb{Z}^n, \quad j = 1, \dots, m$$

be a collection of  $m$  elements of  $\mathbb{C}^n \times \mathbb{Z}^n$ . The data  $\{\mathcal{K}; \beta_1, \dots, \beta_m\}$  is said to define a (regular) *topological fan*  $\Delta$  if the following two conditions are satisfied:

- (a) the data  $\{\mathcal{K}; \mathbf{b}_1, \dots, \mathbf{b}_m\}$  define a simplicial fan in  $\mathbb{R}^n$ ;
- (b) for each  $I \in \mathcal{K}$ , the set  $\{\mathbf{a}_i : i \in I\}$  is a part of basis of  $\mathbb{Z}^n$ .

A topological fan  $\Delta$  is said to be *complete* if the ordinary fan from (a) is complete.

Note that the fan of (a) is not required to be rational or regular, but if  $\mathbf{a}_j = \mathbf{b}_j$  for all  $j$ , then  $\Delta$  becomes a regular ordinary fan.

THEOREM 7.5.7 ([170, Theorem 8.1]). *There is a bijective correspondence between omnioriented topological toric manifolds of dimension  $2n$  and complete topological fans of dimension  $n$ .*

SKETCH OF PROOF. Let  $X$  be a topological toric manifold. By Lemma 7.5.5, the data  $(\mathcal{K}(X); \beta_1(X), \dots, \beta_m(X))$  define a complete topological fan  $\Delta(X)$ .

Now let  $\Delta$  be a complete topological fan, defined by data  $(\mathcal{K}; \beta_1, \dots, \beta_m)$ . For each maximal simplex  $I = \{i_1, \dots, i_n\} \in \mathcal{K}$ , let  $\{\alpha_1^I, \dots, \alpha_n^I\}$  be the dual set of  $\{\beta_{i_1}, \dots, \beta_{i_n}\}$  (compare Lemma 7.5.4). Condition (b) of Definition 7.5.6 guarantees that the complex  $n$ -dimensional representation  $\bigoplus_{k=1}^n \chi^{\alpha_k^I}$  of  $(\mathbb{C}^\times)^n$  is faithful. These representation spaces corresponding to all maximal  $I \in \mathcal{K}$  patch together into a topological space  $X(\Delta)$  locally homeomorphic to  $\mathbb{C}^n$ , and  $(\mathbb{C}^\times)^n$  acts on  $X$  smoothly with an open dense orbit. As in the case of ordinary fans, condition (b) of Definition 7.5.6 guarantees that the space  $X(\Delta)$  is Hausdorff, so it is a smooth manifold. (However, the algebraic criterion for separatedness used in the proof of

Lemma 5.1.4 cannot be used here; a topological argument is needed.) Finally the condition that  $\Delta$  is complete gives that  $X(\Delta)$  is compact, i.e. closed.

An alternative way to proceed is to use an analogue of the quotient construction of toric varieties, described in Section 5.4. To do this, define the coordinate subspace arrangement complement  $U(\mathcal{K})$  by (5.5), and define the homomorphism

$$\lambda: (\mathbb{C}^\times)^m \rightarrow (\mathbb{C}^\times)^n, \quad \lambda(z_1, \dots, z_m) = \prod_{k=1}^m \lambda_{\beta_k}(z_k).$$

Then  $\lambda$  is surjective and its kernel is given by

$$\text{Ker } \lambda = \{(z_1, \dots, z_m) \in (\mathbb{C}^\times)^m : \prod_{i=1}^m z_i^{\langle \alpha, \beta_i \rangle} = 1 \text{ for any } \alpha \in \mathcal{R}^n\},$$

by analogy with (5.3). Then define

$$X(\Delta) = U(\mathcal{K}) / \text{Ker } \lambda = \bigcup_{I \in \mathcal{K}} (\mathbb{C}, \mathbb{C}^\times)^I / \text{Ker } \lambda.$$

The space  $X(\Delta)$  has a smooth action of  $(\mathbb{C}^\times)^m / \text{Ker } \lambda \cong (\mathbb{C}^\times)^n$  with an open dense orbit. Furthermore, for each maximal  $I \in \mathcal{K}$  there is an equivariant diffeomorphism

$$\varphi_I: (\mathbb{C}, \mathbb{C}^\times)^I / \text{Ker } \lambda \rightarrow \bigoplus_{k=1}^n \chi^{\alpha_k^I},$$

where the latter is the faithful smooth  $(\mathbb{C}^\times)^n$ -representation space defined above. Condition (b) of Definition 7.5.6 translates into the condition of  $X(\Delta)$  being Hausdorff. The fact that only the ‘real part’  $(\mathcal{K}; \mathbf{b}_1, \dots, \mathbf{b}_m)$  of the topological fan data matters when deciding whether the quotient is Hausdorff should be clear from the similar argument in the proof of Theorem 6.5.2 (b). Finally,  $X(\Delta)$  is compact because  $\Delta$  is complete. Thus,  $X(\Delta)$  with the local charts  $\{(\mathbb{C}, \mathbb{C}^\times)^I / \text{Ker } \lambda, \varphi_I\}$  is a topological toric manifold.  $\square$

For the classification of topological toric manifolds up to equivariant diffeomorphism or homeomorphism, see [170, Corollary 8.2]

One can restrict the  $(\mathbb{C}^\times)^n$ -action on  $X$  to the compact  $n$ -torus  $\mathbb{T}^n$ . The resulting  $\mathbb{T}^n$ -manifold  $X$  is obviously a locally standard torus manifold, so the quotient  $X/\mathbb{T}^n$  is a manifold with corners.

LEMMA 7.5.8 ([170, Lemma 7.1]). *All faces of  $X/\mathbb{T}^n$  are contractible and the face poset of  $X/\mathbb{T}^n$  coincides with the inverse poset of  $\mathcal{K}(X)$ .*

It follows that  $X/\mathbb{T}^n$  is a homology polytope. As a corollary of Theorem 7.4.35 and Theorem 7.4.41, we obtain the following description of the cohomology of  $X$ , similar to toric or quasitoric manifolds:

PROPOSITION 7.5.9. *Let  $X$  be a topological toric manifold, whose associated topological fan is defined by the data  $(\mathcal{K}(X); \beta_1(X), \dots, \beta_m(X))$ . Then the cohomology ring of  $X$  is given by*

$$H^*(X) \cong \mathbb{Z}[v_1, \dots, v_m] / \mathcal{I},$$

where  $v_i \in H^2(X)$  is the class dual to the characteristic submanifold  $X_i$ , and  $\mathcal{I}$  is the ideal generated by elements of the following two types:

- (a)  $v_{i_1} \cdots v_{i_k}$  with  $\{i_1, \dots, i_k\} \notin \mathcal{K}(X)$ ;

$$(b) \sum_{i=1}^m \langle \mathbf{u}, \mathbf{a}_i(X) \rangle v_i, \text{ for any } \mathbf{u} \in \mathbb{Z}^n.$$

The element  $\mathbf{a}_i(X) \in \mathbb{Z}^n$  here is the second coordinate of  $\beta_i(X)$ , see (7.33).

### 7.6. Relationship between different classes of $T$ -manifolds

The relationship is described schematically in Fig. 7.5. Each class shown in an oval is contained as a proper subclass in the next larger oval, except for one case (topological toric manifolds and quasitoric manifolds), where the relation is slightly more subtle. Different examples are discussed below.

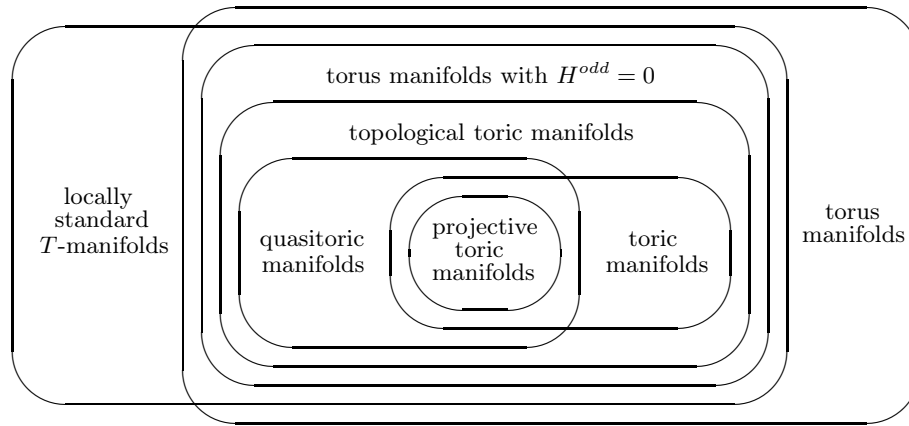

FIGURE 7.5. Classes of  $T$ -manifolds.

Projective toric manifolds are also Hamiltonian toric manifolds (see Sections 5.5 and 6.3). However, when viewed as symplectic manifolds, projective toric manifolds form a smaller class: their symplectic forms represent integral cohomology classes and their moment polytopes are lattice Delzant, while arbitrary Delzant polytope can be realised as the moment polytope of a Hamiltonian toric manifold.

A toric manifold (nonsingular compact toric variety) which is not projective is described in Example 5.2.3.

A projective toric manifold is quasitoric by Proposition 7.3.2.

Many examples of quasitoric manifolds which are not toric can be constructed using the equivariant connected sum operation (Construction 9.1.10). The simplest example is  $\mathbb{C}P^2 \# \mathbb{C}P^2$ . It can be easily seen to be a quasitoric manifold over a 4-gon, but it does not admit an almost complex structure, and therefore cannot be a complex algebraic variety. A non-toric example with an invariant almost complex structure is given in Exercise 7.3.34.

Examples of toric manifolds which is not quasitoric are constructed by Suyama [299]. The basic example is of real dimension 4; its corresponding regular simplicial fan is obtained by subdividing a singular fan whose underlying simplicial complex is the Barnette sphere. More examples in arbitrary dimension can be constructed by subsequent subdivision and suspension.

Any quasitoric manifold  $M$  is  $T$ -equivariantly homeomorphic to a  $T$ -manifold obtained by restricting the  $(\mathbb{C}^\times)^n$ -action on a topological toric manifold to the compact torus  $\mathbb{T}^n \subset (\mathbb{C}^\times)^n$  (see [170, Theorem 10.2]). The easiest way to see this is to

use the classification results (Proposition 7.3.11 and Theorem 7.5.7), and construct a topological fan from the combinatorial quasitoric pair  $(P, \Lambda)$  corresponding to  $M$ . To do this, consider any convex realisation (6.1) of the polytope  $P$ , and define

$$\beta_j = (\mathbf{a}_j + i\mathbf{c}_j, \lambda_j) \in \mathbb{C}^n \times \mathbb{Z}^n, \quad j = 1, \dots, m,$$

where  $\mathbf{a}_j$  are the normal vectors to the facets of  $P$ , and  $\lambda_j$  are the columns of the characteristic matrix  $\Lambda$ . The vectors  $\mathbf{c}_j \in \mathbb{R}^n$  can be chosen arbitrarily. Then the data  $(\mathcal{K}_P; \beta_1, \dots, \beta_m)$  define a topological fan  $\Delta$ . Indeed, condition (a) from Definition 7.5.6 is satisfied because  $(\mathcal{K}_P; \mathbf{a}_1, \dots, \mathbf{a}_m)$  define the normal fan  $\Sigma_P$ , and condition (b) is equivalent to (7.4). Then the topological toric manifold  $X(\Delta)$  is  $T$ -homeomorphic to  $M$  and the restriction of the  $(\mathbb{C}^\times)^n$ -action to the compact torus  $T$  gives the  $T$ -action on  $M$  (this follows by comparing the construction of  $X(\Delta)$  with Proposition 7.3.12).

REMARK. One would expect that the  $T$ -action on a quasitoric manifold  $M$  can be extended to a  $(\mathbb{C}^\times)^n$ -action which gives  $M$  a structure of a topologically toric manifold. This stronger statement would hold if one can replace an equivariant homeomorphism by an equivariant diffeomorphism in Proposition 7.3.6.

In [170, §9] there is constructed a topological toric manifold  $X$  whose associated simplicial complex  $\mathcal{K}(X)$  is the Barnette sphere (see Construction 2.5.5). Since the Barnette sphere is not polytopal, this  $X$  is not a quasitoric manifold.

A toric manifold is topologically toric by definition. An example of a topological toric manifold which is not toric can be constructed from the quasitoric manifold  $\mathbb{C}P^2 \# \mathbb{C}P^2$  as described above. An explicit topological toric atlas on  $\mathbb{C}P^2 \# \mathbb{C}P^2$  and the corresponding topological fan are described in [170, §5, Example].

Any topological toric manifold is a torus manifold with  $H^{odd} = 0$  by Proposition 7.5.9. An even-dimensional sphere is a torus manifold with  $H^{odd} = 0$  (Example 7.4.11), but it is not a topological toric manifold.

An example of a torus manifold with  $H^{odd} \neq 0$  can be constructed as follows. Take any torus manifold  $M$  whose quotient  $Q$  is face-acyclic. Let  $R$  be any closed manifold which is not a homology sphere. Consider the connected sum  $\widehat{Q} = Q \# R$  taken near an interior point of  $Q$ . Then  $\widehat{Q}$  is a manifold with corners with  $\partial\widehat{Q} = \partial Q$ . In particular, all proper faces of  $\widehat{Q}$  are acyclic, but  $\widehat{Q}$  itself is not (we have  $H^*(\widehat{Q}) \cong H^*(R \setminus pt)$ ). Consider the manifold  $\widehat{M} = M(\widehat{Q}, \lambda)$  constructed using the characteristic map of  $M$ , see (7.21). The singular  $T$ -orbits of  $\widehat{M}$  are the same as those of  $M$ , but the free orbits are different. Now the quotient of  $\widehat{M}$  is  $\widehat{Q}$ , which is not face-acyclic. Hence  $H^{odd}(\widehat{M}) \neq 0$  by Theorem 7.4.46 (this can be also easily seen directly). The simplest example is obtained when  $M = \mathbb{C}P^2$  and  $R$  is a 2-torus.

Any torus manifold with  $H^{odd} = 0$  is locally standard by Theorem 7.4.14.

An example of a torus manifold which is not locally standard is given in [170, §11]. A free action of  $T^n$  on the first factor of a product manifold  $T^n \times N^n$  gives an example of a locally standard  $T$ -manifold which is not a torus manifold.

We conclude this section by mentioning that there are *real* analogues of all classes of  $T$ -manifolds considered here, in which the torus  $\mathbb{T}^n$  is replaced by the ‘real torus’  $(\mathbb{Z}_2)^n$  and the algebraic torus  $(\mathbb{C}^\times)^n$  is replaced by  $(\mathbb{R}^\times)^n$ , where  $\mathbb{R}^\times \cong \mathbb{R}_{>} \times \mathbb{Z}_2$  is the multiplicative group of real numbers. The ‘real’ versions of the results of this chapter are often simpler; the reader may recover the details of the proofs himself. *Real toric varieties* feature in *tropical geometry* [173]. Real quasitoric

manifolds are known as *small covers* of simple polytopes; they were introduced by Davis and Januszkiewicz in [90] along with quasitoric manifolds.

### 7.7. Bounded flag manifolds

Bounded flag manifolds  $BF_n$  introduced by Buchstaber and Ray in [61] and subsequently studied in [60] and [62]. Each  $BF_n$  is a projective toric manifold whose moment polytope is combinatorially equivalent to an  $n$ -cube, so that  $BF_n$  is also a quasitoric manifold over a cube. Bounded flag manifolds are the examples of iterated projective bundles, or *Bott towers*, which are studied in the next section. The manifolds  $BF_n$  find numerous application in cobordism theory; they are implicitly present in the work of Conner–Floyd [81] and in the construction of *Ray’s basis* [275] in complex bordism of  $\mathbb{C}P^\infty$  (see details in Section 9.2), as well as used in the construction of toric representatives in complex bordism classes, described in Section 9.1. Bounded flag manifolds also illustrate nicely many constructions and results related to toric and quasitoric manifolds.

CONSTRUCTION 7.7.1 (Bounded flag manifold). A *bounded flag* in  $\mathbb{C}^{n+1}$  is a complete flag

$$\mathcal{U} = \{U_1 \subset U_2 \subset \cdots \subset U_{n+1} = \mathbb{C}^{n+1}, \quad \dim U_i = i\}$$

for which  $U_k$ ,  $2 \leq k \leq n$ , contains the coordinate subspace  $\mathbb{C}^{k-1} = \langle \mathbf{e}_1, \dots, \mathbf{e}_{k-1} \rangle$  spanned by the first  $k-1$  standard basis vectors. Denote by  $BF_n$  the set of all bounded flags in  $\mathbb{C}^{n+1}$ .

Every bounded flag  $\mathcal{U}$  in  $\mathbb{C}^{n+1}$  is uniquely determined by the set of  $n$  lines

$$(7.34) \quad \mathcal{L} = \{l_1, \dots, l_n : l_k \subset \mathbb{C}_k \oplus l_{k+1} \text{ for } 1 \leq k \leq n, \quad l_{n+1} = \mathbb{C}_{n+1}\},$$

where  $\mathbb{C}_k = \langle \mathbf{e}_k \rangle$  is the  $k$ th coordinate line in  $\mathbb{C}^{n+1}$ . Indeed, given a set of lines  $\mathcal{L}$  as above, we can construct a bounded flag  $\mathcal{U}$  by setting  $U_k = \mathbb{C}^{k-1} \oplus l_k$  for  $1 \leq k \leq n+1$ . Conversely, the conditions  $l_k \subset \mathbb{C}_k \oplus l_{k+1}$  and  $U_k = \mathbb{C}^{k-1} \oplus l_k$  allows us to reconstruct the set of lines  $\mathcal{L}$  from a flag  $\mathcal{U}$  in the reverse order  $l_{n+1}, l_n, \dots, l_1$ .

THEOREM 7.7.2. *The action of the algebraic torus  $(\mathbb{C}^\times)^n$  on  $\mathbb{C}^{n+1}$  given by*

$$(t_1, \dots, t_n) \cdot (w_1, \dots, w_n, w_{n+1}) = (t_1 w_1, \dots, t_n w_n, w_{n+1}),$$

where  $(t_1, \dots, t_n) \in (\mathbb{C}^\times)^n$  and  $(w_1, \dots, w_n, w_{n+1}) \in \mathbb{C}^{n+1}$ , induces an action on bounded flags, and therefore makes  $BF_n$  into a smooth toric variety.

PROOF. We first construct a covering of  $BF_n$  by smooth affine charts with regular change of coordinates functions, thereby giving  $BF_n$  a structure of a smooth affine variety. We parametrise bounded flags by sets of lines (7.34). Let  $\mathbf{v}_k$  be a nonzero vector in  $l_k$ , for  $1 \leq k \leq n$ , and set  $\mathbf{v}_{n+1} = \mathbf{e}_{n+1}$  for the last line. Consider two collections of  $n$  opens subsets in  $BF_n$ :

$$V_k^0 = \{\mathcal{U} \in BF_n : l_k \neq \mathbb{C}_k\}, \quad V_k^1 = \{\mathcal{U} \in BF_n : \langle \mathbf{v}_k, \mathbf{e}_k \rangle \neq 0\}, \quad 1 \leq k \leq n.$$

Now define  $2^n$  open subsets

$$V^{\varepsilon_1, \dots, \varepsilon_n} = V_1^{\varepsilon_1} \cap \cdots \cap V_n^{\varepsilon_n}, \quad \text{where } \varepsilon_k = 0, 1,$$

Then  $\{V^{\varepsilon_1, \dots, \varepsilon_n}\}$  is a covering of  $BF_n$ , because  $V_k^0 \cup V_k^1 = BF_n$  for any  $k$ . The condition  $l_k \subset \mathbb{C}_k \oplus l_{k+1}$  implies

$$(7.35) \quad \mathbf{v}_k = z_k \mathbf{e}_k + z_{k+n} \mathbf{v}_{k+1}, \quad 1 \leq k \leq n,$$



for some  $z_i \in \mathbb{C}$ ,  $1 \leq i \leq 2n$ . We have  $z_k \neq 0$  if  $\mathcal{U} \in V_k^1$ , and  $z_{k+n} \neq 0$  if  $\mathcal{U} \in V_k^0$ . Let  $\mathcal{U} \in V^{\varepsilon_1, \dots, \varepsilon_n}$ ; then we can choose the vectors (7.35) in the form  $\mathbf{v}_k = x_k^0 \mathbf{e}_k + \mathbf{v}_{k+1}$  if  $\varepsilon_k = 0$ , and  $\mathbf{v}_k = \mathbf{e}_k + x_k^1 \mathbf{v}_{k+1}$  if  $\varepsilon_k = 1$ , for  $1 \leq k \leq n$ . Then we can identify  $V^{\varepsilon_1, \dots, \varepsilon_n}$  with  $\mathbb{C}^n$  using the affine coordinates  $(x_1^{\varepsilon_1}, \dots, x_n^{\varepsilon_n})$ . The change of coordinate functions are regular on intersections of charts by inspection, so that  $BF_n$  is a smooth algebraic variety, with affine atlas  $\{V^{\varepsilon_1, \dots, \varepsilon_n}\}$ .

Furthermore, the change of coordinate functions are Laurent monomials, which implies that  $BF_n$  is a toric variety. This can also be seen directly, as the torus action defined in the theorem is standard in the affine chart  $V^{0, \dots, 0}$ , that is,

$$(t_1, \dots, t_n) \cdot (x_1^0, \dots, x_n^0) = (t_1 x_1^0, \dots, t_n x_n^0). \quad \square$$

PROPOSITION 7.7.3. *The complete fan  $\Sigma$  corresponding to the toric variety  $BF_n$  has  $2n$  one-dimensional cones generated by the vectors*

$$\mathbf{a}_k^0 = \mathbf{e}_k, \quad \mathbf{a}_k^1 = -\mathbf{e}_1 - \dots - \mathbf{e}_k, \quad 1 \leq k \leq n,$$

and  $2^n$  maximal cones generated by the sets of vectors  $\mathbf{a}_1^{\varepsilon_1}, \dots, \mathbf{a}_n^{\varepsilon_n}$ , where  $\varepsilon_k = 0, 1$ .

PROOF. Each affine chart  $V^{\varepsilon_1, \dots, \varepsilon_n} \subset BF_n$  constructed in the proof of Theorem 7.7.2 corresponds to an  $n$ -dimensional cone  $\sigma^{\varepsilon_1, \dots, \varepsilon_n}$  of the fan  $\Sigma$ , so there are  $2^n$  maximal cones in total. One-dimensional cones of  $\Sigma$  correspond to  $(\mathbb{C}^\times)^n$ -invariant submanifolds of complex codimension 1 in  $BF_n$ . Each of these submanifolds is defined by vanishing of one of the affine coordinates, i.e. by an equation  $x_k^{\varepsilon_k} = 0$ , so there are  $2n$  such submanifolds.

In order to find the generators of the cone  $\sigma^{\varepsilon_1, \dots, \varepsilon_n}$ , we note that the primitive generators of the dual cone  $(\sigma^{\varepsilon_1, \dots, \varepsilon_n})^\vee$  are the weights of the  $(\mathbb{C}^\times)^n$ -representation in the affine space  $\mathbb{C}^n$  corresponding to the chart  $V^{\varepsilon_1, \dots, \varepsilon_n}$ . The  $(\mathbb{C}^\times)^n$ -representation in the chart  $V^{0, \dots, 0}$  is standard, so we have  $\mathbf{a}_k^0 = \mathbf{e}_k$  for  $1 \leq k \leq n$ . In order to find the remaining vectors it is enough to calculate the weights of the torus representation in the chart  $V^{1, \dots, 1}$ .

The coordinates  $(x_1^1, \dots, x_n^1)$  in the chart  $V^{1, \dots, 1}$  are defined from the relations  $\mathbf{v}_k = \mathbf{e}_k + x_k^1 \mathbf{v}_{k+1}$ ,  $1 \leq k \leq n$ , and  $\mathbf{v}_{n+1} = \mathbf{e}_{n+1}$ . An element  $(t_1, \dots, t_n) \in (\mathbb{C}^\times)^n$  acts on  $\mathbf{e}_k$  by multiplication by  $t_k$  for  $1 \leq k \leq n$  and acts on  $\mathbf{e}_{n+1}$  identically (see Theorem 7.7.2). Then it is easy to see that the torus representation is written in the coordinates  $(x_1^1, \dots, x_n^1)$  as follows:

$$(t_1, \dots, t_n) \cdot (x_1^1, \dots, x_n^1) = (t_1^{-1} t_2 x_1^1, \dots, t_{n-1}^{-1} t_n x_{n-1}^1, t_n^{-1} x_n^1).$$

In other words, the weights of this representation are the columns of the matrix

$$W = \begin{pmatrix} -1 & 0 & \dots & 0 & 0 \\ 1 & -1 & \dots & 0 & 0 \\ \vdots & \vdots & \ddots & \vdots & \vdots \\ 0 & 0 & \dots & -1 & 0 \\ 0 & 0 & \dots & 1 & -1 \end{pmatrix}.$$

The generators  $\mathbf{a}_1^1, \dots, \mathbf{a}_n^1$  of the cone  $\sigma^{1, \dots, 1}$  form the dual basis, i.e. they are columns of the matrix  $(W^{-1})^t$ . These are the vectors listed in the lemma.  $\square$

PROPOSITION 7.7.4. *The bounded flag manifold  $BF_n$  is the projective toric variety corresponding to the polytope*

$$P = \{ \mathbf{x} \in \mathbb{R}^n : x_k \geq 0, \quad x_1 + \dots + x_k \leq k, \quad \text{for } 1 \leq k \leq n \}.$$

PROOF. We need to check that the normal fan of this  $P$  is the fan from Proposition 7.7.3. Indeed, the  $2n$  inequalities specifying  $P$  can be written as  $\langle \mathbf{a}_k^0, \mathbf{x} \rangle \geq 0$  and  $\langle \mathbf{a}_k^1, \mathbf{x} \rangle + k \geq 0$ , for  $1 \leq k \leq n$ . Set

$$(7.36) \quad F_k^0 = \{\mathbf{x} \in P: \langle \mathbf{a}_k^0, \mathbf{x} \rangle = 0\} \quad \text{and} \quad F_k^1 = \{\mathbf{x} \in P: \langle \mathbf{a}_k^1, \mathbf{x} \rangle + k = 0\}.$$

Then we need to check that

- (a) each  $F_k^\varepsilon$  ( $\varepsilon = 0, 1$ ) is a facet of  $P$ ;
- (b)  $F_k^0 \cap F_k^1 = \emptyset$ , for  $1 \leq k \leq n$ ;
- (c) the intersection of any  $n$ -tuple  $F_1^{\varepsilon_1}, \dots, F_n^{\varepsilon_n}$  is a vertex of  $P$ .

This is left as an exercise. □

PROPOSITION 7.7.5 ([62]). *The bounded flag manifold  $BF_n$  is a quasitoric manifold over a combinatorial  $n$ -cube  $I^n$ , with characteristic matrix*

$$(7.37) \quad A = \left( \begin{array}{cccc|cccc} 1 & 0 & \dots & 0 & -1 & -1 & \dots & -1 \\ 0 & 1 & \dots & 0 & 0 & -1 & \dots & -1 \\ \vdots & \vdots & \ddots & \vdots & \vdots & \vdots & \ddots & \vdots \\ 0 & 0 & \dots & 1 & 0 & 0 & \dots & -1 \end{array} \right).$$

PROOF. Indeed, the polytope from Proposition 7.7.4 is combinatorially equivalent to a cube. □

EXAMPLE 7.7.6. The manifold  $BF_2$  is isomorphic to the Hirzebruch surface  $F_1$  (or  $F_{-1}$ ) from Example 5.1.8.

We can also describe  $BF_n$  as a toric manifold using the quotient construction (Section 5.4) or symplectic reduction (Section 5.5), as follows. The moment-angle manifold corresponding to a cube  $I^n$  is a product of  $n$  three-dimensional spheres:

$$\mathcal{Z}_{I^n} = \{(z_1, \dots, z_{2n}) \in \mathbb{C}^{2n} : |z_k|^2 + |z_{k+n}|^2 = 1, 1 \leq k \leq n\}.$$

The manifold  $BF_n$  is obtained by taking quotient of  $\mathcal{Z}_{I^n}$  by the kernel  $K$  of the map  $\mathbb{T}^{2n} \rightarrow \mathbb{T}^n$  given by matrix (7.37). We have  $K \cong \mathbb{T}^n$ , and the inclusion  $K(A) \subset \mathbb{T}^{2n}$  is given by

$$(t_1, \dots, t_n) \mapsto (t_1 t_2 \cdots t_{n-1} t_n, t_2 \cdots t_{n-1} t_n, \dots, t_{n-1} t_n, t_n, t_1, t_2, \dots, t_n).$$

Geometrically, the projection  $\mathcal{Z}_{I^n} \rightarrow BF_n$  maps  $\mathbf{z} = (z_1, \dots, z_{2n})$  to the bounded flag defined by the set of lines  $l_1, \dots, l_{n+1}$ , where  $l_k = \langle \mathbf{v}_k \rangle$  and  $\mathbf{v}_k$  is given by (7.35) (an exercise).

The algebraic quotient description of  $BF_n$  is very much similar. Instead of the moment-angle manifold  $\mathcal{Z}_{I^n} \cong (S^3)^n$  we have the space  $U(\Sigma) = (\mathbb{C}^2 \setminus \{\mathbf{0}\})^n$ . The manifold  $BF_n$  is obtained by taking quotient of  $U(\Sigma)$  by the kernel  $G$  of the map of algebraic tori  $(\mathbb{C}^\times)^{2n} \rightarrow (\mathbb{C}^\times)^n$  given by matrix (7.37).

Now we describe the characteristic submanifolds and their corresponding line bundles (7.7). Let  $\pi: BF_n \rightarrow P$  be the quotient projection for the torus action, and let  $\rho_k^\varepsilon$  denote the line bundle corresponding to the characteristic submanifold (or  $(\mathbb{C}^\times)^n$ -invariant divisor)  $\pi^{-1}(F_k^\varepsilon)$ , for  $1 \leq k \leq n$ ,  $\varepsilon = 0, 1$ , see (7.36).

PROPOSITION 7.7.7 ([62]).

- (a) *The characteristic submanifold  $\pi^{-1}(F_k^0)$  is isomorphic to  $BF_{n-1}$ , and  $\pi^{-1}(F_k^1)$  is isomorphic to  $BF_{k-1} \times BF_{n-k}$ , for  $1 \leq k \leq n$ .*

- (b) The line bundle  $\rho_k^0$  is isomorphic to the bundle whose fibre over  $\mathcal{U} \in BF_n$  is the line  $l_k = U_k/\mathbb{C}^{k-1}$ . The line bundle  $\rho_k^1$  is isomorphic to the bundle whose fibre over  $\mathcal{U} \in BF_n$  is the quotient  $(\mathbb{C}_k \oplus l_{k+1})/l_k = U_{k+1}/U_k$ .

PROOF. The submanifold  $\pi^{-1}(F_k^0) \subset BF_n$  is obtained by projecting the submanifold of  $\mathcal{Z}_{I^n}$  given by the equation  $z_k = 0$  onto  $BF_n$ . If  $z_k = 0$ , then the vectors  $\mathbf{v}_1, \dots, \mathbf{v}_n$  defined by (7.35) all belong to the subspace  $\mathbb{C}^{\{1, \dots, n+1\} \setminus k}$ . It follows that  $\pi^{-1}(F_k^0)$  can be identified with the set of bounded flags in  $\mathbb{C}^{\{1, \dots, n+1\} \setminus k}$ , that is, with  $BF_{n-1}$ .

Similarly, the submanifold  $\pi^{-1}(F_k^1)$  is the projection of the submanifold of  $\mathcal{Z}_{I^n}$  given by the equation  $z_k = 1$ . Then (7.35) implies that the vectors  $\mathbf{v}_1, \dots, \mathbf{v}_k$  belong to the subspace  $\mathbb{C}^k \subset \mathbb{C}^{n+1}$ , and the vectors  $\mathbf{v}_{k+1}, \dots, \mathbf{v}_n$  belong to the subspace  $\mathbb{C}^{\{k+1, \dots, n+1\}}$ . Therefore,  $\pi^{-1}(F_k^1)$  can be identified with  $BF_{k-1} \times BF_{n-k}$ .

Statement (b) also follows from (7.35), because the line bundle  $\rho_k^0$  is isomorphic to  $\mathcal{Z}_{I^n} \times_K \mathbb{C}_k$ , and  $\rho_k^1$  is isomorphic to  $\mathcal{Z}_{I^n} \times_K \mathbb{C}_{n+k}$ .  $\square$

PROPOSITION 7.7.8. *The manifold  $BF_n$  is the complex projectivisation of the complex plane bundle  $\underline{\mathbb{C}} \oplus \rho_1^0$  over  $BF_{n-1}$ .*

PROOF. Consider the projection  $BF_n \rightarrow BF_{n-1}$  taking a bounded flag  $\mathcal{U} = \{U_1 \subset U_2 \subset \dots \subset U_n \subset \mathbb{C}^{n+1}\}$  to the flag  $\mathcal{U}' = \mathcal{U}/\mathbb{C}_1$  in  $\mathbb{C}^{2, \dots, n+1} \cong \mathbb{C}^n$ . (More precisely,  $\mathcal{U}' = \{U'_1 \subset U'_2 \subset \dots \subset U'_{n-1}\}$ , where  $U'_k = U_{k+1}/\mathbb{C}_1$ ,  $1 \leq k \leq n-1$ .) The set of lines (7.34) corresponding to  $\mathcal{U}'$  is obtained from the set of lines corresponding to  $\mathcal{U}$  by forgetting the first line. In order to recover the flag  $\mathcal{U}$  from the flag  $\mathcal{U}'$ , one needs to choose a line  $l_1$  in the plane  $\mathbb{C}_1 \oplus l_2$ . Since  $l_2$  is the first line in the set corresponding to the flag  $\mathcal{U}' \in BF_{n-1}$ , we obtain  $BF_n \cong \mathbb{C}P(\underline{\mathbb{C}} \oplus \rho_1^0)$ , as needed.  $\square$

We therefore obtain a tower of fibrations  $BF_n \rightarrow BF_{n-1} \rightarrow \dots \rightarrow BF_1 = \mathbb{C}P^1$ , where each  $BF_k$  is the projectivisation of a complex 2-plane bundle over  $BF_{k-1}$ . In particular, the fibre of each bundle in the tower is  $\mathbb{C}P^1$ . Towers of fibrations arising in this way are called *Bott towers*; they are the subject of the next section.

### Exercises.

7.7.9. The fan described in Proposition 7.7.3 is the normal fan of the polytope from Proposition 7.7.4.

7.7.10. Given  $\mathbf{z} = (z_1, \dots, z_{2n})$ , define the vectors  $\mathbf{v}_{n+1} = \mathbf{e}_{n+1}, \mathbf{v}_n, \dots, \mathbf{v}_1$  by (7.35), and set  $l_k = \langle \mathbf{v}_k \rangle$ ,  $1 \leq k \leq n+1$ . Then the projection  $\mathcal{Z}_{I^n} \rightarrow BF_n$  maps  $\mathbf{z} \in \mathcal{Z}_{I^n}$  to the bounded flag in  $\mathbb{C}^{n+1}$  defined by the set of lines  $l_1, \dots, l_{n+1}$ .

## 7.8. Bott towers

In their study of symmetric spaces, Bott and Samelson [37] introduced a family of complex manifolds obtained as the total spaces of iterated bundles over  $\mathbb{C}P^1$  with fibre  $\mathbb{C}P^1$ . Grossberg and Karshon [137] showed that these manifolds carry an algebraic torus action, and therefore constitute an important family of smooth projective toric varieties, and called them Bott towers. Civan and Ray [78] developed significantly the study of Bott towers by enumerating the invariant stably complex structures and calculating their complex and real  $K$ -theory rings, and cobordism.

Each Bott tower is a projective toric manifold whose corresponding simple polytope is combinatorially equivalent to a cube (a *toric manifold over cube* for short). We have the following hierarchy of classes of  $T$ -manifolds:

Bott towers  $\subset$  toric manifolds over cubes  $\subset$  quasitoric manifolds over cubes

By the result of Dobrinskaya [96], the first inclusion above is in fact an identity (we explain this in Corollary 7.8.12).

Two results were obtained in [210] relating circle actions on Bott towers, their topological structure, and cohomology rings. First (Theorem 7.8.17), if a Bott tower admits a semifree  $\mathbb{S}^1$ -action with isolated fixed points, then it is  $\mathbb{S}^1$ -equivariantly diffeomorphic to a product of 2-spheres. Second (Theorem 7.8.23), a Bott tower whose cohomology ring is isomorphic to that of a product of spheres is actually diffeomorphic to this product. Both theorems can be extended to quasitoric manifolds over cubes, but only in the topological category (Theorems 7.8.19 and 7.8.25). These results have been further extended by several authors, and led to the study of the so-called *cohomological rigidity* property for different classes of manifolds with torus actions; we discuss this circle of problems in the end of this section.

**Definition and main properties.**

DEFINITION 7.8.1. A *Bott tower* of height  $n$  is a tower of fibre bundles

$$B_n \xrightarrow{p_n} B_{n-1} \xrightarrow{p_{n-1}} \dots \longrightarrow B_2 \xrightarrow{p_2} B_1 \longrightarrow pt,$$

of complex manifolds, where  $B_1 = \mathbb{C}P^1$  and  $B_k = \mathbb{C}P(\underline{\mathbb{C}} \oplus \xi_{k-1})$  for  $2 \leq k \leq n$ . Here  $\mathbb{C}P(\cdot)$  denotes complex projectivisation,  $\xi_{k-1}$  is a complex line bundle over  $B_{k-1}$  and  $\underline{\mathbb{C}}$  is a trivial line bundle. The fibre of the bundle  $p_k: B_k \rightarrow B_{k-1}$  is  $\mathbb{C}P^1$ .

A Bott tower  $B_n$  is said to be *topologically trivial* if each  $p_k: B_k \rightarrow B_{k-1}$  is trivial as a smooth fibre bundle; in particular, such  $B_n$  is diffeomorphic to a product of 2-dimensional spheres.

We shall refer to the last stage  $B_n$  in a Bott tower as a *Bott manifold* (although it is also often called by the same name ‘Bott tower’).

In order to describe the cohomology ring of a Bott manifold, we need the following general result:

THEOREM 7.8.2 (see [297, Chapter V]). *Let  $\xi$  be a complex  $n$ -dimensional vector bundle over a finite cell complex  $X$  with complex projectivisation  $\mathbb{C}P(\xi)$ , and let  $u \in H^2(\mathbb{C}P(\xi))$  be the first Chern class of the tautological line bundle over  $\mathbb{C}P(\xi)$ . The integral cohomology ring of  $\mathbb{C}P(\xi)$  is the quotient of the polynomial ring  $H^*(X)[u]$  on a generator  $u$  with coefficients in  $H^*(X)$  by the single relation*

$$u^n - c_1(\xi)u^{n-1} + \dots + (-1)^n c_n(\xi) = 0.$$

COROLLARY 7.8.3.  *$H^*(B_k)$  is a free module over  $H^*(B_{k-1})$  on generators 1 and  $u_k$ , where  $u_k$  is the first Chern class of the tautological line bundle over  $B_k = \mathbb{C}P(\underline{\mathbb{C}} \oplus \xi_{k-1})$ . The ring structure is determined by the single relation*

$$u_k^2 = c_1(\xi_{k-1})u_k.$$

For simplicity, we denote the element  $p_k^*(u_{k-1}) \in H^2(B_k)$  by  $u_{k-1}$ ; similarly, we denote by  $u_i$  each of the elements in  $H^*(B_k)$ ,  $k \geq i$ , which map to each other

by the homomorphisms  $p_k^*$ . Each line bundle  $\xi_{k-1}$  is determined by its first Chern class, which can be written as a linear combination

$$c_1(\xi_{k-1}) = a_{1k}u_1 + a_{2k}u_2 + \cdots + a_{k-1,k}u_{k-1} \in H^2(B_{k-1}).$$

It follows that a Bott tower of height  $n$  is uniquely determined by the list of integers  $\{a_{ij} : 1 \leq i < j \leq n\}$ , where

$$(7.38) \quad u_k^2 = \sum_{i=1}^{k-1} a_{ik}u_iu_k, \quad 1 \leq k \leq n.$$

The cohomology ring of  $B_n$  is the quotient of  $\mathbb{Z}[u_1, \dots, u_n]$  by relations (7.38).

It is convenient to organise the integers  $a_{ij}$  into an upper triangular matrix,

$$(7.39) \quad A = \begin{pmatrix} -1 & a_{12} & \cdots & a_{1n} \\ 0 & -1 & \cdots & a_{2n} \\ \vdots & \vdots & \ddots & \vdots \\ 0 & 0 & \cdots & -1 \end{pmatrix}.$$

EXAMPLE 7.8.4. Let  $n = 2$ . Then a Bott tower  $B_2 \rightarrow B_1$  is determined by a line bundle  $\xi_1$  over  $B_1 = \mathbb{C}P^1$ , i.e.  $B_2$  is a Hirzebruch surface (see Example 5.1.8). We have  $\xi_1 = \eta^k$  for some  $k \in \mathbb{Z}$  where  $\eta^k$  denotes the  $k$ th tensor power of the tautological line bundle over  $\mathbb{C}P^1$ . The cohomology ring is given by

$$H^*(B_2) = \mathbb{Z}[u_1, u_2]/(u_1^2, u_2^2 - ku_1u_2).$$

We have

$$\mathbb{C}P(\underline{\mathbb{C}} \oplus \eta^k) \cong \mathbb{C}P(\underline{\mathbb{C}} \oplus \eta^{k'}) \iff k = k' \pmod{2},$$

where  $\cong$  denotes a diffeomorphism. This is proved by the following observation. First, note that  $\mathbb{C}P(\xi) \cong \mathbb{C}P(\xi \otimes \eta)$  for any complex vector bundle  $\xi$  and line bundle  $\eta$ . Let  $k' - k = 2\ell$  for some  $\ell \in \mathbb{Z}$ , then

$$\mathbb{C}P(\underline{\mathbb{C}} \oplus \eta^k) \cong \mathbb{C}P((\underline{\mathbb{C}} \oplus \eta^k) \otimes \eta^\ell) = \mathbb{C}P(\eta^\ell \oplus \eta^{k+\ell}) \cong \mathbb{C}P(\underline{\mathbb{C}} \oplus \eta^{k'}),$$

where the last diffeomorphism is induced by the vector bundle isomorphism  $\eta^\ell \oplus \eta^{k+\ell} \cong \underline{\mathbb{C}} \oplus \eta^{k'}$ , as both are plane bundles over  $\mathbb{C}P^1$  with equal Chern classes.

On the other hand, a cohomology ring isomorphism  $H^*(\mathbb{C}P(\underline{\mathbb{C}} \oplus \eta^k)) \cong H^*(\mathbb{C}P(\underline{\mathbb{C}} \oplus \eta^{k'}))$  implies that  $k = k' \pmod{2}$  (an exercise).

This example shows that the cohomology ring determines the diffeomorphism type of a Bott manifold  $B_n$  for  $n = 2$ . We may ask if this is true for arbitrary  $n$ ; the questions of this sort are discussed in the last subsection.

EXAMPLE 7.8.5. The bounded flag manifold  $BF_n$  is a Bott manifold. By Proposition 7.7.8,  $BF_n = \mathbb{C}P(\underline{\mathbb{C}} \oplus \rho_1^0)$ , where  $\rho_1^0$  is the line bundle over  $BF_{n-1}$  whose fiber over a bounded flag  $\mathcal{U}$  is its first space  $U_1$ . By Corollary 7.8.3, the ring structure of  $H^*(BF_n)$  is determined by the relation  $u_n^2 = c_1(\rho_1^0)u_n$ . As it is clear from the proof of Proposition 7.7.8,  $\rho_1^0$  is the tautological line bundle over  $BF_{n-1}$  (considered as a complex projectivisation), so  $c_1(\rho_1^0) = u_{n-1}$ . (Warning: the line bundle  $\rho_1^0$  over  $BF_n$  is *not* the pullback of the line bundle  $\rho_1^0$  over  $BF_{n-1}$  by the projection  $p_n : BF_n \rightarrow BF_{n-1}$ , because  $p_n^*(\rho_1^0) = \rho_2^0$ .)

We therefore obtain the identity  $u_n^2 = u_{n-1}u_n$  in  $H^*(BF_n)$ , and matrix (7.39) for the structure of the Bott tower on the bounded flag manifold has the form

$$A = \begin{pmatrix} -1 & 1 & 0 & \cdots & 0 \\ 0 & -1 & 1 & \cdots & 0 \\ \vdots & \vdots & \ddots & \ddots & \vdots \\ 0 & 0 & 0 & \cdots & 1 \\ 0 & 0 & 0 & \cdots & -1 \end{pmatrix}.$$

As a corollary of this example we obtain the following characterisation of bounded flag manifolds:

**PROPOSITION 7.8.6.** *The bounded flag manifold  $BF_n$  is the Bott manifold whose tower structure is defined as follows: in each  $B_k = \mathbb{C}P(\underline{\mathbb{C}} \oplus \xi_{k-1})$  the bundle  $\xi_{k-1}$  is the tautological line bundle over  $B_{k-1} = \mathbb{C}P(\underline{\mathbb{C}} \oplus \xi_{k-2})$ , for  $2 \leq k \leq n$ .*

**Bott towers as toric manifolds.**

**THEOREM 7.8.7.** *The Bott manifold  $B_n$  corresponding to a matrix  $A$  given by (7.39) is isomorphic to the toric manifold corresponding to the complete fan  $\Sigma$  with  $2n$  one-dimensional cones generated by the vectors*

$$\mathbf{a}_k^0 = \mathbf{e}_k, \quad \mathbf{a}_k^1 = -\mathbf{e}_k + a_{k,k+1}\mathbf{e}_{k+1} + \cdots + a_{kn}\mathbf{e}_n \quad (1 \leq k \leq n),$$

and  $2^n$  maximal cones generated by the sets of vectors  $\mathbf{a}_1^{\varepsilon_1}, \dots, \mathbf{a}_n^{\varepsilon_n}$ , where  $\varepsilon_k = 0, 1$ .

**PROOF.** Let  $X_n$  denote the toric manifold corresponding to the fan described in the theorem. We may assume by induction that  $X_{n-1} = B_{n-1}$  (the base of the induction is clear, as  $X_1 = B_1 = \mathbb{C}P^1$ ). By the construction of Section 5.4, the manifold  $X_n$  can be obtained as the quotient of

$$U_n = \{(z_1, \dots, z_{2n}) \in \mathbb{C}^{2n} : |z_k|^2 + |z_{k+n}|^2 \neq 0, 1 \leq k \leq n\} \cong (\mathbb{C}^2 \setminus \{\mathbf{0}\})^n$$

by the action of the group  $G_n \cong (\mathbb{C}^\times)^n$  given by (5.3) (we have  $m = 2n$  here). Explicitly, the inclusion  $G_n \rightarrow (\mathbb{C}^\times)^{2n}$  is given by

$$(t_1, \dots, t_n) \mapsto (t_1, t_1^{-a_{12}}t_2, \dots, t_1^{-a_{1n}}t_2^{-a_{2n}} \cdots t_{n-1}^{-a_{n-1,n}}t_n, t_1, t_2, \dots, t_n).$$

Observe that  $U_n = U_{n-1} \times (\mathbb{C}^2 \setminus \{\mathbf{0}\})$ ,  $G_n = G_{n-1} \times \mathbb{C}^\times$ , and the last factor  $\mathbb{C}^\times$  (corresponding to  $t_n$ ) acts trivially on  $U_{n-1}$ . Therefore, we have

$$\begin{aligned} X_n = U_n/G_n &= (U_{n-1} \times (\mathbb{C}^2 \setminus \{\mathbf{0}\})/\mathbb{C}^\times)/G_{n-1} \\ &= U_{n-1} \times_{G_{n-1}} \mathbb{C}P^1 = \mathbb{C}P(U_{n-1} \times_{G_{n-1}} (\mathbb{C} \oplus \mathbb{C})), \end{aligned}$$

where  $U_{n-1} \times_{G_{n-1}} (\mathbb{C} \oplus \mathbb{C})$  is a complex 2-plane bundle over  $U_{n-1}/G_{n-1} = X_{n-1}$  defined by the representation of the algebraic torus  $G_{n-1} \cong (\mathbb{C}^\times)^{n-1}$  in  $\mathbb{C} \oplus \mathbb{C}$  which is given by the character  $(t_1, \dots, t_{n-1}) \mapsto t_1^{-a_{1n}}t_2^{-a_{2n}} \cdots t_{n-1}^{-a_{n-1,n}}$  on the first summand and is trivial on the second summand.

By the inductive assumption,  $X_{n-1} = B_{n-1}$ . The bundle  $U_{n-1} \times_{G_{n-1}} (\mathbb{C} \oplus \mathbb{C})$  is  $\xi_{n-1} \oplus \underline{\mathbb{C}}$ , where  $\xi_{n-1}$  is the line bundle over  $B_{n-1}$  with first Chern class  $\sum_{i=1}^{n-1} a_{in}u_i$ . Thus,  $X_n = \mathbb{C}P(\xi_{n-1} \oplus \underline{\mathbb{C}}) = B_n$ , and the inductive step is complete.  $\square$

Note that the associated simplicial complex of the fan described in Theorem 7.8.7 is the boundary of a cross-polytope, so the toric manifold is also a quasitoric manifold over a cube. We therefore obtain:

**COROLLARY 7.8.8.** *A Bott tower of height  $n$  determined by matrix  $A$  has a natural action of the torus  $T^n$  making it into a quasitoric manifold over a cube with refined characteristic matrix  $\Lambda = (I \mid A^t)$ , see (7.6).*

**REMARK.** The bounded flag manifold  $BF_n$  has a toric structure described in Proposition 7.7.3, and another toric structure coming from its Bott tower structure via Theorem 7.8.7 (its matrix  $A$  is given in Example 7.8.5). The corresponding fans are not the same, but isomorphic (see Exercise 7.8.33).

**REMARK.** The relations in the face ring of an  $n$ -cube are  $v_i v_{i+n} = 0$ ,  $1 \leq i \leq n$ . These relations together with (7.17) give the relations (7.38) after substitution  $\Lambda = (I \mid A^t)$  and  $u_i = -v_{i+n}$ . In fact, one has  $u_i = c_1(\rho_{i+n})$ , where  $\rho_{i+n}$  is the line bundle (7.7) over the toric manifold  $B_n$  (an exercise). It follows that the description of the cohomology ring of a Bott manifold from Corollary 7.8.3 agrees with the description of the cohomology of a toric manifold from Theorem 7.3.27.

Given a permutation  $\sigma$  of  $n$  elements, denote by  $P(\sigma)$  the corresponding *permutation matrix*, the square matrix of size  $n$  with ones at the positions  $(i, \sigma(i))$  for  $1 \leq i \leq n$ , and zeros elsewhere. There is an action of the symmetric group  $S_n$  on square  $n$ -matrices by conjugations,  $A \mapsto P(\sigma)^{-1}AP(\sigma)$ , or, equivalently, by permutations of the rows and columns of  $A$ .

**PROPOSITION 7.8.9.** *A quasitoric manifold  $M$  over a cube with refined characteristic matrix  $\Lambda = (I \mid \Lambda_\star)$  is equivalent to a Bott manifold if and only if  $\Lambda_\star$  is conjugate by means of a permutation matrix to an upper triangular matrix.*

**PROOF.** Assume that  $\Lambda_\star$  is conjugate by means of a permutation matrix to an upper triangular matrix. Clearly, this condition is equivalent to the conjugacy of  $\Lambda_\star$  to a lower triangular matrix. Consider the action of  $S_n$  on the set of facets of the cube  $\mathbb{I}^n$  by permuting pairs of opposite facets. A rearrangement of facets corresponds to a rearrangement of columns in the characteristic  $n \times 2n$ -matrix  $\Lambda$ , so an element  $\sigma \in S_n$  acts as

$$A \mapsto A \cdot \begin{pmatrix} P(\sigma) & 0 \\ 0 & P(\sigma) \end{pmatrix}.$$

This action does not preserve the refined form of  $\Lambda$ , as  $(I \mid \Lambda_\star)$  becomes  $(P(\sigma) \mid \Lambda_\star P(\sigma))$ . The refined representative in the left coset (7.5) of the latter matrix is given by  $(I \mid P(\sigma)^{-1}\Lambda_\star P(\sigma))$ . (In other words, we must compensate for the permutation of pairs of facets by an automorphism of the torus  $\mathbb{T}^n$  permuting the coordinate subcircles to keep the characteristic matrix in the refined form.) This implies that the action by permutations on pairs of opposite facets induces an action by conjugations on refined submatrices  $\Lambda_\star$ . Hence we may assume, up to an equivalence, that the refined characteristic submatrix  $\Lambda_\star$  of  $M$  is lower triangular. The non-singularity condition (7.4) guarantees that the diagonal entries of  $\Lambda_\star$  are equal to  $\pm 1$ , and we can set all of them equal to  $-1$  by changing the omniorientation of  $M$  if necessary. Now,  $M$  has the same characteristic matrix as the Bott manifold corresponding to the matrix  $A = A_\star^t$  (see Corollary 7.8.8). Therefore,  $M$  and the Bott manifold are equivalent by Proposition 7.3.11.

The converse statement follows from Corollary 7.8.8. □

Our next goal is to characterise Bott manifolds within the class of quasitoric manifolds over cubes more explicitly. Given a subset  $\{i_1, \dots, i_k\} \subset [n]$ , the *principal*

*minor* of a square  $n$ -matrix  $A$  is the determinant of the submatrix formed by the elements in columns and rows with numbers  $i_1, \dots, i_k$ . In the case of Bott manifolds, according to Corollary 7.8.8, all principal minors of the matrix  $-\Lambda_*$  are equal to 1; for an arbitrary quasitoric manifold the non-singularity condition (7.4) only guarantees that all principal minors of  $\Lambda_*$  are equal to  $\pm 1$ .

Recall that an upper triangular matrix is *unipotent* if all its diagonal entries are ones. The following key technical lemma can be retrieved from the proof of Dobrinskaya's general result [96, Theorem 6] characterising quasitoric manifolds over products of simplices which can be decomposed into towers of fibrations.

LEMMA 7.8.10. *Let  $R$  be a commutative integral domain with identity element 1, and let  $A$  be a square  $n$ -matrix ( $n \geq 2$ ) with entries in  $R$ . Suppose that every proper principal minor of  $A$  is equal to 1. If  $\det A = 1$ , then  $A$  is conjugate by means of a permutation matrix to a unipotent upper triangular matrix, otherwise it is permutation-conjugate to a matrix of the following form:*

$$(7.40) \quad \begin{pmatrix} 1 & b_1 & 0 & \dots & 0 \\ 0 & 1 & b_2 & \dots & 0 \\ \vdots & \vdots & \ddots & \ddots & \vdots \\ 0 & 0 & \dots & 1 & b_{n-1} \\ b_n & 0 & \dots & 0 & 1 \end{pmatrix}$$

where  $b_i \neq 0$  for all  $i$ .

PROOF. By assumption the diagonal entries of  $A$  must be ones. We say that the  $i$ th row is *elementary* if its  $i$ th entry is 1 and the other entries are 0. Assuming by induction that the theorem holds for matrices of size  $(n-1)$  we deduce that  $A$  is itself permutation-conjugate to a unipotent upper triangular matrix if and only if it contains an elementary row. We denote by  $A_i$  the square  $(n-1)$ -matrix obtained by removing from  $A$  the  $i$ th column and the  $i$ th row.

We may assume by induction that  $A_n$  is a unipotent upper triangular matrix. Next we apply the induction assumption to  $A_1$ . The permutation of rows and columns transforming  $A_1$  into a unipotent upper triangular matrix turns  $A$  into an 'almost' unipotent upper triangular matrix; the latter may have only one non-zero entry below the diagonal, which must be in the first column. If  $a_{n1} = 0$ , then the  $n$ th row of  $A$  is elementary and  $A$  is permutation-conjugate to a unipotent upper triangular matrix. Otherwise we have

$$A = \begin{pmatrix} 1 & * & * & \dots & * \\ 0 & 1 & * & \dots & * \\ \vdots & \vdots & \ddots & \ddots & \vdots \\ 0 & 0 & \dots & 1 & b_{n-1} \\ b_n & 0 & \dots & 0 & 1 \end{pmatrix},$$

where  $b_{n-1} \neq 0$  and  $b_n \neq 0$  (otherwise  $A$  contains an elementary row). Now let  $a_{1j_1}$  be the last non-zero entry in the first row of  $A$ . If  $A$  does not contain an elementary row, then we may define by induction  $a_{j_i j_{i+1}}$  as the last non-zero non-diagonal entry in the  $j_i$ th row of  $A$ . Clearly, we have

$$1 < j_1 < \dots < j_i < j_{i+1} < \dots < j_k = n$$



for some  $k < n$ . Now, if  $j_i = i + 1$  for  $1 \leq i \leq n - 1$ , then  $A$  is the matrix (7.40) with  $b_i = a_{j_{i-1}j_i}$ ,  $1 \leq i \leq n - 1$ . Otherwise, the submatrix

$$S = \begin{pmatrix} 1 & a_{1j_1} & 0 & \dots & 0 \\ 0 & 1 & a_{j_1j_2} & \dots & 0 \\ \vdots & \vdots & \ddots & \ddots & \vdots \\ 0 & 0 & \dots & 1 & a_{j_{k-1}n} \\ b_n & 0 & \dots & 0 & 1 \end{pmatrix},$$

of  $A$  formed by the columns and rows with indices  $1, j_1, \dots, j_k$  is proper and has determinant  $1 \pm b_n \prod a_{j_i j_{i+1}} \neq 1$ . This contradiction finishes the proof.  $\square$

**THEOREM 7.8.11.** *Let  $M = M(I^n, \Lambda)$  be a quasitoric manifold over a cube with canonical  $T^n$ -invariant smooth structure, and  $\Lambda_\star$  the corresponding refined submatrix. Then the following conditions are equivalent:*

- (a)  $M$  is equivalent to a Bott manifold;
- (b) all the principal minors of  $-\Lambda_\star$  are equal to 1;
- (c)  $M$  admits a  $T^n$ -invariant almost complex structure (with the associated omniorientation).

**PROOF.** The implication (b)  $\Rightarrow$  (a) follows from Lemma 7.8.10 and Proposition 7.8.9. The implication (a)  $\Rightarrow$  (c) is obvious. Let us prove (c)  $\Rightarrow$  (b). Recall the definition of the sign  $\sigma(v)$  and the formula from Lemma 7.3.18 (b) expressing this sign in terms of the combinatorial data. Denote the facets of the cube  $I^n$  by  $F_1^\varepsilon, \dots, F_n^\varepsilon$  ( $\varepsilon = 0, 1$ ), assuming that  $F_k^0 \cap F_k^1 = \emptyset$ , for  $1 \leq k \leq n$ . The normal vectors of facets are  $\mathbf{a}_k^\varepsilon = (-1)^\varepsilon \mathbf{e}_k$ . A vertex of  $I^n$  is given by

$$v = F_1^{\varepsilon_1} \cap \dots \cap F_n^{\varepsilon_n}.$$

Therefore, the expression for the sign  $\sigma(v)$  on the right hand side of the formula from Lemma 7.3.18 is equal to a principal minor of the matrix  $-\Lambda_\star$  (namely, the minor formed by the columns and rows with numbers  $i$  such that  $v \in F_i^1$ ). It remains to note that in the almost complex case the sign of every vertex is 1.  $\square$

**REMARK.** The equivalence (a)  $\Leftrightarrow$  (b) is a particular case of [96, Theorem 6].

**COROLLARY 7.8.12.** *Let  $V$  be a toric manifold whose associated fan is combinatorially equivalent to the fan consisting of cones over the faces of a cross-polytope. Then  $V$  is a Bott manifold.*

**PROOF.** If we view  $V$  as a quasitoric manifold (over a cube), then all the principal minors of the corresponding matrix  $\Lambda_\star$  are equal to 1 by the same reason as in the proof of Theorem 7.8.11. By Lemma 7.8.10, the matrix  $\Lambda_\star$  is permutation-conjugate to a unipotent upper triangular matrix, so the full characteristic matrix  $\Lambda$  has the same form as the characteristic matrix of a Bott manifold. The columns of  $\Lambda$  are the primitive vectors along edges of the fan corresponding to  $V$ , so the combinatorial type of the fan and the matrix  $\Lambda$  determine the fan completely. It follows that the fan of  $V$  is the same as the fan of some Bott manifold, which implies that  $V$  has the structure of a Bott tower.  $\square$

**EXAMPLE 7.8.13.** Corollary 7.8.12 shows that the class of Bott manifolds coincides with the class of toric manifolds over cubes, i.e. the first inclusion in the hierarchy described in the beginning of this section is an identity. This is not the

case for the second inclusion. For example the quasitoric manifold  $M$  over a square with refined characteristic submatrix  $A_\star = \begin{pmatrix} 1 & 2 \\ 1 & 1 \end{pmatrix}$  is not a Bott manifold, because  $A_\star$  is not permutation-conjugate to an upper triangular matrix. This  $M$  is diffeomorphic to  $\mathbb{C}P^2 \# \mathbb{C}P^2$ .

**Semifree circle actions.** Recall that an action of a group is called *semifree* if it is free on the complement to fixed points. A particularly interesting class of *Hamiltonian* semifree circle actions was studied by Hattori, who proved in [152] that a compact symplectic manifold  $M$  carrying a semifree Hamiltonian  $\mathbb{S}^1$ -action with nonempty isolated fixed point set has the same cohomology ring and the same Chern classes as  $\mathbb{C}P^1 \times \cdots \times \mathbb{C}P^1$ , thus imposing a severe restriction on the topological structure of the manifold. Hattori's results were further extended by Tolman and Weitsman, who showed in [309] that a semifree symplectic  $\mathbb{S}^1$ -action with nonempty isolated fixed point set is automatically Hamiltonian, and the *equivariant* cohomology ring and Chern classes of  $M$  also agree with those of  $\mathbb{C}P^1 \times \cdots \times \mathbb{C}P^1$ . In dimensions up to 6 it is known that a symplectic manifold with a  $\mathbb{S}^1$ -action satisfying the properties above is diffeomorphic to a product of 2-spheres, but in higher dimensions this remains open.

Ilinskii considered in [167] an algebraic version of Hattori's question on semifree symplectic  $\mathbb{S}^1$ -actions. Namely, he conjectured that a smooth compact complex algebraic variety  $V$  carrying a semifree action of the algebraic 1-torus  $\mathbb{C}^\times$  with positive number of isolated fixed points is homeomorphic to  $S^2 \times \cdots \times S^2$ . The algebraic and symplectic versions of the conjecture are related via the common subclass of projective varieties; a smooth projective variety is a symplectic manifold. Ilinskii proved the *toric* version of his algebraic conjecture, namely, when  $V$  is a toric manifold and the semifree 1-torus is a subgroup of the acting torus (of dimension  $\dim_{\mathbb{C}} V$ ). The first step of Ilinskii's argument was to show that if  $V$  admits a semifree action of a subcircle with isolated fixed points, then the corresponding fan is combinatorially equivalent to the fan over the faces of a cross-polytope. By Corollary 7.8.12, such a toric manifold  $V$  admits a structure of a Bott tower.

The above described classification of Bott towers can therefore be applied to obtain results on semifree circle actions. According to a result of [210] (Theorem 7.8.16 below), a quasitoric manifold over a cube with a semifree circle action is a Bott tower. By another result of [210], all such Bott towers are topologically trivial, i.e. diffeomorphic to a product of 2-dimensional spheres (Theorem 7.8.17).

A complex  $n$ -dimensional representation of the circle  $\mathbb{S}^1$  is determined by the set of weights  $k_j \in \mathbb{Z}$ ,  $1 \leq j \leq n$ . In appropriate coordinates an element  $s = e^{2\pi i \varphi} \in \mathbb{S}^1$  acts as follows:

$$(7.41) \quad s \cdot (z_1, \dots, z_n) = (e^{2\pi i k_1 \varphi} z_1, \dots, e^{2\pi i k_n \varphi} z_n).$$

The following result is straightforward.

**PROPOSITION 7.8.14.** *A representation of  $\mathbb{S}^1$  in  $\mathbb{C}^n$  is semifree if and only if  $k_j = \pm 1$  for  $1 \leq j \leq n$ .*

Let  $M = M(P, A)$  be a quasitoric manifold. A circle subgroup in  $\mathbb{T}^n$  is determined by a primitive integer vector  $\nu = (\nu_1, \dots, \nu_n)$ :

$$(7.42) \quad S(\nu) = \{(e^{2\pi i \nu_1 \varphi}, \dots, e^{2\pi i \nu_n \varphi}) \in \mathbb{T}^n : \varphi \in \mathbb{R}\}.$$

Given a vertex  $v = F_{j_1} \cap \cdots \cap F_{j_n}$  of  $P$ , we can decompose  $\nu$  in terms of the basis  $\lambda_{j_1}, \dots, \lambda_{j_n}$ :

$$(7.43) \quad \nu = k_1(\nu, v)\lambda_{j_1} + \cdots + k_n(\nu, v)\lambda_{j_n}.$$

PROPOSITION 7.8.15. *A circle  $S(\nu) \subset \mathbb{T}^n$  acts on a quasitoric manifold  $M = M(P, A)$  semifreely and with isolated fixed points if and only if, for every vertex  $v = F_{j_1} \cap \cdots \cap F_{j_n}$ , the coefficients in (7.43) satisfy  $k_i(\nu, v) = \pm 1$  for  $1 \leq i \leq n$ .*

PROOF. It follows from Proposition 7.3.17 that the coefficients  $k_i(\nu, v)$  are the weights of the representation of the circle  $S(\nu)$  in the tangent space to  $M$  at  $v$ . The statement follows from Proposition 7.8.14.  $\square$

THEOREM 7.8.16 ([210]). *Let  $M$  be a quasitoric manifold over a cube  $I^n$ . Assume that the torus acting on  $M$  has a circle subgroup acting semifreely and with isolated fixed points. Then  $M$  is equivalent to a Bott tower.*

PROOF. Let  $A_\star$  be the refined characteristic submatrix of  $M$ . We may assume by induction that every characteristic submanifold of  $M$  is a Bott manifold, so that every proper principal minor of the matrix  $-A_\star$  is 1. Therefore, we are in the situation of Lemma 7.8.10, and  $-A_\star$  is a matrix of one of the two types described there. The second type is ruled out because of the semifreeness assumption. Indeed, let  $A = (I \mid -B)$ , where  $B$  is the matrix (7.40) and assume that  $S(\nu) \subset \mathbb{T}^n$  acts semifreely with isolated fixed points. Applying the criterion from Proposition 7.8.15 to the vertex  $v = F_1^0 \cap \cdots \cap F_n^0$  we obtain  $\nu_i = \pm 1$  for  $1 \leq i \leq n$ . Now we apply the same criterion to the vertex  $v' = F_1^1 \cap \cdots \cap F_n^1$ . Since the submatrix formed by the corresponding columns of  $A$  is precisely  $-B$ , it follows that  $\det B = \pm 1$ . This implies that  $b_i = \pm 1$  in (7.40) for some  $i$ . Therefore, if all the coefficients  $k_j(\nu, v')$  in the expression  $\nu = k_1(\nu, v')\lambda_{n+1} + \cdots + k_n(\nu, v')\lambda_{2n}$  are equal to  $\pm 1$ , then the  $i$ th coordinate of  $\nu$  is  $\nu_i = \pm 1 \pm b_i \neq \pm 1$ : a contradiction.  $\square$

Our next result shows that a Bott tower with a semifree circle subgroup and isolated fixed points is topologically trivial. Let  $t$  (respectively,  $\mathbb{C}$ ) be the standard (respectively, the trivial) complex one-dimensional representation of the circle  $\mathbb{S}^1$ , and let  $\underline{V}$  denote the trivial bundle with fibre  $V$  over a given base. We say that an action of a group  $G$  on a Bott manifold  $B_n$  preserves the tower structure if for each stage  $B_k = \mathbb{C}P(\underline{\mathbb{C}} \oplus \xi_{k-1})$  the line bundle  $\xi_{k-1}$  is  $G$ -equivariant. The intrinsic  $\mathbb{T}^n$ -action on  $B_n$  (see Corollary 7.8.8) obviously preserves the tower structure.

THEOREM 7.8.17 ([210]). *Assume that a Bott manifold  $B_n$  admits a semifree  $\mathbb{S}^1$ -action with isolated fixed points preserving the tower structure. Then the Bott tower is topologically trivial; furthermore,  $B_n$  is  $\mathbb{S}^1$ -equivariantly diffeomorphic to the product  $(\mathbb{C}P(\mathbb{C} \oplus t))^n$ .*

PROOF. We may assume by induction that the  $(n-1)$ th stage of the Bott tower is diffeomorphic to  $(\mathbb{C}P(\mathbb{C} \oplus t))^{n-1}$  and  $B_n = \mathbb{C}P(\underline{\mathbb{C}} \oplus \xi)$  for some  $\mathbb{S}^1$ -equivariant line bundle  $\xi$  over  $(\mathbb{C}P(\mathbb{C} \oplus t))^{n-1}$ .

Let  $\gamma$  be the canonical line bundle over  $\mathbb{C}P(\mathbb{C} \oplus t) \cong \mathbb{C}P^1$ . It carries a unique structure of an  $\mathbb{S}^1$ -equivariant bundle such that

$$(7.44) \quad \gamma|_{(1:0)} = \mathbb{C} \quad \text{and} \quad \gamma|_{(0:1)} = t.$$

We denote by  $x \in H^2(\mathbb{C}P(\mathbb{C} \oplus t))$  the first Chern class of  $\gamma$ , and let  $x_i = \pi_i^*(x) \in H^2(\mathbb{C}P(\mathbb{C} \oplus t)^{n-1})$  be the pullback of  $x$  by the projection  $\pi_i$  onto the  $i$ th factor.

Then  $c_1(\xi) = \sum_{i=1}^{n-1} a_i x_i$  for some  $a_i \in \mathbb{Z}$ . The  $\mathbb{S}^1$ -equivariant line bundles  $\xi$  and  $\otimes_{i=1}^{n-1} \pi_i^*(\gamma^{a_i})$  have the same underlying bundles, so there is an integer  $k$  such that

$$(7.45) \quad \xi = \underline{t}^k \otimes \bigotimes_{i=1}^{n-1} \pi_i^*(\gamma^{a_i})$$

as  $\mathbb{S}^1$ -equivariant line bundles (see [155, Corollary 4.2]).

We encode  $\mathbb{S}^1$ -fixed points in  $\mathbb{C}P(\mathbb{C} \oplus t)^{n-1}$  by sequences  $(p_1^{\varepsilon_1}, \dots, p_{n-1}^{\varepsilon_{n-1}})$ , where  $\varepsilon_i = 0$  or  $1$ , and  $p_i^{\varepsilon_i}$  denotes  $(1 : 0)$  if  $\varepsilon_i = 0$  and  $(0 : 1)$  if  $\varepsilon_i = 1$ . Then it follows from (7.44) and (7.45) that

$$\xi|_{(p_1^{\varepsilon_1}, \dots, p_{n-1}^{\varepsilon_{n-1}})} = t^{k + \sum_{i=1}^{n-1} \varepsilon_i a_i}.$$

The  $\mathbb{S}^1$ -action on  $B_n = \mathbb{C}P(\mathbb{C} \oplus \xi)$  is semifree if and only if  $|k + \sum_{i=1}^{n-1} \varepsilon_i a_i| = 1$  for all possible values of  $\varepsilon_i$ . Setting  $\varepsilon_i = 0$  for all  $i$  we obtain  $|k| = 1$ . Let  $k = 1$  (the case  $k = -1$  is treated similarly). Then  $(a_1, \dots, a_{n-1}) = (0, \dots, 0)$  or  $(0, \dots, 0, -2, 0, \dots, 0)$ . In the former case,  $\xi = \underline{t}$  and  $B_n = \mathbb{C}P(\mathbb{C} \oplus \xi) \cong \mathbb{C}P(\mathbb{C} \oplus t)^n$ . In the latter case we have  $\xi = t\pi_i^*(\gamma^{-2})$  for some  $i$ , so that  $B_n = \pi_i^* \mathbb{C}P(\mathbb{C} \oplus t\gamma^{-2})$ . Since for any  $\mathbb{S}^1$ -vector bundle  $E$  and  $\mathbb{S}^1$ -line bundle  $\eta$  the projectivisations  $\mathbb{C}P(E)$  and  $\mathbb{C}P(E \otimes \eta)$  are  $\mathbb{S}^1$ -diffeomorphic, it follows that  $\mathbb{C}P(\mathbb{C} \oplus t\gamma^{-2}) \cong \mathbb{C}P(\gamma \oplus t\gamma^{-1})$ . The first Chern class of  $\gamma \oplus t\gamma^{-1}$  is zero, so its underlying bundle is trivial. The  $\mathbb{S}^1$ -representation in the fibre of  $\gamma \oplus t\gamma^{-1}$  over a fixed point is isomorphic to  $\mathbb{C} \oplus t$  by (7.44). Therefore,  $\gamma \oplus t\gamma^{-1} = \mathbb{C} \oplus \underline{t}$  as  $\mathbb{S}^1$ -bundles. It follows that  $\mathbb{C}P(\mathbb{C} \oplus t\gamma^{-2}) \cong \mathbb{C}P(\mathbb{C} \oplus \underline{t})$  and  $B_n \cong (\mathbb{C}P(\mathbb{C} \oplus \underline{t}))^n$ .  $\square$

REMARK. The diffeomorphism of Theorem 7.8.17 is not  $\mathbb{T}^n$ -equivariant.

The next example shows that Theorem 7.8.17 cannot be generalised to quasitoric manifolds. However, as we shall see, it holds under the additional assumption that the quotient polytope of the quasitoric manifold is a cube.

EXAMPLE 7.8.18. Let  $M$  be a quasitoric manifold over a  $2k$ -gon with

$$A = \begin{pmatrix} 1 & 0 & 1 & 0 & \cdots & 1 & 0 \\ 0 & 1 & 0 & 1 & \cdots & 0 & 1 \end{pmatrix}.$$

By Corollary 7.8.15, the circle subgroup determined by the vector  $\nu = (1, 1)$  acts semifreely on  $M$ . However, the quotient of  $M$  is not a 2-cube if  $k > 2$ , so  $M$  cannot be homeomorphic to a product of spheres (it can be shown that  $M$  is a connected sum of  $k - 1$  copies of  $S^2 \times S^2$ ).

THEOREM 7.8.19 ([210]). *Let  $M$  a quasitoric manifold  $M$  over a cube  $I^n$ . Assume that the torus acting on  $M$  has a circle subgroup acting semifreely. Then  $M$  is  $\mathbb{S}^1$ -equivariantly homeomorphic to a product of 2-spheres.*

PROOF. By Theorem 7.8.16,  $M$  is equivalent to a Bott tower. By Theorem 7.8.17, it is  $\mathbb{S}^1$ -homeomorphic to a product of spheres.  $\square$

We can also derive Ilinskii’s result on semifree actions on toric manifolds:

THEOREM 7.8.20 ([167]). *A toric manifold  $V$  carrying a semifree action of a circle subgroup with isolated fixed points is diffeomorphic to a product of 2-spheres.*

PROOF. By Theorem 7.8.17, it is sufficient to show that  $V$  is a Bott manifold. A semifree circle subgroup acting on  $V$  also acts semifreely and with isolated fixed points on every characteristic submanifold  $V_j$  of  $V$ . We use induction on the dimension. The base of induction is the case  $\dim_{\mathbb{C}} V = 2$ ; we consider it below. By the inductive hypothesis, each  $V_j$  is a Bott manifold, i.e. its quotient polytope is a combinatorial cube. On the other hand, the quotient polytope of  $V_j$  is the facet  $F_j$  of the quotient polytope  $P$  of  $V$ ; since each  $F_j$  is a cube,  $P$  is also a cube by Exercise 1.1.22. By Corollary 7.8.12,  $V$  is a Bott manifold, and we are done.

It remains to consider the case  $\dim_{\mathbb{C}} V = 2$ . We need to show that the quotient polytope of a complex 2-dimensional toric manifold  $V$  with semifree circle subgroup action and isolated fixed points is a 4-gon.

Let  $\Sigma$  be the fan corresponding to  $V$ . One-dimensional cones of  $\Sigma$  correspond to facets (or edges) of the quotient polygon  $P^2$ . We must show that there are precisely 4 one-dimensional cones. The values of the characteristic function on the facets of  $P^2$  are given by the primitive vectors generating the corresponding one-dimensional cones of  $\Sigma$ . Let  $\nu$  be the vector generating the semifree circle subgroup. We may choose an initial vertex  $v$  of  $P^2$  so that  $\nu$  belongs to the 2-dimensional cone of  $\Sigma$  corresponding to  $v$ . Then we index the primitive generators  $\mathbf{a}_i$ ,  $1 \leq i \leq m$ , of 1-cones so that  $\nu$  is in the cone generated by  $\mathbf{a}_1$  and  $\mathbf{a}_2$ , and any two consecutive vectors span a two-dimensional cone (see Fig. 7.6). This provides us with a refined

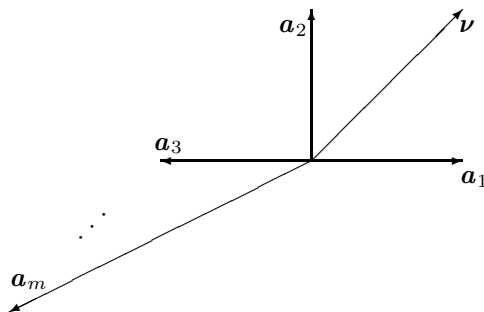

FIGURE 7.6.

characteristic matrix  $A$  of size  $2 \times m$ . We have  $\mathbf{a}_1 = (1, 0)$  and  $\mathbf{a}_2 = (0, 1)$ , and applying the criterion from Proposition 7.8.15 to the first cone  $\mathbb{R}_{\geq} \langle \mathbf{a}_1, \mathbf{a}_2 \rangle$  (that is, to the initial vertex of the polygon) we obtain  $\nu = (1, 1)$ .

The rest of the proof is a case by case analysis using the non-singularity condition (7.4) and Proposition 7.8.15. The reader may be willing to do this himself as an exercise rather than following the argument below.

Consider now the second cone. The non-singularity conditions (7.4) gives us  $\det(\mathbf{a}_2, \mathbf{a}_3) = 1$ , hence  $\mathbf{a}_3 = (-1, *)$ . Writing  $\nu = k_1 \mathbf{a}_2 + k_2 \mathbf{a}_3$  and applying Proposition 7.8.15 to the second cone  $\mathbb{R}_{\geq} \langle \mathbf{a}_2, \mathbf{a}_3 \rangle$  we obtain

$$(1, 1) = \pm(0, 1) \pm (-1, *).$$

Therefore,  $\mathbf{a}_3 = (-1, 0)$  or  $\mathbf{a}_3 = (-1, -2)$ . Similarly, considering the last cone  $\mathbb{R}_{\geq} \langle \mathbf{a}_m, \mathbf{a}_1 \rangle$  we obtain  $\mathbf{a}_m = (*, -1)$ , and then, applying Proposition 7.8.15, we see that  $\mathbf{a}_m = (0, -1)$  or  $\mathbf{a}_m = (-2, -1)$ . The case when  $\mathbf{a}_3 = (-1, -2)$  and  $\mathbf{a}_m = (-2, -1)$  is impossible since then the second and the last cones overlap.

Let  $\mathbf{a}_3 = (-1, -2)$ . Then  $\mathbf{a}_m = (0, -1)$ . Considering the cone  $\mathbb{R}_{\geq} \langle \mathbf{a}_{m-1}, \mathbf{a}_m \rangle$  we obtain  $\mathbf{a}_{m-1} = (-1, 0)$  or  $\mathbf{a}_{m-1} = (-1, -2)$ . In the former case cones overlap, and in the latter case we get  $\mathbf{a}_{m-1} = \mathbf{a}_3$ . This implies  $m = 4$  and we are done.

Let  $\mathbf{a}_3 = (-1, 0)$ . Then considering the third cone  $\mathbb{R}_{\geq} \langle \mathbf{a}_3, \mathbf{a}_4 \rangle$  we obtain  $\mathbf{a}_4 = (0, -1)$  or  $\mathbf{a}_4 = (-2, -1)$ . If  $\mathbf{a}_4 = (0, -1)$ , then  $\mathbf{a}_4 = \mathbf{a}_m$  (otherwise cones overlap), and we are done. Let  $\mathbf{a}_4 = (-2, -1)$ . Then either  $\mathbf{a}_m = (-2, -1) = \mathbf{a}_4$  and we are done, or  $\mathbf{a}_m = (0, -1)$ . In the latter case, we get  $\mathbf{a}_{m-1} = (-1, -2)$  (see the previous paragraph).

We are left with the case  $\mathbf{a}_4 = (-2, -1)$  and  $\mathbf{a}_{m-1} = (-1, -2)$ . The only way to satisfy both (7.4) and the condition of Proposition 7.8.15 without overlapping cones is to set  $\mathbf{a}_5 = (-3, -2)$  and  $\mathbf{a}_{m-2} = (-2, -3)$ . Continuing this process, we obtain  $\mathbf{a}_k = (-k + 2, -k + 3)$ ,  $k \geq 2$ , and  $\mathbf{a}_{m-l} = (-l, -l - 1)$ ,  $l \geq 0$ . This process never stops, as we never get a complete regular fan. So this case is impossible.  $\square$

The proof above leaves three possibilities for the vectors  $\mathbf{a}_3$  and  $\mathbf{a}_4$  of the 2-dimensional fan:  $(-1, 0)$  and  $(0, -1)$ , or  $(-1, 0)$  and  $(-2, -1)$ , or  $(-1, -2)$  and  $(0, -1)$ . The last two pairs correspond to isomorphic fans. The refined characteristic submatrices corresponding to the first two pairs are

$$\begin{pmatrix} -1 & 0 \\ 0 & -1 \end{pmatrix} \quad \text{and} \quad \begin{pmatrix} -1 & -2 \\ 0 & -1 \end{pmatrix}.$$

The first corresponds to  $\mathbb{C}P^1 \times \mathbb{C}P^1$ , and the second to a Bott manifold (Hirzebruch surface) with  $a_{12} = -2$ .

The next result gives an explicit description of matrices (7.39) corresponding to our specific class of Bott towers:

**THEOREM 7.8.21 ([210]).** *A Bott manifold  $B_n$  admits a semifree circle subgroup with isolated fixed points if and only if its matrix (7.39) satisfies the identity*

$$\frac{1}{2}(E - A) = C_1 C_2 \cdots C_n,$$

where  $C_k$  is either the identity matrix or a unipotent upper triangular matrix with only one nonzero element above the diagonal; this element is 1 in the  $k$ th column.

**PROOF.** Assume first that  $B_n$  admits a semifree circle subgroup with isolated fixed points. We have two sets of multiplicative generators for the ring  $H^*(B_n)$ : the set  $\{u_1, \dots, u_n\}$  from Corollary 7.8.3 satisfying identities (7.38), and the set  $\{x_1, \dots, x_n\}$  satisfying  $x_i^2 = 0$  (the latter set exists since  $B_n$  is diffeomorphic to a product of 2-spheres). The reduced sets with  $i \leq k$  can be regarded as the corresponding sets of generators for the  $k$ th stage  $B_k$ . As is clear from the proof of Theorem 7.8.17, we have  $c_1(\xi_{k-1}) = -2c_{i_k k} x_{i_k}$  for some  $i_k < k$ , where  $c_{i_k k} = 1$  or 0. From  $u_k^2 + 2c_{i_k k} x_{i_k} u_k = 0$  we obtain  $x_k = u_k + c_{i_k k} x_{i_k}$ . In other words, the transition matrix  $C_k$  from the basis  $x_1, \dots, x_{k-1}, u_k, \dots, u_n$  of  $H^2(B_n)$  to  $x_1, \dots, x_k, u_{k+1}, \dots, u_n$  may have only one nonzero entry off the diagonal, which is  $c_{i_k k}$ . The transition matrix from  $u_1, \dots, u_n$  to  $x_1, \dots, x_n$  is the product  $D = C_1 C_2 \cdots C_n$ . Then  $D = (d_{jk})$  is a unipotent upper triangular matrix consisting of zeros and ones,  $x_k = \sum_{j=1}^n d_{jk} u_j$  and

$$0 = x_k^2 = \left(u_k + \sum_{j=1}^{k-1} d_{jk} u_j\right)^2 = u_k^2 + 2 \sum_{j=1}^{k-1} d_{jk} u_j u_k + \cdots, \quad 1 \leq k \leq n.$$

On the other hand,  $0 = u_k^2 - \sum_{j=1}^{k-1} a_{jk} u_j u_k$  by (7.38). Comparing the coefficients of  $u_j u_k$  for  $1 \leq j \leq k - 1$  in the last two equations and observing that these elements

are linearly independent in  $H^4(B^{2k})$  we obtain  $2d_{jk} = -a_{jk}$  for  $1 \leq j < k \leq n$ . As both  $D$  and  $-A$  are unipotent upper triangular matrices, this implies  $2D = E - A$ .

Assume now that the matrix  $A$  satisfies  $E - A = 2C_1C_2 \cdots C_n$ . Then for the corresponding Bott tower we have  $\xi_{k-1} = \pi_{i_k}^*(\gamma^{-2c_{i_k k}})$ . Therefore, we may choose a circle subgroup such that  $\xi_{k-1}$  becomes  $t\pi_{i_k}^*(\gamma^{-2c_{i_k k}})$  (as an  $S^1$ -equivariant bundle), for  $1 < k \leq n$ . This circle subgroup acts semifreely and with isolated fixed points as seen from the same argument as in the proof of Theorem 7.8.17.  $\square$

**EXAMPLE 7.8.22.** The condition of Theorem 7.8.21 implies in particular that the matrix (7.39) may have only entries equal to 0 or  $-2$  above the diagonal. However, the hypothesis of Theorem 7.8.21 is stronger. For instance, if

$$A = \begin{pmatrix} -1 & 0 & -2 \\ 0 & -1 & -2 \\ 0 & 0 & -1 \end{pmatrix}$$

then the matrix  $(E - A)/2$  cannot be factored as  $C_1C_2C_3$ . Consequently, the corresponding 3-stage Bott tower does not admit a subcircle acting semifreely and with isolated fixed points. On the other hand, if

$$A = \begin{pmatrix} -1 & -2 & -2 \\ 0 & -1 & 0 \\ 0 & 0 & -1 \end{pmatrix}$$

then we have

$$\frac{1}{2}(E - A) = \begin{pmatrix} 1 & 1 & 1 \\ 0 & 1 & 0 \\ 0 & 0 & 1 \end{pmatrix} = \begin{pmatrix} 1 & 0 & 0 \\ 0 & 1 & 0 \\ 0 & 0 & 1 \end{pmatrix} \begin{pmatrix} 1 & 1 & 0 \\ 0 & 1 & 0 \\ 0 & 0 & 1 \end{pmatrix} \begin{pmatrix} 1 & 0 & 1 \\ 0 & 1 & 0 \\ 0 & 0 & 1 \end{pmatrix}.$$

It is clear that not every topologically trivial Bott manifold admits a semifree subcircle action with isolated fixed points (the latter condition is stronger even for  $n = 2$ ). We now consider the former class in more detail.

**Topologically trivial Bott towers.** The topological triviality of a Bott tower can be detected by its cohomology ring:

**THEOREM 7.8.23 ([210]).** *A Bott tower  $B_n$  is topologically trivial if and only if there is an isomorphism  $H^*(B_n) \cong H^*((S^2)^n)$  of graded rings.*

**PROOF.** Corollary 7.8.3 implies

$$H^*(B_n) = H^*(B_{n-1})[u_n]/(u_n^2 - c_1(\xi_{n-1})u_n).$$

We may therefore write any element of  $H^2(B_n)$  as  $x + bu_n$ , where  $x \in H^2(B_{n-1})$  and  $b \in \mathbb{Z}$ . We have

$$(x + bu_n)^2 = x^2 + 2bxu_n + b^2u_n^2 = x^2 + b(2x + bc_1(\xi_{n-1}))u_n,$$

so that the square of  $x + bu_n$  with  $b \neq 0$  is zero if and only if  $x^2 = 0$  and  $2x + bc_1(\xi_{n-1}) = 0$ . This shows that elements of the form  $x + bu_n$  with  $b \neq 0$  whose squares are zero generate a rank-one free subgroup of  $H^2(B_n)$ .

Assume that  $H^*(B_n) \cong H^*((\mathbb{C}P^1)^n)$ . Then there is a basis  $\{x_1, \dots, x_n\}$  in  $H^2(B_n)$  such that  $x_i^2 = 0$  for all  $i$ . By the observation from the previous paragraph, we may assume that the elements  $x_1, \dots, x_{n-1}$  lie in  $H^2(B_{n-1})$ , and  $x_n$  is not in  $H^2(B_{n-1})$ . Then we can have  $x_n = \sum_{i=1}^{n-1} b_i x_i + u_n$  for some  $b_i \in \mathbb{Z}$ . A product  $\prod_{i \in I} x_i$  with  $I \subset \{1, \dots, n\}$  lies in  $H^*(B_{n-1})$  if and only if  $n \notin I$ . This implies that

the ring  $H^*(B_{n-1})$  is generated by the elements  $x_1, \dots, x_{n-1}$  and is isomorphic to the cohomology ring of  $(\mathbb{C}P^1)^{n-1}$ . Therefore, we may assume by induction that  $B_{n-1} \cong (\mathbb{C}P^1)^{n-1}$ .

Writing  $c_1(\xi_{n-1}) = \sum_{i=1}^{n-1} a_i x_i$ , we obtain

$$0 = x_n^2 = (u_n + \sum_{i=1}^{n-1} b_i x_i)^2 = \sum_{i=1}^{n-1} (a_i + 2b_i) x_i u_n + (\sum_{i=1}^{n-1} b_i x_i)^2.$$

This may hold only if at most one of the  $a_i$  is nonzero (and equal to  $-2b_i$ ) because the elements  $x_i x_j$  and  $x_i u_n$  with  $i < j < n$  form a basis of  $H^4(B_n)$ . Therefore,  $\xi_{n-1}$  is the pullback of the bundle  $\gamma^{-2b_i}$  over  $\mathbb{C}P^1$  by the  $i$ th projection map  $B_{n-1} = (\mathbb{C}P^1)^{n-1} \rightarrow \mathbb{C}P^1$ . Since  $\mathbb{C}P(\underline{\mathbb{C}} \oplus \gamma^{-2b_i})$  is a topologically trivial bundle (see Example 7.8.4), the bundle  $B_n = \mathbb{C}P(\underline{\mathbb{C}} \oplus \xi_{n-1})$  is also trivial.  $\square$

We can now also describe effectively the class of matrices (7.39) corresponding to topologically trivial Bott towers:

**THEOREM 7.8.24.** *A Bott tower is topologically trivial if and only if its corresponding matrix (7.39) satisfies the identity*

$$\frac{1}{2}(E - A) = C_1 C_2 \cdots C_n,$$

where  $C_k$  is either the identity matrix or a unipotent upper triangular matrix with only one nonzero element above the diagonal; this element lies in the  $k$ th column.

**PROOF.** The argument is the same as in the proof of Theorem 7.8.21. The only difference is that the number  $c_{i_k k}$  in the formula  $c_1(\xi_{k-1}) = -2c_{i_k k} x_{i_k}$  is now an arbitrary integer.  $\square$

Theorem 7.8.23 can be generalised to quasitoric manifolds, but only in the topological category:

**THEOREM 7.8.25** ([210, Theorem 5.7]). *A quasitoric manifold  $M$  is homeomorphic to a product  $(S^2)^n$  if and only if there is an isomorphism  $H^*(M) \cong H^*((S^2)^n)$  of graded rings.*

**Generalisations and cohomological rigidity.**

**DEFINITION 7.8.26.** A *generalised Bott tower* of height  $n$  is a tower of bundles

$$B_n \xrightarrow{p_n} B_{n-1} \xrightarrow{p_{n-1}} \cdots \rightarrow B_2 \xrightarrow{p_2} B_1 \rightarrow pt,$$

of complex manifolds, where  $B_1 = \mathbb{C}P^{j_1}$  and each  $B_k$  is the complex projectivisation of a sum of  $j_k + 1$  complex line bundles over  $B_{k-1}$ . The fibre of the bundle  $p_k : B_k \rightarrow B_{k-1}$  is  $\mathbb{C}P^{j_k}$ . A generalised Bott tower is *topologically trivial* if each  $p_k$  is trivial as a smooth bundle.

The last stage  $B_n$  in a generalised Bott tower is a *generalised Bott manifold*.

**REMARK.** A generalised Bott manifold  $B_n$  is a projective toric manifold whose corresponding polytope is combinatorially equivalent to a product of simplices  $\Delta^{j_1} \times \cdots \times \Delta^{j_n}$  (an exercise). In particular,  $B_n$  is a quasitoric manifold over a product of simplices. If we replace ‘a sum of complex line bundles’ by ‘a complex vector bundle’ in the definition, then the resulting tower will not be a toric manifold in general: the torus action on  $B_{k-1}$  lifts to the projectivisation of a sum of line bundles, but not to the projectivisation of an arbitrary vector bundle over  $B_{k-1}$ .



Generalised Bott towers were considered by Dobrinskaya [96], who proved the following result (see Lemma 7.3.18 for the information about the signs of vertices):

**THEOREM 7.8.27** ([96, Corollary 7]). *A quasitoric manifold over a product of simplices  $P = \Delta^{j_1} \times \cdots \times \Delta^{j_n}$  is a generalised Bott manifold if and only if the sign of each vertex of  $P$  is the product of the signs of its corresponding vertices of the simplices  $\Delta^{j_k}$  according to the decomposition of  $P$ . In particular, a toric manifold over a product of simplices is always a generalised Bott manifold.*

**REMARK.** According to the general result [96, Theorem 6], a quasitoric manifold over any product polytope  $P = P_{j_1} \times \cdots \times P_{j_n}$  decomposes into a tower of quasitoric fibre bundles if and only if the sign of each vertex of  $P$  decomposes into the corresponding product.

Theorem 7.8.23 can be extended to generalised Bott towers:

**THEOREM 7.8.28** ([75, Theorem 1.1]). *If the integral cohomology ring of a generalised Bott manifold  $B_n$  is isomorphic to  $H^*(\mathbb{C}P^{j_1} \times \cdots \times \mathbb{C}P^{j_n})$ , then the generalised Bott tower is topologically trivial; in particular,  $B_n$  is diffeomorphic to  $\mathbb{C}P^{j_1} \times \cdots \times \mathbb{C}P^{j_n}$ .*

According to another result of Choi, Masuda and Suh [74, Theorem 8.1], a quasitoric manifold  $M$  over a product of simplices  $P = \Delta^{j_1} \times \cdots \times \Delta^{j_n}$  is homeomorphic to a generalised Bott manifold if  $H^*(M) \cong H^*(\mathbb{C}P^{j_1} \times \cdots \times \mathbb{C}P^{j_n})$ . Therefore, such a quasitoric manifold  $M$  is homeomorphic to  $\mathbb{C}P^{j_1} \times \cdots \times \mathbb{C}P^{j_n}$ .

Since trivial (generalised) Bott towers can be detected by their cohomology rings, a natural question arises of whether *any* two (generalised) Bott manifolds can be distinguished, either smoothly or topologically, by their cohomology rings. This leads to the notion of cohomological rigidity:

**DEFINITION 7.8.29.** Fix a commutative ring  $\mathbf{k}$  with unit. We say that a family of closed manifolds is *cohomologically rigid* over  $\mathbf{k}$  if manifolds in the family are distinguished up to homeomorphism by their cohomology rings with coefficients in  $\mathbf{k}$ . That is, a family is cohomologically rigid if a graded ring isomorphism  $H^*(M_1; \mathbf{k}) \cong H^*(M_2; \mathbf{k})$  implies a homeomorphism  $M_1 \cong M_2$  whenever  $M_1$  and  $M_2$  are in the family.

A manifold  $M$  in the given family is said to be *cohomologically rigid* if for any other manifold  $M'$  in the family a ring isomorphism  $H^*(M; \mathbf{k}) \cong H^*(M'; \mathbf{k})$  implies a homeomorphism  $M \cong M'$ . Obviously a family is cohomologically rigid whenever every its element is rigid.

There is a smooth version of cohomological rigidity for families of smooth manifolds, with homeomorphisms replaced by diffeomorphisms.

**PROBLEM 7.8.30.** Is the family of Bott manifolds cohomologically rigid (over  $\mathbb{Z}$ )? Namely, is it true that any two Bott manifolds  $M_1$  and  $M_2$  with isomorphic integral cohomology rings are homeomorphic (or even diffeomorphic)?

This question is open even for the much larger families of toric and quasitoric manifolds. Namely, there are no known examples of non-homeomorphic (quasi)toric manifolds with isomorphic integral cohomology rings. By the result of Choi, Park and Suh [77], quasitoric manifolds with second Betti number 2 (i.e. over a product of two simplices) are homeomorphic when their cohomology rings are isomorphic.

In the positive direction, Theorem 7.8.23 shows that a topologically trivial Bott manifold is cohomologically rigid in the family of Bott manifolds, in the smooth category. By Theorem 7.8.25, a topologically trivial Bott manifold is cohomologically rigid in the wider family of quasitoric manifolds, but only in the topological category. Smooth cohomological rigidity was established in Choi [71] for Bott manifolds up to dimension 8 (i.e. up to height 4).

There is an  $\mathbb{R}$ -version of this circle of questions, with quasitoric manifolds replaced by *small covers*, (generalised) Bott towers replaced by *real (generalised) Bott towers*, and the cohomology rings taken with coefficients in  $\mathbb{Z}_2$ . A real generalised Bott tower is defined similarly to a complex tower, with the complex projectivisation replaced by the real one.

The family of real Bott manifolds is cohomologically rigid over  $\mathbb{Z}_2$  by the result of Kamishima–Masuda [178] (see also [73]), but the family of generalised Bott manifolds is not [208]. Also, every small cover over a product of simplices is a generalised real Bott tower [74] (this is not true for quasitoric manifolds, see Example 7.8.13). For more results on the cohomological rigidity of (generalised) Bott towers, see the survey articles [211] and [76].

### Exercises.

7.8.31. Let  $\eta^k$  denote the  $k$ th tensor power of the tautological line bundle over  $\mathbb{C}P^1$ , and  $\underline{\mathbb{C}}$  denote the trivial line bundle. Show that there is a cohomology ring isomorphism  $H^*(\mathbb{C}P(\underline{\mathbb{C}} \oplus \eta^k)) \cong H^*(\mathbb{C}P(\underline{\mathbb{C}} \oplus \eta^{k'}))$  if and only if  $k \equiv k' \pmod{2}$ .

7.8.32. Show that the toric manifold described in Theorem 7.8.7 is projective by providing explicitly a polytope  $P$  whose normal fan is  $\Sigma$ . Observe that  $P$  is combinatorially equivalent to a cube (compare Proposition 7.7.4).

7.8.33. The bounded flag manifold  $BF_n$  is a Bott tower, as described in Example 7.8.5. By Theorem 7.8.7, it is isomorphic to the toric manifold whose corresponding fan has generators

$$\mathbf{a}_k^0 = \mathbf{e}_k \quad (1 \leq k \leq n), \quad \mathbf{a}_k^1 = -\mathbf{e}_k + \mathbf{e}_{k+1} \quad (1 \leq k \leq n-1), \quad \mathbf{a}_n^1 = \mathbf{e}_n.$$

This fan is not the same as the one described in Proposition 7.7.3. However, there is a linear isomorphism of  $\mathbb{R}^n$  taking one fan to another, and therefore the corresponding toric manifolds are isomorphic.

7.8.34. Let  $B_n$  be the Bott manifold and  $u_i \in H^2(B_n)$  the canonical cohomology ring generator (obtained by pulling back the first Chern class of the tautological line bundle over  $B_i$  to the top stage  $B_n$ ). Show that  $u_i = c_1(\bar{\rho}_{i+n})$ , where  $\rho_{i+n}$  is the line bundle (7.7) over the toric manifold  $B_n$ . (Hint: use induction.)

7.8.35. A generalised Bott manifold is a projective toric manifold over a product of simplices.

7.8.36. The projectivisation of a complex  $k$ -plane bundle ( $k > 1$ ) over  $\mathbb{C}P^n$  is not necessarily a toric manifold.

## 7.9. Weight graphs

The quotient space  $M^{2n}/T^n$  of a half-dimensional torus action has the orbit stratification (the face structure), therefore providing a natural combinatorial object associated with the action and allowing us to translate equivariant topology

into combinatorics. For the classes of half-dimensional torus actions considered in the previous sections, the quotient  $M^{2n}/T^n$  is contractible or acyclic, so many topological invariants of the action can be expressed in purely combinatorial terms.

In this section we consider another type of combinatorial objects associated to  $T$ -manifolds, which catch some important information about the  $T$ -action and its orbit structure: the so-called *weight graphs* (for particular classes of  $T$ -manifolds these are also known as *GKM-graphs*). A weight graph is an oriented graph with a special labelling of edges, which can be assigned to an effective  $T^k$ -action on  $M^{2n}$  ( $k \leq n$ ) with isolated fixed points under very mild assumption on the action. When  $k < n$  the topology of the quotient  $M^{2n}/T^k$  is often quite complicated, and the weight graph can be viewed as its combinatorial approximation.

In the study of quasitoric manifolds we constructed the correspondence (7.14), which assigns to each oriented edge of the quotient simple polytope  $P$  a weight of the  $T$ -representation at the fixed point corresponding to the origin of the edge. This correspondence can be viewed as a graph  $\Gamma$  with special labels on its oriented edges, and we refer to such an object as a *weight graph*. As it follows from Proposition 7.3.17, defining the correspondence (7.14) is equivalent to defining the characteristic matrix  $\Lambda$ . At the same time, it is well-known that the 1-skeleton of a simple polytope determines its entire combinatorial structure (see e.g. [325, Theorem 3.12]). It follows that the weight graph contains the same information as the combinatorial quasitoric pair  $(P, \Lambda)$ , and therefore it completely determines the torus action on the quasitoric manifold  $M$ . For more general classes of torus actions considered in this chapter, one cannot expect that the weight graph determines the action, but it still contains an important piece of information.

Graphs whose oriented edges are labelled by the weights of a torus action were considered in the works of Musin [236], Hattori and other authors since the 1970s. A renewed interest to these graphs was stimulated by the works of Goresky–Kottwitz–MacPherson [129] and Guillemin–Zara [145] in connection with the study of symplectic manifolds with Hamiltonian torus actions. A related more general class of  $T$ -manifolds has become known as *GKM-manifolds*, and their weight graphs are often referred to as *GKM-graphs*.

A closed  $2n$ -dimensional manifold  $M$  with an effective smooth action of torus  $T^k$  ( $k \leq n$ ) is called a *GKM-manifold* if the fixed point set is finite and nonempty, a  $T^k$ -invariant almost complex structure is given on  $M$ , and the weights of the tangential  $T^k$ -representation at any fixed point are pairwise linearly independent. As in the case of quasitoric manifolds, there is a weight graph associated with each GKM-manifold  $M$  (vertices of the graph correspond to fixed points of  $M$ , and edges correspond to connected components of the set of points of  $M$  with codimension-one stabilisers). As it was shown in [129], many important topological characteristics of a GKM-manifold  $M$  (such as the Betti numbers or the equivariant cohomology) can be described in terms of the weight graph. Axiomatisation of the properties of the weight graph of a GKM-manifold led to the notion of a GKM-graph [145].

Weight graphs arising from locally standard  $T$ -manifolds (or torus manifolds) were studied in [204]. As in the case of GKM-manifolds, axiomatisation of the properties of weight graphs leads to an interesting combinatorial object, known as a  *$T$ -graph* (or *torus graph*).

A  *$T$ -graph* is a finite  $n$ -valent graph  $\Gamma$  (without loops, but with multiple edges allowed) with an *axial function* on the set  $E(\Gamma)$  of oriented edges taking values in

$\text{Hom}(T^n, S^1) = H^2(BT^n)$  and satisfying certain compatibility conditions. These conditions (described below) are similar to those for GKM-graphs, but not exactly the same. The weight graph of a torus manifold is an example of a  $T$ -graph; in this case the values of the axial function are the weights of the tangential representations of  $T^n$  at fixed points.

The equivariant cohomology ring  $H_T^*(\Gamma)$  of a  $T$ -graph  $\Gamma$  can be defined in the same way as for GKM-graphs; when the  $T$ -graph arises from a locally standard torus manifold  $M$  we have  $H_T^*(\Gamma) = H_T^*(M)$ . Furthermore, unlike the case of GKM-graphs, the equivariant cohomology ring of a  $T$ -graph can be described in terms of generators and relations (see Theorem 7.9.12). Such a description is obtained by defining the simplicial poset  $\mathcal{S}(\Gamma)$  associated with a  $T$ -graph  $\Gamma$ ; then  $H_T^*(\Gamma)$  is shown to be isomorphic to the face ring  $\mathbb{Z}[\mathcal{S}(\Gamma)]$ . This theorem continues the series of results identifying the equivariant cohomology of a (quasi)toric manifold [90] and a locally standard  $T$ -manifold (Theorem 7.4.33) with the face ring of the associated polytope, simplicial complex, or simplicial poset.

Although the classes of GKM- and  $T$ -graphs diverge in general, they contain an important subclass of  $n$ -independent GKM-graphs in their intersection.

**Definition of a  $T$ -graph.** This definition is a natural adaptation of the notion of GKM-graph [145] to torus manifolds.

Let  $\Gamma$  be a connected  $n$ -valent graph without loops but possibly with multiple edges. Denote by  $V(\Gamma)$  the set of vertices and by  $E(\Gamma)$  the set of oriented edges (so that each edge enters  $E(\Gamma)$  twice with the opposite orientations). We further denote by  $i(e)$  and  $t(e)$  the initial and terminal points of  $e \in E(\Gamma)$ , respectively, and denote by  $\bar{e}$  the edge  $e$  with the reversed orientation. For  $v \in V(\Gamma)$  we set

$$E(\Gamma)_v = \{e \in E(\Gamma) : i(e) = v\}.$$

A collection  $\theta = \{\theta_e\}$  of bijections

$$\theta_e : E(\Gamma)_{i(e)} \rightarrow E(\Gamma)_{t(e)}, \quad e \in E(\Gamma),$$

is called a *connection* on  $\Gamma$  if

- (a)  $\theta_{\bar{e}}$  is the inverse of  $\theta_e$ ;
- (b)  $\theta_e(e) = \bar{e}$ .

An  $n$ -valent graph  $\Gamma$  with  $g$  edges admits  $((n-1)!)^g$  different connections. Let  $T = T^n$  be an  $n$ -torus. A map

$$\alpha : E(\Gamma) \rightarrow \text{Hom}(T, S^1) = H^2(BT)$$

is called an *axial function* (associated with the connection  $\theta$ ) if it satisfies the following three conditions:

- (a)  $\alpha(\bar{e}) = \pm\alpha(e)$ ;
- (b) elements of  $\alpha(E(\Gamma)_v)$  are pairwise linearly independent (*2-independent*) for each vertex  $v \in V(\Gamma)$ ;
- (c)  $\alpha(\theta_e(e')) \equiv \alpha(e') \pmod{\alpha(e)}$  for any  $e \in E(\Gamma)$  and  $e' \in E(\Gamma)_{i(e)}$ .

We also denote by  $T_e = \ker \alpha(e)$  the codimension-one subtorus in  $T$  determined by  $\alpha$  and  $e$ . Then we may reformulate the condition (c) above as follows: the restrictions of  $\alpha(\theta_e(e'))$  and  $\alpha(e')$  to  $H^*(BT_e)$  coincide.

REMARK. Guillemin and Zara required  $\alpha(\bar{e}) = -\alpha(e)$  in their definition of axial function. A connection  $\theta$  satisfying condition (c) above is unique if elements of  $\alpha(E(\Gamma)_v)$  are 3-independent for each vertex  $v$  (an exercise, see [145]).

DEFINITION 7.9.1. We call  $\alpha$  a  $T$ -axial function if it is  $n$ -independent, i.e. if  $\alpha(E(\Gamma)_v)$  is a basis of  $H^2(BT)$  for each  $v \in V(\Gamma)$ . A triple  $(\Gamma, \theta, \alpha)$  consisting of a graph  $\Gamma$ , a connection  $\theta$  and a  $T$ -axial function  $\alpha$  is called a  $T$ -graph. Since a connection  $\theta$  is uniquely determined by  $\alpha$ , we often suppress it in the notation.

REMARK. Compared with GKM-graphs, the definition of a  $T$ -graph has weaker condition (a) (we only require  $\alpha(\bar{e}) = \pm\alpha(e)$  instead of  $\alpha(\bar{e}) = -\alpha(e)$ ), but stronger condition (b) ( $\alpha$  is required to be  $n$ -independent rather than 2-independent).

EXAMPLE 7.9.2. Let  $M$  be a locally standard torus manifold. Denote by  $\Gamma_M$  the 1-skeleton of the orbit space  $Q = M/T$  (it is easy to see that the 1-skeleton can be defined without the local standardness assumption), and let  $\alpha_M$  be the axial function of Lemma 7.4.24. Then  $(\Gamma_M, \alpha_M)$  is a  $T$ -graph.

EXAMPLE 7.9.3. Two  $T$ -graphs are shown in Fig. 7.7. The first is 2-valent and the second is 3-valent. The axial function  $\alpha$  takes the edges, regardless of their orientation, to the generators  $t_1, t_2 \in H^2(BT^2)$  (respectively,  $t_1, t_2, t_3 \in H^2(BT^3)$ ). These  $T$ -graphs are not GKM-graphs, as the condition  $\alpha(\bar{e}) = -\alpha(e)$  is not satisfied. Both come from torus manifolds,  $S^4$  and  $S^6$ , respectively (see Example 7.4.16).

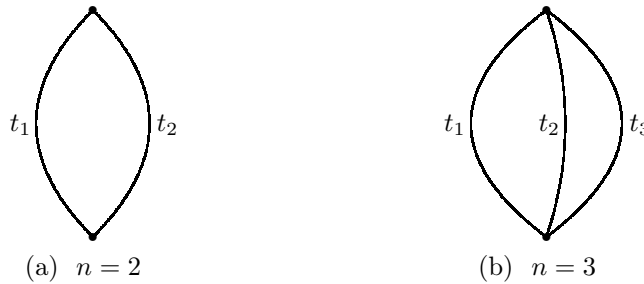

FIGURE 7.7.  $T$ -graphs.

DEFINITION 7.9.4. The equivariant cohomology  $H_T^*(\Gamma)$  of a  $T$ -graph  $\Gamma$  is a set of maps

$$f: V(\Gamma) \rightarrow H^*(BT)$$

such that for every  $e \in E(\Gamma)$  the restrictions of  $f(i(e))$  and  $f(t(e))$  to  $H^*(BT_e)$  coincide. Since  $H^*(BT)$  is a ring, the set of maps from  $V(\Gamma)$  to  $H^*(BT)$ , denoted by  $H^*(BT)^{V(\Gamma)}$ , is also a ring with respect to the vertex-wise multiplication. Its subspace  $H_T^*(\Gamma)$  is a subring because the restriction map  $H^*(BT) \rightarrow H^*(BT_e)$  is multiplicative. Furthermore,  $H_T^*(\Gamma)$  is a  $H^*(BT)$ -algebra.

If  $M$  is a torus manifold with  $H^{odd}(M) = 0$ , then for the corresponding  $T$ -graph  $\Gamma_M$  we have  $H_T^*(\Gamma_M) \cong H_T^*(M)$  by Theorem 7.4.28.

**Calculation of equivariant cohomology.** Here we interpret the results of Section 7.4 on equivariant cohomology of torus manifolds in terms of their associated  $T$ -graphs, thereby providing a purely combinatorial model for this calculation, which is applicable to a wider class of objects.

DEFINITION 7.9.5. Let  $(\Gamma, \theta, \alpha)$  be a  $T$ -graph and  $\Gamma'$  a connected  $k$ -valent subgraph of  $\Gamma$ , where  $0 \leq k \leq n$ . If  $\Gamma'$  is invariant under the connection  $\theta$ , then we say that  $(\Gamma', \alpha|_{E(\Gamma)})$  is a  $k$ -dimensional face of  $\Gamma$ . As usual,  $(n - 1)$ -dimensional faces as called *facets*.

An intersection of faces is invariant under the connection, but can be disconnected. In other words, such an intersection is a union of faces.

The *Thom class* of a  $k$ -dimensional face  $G = (\Gamma', \alpha|E(G'))$  is the map  $\tau_G : V(\Gamma) \rightarrow H^{2(n-k)}(BT)$  defined by

$$(7.46) \quad \tau_G(v) = \begin{cases} \prod_{i(e)=v, e \notin \Gamma'} \alpha(e) & \text{if } v \in V(\Gamma'), \\ 0 & \text{otherwise.} \end{cases}$$

LEMMA 7.9.6. *The Thom class  $\tau_G$  is an element of  $H_T^*(\Gamma)$ .*

PROOF. Let  $e \in E(\Gamma)$ . If neither of the vertices of  $e$  is contained in  $G$ , then the values of  $\tau_G$  on both vertices of  $e$  are zero. If only one vertex of  $e$ , say  $i(e)$ , is contained in  $G$ , then  $\tau_G(t(e)) = 0$ , while  $\tau_G(i(e)) = 0 \pmod{\alpha(e)}$ , so that the restriction of  $\tau_G(i(e))$  to  $H^*(BT_e)$  is also zero. Finally, assume that the whole  $e$  is contained in  $G$ . Let  $e'$  be an edge such that  $i(e') = i(e)$  and  $e' \notin G$ , so that  $\alpha(e')$  is a factor in  $\tau_G(i(e))$ . Since  $G$  is invariant under the connection, it follows that  $\theta_e(e') \notin G$ . Therefore,  $\alpha(\theta_e(e'))$  is a factor in  $\tau_G(t(e))$ . Now we have  $\alpha(\theta_e(e')) \equiv \alpha(e') \pmod{\alpha(e)}$  by the definition of axial function. The same holds for any other factor in  $\tau_G(i(e))$ , whence the restrictions of  $\tau_G(i(e))$  and  $\tau_G(t(e))$  to  $H^*(BT_e)$  coincide.  $\square$

LEMMA 7.9.7. *If  $\Gamma$  is a  $T$ -graph, then there is a unique  $k$ -face containing any given  $k$  elements of  $E(\Gamma)_v$ .*

PROOF. Let  $S \subset E(\Gamma)_v$  be the set of given oriented  $k$  edges with the common origin  $v$ . Consider the graph  $\Gamma'$  obtained by ‘spreading’  $S$  using the connection  $\theta$ . In more detail, at the first step we add to  $S$  all oriented edges of the form  $\theta_e(e')$  where  $e, e' \in S$ . Denote the resulting set by  $S_1$ . At the second step we add to  $S_1$  all oriented edges of the form  $\theta_e(e')$  where  $e, e' \in S_1$  and  $i(e) = i(e')$ , and so on. Since  $\Gamma$  is a finite graph, this process stabilises after a finite number of steps, and we obtain a subgraph  $\Gamma'$  of  $\Gamma$ . This subgraph  $\Gamma'$  is obviously  $\theta$ -invariant. We claim that  $\Gamma'$  is  $k$ -valent. To see this, define for any vertex  $w \in V(\Gamma')$  the subgroup

$$N_w = \mathbb{Z}\langle \alpha(e) : e \in E(\Gamma')_w \rangle \subset H^2(BT).$$

Condition (c) from the definition of the axial function implies that  $N_w = N_{w'}$  for any vertices  $w, w' \in V(\Gamma')$ . Since  $N_v \cong \mathbb{Z}^k$  for the initial vertex  $v$ , it follows that  $N_w \cong \mathbb{Z}^k$  for any  $w \in V(\Gamma')$ . Now, then  $n$ -independence of the axial function implies that there are exactly  $k$  edges in the set  $\{e \in E(\Gamma')_w\}$ , for any vertex  $w$  of  $\Gamma'$ . In other words,  $\Gamma'$  is  $k$ -valent and therefore it defines a  $k$ -face of  $\Gamma$ .  $\square$

COROLLARY 7.9.8. *Faces of a  $T$ -graph  $\Gamma$  form a simplicial poset  $\mathcal{S}(\Gamma)$  of rank  $n$  with respect to reversed inclusion.*

Denote by  $G \vee H$  a minimal face containing both  $G$  and  $H$ . In general such a least upper bound may fail to exist or be non-unique; however it exists and is unique provided that the intersection  $G \cap H$  is non-empty.

LEMMA 7.9.9. *For any two faces  $G$  and  $H$  of  $\Gamma$  the corresponding Thom classes satisfy the relation*

$$(7.47) \quad \tau_G \tau_H = \tau_{G \vee H} \cdot \sum_{E \in G \cap H} \tau_E,$$

where we formally set  $\tau_\Gamma = 1$  and  $\tau_\emptyset = 0$ , and the sum in the right hand side is taken over connected components  $E$  of  $G \cap H$ .

PROOF. We need to check that both sides of the identity take the same values on any vertex  $v$ . The argument is the same as in the proof of Lemma 7.4.26.  $\square$

LEMMA 7.9.10. *The Thom classes  $\tau_G$  corresponding to all proper faces of  $\Gamma$  constitute a set of ring generators for  $H_T^*(\Gamma)$ .*

PROOF. This is proved in the same way as Lemma 7.4.31.  $\square$

Consider the face ring  $\mathbb{Z}[\mathcal{S}(\Gamma)]$ , obtained by taking quotient of the polynomial ring on generators  $v_G$  corresponding to non-empty faces of  $\Gamma$  by relations (7.47). The grading is given by  $\deg v_G = 2(n - \dim G)$ .

EXAMPLE 7.9.11. Let  $\Gamma$  be the torus graph shown in Fig. 7.7 (b). Denote its vertices by  $p$  and  $q$ , the edges by  $e, g, h$ , and their opposite 2-faces by  $E, G, H$ , respectively. The simplicial cell complex  $\mathcal{S}(\Gamma)$  is obtained by gluing two triangles along their boundaries. The face ring  $\mathbb{Z}[\mathcal{S}(\Gamma)]$  is the quotient of the graded polynomial ring

$$\mathbb{Z}[v_E, v_G, v_H, v_p, v_q], \quad \deg v_E = \deg v_G = \deg v_H = 2, \quad \deg v_p = \deg v_q = 6$$

by the two relations

$$v_E v_G v_H = v_p + v_q, \quad v_p v_q = 0.$$

(The generators  $v_e, v_g, v_h$  can be excluded using relations like  $v_e = v_G v_H$ .)

By definition, the equivariant cohomology of a  $T$ -graph comes together with a monomorphism into the sum of polynomial rings:

$$r: H_T^*(\Gamma) \longrightarrow \bigoplus_{V(\Gamma)} H^*(BT).$$

A similar map for the face ring  $\mathbb{Z}[\mathcal{S}(\Gamma)]$  is given by Theorem 3.5.6 (or by Theorem 7.4.23). The latter map can be written in our case as

$$s: \mathbb{Z}[\mathcal{S}(\Gamma)] \longrightarrow \bigoplus_{v \in V(\Gamma)} \mathbb{Z}[\mathcal{S}(\Gamma)] / (v_G : G \not\ni v).$$

THEOREM 7.9.12 ([204]). *The equivariant cohomology ring  $H_T^*(\Gamma)$  of a  $T$ -graph  $\Gamma$  is isomorphic to the face ring  $\mathbb{Z}[\mathcal{S}(\Gamma)]$ . In other words,  $H_T^*(\Gamma)$  is isomorphic to the quotient of the polynomial ring on the Thom classes  $\tau_G$  by relations (7.47).*

PROOF. We define a map

$$\mathbb{Z}[v_G : G \text{ is a face}] \longrightarrow H_T^*(\Gamma)$$

by sending  $v_G$  to  $\tau_G$ . By Lemma 7.9.9, it factors through a map  $\varphi: \mathbb{Z}[\mathcal{S}(\Gamma)] \rightarrow H_T^*(\Gamma)$ . This map is surjective by Lemma 7.9.10. Also,  $\varphi$  is injective, because we have  $s = r \circ \varphi$  and  $s$  is injective by Theorem 3.5.6.  $\square$

**Pseudomanifolds and orientations.** Which simplicial posets arise as the posets of faces of  $T$ -graphs? Here we obtain a partial answer to this question.

The definition of pseudomanifold (Definition 4.6.4) can be extended easily to simplicial posets:

DEFINITION 7.9.13. A simplicial poset  $\mathcal{S}$  of rank  $n$  is called an  $(n - 1)$ -dimensional pseudomanifold (without boundary) if

- (a) for any element  $\sigma \in \mathcal{S}$ , there is an element  $\tau$  of rank  $n$  such that  $\sigma \leq \tau$  (in other words,  $\mathcal{S}$  is *pure*  $(n - 1)$ -dimensional);
- (b) for any element  $\sigma \in \mathcal{S}$  of rank  $(n - 1)$  there are exactly two elements  $\tau$  of rank  $n$  such that  $\sigma < \tau$ ;
- (c) for any two elements  $\tau$  and  $\tau'$  of rank  $n$  there is a sequence of elements  $\tau = \tau_1, \tau_2, \dots, \tau_k = \tau'$  such that  $\text{rank } \tau_i = n$  and  $\tau_i \wedge \tau_{i+1}$  contains an element of rank  $(n - 1)$  for  $i = 1, \dots, k - 1$ .

Simplicial cell decompositions of topological manifolds are pseudomanifolds, but there are pseudomanifolds that do not arise in this way, see Example 7.9.15.

THEOREM 7.9.14 ([204]).

- (a) Let  $\Gamma$  be a torus graph; then  $\mathcal{S}(\Gamma)$  is a pseudomanifold, and the face ring  $\mathbb{Z}[\mathcal{S}(\Gamma)]$  admits an isop;
- (b) Given an arbitrary pseudomanifold  $\mathcal{S}$  and an isop in  $\mathbb{Z}[\mathcal{S}]$ , one can canonically construct a torus graph  $\Gamma_{\mathcal{S}}$ .

Furthermore,  $\Gamma_{\mathcal{S}(\Gamma)} = \Gamma$ .

PROOF. (a) Vertices of  $\mathcal{S}(\Gamma)$  correspond to  $(n - 1)$ -faces of  $\Gamma$ . Since any face of  $\Gamma$  contains a vertex and  $\Gamma$  is  $n$ -valent,  $\mathcal{S}(\Gamma)$  is pure  $(n - 1)$ -dimensional. Condition (b) from the definition of a pseudomanifold follows from the fact that an edge of  $\Gamma$  has exactly two vertices, and (c) follows from the connectivity of  $\Gamma$ . In order to find an isop, we identify  $\mathbb{Z}[\mathcal{S}(\Gamma)]$  with a subset of  $H^*(BT)^{V(\Gamma)}$  (see Theorem 7.9.12) and consider the constant map  $H^*(BT) \rightarrow H^*(BT)^{V(\Gamma)}$ . It factors through a monomorphism  $H^*(BT) \rightarrow \mathbb{Z}[\mathcal{S}(\Gamma)]$ , and Lemma 3.5.8 implies that the image of a basis in  $H^2(BT)$  is an isop.

(b) Let  $\mathcal{S}$  be a pseudomanifold of dimension  $(n - 1)$ . Define a graph  $\Gamma_{\mathcal{S}}$  whose vertices correspond to  $(n - 1)$ -dimensional simplices  $\sigma \in \mathcal{S}$ , and in which the number of edges between two vertices  $\sigma$  and  $\sigma'$  is equal to the number of  $(n - 2)$ -dimensional simplices in  $\sigma \wedge \sigma'$ . Then  $\Gamma_{\mathcal{S}}$  is a connected  $n$ -valent graph, and we need to define an axial function.

We can regard an isop as a map  $\lambda: H^*(BT) \rightarrow \mathbb{Z}[\mathcal{S}]$ . Assume that  $\mathcal{S}$  has  $m$  elements of rank 1 (we do not call them vertices to avoid confusion with the vertices of  $\Gamma$ ) and let  $v_1, \dots, v_m$  be the corresponding degree-two generators of  $\mathbb{Z}[\mathcal{S}]$ . Then for  $t \in H^2(BT)$  we can write

$$\lambda(t) = \sum_{i=1}^m \lambda_i(t) u_i,$$

where  $\lambda_i$  is a linear function on  $H^2(BT)$ , that is, an element of  $H_2(BT)$ . Let  $e$  be an oriented edge of  $\Gamma$  with initial vertex  $v = i(e)$ . Then  $v$  corresponds to an  $(n - 1)$ -simplex of  $\mathcal{S}$ , and we denote by  $I(v) \subset \{1, \dots, m\}$  the corresponding set of rank 1 elements of  $\mathcal{S}$ ; note that  $|I(v)| = n$ . Since  $\lambda$  is an isop, the set  $\{\lambda_i: i \in I(v)\}$  is a basis of  $H_2(BT)$ . Now we define the axial function  $\alpha: E(\Gamma) \rightarrow H^2(BT)$  by



requiring that its value on  $E(\Gamma)_v$  is the dual basis of  $\{\lambda_i : i \in I(v)\}$ . In more detail, the edge  $e$  corresponds to an  $(n-2)$ -simplex of  $\mathcal{S}$  and let  $\ell \in I(v)$  be the unique element which is not in this  $(n-2)$ -simplex. Then we define  $\alpha(e)$  by requiring that

$$(7.48) \quad \langle \alpha(e), \lambda_i \rangle = \delta_{i\ell}, \quad i \in I(v),$$

where  $\delta_{i\ell}$  is the Kronecker delta. We need to check the three conditions from the definition of axial function. Let  $v' = t(e) = i(\bar{e})$ . Note that the intersection of  $I(v)$  and  $I(v')$  consists of at least  $(n-1)$  elements. If  $I(v) = I(v')$  then  $\Gamma$  has only two vertices, like in Example 7.9.3, while  $\mathcal{S}$  is obtained by gluing together two  $(n-1)$ -simplices along their boundaries, see Example 3.6.5. Otherwise,  $|I(v) \cap I(v')| = n-1$  and we have  $\ell \notin I(v')$ . Let  $\ell'$  be an element such that  $\ell' \in I(v')$ , but  $\ell' \notin I(v)$ . Then (7.48) implies that  $\langle \alpha(e), \lambda_i \rangle = \langle \alpha(\bar{e}), \lambda_i \rangle = 0$  for  $i \in I(v) \cap I(v')$ . As we work with integral bases, this implies  $\alpha(\bar{e}) = \pm \alpha(e)$ . It also follows that  $\alpha(E(\Gamma)_v \setminus e)$  and  $\alpha(E(\Gamma)_{v'} \setminus \bar{e})$  give the same bases in the quotient space  $H^2(BT)/\alpha(e)$ . Identifying these bases, we obtain a connection  $\theta_e : E(\Gamma)_v \rightarrow E(\Gamma)_{v'}$  satisfying  $\alpha(\theta_e(e')) \equiv \alpha(e') \pmod{\alpha(e)}$  for any  $e' \in E(\Gamma)_v$ , as needed.

The identity  $\Gamma_{\mathcal{S}(\Gamma)} = \Gamma$  is obvious.  $\square$

Theorem 7.9.14 would have provided a complete characterisation of simplicial posets arising from  $T$ -graphs if one had  $\mathcal{S}(\Gamma_{\mathcal{S}}) = \mathcal{S}$ . However, this is not the case in general, as is shown by the next example:

EXAMPLE 7.9.15. Let  $\mathcal{K}$  be a triangulation of a 2-dimensional sphere different from the boundary of a simplex. Choose two vertices that are not joined by an edge. Let  $\widehat{\mathcal{K}}$  be the complex obtained by identifying these two vertices. Then  $\widehat{\mathcal{K}}$  is a pseudomanifold. If  $\mathbb{Z}[\mathcal{K}]$  admits an Isop, then  $\mathbb{Z}[\widehat{\mathcal{K}}]$  also admits an Isop (this follows easily from Lemma 3.5.8). However,  $\mathcal{S}(\Gamma_{\widehat{\mathcal{K}}}) \neq \widehat{\mathcal{K}}$  (in fact,  $\mathcal{S}(\Gamma_{\widehat{\mathcal{K}}}) = \mathcal{K}$ ). It follows that  $\widehat{\mathcal{K}}$  does not arise from any  $T$ -graph.

DEFINITION 7.9.16. A map  $o : V(\Gamma) \rightarrow \{\pm 1\}$  is called an *orientation* of a  $T$ -graph  $\Gamma$  if  $o(i(e))\alpha(e) = -o(i(\bar{e}))\alpha(\bar{e})$  for any  $e \in E(\Gamma)$ .

EXAMPLE 7.9.17. Let  $M$  be a torus manifold which admits a  $T$ -invariant almost complex structure. The associated axial function  $\alpha_M$  satisfies  $\alpha_M(\bar{e}) = -\alpha_M(e)$  for any oriented edge  $e$ . In this case we can take  $o(v) = 1$  for every  $v \in V(\Gamma_M)$ .

PROPOSITION 7.9.18. *An omniorientation of a torus manifold  $M$  induces an orientation of the associated  $T$ -graph  $\Gamma_M$ .*

PROOF. For any vertex  $v \in M^T = V(\Gamma_M)$  we set  $o(v) = \sigma(v)$ , where  $\sigma(v)$  is the sign of  $v$  (see Lemma 7.3.18).  $\square$

EXAMPLE 7.9.19. Let  $\Gamma$  be a complete graph on four vertices  $v_1, v_2, v_3, v_4$ . Choose a basis  $t_1, t_2, t_3 \in H^2(BT^3)$  and define an axial function by setting

$$\alpha(v_1v_2) = \alpha(v_3v_4) = t_1, \quad \alpha(v_1v_3) = \alpha(v_2v_4) = t_2, \quad \alpha(v_1v_4) = \alpha(v_2v_3) = t_3$$

and  $\alpha(\bar{e}) = \alpha(e)$  for any oriented edge  $e$ . A direct check shows that this  $T$ -graph is not orientable. This graph is associated with the pseudomanifold (simplicial cell complex) shown in Fig. 7.8 via the construction of Theorem 7.9.14 (b). This pseudomanifold  $\mathcal{S}$  is homeomorphic to  $\mathbb{R}P^2$  (the opposite outer edges are identified according to the arrows shown), the ring  $\mathbb{Z}[\mathcal{S}]$  has three two-dimensional generators  $v_p, v_q, v_r$ , which constitute an Isop. Note that  $\mathbb{R}P^2$  itself is non-orientable.

It follows that this  $T$ -graph does not arise from a torus manifold.

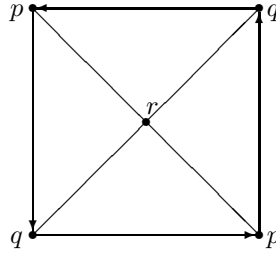

FIGURE 7.8. Simplicial cell decomposition of  $\mathbb{R}P^2$  with 3 vertices.

**PROPOSITION 7.9.20.** *A  $T$ -graph is  $\Gamma$  is orientable if and only if the associated pseudomanifold  $\mathcal{S}(\Gamma)$  is orientable.*

**PROOF.** Let  $v \in V(\Gamma)$  and let  $\sigma$  be the corresponding  $(n-1)$ -simplex of  $\mathcal{S}(\Gamma)$ . The oriented edges in  $E(\Gamma)_v$  canonically correspond to the vertices of  $\sigma$ . Choose a basis of  $H^2(BT)$ . Assume first that  $\mathcal{S}(\Gamma)$  is oriented. Choose a ‘positive’ (i.e. compatible with the orientation) order of vertices of  $\sigma$ ; this allows us to regard  $\alpha(E(\Gamma)_v)$  as a basis of  $H^2(BT)$ . We set  $o(v) = 1$  if it is a positively oriented basis, and  $o(v) = -1$  otherwise. This defines an orientation on  $\Gamma$ . To prove the opposite statement we just reverse this procedure.  $\square$

**Blowing up  $T$ -manifolds and  $T$ -graphs.** Here we elaborate on relating the following three geometric constructions:

- (a) blowing up a torus manifold at a facial submanifold (Construction 7.4.43);
- (b) truncating a simple polytope at a face (Construction 1.1.12) or, more generally, blowing up a GKM graph or a  $T$ -graph;
- (c) stellar subdivision of a simplicial complex or simplicial poset (see Definition 2.7.1 and Section 3.6).

The construction of blow-up of a GKM-graph is described in [145, §2.2.1]. It also applies to  $T$ -graphs and agrees with the topological picture for graphs arising from torus manifolds.

Let  $(\Gamma, \alpha, \theta)$  be a  $T$ -graph and  $G$  its  $k$ -face. The *blow-up* of  $\Gamma$  at  $G$  is a  $T$ -graph  $\tilde{\Gamma}$  which is defined as follows. Its vertex set is  $V(\tilde{\Gamma}) = (V(\Gamma) \setminus V(G)) \cup V(G)^{n-k}$ , that is, each vertex  $p \in V(G)$  is replaced by  $n-k$  new vertices  $\tilde{p}_1, \dots, \tilde{p}_{n-k}$ . It is convenient to choose these new vertices close to  $p$  on the edges from the set  $E_p(\Gamma) \setminus E_p(G)$ , and we denote by  $p'_i$  the endpoint of the edge of  $\Gamma$  containing both  $p$  and  $\tilde{p}_i$ . Furthermore, for any two vertices  $p, q \in G$  joined by an edge  $pq$  we index the corresponding new vertices of  $\tilde{G}$  in the way compatible with the connection, i.e. so that  $\theta_{pq}(pp'_i) = qq'_i$ . Now we need to define the edges of the new graph  $\tilde{\Gamma}$  and the axial function  $\tilde{\alpha}: E(\tilde{\Gamma}) \rightarrow H^*(BT)$ . We have four types of edges in  $\tilde{\Gamma}$ , which are given in the following list together with the values of the axial function:

- (a)  $\tilde{p}_i\tilde{p}_j$  for every  $p \in V(G)$ ;  $\tilde{\alpha}(\tilde{p}_i\tilde{p}_j) = \alpha(pp'_j) - \alpha(pp'_i)$ ;
- (b)  $\tilde{p}_i\tilde{q}_i$  if  $p$  and  $q$  where joined by an edge in  $G$ ;  $\tilde{\alpha}(\tilde{p}_i\tilde{q}_i) = \alpha(pq)$ ;
- (c)  $\tilde{p}_i p'_i$  for every  $p \in V(G)$ ;  $\tilde{\alpha}(\tilde{p}_i p'_i) = \alpha(pp'_i)$ ;
- (d) edges ‘left over from  $\Gamma$ ’, i.e.  $e \in E(\Gamma)$  with  $i(e) \notin V(G)$  and  $t(e) \notin V(G)$ ;  
 $\tilde{\alpha}(e) = \alpha(e)$ ,

see Fig. 7.9 ( $n = 3, k = 1$ ) and Fig. 7.10 ( $n = 3, k = 0$ ).

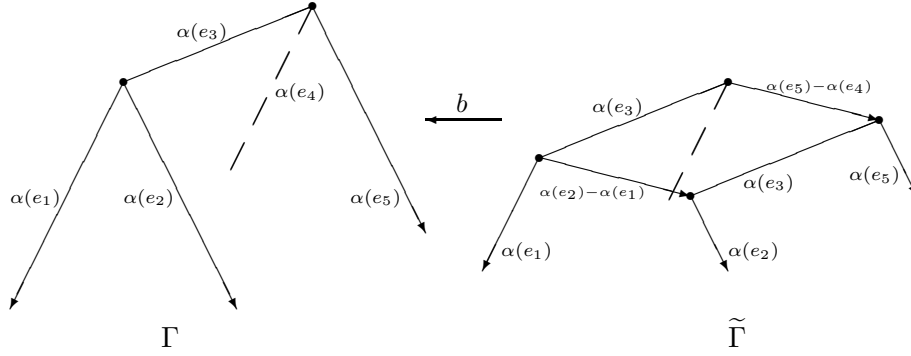

FIGURE 7.9. Blow-up at an edge

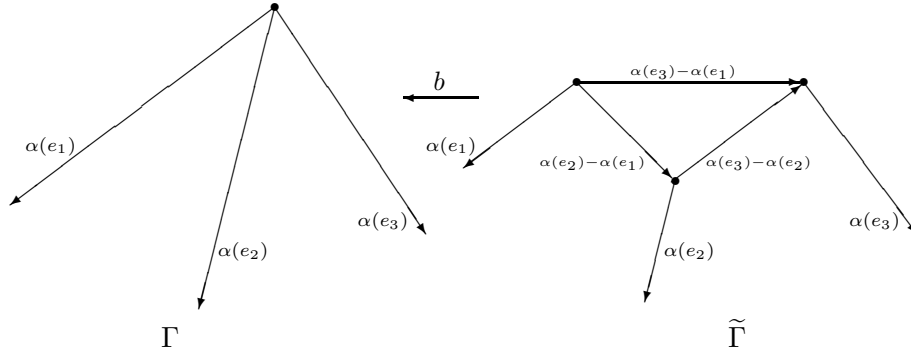

FIGURE 7.10. Blow-up at a vertex

There is a *blow-down map*  $b: \tilde{\Gamma} \rightarrow \Gamma$  taking faces to faces. The face  $G$  is blown up to a new facet  $\tilde{G} \subset \tilde{\Gamma}$  (unless  $G$  is a facet itself, in which case  $\tilde{\Gamma} = \Gamma$ ). For any face  $H \subset \Gamma$  not contained in  $G$ , there is a unique face  $\tilde{H} \subset \tilde{\Gamma}$  that is blown down onto  $H$ . The blow-down map induces a homomorphism in equivariant cohomology  $b^*: H_T^*(\Gamma) \rightarrow H_T^*(\tilde{\Gamma})$ , which is defined by the following commutative diagram

$$(7.49) \quad \begin{array}{ccc} H_T^*(\Gamma) & \xrightarrow{b^*} & H_T^*(\tilde{\Gamma}) \\ r \downarrow & & \downarrow \tilde{r} \\ H^*(BT)^{V(\Gamma)} & \xrightarrow{Vb^*} & H^*(BT)^{V(\tilde{\Gamma})}, \end{array}$$

where  $r$  and  $\tilde{r}$  are the monomorphisms from the definition of equivariant cohomology of a  $T$ -graph, and  $V(b)^*$  is the homomorphism induced by the set map  $V(b): V(\tilde{\Gamma}) \rightarrow V(\Gamma)$ . The next lemma describes the images of the two-dimensional generators  $\tau_F \in H_T^*(\Gamma)$  corresponding to facets  $F \subset \Gamma$ .

**LEMMA 7.9.21.** *For a given facet  $F \subset \Gamma$ , we have  $b^*(\tau_F) = \tau_{\tilde{G}} + \tau_{\tilde{F}}$ , if  $G \subset F$  and  $b^*(\tau_F) = \tau_{\tilde{F}}$  otherwise.*

**PROOF.** We consider diagram (7.49) and check that the images of  $b^*(\tau_F)$  and  $\tau_{\tilde{G}} + \tau_{\tilde{F}}$  (or  $\tau_{\tilde{F}}$ ) under the map  $\tilde{r}$  agree. Take a vertex  $p \in V(\Gamma)$ . If  $p \notin G$ , then  $b^{-1}(p) = p$  and  $r(\tau_F)(p) = \tilde{r}(\tau_{\tilde{F}})(p)$ ,  $\tilde{r}(\tau_{\tilde{G}})(p) = 0$ . Now let  $p \in G$ ; then  $b(\tilde{p}_i) = p$  for  $1 \leq i \leq n - k$ .

First assume  $G \not\subset F$  (see Fig. 7.11). If  $p \notin F$ , then  $r(\tau_F)(p) = \tilde{r}(\tau_{\tilde{F}})(\tilde{p}_i) = 0$ . Otherwise  $p \in F \cap G$ . Let  $e$  be the unique edge such that  $e \in E_p(\Gamma)$  and  $e \notin F$ . Then  $e = pq$  for some  $q \in V(G)$  (because  $G \not\subset F$ ). From (7.46) we obtain

$$r(\tau_F)(p) = \alpha(pq) = \tilde{\alpha}(\tilde{p}_i\tilde{q}_i) = \tilde{r}(\tau_{\tilde{F}})(\tilde{p}_i), \quad 1 \leq i \leq n - k.$$

Then  $Vb^*r(\tau_F) = \tilde{r}(\tau_{\tilde{F}})$ , and therefore,  $b^*(\tau_F) = \tau_{\tilde{F}}$ .

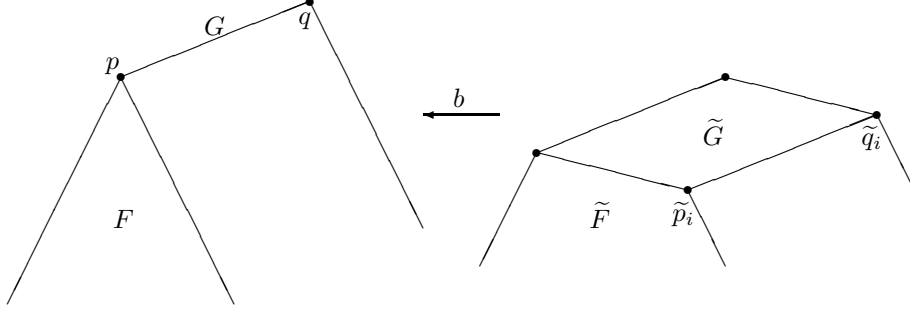

FIGURE 7.11.

Now assume  $G \subset F$  (see Fig. 7.12). In this case the unique edge  $e$  for which  $e \in E_p(\Gamma)$  and  $e \notin F$  is of type  $pp'_j$ . Using (7.46) we calculate

$$\begin{aligned} r(\tau_F)(p) &= \alpha(pp'_j), \\ \tilde{r}(\tau_{\tilde{F}})(\tilde{p}_i) &= \tilde{\alpha}(\tilde{p}_i\tilde{p}_j) = \alpha(pp'_j) - \alpha(pp'_i), \\ \tilde{r}(\tau_{\tilde{G}})(\tilde{p}_i) &= \tilde{\alpha}(\tilde{p}_i\tilde{p}'_i) = \alpha(pp'_i), \quad 1 \leq i \leq n - k. \end{aligned}$$

Then  $Vb^*r(\tau_F) = \tilde{r}(\tau_{\tilde{G}}) + \tilde{r}(\tau_{\tilde{F}})$ , and therefore,  $b^*(\tau_F) = \tau_{\tilde{G}} + \tau_{\tilde{F}}$ . □

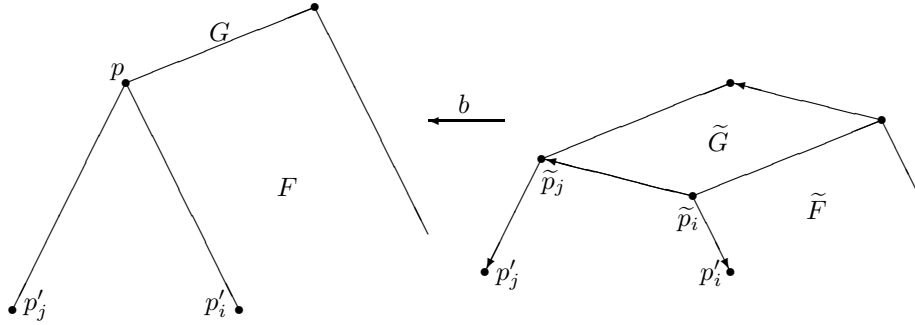

FIGURE 7.12.

**COROLLARY 7.9.22.** *After the identifications  $H_T^*(\Gamma) \cong \mathbb{Z}[\mathcal{S}(\Gamma)]$  and  $H_T^*(\tilde{\Gamma}) \cong \mathbb{Z}[\mathcal{S}(\tilde{\Gamma})]$ , the equivariant cohomology homomorphism  $b^*$  induced by the blow-down map  $b: \tilde{\Gamma} \rightarrow \Gamma$  coincides with the homomorphism  $\beta$  from Lemma 3.6.4.*

**PROOF.** Recall from Theorem 7.9.12 that the poset  $\mathcal{S}(\Gamma)$  is formed by faces of  $\Gamma$  with the reversed inclusion relation, and the isomorphism  $H_T^*(\Gamma) \cong \mathbb{Z}[\mathcal{S}(\Gamma)]$  is established by identifying Thom classes  $\tau_H$  with generators  $v_H$  corresponding to faces  $H \subset \Gamma$ . Let  $\sigma \in \mathcal{S}(\Gamma)$  be the element corresponding to the blown up face  $G$ .

Then an element  $\tau \in \mathcal{S}(\Gamma)$  belongs to  $\text{st}_{\mathcal{S}(\Gamma)} \sigma$  if and only if its corresponding face  $H \subset \Gamma$  satisfies  $G \cap H \neq \emptyset$ . The degree-two generators  $v_1, \dots, v_m$  of  $\mathbb{Z}[\mathcal{S}(\Gamma)]$  and of  $\mathbb{Z}[\mathcal{S}(\tilde{\Gamma})]$  correspond to the generators  $\tau_{F_1}, \dots, \tau_{F_m}$  of  $H_T^*(\Gamma)$  and the generators  $\tau_{\tilde{F}_1}, \dots, \tau_{\tilde{F}_m}$  of  $H_T^*(\tilde{\Gamma})$ , respectively. Making the appropriate identifications, we see that the homomorphism from Lemma 3.6.4 is determined uniquely by the conditions

$$\begin{aligned} \tau_H &\mapsto \tau_H && \text{if } G \cap H = \emptyset, \\ \tau_{F_i} &\mapsto \tau_{\tilde{G}} + \tau_{\tilde{F}_i} && \text{if } G \subset F_i, \\ \tau_{F_i} &\mapsto \tau_{\tilde{F}_i} && \text{if } G \not\subset F_i. \end{aligned}$$

The blow-down map  $b^*$  satisfies these conditions, thus finishing the proof.  $\square$

### Exercises.

7.9.23. A connection  $\theta$  satisfying condition (c) from the definition of axial function is unique if elements of  $\alpha(E(\Gamma)_v)$  are 3-independent for any vertex  $v$ .



## Homotopy theory of polyhedral products

The homotopy-theoretical study of toric spaces, such as moment-angle complexes or general polyhedral products, has recently evolved into a separate branch linking toric topology to unstable homotopy theory. Like toric varieties in algebraic geometry, polyhedral product spaces provide an effective testing ground for many important homotopy-theoretical techniques.

Basic homotopical properties of polyhedral products were described in our 2002 text [55]; these are included in Section 4.3 of this book. Two important developments have followed shortly. First, Grbić and Theriault [132], [133] described a wide class of simplicial complexes  $\mathcal{K}$  whose corresponding moment-angle complex  $\mathcal{Z}_{\mathcal{K}}$  is homotopy equivalent to a wedge of spheres. (This class includes, for example,  $i$ -dimensional skeleta of a simplex  $\Delta^{m-1}$  for all  $i$  and  $m$ .) Second, formality of the Davis–Januszkiewicz space  $DJ(\mathcal{K})$  (or, equivalently, the polyhedral product  $(\mathbb{C}P^\infty)^{\mathcal{K}}$ ) was established by Notbohm and Ray in [243]. (An alternative proof of this result was also given in [57, Lemma 7.35].) The importance of the homotopy-theoretical viewpoint on toric spaces has been emphasised in two papers [63] and [260], both coauthored with Ray and appeared in the proceedings of Osaka 2006 conference on toric topology. Following the earlier work of Panov, Ray and Vogt [261], in [260] categorical methods have been brought to bear on toric topology. We include the main results of [260] and [261] in Sections 8.1 and 8.4.

The idea is to exhibit a toric space as the homotopy colimit of a diagram of spaces over the small category  $\text{CAT}(\mathcal{K})$ , whose objects are the faces of a finite simplicial complex  $\mathcal{K}$  and morphisms are their inclusions. The corresponding  $\text{CAT}(\mathcal{K})$ -diagrams can also be studied in various algebraic Quillen model categories, and their homotopy (co)limits can be interpreted as algebraic models for toric spaces. Such models encode many standard algebraic invariants, and their existence is assured by the Quillen structure. Several illustrative calculations will be provided. In particular, we it is proved that toric and quasitoric manifolds (and various generalisations) are rationally formal, and that the polyhedral product  $(\mathbb{C}P^\infty)^{\mathcal{K}}$  (or the Davis–Januszkiewicz space) is coformal precisely when  $\mathcal{K}$  is flag.

A number of papers on the homotopy-theoretical aspects of toric spaces has appeared since 2008. One of the most important contributions was the 2010 work of Bahri, Bendersky, Cohen and Gitler [14] establishing a decomposition of the suspension of a polyhedral product  $(X, A)^{\mathcal{K}}$  into a wedge of suspensions corresponding to subsets  $I \subset [m]$ . In particular, the moment-angle complex  $\mathcal{Z}_{\mathcal{K}}$  breaks up into a wedge of suspensions of full subcomplexes  $\mathcal{K}_I$  after one suspension, providing a homotopy-theoretical interpretation of the cohomology calculation of Theorem 4.5.8. We include the results of [14] and related results on stable decompositions of polyhedral products in Section 8.3.

In Section 8.4 we study the loop spaces on moment-angle complexes and polyhedral products, by applying both categorical decompositions and the classical homotopy-theoretical approach via the (higher) Whitehead and Samelson products.

In the last section we restrict our attention to the case of flag complexes  $\mathcal{K}$ . We describe the Pontryagin algebra  $H_*(\Omega(\mathbb{C}P^\infty)^\mathcal{K})$  explicitly by generators and relations in Theorem 8.5.2, and also exhibit it as a colimit (or *graph product*) of exterior algebras. For the commutator subalgebra  $H_*(\Omega\mathcal{Z}_\mathcal{K})$  a minimal set of generators was constructed in [131]; it is included as Theorem 8.5.7. Another result of [131] (Theorem 8.5.11) gives a complete characterisation of the class of flag complexes  $\mathcal{K}$  for which the moment-angle complex  $\mathcal{Z}_\mathcal{K}$  is homotopy equivalent to a wedge of spheres.

Background material on model categories and homotopy (co)limits is given in Appendix C, further references can be also found there.

### 8.1. Rational homotopy theory of polyhedral products

Here we construct several decompositions of polyhedral products into colimits and homotopy colimits of diagrams over  $\text{CAT}(\mathcal{K})$ . We also establish formality of polyhedral powers  $X^\mathcal{K}$  with formal  $X$ , as well as formality of (quasi)toric manifolds and some torus manifolds. This contrasts the situation with moment-angle complexes  $\mathcal{Z}_\mathcal{K} = (D^2, S^1)^\mathcal{K}$ , which are not formal in general (see Section 4.9).

The indexing category for all diagrams in this section is  $\text{CAT}(\mathcal{K})$  (simplices of a finite simplicial complex  $\mathcal{K}$  and their inclusions) or its opposite  $\text{CAT}(\mathcal{K})^{op}$ . We recall the following diagrams and their (co)limits which appeared earlier in this book:

- $\text{CAT}(\mathcal{K})^{op}$ -diagram  $\mathbf{k}[\cdot]^\mathcal{K}$  in CGA, see Exercise 3.1.15 and Lemma 3.5.11; its limit is the face ring  $\mathbf{k}[\mathcal{K}]$ ;
- $\text{CAT}(\mathcal{K})$ -diagram  $\mathcal{D}_\mathcal{K}(D^2, S^1)$  in TOP, see (4.3); its colimit is the moment-angle complex  $\mathcal{Z}_\mathcal{K} = (D^2, S^1)^\mathcal{K}$ ;
- $\text{CAT}(\mathcal{K})$ -diagram  $\mathcal{D}_\mathcal{K}(\mathbf{X}, \mathbf{A})$  in TOP, see (4.7); its colimit is the polyhedral product  $(\mathbf{X}, \mathbf{A})^\mathcal{K}$ ;

We can generalise the first diagram above as follows. Given a sequence  $\mathbf{C} = (C_1, \dots, C_m)$  of commutative dg-algebras over  $\mathbb{Q}$ , define the diagram

$$(8.1) \quad \mathcal{D}^\mathcal{K}(\mathbf{C}): \text{CAT}(\mathcal{K})^{op} \rightarrow \text{CDGA}, \quad I \mapsto \bigotimes_{i \in I} C_i,$$

by mapping a morphism  $I \subset J$  to the surjection  $\bigotimes_{i \in J} C_i \rightarrow \bigotimes_{i \in I} C_i$  sending each  $C_i$  with  $i \notin I$  to 1. Then the diagram  $\mathbf{k}[\cdot]^\mathcal{K}$  corresponds to the case  $C_i = \mathbf{k}[v]$ , the polynomial algebra on one generator of degree 2.

PROPOSITION 8.1.1.

- (a) *The diagram  $\mathcal{D}^\mathcal{K}(\mathbf{C})$  is Reedy fibrant. Therefore, there is a weak equivalence  $\lim \mathcal{D}^\mathcal{K}(\mathbf{C}) \xrightarrow{\simeq} \text{holim } \mathcal{D}^\mathcal{K}(\mathbf{C})$ . In particular, there is a weak equivalence  $\mathbb{Q}[\mathcal{K}] = \lim \mathbb{Q}[\cdot]^\mathcal{K} \xrightarrow{\simeq} \text{holim } \mathbb{Q}[\cdot]^\mathcal{K}$ .*
- (b) *The diagram  $\mathcal{D}_\mathcal{K}(\mathbf{X}, \mathbf{A})$  is Reedy cofibrant whenever each  $A_i \rightarrow X_i$  is a cofibration (e.g. when  $(X_i, A_i)$  is a cellular pair). Under this condition, there is a weak equivalence  $\text{hocolim } \mathcal{D}_\mathcal{K}(\mathbf{X}, \mathbf{A}) \xrightarrow{\simeq} (\mathbf{X}, \mathbf{A})^\mathcal{K}$ .*

PROOF. (a) Recall from Section C.1 that a  $\text{CAT}^{op}(\mathcal{K})$ -diagram  $\mathcal{C}$  is Reedy fibrant when the canonical map  $\mathcal{C}(I) \rightarrow \lim_{\mathcal{C}(\mathcal{K}^{op}(\partial\Delta(I)))} \mathcal{C}(I)$  is a fibration for each



$I \in \mathcal{K}$ . In our case,

$$\mathcal{D}^{\mathcal{K}}(\mathbf{C})(I) = \bigotimes_{i \in I} C_i, \quad \lim \mathcal{D}^{\mathcal{K}}(\mathbf{C})|_{\text{CAT}^{\text{op}}(\partial\Delta(I))} = \bigotimes_{i \in I} C_i/\mathcal{I},$$

where  $\mathcal{I}$  is the ideal generated by all products  $\prod_{i \in I} c_i$  with  $c_i \in C_i^+$ . Hence the Reedy fibrance condition is satisfied. Proposition C.3.3 implies that the canonical map  $\lim \mathcal{D}^{\mathcal{K}}(\mathbf{C}) \xrightarrow{\simeq} \text{holim } \mathcal{D}^{\mathcal{K}}(\mathbf{C})$  is a weak equivalence.

(b) A  $\text{CAT}(\mathcal{K})$ -diagram  $\mathcal{D}$  in  $\text{TOP}$  is Reedy cofibrant whenever each map  $\text{colim } \mathcal{D}|_{\text{CAT}(\partial\Delta(I))} \rightarrow \mathcal{D}(I)$  is a cofibration. In our case,

$$\text{colim } \mathcal{D}_{\mathcal{K}}(\mathbf{X}, \mathbf{A})|_{\text{CAT}(\partial\Delta(I))} = (\mathbf{X}, \mathbf{A})^{\partial\Delta(I)} \times \mathbf{A}^{[m] \setminus I}, \quad \mathcal{D}_{\mathcal{K}}(\mathbf{X}, \mathbf{A})(I) = (\mathbf{X}, \mathbf{A})^I,$$

so the Reedy cofibrance condition is satisfied.  $\square$

We now consider more specific models for particular polyhedral products and quasitoric manifolds. All cohomology in this section is with rational coefficients.

**Formality of  $\mathbf{X}^{\mathcal{K}}$  and  $(\mathbb{C}P^\infty)^{\mathcal{K}}$ .** Recall that we use the notation  $\mathbf{X}^{\mathcal{K}}$  for the polyhedral product  $(\mathbf{X}, pt)^{\mathcal{K}}$ , and a space  $X$  is formal if the commutative dg-algebra  $A_{PL}(X) = A^*(S_\bullet X)$  is weakly equivalent to its cohomology  $H^*(X)$ .

**THEOREM 8.1.2.** *If each space  $X_i$  in  $\mathbf{X} = (X_1, \dots, X_m)$  is formal, then the polyhedral product  $\mathbf{X}^{\mathcal{K}}$  is also formal.*

**PROOF.** For notational clarity, we denote the colimit of the diagram  $\mathcal{D}_{\mathcal{K}}(\mathbf{X}, pt)$  defining  $\mathbf{X}^{\mathcal{K}}$  by  $\text{colim}_I \mathbf{X}^I$ , where  $I \in \mathcal{K}$ . We shall prove that  $A_{PL} = A^*S_\bullet$  maps this colimit to the limit of dg-algebras  $A_{PL}(\mathbf{X}^I) \cong \bigotimes_{i \in I} A_{PL}(X_i)$ . For this it is convenient to work with simplicial sets, as the definition of the polynomial de Rham functor  $A^*$  implies that it takes colimits in  $\text{SSET}$  to limits in  $\text{CDGA}$ , see [39, §13.5].

We have a natural weak equivalence  $|S_\bullet(\mathbf{X}^I)| \rightarrow \mathbf{X}^I$ . Since the total singular complex functor  $S_\bullet$  is right adjoint, it preserves products, so we have an equivalence  $|(S_\bullet \mathbf{X})^I| \rightarrow \mathbf{X}^I$ . The  $\text{CAT}(\mathcal{K})$ -diagram  $\mathcal{D}_{\mathcal{K}}(\mathbf{X}, pt)$  given by  $I \mapsto \mathbf{X}^I$  is cofibrant by Proposition 8.1.1, and the diagram  $I \mapsto |(S_\bullet \mathbf{X})^I|$  is cofibrant by the same reason. We therefore have a weak equivalence  $\text{colim}_I |(S_\bullet \mathbf{X})^I| \rightarrow \text{colim}_I \mathbf{X}^I$  by Proposition C.3.4. Applying  $A_{PL}$ , we obtain the zigzag

$$A_{PL}(\mathbf{X}^{\mathcal{K}}) = A_{PL} \text{colim}_I \mathbf{X}^I \xrightarrow{\simeq} A_{PL} \text{colim}_I |(S_\bullet \mathbf{X})^I| \cong A_{PL} |\text{colim}_I (S_\bullet \mathbf{X})^I|,$$

where in the last identity we used the fact that the realisation functor is left adjoint and therefore preserves colimits. Given an arbitrary simplicial set  $Y_\bullet$ , there is a quasi-isomorphism  $A_{PL}(|Y_\bullet|) = A^*(S_\bullet |Y_\bullet|) \xrightarrow{\simeq} A^*(Y_\bullet)$  induced by the equivalence  $Y_\bullet \rightarrow S_\bullet |Y_\bullet|$ . We therefore can continue the zigzag above as

$$A_{PL} |\text{colim}_I (S_\bullet \mathbf{X})^I| \xrightarrow{\simeq} A^*(\text{colim}_I (S_\bullet \mathbf{X})^I) \cong \lim_I A^*(S_\bullet \mathbf{X})^I = \lim_I A_{PL}(\mathbf{X}^I).$$

Now, since each  $X_i$  is formal, there is a zigzag of quasi-isomorphisms  $A_{PL}(X_i) \leftarrow \dots \rightarrow H^*(X_i)$ . Applying Proposition 8.1.1 (a) for the case  $C_i = A_{PL}(X_i)$  and  $C_i = H^*(X_i)$  we obtain that both the corresponding diagrams  $\mathcal{D}^{\mathcal{K}}(\mathbf{C})$  are fibrant, so their limits are weakly equivalent by Proposition C.3.4:

$$\lim_I A_{PL}(\mathbf{X}^I) \xleftarrow{\simeq} \dots \xrightarrow{\simeq} \lim_I H^*(\mathbf{X}^I)$$

(here we also use the fact that  $H^*(\mathbf{X}^I) \cong \bigotimes_{i \in I} H^*(X_i)$ , as we work with rational coefficients). The proof is finished by appealing to the isomorphism

$$\lim_I H^*(\mathbf{X}^I) \cong H^*(\mathbf{X}^{\mathcal{K}}).$$

In the case  $X_i = \mathbb{C}P^\infty$  this is proved in Proposition 4.3.1 (we only need this case in this section). For the general case, the proof will be given in Section 8.3.  $\square$

**COROLLARY 8.1.3.** *The Davis–Januszkiewicz space  $ET^m \times_{T^m} \mathcal{Z}_{\mathcal{K}}$  is formal.*

**PROOF.** This follows from the homotopy equivalence  $(\mathbb{C}P^\infty)^{\mathcal{K}} \simeq ET^m \times_{T^m} \mathcal{Z}_{\mathcal{K}}$  of Theorem 4.3.2.  $\square$

**REMARK.** The case  $X_i = \mathbb{C}P^\infty$  of Theorem 8.1.2 (formality of the Davis–Januszkiewicz space) was proved in [243, Theorem 5.5] and [57, Lemma 7.35]. According to [243, Theorem 4.8], the space  $(\mathbb{C}P^\infty)^{\mathcal{K}}$  is *integrally* formal, i.e. the singular cochain algebra  $C^*((\mathbb{C}P^\infty)^{\mathcal{K}}; \mathbb{Z})$  is formal as a non-commutative dg-algebra.

The result of Theorem 8.1.2 cannot be extended to polyhedral products of the form  $(\mathbf{X}, \mathbf{A})^{\mathcal{K}}$ . Although  $\lim_I A_{PL}((\mathbf{X}, \mathbf{A})^I)$  is still a model for  $A_{PL}(\mathbf{X}, \mathbf{A})^{\mathcal{K}}$  (see the next subsection), the  $\text{CAT}(\mathcal{K})^{op}$ -diagram  $I \mapsto H^*((\mathbf{X}, \mathbf{A})^I)$  is *not* fibrant in general, and therefore its limit is neither isomorphic to  $\lim_I A_{PL}((\mathbf{X}, \mathbf{A})^I)$ , nor to  $H^*((\mathbf{X}, \mathbf{A})^{\mathcal{K}})$ . Indeed, as we have seen in Section 4.9, the moment-angle complex  $\mathcal{Z}_{\mathcal{K}} = (D^2, S^1)^{\mathcal{K}}$  is not formal in general.

The argument in the proof of Theorem 8.1.2 shows that rational cohomology, as a functor from TOP to CDGA, maps homotopy colimit of diagram  $\mathcal{D}_{\mathcal{K}}(\mathbf{X}, pt)$  to homotopy limit of diagram  $\mathcal{D}^{\mathcal{K}}(H^*(\mathbf{X}))$ .

The coformality of  $(\mathbb{C}P^\infty)^{\mathcal{K}}$  is explored in Theorem 8.5.6.

**Models for  $(\mathbf{X}, \mathbf{A})^{\mathcal{K}}$  and  $\mathcal{Z}_{\mathcal{K}}$ .** Given a polyhedral product  $(\mathbf{X}, \mathbf{A})^{\mathcal{K}} = \text{colim}_I (\mathbf{X}, \mathbf{A})^I$ , we can consider the  $\text{CAT}(\mathcal{K})^{op}$ -diagram of commutative dg-algebras defined by  $I \mapsto A_{PL}((\mathbf{X}, \mathbf{A})^I)$ , and denote its limit by  $\lim_I A_{PL}((\mathbf{X}, \mathbf{A})^I)$ .

**PROPOSITION 8.1.4.** *There is a quasi-isomorphism of commutative dg-algebras*

$$A_{PL}((\mathbf{X}, \mathbf{A})^{\mathcal{K}}) \xrightarrow{\simeq} \lim_I A_{PL}((\mathbf{X}, \mathbf{A})^I).$$

**PROOF.** Repeat literally the argument in the first part of proof of Theorem 8.1.2 (before appealing to the formality of  $X_i$ ).  $\square$

More specific models can be obtained in the particular case  $\mathcal{Z}_{\mathcal{K}} = (D^2, S^1)^{\mathcal{K}}$ .

Alongside with the diagram  $\mathcal{D}_{\mathcal{K}}(D^2, S^1)$  we consider the  $\text{CAT}(\mathcal{K})$ -diagram  $\mathcal{D}_{\mathcal{K}}(pt, S^1)$  in TOP whose value on  $I \subset J$  is the quotient map of tori

$$(8.2) \quad T^m / T^I = (S^1)^{[m] \setminus I} \rightarrow (S^1)^{[m] \setminus J} = T^m / T^J.$$

This diagram is not cofibrant; we denote its homotopy colimit by  $\text{hocolim}_I T^m / T^I$ .

**PROPOSITION 8.1.5 ([261]).** *There is a weak equivalence  $\mathcal{Z}_{\mathcal{K}} \simeq \text{hocolim}_I T^m / T^I$ .*

**PROOF.** Objectwise projections  $(D^2, S^1)^I \rightarrow (S^1)^{[m] \setminus I}$  induce a weak equivalence of diagrams  $\mathcal{D}_{\mathcal{K}}(D^2, S^1) \rightarrow \mathcal{D}_{\mathcal{K}}(pt, S^1)$ , whose source is Reedy cofibrant but whose target is not. Proposition C.3.2 therefore determines a weak equivalence

$$\mathcal{Z}_{\mathcal{K}} = \text{colim}_I (D^2, S^1)^I \xrightarrow{\simeq} \text{hocolim}_I T^m / T^I. \quad \square$$

In order to obtain a rational model of  $\mathcal{Z}_{\mathcal{K}}$  from this homotopy limit decomposition, we consider  $\text{CAT}^{op}(\mathcal{K})$ -diagrams  $\Lambda[m] \otimes \mathbb{Q}[\cdot]^{\mathcal{K}}$  and  $\Lambda[m] / \Lambda[\cdot]^{\mathcal{K}}$  in CDGA. The first is obtained by objectwise tensoring the diagram  $\mathbb{Q}[\cdot]^{\mathcal{K}}$  with the exterior algebra  $\Lambda[m] = \Lambda[u_1, \dots, u_m]$ ,  $\deg u_i = 1$ , and imposing the standard Koszul differential. So the value of  $\Lambda[m] \otimes \mathbb{Q}[\cdot]^{\mathcal{K}}$  on  $I \subset J$  is the quotient map

$$(\Lambda[m] \otimes \mathbb{Q}[v_i : i \in J], d) \rightarrow (\Lambda[m] \otimes \mathbb{Q}[v_i : i \in I], d),$$

where  $d$  is defined on  $\Lambda[m] \otimes \mathbb{Q}[v_i : i \in I]$  by  $du_i = v_i$  for  $i \in I$  and  $du_i = 0$  otherwise. The value of the second diagram  $\Lambda[m]/\Lambda[\cdot]^\mathcal{K}$  on  $I \subset J$  is the monomorphism

$$\Lambda[u_i : i \notin J] \rightarrow \Lambda[u_i : i \notin I]$$

of algebras with zero differential. Objectwise projections induce a weak equivalence

$$(8.3) \quad \Lambda[m] \otimes \mathbb{Q}[\cdot]^\mathcal{K} \rightarrow \Lambda[m]/\Lambda[\cdot]^\mathcal{K}$$

in  $[\text{CAT}^{op}(\mathcal{K}), \text{CDGA}]$ , whose source is Reedy fibrant but whose target is not.

The following result describes the first algebraic model of  $\mathcal{Z}_\mathcal{K}$ , and also recovers the main result of Section 4.5 with rational coefficients.

**THEOREM 8.1.6 ([260]).** *The commutative differential graded algebras  $A_{PL}(\mathcal{Z}_\mathcal{K})$  and  $\text{holim } \Lambda[m]/\Lambda[\cdot]^\mathcal{K} = \text{holim}_I \Lambda[u_i : i \notin I]$  are weakly equivalent in CDGA.*

**PROOF.** We first construct models for the products of disks and circles  $(D^2, S^1)^I$  which are compatible with the inclusions  $(D^2, S^1)^I \subset (D^2, S^1)^J$  forming the diagram  $\mathcal{D}_\mathcal{K}(D^2, S^1)$ . The model of a single disk  $D^2$  is the Koszul algebra  $(\Lambda[u] \otimes \mathbb{Q}[v], d)$ . The map  $\Lambda[u] \otimes \mathbb{Q}[v] \rightarrow A_{PL}(D^2)$  takes  $u$  to the form  $\omega = xdy - ydx$  (where  $(x, y) \in D^2$  are the standard cartesian coordinates), and takes  $v$  to its differential  $2dx \wedge dy$ . It is important that the map  $\Lambda[u] \otimes \mathbb{Q}[v] \rightarrow A_{PL}(D^2)$  restricts to the quasi-isomorphism  $\Lambda[u] \rightarrow A_{PL}(S^1)$  taking  $u$  to the form  $d\varphi$  representing a generator of  $H^1(S^1)$ . (Here  $\varphi$  is the polar angle; note that the restriction of  $xdy - ydx = r^2 d\varphi$  to  $S^1$  is closed, but not exact, because  $\varphi$  is not a globally defined function.) Taking product yields compatible quasi-isomorphisms

$$(\Lambda[u_1, \dots, u_m] \otimes \mathbb{Q}[v_i : i \in I], d) \xrightarrow{\simeq} A_{PL}((D^2, S^1)^I),$$

and therefore a weak equivalence of Reedy fibrant diagrams in CDGA. Their limits are therefore quasi-isomorphic, which together with the quasi-isomorphisms of Proposition 8.1.4, Proposition C.3.3 and (8.3) gives the required zigzag

$$\begin{aligned} A_{PL}(\mathcal{Z}_\mathcal{K}) &= A_{PL}((D^2, S^1)^\mathcal{K}) \xrightarrow{\simeq} \lim_I A_{PL}((D^2, S^1)^I) \\ &\xleftarrow{\simeq} \lim_I (\Lambda[u_1, \dots, u_m] \otimes \mathbb{Q}[v_i : i \in I], d) \xrightarrow{\simeq} \text{holim}_I \Lambda[u_i : i \notin I]. \quad \square \end{aligned}$$

On the other hand, the zigzag above together with Exercise 3.1.15 (or Lemma 3.5.11) gives a weak equivalence

$$(8.4) \quad A_{PL}(\mathcal{Z}_\mathcal{K}) \simeq \lim_I (\Lambda[m] \otimes \mathbb{Q}[v_i : i \in I], d) = (\Lambda[m] \otimes \mathbb{Q}[\mathcal{K}], d),$$

which implies the isomorphism of Theorem 4.5.4 in the case of rational coefficients:

$$H^*(\mathcal{Z}_\mathcal{K}; \mathbb{Q}) \cong H(\Lambda[u_1, \dots, u_m] \otimes \mathbb{Q}[\mathcal{K}], d).$$

To obtain the second algebraic model for  $\mathcal{Z}_\mathcal{K}$  we regard it as the homotopy fibre of the inclusion  $(\mathbb{C}P^\infty)^\mathcal{K} \hookrightarrow (\mathbb{C}P^\infty)^m = BT^m$  (see Theorem 4.3.2). We therefore can identify  $\mathcal{Z}_\mathcal{K}$  with the limit of the following diagram in TOP:

$$(8.5) \quad \begin{array}{ccc} & ET^m & \\ & \downarrow & \\ (\mathbb{C}P^\infty)^\mathcal{K} & \longrightarrow & BT^m \end{array}$$

This diagram is fibrant for the appropriate Reedy structure, as  $ET^m \rightarrow BT^m$  is a fibration (see Proposition C.3.5 (b)), so its limit is weakly equivalent to the homotopy limit.

Now we apply  $A_{PL}$  to (8.5), on the understanding that it does not generally convert pullbacks to pushouts [39, §3]. We obtain the diagram

$$(8.6) \quad \begin{array}{ccc} A_{PL}(BT^m) & \longrightarrow & A_{PL}(ET^m) \\ \downarrow & & \\ A_{PL}((\mathbb{C}P^\infty)^\mathcal{K}) & & \end{array}$$

in CDGA, which is not Reedy cofibrant. Here is the second model for  $\mathcal{Z}_\mathcal{K}$ :

**THEOREM 8.1.7 ([260]).** *The algebra  $A_{PL}(\mathcal{Z}_\mathcal{K})$  is weakly equivalent the homotopy colimit of (8.6) in CDGA.*

**PROOF.** There is an objectwise weak equivalence mapping the diagram

$$\begin{array}{ccc} \mathbb{Q}[v_1, \dots, v_m] & \longrightarrow & (\Lambda[u_1, \dots, u_m] \otimes \mathbb{Q}[v_1, \dots, v_m], d) \\ \downarrow & & \\ \mathbb{Q}[\mathcal{K}] & & \end{array}$$

to (8.6); here the upper arrow  $\mathbb{Q}[m] \rightarrow (\Lambda[m] \otimes \mathbb{Q}[m], d)$  is the standard model for the fibration  $ET^m \rightarrow BT^m$ , and  $\mathbb{Q}[\mathcal{K}]$  is a model for  $A_{PL}((\mathbb{C}P^\infty)^\mathcal{K})$  by Theorem 8.1.2. The above diagram is cofibrant, because the upper arrow is a cofibration in CDGA, and its colimit is  $(\Lambda[m] \otimes \mathbb{Q}[\mathcal{K}], d)$ . So the result follows from (8.4).  $\square$

Theorem 8.1.7 chimes with the rational models of fibrations from [112, §15(c)].

**REMARK.** We may summarise the results of Theorems 8.1.6 and 8.1.7 as follows. As functors  $\text{TOP} \rightarrow \text{CDGA}$ , both rational cohomology and  $A_{PL}$  map homotopy colimits to homotopy limits on diagrams  $\mathcal{D}_\mathcal{K}(pt, S^1)$ ,  $I \mapsto T^m/T^I$ , and map homotopy limits to homotopy colimits on diagrams (8.5).

**Models for toric and quasitoric manifolds.** Let  $M = M(P, \Lambda)$  be a quasitoric manifold over a simple  $n$ -polytope  $P$  with characteristic map  $\Lambda: \mathbb{Z}^n \rightarrow \mathbb{Z}^n$ . Here we denote by  $\mathcal{K}$  the dual sphere triangulation  $\mathcal{K}_P$  of  $P$ . We recall from Proposition 7.3.12 that  $M$  can be identified with the quotient of the moment-angle manifold  $\mathcal{Z}_P = \mathcal{Z}_\mathcal{K}$  by the free action of the  $(m - n)$ -torus  $K(\Lambda) = \text{Ker}(\Lambda: T^m \rightarrow T^n)$ ; we denote the map of tori defined by  $\Lambda$  by the same letter for simplicity. All results below are equally applicable to toric manifolds  $M$ , in which case  $\mathcal{K}$  is the underlying complex of the corresponding complete regular simplicial fan.

Our topological and algebraic models of  $M$  are obtained from those of  $\mathcal{Z}_\mathcal{K}$  by the appropriate factorisation by the action of  $K(\Lambda)$ .

We consider the  $\text{CAT}(\mathcal{K})$ -diagram  $\mathcal{D}_\mathcal{K}(pt, S^1)/K(\Lambda)$  obtained by factorisation of (8.2); its value on  $I \subset J$  is the quotient map of tori

$$T^n/\Lambda(T^I) \rightarrow T^n/\Lambda(T^J),$$

where we identified  $T^m/K(\Lambda)$  with  $T^n$ . This diagram is not cofibrant; we denote its homotopy colimit by  $\text{hocolim}_I T^n/\Lambda(T^I)$ .

The following result was first proved by Welker, Ziegler and Živaljević in [321]. It appears to be the earliest mention of homotopy colimits in the toric context, and refers to a diagram that is clearly not Reedy cofibrant:

**PROPOSITION 8.1.8.** *There is a weak equivalence  $M \simeq \text{hocolim}_I T^n/\Lambda(T^I)$ .*

PROOF. As in the proof of Proposition 8.1.5, we consider objectwise projections  $(D^2, S^1)^I \rightarrow T^m/T^I = (S^1)^{[m] \setminus I}$ , and take quotients by the action of  $K(\Lambda)$ . As a result, we obtain a weak equivalence

$$M = \mathcal{Z}_{\mathcal{K}}/K(\Lambda) = \operatorname{colim}_I ((D^2, S^1)^I/K(\Lambda)) \xrightarrow{\simeq} \operatorname{hocolim}_I T^m/\Lambda(T^I). \quad \square$$

Next we construct an analogue of the algebraic model (8.4) for quasitoric manifolds. For this we consider the elements

$$t_i = \lambda_{i1}v_1 + \cdots + \lambda_{im}v_m, \quad 1 \leq i \leq n,$$

in the face ring  $\mathbb{Q}[\mathcal{K}] = \mathbb{Q}[v_1, \dots, v_m]/\mathcal{I}_{\mathcal{K}}$  corresponding to the rows of matrix  $\Lambda$ .

LEMMA 8.1.9. *For a toric or quasitoric manifold  $M$ , the algebra  $A_{PL}(M)$  is weakly equivalent to the commutative dg-algebra*

$$(\Lambda[x_1, \dots, x_n] \otimes \mathbb{Q}[\mathcal{K}], d), \quad \text{with } dx_i = t_i, \quad dv_i = 0.$$

PROOF. The argument is similar to that for Theorem 8.1.6. We consider a  $\operatorname{CAT}^{op}(\mathcal{K})$ -diagram  $\Lambda[n] \otimes \mathbb{Q}[\cdot]^{\mathcal{K}}$ , whose value on  $I \subset J$  is the quotient map

$$(\Lambda[x_1, \dots, x_n] \otimes \mathbb{Q}[v_i: i \in J], d) \rightarrow (\Lambda[x_1, \dots, x_n] \otimes \mathbb{Q}[v_i: i \in I], d),$$

where  $d$  is defined on  $\Lambda[n] \otimes \mathbb{Q}[v_i: i \in I]$  by  $dx_i = t_i$  for  $i \in I$  and  $dx_i = 0$  otherwise. Then define quasi-isomorphisms

$$(\Lambda[x_1, \dots, x_n] \otimes \mathbb{Q}[v_i: i \in I], d) \xrightarrow{\simeq} A_{PL}((D^2, S^1)^I/K(\Lambda))$$

by sending each  $x_i$  to the  $K(\Lambda)$ -invariant 1-form  $\lambda_{i1}r_1^2d\varphi_1 + \cdots + \lambda_{im}r_m^2d\varphi_m$ , where  $(r_i, \varphi_i)$  are polar coordinates on the  $i$ th disk or circle. These quasi-isomorphisms are compatible with the maps corresponding to inclusions of simplices  $I \subset J$  and therefore provide a weak equivalence of Reedy fibrant diagrams in CDGA. Their limits are therefore quasi-isomorphic, and we obtain the required zigzag

$$\begin{aligned} A_{PL}(M) &= A_{PL}((D^2, S^1)^{\mathcal{K}}/K(\Lambda)) \xrightarrow{\simeq} \lim_I A_{PL}((D^2, S^1)^I/K(\Lambda)) \\ &\xleftarrow{\simeq} \lim_I (\Lambda[x_1, \dots, x_n] \otimes \mathbb{Q}[v_i: i \in I], d) = (\Lambda[x_1, \dots, x_n] \otimes \mathbb{Q}[\mathcal{K}], d). \quad \square \end{aligned}$$

REMARK. The (quasi)toric manifold  $M = M(P, \Lambda)$  is the homotopy fibre of the composition of the inclusion  $(\mathbb{C}P^\infty)^{\mathcal{K}} \rightarrow BT^m$  and the map  $B\Lambda: BT^m \rightarrow BT^n$  (an exercise). In other words, there is a homotopy pullback diagram

$$(8.7) \quad \begin{array}{ccc} M & \longrightarrow & ET^n \\ \downarrow & & \downarrow \\ (\mathbb{C}P^\infty)^{\mathcal{K}} & \xrightarrow{i} & BT^m \xrightarrow{B\Lambda} BT^n \end{array}$$

The model of Lemma 8.1.9 can be obtained by applying the results of [112, §15(c)] to the fibration  $M \rightarrow (\mathbb{C}P^\infty)^{\mathcal{K}}$  above.

Now we can prove the main result of this subsection:

THEOREM 8.1.10 ([260]). *Every toric or quasitoric manifold is formal.*

PROOF. We use the model of Lemma 8.1.9 and utilise the fact that  $\mathbb{Q}[\mathcal{K}]$  is Cohen–Macaulay (Corollary 3.3.13), i.e.  $\mathbb{Q}[\mathcal{K}]$  is free as module over  $\mathbb{Q}[t_1, \dots, t_n]$ .

Hence  $\otimes_{\mathbb{Q}[t_1, \dots, t_n]} \mathbb{Q}[\mathcal{K}]$  is a right exact functor, and applying it to the quasi-isomorphism  $(\Lambda[u_1, \dots, u_n] \otimes \mathbb{Q}[t_1, \dots, t_n], d) \rightarrow \mathbb{Q}$  yields a quasi-isomorphism

$$(\Lambda[u_1, \dots, u_n] \otimes \mathbb{Q}[\mathcal{K}], d) \rightarrow \mathbb{Q}[\mathcal{K}]/(t_1, \dots, t_n),$$

which is given by the projection onto the second factor. Since  $\mathbb{Q}[\mathcal{K}]/(t_1, \dots, t_n) \cong H^*(M)$  by Theorem 7.3.27, the result follows from Lemma 8.1.9.  $\square$

Similar arguments apply more generally to torus manifolds over homology polytopes (see Section 7.4), and even to arbitrary torus manifolds with zero odd dimensional cohomology. In the latter case,  $\mathbb{Q}[\mathcal{K}]$  is replaced by the face ring  $\mathbb{Q}[\mathcal{S}]$  of an appropriate simplicial poset  $\mathcal{S}$  (see exercises below).

Note also that the formality of projective toric manifolds follows immediately from the fact that they are Kähler.

### Exercises.

8.1.11. Construct the homotopy pullback diagram (8.7).

8.1.12. Extend the argument of Theorem 8.1.2 to show that the polyhedral power  $(\mathbb{C}P^\infty, pt)^{\mathcal{S}}$  (see Construction 4.10.1) is formal for any simplicial poset  $\mathcal{S}$ .

8.1.13. Show that a torus manifold  $M$  with  $H^{\text{odd}}(M; \mathbb{Z}) = 0$  is formal. (Hint use Theorem 7.4.35 establishing an isomorphism  $H^*(M) \cong \mathbb{Q}[\mathcal{S}]$ , where  $\mathbb{Q}[\mathcal{S}]$  is the face ring of the simplicial poset dual to the quotient  $M/T = Q$ , and use Lemma 7.4.34 to show that  $\mathbb{Q}[\mathcal{S}]$  is free over  $\mathbb{Q}[t_1, \dots, t_n]$ .)

## 8.2. Wedges of spheres and connected sums of sphere products

There are two situations when the homotopy type of the moment-angle complex  $\mathcal{Z}_{\mathcal{K}}$  can be described explicitly. The first concerns a family of examples of polytopal sphere triangulations  $\mathcal{K}$  for which  $\mathcal{Z}_{\mathcal{K}}$  is homeomorphic to a connected sum of sphere products, with two spheres in each product. The proofs use differential topology and surgery theory; we included sample results as Theorem 4.6.12 and Theorem 6.2.10 and refer to a more detailed account in the work of Gitler and López de Medrano [127]. The second situation is when  $\mathcal{Z}_{\mathcal{K}}$  is homotopy equivalent to a wedge of spheres; the corresponding families of examples of  $\mathcal{K}$  were constructed by Grbić and Theriault in [132], [133] and are reviewed here.

**THEOREM 8.2.1 ([133]).** *Let  $\mathcal{K} = \mathcal{K}_1 \cup_I \mathcal{K}_2$  be a simplicial complex obtained by gluing  $\mathcal{K}_1$  and  $\mathcal{K}_2$  along a common face, which may be empty. If  $\mathcal{Z}_{\mathcal{K}_1}$  and  $\mathcal{Z}_{\mathcal{K}_2}$  are homotopy equivalent to wedges of spheres, then  $\mathcal{Z}_{\mathcal{K}}$  is also homotopy equivalent to a wedge of spheres.*

We reproduce the proof from [133], which uses two lemmata.

LEMMA 8.2.2 (Cube Lemma). *Suppose there is a homotopy commutative diagram of spaces*

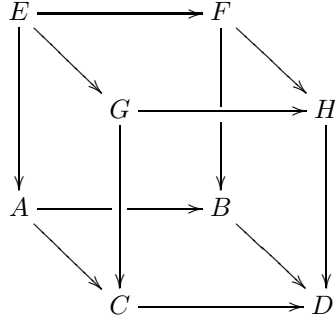

*Suppose the bottom face is a homotopy pushout and the four sides are homotopy pullbacks. Then the top face is a homotopy pushout.*

PROOF. See [212, Theorem 25]. Note that the statement is fairly straightforward in the case when  $D = B \cup_A C$  and the vertical arrows are locally trivial fibre bundles obtained by pulling back the bundle  $H \rightarrow D$  along the arrows of the bottom face. This will be enough for our purposes.  $\square$

The *join* of spaces  $A, B$  is defined as the identification space

$$A * B = A \times B \times \mathbb{I} / (a, b_1, 0) \sim (a, b_2, 0), (a_1, b, 1) \sim (a_2, b, 1).$$

The product  $A \times B$  embeds into the join as  $A \times B \times \frac{1}{2}$ . Furthermore, the lower half

$$A * B_{\leq \frac{1}{2}} = \{(a, b, t) \in A * B : t \leq \frac{1}{2}\},$$

of the join is the mapping cylinder of the first projection  $\pi_1 : A \times B \rightarrow A$ , and the upper half  $A * B_{\geq \frac{1}{2}}$  is the mapping cylinder of the second projection  $\pi_2 : A \times B \rightarrow B$ . It follows that there is a homotopy pushout diagram

$$(8.8) \quad \begin{array}{ccc}
 A \times B & \xrightarrow{\pi_2} & B \\
 \pi_1 \downarrow & & \downarrow \\
 A & \longrightarrow & A * B,
 \end{array}$$

which can be viewed as the homotopy-theoretic definition of the join.

For pointed spaces  $A, B$ , there are canonical homotopy equivalences  $\Sigma A \wedge B \simeq \Sigma(A \wedge B) \simeq A * B$ , where  $A \wedge B = (A \times B) / (A \times pt \cup pt \times B)$  is the smash product. The *left half-smash product* is  $A \rtimes B = A \times B / (A \times pt)$  and the *right half-smash product* is  $A \times B = A \times B / (pt \times B)$ . Let  $\epsilon_A$  denote the map collapsing  $A$  to a point.

LEMMA 8.2.3. *Let  $A, B, C$  and  $D$  be spaces. Define  $Q$  as the homotopy pushout*

$$\begin{array}{ccc}
 A \times B & \xrightarrow{\epsilon_A \times \text{id}_B} & C \times B \\
 \text{id}_A \times \epsilon_B \downarrow & & \downarrow \\
 A \times D & \longrightarrow & Q.
 \end{array}$$

*Then  $Q \simeq (A * B) \vee (C \times B) \vee (A \times D)$ .*

PROOF. We can decompose the pushout square above as

$$(8.9) \quad \begin{array}{ccccc} A \times B & \xrightarrow{\pi_2} & B & \xrightarrow{i_2} & C \times B \\ \pi_1 \downarrow & & \downarrow & & \downarrow \\ A & \longrightarrow & A * B & \xrightarrow{j_2} & E \\ i_1 \downarrow & & j_1 \downarrow & & \downarrow \\ A \times D & \longrightarrow & F & \longrightarrow & Q, \end{array}$$

where  $i_1$  and  $i_2$  denote the inclusions into the first and second factor, and each small square is a homotopy pushout.

Since the map  $A \rightarrow A * B$  is null homotopic, we can pinch out  $A$  in the left bottom square above to obtain a homotopy pushout

$$\begin{array}{ccc} pt & \longrightarrow & A * B \\ \downarrow & & \downarrow j_1 \\ A \times D & \longrightarrow & F. \end{array}$$

Hence  $F \simeq (A * B) \vee (A \times D)$  and  $j_1$  is homotopic to the inclusion into the first wedge summand. Similarly,  $E \simeq (A * B) \vee (C \times B)$ . The required decomposition of  $Q$  now follows by considering the right bottom square in (8.9).  $\square$

PROOF OF THEOREM 8.2.1. Recall from Theorem 4.3.2 that  $\mathcal{Z}_{\mathcal{K}}$  is the homotopy fibre of the canonical inclusion  $i: (\mathbb{C}P^\infty)^{\mathcal{K}} \rightarrow (\mathbb{C}P^\infty)^m = BT^m$ . Assume that  $\mathcal{K}_1$  is a simplicial complex on  $[m_1]$ ,  $\mathcal{K}_2$  is a simplicial complex on  $[m_2]$  and  $\mathcal{K}$  is a simplicial complex on  $[m]$ , so that  $m = m_1 + m_2 - |I|$ . By some abuse of notation we assume that the set  $[m_1]$  is included as the first  $m_1$  elements in  $[m]$ , and  $[m_2]$  is included as the last  $m_2$  elements. This defines the inclusions like  $(\mathbb{C}P^\infty)^{m_1} \rightarrow (\mathbb{C}P^\infty)^m$ ,  $(\mathbb{C}P^\infty)^{\mathcal{K}_2} \rightarrow (\mathbb{C}P^\infty)^{\mathcal{K}}$ , etc. We have a pushout square

$$\begin{array}{ccc} (\mathbb{C}P^\infty)^I & \longrightarrow & (\mathbb{C}P^\infty)^{\mathcal{K}_1} \\ \downarrow & & \downarrow \\ (\mathbb{C}P^\infty)^{\mathcal{K}_2} & \longrightarrow & (\mathbb{C}P^\infty)^{\mathcal{K}}. \end{array}$$

Map each of the four corners of this pushout into  $(\mathbb{C}P^\infty)^m$  and take homotopy fibres. This gives homotopy fibrations

$$\begin{aligned} T^{m-m_2} \times T^{m-m_1} = T^{m-|I|} &\rightarrow (\mathbb{C}P^\infty)^I \rightarrow (\mathbb{C}P^\infty)^m, \\ \mathcal{Z}_{\mathcal{K}_1} \times T^{m-m_1} &\rightarrow (\mathbb{C}P^\infty)^{\mathcal{K}_1} \rightarrow (\mathbb{C}P^\infty)^m, \\ T^{m-m_2} \times \mathcal{Z}_{\mathcal{K}_2} &\rightarrow (\mathbb{C}P^\infty)^{\mathcal{K}_2} \rightarrow (\mathbb{C}P^\infty)^m, \\ \mathcal{Z}_{\mathcal{K}} &\rightarrow (\mathbb{C}P^\infty)^{\mathcal{K}} \rightarrow (\mathbb{C}P^\infty)^m. \end{aligned}$$

Including  $(\mathbb{C}P^\infty)^I$  into  $(\mathbb{C}P^\infty)^{\mathcal{K}_1}$  gives a homotopy pullback diagram

$$\begin{array}{ccccccc} \Omega BT^m & \longrightarrow & T^{m-|I|} & \longrightarrow & (\mathbb{C}P^\infty)^I & \longrightarrow & BT^m \\ \parallel & & \downarrow \theta & & \downarrow & & \parallel \\ \Omega BT^m & \longrightarrow & \mathcal{Z}_{\mathcal{K}_1} \times T^{m-m_1} & \longrightarrow & (\mathbb{C}P^\infty)^{\mathcal{K}_1} & \longrightarrow & BT^m \end{array}$$



for some map  $\theta$  of fibres. We now identify  $\theta$ . With  $BT^m = \prod_{i=1}^m \mathbb{C}P^\infty$ , the pullback just described is the product of the homotopy pullback

$$\begin{array}{ccccccc} \Omega BT^{m_1} & \longrightarrow & T^{m-m_2} & \longrightarrow & (\mathbb{C}P^\infty)^I & \longrightarrow & BT^{m_1} \\ \parallel & & \downarrow \theta' & & \downarrow & & \parallel \\ \Omega BT^{m_1} & \longrightarrow & \mathcal{Z}_{\mathcal{K}_1} & \longrightarrow & (\mathbb{C}P^\infty)^{\mathcal{K}_1} & \longrightarrow & BT^{m_1} \end{array}$$

and the path-loop fibration  $T^{m-m_1} \rightarrow pt \rightarrow BT^{m-m_1}$ . So  $\theta = \theta' \times \text{id}_{T^{m-m_1}}$ . Further,  $T^{m-m_2}$  is a retract of  $\Omega BT^{m_1} \simeq T^{m_1}$  and  $\Omega BT^{m_1} \rightarrow \mathcal{Z}_{\mathcal{K}_1}$  is null homotopic since  $\Omega BT^{m_1}$  is a retract of  $\Omega((\mathbb{C}P^\infty)^{\mathcal{K}_1})$ . Hence  $\theta' \simeq \epsilon_{T^{m-m_2}}$  and therefore  $\theta \simeq \epsilon_{T^{m-m_2}} \times \text{id}_{T^{m-m_1}}$ . A similar argument for the inclusion of  $(\mathbb{C}P^\infty)^I$  into  $(\mathbb{C}P^\infty)^{\mathcal{K}_2}$  shows that the map of fibres  $T^{m-m_2} \times T^{m-m_1} \rightarrow T^{m-m_2} \times \mathcal{Z}_{\mathcal{K}_2}$  is homotopic to  $\text{id}_{T^{m-m_2}} \times \epsilon_{T^{m-m_1}}$ .

Collecting all this information about homotopy fibres, Lemma 8.2.2 shows that there is a homotopy pushout

$$\begin{array}{ccc} T^{m-m_2} \times T^{m-m_1} & \xrightarrow{\epsilon \times \text{id}} & \mathcal{Z}_{\mathcal{K}_1} \times T^{m-m_1} \\ \text{id} \times \epsilon \downarrow & & \downarrow \\ T^{m-m_2} \times \mathcal{Z}_{\mathcal{K}_2} & \longrightarrow & \mathcal{Z}_{\mathcal{K}}. \end{array}$$

Lemma 8.2.3 then gives a homotopy decomposition

$$(8.10) \quad \mathcal{Z}_{\mathcal{K}} \simeq (T^{m-m_2} * T^{m-m_1}) \vee (\mathcal{Z}_{\mathcal{K}_1} \rtimes T^{m-m_1}) \vee (T^{m-m_2} \ltimes \mathcal{Z}_{\mathcal{K}_2}).$$

To show  $\mathcal{Z}_{\mathcal{K}}$  is homotopy equivalent to a wedge of spheres, we show that each of  $T^{m-m_2} * T^{m-m_1}$ ,  $\mathcal{Z}_{\mathcal{K}_1} \rtimes T^{m-m_1}$  and  $T^{m-m_2} \ltimes \mathcal{Z}_{\mathcal{K}_2}$  is homotopy equivalent to a wedge of spheres. First, observe that the suspension of a product of spheres is homotopy equivalent to a wedge of spheres, so  $T^{m-m_2} * T^{m-m_1}$  is homotopy equivalent to a wedge of spheres. Second, as  $\mathcal{Z}_{\mathcal{K}_1}$  is homotopy equivalent to a wedge of spheres we can write  $\mathcal{Z}_{\mathcal{K}_1} \simeq \Sigma W$ , where  $W$  is a wedge of spheres (note that  $\mathcal{Z}_{\mathcal{K}_1}$  is 2-connected by Proposition 4.3.5 (a)). We then have  $\mathcal{Z}_{\mathcal{K}_1} \rtimes T^{m-m_1} \simeq \Sigma W \rtimes T^{m-m_1} \simeq \Sigma W \vee (\Sigma T^{m-m_1} \wedge W)$ . Now  $\Sigma T^{m-m_1}$  is homotopy equivalent to a wedge of spheres. Therefore, as  $W$  is homotopy equivalent to a wedge of spheres so is  $\Sigma T^{m-m_1} \wedge W$ . Hence  $\mathcal{Z}_{\mathcal{K}_1} \rtimes T^{m-m_1}$  is homotopy equivalent to a wedge of spheres. The decomposition of the summand  $T^{m-m_2} \ltimes \mathcal{Z}_{\mathcal{K}_2}$  into a wedge of spheres is exactly as for  $\mathcal{Z}_{\mathcal{K}_1} \rtimes T^{m-m_1}$ .  $\square$

**COROLLARY 8.2.4.** *Assume that there is an order  $I_1, \dots, I_s$  of the maximal faces of  $\mathcal{K}$  such that  $(\bigcup_{j < k} I_j) \cap I_k$  is a single face for each  $k = 1, \dots, s$ . Then  $\mathcal{Z}_{\mathcal{K}}$  has homotopy type of a wedge of spheres.*

As an application, we describe the homotopy type of  $\mathcal{Z}_{\mathcal{K}}$  for two particular series of  $\mathcal{K}$ : 0-dimensional complexes and trees (connected graphs without cycles).

**PROPOSITION 8.2.5.** *Let  $\mathcal{K}$  be  $m$  disjoint points,  $m \geq 2$ . Then*

$$(8.11) \quad \mathcal{Z}_{\mathcal{K}} \simeq \bigvee_{k=2}^m (S^{k+1})^{\vee(k-1)} \binom{m}{k}.$$

PROOF. Let  $\mathcal{K}_m$  denote the complex consisting of  $m$  disjoint points. Applying (8.10) to the decomposition  $\mathcal{K}_m = \mathcal{K}_{m-1} \sqcup \mathcal{K}_1$  we obtain

$$(8.12) \quad \mathcal{Z}_{\mathcal{K}_m} \simeq (T^{m-1} * T^1) \vee (\mathcal{Z}_{\mathcal{K}_{m-1}} \rtimes T^1)$$

(the third wedge summand vanishes because  $\mathcal{Z}_{\mathcal{K}_1} \simeq pt$ ). An inductive argument using the decomposition  $\Sigma(A \times B) \simeq \Sigma A \vee \Sigma B \vee (\Sigma A \wedge B)$  shows that

$$T^{m-1} * T^1 \simeq \Sigma \Sigma T^{m-1} \simeq \bigvee_{k=2}^m (S^{k+1})^{\vee \binom{m-1}{k-1}}.$$

Assuming by induction that (8.11) holds for  $\mathcal{K}_{m-1}$ , we obtain

$$\mathcal{Z}_{\mathcal{K}_{m-1}} \rtimes T^1 \simeq \mathcal{Z}_{\mathcal{K}_{m-1}} \vee \Sigma \mathcal{Z}_{\mathcal{K}_{m-1}} \simeq \bigvee_{k=2}^{m-1} (S^{k+1})^{\vee \binom{m-1}{k-1}} \vee \bigvee_{k=3}^m (S^{k+1})^{\vee \binom{m-1}{k-1}}.$$

Substituting the last two formulae into (8.12) we finally obtain (8.11). □

Observe that  $\mathcal{Z}_{\mathcal{K}}$  corresponding to  $m$  disjoint points is the homotopy fibre of the inclusion of the  $m$ -fold wedge  $(\mathbb{C}P^\infty)^{\vee m}$  into the  $m$ -fold product  $(\mathbb{C}P^\infty)^m$ . As we have seen in Example 4.7.6,  $\mathcal{Z}_{\mathcal{K}_m}$  is homotopy equivalent to the complement of the union of all coordinate planes of codimension two in  $\mathbb{C}^m$ . In this context the result of Proposition 8.2.5 was obtained in [132].

The homotopy type of  $\mathcal{Z}_{\mathcal{K}}$  corresponding to a tree with  $m + 1$  vertices depends only on the number of vertices and does not depend of the form of the tree; also, the homotopy type of  $\mathcal{Z}_{\mathcal{K}}$  corresponding to a tree with  $m + 1$  vertices is the same as that of  $\mathcal{Z}_{\mathcal{K}}$  corresponding to  $m$  disjoint points:

PROPOSITION 8.2.6. *Let  $\mathcal{K}$  be a tree with  $m + 1$  vertices,  $m \geq 2$ . Then*

$$\mathcal{Z}_{\mathcal{K}} \simeq \bigvee_{k=2}^m (S^{k+1})^{\vee \binom{m}{k-1}}.$$

PROOF. This time we use the decomposition  $\mathcal{K}_m = \mathcal{K}_{m-1} \cup_v \mathcal{K}_1$ , where  $\mathcal{K}_m$  denotes a tree with  $m + 1$  vertices (so that  $\mathcal{K}_1$  is a segment), and the union is taken along a common vertex  $v$ . The rest of the proof is as for Proposition 8.2.5. □

One can notice the similarity between the wedge decomposition of Proposition 8.2.6 and the connected sum decomposition of Theorem 4.6.12. The nature of this similarity is explained in the work of Theriault [304].

A simplicial complex  $\mathcal{K}$  is *shifted* if there is an ordering of its vertices such that whenever  $I \in \mathcal{K}$ ,  $i \in I$  and  $i < j$ , then  $(I \setminus \{i\}) \cup \{j\} \in \mathcal{K}$ .

THEOREM 8.2.7 ([133, Theorem 9.4]). *If  $\mathcal{K}$  is a shifted complex, then  $\mathcal{Z}_{\mathcal{K}}$  is homotopy equivalent to a wedge of spheres.*

IDEA OF PROOF. For any simplicial complex  $\mathcal{K}$  on  $[m]$  there is a pushout square

$$\begin{array}{ccc} \text{lk}_{\{m\}} \mathcal{K} & \longrightarrow & \mathcal{K}_{\{1, \dots, m-1\}} \\ \downarrow & & \downarrow \\ \text{st}_{\{m\}} \mathcal{K} & \longrightarrow & \mathcal{K}, \end{array}$$

where  $\mathcal{K}_{\{1, \dots, m-1\}}$  denotes the restriction of  $\mathcal{K}$  to the first  $m - 1$  vertices. It gives rise to a pushout square of the corresponding polyhedral products  $(\mathbb{C}P^\infty)^{\mathcal{K}}$  and,

by application of Lemma 8.2.2, to a pushout square of the moment-angle complexes  $\mathcal{Z}_{\mathcal{K}}$ . The key observation is that if  $\mathcal{K}$  is shifted, then all three subcomplexes  $\text{lk}_{\{m\}} \mathcal{K}$ ,  $\text{st}_{\{m\}} \mathcal{K}$  and  $\mathcal{K}_{\{1, \dots, m-1\}}$  are also shifted, with respect to the induced ordering of vertices. This allows us to use induction, in a way similar to the proof of Theorem 8.2.1.  $\square$

The  $i$ -dimensional skeleton of a simplex  $\Delta^{m-1}$  is a shifted complex. In this case the dimensions of spheres in the wedge decomposition of  $\mathcal{Z}_{\mathcal{K}}$  can be described explicitly; this result was given as Theorem 4.7.7. It also follows from a result of Porter [264] for general polyhedral products, which we state in the next section.

Not all complexes  $\mathcal{K}$  obtained by iterative gluing along a common face are shifted (see Exercise 8.2.8), and not all shifted complexes can be obtained by iterative gluing along a common face. So one can obtain even a wider class of simplicial complexes  $\mathcal{K}$  whose corresponding  $\mathcal{Z}_{\mathcal{K}}$  are wedges of spheres by combining the results of Theorem 8.2.1 and Theorem 8.2.7.

**Exercises.**

8.2.8. The tree  is a shifted complex, but  is not.

8.2.9. Let  $\mathcal{K}$  be the graph . Describe the homotopy type of  $\mathcal{Z}_{\mathcal{K}}$ .

8.2.10. Let  $\mathcal{K}$  be a complex obtained by iteration of the operation of attaching a  $k$ -simplex along a common  $(k - 1)$ -face, starting from a  $k$ -simplex (so  $\mathcal{K}$  is a tree when  $k = 1$ ). Describe the homotopy type of  $\mathcal{Z}_{\mathcal{K}}$ .

**8.3. Stable decompositions of polyhedral products**

Several important results on wedge decomposition of polyhedral products after one suspension were obtained in the work of Bahri, Bendersky, Cohen and Gitler [14]. These can be seen as far-reaching generalisations of the classical decomposition  $\Sigma(A \times B) \simeq \Sigma A \vee \Sigma B \vee (\Sigma A \wedge B)$ . The proofs given below are reproduced from [14] with few or no modifications. Homotopy theory of polyhedral products has become quite an active area, and we also review some recent results on stable and unstable decompositions in the end of this section.

We start by defining the smash version of the polyhedral product.

CONSTRUCTION 8.3.1 (polyhedral smash product). The initial setup is again a simplicial complex  $\mathcal{K}$  on  $[m]$  and a sequence of  $m$  pairs of pointed cell complexes

$$(\mathbf{X}, \mathbf{A}) = \{(X_1, A_1), \dots, (X_m, A_m)\}.$$

We denote the  $m$ -fold smash product of the  $X_i$  by

$$\mathbf{X}^{\wedge m} = X_1 \wedge X_2 \wedge \dots \wedge X_m.$$

Then the *polyhedral smash product*  $(\mathbf{X}, \mathbf{A})^{\wedge \mathcal{K}}$  is defined as the image of  $(\mathbf{X}, \mathbf{A})^{\mathcal{K}}$  under the projection  $\mathbf{X}^m \rightarrow \mathbf{X}^{\wedge m}$ . More specifically, for each  $I \subset [m]$  we set

$$(\mathbf{X}, \mathbf{A})^{\wedge I} = \{(x_1, \dots, x_m) \in X_1 \wedge X_2 \wedge \dots \wedge X_m : x_j \in A_j \text{ for } j \notin I\},$$

then

$$(\mathbf{X}, \mathbf{A})^{\wedge \mathcal{K}} = \bigcup_{I \in \mathcal{K}} (\mathbf{X}, \mathbf{A})^{\wedge I} = \bigcup_{I \in \mathcal{K}} \left( \bigwedge_{i \in I} X_i \wedge \bigwedge_{i \notin I} A_i \right).$$

Using the categorical language, define the  $\text{CAT}(\mathcal{K})$ -diagram

$$(8.13) \quad \begin{aligned} \widehat{\mathcal{D}}_{\mathcal{K}}(\mathbf{X}, \mathbf{A}) : \text{CAT}(\mathcal{K}) &\longrightarrow \text{TOP}, \\ I &\longmapsto (\mathbf{X}, \mathbf{A})^{\wedge I}, \end{aligned}$$

which maps the morphism  $I \subset J$  to the inclusion  $(\mathbf{X}, \mathbf{A})^{\wedge I} \subset (\mathbf{X}, \mathbf{A})^{\wedge J}$ . Then

$$(\mathbf{X}, \mathbf{A})^{\wedge \mathcal{K}} = \text{colim}_{I \in \mathcal{K}} \widehat{\mathcal{D}}_{\mathcal{K}}(\mathbf{X}, \mathbf{A}) = \text{colim}_{I \in \mathcal{K}} (\mathbf{X}, \mathbf{A})^{\wedge I}.$$

In the case when all the pairs  $(X_i, A_i)$  are the same, i.e.  $X_i = X$  and  $A_i = A$ , we use the notation  $(X, A)^{\wedge \mathcal{K}}$  for  $(\mathbf{X}, \mathbf{A})^{\wedge \mathcal{K}}$ . Also, if each  $A_i = pt$ , then we use the abbreviated notation  $\mathbf{X}^{\wedge \mathcal{K}}$  for  $(\mathbf{X}, pt)^{\wedge \mathcal{K}}$ , and  $X^{\wedge \mathcal{K}}$  for  $(X, pt)^{\wedge \mathcal{K}}$ .

An inductive argument using the decomposition  $\Sigma(A \times B) \simeq \Sigma A \vee \Sigma B \vee (\Sigma A \wedge B)$  shows that there is a natural pointed homotopy equivalence

$$(8.14) \quad \Sigma(X_1 \times \cdots \times X_m) \xrightarrow{\simeq} \Sigma\left(\bigvee_{J \subset [m]} \mathbf{X}^{\wedge J}\right).$$

For each  $J \subset [m]$ , define the subfamily

$$(\mathbf{X}_J, \mathbf{A}_J) = \{(X_j, A_j) : j \in J\}.$$

The first result shows that the polyhedral product splits after one suspension into a wedge of polyhedral smash products corresponding to all full subcomplexes of  $\mathcal{K}$ :

**THEOREM 8.3.2 ([14]).** *For any sequence  $(\mathbf{X}, \mathbf{A})$  of pairs of pointed cell complexes, homotopy equivalence (8.14) induces a natural pointed homotopy equivalence*

$$\Sigma(\mathbf{X}, \mathbf{A})^{\mathcal{K}} \xrightarrow{\simeq} \Sigma\left(\bigvee_{J \subset [m]} (\mathbf{X}_J, \mathbf{A}_J)^{\wedge \mathcal{K}_J}\right).$$

**PROOF.** We have  $(\mathbf{X}, \mathbf{A})^{\mathcal{K}} = \text{colim}_{I \in \mathcal{K}} \mathcal{D}_{\mathcal{K}}(\mathbf{X}, \mathbf{A}) = \text{colim}_{I \in \mathcal{K}} (\mathbf{X}, \mathbf{A})^I$ , where  $\mathcal{D}_{\mathcal{K}}(\mathbf{X}, \mathbf{A})$  is diagram (4.7). Define another diagram

$$\begin{aligned} \mathcal{E}_{\mathcal{K}}(\mathbf{X}, \mathbf{A}) : \text{CAT}(\mathcal{K}) &\longrightarrow \text{TOP}, \\ I &\longmapsto \bigvee_{J \subset [m]} (\mathbf{X}_J, \mathbf{A}_J)^{\wedge (I \cap J)}. \end{aligned}$$

By (8.14), there is a natural pointed homotopy equivalence

$$\Sigma(\mathbf{X}, \mathbf{A})^I \xrightarrow{\simeq} \Sigma\left(\bigvee_{J \subset [m]} (\mathbf{X}_J, \mathbf{A}_J)^{\wedge (I \cap J)}\right)$$

The diagrams  $\mathcal{D}_{\mathcal{K}}(\mathbf{X}, \mathbf{A})$ ,  $\mathcal{E}_{\mathcal{K}}(\mathbf{X}, \mathbf{A})$ , as well as  $\Sigma \mathcal{D}_{\mathcal{K}}(\mathbf{X}, \mathbf{A})$ ,  $\Sigma \mathcal{E}_{\mathcal{K}}(\mathbf{X}, \mathbf{A})$ , are obviously cofibrant, so the objectwise homotopy equivalence above induces a homotopy equivalence of their colimits (see Proposition C.3.4). It remains to note that

$$\begin{aligned} \text{colim } \Sigma \mathcal{D}_{\mathcal{K}}(\mathbf{X}, \mathbf{A}) &= \Sigma \text{colim } \mathcal{D}_{\mathcal{K}}(\mathbf{X}, \mathbf{A}) = \Sigma(\mathbf{X}, \mathbf{A})^{\mathcal{K}}, \\ \text{colim } \Sigma \mathcal{E}_{\mathcal{K}}(\mathbf{X}, \mathbf{A}) &= \text{colim}_{I \in \mathcal{K}} \Sigma\left(\bigvee_{J \subset [m]} (\mathbf{X}_J, \mathbf{A}_J)^{\wedge (I \cap J)}\right) \\ &= \Sigma\left(\bigvee_{J \subset [m]} \text{colim}_{(I \cap J) \in \mathcal{K}_J} (\mathbf{X}_J, \mathbf{A}_J)^{\wedge (I \cap J)}\right) \\ &= \Sigma\left(\bigvee_{J \subset [m]} (\mathbf{X}_J, \mathbf{A}_J)^{\wedge \mathcal{K}_J}\right). \quad \square \end{aligned}$$

The homotopy type of the wedge summands  $(\mathbf{X}_J, \mathbf{A}_J)^{\wedge \mathcal{K}_J}$  can be described explicitly in the case when the inclusions  $A_k \hookrightarrow X_k$  are null-homotopic:

**THEOREM 8.3.3 ([14]).** *Let  $\mathcal{K}$  be a simplicial complex on  $[m]$ , and let  $(\mathbf{X}, \mathbf{A})$  be a sequence of pairs of cell complexes with the property that the inclusion  $A_k \hookrightarrow X_k$  is null-homotopic for all  $k$ . Then there is a homotopy equivalence*

$$(\mathbf{X}, \mathbf{A})^{\wedge \mathcal{K}} \xrightarrow{\simeq} \bigvee_{I \in \mathcal{K}} |\mathrm{lk}_{\mathcal{K}} I| * (\mathbf{X}, \mathbf{A})^{\wedge I},$$

where  $|\mathrm{lk}_{\mathcal{K}} I|$  is the geometric realisation of the link of  $I$  in  $\mathcal{K}$ .

**PROOF.** By hypothesis, there is a homotopy  $F_k: A_k \times \mathbb{I} \rightarrow X_k$  such that  $F_k(a, 0) = i_k(a)$  and  $F_k(a, 1) = pt$ , where  $i_k: A_k \rightarrow X_k$  is the inclusion. By the homotopy extension property, there exists  $\widehat{F}_k: X_k \times \mathbb{I} \rightarrow X_k$  with  $\widehat{F}_k(x, 0) = x$ ,  $\widehat{F}_k(x, 1) = g_k(x)$  where  $g_k: X_k \rightarrow X_k$  is a map such that  $g_k(a) = pt$  for all  $a \in A_k$ . Hence there is a commutative diagram

$$\begin{array}{ccc} A_k & \xrightarrow{\mathrm{id}} & A_k \\ i_k \downarrow & & \downarrow \epsilon \\ X_k & \xrightarrow{g_k} & X_k \end{array}$$

where  $\epsilon: A_k \rightarrow X_k$  is the constant map to the basepoint. Along with the diagram  $\widehat{\mathcal{D}}_{\mathcal{K}} = \widehat{\mathcal{D}}_{\mathcal{K}}(\mathbf{X}, \mathbf{A})$  given by (8.13), define a new diagram

$$\widehat{\mathcal{E}}_{\mathcal{K}}: \mathrm{CAT}(\mathcal{K}) \longrightarrow \mathrm{TOP}, \quad I \longmapsto (\mathbf{X}, \mathbf{A})^{\wedge I},$$

which maps the non-identity morphism  $I \subset J$  to the constant map  $(\mathbf{X}, \mathbf{A})^{\wedge I} \rightarrow (\mathbf{X}, \mathbf{A})^{\wedge J}$  to the basepoint. For every  $I \in \mathcal{K}$ , define

$$\alpha(I): \widehat{\mathcal{D}}_{\mathcal{K}}(I) \rightarrow \widehat{\mathcal{E}}_{\mathcal{K}}(I)$$

by  $\alpha(I) = \alpha_1(I) \wedge \cdots \wedge \alpha_m(I)$  where

$$\alpha_k(I) = \begin{cases} g_k: X_k \rightarrow X_k & \text{if } k \in I, \\ \mathrm{id}: A_k \rightarrow A_k & \text{if } k \notin I. \end{cases}$$

Since the  $g_k$  are homotopy equivalences, so is  $\alpha(I)$  for all  $I \in \mathcal{K}$ . Furthermore, if  $I \subset J$ , the following diagram commutes:

$$\begin{array}{ccc} \widehat{\mathcal{D}}_{\mathcal{K}}(I) & \xrightarrow{\alpha(I)} & \widehat{\mathcal{E}}_{\mathcal{K}}(I) \\ \downarrow & & \downarrow \\ \widehat{\mathcal{D}}_{\mathcal{K}}(J) & \xrightarrow{\alpha(J)} & \widehat{\mathcal{E}}_{\mathcal{K}}(J). \end{array}$$

Hence the maps  $\alpha(I)$  give a weak equivalence of diagrams  $\widehat{\mathcal{D}}_{\mathcal{K}} \rightarrow \widehat{\mathcal{E}}_{\mathcal{K}}$ , which gives a homotopy equivalence

$$\mathrm{hocolim} \widehat{\mathcal{D}}_{\mathcal{K}} \xrightarrow{\simeq} \mathrm{hocolim} \widehat{\mathcal{E}}_{\mathcal{K}}.$$

Finally, the diagram  $\widehat{\mathcal{E}}_{\mathcal{K}}$  satisfies the conditions of Lemma C.3.6, so we get a homotopy equivalence

$$\mathrm{hocolim} \widehat{\mathcal{E}}_{\mathcal{K}} \xrightarrow{\simeq} \bigvee_{I \in \mathcal{K}} |\mathrm{lk}_{\mathcal{K}} I| * (\mathbf{X}, \mathbf{A})^{\wedge I}$$

(upper semi-intervals in the face poset of  $\mathcal{K}$  are links). The result follows since  $\text{hocolim } \widehat{D}_{\mathcal{K}} = (\mathbf{X}, \mathbf{A})^{\wedge \mathcal{K}}$ .  $\square$

Two special cases of Theorem 8.3.3 are presented next where either  $A_i$  are contractible for all  $i$  or  $X_i$  are contractible for all  $i$ .

**THEOREM 8.3.4 ([14]).** *Let  $\mathcal{K}$  be a simplicial complex on  $[m]$ , and let  $(\mathbf{X}, \mathbf{A})$  be a sequence of pairs of cell complexes with the property that all the  $A_i$  are contractible. Then there is a homotopy equivalence*

$$\Sigma(\mathbf{X}, \mathbf{A})^{\mathcal{K}} \xrightarrow{\simeq} \Sigma\left(\bigvee_{I \in \mathcal{K}} \mathbf{X}^{\wedge I}\right).$$

**PROOF.** When all the  $A_i$  are contractible, the space  $(\mathbf{X}, \mathbf{A})^{\wedge I}$  is also contractible unless  $I = [m]$ . By Theorem 8.3.3,

$$(\mathbf{X}_J, \mathbf{A}_J)^{\wedge \mathcal{K}_J} \simeq \bigvee_{I \in \mathcal{K}_J} |\text{lk}_{\mathcal{K}_J} I| * (\mathbf{X}_J, \mathbf{A}_J)^{\wedge I},$$

which is contractible unless  $J \in \mathcal{K}_J$ , i.e.  $J \in \mathcal{K}$ . In the latter case we have  $(\mathbf{X}_J, \mathbf{A}_J)^{\wedge \mathcal{K}_J} = \mathbf{X}^{\wedge J}$ . By Theorem 8.3.2,

$$\Sigma(\mathbf{X}, \mathbf{A})^{\mathcal{K}} \simeq \Sigma\left(\bigvee_{J \subset [m]} (\mathbf{X}_J, \mathbf{A}_J)^{\wedge \mathcal{K}_J}\right) = \Sigma\left(\bigvee_{J \in \mathcal{K}} \mathbf{X}^{\wedge J}\right). \quad \square$$

**REMARK.** An interesting corollary of Theorem 8.3.4 is that the polyhedral products  $X^{\mathcal{K}} = (X, pt)^{\mathcal{K}}$  corresponding to simplicial complexes  $\mathcal{K}$  with the same  $f$ -vectors become homotopy equivalent after one suspension.

**THEOREM 8.3.5 ([14]).** *Let  $\mathcal{K}$  be a simplicial complex on  $[m]$ , and let  $(\mathbf{X}, \mathbf{A})$  be a sequence of pairs of cell complexes with the property that all the  $X_i$  are contractible. Then there is a homotopy equivalence*

$$\Sigma(\mathbf{X}, \mathbf{A})^{\mathcal{K}} \xrightarrow{\simeq} \Sigma\left(\bigvee_{J \notin \mathcal{K}} |\mathcal{K}_J| * \mathbf{A}^{\wedge J}\right).$$

**PROOF.** Since all the  $X_i$  are contractible, all of the spaces  $(\mathbf{X}, \mathbf{A})^{\wedge I}$  are also contractible with the possible exception of  $(\mathbf{X}, \mathbf{A})^{\wedge \emptyset} = \mathbf{A}^{\wedge m}$ . By Theorem 8.3.3,

$$(\mathbf{X}_J, \mathbf{A}_J)^{\wedge \mathcal{K}_J} \simeq \bigvee_{I \in \mathcal{K}_J} |\text{lk}_{\mathcal{K}_J} I| * (\mathbf{X}_J, \mathbf{A}_J)^{\wedge I} = |\text{lk}_{\mathcal{K}_J} \emptyset| * (\mathbf{X}_J, \mathbf{A}_J)^{\wedge \emptyset} = |\mathcal{K}_J| * \mathbf{A}^{\wedge J}$$

which is contractible if  $J \in \mathcal{K}$ . By Theorem 8.3.2,

$$\Sigma(\mathbf{X}, \mathbf{A})^{\mathcal{K}} \simeq \Sigma\left(\bigvee_{J \subset [m]} (\mathbf{X}_J, \mathbf{A}_J)^{\wedge \mathcal{K}_J}\right) = \Sigma\left(\bigvee_{J \notin \mathcal{K}} |\mathcal{K}_J| * \mathbf{A}^{\wedge J}\right). \quad \square$$

COROLLARY 8.3.6.

- (a) Let  $(\mathbf{X}, \mathbf{A}) = (D^1, S^0)$ , so that  $(\mathbf{X}, \mathbf{A})^{\mathcal{K}}$  is the real moment-angle complex  $\mathcal{R}_{\mathcal{K}}$ . Then there is a homotopy equivalence

$$\Sigma \mathcal{R}_{\mathcal{K}} \xrightarrow{\simeq} \bigvee_{J \notin \mathcal{K}} \Sigma^2 |\mathcal{K}_J|.$$

- (b) Let  $(\mathbf{X}, \mathbf{A}) = (D^2, S^1)$ , so that  $(\mathbf{X}, \mathbf{A})^{\mathcal{K}}$  is the moment-angle complex  $\mathcal{Z}_{\mathcal{K}}$ . Then there is a homotopy equivalence

$$\Sigma \mathcal{Z}_{\mathcal{K}} \xrightarrow{\simeq} \bigvee_{J \notin \mathcal{K}} \Sigma^{2+|J|} |\mathcal{K}_J|.$$

The above decomposition of  $\Sigma \mathcal{Z}_{\mathcal{K}}$  implies the additive isomorphism

$$H^k(\mathcal{Z}_{\mathcal{K}}; \mathbb{Z}) \cong \bigoplus_{J \subset [m]} \tilde{H}^{k-|J|-1}(\mathcal{K}_J; \mathbb{Z})$$

of Theorem 4.5.8. Similarly, the decomposition of  $\Sigma \mathcal{R}_{\mathcal{K}}$  implies the isomorphism

$$H^k(\mathcal{R}_{\mathcal{K}}; \mathbb{Z}) \cong \bigoplus_{J \subset [m]} \tilde{H}^{k-1}(\mathcal{K}_J; \mathbb{Z}).$$

Another result of [14] describes the cohomology ring of a polyhedral product  $\mathbf{X}^{\mathcal{K}}$  and generalises the isomorphism  $H^*((\mathbb{C}P^\infty)^{\mathcal{K}}; \mathbb{Z}) \cong \mathbb{Z}[\mathcal{K}]$  of Proposition 4.3.1:

THEOREM 8.3.7 ([14]). Let  $\mathbf{X} = (X_1, \dots, X_m)$  be a sequence of pointed cell complexes, and let  $\mathbf{k}$  be a ring such that the natural map

$$H^*(X_{j_1}; \mathbf{k}) \otimes \cdots \otimes H^*(X_{j_k}; \mathbf{k}) \rightarrow H^*(X_{j_1} \times \cdots \times X_{j_k}; \mathbf{k})$$

is an isomorphism for any  $\{j_1, \dots, j_k\} \subset [m]$ . There is an isomorphism of algebras

$$H^*(\mathbf{X}^{\mathcal{K}}; \mathbf{k}) \cong (H^*(X_1; \mathbf{k}) \otimes \cdots \otimes H^*(X_m; \mathbf{k})) / \mathcal{I},$$

where  $\mathcal{I}$  is the generalised Stanley–Reisner ideal, generated by elements  $x_{j_1} \otimes \cdots \otimes x_{j_k}$  for which  $x_{j_i} \in \tilde{H}^*(X_{j_i}; \mathbf{k})$  and  $\{j_1, \dots, j_k\} \notin \mathcal{K}$ . Furthermore, the inclusion  $\mathbf{X}^{\mathcal{K}} \rightarrow X_1 \times \cdots \times X_m$  induces the quotient projection in cohomology.

PROOF. By Theorem 8.3.4, there are homotopy equivalences

$$\Sigma(X_1 \times \cdots \times X_m) \xrightarrow{\simeq} \Sigma\left(\bigvee_{J \subset [m]} \mathbf{X}^{\wedge J}\right), \quad \Sigma \mathbf{X}^{\mathcal{K}} \xrightarrow{\simeq} \Sigma\left(\bigvee_{J \in \mathcal{K}} \mathbf{X}^{\wedge J}\right).$$

Naturality implies that the map  $\Sigma \mathbf{X}^{\mathcal{K}} \rightarrow \Sigma(X_1 \times \cdots \times X_m)$  is split with cofibre  $\Sigma(\bigvee_{J \notin \mathcal{K}} \mathbf{X}^{\wedge J})$ . Hence there is a split cofibration

$$\Sigma\left(\bigvee_{J \in \mathcal{K}} \mathbf{X}^{\wedge J}\right) \rightarrow \Sigma\left(\bigvee_{J \subset [m]} \mathbf{X}^{\wedge J}\right) \rightarrow \Sigma\left(\bigvee_{J \notin \mathcal{K}} \mathbf{X}^{\wedge J}\right).$$

Under the given condition on  $\mathbf{k}$  there is a ring isomorphism

$$\tilde{H}^*(X_1 \times \cdots \times X_m; \mathbf{k}) \cong \bigoplus_{J \subset [m]} \tilde{H}^*(X_{j_1}; \mathbf{k}) \otimes \cdots \otimes \tilde{H}^*(X_{j_k}; \mathbf{k}).$$

The natural inclusion map  $\Sigma \mathbf{X}^{\mathcal{K}} \rightarrow \Sigma(X_1 \times \cdots \times X_m)$  induces a map

$$\tilde{H}^*(X_1 \times \cdots \times X_m; \mathbf{k}) \rightarrow \tilde{H}^*(\mathbf{X}^{\mathcal{K}}; \mathbf{k}),$$

which corresponds to the projection map

$$\bigoplus_{J \subset [m]} \tilde{H}^*(X_{j_1}; \mathbf{k}) \otimes \cdots \otimes \tilde{H}^*(X_{j_k}; \mathbf{k}) \rightarrow \bigoplus_{J \in \mathcal{K}} \tilde{H}^*(X_{j_1}; \mathbf{k}) \otimes \cdots \otimes \tilde{H}^*(X_{j_k}; \mathbf{k}).$$

Its kernel is exactly

$$\bigoplus_{J \notin \mathcal{K}} \tilde{H}^*(X_{j_1}; \mathbf{k}) \otimes \cdots \otimes \tilde{H}^*(X_{j_k}; \mathbf{k})$$

which is the generalised Stanley–Reisner ideal  $\mathcal{I}$  by inspection. □

As in the case of the face ring  $\mathbf{k}[\mathcal{K}] = H^*((\mathbb{C}P^\infty)^\mathcal{K}; \mathbf{k})$ , which can be decomposed as the limit of the  $\text{CAT}(\mathcal{K})^{op}$ -diagram of polynomial algebras  $\mathbf{k}[v_i : i \in I] = H^*((\mathbb{C}P^\infty)^I; \mathbf{k})$ , the isomorphism of Theorem 8.3.7 can be interpreted as

$$H^*(\mathbf{X}^\mathcal{K}; \mathbf{k}) \cong \lim_{I \in \mathcal{K}} H^*(\mathbf{X}^I; \mathbf{k}).$$

This isomorphism was used in the proof of Theorem 8.1.2.

There are several important situations when the isomorphism of Theorem 8.3.5 can be desuspended. As we have seen in the previous section, this is the case for the pairs  $(\mathbf{X}, \mathbf{A}) = (D^2, S^1)$  when  $\mathcal{K}$  is obtained by iterative gluing along a common face or when  $\mathcal{K}$  is shifted complex. More generally, the following result, conjectured in [14], was proved independently by Grbić–Theriault and Iriye–Kishimoto:

**THEOREM 8.3.8** ([134, Theorem 1.1], [168, Theorem 1.7]). *Let  $\mathcal{K}$  be a shifted complex. Let  $\mathbf{A} = (A_1, \dots, A_m)$  be a sequence of pointed cell complexes, and let cone  $A$  denote the cone on  $A$ . Then there is a homotopy equivalence*

$$(\text{cone } \mathbf{A}, \mathbf{A})^\mathcal{K} \xrightarrow{\cong} \bigvee_{J \notin \mathcal{K}} |\mathcal{K}_J| * \mathbf{A}^{\wedge J}.$$

Here is a case where the wedge summands can be described very explicitly:

**COROLLARY 8.3.9.** *Let  $\mathcal{K}_i$  be the  $i$ -dimensional skeleton of the simplex  $\Delta^{m-1}$ . Then there is a homotopy equivalence*

$$(\text{cone } \mathbf{A}, \mathbf{A})^{\mathcal{K}_i} \xrightarrow{\cong} \bigvee_{k=i+2}^m \left( \bigvee_{1 \leq j_1 < \dots < j_k \leq m} (\Sigma^{i+1} A_{j_1} \wedge \dots \wedge A_{j_k})^{\vee \binom{k-1}{i+1}} \right).$$

The proof of this corollary is left as an exercise. In the case when each  $A_i$  is a loop space,  $A_i = \Omega B_i$ , the space  $(\text{cone } \Omega \mathbf{B}, \Omega \mathbf{B})^{\mathcal{K}_i}$  is the homotopy fibre of the inclusion  $\mathbf{B}^{\mathcal{K}_i} \rightarrow \mathbf{B}^m$  (see Example 4.2.6.5 and Exercise 4.3.10) and decomposition above was obtained by Porter [264]. In the case  $A_i = S^1$ , Corollary 8.3.9 turns into Theorem 4.7.7.

The wedge decomposition of Theorem 8.3.5 can be used to describe the ring structure for the cohomology of  $(\mathbf{X}, \mathbf{A})^\mathcal{K}$ , see [16].

**Exercises.**

8.3.10. Deduce Corollary 8.3.9 from Theorem 8.3.8.

**8.4. Loop spaces, Whitehead and Samelson products**

We now turn our attention to topological and algebraic models for the loop spaces  $\Omega(\mathbb{C}P^\infty)^\mathcal{K}$  and  $\Omega \mathcal{Z}_\mathcal{K}$ . We can view the latter as objects in the category TMON of topological monoids by considering Moore loops (of arbitrary length), whose composition is strictly associative.



**Pontryagin algebras, Whitehead and Samelson products.** We loop the fibration  $\mathcal{Z}_{\mathcal{K}} \rightarrow (\mathbb{C}P^\infty)^{\mathcal{K}} \rightarrow (\mathbb{C}P^\infty)^m$  to obtain a fibration

$$(8.15) \quad \Omega\mathcal{Z}_{\mathcal{K}} \longrightarrow \Omega(\mathbb{C}P^\infty)^{\mathcal{K}} \longrightarrow T^m.$$

It admits a section, defined by the  $m$  generators of  $\pi_2((\mathbb{C}P^\infty)^{\mathcal{K}}) \cong \mathbb{Z}^m$ , and therefore splits in TOP. So we have a homotopy equivalence

$$\Omega(\mathbb{C}P^\infty)^{\mathcal{K}} \xrightarrow{\cong} \Omega\mathcal{Z}_{\mathcal{K}} \times T^m$$

which does *not* preserve monoid structures.

PROPOSITION 8.4.1. *There is an exact sequence of homotopy Lie algebras*

$$0 \longrightarrow \pi_*(\Omega\mathcal{Z}_{\mathcal{K}}) \otimes \mathbb{Q} \longrightarrow \pi_*(\Omega(\mathbb{C}P^\infty)^{\mathcal{K}}) \otimes \mathbb{Q} \longrightarrow CL(u_1, \dots, u_m) \longrightarrow 0,$$

where  $CL(u_1, \dots, u_m)$  denotes the commutative Lie algebra with generators  $u_i$ ,  $\deg u_i = 1$ , and an exact sequence of Pontryagin algebras

$$(8.16) \quad 0 \longrightarrow H_*(\Omega\mathcal{Z}_{\mathcal{K}}; \mathbf{k}) \longrightarrow H_*(\Omega(\mathbb{C}P^\infty)^{\mathcal{K}}; \mathbf{k}) \longrightarrow \Lambda[u_1, \dots, u_m] \longrightarrow 0,$$

for any commutative ring  $\mathbf{k}$  with unit.

PROOF. The first exact sequence follows by considering the homotopy exact sequence of the fibration (8.15), whose connecting homomorphism is zero because the fibration is trivial.

Since  $H_*(T^m; \mathbf{k}) = \Lambda[u_1, \dots, u_m]$  is a finitely generated free  $\mathbf{k}$ -module, the Künneth formula gives an isomorphism of  $\mathbf{k}$ -modules

$$H_*(\Omega(\mathbb{C}P^\infty)^{\mathcal{K}}; \mathbf{k}) \cong H_*(\Omega\mathcal{Z}_{\mathcal{K}}; \mathbf{k}) \otimes \Lambda[u_1, \dots, u_m]$$

and therefore an exact sequence of  $\mathbf{k}$ -algebras (8.16).  $\square$

The homotopy group  $\pi_2((\mathbb{C}P^\infty)^{\mathcal{K}}) \cong \mathbb{Z}^m$  has  $m$  canonical generators represented by the maps

$$\widehat{\mu}_i: S^2 \longrightarrow \mathbb{C}P^\infty \longrightarrow (\mathbb{C}P^\infty)^{\vee m} \longrightarrow (\mathbb{C}P^\infty)^{\mathcal{K}}$$

for  $1 \leq i \leq m$ , where the left map is the inclusion of the bottom cell, the middle map is the inclusion of the  $i$ th wedge summand, and the right map is the canonical inclusion of polyhedral powers corresponding to the inclusion of the discrete  $m$ -point complex into  $\mathcal{K}$ . Let

$$\mu_i: S^1 \longrightarrow \Omega(\mathbb{C}P^\infty)^{\mathcal{K}}$$

be the adjoint of  $\widehat{\mu}_i$ , and let  $u_i$  denote the Hurewicz image of  $\mu_i$  in  $H_1(\Omega(\mathbb{C}P^\infty)^{\mathcal{K}})$ .

We shall be interested in elements of  $\pi_*(\Omega(\mathbb{C}P^\infty)^{\mathcal{K}})$  represented by Samelson products of the  $\mu_i$  (see Section B.1 for the definition).

PROPOSITION 8.4.2. *The Samelson products of the canonical generators  $\mu_i \in \pi_1(\Omega(\mathbb{C}P^\infty)^{\mathcal{K}})$  satisfy the identities*

$$[\mu_i, \mu_i]_s = 0, \quad [\mu_i, \mu_j]_s = 0 \quad \text{if and only if} \quad \{i, j\} \in \mathcal{K}.$$

PROOF. By adjunction, we can work with the Whitehead products instead. The Whitehead square  $[\widehat{\mu}_i, \widehat{\mu}_i]_w$  is zero in  $\pi_3((\mathbb{C}P^\infty)^{\mathcal{K}})$ , because it is zero in  $\pi_3(\mathbb{C}P^\infty) = 0$ . Furthermore, the map  $\widehat{\mu}_i \vee \widehat{\mu}_j: S^2 \vee S^2 \rightarrow (\mathbb{C}P^\infty)^{\mathcal{K}}$  with  $i \neq j$  extends to a map  $S^2 \times S^2 \rightarrow (\mathbb{C}P^\infty)^{\mathcal{K}}$  whenever  $\{i, j\}$  is an edge of  $\mathcal{K}$ , which implies that  $[\widehat{\mu}_i, \widehat{\mu}_j]_w = 0$  whenever  $\{i, j\} \in \mathcal{K}$ .  $\square$

COROLLARY 8.4.3. *The algebra  $H_*(\Omega(\mathbb{C}P^\infty)^\mathcal{K}; \mathbf{k})$  contains the subalgebra*

$$(8.17) \quad T\langle u_1, \dots, u_m \rangle / (u_i^2 = 0, \quad u_i u_j + u_j u_i = 0 \text{ if } \{i, j\} \in \mathcal{K}),$$

where  $u_i \in H_1(\Omega(\mathbb{C}P^\infty)^\mathcal{K}; \mathbf{k})$  is the Hurewicz image of  $\mu_i \in \pi_1(\Omega(\mathbb{C}P^\infty)^\mathcal{K})$ .

The subalgebra above maps onto the ‘fully commutative’ algebra  $\Lambda[u_1, \dots, u_m]$  under the projection map of (8.16).

In the homotopy fibration (8.15), since  $\pi_k(T^m) = 0$  for  $k > 1$ , any iterated Samelson product of the form  $[\mu_{i_1}, [\mu_{i_2}, \dots [\mu_{i_{k-1}}, \mu_{i_k}] \dots]]$  with  $k > 1$  composes trivially into  $T^m$  and so lifts to  $\Omega\mathcal{Z}_\mathcal{K}$ .

The Whitehead product  $[\widehat{\mu}_i, \widehat{\mu}_j]_w: S^3 \rightarrow (\mathbb{C}P^\infty)^\mathcal{K}$  is nontrivial whenever  $\{i, j\}$  is a missing edge of  $\mathcal{K}$ . We may generalise this construction by considering missing faces  $I = \{i_1, \dots, i_k\}$  of  $\mathcal{K}$  (recall that this means that  $I \notin \mathcal{K}$ , but any proper subset of  $I$  is in  $\mathcal{K}$ ). Geometrically a missing face defines a subcomplex  $\partial\Delta(I) \subset \mathcal{K}$ . Define the *k-fold higher Whitehead product*  $[\widehat{\mu}_{i_1}, \dots, \widehat{\mu}_{i_k}]_w$  as the composite

$$(8.18) \quad [\widehat{\mu}_{i_1}, \dots, \widehat{\mu}_{i_k}]_w: S^{2k-1} \xrightarrow{w} (S^2)^{\partial\Delta(I)} \rightarrow (\mathbb{C}P^\infty)^{\partial\Delta(I)} \rightarrow (\mathbb{C}P^\infty)^\mathcal{K}$$

where  $(S^2)^{\partial\Delta(I)}$  is the fat wedge of  $k$  spheres,  $w$  is the attaching map of the  $2k$ -cell in the product  $(S^2)^I$ , and the last two maps of the polyhedral products are induced by the inclusions  $S^2 \rightarrow \mathbb{C}P^\infty$  and  $\partial\Delta(I) \rightarrow \mathcal{K}$ . The *k-fold higher Samelson product*  $[\mu_{i_1}, \dots, \mu_{i_k}]_s$  is defined as the adjoint of  $[\widehat{\mu}_{i_1}, \dots, \widehat{\mu}_{i_k}]_w$ :

$$[\mu_{i_1}, \dots, \mu_{i_k}]_s: S^{2k-2} \rightarrow \Omega(\mathbb{C}P^\infty)^\mathcal{K}.$$

REMARK. As it is standard with higher operations, the higher product  $[\mu_{i_1}, \dots, \mu_{i_k}]$  is defined only when all shorter higher products of the  $\mu_{i_1}, \dots, \mu_{i_k}$  (corresponding to proper subsets of  $I$ ) are trivial. The general definition of higher Whitehead and Samelson products (see [323]) requires treatment of the indeterminacy, which we avoided in the case of the polyhedral product  $(\mathbb{C}P^\infty)^\mathcal{K}$  by the canonical choice of map (8.18).

As in the case of standard (2-fold) products, higher Whitehead and Samelson products of the  $\mu_i$  can be iterated and lifted to  $\Omega\mathcal{Z}_\mathcal{K}$ . We summarise this observation as follows:

PROPOSITION 8.4.4. *Any iterated higher Whitehead product  $\widehat{\nu}: S^p \rightarrow (\mathbb{C}P^\infty)^\mathcal{K}$  of the canonical maps  $\widehat{\mu}_i: S^2 \rightarrow (\mathbb{C}P^\infty)^\mathcal{K}$  lifts to a map  $S^p \rightarrow \mathcal{Z}_\mathcal{K}$ .*

*Similarly, any iterated higher Samelson product  $\nu: S^{p-1} \rightarrow \Omega(\mathbb{C}P^\infty)^\mathcal{K}$  of the  $\mu_i: S^1 \rightarrow \Omega(\mathbb{C}P^\infty)^\mathcal{K}$  lifts to a map  $S^{p-1} \rightarrow \Omega\mathcal{Z}_\mathcal{K}$ .*

Lifts  $S^p \rightarrow \mathcal{Z}_\mathcal{K}$  of higher iterated Whitehead products of the  $\widehat{\mu}_i$  provide important family of spherical classes in  $H_*(\mathcal{Z}_\mathcal{K})$ . We may ask the following question:

PROBLEM 8.4.5. Assume that  $\mathcal{Z}_\mathcal{K}$  is homotopy equivalent to a wedge of spheres. Is it true that all wedge summands are represented by lifts  $S^p \rightarrow \mathcal{Z}_\mathcal{K}$  of higher iterated Whitehead products of the canonical maps  $\mu_i: S^2 \rightarrow (\mathbb{C}P^\infty)^\mathcal{K}$ ?

For all known classes of examples when  $\mathcal{Z}_\mathcal{K}$  is a wedge of spheres, the answer to the above question is positive. We shall give some evidence below.

EXAMPLE 8.4.6.

1. Let  $\mathcal{K}$  be two points. The fibration (8.15) becomes

$$\Omega S^3 \rightarrow \Omega(\mathbb{C}P^\infty \vee \mathbb{C}P^\infty) \rightarrow S^1 \times S^1,$$

and the corresponding sequence of Pontryagin algebras (8.16) is

$$0 \longrightarrow \mathbf{k}[w] \xrightarrow{i} T\langle u_1, u_2 \rangle / (u_1^2, u_2^2) \xrightarrow{j} \Lambda[u_1, u_2] \longrightarrow 0$$

where  $\mathbf{k}[w] = H_*(\Omega S^3; \mathbf{k})$ ,  $\deg w = 2$ , the map  $i$  takes  $w$  to the commutator  $u_1 u_2 + u_2 u_1$ , and  $j$  is the projection to the quotient by the ideal generated by  $u_1 u_2 + u_2 u_1$  (an exercise). So

$$H_*(\Omega(\mathbb{C}P^\infty \vee \mathbb{C}P^\infty); \mathbf{k}) = T\langle u_1, u_2 \rangle / (u_1^2, u_2^2) = \Lambda[u_1] \star \Lambda[u_2]$$

is the free product of two exterior algebras and  $i(\mathbf{k}[w])$  is its commutator subalgebra. In particular, exact sequence (8.16) does not split multiplicatively in this example.

Here  $u_1, u_2$  are the Hurewitz images of  $\mu_1, \mu_2$ , the commutator  $u_1 u_2 + u_2 u_1$  is the Hurewitz image of the Samelson product  $[\mu_1, \mu_2]_s: S^2 \rightarrow \Omega(\mathbb{C}P^\infty \vee \mathbb{C}P^\infty)$ , and  $w \in H_2(\Omega S^3)$  is the Hurewitz image of the lift of  $[\mu_1, \mu_2]_s$  to  $\Omega S^3$ .

2. Now let  $\mathcal{K} = \partial \Delta^2$ , the boundary of a triangle. The fibration (8.15) becomes

$$\Omega S^5 \rightarrow \Omega(\mathbb{C}P^\infty)^{\partial \Delta^2} \rightarrow T^3,$$

where  $\Omega(\mathbb{C}P^\infty)^{\partial \Delta^2}$  is the fat wedge of 3 copies of  $\mathbb{C}P^\infty$ . We have  $H_*(\Omega S^5; \mathbf{k}) = \mathbf{k}[w]$ ,  $\deg w = 4$ . Algebra (8.17) is isomorphic to  $\Lambda[u_1, u_2, u_3]$ , so the sequence of Pontryagin algebras (8.16) splits multiplicatively in this example:

$$0 \longrightarrow \mathbf{k}[w] \longrightarrow \mathbf{k}[w] \otimes \Lambda[u_1, u_2, u_3] \longrightarrow \Lambda[u_1, u_2, u_3] \longrightarrow 0.$$

Here  $w \in H_4(\Omega(\mathbb{C}P^\infty)^{\partial \Delta^2}; \mathbf{k})$  is the Hurewicz image of the higher Samelson product  $[\mu_1, \mu_2, \mu_3]_s \in \pi_4(\Omega(\mathbb{C}P^\infty)^{\partial \Delta^2})$ , which lifts to  $\Omega S^5$ . The fact that  $[\mu_1, \mu_2, \mu_3]_s$  is a nontrivial higher Samelson product (and its Hurewicz image  $w$  is the ‘higher commutator product’ of  $u_1, u_2, u_3$ ) constitutes the additional information necessary to distinguish between the topological monoids  $\Omega(\mathbb{C}P^\infty)^{\partial \Delta^2}$  and  $\Omega S^5 \times T^3$ .

This calculation generalises easily to the case  $\mathcal{K} = \partial \Delta^{m-1}$ , showing that

$$H_*(\Omega(\mathbb{C}P^\infty)^{\mathcal{K}}; \mathbf{k}) \cong \mathbf{k}[w] \otimes \Lambda[u_1, \dots, u_m]$$

where  $\deg w = 2m - 2$ .

**Topological models for loop spaces.** We consider the diagram

$$(8.19) \quad \mathcal{D}_{\mathcal{K}}(S^1): \text{CAT}(\mathcal{K}) \rightarrow \text{TMON}$$

whose value on the morphism  $I \subset J$  is the monomorphism of tori  $T^I \rightarrow T^J$ . The classifying space diagram  $B\mathcal{D}_{\mathcal{K}}(S^1)$  is  $\mathcal{D}_{\mathcal{K}}(\mathbb{C}P^\infty, pt): \text{CAT}(\mathcal{K}) \rightarrow \text{TOP}$  with colimit  $(\mathbb{C}P^\infty)^{\mathcal{K}}$ . We denote the colimit and homotopy colimit of  $\mathcal{D}_{\mathcal{K}}(S^1)$  by  $\text{colim}_{I \in \mathcal{K}}^{\text{TMON}} T^I$  and  $\text{hocolim}_{I \in \mathcal{K}}^{\text{TMON}} T^I$ , respectively.

**THEOREM 8.4.7 ([261]).** *There is a commutative diagram*

$$(8.20) \quad \begin{array}{ccc} \Omega \text{hocolim}_{I \in \mathcal{K}}^{\text{TOP}} BT^I & \xrightarrow[\simeq]{g} & \text{hocolim}_{I \in \mathcal{K}}^{\text{TMON}} T^I \\ \Omega p^{\text{TOP}} \downarrow \simeq & & \downarrow p^{\text{TMON}} \\ \Omega(\mathbb{C}P^\infty)^{\mathcal{K}} & \xlongequal{\quad} & \Omega \text{colim}_{I \in \mathcal{K}}^{\text{TOP}} BT^I \longrightarrow \text{colim}_{I \in \mathcal{K}}^{\text{TMON}} T^I \end{array}$$

in  $\text{Ho}(\text{TMON})$ , where the top and left homomorphisms are homotopy equivalences.

**PROOF.** We apply Corollary C.3.8 with  $\mathcal{D} = \mathcal{D}_{\mathcal{K}}(S^1)$ . The left projection  $\Omega p^{\text{TOP}}: \Omega \text{hocolim}_{I \in \mathcal{K}}^{\text{TOP}} BT^I \rightarrow \Omega \text{colim}_{I \in \mathcal{K}}^{\text{TOP}} BT^I$  is a weak equivalence because  $B\mathcal{D}_{\mathcal{K}}(S^1) = \mathcal{D}_{\mathcal{K}}(\mathbb{C}P^\infty, pt)$  is a cofibrant diagram in  $\text{TOP}$ .  $\square$

COROLLARY 8.4.8. *There is a weak equivalence*

$$\Omega(\mathbb{C}P^\infty)^\mathcal{K} \simeq \operatorname{hocolim}_{I \in \mathcal{K}}^{\text{TMON}} T^I$$

in TMON.

The right projection  $p^{\text{TMON}}$  (and therefore the bottom homomorphism in (8.20)) is not a weak equivalence in general, because  $\mathcal{D}_\mathcal{K}(S^1)$  is *not* a cofibrant diagram in TMON. The appropriate examples are discussed below.

EXAMPLE 8.4.9.

1. Let  $\mathcal{K}$  be two points. Then

$$(\mathbb{C}P^\infty)^\mathcal{K} = \mathbb{C}P^\infty \vee \mathbb{C}P^\infty, \quad \operatorname{colim}_{I \in \mathcal{K}}^{\text{TMON}} \mathcal{D}_\mathcal{K}(S^1) = S^1 \star S^1$$

where  $\star$  denotes the free product of topological monoids, i.e. the coproduct in TMON. The bottom homomorphism in (8.20) is  $\Omega(\mathbb{C}P^\infty \vee \mathbb{C}P^\infty) \rightarrow S^1 \star S^1$ , it is a weak equivalence in TMON.

2. Now let  $\mathcal{K} = \partial\Delta^2$ . The loop space  $\Omega(\mathbb{C}P^\infty)^{\partial\Delta^2}$  is described in Example 8.4.6.2. On the other hand, the colimit of  $\mathcal{D}_\mathcal{K}(S^1)$  is obtained by taking quotient of  $T^{\{1\}} \star T^{\{2\}} \star T^{\{3\}}$  by the commutativity relations

$$t_1 \star t_2 = t_2 \star t_1, \quad t_2 \star t_3 = t_3 \star t_2, \quad t_3 \star t_1 = t_1 \star t_3$$

for  $t_i \in T^{\{i\}}$ , so that  $\operatorname{colim}_{I \in \mathcal{K}}^{\text{TMON}} T^I = T^3$ . It follows that the bottom map  $\Omega(\mathbb{C}P^\infty)^{\partial\Delta^2} \rightarrow T^3$  in (8.20) is not a weak equivalence; it has kernel  $\Omega S^5$ .

The diagram  $\mathcal{D} = \mathcal{D}_\mathcal{K}(S^1): \text{CAT}(\mathcal{K}) \rightarrow \text{TMON}$  is not cofibrant in this example. Indeed, if we take  $I = \{1, 2\}$ , then the induced diagram over the overcategory  $\text{CAT}(\mathcal{K}) \downarrow I = \text{CAT}(\Delta(I))$  has the form

$$\begin{array}{ccc} pt & \longrightarrow & T^{\{1\}} \\ \downarrow & & \downarrow \\ T^{\{2\}} & \longrightarrow & T^{\{1\}} \times T^{\{2\}} \end{array}$$

The map  $\operatorname{colim} \mathcal{D}|_{\text{CAT}(\partial\Delta(I))} \rightarrow \mathcal{D}(I)$  is the projection  $T^{\{1\}} \star T^{\{2\}} \rightarrow T^{\{1\}} \times T^{\{2\}}$  from the free product to the cartesian product, which is not a cofibration in TMON.

**Algebraic models for loop spaces.** Our next aim is to obtain an algebraic analogue of Theorem 8.4.7. We work over a commutative ring  $\mathbf{k}$ .

We define the *face coalgebra*  $\mathbf{k}\langle\mathcal{K}\rangle$  as the graded dual of the face ring  $\mathbf{k}[\mathcal{K}]$ . As a  $\mathbf{k}$ -module,  $\mathbf{k}\langle\mathcal{K}\rangle$  is free on generators  $v_\sigma$  corresponding to multisets of  $m$  elements of the form

$$\sigma = \{\underbrace{1, \dots, 1}_{k_1}, \underbrace{2, \dots, 2}_{k_2}, \dots, \underbrace{m, \dots, m}_{k_m}\}$$

such that *support* of  $\sigma$  (i.e. the set  $I_\sigma = \{i \in [m]: k_i \neq 0\}$ ) is a simplex of  $\mathcal{K}$ . The element  $v_\sigma$  is dual to the monomial  $v_1^{k_1} v_2^{k_2} \dots v_m^{k_m} \in \mathbf{k}[\mathcal{K}]$ . The comultiplication takes the form

$$\Delta v_\sigma = \sum_{\sigma = \tau \sqcup \tau'} v_\tau \otimes v_{\tau'}$$

where the sum ranges over all partitions of  $\sigma$  into submultisets  $\tau$  and  $\tau'$ .

We recall the Adams cobar construction  $\Omega_*: \text{DGC} \rightarrow \text{DGA}$ , see (C.9), and the Quillen functor  $L_*: \text{DGC} \rightarrow \text{DGL}$ , see (C.11). The loop algebra  $\Omega_* \mathbf{k}\langle\mathcal{K}\rangle$  is our first algebraic model for  $\Omega(\mathbb{C}P^\infty)^\mathcal{K}$ :

PROPOSITION 8.4.10. *There is an isomorphism of graded algebras*

$$H_*(\Omega(\mathbb{C}P^\infty)^{\mathcal{K}}; \mathbf{k}) \cong H(\Omega_*\mathbf{k}\langle\mathcal{K}\rangle) = \text{Cotor}_{\mathbf{k}\langle\mathcal{K}\rangle}(\mathbf{k}, \mathbf{k}).$$

PROOF. By dualising the integral formality results of [243, Theorem 4.8], we obtain a zigzag of quasi-isomorphisms

$$(8.21) \quad C_*((\mathbb{C}P^\infty)^{\mathcal{K}}; \mathbf{k}) \xleftarrow{\cong} \dots \xrightarrow{\cong} \mathbf{k}\langle\mathcal{K}\rangle.$$

in DGC (when  $\mathbf{k} = \mathbb{Q}$  this follows from Theorem 8.1.2). Since  $\Omega_*$  preserves quasi-isomorphisms, the zigzag above combines with Adams' result (Theorem C.2.1) to obtain the required isomorphism of algebras.  $\square$

REMARK. When  $\mathbf{k}$  is a field, there are isomorphisms

$$H_*(\Omega(\mathbb{C}P^\infty)^{\mathcal{K}}; \mathbf{k}) \cong \text{Cotor}_{\mathbf{k}\langle\mathcal{K}\rangle}(\mathbf{k}, \mathbf{k}) \cong \text{Ext}_{\mathbf{k}\langle\mathcal{K}\rangle}(\mathbf{k}, \mathbf{k}).$$

The graded algebra underlying the cobar construction  $\Omega_*\mathbf{k}\langle\mathcal{K}\rangle$  is the tensor algebra  $T(s^{-1}\overline{\mathbf{k}\langle\mathcal{K}\rangle})$  on the desuspended  $\mathbf{k}$ -module  $\overline{\mathbf{k}\langle\mathcal{K}\rangle} = \text{Ker}(\varepsilon: \mathbf{k}\langle\mathcal{K}\rangle \rightarrow \mathbf{k})$ ; the differential is defined on generators by

$$d(s^{-1}v_\sigma) = \sum_{\sigma=\tau\sqcup\tau'; \tau, \tau' \neq \emptyset} s^{-1}v_\tau \otimes s^{-1}v_{\tau'},$$

because  $d = 0$  on  $\mathbf{k}\langle\mathcal{K}\rangle$ . For future purposes it is convenient to write  $s^{-1}v_\sigma$  as  $\chi_\sigma$  for any multiset  $\sigma$ .

We define now some algebraic diagrams over  $\text{CAT}(\mathcal{K})$ . Our previous algebraic diagrams such as (8.1) were commutative, contravariant and cohomological, but to investigate the loop space  $\Omega(\mathbb{C}P^\infty)^{\mathcal{K}}$  we introduce models that are covariant and homological. We consider the diagram

$$\mathbf{k}[\cdot]_{\mathcal{K}}: \text{CAT}(\mathcal{K}) \rightarrow \text{DGA}, \quad I \mapsto \mathbf{k}[v_i: i \in I]$$

which maps a morphism  $I \subset J$  to the monomorphism of polynomial algebras  $\mathbf{k}[v_i: i \in I] \rightarrow \mathbf{k}[v_i: i \in J]$  with  $\deg v_i = 2$  and zero differential. Similarly, we define the diagrams

$$(8.22) \quad \begin{aligned} \Lambda[\cdot]_{\mathcal{K}}: \text{CAT}(\mathcal{K}) &\rightarrow \text{DGA}, & I &\mapsto \Lambda[u_i: i \in I], & \deg u_i &= 1, \\ \mathbf{k}\langle\cdot\rangle_{\mathcal{K}}: \text{CAT}(\mathcal{K}) &\rightarrow \text{DGC}, & I &\mapsto \mathbf{k}\langle v_i: i \in I \rangle, & \deg v_i &= 2, \\ CL(\cdot)_{\mathcal{K}}: \text{CAT}(\mathcal{K}) &\rightarrow \text{DGL}, & I &\mapsto CL(u_i: i \in I), & \deg u_i &= 1, \end{aligned}$$

where  $\mathbf{k}\langle v_i: i \in I \rangle$  denotes the free commutative coalgebra and  $CL(u_i: i \in I)$  denotes the commutative Lie algebra on  $|I|$  generators.

The individual algebras and coalgebras in these diagrams are all commutative, but the context demands they be interpreted in the non-commutative categories; this is especially important when forming limits and colimits.

Note that  $\text{colim}^{\text{DGC}} \mathbf{k}\langle\cdot\rangle_{\mathcal{K}} = \mathbf{k}\langle\mathcal{K}\rangle$ , while  $\text{colim}^{\text{DGA}} \Lambda[\cdot]_{\mathcal{K}}$  is the non-commutative algebra (8.17) (an exercise).

PROPOSITION 8.4.11. *There are acyclic fibrations*

$$\Omega_*\mathbf{k}\langle v_i: i \in I \rangle \xrightarrow{\cong} \Lambda[u_i: i \in I] \quad \text{and} \quad L_*\mathbf{k}\langle v_i: i \in I \rangle \xrightarrow{\cong} CL(u_i: i \in I)$$

in DGA and DGL respectively, for any set  $I \subset [m]$ .

PROOF. We define the first map by  $\chi_i \mapsto u_i$  for  $1 \leq i \leq m$ . Because

$$(8.23) \quad d\chi_{ii} = \chi_i \otimes \chi_i, \quad d\chi_{ij} = \chi_i \otimes \chi_j + \chi_j \otimes \chi_i \quad \text{for } i \neq j$$

hold in  $\Omega_*\mathbf{k}\langle v_i : i \in I \rangle$ , the map is consistent with the exterior relations in its target. So it is an epimorphism and quasi-isomorphism in DGA, and hence an acyclic fibration. The corresponding result for DGL follows by restriction to primitives.  $\square$

Observe that the diagram  $\Lambda[\cdot]_{\mathcal{K}}$  in DGA can be thought of as the diagram of homology algebras of topological monoids in the diagram  $\mathcal{D}_{\mathcal{K}}(S^1)$ , see (8.19), and the diagram  $\mathbf{k}\langle \cdot \rangle_{\mathcal{K}}$  in DGC is the diagram of homology coalgebras of spaces in the classifying diagram  $B\mathcal{D}_{\mathcal{K}}(S^1)$ . This relationship extends to the following algebraic analogue of Theorem 8.4.7:

THEOREM 8.4.12 ([260]). *There is a commutative diagram*

$$(8.24) \quad \begin{array}{ccc} \Omega_* \operatorname{hocolim}^{\operatorname{DGC}} \mathbf{k}\langle \cdot \rangle_{\mathcal{K}} & \xrightarrow[\simeq]{h} & \operatorname{hocolim}^{\operatorname{DGA}} \Lambda[\cdot]_{\mathcal{K}} \\ \Omega_* p^{\operatorname{DGC}} \downarrow \simeq & & \downarrow p^{\operatorname{DGA}} \\ \Omega_* \mathbf{k}\langle \mathcal{K} \rangle & \longrightarrow & \operatorname{colim}^{\operatorname{DGA}} \Lambda[\cdot]_{\mathcal{K}} \end{array}$$

in  $\operatorname{Ho}(\operatorname{DGA})$ , where the top and left arrows are isomorphisms.

PROOF. This follows by considering the diagram

$$\begin{array}{ccccc} \Omega_* \operatorname{hocolim}^{\operatorname{DGC}} \mathbf{k}\langle \cdot \rangle_{\mathcal{K}} & & \operatorname{hocolim}^{\operatorname{DGA}} \Omega_* \mathbf{k}\langle \cdot \rangle_{\mathcal{K}} & \xrightarrow{\simeq} & \operatorname{hocolim}^{\operatorname{DGA}} \Lambda[\cdot]_{\mathcal{K}} \\ \Omega_* p^{\operatorname{DGC}} \downarrow \simeq & & p^{\operatorname{DGA}} \downarrow \simeq & & p^{\operatorname{DGA}} \downarrow \\ \Omega_* \operatorname{colim}^{\operatorname{DGC}} \mathbf{k}\langle \cdot \rangle_{\mathcal{K}} & \xleftarrow{\cong} & \operatorname{colim}^{\operatorname{DGA}} \Omega_* \mathbf{k}\langle \cdot \rangle_{\mathcal{K}} & \longrightarrow & \operatorname{colim}^{\operatorname{DGA}} \Lambda[\cdot]_{\mathcal{K}} \\ \parallel & & & & \\ \Omega_* \mathbf{k}\langle \mathcal{K} \rangle & & & & \end{array}$$

Here the top right horizontal map is induced by the map of diagrams  $\Omega_* \mathbf{k}\langle \cdot \rangle_{\mathcal{K}} \rightarrow \Lambda[\cdot]_{\mathcal{K}}$  whose objectwise maps are acyclic fibrations from Proposition 8.4.11; the map of homotopy colimits is a weak equivalence because the map of diagrams is an acyclic Reedy fibration. The right square is commutative. The central vertical map is a weak equivalence because the diagram  $\Omega_* \mathbf{k}\langle \cdot \rangle_{\mathcal{K}}$  is Reedy cofibrant. The bottom left horizontal map is an isomorphism because  $\Omega_*$  is left adjoint. The left vertical map is a weak equivalence because the diagram  $\mathbf{k}\langle \cdot \rangle_{\mathcal{K}}$  is Reedy cofibrant and  $\Omega_*$  preserves weak equivalences. The resulting zigzag of quasi-isomorphisms

$$\Omega_* \operatorname{hocolim}^{\operatorname{DGC}} \mathbf{k}\langle \cdot \rangle_{\mathcal{K}} \xrightarrow{\simeq} \cdots \xrightarrow{\simeq} \operatorname{hocolim}^{\operatorname{DGA}} \Lambda[\cdot]_{\mathcal{K}}$$

induces an isomorphism in the homotopy category  $\operatorname{Ho}(\operatorname{DGA})$ ; we denote it by  $h$ .  $\square$

As in the case of diagram (8.20), the right and bottom maps in (8.24) are not weak equivalences in general, because  $\Lambda[\cdot]_{\mathcal{K}}$  is *not* a cofibrant diagram in DGA.

The following statement is proved similarly.

THEOREM 8.4.13 ([260]). *There is a homotopy commutative diagram*

$$(8.25) \quad \begin{array}{ccc} L_* \operatorname{hocolim}^{\operatorname{DGC}} \mathbb{Q}\langle \cdot \rangle_{\mathcal{K}} & \xrightarrow[\simeq]{} & \operatorname{hocolim}^{\operatorname{DGL}} CL(\cdot)_{\mathcal{K}} \\ L_* p^{\operatorname{DGC}} \downarrow \simeq & & \downarrow p^{\operatorname{DGL}} \\ L_* \mathbb{Q}\langle \mathcal{K} \rangle & \longrightarrow & \operatorname{colim}^{\operatorname{DGL}} CL(\cdot)_{\mathcal{K}} \end{array}$$

in  $Ho(\text{DGL})$ , where the top and left arrows are isomorphisms.

The homotopy colimit decomposition above defines our second algebraic model for  $\Omega(\mathbb{C}P^\infty)^\mathcal{K}$ :

**COROLLARY 8.4.14.** *For any simplicial complex  $\mathcal{K}$  and commutative ring  $\mathbf{k}$ , there are isomorphisms*

$$\begin{aligned} H_*(\Omega(\mathbb{C}P^\infty)^\mathcal{K}; \mathbf{k}) &\cong H(\text{hocolim}^{\text{DGA}} \Lambda[\cdot]_\mathcal{K}) \\ \pi_*(\Omega(\mathbb{C}P^\infty)^\mathcal{K}) \otimes_{\mathbb{Z}} \mathbb{Q} &\cong H(\text{hocolim}^{\text{DGL}} CL(\cdot)_\mathcal{K}) \end{aligned}$$

of graded algebras and Lie algebras respectively.

**EXAMPLE 8.4.15.**

1. Let  $\mathcal{K}$  be a discrete complex on  $m$  vertices, so that  $(\mathbb{C}P^\infty)^\mathcal{K}$  is a wedge of  $m$  copies of  $\mathbb{C}P^\infty$ . The cobar construction  $\Omega_*\mathbf{k}(\mathcal{K})$  on the corresponding face coalgebra is generated as an algebra by the elements of the form  $\chi_{i\dots i}$  with  $i \in [m]$ . The first identity of (8.23) still holds, but  $\chi_i \otimes \chi_j + \chi_j \otimes \chi_i$  is no longer a boundary for  $i \neq j$  since there is no element  $\chi_{ij}$  in  $\Omega_*\mathbf{k}(\mathcal{K})$ . We obtain a quasi-isomorphism

$$\Omega_*\mathbf{k}(\mathcal{K}) \xrightarrow{\simeq} T_{\mathbf{k}}(u_1, \dots, u_m) / (u_i^2 = 0, 1 \leq i \leq m)$$

that maps  $\chi_i$  to  $u_i$ . The right hand side is isomorphic to  $H_*(\Omega(\mathbb{C}P^\infty)^\mathcal{K}; \mathbf{k})$ ; it is the coproduct (the free product) of  $m$  algebras  $\Lambda[u_i]$ . Therefore, the bottom map  $\Omega_*\mathbf{k}(\mathcal{K}) \rightarrow \text{colim}^{\text{DGA}} \Lambda[\cdot]_\mathcal{K}$  in (8.24) is a quasi-isomorphism in this example.

The algebra  $H_*(\Omega\mathcal{Z}_\mathcal{K}; \mathbf{k})$  is the commutator subalgebra of  $H_*(\Omega(\mathbb{C}P^\infty)^\mathcal{K}; \mathbf{k})$  according to (8.16). It contains iterated commutators  $[u_{i_1}, [u_{i_2}, \dots [u_{i_{k-1}}, u_{i_k}] \dots]]$  with  $k \geq 2$  corresponding to iterated Samelson products in  $\pi_*(\Omega(\mathbb{C}P^\infty)^\mathcal{K})$ . On the other hand,  $\mathcal{Z}_\mathcal{K}$  is a wedge of spheres given by (8.11). Therefore,  $H_*(\Omega\mathcal{Z}_\mathcal{K}; \mathbf{k})$  is a free (tensor) algebra on the generators corresponding to the wedge summands. So the number of independent iterated commutators of length  $k$  is  $(k-1)\binom{m}{k}$ . This fact can be proved purely algebraically, see Corollary 8.5.8 below. There are no higher Samelson products (and higher iterated commutators) in this example, as  $\mathcal{K}$  does not have missing faces with  $> 2$  vertices.

2. Let  $\mathcal{K} = \partial\Delta^2$ . As we have seen in Example 8.4.6.2,

$$H_*(\Omega(\mathbb{C}P^\infty)^\mathcal{K}; \mathbf{k}) \cong \mathbf{k}[w] \otimes \Lambda[u_1, u_2, u_3].$$

This can also be seen algebraically using the cobar model  $\Omega_*\mathbf{k}(\mathcal{K})$ . Here  $u_i$  is the homology classes of the element  $\chi_i$ , and  $w \in H_4(\Omega(\mathbb{C}P^\infty)^\mathcal{K}; \mathbf{k})$  is the homology class of the 4-dimensional cycle

$$\psi = \chi_1\chi_{23} + \chi_2\chi_{13} + \chi_3\chi_{12} + \chi_{12}\chi_3 + \chi_{13}\chi_2 + \chi_{23}\chi_1,$$

whose failure to bound is due to the non-existence of  $\chi_{123}$ . Relations (8.23) hold, and give rise to the exterior relations between  $u_1, u_2, u_3$ . Furthermore, a direct check shows that  $\chi_i\psi - \psi\chi_i$  is a boundary, which implies that  $u_i$  commutes with  $w$  in  $H_*(\Omega(\mathbb{C}P^\infty)^\mathcal{K}; \mathbf{k})$  for  $1 \leq i \leq 3$ .

Here the colimit of  $\Lambda[\cdot]_\mathcal{K}$  in DGA is obtained by taking quotient of  $T_{\mathbf{k}}(u_1, u_2, u_3)$  by all exterior relations. Therefore,  $\text{colim}^{\text{DGA}} \Lambda[\cdot]_\mathcal{K} = \Lambda[u_1, u_2, u_3]$  and the bottom map  $\Omega_*\mathbf{k}(\mathcal{K}) \rightarrow \text{colim}^{\text{DGA}} \Lambda[\cdot]_\mathcal{K}$  in (8.24) is *not* a quasi-isomorphism in this example.

3. Let  $\mathcal{K} = \text{sk}^1\partial\Delta^3$ , the 1-skeleton of a 3-simplex, or a complete graph on 4 vertices. Arguments similar to those of the previous example show that the

Pontryagin algebra  $H_*(\Omega(\mathbb{C}P^\infty)^\mathcal{K}; \mathbf{k})$  contains 1-dimensional classes  $u_1, \dots, u_4$  and 4-dimensional classes  $w_{123}, w_{124}, w_{134}, w_{234}$ , corresponding to the four missing faces with three vertices each. For example,  $w_{123}$  is the homology class of the cycle  $\psi_{123}$  which may be thought of as the ‘boundary of the non-existing element  $\chi_{123}$ ’. Identities (8.23) give rise to the exterior relations between  $u_1, \dots, u_4$ . We may easily check that  $u_i$  commutes with  $w_{jkl}$  if  $i \in \{j, k, l\}$ . There are four remaining non-trivial commutators of the form  $[u_i, w_{jkl}]$  with all  $i, j, k, l$  different.

It follows that the commutator subalgebra  $H_*(\Omega\mathcal{Z}_\mathcal{K}; \mathbf{k})$  contains four higher commutators  $w_{jkl} = [u_j, u_k, u_l]$  (the Hurewicz images of the higher Samelson products  $[\mu_j, \mu_k, \mu_l]_s$ ) and four iterated commutators  $[u_i, w_{jkl}]$ . On the other hand, Theorem 4.7.7 gives a homotopy equivalence

$$\mathcal{Z}_\mathcal{K} \simeq (S^5)^{\vee 4} \vee (S^6)^{\vee 3},$$

which implies that  $H_*(\Omega\mathcal{Z}_\mathcal{K}; \mathbf{k})$  is a free algebra on four 4-dimensional and *three* 5-dimensional generators. The point is that the commutators  $[u_i, w_{jkl}]$  are subject to one extra relation, which can be derived as follows. Consider the relation

$$(8.26) \quad d\chi_{1234} = (\chi_1\chi_{234} + \chi_{234}\chi_1) + \dots + (\chi_4\chi_{123} + \chi_{123}\chi_4) + \beta$$

in  $\Omega_*\mathbf{k}\langle v_1, v_2, v_3, v_4 \rangle$ , where  $\beta$  consists of terms  $\chi_\sigma\chi_\tau$  such that  $|\sigma| = |\tau| = 2$ . Denote the first four summands on the right hand side of (8.26) by  $\alpha_1, \alpha_2, \alpha_3, \alpha_4$  respectively, and apply the differential to both sides. Observing that  $d\alpha_1 = -\chi_1\psi_{234} + \psi_{234}\chi_1 = -[\chi_1, \psi_{234}]$ , and similarly for  $d\alpha_2, d\alpha_3$  and  $d\alpha_4$ , we obtain

$$[\chi_1, \psi_{234}] + [\chi_2, \psi_{134}] + [\chi_3, \psi_{124}] + [\chi_4, \psi_{123}] = d\beta.$$

The outcome is an isomorphism

$$H_*(\Omega(\mathbb{C}P^\infty)^\mathcal{K}; \mathbf{k}) \cong T_{\mathbf{k}}(u_1, u_2, u_3, u_4, w_{123}, w_{124}, w_{134}, w_{234})/\mathcal{I},$$

where  $\deg w_{ijk} = 4$  and  $\mathcal{I}$  is generated by three types of relation:

- exterior algebra relations for  $u_1, u_2, u_3, u_4$ ;
- $[u_i, w_{jkl}] = 0$  for  $i \in \{j, k, l\}$ ;
- $[u_1, w_{234}] + [u_2, w_{134}] + [u_3, w_{124}] + [u_4, w_{123}] = 0$ .

As  $w_{ijk}$  is the higher commutator of  $u_i, u_j$  and  $u_k$ , the third relation may be considered as a higher analogue of the Jacobi identity.

It is a challenging task to construct explicit algebraic models for  $\Omega(\mathbb{C}P^\infty)^\mathcal{K}$  and  $\Omega\mathcal{Z}_\mathcal{K}$  which would include a description of the Pontryagin algebra structure, as well as higher Samelson and commutator products. The situation is considerably simpler when  $\mathcal{K}$  is a flag complex, as there are no higher products; this is the subject of the next section.

**Exercises.**

8.4.16. For any  $2n$ -dimensional (quasi)toric manifold  $M$ , show that there is a fibration

$$\Omega M \longrightarrow \Omega(\mathbb{C}P^\infty)^\mathcal{K} \longrightarrow T^n,$$

which splits in TOP.

8.4.17. For the classes of simplicial complexes  $\mathcal{K}$  described in Propositions 8.2.5 and 8.2.6 (discrete complexes and trees), show that each wedge summand of  $\mathcal{Z}_\mathcal{K}$  is represented by a lift  $S^p \rightarrow \mathcal{Z}_\mathcal{K}$  of iterated Whitehead products of the  $\mu_i: S^2 \rightarrow (\mathbb{C}P^\infty)^\mathcal{K}$  (no higher products appear here). Describe the corresponding iterated



brackets explicitly. In particular, the answer to Problem 8.4.5 is positive for these two classes of  $\mathcal{K}$ .

8.4.18. Show that  $H^*(\Omega(\mathbb{C}P^\infty \vee \mathbb{C}P^\infty); \mathbf{k}) = T\langle u_1, u_2 \rangle / (u_1^2, u_2^2)$  and describe the sequence of Pontryagin algebras corresponding to the fibration  $\Omega S^3 \rightarrow \Omega(\mathbb{C}P^\infty \vee \mathbb{C}P^\infty) \rightarrow S^1 \times S^1$ .

8.4.19. Show that  $\text{colim}^{\text{dga}} \Lambda[\cdot]_{\mathcal{K}}$  is the algebra given by (8.17).

### 8.5. The case of flag complexes

In this section we study the loop spaces associated with *flag complexes*  $\mathcal{K}$ . Such complexes have significantly simpler combinatorial properties, which are reflected in the homotopy theory of the toric spaces. We modify results of the previous section in this context, and focus on applications to the Pontryagin rings and homotopy Lie algebras of  $\Omega(\mathbb{C}P^\infty)^{\mathcal{K}}$  and  $\Omega\mathcal{Z}_{\mathcal{K}}$ . We also describe completely the class of flag complexes  $\mathcal{K}$  for which  $\mathcal{Z}_{\mathcal{K}}$  is homotopy equivalent to a wedge of spheres.

For any simplicial complex  $\mathcal{K}$  on  $[m]$ , recall that a subset  $I \subset [m]$  is called a missing face when every proper subset lies in  $\mathcal{K}$ , but  $I$  itself does not. If every missing face of  $\mathcal{K}$  has 2 vertices, then  $\mathcal{K}$  is a flag complex; equivalently,  $\mathcal{K}$  is flag when every set of vertices that is pairwise connected spans a simplex. A flag complex is therefore determined by its 1-skeleton, which is a graph. When  $\mathcal{K}$  is flag, we may express the face ring as

$$\mathbf{k}[\mathcal{K}] = T_{\mathbf{k}}(v_1, \dots, v_m) / (v_i v_j - v_j v_i = 0 \text{ for } \{i, j\} \in \mathcal{K}, v_i v_j = 0 \text{ for } \{i, j\} \notin \mathcal{K}).$$

It is therefore *quadratic*, in the sense that it is the quotient of a free algebra by quadratic relations.

The following result of Fröberg allows us to calculate the Yoneda algebras  $\text{Ext}_A(\mathbf{k}, \mathbf{k})$  explicitly for a class of quadratic algebras  $A$  that includes face rings of flag complexes.

PROPOSITION 8.5.1 ([119, §3]). *When  $\mathbf{k}$  is a field and  $\mathcal{K}$  is a flag complex, there is an isomorphism of graded algebras*

$$(8.27) \quad \text{Ext}_{\mathbf{k}[\mathcal{K}]}(\mathbf{k}, \mathbf{k}) \cong T_{\mathbf{k}}(u_1, \dots, u_m) / (u_i^2 = 0, u_i u_j + u_j u_i = 0 \text{ for } \{i, j\} \in \mathcal{K}).$$

REMARK. The algebra on the right hand side of (8.27) is the *quadratic dual* of  $\mathbf{k}[\mathcal{K}]$ . A quadratic algebra  $A$  is called *Koszul* if its quadratic dual coincides with  $\text{Ext}_A(\mathbf{k}, \mathbf{k})$ , so Proposition 8.5.1 asserts that  $\mathbf{k}[\mathcal{K}]$  is Koszul when  $\mathcal{K}$  is flag.

When  $\mathcal{K}$  is flag, (8.17) is the whole Pontryagin algebra  $H_*(\Omega(\mathbb{C}P^\infty)^{\mathcal{K}}; \mathbf{k})$ :

THEOREM 8.5.2 ([260]). *For any flag complex  $\mathcal{K}$ , there are isomorphisms*

$$\begin{aligned} H_*(\Omega(\mathbb{C}P^\infty)^{\mathcal{K}}; \mathbf{k}) &\cong T_{\mathbf{k}}(u_1, \dots, u_m) / (u_i^2 = 0, u_i u_j + u_j u_i = 0 \text{ for } \{i, j\} \in \mathcal{K}) \\ \pi_*(\Omega(\mathbb{C}P^\infty)^{\mathcal{K}}) \otimes_{\mathbb{Z}} \mathbb{Q} &\cong FL(u_1, \dots, u_m) / ([u_i, u_i] = 0, [u_i, u_j] = 0 \text{ for } \{i, j\} \in \mathcal{K}), \end{aligned}$$

where  $\mathbf{k}$  is  $\mathbb{Z}$  or a field,  $FL(\cdot)$  denotes a free Lie algebra and  $\deg u_i = 1$ .

PROOF. By Proposition 8.4.10,  $H_*(\Omega(\mathbb{C}P^\infty)^{\mathcal{K}}; \mathbf{k}) \cong \text{Cotor}_{\mathbf{k}(\mathcal{K})}(\mathbf{k}, \mathbf{k})$ . When  $\mathbf{k}$  is a field,  $\text{Cotor}_{\mathbf{k}(\mathcal{K})}(\mathbf{k}, \mathbf{k}) \cong \text{Ext}_{\mathbf{k}[\mathcal{K}]}(\mathbf{k}, \mathbf{k})$  by (C.10), and the first required isomorphism follows from Proposition 8.5.1.

Now let  $\mathbf{k} = \mathbb{Z}$ . Denote by  $A$  algebra (8.17) with  $\mathbf{k} = \mathbb{Z}$ . Then  $A$  includes as a subalgebra in  $H_*(\Omega(\mathbb{C}P^\infty)^{\mathcal{K}}; \mathbb{Z})$  by Corollary 8.4.3. Consider the exact sequence

$$0 \rightarrow A \xrightarrow{i} H_*(\Omega(\mathbb{C}P^\infty)^{\mathcal{K}}; \mathbb{Z}) \rightarrow R \rightarrow 0$$

where  $R$  is the cokernel of  $i$ . By tensoring with a field  $\mathbf{k}$  we obtain an exact sequence

$$A \otimes \mathbf{k} \xrightarrow{i \otimes \mathbf{k}} H_*(\Omega(\mathbb{C}P^\infty)^\mathcal{K}; \mathbb{Z}) \otimes \mathbf{k} \longrightarrow R \otimes \mathbf{k} \rightarrow 0$$

The composite map

$$A \otimes \mathbf{k} \xrightarrow{i \otimes \mathbf{k}} H_*(\Omega(\mathbb{C}P^\infty)^\mathcal{K}; \mathbb{Z}) \otimes \mathbf{k} \xrightarrow{j} H_*(\Omega(\mathbb{C}P^\infty)^\mathcal{K}; \mathbf{k})$$

is an isomorphism by the argument in the previous paragraph, and  $j$  is a monomorphism by the universal coefficient theorem. Therefore,  $i \otimes \mathbf{k}$  is also an isomorphism, which implies that  $R \otimes \mathbf{k} = 0$  for any field  $\mathbf{k}$ . Thus,  $R = 0$  and  $i$  is an isomorphism.

The isomorphism of Lie algebras follows by restriction to primitives.  $\square$

The authors are grateful to Kouyemon Iriye and Jie Wu for pointing out that the original argument of [260] for the theorem above can be extended to the case  $\mathbf{k} = \mathbb{Z}$ .

The associative algebra and the Lie algebra from Theorem 8.5.2 are examples of *graph products*, by which one usually means algebraic objects described by generators corresponding to the vertices in a simple graph, with each edge giving rise to a commutativity relation between the generators corresponding to its two ends. These two graph products can be also described as the colimits of the diagrams  $\Lambda[\cdot]_\mathcal{K}$  and  $CL(\cdot)_\mathcal{K}$  in DGA and DGL respectively, see (8.22). It follows that the bottom maps in (8.24) and (8.25) are quasi-isomorphisms when  $\mathcal{K}$  is flag, and homotopy colimit in the models of Corollary 8.4.14 can be replaced by colimit:

COROLLARY 8.5.3. *For any flag complex  $\mathcal{K}$ , there are isomorphisms*

$$\begin{aligned} H_*(\Omega(\mathbb{C}P^\infty)^\mathcal{K}; \mathbf{k}) &\cong \operatorname{colim}^{\text{DGA}} \Lambda[\cdot]_\mathcal{K} \\ \pi_*(\Omega(\mathbb{C}P^\infty)^\mathcal{K}) \otimes_{\mathbb{Z}} \mathbb{Q} &\cong \operatorname{colim}^{\text{DGL}} CL(\cdot)_\mathcal{K} \end{aligned}$$

of graded algebras and Lie algebras respectively, where  $\mathbf{k} = \mathbb{Z}$  or a field.

REMARK. The bottom homomorphism

$$\Omega(\mathbb{C}P^\infty)^\mathcal{K} \rightarrow \operatorname{colim}_{I \in \mathcal{K}}^{\text{TMON}} T^I$$

in the topological model (8.20) is also a homotopy equivalence when  $\mathcal{K}$  is flag, by [261, Proposition 6.3]. Furthermore, there are analogues of this result for other polyhedral powers. Interesting cases are  $(\mathbb{R}P^\infty)^\mathcal{K}$  and  $(S^1)^\mathcal{K}$ , for which there are homotopy equivalence homomorphisms

$$(8.28) \quad \begin{aligned} \Omega(\mathbb{R}P^\infty)^\mathcal{K} &\xrightarrow{\cong} \operatorname{colim}_{I \in \mathcal{K}}^{\text{TMON}} \mathbb{Z}_2^I, \\ \Omega(S^1)^\mathcal{K} &\xrightarrow{\cong} \operatorname{colim}_{I \in \mathcal{K}}^{\text{TMON}} \mathbb{Z}^I. \end{aligned}$$

Since  $\mathbb{Z}_2$  and  $\mathbb{Z}$  are discrete groups, the colimit in TMON is the ordinary colimit of groups, and the two colimits above have the following graph product presentations:

$$\begin{aligned} \operatorname{colim}_{I \in \mathcal{K}}^{\text{GRP}} \mathbb{Z}_2^I &= F(g_1, \dots, g_m) / (g_i^2 = 0, g_i g_j = g_j g_i \text{ for } \{i, j\} \in \mathcal{K}), \\ \operatorname{colim}_{I \in \mathcal{K}}^{\text{GRP}} \mathbb{Z}^I &= F(g_1, \dots, g_m) / (g_i g_j = g_j g_i \text{ for } \{i, j\} \in \mathcal{K}) \end{aligned}$$

where  $F(g_1, \dots, g_m)$  denotes a free group on  $m$  generators. The two groups above are known as the *right-angled Coxeter group* and the *right-angled Artin group* corresponding to the 1-skeleton (graph) of the flag complex  $\mathcal{K}$ .

Homotopy equivalences (8.28) imply that the polyhedral power  $(\mathbb{R}P^\infty)^\mathcal{K}$  is the classifying space for the right-angled Coxeter group  $\operatorname{colim}_{I \in \mathcal{K}}^{\text{GRP}} \mathbb{Z}_2^I$  and  $(S^1)^\mathcal{K}$  is the classifying space for the right-angled Artin group  $\operatorname{colim}_{I \in \mathcal{K}}^{\text{GRP}} \mathbb{Z}^I$ . The former result is

implicit in the work of Davis and Januszkiewicz [90], and the latter is due to Kim and Roush [184]. Note that  $(S^1)^\mathcal{K}$  is a finite cell complex.

PROPOSITION 8.5.4. *For a flag complex  $\mathcal{K}$ , the Poincaré series of the Pontryagin algebras  $H_*(\Omega(\mathbb{C}P^\infty)^\mathcal{K}; \mathbf{k})$  and  $H_*(\Omega\mathcal{Z}_\mathcal{K}; \mathbf{k})$  are given by*

$$F(H_*(\Omega(\mathbb{C}P^\infty)^\mathcal{K}; \mathbf{k}); \lambda) = \frac{(1 + \lambda)^n}{1 - h_1\lambda + \cdots + (-1)^n h_n \lambda^n},$$

$$F(H_*(\Omega\mathcal{Z}_\mathcal{K}; \mathbf{k}); \lambda) = \frac{1}{(1 + \lambda)^{m-n} (1 - h_1\lambda + \cdots + (-1)^n h_n \lambda^n)},$$

where  $(h_0, h_1, \dots, h_n)$  is the  $h$ -vector of  $\mathcal{K}$ .

PROOF. Since  $H_*(\Omega(\mathbb{C}P^\infty)^\mathcal{K}; \mathbf{k})$  is the quadratic dual of  $\mathbf{k}[\mathcal{K}]$ , the identity

$$F(\mathbf{k}[\mathcal{K}]; -\lambda) \cdot F(H_*(\Omega(\mathbb{C}P^\infty)^\mathcal{K}; \lambda) = 1$$

follows from Fröberg [119, §4] (in the identity above it is assumed that the generators of  $\mathbf{k}[\mathcal{K}]$  have degree one). The Poincaré series of the face ring is given by Theorem 3.1.10, whence the first formula follows. The second formula follows from exact sequence (8.16).  $\square$

The Poincaré series of  $\pi_*(\Omega(\mathbb{C}P^\infty)^\mathcal{K}) \otimes_{\mathbb{Z}} \mathbb{Q}$  (and therefore the ranks of homotopy groups of  $(\mathbb{C}P^\infty)^\mathcal{K}$  and  $\mathcal{Z}_\mathcal{K}$ ) can also be calculated in the flag case, although less explicitly. See [95, §4.2].

EXAMPLE 8.5.5. Let  $\mathcal{K} = \partial\Delta^n$ , so that  $h_0 = \cdots = h_n = 1$ . Then  $\Omega(\mathbb{C}P^\infty)^\mathcal{K} \simeq \Omega S^{2n+1} \times T^{n+1}$ , and

$$F(H_*(\Omega(\mathbb{C}P^\infty)^\mathcal{K}); \lambda) = \frac{(1 + \lambda)^{n+1}}{1 - \lambda^{2n}}.$$

On the other hand, Proposition 8.5.4 gives

$$\frac{(1 + \lambda)^n}{1 - \lambda + \lambda^2 + \cdots + (-1)^n \lambda^n} = \frac{(1 + \lambda)^{n+1}}{1 + (-1)^n \lambda^{n+1}}.$$

The formulae agree if  $n = 1$ , in which case  $\mathcal{K}$  is flag, but differ otherwise.

We recall from Section C.1 that a space  $X$  is *coformal* when its Quillen model  $Q(X)$  is weakly equivalent to the rational homotopy Lie algebra  $\pi_*(\Omega X) \otimes_{\mathbb{Z}} \mathbb{Q}$  as objects in DGL. The space  $(\mathbb{C}P^\infty)^\mathcal{K}$  is always formal by Theorem 8.1.2, while its coformality depends on  $\mathcal{K}$ :

THEOREM 8.5.6. *The space  $(\mathbb{C}P^\infty)^\mathcal{K}$  is coformal if and only if  $\mathcal{K}$  is flag.*

PROOF. If  $\mathcal{K}$  is flag, Theorem 8.4.12 together with Corollary 8.5.3 provide an acyclic fibration

$$\Omega_* \mathbb{Q}\langle \mathcal{K} \rangle \cong \Omega_* \operatorname{colim}^{\text{DGC}} \mathbb{Q}\langle \cdot \rangle_{\mathcal{K}} \xrightarrow{\simeq} \operatorname{colim}^{\text{DGA}} \Lambda[\cdot]_{\mathcal{K}}$$

in  $\text{DGA}_{\mathbb{Q}}$ . Restricting to primitives yields a quasi-isomorphism  $e: L_* \mathbb{Q}\langle \mathcal{K} \rangle \xrightarrow{\simeq} \pi_*(\Omega(\mathbb{C}P^\infty)^\mathcal{K}) \otimes_{\mathbb{Z}} \mathbb{Q}$  in DGL.

Now choose a minimal model  $M_{\mathcal{K}} \rightarrow \mathbb{Q}[\mathcal{K}]$  for the face ring in  $\text{CDGA}_{\mathbb{Q}}$ . Its graded dual  $\mathbb{Q}\langle \mathcal{K} \rangle \rightarrow C_{\mathcal{K}}$  is a minimal model for  $\mathbb{Q}\langle \mathcal{K} \rangle$  in  $\text{CDGC}$  (see [241, §5]), so  $\Omega_* \mathbb{Q}\langle \mathcal{K} \rangle \rightarrow \Omega_* C_{\mathcal{K}}$  is a weak equivalence in DGA. Restricting to primitives provides the central map in the zigzag

$$(8.29) \quad L_{\mathcal{K}} \xrightarrow{\simeq} L_* C_{\mathcal{K}} \xleftarrow{\simeq} L_* \mathbb{Q}\langle \mathcal{K} \rangle \xrightarrow{e} \pi_*(\Omega(\mathbb{C}P^\infty)^\mathcal{K}) \otimes_{\mathbb{Z}} \mathbb{Q}$$

of quasi-isomorphisms in DGL, where  $L_{\mathcal{K}}$  is a minimal model for  $(\mathbb{C}P^\infty)^{\mathcal{K}}$  in DGL [241, §8]. Hence  $(\mathbb{C}P^\infty)^{\mathcal{K}}$  is coformal.

On the other hand, every missing face of  $\mathcal{K}$  with  $> 2$  vertices determines a nontrivial higher Samelson bracket in  $\pi_*(\Omega(\mathbb{C}P^\infty)^{\mathcal{K}}) \otimes_{\mathbb{Z}} \mathbb{Q}$ . The existence of such brackets in  $\pi_*(\Omega X) \otimes_{\mathbb{Z}} \mathbb{Q}$  ensures that  $X$  cannot be coformal, just as higher Massey products in  $H^*(X; \mathbb{Q})$  obstruct formality.  $\square$

Unlike the situation with the Pontryagin algebra  $H_*(\Omega(\mathbb{C}P^\infty)^{\mathcal{K}})$ , we are unable to describe the structure of its commutator subalgebra  $H_*(\Omega Z_{\mathcal{K}})$  completely even in the flag case. However, the following result identifies a minimal set of multiplicative generators as a specific set of iterated commutators of the  $u_i$ :

**THEOREM 8.5.7** ([131, Theorem 4.3]). *Assume that  $\mathcal{K}$  is flag and  $\mathbf{k}$  is a field. The algebra  $H_*(\Omega Z_{\mathcal{K}}; \mathbf{k})$ , viewed as the commutator subalgebra of (8.17) via exact sequence (8.16), is multiplicatively generated by  $\sum_{I \subset [m]} \dim \tilde{H}^0(\mathcal{K}_I)$  iterated commutators of the form*

$$[u_j, u_i], \quad [u_{k_1}, [u_j, u_i]], \quad \dots, \quad [u_{k_1}, [u_{k_2}, \dots [u_{k_{m-2}}, [u_j, u_i]] \dots]]$$

where  $k_1 < k_2 < \dots < k_p < j > i$ ,  $k_s \neq i$  for any  $s$ , and  $i$  is the smallest vertex in a connected component not containing  $j$  of the subcomplex  $\mathcal{K}_{\{k_1, \dots, k_p, j, i\}}$ . Furthermore, this multiplicative generating set is minimal, that is, the commutators above form a basis in the submodule of indecomposables in  $H_*(\Omega Z_{\mathcal{K}}; \mathbf{k})$ .

**REMARK.** To help clarify the statement of Theorem 8.5.7, it is useful to consider which brackets  $[u_j, u_i]$  are in the list of multiplicative generators for  $H_*(\Omega Z_{\mathcal{K}}; \mathbf{k})$ . If  $\{j, i\} \in \mathcal{K}$  then  $i$  and  $j$  are in the same connected component of the subcomplex  $\mathcal{K}_{\{j, i\}}$ , so  $[u_j, u_i]$  is not a multiplicative generator. On the other hand, if  $\{j, i\} \notin \mathcal{K}$  then the subcomplex  $\mathcal{K}_{\{j, i\}}$  consists of the two distinct points  $i$  and  $j$ , and  $i$  is the smallest vertex in its connected component of  $\mathcal{K}_{\{j, i\}}$  which does not contain  $j$ , so  $[u_j, u_i]$  is a multiplicative generator.

For a given  $I = \{k_1, \dots, k_p, j, i\}$ , the number of the commutators containing all  $u_{k_1}, \dots, u_{k_p}, u_j, u_i$  in the set above is equal to  $\dim \tilde{H}^0(\mathcal{K}_I)$  (one less the number of connected components in  $\mathcal{K}_I$ ), so there are indeed  $\sum_{I \subset [m]} \dim \tilde{H}^0(\mathcal{K}_I)$  commutators in total. More details are given in examples below.

An important particular case of Theorem 8.5.7 corresponds to  $\mathcal{K}$  consisting of  $m$  disjoint points. This result may be of independent algebraic interest, as it is an analogue of the description of a basis in the commutator subalgebra of a free algebra, given by Cohen and Neisendorfer [80]:

**COROLLARY 8.5.8.** *Let  $A$  be the commutator subalgebra of the algebra  $T\langle u_1, \dots, u_m \rangle / (u_i^2 = 0)$ , that is,  $A$  is the algebra defined by the exact sequence*

$$1 \longrightarrow A \longrightarrow T\langle u_1, \dots, u_m \rangle / (u_i^2 = 0) \longrightarrow \Lambda[u_1, \dots, u_m] \longrightarrow 1$$

where  $\deg u_i = 1$ . Then  $A$  is a free associative algebra minimally generated by the iterated commutators of the form

$$[u_j, u_i], \quad [u_{k_1}, [u_j, u_i]], \quad \dots, \quad [u_{k_1}, [u_{k_2}, \dots [u_{k_{m-2}}, [u_j, u_i]] \dots]]$$

where  $k_1 < k_2 < \dots < k_p < j > i$  and  $k_s \neq i$  for any  $s$ . Here, the number of commutators of length  $\ell$  is equal to  $(\ell - 1) \binom{m}{\ell}$ .

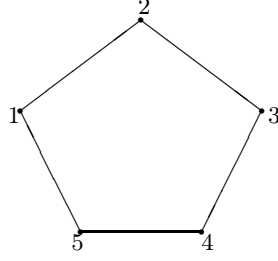

FIGURE 8.1. Boundary of pentagon.

EXAMPLE 8.5.9. Let  $\mathcal{K}$  be the boundary of pentagon, shown in Fig. 8.1. Theorem 8.5.7 gives the following 10 generators for the algebra  $H_*(\Omega\mathcal{Z}_{\mathcal{K}})$ :

$$\begin{aligned} a_1 &= [u_3, u_1], & a_2 &= [u_4, u_1], & a_3 &= [u_4, u_2], & a_4 &= [u_5, u_2], & a_5 &= [u_5, u_3], \\ b_1 &= [u_4, [u_5, u_2]], & b_2 &= [u_3, [u_5, u_2]], & b_3 &= [u_1, [u_5, u_3]], \\ b_4 &= [u_3, [u_4, u_1]], & b_5 &= [u_2, [u_4, u_1]], \end{aligned}$$

where  $\deg a_i = 2$  and  $\deg b_i = 3$ . In the notation of the beginning of the previous section,  $a_1$  is the Hurewicz image of the Samelson product  $[\mu_3, \mu_1]: S^2 \rightarrow \Omega(\mathbb{C}P^\infty)^{\mathcal{K}}$  lifted to  $\Omega\mathcal{Z}_{\mathcal{K}}$ , and  $b_1$  is the Hurewicz image of the iterated Samelson product  $[\mu_4, [\mu_5, \mu_2]]: S^3 \rightarrow \Omega(\mathbb{C}P^\infty)^{\mathcal{K}}$  lifted to  $\Omega\mathcal{Z}_{\mathcal{K}}$ ; the other  $a_i$  and  $b_i$  are described similarly. We therefore have adjoint maps

$$\iota: (S^2 \vee S^3)^{\vee 5} \rightarrow \Omega\mathcal{Z}_{\mathcal{K}} \quad \text{and} \quad j: (S^3 \vee S^4)^{\vee 5} \rightarrow \mathcal{Z}_{\mathcal{K}}$$

corresponding to the wedge of all  $a_i$  and  $b_i$ . Now a calculation using relations from Theorem 8.5.2 and the Jacobi identity shows that  $a_i$  and  $b_i$  satisfy the relation

$$(8.30) \quad -[a_1, b_1] + [a_2, b_2] + [a_3, b_3] - [a_4, b_4] + [a_5, b_5] = 0,$$

where  $[a_i, b_i] = a_i b_i - b_i a_i$ . (One can make all the commutators to enter the sum with positive signs by changing the order the elements in the commutators defining  $a_i, b_i$ .) This relation has a topological meaning. In general, suppose that  $M$  and  $N$  are  $d$ -dimensional manifolds. Let  $\overline{M}$  be the  $(d-1)$ -skeleton of  $M$ , or equivalently,  $\overline{M}$  is obtained from  $M$  by removing a disc in the interior of the  $d$ -cell of  $M$ . Define  $\overline{N}$  similarly. Suppose that  $f: S^{d-1} \rightarrow \overline{M}$  and  $g: S^{d-1} \rightarrow \overline{N}$  are the attaching maps for the top cells in  $M$  and  $N$ . Then the attaching map for the top cell in the connected sum  $M \# N$  is  $S^{d-1} \xrightarrow{f+g} \overline{M} \vee \overline{N}$ . In our case,  $S^3 \times S^4$  is a manifold and the attaching map  $S^6 \rightarrow S^3 \vee S^4$  for its top cell is the Whitehead product  $[s_1, s_2]_w$ , where  $s_1$  and  $s_2$  respectively are the inclusions of  $S^3$  and  $S^4$  into  $S^3 \vee S^4$ . The attaching map for the top cell of the 5-fold connected sum  $(S^3 \times S^4)^{\#5}$  is therefore the sum of five such Whitehead products. Composing it with  $j$  into  $\mathcal{Z}_{\mathcal{K}}$  and passing to the adjoint map we obtain  $\sum_{i=1}^5 \pm [a_i, b_i]$  (the signs depend on the orientation chosen, see Construction D.3.9). By (8.30), this sum is null homotopic. Thus the inclusion  $j: (S^3 \vee S^4)^{\vee 5} \rightarrow \mathcal{Z}_{\mathcal{K}}$  extends to a map

$$\tilde{j}: (S^3 \times S^4)^{\#5} \rightarrow \mathcal{Z}_{\mathcal{K}}.$$

Furthermore, a calculation using Theorem 4.5.4 shows that  $\tilde{j}$  induces an isomorphism in cohomology (see Example 4.6.10), that is,  $\tilde{j}$  is a homotopy equivalence. Since both  $(S^3 \times S^4)^{\#5}$  and  $\mathcal{Z}_{\mathcal{K}}$  are manifolds, the complement of  $(S^3 \vee S^4)^{\vee 5}$  in

$(S^3 \times S^4)^{\#5}$  and  $\mathcal{Z}_{\mathcal{K}}$  is a 7-disc, so that the extension map  $\tilde{j}$  can be chosen to be one-to-one, which implies that  $\tilde{j}$  is a homeomorphism.

We also obtain that  $H_*(\Omega\mathcal{Z}_{\mathcal{K}})$  is the quotient of a free algebra on ten generators  $a_i, b_i$  by relation (8.30). Its Poincaré series is given by Proposition 8.5.4:

$$P(H_*(\Omega\mathcal{Z}_{\mathcal{K}}); \lambda) = \frac{1}{1 - 5\lambda^2 - 5\lambda^3 + \lambda^5}.$$

The summand  $t^5$  in the denominator is what differs the Poincaré series of the one-relator algebra  $H_*(\Omega\mathcal{Z}_{\mathcal{K}})$  from that of the free algebra  $H_*(\Omega(S^3 \vee S^4)^{\vee 5})$ .

A similar argument can be used to show that  $\mathcal{Z}_{\mathcal{K}}$  is homeomorphic to a connected sum of sphere products when  $\mathcal{K}$  is a boundary of a  $m$ -gon with  $m \geq 4$ , therefore giving a homotopical proof of a particular case of Theorem 4.6.12. It would be interesting to give a homotopical proof of this theorem in general.

Another result of [131] identifies the class of flag complexes  $\mathcal{K}$  for which  $\mathcal{Z}_{\mathcal{K}}$  has homotopy type of a wedge of spheres.

We recall from Definition 4.9.5 that  $\mathbf{k}[\mathcal{K}]$  is a *Golod ring* and  $\mathcal{K}$  is a *Golod complex* when the multiplication and all higher Massey products in  $\text{Tor}_{\mathbf{k}[v_1, \dots, v_m]}(\mathbf{k}[\mathcal{K}], \mathbf{k}) = H(\Lambda[u_1, \dots, u_m] \otimes \mathbf{k}[\mathcal{K}], d)$  are trivial.

We also need some terminology from graph theory. Let  $\Gamma$  be a graph on the vertex set  $[m]$ . A *clique* of  $\Gamma$  is a subset  $I$  of vertices such that every two vertices in  $I$  are connected by an edge. Each flag complex  $\mathcal{K}$  is the *clique complex* of its one-skeleton  $\Gamma = \mathcal{K}^1$ , that is, the simplicial complex formed by filling in each clique of  $\Gamma$  by a face.

A graph  $\Gamma$  is called *chordal* if each of its cycles with  $\geq 4$  vertices has a chord (an edge joining two vertices that are not adjacent in the cycle). Equivalently, a chordal graph is a graph with no induced cycles of length more than three.

The following result gives an alternative characterisation of chordal graphs.

**THEOREM 8.5.10** (Fulkerson–Gross [121]). *A graph is chordal if and only if its vertices can be ordered in such a way that, for each vertex  $i$ , the lesser neighbours of  $i$  form a clique.*

Such an order of vertices is called a *perfect elimination order*.

**THEOREM 8.5.11** ([131]). *Let  $\mathcal{K}$  be a flag complex and  $\mathbf{k}$  a field. The following conditions are equivalent:*

- (a)  $\mathbf{k}[\mathcal{K}]$  is a Golod ring;
- (b) the multiplication in  $H^*(\mathcal{Z}_{\mathcal{K}}; \mathbf{k})$  is trivial;
- (c)  $\Gamma = \mathcal{K}^1$  is a chordal graph;
- (d)  $\mathcal{Z}_{\mathcal{K}}$  has homotopy type of a wedge of spheres.

**PROOF.** (a) $\Rightarrow$ (b) This is by definition of Golodness and Theorem 4.5.4.

(b) $\Rightarrow$ (c) Assume that  $\mathcal{K}^1$  is not chordal, and choose an induced chordless cycle  $I$  with  $|I| \geq 4$ . Then the full subcomplex  $\mathcal{K}_I$  is the same cycle (the boundary of an  $|I|$ -gon), and therefore  $\mathcal{Z}_{\mathcal{K}_I}$  is a connected sum of sphere products. Hence,  $H^*(\mathcal{Z}_{\mathcal{K}_I})$  has nontrivial products (this can be also seen directly by using Theorem 4.5.8). Then, by Theorem 4.5.8, the same nontrivial products appear in  $H^*(\mathcal{Z}_{\mathcal{K}})$ .

(c) $\Rightarrow$ (d) Assume that the vertices of  $\mathcal{K}$  are in perfect elimination order. We assign to each vertex  $i$  the clique  $I_i$  consisting of  $i$  and the lesser neighbours of  $i$ . Each maximal face of  $\mathcal{K}$  (that is, each maximal clique of  $\mathcal{K}^1$ ) is obtained in this way,

so we get an induced order on the maximal faces:  $I_{i_1}, \dots, I_{i_s}$ . Then, for each  $k = 1, \dots, s$ , the simplicial complex  $\bigcup_{j < k} I_{i_j}$  is flag (since it is the full subcomplex  $\mathcal{K}_{\{1, 2, \dots, i_{k-1}\}}$  in a flag complex). The intersection  $(\bigcup_{j < k} I_{i_j}) \cap I_{i_k}$  is a clique, so it is a face of  $\bigcup_{j < k} I_{i_j}$ . Therefore,  $\mathcal{Z}_{\mathcal{K}}$  has homotopy type of a wedge of spheres by Corollary 8.2.4.

(d) $\Rightarrow$ (a) This is by definition of the Golod property and the fact that the cohomology of the wedge of spheres contains only trivial Massey products.  $\square$

**COROLLARY 8.5.12.** *Assume that  $\mathcal{K}$  is flag with  $m$  vertices, and  $\mathcal{Z}_{\mathcal{K}}$  has homotopy type of a wedge of spheres. Then*

- (a) *the maximal dimension of spheres in the wedge is  $m + 1$ ;*
- (b) *the number of spheres of dimension  $\ell + 1$  in the wedge is given by  $\sum_{|I|=\ell} \dim \tilde{H}^0(\mathcal{K}_I)$ , for  $2 \leq \ell \leq m$ ;*
- (c)  *$H^i(\mathcal{K}_I) = 0$  for  $i > 0$  and all  $I$ .*

**PROOF.** If  $\mathcal{Z}_{\mathcal{K}}$  is a wedge of spheres, then  $H_*(\Omega \mathcal{Z}_{\mathcal{K}})$  is a free algebra on generators described by Theorem 8.5.7, which implies (a) and (b). It also follows that  $H^*(\mathcal{Z}_{\mathcal{K}}) \cong \bigoplus_{J \subset [m]} \tilde{H}^0(\mathcal{K}_J)$ . On the other hand,  $H^*(\mathcal{Z}_{\mathcal{K}}) \cong \bigoplus_{J \subset [m]} \tilde{H}^*(\mathcal{K}_J)$  by Theorem 4.5.8, whence (c) follows.  $\square$

**REMARK.** The equivalence of (a), (b) and (c) in Theorem 8.5.11 was proved in [28]. All the implications in the proof of Theorem 8.5.11 except (c) $\Rightarrow$ (d) are valid for arbitrary  $\mathcal{K}$ , with the same arguments. However, (c) $\Rightarrow$ (d) fails in the non-flag case. Indeed, if  $\mathcal{K}$  be the triangulation of  $\mathbb{R}P^2$  from Example 3.2.12.4, then  $\mathcal{K}^1$  is a complete graph, so it is chordal. However,  $\mathcal{Z}_{\mathcal{K}}$  is not homotopy equivalent to a wedge of spheres, because it has 2-torsion in homology. Furthermore, this  $\mathcal{K}$  is a Golod complex by Exercise 4.9.7. The following question is still open:

**PROBLEM 8.5.13 ([131]).** Assume that  $H^*(\mathcal{Z}_{\mathcal{K}})$  has trivial multiplication, so that  $\mathcal{K}$  is Golod, over any field. Is it true that  $\mathcal{Z}_{\mathcal{K}}$  is a co- $H$ -space, or even a suspension, as in all known examples?

### Exercises.

8.5.14. Shown that the generators  $a_1, \dots, a_5, b_1, \dots, b_5$  of the Pontryagin algebra  $H^*(\Omega \mathcal{Z}_{\mathcal{K}})$  from Example 8.5.9 satisfy relation (8.30).

8.5.15 ([131, Example 3.3]). Describe explicitly the homotopy type of  $\mathcal{Z}_{\mathcal{K}}$  when  $\mathcal{K}$  is the triangulation of  $\mathbb{R}P^2$  from Example 3.2.12.4.





## Torus actions and complex cobordism

Here we consider applications of toric methods in the theory of complex cobordism. In particular, we describe new families of toric generators of complex bordism ring and quasitoric representatives in bordism classes. We also develop the theory of torus-equivariant genera with applications to rigidity and fibre multiplicativity problems, and provide explicit formulae for bordism classes and genera of quasitoric manifolds and their generalisations via localisation techniques.

We refer to Appendices D and E for the background material on complex (co)bordism and Hirzebruch genera.

As usual, when working with cobordism we assume all manifolds to be smooth and compact. We denote by  $[M]$  the bordism class in  $\Omega_{2n}^U$  of  $2n$ -dimensional stably complex manifold  $M$ , and denote by  $\langle M \rangle \in H_{2n}(M)$  its fundamental homology class defined by the orientation arising from the stably complex structure.

### 9.1. Toric and quasitoric representatives in complex bordism classes

Describing multiplicative generators for the complex bordism ring  $\Omega^U$  and representing bordism classes by manifolds with specific nice properties are well-known questions in cobordism theory. For the application of toric methods, it is important to represent complex bordism classes by manifolds with nicely behaving torus actions preserving the stably complex structure. In the context of oriented bordism, this question goes back to the fundamental work of Conner–Floyd [81].

The most ‘nicely behaving’ torus actions that we have at our disposal are the torus actions on toric and quasitoric manifolds. Such an action does not exist on Milnor hypersurfaces  $H_{ij}$ , which constitute the most well-known multiplicative generator set for  $\Omega^U$  (see Theorem 9.1.4). An alternative multiplicative generator set for  $\Omega^U$  consisting of projective toric manifolds  $B_{ij}$  was constructed by Buchstaber and Ray in [60]. Each  $B_{ij}$  is a complex projectivisation of a sum of line bundles over the bounded flag manifold  $B_i$ ; in particular,  $B_{ij}$  is a generalised Bott manifold.

It seems likely that a *minimal* set of ring generators of  $\Omega^U$  can be found among toric manifolds, i.e. there exist projective toric manifolds  $X_i$  whose bordism classes  $a_i = [X_i]$  are polynomial generators of the bordism ring:  $\Omega^U \cong \mathbb{Z}[a_1, a_2, \dots]$ . A partial result in this direction was obtained by Wilfong [322]. Nevertheless, not any complex bordism class can be represented by a toric manifold. The reason is that toric manifolds are very special algebraic varieties, and there are many restrictions on their characteristic numbers. For example, the Todd genus of a toric manifold is equal to 1, which implies that the bordism class of a disjoint union of toric manifolds cannot be represented by a toric manifold.

The main result of this section is Theorem 9.1.16 (originally proved in [58]), which shows that any complex bordism class (in dimensions  $> 2$ ) contains a quasitoric manifold. A canonical torus-invariant stably complex structure is induced

by an omniorientation of a quasitoric manifold, see Corollary 7.3.15. The above mentioned result of [60] provides an additive basis for each bordism group  $\Omega_{2n}^U$  represented by toric manifolds; it implies that any complex bordism class can be represented by a disjoint union of toric manifolds. The next step is to replace disjoint unions by connected sums. There is the standard construction of connected sum of  $T$ -manifolds at their fixed points. (The connected sum of two stably complex manifolds  $M_1$  and  $M_2$  always admits a stably complex structure representing the bordism class  $[M_1] + [M_2]$ .) Davis–Januzkiewicz [90] proposed to use this construction to make the connected sum  $M_1 \# M_2$  of two quasitoric manifolds  $M_1$  and  $M_2$  into a quasitoric manifold over the connected sum  $P_1 \# P_2$  of quotient polytopes. However, the main difficulty here is that one needs to keep track of both the torus action and the stably complex structure on the connected sum of manifolds. It turns out that the connected sum  $M_1 \# M_2$  does not always admit an omniorientation such that the bordism class  $[M_1 \# M_2] \in \Omega^U$  of the induced  $T^k$ -invariant stably complex structure represents the sum  $[M_1] + [M_2]$ ; this depends on the sign pattern of fixed points of the manifolds.

In order to overcome the difficulty describe above, we replace  $M_2$  by a bordant quasitoric manifold  $M'_2$  whose quotient polytope is  $I^n \# P_2$  (a connected sum of  $P_2$  with an  $n$ -cube). Then we show that the connected sum  $M_1 \# M'_2$  admits a stably complex structure which is invariant under the torus action and represents the bordism class  $[M_1] + [M'_2] = [M_1] + [M_2]$ ; the quotient polytope of  $M_1 \# M'_2$  is  $P_1 \# I^n \# P_2$ . This allows us to finish the proof of the main result.

This result on quasitoric representatives can be viewed as an answer to a toric version of the famous Hirzebruch question (see Problem D.5.10) on bordism classes representable by connected nonsingular algebraic varieties. Note that quasitoric manifolds are connected by definition.

Using the constructions of Chapter 6 we can interpret this result as follows: each complex bordism class can be represented by the quotient of a nonsingular complete intersection of real quadrics by a free torus action.

**Milnor hypersurfaces  $H_{ij}$  are not quasitoric.** Milnor hypersurfaces

$$H_{ij} = \{(z_0 : \cdots : z_i) \times (w_0 : \cdots : w_j) \in \mathbb{C}P^i \times \mathbb{C}P^j : z_0 w_0 + \cdots + z_i w_i = 0\}$$

(corresponding to pairs of integers  $j \geq i \geq 0$ ) form the most well-known set of multiplicative generators of the complex bordism ring  $\Omega^U$ , see Theorem D.5.7. However, as it was shown in [60], the manifold  $H_{ij}$  is not (quasi)toric when  $i > 1$ . We give the argument below.

**CONSTRUCTION 9.1.1.** Let  $\mathbb{C}^{i+1} \subset \mathbb{C}^{j+1}$  be the subspace generated by the first  $i + 1$  vectors of the standard basis of  $\mathbb{C}^{j+1}$ . We identify  $\mathbb{C}P^i$  with the set of lines  $l \subset \mathbb{C}^{i+1}$ . To each line  $l$  we assign the set of hyperplanes  $W \subset \mathbb{C}^{j+1}$  containing  $l$ . This set can be identified with  $\mathbb{C}P^{j-1}$ . Consider the set of pairs

$$E = \{(l, W) : l \subset W, l \subset \mathbb{C}^{i+1}, W \subset \mathbb{C}^{j+1}\}.$$

The projection  $(l, W) \mapsto l$  defines a bundle  $E \rightarrow \mathbb{C}P^i$  with fibre  $\mathbb{C}P^{j-1}$ .

**LEMMA 9.1.2.** *Milnor hypersurface  $H_{ij}$  is identified with the space  $E$  above.*

**PROOF.** Indeed, a line  $l \subset \mathbb{C}^{i+1}$  can be given by its generating vector with homogeneous coordinates  $(z_0 : z_1 : \cdots : z_i)$ . A hyperplane  $W \subset \mathbb{C}^{j+1}$  is given by a

linear form with coefficients  $w_0, w_1, \dots, w_j$ . The condition  $l \subset W$  is equivalent to the equation in the definition of  $H_{ij}$ .  $\square$

**THEOREM 9.1.3.** *The cohomology ring of  $H_{ij}$  is given by*

$$H^*(H_{ij}) \cong \mathbb{Z}[u, v] / (u^{i+1}, (u^i + u^{i-1}v + \dots + uv^{i-1} + v^i)v^{j-i}),$$

where  $\deg u = \deg v = 2$ .

**PROOF.** We use the notation from Construction 9.1.1. Let  $\zeta$  denotes the vector bundle over  $\mathbb{C}P^i$  whose fibre over  $l \in \mathbb{C}P^i$  is the  $j$ -plane  $l^\perp \subset \mathbb{C}^{j+1}$ . Then  $H_{ij}$  is identified with the projectivisation  $\mathbb{C}P(\zeta)$ . Indeed, for any line  $l' \subset l^\perp$  representing a point in the fibre of the bundle  $\mathbb{C}P(\zeta)$  over  $l \in \mathbb{C}P^i$ , the hyperplane  $W = (l')^\perp \subset \mathbb{C}^{j+1}$  contains  $l$ , so that the pair  $(l, W)$  defines a point in  $H_{ij}$  by Lemma 9.1.2. The rest of the proof reproduces the general argument for the description of the cohomology of a complex projectivisation (see Theorem 7.8.2).

Denote by  $\eta$  the tautological line bundle over  $\mathbb{C}P^i$  (its fibre over  $l \in \mathbb{C}P^i$  is the line  $l$ ). Then  $\eta \oplus \zeta$  is a trivial  $(j + 1)$ -plane bundle. Set  $w = c_1(\bar{\eta}) \in H^2(\mathbb{C}P^i)$  and consider the total Chern class  $c(\eta) = 1 + c_1(\eta) + c_2(\eta) + \dots$ . Since  $c(\eta)c(\zeta) = 1$  and  $c(\eta) = 1 - w$ , it follows that

$$(9.1) \quad c(\zeta) = 1 + w + \dots + w^i.$$

Consider the projection  $p: \mathbb{C}P(\zeta) \rightarrow \mathbb{C}P^i$ . Denote by  $\gamma$  the tautological line bundle over  $\mathbb{C}P(\zeta)$ , whose fibre over  $l' \in \mathbb{C}P(\zeta)$  is the line  $l'$ . Let  $\gamma^\perp$  denote the  $(j - 1)$ -plane bundle over  $\mathbb{C}P(\zeta)$  whose fibre over  $l' \subset l^\perp$  is the orthogonal complement to  $l'$  in  $l^\perp$  (by definition, a point of  $\mathbb{C}P(\zeta)$  is represented by a line  $l'$  in a fibre  $l^\perp$  of bundle  $\zeta$ ). It is easy to see that  $p^*(\zeta) = \gamma \oplus \gamma^\perp$ . We set  $v = c_1(\bar{\gamma}) \in H^2(\mathbb{C}P(\zeta))$  and  $u = p^*(w) \in H^2(\mathbb{C}P^i)$ . Then  $u^{i+1} = 0$ . We have  $c(\gamma) = 1 - v$  and  $c(p^*(\zeta)) = c(\gamma)c(\gamma^\perp)$ , hence

$$c(\gamma^\perp) = p^*(c(\zeta))(1 - v)^{-1} = (1 + u + \dots + u^i)(1 + v + v^2 + \dots),$$

see (9.1). Since  $\gamma^\perp$  is a  $(j - 1)$ -plane bundle, it follows that  $c_j(\gamma^\perp) = 0$ . Calculating the homogeneous component of degree  $j$  in the identity above, we obtain the second relation  $v^{j-i} \sum_{k=0}^i u^k v^{i-k} = 0$ . It follows that there is a homomorphism  $\mathbb{Z}[u, v] \rightarrow H^*(\mathbb{C}P(\zeta))$  which factors through a homomorphism  $R \rightarrow H^*(\mathbb{C}P(\zeta))$ , where  $R$  is the quotient ring of  $\mathbb{Z}[u, v]$  given in the theorem.

It remains to observe that  $R \rightarrow H^*(\mathbb{C}P(\zeta))$  is actually an isomorphism. This follows by considering the Serre spectral sequence of the bundle  $p: \mathbb{C}P(\zeta) \rightarrow \mathbb{C}P^i$ . Since both  $\mathbb{C}P^i$  and  $\mathbb{C}P^{j-1}$  have only even-dimensional cells, the spectral sequence collapses at  $E_2$ . It follows that  $\mathbb{Z}[u, v] \rightarrow H^*(\mathbb{C}P(\zeta))$  is an epimorphism, and therefore so is  $R \rightarrow H^*(\mathbb{C}P(\zeta))$ . Furthermore, the cohomology groups of  $\mathbb{C}P(\zeta)$  are the same as those of  $\mathbb{C}P^i \times \mathbb{C}P^{j-1}$ , which implies that  $R \rightarrow H^*(\mathbb{C}P(\zeta))$  is a monomorphism.  $\square$

**THEOREM 9.1.4.** *There is no torus action on the Milnor hypersurface  $H_{ij}$  with  $i > 1$  making it into a quasitoric manifold.*

**PROOF.** The cohomology of a quasitoric manifold has the form  $\mathbb{Z}[v_1, \dots, v_m] / \mathcal{I}$ , where  $\mathcal{I}$  is the sum of two ideals, one generated by square-free monomials and another generated by linear forms (see Theorem 7.3.27). We may assume that the characteristic matrix  $A$  has reduced form (7.6) and express the first  $n$  generators

$v_1, \dots, v_n$  via the last  $m - n$  ones by means of linear relations with integer coefficients. Therefore, we have

$$\mathbb{Z}[v_1, \dots, v_m]/\mathcal{I} \cong \mathbb{Z}[w_1, \dots, w_{m-n}]/\mathcal{I}',$$

where  $\mathcal{I}'$  is an ideal with basis consisting of products of  $\geq 2$  integers linear forms.

Assume now that  $H_{ij}$  is a quasitoric manifold. Then we have

$$\mathbb{Z}[w_1, \dots, w_{m-n}]/\mathcal{I}' \cong \mathbb{Z}[u, v]/\mathcal{I}'',$$

where  $\mathcal{I}''$  is the ideal from Theorem 9.1.3. Comparing the dimensions of linear (degree-two) components above, we obtain  $m - n = 2$ , so that  $w_1, w_2$  can be identified with  $u, v$  after a linear change of variables. Thus, the ideal  $\mathcal{I}''$  has a basis consisting of polynomials which are decomposable into linear factors over  $\mathbb{Z}$ , which is impossible for  $i > 1$ . □

REMARK.  $H_{ij}$  is a projectivisation of a complex  $j$ -plane bundle over  $\mathbb{C}P^i$ , but this bundle does not split into a sum of line bundles, preventing  $H_{ij}$  from carrying an effective  $T^{i+j-1}$ -action. See the remark after Definition 7.8.26 and Exercise 9.1.23.

**Toric generators for the bordism ring  $\Omega^U$ .** Here we describe, following [60] and [58], a family of toric manifolds  $\{B_{ij}, 0 \leq i \leq j\}$  satisfying the condition  $s_{i+j-1}[B_{ij}] = s_{i+j-1}[H_{ij}]$ , where  $s_n[M]$  denotes the characteristic number defined by (D.8). This implies that the family  $\{B_{ij}\}$  multiplicatively generates the complex bordism ring, by the same argument as Theorem D.5.7.

CONSTRUCTION 9.1.5. Given a pair of integers  $0 \leq i \leq j$ , we introduce the manifold  $B_{ij}$  consisting of pairs  $(\mathcal{U}, W)$ , where

$$\mathcal{U} = \{U_1 \subset U_2 \subset \dots \subset U_{i+1} = \mathbb{C}^{i+1}, \quad \dim U_k = k\}$$

is a bounded flag in  $\mathbb{C}^{i+1}$  (that is,  $U_k \supset \mathbb{C}^{k-1}$ , see Construction 7.7.1) and  $W$  is a hyperplane in  $\mathbb{C}^{j+1}$  containing  $U_1$ . The projection  $(\mathcal{U}, W) \mapsto \mathcal{U}$  describes  $B_{ij}$  as the projectivisation of a  $j$ -plane bundle over the bounded flag manifold  $BF_i$ . This bundle splits into a sum of line bundles:

$$B_{ij} = \mathbb{C}P(\rho_1^1 \oplus \dots \oplus \rho_i^1 \oplus \underline{\mathbb{C}}^{j-i}),$$

where  $\rho_1^1, \dots, \rho_i^1$  are the line bundles over  $BF_i$  described in Proposition 7.7.7 (the splitting follows from the fact that  $W$  can be identified with a line in  $U_1^\perp \oplus \mathbb{C}^{j-i}$  using the Hermitian scalar product in  $\mathbb{C}^{j+1}$ ). Therefore,  $B_{ij}$  is a generalised Bott manifold (see Definition 7.8.26). It follows that  $B_{ij}$  is a toric manifold, and also a quasitoric manifold over the combinatorial polytope  $I^i \times \Delta^{j-1}$ . The description of the corresponding characteristic matrix and characteristic submanifolds can be found in [62, Examples 2.9, 4.5] or [58, Example 3.13].

PROPOSITION 9.1.6. *Let  $f: BF_i \rightarrow \mathbb{C}P^i$  be the map sending a bounded flag  $\mathcal{U}$  to its first line  $U_1 \subset \mathbb{C}^{i+1}$ . Then the bundle  $B_{ij} \rightarrow BF_i$  is induced from the bundle  $H_{ij} \rightarrow \mathbb{C}P^i$  by means of the map  $f$ :*

$$\begin{array}{ccc} B_{ij} & \longrightarrow & H_{ij} \\ \downarrow & & \downarrow \\ BF_i & \xrightarrow{f} & \mathbb{C}P^i \end{array}.$$

PROOF. This follows from Lemma 9.1.2. □

**THEOREM 9.1.7.** *We have  $s_{i+j-1}[B_{ij}] = s_{i+j-1}[H_{ij}]$ , where the characteristic number  $s_{i+j-1}$  of Milnor hypersurface  $H_{ij}$  is given by Lemma D.5.6.*

**PROOF.** We first prove a lemma:

**LEMMA 9.1.8.** *Let  $f: M \rightarrow N$  be a degree  $d$  map of  $2i$ -dimensional stably complex manifolds, and let  $\xi$  be a complex  $j$ -plane bundle over  $N$ ,  $j > 1$ . Then*

$$s_{i+j-1}[\mathbb{C}P(f^*\xi)] = d \cdot s_{i+j-1}[\mathbb{C}P(\xi)].$$

**PROOF.** Let  $p: \mathbb{C}P(\xi) \rightarrow N$  be the projection,  $\gamma$  the tautological bundle over  $\mathbb{C}P(\xi)$ , and  $\gamma^\perp$  the complementary bundle, so that  $\gamma \oplus \gamma^\perp = p^*(\xi)$ . Then we have

$$\mathcal{T}(\mathbb{C}P(\xi)) = p^*\mathcal{T}N \oplus \mathcal{T}_F(\mathbb{C}P(\xi)),$$

where  $\mathcal{T}_F(\mathbb{C}P(\xi))$  is the tangent bundle along the fibres of the projection  $p$ . Since  $\mathcal{T}_F(\mathbb{C}P(\xi)) = \text{Hom}(\gamma, \gamma^\perp)$  and  $\text{Hom}(\gamma, \gamma) = \underline{\mathbb{C}}$ , it follows that

$$\mathcal{T}_F(\mathbb{C}P(\xi)) \oplus \underline{\mathbb{C}} = \text{Hom}(\gamma, \gamma \oplus \gamma^\perp).$$

Therefore,

$$(9.2) \quad \begin{aligned} \mathcal{T}(\mathbb{C}P(\xi)) \oplus \underline{\mathbb{C}} &= p^*\mathcal{T}N \oplus \text{Hom}(\gamma, \gamma \oplus \gamma^\perp) = \\ &= p^*\mathcal{T}N \oplus \text{Hom}(\gamma, p^*\xi) = p^*\mathcal{T}N \oplus (\bar{\gamma} \otimes p^*\xi), \end{aligned}$$

where  $\bar{\gamma} = \text{Hom}(\gamma, \underline{\mathbb{C}})$ .

The map  $f: M \rightarrow N$  induces a map  $\tilde{f}: \mathbb{C}P(f^*\xi) \rightarrow \mathbb{C}P(\xi)$  such that

- $p\tilde{f} = fp_1$ , where  $p_1: \mathbb{C}P(f^*\xi) \rightarrow M$  is the projection;
- $\deg \tilde{f} = \deg f$ ;
- $\tilde{f}^*\gamma$  is the tautological bundle over  $\mathbb{C}P(f^*\xi)$ .

Using (9.2), we calculate

$$s_{i+j-1}(\mathcal{T}(\mathbb{C}P(\xi))) = p^*s_{i+j-1}(\mathcal{T}N) + s_{i+j-1}(\bar{\gamma} \otimes p^*\xi) = s_{i+j-1}(\bar{\gamma} \otimes p^*\xi)$$

(since  $i+j-1 > i$ ), and similarly for  $\mathcal{T}(\mathbb{C}P(f^*\xi))$ . Thus,

$$\begin{aligned} s_{i+j-1}[\mathbb{C}P(f^*\xi)] &= s_{i+j-1}(\mathcal{T}(\mathbb{C}P(f^*\xi))) \langle \mathbb{C}P(f^*\xi) \rangle \\ &= s_{i+j-1}((\tilde{f}^*\bar{\gamma}) \otimes p_1^*f^*\xi) \langle \mathbb{C}P(f^*\xi) \rangle = s_{i+j-1}(\tilde{f}^*(\bar{\gamma} \otimes p^*\xi)) \langle \mathbb{C}P(f^*\xi) \rangle \\ &= s_{i+j-1}(\bar{\gamma} \otimes p^*\xi) \tilde{f}_* \langle \mathbb{C}P(f^*\xi) \rangle = d \cdot s_{i+j-1}(\bar{\gamma} \otimes p^*\xi) \langle \mathbb{C}P(\xi) \rangle \\ &= d \cdot s_{i+j-1}[\mathbb{C}P(\xi)]. \quad \square \end{aligned}$$

To finish the proof of Theorem 9.1.7 we note that the map  $f: BF_i \rightarrow \mathbb{C}P^i$  from Proposition 9.1.6 has degree 1. (The map  $f: BF_i \rightarrow \mathbb{C}P^i$  is birational: it is an isomorphism on the affine chart  $V^{0, \dots, 0} = \{\mathcal{U} \in BF_i: U_1 \not\subset \mathbb{C}^i\}$ , because a bounded flag in  $V^{0, \dots, 0} \subset BF_i$  is uniquely determined by its first line  $U_1$ .)  $\square$

**THEOREM 9.1.9 ([60]).** *The bordism classes of toric varieties  $B_{ij}$ ,  $0 \leq i \leq j$ , multiplicatively generate the complex bordism ring  $\Omega_*^U$ . Therefore, every complex bordism class contains a disjoint union of toric manifolds.*

**PROOF.** The first statement follows from Theorems 9.1.7 and D.5.7. A product of toric manifolds is toric, but a disjoint union of toric manifolds is not, since toric manifolds are connected by definition.  $\square$

REMARK. The manifolds  $H_{ij}$  and  $B_{ij}$  are not bordant in general, although  $H_{0j} = B_{0j} = \mathbb{C}P^{j-1}$  and  $H_{1j} = B_{1j}$ . The proof of Lemma 9.1.8 uses specific properties of the number  $s_n$ , and it does not work for arbitrary characteristic numbers.

**Connected sums.** Our next goal is to replace the disjoint union of toric manifolds by a version of connected sum, which will be a quasitoric manifold.

CONSTRUCTION 9.1.10 (Equivariant connected sum at fixed points). We give the construction for quasitoric manifolds only, although it can be generalised easily to locally standard  $T$ -manifolds. Let  $M' = M(P', A')$  and  $M'' = M(P'', A'')$  be two quasitoric manifolds over  $n$ -polytopes  $P'$  and  $P''$ , respectively (see Section 7.3). We assume that both characteristic matrices  $A'$  and  $A''$  are in the refined form (7.6), and denote by  $x'$  and  $x''$  the initial vertices (given by the intersection of the first  $n$  facets) of  $P'$  and  $P''$ , respectively.

Consider the connected sum of polytopes  $P' \# P'' = P' \#_{x', x''} P''$  (see Construction 1.1.13). By definition, the *equivariant connected sum*  $M' \# M'' = M' \#_{x', x''} M''$  is the quasitoric manifold over  $P' \# P''$  with characteristic matrix

$$(9.3) \quad A_{\#} = \begin{pmatrix} 1 & 0 & \cdots & 0 & \lambda'_{1,n+1} & \cdots & \lambda'_{1,m'} & \lambda''_{1,n+1} & \cdots & \lambda''_{1,m''} \\ 0 & 1 & \cdots & 0 & \lambda'_{2,n+1} & \cdots & \lambda'_{2,m'} & \lambda''_{2,n+1} & \cdots & \lambda''_{2,m''} \\ \vdots & \vdots & \ddots & \vdots & \vdots & \ddots & \vdots & \vdots & \ddots & \vdots \\ 0 & 0 & \cdots & 1 & \lambda'_{n,n+1} & \cdots & \lambda'_{n,m'} & \lambda''_{n,n+1} & \cdots & \lambda''_{n,m''} \end{pmatrix}.$$

Note that the matrix  $A_{\#}$  is not refined, because the first  $n$  facets of  $P' \# P''$  do not intersect.

The manifold  $M' \# M''$  is  $T^n$ -equivariantly diffeomorphic to the manifold obtained by removing from  $M'$  and  $M''$  invariant neighbourhoods of the fixed points corresponding to  $x'$  and  $x''$  with subsequent  $T^n$ -equivariant identification of the boundaries of these neighbourhoods. The latter manifold becomes the standard connected sum  $M' \# M''$  (see Construction D.3.9) if we forget the action.

In order to define an omniorientation (and therefore an invariant stably complex structure) on  $M' \# M''$  we need to specify an orientation of  $M' \# M''$  along with matrix (9.3).

Since both  $M'$  and  $M''$  are oriented, the quasitoric manifold  $M' \# M''$  can be oriented so as to be oriented diffeomorphic either to the oriented connected sum  $M' \# M''$ , or to  $M' \# \overline{M''}$  (see Construction D.3.9). In the first case we say that the orientation of  $M' \# M''$  is *compatible* with the orientations of  $M'$  and  $M''$ .

The existence of a compatible orientation on  $M' \# M''$  can be detected from the combinatorial quasitoric pairs  $(P', A')$  and  $(P'', A'')$ . We recall the notion of sign of a fixed point of a quasitoric manifold  $M$  (or a vertex of the quotient polytope  $P$ ). By Lemma 7.3.18, the sign  $\sigma(x)$  of a vertex  $x = F_{j_1} \cap \cdots \cap F_{j_n}$  measures the difference between the orientations of  $\mathcal{T}_x M$  and  $(\rho_{j_1} \oplus \cdots \oplus \rho_{j_n})|_x$ . Therefore,

$$\sigma(x) = v_{j_1} \cdots v_{j_n} \langle M \rangle,$$

where  $v_i = c_1(\rho_i) \in H^2(M)$ ,  $1 \leq i \leq m$ , are the ring generators of  $H^*(M)$  and  $\langle M \rangle \in H_{2n}(M)$  is the fundamental homology class.

LEMMA 9.1.11. *The equivariant connected sum  $M' \#_{x', x''} M''$  of omnioriented quasitoric manifolds admits an orientation compatible with the orientations of  $M'$  and  $M''$  if and only if  $\sigma(x') = -\sigma(x'')$ .*

PROOF. Denote by  $\rho'_j$ ,  $1 \leq j \leq m'$ , the complex line bundles (7.7) corresponding to the characteristic submanifolds of  $M'$  (or to the facets of  $P'$ ), and similarly for  $\rho''_k$ ,  $1 \leq k \leq m''$ , and  $M''$ . We also denote

$$c_1(\rho'_j) = v'_j, \quad c_1(\rho''_k) = v''_k, \quad 1 \leq j \leq m', \quad 1 \leq k \leq m''.$$

The facets of the polytope  $P' \# P''$  are of three types:  $n$  facets arising from the identifications of facets meeting at  $x'$  and  $x''$ ,  $(m' - n)$  facets coming from  $P'$ , and  $(m'' - n)$  facets coming from  $P''$ . We denote the corresponding line bundles over  $M' \# M''$  by  $\xi_i$ ,  $\xi'_j$  and  $\xi''_k$ , respectively (they correspond to the columns of the characteristic matrix (9.3)). Consider their first Chern classes in  $H^2(M' \# M'')$ :

$$\begin{aligned} w_i &= c_1(\xi_i), & w'_j &= c_1(\xi'_j), & w''_k &= c_1(\xi''_k), \\ 1 \leq i \leq n, & & n+1 \leq j \leq m', & & n+1 \leq k \leq m''. \end{aligned}$$

Now consider the maps  $p': M' \# M'' \rightarrow M'$  and  $p'': M' \# M'' \rightarrow M''$  pinching one of the connected summands to a point. We have  $p'^*(\rho'_j) = \xi'_j$  for  $n+1 \leq j \leq m'$  and  $p''^*(\rho''_k) = \xi''_k$  for  $n+1 \leq k \leq m''$ . Relations (7.17) in the cohomology ring of  $M' \# M''$  take the form

$$w_i = -\lambda'_{i,n+1} w'_{n+1} - \cdots - \lambda'_{i,m'} w'_{m'} - \lambda''_{i,n+1} w''_{n+1} - \cdots - \lambda''_{i,m''} w''_{m''}.$$

It follows that

$$(9.4) \quad w_i = p'^* v'_i + p''^* v''_i, \quad 1 \leq i \leq n.$$

Since the first  $n$  facets of  $P' \# P''$  do not intersect, it follows that  $w_1 \cdots w_n = 0$  in  $H^{2n}(M' \# M'')$ , hence

$$(p'^* v'_1 + p''^* v''_1) \cdots (p'^* v'_n + p''^* v''_n) = p'^*(v'_1 \cdots v'_n) + p''^*(v''_1 \cdots v''_n) = 0.$$

For any choice of an orientation with the corresponding fundamental class  $\langle M' \# M'' \rangle \in H_{2n}(M' \# M'')$ , we obtain

$$v'_1 \cdots v'_n \langle p'_* \langle M' \# M'' \rangle \rangle + v''_1 \cdots v''_n \langle p''_* \langle M' \# M'' \rangle \rangle = 0.$$

An orientation of  $M' \# M''$  is compatible with the orientations of  $M'$  and  $M''$  if and only if  $p'_* \langle M' \# M'' \rangle = \langle M' \rangle$  and  $p''_* \langle M' \# M'' \rangle = \langle M'' \rangle$ . Substituting this to the identity above, we obtain  $\sigma(x') + \sigma(x'') = 0$ .  $\square$

PROPOSITION 9.1.12. *Let  $M' = M(P', A'')$  and  $M'' = M(P'', A'')$  be two omnioriented quasitoric manifolds, and assume that  $\sigma(x') = -\sigma(x'')$ . Then the stably complex structure defined on the equivariant connected sum  $M' \#_{x', x''} M''$  by the characteristic matrix (9.3) and the compatible orientation is equivalent to the sum of the canonical stably complex structures on  $M'$  and  $M''$ . In particular, the corresponding complex bordism classes satisfy*

$$[M' \# M''] = [M'] + [M''].$$

PROOF. The connected sum of the two canonical stably complex structures on  $M'$  and  $M''$  is defined by the isomorphism

$$(9.5) \quad \mathcal{T}(M' \# M'') \oplus \mathbb{Z}^{2(m'+m''-n)} \xrightarrow{\cong} p'^*(\rho'_1 \oplus \cdots \oplus \rho'_{m'}) \oplus p''^*(\rho''_1 \oplus \cdots \oplus \rho''_{m''})$$

(see Construction D.3.9). We have  $p'^*(\rho'_j) = \xi'_j$  for  $n+1 \leq j \leq m'$  and  $p''^*(\rho''_k) = \xi''_k$  for  $n+1 \leq k \leq m''$ . Furthermore, we claim that  $p'^*(\rho'_i) \oplus p''^*(\rho''_i) = \xi_i \oplus \mathbb{C}$  for  $1 \leq i \leq n$ . Indeed, relations (7.17) for  $M'$  imply

$$p'^*(\rho'_i) = (\xi'_{n+1})^{-\lambda'_{i,n+1}} \otimes \cdots \otimes (\xi'_{m'})^{-\lambda'_{i,m'}}, \quad 1 \leq i \leq n,$$

and the same relations for  $M''$  imply

$$p''^*(\rho''_i) = (\xi''_{n+1})^{-\lambda''_{i,n+1}} \otimes \cdots \otimes (\xi''_{m''})^{-\lambda''_{i,m''}}, \quad 1 \leq i \leq n.$$

The line bundle  $\xi'_j$  over  $M' \# M''$  has a section whose zero set is precisely the characteristic submanifold corresponding to the facet  $F'_j \subset P' \# P''$ , for  $n+1 \leq j \leq m'$ . There is an analogous property of the bundles  $\xi''_k$ , for  $n+1 \leq k \leq m''$ . Now, since the facets  $F'_j$  and  $F''_k$  do not intersect in  $P' \# P''$  for any  $j$  and  $k$ , the bundle  $p'^*(\rho'_i) \oplus p''^*(\rho''_i)$  has a nowhere vanishing section, for  $1 \leq i \leq n$ . Therefore,  $p'^*(\rho'_i) \oplus p''^*(\rho''_i) = \eta \oplus \underline{\mathbb{C}}$  for some line bundle  $\eta$ . By comparing the first Chern classes and using (9.4), we obtain  $\eta = \xi_i$ , as needed.

Then the stably complex structure (9.5) takes the form

$$\begin{aligned} \mathcal{T}(M' \# M'') \oplus \mathbb{R}^{2(m'+m''-n)} &\xrightarrow{\cong} \\ &\xrightarrow{\cong} \xi_1 \oplus \cdots \oplus \xi_n \oplus \xi'_{n+1} \oplus \cdots \oplus \xi'_{m'} \oplus \xi''_{n+1} \oplus \cdots \oplus \xi''_{m''} \oplus \underline{\mathbb{C}}^n. \end{aligned}$$

This differs by a trivial summand  $\underline{\mathbb{C}}^n$  from the stably complex structure defined by matrix (9.3). □

**COROLLARY 9.1.13.** *The complex bordism class  $[M' \# M'']$  does not depend on the choice of initial vertices and the ordering of facets of  $P'$  and  $P''$ .*

The relationship between the equivariant connected sum  $M' \#_{x',x''} M''$  of omnioriented quasitoric manifolds and the standard connected sum  $M' \# M''$  of oriented (or stably complex) manifolds is now clear: the two operations produce the same manifold if and only if  $\sigma(x') = -\sigma(x'')$ . Otherwise the equivariant connected sum gives  $M' \# \overline{M''}$  or  $\overline{M'} \# M''$  depending on the choice of orientation. This implies that the equivariant connected sum cannot always be used to obtain the sum of bordism classes. If the sign of every vertex of  $P$  is positive, for example, then it is impossible to obtain the bordism class  $2[M]$  directly from  $M \# M$ . This is the case when  $M$  is a toric manifold.

**Proof of the main result.** We start with an example.

**EXAMPLE 9.1.14.** Consider the standard cube  $I^n$  with the orientation induced from  $\mathbb{R}^n$ . The quasitoric manifold over  $I^n$  corresponding to the characteristic  $n \times 2n$ -matrix  $(I \mid -I)$  (where  $I$  is the unit  $n \times n$ -matrix) is the product  $(\mathbb{C}P^1)^n$  with the standard complex structure. It represents a nontrivial complex bordism class, and the signs of all vertices of the cube are positive.

On the other hand, we can consider the omnioriented quasitoric manifold over  $I^n$  corresponding to the matrix  $(I \mid I)$ . It is easy to see that the corresponding stably complex structure on  $(\mathbb{C}P^1)^n \cong (S^2)^n$  is the product of  $n$  copies of the trivial structure on  $\mathbb{C}P^1$  from Example D.3.1. We denote this omnioriented quasitoric manifold by  $S$ . The bordism class  $[S]$  is zero, and the sign of a vertex  $(\varepsilon_1, \dots, \varepsilon_n) \in I^n$  where  $\varepsilon_i = 0$  or  $1$  is given by

$$\sigma(\varepsilon_1, \dots, \varepsilon_n) = (-1)^{\varepsilon_1} \cdots (-1)^{\varepsilon_n}.$$

So adjacent vertices of  $I^n$  have opposite signs.

We are now in a position to prove the next key lemma which emphasises an important principle; however unsuitable a quasitoric manifold  $M$  may be for the formation of connected sums, a good alternative representative always exists within the complex bordism class  $[M]$ .



LEMMA 9.1.15. *Let  $M$  be an omnioriented quasitoric manifold of dimension  $> 2$  over a polytope  $P$ . Then there exists an omnioriented  $M'$  over a polytope  $P'$  such that  $[M'] = [M]$  and  $P'$  has at least two vertices of opposite sign.*

PROOF. Suppose that  $x$  is the initial vertex of  $P$ . Let  $S$  be the omnioriented product of 2-spheres of Example 9.1.14, with initial vertex  $w = (0, \dots, 0)$ .

If  $\sigma(x) = -1$ , define  $M'$  to be  $S \#_{w,x} M$  over  $P' = I^n \#_{w,x} P$ . Then  $[M'] = [M]$ , because  $S$  bounds. Moreover, there is a pair of adjacent vertices of  $I^n$  which survive under formation of connected sum  $I^n \#_{w,x} P$  (because  $n > 1$ ). These two vertices have opposite signs, as sought.

If  $\sigma(x) = 1$ , we make the same construction using the opposite orientation of  $I^n$  (and therefore of  $S$ ). Since  $-S$  also bounds, the same conclusions hold.  $\square$

We may now complete the proof of the main result.

THEOREM 9.1.16 ([58]). *In dimensions  $> 2$ , every complex bordism class contains a quasitoric manifold, necessarily connected, whose stably complex structure is induced by an omniorientation, and is therefore compatible with the torus action.*

PROOF. Consider bordism classes  $[M_1]$  and  $[M_2]$  in  $\Omega_n^U$ , represented by omnioriented quasitoric manifolds over polytopes  $P_1$  and  $P_2$  respectively. It then suffices to construct a quasitoric manifold  $M$  such that  $[M] = [M_1] + [M_2]$ , because Theorem 9.1.9 gives an additive basis of  $\Omega_n^U$  represented by quasitoric manifolds.

Firstly, we follow Lemma 9.1.15 and replace  $M_2$  by  $M'_2$  over  $P'_2 = \mathbb{I}^n \# P_2$ . Then we choose the initial vertex of  $P'_2$  so as to ensure that it has the opposite sign to the initial vertex of  $P_1$ , thereby guaranteeing the construction of  $M_1 \# M'_2$  over  $P_1 \# P'_2$ . The resulting omniorientation defines the required bordism class, by Proposition 9.1.12 and Lemma 9.1.15.  $\square$

Combining Theorem 9.1.16 with Proposition 7.3.12 and the quadratic description (6.3) of the moment-angle manifold  $\mathcal{Z}_P$  leads to another interesting conclusion relating toric topology to complex cobordism:

THEOREM 9.1.17. *Every complex bordism class may be represented by a stably complex manifold obtained as the quotient of a free torus action on a complete intersection of real quadrics.*

One further deduction from Theorem 9.1.16 is the following result of Ray:

THEOREM 9.1.18 ([275]). *Every complex bordism class contains a representative whose stable tangent bundle is a sum of line bundles.*

**Examples.** Here we consider some examples of 4-dimensional quasitoric manifolds (i.e.  $n = 2$ ) illustrating the constructions of this section.

EXAMPLE 9.1.19. When  $n = 2$ , the complex bordism class  $[\mathbb{C}P^2]$  of the standard complex structure of Example 7.3.21 is an additive generator of the group  $\Omega_4^U \cong \mathbb{Z}^2$ , with  $c_2(\mathbb{C}P^2) = 3$  and all signs of the vertices of the quotient 2-simplex  $\Delta^2$  being positive.

The question then arises of representing the bordism class  $2[\mathbb{C}P^2]$  by an omnioriented quasitoric manifold  $M$ . We cannot expect to use  $\mathbb{C}P^2 \# \mathbb{C}P^2$  for  $M$ , because no vertices of sign  $-1$  are available in  $\Delta^2$ , as required by Lemma 9.1.11. Moreover,  $M$  must satisfy  $c_2(M) = 6$ , by additivity, so the quotient polytope  $P$  has 6 or more

vertices (see Exercise 7.3.37). It follows that  $P$  cannot be  $\Delta^2 \# \Delta^2$ , which is a square! So we proceed to appealing to Lemma 9.1.15, and replace the second copy of  $\mathbb{C}P^2$  by the omnioriented quasitoric manifold  $(-S) \# \mathbb{C}P^2$  over  $P' = I^2 \# \Delta^2$ . Of course  $(-S) \# \mathbb{C}P^2$  is bordant to  $\mathbb{C}P^2$ , and  $P'$  is a pentagon. These observations lead naturally to our second example:

EXAMPLE 9.1.20. The quasitoric manifold  $M = \mathbb{C}P^2 \# (-S) \# \mathbb{C}P^2$  represents the bordism class  $2[\mathbb{C}P^2]$ , and its quotient polytope is  $\Delta^2 \# I^2 \# \Delta^2$ , which is a hexagon. Fig. 9.1 illustrates the procedure diagrammatically, in terms of characteristic functions and orientations. Every vertex of the hexagon has sign 1, so  $M$  admits an equivariant almost complex structure by Theorem 7.3.23; in fact it coincides with the manifold from Exercise 7.3.34.

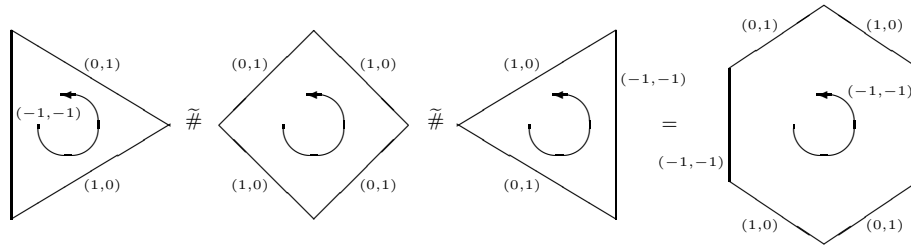

FIGURE 9.1. Equivariant connected sum  $\mathbb{C}P^2 \# (-S) \# \mathbb{C}P^2$ .

Our third example shows a related 4-dimensional situation in which the connected sum of the quotient polytopes does support a compatible orientation.

EXAMPLE 9.1.21. Let  $\overline{\mathbb{C}P^2}$  denote the quasitoric manifold obtained by reverting the standard orientation of  $\mathbb{C}P^2$  (equivalently, reverting the orientation of the standard simplex  $\Delta^2$ ). Every vertex has sign  $-1$ , and we may construct  $\mathbb{C}P^2 \# \overline{\mathbb{C}P^2}$  as an omnioriented quasitoric manifold over  $\Delta^2 \# \Delta^2$ . The corresponding characteristic functions and orientations are shown in Fig. 9.2. Of course  $[\overline{\mathbb{C}P^2}] = -[\mathbb{C}P^2]$ . So

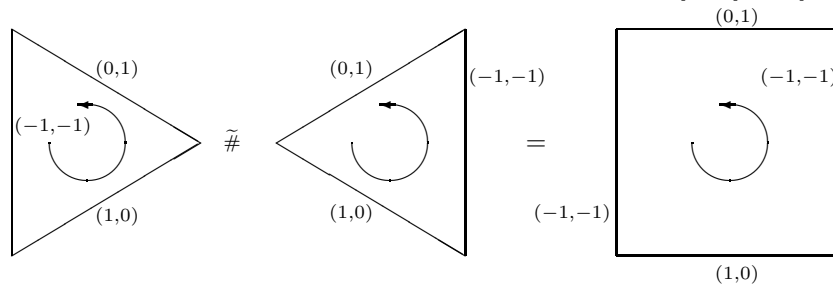

FIGURE 9.2. Equivariant connected sum  $\mathbb{C}P^2 \# \overline{\mathbb{C}P^2}$ .

$[\mathbb{C}P^2] + [\overline{\mathbb{C}P^2}] = 0$  in  $\Omega_4^U$ , and the manifold  $\mathbb{C}P^2 \# \overline{\mathbb{C}P^2}$  bounds by Proposition 9.1.12.

A situation similar to that of Example 9.1.20 arises in higher dimensions, when we consider the problem of representing complex bordism classes by toric manifolds. For any such  $V$ , the top Chern number  $c_n[V]$  coincides with the Euler characteristic, and is therefore equal to the number of vertices of the quotient polytope  $P$ .

Suppose that toric manifolds  $V_1$  and  $V_2$  are of dimension  $\geq 4$ , and have quotient polytopes  $P_1$  and  $P_2$  respectively. Then  $c_n[V_1] = f_0(P_1)$  and  $c_n[V_2] = f_0(P_2)$ , yet  $f_0(P_1 \# P_2) = f_0(P_1) + f_0(P_2) - 2$ , where  $f_0(\cdot)$  denotes the number of vertices. Since  $c_n([V_1] + [V_2]) = c_n[V_1] + c_n[V_2]$ , no omnioriented quasitoric manifold over  $P_1 \# P_2$  can represent  $[V_1] + [V_2]$  (see Exercise 7.3.37). This objection vanishes for  $P_1 \# I^n \# P_2$ , because it enjoys additional  $2^n - 2$  vertices with opposite signs.

### Exercises.

9.1.22. Construct an effective action of a  $j$ -dimensional torus  $T^j$  on a Milnor hypersurface  $H_{ij}$  and a representation of  $T^j$  in  $\mathbb{C}^{(i+1)(j+1)}$  such that the composition  $H_{ij} \rightarrow \mathbb{C}P^i \times \mathbb{C}P^j \rightarrow \mathbb{C}P^{(i+1)(j+1)-1}$  with the Segre embedding becomes equivariant. Describe the fixed points of this action.

9.1.23. A torus  $T^{i+j-1}$  cannot act effectively with isolated fixed points on a Milnor hypersurface  $H_{ij}$  with  $i > 1$ . (Hint: use Theorem 7.4.35 and other results of Section 7.4.)

9.1.24. Show that the Milnor hypersurface  $H_{11}$  is isomorphic (as a complex manifold) to the Hirzebruch surface  $F_1$  from Example 5.1.8. In particular,  $H_{11}$  is not homeomorphic to  $F_0 = \mathbb{C}P^1 \times \mathbb{C}P^1$  (see Exercise 5.1.13).

9.1.25. Show by comparing the cohomology rings that  $H_{1j}$  is not homeomorphic to  $\mathbb{C}P^1 \times \mathbb{C}P^{j-1}$ . On the other hand, the two manifolds are complex bordant by Exercise D.5.14.

9.1.26. The procedure described in Example 9.1.20 allows one to construct an almost complex quasitoric manifold  $M$  (with all signs positive) representing the sum of cobordism classes  $[V_1] + [V_2]$  of any two projective toric manifolds of real dimension 4. Describe a similar procedure giving almost complex quasitoric representatives for  $[V_1] + [V_2]$  in dimension 6. (Hint: modify the intermediate zero-cobordant manifold  $S$ .) What about higher dimensions?

## 9.2. The universal toric genus

A theory of equivariant genera for stably complex manifolds equipped with compatible actions of a torus  $T^k$  was developed in [59]. This theory focuses on the notion of *universal toric genus*  $\Phi$ , defined on stably complex  $T^k$ -manifolds and taking values in the complex cobordism ring  $U^*(BT^k)$  of the classifying space. The construction of  $\Phi$  goes back to the works of tom Dieck, Krichever and Löffler from the 1970s. The universal toric genus  $\Phi$  is an equivariant analogue of the universal Hirzebruch genus (Example E.3.5) corresponding to the identity homomorphism from the complex cobordism ring  $\Omega_U$  to itself.

Here is an idea behind the construction of  $\Phi$ ; details are provided below. We start by defining a composite transformation of  $T^k$ -equivariant cohomology functors

$$(9.6) \quad \Phi_X: U_{T^k}^*(X) \xrightarrow{\nu} MU_{T^k}^*(X) \xrightarrow{\alpha} U^*(ET^k \times_{T^k} X).$$

Here  $U_{T^k}^*(X)$  (respectively  $MU_{T^k}^*(X)$ ) denotes the *geometric* (respectively the *homotopic*)  $T^k$ -equivariant complex cobordism ring of a  $T^k$ -manifold  $X$ , and  $U^*(ET^k \times_{T^k} X)$  denotes the ordinary complex cobordism of the Borel construction. (Note that the geometric and homotopical versions of equivariant cobordism are different, because of the lack of equivariant transversality.)

By restricting (9.6) to the case  $X = pt$  we get a homomorphism of  $\Omega_U$ -modules

$$\Phi: \Omega_{U:T^k} \rightarrow \Omega_U[[u_1, \dots, u_k]]$$

from the geometric  $T^k$ -(co)bordism ring  $U_{T^k}^*(pt) = \Omega_{U:T^k}^* = \Omega_{-*}^{U:T^k}$  to the ring  $U^*(BT^k) = \Omega_U[[u_1, \dots, u_k]]$ . Here  $u_j$  is the cobordism Chern class  $c_1^U(\bar{\eta}_j)$  of the canonical line bundle (the conjugate of the Hopf bundle) over the  $j$ th factor of  $BT^k = (\mathbb{C}P^\infty)^k$ , for  $1 \leq j \leq k$ . We refer to  $\Phi$  as the *universal toric genus*. It assigns to a bordism class  $[M, c_{\mathcal{T}}] \in \Omega_{2n}^{U:T^k}$  of a  $2n$ -dimensional stably complex  $T^k$ -manifold  $M$  the ‘cobordism class’ of the map  $ET^k \times_{T^k} M \rightarrow BT^k$ . The value  $\Phi(M)$  is a power series in  $u_1, \dots, u_k$  with coefficients in  $\Omega_U$  and constant term  $[M]$ .

We now proceed to providing the details of the construction. All our  $T^k$ -spaces  $X$  have homotopy type of cell complexes. It is often important to take account of basepoints, in which case we insist that they be fixed by  $T^k$ . If  $X$  itself does not have a  $T^k$ -fixed point, then a disjoint fixed basepoint can be added; the result is denoted by  $X_+$ .

**Homotopic equivariant cobordism.** The homotopic version of equivariant cobordism is defined via the Thom  $T^k$ -spectrum  $MU_{T^k}$ , whose spaces are indexed by the inclusion poset of complex representations  $V$  of  $T^k$  (of complex dimension  $|V|$ ). Each  $MU_{T^k}(V)$  is the Thom  $T^k$ -space of the universal  $|V|$ -dimensional complex  $T^k$ -equivariant vector bundle  $\gamma_V$  over  $BU_{T^k}(V)$ , and each spectrum map  $\Sigma^{2(|W|-|V|)}MU_{T^k}(V) \rightarrow MU_{T^k}(W)$  is induced by the inclusion  $V \subset W$  of a  $T^k$ -submodule. The *homotopic  $T^k$ -equivariant complex cobordism group*  $MU_{T^k}^n(X)$  of a pointed  $T^k$ -space  $X$  is defined by stabilising the pointed  $T^k$ -homotopy sets:

$$MU_{T^k}^n(X) = \lim_{\rightarrow} [\Sigma^{2|V|-n}(X_+), MU_{T^k}(V)]_{T^k},$$

The details of this construction can be found in [214, Chapters XXV–XXVIII].

Applying the Borel construction to  $\gamma_V$  yields a complex  $|V|$ -dimensional bundle  $ET^k \times_{T^k} \gamma_V$  over  $ET^k \times_{T^k} BU_{T^k}(V)$ , whose Thom space is  $ET_+^k \wedge_{T^k} MU_{T^k}(V)$ . The classifying map for the bundle  $ET^k \times_{T^k} \gamma_V$  induces a map of Thom spaces  $ET_+^k \wedge_{T^k} MU_{T^k}(V) \rightarrow MU(|V|)$ . Now consider a  $T^k$ -map  $\Sigma^{2|V|-n}(X_+) \rightarrow MU_{T^k}(V)$  representing a homotopic cobordism class in  $MU_{T^k}^n(X)$ . By applying the Borel construction and composing with the classifying map above, we obtain a composite map of Thom spaces

$$\Sigma^{2|V|-n}(ET^k \times_{T^k} X)_+ \longrightarrow ET_+^k \wedge_{T^k} MU_{T^k}(V) \rightarrow MU(|V|).$$

This construction is homotopy invariant, so we get a map

$$[\Sigma^{2|V|-n}(X_+), MU_{T^k}(V)]_{T^k} \longrightarrow [\Sigma^{2|V|-n}(ET^k \times_{T^k} X)_+, MU(|V|)].$$

Furthermore, it preserves stabilisation and therefore yields the transformation

$$\alpha: MU_{T^k}^*(X) \longrightarrow U^*(ET^k \times_{T^k} X),$$

which is multiplicative and preserves Thom classes [310, Proposition 1.2].

The construction of  $\alpha$  may be also interpreted using the homomorphism  $MU_{T^k}^*(X) \rightarrow MU_{T^k}^*(ET^k \times X)$  induced by the  $T^k$ -projection  $ET^k \times X \rightarrow X$ ; since  $T^k$  acts freely on  $ET^k \times X$ , the target may be replaced by  $U^*(ET^k \times_{T^k} X)$ . Moreover,  $\alpha$  is an isomorphism whenever  $X$  is compact and  $T^k$  acts freely.

REMARK. According to the result of Löffler [214, Chapter XXVII],  $\alpha$  is the homomorphism of completion with respect to the augmentation ideal in  $MU_{T^k}^*(X)$ .

**Geometric equivariant cobordism.** The geometric version of equivariant cobordism can be defined naturally by providing an equivariant version of Quillen’s geometric approach [273] to complex cobordism via *complex oriented maps* (see Construction D.3.3). However, this approach relies on normal complex structures, whereas many of our examples present themselves most readily in terms of tangential information. In the non-equivariant situation, the two forms of data are, of course, interchangeable; but the same does not hold equivariantly. This fact was often ignored in early literature, and appears only to have been made explicit in 1995, by Comezaña [214, Chapter XXVIII, §3]. As we shall see below, tangential structures may be converted to normal, but the procedure is not reversible.

We recall from Construction D.3.3 that elements in the cobordism group  $U^{-d}(X)$  of a manifold  $X$  can be represented by *stably tangentially complex* bundles  $\pi: E \rightarrow X$  with  $d$ -dimensional fibre  $F$ , i.e. by those  $\pi$  for which the bundle  $\mathcal{T}_F(E)$  of tangents along the fibre is equipped with a stably complex structure  $c_{\mathcal{T}}(\pi)$ .

If  $\pi$  is  $T^k$ -equivariant bundle, then it is stably tangentially complex *as a  $T^k$ -equivariant bundle* when  $c_{\mathcal{T}}(\pi)$  is also  $T^k$ -equivariant. The notions of *equivariant equivalence* and *equivariant cobordism* apply to such bundles accordingly.

The *geometric  $T^k$ -equivariant complex cobordism group*  $U_{T^k}^{-d}(X)$  consists of equivariant cobordism classes of  $d$ -dimensional stably tangentially complex  $T^k$ -equivariant bundles over  $X$ . If  $X = pt$ , then we may identify both  $F$  and  $E$  with some  $d$ -dimensional smooth  $T^k$ -manifold  $M$ , and  $\mathcal{T}_F(E)$  with its tangent bundle  $\mathcal{T}(M)$ . So  $c_{\mathcal{T}}(\pi)$  reduces to a  $T^k$ -equivariant stably tangentially complex structure  $c_{\mathcal{T}}$  on  $M$ , and its cobordism class belongs to the group  $\Omega_{U:T^k}^{-d} = U_{T^k}^{-d}(pt)$  (the cobordism group of point). The bordism group of point is given by  $\Omega_d^{U:T^k} = \Omega_{U:T^k}^{-d}$ . The direct sums  $\Omega^{U:T^k} = \Omega_*^{U:T^k} = \bigoplus_d \Omega_d^{U:T^k}$  and  $\Omega_{U:T^k} = \bigoplus_d \Omega_{U:T^k}^d$  are the *geometric  $T^k$ -equivariant bordism* and *cobordism rings* respectively, and  $U_{T^k}^*(X)$  is a graded  $\Omega_{U:T^k}$ -module under cartesian product. Furthermore,  $U_{T^k}^*(\cdot)$  is functorial with respect to pullback along smooth  $T^k$ -maps  $Y \rightarrow X$ .

PROPOSITION 9.2.1. *Given any smooth compact  $T^k$ -manifold  $X$ , there are canonical homomorphisms*

$$\nu: U_{T^k}^{-d}(X) \rightarrow MU_{T^k}^{-d}(X), \quad d \geq 0.$$

PROOF. The idea is to convert the tangential structure used in the definition of geometric cobordism group  $U_{T^k}^{-d}(X)$  to the normal structure required for the Pontryagin–Thom collapse map in the homotopical approach.

Let  $\pi$  in  $\Omega_{U:T^k}^{-d}(X)$  denote the cobordism class of a stably tangentially complex  $T^k$ -bundle  $\pi: E \rightarrow X$ . Choose a  $T^k$ -equivariant embedding  $i: E \rightarrow V$  into a complex  $T^k$ -representation space  $V$  (see Theorem B.3.2) and consider the embedding  $(\pi, i): E \rightarrow X \times V$ . It is a map of vector bundles over  $X$  which is  $T^k$ -equivariant with respect to the diagonal action on  $X \times V$ . There is an equivariant isomorphism  $c: \tau_F(E) \oplus \nu(\pi, i) \rightarrow \underline{V} = E \times V$  of bundles over  $E$ , where  $\nu(\pi, i)$  is the normal bundle of  $(\pi, i)$ . Now combine  $c$  with the stably complex structure isomorphism  $c_{\mathcal{T}}(\pi): \mathcal{T}_F(E) \oplus \mathbb{R}^{2l-d} \rightarrow \xi$  to obtain an equivariant isomorphism

$$(9.7) \quad \underline{W} \oplus \nu(\pi, i) \longrightarrow \xi^\perp \oplus \underline{V} \oplus \mathbb{R}^{2l-d},$$

where  $\underline{W} = \xi^\perp \oplus \xi$  is a  $T^k$ -decomposition for some complex representation space  $W$ .

If  $d$  is even, (9.7) determines a complex  $T^k$ -structure on an equivariant stabilisation of  $\nu(\pi, i)$ ; if  $d$  is odd, a further summand  $\mathbb{R}$  must be added. For notational

convenience, assume the former, and write  $d = 2n$ . We compose (9.7) with the classifying map  $\xi^\perp \oplus \underline{V} \oplus \underline{\mathbb{C}}^{l-n} \rightarrow \gamma_R$ , where  $R$  is a  $T^k$ -representation of complex dimension  $|R| = |V| + |W| - n$  and then pass to the Thom spaces to get a sequence of  $T^k$ -equivariant maps

$$\Sigma^{2|W|} Th(\nu(\pi, i)) \longrightarrow Th(\xi^\perp \oplus \underline{V} \oplus \mathbb{R}^{2l-d}) \longrightarrow Th(\gamma_R) = MU_{T^k}(R).$$

We compose this with the Pontryagin–Thom collapse map on  $\nu(\pi, i)$  to obtain

$$f(\pi): \Sigma^{2|V|+2|W|} X_+ = \Sigma^{2|R|-d} X_+ \longrightarrow MU_{T^k}(R).$$

If  $\pi$  and  $\pi'$  are equivalent, then  $f(\pi)$  and  $f(\pi')$  differ only by suspension; if they are cobordant, then  $f(\pi)$  and  $f(\pi')$  are stably  $T^k$ -homotopic. So we define  $\nu(\pi)$  to be the  $T^k$ -homotopy class of  $f(\pi)$ , as an element of  $MU_{T^k}^{-d}(X)$ .

The linearity of  $\nu$  follows immediately from the fact that addition in  $U_{T^k}^{-d}(X)$  is induced by disjoint union. □

The proof of Proposition 9.2.1 also shows that  $\nu$  factors through the geometric cobordism group of stably normally complex  $T^k$ -manifolds over  $X$ .

**The universal toric genus.** For any smooth compact  $T^k$ -manifold  $X$ , we define the homomorphism

$$\Phi_X: U_{T^k}^*(X) \xrightarrow{\nu} MU_{T^k}^*(X) \xrightarrow{\alpha} U^*(ET^k \times_{T^k} X).$$

DEFINITION 9.2.2. The homomorphism

$$\Phi: \Omega_{U:T^k} \longrightarrow \Omega_U[[u_1, \dots, u_k]]$$

corresponding to the case  $X = pt$  above is called the *universal toric genus*.

The genus  $\Phi$  is a multiplicative cobordism invariant of stably complex  $T^k$ -manifolds, and it takes values in the ring  $\Omega_U[[u_1, \dots, u_k]]$ . As such it is an equivariant extension of Hirzebruch’s original notion of genus (see Appendix E.3), and is closely related to the theory of formal group laws. We explore this relation and study other equivariant genera in the next sections.

REMARK. By the result of Hanke [149] and Löffler [196, (3.1) Satz], when  $X = pt$ , both homomorphisms  $\nu$  and  $\alpha$  are monic; therefore so is  $\Phi$ .

On the other hand, there are two important reasons why  $\nu$  cannot be epic. Firstly, it is defined on stably tangential structures by converting them into stably normal information; this procedure cannot be reversed equivariantly, because the former are stabilised only by trivial representations of  $T^k$ , whereas the latter are stabilised by arbitrary representations  $V$ . Secondly, homotopical equivariant cobordism groups are periodic, and each  $T^k$ -representation  $W$  gives rise to an invertible Euler class  $e(W)$  in  $MU_{T^k}^{2|W|}(pt)$ , while  $U_{T^k}^d(pt) = \Omega_{U:T^k}^d$  is zero for positive  $d$ ; this phenomenon exemplifies the failure of equivariant transversality.

In geometric terms, the universal toric genus  $\Phi$  assigns to a geometric bordism class  $[M, c_T] \in \Omega_d^{U:T^k}$  of a  $d$ -dimensional stably complex  $T^k$ -manifold  $M$  the ‘cobordism class’ of the map  $ET^k \times_{T^k} M \rightarrow BT^k$ . Since both  $ET^k \times_{T^k} M$  and  $BT^k$  are infinite-dimensional, one needs to use their finite approximations to define the cobordism class  $\Phi(M)$  purely in terms of stably complex structures. Here is a conceptual way to make this precise.

PROPOSITION 9.2.3. *Let  $[M] \in \Omega_{U:T^k}$  be a geometric equivariant cobordism class represented by a  $d$ -dimensional  $T^k$ -manifold  $M$ . Then*

$$\Phi(M) = (\text{id} \times_{T^k} \pi)_! 1,$$

where

$$(\text{id} \times_{T^k} \pi)_!: U^*(ET^k \times_{T^k} M) \longrightarrow U^{*-d}(ET^k \times_{T^k} pt) = U^{*-d}(BT^k)$$

is the Gysin homomorphism in cobordism induced by the projection  $\pi: M \rightarrow pt$ .

PROOF. Choose an equivariant embedding  $M \rightarrow V$  into a complex representation space. Then the projection  $\text{id} \times_{T^k} \pi: ET^k \times_{T^k} M \rightarrow BT^k$  factorises as

$$ET^k \times_{T^k} M \xrightarrow{i} ET^k \times_{T^k} V \longrightarrow BT^k.$$

We can approximate  $ET^k$  by the products  $(S^{2q+1})^k$  with the diagonal action of  $T^k$ . Then the above sequence is approximated by the appropriate factorisations of smooth bundles over finite-dimensional manifolds,

$$(9.8) \quad (S^{2q+1})^k \times_{T^k} M \xrightarrow{i_q} (S^{2q+1})^k \times_{T^k} V \longrightarrow (\mathbb{C}P^q)^k.$$

This defines a complex orientation for the map  $(S^{2q+1})^k \times_{T^k} M \rightarrow (\mathbb{C}P^q)^k$  (see Construction D.3.3) and therefore a complex cobordism class in  $U^{-d}((\mathbb{C}P^q)^k)$ , which we denote by  $\Phi_q(M)$ . By definition of the Gysin homomorphism (Construction D.3.6),  $\Phi_q(M) = (\text{id}_q \times_{T^k} \pi)_! 1$ , where  $\text{id}_q$  is the identity map of  $(S^{2q+1})^k$ . As  $q$  increases, the classes  $\Phi_q(M)$  form an inverse system, whose limit is  $\Phi(M) \in U^{-d}(BT^k)$ . In particular,  $\Phi(M) = (\text{id} \times_{T^k} \pi)_! 1$ .  $\square$

**Coefficients of the expansion of  $\Phi(M)$ .** Recall that the cobordism ring  $U^*(\mathbb{C}P^\infty)$  is isomorphic to  $\Omega_U[[u]]$ , where  $u = c_1^U(\bar{\eta}) \in U^2(\mathbb{C}P^\infty)$  is the generator represented geometrically by a codimension-one complex projective subspace  $\mathbb{C}P^{\infty-1} \subset \mathbb{C}P^\infty$  (viewed as the direct limit of inclusions  $\mathbb{C}P^{N-1} \subset \mathbb{C}P^N$ ).

A basis for the  $\Omega_U$ -module  $\Omega_U[[u_1, \dots, u_k]] = U^*(BT^k)$  in dimension  $2|\omega|$  is given by the monomials  $u^\omega = u_1^{\omega_1} \cdots u_k^{\omega_k}$ , where  $\omega$  ranges over nonnegative integral vectors  $(\omega_1, \dots, \omega_k)$ , and  $|\omega| = \sum_j \omega_j$ . A monomial  $u^\omega$  is represented geometrically by a  $k$ -fold product of complex projective subspaces of codimension  $(\omega_1, \dots, \omega_k)$  in  $(\mathbb{C}P^\infty)^k$ . If we write

$$(9.9) \quad \Phi(M) = \sum_{\omega} g_{\omega}(M) u^{\omega}$$

in  $\Omega_U[[u_1, \dots, u_k]]$ , then the coefficients  $g_{\omega}(M)$  lie in  $\Omega_U^{-2(|\omega|+n)}$ . We shall describe their representatives geometrically as universal operations on  $M$ . The cobordism class  $g_{\omega}(M)$  will be represented by the total space  $G_{\omega}(M)$  of a bundle with fibre  $M$  over the product  $B_{\omega} = B_{\omega_1} \times \cdots \times B_{\omega_k}$ , where each  $B_{\omega_i}$  is the *bounded flag manifold* (Section 7.7), albeit with the stably complex structure representing zero in  $\Omega_{2\omega_i}^U$  and therefore not equivalent to the standard complex structure on  $BF_{\omega_i}$ .

We start by describing stably complex structures on  $BF_n$ .

CONSTRUCTION 9.2.4. We denote by  $\xi_n$  the ‘tautological’ line bundle over the bounded flag manifold  $BF_n$ , whose fibre over  $\mathcal{U} \in BF_n$  is the first space  $U_1$ . We recall from Proposition 7.8.6 that  $BF_n$  has a structure of a Bott tower in which each stage  $B_k = BF_k$  is the projectivisation  $\mathbb{C}P(\xi_{k-1} \oplus \underline{\mathbb{C}})$ . We shall denote the pullback of  $\xi_i$  to the top stage  $BF_n$  by the same symbol  $\xi_i$ , so that we have  $n$  line bundles  $\xi_1, \dots, \xi_n$  over  $BF_n$ .

Using the matrix  $A$  corresponding to the Bott manifold  $BF_n$  (described in Example 7.8.5), we identify  $BF_n$  with the quotient of the product of 3-spheres

$$(9.10) \quad (S^3)^n = \{(z_1, \dots, z_{2n}) \in \mathbb{C}^{2n} : |z_k|^2 + |z_{k+n}|^2 = 1, 1 \leq k \leq n\}$$

by the action of  $T^n$  given by

$$(9.11) \quad (z_1, \dots, z_{2n}) \mapsto (t_1 z_1, t_1^{-1} t_2 z_2, \dots, t_{n-1}^{-1} t_n z_n, t_1 z_{n+1}, t_2 z_{n+2}, \dots, t_n z_{2n})$$

(see the proof of Theorem 7.8.7). The manifold  $BF_n$  is a complex algebraic variety (a toric manifold). The corresponding stably complex structure can be described by viewing  $BF_n$  as a quasitoric manifold and applying Theorem 7.3.14, which gives

$$(9.12) \quad \mathcal{T}(BF_n) \oplus \underline{\mathbb{C}}^n \cong \rho_1 \oplus \dots \oplus \rho_m,$$

where the  $\rho_i$  are the line bundles (7.7) corresponding to characteristic submanifolds. We have  $c_1(\rho_i) = v_i \in H^2(BF_n)$ ,  $1 \leq i \leq 2n$ , the canonical ring generators of the cohomology ring of  $BF_n$  viewed as a quasitoric manifold. On the other hand, we have the cohomology ring generators  $u_k = c_1(\xi_k)$ ,  $1 \leq k \leq n$ , for the Bott manifold  $BF_n$ . The two sets are related by the identities  $u_k = -v_{k+n}$  (see Exercise 7.8.34). Then identities (7.17) in  $H^*(BF_n)$  imply that  $v_1 = -u_1$  and  $v_k = u_{k-1} - u_k$ , or equivalently,  $\rho_1 = \bar{\xi}_1$  and  $\rho_k = \xi_{k-1} \bar{\xi}_k$  (where we dropped the sign of tensor product of line bundles), for  $2 \leq k \leq n$ . The stably complex structure (9.12) therefore becomes

$$(9.13) \quad \mathcal{T}(BF_n) \oplus \underline{\mathbb{C}}^n \cong \bar{\xi}_1 \oplus \xi_1 \bar{\xi}_2 \oplus \dots \oplus \xi_{n-1} \bar{\xi}_n \oplus \bar{\xi}_1 \oplus \bar{\xi}_2 \oplus \dots \oplus \bar{\xi}_n$$

(note that when  $n = 1$  we obtain the standard isomorphism  $\mathcal{T}CP^1 \oplus \underline{\mathbb{C}} \cong \bar{\eta} \oplus \bar{\eta}$ , as  $\xi_1 = \eta$  is the tautological line bundle).

We shall change the stably complex structure on  $BF_n$  so that the resulting bordism class in  $\Omega_{2n}^U$  will be zero. To see that this is possible, we regard  $BF_n$  as a *sphere bundle* over  $BF_{n-1}$  rather than the complex projectivisation  $CP(\xi_{n-1} \oplus \underline{\mathbb{C}})$ . If a stably complex structure  $c_{\mathcal{T}}$  on  $BF_n$  restricts to a trivial stably complex structure on each fibre  $S^2$  (see Example D.3.1), then  $c_{\mathcal{T}}$  extends over the associated 3-disk bundle, so it is cobordant to zero.

So we need to change the stably complex structure (9.13) so that the new structure restricts to a trivial one on each fibre  $S^2$ . We decompose  $(S^3)^n$  as  $(S^3)^{n-1} \times S^3$  and  $T^n$  as  $T^{n-1} \times T^1$ , then  $T^1$  acts trivially on  $(S^3)^{n-1}$  by (9.11), and we obtain

$$(9.14) \quad BF_n = (S^3)^n / T^n = ((S^3)^{n-1} \times (S^3 / T^1)) / T^{n-1} = BF_{n-1} \times_{T^{n-1}} S^2.$$

Here  $T^1$  acts on  $S^3$  diagonally, so the stably complex structure on  $S^2$  is the standard structure of  $CP^1$  (see Example 7.3.16).

Now change the torus action (9.11) to the following:

$$(9.15) \quad (z_1, \dots, z_{2n}) \mapsto (t_1 z_1, t_1^{-1} t_2 z_2, \dots, t_{n-1}^{-1} t_n z_n, t_1^{-1} z_{n+1}, t_2^{-1} z_{n+2}, \dots, t_n^{-1} z_{2n}).$$

Then decomposition (9.14) is still valid, but now  $T^1$  acts on  $S^3$  antidiagonally, so the stably complex structure on  $S^2$  is trivial, as needed. The resulting stably complex structure on  $BF_n$  is given by the isomorphism

$$(9.16) \quad \mathcal{T}(BF_n) \oplus \underline{\mathbb{R}}^{2n} \cong \bar{\xi}_1 \oplus \xi_1 \bar{\xi}_2 \oplus \dots \oplus \xi_{n-1} \bar{\xi}_n \oplus \xi_1 \oplus \xi_2 \oplus \dots \oplus \xi_n,$$

and its cobordism class in  $\Omega_{2n}^U$  is zero.



DEFINITION 9.2.5. We denote by  $B_n$  the manifold  $BF_n$  with zero-cobordant stably complex structure (9.16). The ‘tautological’ line bundle  $\xi_n$  is classified by a map  $B_n \rightarrow \mathbb{C}P^\infty$  and therefore defines a bordism class  $\beta_n \in U_{2n}(\mathbb{C}P^\infty)$ . We also set  $\beta_0 = 1$ . The set of bordism classes  $\{\beta_n : n \geq 0\}$  is called *Ray’s basis* of the  $\Omega_U$ -module  $U_*(\mathbb{C}P^\infty)$ .

PROPOSITION 9.2.6 ([275]). *The bordism classes  $\{\beta_n : n \geq 0\}$  form a basis of the free  $\Omega_U$ -module  $U_*(\mathbb{C}P^\infty)$  which is dual to the basis  $\{u^k : k \geq 0\}$  of the  $\Omega_U$ -module  $U^*(\mathbb{C}P^\infty) = \Omega_U[[u]]$ . Here  $u = c_1^U(\bar{\eta})$  is the cobordism first Chern class of the canonical line bundle over  $\mathbb{C}P^\infty$  (represented by  $\mathbb{C}P^{\infty-1} \subset \mathbb{C}P^\infty$ ).*

PROOF. Since  $[B_n] = 0$  in  $\Omega_U$ , the bordism class  $\beta_n$  lies in the reduced bordism module  $\tilde{U}_{2n}(\mathbb{C}P^\infty)$  for  $n > 0$ . Therefore, to show that  $\{\beta_n : n \geq 0\}$  and  $\{u^k : k \geq 0\}$  are dual bases it is enough to verify the property

$$u \frown \beta_n = \beta_{n-1}$$

(the  $\frown$ -product is defined in Construction D.3.4). The bordism class  $u \frown \beta_n$  is obtained by making the map  $B_n \rightarrow \mathbb{C}P^\infty$  transverse to the zero section  $\mathbb{C}P^{\infty-1}$  of  $\mathbb{C}P^\infty = MU(1)$  or, equivalently, by restricting the map  $B_n \rightarrow \mathbb{C}P^\infty$  to the zero set of a transverse section of the line bundle  $\xi_n$ . As is clear from the proof of Proposition 7.7.7, the zero set of a transverse section of  $\xi_n = \rho_1^0$  is obtained by setting  $z_1 = 0$  in (9.10) and (9.15), which gives precisely  $B_{n-1}$ .  $\square$

For a nonnegative integer vector  $\omega = (\omega_1, \dots, \omega_k)$ , define the manifold  $B_\omega = B_{\omega_1} \times \dots \times B_{\omega_k}$  and the corresponding product bordism class  $\beta_\omega \in U_{2|\omega|}(BT^k)$ .

COROLLARY 9.2.7. *The set  $\{\beta_\omega\}$  is a basis of the free  $\Omega_U$ -module  $U_*(BT^k)$ ; this basis is dual to the basis  $\{u^\omega\}$  of  $U^*(BT^k) = \Omega_U[[u_1, \dots, u_k]]$ .*

DEFINITION 9.2.8. Let  $M$  be a tangentially stably complex  $T^k$ -manifold  $M$ . Let  $T^\omega$  be the torus  $T^{\omega_1} \times \dots \times T^{\omega_k}$  and  $(S^3)^\omega$  the product  $(S^3)^{\omega_1} \times \dots \times (S^3)^{\omega_k}$ , on which  $T^\omega$  acts coordinatewise by (9.15). Define the manifold

$$G_\omega(M) = (S^3)^\omega \times_{T^\omega} M,$$

where  $T^\omega$  acts on  $M$  via the representation

$$(t_{1,1}, \dots, t_{1,\omega_1}; \dots; t_{k,1}, \dots, t_{k,\omega_k}) \longmapsto (t_{1,\omega_1}, \dots, t_{k,\omega_k}).$$

The stably complex structure on  $G_\omega(M)$  is induced by the tangential structures on the base and fibre of the bundle  $M \rightarrow G_\omega(M) \rightarrow B_\omega$ .

THEOREM 9.2.9 ([59]). *The manifold  $G_\omega(M)$  represents the bordism class of the coefficient  $g_\omega(M) \in \Omega_U^{-2(|\omega|+n)}$  of (9.9). In particular, the constant term of  $\Phi(M) \in \Omega^U[[u_1, \dots, u_k]]$  is  $[M] \in \Omega_U^{-2n}$ .*

PROOF. By Corollary 9.2.7, the coefficient  $g_\omega(M)$  is identified with the Kronecker product  $\langle \Phi(M), \beta_\omega \rangle$  (see Construction D.3.4). In terms of (9.8), it is represented on the pullback of the diagram

$$B_\omega \longrightarrow (\mathbb{C}P^q)^k \longleftarrow (S^{2q+1})^k \times_{T^k} M$$

for suitably large  $q$ , and therefore on the pullback of the diagram

$$B_\omega \longrightarrow BT^k \longleftarrow ET^k \times_{T^k} M$$

of direct limits. The latter pullback is exactly  $G_\omega(M)$ .  $\square$

REMARK. There is also a similar description of the coefficients in the expansion of  $\Phi_X(\pi)$  for the transformation (9.6) in the case when  $U^*(ET^k \times_{T^k} X)$  is a finitely generated free  $U^*(BT^k)$ -module, see [59, Theorem 3.15].

### Exercises.

9.2.10. Proposition 9.2.3 can be generalised to the following description of homomorphism  $\Phi_X$  given by (9.6). Let  $\pi \in U_{T^k}^{-d}(X)$  be a geometric cobordism class represented by a  $T^k$ -equivariant bundle  $\pi: E \rightarrow X$ . Then

$$\Phi_X(\pi) = (1 \times_{T^k} \pi)_! 1,$$

where

$$(1 \times_{T^k} \pi)_!: U^*(ET^k \times_{T^k} E) \longrightarrow U^{*-d}(ET^k \times_{T^k} X)$$

is the Gysin homomorphism in cobordism.

9.2.11. The original approach of [275] to define a zero-cobordant stably tangent structure on  $BF_n$  is as follows. One can identify  $BF_n$  with the sphere bundle  $S(\xi_{n-1} \oplus \underline{\mathbb{R}})$  (rather than with  $\mathbb{C}P(\xi_{n-1} \oplus \underline{\mathbb{C}})$ ). Let  $\pi_n: S(\xi_{n-1} \oplus \underline{\mathbb{R}}) \rightarrow BF_{n-1}$  be the projection; show that the tangent bundle of  $BF_n$  satisfies

$$\mathcal{T}BF_n \oplus \underline{\mathbb{R}} \cong \pi_n^*(\mathcal{T}BF_{n-1} \oplus \xi_{n-1} \oplus \underline{\mathbb{R}}).$$

By identifying  $\pi_n^*\xi_{n-1}$  with  $\xi_{n-1}$  (as bundles over  $BF_n$ ), we obtain inductively

$$\mathcal{T}BF_n \oplus \underline{\mathbb{R}} \cong \xi_1 \oplus \xi_2 \oplus \cdots \oplus \xi_{n-1} \oplus \underline{\mathbb{R}}.$$

Show that this stably complex structure is equivalent to that of (9.16). (Hint: calculate the total Chern classes.)

9.2.12. There is a canonical  $T^k$ -action on  $G_\omega(M)$  and  $B_\omega$  making  $G_\omega(M) \rightarrow B_\omega$  into a  $T^k$ -equivariant bundle.

### 9.3. Equivariant genera, rigidity and fibre multiplicativity

Recall that a *genus* is a multiplicative cobordism invariant of stably complex manifolds, i.e. a ring homomorphism  $\varphi: \Omega_U \rightarrow R$  to a commutative ring with unit. We only consider genera taking values in torsion-free rings  $R$ ; such  $\varphi$  are uniquely determined by series  $f(x) = x + \cdots \in R \otimes \mathbb{Q}[[x]]$  via *Hirzebruch's correspondence* (Construction E.3.1).

Historically, equivariant extensions of genera were first considered by Atiyah and Hirzebruch [10], who established the *rigidity* property of the  $\chi_y$ -genus and  $\hat{A}$ -genus of  $S^1$ -manifolds. The origins of these concepts lie in the Atiyah–Bott fixed point formula [9], which also acted as a catalyst for the development of equivariant index theory. This development culminated in the celebrated result of Taubes [302] establishing the rigidity of the Ochanine–Witten *elliptic genus* on spin  $S^1$ -manifolds.

Here we develop an approach to equivariant genera and rigidity based solely on the complex cobordism theory. It allows us to define an equivariant extension and the appropriate concept of rigidity for an arbitrary Hirzebruch genus, and agrees with the classical index-theoretical approach when the genus is the index of an elliptic complex.

**9.3.1. Equivariant genera.** Our definition of an equivariant genus uses a universal transformation of cohomology theories, studied in [47]:

CONSTRUCTION 9.3.1 (Chern–Dold character). Consider multiplicative transformations of cohomology theories

$$h: U^*(X) \rightarrow H^*(X; \Omega_U \otimes \mathbb{Q}).$$

Such  $h$  is determined uniquely by a series  $h(u) \in H^2(\mathbb{C}P^\infty; \Omega_U \otimes \mathbb{Q}) = \Omega_U \otimes \mathbb{Q}[[x]]$ , where  $u = c_1^U(\bar{\eta}) \in U^2(\mathbb{C}P^\infty)$  and  $x = c_1^H(\bar{\eta}) \in H^2(\mathbb{C}P^\infty)$ .

The *Chern–Dold character* is the unique multiplicative transformation

$$\text{ch}_U: U^*(X) \rightarrow H^*(X; \Omega_U \otimes \mathbb{Q})$$

which reduces to the canonical inclusion  $\Omega_U \rightarrow \Omega_U \otimes \mathbb{Q}$  in the case  $X = pt$ .

PROPOSITION 9.3.2. *The Chern–Dold character satisfies*

$$\text{ch}_U(u) = f_U(x),$$

where  $f_U(x)$  is the exponential of the formal group law  $F_U$  of geometric cobordisms.

PROOF. Since  $\text{ch}_U$  acts identically on  $\Omega_U$ , it follows that

$$(9.17) \quad \text{ch}_U F_U(v_1, v_2) = F_U(\text{ch}_U(v_1), \text{ch}_U(v_2))$$

for any  $v_1, v_2 \in U^2(\mathbb{C}P^\infty)$ . Let  $f(x)$  denote the series  $\text{ch}_U(u) \in \Omega_U \otimes \mathbb{Q}[[x]]$ . Let  $v_i = c_1^U(\xi_i)$  and  $x_i = c_1^H(\xi_i)$  for  $i = 1, 2$ . Then

$$\begin{aligned} \text{ch}_U F_U(v_1, v_2) &= \text{ch}_U(c_1^U(\xi_1 \otimes \xi_2)) = f(c_1^H(\xi_1 \otimes \xi_2)) = f(x_1 + x_2), \\ \text{ch}_U(v_1) &= f(x_1), \quad \text{ch}_U(v_2) = f(x_2). \end{aligned}$$

Substituting these expressions in (9.17) we get  $f(x_1 + x_2) = F_U(f(x_1), f(x_2))$ , which means that  $f(x)$  is the exponential of  $F_U$ . □

Given a Hirzebruch genus  $\varphi: \Omega \rightarrow R \otimes \mathbb{Q}$  corresponding to  $f(x) \in R \otimes \mathbb{Q}[[x]]$ , we define a multiplicative transformation

$$h_\varphi: U^*(X) \xrightarrow{\text{ch}_U} H^*(X; \Omega_U \otimes \mathbb{Q}) \xrightarrow{\varphi} H^*(X; R \otimes \mathbb{Q})$$

where the second homomorphism acts by  $\varphi$  on the coefficients only. In the case  $X = BT^k$  we obtain a homomorphism

$$h_\varphi: \Omega_U[[u_1, \dots, u_k]] \rightarrow R \otimes \mathbb{Q}[[x_1, \dots, x_k]]$$

which acts on the coefficients as  $\varphi$  and sends  $u_i$  to  $f(x_i)$  for  $1 \leq i \leq k$ .

DEFINITION 9.3.3 (equivariant genus). The  $T^k$ -equivariant extension of  $\varphi$  is the ring homomorphism

$$\varphi^T: \Omega_{U:T^k} \rightarrow R \otimes \mathbb{Q}[[x_1, \dots, x_k]]$$

defined as the composition  $h_\varphi \cdot \Phi$  with the universal toric genus.

REMARK. In the definition of equivariant genus from [59], the generator  $u_i$  was sent to  $x_i$  instead of  $f(x_i)$ . Although this does not affect the notion of rigidity defined below, Definition 9.3.3 is a more natural extension of Krichever’s and Atiyah–Hirzebruch’s approaches.

**Rigidity.** Krichever [188], [189] considers rational valued genera  $\varphi: \Omega_U \rightarrow \mathbb{Q}$ , and equivariant extensions  $\varphi^K: \Omega_{U:T^k} \rightarrow K^*(BT^k) \otimes \mathbb{Q}$ . The equivariant genus  $\varphi^K$  is related to ours  $\varphi^T$  via a natural transformation  $U^*(X) \rightarrow K^*(X) \otimes \mathbb{Q}$  defined by  $\varphi$ , as explained below. If  $\varphi(M)$  can be realised as the index  $\text{ind}(\mathcal{E})$  of an elliptic complex  $\mathcal{E}$  of complex vector bundles over  $M$  (see e.g. [161]), then for any  $T^k$ -manifold  $M$  this index has a natural  $T^k$ -equivariant extension  $\text{ind}^{T^k}(\mathcal{E})$  which is an element of the complex representation ring  $R_U(T^k)$ , and hence in its completion  $K^0(BT^k)$ . Krichever’s interpretation of rigidity is to require that  $\varphi^K$  should lie the subring of constants  $\mathbb{Q}$  for every  $M$ . In the case of an index, this amounts to insisting that the corresponding  $T^k$ -representation is always trivial, and therefore conforms to Atiyah and Hirzebruch’s original notion [10].

The composition of  $h_\varphi: U^{\text{even}}(X) \rightarrow H^{\text{even}}(X; \mathbb{Q})$  with the inverse of the Chern character  $\text{ch}: K^0(X) \otimes \mathbb{Q} \xrightarrow{\cong} H^{\text{even}}(X; \mathbb{Q})$  gives the transformation

$$h_\varphi^K = \text{ch}^{-1} \cdot h_\varphi: U^{\text{even}}(X) \rightarrow K^0(X) \otimes \mathbb{Q},$$

considered by Krichever in [188]. The transformation  $U^{\text{odd}}(X) \rightarrow K^1(X) \otimes \mathbb{Q}$  is defined similarly; together they give a transformation  $h_\varphi^K: U^*(X) \rightarrow K^*(X) \otimes \mathbb{Q}$ .

REMARK. In the case of the Todd genus  $\text{td}: \Omega_U \rightarrow \mathbb{Z}$  this construction gives the Conner–Floyd transformation  $U^* \rightarrow K^*$  described after Example E.3.6.

Krichever [189] referred to a genus  $\varphi: \Omega_U \rightarrow \mathbb{Q}$  as *rigid* if the composition

$$\varphi^K: \Omega_{U:T^k} \xrightarrow{\Phi} U^*(BT^k) \xrightarrow{h_\varphi^K} K^0(BT^k) \otimes \mathbb{Q}$$

belongs to the subring  $\mathbb{Q} \subset K^0(BT^k) \otimes \mathbb{Q}$ , i.e. satisfies  $\varphi^K(M) = \varphi(M)$  for any  $[M] \in \Omega_{U:T^k}$ . Definition 9.3.3 of equivariant genera based on the notion of the universal toric genus leads naturally to the following version of rigidity, which subsumes the approaches of Atiyah–Hirzebruch and Krichever:

DEFINITION 9.3.4. A genus  $\varphi: \Omega_U \rightarrow R$  is  *$T^k$ -rigid* on a stably complex  $T^k$ -manifold  $M$  whenever  $\varphi^T: \Omega_{U:T^k} \rightarrow R \otimes \mathbb{Q}[[u_1, \dots, u_k]]$  satisfies  $\varphi^T(M) = \varphi(M)$ ; if this holds for every  $M$ , then  $\varphi$  is  *$T^k$ -rigid*.

Since the Chern character  $\text{ch}: K^0(X) \otimes \mathbb{Q} \rightarrow H^{\text{even}}(X; \mathbb{Q})$  is an isomorphism, a rational genus  $\varphi$  is  $T^k$ -rigid in the sense of Definition 9.3.4 if and only if it is rigid in the sense of Krichever (and therefore in the original index-theoretical sense of Atiyah–Hirzebruch if  $\varphi$  is an index).

In Section 9.5 we shall describe how toric methods can be applied to establish the rigidity property for several fundamental Hirzebruch genera. Now we consider another important property of genera.

**Fibre multiplicativity.** The following definition extends that of Hirzebruch [161, Chapter 4] for the oriented case. It applies to fibre bundles of the form  $M \rightarrow E \times_G M \xrightarrow{\pi} B$ , where  $M$  and  $B$  are closed, connected and stably tangentially complex,  $G$  is a compact Lie group of positive rank whose action preserves the stably complex structure on  $M$ , and  $E \rightarrow B$  is a principal  $G$ -bundle. In these circumstances, the bundle  $\pi$  is stably tangentially complex, and  $N = E \times_G M$  inherits a canonical stably complex structure.

DEFINITION 9.3.5. A genus  $\varphi: \Omega_U \rightarrow R$  is *fibre multiplicative with respect to* the stably complex manifold  $M$  whenever  $\varphi(N) = \varphi(M)\varphi(B)$  for any such bundle  $\pi$  with fibre  $M$ ; if this holds for every  $M$ , then  $\varphi$  is *fibre multiplicative*.

For rational genera in the oriented category, Ochanine [249, Proposition 1] proved that rigidity is equivalent to fibre multiplicativity (see also [161, Chapter 4]). In the toric case, we have the following stably complex analogue, whose conclusions are integral. It refers to bundles  $E \times_G M \xrightarrow{\pi} B$  of the form required by Definition 9.3.5, where  $G$  has maximal torus  $T^k$  with  $k \geq 1$ .

**THEOREM 9.3.6 ([59]).** *If the genus  $\varphi$  is  $T^k$ -rigid on  $M$ , then it is fibre multiplicative with respect to  $M$  for bundles whose structure group  $G$  has the property that  $U^*(BG)$  is torsion-free.*

*On the other hand, if  $\varphi$  is fibre multiplicative with respect to a stably tangentially complex  $T^k$ -manifold  $M$ , then it is  $T^k$ -rigid on  $M$ .*

**PROOF.** Let  $\varphi$  be  $T^k$ -rigid on  $M$ , and consider the pullback squares

$$\begin{array}{ccccc} E \times_G M & \xrightarrow{f'} & EG \times_G M & \xleftarrow{i'} & ET^k \times_{T^k} M \\ \pi \downarrow & & \pi^G \downarrow & & \pi^{T^k} \downarrow \\ B & \xrightarrow{f} & BG & \xleftarrow{i} & BT^k, \end{array}$$

where  $\pi^G$  is universal,  $i$  is induced by inclusion, and  $f$  classifies  $\pi$ . By Proposition 9.2.3 and commutativity of the right square,  $\pi_!^G 1 = [M] \cdot 1 + \beta$ , where  $1 \in U^0(EG \times_G M)$  and  $\beta \in \tilde{U}^{-2n}(BG)$ . By commutativity of the left square,  $\pi_! 1 = [M] \cdot 1 + f^* \beta$  in  $U^{-2n}(B)$ . Applying the Gysin homomorphism associated with the augmentation map  $\varepsilon^B : B \rightarrow pt$  yields

$$(9.18) \quad [E \times_G M] = \varepsilon_!^B \pi_! 1 = [M][B] + \varepsilon_!^B f^* \beta$$

in  $\Omega_{2(n+b)}^U$ , where  $\dim B = 2b$ ; so  $\varphi(E \times_G M) = \varphi(M)\varphi(B) + \varphi(\varepsilon_!^B f^* \beta)$ . Moreover,  $i^* \beta = \sum_{|\omega| > 0} g_\omega(M) u^\omega$  in  $U^{-2n}(BT^k)$ , so  $\varphi(i^* \beta) = 0$  because  $\varphi$  is  $T^k$ -rigid. The assumptions on  $G$  ensure that  $i^*$  is injective, which implies that  $\varphi(\beta) = 0$  in  $U^*(BG) \otimes_\varphi R$ . Fibre multiplicativity then follows from (9.18).

Conversely, suppose that  $\varphi$  is fibre multiplicative with respect to  $M$ , and consider the manifold  $G_\omega(M)$  of Theorem 9.2.9. By Definition 9.2.8, it is the total space of the bundle  $(S^3)^\omega \times_{T^\omega} M \rightarrow B_\omega$ , which has structure group  $T^k$ ; therefore  $\varphi(G_\omega(M)) = 0$ , because  $B_\omega$  bounds for every  $|\omega| > 0$ . So  $\varphi$  is  $T^k$ -rigid on  $M$ .  $\square$

**REMARK.** We may define  $\varphi$  to be  $G$ -rigid when  $\varphi(\beta) = 0$ , as in the proof of Theorem 9.3.6. It follows that  $T$ -rigidity implies  $G$ -rigidity for any  $G$  such that  $\Omega_U^*(BG)$  is torsion-free.

**EXAMPLE 9.3.7.** The signature (or the  $L$ -genus, see Example E.3.6.2) is fibre multiplicative over any simply connected base [161, Chapter 4], and so is rigid.

### 9.4. Isolated fixed points: localisation formulae

In this section we focus on stably tangentially complex  $T^k$ -manifolds  $(M^{2n}, c_{\mathcal{T}})$  for which the fixed points  $p$  are isolated; in other words, the fixed point set  $M^T$  is finite. We proceed by deducing a localisation formula for  $\Phi(M)$  in terms of fixed point data. We give several illustrative examples, and describe the consequences for certain non-equivariant genera and their  $T^k$ -equivariant extensions.

Localisation theorems in equivariant generalised cohomology theories appear in the works of tom Dieck [310], Quillen [273], Krichever [188], Kawakubo [180],

and elsewhere. We prove our Theorem 9.4.1 by interpreting their results in the case of isolated fixed points, and identifying the signs explicitly.

Each integer vector  $\mathbf{w} = (w_1, \dots, w_k) \in \mathbb{Z}^k$  determines a line bundle

$$\bar{\eta}^{\mathbf{w}} = \bar{\eta}_1^{w_1} \otimes \cdots \otimes \bar{\eta}_k^{w_k}$$

over  $BT^k = (\mathbb{C}P^\infty)^k$ , where  $\bar{\eta}_j$  is the canonical line bundle over the  $j$ th factor. Let

$$[\mathbf{w}, \mathbf{u}] = c_1^U(\bar{\eta}^{\mathbf{w}})$$

denote the cobordism first Chern class of  $\bar{\eta}^{\mathbf{w}}$ . It is given by the power series

$$F_U(\underbrace{u_1, \dots, u_1}_{w_1}, \dots, \underbrace{u_k, \dots, u_k}_{w_k}) \in U^2(BT^k),$$

where  $F_U(u_1, \dots, u_k)$  is the iterated substitution  $F_U(\cdots F_U(F_U(u_1, u_2), u_3), \dots, u_k)$  in the formal group law of geometric cobordisms, see Section E.2. Modulo decomposables we have that

$$(9.19) \quad [\mathbf{w}, \mathbf{u}] \equiv w_1 u_1 + \cdots + w_k u_k,$$

and it is convenient to rewrite the right hand side as a scalar product  $\langle \mathbf{w}, \mathbf{u} \rangle$ .

Let  $p$  be an isolated fixed point for the  $T^k$ -action on  $M$ . We recall from Section D.6 that the weights  $\mathbf{w}_j(p) \in \mathbb{Z}^k$  and the sign  $\sigma(p) = \pm 1$  are defined, and refer to  $\{\mathbf{w}_j(p), \sigma(p) : 1 \leq j \leq n, p \in M^T\}$  as the *fixed point data* of  $(M, c_T)$ .

**THEOREM 9.4.1** (localisation formula). *For any stably tangentially complex  $2n$ -dimensional  $T^k$ -manifold  $M$  with isolated fixed points  $M^T$ , the equation*

$$(9.20) \quad \Phi(M) = \sum_{p \in M^T} \sigma(p) \prod_{j=1}^n \frac{1}{[\mathbf{w}_j(p), \mathbf{u}]}$$

is satisfied in  $U^{-2n}(BT^k)$ .

**REMARK.** The summands on the right hand side of (9.20) formally belong to the localised ring  $S^{-1}U^*(BT^k)$  where  $S$  is the set of equivariant Euler classes of nontrivial representation of  $T^k$ .

**PROOF.** Choose an equivariant embedding  $i: M \rightarrow V$  into a complex  $N$ -dimensional representation space  $V$  and consider the commutative diagram

$$(9.21) \quad \begin{array}{ccc} M^T & \xrightarrow{r_M} & M \\ i^T \downarrow & & \downarrow i \\ V^T & \xrightarrow{r_V} & V \end{array}$$

where  $V^T \subset V$  is the  $T^k$ -fixed subspace,  $r_M$  and  $r_V$  denote the inclusions of fixed points, and  $i^T$  is the restriction of  $i$  to  $M^T$ .

We restrict (9.21) to a tubular neighbourhood of  $M^T$  in  $V$ , which can be identified with the total space  $E$  of the normal bundle  $\nu = \nu(M^T \rightarrow V)$ :

$$(9.22) \quad \begin{array}{ccc} M^T & \xrightarrow{r_M} & E_1 \\ i^T \downarrow & & \downarrow i \\ E_2 & \xrightarrow{r_V} & E \end{array}$$

where  $E_1 = \nu(r_M)$  and  $E_2 = \nu(i^T)$ . The normal bundle  $\nu$  decomposes as

$$(9.23) \quad \nu = \nu(r_M) \oplus r_M^*(\nu(i)) = \nu(r_M) \oplus \nu(i^T) \oplus \zeta,$$

where  $\zeta$  is the ‘excess’ bundle over  $M^T$ , whose fibres are the non-trivial parts of the  $T^k$ -representations in the fibres of  $r_M^*\nu(i)$ . We therefore rewrite (9.22) as

$$(9.24) \quad \begin{array}{ccc} M^T & \xrightarrow{r_M} & E_1 \\ i^T \downarrow & & \downarrow i \\ E_2 & \xrightarrow{r_V} & E_1 \oplus E_2 \oplus F, \end{array}$$

where  $F$  is the total space of  $\zeta$ . Since all relevant bundles are complex, we have Gysin–Thom isomorphisms (see Construction D.3.6 and Exercise D.3.14)

$$\begin{aligned} i_1: U^*(M) &\xrightarrow{\cong} U^{*+p}(Th(\nu(i))) = U^{*+p}(V, V \setminus M) = U^{*+p}(E, E \setminus E_1), \\ i_1^T: U^*(M^T) &\xrightarrow{\cong} U^{*+q}(Th(\nu(i^T))) = U^{*+q}(V^T, V^T \setminus M^T) = U^{*+q}(E_2, E_2 \setminus M^T), \end{aligned}$$

where  $p = \dim V - \dim M$  and  $q = \dim V^T - \dim M^T$ . Let  $i_1: E_1 \rightarrow E_1 \oplus E_2$ ,  $i_2: E_2 \rightarrow E_1 \oplus E_2$  and  $k: E_1 \oplus E_2 \rightarrow E$  be the inclusion maps. Then for  $x \in U^*(M)$ ,

$$r_V^*i_1x = i_2^*k^*k!i_1x = i_2^*(e(\nu(k)) \cdot i_1x).$$

Since  $i_2^*(\nu(k)) = \pi^*(\zeta)$ , where  $\pi: E_2 \rightarrow M$  is the projection, the last term above can be written as

$$\begin{aligned} \pi^*(e(\zeta)) \cdot i_2^*i_1x &= \pi^*(e(\zeta)) \cdot i_1^T r_M^*x && \text{by Proposition D.3.7 (e)} \\ &= i_1^T(i_1^T \pi^*(e(\zeta)) \cdot r_M^*x) && \text{by Proposition D.3.7 (d)} \\ &= i_1^T(e(\zeta) \cdot r_M^*x). \end{aligned}$$

We therefore obtain

$$(9.25) \quad r_V^*i_1x = i_1^T(e(\zeta) \cdot r_M^*x)$$

in  $U^{*+p}(V^T, V^T \setminus M^T)$ .

Given a  $T^k$ -equivariant map  $f: M \rightarrow N$  we denote by  $\widehat{f}$  its ‘Borelification’, i.e. the map  $ET^k \times_{T^k} M \rightarrow ET^k \times_{T^k} N$ . Applying this procedure to (9.21) we obtain a commutative diagram

$$(9.26) \quad \begin{array}{ccc} BT^k \times M^T & \xrightarrow{\widehat{r}_M} & ET^k \times_{T^k} M \\ \widehat{i}^T \downarrow & & \downarrow \widehat{i} \\ BT^k \times V^T & \xrightarrow{\widehat{r}_V} & ET^k \times_{T^k} V. \end{array}$$

Using the finite-dimensional approximation of the above diagram (as in the proof of Proposition 9.2.3) we can view it as a diagram of proper maps of smooth manifolds and therefore apply Gysin homomorphisms in cobordism. By analogy with (9.25) we obtain for  $x \in U^*(ET^k \times_{T^k} M)$ ,

$$(9.27) \quad \widehat{r}_V^*\widehat{i}_1x = \widehat{i}_1^T(e(\widehat{\zeta}) \cdot \widehat{r}_M^*x),$$

where  $\widehat{\zeta}$  is the ‘excess’ bundle over  $BT^k \times M^T$  defined similarly to (9.23).

Similarly, by considering the diagram

$$\begin{array}{ccc} \mathbf{0} & \xlongequal{\quad} & \mathbf{0} \\ j^T \downarrow & & \downarrow j \\ V^T & \xrightarrow{r_V} & V \end{array}$$

we obtain for  $y \in U^*(BT^k)$ ,

$$(9.28) \quad \widehat{r}_V^* \widehat{j}_! y = \widehat{j}_!^T (e(\widehat{\zeta}_V) \cdot y),$$

where  $\zeta_V$  is the nontrivial part of the  $T^k$ -representation  $V$ , i.e.  $V = V^T \oplus \zeta_V$ . Let  $\pi: M \rightarrow pt$  and  $\pi^T: M^T \rightarrow pt$  be the projections. Then  $\widehat{i}_! = \widehat{j}_! \cdot \widehat{\pi}_!$ ,  $\widehat{i}_!^T = \widehat{j}_!^T \cdot \widehat{\pi}_!^T$ . Substituting  $y = \widehat{\pi}_! x$  in (9.28) we obtain

$$\widehat{r}_V^* \widehat{i}_! x = \widehat{j}_!^T (e(\widehat{\zeta}_V) \cdot \widehat{\pi}_! x)$$

Comparing this to (9.27) and using the fact that

$$\widehat{j}_!^T: U^*(BT^k) \rightarrow U^{*+r}(Th(\nu(\widehat{j}^T))) = U^{*+r}(\Sigma^r BT^k)$$

is an isomorphism (here  $r = \dim V^T$ ), we finally obtain

$$e(\widehat{\zeta}_V) \cdot \widehat{\pi}_! x = \widehat{\pi}_!^T (e(\widehat{\zeta}) \cdot \widehat{r}_M^* x).$$

Now set  $x = 1$ . Then  $\widehat{\pi}_! 1 = \Phi(M)$  by Proposition 9.2.3 and  $\widehat{r}_M^* 1 = 1$ . We get

$$(9.29) \quad e(\widehat{\zeta}_V) \cdot \Phi(M) = \widehat{\pi}_!^T (e(\widehat{\zeta})).$$

This formula is valid without restrictions on the fixed point set. Now, if  $M^T$  is finite, then  $\widehat{\pi}_!^T (e(\widehat{\zeta})) = \sum_{p \in M^T} e(\widehat{\zeta}|_p)$ . Recall that  $\zeta$  is defined from the decomposition  $\nu = \nu(r_M) \oplus \nu(i^T) \oplus \zeta$ , in which  $\nu|_p = \nu(M^T \rightarrow V)|_p$  can be identified with  $V$  and  $\nu(i^T)|_p$  can be identified with  $V^T$  (because  $p$  is isolated). Since  $V = V^T \oplus \zeta_V$ , it follows that  $e(\widehat{\zeta}_V) = e(\nu(\widehat{r}_M)|_p) e(\widehat{\zeta}|_p)$  for any  $p \in M^T$ . We therefore can rewrite (9.29) as

$$\Phi(M) = \sum_{p \in M^T} \frac{1}{e(\nu(\widehat{r}_M)|_p)}.$$

It remains to note that  $\nu(r_M)|_p = \nu(p \rightarrow M)$  is the tangential  $T^k$ -representation  $\mathcal{T}_p M$ , so  $\nu(\widehat{r}_M)|_p$  is the bundle  $ET^k \times_{T^k} \mathcal{T}_p M$  over  $BT^k$ , whose Euler class is

$$e(\nu(\widehat{r}_M)|_p) = \sigma(p) \prod_{j=1}^n [\mathbf{w}_j(p), \mathbf{u}]$$

by the definition of sign  $\sigma(p)$  and weights  $\mathbf{w}_j(p)$ . □

REMARK. If the structure  $\mathcal{C}_{\mathcal{T}}$  is almost complex, then  $\sigma(x) = 1$  for all fixed points  $x$ , and (9.20) reduces to Krichever's formula [189, (2.7)].

The left-hand side of (9.20) lies in  $\Omega_U[[u_1, \dots, u_k]]$ , whereas the right-hand side appears to belong to an appropriate localisation. It follows that all terms of negative degree must cancel, thereby imposing substantial restrictions on the fixed point data. These may be made explicit by rewriting (9.19) as

$$(9.30) \quad [\mathbf{w}, t\mathbf{u}] \equiv (w_1 u_1 + \dots + w_k u_k) t \pmod{t^2}$$



in  $\Omega_U[[u_1, \dots, u_k, t]]$ , and then defining the power series

$$(9.31) \quad \sum_l \mathfrak{f}_l t^l = t^n \Phi(M)(t\mathbf{u}) = \sum_{p \in M^T} \sigma(p) \prod_{j=1}^n \frac{t}{[\mathbf{w}_j(p), t\mathbf{u}]}$$

over the localisation of  $\Omega_U[[u_1, \dots, u_k]]$ .

PROPOSITION 9.4.2. *The coefficients  $\mathfrak{f}_l$  are zero for  $0 \leq l < n$ , and satisfy*

$$\mathfrak{f}_{n+m} = \sum_{|\omega|=m} g_\omega(M) u^\omega$$

for  $m \geq 0$ ; in particular,  $\mathfrak{f}_n = [M]$ .

PROOF. Combine the definitions of  $\mathfrak{f}_l$  in (9.31) and  $g_\omega$  in (9.9). □

REMARK. The equations  $\mathfrak{f}_l = 0$  for  $0 \leq l < n$  are the  $T^k$ -analogues of the *Conner–Floyd relations* for  $\mathbb{Z}_p$ -actions [246, Appendix 4]; the extra equation  $\mathfrak{f}_n = [M]$  provides an expression for the cobordism class of  $M$  in terms of fixed point data. This is important because, according to Theorem 9.1.16, every element of  $\Omega_U$  may be represented by a stably tangentially complex  $T^k$ -manifold with isolated fixed points. We explore on this in the next section.

Now let  $\varphi: \Omega_U \rightarrow R$  be a genus taking values in a torsion-free ring  $R$ , with the corresponding series  $f(x) = x + \dots \in R \otimes \mathbb{Q}[[x]]$ . We may adapt Theorem 9.4.1 to express  $\varphi(M)$  in terms of fixed point data. The resulting formula is much simpler, because the formal group law  $\varphi F_U$  may be linearised over  $R \otimes \mathbb{Q}$ :

PROPOSITION 9.4.3. *Let  $\varphi: \Omega_U \rightarrow R$  be a genus with torsion-free  $R$ , and let  $M$  be a stably tangentially complex  $2n$ -dimensional  $T^k$ -manifold with isolated fixed points  $M^T$ . Then the equivariant genus  $\varphi^T(M) = \varphi(M) + \dots$  is given by*

$$(9.32) \quad \varphi^T(M) = \sum_{p \in M^T} \sigma(p) \prod_{j=1}^n \frac{1}{f(\langle \mathbf{w}_j(p), \mathbf{x} \rangle)},$$

where  $\langle \mathbf{w}, \mathbf{x} \rangle = w_1 x_1 + \dots + w_k x_k$  for  $\mathbf{w} = (w_1, \dots, w_k)$ .

PROOF. By Theorem E.3.3,  $f(x)$  is the exponential series of the formal group law  $\varphi F_U$ , i.e.  $\varphi F_U(u_1, u_2) = f(f^{-1}(u_1) + f^{-1}(u_2))$ , and therefore  $h_\varphi F_U(u_1, u_2) = f(x_1 + x_2)$ . An iterated application of this formula gives  $h_\varphi([\mathbf{w}_j(p), \mathbf{u}]) = f(\langle \mathbf{w}_j(p), \mathbf{x} \rangle)$ . Since  $\varphi^T = h_\varphi \cdot \Phi$ , the result follows from Theorem 9.4.1. □

EXAMPLE 9.4.4. The augmentation genus  $\varepsilon: \Omega_U \rightarrow \mathbb{Z}$  corresponds to the series  $f(x) = x$ ; it vanishes on any  $M^{2n}$  with  $n > 0$ . Formula (9.32) then gives

$$(9.33) \quad \sum_{p \in M^T} \sigma(p) \prod_{j=1}^n \frac{1}{\langle \mathbf{w}_j(p), \mathbf{x} \rangle} = 0.$$

Let  $M = \mathbb{C}P^n$  on which  $T^{n+1}$  acts homogeneous coordinatewise. There are  $n + 1$  fixed points  $p_0, \dots, p_n$ , each having a single nonzero coordinate. So the weight vector  $\mathbf{w}_j(p_k)$  is  $\mathbf{e}_j - \mathbf{e}_k$  for  $0 \leq j \leq n$ ,  $j \neq k$ , and every  $\sigma(p_k)$  is positive; thus (9.33) reduces to the classical identity

$$\sum_{k=0}^n \prod_{\substack{0 \leq j \leq n \\ j \neq k}} \frac{1}{x_j - x_k} = 0.$$

EXAMPLE 9.4.5. Consider the  $S^1$ -action preserving the standard complex structure on  $\mathbb{C}P^1$ . It has two fixed points, both with signs 1 and weights 1 and  $-1$ , respectively (see Example D.6.3). Theorem 9.4.1 gives the following expression for the universal toric genus:

$$\Phi(\mathbb{C}P^1) = \frac{1}{u} + \frac{1}{\bar{u}}$$

in  $U^{-2}(\mathbb{C}P^\infty)$  where  $\bar{u} = [-1, u]$  is the inverse series in the formal group law of geometric cobordisms.

By Theorem 9.4.3, a genus  $\varphi: \Omega_U \rightarrow R$  is rigid on  $\mathbb{C}P^1$  only if its defining series  $f(x)$  satisfies the equation

$$(9.34) \quad \frac{1}{f(x)} + \frac{1}{f(-x)} = c$$

in  $R \otimes \mathbb{Q}[[x]]$ . The general analytic solution is of the form

$$(9.35) \quad f(x) = \frac{x}{q(x^2) + cx/2}, \quad \text{where } q(0) = 1$$

(an exercise). The Todd genus of Example E.3.6.3 is defined by the series  $f(x) = 1 - e^{-x}$ , and (9.34) is satisfied with  $c = 1$ . So  $\text{td}$  is  $T$ -rigid on  $\mathbb{C}P^1$ , and

$$q(x^2) = \frac{x}{2} \cdot \frac{e^{x/2} + e^{-x/2}}{e^{x/2} - e^{-x/2}}$$

in  $\mathbb{Q}[[x]]$ . In fact  $\text{td}$  is fibre multiplicative with respect to  $\mathbb{C}P^1$  by [160], so rigidity also follows from Theorem 9.3.6.

We can also consider the  $S^1$ -action on  $M = \mathbb{C}P^1$  with trivial stably complex structure. It has two fixed points of signs 1 and  $-1$ , both with weights 1. Theorem 9.4.1 gives the universal toric genus  $\Phi(M) = \frac{1}{u} - \frac{1}{u} = 0$ , which also follows from the fact that  $M$  bounds equivariantly.

Another classical application of the localisation formula is the Atiyah–Hirzebruch formula [10] expressing the  $\chi_y$ -genus of a complex  $S^1$ -manifold in terms of the fixed point data. We discuss a generalisation of this formula due to Krichever [188]. It refers to the 2-parameter  $\chi_{a,b}$ -genus corresponding to the series

$$(9.36) \quad f(x) = \frac{e^{ax} - e^{bx}}{ae^{bx} - be^{ax}} \in \mathbb{Q}[a, b].$$

The  $\chi_y$ -genus (Example E.3.7) corresponds to the parameter values  $a = y, b = -1$ .

We choose a circle subgroup in  $T^k$  defined by a primitive vector  $\nu \in \mathbb{Z}^k$ :

$$S(\nu) = \{(e^{2\pi i \nu_1 \varphi}, \dots, e^{2\pi i \nu_k \varphi}) \in \mathbb{T}^k : \varphi \in \mathbb{R}\}.$$

We have  $M^{S(\nu)} = M^T$  for a generic circle  $S(\nu)$  (see Lemma 7.4.3). The weights of the tangential representation of  $S(\nu)$  at  $p$  are  $\langle \mathbf{w}_j(p), \nu \rangle, 1 \leq j \leq n$ . If fixed points  $M^T$  are isolated and  $M^{S(\nu)} = M^T$ , then

$$(9.37) \quad \langle \mathbf{w}_j(p), \nu \rangle \neq 0 \quad \text{for } 1 \leq j \leq n \text{ and any } p \in M^T.$$

We define the *index*  $\text{ind}_\nu p$  as the number of negative weights at  $p$ , i.e.

$$\text{ind}_\nu p = \#\{j : \langle \mathbf{w}_j(p), \nu \rangle < 0\}.$$

THEOREM 9.4.6 (generalised Atiyah–Hirzebruch formula [188]). *The  $\chi_{a,b}$ -genus is  $T^k$ -rigid. Furthermore, the  $\chi_{a,b}$ -genus of a stably tangentially complex  $2n$ -dimensional  $T^k$ -manifold  $M$  with finite  $M^T$  is given by*

$$(9.38) \quad \chi_{a,b}(M) = \sum_{p \in M^T} \sigma(p)(-a)^{\text{ind}_\nu p}(-b)^{n-\text{ind}_\nu p}$$

for any  $\nu \subset \mathbb{Z}^k$  satisfying  $M^{S(\nu)} = M^T$ .

REMARK. The original formula of Atiyah–Hirzebruch [10] was given for complex manifolds. Krichever implicitly assumed manifolds to be almost complex when deducing his formula, as no signs were mentioned in [188]. However his proof, presented below, automatically extends to the stably complex situation by incorporating the signs of fixed points.

Also, both Atiyah–Hirzebruch’s and Krichever’s formulae are valid without assuming the fixed points to be isolated, see Exercise 9.4.9. We give the formula in the case of isolated fixed points to emphasise the role of signs.

PROOF OF THEOREM 9.38. We establish the rigidity and prove the formula for  $M$  with isolated fixed points only; the proof in the general case is similar. By Proposition 9.4.3, to prove the  $T^k$ -rigidity on  $M$  it suffices to prove that  $\chi_{a,b}^{S(\nu)}$  is constant for any  $S(\nu)$  satisfying  $M^{S(\nu)} = M^T$ . Formula (9.32) gives

$$(9.39) \quad \chi_{a,b}^{S(\nu)}(M) = \sum_{p \in M^T} \sigma(p) \prod_{j=1}^n \frac{ae^{b\langle \mathbf{w}_j(p), \nu \rangle x} - be^{a\langle \mathbf{w}_j(p), \nu \rangle x}}{e^{a\langle \mathbf{w}_j(p), \nu \rangle x} - e^{b\langle \mathbf{w}_j(p), \nu \rangle x}}.$$

This expression belongs to  $\mathbb{Z}[a, b][[x]]$  (that is, it is non-singular at zero) and its constant term is  $\chi_{a,b}(M)$ . We denote  $\omega_j = \langle \mathbf{w}_j(p), \nu \rangle$  and  $e^{(a-b)x} = q$ ; then we may rewrite each factor in the product above as

$$(9.40) \quad \frac{ae^{b\omega_j x} - be^{a\omega_j x}}{e^{a\omega_j x} - e^{b\omega_j x}} = \frac{a - bq^{\omega_j}}{q^{\omega_j} - 1}.$$

Then (9.39) takes the following form:

$$(9.41) \quad \chi_{a,b}^{S(\nu)}(M) = \sum_{p \in M^T} \sigma(p) \prod_{j=1}^n \frac{a - bq^{\omega_j}}{q^{\omega_j} - 1}.$$

Now we let  $q \rightarrow \infty$ . Then (9.40) has limit  $-b$  if  $\omega_j > 0$  and limit  $-a$  if  $\omega_j < 0$ . Therefore, the limit of (9.41) is

$$\sum_{p \in M^T} \sigma(p)(-a)^{\text{ind}_\nu p}(-b)^{n-\text{ind}_\nu p}.$$

Similarly, the limit of (9.41) as  $q \rightarrow 0$  is

$$\sum_{p \in M^T} \sigma(p)(-a)^{n-\text{ind}_\nu p}(-b)^{\text{ind}_\nu p}.$$

Therefore,  $\chi_{a,b}^{S(\nu)}(M)$  has value for  $q = 0$  as well as for  $q = \infty$ . Since it is a finite Laurent series in  $q$ , it must be constant in  $q$ , and its value coincides with either of the limits above.  $\square$

REMARK. It follows also that the right hand side of (9.38) is independent of  $\nu$ ; the two limits above are taken to each other by substitution  $\nu \rightarrow -\nu$ .

**Exercises.**

9.4.7. The general analytic solution of (9.34) is given by (9.35).

9.4.8. The formal group law corresponding to the  $\chi_{a,b}$ -genus is given by

$$F(u, v) = \frac{u + v + (a + b)uv}{1 - ab \cdot uv}.$$

9.4.9. Let  $M$  be a stably tangentially complex  $T^k$ -manifold  $M$  with fixed point set  $M^T$ . Then

$$\chi_{a,b}(M) = \sum_{F \subset M^T} \chi_{a,b}(F)(-a)^{\text{ind}_\nu F} (-b)^{\ell - \text{ind}_\nu F}$$

for any  $\nu \subset \mathbb{Z}^k$  satisfying  $M^{S(\nu)} = M^T$ , where the sum is taken over connected fixed submanifolds  $F \subset M^T$ ,  $2\ell = \dim M - \dim F$ , and  $\text{ind}_\nu F$  is the number of negative weights of the  $S(\nu)$ -action in the normal bundle of  $F$ .

**9.5. Quasitoric manifolds and genera**

In the case of quasitoric manifolds, the combinatorial description of signs of fixed points and weights obtained in Section 7.3 opens a way to effective calculation of characteristic numbers and Hirzebruch genera using localisation techniques. We illustrate this approach by presenting formulae expressing the  $\chi_{a,b}$ -genus (in particular, the signature and the Todd genus) of a quasitoric manifold as a sum of contributions depending only on the ‘local combinatorics’ near the vertices of the quotient polytope. These formulae were obtained in [256]; they can also be deduced from the results of [206] in the more general context of torus manifolds.

Localisation formulae for genera on quasitoric manifolds can be interpreted as functional equations on the series  $f(x)$ . By resolving these equations for particular examples of quasitoric manifolds one may derive different ‘universality theorems’ for rigid genera. For example, according to a result of Musin [237], the  $\chi_{a,b}$ -genus is universal for  $T^k$ -rigid genera (this implies that any  $T^k$ -rigid rational genus is  $\chi_{a,b}$  for some rational parameters  $a, b$ ). We prove this result as Theorem 9.5.6 by resolving the functional equation coming from localisation formula (9.32) on  $\mathbb{C}P^2$  with a nonstandard omniorientation.

We assume given a combinatorial quasitoric pair  $(P, A)$  (see Definition 7.3.10) and the corresponding omnioriented quasitoric manifold  $M = M(P, A)$ . This fixes a  $T^n$ -invariant stably complex structure on  $M$  and the corresponding bordism class  $[M] \in \Omega_{2n}^U$ , as described in Corollary 7.3.15.

Any fixed point  $v \in M$  is given by the intersection of  $n$  characteristic submanifolds  $v = M_{j_1} \cap \dots \cap M_{j_n}$  and corresponds to a vertex of the polytope  $P$ , which we also denote by  $v$ . The expressions for the weights  $\mathbf{w}_j(v)$  and the sign  $\sigma(v)$  in terms of the quasitoric pair  $(P, A)$  are given by Proposition 7.3.17 and Lemma 7.3.18.

In the quasitoric case the condition (9.37) guarantees that the circle  $S(\nu)$  satisfies  $M^T = M^{S(\nu)}$  (an exercise).

EXAMPLE 9.5.1 (Chern number  $c_n[M]$ ). The series (9.36) defining the  $\chi_{a,b}$ -genus has limit as  $a - b \rightarrow 0$ , which can be calculated as follows:

$$\frac{e^{ax} - e^{bx}}{ae^{bx} - be^{ax}} = \frac{1 - e^{(b-a)x}}{ae^{(b-a)x} - b} = \frac{(a - b)x + \dots}{(a - b) - a(a - b)x + \dots} = \frac{x}{1 - ax}.$$

For  $a = b = -1$  we obtain the defining series for the top Chern number  $c_n[M]$  (see Example E.3.6.1). Plugging these values into (9.38) we obtain

$$c_n[M] = \sum_{v \in M^T} \sigma(M),$$

which we already know from Exercise 7.3.37. When all signs are positive, we obtain  $c_n[M] = \chi(M) = f_0(P)$ , i.e. the Euler characteristic of  $M$  is equal to the number of vertices of  $P$ .

EXAMPLE 9.5.2 (signature). Substituting  $a = 1, b = -1$  in (9.36) we obtain the series  $\tanh(x)$  defining the  $L$ -genus or the signature (see Example E.3.6.2). Being an oriented cobordism invariant, the signature  $\text{sign}(M)$  does not depend on the stably complex structure, i.e. only the global orientation part of the omniorientation data affects the signature. The following statement gives a formula for  $\text{sign}(M)$  which depends only on the orientation:

PROPOSITION 9.5.3. *For an oriented quasitoric manifold  $M$ ,*

$$\text{sign}(M) = \sum_{v \in M^T} \det(\tilde{\mathbf{w}}_1(v), \dots, \tilde{\mathbf{w}}_n(v)),$$

where  $\tilde{\mathbf{w}}_j(v)$  are the vectors defined by the conditions

$$\tilde{\mathbf{w}}_j(v) = \pm \mathbf{w}_j(v) \quad \text{and} \quad (\tilde{\mathbf{w}}_j(v), \nu) > 0, \quad 1 \leq j \leq n.$$

PROOF. Plugging  $a = 1, b = -1$  into (9.38) we obtain

$$(9.42) \quad \text{sign}(M) = \sum_{v \in M^T} (-1)^{\text{ind}_\nu(v)} \sigma(v).$$

Using expression (7.15) for the sign  $\sigma(v)$  we calculate

$$(-1)^{\text{ind}_\nu(v)} \sigma(v) = (-1)^{\text{ind}_\nu(v)} \det(\mathbf{w}_1(v), \dots, \mathbf{w}_n(v)) = \det(\tilde{\mathbf{w}}_1(v), \dots, \tilde{\mathbf{w}}_n(v)),$$

which implies the required formula.  $\square$

If  $M$  is a projective toric manifold  $V_P$ , then  $\sigma(v) = 1$  for any  $v$  and formula (9.42) gives

$$\text{sign}(V_P) = \sum_v (-1)^{\text{ind}_\nu(v)}.$$

Furthermore, in this case the weights  $\mathbf{w}_1(v), \dots, \mathbf{w}_n(v)$  are the primitive vectors along the edges of  $P$  pointing out of  $v$  (see Example 7.3.19). It follows that the index  $\text{ind}_\nu(v)$  coincides with the index defined in the proof of Dehn–Sommerville equations (Theorem 1.3.4), and we obtain the formula known in toric geometry (see [250, Theorem 3.12]):

$$\text{sign}(V_P) = \sum_{k=0}^n (-1)^k h_k(P).$$

Note that if  $n$  is odd then the sum vanishes by the Dehn–Sommerville equations.

EXAMPLE 9.5.4 (Todd genus). Substituting  $a = 0, b = -1$  in (9.36) we obtain the series  $1 - e^{-x}$  defining the Todd genus (see Example E.3.6.3). We cannot plug  $a = 0$  directly into (9.38), but it is clear from the proof that when  $a = 0$ , only

vertices of index 0 contribute  $(-b)^n$  to the sum. This gives the following formula for the Todd genus of a quasitoric manifold:

$$(9.43) \quad \text{td}(M) = \sum_{v: \text{ind}_\nu(v)=0} \sigma(v).$$

When  $M$  is projective toric manifold  $V_P$ , there is only one vertex of index 0. It is the ‘bottom’ vertex, which has all incident edges pointing out (in the notation used in the proof of Theorem 1.3.4). Since  $\sigma(v) = 1$  for every  $v \in P$ , formula (9.43) gives  $\text{td}(V_P) = 1$ , which is well-known (see, e.g. [122, §5.3]).

In the almost complex case we have the following result:

**PROPOSITION 9.5.5.** *If a quasitoric manifold  $M$  admits an equivariant almost complex structure, then  $\text{td}(M) > 0$ .*

**PROOF.** We choose a compatible omniorientation, so that  $\sigma(v) > 0$  for any  $v$ . Then (9.43) implies  $\text{td}(M) \geq 0$ , and we need to show that there is at least one vertex of index 0. Let  $v$  be any vertex. Since  $w_1(v), \dots, w_n(v)$  are linearly independent, we may choose  $\nu$  so that  $\langle w_j(v), \nu \rangle > 0$  for any  $j$ . Then  $\text{ind}_\nu v = 0$ . The result follows by observation that  $\text{td}(M)$  is independent of  $\nu$ .  $\square$

A description of  $\text{td}(M)$  which is independent of  $\nu$  is outlined in Exercise 9.5.8.

The following result of Musin [236] can be proved by application of localisation formula for quasitoric manifolds:

**THEOREM 9.5.6.** *The 2-parameter genus  $\chi_{a,b}$  is universal for  $T^k$ -rigid genera. In particular, any  $T^k$ -rigid rational genus is  $\chi_{a,b}$  for some rational parameters  $a, b$ .*

**PROOF.** The rigidity of  $\chi_{a,b}$  is established by Theorem 9.38. To see that any  $T^k$ -rigid genus is  $\chi_{a,b}$  we solve the functional equation arising from the localisation formula for one particular example of  $T^k$ -manifold.

We consider the quasitoric manifold  $M = \mathbb{C}P^2$  with a nonstandard omniorientation defined by the characteristic matrix

$$A = \begin{pmatrix} 1 & 0 & 1 \\ 0 & 1 & -1 \end{pmatrix}$$

It has three fixed points  $v_1, v_2, v_3$ , whose corresponding minors  $A_{v_i}$  are obtained by deleting the  $i$ th column of  $A$ . The weights are given by  $\{(1, 0), (1, 1)\}$ ,  $\{(0, -1), (1, 1)\}$  and  $\{(0, 1), (1, 0)\}$ , respectively, see Fig. 9.3. The signs are calculated using formula (7.15):

$$\sigma(v_1) = \begin{vmatrix} 1 & 1 \\ 1 & 0 \end{vmatrix} = -1, \quad \sigma(v_2) = \begin{vmatrix} 0 & 1 \\ -1 & 1 \end{vmatrix} = 1, \quad \sigma(v_3) = \begin{vmatrix} 1 & 0 \\ 0 & 1 \end{vmatrix} = 1.$$

Plugging these data into formula (9.32) we obtain that a genus  $\varphi$  is rigid on  $M$  only if its defining series  $f(x)$  satisfies the equation

$$-\frac{1}{f(x_1)f(x_1+x_2)} + \frac{1}{f(-x_2)f(x_1+x_2)} + \frac{1}{f(x_1)f(x_2)} = c.$$

Interchanging  $x_1$  and  $x_2$  gives

$$(9.44) \quad -\frac{1}{f(x_2)f(x_1+x_2)} + \frac{1}{f(-x_1)f(x_1+x_2)} + \frac{1}{f(x_2)f(x_1)} = c,$$

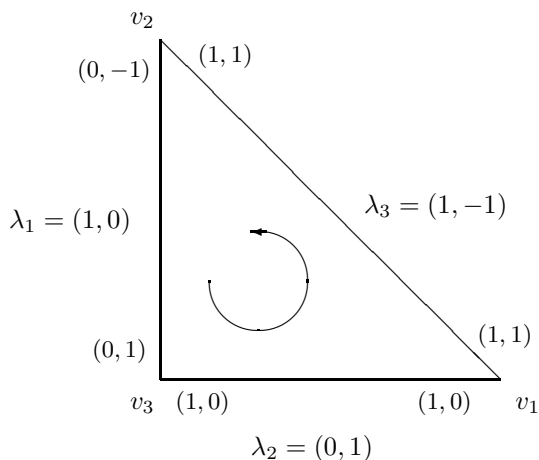

FIGURE 9.3.  $\mathbb{C}P^2$  with nonstandard omniorientation

and subtraction yields

$$\left(\frac{1}{f(x_1)} + \frac{1}{f(-x_1)}\right) \frac{1}{f(x_1 + x_2)} = \left(\frac{1}{f(x_2)} + \frac{1}{f(-x_2)}\right) \frac{1}{f(x_1 + x_2)}.$$

It follows that

$$\frac{1}{f(x)} + \frac{1}{f(-x)} = c' \quad \text{and} \quad \frac{1}{f(-x)} = c' - \frac{1}{f(x)}$$

for some constant  $c'$ . Substituting in (9.44) gives

$$\left(\frac{1}{f(x_1)} + \frac{1}{f(x_2)} - c'\right) \frac{1}{f(x_1 + x_2)} = \frac{1}{f(x_1)f(x_2)} - c,$$

which rearranges to

$$f(x_1 + x_2) = \frac{f(x_1) + f(x_2) - c'f(x_1)f(x_2)}{1 - cf(x_1)f(x_2)}.$$

So  $f$  is the exponential series of the formal group law  $F(x_1, x_2)$  corresponding to  $\chi_{a,b}$ , with  $c' = -a - b$  and  $c = ab$  (see Exercise 9.4.8).  $\square$

**Exercises.**

9.5.7. If  $\nu \in \mathbb{Z}^n$  satisfies (9.37), then the circle subgroup  $S(\nu) \subset T^n$  acts on the quasitoric manifold  $M$  with isolated fixed points corresponding to the vertices of the quotient polytope  $P$ .

9.5.8. Let  $M = M(P, \Lambda)$  be a quasitoric manifold. We realise the dual complex  $\mathcal{K}_P$  as a triangulated sphere with vertices at the unit vectors  $\frac{\mathbf{a}_i}{|\mathbf{a}_i|}$ ,  $i = 1, \dots, m$ . Then one can define a continuous piecewise smooth map  $f: S^{n-1} \rightarrow S^{n-1}$  by sending  $\frac{\mathbf{a}_i}{|\mathbf{a}_i|}$  to  $\frac{\lambda_i}{|\lambda_i|}$  (here  $\lambda_i$  is the  $i$ th column of  $\Lambda$ ) and extending the map smoothly on the spherical simplices corresponding to  $I \in K_P$ . Such an extension is well defined because the vectors  $\{\lambda_i: i \in I\}$  are linearly independent, so one always chooses the smallest spherical simplex spanned by them.

Show that  $\text{td}(M) = \deg f$ . (Hint: the number of preimages of  $\frac{\nu}{|\nu|} \in S^{n-1}$  under  $f$  is equal to the number of maximal simplices  $I_\nu \in \mathcal{K}$  such that all coefficients in the decomposition of  $\nu$  via  $\{\lambda_i : i \in I_\nu\}$  are positive; these coefficients are  $\langle \mathbf{w}_i(v), \nu \rangle$ .)

More generally, the Todd genus of a torus manifold can be calculated in this way as the *degree* of the corresponding multi-fan, see [153, §3].

9.5.9. Calculate  $c_n[M]$ , the signature and the Todd genus for quasitoric manifolds of Example 7.3.21, Example 7.3.22 and Exercise 7.3.34.



## Commutative and homological algebra

Here we review some basic algebraic notions and results in a way suited for topological applications. In order to make algebraic constructions compatible with topological ones we sometimes use a notation which may seem unusual to a reader with an algebraic background. This in particular concerns the way we treat gradings and resolutions.

We fix a ground ring  $\mathbf{k}$ , which is always assumed to be a field or the ring  $\mathbb{Z}$  of integers. In the latter case by a ‘ $\mathbf{k}$ -vector space of dimension  $d$ ’ we mean an abelian group of rank  $d$ .

### A.1. Algebras and modules

A  $\mathbf{k}$ -*algebra* (or simply *algebra*)  $A$  is a ring which is also a  $\mathbf{k}$ -vector space, and whose multiplication  $A \times A \rightarrow A$  is  $\mathbf{k}$ -bilinear. (The latter condition is void if  $\mathbf{k} = \mathbb{Z}$ , so  $\mathbb{Z}$ -algebras are ordinary rings.) All our algebras will be commutative and with unit 1, unless explicitly stated otherwise. The basic example is  $A = \mathbf{k}[v_1, \dots, v_m]$ , the *polynomial algebra* in  $m$  generators, for which we shall often use a shortened notation  $\mathbf{k}[m]$ .

An algebra  $A$  is *finitely generated* if there are finitely many elements  $a_1, \dots, a_n$  of  $A$  such that every element of  $A$  can be written as a polynomial in  $a_1, \dots, a_n$  with coefficients in  $\mathbf{k}$ . Therefore, a finitely generated algebra is the quotient of a polynomial algebra by an ideal.

An  $A$ -*module* is a  $\mathbf{k}$ -vector space  $M$  on which  $A$  acts linearly, that is, there is a map  $A \times M \rightarrow M$  which is  $\mathbf{k}$ -linear in each argument and satisfies  $1m = m$  and  $(ab)m = a(bm)$  for all  $a, b \in A, m \in M$ . Any ideal  $I$  of  $A$  is an  $A$ -module. If  $A = \mathbf{k}$ , then an  $A$ -module is a  $\mathbf{k}$ -vector space.

An  $A$ -module  $M$  is *finitely generated* if there exist  $x_1, \dots, x_n$  in  $M$  such that every element  $x$  of  $M$  can be written (not necessarily uniquely) as  $x = a_1x_1 + \dots + a_nx_n$ ,  $a_i \in A$ .

An algebra  $A$  is  $\mathbb{Z}$ -*graded* (or simply *graded*) if it is represented as a direct sum  $A = \bigoplus_{i \in \mathbb{Z}} A^i$  such that  $A^i \cdot A^j \subset A^{i+j}$ . Elements  $a \in A^i$  are said to be *homogeneous* of degree  $i$ , denoted  $\deg a = i$ . The set of homogeneous elements of  $A$  is denoted by  $\mathcal{H}(A) = \bigcup_i A^i$ . An ideal  $I$  of  $A$  is *homogeneous* if it is generated by homogeneous elements. In most cases our graded algebras will be either *nonpositively graded* (i.e.  $A^i = 0$  for  $i > 0$ ) or *nonnegatively graded* (i.e.  $A^i = 0$  for  $i < 0$ ); the latter is also called an  $\mathbb{N}$ -graded algebra. A nonnegatively graded algebra  $A$  is *connected* if  $A^0 = \mathbf{k}$ . For a nonnegatively graded algebra  $A$ , define the *positive ideal* by  $A^+ = \bigoplus_{i > 0} A^i$ ; if  $A$  is connected and  $\mathbf{k}$  is a field then  $A^+$  is a maximal ideal.

If  $A$  is a graded algebra, then an  $A$ -module  $M$  is *graded* if  $M = \bigoplus_{i \in \mathbb{Z}} M^i$  such that  $A^i \cdot M^j \subset M^{i+j}$ . An  $A$ -module map  $f: M \rightarrow N$  between two graded

modules is *degree-preserving* (or of *degree 0*) if  $f(M^i) \subset N^i$ , and is of *degree  $k$*  if  $f(M^i) \subset N^{i+k}$  for all  $i$ .

Graded algebras arising in topology are often *graded-commutative* (or *skew-commutative*) rather than commutative in the usual sense. This means that

$$ab = (-1)^{ij} ba \quad \text{for any } a \in A^i, b \in A^j.$$

If the characteristic of  $\mathbf{k}$  is not 2, then the square of an odd-degree element in a graded-commutative algebra is zero. To avoid confusion we double the grading in commutative algebras  $A$ ; the resulting graded algebras  $A = \bigoplus_{i \in \mathbb{Z}} A^{2i}$  are commutative in either sense.

For example, we make the polynomial algebra  $\mathbf{k}[v_1, \dots, v_m]$  graded by setting  $\deg v_i = 2$ . It then becomes a *free* graded commutative algebra on  $m$  generators of degree two (free means no relations apart from the graded commutativity). The *exterior algebra*  $\Lambda[u_1, \dots, u_m]$  has relations  $u_i^2 = 0$  and  $u_i u_j = -u_j u_i$ . We shall assume  $\deg u_i = 1$  unless otherwise specified. An exterior algebra is a free graded commutative algebra if the characteristic of  $\mathbf{k}$  is not 2.

*Bigraded* (i.e.  $\mathbb{Z} \oplus \mathbb{Z}$ -graded) and *multigraded* ( $\mathbb{Z}^m$ -graded) algebras  $A$  are defined similarly; their homogeneous elements  $a \in A$  have *bidegree*  $\text{bideg } a = (i, j) \in \mathbb{Z} \oplus \mathbb{Z}$  or *multidegree*  $\text{mdeg } a = \mathbf{i} \in \mathbb{Z}^m$  respectively.

We continue assuming  $A$  to be (graded) commutative. The *tensor product*  $M \otimes_A N$  of  $A$ -modules  $M$  and  $N$  is the quotient of a free  $A$ -module with generator set  $M \times N$  by the submodule generated by all elements of the following types:

$$\begin{aligned} (x + x', y) - (x, y) - (x', y), & \quad (x, y + y') - (x, y) - (x, y'), \\ (ax, y) - a(x, y), & \quad (x, ay) - a(x, y), \end{aligned}$$

where  $x, x' \in M$ ,  $y, y' \in N$ ,  $a \in A$ . For each basis element  $(x, y)$ , its image in  $M \otimes_A N$  is denoted by  $x \otimes y$ .

We shall denote the tensor product  $M \otimes_{\mathbf{k}} N$  of  $\mathbf{k}$ -vector spaces by simply  $M \otimes N$ . For example, if  $M = N = \mathbf{k}[v]$ , then  $M \otimes N = \mathbf{k}[v_1, v_2]$ .

The tensor product  $A \otimes B$  of graded-commutative algebras  $A$  and  $B$  is a graded commutative algebra, with the multiplication defined on homogeneous elements by

$$(a \otimes b) \cdot (a' \otimes b') = (-1)^{\deg b \deg a'} aa' \otimes bb'.$$

An  $A$ -module  $F$  is *free* if it is isomorphic to a direct sum  $\bigoplus_{i \in I} F_i$ , where each  $F_i$  is isomorphic to  $A$  as an  $A$ -module. If both  $A$  and  $F$  are graded then every  $F_i$  is isomorphic to a  $j$ -fold *suspension*  $s^j A$  for some  $j$ , where  $s^j A$  is the graded  $A$ -module with  $(s^j A)^k = A^{k-j}$ . A *basis* of a free  $A$ -module  $F$  is a set  $\mathcal{S}$  of elements of  $F$  such that each  $x \in F$  can be uniquely written as a finite linear combination of elements of  $\mathcal{S}$  with coefficients in  $A$ . If  $A$  is finitely generated then all bases have the same cardinality (an exercise), called the *rank* of  $F$ . If  $\mathcal{S}$  is a basis of a free  $A$ -module  $F$ , then for any  $A$ -module  $M$  a set map  $\mathcal{S} \rightarrow M$  extends uniquely to an  $A$ -module homomorphism  $F \rightarrow M$ .

A module  $P$  is *projective* if for any epimorphism of modules  $p: M \rightarrow N$  and homomorphism  $f: P \rightarrow N$ , there is a homomorphism  $f': P \rightarrow M$  such that  $pf' =$

$f$ . This is described by the following commutative diagram:

$$\begin{array}{ccccc} M & \xrightarrow{p} & N & \longrightarrow & 0 \\ & \swarrow f' & \uparrow f & & \\ & & P & & \end{array}$$

Equivalently  $P$  is projective if it is a direct summand of a free module (an exercise). In particular, free modules are projective.

A sequence of homomorphisms of  $A$ -modules

$$\dots \longrightarrow M_1 \xrightarrow{f_1} M_2 \xrightarrow{f_2} M_3 \xrightarrow{f_3} M_4 \longrightarrow \dots$$

is called an *exact sequence* if  $\text{Im } f_i = \text{Ker } f_{i+1}$  for all  $i$ .

A *chain complex* is a sequence  $C_* = \{C_i, \partial_i\}$  of  $A$ -modules  $C_i$  and homomorphisms  $\partial_i: C_i \rightarrow C_{i-1}$  such that  $\partial_i \partial_{i+1} = 0$ . This is usually written as

$$\dots \longrightarrow C_{i+1} \xrightarrow{\partial_{i+1}} C_i \xrightarrow{\partial_i} C_{i-1} \longrightarrow \dots$$

The condition  $\partial_i \partial_{i+1} = 0$  implies that  $\text{Im } \partial_{i+1} \subset \text{Ker } \partial_i$ . The elements of  $\text{Ker } \partial$  are called *cycles*, and the elements of  $\text{Im } \partial$  are *boundaries*. The  *$i$ th homology group* (or *homology module*) of  $C_*$  is defined by

$$H_i(C_*) = \text{Ker } \partial_i / \text{Im } \partial_{i+1}.$$

A *cochain complex* is a sequence  $C^* = \{C^i, d^i\}$  of  $A$ -modules  $C^i$  and homomorphisms  $d^i: C^i \rightarrow C^{i+1}$  such that  $d^i d^{i-1} = 0$ . This is usually written as

$$\dots \longrightarrow C^{i-1} \xrightarrow{d^{i-1}} C^i \xrightarrow{d^i} C^{i+1} \longrightarrow \dots$$

The elements of  $\text{Ker } d$  are called *cocycles*, and the elements of  $\text{Im } d$  are *coboundaries*. The  *$i$ th cohomology group* (or *cohomology module*) of  $C^*$  is defined by

$$H^i(C^*) = \text{Ker } d^i / \text{Im } d^{i-1}.$$

A cochain complex may be also viewed as a graded  $\mathbf{k}$ -vector space  $C^* = \bigoplus_i C^i$  in which every graded component  $C^i$  is an  $A$ -module, together with an  $A$ -linear map  $d: C^* \rightarrow C^*$  raising the degree by 1 and satisfying the condition  $d^2 = 0$ .

Note that a chain complex may be turned to a cochain complex by inverting the grading (i.e. turning the  $i$ th graded component into the  $(-i)$ th).

A *map of cochain complexes* is a graded  $A$ -module map  $f: C^* \rightarrow D^*$  which commutes with the differentials. Such a map induces a map in cohomology  $\tilde{f}: H(C^*) \rightarrow H(D^*)$ , which is also an  $A$ -module map.

Let  $f, g: C^* \rightarrow D^*$  be two maps of cochain complexes. A *cochain homotopy* between  $f$  and  $g$  is a set of maps  $s = \{s^i: C^i \rightarrow D^{i-1}\}$  satisfying the identities

$$ds + sd = f - g$$

(more precisely,  $d^{i-1}s^i + s^{i+1}d^i = f^i - g^i$ ). This is described by the following commutative diagram

$$\begin{array}{ccccccc} \dots & \longrightarrow & C^{i-1} & \xrightarrow{d^{i-1}} & C^i & \xrightarrow{d^i} & C^{i+1} & \longrightarrow & \dots \\ & & \searrow s^{i-1} & \downarrow & \searrow s^i & \downarrow f^i - g^i & \searrow s^{i+1} & \downarrow & \\ \dots & \longrightarrow & D^{i-1} & \xrightarrow{d^{i-1}} & D^i & \xrightarrow{d^i} & D^{i+1} & \longrightarrow & \dots \end{array}$$

If there is a cochain homotopy between  $f$  and  $g$ , then  $f$  and  $g$  induce the same map in cohomology (an exercise). A *chain homotopy* between maps of chain complexes is defined similarly.

A *differential graded algebra* (a *dg-algebra* for short) is a graded algebra  $A$  together with a  $\mathbf{k}$ -linear map  $d: A \rightarrow A$ , called the *differential*, which raises the degree by one, and satisfies the identity  $d^2 = 0$  (so that  $\{A^i, d^i\}$  is a cochain complex) and the *Leibniz identity*

$$(A.1) \quad d(a \cdot b) = da \cdot b + (-1)^i a \cdot db \quad \text{for } a \in A^i, b \in A.$$

In order to emphasise the differential, we may display a dg-algebra  $A$  as  $(A, d)$ . Its cohomology  $H(A, d) = \text{Ker } d / \text{Im } d$  is a graded algebra (an exercise). Differential graded algebras whose differential lowers the degree by one are also considered, in which case homology is a graded algebra.

A *quasi-isomorphism* between dg-algebras is a homomorphism  $f: A \rightarrow B$  which induces an isomorphism in cohomology,  $\tilde{f}: H(A) \xrightarrow{\cong} H(B)$ .

### Exercises.

A.1.1. If  $A$  is a finitely generated algebra, then all bases of a free  $A$ -module have the same cardinality.

A.1.2. A module is projective if and only if it is a direct summand of a free module.

A.1.3. Prove the following extended version of the *5-lemma*. Let

$$\begin{array}{ccccccccc} C^1 & \longrightarrow & C^2 & \longrightarrow & C^3 & \longrightarrow & C^4 & \longrightarrow & C^5 \\ \downarrow f^1 & & \downarrow f^2 & & \downarrow f^3 & & \downarrow f^4 & & \downarrow f^5 \\ D^1 & \longrightarrow & D^2 & \longrightarrow & D^3 & \longrightarrow & D^4 & \longrightarrow & D^5 \end{array}$$

be a commutative diagram with exact rows. Then

- (a) if  $f^2$  and  $f^4$  are monomorphisms and  $f^1$  is an epimorphism, then  $f^3$  is a monomorphism;
- (b) if  $f^2$  and  $f^4$  are epimorphisms and  $f^5$  is a monomorphism, then  $f^3$  is an epimorphism.

Therefore, if  $f^1, f^2, f^4, f^5$  are isomorphisms, then  $f^3$  is also an isomorphism.

A.1.4. Cochain homotopic maps between cochain complexes induce the same maps in cohomology.

A.1.5. The cohomology of a differential graded algebra is a graded algebra.

## A.2. Homological theory of graded rings and modules

From now on we assume that  $A$  is a commutative finitely generated  $\mathbf{k}$ -algebra with unit, graded by nonnegative even numbers (i.e.  $A = \bigoplus_{i \geq 0} A^i$ ) and connected (i.e.  $A^0 = \mathbf{k}$ ). The basic example to keep in mind is  $A = \mathbf{k}[m] = \mathbf{k}[v_1, \dots, v_m]$  with  $\deg v_i = 2$ , however we shall need a greater generality occasionally. We also assume that all  $A$ -modules  $M$  are nonnegatively graded and finitely generated, and all module maps are degree-preserving, unless the contrary is explicitly stated.

A *free* (respectively, *projective*) *resolution* of  $M$  is an exact sequence of  $A$ -modules

$$(A.2) \quad \cdots \xrightarrow{d} R^{-i} \xrightarrow{d} \cdots \xrightarrow{d} R^{-1} \xrightarrow{d} R^0 \rightarrow M \rightarrow 0$$

in which all  $R^{-i}$  are free (respectively, projective)  $A$ -modules. A free resolution exists for every  $M$  (an exercise, or see constructions below). The minimal number  $p$  for which there exists a projective resolution (A.2) with  $R^{-i} = 0$  for  $i > p$  is called the *projective* (or *homological*) *dimension* of the module  $M$ ; we shall denote it by  $\text{pdim}_A M$  or simply  $\text{pdim } M$ . If such  $p$  does not exist, we set  $\text{pdim } M = \infty$ . The module  $M_i = \text{Ker}[d: R^{-i+1} \rightarrow R^{-i+2}]$  is called the  *$i$ th syzygy module* for  $M$ .

If  $\mathbf{k}$  is a field and  $A$  is as above, then an  $A$ -module is projective if and only if it is free (see Exercise A.2.15), and we therefore need not to distinguish between free and projective resolutions in this case.

We can convert a resolution (A.2) into a bigraded  $\mathbf{k}$ -vector space  $R = \bigoplus_{i,j} R^{-i,j}$  where  $R^{-i,j} = (R^{-i})^j$  is the  $j$ th graded component of the module  $R^{-i}$ , and the  $(-i, j)$ th component of  $d$  acts as  $d^{-i,j}: R^{-i,j} \rightarrow R^{-i+1,j}$ . We refer to the first grading of  $R$  as *external*; it comes from the indexing of the terms in the resolution and is therefore nonpositive by our convention. The second, *internal*, grading of  $R$  comes from the grading in the modules  $R^{-i}$  and is therefore even and nonnegative. The *total* degree of an element of  $R$  is defined as the sum of its external and internal degrees. We can view  $A$  as a bigraded algebra with trivial first grading (i.e.  $A^{i,j} = 0$  for  $i \neq 0$  and  $A^{0,j} = A^j$ ); then  $R$  becomes a bigraded  $A$ -module.

If we drop the term  $M$  in resolution (A.2), then the resulting cochain complex is exactly  $R$  (with respect to its external grading), and we have

$$H^{-i,j}(R, d) = \text{Ker } d^{-i,j} / \text{Im } d^{-i-1,j} = 0 \quad \text{for } i > 0,$$

$$H^{0,j}(R, d) = M^j.$$

We may view  $M$  as a trivial cochain complex  $0 \rightarrow M \rightarrow 0$ , or as a bigraded module with trivial external grading, i.e.  $M^{i,j} = 0$  for  $i \neq 0$  and  $M^{0,j} = M^j$ . Then resolution (A.2) can be interpreted as a map of cochain complexes of  $A$ -modules:

$$(A.3) \quad \begin{array}{ccccccc} \cdots & \longrightarrow & R^{-i} & \xrightarrow{d} & \cdots & \xrightarrow{d} & R^{-1} & \xrightarrow{d} & R^0 & \longrightarrow & 0 \\ & & \downarrow & & & & \downarrow & & \downarrow & & \\ \cdots & \longrightarrow & 0 & \longrightarrow & \cdots & \longrightarrow & 0 & \longrightarrow & M & \longrightarrow & 0 \end{array}$$

or simply as a map  $(R, d) \rightarrow (M, 0)$  inducing an isomorphism in cohomology.

The *Poincaré series* of a graded  $\mathbf{k}$ -vector space  $V = \bigoplus_i V^i$  whose graded components are finite-dimensional is given by

$$F(V; \lambda) = \sum_i (\dim_{\mathbf{k}} V^i) \lambda^i.$$

PROPOSITION A.2.1. *Let (A.2) be a finite free resolution of an  $A$ -module, in which  $R^{-i}$  is a free module of rank  $q_i$  on generators of degrees  $d_{1i}, \dots, d_{q_i i}$ . Then*

$$F(M; \lambda) = F(A; \lambda) \sum_{i \geq 0} (-1)^i (\lambda^{d_{1i}} + \cdots + \lambda^{d_{q_i i}}).$$

PROOF. Since  $H^{-i,j}(R, d) = 0$  for  $i > 0$  and  $H^{0,j}(R, d) = M^j$ , we obtain

$$\sum_{i \geq 0} (-1)^i \dim_{\mathbf{k}} R^{-i,j} = \dim_{\mathbf{k}} M^j$$

by a basic property of the Euler characteristic. Multiplying by  $\lambda^j$  and summing up over  $j$  we obtain

$$\sum_{i \geq 0} (-1)^i F(R^{-i}; \lambda) = F(M; \lambda).$$

Since each  $R^{-i}$  is a free  $A$ -module, its Poincaré series is given by  $F(R^{-i}; \lambda) = F(A; \lambda)(\lambda^{d_{1i}} + \dots + \lambda^{d_{q_i i}})$ , which implies the required formula.  $\square$

CONSTRUCTION A.2.2 (minimal resolution). Let  $\mathbf{k}$  be a field, and let  $M = \bigoplus_{i \geq 0} M^i$  be a graded  $A$ -module, which is not necessarily finitely generated, but for which every graded component  $M^i$  is finite-dimensional as a  $\mathbf{k}$ -vector space. There is the following canonical way to construct a free resolution for  $M$ .

Take the lowest degree  $i$  in which  $M^i \neq 0$  and choose a  $\mathbf{k}$ -vector space basis in  $M^i$ . Span an  $A$ -submodule  $M_1$  by this basis and then take the lowest degree in which  $M \neq M_1$ . In this degree choose a  $\mathbf{k}$ -vector space basis in the complement of  $M_1$ , and span a module  $M_2$  by this basis and  $M_1$ . Continuing this process we obtain a system of generators for  $M$  which has a finite number of elements in each degree, and has the property that images of the generators form a basis of the  $\mathbf{k}$ -vector space  $M \otimes_A \mathbf{k} = M/(A^+ \cdot M)$ . A system of generators of  $M$  obtained in this way is referred to as *minimal* (or as a *minimal basis*).

Now choose a minimal generating set in  $M$  and span by its elements a free  $A$ -module  $R_{\min}^0$ . Then we have an epimorphism  $R_{\min}^0 \rightarrow M$ . Next we choose a minimal basis in the kernel of this epimorphism, and span by it a free module  $R_{\min}^{-1}$ . Then choose a minimal basis in the kernel of the map  $R_{\min}^{-1} \rightarrow R_{\min}^0$ , and so on. At the  $i$ th step we choose a minimal basis in the kernel of the map  $d: R_{\min}^{-i+1} \rightarrow R_{\min}^{-i+2}$  constructed in the previous step, and span a free module  $R_{\min}^{-i}$  by this basis. As a result we obtain a free resolution of  $M$ , which is referred to as *minimal*. A minimal resolution is unique up to an isomorphism.

PROPOSITION A.2.3. *For a minimal resolution of  $M$ , the induced maps*

$$R_{\min}^{-i} \otimes_A \mathbf{k} \rightarrow R_{\min}^{-i+1} \otimes_A \mathbf{k}$$

*are zero for  $i \geq 1$ .*

PROOF. By construction, the map  $R_{\min}^0 \otimes_{\mathbf{k}} A \rightarrow M \otimes_{\mathbf{k}} A$  is an isomorphism, which implies that the kernel of the map  $R_{\min}^0 \rightarrow M$  is contained in  $A^+ \cdot R_{\min}^0$ . Similarly, for each  $i \geq 1$  the kernel of the map  $d: R_{\min}^{-i} \rightarrow R_{\min}^{-i+1}$  is contained in  $A^+ \cdot R_{\min}^{-i}$ , and therefore the image of the same map is contained in  $A^+ \cdot R_{\min}^{-i+1}$ . This implies that the induced maps  $R_{\min}^{-i} \otimes_A \mathbf{k} \rightarrow R_{\min}^{-i+1} \otimes_A \mathbf{k}$  are zero.  $\square$

REMARK. If  $\mathbf{k} = \mathbb{Z}$  then the above described inductive procedure still gives a minimal basis for an  $A$ -module  $M$ , but the kernel of the map  $d: R_{\min}^0 \rightarrow M$  may not be contained in  $A^+ \cdot R_{\min}^0$ , and the induced map  $R_{\min}^{-1} \otimes_A \mathbb{Z} \rightarrow R_{\min}^0 \otimes_A \mathbb{Z}$  may be nonzero.

CONSTRUCTION A.2.4 (Koszul resolution). Let  $A = \mathbf{k}[v_1, \dots, v_m]$  and  $M = \mathbf{k}$  with the  $A$ -module structure given by the augmentation map sending each  $v_i$  to zero. We turn the tensor product

$$E = E_m = \Lambda[u_1, \dots, u_m] \otimes \mathbf{k}[v_1, \dots, v_m]$$

into a *bigraded differential algebra* by setting

$$(A.4) \quad \begin{aligned} \text{bideg } u_i &= (-1, 2), & \text{bideg } v_i &= (0, 2), \\ du_i &= v_i, & dv_i &= 0 \end{aligned}$$

and requiring  $d$  to satisfy the Leibniz identity (A.1). Then  $(E, d)$  together with the augmentation map  $\varepsilon: E \rightarrow \mathbf{k}$  defines a cochain complex of  $\mathbf{k}[m]$ -modules

$$(A.5) \quad 0 \rightarrow \Lambda^m[u_1, \dots, u_m] \otimes \mathbf{k}[v_1, \dots, v_m] \xrightarrow{d} \dots \\ \xrightarrow{d} \Lambda^1[u_1, \dots, u_m] \otimes \mathbf{k}[v_1, \dots, v_m] \xrightarrow{d} \mathbf{k}[v_1, \dots, v_m] \xrightarrow{\varepsilon} \mathbf{k} \rightarrow 0,$$

where  $\Lambda^i[u_1, \dots, u_m]$  is the subspace of  $\Lambda[u_1, \dots, u_m]$  generated by monomials of length  $i$ . We shall show that the complex above is an exact sequence, or equivalently, that  $\varepsilon: (E, d) \rightarrow [\mathbf{k}, 0]$  is a quasi-isomorphism. There is an obvious inclusion  $\eta: \mathbf{k} \rightarrow E$  such that  $\varepsilon\eta = \text{id}$ . To finish the proof we shall construct a cochain homotopy between  $\text{id}$  and  $\eta\varepsilon$ , that is, a set of  $\mathbf{k}$ -linear maps  $s = \{s^{-i, 2j}: E^{-i, 2j} \rightarrow E^{-i-1, 2j}\}$  satisfying the identity

$$(A.6) \quad ds + sd = \text{id} - \eta\varepsilon.$$

For  $m = 1$  we define the map  $s_1: E_1^{0,*} = \mathbf{k}[v] \rightarrow E_1^{-1,*}$  by the formula

$$s_1(a_0 + a_1v + \dots + a_jv^j) = u(a_1 + a_2v + \dots + a_jv^{j-1}).$$

Then for  $f = a_0 + a_1v + \dots + a_jv^j \in E_1^{0,*}$  we have  $ds_1f = f - a_0 = f - \eta\varepsilon f$  and  $s_1df = 0$ . On the other hand, for  $uf \in E_1^{-1,*}$  we have  $s_1d(uf) = uf$  and  $ds_1(uf) = 0$ . In any case (A.6) holds. Now we may assume by induction that for  $m = k - 1$  the required cochain homotopy  $s_{k-1}: E_{k-1} \rightarrow E_{k-1}$  is already constructed. Since  $E_k = E_{k-1} \otimes E_1$ ,  $\varepsilon_k = \varepsilon_{k-1} \otimes \varepsilon_1$  and  $\eta_k = \eta_{k-1} \otimes \eta_1$ , a direct calculation shows that the map

$$s_k = s_{k-1} \otimes \text{id} + \eta_{k-1}\varepsilon_{k-1} \otimes s_1$$

is a cochain homotopy between  $\text{id}$  and  $\eta_k\varepsilon_k$ .

Since  $\Lambda^i[u_1, \dots, u_m] \otimes \mathbf{k}[m]$  is a free  $\mathbf{k}[m]$ -module, (A.5) is a free resolution for the  $\mathbf{k}[m]$ -module  $\mathbf{k}$ . It is known as the *Koszul resolution*. It can be shown to be minimal (an exercise).

Let (A.2) be a projective resolution of an  $A$ -module  $M$ , and  $N$  is another  $A$ -module. Applying the functor  $\otimes_A N$  to (A.3) we obtain a homomorphism of cochain complexes

$$(R \otimes_A N, d) \rightarrow (M \otimes_A N, 0),$$

which does not induce a cohomology isomorphism in general. The  $(-i)$ th graded cohomology module of the cochain complex

$$(A.7) \quad \dots \rightarrow R^{-i} \otimes_A N \rightarrow \dots \rightarrow R^{-1} \otimes_A N \rightarrow R^0 \otimes_A N \rightarrow 0$$

is denoted by  $\text{Tor}_A^{-i}(M, N)$ . We shall also consider the bigraded  $A$ -module

$$\text{Tor}_A(M, N) = \bigoplus_{i, j \geq 0} \text{Tor}_A^{-i, j}(M, N)$$

where  $\text{Tor}_A^{-i, j}(M, N)$  is the  $j$ th graded component of  $\text{Tor}_A^{-i}(M, N)$

The following properties of  $\text{Tor}_A^{-i}(M, N)$  are well-known (see e.g. [203]).

**THEOREM A.2.5.**

- (a) The module  $\mathrm{Tor}_A^{-i}(M, N)$  does not depend, up to isomorphism, on a choice of resolution (A.2);
- (b)  $\mathrm{Tor}_A^{-i}(\cdot, N)$  and  $\mathrm{Tor}_A^{-i}(M, \cdot)$  are covariant functors;
- (c)  $\mathrm{Tor}_A^0(M, N) = M \otimes_A N$ ;
- (d)  $\mathrm{Tor}_A^{-i}(M, N) \cong \mathrm{Tor}_A^{-i}(N, M)$ ;
- (e) An exact sequence of  $A$ -modules

$$0 \longrightarrow M_1 \longrightarrow M_2 \longrightarrow M_3 \longrightarrow 0$$

induces the following long exact sequence:

$$\begin{aligned} \cdots \longrightarrow \mathrm{Tor}_A^{-i}(M_1, N) &\longrightarrow \mathrm{Tor}_A^{-i}(M_2, N) \longrightarrow \mathrm{Tor}_A^{-i}(M_3, N) \longrightarrow \cdots \\ \cdots \longrightarrow \mathrm{Tor}_A^{-1}(M_1, N) &\longrightarrow \mathrm{Tor}_A^{-1}(M_2, N) \longrightarrow \mathrm{Tor}_A^{-1}(M_3, N) \\ &\longrightarrow \mathrm{Tor}_A^0(M_1, N) \longrightarrow \mathrm{Tor}_A^0(M_2, N) \longrightarrow \mathrm{Tor}_A^0(M_3, N) \longrightarrow 0. \end{aligned}$$

In the case  $N = \mathbf{k}$  the Tor-modules can be read from a minimal resolution of  $M$  as follows:

PROPOSITION A.2.6. *Let  $\mathbf{k}$  be a field, and let (A.2) be a minimal resolution of an  $A$ -module  $M$ . Then*

$$\begin{aligned} \mathrm{Tor}_A^{-i}(M, \mathbf{k}) &\cong R_{\min}^{-i} \otimes_A \mathbf{k}, \\ \dim_{\mathbf{k}} \mathrm{Tor}_A^{-i}(M, \mathbf{k}) &= \mathrm{rank} R_{\min}^{-i}. \end{aligned}$$

PROOF. Indeed, the differentials in the cochain complex

$$\cdots \longrightarrow R_{\min}^{-i} \otimes_A \mathbf{k} \longrightarrow \cdots \longrightarrow R_{\min}^{-1} \otimes_A \mathbf{k} \longrightarrow R_{\min}^0 \otimes_A \mathbf{k} \longrightarrow 0$$

are all trivial by Proposition A.2.3.  $\square$

COROLLARY A.2.7. *Let  $\mathbf{k}$  be a field, and let  $M$  be a  $A$ -module. Then*

$$\mathrm{pdim} M = \max\{i: \mathrm{Tor}_A^{-i}(M, \mathbf{k}) \neq 0\}.$$

COROLLARY A.2.8. *If  $\mathbf{k}$  is a field, then  $\mathrm{pdim} M \leq m$  for any  $\mathbf{k}[v_1, \dots, v_m]$ -module  $M$ .*

PROOF. By the previous corollary and Theorem A.2.5 (d),

$$\mathrm{pdim} M = \max\{i: \mathrm{Tor}_{\mathbf{k}[m]}^{-i}(M, \mathbf{k}) \neq 0\} = \max\{i: \mathrm{Tor}_{\mathbf{k}[m]}^{-i}(\mathbf{k}, M) \neq 0\}.$$

Using the Koszul resolution for the  $\mathbf{k}[m]$ -module  $\mathbf{k}$  we obtain

$$\begin{aligned} \mathrm{Tor}_{\mathbf{k}[m]}^{-i}(\mathbf{k}, M) &= H^{-i}(\Lambda[u_1, \dots, u_m] \otimes_{\mathbf{k}[m]} M, d) \\ &= H^{-i}(\Lambda[u_1, \dots, u_m] \otimes M, d). \end{aligned}$$

Therefore,

$$\mathrm{pdim} M = \max\{i: \mathrm{Tor}_{\mathbf{k}[m]}^{-i}(\mathbf{k}, M) \neq 0\} \leq \max\{i: \Lambda^i[u_1, \dots, u_m] \otimes M \neq 0\} = m. \quad \square$$

EXAMPLE A.2.9. Let  $A = \mathbf{k}[v_1, \dots, v_m]$  and  $M = N = \mathbf{k}$ . By the minimality of the Koszul resolution,

$$\mathrm{Tor}_{\mathbf{k}[v_1, \dots, v_m]}(\mathbf{k}, \mathbf{k}) = \Lambda[u_1, \dots, u_m]$$

and  $\mathrm{pdim}_A \mathbf{k} = m$ .



We note that in general there is no canonical way to define a multiplication in  $\text{Tor}_A(M, N)$ , even if both  $M$  and  $N$  are  $A$ -algebras rather than just  $A$ -modules. However, in the particular case when  $A = \mathbf{k}[m]$ ,  $M$  is an algebra with a unit and  $N = \mathbf{k}$  there is the following canonical way to define a product in  $\text{Tor}_A(M, N)$ , extending the previous example. We consider the differential bigraded algebra  $(\Lambda[u_1, \dots, u_m] \otimes M, d)$  whose bigrading and differential are defined similarly to (A.4):

$$(A.8) \quad \begin{aligned} \text{bideg } u_i &= (-1, 2), & \text{bideg } x &= (0, \deg x) \quad \text{for } x \in M, \\ du_i &= v_i \cdot 1, & dx &= 0 \end{aligned}$$

(here  $v_i \cdot 1$  is the element of  $M$  obtained by applying  $v_i \in \mathbf{k}[m]$  to  $1 \in M$ , and we identify  $u_i$  with  $u_i \otimes 1$  and  $x$  with  $1 \otimes x$  for simplicity). Using the fact that the cohomology of a differential graded algebra is a graded algebra we obtain:

LEMMA A.2.10. *Let  $M$  be a graded  $\mathbf{k}[v_1, \dots, v_m]$ -algebra. Then  $\text{Tor}_{\mathbf{k}[m]}(M, \mathbf{k})$  is a bigraded  $\mathbf{k}$ -algebra whose product is defined via the isomorphism*

$$\text{Tor}_{\mathbf{k}[v_1, \dots, v_m]}(M, \mathbf{k}) \cong H(\Lambda[u_1, \dots, u_m] \otimes M, d).$$

PROOF. Using the Koszul resolution in the definition of  $\text{Tor}_{\mathbf{k}[m]}(\mathbf{k}, M)$  and Theorem A.2.5 (d) we calculate

$$\begin{aligned} \text{Tor}_{\mathbf{k}[m]}(M, \mathbf{k}) &\cong \text{Tor}_{\mathbf{k}[m]}(\mathbf{k}, M) \\ &= H(\Lambda[u_1, \dots, u_m] \otimes \mathbf{k}[m] \otimes_{\mathbf{k}[m]} M, d) \cong H(\Lambda[u_1, \dots, u_m] \otimes M, d). \quad \square \end{aligned}$$

The algebra  $(\Lambda[u_1, \dots, u_m] \otimes M, d)$  is known as the *Koszul algebra* (or the *Koszul complex*) of  $M$ .

REMARK. Lemma A.2.10 holds also in the case when  $M$  does not have unit (e.g., when it is a graded ideal in  $\mathbf{k}[m]$ ). In this case formula (A.8) for the differential needs to be modified as follows:

$$d(u_i x) = v_i \cdot x, \quad dx = 0 \quad \text{for } x \in M.$$

We finish this discussion of  $\text{Tor}_{\mathbf{k}[m]}(M, \mathbf{k})$  by mentioning an important conjecture of commutative homological algebra.

CONJECTURE A.2.11 (Horrocks, see [46, p. 453]). *Let  $M$  be a graded  $\mathbf{k}[v_1, \dots, v_m]$ -module such that  $\dim_{\mathbf{k}} M < \infty$ , where  $\mathbf{k}$  is a field. Then*

$$\dim_{\mathbf{k}} \text{Tor}_{\mathbf{k}[v_1, \dots, v_m]}^{-i}(M, \mathbf{k}) \geq \binom{m}{i}.$$

It is sometimes formulated in a weaker form:

CONJECTURE A.2.12 (weak Horrocks' Conjecture). *Let  $M$  be a graded  $\mathbf{k}[v_1, \dots, v_m]$ -module such that  $\dim_{\mathbf{k}} M < \infty$ , where  $\mathbf{k}$  is a field. Then*

$$\dim_{\mathbf{k}} \text{Tor}_{\mathbf{k}[v_1, \dots, v_m]}(M, \mathbf{k}) \geq 2^m.$$

If the algebra  $A$  is not necessarily commutative, then  $\text{Tor}_A(M, N)$  is defined for a right  $A$ -module  $M$  and a left  $A$ -module  $N$  in the same way as above. However, in this case  $\text{Tor}_A(M, N)$  is no longer an  $A$ -module, and is just a  $\mathbf{k}$ -vector space. If both  $M$  and  $N$  are  $A$ -bimodules, then  $\text{Tor}_A(M, N)$  is an  $A$ -bimodule itself.

The construction of  $\text{Tor}$  can also be extended to the case of differential graded modules and algebras, see Section B.4.

In the standard notation adopted in the algebraic literature, the modules in a resolution (A.2) are numbered by nonnegative rather than nonpositive integers:

$$\cdots \xrightarrow{d} R^i \xrightarrow{d} \cdots \xrightarrow{d} R^1 \xrightarrow{d} R^0 \rightarrow M \rightarrow 0.$$

In this notation, the  $i$ th Tor-module is denoted by  $\mathrm{Tor}_i^A(M, N)$ ,  $i \geq 0$  (note that (A.7) becomes a chain complex, and  $\mathrm{Tor}_*^A(M, N)$  is its homology). Therefore, the two notations are related by

$$\mathrm{Tor}_A^{-i}(M, N) = \mathrm{Tor}_i^A(M, N).$$

Applying the functor  $\mathrm{Hom}_A(\cdot, N)$  to (A.3) (with  $R^{-i}$  replaced by  $R^i$ ) we obtain the cochain complex

$$0 \rightarrow \mathrm{Hom}_A(R^0, N) \rightarrow \mathrm{Hom}_A(R^1, N) \rightarrow \cdots \rightarrow \mathrm{Hom}_A(R^i, N) \rightarrow \cdots.$$

Its  $i$ th cohomology module is denoted by  $\mathrm{Ext}_A^i(M, N)$ .

The properties of the functor  $\mathrm{Ext}$  are similar to those given by Theorem A.2.5 for  $\mathrm{Tor}$ , with the exception of (d):

**THEOREM A.2.13.**

- (a) *The module  $\mathrm{Ext}_A^i(M, N)$  does not depend, up to isomorphism, on a choice of resolution (A.2);*
- (b)  *$\mathrm{Ext}_A^i(\cdot, N)$  is a contravariant functor, and  $\mathrm{Ext}_A^i(M, \cdot)$  is a covariant functor;*
- (c)  *$\mathrm{Ext}_A^0(M, N) = \mathrm{Hom}_A(M, N)$ ;*
- (d) *An exact sequence of  $A$ -modules*

$$0 \rightarrow M_1 \rightarrow M_2 \rightarrow M_3 \rightarrow 0$$

*induces the following long exact sequence:*

$$\begin{aligned} 0 \rightarrow \mathrm{Ext}_A^0(M_3, N) \rightarrow \mathrm{Ext}_A^0(M_2, N) \rightarrow \mathrm{Ext}_A^0(M_1, N) \\ \rightarrow \mathrm{Ext}_A^1(M_3, N) \rightarrow \mathrm{Ext}_A^1(M_2, N) \rightarrow \mathrm{Ext}_A^1(M_1, N) \rightarrow \cdots \\ \cdots \rightarrow \mathrm{Ext}_A^i(M_3, N) \rightarrow \mathrm{Ext}_A^i(M_2, N) \rightarrow \mathrm{Ext}_A^i(M_1, N) \rightarrow \cdots; \end{aligned}$$

- (e) *An exact sequence of  $A$ -modules*

$$0 \rightarrow N_1 \rightarrow N_2 \rightarrow N_3 \rightarrow 0$$

*induces the following long exact sequence:*

$$\begin{aligned} 0 \rightarrow \mathrm{Ext}_A^0(M, N_1) \rightarrow \mathrm{Ext}_A^0(M, N_2) \rightarrow \mathrm{Ext}_A^0(M, N_3) \\ \rightarrow \mathrm{Ext}_A^1(M, N_1) \rightarrow \mathrm{Ext}_A^1(M, N_2) \rightarrow \mathrm{Ext}_A^1(M, N_3) \rightarrow \cdots \\ \cdots \rightarrow \mathrm{Ext}_A^i(M, N_1) \rightarrow \mathrm{Ext}_A^i(M, N_2) \rightarrow \mathrm{Ext}_A^i(M, N_3) \rightarrow \cdots. \end{aligned}$$

### Exercises.

A.2.14. Show that a free resolution exists for every  $A$ -module  $M$ . (Hint: use the fact that every module is the quotient of a free module.)

A.2.15. If  $\mathbf{k}$  is a field and  $A = \mathbf{k}[m]$ , then every projective graded  $A$ -module is free (hint: see [203, Lemma VII.6.2]). This is also true in the ungraded case, but is much harder to prove (a theorem of Quillen and Suslin, settling the famous problem of Serre). More generally, if  $A$  is a finitely generated nonnegatively graded commutative connected algebra over a field  $\mathbf{k}$ , then every projective  $A$ -module is

free (see [106, Theorem A3.2]). Give an example of a projective module over a ring which is not free.

A.2.16. The Koszul resolution is minimal.

### A.3. Regular sequences and Cohen–Macaulay algebras

Cohen–Macaulay algebras and modules play an important role in commutative algebra, algebraic geometry and combinatorics. Their definition uses the notion of a regular sequence (see Definition A.3.1 below), which also plays an important role in algebraic topology, namely in the construction of new cohomology theories (see [191] and Appendix, Section E.3). In the case of finitely generated algebras over a field  $\mathbf{k}$ , an algebra is Cohen–Macaulay if and only if it is a free module of finite rank over a polynomial subalgebra.

Here we consider nonnegatively evenly graded finitely generated commutative connected algebras  $A$  over a field  $\mathbf{k}$  and finitely generated nonnegatively graded  $A$ -modules  $M$  (the case  $\mathbf{k} = \mathbb{Z}$  requires extra care, and is treated separately in some particular cases in the main chapters of the book). The positive part  $A^+$  is the unique homogeneous maximal ideal of  $A$ , and the results we discuss here are parallel to those from the homological theory of Noetherian local rings (we refer to [45, Chapters 1–2] or [106, Chapter 19] for the details).

Given a sequence of elements  $\mathbf{t} = (t_1, \dots, t_k)$  of  $A$ , we denote by  $A/\mathbf{t}$  the quotient of  $A$  by the ideal generated by  $\mathbf{t}$ , and denote by  $M/\mathbf{t}M$  the quotient of  $M$  by the submodule  $t_1M + \dots + t_kM$ . An element  $t \in A$  is called a *zero divisor* on  $M$  if  $tx = 0$  for some nonzero  $x \in M$ . An element  $t \in A$  is not a zero divisor on  $M$  if and only if the map  $M \xrightarrow{t} M$  given by multiplication by  $t$  is injective.

DEFINITION A.3.1. Let  $M$  be an  $A$ -module. A homogeneous sequence  $\mathbf{t} = (t_1, \dots, t_k) \in \mathcal{H}(A^+)$  is called an  *$M$ -regular sequence* if  $t_{i+1}$  is not a zero divisor on  $M/(t_1M + \dots + t_iM)$  for  $0 \leq i < k$ . We often refer to  $A$ -regular sequences simply as *regular*.

The importance of regular sequences in homological algebra builds on the fundamental fact that an exact sequence of modules remains exact after taking quotients by a regular sequence:

PROPOSITION A.3.2. Assume given an exact sequence of  $A$ -modules:

$$\dots \longrightarrow S^i \xrightarrow{f_i} S^{i-1} \xrightarrow{f_{i-1}} \dots \xrightarrow{f_1} S^0 \xrightarrow{f_0} M \longrightarrow 0$$

If  $\mathbf{t}$  is an  $M$ -regular and  $S^i$ -regular sequence for all  $i \geq 0$ , then

$$\dots \longrightarrow S^i/\mathbf{t}S^i \xrightarrow{\bar{f}_i} S^{i-1}/\mathbf{t}S^{i-1} \xrightarrow{\bar{f}_{i-1}} \dots \xrightarrow{\bar{f}_1} S^0/\mathbf{t}S^0 \xrightarrow{\bar{f}_0} M/\mathbf{t}M \longrightarrow 0$$

is an exact sequence of  $A/\mathbf{t}$ -modules.

PROOF. Using induction we reduce the statement to the case when  $\mathbf{t}$  consists of a single element  $t$ . Since

$$S^i/\mathbf{t}S^i = S^i \otimes_A (A/\mathbf{t}),$$

and  $\otimes_A(A/\mathbf{t})$  is a right exact functor, it is enough to verify exactness of the quotient sequence starting from the term  $S^1/\mathbf{t}S^1$ .

Consider the following fragment of the quotient sequence ( $i \geq 1$ ):

$$S^{i+1}/tS^{i+1} \xrightarrow{\bar{f}_{i+1}} S^i/tS^i \xrightarrow{\bar{f}_i} S^{i-1}/tS^{i-1} \xrightarrow{\bar{f}_{i-1}} S^{i-2}/tS^{i-2}$$

(where we denote  $S^{-1} = M$ ). For any element  $x \in S^i$  we denote by  $\bar{x}$  its residue class in  $S^i/tS^i$ . Let  $\bar{f}_i(\bar{x}) = 0$ , then  $f_i(x) = ty$  for some  $y \in S^{i-1}$  and  $tf_{i-1}(y) = 0$ . Since  $t$  is  $S^{i-2}$ -regular, we have  $f_{i-1}(y) = 0$ . Hence, there is  $x' \in S^i$  such that  $y = f_i(x')$ . This implies that  $f_i(x - tx') = 0$ . Therefore,  $x - tx' \in f_{i+1}(S^{i+1})$  and  $\bar{x} \in \bar{f}_{i+1}(S^{i+1}/tS^{i+1})$ . Thus, the quotient sequence is exact.  $\square$

The following proposition is often used as the definition of regular sequences:

**PROPOSITION A.3.3.** *A sequence  $t_1, \dots, t_k \in \mathcal{H}(A^+)$  is  $M$ -regular if and only if  $M$  is a free (not necessarily finitely generated)  $\mathbf{k}[t_1, \dots, t_k]$ -module.*

**PROOF.** If  $M$  is a free  $\mathbf{k}[t_1, \dots, t_k]$ -module, then  $M/(t_1M + \dots + t_{i-1}M)$  is a free  $\mathbf{k}[t_i, \dots, t_k]$ -module, which implies that  $t_i$  is  $M/(t_1M + \dots + t_{i-1}M)$ -regular for  $1 \leq i \leq k$ . Therefore,  $t_1, \dots, t_k$  is an  $M$ -regular sequence.

Conversely, let  $\mathbf{t} = (t_1, \dots, t_k)$  be an  $M$ -regular sequence. Consider a minimal resolution  $(R_{\min}, d)$  for the  $\mathbf{k}[\mathbf{t}]$ -module  $M$ . Then, by Proposition A.3.2, the sequence of  $\mathbf{k}$ -modules

$$\dots \longrightarrow R_{\min}^{-1}/\mathbf{t}R_{\min}^{-1} \longrightarrow R_{\min}^0/\mathbf{t}R_{\min}^0 \longrightarrow M/\mathbf{t}M \longrightarrow 0$$

is exact. Note that  $R_{\min}^{-i}/\mathbf{t}R_{\min}^{-i} = R_{\min}^{-i} \otimes_{\mathbf{k}[\mathbf{t}]} \mathbf{k}$ . Since the resolution is minimal, the map  $R_{\min}^0 \otimes_{\mathbf{k}[\mathbf{t}]} \mathbf{k} \rightarrow M \otimes_{\mathbf{k}[\mathbf{t}]} \mathbf{k}$  is an isomorphism. Hence,  $R_{\min}^{-i} \otimes_{\mathbf{k}[\mathbf{t}]} \mathbf{k} = 0$  for  $i > 0$ , which implies that  $R_{\min}^{-i} = 0$ . Thus,  $R_{\min}^0 \rightarrow M$  is an isomorphism, i.e.  $M$  is a free  $\mathbf{k}[\mathbf{t}]$ -module.  $\square$

The following is a direct corollary of Proposition A.3.3:

**PROPOSITION A.3.4.** *The property of being a regular sequence does not depend on the order of elements in  $\mathbf{t} = (t_1, \dots, t_k)$ .*

**LEMMA A.3.5.** *Let  $\mathbf{t}$  be a sequence of elements of  $A$  which is  $A$ -regular and  $M$ -regular. Then*

$$\text{Tor}_A^{-i}(M, \mathbf{k}) = \text{Tor}_{A/\mathbf{t}}^{-i}(M/\mathbf{t}M, \mathbf{k}).$$

**PROOF.** Applying Proposition A.3.2 to a minimal resolution of  $M$ , we obtain a minimal resolution of the  $A/\mathbf{t}$ -module  $M/\mathbf{t}M$ . The rest follows from Proposition A.2.6.  $\square$

An  $M$ -regular sequence is *maximal* if it is not contained in an  $M$ -regular sequence of greater length.

**THEOREM A.3.6 (D. Rees).** *All maximal  $M$ -regular sequences in  $A$  have the same length given by*

$$(A.9) \quad \text{depth}_A M = \min\{i: \text{Ext}_A^i(\mathbf{k}, M) \neq 0\}.$$

This number given by (A.9) is referred to as the *depth* of  $M$ ; the simplified notation  $\text{depth } M$  will be used whenever it creates no confusion. The proof of Theorem A.3.6 uses the following fact:

**LEMMA A.3.7.** *Let  $\mathbf{t} = (t_1, \dots, t_n) \in \mathcal{H}(A^+)$  be a  $M$ -regular sequence. Then*

$$\text{Ext}_A^n(\mathbf{k}, M) \cong \text{Hom}_A(\mathbf{k}, M/\mathbf{t}M).$$

PROOF. We use induction on  $n$ . The case  $n = 0$  is tautological. It follows from Lemma A.3.4 that  $t_n$  is an  $M$ -regular element, so we have the exact sequence

$$0 \longrightarrow M \xrightarrow{-t_n} M \longrightarrow M/t_n M \longrightarrow 0.$$

The map  $\text{Ext}_A^i(\mathbf{k}, M) \rightarrow \text{Ext}_A^i(\mathbf{k}, M)$  induced by multiplication by  $t_n$  is zero (an exercise). Therefore, the second long exact sequence for  $\text{Ext}$  induced by the short exact sequence above splits into short exact sequences of the form

$$0 \longrightarrow \text{Ext}_A^{n-1}(\mathbf{k}, M) \longrightarrow \text{Ext}_A^{n-1}(\mathbf{k}, M/t_n M) \longrightarrow \text{Ext}_A^n(\mathbf{k}, M) \longrightarrow 0.$$

Let  $\mathbf{t}' = (t_1, \dots, t_{n-1})$ . By induction,

$$\text{Ext}_A^{n-1}(\mathbf{k}, M) \cong \text{Hom}_A(\mathbf{k}, M/\mathbf{t}'M) = 0,$$

where the latter identity follows from Exercise A.3.17, since  $t_n$  is  $M/\mathbf{t}'M$ -regular. Now the exact sequence above implies that

$$\text{Ext}_A^n(\mathbf{k}, M) \cong \text{Ext}_A^{n-1}(\mathbf{k}, M/t_n M) \cong \text{Hom}_A(\mathbf{k}, M/\mathbf{t}M),$$

where the latter identity follows by induction. □

PROOF OF THEOREM A.3.6. Let  $\mathbf{t} = (t_1, \dots, t_n)$  be a maximal  $M$ -regular sequence. Then, by Lemma A.3.7 and Exercise A.3.17,

$$\text{Ext}_A^n(\mathbf{k}, M) \cong \text{Hom}_A(\mathbf{k}, M/\mathbf{t}M) \neq 0,$$

as  $A$  does not contain an  $M/\mathbf{t}M$ -regular element. On the other hand,

$$\text{Ext}_A^i(\mathbf{k}, M) \cong \text{Hom}_A(\mathbf{k}, M/(t_1 M + \dots + t_i M)) = 0$$

for  $i < n$ , since  $t_{i+1}$  is  $M/(t_1 M + \dots + t_i M)$ -regular. □

The following fundamental result relates the depth to the projective dimension:

THEOREM A.3.8 (Auslander–Buchsbaum). *Let  $M \neq 0$  be an  $A$ -module such that  $\text{pdim } M < \infty$ . Then*

$$\text{pdim } M + \text{depth } M = \text{depth } A.$$

PROOF. First let  $\text{depth } A = 0$ . Assume that  $\text{pdim } M = p > 0$ . Consider the minimal resolution for  $M$  (which is finite by hypothesis):

$$0 \rightarrow R_{\min}^{-p} \xrightarrow{d_p} R_{\min}^{-p+1} \longrightarrow \dots \longrightarrow R_{\min}^0 \longrightarrow M \rightarrow 0.$$

Since  $\text{depth } A = 0$ , we have  $\text{Hom}_A(\mathbf{k}, A) = \text{Ext}_A^0(\mathbf{k}, A) \neq 0$  by Theorem A.3.6, i.e. there is a monomorphism of  $A$ -modules  $i: \mathbf{k} \rightarrow A$ . In the commutative diagram

$$\begin{array}{ccc} R^{-p} \otimes_A \mathbf{k} & \xrightarrow{d_p \otimes_A \mathbf{k}} & R^{-p+1} \otimes_A \mathbf{k} \\ \text{id} \otimes_A i \downarrow & & \downarrow \text{id} \otimes_A i \\ R^{-p} & \xrightarrow{d_p} & R^{-p+1} \end{array}$$

the maps  $d_p$  and  $\text{id} \otimes_A i$  are injective (the latter because the module  $R^{-p}$  is free). Hence  $d_p \otimes_A \mathbf{k}$  is also injective, which contradicts minimality of the resolution. We obtaine  $\text{pdim } M = 0$ , i.e.  $M$  is a free  $A$ -module and  $\text{depth } M = \text{depth } A = 0$ .

Now let  $\text{depth } A > 0$ . Assume that  $\text{depth } M = 0$ . Consider the first syzygy module  $M_1 = \text{Ker}[R^0 \rightarrow M]$  for  $M$ . It follows from (A.9) and the exact sequence for  $\text{Ext}$  that  $\text{depth } M_1 = 1$ . Since  $\text{pdim } M_1 = \text{pdim } M - 1$ , it is enough to prove the Auslander–Buchsbaum formula for the module  $M_1$ . Hence, we may assume that

$\text{depth } M > 0$ . This implies that there is an element  $t \in A$  which is  $A$ -regular and  $M$ -regular (an exercise). Then

$$\text{depth}_{A/t} A/t = \text{depth}_A A - 1, \quad \text{depth}_{A/t} M/tM = \text{depth}_A M - 1$$

by the definition of depth, and

$$\text{pdim}_{A/t} M/tM = \text{pdim}_A M$$

by Corollary A.2.7 and Lemma A.3.5. Now we finish by induction on  $\text{depth } A$ .  $\square$

The *dimension* of  $A$ , denoted  $\dim A$ , is the maximal number of elements of  $A$  algebraically independent over  $\mathbf{k}$ . The *dimension* of an  $A$ -module  $M$  is  $\dim M = \dim(A/\text{Ann } M)$ , where  $\text{Ann } M = \{a \in A : aM = 0\}$  is the *annihilator* of  $M$ .

DEFINITION A.3.9. A sequence  $t_1, \dots, t_n$  of algebraically independent homogeneous elements of  $A$  is called a *homogeneous system of parameters* (briefly *hsop*) for  $M$  if  $\dim M/(t_1M + \dots + t_nM) = 0$ . Equivalently,  $t_1, \dots, t_n$  is an *hsop* if  $n = \dim M$  and  $M$  is a finitely-generated  $\mathbf{k}[t_1, \dots, t_n]$ -module.

An *hsop* consisting of linear elements (i.e. elements of lowest positive degree 2) is referred to as a *linear system of parameters* (briefly *lsop*).

The following result (due to Hilbert) is a graded version of the well-known *Noether Normalisation Lemma*:

THEOREM A.3.10 ([45, Theorem 1.5.17]). *An hsop exists for any  $A$ -module  $M$ . If  $\mathbf{k}$  is an infinite field and  $A$  is generated by degree-two elements, then a lsop can be chosen for  $M$ .*

It is easy to see that a regular sequence consists of algebraically independent elements, which implies that  $\text{depth } M \leq \dim M$ .

DEFINITION A.3.11.  $M$  is a *Cohen–Macaulay  $A$ -module* if  $\text{depth } M = \dim M$ , that is, if  $A$  contains an  $M$ -regular sequence  $t_1, \dots, t_n$  of length  $n = \dim M$ . If  $A$  is a Cohen–Macaulay  $A$ -module, then it is called a *Cohen–Macaulay algebra*.

By Proposition A.3.13,  $A$  is a Cohen–Macaulay algebra if and only if it is a free finitely generated module over a polynomial subalgebra.

PROPOSITION A.3.12. *Let  $M$  be a Cohen–Macaulay  $A$ -module. Then a sequence  $\mathbf{t} = (t_1, \dots, t_k) \in \mathcal{H}(A^+)$  is  $M$ -regular if and only if it is a part of an *hsop* for  $M$ .*

PROOF. Let  $\dim M = n$ . Assume that  $\mathbf{t}$  is an  $M$ -regular sequence. The fact that  $t_i$  is an  $M/(t_1M + \dots + t_{i-1}M)$ -regular element implies that

$$\dim M/(t_1M + \dots + t_iM) = \dim M/(t_1M + \dots + t_{i-1}M) - 1, \quad i = 1, \dots, k$$

(an exercise). Therefore,  $\dim M/\mathbf{t}M = n - k$ , i.e.  $\mathbf{t}$  is a part of an *hsop* for  $M$ .

For the other direction, see [45, Theorem 2.1.2 (c)].  $\square$

In particular, any *hsop* in a Cohen–Macaulay algebra  $A$  is regular.

PROPOSITION A.3.13. *An algebra is Cohen–Macaulay if and only if it is a free finitely generated module over a polynomial subalgebra.*

PROOF. Assume that  $A$  is Cohen–Macaulay and  $\dim A = n$ . Then there is a regular sequence  $\mathbf{t} = (t_1, \dots, t_n)$  in  $A$ . By the previous proposition,  $\mathbf{t}$  is an *hsop*, so that  $\dim A/\mathbf{t} = 0$  and therefore  $A$  is a finitely generated  $\mathbf{k}[t_1, \dots, t_n]$ -module. This module is also free by Proposition A.3.3.

On the other hand, if  $A$  is free finitely generated over  $\mathbf{k}[t_1, \dots, t_n]$  where  $t_1, \dots, t_n \in A$ , then  $\dim A = n$  and  $t_1, \dots, t_n$  is a regular sequence by Proposition A.3.3, so that  $A$  is Cohen–Macaulay.  $\square$

PROPOSITION A.3.14. *If  $A$  is Cohen–Macaulay with an lsop  $\mathbf{t} = (t_1, \dots, t_n)$ , then there is the following formula for the Poincaré series of  $A$ :*

$$F(A; \lambda) = \frac{F(A/(t_1, \dots, t_n); \lambda)}{(1 - \lambda^2)^n},$$

where  $F(A/(t_1, \dots, t_n); \lambda)$  is a polynomial with nonnegative integer coefficients.

PROOF. Since  $A$  is a free finitely generated module over  $\mathbf{k}[t_1, \dots, t_n]$ , we have an isomorphism of  $\mathbf{k}$ -vector spaces  $A \cong (A/\mathbf{t}) \otimes \mathbf{k}[t_1, \dots, t_n]$ . Calculating the Poincaré series of both sides yields the required formula.  $\square$

REMARK. If  $A$  is generated by its elements  $a_1, \dots, a_n$  of positive degrees  $d_1, \dots, d_n$  respectively, then it may be shown that the Poincaré series of  $A$  is a rational function of the form

$$F(A; \lambda) = \frac{P(\lambda)}{(1 - \lambda^{d_1})(1 - \lambda^{d_2}) \dots (1 - \lambda^{d_n})},$$

where  $P(\lambda)$  is a polynomial with integer coefficients. However, in general the polynomial  $P(\lambda)$  cannot be given explicitly, and some of its coefficients may be negative.

### Exercises.

A.3.15. An  $M$ -regular sequence consists of algebraically independent elements.

A.3.16. The map  $\text{Ext}_A^i(\mathbf{k}, M) \rightarrow \text{Ext}_A^i(\mathbf{k}, M)$  induced by multiplication by an element  $x \in \mathcal{H}(A^+)$  is zero.

A.3.17. The following conditions are equivalent for an  $A$ -module  $M$ :

- (a) Every element of  $\mathcal{H}(A^+)$  is a zero divisor on  $M$ , i.e.  $\text{depth } M = 0$ ;
- (b)  $\text{Hom}_A(\mathbf{k}, M) \neq 0$ .

(Hint: show that if  $\mathcal{H}(A^+)$  consists of zero divisors on  $M$  then the ideal  $A^+$  annihilates a homogeneous element of  $M$ , see [106, Corollary 3.2].)

A.3.18. Let  $\text{depth } A > 0$ , let  $M$  be an  $A$ -module with  $\text{depth } M = 0$ , and let  $M_1 = \text{Ker}[R^0 \rightarrow M]$  be the first syzygy module for  $M$ . Then  $\text{depth } M_1 = 1$ .

A.3.19. If  $\text{depth } A > 0$  and  $\text{depth } M > 0$ , then there exists an element  $t \in A$  which is  $A$ -regular and  $M$ -regular.

A.3.20. Theorem A.3.8 does not hold if  $\text{pdim } M = \infty$ .

A.3.21. Show that  $\dim A = 0$  if and only if  $A$  is finite-dimensional as a  $\mathbf{k}$ -vector space. Is it true that  $\text{depth } A = 0$  implies that  $\dim_{\mathbf{k}} A$  is finite?

A.3.22. Give an example of an algebra  $A$  over a field  $\mathbf{k}$  of finite characteristic which is generated by linear elements, but does not have an lsop.

A.3.23. A regular sequence consists of algebraically independent elements.

A.3.24. If  $t \in \mathcal{H}(A^+)$  is an  $M$ -regular element, then  $\dim M/tM = \dim M - 1$ .

A.3.25. Let  $\mathbf{k} = \mathbb{Z}$ . Show that if  $A$  is a free finitely generated module over a polynomial subalgebra  $\mathbb{Z}[t_1, \dots, t_k]$  then  $t_{i+1}$  is not a zero divisor on  $A/(t_1, \dots, t_i)$  for  $0 \leq i < k$ , but the converse is not true. Therefore, the two possible definitions of a regular sequence over  $\mathbb{Z}$  do not agree. (The reason why Proposition A.3.13 fails over  $\mathbb{Z}$  is that minimal resolutions do not have the required good properties, see the remark after Construction A.2.2.)

#### A.4. Formality and Massey products

Here we develop the algebraic formalism used in rational homotopy theory. We work with dg-algebras  $A = \bigoplus_{i \geq 0} A^i$  over a field  $\mathbf{k}$  of zero characteristic (usually  $\mathbb{R}$  or  $\mathbb{Q}$ ). We do not assume  $A$  to be finitely generated. Commutativity of dg-algebras is always understood in the graded sense.

A dg-algebra  $A$  is called *homologically connected* if  $H^0(A, d) = \mathbf{k}$ .

Recall that a homomorphism between dg-algebras  $(A, d_A)$  and  $(B, d_B)$  is a  $\mathbf{k}$ -linear map  $f: A \rightarrow B$  which preserves degrees, i.e.  $f(A^i) \subset B^i$ , and satisfies  $f(ab) = f(a)f(b)$  and  $d_B f(a) = f(d_A a)$  for all  $a, b \in A$ . Such a homomorphism induces a homomorphism  $\tilde{f}: H(A, d_A) \rightarrow H(B, d_B)$  of cohomology algebras. We refer to  $f$  as a *quasi-isomorphism* if  $\tilde{f}$  is an isomorphism. The equivalence relation generated by quasi-isomorphisms of dg-algebras is referred to as *weak equivalence*. Since quasi-isomorphisms are often not invertible, a weak equivalence between  $A$  and  $B$  implies only the existence of a zigzag of quasi-isomorphisms of the form

$$A \leftarrow A_1 \rightarrow A_2 \leftarrow A_3 \rightarrow \cdots \leftarrow A_k \rightarrow B.$$

A dg-algebra  $B$  weakly equivalent to  $A$  is called a *model* of  $A$ . The above ‘long’ zigzag of quasi-isomorphisms can be reduced to a ‘short’ zigzag  $A \leftarrow M \rightarrow B$  using the notion of a minimal model.

DEFINITION A.4.1. A commutative dg-algebra  $M = \bigoplus_{i \geq 0} M^i$  is called *minimal* (in the sense of Sullivan) if the following three conditions are satisfied:

- (a)  $M^0 = \mathbf{k}$  and  $d(M^0) = 0$ ;
- (b)  $M$  is a free commutative dg-algebra, i.e.

$$M = \Lambda[x_k : \deg x_k \text{ is odd}] \otimes \mathbf{k}[x_k : \deg x_k \text{ is even}],$$

there are only finitely many generators in each degree, and

$$\deg x_k \leq \deg x_l \quad \text{for } k \leq l;$$

- (c)  $dx_k$  is a polynomial on generators  $x_1, \dots, x_{k-1}$ , for each  $k \geq 1$  (this is called the *nilpotence condition* on  $d$ ).

Clearly, a minimal dg-algebra  $M$  is *simply connected* (i.e.  $H^1(M, d) = 0$ ) if and only if  $M^1 = 0$ . In this case  $\deg x_k \geq 2$  for each  $k$ , and the nilpotence condition is equivalent to the *decomposability* of  $d$ , i.e.

$$d(M) \subset M^+ \cdot M^+,$$

where  $M^+$  is the subspace generated by elements of positive degree. For non-simply connected dg-algebras decomposability does not imply nilpotence: the algebra  $\Lambda[x, y]$ ,  $\deg x = \deg y = 1$ , with  $dx = 0$ ,  $dy = xy$  is not minimal.

DEFINITION A.4.2. A minimal dg-algebra  $M$  is called a *minimal model* for a commutative dg-algebra  $A$  if there is a quasi-isomorphism  $h: M \rightarrow A$ .



THEOREM A.4.3.

- (a) For each homologically connected commutative dg-algebra  $A$  satisfying the condition  $\dim H^i[A] < \infty$  for all  $i$ , there exists a minimal model  $M_A$ , which is unique up to isomorphism.
- (b) A homomorphism of commutative dg-algebras  $f: A \rightarrow B$  lifts to a homomorphism  $\widehat{f}: M_A \rightarrow M_B$  closing the commutative diagram

$$\begin{array}{ccc} M_A & \xrightarrow{\widehat{f}} & M_B \\ h_A \downarrow & & \downarrow h_B \\ A & \xrightarrow{f} & B. \end{array}$$

- (c) If  $f$  is a quasi-isomorphism, then  $\widehat{f}$  is an isomorphism.

REMARK. Minimal models can be also defined for dg-algebras  $A$  which do not satisfy the finiteness condition  $\dim H^i[A] < \infty$ , but we shall not need this.

This theorem is due to Sullivan (simply connected case) and Halperin (general). A proof can be found in [194, Theorem II.6] or [112, §12].

COROLLARY A.4.4. A weak equivalence between two commutative dg-algebras  $A, B$  satisfying the condition of Theorem A.4.3 can be represented by a ‘short’ zigzag  $A \leftarrow M \rightarrow B$  of quasi-isomorphisms, where  $M$  is the minimal model for  $A$  (or  $B$ ).

DEFINITION A.4.5. A dg-algebra is  $A$  called *formal* if it is weakly equivalent to its cohomology  $H[A]$  (viewed as a dg-algebra with zero differential).

COROLLARY A.4.6. A commutative dg-algebra  $A$  with the minimal model  $M_A$  is formal if and only if  $M_A$  is formal. In this case there is a zigzag of quasi-isomorphisms  $A \leftarrow M_A \rightarrow H[A]$ .

If  $A$  is formal with minimal model  $M_A$ , then the minimal model can be recovered from the cohomology algebra  $H[A]$  using an inductive procedure.

REMARK. Even if  $A$  is formal, the zigzag  $A \leftarrow M_A \rightarrow H[A]$  usually cannot be reduced to a single quasi-isomorphism  $A \rightarrow H[A]$  or  $H[A] \rightarrow A$ .

EXAMPLE A.4.7. Let  $M$  be a dg-algebra with three generators  $a_1, a_2, a_3$  of degree 1 and differential given by

$$da_1 = da_2 = 0, \quad da_3 = a_1a_2.$$

This  $M$  is minimal, but not formal. Indeed the first degree cohomology  $H^1[M]$  is generated by the classes  $\alpha_1, \alpha_2$  corresponding to the cocycles  $a_1, a_2$ , and we have  $\alpha_1\alpha_2 = 0$ . Assume there is a quasi-isomorphism  $f: M \rightarrow H[M]$ ; then we have  $f(a_3) = k_1\alpha_1 + k_2\alpha_2$  for some  $k_1, k_2 \in \mathbf{k}$ . This implies that  $f(a_1a_3) = 0$ , which is impossible since  $a_1a_3$  represents a nontrivial cohomology class.

We next review Massey products, which provide a simple and effective tool for establishing nonformality of a dg-algebra. Massey products constitute a series of higher-order operations (or *brackets*) in the cohomology of a dg-algebra, with the second-order operation coinciding with the cohomology multiplication, while the higher-order brackets are only defined for certain tuples of cohomology classes. We shall only consider triple (third-order) Massey products here.

CONSTRUCTION A.4.8 (triple Massey product). Let  $A$  be a dg-algebra, and let  $\alpha_1, \alpha_2, \alpha_3$  be three cohomology classes such that  $\alpha_1\alpha_2 = \alpha_2\alpha_3 = 0$  in  $H[A]$ . Choose their representing cocycles  $a_i \in A^{k_i}$ ,  $i = 1, 2, 3$ . Since the pairwise cohomology products vanish, there are elements  $a_{12} \in A^{k_1+k_2-1}$  and  $a_{23} \in A^{k_2+k_3-1}$  such that

$$da_{12} = a_1a_2 \quad \text{and} \quad da_{23} = a_2a_3.$$

Then one easily checks that

$$(-1)^{k_1+1}a_1a_{23} + a_{12}a_3$$

is a cocycle in  $A^{k_1+k_2+k_3-1}$ . Its cohomology class is called a (triple) *Massey product* of  $\alpha_1, \alpha_2$  and  $\alpha_3$ , and denoted by  $\langle \alpha_1, \alpha_2, \alpha_3 \rangle$ .

More precisely, the Massey product  $\langle \alpha_1, \alpha_2, \alpha_3 \rangle$  is the set of all elements in  $H^{k_1+k_2+k_3-1}[A]$  obtained by the above procedure. Since there are choices of  $a_{12}$  and  $a_{23}$  involved, the set  $\langle \alpha_1, \alpha_2, \alpha_3 \rangle$  may consist of more than one element. In fact,  $a_{12}$  is defined up to addition of a cocycle in  $A^{k_1+k_2-1}$ , and  $a_{23}$  is defined up to a cocycle in  $A^{k_2+k_3-1}$ . Therefore, any two elements in  $\langle \alpha_1, \alpha_2, \alpha_3 \rangle$  differ by an element of the subset

$$\alpha_1 \cdot H^{k_2+k_3-1}[A] + \alpha_3 \cdot H^{k_1+k_2-1}[A] \subset H^{k_1+k_2+k_3-1}[A],$$

which is called the *indeterminacy* of the Massey product  $\langle \alpha_1, \alpha_2, \alpha_3 \rangle$ .

A Massey product  $\langle \alpha_1, \alpha_2, \alpha_3 \rangle$  is called *trivial* (or *vanishing*) if it contains zero. Clearly, a Massey product  $\langle \alpha_1, \alpha_2, \alpha_3 \rangle$  is trivial if and only if its image in the quotient algebra  $H[A]/(\alpha_1, \alpha_3)$  is zero.

PROPOSITION A.4.9. *Let  $f: A \rightarrow B$  be a quasi-isomorphism of dg-algebras. Then all Massey products in  $H[A]$  are trivial if and only if they are all trivial in  $H[B]$ .*

PROOF. Assume that all Massey products in  $H[B]$  are trivial. Let  $\langle \alpha_1, \alpha_2, \alpha_3 \rangle$  be a Massey product in  $H[A]$ . We define elements  $a_1, a_2, a_3, a_{12}, a_{23} \in A$  as in Construction A.4.8, and set  $b_i = f(a_i)$ ,  $b_{ij} = f(a_{ij})$ . Let  $\beta_i$  denote the cohomology class corresponding to the cocycle  $b_i$ . Since  $\beta_1\beta_2 = \tilde{f}(\alpha_1\alpha_2) = 0$  and  $\beta_2\beta_3 = 0$ , the Massey product  $\langle \beta_1, \beta_2, \beta_3 \rangle$  is defined. By the assumption,  $0 \in \langle \beta_1, \beta_2, \beta_3 \rangle$ . This means that we may choose  $b'_{12}, b'_{23} \in B$  in such a way that

$$b_1b_2 = db'_{12}, \quad b_2b_3 = db'_{23}, \quad \text{and} \quad (-1)^{k_1+1}b_1b'_{23} + b'_{12}b_3 = db_{123}$$

for some  $b_{123} \in B^{k_1+k_2+k_3-2}$ . Since  $db_{12} = b_1b_2$ , we have  $d(b'_{12} - b_{12}) = 0$ . Since  $f: A \rightarrow B$  is a quasi-isomorphism, there is a cocycle  $c_{12} \in A$  such that  $f(c_{12}) = b'_{12} - b_{12}$ , and similarly there is a cocycle  $c_{23} \in A$  such that  $f(c_{23}) = b'_{23} - b_{23}$ . Set

$$a'_{12} = a_{12} + c_{12}, \quad a'_{23} = a_{23} + c_{23}.$$

Then  $da'_{12} = da_{12} = a_1a_2$  and similarly  $da'_{23} = a_2a_3$ . Therefore, the cohomology class of  $c = (-1)^{k_1+1}a_1a'_{23} + a'_{12}a_3$  is a Massey product of  $\alpha_1, \alpha_2, \alpha_3$ . Then

$$f(c) = (-1)^{k_1+1}b_1b'_{23} + b'_{12}b_3 = db_{123}.$$

Since  $f$  is a quasi-isomorphism,  $c$  is a coboundary, i.e.  $c = da_{123}$  for some  $a_{123} \in A$ . Therefore, the Massey product  $\langle \alpha_1, \alpha_2, \alpha_3 \rangle$  is trivial.

The fact that the triviality of Massey products in  $H[A]$  implies their triviality in  $H[B]$  is proved similarly (an exercise).  $\square$

COROLLARY A.4.10. *If a dg-algebra  $A$  is formal, then all Massey products in  $H[A]$  are trivial.*

PROOF. Apply Proposition A.4.9 to a zigzag  $A \leftarrow \cdots \rightarrow H[A]$  of quasi-isomorphisms and use that fact that all Massey products for the dg-algebra  $H[A]$  with zero differential are trivial.  $\square$

**Exercises.**

A.4.11. Let  $A \rightarrow B$  be a quasi-isomorphism of dg-algebras. Show that the triviality of Massey products in  $H[A]$  implies their triviality in  $H[B]$ .

A.4.12. Find a nontrivial Massey product in the cohomology of the dg-algebra of Example A.4.7.



## Algebraic topology

### B.1. Homotopy and homology

Here we collect the basic constructions and facts, with almost no proofs. For the details the reader is referred to standard sources on algebraic topology, such as [115], [151] or [248]. Unlike the other appendices, we do not include exercises here, as there would be too many of them.

All spaces here are topological spaces, and all maps are continuous. We denote by  $\mathbf{k}$  a commutative ring with unit (usually  $\mathbb{Z}$  or a field; in fact an abelian group is enough until we start considering the multiplication in cohomology).

**Basic homotopy theory.** Two maps  $f, g: X \rightarrow Y$  of spaces are *homotopic* (denoted by  $f \simeq g$ ) if there is a map  $F: X \times \mathbb{I} \rightarrow Y$  (where  $\mathbb{I} = [0, 1]$  is the unit interval) such that  $F|_{X \times 0} = f$  and  $F|_{X \times 1} = g$ . We denote the map  $F|_{X \times t}: X \rightarrow Y$  by  $F_t$ , for  $t \in \mathbb{I}$ . Homotopy is an equivalence relation, and we denote by  $[X, Y]$  the set of homotopy classes of maps from  $X$  to  $Y$ .

Two spaces  $X$  and  $Y$  are *homotopy equivalent* if there are maps  $f: X \rightarrow Y$  and  $g: Y \rightarrow X$  such that  $g \circ f$  and  $f \circ g$  are homotopic to the identity maps of  $X$  and  $Y$  respectively. The *homotopy type* of a space  $X$  is the class of spaces homotopy equivalent to  $X$ .

A space  $X$  is *contractible* if it is homotopy equivalent to a point.

A *pair*  $(X, A)$  of spaces consists of a space  $X$  and its subspace  $A$ . A *map of pairs*  $f: (X, A) \rightarrow (Y, B)$  is a continuous map  $f: X \rightarrow Y$  such that  $f(A) \subset B$ .

A *pointed space* (or *based space*) is a pair  $(X, pt)$  where  $pt$  is a point of  $X$ , called the *basepoint*. We denote by  $X_+$  the pointed space  $(X \sqcup pt, pt)$ , where  $X \sqcup pt$  is  $X$  with a disjoint point added. A *map of pointed spaces* (or *pointed map*) is a map of pairs  $(X, pt) \rightarrow (Y, pt)$ . We denote a pointed space  $(X, pt)$  simply by  $X$  whenever the choice of the basepoint is clear or irrelevant. Given two pointed spaces  $(X, pt)$  and  $(Y, pt)$ , their *wedge* (or *bouquet*) is defined as the pointed space  $X \vee Y$  obtained by attaching  $X$  and  $Y$  at the basepoints. Then  $X \vee Y$  is contained as a pointed subspace in the product  $X \times Y$ , and the quotient  $X \wedge Y = (X \times Y)/(X \vee Y)$  is called the *smash product* of  $X$  and  $Y$ .

For any pointed space  $(X, pt)$  the set of homotopy classes of pointed maps  $(S^k, pt) \rightarrow (X, pt)$  (where  $S^k$  is a  $k$ -dimensional sphere,  $k \geq 0$ ) is a group for  $k > 0$ , which is called the  *$k$ th homotopy group* of  $(X, pt)$  and denoted by  $\pi_k(X, pt)$  or simply  $\pi_k(X)$ . We have that  $\pi_0(X)$  is the set of path connected components of  $X$ . The group  $\pi_1(X)$  is called the *fundamental group* of  $X$ . The groups  $\pi_k(X)$  are abelian for  $k > 1$ . A pointed map  $f: X \rightarrow Y$  induces a homomorphism  $f_*: \pi_k(X) \rightarrow \pi_k(Y)$  for each  $k$ , and the homomorphisms induced by homotopic maps are the same.

A *locally trivial fibration* (or a *fibre bundle*) is a quadruple  $(E, B, F, p)$  where  $E, B, F$  are spaces and  $p$  is a map  $E \rightarrow B$  such that for any point  $x \in B$  there is a neighbourhood  $U \subset B$  and a homeomorphism  $\varphi: p^{-1}(U) \xrightarrow{\cong} U \times F$  closing the commutative diagram

$$\begin{array}{ccc} p^{-1}(U) & \xrightarrow{\varphi} & U \times F \\ & \searrow p & \swarrow \\ & B & \end{array}$$

The space  $E$  is called the *total space*,  $B$  the *base*, and  $F$  the *fibre* of the fibre bundle. The terms ‘locally trivial fibration’ and ‘fibre bundle’ are also often used for the map  $p: E \rightarrow B$ .

A *cell complex* (or a *CW-complex*) is a Hausdorff topological space  $X$  represented as a union  $\bigcup e_i^q$  of pairwise nonintersecting subsets  $e_i^q$ , called *cells*, in such a way that for each cell  $e_i^q$  there is a map of a closed  $q$ -disk  $D^q$  to  $X$  (the *characteristic map* of  $e_i^q$ ) whose restriction to the interior of  $D^q$  is a homeomorphism onto  $e_i^q$ . Furthermore, the following two conditions are assumed:

- (C) the boundary  $\bar{e}_i^q \setminus e_i^q$  of a cell is contained in a union of finitely many cells of dimensions  $< q$ ;
- (W) a subset  $Y \subset X$  is closed if and only the intersection  $Y \cap \bar{e}_i^q$  is closed for every cell  $e_i^q$  (i.e. the topology of  $X$  is the weakest topology in which all characteristic maps are continuous).

The union of cells of  $X$  of dimension  $\leq n$  is called the  *$n$ th skeleton* of  $X$  and denoted by  $\text{sk}^n X$  or by  $X^n$ . A cell complex  $X$  can be obtained from its 0th skeleton  $\text{sk}^0 X$  (which is a discrete set) by iterating the operation of *attaching a cell*: a space  $Z$  is obtained from  $Y$  by attaching an  $n$ -cell along a map  $f: S^{n-1} \rightarrow Y$  if  $Z$  is the pushout of the form

$$(B.1) \quad \begin{array}{ccc} S^{n-1} & \xrightarrow{f} & Y \\ \downarrow & & \downarrow \\ D^n & \longrightarrow & Z \end{array}$$

We use the notation  $Z = Y \cup_f D^n$ .

A *cell subcomplex* of a cell complex  $X$  is a closed subspace which is a union of cells of  $X$ . Each skeleton of  $X$  is a cell subcomplex.

A map  $f: X \rightarrow Y$  between cell complexes is called a *cellular map* if  $f(\text{sk}^n X) \subset \text{sk}^n Y$  for all  $n$ .

**THEOREM B.1.1 (Cellular approximation).** *A map between cell complexes is homotopic to a cellular map.*

For any integer  $n > 0$  and any group  $\pi$  (which is assumed to be abelian if  $n > 1$ ) there exists a connected cell complex  $K(\pi, n)$  such that  $\pi_n(K(\pi, n)) \cong \pi$  and  $\pi_k(K(\pi, n)) = 0$  for  $k \neq n$ . (A cell complex  $K(\pi, n)$  can be constructed by taking the wedge of  $n$ -spheres corresponding to a set of generators of  $\pi$  and then killing the higher homotopy groups by attaching cells.) The space  $K(\pi, n)$  is called the *Eilenberg–Mac Lane space* (corresponding to  $n$  and  $\pi$ ), and it is unique up to homotopy equivalence. Examples of Eilenberg–Mac Lane spaces include the circle

$S^1 = K(\mathbb{Z}, 1)$ , the infinite-dimensional real projective space  $\mathbb{R}P^\infty = K(\mathbb{Z}_2, 1)$  and the infinite-dimensional complex projective space  $\mathbb{C}P^\infty = K(\mathbb{Z}, 2)$ .

A space  $X$  which is homotopy equivalent to  $K(\pi, 1)$  for some  $\pi$  is called *aspherical*. Any surface (a closed 2-dimensional manifold) which is not a 2-sphere or a real projective plane is aspherical.

A locally trivial fibration  $p: E \rightarrow B$  satisfies the following *covering homotopy property* (CHP for short) with respect to maps of cell complexes  $Y$ : for any homotopy  $F: Y \times \mathbb{I} \rightarrow B$  and any map  $f: Y \rightarrow E$  such that  $p \circ f = F_0$  there is a covering homotopy  $\tilde{F}: Y \times \mathbb{I} \rightarrow E$ , satisfying  $\tilde{F}_0 = f$  and  $p \circ \tilde{F} = F$ . This is described by the commutative diagram

$$(B.2) \quad \begin{array}{ccc} Y & \xrightarrow{f} & E \\ i_0 \downarrow & \nearrow \tilde{F} & \downarrow p \\ Y \times \mathbb{I} & \xrightarrow{F} & B. \end{array}$$

A map  $p: E \rightarrow B$  satisfying the CHP with respect to maps of cell complexes  $Y \rightarrow B$  is called a *Serre fibration*. A map  $p: E \rightarrow B$  satisfying CHP with respect to all maps  $Y \rightarrow B$  is called a *Hurewicz fibration*. The difference between Serre and Hurewicz fibrations is not important for our constructions and will be ignored; we shall use the term *fibration* for both of them. A fibre bundle is a fibration, but not every fibration is a fibre bundle. All fibres  $p^{-1}(b)$ ,  $b \in B$ , of a fibration are homotopy equivalent if  $B$  is connected.

**THEOREM B.1.2** (Exact sequence of fibration). *For a fibration  $p: E \rightarrow B$  with fibre  $F$  there exists a long exact sequence*

$$\cdots \rightarrow \pi_k(F) \xrightarrow{i_*} \pi_k(E) \xrightarrow{p_*} \pi_k(B) \xrightarrow{\partial} \pi_{k-1}(F) \rightarrow \cdots$$

where the map  $i_*$  is induced by the inclusion of the fibre  $i: F \rightarrow E$ , the map  $p_*$  is induced by the projection  $p: E \rightarrow B$ , and  $\partial$  is the connecting homomorphism.

The connecting homomorphism  $\partial$  is defined as follows. Take an element  $\gamma \in \pi_k(B)$  and choose a representative  $g: S^k \rightarrow B$  in the homotopy class  $\gamma$ . By considering the composition  $S^{k-1} \times \mathbb{I} \rightarrow S^k \xrightarrow{g} B$  (where the first map contracts the top and bottom bases of the cylinder to the north and south poles of the sphere), we may view the map  $g$  as a homotopy  $F: S^{k-1} \times \mathbb{I} \rightarrow B$  of the trivial map  $F_0: S^{k-1} \rightarrow pt$  with  $F_1$  also being trivial. Using the CHP we lift  $F$  to a homotopy  $\tilde{F}: S^{k-1} \times \mathbb{I} \rightarrow E$  with  $\tilde{F}_0$  still trivial, but  $\tilde{F}_1: S^{k-1} \rightarrow E$  being trivial only after projecting onto  $B$ . The latter condition means that  $\tilde{F}_1$  is in fact a map  $S^{k-1} \rightarrow F$ , homotopy class of which we take for  $\partial\gamma$ .

The *path space* of a space  $X$  is the space  $PX$  of pointed maps  $(\mathbb{I}, 0) \rightarrow (X, pt)$ . The *loop space*  $\Omega X$  is the space of pointed maps  $f: (\mathbb{I}, 0) \rightarrow (X, pt)$  such that  $f(1) = pt$ . The map  $p: PX \rightarrow X$  given by  $p(f) = f(1)$  is a fibration, with fibre (homotopy equivalent to)  $\Omega X$ .

**PROPOSITION B.1.3.** *For any map  $f: X \rightarrow Y$  there exist a homotopy equivalence  $h: X \rightarrow \tilde{X}$  and a fibration  $p: \tilde{X} \rightarrow Y$  such that  $f = p \circ h$ . Furthermore, this*

decomposition is functorial in the sense that a commutative diagram of maps

$$\begin{array}{ccc} X & \longrightarrow & X' \\ f \downarrow & & \downarrow f' \\ Y & \longrightarrow & Y' \end{array}$$

induces a commutative diagram

$$\begin{array}{ccccc} X & \longrightarrow & X' & & \\ f \downarrow & \searrow h & \downarrow f' & \searrow h' & \\ & \tilde{X} & & & \tilde{X}' \\ & \swarrow p & & \swarrow p' & \\ Y & \longrightarrow & Y' & & \end{array}$$

PROOF. Let  $\tilde{X}$  be the set of pairs  $(x, g)$  consisting of a point  $x \in X$  and a path  $g: \mathbb{I} \rightarrow Y$  with  $g(0) = f(x)$ . This is described by the pullback diagram

$$\begin{array}{ccc} \tilde{X} & \longrightarrow & Y^{\mathbb{I}} \\ \downarrow & & \downarrow p_0 \\ X & \xrightarrow{f} & Y \end{array}$$

where  $Y^{\mathbb{I}}$  is the space of all paths  $g: \mathbb{I} \rightarrow Y$  and the map  $p_0$  takes  $g$  to  $g(0)$ .

Then the homotopy equivalence  $h: X \rightarrow \tilde{X}$  is given by  $h(x) = (x, c_{f(x)})$ , where  $c_{f(x)}: \mathbb{I} \rightarrow Y$  is the constant path  $t \mapsto f(x)$ , and the fibration  $p: \tilde{X} \rightarrow Y$  is given by  $p(x, h) = h(1)$ . The functoriality property follows by inspection.  $\square$

A space homotopy equivalent to the fibre of the fibration  $p: \tilde{X} \rightarrow Y$  from Proposition B.1.3 is referred to as the *homotopy fibre* of the map  $f: X \rightarrow Y$ , and denoted by  $\text{hofib } f$ . The functoriality of the construction of  $\tilde{X}$  implies that the homotopy fibre is well-defined: for any other decomposition  $f = p' \circ h'$  into a composition of a fibration  $p'$  and a homotopy equivalence  $h'$  the homotopy fibre of  $f$  is homotopy equivalent to the fibre of  $p'$ . The homotopy fibre of the inclusion  $pt \rightarrow X$  is the loop space  $\Omega X$ .

An inclusion  $i: A \rightarrow X$  of a cell subcomplex in a cell complex  $X$  satisfies the following *homotopy extension property* (HEP for short): for any map  $f: X \rightarrow Y$ , a homotopy  $F: A \times \mathbb{I} \rightarrow Y$  such that  $F_0 = f|_A$  can be extended to a homotopy  $\hat{F}: X \times \mathbb{I} \rightarrow Y$  such that  $\hat{F}_0 = \hat{f}$  and  $\hat{F}|_{A \times \mathbb{I}} = F$ . This is described by the commutative diagram

$$(B.3) \quad \begin{array}{ccc} A & \xrightarrow{F'} & Y^{\mathbb{I}} \\ i \downarrow & \nearrow \hat{F}' & \downarrow p_0 \\ X & \xrightarrow{f} & Y \end{array}$$

where  $F'$  is the *adjoint* of  $F$  (i.e.  $F'(a) = h$  where  $h(t) = F(a, t) \in Y$ ), the map  $p_0$  takes  $h$  to  $h(0)$ , and  $\hat{F}'$  is the adjoint of  $\hat{F}$ .



A map  $i: A \rightarrow X$  satisfying the HEP is called a *cofibration*, and  $X/i(A)$  is its *cofibre*. A pair  $(X, A)$  for which  $i: A \rightarrow X$  is a cofibration is called a *Borsuk pair*.

Diagram (B.2) expresses the fact that fibrations obey the *right lifting property* with respect to particular cofibrations  $Y \rightarrow Y \times \mathbb{I}$ , which are also homotopy equivalences. Similarly, diagram (B.3) expresses the fact that cofibrations obey the *left lifting property* with respect to particular fibrations  $Y^{\mathbb{I}} \rightarrow Y$ , which are also homotopy equivalences. This will be important for axiomatising homotopy theory via the concept of *model category*, see Section C.1.

The *cone* over a space  $X$  is the quotient space  $\text{cone } X = (X \times \mathbb{I})/(X \times 1)$ . The *suspension*  $\Sigma X$  is the quotient  $(\text{cone } X)/(X \times 0)$ . There are inclusions  $X \hookrightarrow \text{cone } X \hookrightarrow \Sigma X$  of closed subspaces, where the first map is given by  $x \mapsto (x, 0)$  and the second by  $(x, t) \mapsto (x, (t+1)/2)$  for  $x \in X, t \in \mathbb{I}$ . The inclusion  $i: X \rightarrow \text{cone } X$  is a cofibration, with cofibre  $\Sigma X$ .

PROPOSITION B.1.4. *For any map  $f: X \rightarrow Y$  there exist a cofibration  $i: X \rightarrow \widehat{Y}$  and a homotopy equivalence  $h: \widehat{Y} \rightarrow Y$  such that  $f = h \circ i$ . This decomposition is functorial.*

PROOF. Let  $\widehat{Y}$  be the quotient of  $(X \times \mathbb{I}) \sqcup Y$  obtained by identifying  $x \times 0 \in X \times \mathbb{I}$  with  $f(x) \in Y$ . This is described by the pushout diagram

$$\begin{array}{ccc} X & \xrightarrow{f} & Y \\ i_0 \downarrow & & \downarrow \\ X \times \mathbb{I} & \longrightarrow & \widehat{Y} \end{array}$$

where the map  $i_0$  takes  $x$  to  $x \times 0$ .

The cofibration  $i: X \rightarrow \widehat{Y}$  is given by  $i(x) = x \times 1$ , and the homotopy equivalence  $h: \widehat{Y} \rightarrow Y$  is given by  $h(x \times t) = f(x)$  and  $h(y) = y$ .  $\square$

The space  $\widehat{Y}$  from Proposition B.1.4 is known as the *mapping cylinder* of the map  $f: X \rightarrow Y$ . The space  $\widehat{Y}/i(X) = \widehat{Y}/(X \times 1)$  is known as the *mapping cone* of  $f: X \rightarrow Y$ . A space homotopy equivalent to the mapping cone of  $f$  is called the *homotopy cofibre* of the map  $f: X \rightarrow Y$ . The homotopy cofibre of the projection  $X \rightarrow pt$  is the suspension  $\Sigma X$ .

**Simplicial homology and cohomology.** Let  $\mathcal{K}$  be a simplicial complex on the set  $[m] = \{1, \dots, m\}$ . An *oriented  $q$ -simplex*  $\sigma$  of  $\mathcal{K}$  is a  $k$ -simplex  $I = \{i_1, \dots, i_{q+1}\} \in \mathcal{K}$  together with an equivalence class of total orderings of the set  $I$ , two orderings being equivalent if they differ by an even permutation. Denote by  $[I]$  the oriented  $q$ -simplex with the equivalence class of orderings containing  $i_1 < \dots < i_{q+1}$ .

Define the  *$q$ th simplicial chain group (or module)*  $C_q(\mathcal{K}; \mathbf{k})$  with coefficients in  $\mathbf{k}$  as the free  $\mathbf{k}$ -module with basis consisting of oriented  $q$ -simplices of  $\mathcal{K}$ , modulo the relations  $\sigma + \bar{\sigma} = 0$  whenever  $\sigma$  and  $\bar{\sigma}$  are differently oriented  $q$ -simplices corresponding to the same simplex of  $\mathcal{K}$ . Therefore,  $C_q(\mathcal{K}, \mathbf{k})$  is a free  $\mathbf{k}$ -module of rank  $f_q(\mathcal{K})$  (the number of  $q$ -simplices of  $\mathcal{K}$ ) for  $q \geq 0$ , and  $C_q(\mathcal{K}; \mathbf{k}) = 0$  for  $q < 0$ .

Define the *simplicial chain boundary homomorphisms*

$$\begin{aligned} \partial_q: C_q(\mathcal{K}; \mathbf{k}) &\rightarrow C_{q-1}(\mathcal{K}; \mathbf{k}), \quad q \geq 1, \\ \partial_q[i_1, \dots, i_{q+1}] &= \sum_{j=1}^{q+1} (-1)^{j-1} [i_1, \dots, \widehat{i_j}, \dots, i_{q+1}], \end{aligned}$$

where  $\widehat{i_j}$  denotes that  $i_j$  is missing. It is easily checked that  $\partial_q \partial_{q+1} = 0$ , so that  $C_*(\mathcal{K}; \mathbf{k}) = \{C_q(\mathcal{K}; \mathbf{k}), \partial_q\}$  is a chain complex, called the *simplicial chain complex* of  $\mathcal{K}$  (with coefficients in  $\mathbf{k}$ ).

The  $q$ th *simplicial homology group of  $\mathcal{K}$  with coefficients in  $\mathbf{k}$* , denoted by  $H_q(\mathcal{K}; \mathbf{k})$ , is defined as the  $q$ th homology group of the simplicial chain complex  $C_*(\mathcal{K}; \mathbf{k})$ .

The *Euler characteristic*  $\chi(\mathcal{K})$  of  $\mathcal{K}$  is defined by

$$\chi(\mathcal{K}) = \sum_{q \geq 0} (-1)^q \text{rank } H_q(\mathcal{K}; \mathbf{k}).$$

It is also given by

$$\chi(\mathcal{K}) = f_0 - f_1 + f_2 - \dots,$$

where  $f_i$  is the number of  $i$ -simplices of  $\mathcal{K}$ , and therefore  $\chi(\mathcal{K})$  is independent of  $\mathbf{k}$ .

The *augmented simplicial chain complex*  $\widetilde{C}_*(\mathcal{K}; \mathbf{k})$  is obtained by taking into account the empty simplex  $\emptyset \in \mathcal{K}$ . That is,  $\widetilde{C}_q(\mathcal{K}; \mathbf{k}) = C_q(\mathcal{K}; \mathbf{k})$  for  $q \neq -1$  and  $\widetilde{C}_{-1}(\mathcal{K}; \mathbf{k}) \cong \mathbf{k}$  is a free  $\mathbf{k}$ -module with basis  $[\emptyset]$ , so that  $\widetilde{C}_*(\mathcal{K}; \mathbf{k})$  is written as

$$\dots \rightarrow C_q(\mathcal{K}; \mathbf{k}) \xrightarrow{\partial_q} \dots \rightarrow C_1(\mathcal{K}; \mathbf{k}) \xrightarrow{\partial_1} C_0(\mathcal{K}; \mathbf{k}) \xrightarrow{\varepsilon} \widetilde{C}_{-1}(\mathcal{K}; \mathbf{k}) \rightarrow 0,$$

where  $\varepsilon = \partial_0$  is the *augmentation* taking each vertex  $[i]$  to  $[\emptyset]$ .

The  $q$ th homology group of  $\widetilde{C}_*(\mathcal{K}; \mathbf{k})$  is called the  *$q$ th reduced simplicial homology group of  $\mathcal{K}$  with coefficients in  $\mathbf{k}$*  and is denoted by  $\widetilde{H}_q(\mathcal{K}; \mathbf{k})$ . We have that  $H_q(\mathcal{K}; \mathbf{k}) = \widetilde{H}_q(\mathcal{K}; \mathbf{k})$  for  $q \geq 1$ , and  $H_0(\mathcal{K}; \mathbf{k}) \cong \widetilde{H}_0(\mathcal{K}; \mathbf{k}) \oplus \mathbf{k}$  unless  $\mathcal{K}$  consists of  $\emptyset$  only, in which case  $\widetilde{H}_{-1}(\emptyset; \mathbf{k}) \cong \mathbf{k}$ .

The *simplicial cochain complex* of  $\mathcal{K}$  with coefficients in  $\mathbf{k}$  is defined to be

$$C^*(\mathcal{K}; \mathbf{k}) = \text{Hom}_{\mathbf{k}}(C_*(\mathcal{K}; \mathbf{k}), \mathbf{k}).$$

In explicit terms,  $C^*(\mathcal{K}; \mathbf{k}) = \{C^q(\mathcal{K}; \mathbf{k}), d_q\}$ . Here  $C^q(\mathcal{K}; \mathbf{k})$  is the  $q$ th *simplicial cochain group (or module) of  $\mathcal{K}$  with coefficients in  $\mathbf{k}$* ; it is a free  $\mathbf{k}$ -module with basis consisting of simplicial cochains  $\alpha_I$  corresponding to  $q$ -simplices  $I \in \mathcal{K}$ ; the cochain  $\alpha_I$  takes value 1 on the oriented simplex  $[I]$  and vanishes on all other oriented simplices. The value of the *cochain differential*

$$d_q = \partial_{q+1}^*: C^q(\mathcal{K}; \mathbf{k}) \rightarrow C^{q+1}(\mathcal{K}; \mathbf{k})$$

on the basis elements is given by

$$d\alpha_I = \sum_{j \in [m] \setminus I, j \cup I \in \mathcal{K}} \varepsilon(j, j \cup I) \alpha_{j \cup I},$$

where the sign is given by  $\varepsilon(j, j \cup I) = (-1)^{r-1}$  if  $j$  is the  $r$ th element of the set  $j \cup I \subset [m]$ , written in increasing order.

The  $q$ th *simplicial cohomology group of  $\mathcal{K}$  with coefficients in  $\mathbf{k}$* , denoted by  $H^q(\mathcal{K}; \mathbf{k})$ , is defined as the  $q$ th cohomology group of the cochain complex  $C^*(\mathcal{K}; \mathbf{k})$ .

The  $q$ th reduced simplicial cohomology group of  $\mathcal{K}$  with coefficients in  $\mathbf{k}$ , denoted by  $\tilde{H}^q(\mathcal{K}; \mathbf{k})$ , is defined as the  $q$ th cohomology group of the cochain complex

$$0 \rightarrow \mathbf{k} \xrightarrow{d_{-1}} C^0(\mathcal{K}; \mathbf{k}) \xrightarrow{d_0} C^1(\mathcal{K}; \mathbf{k}) \xrightarrow{d_1} \cdots \rightarrow C^q(\mathcal{K}; \mathbf{k}) \xrightarrow{d_q} \cdots$$

obtained by applying the functor  $\text{Hom}$  to the augmented chain complex  $\tilde{C}_*(\mathcal{K}; \mathbf{k})$ . The map  $d_{-1}$  takes  $1 = \alpha_\emptyset$  to the sum of  $\alpha_{\{i\}}$  corresponding to all vertices  $\{i\} \in \mathcal{K}$ . We have that  $H^q(\mathcal{K}; \mathbf{k}) = \tilde{H}^q(\mathcal{K}; \mathbf{k})$  for  $q \geq 1$ , and  $H^0(\mathcal{K}; \mathbf{k}) \cong \tilde{H}^0(\mathcal{K}; \mathbf{k}) \oplus \mathbf{k}$  unless  $\mathcal{K}$  consists of  $\emptyset$  only, in which case  $\tilde{H}^{-1}(\emptyset; \mathbf{k}) \cong \mathbf{k}$ .

**Singular homology and cohomology.** Let  $X$  be a topological space. A *singular  $q$ -simplex* of  $X$  is a continuous map  $f: \Delta^q \rightarrow X$ . The  $q$ th *singular chain group*  $C_q(X; \mathbf{k})$  of  $X$  with coefficients in  $\mathbf{k}$  is the free  $\mathbf{k}$ -module generated by all singular  $q$ -simplices.

For each  $i = 1, \dots, q+1$  there is a linear map  $\varphi_q^i: \Delta^{q-1} \rightarrow \Delta^q$  which sends  $\Delta^{q-1}$  to the face of  $\Delta^q$  opposite its  $i$ th vertex, preserving the order of vertices. The  $i$ th *face* of a singular simplex  $f: \Delta^q \rightarrow X$ , denoted by  $f^{(i)}$  is defined to be the singular  $(q-1)$ -simplex given by the composition

$$f^{(i)} = f \circ \varphi_q^i: \Delta^{q-1} \rightarrow \Delta^q \rightarrow X.$$

The *singular chain boundary homomorphisms* are given by

$$\begin{aligned} \partial_q: C_q(X; \mathbf{k}) &\rightarrow C_{q-1}(X; \mathbf{k}), \quad q \geq 1, \\ \partial_q f &= \sum_{i=1}^{q+1} (-1)^{i-1} f^{(i)}. \end{aligned}$$

Then  $\partial_q \partial_{q+1} = 0$ , so that  $C_*(X; \mathbf{k}) = \{C_q(X; \mathbf{k}), \partial_q\}$  is a chain complex, called the *singular chain complex* of  $X$  (with coefficients in  $\mathbf{k}$ ).

The  $q$ th *singular homology group* of  $X$  with coefficients in  $\mathbf{k}$ , denoted by  $H_q(X; \mathbf{k})$ , is the  $q$ th homology group of the singular chain complex  $C_*(X; \mathbf{k})$ .

Assume that a space  $X$  has only finite number of nontrivial homology groups (with  $\mathbb{Z}$  coefficients), and each of these groups has finite rank. Then the *Euler characteristic*  $\chi(X)$  of  $X$  is defined by

$$\chi(X) = \sum_{q \geq 0} (-1)^q \text{rank } H_q(X; \mathbb{Z}).$$

**PROPOSITION B.1.5.** *The group  $H_0(X; \mathbf{k})$  is a free  $\mathbf{k}$ -module of rank equal to the number of path connected components of  $X$ .*

The *augmented singular chain complex*  $\tilde{C}_*(X; \mathbf{k})$  is defined by  $\tilde{C}_q(X; \mathbf{k}) = C_q(X; \mathbf{k})$  for  $q \neq -1$  and  $\tilde{C}_{-1}(X; \mathbf{k}) = \mathbf{k}$ ; the *augmentation*  $\varepsilon = \partial_0: C_0(X; \mathbf{k}) \rightarrow \mathbf{k}$  is given by  $\varepsilon(f) = 1$  for all singular 0-simplices  $f$ .

The  $q$ th homology group of  $\tilde{C}_*(X; \mathbf{k})$  is called the  $q$ th *reduced singular homology group* of  $X$  with coefficients in  $\mathbf{k}$  and is denoted by  $\tilde{H}_q(X; \mathbf{k})$ . We have  $H_q(X; \mathbf{k}) = \tilde{H}_q(X; \mathbf{k})$  for  $q \geq 1$ , and  $H_0(X; \mathbf{k}) \cong \tilde{H}_0(X; \mathbf{k}) \oplus \mathbf{k}$  if  $X$  is nonempty.

A nonempty space  $X$  is *acyclic* if  $\tilde{H}_q(X; \mathbb{Z}) = 0$  for all  $q$ .

We shall drop the coefficient group  $\mathbf{k}$  in the notation of chains and homology occasionally.

For any simplicial complex  $\mathcal{K}$ , there is an obvious inclusion  $i: C_q(\mathcal{K}) \rightarrow C_q(|\mathcal{K}|)$  of the simplicial chain groups into the singular chain groups of the geometric realization  $\mathcal{K}$ , defining an inclusion of chain complexes.

**THEOREM B.1.6.** *The map  $i: C_q(\mathcal{K}) \rightarrow C_q(|\mathcal{K}|)$  induces an isomorphism  $H_q(\mathcal{K}) \xrightarrow{\cong} H_q(|\mathcal{K}|)$  between the simplicial homology groups of  $\mathcal{K}$  and the singular homology groups of  $|\mathcal{K}|$ .*

If  $(X, A)$  is pair of spaces, then  $C_*(A)$  is a chain subcomplex in  $C_*(X)$  (that is,  $C_q(A)$  is a submodule of  $C_q(X)$  and  $\partial_q C_q(A) \subset C_{q-1}(A)$ ). The quotient complex

$$C_*(X, A) = \{C_q(X, A) = C_q(X)/C_q(A), \bar{\partial}_q: C_q(X, A) \rightarrow C_{q-1}(X, A)\}$$

is called the *singular chain complex of the pair  $(X, A)$* . Its  $q$ th homology group  $H_q(X, A)$  is called the  *$q$ th singular homology group of  $(X, A)$* , or  *$q$ th relative singular homology group of  $X$  modulo  $A$* . Note that  $H_q(X) = H_q(X, \emptyset)$  and  $\tilde{H}_q(X) = H_q(X, pt)$ .

The *singular cochain complex*  $C^*(X; \mathbf{k}) = \{C^q(X; \mathbf{k}), d_q\}$  is defined to be

$$C^*(X; \mathbf{k}) = \text{Hom}_{\mathbf{k}}(C_*(X; \mathbf{k}), \mathbf{k}).$$

Its  $q$ th cohomology group is called the  *$q$ th singular cohomology group of  $X$*  and denoted by  $H^q(X; \mathbf{k})$ . The *reduced singular cohomology groups*  $\tilde{H}^q(X; \mathbf{k})$  and the *relative cohomology groups*  $H^q(X, A)$  are defined similarly.

The ranks of the groups  $H_q(X; \mathbb{Z})$  and  $H^q(X; \mathbb{Z})$  coincide, and the number  $b^q(X) = \text{rank } H^q(X; \mathbb{Z})$  is called the  *$q$ th Betti number of  $X$* . The Betti numbers with coefficients in a field  $\mathbf{k}$  are defined similarly.

The (co)homology groups have the following fundamental properties.

**THEOREM B.1.7** (Functoriality and homotopy invariance). *A map  $f: X \rightarrow Y$  induces homomorphisms  $f_*: H_q(X; \mathbf{k}) \rightarrow H_q(Y; \mathbf{k})$  and  $f^*: H^q(Y; \mathbf{k}) \rightarrow H^q(X; \mathbf{k})$ . If two maps  $f, g: X \rightarrow Y$  are homotopic, then  $f_* = g_*$  and  $f^* = g^*$ .*

We omit the coefficient group  $\mathbf{k}$  in the notation for the rest of this subsection.

**THEOREM B.1.8** (Exact sequences of pairs). *For any pair  $(X, A)$  there are long exact sequences*

$$\begin{aligned} \cdots \rightarrow H_q(A) \xrightarrow{i_*} H_q(X) \xrightarrow{j_*} H_q(X, A) \xrightarrow{\partial} H_{q-1}(A) \rightarrow \cdots, \\ \cdots \rightarrow H^q(X, A) \xrightarrow{j^*} H^q(X) \xrightarrow{i^*} H^q(A) \xrightarrow{d} H^{q+1}(X, A) \rightarrow \cdots \end{aligned}$$

*Furthermore, if the inclusion  $A \rightarrow X$  is a cofibration (e.g., if it is an inclusion of a cell subcomplex), then the quotient projection  $(X, A) \rightarrow (X/A, pt)$  induces isomorphisms*

$$H_q(X, A) \cong H_q(X/A, pt) = \tilde{H}_q(X/A), \quad H^q(X, A) \cong H^q(X/A, pt) = \tilde{H}^q(X/A).$$

In the homology exact sequence of a pair, the map  $i_*$  is induced by the inclusion  $A \rightarrow X$ , the map  $j_*$  is induced by the map of pairs  $(X, \emptyset) \rightarrow (X, A)$ , and the *connecting homomorphism*  $\partial$  is the homology homomorphism corresponding the boundary homomorphism sending a relative cocycle  $c \in C_q(X, A)$  to  $\partial c \in C_q(A)$ . The maps in the cohomology exact sequence are defined dually.

Let  $(X, A)$  be a pair and  $B \subset A$  be a subspace. The inclusion of pairs  $(X \setminus B, A \setminus B) \rightarrow (X, A)$  induces maps

$$H_q(X \setminus B, A \setminus B) \rightarrow H_q(X, A),$$

which are referred to as the *excision homomorphisms*.

**THEOREM B.1.9 (Excision).** *If the closure of  $B$  is contained in the interior of  $A$ , then the excision homomorphisms  $H_q(X \setminus B, A \setminus B) \rightarrow H_q(X, A)$  are isomorphisms.*

**THEOREM B.1.10 (Mayer–Vietoris exact sequences).** *Let  $X$  be a space,  $A \subset X$ ,  $B \subset X$  and  $A \cup B = X$ . Assume that the excision homomorphisms*

$$H_q(B, A \cap B) \rightarrow H_q(X, A) \quad \text{and} \quad H_q(A, A \cap B) \rightarrow H_q(X, B)$$

*are isomorphisms for all  $q$ . Then there are exact sequences*

$$\begin{aligned} \cdots \rightarrow H_q(A \cap B) \xrightarrow{\beta} H_q(A) \oplus H_q(B) \xrightarrow{\alpha} H_q(X) \xrightarrow{\delta} H_{q-1}(A \cap B) \rightarrow \cdots, \\ \cdots \rightarrow H^q(X) \xrightarrow{\alpha} H^q(A) \oplus H^q(B) \xrightarrow{\beta} H^q(A \cap B) \xrightarrow{\delta} H^{q+1}(X) \rightarrow \cdots. \end{aligned}$$

In the homology Mayer–Vietoris sequence, the map  $\beta$  is the difference of the homomorphism induced by the inclusions  $A \cap B \rightarrow A$  and  $A \cap B \rightarrow B$ , the map  $\alpha$  is the sum of the homomorphism induced by the inclusions  $A \rightarrow X$  and  $B \rightarrow X$ , and the connecting homomorphism  $\delta$  is the composite

$$H_q(X) \xrightarrow{j_*} H_q(X, A) = H_q(B, A \cap B) \xrightarrow{\partial} H_{q-1}(A \cap B).$$

The first key calculation of homology groups follows directly from the general properties above:

**PROPOSITION B.1.11.** *The  $n$ -disk  $D^n$  is acyclic, and the reduced homology of an  $n$ -sphere  $S^n$  is given by  $\tilde{H}_n(S^n; \mathbf{k}) \cong \mathbf{k}$  and  $\tilde{H}_i(S^n; \mathbf{k}) = 0$  for  $i \neq n$ .*

Here is another direct corollary:

**THEOREM B.1.12 (Suspension isomorphism).** *For any space  $X$  and any  $q > 0$  there are isomorphisms*

$$\tilde{H}_q(\Sigma X) \cong \tilde{H}_{q-1}(X) \quad \text{and} \quad \tilde{H}^q(\Sigma X) \cong \tilde{H}^{q-1}(X).$$

A closed connected topological  $n$ -dimensional manifold  $X$  is *orientable* over  $\mathbf{k}$  if  $H_n(X; \mathbf{k}) \cong \mathbf{k}$ . Every compact connected manifold is oriented over  $\mathbb{Z}_2$  or any field of characteristic two.

**THEOREM B.1.13 (Poincaré duality).** *If a closed connected  $n$ -manifold is orientable over  $\mathbf{k}$ , then  $H_q(X; \mathbf{k}) \cong H^{n-q}(X; \mathbf{k})$ .*

**Cellular homology, and cohomology multiplication.** Let  $X$  be a cell complex with skeletons  $\text{sk}^n X = X^n$  for  $n = 0, 1, 2, \dots$

We start with the case  $\mathbf{k} = \mathbb{Z}$ , and omit this coefficient group in the notation. The group  $\mathcal{C}_q(X) = H_q(X^q, X^{q-1})$  is called the  *$q$ th cellular chain group*. This is a free abelian group with basis the  $q$ -dimensional cells of  $X$ , and therefore a cellular chain may be viewed as an integral combination of cells of  $X$ .

The *cellular boundary homomorphism*  $\partial_q: \mathcal{C}_q(X) \rightarrow \mathcal{C}_{q-1}(X)$  is defined as the composition

$$\partial_q: \mathcal{C}_q(X) = H_q(X^q, X^{q-1}) \rightarrow H_{q-1}(X^{q-1}) \rightarrow H_{q-1}(X^{q-1}, X^{q-2}) = \mathcal{C}_{q-1}(X)$$

of homomorphisms from the homology exact sequences of pairs  $(X^q, X^{q-1})$  and  $(X^{q-1}, X^{q-2})$ . The resulting chain complex

$$\cdots \rightarrow \mathcal{C}_q(X) \xrightarrow{\partial_q} \cdots \rightarrow \mathcal{C}_1(X) \xrightarrow{\partial_1} \mathcal{C}_0(X) \rightarrow 0$$

is called the *cellular chain complex* of  $X$ . Its  $q$ th homology group, which we denote by  $\mathcal{H}_q(X)$  for the moment, is called the  *$q$ th cellular homology group* of  $X$ .

**THEOREM B.1.14.** *For any cell complex  $X$ , there is a canonical isomorphism  $\mathcal{H}_q(X) \cong H_q(X)$  between the cellular and singular homology groups.*

The cellular homology groups  $\mathcal{H}_q(X; \mathbf{k})$  with coefficients in  $\mathbf{k}$  and the cohomology groups  $\mathcal{H}^q(X; \mathbf{k})$  are defined similarly; they are canonically isomorphic to the appropriate singular homology and cohomology groups.

We shall therefore not distinguish between the singular and cellular homology and cohomology groups of cell complexes.

The product  $X_1 \times X_2$  of cell complexes is a cell complex with cells of the form  $e_1 \times e_2$ , where  $e_1$  is a cell of  $X_1$  and  $e_2$  is a cell of  $X_2$ .

Given two cellular cochains  $c_1 \in \mathcal{C}^{q_1}(X)$  and  $c_2 \in \mathcal{C}^{q_2}(X)$ , define their *product* as the cochain  $c_1 \times c_2 \in \mathcal{C}^{q_1+q_2}(X \times X)$  whose value on a cell  $e_1 \times e_2$  of  $X \times X$  is given by  $(-1)^{q_1 q_2} c_1(e_1) c_2(e_2)$ . This product satisfies the identity

$$\delta(c_1 \times c_2) = \delta c_1 \times c_2 + (-1)^{q_1} c_1 \times \delta c_2,$$

where  $\delta$  is the cellular cochain differential, and therefore defines a map of cochain complexes

$$\mathcal{C}^*(X) \otimes \mathcal{C}^*(X) \rightarrow \mathcal{C}^*(X \times X)$$

and induces a cohomology map

$$\times: H^{q_1}(X) \otimes H^{q_2}(X) \rightarrow H^{q_1+q_2}(X \times X),$$

which is called the (cohomology)  $\times$ -*product*.

The composition of the  $\times$ -product with the cohomology map induced by the *diagonal map*  $\Delta: X \rightarrow X \times X$ ,  $\Delta(x) = (x, x)$ , defines a product

$$\smile: H^{q_1}(X) \otimes H^{q_2}(X) \xrightarrow{\times} H^{q_1+q_2}(X \times X) \xrightarrow{\Delta^*} H^{q_1+q_2}(X),$$

which is called the *cup product*, or *cohomology product*. It turns  $H^*(X) = \bigoplus_{q \geq 0} H^q(X)$  into an associative and graded commutative ring. This ring structure on  $H^*(X)$  is a homotopy invariant of  $X$ ; it does not depend on the cell complex structure. It is also functorial, in the sense that a map  $f: X \rightarrow Y$  induces a ring homomorphism  $f^*: H^*(Y) \rightarrow H^*(X)$ .

There is also a relative version of the cohomology product, given by the map

$$H^{q_1}(X; A) \otimes H^{q_2}(X, B) \longrightarrow H^{q_1+q_2}(X, A \cup B).$$

**Whitehead product, Samelson product and Pontryagin product.** Let  $w: S^{k+l-1} \rightarrow S^k \vee S^l$  be the attaching map of the  $(k+l)$ -cell of  $S^k \times S^l$  with the standard cell structure. Explicitly, the map  $w$  can be defined as the composition

$$S^{k+l-1} = \partial(D^k \times D^l) = D^k \times S^{l-1} \cup_{S^{k-1} \times S^{l-1}} S^{k-1} \times D^l \rightarrow S^k \vee S^l,$$

where the last map consists of two projections

$$\begin{aligned} D^k \times S^{l-1} &\rightarrow D^k \rightarrow D^k/S^{k-1} = S^k \hookrightarrow S^k \vee S^l \quad \text{and} \\ S^{k-1} \times D^l &\rightarrow D^l \rightarrow D^l/S^{l-1} = S^l \hookrightarrow S^k \vee S^l \end{aligned}$$

and maps  $S^{k-1} \times S^{l-1}$  to the basepoint.

Given two pointed maps  $f: S^k \rightarrow X$  and  $g: S^l \rightarrow X$ , their *Whitehead product* is defined as the composition

$$[f, g]_w: S^{k+l-1} \xrightarrow{w} S^k \vee S^l \xrightarrow{f \vee g} X.$$

It gives rise to a well-defined product

$$[\cdot, \cdot]_w: \pi_k(X) \times \pi_l(X) \rightarrow \pi_{k+l-1}(X),$$

which is also called the Whitehead product. When  $k = l = 1$ , the Whitehead product is the commutator product in  $\pi_1(X)$ . We have  $[f, g]_w = 0$  in  $\pi_{k+l-1}(X)$  whenever the map  $f \vee g: S^k \vee S^l \rightarrow X$  extends to a map  $S^k \times S^l \rightarrow X$ .

THEOREM B.1.15.

(a) If  $\alpha \in \pi_k(X)$  and  $\beta, \gamma \in \pi_l(X)$  with  $l > 1$ , then

$$[\alpha, \beta + \gamma]_w = [\alpha, \beta]_w + [\alpha, \gamma]_w.$$

(b) If  $\alpha \in \pi_k(X)$  and  $\beta \in \pi_l(X)$  with  $k, l > 1$ , then

$$[\alpha, \beta]_w = (-1)^{kl} [\beta, \alpha]_w.$$

(c) If  $\alpha \in \pi_k(X)$ ,  $\beta \in \pi_l(X)$  and  $\gamma \in \pi_m(X)$  with  $k, l, m > 1$ , then

$$(-1)^{km} [[\alpha, \beta]_w, \gamma]_w + (-1)^{lk} [[\beta, \gamma]_w, \alpha]_w + (-1)^{ml} [[\gamma, \alpha]_w, \beta]_w = 0.$$

Now consider the loop space  $\Omega X$ . The commutator of loops,  $(x, y) \mapsto xyx^{-1}y^{-1}$ , induces a map  $c: \Omega X \wedge \Omega X \rightarrow \Omega X$ . Given two pointed maps  $f: S^p \rightarrow \Omega X$  and  $g: S^q \rightarrow \Omega X$ , their *Samelson product* is defined as

$$[f, g]_s: S^{p+q} = S^p \wedge S^q \xrightarrow{f \wedge g} \Omega X \wedge \Omega X \xrightarrow{c} \Omega X.$$

It gives rise to a well-defined product

$$[\cdot, \cdot]_s: \pi_p(\Omega X) \times \pi_q(\Omega X) \rightarrow \pi_{p+q}(\Omega X),$$

which is also called the Samelson product.

THEOREM B.1.16.

(a) If  $\varphi \in \pi_p(\Omega X)$  and  $\psi, \eta \in \pi_q(\Omega X)$ , then

$$[\varphi, \psi + \eta]_s = [\varphi, \psi]_s + [\varphi, \eta]_s.$$

(b) If  $\varphi \in \pi_p(\Omega X)$  and  $\psi \in \pi_q(\Omega X)$ , then

$$[\varphi, \psi]_s = -(-1)^{pq} [\psi, \varphi]_s.$$

(c) If  $\varphi \in \pi_p(\Omega X)$ ,  $\psi \in \pi_q(\Omega X)$  and  $\eta \in \pi_r(\Omega X)$ , then

$$[\varphi, [\psi, \eta]_s]_s = [[\varphi, \psi]_s, \eta]_s + (-1)^{pq} [\psi, [\varphi, \eta]_s]_s.$$

The Samelson bracket makes the rational vector space  $\pi_*(\Omega X) \otimes \mathbb{Q}$  into a graded Lie algebra, see (C.8). It is called the *rational homotopy Lie algebra* of  $X$ .

The *Pontryagin product* is defined as the composition

$$H_*(\Omega X; \mathbf{k}) \otimes H_*(\Omega X; \mathbf{k}) \xrightarrow{\times} H_*(\Omega X \times \Omega X; \mathbf{k}) \xrightarrow{m_*} H_*(\Omega X; \mathbf{k}),$$

where  $\mathbf{k}$  is a commutative ring with unit,  $\times$  is the homology cross-product, and  $m: \Omega X \times \Omega X \rightarrow \Omega X$  is the loop multiplication. Pontryagin product makes  $H_*(\Omega X; \mathbf{k})$  into an associative (but not generally commutative) algebra with unit.

Whitehead, Samelson and Pontryagin products are related by the following classical result of Samelson:

THEOREM B.1.17 ([280]). *There is a choice of adjunction isomorphism  $t: \pi_n(X) \rightarrow \pi_{n-1}(\Omega X)$  such that*

$$t[\alpha, \beta]_w = (-1)^{k-1} [t\alpha, t\beta]_s$$

for  $\alpha \in \pi_k(X)$  and  $\beta \in \pi_l(X)$ . Furthermore, if  $h: \pi_n(\Omega X) \rightarrow H_n(\Omega X)$  is the Hurewicz homomorphism and  $\star$  denotes the Pontryagin product, then

$$h[\varphi, \psi]_s = h(\varphi) \star h(\psi) - (-1)^{pq} h(\psi) \star h(\varphi)$$

for  $\varphi \in \pi_p(\Omega X)$  and  $\psi \in \pi_q(\Omega X)$ .

It follows that the Pontryagin algebra  $H_*(\Omega X, \mathbb{Q})$  is the *universal enveloping algebra* of the graded Lie algebra  $\pi_*(\Omega X) \otimes \mathbb{Q}$ , and  $\pi_*(\Omega X) \otimes \mathbb{Q}$  is the Lie algebra of *primitive elements* in the Hopf algebra  $H_*(\Omega X, \mathbb{Q})$ .

More details on the relationship between the three products, including their generalisations to  $H$ -spaces, can be found in the monograph by Neisendorfer [240].

## B.2. Elements of rational homotopy theory

We only review some basis notions and results here. For a detailed account of this much elaborated theory we refer to [39], [194] and [112].

DEFINITION B.2.1. A map  $f: X \rightarrow Y$  between spaces is called a *rational equivalence* if it induces isomorphisms in all rational homotopy groups, that is,  $f_*: \pi_i(X) \otimes \mathbb{Q} \rightarrow \pi_i(Y) \otimes \mathbb{Q}$  is an isomorphism for all  $i$ .

The *rational homotopy type* of  $X$  is its equivalence class in the equivalence relation generated by rational equivalences.

PROPOSITION B.2.2. *If both  $X$  and  $Y$  are simply connected, then  $f: X \rightarrow Y$  is a rational equivalence if and only if  $f_*: H_i(X; \mathbb{Q}) \rightarrow H_i(Y; \mathbb{Q})$  (or equivalently,  $f^*: H^i(Y; \mathbb{Q}) \rightarrow H^i(X; \mathbb{Q})$ ) is an isomorphism for each  $i$ .*

A space  $X$  is *nilpotent* if its fundamental group  $\pi_1(X)$  is nilpotent and  $\pi_1(X)$  acts nilpotently on higher homotopy groups  $\pi_n(X)$ . Simply connected spaces are obviously nilpotent.

Rational homotopy theory, whose foundation was laid in the work of Quillen [271] and Sullivan [298], translates the study of the rational homotopy type of nilpotent spaces  $X$  into the algebraic language of dg-algebras and minimal models (see Section A.4). This translation is made via Sullivan's *algebra of piecewise polynomial differential forms*  $A_{PL}(X)$ , whose properties we briefly discuss below. Further remarks relating rational homotopy theory to the theory of model categories are given in Section C.1.

The most basic dg-algebra model of a space  $X$  is its singular cochains  $C^*(X; \mathbf{k})$ . However, this dg-algebra is non-commutative, and therefore is difficult to handle. If  $X$  is a smooth manifold, and  $\mathbf{k} = \mathbb{R}$ , then we may consider the dg-algebra  $\Omega^*(X)$  of de Rham differential forms instead of  $C^*(X; \mathbb{R})$ . It provides a functorial (with respect to smooth maps) and commutative dg-algebra model for  $X$ , with the same cohomology  $H^*(X; \mathbb{R})$ . It is therefore natural to ask whether a functorial commutative dg-algebra model exists for arbitrary cell complexes  $X$  over a field  $\mathbf{k}$  of characteristic zero (over finite fields there are secondary cohomological operations obstructing such a construction). A first construction of a commutative dg-algebra model which worked for simplicial complexes was suggested by Thom in the end of the 1950s. Later, in the mid-1970s, Sullivan provided a functorial construction of



a dg-algebra model  $A_{PL}(X)$  whose cohomology is  $H^*(X; \mathbb{Q})$ , using similar ideas as those of Thom (a combinatorial version of differential forms).

The algebra  $A_{PL}(X)$  has the following two important properties.

THEOREM B.2.3 (PL de Rham Theorem).

(a)  $A_{PL}(X)$  is weakly equivalent to  $C^*(X; \mathbb{Q})$  via a short zigzag of the form

$$A_{PL}(X) \rightarrow D(X) \leftarrow C^*(X; \mathbb{Q}),$$

where  $D(X)$  is another naturally defined dg-algebra;

(b) there is a natural map of cochain complexes  $A_{PL}(X) \rightarrow C^*(X; \mathbb{Q})$ , the ‘Stokes map’, which induces an isomorphism in cohomology.

(c) if  $X$  is a smooth manifold, then the dg-algebra  $\Omega^*(X)$  of de Rham forms is weakly equivalent to  $A_{PL}(X) \otimes_{\mathbb{Q}} \mathbb{R}$ .

The proof of (a) can be found in [194, §III.3] or in [112, Corollary 10.10]. For (b), see [39, §2], and for (c), see [194, Theorem V.2] or [112, Theorem 11.4].

DEFINITION B.2.4. Given a cell complex  $X$ , we refer to any commutative dg-algebra  $A$  weakly equivalent to  $A_{PL}(X)$  as a (rational) *model* of  $X$ . The minimal model of  $A_{PL}(X)$  is called the *minimal model* of  $X$ , and is denoted by  $M_X$ .

In the case of nilpotent spaces, the rational homotopy type of  $X$  is fully determined by the commutative dg-algebra  $A_{PL}(X)$  or its minimal model  $M_X$ . More precisely, there is the following fundamental result.

THEOREM B.2.5. *There is a bijective correspondence between the set of rational homotopy types of nilpotent spaces and the set of classes of isomorphic minimal dg-algebras over  $\mathbb{Q}$ . Under this correspondence, there is a natural isomorphism*

$$\text{Hom}(\pi_i(X), \mathbb{Q}) \cong M_X^i / (M_X^+ \cdot M_X^+),$$

*i.e. the rank of the  $i$ th rational homotopy group of  $X$  equals the number of generators of degree  $i$  in the minimal model of  $X$ .*

For the proof, see [194, Theorem IV.8].

DEFINITION B.2.6. A space  $X$  is *formal* if  $C^*(X; \mathbb{Q})$  is a formal dg-algebra (equivalently, if  $A_{PL}(X)$  is a formal commutative dg-algebra, see Definition A.4.5).

If  $X$  is nilpotent, then it is formal if and only if there is a quasi-isomorphism  $M_X \rightarrow H^*(X; \mathbb{Q})$ . If  $X$  is a smooth manifold, then it is formal if and only if the de Rham algebra  $\Omega^*(X)$  is formal; in this case we can define  $M_X$  as the minimal model of  $\Omega^*(X)$  instead of  $A_{PL}(X)$ .

EXAMPLE B.2.7.

1. Let  $X = S^{2n+1}$  be an odd sphere,  $n \geq 1$ . Then

$$M_X = \Lambda[x], \quad \deg x = 2n + 1, \quad dx = 0.$$

There is a quasi-isomorphism  $M_X \rightarrow \Omega^*(X)$  sending  $x$  to the volume form of  $S^{2n+1}$ .

2. Let  $X = S^{2n}$ ,  $n \geq 1$ . Then

$$M_X = \Lambda[y] \otimes \mathbb{R}[x], \quad \deg x = 2n, \deg y = 4n - 1, \quad dx = 0, dy = x^2.$$

The map  $M_X \rightarrow \Omega^*(X)$  sends  $x$  to the volume form of  $S^{2n}$  and  $y$  to zero.

3. Let  $X = \mathbb{C}P^n$ ,  $n \geq 1$ . Then

$$M_X = \Lambda[y] \otimes \mathbb{R}[x], \quad \deg x = 2, \deg y = 2n + 1, \quad dx = 0, dy = x^{n+1}.$$

There is a quasi-isomorphism  $M_X \rightarrow \Omega^*(X)$  sending  $x$  to the Fubini–Study 2-form  $\omega = \frac{i}{2\pi} \partial\bar{\partial} \log |z|^2 \in \Omega^2(\mathbb{C}P^n)$  and  $y$  to zero.

4. Let  $X = \mathbb{C}P^\infty$ . Then

$$M_X = \mathbb{Q}[v] = H^*(X; \mathbb{Q}), \quad \deg v = 2, \quad dv = 0.$$

5. Let  $X = \mathbb{C}P^\infty \vee \mathbb{C}P^\infty$ . Then

$$\begin{aligned} H^*(X; \mathbb{Q}) &= \mathbb{Q}[v_1, v_2]/(v_1v_2), \quad \deg v_1 = \deg v_2 = 2, \\ M_X &= \mathbb{Q}[v_1, v_2, w], \quad \deg w = 3, \quad dv_1 = dv_2 = 0, \quad dw = v_1v_2, \end{aligned}$$

and the map  $M_X \rightarrow H^*(X; \mathbb{Q})$  sends  $w$  to zero. Theorem B.2.5 gives the following nontrivial rational homotopy groups:

$$\pi_2(X) \otimes \mathbb{Q} = \mathbb{Q}^2, \quad \pi_3(X) \otimes \mathbb{Q} = \mathbb{Q}.$$

This conforms with the homotopy fibration

$$S^3 \rightarrow \mathbb{C}P^\infty \vee \mathbb{C}P^\infty \rightarrow \mathbb{C}P^\infty \times \mathbb{C}P^\infty$$

(see Example 4.3.4).

In all examples above the space  $X$  is formal (an exercise). Here is an example of a nonformal manifold.

EXAMPLE B.2.8. Let  $G$  be the *Heisenberg group* consisting of matrices

$$\begin{pmatrix} 1 & x & z \\ 0 & 1 & y \\ 0 & 0 & 1 \end{pmatrix}, \quad x, y, z \in \mathbb{R},$$

and let  $\Gamma = G_{\mathbb{Z}}$  be the subgroup consisting of matrices with  $x, y, z \in \mathbb{Z}$ . The quotient manifold  $X = G/\Gamma$  is the classifying space for the nilpotent group  $\Gamma = \pi_1(X)$ , i.e.  $X = K(\Gamma, 1)$ . The minimal model  $M_X$  is generated by the left-invariant forms

$$\omega_1 = dx, \quad \omega_2 = dy, \quad \omega_3 = xdy - dz.$$

This dg-algebra is isomorphic to the dg-algebra of Example A.4.7. Therefore, the manifold  $X$  is not formal.

### Exercises.

B.2.9. Show that all spaces of Example B.2.7 are formal.

## B.3. Group actions and equivariant cohomology

There is a vast literature available on this classical subject; we mention the monographs of Bredon [41], Hsiang [164], Allday–Puppe [4] and Guillemin–Ginzburg–Karshon [142], among others. We briefly review some basic concepts and results used in the main part of the book.

Let  $X$  be a Hausdorff space and  $G$  a Hausdorff topological group. One says that  $G$  *acts* on  $X$  if for any element  $g \in G$  there is a homeomorphism  $\varphi_g : X \rightarrow X$ , and the assignment  $g \mapsto \varphi_g$  respects the algebraic and topological structure. In more precise terms, a (left) *action* of  $G$  on  $X$  is given by a continuous map

$$G \times X \rightarrow X, \quad (g, x) \mapsto gx$$

such that  $g(hx) = (gh)x$  for any  $g, h \in G$ ,  $x \in X$ , and  $ex = x$ , where  $e$  is the unit of  $G$ . The space  $X$  is called a (left) *G-space*. Right actions and right  $G$ -spaces are

defined similarly. In the case when  $G$  is an abelian group, the notions of left and right action coincide.

A continuous map  $f: X \rightarrow Y$  of  $G$ -spaces is *equivariant* if it commutes with the group actions, i.e.  $f(gx) = g \cdot f(x)$  for all  $g \in G$  and  $x \in X$ . A map  $f$  is *weakly equivariant* if there is an automorphism  $\psi: G \rightarrow G$  such that  $f(gx) = \psi(g)(f(x))$  for all  $g \in G$  and  $x \in X$ . A weakly equivariant map corresponding to an automorphism  $\psi$  is also referred to as  *$\psi$ -equivariant*.

Let  $x \in X$ . The set

$$G_x = \{g \in G: gx = x\}$$

of elements of  $G$  fixing the point  $x$  is a closed subgroup in  $G$ , called the *stationary subgroup*, or the *stabiliser* of  $x$ . The subspace

$$Gx = \{gx \in X: g \in G\} \subset X$$

is called the *orbit* of  $x$  with respect to the action of  $G$  (or the  *$G$ -orbit* for short). If points  $x$  and  $y$  are in the same orbit, then their stabilisers  $G_x$  and  $G_y$  are conjugate subgroups in  $G$ . The *type* of an orbit  $Gx$  is the conjugation class of stabiliser subgroups of points in  $Gx$ .

The set of all orbits is denoted by  $X/G$ , and we have the canonical projection  $\pi: X \rightarrow X/G$ . The space  $X/G$  with the standard quotient topology (a subset  $U \subset X/G$  is open if and only if  $\pi^{-1}(U)$  is open) is referred to as the *orbit space*, or the *quotient space*. If  $G$  is a compact group, then the quotient  $X/G$  is Hausdorff, and the projection  $\pi: X \rightarrow X/G$  is a closed and proper map (i.e. the image of a closed subset is closed, and the preimage of a compact subset is compact).

A point  $x \in X$  is *fixed* if  $Gx = x$ , i.e.  $G_x = G$ . The set of all fixed points of a  $G$ -space  $X$  will be denoted by  $X^G$ . A  $G$ -action on  $X$  is

- *effective* if the trivially acting subgroup  $\{g \in G: gx = x \text{ for all } x \in X\}$  is trivial (consists of the single element  $e \in G$ );
- *free* if all stabilisers  $G_x$  are trivial;
- *almost free* if all stabilisers  $G_x$  are finite subgroups of  $G$ ;
- *semifree* if any stabiliser  $G_x$  is either trivial or is the whole  $G$ ;
- *transitive* if for any two points  $x, y \in X$  there is an element  $g \in G$  such that  $gx = y$  (i.e.  $X$  is a single orbit of the  $G$ -action).

A *principal  $G$ -bundle* is a locally trivial bundle  $p: X \rightarrow B$  such that  $G$  acts on  $X$  preserving fibres, and the induced  $G$ -action on each fibre is free and transitive. It follows that each fibre is homeomorphic to  $G$ , the  $G$ -action on  $X$  is free, the  $G$ -orbits are precisely the fibres, and the projection  $p: X \rightarrow B$  induces a homeomorphism between the quotient  $X/G$  and the base  $B$ . Therefore  $p$  can be regarded as the projection onto the orbit space of a free  $G$ -action. If the group  $G$  is compact, the converse is also true under some mild topological assumptions on  $X$ : a free  $G$ -space  $X$  is the total space of a principal  $G$ -bundle (see [41, Chapter II]). Therefore, in this case the notions of a principal  $G$ -bundle and a free  $G$ -action are equivalent.

Now let  $G$  be a compact Lie group. Then there exists a principal  $G$ -bundle  $EG \rightarrow BG$  whose total space  $EG$  is contractible. This bundle has the following universality property. Let  $E \rightarrow B$  be another principal  $G$ -bundle over a cell complex  $B$ . Then there is a unique up to homotopy map  $f: B \rightarrow BG$  such that the pullback of the bundle  $EG \rightarrow BG$  along  $f$  is the bundle  $E \rightarrow B$ . The space  $EG$  is referred to as the *universal  $G$ -space*, and the space  $BG$  is the *classifying space* for free  $G$ -actions (or simply the classifying space for  $G$ ).

Let  $X$  be a  $G$ -space. The *diagonal*  $G$ -action on  $EG \times X$ , given by

$$g(e, x) = (ge, gx), \quad g \in G, e \in EG, x \in X,$$

is free. Its orbit space is denoted by  $EG \times_G X$  (we shall also use the notation  $B_G X$ ) and is called the *Borel construction*, or the *homotopy quotient* of  $X$  by  $G$ . (The latter term is used since the free  $G$ -space  $EG \times X$  is homotopy equivalent to the  $G$ -space  $X$ .) There are two canonical projections

$$(B.4) \quad \begin{array}{ccc} EG \times X \rightarrow EG & & EG \times X \rightarrow X \\ (e, x) \mapsto e & \text{and} & (e, x) \mapsto x. \end{array}$$

After taking quotient by the  $G$ -actions, the second projection above induces a map  $EG \times_G X \rightarrow X/G$  between the homotopy and ordinary quotients, which is a homotopy equivalence when the  $G$ -action is free. The first projection gives rise to a bundle  $EG \times_G X \rightarrow BG$  with fibre  $X$  and structure group  $G$ , called the bundle *associated* with the  $G$ -space  $X$ .

More generally, if  $E \rightarrow B$  is a principal  $G$ -bundle (i.e.  $E$  is a free  $G$ -space) and  $X$  is a  $G$ -space, then we have a bundle  $E \times_G X \rightarrow B$  over  $B$  with fibre  $X$ . When  $X$  is an  $n$ -dimensional  $G$ -representation space, we obtain a *vector bundle* over  $B$  with structure group  $G$ . *Real, oriented* and *complex*  $n$ -dimensional ( $n$ -plane) vector bundles correspond to the cases  $G = GL(n, \mathbb{R})$ ,  $SO(n)$  and  $GL(n, \mathbb{C})$ , respectively. By introducing appropriate metrics, their structure groups can be reduced to  $O(n)$ ,  $SO(n)$  and  $U(n)$ , respectively.

Now let a compact Lie group  $G$  act on a smooth manifold  $M$  by diffeomorphisms. Given a point  $x \in M$  with stabiliser  $G_x$  and orbit  $Gx$ , the differential of the action of an element  $g \in G_x$  is a linear transformation of the tangent space  $\mathcal{T}_x M$  which is the identity on the tangent space to the orbit of  $x$ . Therefore, we obtain the induced representation of  $G_x$  in the space  $\mathcal{T}_x M / \mathcal{T}_x(Gx)$  of the orbit, which is called the *isotropy representation*. In particular, when  $x$  is a fixed point (i.e.  $G_x = G$  and  $Gx = x$ ), we obtain a representation of  $G$  in  $\mathcal{T}_x M$ , which is also called the *tangential representation* of  $G$  at a fixed point  $x$ .

**THEOREM B.3.1 (Slice Theorem).** *Let a compact Lie group  $G$  act on a smooth manifold  $M$ . Then, for each point  $x \in M$ , the orbit  $Gx$  has a  $G$ -invariant neighbourhood  $G$ -equivariantly diffeomorphic to  $G \times_{G_x} (\mathcal{T}_x M / \mathcal{T}_x(Gx))$ . The latter is a vector bundle with fibre  $\mathcal{T}_x M / \mathcal{T}_x(Gx)$  over  $G/G_x \cong Gx$  and the diffeomorphism takes the orbit  $Gx$  to the zero section of this bundle.*

The slice theorem was proved by Koszul in the beginning of 1950s. Its more general version for proper actions of noncompact Lie groups was proved by Palais; this proof can be found e.g. in [142, Theorem B.23] The slice theorem has many important consequences. One is that the union of orbits of a given type is a (smooth, but possibly disconnected) submanifold of  $M$ . In particular, the fixed point set  $M^G$  is a submanifold. Another consequence is that the quotient  $M/G$  by a free action of  $G$  is a smooth manifold.

The second fundamental result is the equivariant embedding theorem:

**THEOREM B.3.2.** *Let a compact Lie group  $G$  act on a compact smooth manifold  $M$ . Then there exist an equivariant embedding of  $M$  into a finite-dimensional linear representation space of  $G$ .*

This theorem was proved by Mostow and Palais in 1957 (instead of compactness of  $M$  they only assumed it to have a finite number of  $G$ -orbit types). A simple proof in the case of compact  $M$  (due to Mostow) can be found in [142, Theorem B.50].

The *equivariant cohomology* of  $X$  with coefficients in a ring  $\mathbf{k}$  is defined by

$$H_G^*(X; \mathbf{k}) = H^*(EG \times_G X; \mathbf{k}).$$

Hence,  $H_G^*(pt; \mathbf{k}) = H^*(BG; \mathbf{k})$ , and the projection  $EG \times_G X \rightarrow BG$  turns  $H_G^*(X; \mathbf{k})$  into a  $H_G^*(pt; \mathbf{k})$ -module.

For a pair of  $G$ -spaces  $(X, A)$  (where the inclusion  $A \subset X$  is an equivariant map), there is a long exact sequence

$$\cdots \rightarrow H_G^q(X, A) \xrightarrow{j^*} H_G^q(X) \xrightarrow{i^*} H_G^q(A) \xrightarrow{d} H_G^{q+1}(X, A) \rightarrow \cdots$$

Its existence follows from the exact sequence in ordinary cohomology and the equivariant homeomorphism  $(EG \times X)/(EG \times A) \cong (EG \times (X/A))/(EG \times pt)$ .

A bundle  $\pi: E \rightarrow X$  with fibre  $F$  is called a  *$G$ -equivariant bundle* if  $\pi$  is an equivariant map of  $G$ -spaces. By applying the Borel construction to a  $G$ -equivariant bundle  $\pi: E \rightarrow X$  we obtain a bundle  $B_G E \rightarrow B_G X$  with the same fibre  $F$ . The *equivariant characteristic classes* of a  $G$ -equivariant vector bundle  $\pi: E \rightarrow X$  are defined as the ordinary characteristic classes of the corresponding bundle  $B_G E \rightarrow B_G X$ . For example, the *equivariant Stiefel–Whitney classes* of a  $G$ -equivariant vector bundle  $\pi: E \rightarrow X$  belong to  $H_G^*(X; \mathbb{Z}_2)$  and are denoted by  $w_i^G(E)$ . If  $E \rightarrow X$  is an oriented  $G$ -equivariant vector bundle, then the *equivariant Euler class*  $e^G(E) \in H_G^*(X; \mathbb{Z})$  is defined. If  $E \rightarrow X$  is a complex bundle and the  $G$ -action preserves the fibrewise complex structure, then the *equivariant Chern classes*  $c_i^G(E) \in H_G^{2i}(X; \mathbb{Z})$  are defined.

Now let  $M$  be a smooth oriented  $G$ -manifold of dimension  $n$ , where  $G$  is a compact Lie group. Let  $N \subset M$  be a  $G$ -invariant (e.g., fixed) oriented submanifold of codimension  $k$ . We can identify the  $G$ -equivariant normal bundle  $\nu(N \subset M)$  with a  $G$ -invariant tubular neighbourhood  $U$  of  $N$  in  $M$  by means of a  $G$ -equivariant diffeomorphism. The same diffeomorphism identifies the Thom space  $Th \nu$  (see Section D.2) of the bundle  $\nu$  with the quotient space  $\overline{U}/\partial\overline{U}$ . We have the embedding  $i: N \subset M$ , the projection  $\pi: U \rightarrow N$ , and the *Pontryagin–Thom map*  $p: M \rightarrow Th \nu$  contracting the complement  $M \setminus U$  to a point. In equivariant cohomology, the *Thom class*  $\tau_N \in H_G^k(Th \nu)$  is uniquely determined by the identity

$$(\alpha \cdot p^*(\tau_N), \langle M \rangle) = (i^* \alpha, \langle N \rangle),$$

for any  $\alpha \in H_G^{n-k}(M)$ . Here  $\langle M \rangle \in H_n^G(M)$  denotes the fundamental class of  $M$  in equivariant homology. The *Gysin homomorphism* in equivariant cohomology is defined by the composition

$$H_G^{*-k}(N) \xrightarrow{\pi^*} H_G^{*-k}(U) \xrightarrow{\tau_N} H_G^*(Th \nu) \xrightarrow{p^*} H_G^*(M),$$

and is denoted by  $i_*$ . Then  $i^*(i_*(1)) \in H_G^k(N)$  is the equivariant Euler class of the normal bundle  $\nu(N \subset M)$ .

**Exercises.**

B.3.3. Let  $G$  be a compact group acting on a Hausdorff space  $X$ . Show that the  $G$ -orbits are closed, the orbit space  $X/G$  is Hausdorff, and the projection  $\pi: X \rightarrow X/G$  is a closed and proper map.

B.3.4. If the quotient  $X/G$  is Hausdorff, then all  $G$ -orbits are closed.

B.3.5. Give an example of a Hausdorff space  $X$  with a  $G$ -action whose orbits are closed, but the quotient  $X/G$  is not Hausdorff.

B.3.6. Show that any complex line bundle over the complex projective space  $\mathbb{C}P^n$  has the form  $S^{2n+1} \times_{S^1} \mathbb{C}$ . Here the  $S^1$ -action on  $S^{2n+1}$  is standard (the diagonal action on a unit sphere in  $\mathbb{C}^{n+1}$ , with quotient  $\mathbb{C}P^n$ ), and  $\mathbb{C}$  is a certain 1-dimensional  $S^1$ -representation space. The same line bundle can be also given as  $(\mathbb{C}^{n+1} \setminus \{0\}) \times_{\mathbb{C}^\times} \mathbb{C}$ , where  $\mathbb{C}^\times = GL(1, \mathbb{C})$ .

In particular, when  $\mathbb{C}$  is the standard (weight 1)  $S^1$ -representation space (given by  $S^1 \times \mathbb{C} \rightarrow \mathbb{C}$ ,  $(g, z) \mapsto gz$ ), the bundle  $S^{2n+1} \times_{S^1} \mathbb{C}$  is the *canonical* line bundle over  $\mathbb{C}P^n$  (it is also known as the line bundle of hyperplane section and denoted by  $\mathcal{O}(1)$  in algebraic geometry literature). The *Hopf* (or *tautological*) line bundle, whose fibre over a line  $\ell \in \mathbb{C}P^n$  is  $\ell$  itself, corresponds to the  $S^1$ -representation of weight  $-1$ , given by  $(g, z) \mapsto g^{-1}z$ .

B.3.7. Deduce from the slice theorem that if a compact Lie group  $G$  acts smoothly on a smooth manifold  $M$ , then the union of orbits of a given type (in particular, the fixed point set  $M^G$ ) is a submanifold of  $M$ . Also, deduce that if the action is free then the quotient  $M/G$  is a smooth manifold.

B.3.8. Show that if a compact Lie group  $G$  acts on  $M$  effectively and  $M$  is connected, then the isotropy representation  $G_x \rightarrow GL(\mathcal{T}_x M / \mathcal{T}_x(Gx))$  is faithful.

#### B.4. Eilenberg–Moore spectral sequences

In their paper [105] of 1966, Eilenberg and Moore constructed a spectral sequence, which became one of the important computational tools of algebraic topology. In particular, it provides a method for calculation of the cohomology of the fibre of a bundle  $E \rightarrow B$  using the canonical  $H^*(B)$ -module structure on  $H^*(E)$ . This spectral sequence can be considered as an extension of Adams' approach to calculating cohomology of loop spaces [1]. In the 1960–70s applications of the Eilenberg–Moore spectral sequence led to many important results on cohomology of homogeneous spaces for Lie groups. More recently it has been used for different calculations with toric spaces. This section contains the necessary information about the spectral sequence; we mainly follow L. Smith's paper [287] in this description. For a detailed account of differential homological algebra and the Eilenberg–Moore spectral sequence, as well as its applications which go beyond the scope of this book, we refer to McCleary's book [215].

Here we assume that  $\mathbf{k}$  is a field. The following theorem provides an algebraic setup for the Eilenberg–Moore spectral sequence.

**THEOREM B.4.1** (Eilenberg–Moore [287, Theorem 1.2]). *Let  $A$  be a differential graded  $\mathbf{k}$ -algebra, and let  $M, N$  be differential graded  $A$ -modules. Then there exists a spectral sequence  $\{E_r, d_r\}$  converging to  $\mathrm{Tor}_A(M, N)$  and whose  $E_2$ -term is*

$$E_2^{-i,j} = \mathrm{Tor}_{H[A]}^{-i,j}(H[M], H[N]), \quad i, j \geq 0,$$

where  $H[\cdot]$  denotes the algebra or module of cohomology.

**REMARK.** The construction of  $\mathrm{Tor}$  for differential graded objects requires some additional considerations (see e.g. [287] or [203, Chapter XII]).

The spectral sequence of Theorem B.4.1 lives in the second quadrant and its differentials  $d_r$  add  $(r, 1 - r)$  to the bidegree, for  $r \geq 1$ . We shall refer to it as the *algebraic Eilenberg–Moore spectral sequence*. Its  $E_\infty$ -term is expressed via a certain decreasing filtration  $\{F^{-p} \operatorname{Tor}_A(M, N)\}$  in  $\operatorname{Tor}_A(M, N)$  by the formula

$$E_\infty^{-p, n+p} = F^{-p} \left( \sum_{-i+j=n} \operatorname{Tor}_A^{-i, j}(M, N) \right) / F^{-p+1} \left( \sum_{-i+j=n} \operatorname{Tor}_A^{-i, j}(M, N) \right).$$

Topological applications of Theorem B.4.1 arise in the case when  $A, M, N$  are cochain algebras of topological spaces. The classical situation is described by the commutative diagram

$$(B.5) \quad \begin{array}{ccc} E & \longrightarrow & E_0 \\ \downarrow & & \downarrow \\ B & \longrightarrow & B_0, \end{array}$$

where  $E_0 \rightarrow B_0$  is a Serre fibre bundle with fibre  $F$  over a simply connected base  $B_0$ , and  $E \rightarrow B$  is the pullback along a continuous map  $B \rightarrow B_0$ . For any space  $X$ , let  $C^*(X)$  denote the singular  $\mathbf{k}$ -cochain algebra of  $X$ . Then  $C^*(E_0)$  and  $C^*(B)$  are  $C^*(B_0)$ -modules. Under these assumptions the following statement holds.

LEMMA B.4.2 ([287, Proposition 3.4]).  *$\operatorname{Tor}_{C^*(B_0)}(C^*(E_0), C^*(B))$  is a  $\mathbf{k}$ -algebra in a natural way, and there is a canonical isomorphism of algebras*

$$\operatorname{Tor}_{C^*(B_0)}(C^*(E_0), C^*(B)) \rightarrow H^*(E).$$

Applying Theorem B.4.1 in the case  $A = C^*(B_0)$ ,  $M = C^*(E_0)$ ,  $N = C^*(B)$  and taking into account Lemma B.4.2, we come to the following statement.

THEOREM B.4.3 (Eilenberg–Moore). *There exists a spectral sequence  $\{E_r, d_r\}$  of commutative algebras converging to  $H^*(E)$  with*

$$E_2^{-i, j} = \operatorname{Tor}_{H^*(B_0)}^{-i, j}(H^*(E_0), H^*(B)).$$

The spectral sequence of Theorem B.4.3 is known as the (topological) *Eilenberg–Moore spectral sequence*. The case when  $B$  is a point is of particular importance, and we state the corresponding result separately.

COROLLARY B.4.4. *Let  $E \rightarrow B$  be a fibration over a simply connected space  $B$  with fibre  $F$ . Then there exists a spectral sequence  $\{E_r, d_r\}$  of commutative algebras converging to  $H^*(F)$  with*

$$E_2 = \operatorname{Tor}_{H^*(B_0)}(H^*(E_0), \mathbf{k}).$$

We refer to the spectral sequence of Corollary B.4.4 as the *Eilenberg–Moore spectral sequence of the fibration  $E \rightarrow B$* . In the case when  $E_0$  is a contractible we obtain a spectral sequence converging to the cohomology of the loop space  $\Omega B_0$ .

REMARK. As we outlined in Section B.2, the Sullivan algebra  $A_{PL}(X)$  provides a commutative rational model for  $X$ . It can be proved [39, §3] that the above results on the Eilenberg–Moore spectral sequence hold over  $\mathbb{Q}$  with  $C^*$  replaced by  $A_{PL}$ . This result is not a direct corollary of algebraic properties of  $\operatorname{Tor}$ , since the integration map  $A_{PL}(X) \rightarrow C^*(X, \mathbb{Q})$  is not multiplicative.





## Categorical constructions

In this appendix we introduce aspects of category theory that are directly relevant to the study of toric spaces. Our exposition follows closely the introductory sections of the work of Panov and Ray [260].

### C.1. Diagrams and model categories

We use small capitals to denote categories. The set of morphisms between objects  $c$  and  $d$  in a category  $\mathcal{C}$  will be denoted by  $\text{Mor}_{\mathcal{C}}(c, d)$ , or simply by  $\mathcal{C}(c, d)$ . The *opposite category*  $\mathcal{C}^{op}$  has the same objects with morphisms reverted.

We shall work with the following categories of combinatorial origin:

- SET: sets and set maps;
- $\Delta$ : finite ordered sets  $[n]$  and nondecreasing maps;
- $\text{CAT}(\mathcal{K})$ : simplices of a finite simplicial complex  $\mathcal{K}$  and their inclusions (the *face category* of  $\mathcal{K}$ ).

Here  $\text{CAT}(\mathcal{K})$  is an example of a more general *poset category*  $\mathcal{P}$ , whose objects are elements  $\sigma$  of a poset  $(\mathcal{P}, \leq)$  and there is a morphism  $\sigma \rightarrow \tau$  whenever  $\sigma \leq \tau$ .

A category is *small* if both its objects and morphisms are sets. Among the three basic categories above,  $\Delta$  and  $\text{CAT}(\mathcal{K})$  are small, while SET is not. Furthermore,  $\text{CAT}(\mathcal{K})$  is finite.

Given a small category  $\mathcal{S}$  and an arbitrary category  $\mathcal{C}$ , a covariant functor  $\mathcal{D}: \mathcal{S} \rightarrow \mathcal{C}$  is known as an *s-diagram* in  $\mathcal{C}$ . The source  $\mathcal{S}$  is referred to as the *indexing category* of the diagram  $\mathcal{D}$ . Such diagrams are themselves the objects of a *diagram category*  $[\mathcal{S}, \mathcal{C}]$ , whose morphisms are natural transformations. When  $\mathcal{S}$  is  $\Delta^{op}$ , the diagrams are known as *simplicial objects* in  $\mathcal{C}$ , and are written as  $\mathcal{D}_{\bullet}$ ; the object  $\mathcal{D}[n]$  is abbreviated to  $\mathcal{D}_n$  for every  $n \geq 0$ , and forms the *n-simplices* of  $\mathcal{D}_{\bullet}$ . A *simplicial set* is therefore a simplicial object in SET, i.e. an object in the diagram category  $[\Delta^{op}, \text{SET}]$ .

We may interpret every object  $c$  of  $\mathcal{C}$  as a *constant s-diagram*, and so define the constant functor  $\kappa: \mathcal{C} \rightarrow [\mathcal{S}, \mathcal{C}]$ . Whenever  $\kappa$  admits a right or left adjoint  $[\mathcal{S}, \mathcal{C}] \rightarrow \mathcal{C}$ , it is known as the *limit* or *colimit* functor respectively. In more detail, the limit of a diagram  $\mathcal{D}: \mathcal{S} \rightarrow \mathcal{C}$  is an object  $\lim \mathcal{D}$  in  $\mathcal{C}$  for which there are natural identifications of the morphism sets,

$$\text{Mor}_{[\mathcal{S}, \mathcal{C}]}(\kappa(c), \mathcal{D}) \cong \text{Mor}_{\mathcal{C}}(c, \lim \mathcal{D})$$

for any object  $c$  of  $\mathcal{C}$ . Similarly,  $\text{colim } \mathcal{D}$  satisfies

$$\text{Mor}_{\mathcal{C}}(\text{colim } \mathcal{D}, c) \cong \text{Mor}_{[\mathcal{S}, \mathcal{C}]}(\mathcal{D}, \kappa(c)).$$

Simple examples are *products* and more general *pullbacks*, which are limits over the indexing category  $\bullet \rightarrow \bullet \leftarrow \bullet$ . Similarly, *coproducts* and more general *pushouts* are colimits over the indexing category  $\bullet \leftarrow \bullet \rightarrow \bullet$ .

For any object  $c$  of  $\mathcal{C}$ , the objects of the *overcategory*  $\mathcal{C} \downarrow c$  are morphisms  $f: b \rightarrow c$  with fixed target, and the morphisms are the corresponding commutative triangles; the full subcategory  $\mathcal{C} \downarrow c$  is given by restricting attention to non-identities  $f$ . Similarly, the objects of the *undercategory*  $c \downarrow \mathcal{C}$  are morphisms  $f: c \rightarrow d$  with fixed source, and the morphisms are the corresponding triangles;  $c \downarrow \mathcal{C}$  is given by restriction to the non-identities. In  $\text{CAT}(\mathcal{K})$  for example, we have

$$\begin{aligned} \text{CAT}(\mathcal{K}) \downarrow I &= \text{CAT}(\Delta(I)), & \text{CAT}(\mathcal{K}) \downarrow I &= \text{CAT}(\partial\Delta(I)), \\ I \downarrow \text{CAT}(\mathcal{K}) &= \text{CAT}(\text{st}_{\mathcal{K}} I), & I \downarrow \text{CAT}(\mathcal{K}) &= \text{CAT}(\text{lk}_{\mathcal{K}} I), \end{aligned}$$

for any  $I \in \mathcal{K}$ , where  $\Delta(I)$  and  $\partial\Delta(I)$  denote the simplex with vertices  $I$  and its boundary, and star and link are given in Definition 2.2.13.

A *model category*  $\text{MC}$  is a category which is closed with respect to formation of small limits and colimits, and contains three *distinguished* classes of morphisms: *weak equivalences*  $w$ , *fibrations*  $p$ , and *cofibrations*  $i$ . Unless otherwise stated, these letters denote such morphisms henceforth. A fibration or cofibration is *acyclic* whenever it is also a weak equivalence. The three distinguished morphisms are required to satisfy the following axioms (see Hirschhorn [158, Definition 7.1.3]):

- (a) a retract of a distinguished morphism is a distinguished morphism of the same class;
- (b) if  $f' \cdot f$  is a composition of morphisms  $f$  and  $f'$ , and two of the three morphisms  $f$ ,  $f'$  and  $f' \cdot f$  is a weak equivalence, then so is the third;
- (c) acyclic cofibrations obey the left lifting property with respect to fibrations, and cofibrations obey the left lifting property with respect to acyclic fibrations;
- (d) every morphism  $f$  factorises functorially as

$$(C.1) \quad h = p \cdot i = p' \cdot i',$$

for some acyclic  $p$  and  $i'$ .

These strengthen Quillen's original axioms for a closed model category [270] in two minor but significant ways. Quillen demanded only closure with respect to *finite* limits and colimits, and only existence of factorisation (C.1) rather than its functoriality. When using results of pioneering authors such as Bousfield and Gugenheim [39] and Quillen [271], we must take account of these differences.

The axioms for a model category are actually self-dual, in the sense that any general statement concerning fibrations, cofibrations, limits, and colimits is equivalent to the statement in which they are replaced by cofibrations, fibrations, colimits, and limits respectively. In particular,  $\text{MC}^{op}$  always admits a dual model structure.

The axioms imply that initial and terminal objects  $\circ$  and  $*$  exist in  $\text{MC}$ , and that  $\text{MC} \downarrow M$  and  $M \downarrow \text{MC}$  inherit model structures for any object  $M$ .

An object of  $\text{MC}$  is *cofibrant* when the natural morphism  $\circ \rightarrow M$  is a cofibration, and is *fibrant* when the natural morphism  $M \rightarrow *$  is a fibration. A *cofibrant approximation* to an object  $N$  is a weak equivalence  $N' \rightarrow N$  with cofibrant source, and a *fibrant approximation* is a weak equivalence  $N \rightarrow N''$  with fibrant target. The full subcategories  $\text{MC}_c$ ,  $\text{MC}_f$  and  $\text{MC}_{cf}$  are defined by restricting attention to those objects of  $\text{MC}$  that are respectively cofibrant, fibrant, and both. When applied to  $\circ \rightarrow N$  and  $N \rightarrow *$ , the factorisations (C.1) determine a *cofibrant replacement* functor  $\omega: \text{MC} \rightarrow \text{MC}_c$ , and a *fibrant replacement* functor  $\varphi: \text{MC} \rightarrow \text{MC}_f$ . It follows from the definitions that  $\omega$  and  $\varphi$  preserve weak equivalences, and that the

associated acyclic fibrations  $\omega(N) \rightarrow N$  and acyclic cofibrations  $N \rightarrow \varphi(N)$  form cofibrant and fibrant approximations respectively. These ideas are central to the definition of homotopy limits and colimits given in Section C.3 below.

Weak equivalences need not be invertible, so objects  $M$  and  $N$  are deemed to be *weakly equivalent* if they are linked by a zigzag  $M \xleftarrow{e_1} \cdots \xrightarrow{e_n} N$  in  $\text{MC}$ ; this is the smallest equivalence relation generated by the weak equivalences. An important consequence of the axioms is the existence of a localisation functor  $\gamma: \text{MC} \rightarrow \text{Ho}(\text{MC})$ , such that  $\gamma(w)$  is an isomorphism in the *homotopy category*  $\text{Ho}(\text{MC})$  for every weak equivalence  $w$  (i.e.  $\text{Ho}(\text{MC})$  is obtained from  $\text{MC}$  by inverting all weak equivalences). Here  $\text{Ho}(\text{MC})$  has the same objects as  $\text{MC}$ , and is equivalent to a category whose objects are those of  $\text{MC}_{cf}$ , but whose morphisms are homotopy classes of morphisms between them.

Any functor  $F$  of model categories that preserves weak equivalences induces a functor  $\text{Ho}(F)$  on their homotopy categories. Examples include

$$(C.2) \quad \text{Ho}(\omega): \text{Ho}(\text{MC}) \rightarrow \text{Ho}(\text{MC}_c) \quad \text{and} \quad \text{Ho}(\varphi): \text{Ho}(\text{MC}) \rightarrow \text{Ho}(\text{MC}_f).$$

Such functors often occur as adjoint pairs

$$(C.3) \quad F: \text{MB} \rightleftarrows \text{MC} : G,$$

where  $F$  is *left Quillen* if it preserves cofibrations and acyclic cofibrations, and  $G$  is *right Quillen* if it preserves fibrations and acyclic fibrations. Either of these implies the other, leading to the notion of a *Quillen pair*  $(F, G)$ ; then Ken Brown's Lemma [158, Lemma 7.7.1] applies to show that  $F$  and  $G$  preserve all weak equivalences on  $\text{MB}_c$  and  $\text{MC}_f$  respectively. So they may be combined with (C.2) to produce an adjoint pair of *derived functors*

$$LF: \text{Ho}(\text{MB}) \rightleftarrows \text{Ho}(\text{MC}) : RG,$$

which are equivalences of the homotopy categories (or certain of their full subcategories) in favourable cases.

Our first examples of model categories are of topological origin, as follows:

- TOP: pointed topological spaces and pointed continuous maps;
- TMON: topological monoids and continuous homomorphisms;
- SSETS: simplicial sets.

Homotopy theorists often impose restrictions on topological spaces defining the category TOP, ensuring that it behaves nicely with respect to formation of limits and colimits, etc. For example, TOP is often defined to consist of *compactly generated Hausdorff spaces* (a space  $X$  is compactly generated if a subset  $A$  is closed whenever the intersection of  $A$  with any compact subset of  $X$  is closed), or *k-spaces* [315]. We ignore this subtlety however, as spaces we work with will be nice enough anyway.

There is a model structure on TOP in which fibrations are Hurewicz fibrations, cofibrations are defined by the homotopy extension property (B.3), and weak equivalences are homotopy equivalences. However, in the more convenient and standard model structure on TOP, weak equivalences are maps inducing isomorphisms of homotopy groups, fibrations are Serre fibrations, and cofibrations obey the left lifting property with respect to acyclic fibrations (this is a narrower class than maps obeying the the HEP (B.3)). The axioms for this model structure on TOP are verified in [163, Theorem 2.4.23], for example.

In either of the model structures above, cell complexes are cofibrant objects in TOP. Recall that a cell complex can be defined as a result of iterating the

operation of attaching a cell, i.e. pushing out the standard cofibration  $S^{n-1} \rightarrow D^n$ , see (B.1). In the second (standard) model structure on TOP, every space  $X$  has a *cellular model*, i.e. there is a weak equivalence  $W \rightarrow X$  with  $W$  a cell complex, providing a cofibrant approximation. Two weakly equivalent topological spaces have homotopy equivalent cellular models. Cellular models are not functorial, however. A genuine cofibrant replacement functor  $\omega(X) \rightarrow X$  must be constructed with care, and is defined in [102, §98], for example.

A *topological monoid* is a space with a continuous associative product and identity element. We assume that topological monoids are pointed by their identities, so that TMON is a subcategory of TOP. The model structure for TMON is originally due to Schwänzl and Vogt [281], and may also be deduced from Schwede and Shipley's theory [283] of monoids in monoidal model categories; weak equivalences and fibrations are those homomorphisms which are weak equivalences and fibrations in TOP, and cofibrations obey the appropriate lifting property.

In the standard model structure on SSET, weak equivalences are maps of simplicial sets whose realisations are weak equivalences of spaces, fibrations are *Kan fibrations* (whose realisations are Serre fibrations), and cofibrations are monomorphisms of simplicial sets. There is a Quillen equivalence

$$|\cdot| : \text{SSET} \rightleftarrows \text{TOP} : S_\bullet,$$

where  $|\cdot|$  denotes the *geometric realisation* of a simplicial set, and  $S_\bullet$  is the total singular complex of a space. It induces an equivalence of homotopy categories of simplicial sets and topological spaces.

Our algebraic categories are defined over arbitrary commutative rings  $\mathbf{k}$ , but tend only to acquire model structures when  $\mathbf{k}$  is a field of characteristic zero.

- $\text{CH}_{\mathbf{k}}$  and  $\text{COCH}_{\mathbf{k}}$ : augmented chain and cochain complexes;
- $\text{CDGA}_{\mathbf{k}}$ : commutative augmented differential graded algebras, with cohomology differential (raising the degree by 1);
- $\text{CDGC}_{\mathbf{k}}$ : cocommutative coaugmented differential graded coalgebras, with homology differential (lowering the degree by 1);
- $\text{DGA}_{\mathbf{k}}$ : augmented differential graded algebras, with homology differential;
- $\text{DGC}_{\mathbf{k}}$ : coaugmented differential graded coalgebras, with homology differential;
- $\text{DGL}$ : differential graded Lie algebras over  $\mathbb{Q}$ , with homology differential.

For any model structure on these categories, weak equivalences are the *quasi-isomorphisms*, which induce isomorphisms in homology or cohomology. The fibrations and cofibrations are described in Section C.2 below. The augmentations and coaugmentations act as algebraic analogues of basepoints.

We reserve the notation AMC for any of the algebraic model categories above, and assume that objects are graded over the nonnegative integers. We denote the full subcategory of connected objects by  $\text{AMC}_0$ . In order to emphasise the differential, we may display an object  $M$  as  $(M, d)$ . The (co)homology group  $H(M, d)$  is also an  $R$ -module, and inherits all structure on  $M$  except for the differential. Nevertheless, we may interpret any graded algebra, coalgebra or Lie algebra as an object of the corresponding differential category, by imposing  $d = 0$ .

Extending Definition A.4.5, we refer to an object  $(M, d)$  is *formal in AMC* whenever there exists a zigzag of quasi-isomorphisms

$$(C.4) \quad (M, d) = M_1 \xleftarrow{\simeq} \cdots \xrightarrow{\simeq} M_k = (H(M), 0).$$

Formality only has meaning in an algebraic model category.

There is special class of cofibrant objects in  $\text{CDGA}_{\mathbb{Q}}$ , which are analogous to cell complexes in  $\text{TOP}$ . These are minimal dg-algebras, see Definition A.4.1. Any minimal dg-algebra can be constructed by successive pushouts of the form

$$(C.5) \quad \begin{array}{ccc} S_{\mathbb{Q}}(x) & \xrightarrow{f} & (A, d_A) \\ \downarrow j & & \downarrow \\ S_{\mathbb{Q}}(w, dw) & \longrightarrow & B = (A \otimes S(w), d_B) \end{array}$$

in a way similar to constructing cell complexes by pushouts (B.1). Here  $S_{\mathbb{Q}}(x)$  denotes a free commutative dg-algebra with one generator  $x$  of positive degree and zero differential, so that  $S_{\mathbb{Q}}(x)$  is the exterior algebra  $\Lambda_{\mathbb{Q}}[x]$  when  $\deg x$  is odd and the polynomial algebra  $\mathbb{Q}[x]$  when  $\deg x$  is even. The dg-algebra  $S_{\mathbb{Q}}(x, dx)$  has zero cohomology. The map  $j$  is defined by  $j(x) = dw$ . The differential in the pushout dg-algebra  $B \cong A \otimes S_{\mathbb{Q}}(w)$  is given by

$$d_B(a \otimes 1) = d_A a \otimes 1, \quad d_B(1 \otimes w) = f(x) \otimes 1.$$

Theorem A.4.3 asserts the existence of a cofibrant approximation  $f: M_A \rightarrow A$  for a homologically connected dg-algebra  $A$ , where  $M_A$  is a *minimal model* for  $A$ ; any two minimal models for  $A$  are necessarily isomorphic, and  $M_A$  and  $M_B$  are isomorphic for quasi-isomorphic  $A$  and  $B$ . The advantage of  $M_A$  is that it simplifies many calculations concerning  $A$ ; disadvantages include the fact that it may be difficult to describe for relatively straightforward objects  $A$ , and that it cannot be chosen functorially. A genuine cofibrant replacement functor requires additional care, and seems first to have been made explicit in [39, §4.7].

Sullivan’s approach to rational homotopy theory is based on the PL-cochain functor  $A_{PL}: \text{TOP} \rightarrow \text{CDGA}_{\mathbb{Q}}$ . Basic results related to this approach are given in Section B.2. Following [112],  $A_{PL}(X)$  is defined as  $A^*(S_{\bullet}X)$ , where  $S_{\bullet}(X)$  denotes the total singular complex of  $X$  and  $A^*: \text{SSET} \rightarrow \text{CDGA}_{\mathbb{Q}}$  is the polynomial de Rham functor of [39]. The PL-de Rham Theorem (Theorem B.2.3) yields a natural isomorphism  $H(A_{PL}(X)) \rightarrow H^*(X, \mathbb{Q})$ , so  $A_{PL}(X)$  provides a commutative replacement for rational singular cochains, and  $A_{PL}$  descends to homotopy categories. Bousfield and Gugenheim prove that it restricts to an equivalence of appropriate full subcategories of  $\text{Ho}(\text{TOP})$  and  $\text{Ho}(\text{CDGA}_{\mathbb{Q}})$ . In other words, it provides a contravariant algebraic model for the rational homotopy theory of well-behaved spaces.

Quillen’s approach involves the homotopy groups  $\pi_*(\Omega X) \otimes_{\mathbb{Z}} \mathbb{Q}$ , which form the *rational homotopy Lie algebra of  $X$*  under the *Samelson product*. He constructs a covariant functor  $Q: \text{TOP} \rightarrow \text{DGL}$ , and a natural isomorphism

$$H[Q(X)] \xrightarrow{\cong} \pi_*(\Omega X) \otimes_{\mathbb{Z}} \mathbb{Q}.$$

for any simply connected  $X$ . He concludes that  $Q$  passes to an equivalence of homotopy categories; in other words, its derived functor provides a covariant algebraic model for the rational homotopy theory of simply connected spaces.

We recall from Definition B.2.6 that a space  $X$  is *formal* when  $A_{PL}(X)$  is formal in  $\text{CDGA}_{\mathbb{Q}}$ . A space  $X$  is referred to as *coformal* when  $Q(X)$  is formal in  $\text{DGL}$ .

The importance of categories of simplicial objects is due in part to the structure of the indexing category  $\Delta^{op}$ . Every object  $[n]$  has *degree  $n$* , and every morphism may be factored uniquely as a composition of morphisms that raise and lower degree.

These properties are formalised in the notion of a *Reedy category*  $A$ , which admits generating subcategories  $A_+$  and  $A_-$  whose non-identity morphisms raise and lower degree respectively. The diagram category  $[A, \text{MC}]$  then supports a canonical model structure of its own [158, Theorem 15.3.4]. By duality,  $A^{op}$  is also Reedy, with  $(A^{op})_+ = (A_-)^{op}$  and vice-versa. A simple example is provided by  $\text{CAT}(\mathcal{K})$ , whose degree function assigns the dimension  $|I| - 1$  to each simplex  $I$  of  $\mathcal{K}$ . So  $\text{CAT}_+(\mathcal{K})$  is the same as  $\text{CAT}(\mathcal{K})$ , and  $\text{CAT}_-(\mathcal{K})$  consists entirely of identities.

In the Reedy model structure on  $[\text{CAT}(\mathcal{K}), \text{MC}]$ , weak equivalences  $w: \mathcal{C} \rightarrow \mathcal{D}$  are given *objectwise*, in the sense that  $w(I): \mathcal{C}(I) \rightarrow \mathcal{D}(I)$  is a weak equivalence in MC for every  $I \in \mathcal{K}$ . Fibrations are also objectwise. To describe the cofibrations, we restrict  $\mathcal{C}$  and  $\mathcal{D}$  to the overcategories  $\text{CAT}(\mathcal{K}) \Downarrow I = \text{CAT}(\partial\Delta(I))$ , and write  $L_I\mathcal{C}$  and  $L_I\mathcal{D}$  for their respective colimits. So  $L_I$  is the *latching functor* of [163], and  $g: \mathcal{C} \rightarrow \mathcal{D}$  is a cofibration precisely when the induced maps

$$(C.6) \quad \mathcal{C}(I) \amalg_{L_I\mathcal{C}} L_I\mathcal{D} \longrightarrow \mathcal{D}(I)$$

are cofibrations in MC for all  $I \in \mathcal{K}$ . Thus  $\mathcal{D}: \text{CAT}(\mathcal{K}) \rightarrow \text{MC}$  is cofibrant when every canonical map  $\text{colim } \mathcal{D}|_{\text{CAT}(\partial\Delta(I))} \rightarrow \mathcal{D}(I)$  is a cofibration.

In the dual model structure on  $[\text{CAT}^{op}(\mathcal{K}), \text{MC}]$ , weak equivalences and cofibrations are given objectwise. To describe the fibrations, we restrict  $\mathcal{C}$  and  $\mathcal{D}$  to the undercategories  $\text{CAT}^{op}(\partial\Delta(I))$ , and write  $M_I\mathcal{C}$  and  $M_I\mathcal{D}$  for their respective limits. So  $M_I$  is the *matching functor* of [163], and  $f: \mathcal{C} \rightarrow \mathcal{D}$  is a fibration precisely when the induced maps

$$(C.7) \quad \mathcal{C}(I) \longrightarrow \mathcal{D}(I) \times_{M_I\mathcal{D}} M_I\mathcal{C}$$

are fibrations in MC for all  $I \in \mathcal{K}$ . Thus  $\mathcal{C}: \text{CAT}^{op}(\mathcal{K}) \rightarrow \text{MC}$  is fibrant when every canonical map  $\mathcal{C}(I) \rightarrow \lim \mathcal{C}|_{\text{CAT}^{op}(\partial\Delta(I))}$  is a fibration.

### C.2. Algebraic model categories

Here we give further details of the algebraic model categories introduced in the previous section. We describe the fibrations and cofibrations in each category, comment on the status of the strengthened axioms, and give simple examples in less familiar cases. We also discuss two important adjoint pairs.

So far as general algebraic notation is concerned, we work over an arbitrary commutative ring  $\mathbf{k}$ . We indicate the coefficient ring  $\mathbf{k}$  by means of a subscript when necessary, but often omit it. In some situations  $\mathbf{k}$  is restricted to the rational numbers  $\mathbb{Q}$ , in this case we always clearly indicate it in the notation.

We consider finite sets  $\mathcal{W}$  of generators  $w_1, \dots, w_m$ . We write the graded tensor  $\mathbf{k}$ -algebra on  $\mathcal{W}$  as  $T_{\mathbf{k}}(w_1, \dots, w_m)$ , and use the abbreviation  $T_{\mathbf{k}}(\mathcal{W})$  whenever possible. Its symmetrisation  $S_{\mathbf{k}}(\mathcal{W})$  is the graded commutative  $\mathbf{k}$ -algebra generated by  $\mathcal{W}$ . If  $\mathcal{U}, \mathcal{V} \subset \mathcal{W}$  are the subsets of odd and even grading respectively, then  $S_{\mathbf{k}}(\mathcal{W})$  is the tensor product of the exterior algebra  $\Lambda_{\mathbf{k}}[\mathcal{U}]$  and the polynomial algebra  $\mathbf{k}[\mathcal{V}]$ . When  $\mathbf{k}$  is a field of characteristic zero, it is also convenient to denote the free graded Lie algebra on  $\mathcal{W}$  and its commutative counterpart by  $FL_{\mathbf{k}}(\mathcal{W})$  and  $CL_{\mathbf{k}}(\mathcal{W})$  respectively; the latter is nothing more than a free  $\mathbf{k}$ -module.

Almost all of our graded algebras have finite type, leading to a natural coalgebraic structure on their duals. We write the free tensor coalgebra on  $\mathcal{W}$  as  $T_{\mathbf{k}}\langle \mathcal{W} \rangle$ ;

it is isomorphic to  $T_{\mathbf{k}}(\mathcal{W})$  as  $\mathbf{k}$ -modules, and its diagonal is given by

$$\Delta(w_{j_1} \otimes \cdots \otimes w_{j_r}) = \sum_{k=0}^r (w_{j_1} \otimes \cdots \otimes w_{j_k}) \otimes (w_{j_{k+1}} \otimes \cdots \otimes w_{j_r}).$$

The submodule  $S_{\mathbf{k}}(\mathcal{W})$  of symmetric elements ( $w_i \otimes w_j + (-1)^{\deg w_i \deg w_j} w_j \otimes w_i$ , for example) is the graded cocommutative  $\mathbf{k}$ -coalgebra cogenerated by  $\mathcal{W}$ .

Given  $\mathcal{W}$ , we may sometimes define a differential by denoting the set of elements  $dw_1, \dots, dw_m$  by  $d\mathcal{W}$ . For example, we write the free dg-algebra on a single generator  $w$  of positive dimension as  $T_{\mathbf{k}}(w, dw)$ ; the notation is designed to reinforce the fact that its underlying algebra is the tensor  $\mathbf{k}$ -algebra on elements  $w$  and  $dw$ . Similarly,  $T_{\mathbf{k}}(w, dw)$  is the free differential graded coalgebra on  $w$ . For further information on differential graded coalgebras, [166] remains a valuable source.

**Chain and cochain complexes.** The existence of a model structure on categories of chain complexes was first proposed by Quillen [270], whose view of homological algebra as homotopy theory in  $\text{CH}_{\mathbf{k}}$  was a crucial insight. Variations involving bounded and unbounded complexes are studied by Hovey [163], for example. In  $\text{CH}_{\mathbf{k}}$ , we assume that the fibrations are epimorphic in positive degrees and the cofibrations are monomorphic with degree-wise projective cokernel [102]. In particular, every object is fibrant.

The existence of limits and colimits is assured by working dimensionwise, and functoriality of the factorisations (C.1) follows automatically from the fact that  $\text{CH}_{\mathbf{k}}$  is *cofibrantly generated* [163, Chapter 2].

Model structures on  $\text{COCH}_{\mathbf{k}}$  are established by analogous techniques. It is usual to assume that the fibrations are epimorphic with degree-wise injective kernel, and the cofibrations are monomorphic in positive degrees. Then every object is cofibrant. There is an alternative structure based on projectives, but we shall only refer to the rational case so we ignore the distinction.

Tensor product of (co)chain complexes invests  $\text{CH}_{\mathbf{k}}$  and  $\text{COCH}_{\mathbf{k}}$  with the structure of a monoidal model category, as defined by Schwede and Shipley [283].

**Commutative differential graded algebras.** We consider commutative differential graded algebras over  $\mathbb{Q}$  with cohomology differentials, so they are commutative monoids in  $\text{COCH}_{\mathbb{Q}}$ . A model structure on  $\text{CDGA}_{\mathbb{Q}}$  was first defined in this context by Bousfield and Gugenheim [39], and has played a significant role in the theoretical development of rational homotopy theory ever since. The fibrations are epimorphic, and the cofibrations are determined by the appropriate lifting property; some care is required to identify sufficiently many explicit cofibrations.

Limits in  $\text{CDGA}_{\mathbb{Q}}$  are created in the underlying category  $\text{COCH}_{\mathbb{Q}}$  and endowed with the natural algebra structure, whereas colimits exist because  $\text{CDGA}_{\mathbb{Q}}$  has finite coproducts and filtered colimits. The proof of the factorisation axioms in [39] is already functorial.

By way of example, we note that the product of algebras  $A$  and  $B$  is their augmented sum  $A \oplus B$ , defined by pulling back the diagram of augmentations,

$$\begin{array}{ccc} A \oplus B & \longrightarrow & A \\ \downarrow & & \downarrow \varepsilon_A \\ B & \xrightarrow{\varepsilon_B} & \mathbb{Q} \end{array}$$

in COCH and imposing the standard multiplication on the result. The coproduct is their tensor product  $A \otimes B$  over  $\mathbb{Q}$ . Examples of cofibrations include extensions  $A \rightarrow (A \otimes S(w), d)$  given by (C.5); such an extension is determined by a cocycle  $z = f(x)$  in  $A$ . This illustrates the fact that the pushout of a cofibration is a cofibration. A larger class of cofibrations  $A \rightarrow A \otimes S(\mathcal{W})$  is given by iteration, for any set  $\mathcal{W}$  of positive dimensional generators corresponding to cocycles in  $A$ .

The factorisations (C.1) are only valid over fields of characteristic 0, so the model structure does not extend to  $\text{CDGA}_{\mathbf{k}}$  for arbitrary rings  $\mathbf{k}$ .

**Differential graded algebras.** Our differential graded algebras have homology differentials, and are the monoids in  $\text{CH}_{\mathbf{k}}$ . A model category structure in  $\text{DGA}_{\mathbf{k}}$  is therefore induced by applying Quillen's path object argument, as in [283]; a similar structure was first proposed by Jardine [176] (albeit with cohomology differentials), who proceeds by modifying the methods of [39]. Fibrations are epimorphisms, and cofibrations are determined by the appropriate lifting property.

Limits are created in  $\text{CH}_{\mathbf{k}}$ , whereas colimits exist because  $\text{DGA}_{\mathbf{k}}$  has finite coproducts and filtered colimits. Functoriality of the factorisations follows by adapting the proofs of [39], and works over arbitrary  $\mathbf{k}$ .

For example, the coproduct of algebras  $A$  and  $B$  is the free product  $A \star B$ , formed by factoring out an appropriate differential graded ideal [176] from the free (tensor) algebra  $T_{\mathbf{k}}(A \otimes B)$  on the chain complex  $A \otimes B$ . Examples of cofibrations include the extensions  $A \rightarrow (A \star T_{\mathbf{k}}(w), d)$ , determined by cycles  $z$  in  $A$ . By analogy with the commutative case, such an extension is defined by the pushout diagram

$$\begin{array}{ccc} T_{\mathbf{k}}(x) & \xrightarrow{f} & A \\ \downarrow j & & \downarrow \\ T_{\mathbf{k}}(w, dw) & \longrightarrow & A \star T_{\mathbf{k}}(w) \end{array}$$

where  $f(x) = z$  and  $j(x) = dw$ . The differential on  $A \star T_{\mathbf{k}}(w)$  is given by

$$d(a \star 1) = d_A a \star 1, \quad d(1 \star w) = f(x) \star 1.$$

Further cofibrations  $A \rightarrow A \star T_{\mathbf{k}}(\mathcal{W})$  arise by iteration, for any set  $\mathcal{W}$  of positive dimensional generators corresponding to cycles in  $A$ .

**Cocommutative differential graded coalgebras.** The cocommutative comonoids in  $\text{CH}_{\mathbf{k}}$  are the objects of  $\text{CDGC}_{\mathbf{k}}$ , and the morphisms preserve comultiplication. The model structure is defined only over fields of characteristic 0; in view of our applications, we shall restrict attention to the case  $\mathbb{Q}$ . In practice, we interpret  $\text{CDGC}_{\mathbb{Q}}$  as the full subcategory  $\text{CDGC}_{0, \mathbb{Q}}$  of connected objects  $C$ , which are necessarily coaugmented. Model structure was first defined on the category of simply connected rational cocommutative coalgebras by Quillen [271], and refined to  $\text{CDGC}_{0, \mathbb{Q}}$  by Neisendorfer [239]. The cofibrations are monomorphisms, and the fibrations are determined by the appropriate lifting property.

Limits exist because  $\text{CDGC}_{\mathbb{Q}}$  has finite products and filtered limits, whereas colimits are created in  $\text{CH}_{\mathbb{Q}}$ , and endowed with the natural coalgebra structure. Functoriality of the factorisations again follows by adapting the proofs of [39].

For example, the product of coalgebras  $C$  and  $D$  is their tensor product  $C \otimes D$  over  $\mathbb{Q}$ . The coproduct is their coaugmented sum, given by pushing out the diagram



of coaugmentations

$$\begin{array}{ccc} \mathbb{Q} & \xrightarrow{\delta_C} & C \\ \delta_D \downarrow & & \downarrow \\ D & \longrightarrow & C \oplus D \end{array}$$

in  $\text{CH}_{\mathbb{Q}}$  and imposing the standard comultiplication on the result. Examples of fibrations include the projections  $(C \otimes S_{\mathbb{Q}}\langle dt \rangle, d) \rightarrow C$ , which are determined by cycles  $z$  in  $C$  and defined by the pullback diagram

$$\begin{array}{ccc} C \otimes S\langle dt \rangle & \longrightarrow & S\langle t, dt \rangle \\ \downarrow & & \downarrow q \\ C & \xrightarrow{h} & S\langle x \rangle \end{array}$$

where  $q(t) = x$ ,  $q(dt) = 0$  and  $h(z) = x$ . The differential on  $C \otimes S_{\mathbb{Q}}\langle dt \rangle$  satisfies

$$d(z \otimes 1) = 1 \otimes dt, \quad d(1 \otimes dt) = 0.$$

This illustrates the fact that the pullback of a fibration is a fibration. Further fibrations  $C \otimes S_{\mathbb{Q}}\langle dT \rangle \rightarrow C$  are given by iteration, for any set  $T$  of generators corresponding to elements of degree  $\geq 2$  in  $C$ .

**Differential graded coalgebras.** Model structures on more general categories of differential graded coalgebras have been publicised by Getzler and Gerss [126], who also work over a field. Once again, we restrict attention to  $\mathbb{Q}$ . The objects of  $\text{DGC}_{\mathbb{Q}}$  are comonoids in  $\text{CH}_{\mathbb{Q}}$ , and the morphisms preserve comultiplication. The cofibrations are monomorphisms, and the fibrations are determined by the appropriate lifting property.

Limits exist because  $\text{DGC}_{\mathbb{Q}}$  has finite products and filtered limits, and colimits are created in  $\text{CH}_{\mathbb{Q}}$ . Functoriality of factorisations follows from the fact that the model structure is cofibrantly generated.

For example, the product of coalgebras  $C$  and  $D$  is the cofree product  $C \star D$  [126]. Their coproduct is the coaugmented sum, as in the case of  $\text{CDGC}_{\mathbb{Q}}$ . Examples of fibrations include the projections  $[C \star T_{\mathbb{Q}}\langle dt \rangle, d] \rightarrow C$ , which are determined by cycles  $z$  in  $C$  and defined by the pullback diagram

$$\begin{array}{ccc} C \star T_{\mathbb{Q}}\langle dt \rangle & \longrightarrow & T_{\mathbb{Q}}\langle t, dt \rangle \\ \downarrow & & \downarrow q \\ C & \xrightarrow{h} & T_{\mathbb{Q}}\langle x \rangle \end{array}$$

where  $q(t) = x$ ,  $q(dt) = 0$  and  $h(z) = x$ .

**Differential graded Lie algebras.** A (rational) differential graded Lie algebra  $L$  is a chain complex in  $\text{CH}_{\mathbb{Q}}$ , equipped with a bracket morphism  $[\cdot, \cdot]: L \otimes L \rightarrow L$  satisfying signed versions of the antisymmetry and Jacobi identity:

$$(C.8) \quad [x, y] = -(-1)^{\deg x \deg y} [y, x], \quad [x, [y, z]] = [[x, y], z] + (-1)^{\deg x \deg y} [y, [x, z]].$$

Differential graded Lie algebras over  $\mathbb{Q}$  are the objects of the category  $\text{DGL}$ . Quillen [271] originally defined a model structure on the subcategory of *reduced* objects, which was extended to  $\text{DGL}$  by Neisendorfer [239]. Fibrations are epimorphisms, and cofibrations are determined by the appropriate lifting property.

Limits are created in  $\text{CH}_{\mathbb{Q}}$ , whereas colimits exist because DGL has finite coproducts and filtered colimits. Functoriality of the factorisations follows by adapting the proofs of [239].

For example, the product of Lie algebras  $L$  and  $M$  is their product  $L \oplus M$  as chain complexes, with the induced bracket structure. Their coproduct is the free product  $L \star M$ , obtained by factoring out an appropriate differential graded ideal from the free Lie algebra  $FL(L \otimes M)$  on the chain complex  $L \otimes M$ . Examples of cofibrations include the extensions  $L \rightarrow (L \star FL(w), d)$ , which are determined by cycles  $z$  in  $L$  and defined by the pushout diagram

$$\begin{array}{ccc} FL(x) & \xrightarrow{f} & L \\ \downarrow j & & \downarrow \\ FL(w, dw) & \longrightarrow & L \star FL(w) \end{array}$$

where  $f(x) = z$  and  $j(x) = dw$ . The differential on  $L \star FL(w)$  is given by

$$d(l \star 1) = d_L l \star 1, \quad d(1 \star w) = z \star 1.$$

For historical reasons, a differential graded Lie algebra  $L$  is said to be *coformal* whenever it is formal in DGL.

**Adjoint pairs.** Following Moore [234], [166], we consider the algebraic *classifying functor*  $B_*$  and the *loop functor*  $\Omega_*$  as an adjoint pair

$$(C.9) \quad \Omega_* : \text{DGC}_{0,\mathbf{k}} \rightleftarrows \text{DGA}_{\mathbf{k}} : B_*$$

For any object  $A$  of  $\text{DGA}_{\mathbf{k}}$ , the classifying coalgebra  $B_*A$  agrees with Eilenberg and Mac Lane’s normalised *bar construction* as objects of  $\text{CH}_{\mathbf{k}}$ . For any object  $C$  of  $\text{DGC}_{0,\mathbf{k}}$ , the loop algebra  $\Omega_*C$  is given by the tensor algebra  $T_{\mathbf{k}}(s^{-1}\overline{C})$  on the desuspended  $\mathbf{k}$ -module  $\overline{C} = \text{Ker}(\varepsilon : C \rightarrow \mathbf{k})$ , and agrees with Adams’ *cobar construction* [1] as objects of  $\text{CH}_{\mathbf{k}}$ .

The classical result of Adams links the Moore loop functor  $\Omega : \text{TOP} \rightarrow \text{TMON}$  with its algebraic analogue  $\Omega_*$ :

**THEOREM C.2.1 ([1]).** *For a simply connected pointed space  $X$  and a commutative ring  $\mathbf{k}$ , there is a natural isomorphism of graded algebras*

$$H(\Omega_*C_*(X; \mathbf{k})) \cong H_*(\Omega X; \mathbf{k}),$$

where  $C_*(X; \mathbf{k})$  denotes the suitably reduced singular chain complex of  $X$ .

The isomorphism of Theorem C.2.1 is induced by a natural homomorphism

$$\Omega_*C_*(X; \mathbf{k}) \longrightarrow CU_*(\Omega X; \mathbf{k})$$

of  $\text{DGA}_{\mathbf{k}}$ , where  $CU_*(\Omega X; \mathbf{k})$  denotes the suitably reduced cubical chains on  $\Omega X$  with the dg-algebra structure induced from composition of Moore loops.

The graded homology algebra  $H(\Omega_*C)$  is denoted by  $\text{Cotor}_C(\mathbf{k}, \mathbf{k})$ . When  $\mathbf{k}$  is a field, there is an isomorphism

$$(C.10) \quad \text{Cotor}_C(\mathbf{k}, \mathbf{k}) \cong \text{Ext}_{C^*}(\mathbf{k}, \mathbf{k})$$

of graded algebras [267, page 41], where  $C^*$  is the graded algebra dual to  $C$  and  $\text{Ext}_{C^*}(\mathbf{k}, \mathbf{k})$  is the *Yoneda algebra* of  $C^*$  [203].

PROPOSITION C.2.2. *The loop functor  $\Omega_*$  preserves cofibrations of connected coalgebras and weak equivalences of simply connected coalgebras; the classifying functor  $B_*$  preserves fibrations of connected algebras and all weak equivalences.*

PROOF. The fact that  $B_*$  and  $\Omega_*$  preserve weak equivalences of algebras and simply connected coalgebras respectively is proved by standard arguments with the Eilenberg–Moore spectral sequence [111, page 538]. The additional assumption for coalgebras is necessary to ensure that the cobar spectral sequence converges, because the relevant filtration is decreasing.

Given any cofibration  $i: C_1 \rightarrow C_2$  of connected coalgebras, we must check that  $\Omega_*i: \Omega_*C_1 \rightarrow \Omega_*C_2$  satisfies the left lifting property with respect to any acyclic fibration  $p: A_1 \rightarrow A_2$  in  $\text{DGA}_{\mathbf{k}}$ . This involves finding lifts  $\Omega_*C_2 \rightarrow A_1$  and  $C_2 \rightarrow B_*A_1$  in the respective diagrams

$$\begin{array}{ccc} \Omega_*C_1 & \longrightarrow & A_1 \\ \Omega_*i \downarrow & & \downarrow p \\ \Omega_*C_2 & \longrightarrow & A_2 \end{array} \quad \text{and} \quad \begin{array}{ccc} C_1 & \longrightarrow & B_*A_1 \\ i \downarrow & & \downarrow B_*p \\ C_2 & \longrightarrow & B_*A_2 \end{array} ;$$

each lift implies the other, by adjointness. Since  $p$  is an acyclic fibration, its kernel  $A$  satisfies  $H(A) \cong \mathbf{k}$ . In this circumstances, the projection  $B_*p$  splits by [166, Theorem IV.2.5], so  $B_*A_1$  is isomorphic to the cofree product  $B_*A_2 \star B_*A$ . Therefore,  $B_*p$  is an acyclic fibration in  $\text{DGC}_{0,\mathbf{k}}$ , and our lift is assured.

A second application of adjointness shows that  $B_*$  preserves all fibrations of connected algebras.  $\square$

REMARK. It follows from Proposition C.2.2 that the restriction of (C.9) to simply connected coalgebras and connected algebras respectively,

$$\Omega_*: \text{DGC}_{1,\mathbf{k}} \rightleftarrows \text{DGA}_{0,\mathbf{k}} : B_*$$

acts as a Quillen pair, and induces an adjoint pair of equivalences on appropriate full subcategories of the homotopy categories. An example is given in [111, p. 538] which shows that  $\Omega_*$  fails to preserve quasi-isomorphisms (or even acyclic cofibrations) if the coalgebras are not simply connected.

Over  $\mathbb{Q}$ , the adjunction maps  $C \mapsto B_*\Omega_*C$  and  $\Omega_*B_*A \mapsto A$  are quasi-isomorphisms for any objects  $A$  and  $C$ .

Following Neisendorfer [239, Proposition 7.2], we consider a second pair of adjoint functors

$$(C.11) \quad L_*: \text{CDGC}_{0,\mathbb{Q}} \rightleftarrows \text{DGL} : M_*$$

whose derived functors induce an equivalence between  $Ho(\text{CDGC}_{0,\mathbb{Q}})$  and a certain full subcategory of  $Ho(\text{DGL})$ . This extends Quillen’s original results [271] for  $L_*$  and  $M_*$ , which apply only to simply connected coalgebras and connected Lie algebras. Given a connected cocommutative coalgebra  $C$ , the underlying graded Lie algebra of  $L_*C$  is the free Lie algebra  $FL(s^{-1}\overline{C}) \subset T(s^{-1}\overline{C})$ . This is preserved by the differential in  $\Omega_*C$  because  $C$  is cocommutative, thereby identifying  $L_*C$  as the differential graded Lie algebra of primitives in  $\Omega_*C$ . The right adjoint functor  $M_*$  may be regarded as a generalisation to differential graded objects of the standard complex for calculating the cohomology of Lie algebras. Given any  $L$  in  $\text{DGL}$  the underlying cocommutative coalgebra of  $M_*L$  is the symmetric coalgebra  $C(sL)$  on the suspended vector space  $L$ .

The ordinary (topological) classifying space functor  $B: \text{TOP} \rightarrow \text{TMON}$  and the Moore loop functor  $\Omega: \text{TMON} \rightarrow \text{TOP}$  are not formally adjoint, because  $\Omega$  does not preserve products. However, as it was shown by Vogt [317], after passing to appropriate localisations,  $\Omega$  becomes *right* adjoint to  $B$  in the homotopy categories.

There is also a similar result in simplicial category: the loop functor from simplicial sets to simplicial groups is *left* adjoint to the classifying functor, as in the case of algebraic functors  $\Omega_*$  and  $B_*$ .

### C.3. Homotopy limits and colimits

The  $\lim$  and  $\text{colim}$  functors  $[A, \text{MC}] \rightarrow \text{MC}$  do not generally preserve weak equivalences, and the theory of homotopy limits and colimits has been developed to remedy this deficiency. We outline their construction in this section, and discuss basic properties.

With  $\text{CAT}(\mathcal{K})$  and  $\text{CAT}^{op}(\mathcal{K})$  in mind as primary examples, we assume throughout that  $A$  is a finite Reedy category.

A Reedy category  $A$  has *cofibrant constants* if the constant  $A$ -diagram  $M$  is cofibrant in  $[A, \text{MC}]$ , for any cofibrant object  $M$  of an arbitrary model category  $\text{MC}$ . Similarly,  $A$  has *fibrant constants* if the constant  $A$ -diagram  $N$  is fibrant for any fibrant object  $N$  of  $\text{MC}$ .

As shown in [158, Theorem 15.10.8], a Reedy category  $A$  has fibrant constants if and only if the first pair of adjoint functors

$$(C.12) \quad \text{colim}: [A, \text{MC}] \rightleftarrows \text{MC} : \kappa, \quad \kappa: \text{MC} \rightleftarrows [A, \text{MC}] : \lim$$

is a Quillen pair (i.e.  $\text{colim}$  is left Quillen) for every model category  $\text{MC}$ . Similarly,  $A$  has cofibrant constants if and only if the second pair above is a Quillen pair, i.e.  $\lim$  is right Quillen.

We now apply the fibrant and cofibrant replacement functors associated to the Reedy model structure on  $[A, \text{MC}]$ , and their homotopy functors (C.2).

DEFINITION C.3.1. For any Reedy category  $A$  with fibrant and cofibrant constants, and any model category  $\text{MC}$ :

- (a) the *homotopy colimit* functor is the composition

$$\text{hocolim}: Ho [A, \text{MC}] \xrightarrow{Ho(\omega)} Ho [A, \text{MC}]_c \xrightarrow{Ho(\text{colim})} Ho(\text{MC});$$

- (b) the *homotopy limit* functor is the composition

$$\text{holim}: Ho [A, \text{MC}] \xrightarrow{Ho(\varphi)} Ho [A, \text{MC}]_f \xrightarrow{Ho(\lim)} Ho(\text{MC}).$$

REMARK. Definition C.3.1 incorporates the fact that  $\text{holim}$  and  $\text{hocolim}$  map objectwise weak equivalences of diagrams to weak equivalences in  $\text{MC}$ .

The Reedy categories  $\text{CAT}(\mathcal{K})$  and  $\text{CAT}^{op}(\mathcal{K})$  satisfy the criteria of [158, Proposition 15.10.2] and therefore have fibrant and cofibrant constants, for every simplicial complex  $\mathcal{K}$ . This implies that  $\text{holim}$  and  $\text{hocolim}: Ho [\text{CAT}(\mathcal{K}), \text{MC}] \rightarrow Ho(\text{MC})$  are defined; and similarly for  $\text{CAT}^{op}(\mathcal{K})$ .

Describing explicit models for homotopy limits and colimits has been a major objective for homotopy theorists since their study was initiated by Bousfield and Kan [40] and Vogt [316]. In terms of Definition C.3.1, the issue is to choose fibrant and cofibrant replacement functors  $\varphi$  and  $\omega$ . Many alternatives exist, including those defined by the two-sided bar and cobar constructions of [261] or the frames

of [158, §16.6], but no single description yet appears to be convenient in all cases. Instead, we accept a variety of possibilities, which are often implicit; the next few results ensure that they are as compatible and well-behaved as we need.

**PROPOSITION C.3.2.** *Any cofibrant approximation  $\mathcal{D}' \xrightarrow{\simeq} \mathcal{D}$  of diagrams induces a weak equivalence  $\operatorname{colim} \mathcal{D}' \xrightarrow{\simeq} \operatorname{hocolim} \mathcal{D}$  in MC; and any fibrant approximation  $\mathcal{D} \xrightarrow{\simeq} \mathcal{D}''$  induces a weak equivalence  $\operatorname{holim} \mathcal{D} \xrightarrow{\simeq} \operatorname{lim} \mathcal{D}''$ .*

**PROOF.** Using the left lifting property (axiom (c)) of the cofibration  $\circ \rightarrow \mathcal{D}'$  with respect to the acyclic fibration  $\omega(\mathcal{D}) \rightarrow \mathcal{D}$  we obtain a factorisation  $\mathcal{D}' \rightarrow \omega(\mathcal{D}) \rightarrow \mathcal{D}$ , in which the left hand map is a weak equivalence by axiom (b). But  $\mathcal{D}'$  and  $\omega(\mathcal{D})$  are cofibrant, and  $\operatorname{colim}$  is left Quillen, so the induced map  $\operatorname{colim} \mathcal{D}' \rightarrow \operatorname{colim} \omega(\mathcal{D})$  is a weak equivalence, as required. The proof for  $\operatorname{lim}$  is dual.  $\square$

**REMARK.** Such arguments may be strengthened to include uniqueness statements, and show that the replacements  $\varphi(\mathcal{D})$  and  $\omega(\mathcal{D})$  are themselves unique up to homotopy equivalence over  $\mathcal{D}$ , see [158, Proposition 8.1.8].

**PROPOSITION C.3.3.** *For any cofibrant diagram  $\mathcal{D}$  and fibrant diagram  $\mathcal{E}$ , there are natural weak equivalences  $\operatorname{hocolim} \mathcal{D} \xrightarrow{\simeq} \operatorname{colim} \mathcal{D}$  and  $\operatorname{lim} \mathcal{E} \xrightarrow{\simeq} \operatorname{holim} \mathcal{E}$ .*

**PROOF.** For  $\mathcal{D}$ , it suffices to apply the left Quillen functor  $\operatorname{colim}$  to the acyclic fibration  $\omega(\mathcal{D}) \rightarrow \mathcal{D}$ . The proof for  $\mathcal{E}$  is dual.  $\square$

**PROPOSITION C.3.4.** *A weak equivalence  $\mathcal{D}' \xrightarrow{\simeq} \mathcal{D}$  of cofibrant diagrams induces a weak equivalence  $\operatorname{colim} \mathcal{D}' \xrightarrow{\simeq} \operatorname{colim} \mathcal{D}$ , and a weak equivalence  $\mathcal{E} \xrightarrow{\simeq} \mathcal{E}'$  of fibrant diagrams induces a weak equivalence  $\operatorname{lim} \mathcal{E} \xrightarrow{\simeq} \operatorname{lim} \mathcal{E}'$ .*

**PROOF.** This follows from Propositions C.3.2 and C.3.3.  $\square$

**PROPOSITION C.3.5.** *In any model category MC:*

- (a) *if all three objects of a pushout diagram  $\mathcal{D}: L \leftarrow M \rightarrow N$  are cofibrant, and either of the maps is a cofibration, then there exists a weak equivalence  $\operatorname{hocolim} \mathcal{D} \xrightarrow{\simeq} \operatorname{colim} \mathcal{D}$ ;*
- (b) *if all three objects of a pullback diagram  $\mathcal{E}: P \rightarrow Q \leftarrow R$  are fibrant, and either of the maps is a fibration, then there exists a weak equivalence  $\operatorname{lim} \mathcal{E} \xrightarrow{\simeq} \operatorname{holim} \mathcal{E}$ .*

**PROOF.** For (a), assume that  $M \rightarrow N$  is a cofibration, and that the indexing category  $\mathbf{B}$  for  $\mathcal{D}$  has non-identity morphisms  $\lambda \leftarrow \mu \rightarrow \nu$ . The degree function  $\deg(\lambda) = 0$ ,  $\deg(\mu) = 1$ , and  $\deg(\nu) = 2$  turns  $\mathbf{B}$  into a Reedy category with fibrant constants, and ensures that  $\mathcal{D}$  is cofibrant. So Proposition C.3.3 applies. If  $M \rightarrow L$  is a cofibration, the corresponding argument holds by symmetry.

For (b), the proofs are dual.  $\square$

There is an important situation when the homotopy colimit over a poset category can be described explicitly:

**LEMMA C.3.6 (Wedge Lemma [321, Lemma 4.9]).** *Let  $(\mathcal{P}, \leq)$  be a poset with initial element  $\hat{0}$ , and let  $\mathbf{P}$  be the corresponding poset category. Suppose there is diagram  $\mathcal{D}: \mathbf{P} \rightarrow \mathbf{TOP}$  of spaces so that  $\mathcal{D}(\hat{0}) = pt$  and  $\mathcal{D}(\sigma) \rightarrow \mathcal{D}(\tau)$  is the constant map to the basepoint for all  $\sigma < \tau$  in  $\mathbf{P}$ . Then there is a homotopy equivalence*

$$\operatorname{hocolim} \mathcal{D} \xrightarrow{\simeq} \bigvee_{\sigma \in \mathcal{P}} (|\operatorname{ord}(\mathcal{P}_{>\sigma})| * \mathcal{D}(\sigma)),$$

where  $|\text{ord}(\mathcal{P}_{>\sigma})|$  is the geometric realisation of the order complex of the upper semi-interval  $\mathcal{P}_{>\sigma} = \{\tau \in \mathcal{P} : \tau > \sigma\}$ .

According to a result of Panov, Ray and Vogt, the classifying space functor  $B: \text{TMON} \rightarrow \text{TOP}$  commutes with homotopy colimits (of topological monoids and topological spaces, respectively) in the following sense:

**THEOREM C.3.7** ([261, Theorem 7.12, Proposition 7.15]). *For any diagram  $\mathcal{D}: \mathbb{A} \rightarrow \text{TMON}$  of well-pointed topological monoids with the homotopy types of cell complexes, there is a natural homotopy equivalence*

$$g: \text{hocolim}^{\text{TOP}} B\mathcal{D} \xrightarrow{\simeq} B \text{hocolim}^{\text{TMON}} \mathcal{D}.$$

Furthermore, there is a commutative square

$$(C.13) \quad \begin{array}{ccc} \text{hocolim}^{\text{TOP}} B\mathcal{D} & \xrightarrow{\simeq} & B \text{hocolim}^{\text{TMON}} \mathcal{D} \\ \downarrow p^{\text{TOP}} & & \downarrow Bp^{\text{TMON}} \\ \text{colim}^{\text{TOP}} B\mathcal{D} & \longrightarrow & B \text{colim}^{\text{TMON}} \mathcal{D} \end{array}$$

where  $p^{\text{TOP}}$  and  $p^{\text{TMON}}$  are the natural projections.

A weaker version of the theorem above can be stated for the Moore loop functor:

**COROLLARY C.3.8.** *For  $\mathcal{D}: \mathbb{A} \rightarrow \text{TMON}$  as above, there is a commutative square*

$$\begin{array}{ccc} \Omega \text{hocolim}^{\text{TOP}} B\mathcal{D} & \xrightarrow{\simeq} & \text{hocolim}^{\text{TMON}} \mathcal{D} \\ \downarrow \Omega p^{\text{TOP}} & & \downarrow p^{\text{TMON}} \\ \Omega \text{colim}^{\text{TOP}} B\mathcal{D} & \longrightarrow & \text{colim}^{\text{TMON}} \mathcal{D} \end{array}$$

in  $\text{Ho}(\text{TMON})$ , where the upper homomorphism is a homotopy equivalence.

**PROOF.** This follows by applying  $\Omega$  to (C.13) and then composing the horizontal maps with the canonical weak equivalence  $\Omega BG \rightarrow G$  in  $\text{TMON}$ , where  $G = \text{hocolim}^{\text{TMON}} \mathcal{D}$  and  $\text{colim}^{\text{TMON}} \mathcal{D}$  respectively.  $\square$

The lower map in the diagram above is not a homotopy equivalence in general, although  $\Omega$  preserves coproducts. Appropriate examples are given in Section 8.4.

## Bordism and cobordism

Here we summarise the required facts from the theory of bordism and cobordism, with the most attention given to complex (co)bordism. Cobordism theory is one of the deepest and most influential parts of algebraic topology, which experienced a spectacular development in the 1960s. Proofs of results presented here would require a separate monograph and a substantial background in algebraic topology. There are exceptions where the proofs are concise and included here. For the rest an interested reader is referred to the works of Novikov [246], [248], and monographs of Conner–Floyd [81], [82] and Stong [297].

We consider topological spaces which have the homotopy type of cell complexes. All manifolds are assumed to be smooth, compact and closed (without boundary), unless otherwise specified.

### D.1. Bordism of manifolds

Given two  $n$ -dimensional manifolds  $M_0$  and  $M_1$ , a *bordism* between them is an  $(n + 1)$ -dimensional manifold  $W$  with boundary, whose boundary is the disjoint union of  $M_0$  and  $M_1$ , that is,  $\partial W = M_0 \sqcup M_1$ . If such a  $W$  exists,  $M_0$  and  $M_1$  are called *bordant*. The bordism relation splits the set of manifolds into equivalence classes (see Fig. D.1.1), which are called *bordism classes*.

We denote the bordism class of  $M$  by  $[M]$ , and denote by  $\Omega_n^O$  the set of bordism classes of  $n$ -dimensional manifolds. Then  $\Omega_n^O$  is an Abelian group with respect to the disjoint union operation:  $[M_1] + [M_2] = [M_1 \sqcup M_2]$ . Zero is represented by the bordism class of the empty set (which is counted as a manifold in any dimension), or by the bordism class of any manifold which bounds. We also have  $\partial(M \times I) = M \sqcup M$ . Hence,  $2[M] = 0$  and  $\Omega_n^O$  is a 2-torsion group.

Set  $\Omega^O = \bigoplus_{n \geq 0} \Omega_n^O$ . The direct product of manifolds induces a multiplication of bordism classes, namely  $[M_1] \times [M_2] = [M_1 \times M_2]$ . It makes  $\Omega^O$  a graded commutative ring, the *unoriented bordism ring*.

For any space  $X$  the bordism relation can be extended to maps of manifolds to  $X$ : two maps  $M_1 \rightarrow X$  and  $M_2 \rightarrow X$  are *bordant* if there is a bordism  $W$  between  $M_1$  and  $M_2$  and the map  $M_1 \sqcup M_2 \rightarrow X$  extends to a map  $W \rightarrow X$ . The set of bordism classes of maps  $M \rightarrow X$  with  $\dim M = n$  forms an abelian group called the  *$n$ -dimensional unoriented bordism group of  $X$*  and denoted  $O_n(X)$  (other notations:  $N_n(X)$ ,  $MO_n(X)$ ). We note that  $O_n(pt) = \Omega_n^O$ , where  $pt$  is a point.

The bordism group  $O_n(X, A)$  of a pair  $A \subset X$  is defined as the set of bordism classes of maps of manifolds with boundary,  $(M, \partial M) \rightarrow (X, A)$ , where  $\dim M = n$ . (Two such maps  $f_0: (M_0, \partial M_0) \rightarrow (X, A)$  and  $f_1: (M_1, \partial M_1) \rightarrow (X, A)$  are *bordant*

FIGURE D.1. Transitivity of the bordism relation.

if there is  $W$  such that  $\partial W = M_0 \cup M_1 \cup M$ , where  $M$  is a bordism between  $\partial M_0$  and  $\partial M_1$ , and a map  $f: W \rightarrow X$  such that  $f|_{M_0} = f_0$ ,  $f|_{M_1} = f_1$  and  $f(M) \subset A$ .) We have  $O_n(X, \varnothing) = O_n(X)$ .

There is an obviously defined map  $\Omega_m^O \times O_n(X) \rightarrow O_{m+n}(X)$  turning  $O_*(X) = \bigoplus_{n \geq 0} O_n(X)$  into a graded  $\Omega^O$ -module. The assignment  $X \mapsto O_*(X)$  defines a *generalised homology theory*, that is, it is functorial in  $X$ , homotopy invariant, has the excision property and exact sequences of pairs.

## D.2. Thom spaces and cobordism functors

A remarkable geometric construction due to Pontryagin and Thom reduces the calculation of the bordism groups  $O_n(X)$  to a homotopical problem. Here we assume known basic facts from the theory of vector bundles.

Given an  $n$ -dimensional real Euclidean vector bundle  $\xi$  with total space  $E = E\xi$  and Hausdorff compact base  $X$ , the *Thom space* of  $\xi$  is defined as the quotient

$$Th \xi = E/E_{\geq 1},$$

where  $E_{\geq 1}$  is the subspace consisting of vectors of length  $\geq 1$  in the fibres of  $\xi$ . Equivalently,  $Th \xi = BE/SE$ , where  $BE$  is the total space of the  $n$ -ball bundle associated with  $\xi$  and  $SE = \partial BE$  is the  $(n-1)$ -sphere bundle. Also,  $Th \xi$  is the one-point compactification of  $E$ . The Thom space  $Th \xi$  has a canonical basepoint, the image of  $E_{\geq 1}$ .

PROPOSITION D.2.1. *If  $\xi$  and  $\eta$  are vector bundles over  $X$  and  $Y$  respectively, and  $\xi \times \eta$  is the product vector bundle over  $X \times Y$ , then*

$$Th(\xi \times \eta) = Th \xi \wedge Th \eta.$$

The proof is left as an exercise.

EXAMPLE D.2.2.

1. Regarding  $\mathbb{R}^k$  as the total space of a  $k$ -plane bundle over a point, we obtain that the corresponding Thom space  $Th(\mathbb{R}^k)$  is a  $k$ -sphere  $S^k$ .
2. If  $\xi$  is a 0-dimensional bundle over  $X$ , then  $Th \xi = X_+ = X \sqcup pt$ .
3. Let  $\mathbb{R}^k$  denote the trivial  $k$ -plane bundle over  $X$ . The Whitney sum  $\xi \oplus \mathbb{R}^k$  can be identified with the product bundle  $\xi \times \mathbb{R}^k$ , where  $\mathbb{R}^k$  is the  $k$ -plane bundle over a point. Then Proposition D.2.1 implies that

$$Th(\xi \oplus \mathbb{R}^k) = \Sigma^k Th \xi,$$

where  $\Sigma^k$  denote the  $k$ -fold suspension.

4. Combining the previous two examples, we obtain

$$Th(\mathbb{R}^k) = \Sigma^k X \vee S^k.$$

CONSTRUCTION D.2.3 (Pontryagin–Thom construction). Let  $M$  be a submanifold in  $\mathbb{R}^m$  with normal bundle  $\nu = \nu(M \subset \mathbb{R}^m)$ . The *Pontryagin–Thom map*

$$S^m \rightarrow Th \nu$$

identifies the tubular neighbourhood of  $M$  in  $\mathbb{R}^m \subset S^m$  with the set of vectors of length  $< 1$  in the fibres of  $\nu$ , and collapses the complement of the tubular neighbourhood to the basepoint of the Thom space  $Th \nu$ .



This construction can be generalised to submanifolds  $M \subset E\xi$  in the total space of an arbitrary  $m$ -plane bundle  $\xi$  over a manifold, giving the collapse map

$$(D.1) \quad Th \xi \rightarrow Th \nu,$$

where  $\nu = \nu(M \subset E\xi)$ . Note that the Pontryagin–Thom collapse map is a particular case of (D.1), as  $S^m$  is the Thom space of an  $m$ -plane bundle over a point.

Recall that a smooth map  $f: W \rightarrow Z$  of manifolds is called *transverse* along a submanifold  $Y \subset Z$  if, for every  $w \in f^{-1}(Y)$ , the image of the tangent space to  $W$  at  $w$  together with the tangent space to  $Y$  at  $f(w)$  spans the tangent space to  $Z$  at  $f(w)$ :

$$f_*\mathcal{T}_w W + \mathcal{T}_{f(w)} Y = \mathcal{T}_{f(w)} Z.$$

If  $f: W \rightarrow Z$  is transverse along  $Y \subset Z$ , then  $f^{-1}(Y)$  is a submanifold in  $W$  of codimension equal to the codimension of  $Y$  in  $Z$ .

CONSTRUCTION D.2.4 (cobordism classes of  $\eta$ -submanifolds in  $E\xi$ ). Let  $\xi$  be an  $m$ -plane bundle with total space  $E\xi$  over a manifold  $X$ , and let  $\eta$  be an  $n$ -plane bundle over a manifold  $Y$ . An  $\eta$ -submanifold of  $E\xi$  is a pair  $(M, f)$  consisting of a submanifold  $M$  in  $E\xi$  and a map

$$f: \nu(M \subset E\xi) \rightarrow \eta$$

such that  $f$  is an isomorphism on each fibre (so that the codimension of  $M$  in  $E\xi$  is  $n$ ). Two  $\eta$ -submanifolds  $(M_0, f_0)$  and  $(M_1, f_1)$  are *cobordant* if there is an  $\eta$ -submanifold with boundary  $(W, f)$  in the cylinder  $E\xi \times I \subset E(\xi \oplus \mathbb{R})$  such that

$$\partial(W, f) = ((M_0, f_0) \times 0) \cup ((M_1, f_1) \times 1).$$

THEOREM D.2.5. *The set of cobordism classes of  $\eta$ -submanifolds in  $E\xi$  is in one-to-one correspondence with the set  $[Th\xi, Th\eta]$  of homotopy classes of based maps of Thom spaces.*

PROOF. Assume given a based map  $g: Th \xi \rightarrow Th \eta$ . By changing  $g$  within its homotopy class we may achieve that  $g$  is transverse along the zero section  $Y \subset Th \eta$  (transversality is a local condition, and both  $Th \xi$  and  $Th \eta$  are manifolds outside the basepoints). Since  $\eta$  is an  $n$ -plane bundle,  $M = g^{-1}(Y)$  is a submanifold of codimension  $n$  in  $E\xi = Th \xi \setminus pt$  such that

$$\nu(M \subset E\xi) = g^*(\nu(Y \subset E\eta)) = g^*\eta.$$

That is,  $M$  is an  $\eta$ -submanifold in  $E\xi$ .

Conversely, assume given an  $\eta$ -submanifold  $M \subset E\xi$ . We therefore have the map of Thom spaces  $Th \nu \rightarrow Th \eta$  (induced by the map of  $\nu$  to  $\eta$ ), whose composition with the collapse map (D.1) gives the required map  $Th \xi \rightarrow Th \eta$ .

The fact that homotopic based maps  $Th \xi \rightarrow Th \eta$  correspond to cobordant  $\eta$ -submanifolds, and vice versa, is left as an exercise.  $\square$

CONSTRUCTION D.2.6 (cobordism groups). Let  $\eta_k$  be the universal vector  $k$ -plane bundle  $EO(k) \rightarrow BO(k)$ . Following the original notation of Thom, we denote  $MO(k) = Th \eta_k$ .

Every submanifold  $M \subset \mathbb{R}^{n+k}$  of dimension  $n$  is an  $\eta_k$ -submanifold via the classifying map of the normal bundle  $\nu(M \subset \mathbb{R}^{n+k})$ . Denote by  $\Omega_O^{-n,k}$  the set of cobordism classes of  $M \subset \mathbb{R}^{n+k}$ . The base of  $\eta_k$  is not a manifold, but it is a direct

limit of Grassmannians, and a simple limit argument shows that Theorem D.2.5 still holds for  $\eta_k$ -submanifolds. Hence,

$$\Omega_O^{-n,k} = [S^{n+k}, Th \eta_k] = \pi_{n+k}(MO(k)).$$

There is the stabilisation map  $\Omega_O^{-n,k} \rightarrow \Omega_O^{-n,k+1}$  obtained by composing the suspended map  $S^{n+k+1} \rightarrow \Sigma MO(k)$  with the map  $\Sigma MO(k) \rightarrow MO(k+1)$  induced by the bundle map  $\eta_k \oplus \mathbb{R} \rightarrow \eta_{k+1}$ . The  $(-n)$ th cobordism group is defined by

$$(D.2) \quad \Omega_O^{-n} = \lim_{k \rightarrow \infty} \Omega_O^{-n,k} = \lim_{k \rightarrow \infty} \pi_{n+k}(MO(k)).$$

PROPOSITION D.2.7. *We have a canonical isomorphism*

$$\Omega_O^{-n} \cong \Omega_n^O$$

*between the cobordism and bordism groups, for  $n \geq 0$ . In other words, two  $n$ -dimensional manifolds  $M_0$  and  $M_1$  are bordant if and only if there exist embeddings of  $M_0$  and  $M_1$  in the same  $\mathbb{R}^{n+k}$  which are cobordant.*

PROOF. Forgetting the embedding  $M \subset \mathbb{R}^{n+k}$  we obtain a map  $\Omega_O^{-n,k} \rightarrow \Omega_n^O$ , which may be shown to be a group homomorphism. It is compatible with the stabilisation maps, and therefore defines a homomorphism  $\Omega_O^{-n} \rightarrow \Omega_n^O$ . Since every manifold  $M$  may be embedded in some  $\mathbb{R}^{n+k}$ , it is an isomorphism.  $\square$

Together with (D.2), Proposition D.2.7 gives a homotopical interpretation for the (unoriented) bordism groups. This also implies that the notions of the ‘bordism class’ and ‘cobordism class’ of a manifold  $M$  are interchangeable. Theorem D.2.5 may be applied further to obtain a homotopical interpretation for the bordism groups  $O_n(X)$  of a space  $X$ :

CONSTRUCTION D.2.8 (bordism and cobordism groups of a space). Let  $X$  be a space. We set  $\xi = \mathbb{R}^{n+k}$  (an  $(n+k)$ -plane bundle over a point) and  $\eta = X \times \eta_k$  (the product of a 0-plane bundle over  $X$  and the universal  $k$ -plane bundle  $\eta_k$  over  $BO(k)$ ), and consider cobordism classes of  $\eta$ -submanifolds in  $E\xi$ . Such a submanifold is described by a pair  $(f, \iota)$  consisting of a map  $f: M \rightarrow X$  from an  $n$ -dimensional manifold to  $X$  and an embedding  $\iota: M \rightarrow \mathbb{R}^{n+k}$  (the bundle map from  $\nu(\iota)$  to  $\eta$  is the product of the map  $E\nu(\iota) \rightarrow M \rightarrow X$  and the classifying map of  $\nu(\iota)$ ). By Theorem D.2.5, the set of cobordism classes of  $\eta$ -submanifolds in  $E\xi$  is given by

$$[S^{n+k}, Th(X \times \eta_k)] = \pi_{n+k}((X_+) \wedge MO(k)).$$

As in the proof of Proposition D.2.7, there is the map from the above set of cobordism classes to the bordism group  $O_n(X)$ , which forgets the embedding  $M \subset \mathbb{R}^{n+k}$ . A stabilisation argument shows that

$$(D.3) \quad O_n(X) = \lim_{k \rightarrow \infty} \pi_{k+n}((X_+) \wedge MO(k)),$$

providing a homotopical interpretation for the bordism groups of  $X$ .

We define the *cobordism groups* of  $X$  as

$$(D.4) \quad O^n(X) = \lim_{k \rightarrow \infty} [\Sigma^{k-n}(X_+), MO(k)].$$

If  $X$  is a (not necessarily compact) manifold, then the groups  $O^n(X)$  may also be obtained by stabilising the set of cobordism classes of  $\eta$ -submanifolds in  $E\xi$ . Namely, we need to set  $\xi = \mathbb{R}^{k-n}$  (the trivial  $(k-n)$ -plane bundle over  $X$ ), and  $\eta = \eta_k$ . In other words, a cobordism class in  $O^n(X)$  is described by the composition

$$(D.5) \quad M \hookrightarrow X \times \mathbb{R}^{k-n} \longrightarrow X,$$

where the first map is an embedding of codimension  $k$ .

The maps of Thom spaces  $MO(k) \wedge MO(l) \rightarrow MO(k+l)$  (induced by the classifying maps  $\eta_k \times \eta_l \rightarrow \eta_{k+l}$ ) turn  $O^*(X) = \prod_{n \in \mathbb{Z}} O^n(X)$  into a graded ring, called the *unoriented cobordism ring of  $X$* . (One needs to consider direct product instead of direct sum to take care of infinite complexes like  $\mathbb{R}P^\infty$ .)

**Exercises.**

D.2.9. Prove Proposition D.2.1.

D.2.10. If  $\eta$  is the tautological line bundle over  $\mathbb{R}P^n$  (respectively,  $\mathbb{C}P^n$ ), then  $Th \eta$  can be identified with  $\mathbb{R}P^{n+1}$  (respectively,  $\mathbb{C}P^{n+1}$ ).

D.2.11. Prove that cobordism of  $\eta$ -submanifolds is an equivalence relation.

D.2.12. Complete the proof of Theorem D.2.5.

D.2.13. The forgetful map  $\Omega_O^{-n,k} \rightarrow \Omega_n^O$  is a homomorphism of groups.

D.2.14. Given any  $(k-n)$ -plane bundle  $\xi$  over a manifold  $X$  and an embedding  $M \hookrightarrow E\xi$  of codimension  $k$ , the composition

$$M \hookrightarrow E\xi \longrightarrow X$$

determines a cobordism class in  $O^n(X)$ . (Hint: reduce to (D.5) by embedding  $\xi$  into a trivial bundle over the same  $X$ .)

D.2.15 (Poincaré–Atiyah duality [7] in unoriented bordism). If  $X$  is an  $n$ -dimensional manifold, then

$$O^{n-k}(X) = O_k(X) \quad \text{for any } k.$$

In particular, for  $X = pt$  we obtain the isomorphisms of Proposition D.2.7.

**D.3. Oriented and complex bordism**

The bordism relation may be extended to manifolds endowed with some additional structure, which leads to important bordism theories.

The simplest additional structure is an orientation. By definition, two oriented  $n$ -dimensional manifolds  $M_1$  and  $M_2$  are *oriented bordant* if there is an oriented  $(n+1)$ -dimensional manifold  $W$  with boundary such that  $\partial W = M_1 \sqcup \overline{M_2}$ , where  $\overline{M_2}$  denotes  $M_2$  with the orientation reversed. The *oriented bordism groups*  $\Omega_n^{SO}$  and the *oriented bordism ring*  $\Omega^{SO} = \bigoplus_{n \geq 0} \Omega_n^{SO}$  are defined accordingly. Given an oriented manifold  $M$ , the manifold  $M \times I$  has the canonical orientation such that  $\partial(M \times I) = M \sqcup \overline{M}$ . Hence,  $-[M] = [\overline{M}]$  in  $\Omega_n^{SO}$ . Unlike  $\Omega_n^O$ , elements of  $\Omega_n^{SO}$  generally do not have order 2.

Complex structure gives another important example of an additional structure on manifolds. However, a direct attempt to define the bordism relation on complex manifolds fails because the manifold  $W$  must be odd-dimensional and therefore cannot be complex. This can be remedied by considering *stably complex* (also known as *stably almost complex* or *quasicomplex*) structures.

Let  $TM$  denote the tangent bundle of  $M$ . We say that  $M$  admits a *tangential stably complex structure* if there is an isomorphism of real vector bundles

$$(D.6) \quad c_{\mathcal{T}}: TM \oplus \mathbb{R}^k \rightarrow \xi$$

between the ‘stable’ tangent bundle and a complex vector bundle  $\xi$  over  $M$ . Some of the choices of such isomorphisms are deemed to be equivalent, that is, determine the same stably complex structures. This equivalence relation is generated by

- (a) additions of trivial complex summands; that is,  $c_{\mathcal{T}}$  is equivalent to

$$\mathcal{T}M \oplus \underline{\mathbb{R}}^k \oplus \underline{\mathbb{C}} \xrightarrow{c_{\mathcal{T}} \oplus \text{id}} \xi \oplus \underline{\mathbb{C}},$$

where  $\underline{\mathbb{C}}$  in the left hand side is canonically identified with  $\underline{\mathbb{R}}^2$ ;

- (b) compositions with isomorphisms of complex bundles; that is,  $c_{\mathcal{T}}$  is equivalent to  $\varphi \cdot c_{\mathcal{T}}$  for every  $\mathbb{C}$ -linear isomorphism  $\varphi: \xi \rightarrow \zeta$ .

The equivalence class of  $c_{\mathcal{T}}$  may be described homotopically as the equivalence class of lifts of the map  $M \rightarrow BO(2N)$  classifying the stable tangent bundle to a map  $M \rightarrow BU(N)$  up to homotopy and stabilisation (see [297, Chapters II, VII]). A *tangential stably complex manifold* is a pair consisting of  $M$  and an equivalence class of isomorphisms  $c_{\mathcal{T}}$ ; we shall use a simplified notation  $(M, c_{\mathcal{T}})$  for such pairs. This notion is a generalisation of complex and *almost complex* manifolds (where the latter means a manifold with a choice of a complex structure on  $\mathcal{T}M$ , that is, a stably complex structure (D.6) with  $k = 0$ ).

We say that  $M$  admits a *normal complex structure* if there is an embedding  $i: M \hookrightarrow \mathbb{R}^N$  with the property that the normal bundle  $\nu(i)$  admits a structure of a complex vector bundle. There is an appropriate notion of stable equivalence for such embeddings  $i$ , and a normal complex structure  $c_{\nu}$  on  $M$  is defined as the corresponding equivalence class. Tangential and normal stably complex structures on  $M$  determine each other by means of the canonical isomorphism  $\mathcal{T}M \oplus \nu(i) \cong \underline{\mathbb{R}}^N$ .

EXAMPLE D.3.1. Let  $M = \mathbb{C}P^1$ . The standard complex structure on  $M$  is equivalent to the stably complex structure determined by the isomorphism

$$\mathcal{T}(\mathbb{C}P^1) \oplus \underline{\mathbb{R}}^2 \xrightarrow{\cong} \bar{\eta} \oplus \bar{\eta}$$

where  $\eta$  is the tautological line bundle. On the other hand, one can view  $\mathbb{C}P^1$  as  $S^2$  embedded into  $\mathbb{R}^4 \cong \mathbb{C}^2$  with trivial normal bundle. We therefore have an isomorphism

$$\mathcal{T}(\mathbb{C}P^1) \oplus \underline{\mathbb{R}}^2 \xrightarrow{\cong} \underline{\mathbb{C}}^2 \cong \eta \oplus \bar{\eta}$$

which determines a trivial stably complex structure on  $\mathbb{C}P^1$ .

The bordism relation can be defined between stably complex manifolds by taking account of the stably complex structure in the bordism relation. As in the case of unoriented bordism, the set of bordism classes  $[M, c_{\mathcal{T}}]$  of  $n$ -dimensional stably complex manifolds is an Abelian group with respect to disjoint union. This group is called the *n-dimensional complex bordism group* and denoted by  $\Omega_n^U$ . The sphere  $S^n$  has the canonical normally complex structure determined by a complex structure on the trivial normal bundle of the embedding  $S^n \hookrightarrow \mathbb{R}^{n+2}$ . The corresponding bordism class represents the zero element in  $\Omega_n^U$ . The opposite element to the bordism class  $[M, c_{\mathcal{T}}]$  in the group  $\Omega_n^U$  may be represented by the same manifold  $M$  with the stably complex structure determined by the isomorphism

$$\mathcal{T}M \oplus \underline{\mathbb{R}}^k \oplus \underline{\mathbb{C}} \xrightarrow{c_{\mathcal{T}} \oplus \tau} \xi \oplus \underline{\mathbb{C}}$$

where  $\tau: \mathbb{C} \rightarrow \mathbb{C}$  is the complex conjugation. We shall use the abbreviated notations  $[M]$  and  $[\bar{M}]$  for the complex bordism class and its opposite whenever the stably

complex structure  $c_{\mathcal{T}}$  is clear from the context. There is a stably complex structure on  $M \times I$  such that  $\partial(M \times I) = M \sqcup \overline{M}$ .

The direct product of stably complex manifolds turns  $\Omega^U = \bigoplus_{n \geq 0} \Omega_n^U$  into a graded ring, called the *complex bordism ring*.

CONSTRUCTION D.3.2 (homotopic approach to cobordism). The *complex bordism groups*  $U_n(X)$  and *cobordism groups*  $U^n(X)$  may be defined homotopically similarly to (D.3) and (D.4):

$$(D.7) \quad \begin{aligned} U_n(X) &= \lim_{k \rightarrow \infty} \pi_{2k+n}((X_+) \wedge MU(k)), \\ U^n(X) &= \lim_{k \rightarrow \infty} [\Sigma^{2k-n}(X_+), MU(k)], \end{aligned}$$

where  $MU(k)$  is the Thom space of the universal complex  $k$ -plane bundle  $EU(k) \rightarrow BU(k)$ . Here the direct limit uses the maps  $\Sigma^2 MU(k) \rightarrow MU(k+1)$ .

CONSTRUCTION D.3.3 (geometric approach to cobordism). Both groups  $U_n(X)$  and  $U^n(X)$  may also be defined geometrically, in a way similar to the geometric construction of unoriented bordism and cobordism groups (Construction D.2.8). The complex bordism group  $U_n(X)$  consists of bordism classes of maps  $M \rightarrow X$  of stably complex  $n$ -dimensional manifolds  $M$  to  $X$ .

The complex cobordism group  $U^n(X)$  of a manifold  $X$  may be defined via cobordisms of  $\eta$ -submanifolds in  $E\xi$ , like in the unoriented case. Let  $\xi = X \times \mathbb{R}^{2k-n}$  (a trivial bundle), and let  $\eta$  be the canonical (universal) complex  $k$ -plane bundle over  $BU(k)$ . Then an  $\eta$ -submanifold  $M$  in  $E\xi$  defines a composite map of manifolds

$$M \hookrightarrow X \times \mathbb{R}^{2k-n} \longrightarrow X$$

(compare (D.5)), where the first map is an embedding whose normal bundle has a structure of a complex  $k$ -plane bundle, and the second map is the projection onto the first factor. A map  $M \rightarrow X$  between manifolds which can be decomposed as above is said to be *complex orientable of codimension  $n$* . A choice of this decomposition together with a complex bundle structure in the normal bundle is called a *complex orientation* of the map  $M \rightarrow X$ . As usual, the equivalence relation on the set of complex orientations of  $M \rightarrow X$  is generated by bundle isomorphisms and stabilisations. The group  $U^n(X)$  consists of cobordism classes of complex oriented maps  $M \rightarrow X$  of codimension  $n$ .

Let  $y \in U^n(Y)$  be a cobordism class represented by a complex oriented map  $M \rightarrow Y$ , and let  $f: X \rightarrow Y$  be a map of manifolds. If these two maps are transverse, the cobordism class  $f^*(y) \in U^n(X)$  is represented by the pullback  $X \times_Y M \rightarrow X$  with the induced complex orientation.

When  $M \rightarrow X$  is a fibre bundle with fibre  $F$ , the normal structure used in the definition of a complex orientation can be converted to a tangential structure. Namely, an equivalence class of complex orientations of the bundle projection  $M \rightarrow X$  is determined by a choice of stably complex structure for the bundle  $\mathcal{T}_F(M)$  of tangents along the fibres of  $M \rightarrow X$  (an exercise). Such a bundle  $M \rightarrow X$  is called *stably tangentially complex*.

The equivalence of the homotopic and geometric approaches to cobordism is established using transversality arguments and the Pontryagin–Thom construction, as in the unoriented case.

If  $X = pt$ , then we obtain

$$U^{-n}(pt) = U_n(pt) = \Omega_n^U$$

for  $n \geq 0$ , from either the homotopic or geometric description of the (co)bordism groups. We also set  $\Omega_U^{-n} = U^{-n}(pt)$  and  $\Omega_U = \bigoplus_{n \geq 0} \Omega_U^{-n}$ .

CONSTRUCTION D.3.4 (pairing and products). The product operations in cobordism are defined using the maps of Thom spaces  $MU(k) \wedge MU(l) \rightarrow MU(k+l)$  induced by the classifying maps of the products of canonical bundles.

There is a canonical pairing (the *Kronecker product*)

$$\langle \cdot, \cdot \rangle: U^m(X) \otimes U_n(X) \rightarrow \Omega_{n-m}^U,$$

the  $\frown$ -product

$$\frown: U^m(X) \otimes U_n(X) \rightarrow U_{n-m}(X),$$

and the  $\smile$ -product (or simply *product*)

$$\smile: U^m(X) \otimes U^n(X) \rightarrow U^{m+n}(X),$$

defined as follows. Assume given a cobordism class  $x \in U^m(X)$  represented by a map  $\Sigma^{2l-m} X_+ \rightarrow MU(l)$  and a bordism class  $\alpha \in U_n(X)$  represented by a map  $S^{2k+n} \rightarrow X_+ \wedge MU(k)$ . Then  $\langle x, \alpha \rangle \in \Omega_{n-m}^U$  is represented by the composite map

$$S^{2k+2l+n-m} \xrightarrow{\Sigma^{2l-m}\alpha} \Sigma^{2l-m} X_+ \wedge MU(k) \xrightarrow{x \wedge \text{id}} MU(l) \wedge MU(k) \rightarrow MU(l+k)$$

If  $\Delta: X_+ \rightarrow (X \times X)_+ = X_+ \wedge X_+$  is the diagonal map, then  $x \frown \alpha \in U_{n-m}(X)$  is represented by the composite map

$$S^{2k+2l+n-m} \xrightarrow{\Sigma^{2l-m}\alpha} \Sigma^{2l-m} X_+ \wedge MU(k) \xrightarrow{\Sigma^{2l-m}\Delta \wedge \text{id}} X_+ \wedge \Sigma^{2l-m} X_+ \wedge MU(k) \\ \xrightarrow{\text{id} \wedge x \wedge \text{id}} X_+ \wedge MU(l) \wedge MU(k) \rightarrow X_+ \wedge MU(l+k)$$

The  $\smile$ -product is defined similarly; it turns  $U^*(X) = \prod_{n \in \mathbb{Z}} U^n(X)$  into a graded ring, called the *complex cobordism ring of X*. It is a module over  $\Omega_U$ .

The products operations can be also interpreted geometrically.

For example, assume that  $x \in U^m(X)$  is represented by an embedding of manifolds  $M^{k-m} \rightarrow X = X^k$  with a complex structure in the normal bundle, and  $\alpha \in U_n(X)$  is represented by an embedding  $N^n \rightarrow X^k$  of a tangentially stably complex manifold  $N$ . Assume further that  $M$  and  $N$  intersect transversely in  $X$ , i.e.  $\dim M \cap N = n - m$ . Then  $\langle x, \alpha \rangle$  is the bordism class of the intersection  $M \cap N$ , and  $x \frown \alpha$  is the bordism class of the embedding  $M \cap N \rightarrow X$ . The tangential complex structure of  $M \cap N$  is defined by the tangential structure of  $N$  and the complex structure in the normal bundle of  $M \cap N \rightarrow N$  induced from the normal bundle of  $M \rightarrow X$ .

Similarly, if  $x \in U^{-d}(X)$  is represented by a smooth fibre bundle  $E^{k+d} \rightarrow X^k$  and  $\alpha \in U_n(X)$  is represented by a smooth map  $N \rightarrow X$ , then  $\langle x, \alpha \rangle \in \Omega_{n+d}^U$  is the bordism class of the pull-back  $E'$ , and  $x \frown \alpha \in U_{n+d}(X)$  is the bordism class of the composite map  $E' \rightarrow X$  in the pull-back diagram

$$\begin{array}{ccc} E' & \longrightarrow & E \\ \downarrow & & \downarrow \\ N & \longrightarrow & X \end{array}$$

CONSTRUCTION D.3.5 (Poincaré–Atiyah duality in cobordism). Let  $X$  be a manifold of dimension  $d$ . The inclusion of a point  $pt \subset X$  defines the bordism class  $1 \in U_0(X)$  and the *fundamental cobordism class of X* in  $U^d(X)$ . (The normal

bundle of a point has a complex structure if  $d$  is even, otherwise the normal bundle of a point in  $X \times \mathbb{R}$  has a complex structure.)

The identity map  $X \rightarrow X$  defines the cobordism class  $1 \in U^0(X)$ . It defines the *fundamental bordism class of  $X$*  in  $U_d(X)$  only when  $X$  is stably complex.

Now let  $X$  be stably complex manifold with fundamental bordism class  $[X] \in U_d(X)$ . The map

$$D = \cdot \frown [X]: U^k(X) \rightarrow U_{d-k}(X), \quad x \mapsto x \frown [X]$$

is an isomorphism (an exercise); it is called the *Poincaré-Atiyah duality* map.

CONSTRUCTION D.3.6 (Gysin homomorphism). Let  $f: X^k \rightarrow Y^{k+d}$  be a complex oriented map of codimension  $d$  between manifolds (manifolds may be not compact, in which case  $f$  is assumed to be proper). It induces a covariant map

$$f_!: U^n(X) \rightarrow U^{n+d}(Y)$$

called the *Gysin homomorphism*, whose geometric definition is as follows. Let  $x \in U^n(X)$  be represented by a complex oriented map  $g: M^{k-n} \rightarrow X^k$ . Then  $f_!(x)$  is represented by the composition  $fg$ .

PROPOSITION D.3.7. *The Gysin homomorphism has the following properties:*

- (a)  $f_!: U^*(X) \rightarrow U^{*+d}(Y)$  depends only on the homotopy class of  $f$ ;
- (b)  $f_!$  is a homomorphism of  $\Omega_U$ -modules;
- (c)  $(fg)_! = f_!g_!$ ;
- (d)  $f_!(x \cdot f^*(y)) = f_!(x) \cdot y$  for any  $x \in U^n(X)$ ,  $y \in U^m(Y)$ ;
- (e) assume that

$$\begin{array}{ccc} X \times_Y Z & \xrightarrow{g'} & X \\ f' \downarrow & & \downarrow f \\ Z & \xrightarrow{g} & Y \end{array}$$

is a pullback square of manifolds, where  $g$  is transverse to  $f$  and  $f'$  is endowed with the pullback of the complex orientation of  $f$ . Then

$$g^* f_! = f'_! g'^*: U^*(X) \rightarrow U^{*+d}(Z).$$

PROOF. (a) is clear from the homotopic definition of cobordism, while the other properties follow easily from the geometric definition. For example, to prove (d) one needs to choose maps  $Z \rightarrow X$  and  $W \rightarrow Y$  representing  $x$  and  $y$ , respectively, and consider the commutative diagram

$$\begin{array}{ccccc} Z \times_Y W & \longrightarrow & X \times_Y W & \longrightarrow & W \\ \downarrow & & \downarrow & & \downarrow \\ Z & \longrightarrow & X & \xrightarrow{f} & Y \end{array}$$

Both sides of (d) are represented by the composite map  $Z \times_Y W \rightarrow Y$  above.  $\square$

Let  $\xi$  be a complex  $n$ -plane bundle with total space  $E$  over a manifold  $X$  and let  $i: X \rightarrow E$  be the zero section. The element  $i^*i_!1 \in U^{2n}(X)$  where  $1 \in U^0(X)$  is called the *Euler class* of  $\xi$  and is denoted by  $e(\xi)$ .

CONSTRUCTION D.3.8 (geometric cobordisms). For any cell complex  $X$  the cohomology group  $H^2(X)$  can be identified with the set  $[X, \mathbb{C}P^\infty]$  of homotopy classes of maps into  $\mathbb{C}P^\infty$ . Since  $\mathbb{C}P^\infty = MU(1)$ , it follows from (D.7) that every

element  $x \in H^2(X)$  determines a cobordism class  $u_x \in U^2(X)$ . The elements of  $U^2(X)$  obtained in this way are called *geometric cobordisms* of  $X$ . We therefore may view  $H^2(X)$  as a subset in  $U^2(X)$ , however the group operation in  $H^2(X)$  is not obtained by restricting the group operation in  $U^2(X)$  (the relationship between the two operations is discussed in Appendix E).

When  $X$  is a manifold, geometric cobordisms may be described by submanifolds  $M \subset X$  of codimension 2 with a fixed complex structure on the normal bundle.

Indeed, every  $x \in H^2(X)$  corresponds to a homotopy class of maps  $f_x: X \rightarrow \mathbb{C}P^\infty$ . The image  $f_x(X)$  is contained in some  $\mathbb{C}P^N \subset \mathbb{C}P^\infty$ , and we may assume that  $f_x(X)$  is transverse to a certain hyperplane  $H \subset \mathbb{C}P^N$ . Then  $M_x = f_x^{-1}(H)$  is a codimension-2 submanifold in  $X$  whose normal bundle acquires a complex structure by restriction of the complex structure on the normal bundle of  $H \subset \mathbb{C}P^N$ . Changing the map  $f_x$  within its homotopy class does not affect the bordism class of the embedding  $M_x \rightarrow X$ .

Conversely, assume given a submanifold  $M \subset X$  of codimension 2 whose normal bundle is endowed with a complex structure. Then the composition

$$X \rightarrow Th(\nu) \rightarrow MU(1) = \mathbb{C}P^\infty$$

of the Pontryagin–Thom collapse map  $X \rightarrow Th(\nu)$  and the map of Thom spaces corresponding to the classifying map  $M \rightarrow BU(1)$  of  $\nu$  defines an element  $x_M \in H^2(X)$ , and therefore a geometric cobordism.

If  $X$  is an oriented manifold, then a choice of complex structure on the normal bundle of a codimension-2 embedding  $M \subset X$  is equivalent to orienting  $M$ . The image of the fundamental class of  $M$  in  $H_*(X)$  is Poincaré dual to  $x_M \in H^2(X)$ .

**CONSTRUCTION D.3.9 (connected sum).** For manifolds of positive dimension the disjoint union  $M_1 \sqcup M_2$  representing the sum of bordism classes  $[M_1] + [M_2]$  may be replaced by their *connected sum*, which represents the same bordism class.

The connected sum  $M_1 \# M_2$  of manifolds  $M_1$  and  $M_2$  of the same dimension  $n$  is constructed as follows. Choose points  $v_1 \in M_1$  and  $v_2 \in M_2$ , and take closed  $\varepsilon$ -balls  $B_\varepsilon(v_1)$  and  $B_\varepsilon(v_2)$  around them (both manifolds may be assumed to be endowed with a Riemannian metric). Fix an isometric embedding  $f$  of a pair of standard  $\varepsilon$ -balls  $D^n \times S^0$  (here  $S^0 = \{0, 1\}$ ) into  $M_1 \sqcup M_2$  which maps  $D^n \times 0$  onto  $B_\varepsilon(v_1)$  and  $D^n \times 1$  onto  $B_\varepsilon(v_2)$ . If both  $M_1$  and  $M_2$  are oriented we additionally require the embedding  $f$  to preserve the orientation on the first ball and reverse in on the second. Now, using this embedding, replace in  $M_1 \sqcup M_2$  the pair of balls  $D^n \times S^0$  by a ‘pipe’  $S^{n-1} \times D^1$ . After smoothing the angles in the standard way we obtain a smooth manifold  $M_1 \# M_2$ .

If both  $M_1$  and  $M_2$  are connected the smooth structure on  $M_1 \# M_2$  does not depend on a choice of points  $v_1, v_2$  and embedding  $D^n \times S^0 \hookrightarrow M_1 \sqcup M_2$ . It does however depend on the orientations;  $M_1 \# M_2$  and  $M_1 \# \overline{M_2}$  are not diffeomorphic in general. For example, the manifolds  $\mathbb{C}P^2 \# \mathbb{C}P^2$  and  $\mathbb{C}P^2 \# \overline{\mathbb{C}P^2}$  are not diffeomorphic (and not even homotopy equivalent because they have different signatures).

There are smooth contraction maps  $p_1: M_1 \# M_2 \rightarrow M_1$  and  $p_2: M_1 \# M_2 \rightarrow M_2$ . In the oriented case the manifold  $M_1 \# M_2$  can be oriented in such a way that both contraction maps preserve the orientations.

A bordism between  $M_1 \sqcup M_2$  and  $M_1 \# M_2$  may be constructed as follows. Consider a cylinder  $M_1 \times I$ , from which we remove an  $\varepsilon$ -neighbourhood  $U_\varepsilon(v_1 \times 1)$



FIGURE D.2. Disjoint union and connected sum.

of the point  $v_1 \times 1$ . Similarly, remove the neighbourhood  $U_\varepsilon(v_2 \times 1)$  from  $M_2 \times I$  (each of these two neighbourhoods can be identified with the half of a standard open  $(n + 1)$ -ball). Now connect the two remainders of cylinders by a ‘half pipe’  $S_{\leq}^n \times I$  in such a way that the half-sphere  $S_{\leq}^n \times 0$  is identified with the half-sphere on the boundary of  $U_\varepsilon(v_1 \times 1)$ , and  $S_{\leq}^n \times 1$  is identified with the half-sphere on the boundary of  $U_\varepsilon(v_2 \times 1)$ . Smoothing the angles we obtain a manifold with boundary  $M_1 \sqcup M_2 \sqcup (M_1 \# M_2)$  (or  $\overline{M}_1 \sqcup \overline{M}_2 \sqcup (M_1 \# M_2)$  in the oriented case), see Fig. D.2.

Finally, if  $M_1$  and  $M_2$  are stably complex manifolds, then there is a canonical stably complex structure on  $M_1 \# M_2$ , which is constructed as follows. Assume the stably complex structures on  $M_1$  and  $M_2$  are determined by isomorphisms

$$c_{\mathcal{T},1}: \mathcal{T}M_1 \oplus \mathbb{R}^{k_1} \rightarrow \xi_1 \quad \text{and} \quad c_{\mathcal{T},2}: \mathcal{T}M_2 \oplus \mathbb{R}^{k_2} \rightarrow \xi_2.$$

Using the isomorphism  $\mathcal{T}(M_1 \# M_2) \oplus \mathbb{R}^n \cong p_1^* \mathcal{T}M_1 \oplus p_2^* \mathcal{T}M_2$ , we define a stably complex structure on  $M_1 \# M_2$  by the isomorphism

$$\begin{aligned} \mathcal{T}(M_1 \# M_2) \oplus \mathbb{R}^{n+k_1+k_2} \\ \cong p_1^* \mathcal{T}M_1 \oplus \mathbb{R}^{k_1} \oplus p_2^* \mathcal{T}M_2 \oplus \mathbb{R}^{k_2} \xrightarrow{c_{\mathcal{T},1} \oplus c_{\mathcal{T},2}} p_1^* \xi_1 \oplus p_2^* \xi_2. \end{aligned}$$

We shall refer to this stably complex structure as the *connected sum of stably complex structures* on  $M_1$  and  $M_2$ . The corresponding complex bordism class is  $[M_1] + [M_2]$ .

**Exercises.**

D.3.10. Assume given a complex  $(k - l)$ -plane bundle  $\xi$  over a manifold  $X$  and an embedding  $M \hookrightarrow E\xi$  whose normal bundle has a structure of a complex  $k$ -plane bundle. Then the composition

$$M \hookrightarrow E\xi \longrightarrow X$$

determines a complex orientation for the map  $M \rightarrow X$  of codimension  $2l$ , and therefore a complex cobordism class in  $U^{2l}(X)$ . (Compare Exercise D.2.14.)

Similarly, an embedding  $M \hookrightarrow E(\xi \oplus \mathbb{R})$  whose normal bundle has a structure of a complex  $k$ -plane bundle determines a complex cobordism class in  $U^{2l-1}(X)$ , via the composition

$$M \hookrightarrow E(\xi \oplus \mathbb{R}) \longrightarrow X.$$

This is how complex orientations were defined in [273].

D.3.11. Let  $\pi: E \rightarrow B$  be a bundle with fibre  $F$ . The map  $\pi$  is complex oriented if and only a stably complex structure is chosen for the bundle  $\mathcal{T}_F(E)$  of tangents along the fibres of  $\pi$ .

D.3.12. The Poincaré–Atiyah duality map

$$D = \cdot \frown [X]: U^k(X) \rightarrow U_{d-k}(X), \quad x \mapsto x \frown [X]$$

is an isomorphism for any stably complex manifold  $X$  of dimension  $d$ .

D.3.13. Let  $f: X^d \rightarrow Y^{p+d}$  be a complex oriented map of manifolds, and let  $D_X: U^k(X) \rightarrow U_{d-k}(X)$ ,  $D_Y: U^{p+k}(Y) \rightarrow U_{d-k}(Y)$  be the duality isomorphisms for  $X, Y$ . Then the Gysin homomorphism satisfies  $f_! = D_Y^{-1} f_* D_X$ .

D.3.14. Let  $\xi$  be a complex  $n$ -plane bundle over a manifold  $M$  with total space  $E$ , and let  $i: M \rightarrow E$  be the inclusion of zero section. Define the Gysin homomorphism

$$i_!: U^*(M) \rightarrow U^{*+2n}(E, E \setminus M) = U^{*+2n}(Th(\xi))$$

by analogy with Construction D.3.6 and show that  $i_!$  is an isomorphism. It is called the *Gysin–Thom isomorphism* corresponding to  $\xi$ .

#### D.4. Structure results

Let  $M$  be an  $n$ -dimensional manifold and let  $f: M \rightarrow BO(n)$  be the classifying map of the tangent bundle. Given a universal Stiefel–Whitney characteristic class  $w \in H^*(BO(n); \mathbb{Z}_2) = \mathbb{Z}_2[w_1, \dots, w_n]$  of  $n$ -plane bundles, the corresponding *tangential Stiefel–Whitney characteristic number*  $w[M]$  is defined as the result of pairing of  $f^*(w) \in H^n(M; \mathbb{Z}_2)$  with the fundamental class  $\langle M \rangle \in H_n(M; \mathbb{Z}_2)$ . The number  $w[M]$  is an unoriented bordism invariant.

*Tangential Chern characteristic numbers*  $c[M]$  of stably complex  $2n$ -manifolds and *Pontryagin characteristic numbers*  $p[M]$  of oriented  $4n$ -manifolds are defined similarly; they are complex and oriented bordism invariants, respectively.

Normal characteristic numbers are of equal importance in cobordism theory. If  $M \hookrightarrow \mathbb{R}^N$  is an embedding with a fixed complex structure in the normal bundle  $\nu$ , classified by the map  $g: \nu \rightarrow BU(n)$ , then the *normal Chern characteristic number*  $\bar{c}[M]$  corresponding to  $c \in H^*(BU(n)) = \mathbb{Z}[c_1, \dots, c_n]$  is defined as  $(g^*c)\langle M \rangle$ . Normal Stiefel–Whitney and Pontryagin numbers are defined similarly. Since  $\mathcal{T}M \oplus \nu = \mathbb{R}^N$ , the tangential and normal characteristic numbers determine each other.

In what follows, all characteristic numbers will be tangential.

The theory of unoriented (co)bordism was the first to be completed: the coefficient ring  $\Omega^O$  was calculated by Thom, and the bordism groups  $O_*(X)$  of cell complexes  $X$  were reduced to homology groups of  $X$  with coefficients in  $\Omega^O$ . The corresponding results are summarised as follows.

##### THEOREM D.4.1.

- (a) *Two manifolds are unorientedly bordant if and only if they have identical sets of Stiefel–Whitney characteristic numbers.*
- (b)  *$\Omega^O$  is a polynomial ring over  $\mathbb{Z}_2$  with one generator  $a_i$  in every positive dimension  $i \neq 2^k - 1$ .*
- (c) *For every cell complex  $X$  the module  $O_*(X)$  is a free graded  $\Omega^O$ -module isomorphic to  $H_*(X; \mathbb{Z}_2) \otimes_{\mathbb{Z}_2} \Omega^O$ .*

Parts (a) and (b) were done by Thom [305]. Part (c) was first formulated by Conner and Floyd [81]; it also follows from the results of Thom.

##### THEOREM D.4.2.

- (a)  *$\Omega^U \otimes \mathbb{Q}$  is a polynomial ring over  $\mathbb{Q}$  generated by the bordism classes of complex projective spaces  $\mathbb{C}P^i$ ,  $i \geq 1$ .*
- (b) *Two stably complex manifolds are bordant if and only if they have identical sets of Chern characteristic numbers.*
- (c)  *$\Omega^U$  is a polynomial ring over  $\mathbb{Z}$  with one generator  $a_i$  in every even dimension  $2i$ , where  $i \geq 1$ .*

Part (a) can be proved by the methods of Thom. Part (b) follows from the results of Milnor [226] and Novikov [244]. Part (c) is the most difficult one; it was done by Novikov [244] using the Adams spectral sequence and structure theory of Hopf algebras (see also [245] for a more detailed account) and Milnor (unpublished<sup>1</sup>). Another more geometric proof was given by Stong [297].

Note that part (c) of Theorem D.4.1 does not extend to complex bordism;  $U_*(X)$  is not a free  $\Omega^U$ -module in general (although it is a free  $\Omega^U$ -module if  $H_*(X; \mathbb{Z})$  is free abelian). Unlike the case of unoriented bordism, the calculation of complex bordism of a space  $X$  does not reduce to calculating the coefficient ring  $\Omega^U$  and homology groups  $H_*(X)$ . The theory of complex (co)bordism is much richer than its unoriented analogue, and at the same time is not as complicated as oriented bordism or other bordism theories with additional structure, since the coefficient ring does not have torsion. Thanks to this, complex cobordism theory found many striking and important applications in algebraic topology and beyond. Many of these applications were outlined in the pioneering work of Novikov [246].

The calculation of the oriented bordism ring was completed by Novikov [244] (ring structure modulo torsion and odd torsion) and Wall [320] (even torsion), with important earlier contributions made by Rokhlin, Averbuch, and Milnor. Unlike complex bordism, the ring  $\Omega^{SO}$  has additive torsion. We give only a partial result here (which does not fully describe the torsion elements).

**THEOREM D.4.3.**

- (a)  $\Omega^{SO} \otimes \mathbb{Q}$  is a polynomial ring over  $\mathbb{Q}$  generated by the bordism classes of complex projective spaces  $\mathbb{C}P^{2i}$ ,  $i \geq 1$ .
- (b) The subring  $\text{Tors} \subset \Omega^{SO}$  of torsion elements contains only elements of order 2. The quotient  $\Omega^{SO}/\text{Tors}$  is a polynomial ring over  $\mathbb{Z}$  with one generator  $a_i$  in every dimension  $4i$ , where  $i \geq 1$ .
- (c) Two oriented manifolds are bordant if and only if they have identical sets of Pontryagin and Stiefel–Whitney characteristic numbers.

### D.5. Ring generators

To describe a set of ring generators for  $\Omega^U$  we shall need a special characteristic class of complex vector bundles. Let  $\xi$  be a complex  $k$ -plane bundle over a manifold  $M$ . Write its total Chern class formally as follows:

$$c(\xi) = 1 + c_1(\xi) + \cdots + c_k(\xi) = (1 + x_1) \cdots (1 + x_k),$$

so that  $c_i(\xi) = \sigma_i(x_1, \dots, x_k)$  is the  $i$ th elementary symmetric function in formal indeterminates. These indeterminates acquire a geometric meaning if  $\xi$  is a sum  $\xi_1 \oplus \cdots \oplus \xi_k$  of line bundles; then  $x_j = c_1(\xi_j)$ ,  $1 \leq j \leq k$ . Consider the polynomial

$$P_n(x_1, \dots, x_k) = x_1^n + \cdots + x_k^n$$

and express it via the elementary symmetric functions:

$$P_n(x_1, \dots, x_k) = s_n(\sigma_1, \dots, \sigma_k).$$

Substituting the Chern classes for the elementary symmetric functions we obtain a certain characteristic class of  $\xi$ :

$$s_n(\xi) = s_n(c_1(\xi), \dots, c_k(\xi)) \in H^{2n}(M).$$

---

<sup>1</sup>Milnor's proof was announced in [159]; it was intended to be included in the second part of [226], but has never been published.

This characteristic class plays an important role in detecting the polynomial generators of the complex bordism ring, because of the following properties (which follow immediately from the definition).

PROPOSITION D.5.1. *The characteristic class  $s_n$  satisfies*

- (a)  $s_n(\xi) = 0$  if  $\xi$  is a bundle over  $M$  and  $\dim M < 2n$ ;
- (b)  $s_n(\xi \oplus \eta) = s_n(\xi) + s_n(\eta)$ ;
- (c)  $s_n(\xi) = c_1(\xi)^n$  if  $\xi$  is a line bundle.

Given a stably complex  $2n$ -manifold  $(M, c_{\mathcal{T}})$ , define its characteristic number

$$(D.8) \quad s_n[M] = s_n(\mathcal{T}M)\langle M \rangle \in \mathbb{Z}.$$

Here  $s_n(\mathcal{T}M)$  is understood to be  $s_n(\xi)$ , where  $\xi$  is the complex bundle from (D.6).

COROLLARY D.5.2. *If a bordism class  $[M] \in \Omega_{2n}^U$  decomposes as  $[M_1] \times [M_2]$  where  $\dim M_1 > 0$  and  $\dim M_2 > 0$ , then  $s_n[M] = 0$ .*

It follows that the characteristic number  $s_n$  vanishes on decomposable elements of  $\Omega_{2n}^U$ . It also detects indecomposables that may be chosen as polynomial generators. The following result featured in the proof of Theorem D.4.2.

THEOREM D.5.3. *A bordism class  $[M] \in \Omega_{2n}^U$  may be chosen as a polynomial generator  $a_n$  of the ring  $\Omega^U$  if and only if*

$$s_n[M] = \begin{cases} \pm 1, & \text{if } n \neq p^k - 1 \text{ for any prime } p; \\ \pm p, & \text{if } n = p^k - 1 \text{ for some prime } p. \end{cases}$$

There is no universal description of connected manifolds representing the polynomial generators  $a_n \in \Omega^U$ . On the other hand, there is a particularly nice family of manifolds whose bordism classes generate the whole ring  $\Omega^U$ . This family is redundant though, so there are algebraic relations between their bordism classes.

CONSTRUCTION D.5.4 (Milnor hypersurfaces). Fix a pair of integers  $j \geq i \geq 0$  and consider the product  $\mathbb{C}P^i \times \mathbb{C}P^j$ . Its algebraic subvariety

$$(D.9) \quad H_{ij} = \{(z_0 : \cdots : z_i) \times (w_0 : \cdots : w_j) \in \mathbb{C}P^i \times \mathbb{C}P^j : z_0 w_0 + \cdots + z_i w_i = 0\}$$

is called a *Milnor hypersurface*. Note that  $H_{0j} \cong \mathbb{C}P^{j-1}$ .

Denote by  $p_1$  and  $p_2$  the projections of  $\mathbb{C}P^i \times \mathbb{C}P^j$  onto its factors. Let  $\eta$  be the tautological line bundle over a complex projective space and  $\bar{\eta}$  its conjugate (the canonical line bundle). We have

$$H^*(\mathbb{C}P^i \times \mathbb{C}P^j) = \mathbb{Z}[x, y]/(x^{i+1} = 0, y^{j+1} = 0)$$

where  $x = p_1^*c_1(\bar{\eta})$ ,  $y = p_2^*c_1(\bar{\eta})$ .

PROPOSITION D.5.5. *The geometric cobordism in  $\mathbb{C}P^i \times \mathbb{C}P^j$  corresponding to the element  $x + y \in H^2(\mathbb{C}P^i \times \mathbb{C}P^j)$  is represented by the submanifold  $H_{ij}$ . In particular, the image of the fundamental class  $\langle H_{ij} \rangle$  in  $H_{2(i+j-1)}(\mathbb{C}P^i \times \mathbb{C}P^j)$  is Poincaré dual to  $x + y$ .*

PROOF. We have  $x + y = c_1(p_1^*(\bar{\eta}) \otimes p_2^*(\bar{\eta}))$ . The classifying map  $f_{x+y}: \mathbb{C}P^i \times \mathbb{C}P^j \rightarrow \mathbb{C}P^\infty$  is the composition of the Segre embedding

$$\begin{aligned} \sigma: \mathbb{C}P^i \times \mathbb{C}P^j &\rightarrow \mathbb{C}P^{(i+1)(j+1)-1}, \\ (z_0 : \cdots : z_i) \times (w_0 : \cdots : w_j) &\mapsto (z_0 w_0 : z_0 w_1 : \cdots : z_k w_l : \cdots : z_i w_j), \end{aligned}$$

and the embedding  $\mathbb{C}P^{ij+i+j} \rightarrow \mathbb{C}P^\infty$ . The codimension 2 submanifold in  $\mathbb{C}P^i \times \mathbb{C}P^j$  corresponding to the cohomology class  $x + y$  is obtained as the preimage  $\sigma^{-1}(H)$  of a generally positioned hyperplane in  $\mathbb{C}P^{ij+i+j}$  (that is, a hyperplane  $H$  transverse to the image of the Segre embedding, see Construction D.3.8). By (D.9), the Milnor hypersurface is exactly  $\sigma^{-1}(H)$  for one such hyperplane  $H$ .  $\square$

LEMMA D.5.6.

$$s_{i+j-1}[H_{ij}] = \begin{cases} j, & \text{if } i = 0; \\ 2, & \text{if } i = j = 1; \\ 0, & \text{if } i = 1, j > 1; \\ -\binom{i+j}{i}, & \text{if } i > 1. \end{cases}$$

PROOF. Let  $i = 0$ . Since the stably complex structure on  $H_{0j} = \mathbb{C}P^{j-1}$  is determined by the isomorphism  $\mathcal{T}(\mathbb{C}P^{j-1}) \oplus \mathbb{C} \cong \bar{\eta} \oplus \cdots \oplus \bar{\eta}$  ( $j$  summands) and  $x = c_1(\bar{\eta})$ , we have

$$s_{j-1}[\mathbb{C}P^{j-1}] = jx^{j-1}\langle \mathbb{C}P^{j-1} \rangle = j.$$

Now let  $i > 0$ . Then

$$\begin{aligned} s_{i+j-1}(\mathcal{T}(\mathbb{C}P^i \times \mathbb{C}P^j)) &= (i+1)x^{i+j-1} + (j+1)y^{i+j-1} \\ &= \begin{cases} 2x^j + (j+1)y^j, & \text{if } i = 1; \\ 0, & \text{if } i > 1. \end{cases} \end{aligned}$$

Denote by  $\nu$  the normal bundle of the embedding  $\iota: H_{ij} \rightarrow \mathbb{C}P^i \times \mathbb{C}P^j$ . Then

$$(D.10) \quad \mathcal{T}(H_{ij}) \oplus \nu = \iota^*(\mathcal{T}(\mathbb{C}P^i \times \mathbb{C}P^j)).$$

Since  $c_1(\nu) = \iota^*(x + y)$ , we obtain  $s_{i+j-1}(\nu) = \iota^*(x + y)^{i+j-1}$ .

Assume  $i = 1$ . Then (D.10) and Proposition D.5.1 imply that

$$\begin{aligned} s_j[H_{1j}] &= s_j(\mathcal{T}(H_{1j}))\langle H_{1j} \rangle = \iota^*(2x^j + (j+1)y^j - (x+y)^j)\langle H_{1j} \rangle \\ &= (2x^j + (j+1)y^j - (x+y)^j)(x+y)\langle \mathbb{C}P^1 \times \mathbb{C}P^j \rangle = \begin{cases} 2, & \text{if } j = 1; \\ 0, & \text{if } j > 1. \end{cases} \end{aligned}$$

Assume now that  $i > 1$ . Then  $s_{i+j-1}(\mathcal{T}(\mathbb{C}P^i \times \mathbb{C}P^j)) = 0$ , and we obtain from (D.10) and Proposition D.5.1 that

$$\begin{aligned} s_{i+j-1}[H_{ij}] &= -s_{i+j-1}(\nu)\langle H_{ij} \rangle = -\iota^*(x+y)^{i+j-1}\langle H_{ij} \rangle \\ &= -(x+y)^{i+j}\langle \mathbb{C}P^i \times \mathbb{C}P^j \rangle = -\binom{i+j}{i}. \end{aligned}$$

$\square$

REMARK. Since  $s_1[H_{11}] = 2 = s_1[\mathbb{C}P^1]$  the manifold  $H_{11}$  is bordant to  $\mathbb{C}P^1$ . In fact  $H_{11} \cong \mathbb{C}P^1$  (an exercise).

THEOREM D.5.7. *The bordism classes  $\{[H_{ij}], 0 \leq i \leq j\}$  multiplicatively generate the ring  $\Omega^U$ .*

PROOF. A simple calculation shows that

$$\text{g.c.d.} \left( \binom{n+1}{i}, 1 \leq i \leq n \right) = \begin{cases} p, & \text{if } n = p^k - 1, \\ 1, & \text{otherwise.} \end{cases}$$

Now Lemma D.5.6 implies that a certain integer linear combination of bordism classes  $[H_{ij}]$  with  $i + j = n + 1$  can be taken as the polynomial generator  $a_n$  of  $\Omega^U$ , see Theorem D.5.3.  $\square$

REMARK. There is no universal description for a linear combination of bordism classes  $[H_{ij}]$  with  $i + j = n + 1$  giving the polynomial generator of  $\Omega^U$ .

All algebraic relations between the classes  $[H_{ij}]$  arise from the associativity of the formal group law of geometric cobordism (see Corollary E.2.4).

EXAMPLE D.5.8. Since  $s_1[\mathbb{C}P^1] = 2$ ,  $s_2[\mathbb{C}P^2] = 3$ , the bordism classes  $[\mathbb{C}P^1]$  and  $[\mathbb{C}P^2]$  may be taken as polynomial generators  $a_1$  and  $a_2$  of  $\Omega^U$ . However  $[\mathbb{C}P^3]$  cannot be taken as  $a_3$ , since  $s_3[\mathbb{C}P^3] = 4$ , while  $s_3(a_3) = \pm 2$ . The bordism class  $[H_{22}] + [\mathbb{C}P^3]$  may be taken as  $a_3$ .

Theorem D.5.7 admits the following important addendum, which is due to Milnor (see [297, Chapter 7] for the proof).

THEOREM D.5.9 (Milnor). *Every bordism class  $x \in \Omega_n^U$  with  $n > 0$  contains a nonsingular algebraic variety (not necessarily connected).*

The proof of this fact uses a construction of a (possibly disconnected) algebraic variety representing the class  $-[M]$  for any bordism class  $[M] \in \Omega_n^U$  of  $2n$ -dimensional manifold. The following question is still open.

PROBLEM D.5.10 (Hirzebruch). Describe the set of bordism classes in  $\Omega^U$  containing connected nonsingular algebraic varieties.

EXAMPLE D.5.11. The group  $\Omega_2^U$  is isomorphic to  $\mathbb{Z}$  and is generated by  $[\mathbb{C}P^1]$ . Every class  $k[\mathbb{C}P^1] \in \Omega_2^U$  contains a nonsingular algebraic variety, namely, a disjoint union of  $k$  copies of  $\mathbb{C}P^1$  for  $k > 0$  and a Riemann surface of genus  $(1 - k)$  for  $k \leq 0$ . Connected algebraic varieties are contained only in the classes  $k[\mathbb{C}P^1]$  with  $k \leq 1$ .

### Exercises.

D.5.12. Properties listed in Proposition D.5.1 determine the characteristic class  $s_n$  uniquely.

D.5.13. Show that  $H_{11} \cong \mathbb{C}P^1$ .

D.5.14. Show that  $H_{1j}$  is complex bordant to  $\mathbb{C}P^1 \times \mathbb{C}P^{j-1}$ . (Hint: calculate the characteristic numbers; no geometric construction of this bordism is known!)

D.5.15. An alternative set of ring generators of  $\Omega^U$  can be constructed as follows. Let  $M_k^{2n}$  be a submanifold in  $\mathbb{C}P^{n+1}$  dual to  $kx \in H^2(\mathbb{C}P^{n+1})$ , where  $k$  is a positive integer, and  $x$  is the first Chern class of the hyperplane section bundle. For example, one can take  $M_k^{2n}$  to be a nonsingular hypersurface of degree  $k$ . Then the set  $\{[M_k^{2n}] : n \geq 1, k \geq 1\}$  multiplicatively generates the ring  $\Omega^U$ .

## D.6. Invariant stably complex structures

Let  $M$  be a  $2n$ -dimensional manifold with a stably complex structure determined by the isomorphism

$$(D.11) \quad c_{\mathcal{T}}: TM \oplus \mathbb{R}^{2(l-n)} \rightarrow \xi.$$

Assume that the torus  $T^k$  acts on  $M$ .

DEFINITION D.6.1. A stably complex structure  $c_{\mathcal{T}}$  is  $T^k$ -invariant if for every  $\mathbf{t} \in T^k$  the composition

$$(D.12) \quad r(\mathbf{t}): \xi \xrightarrow{c_{\mathcal{T}}^{-1}} \mathcal{T}M \oplus \underline{\mathbb{R}}^{2(l-n)} \xrightarrow{d\mathbf{t} \oplus \text{id}} \mathcal{T}M \oplus \underline{\mathbb{R}}^{2(l-n)} \xrightarrow{c_{\mathcal{T}}} \xi$$

is a complex bundle map, where  $d\mathbf{t}$  is the differential of the action by  $\mathbf{t}$ . In other words, (D.12) determines a representation  $r: T^k \rightarrow \text{Hom}_{\mathbb{C}}(\xi, \xi)$ .

Let  $x \in M$  be an isolated fixed point of the  $T^k$ -action on  $M$ . Then we have a representation  $r_x: T^k \rightarrow GL(l, \mathbb{C})$  in the fibre of  $\xi$  over  $x$ . This fibre  $\xi_x \cong \mathbb{C}^l$  decomposes as  $\mathbb{C}^n \oplus \mathbb{C}^{l-n}$ , where  $r_x$  has no trivial summands on  $\mathbb{C}^n$  and is trivial on  $\mathbb{C}^{l-n}$ . The nontrivial part of  $r_x$  decomposes into a sum  $r_{i_1} \oplus \cdots \oplus r_{i_n}$  of one-dimensional complex  $T^k$ -representations. In the corresponding coordinates  $(z_1, \dots, z_n)$ , an element  $\mathbf{t} = (e^{2\pi i \varphi_1}, \dots, e^{2\pi i \varphi_k}) \in T^k$  acts by

$$\mathbf{t} \cdot (z_1, \dots, z_n) = (e^{2\pi i \langle \mathbf{w}_1, \varphi \rangle} z_1, \dots, e^{2\pi i \langle \mathbf{w}_n, \varphi \rangle} z_n),$$

where  $\varphi = (\varphi_1, \dots, \varphi_k) \in \mathbb{R}^k$  and  $\mathbf{w}_j \in \mathbb{Z}^k$ ,  $1 \leq j \leq n$ , are the *weights* of the representation  $r_x$  at the fixed point  $x$ . Also, the isomorphism  $c_{\mathcal{T},x}$  of (D.11) induces an orientation of the tangent space  $\mathcal{T}_x(M)$ .

DEFINITION D.6.2. For any fixed point  $x \in M$ , the *sign*  $\sigma(x)$  is  $+1$  if the isomorphism

$$\mathcal{T}_x(M) \xrightarrow{\text{id} \oplus 0} \mathcal{T}_x(M) \oplus \underline{\mathbb{R}}^{2(l-n)} \xrightarrow{c_{\mathcal{T},x}} \xi_x \cong \mathbb{C}^n \oplus \mathbb{C}^{l-n} \xrightarrow{p} \mathbb{C}^n,$$

respects the canonical orientations, and  $-1$  if it does not; here  $p$  is the projection onto the first summand.

So  $\sigma(x)$  compares the orientations induced by  $r_x$  and  $c_{\mathcal{T},x}$  on  $\mathcal{T}_x(M)$ . If  $M$  is an almost complex  $T^k$ -manifold (i.e.  $l = n$ ) then  $\sigma(x) = 1$  for every fixed point  $x$ .

EXAMPLE D.6.3. We let the circle  $T^1 = S^1$  act on  $\mathbb{C}P^1$  in homogeneous coordinates by  $t \cdot (z_0 : z_1) = (z_0 : tz_1)$ . This action has two fixed points  $(0 : 1)$  and  $(1 : 0)$ . In the standard stably complex structure (see Example D.3.1) the signs of both vertices are positive (this structure is complex and the map in Definition D.6.2 is a complex linear map  $\mathbb{C} \rightarrow \mathbb{C}$ ).

On the other hand, the trivial stably complex structure on  $\mathbb{C}P^1 \cong S^2$  may be thought of as induced from the embedding of  $S^2$  into  $\mathbb{R}^3 \oplus \mathbb{R}^1$  with trivial normal bundle, which can be made complex by identifying it with  $\underline{\mathbb{C}}$ . We therefore may think of the circle action as the rotation of the unit sphere in  $\mathbb{R}^3$  around the vertical axis. The fixed points are the north and south poles. The rotations induced on the tangent planes to the two fixed points are in different directions. Therefore the signs of the two fixed points are different (which sign is positive depends on the convention one uses to induce an orientation on  $S^2$  from the orientation of  $\mathbb{R}^3$ ).





## Formal group laws and Hirzebruch genera

The theory of *formal groups* originally appeared in algebraic geometry and plays an important role in number theory and cryptography. Formal groups laws were brought into bordism theory in the pioneering work of Novikov [246], and provided a very powerful tool for the theory of group actions on manifolds and generalised homology theories. Early applications of formal group laws in cobordism concerned finite group actions on manifolds, or ‘differentiable periodic maps’. Subsequent developments included constructions of complex oriented cohomology theories and applications to *Hirzebruch genera*, one of the most important class of invariants of manifolds.

### E.1. Elements of the theory of formal group laws

Let  $R$  be a commutative ring with unit.

A formal power series  $F(u, v) \in R[[u, v]]$  is called a (commutative one-dimensional) *formal group law* over  $R$  if it satisfies the following equations:

- (a)  $F(u, 0) = u, F(0, v) = v$ ;
- (b)  $F(F(u, v), w) = F(u, F(v, w))$ ;
- (c)  $F(u, v) = F(v, u)$ .

The original example of a formal group law over a field  $\mathbf{k}$  is provided by the expansion near the unit of the multiplication map  $G \times G \rightarrow G$  in a one-dimensional algebraic group over  $\mathbf{k}$ . This also explains the terminology.

A formal group law  $F$  over  $R$  is called *linearisable* if there exists a coordinate change  $u \mapsto g_F(u) = u + \sum_{i>1} g_i u^i \in R[[u]]$  such that

$$(E.1) \quad g_F(F(u, v)) = g_F(u) + g_F(v).$$

Note that every formal group law over  $R$  determines a formal group law over  $R \otimes \mathbb{Q}$ .

**THEOREM E.1.1.** *Every formal group law  $F$  is linearisable over  $R \otimes \mathbb{Q}$ .*

**PROOF.** Consider the series  $\omega(u) = \left. \frac{\partial F(u, w)}{\partial w} \right|_{w=0}$ . Then

$$\omega(F(u, v)) = \left. \frac{\partial F(F(u, v), w)}{\partial w} \right|_{w=0} = \frac{\partial F(F(u, w), v)}{\partial F(u, w)} \cdot \left. \frac{\partial F(u, w)}{\partial w} \right|_{w=0} = \frac{\partial F(u, v)}{\partial u} \omega(u).$$

We therefore have  $\frac{du}{\omega(u)} = \frac{dF(u, v)}{\omega(F(u, v))}$ . Set

$$(E.2) \quad g(u) = \int_0^u \frac{dv}{\omega(v)};$$

then  $dg(u) = dg(F(u, v))$ . This implies that  $g(F(u, v)) = g(u) + C$ . Since  $F(0, v) = v$  and  $g(0) = 0$ , we get  $C = g(v)$ . Thus,  $g(F(u, v)) = g(u) + g(v)$ .  $\square$

A series  $g_F(u) = u + \sum_{i>1} g_i u^i$  satisfying equation (E.1) is called a *logarithm* of the formal group law  $F$ ; Theorem E.1.1 shows that a formal group law over  $R \otimes \mathbb{Q}$  always has a logarithm. Its functional inverse series  $f_F(t) \in R \otimes \mathbb{Q}[[t]]$  is called an *exponential* of the formal group law, so that we have  $F(u, v) = f_F(g_F(u) + g_F(v))$  over  $R \otimes \mathbb{Q}$ . If  $R$  does not have torsion (i.e.  $R \rightarrow R \otimes \mathbb{Q}$  is monomorphic), the latter formula shows that a formal group law (as a series with coefficients in  $R$ ) is fully determined by its logarithm (which is a series with coefficients in  $R \otimes \mathbb{Q}$ ).

EXAMPLE E.1.2. An example of a formal group law is given by the series

$$(E.3) \quad F(u, v) = (1 + u)(1 + v) - 1 = u + v + uv,$$

over  $\mathbb{Z}$ , called the *multiplicative formal group law*. Introducing a formal indeterminate  $\beta$  of degree  $-2$ , we may consider the 1-parameter extension of the multiplicative formal group law, given by  $F_\beta(u, v) = u + v - \beta uv$ , with coefficients in  $\mathbb{Z}[\beta]$ . Its logarithm and exponential series are given by

$$g(u) = -\frac{\ln(1 - \beta u)}{\beta}, \quad f(x) = \frac{1 - e^{-\beta x}}{\beta}.$$

Let  $F = \sum_{k,l} a_{kl} u^k v^l$  be a formal group law over a ring  $R$  and  $r: R \rightarrow R'$  a ring homomorphism. Denote by  $r(F)$  the formal series  $\sum_{k,l} r(a_{kl}) u^k v^l \in R'[[u, v]]$ ; then  $r(F)$  is a formal group law over  $R'$ .

A formal group law  $\mathcal{F}$  over a ring  $A$  is *universal* if for any formal group law  $F$  over any ring  $R$  there exists a unique homomorphism  $r: A \rightarrow R$  such that  $F = r(\mathcal{F})$ .

PROPOSITION E.1.3. *If a universal formal group law  $\mathcal{F}$  over  $A$  exists, then*

- (a) *the ring  $A$  is multiplicatively generated by the coefficients of the series  $\mathcal{F}$ ;*
- (b)  *$\mathcal{F}$  is unique: if  $\mathcal{F}'$  is another universal formal group law over  $A'$ , then there is an isomorphism  $r: A \rightarrow A'$  such that  $\mathcal{F}' = r(\mathcal{F})$ .*

PROOF. To prove the first statement, denote by  $A'$  the subring in  $A$  generated by the coefficients of  $\mathcal{F}$ . Then there is a monomorphism  $i: A' \rightarrow A$  satisfying  $i(\mathcal{F}) = \mathcal{F}$ . On the other hand, by universality there exists a homomorphism  $r: A \rightarrow A'$  satisfying  $r(\mathcal{F}) = \mathcal{F}$ . It follows that  $ir(\mathcal{F}) = \mathcal{F}$ . This implies that  $ir = \text{id}: A \rightarrow A$  by the uniqueness requirement in the definition of  $\mathcal{F}$ . Thus  $A' = A$ . The second statement is proved similarly.  $\square$

THEOREM E.1.4 (Lazard [192]). *The universal formal group law  $\mathcal{F}$  exists, and its coefficient ring  $A$  is isomorphic to the polynomial ring  $\mathbb{Z}[a_1, a_2, \dots]$  on an infinite number of generators.*

## E.2. Formal group law of geometric cobordisms

The applications of formal group laws in cobordism theory build upon the following fundamental construction.

CONSTRUCTION E.2.1 (Formal group law of geometric cobordisms [246]). Let  $X$  be a cell complex and  $u, v \in U^2(X)$  two geometric cobordisms (see Construction D.3.8) corresponding to elements  $x, y \in H^2(X)$  respectively. Denote by  $u +_H v$  the geometric cobordism corresponding to the cohomology class  $x + y$ .

PROPOSITION E.2.2. *The following relation holds in  $U^2(X)$ :*

$$(E.4) \quad u +_H v = F_U(u, v) = u + v + \sum_{k \geq 1, l \geq 1} \alpha_{kl} u^k v^l,$$

where the coefficients  $\alpha_{kl} \in \Omega_U^{-2(k+l-1)}$  do not depend on  $X$ . The series  $F_U(u, v)$  given by (E.4) is a formal group law over the complex cobordism ring  $\Omega_U$ .

PROOF. We first do calculations with the universal example  $X = \mathbb{C}P^\infty \times \mathbb{C}P^\infty$ . Then

$$U^*(\mathbb{C}P^\infty \times \mathbb{C}P^\infty) = \Omega_U^*[[\underline{u}, \underline{v}]],$$

where  $\underline{u}, \underline{v}$  are canonical geometric cobordisms given by the projections of  $\mathbb{C}P^\infty \times \mathbb{C}P^\infty$  onto its factors. We therefore have the following relation in  $U^2(\mathbb{C}P^\infty \times \mathbb{C}P^\infty)$ :

$$(E.5) \quad \underline{u} +_H \underline{v} = \sum_{k, l \geq 0} \alpha_{kl} \underline{u}^k \underline{v}^l,$$

where  $\alpha_{kl} \in \Omega_U^{-2(k+l-1)}$ .

Now let the geometric cobordisms  $u, v \in U^2(X)$  be given by maps  $f_u, f_v: X \rightarrow \mathbb{C}P^\infty$  respectively. Then  $u = (f_u \times f_v)^*(\underline{u})$ ,  $v = (f_u \times f_v)^*(\underline{v})$  and  $u +_H v = (f_u \times f_v)^*(\underline{u} +_H \underline{v})$ , where  $f_u \times f_v: X \rightarrow \mathbb{C}P^\infty \times \mathbb{C}P^\infty$ . Applying the  $\Omega_U$ -module map  $(f_u \times f_v)^*$  to (E.5) we obtain the required formula (E.4). The identities (a) and (c) for  $F_U(u, v)$  are obvious, and the associativity (b) follows from the identity  $(u +_H v) +_H w = F_U(F_U(u, v), w)$  and the associativity of  $+_H$ .  $\square$

Series (E.4) is called the *formal group law of geometric cobordisms*; nowadays it is also usually referred to as the *complex cobordism formal group law*.

By definition, the geometric cobordism  $u \in U^2(X)$  is the first *Conner–Floyd Chern class*  $c_1^U(\xi)$  of the complex line bundle  $\xi$  over  $X$  obtained by pulling back the canonical bundle along the map  $f_u: X \rightarrow \mathbb{C}P^\infty$  (it also coincides with the Euler class  $e(\xi)$  as defined in Section D.3). It follows that the formal group law of geometric cobordisms gives an expression of  $c_1^U(\xi \otimes \eta) \in U^2(X)$  in terms of the classes  $u = c_1^U(\xi)$  and  $v = c_1^U(\eta)$  of the factors:

$$c_1^U(\xi \otimes \eta) = F_U(u, v).$$

The coefficients of the formal group law of geometric cobordisms and its logarithms may be described geometrically by the following results.

THEOREM E.2.3 (Buchstaber [47, Theorem 4.8]).

$$F_U(u, v) = \frac{\sum_{i, j \geq 0} [H_{ij}] u^i v^j}{\left( \sum_{r \geq 0} [\mathbb{C}P^r] u^r \right) \left( \sum_{s \geq 0} [\mathbb{C}P^s] v^s \right)},$$

where  $H_{ij}$  ( $0 \leq i \leq j$ ) are Milnor hypersurfaces (D.9) and  $H_{ji} = H_{ij}$ .

PROOF. Set  $X = \mathbb{C}P^i \times \mathbb{C}P^j$  in Proposition E.2.2. Consider the Poincaré–Atiyah duality map  $D: U^2(\mathbb{C}P^i \times \mathbb{C}P^j) \rightarrow U_{2(i+j)-2}(\mathbb{C}P^i \times \mathbb{C}P^j)$  (Construction D.3.5) and the map  $\varepsilon: U_*(\mathbb{C}P^i \times \mathbb{C}P^j) \rightarrow U_*(pt) = \Omega^U$  induced by the projection  $\mathbb{C}P^i \times \mathbb{C}P^j \rightarrow pt$ . Then the composition

$$\varepsilon D: U^2(\mathbb{C}P^i \times \mathbb{C}P^j) \rightarrow \Omega_{2(i+j)-2}^U$$

takes geometric cobordisms to the bordism classes of the corresponding submanifolds. In particular,  $\varepsilon D(u +_H v) = [H_{ij}]$ ,  $\varepsilon D(u^k v^l) = [\mathbb{C}P^{i-k}][\mathbb{C}P^{j-l}]$ . Applying  $\varepsilon D$  to (E.4) we obtain

$$[H_{ij}] = \sum_{k,l} \alpha_{kl} [\mathbb{C}P^{i-k}][\mathbb{C}P^{j-l}].$$

Therefore,

$$\sum_{i,j} [H_{ij}] u^i v^j = \left( \sum_{k,l} \alpha_{kl} u^k v^l \right) \left( \sum_{i \geq k} [\mathbb{C}P^{i-k}] u^{i-k} \right) \left( \sum_{j \geq l} [\mathbb{C}P^{j-l}] v^{j-l} \right),$$

which implies the required formula. □

**COROLLARY E.2.4.** *The coefficients of the formal group law of geometric cobordisms generate the complex cobordism ring  $\Omega_U$ .*

**PROOF.** By Theorem D.5.7,  $\Omega_U$  is generated by the cobordism classes  $[H_{ij}]$ , which can be integrally expressed via the coefficients of  $F_U$  using Theorem E.2.3. □

**THEOREM E.2.5** (Mishchenko [246, Appendix 1]). *The logarithm of the formal group law of geometric cobordisms is given by*

$$g_U(u) = u + \sum_{k \geq 1} \frac{[\mathbb{C}P^k]}{k+1} u^{k+1} \in \Omega_U \otimes \mathbb{Q}[[u]].$$

**PROOF.** By (E.2),

$$dg_U(u) = \frac{du}{\left. \frac{\partial F_U(u,v)}{\partial v} \right|_{v=0}}.$$

Using the formula of Theorem E.2.3 and the identity  $H_{i0} = \mathbb{C}P^{i-1}$ , we calculate

$$\frac{dg_U(u)}{du} = \frac{1 + \sum_{k > 0} [\mathbb{C}P^k] u^k}{1 + \sum_{i > 0} ([H_{i1}] - [\mathbb{C}P^1][\mathbb{C}P^{i-1}]) u^i}.$$

Now  $[H_{i1}] = [\mathbb{C}P^1][\mathbb{C}P^{i-1}]$  (see Exercise D.5.14). It follows that  $\frac{dg_U(u)}{du} = 1 + \sum_{k > 0} [\mathbb{C}P^k] u^k$ , which implies the required formula. □

Using these calculations the following most important property of the formal group law  $F_U$  can be easily established:

**THEOREM E.2.6** (Quillen [272, Theorem 2]). *The formal group law  $F_U$  of geometric cobordisms is universal.*

**PROOF.** Let  $\mathcal{F}$  be the universal formal group law over a ring  $A$ . Then there is a homomorphism  $r: A \rightarrow \Omega_U$  which takes  $\mathcal{F}$  to  $F_U$ . The series  $\mathcal{F}$ , viewed as a formal group law over the ring  $A \otimes \mathbb{Q}$ , has the universality property for all formal group laws over  $\mathbb{Q}$ -algebras. By Theorem E.1.1, such a formal group law is determined by its logarithm, which is a series with leading term  $u$ . It follows that if we write the logarithm of  $\mathcal{F}$  as  $\sum b_k \frac{u^{k+1}}{k+1}$  then the ring  $A \otimes \mathbb{Q}$  is the polynomial ring  $\mathbb{Q}[b_1, b_2, \dots]$ . By Theorem E.2.5,  $r(b_k) = [\mathbb{C}P^k] \in \Omega_U$ . Since  $\Omega_U \otimes \mathbb{Q} \cong \mathbb{Q}[[\mathbb{C}P^1], [\mathbb{C}P^2], \dots]$ , this implies that  $r \otimes \mathbb{Q}$  is an isomorphism.

By Theorem E.1.4 the ring  $A$  does not have torsion, so  $r$  is a monomorphism. On the other hand, Theorem E.2.3 implies that the image  $r(A)$  contains the bordism classes  $[H_{ij}] \in \Omega_U$ ,  $0 \leq i \leq j$ . Since these classes generate the whole ring  $\Omega_U$  (Theorem D.5.7), the map  $r$  is onto and thus an isomorphism. □

REMARK. Complex cobordism theory is the *universal complex-oriented cohomology theory*, i.e. it is universal in the category of cohomology theories in which the first Chern class is defined for complex bundles. This implies that the formal group law  $F_U$  of geometric cobordisms is universal among formal group laws realised by complex-oriented cohomology theories. Theorem E.2.6 establishes the universality of  $F_U$  among all formal group laws. It therefore opens a way for application of results from the algebraic theory of formal groups in cobordism.

### E.3. Hirzebruch genera

Every homomorphism  $\varphi: \Omega^U \rightarrow R$  from the complex bordism ring to a commutative ring  $R$  with unit can be regarded as a multiplicative characteristic of manifolds which is an invariant of bordism classes. Such a homomorphism is called a (complex)  $R$ -genus. (The term ‘*multiplicative genus*’ is also used, to emphasise that such a genus is a ring homomorphism.)

Assume that the ring  $R$  does not have additive torsion. Then every  $R$ -genus  $\varphi$  is fully determined by the corresponding homomorphism  $\Omega^U \otimes \mathbb{Q} \rightarrow R \otimes \mathbb{Q}$ , which we shall also denote by  $\varphi$ . A construction due to Hirzebruch [160] describes homomorphisms  $\varphi: \Omega^U \otimes \mathbb{Q} \rightarrow R \otimes \mathbb{Q}$  by means of universal  $R$ -valued characteristic classes of special type.

CONSTRUCTION E.3.1 (Hirzebruch genera). Let  $BU = \lim_{n \rightarrow \infty} BU(n)$ . Then  $H^*(BU)$  is isomorphic to the ring of formal power series  $\mathbb{Z}[[c_1, c_2, \dots]]$  in universal Chern classes,  $\deg c_k = 2k$ . The set of tangential Chern characteristic numbers of a given manifold  $M$  defines an element in  $\text{Hom}(H^*(BU), \mathbb{Z})$ , which belongs to the subgroup  $H_*(BU)$  in the latter group. We therefore obtain a group homomorphism

$$(E.6) \quad \Omega^U \rightarrow H_*(BU).$$

Since the product in  $H_*(BU)$  arises from the maps  $BU(k) \times BU(l) \rightarrow BU(k+l)$  corresponding to the product of vector bundles, and the Chern classes have the appropriate multiplicative property, the map (E.6) is a ring homomorphism.

Part 2 of Theorem D.4.2 says that (E.6) is a monomorphism, and Part 1 of the same theorem says that the map  $\Omega^U \otimes \mathbb{Q} \rightarrow H_*(BU; \mathbb{Q})$  is an isomorphism. It follows that every homomorphism  $\varphi: \Omega^U \otimes \mathbb{Q} \rightarrow R \otimes \mathbb{Q}$  can be interpreted as an element of

$$\text{Hom}_{\mathbb{Q}}(H_*(BU; \mathbb{Q}), R \otimes \mathbb{Q}) = H^*(BU; \mathbb{Q}) \otimes R,$$

or as a sequence of homogeneous polynomials  $\{K_i(c_1, \dots, c_i), i \geq 0\}$ ,  $\deg K_i = 2i$ . This sequence of polynomials cannot be chosen arbitrarily; the fact that  $\varphi$  is a ring homomorphism imposes certain conditions. These conditions may be described as follows: an identity

$$1 + c_1 + c_2 + \dots = (1 + c'_1 + c'_2 + \dots) \cdot (1 + c''_1 + c''_2 + \dots)$$

implies the identity

$$(E.7) \quad \sum_{n \geq 0} K_n(c_1, \dots, c_n) = \sum_{i \geq 0} K_i(c'_1, \dots, c'_i) \cdot \sum_{j \geq 0} K_j(c''_1, \dots, c''_j).$$

A sequence of homogeneous polynomials  $\mathcal{K} = \{K_i(c_1, \dots, c_i), i \geq 0\}$  with  $K_0 = 1$  satisfying the identities (E.7) is called a *multiplicative Hirzebruch sequence*.

PROPOSITION E.3.2. *A multiplicative sequence  $\mathcal{K}$  is completely determined by the series*

$$Q(x) = 1 + q_1x + q_2x^2 + \cdots \in R \otimes \mathbb{Q}[[x]],$$

where  $x = c_1$ , and  $q_i = K_i(1, 0, \dots, 0)$ ; moreover, every series  $Q(x)$  as above determines a multiplicative sequence.

PROOF. Indeed, by considering the identity

$$(E.8) \quad 1 + c_1 + \cdots + c_n = (1 + x_1) \cdots (1 + x_n)$$

we obtain from (E.7) that

$$Q(x_1) \cdots Q(x_n) = 1 + K_1(c_1) + K_2(c_1, c_2) + \cdots + K_n(c_1, \dots, c_n) + K_{n+1}(c_1, \dots, c_n, 0) + \cdots \quad \square$$

Along with the series  $Q(x)$  it is convenient to consider the series  $f(x) \in R \otimes \mathbb{Q}[[x]]$  with leading term  $x$  given by the identity

$$Q(x) = \frac{x}{f(x)}.$$

It follows that the  $n$ th term  $K_n(c_1, \dots, c_n)$  in the multiplicative Hirzebruch sequence corresponding to a genus  $\varphi: \Omega^U \otimes \mathbb{Q} \rightarrow R \otimes \mathbb{Q}$  is the degree- $2n$  part of the series  $\prod_{i=1}^n \frac{x_i}{f(x_i)} \in R \otimes \mathbb{Q}[[c_1, \dots, c_n]]$ . By some abuse of notation, we regard  $\prod_{i=1}^n \frac{x_i}{f(x_i)}$  as a characteristic class of complex  $n$ -plane bundles. Then the value of  $\varphi$  on an  $2n$ -dimensional stably complex manifold  $M$  is given by

$$(E.9) \quad \varphi[M] = \left( \prod_{i=1}^n \frac{x_i}{f(x_i)} (\mathcal{T}M) \right) \langle M \rangle,$$

where the Chern classes  $c_1, \dots, c_n$  are expressed via the indeterminates  $x_1, \dots, x_n$  by the relation (E.8), and the degree- $2n$  part of  $\prod_{i=1}^n \frac{x_i}{f(x_i)}$  is taken to obtain a characteristic class of  $\mathcal{T}M$ . We shall also denote the ‘characteristic class’  $\prod_{i=1}^n \frac{x_i}{f(x_i)}$  of a complex  $n$ -plane bundle  $\xi$  by  $\varphi(\xi)$ ; so that  $\varphi[M] = \varphi(\mathcal{T}M) \langle M \rangle$ .

We refer to the homomorphism  $\varphi: \Omega^U \rightarrow R \otimes \mathbb{Q}$  given by (E.9) as the *Hirzebruch genus* corresponding to the series  $f(x) = x + \cdots \in R \otimes \mathbb{Q}[[x]]$ .

REMARK. A parallel theory of genera exists for oriented manifolds. These genera are homomorphisms  $\Omega^{SO} \rightarrow R$  from the oriented bordism ring, and the Hirzebruch construction expresses genera over torsion-free rings via Pontryagin characteristic classes (which replace the Chern classes).

Given a torsion-free ring  $R$  and a series  $f(x) \in R \otimes \mathbb{Q}[[x]]$  one may ask whether the corresponding Hirzebruch genus  $\varphi: \Omega^U \rightarrow R \otimes \mathbb{Q}$  actually takes values in  $R$ . This constitutes the *integrality problem* for  $\varphi$ . A solution to this problem can be obtained using the theory of formal group laws.

Every genus  $\varphi: \Omega^U \rightarrow R$  gives rise to a formal group law  $\varphi(F_U)$  over  $R$ , where  $F_U$  is the formal group of geometric cobordisms (Construction E.2.1).

THEOREM E.3.3 (Novikov [247]). *For every genus  $\varphi: \Omega^U \rightarrow R$ , the exponential of the formal group law  $\varphi(F_U)$  is the series  $f(x) \in R \otimes \mathbb{Q}[[x]]$  corresponding to  $\varphi$ .*

This can be proved either directly, by appealing to the construction of geometric cobordisms, or indirectly, by calculating the values of  $\varphi$  on projective spaces and comparing to the formula for the logarithm of the formal group law.

1ST PROOF. Let  $X$  be a stably complex  $d$ -manifold with  $x, y \in H^2(X)$ , and let  $u, v \in U^2(X)$  be the corresponding geometric cobordisms (see Construction D.3.8) represented by codimension-2 submanifolds  $M_x \subset X$  and  $M_y \subset X$  respectively. Then  $u^k v^l \in U^{2(k+l)}(X)$  is represented by a submanifold of codimension  $2(k+l)$ , which we denote by  $M_{kl}$ . By (E.4), we have the following relation in  $U^2(X)$ :

$$[M_{x+y}] = \sum_{k,l \geq 0} \alpha_{kl} [M_{kl}]$$

where  $M_{x+y} \subset X$  is the codimension-2 submanifold dual to  $x+y \in H^2(X)$ . We apply the composition  $\varepsilon D$  of the Poincaré–Atiyah duality map  $D: U^2(X) \rightarrow U_{d-2}(X)$  and the augmentation  $U_{d-2}(X) \rightarrow \Omega_{d-2}^U$  to the identity above, and then apply the genus  $\varphi$  to the resulting identity in  $\Omega_{d-2}^U$  to obtain

$$(E.10) \quad \varphi[M_{x+y}] = \sum \varphi(\alpha_{kl}) \varphi[M_{kl}].$$

Let  $\iota: M_{x+y} \subset X$  be the embedding. Considering the decomposition

$$\iota^*(\mathcal{T}X) = \mathcal{T}M_{x+y} \oplus \nu(\iota)$$

and using the multiplicativity of the characteristic class  $\varphi$  we obtain

$$\iota^* \varphi(\mathcal{T}X) = \varphi(\mathcal{T}M_{x+y}) \cdot \iota^* \left( \frac{x+y}{f(x+y)} \right).$$

Therefore,

$$(E.11) \quad \varphi[M_{x+y}] = \iota^* \left( \varphi(\mathcal{T}X) \cdot \frac{f(x+y)}{x+y} \right) \langle M_{x+y} \rangle = (\varphi(\mathcal{T}X) \cdot f(x+y)) \langle X \rangle.$$

Similarly, by considering the embedding  $M_{kl} \rightarrow X$  we obtain

$$(E.12) \quad \varphi[M_{kl}] = (\varphi(\mathcal{T}X) \cdot f(x)^k f(y)^l) \langle X \rangle.$$

Plugging (E.11) and (E.12) into (E.10) we finally obtain

$$f(x+y) = \sum_{k,l \geq 0} \varphi(\alpha_{kl}) f(x)^k f(y)^l.$$

This implies, by definition, that  $f$  is the exponential of  $\varphi(F_U)$ . □

2ND PROOF. The complex bundle isomorphism  $\mathcal{T}(\mathbb{C}P^k) \oplus \underline{\mathbb{C}} = \bar{\eta} \oplus \cdots \oplus \bar{\eta}$  ( $k+1$  summands) allows us to calculate the value of a genus on  $\mathbb{C}P^k$  explicitly. Let  $x = c_1(\bar{\eta}) \in H^2(\mathbb{C}P^k)$  and let  $g$  be the series functionally inverse to  $f$ ; then

$$\begin{aligned} \varphi[\mathbb{C}P^k] &= \left( \frac{x}{f(x)} \right)^{k+1} \langle \mathbb{C}P^k \rangle \\ &= \text{coefficient of } x^k \text{ in } \left( \frac{x}{f(x)} \right)^{k+1} = \text{res}_0 \left( \frac{1}{f(x)} \right)^{k+1} \\ &= \frac{1}{2\pi i} \oint \left( \frac{1}{f(x)} \right)^{k+1} dx = \frac{1}{2\pi i} \oint \frac{1}{u^{k+1}} g'(u) du \\ &= \text{res}_0 \left( \frac{g'(u)}{u^{k+1}} \right) = \text{coefficient of } u^k \text{ in } g'(u). \end{aligned}$$

(Integrating over a closed path around zero makes sense only for convergent power series with coefficients in  $\mathbb{C}$ , however the result holds for all power series with coefficients in  $R \otimes \mathbb{Q}$ .) Therefore,

$$g'(u) = \sum_{k \geq 0} \varphi[\mathbb{C}P^k] u^k.$$

Theorem E.2.5 then implies that  $g$  is the logarithm of the formal group law  $\varphi(F_U)$ , and thus  $f$  is its exponential.  $\square$

Now we can formulate the following criterion for the integrality of a genus:

**THEOREM E.3.4.** *Let  $R$  be a torsion-free ring and  $f(x) \in R \otimes \mathbb{Q}[[x]]$ . The corresponding genus  $\varphi: \Omega^U \rightarrow R \otimes \mathbb{Q}$  takes values in  $R$  if and only if the coefficients of the formal group law  $\varphi(F_U)(u, v) = f(f^{-1}(u) + f^{-1}(v))$  belong to  $R$ .*

**PROOF.** This follows from Theorem E.3.3 and Corollary E.2.4.  $\square$

**EXAMPLE E.3.5.** The *universal genus* maps a stably complex manifold  $M$  to its bordism class  $[M] \in \Omega^U$  and therefore corresponds to the identity homomorphism  $\varphi_U: \Omega^U \rightarrow \Omega^U$ . The corresponding characteristic class with coefficients in  $\Omega^U \otimes \mathbb{Q}$ , the *universal Hirzebruch genus*, was studied in [47]; its corresponding series  $f_U(x)$  is the exponential of the universal formal group law of geometric cobordisms.

**EXAMPLE E.3.6.** We take  $R = \mathbb{Z}$  in these examples.

1. The top Chern number  $c_n[M]$  is a Hirzebruch genus, and its corresponding  $f$ -series is  $f(x) = \frac{x}{1+x}$ . The value of this genus on a stably complex manifold  $(M, c_{\mathcal{T}})$  equals the Euler characteristic of  $M$  if  $c_{\mathcal{T}}$  is an *almost* complex structure.

2. The  $L$ -genus  $L[M]$  corresponds to the series  $f(x) = \tanh(x)$  (the hyperbolic tangent). It is equal to the *signature*  $\text{sign}(M)$  by the classical Hirzebruch formula [160].

3. The *Todd genus*  $\text{td}[M]$  corresponds to the series  $f(x) = 1 - e^{-x}$ . The corresponding formal group law is given by  $F(u, v) = u + v - uv$ , compare Example (E.3). By Theorem E.3.4, the Todd genus is integral on any complex bordism class. Furthermore, it takes value 1 on every complex projective space  $\mathbb{C}P^k$ .

The ‘trivial’ genus  $\varepsilon: \Omega_U \rightarrow \mathbb{Z}$  corresponding to the series  $f(x) = x$  gives rise to the *augmentation transformation*  $U^* \rightarrow H^*$  from complex cobordism to ordinary cohomology (also known as the *Thom homomorphism*). More generally, for every genus  $\varphi: \Omega_U \rightarrow R$  and a space  $X$  we may set  $h_{\varphi}^*(X) = U^*(X) \otimes_{\Omega_U} R$ . Under certain conditions guaranteeing the exactness of the sequences of pairs (known as the *Landweber Exact Functor Theorem* [191]) the functor  $h_{\varphi}^*(\cdot)$  gives rise to a complex-oriented cohomology theory with the coefficient ring  $R$ .

As an example of this procedure, consider the genus corresponding to the 1-parameter extension of the multiplicative formal group law, see Example E.1.2. It is also usually called the *Todd genus*, and takes values in the ring  $\mathbb{Z}[\beta]$ ,  $\deg \beta = -2$ . By interpreting  $\beta = 1 - \bar{\eta}$  as the *Bott element* in the complex  $K$ -group  $\tilde{K}^0(S^2) = K^{-2}(pt)$  we obtain a homomorphism  $\text{td}: \Omega_U \rightarrow K^*(pt)$ . It gives rise to a multiplicative transformation  $U^* \rightarrow K^*$  from complex cobordism to complex  $K$ -theory introduced by Conner and Floyd [82]. In this paper Conner and Floyd proved that complex cobordism determines complex  $K$ -theory by means of the isomorphism  $K^*(X) = U^*(X) \otimes_{\Omega_U} \mathbb{Z}[\beta]$ , where the  $\Omega_U$ -module structure on  $\mathbb{Z}[\beta]$  is given by the Todd genus. Their proof makes use of the Conner–Floyd Chern classes; several proofs were given subsequently, including one which follows directly from the Landweber exact functor theorem.



EXAMPLE E.3.7. Another important example from the original work of Hirzebruch is given by the  $\chi_y$ -genus. It corresponds to the series

$$f(x) = \frac{1 - e^{-x(1+y)}}{1 + ye^{-x(1+y)}},$$

where  $y \in \mathbb{R}$  is a parameter. Setting  $y = -1$ ,  $y = 0$  and  $y = 1$  we get  $c_n[M]$ , the Todd genus  $\text{td}[M]$  and the  $L$ -genus  $L[M] = \text{sign}(M)$  respectively.

If  $M$  is a complex manifold then the value  $\chi_y[M]$  can be calculated in terms of the Euler characteristics of *Dolbeault complexes* on  $M$ , see [160].

**Exercises.**

E.3.8. The formal group law corresponding to the  $\chi_y$ -genus is given by

$$F(u, v) = \frac{u + v + (y - 1)uv}{1 + y \cdot uv}.$$



## Bibliography

- [1] J. Frank Adams. *On the cobar construction*. Proc. Nat. Acad. Sci. USA **42** (1956), 409–412.
- [2] Ron M. Adin. *A new cubical  $h$ -vector*. Discrete Math. **157** (1996), no. 1–3, 3–14.
- [3] Selman Akbulut and John D. McCarthy. *Casson's Invariant for Oriented Homology 3-spheres*. Math. Notes, 36. Princeton Univ. Press, Princeton, NJ, 1990.
- [4] Christopher Allday and Volker Puppe. *Cohomological methods in transformation groups*. Cambridge Studies in Adv. Math., 32. Cambridge Univ. Press, Cambridge, 1993.
- [5] Henri Anceaux and Ildefonso Castro. *Construction of Hamiltonian-minimal Lagrangian submanifolds in complex Euclidean space*. Results Math. **60** (2011), no. 1–4, 325–349.
- [6] Ivan Arzhantsev, Ulrich Derenthal, Jürgen Hausen and Antonio Laface. *Cox rings*. Cambridge Studies in Adv. Math., Cambridge Univ. Press, Cambridge, to appear; arXiv:1003.4229.
- [7] Michael Atiyah. *Bordism and cobordism*. Proc. Cambridge Philos. Soc. **57** (1961), 200–208.
- [8] Michael Atiyah. *Convexity and commuting Hamiltonians*. Bull. London Math. Soc. **14** (1982), no. 1, 1–15.
- [9] Michael Atiyah and Raoul Bott. *A Lefschetz fixed point formula for elliptic complexes. I*. Ann. of Math. (2) **86** (1967), no. 2, 374–407.
- [10] Michael Atiyah and Friedrich Hirzebruch. *Spin-manifolds and group actions*. In: *Essays in Topology and Related Topics*. Springer-Verlag, Berlin-Heidelberg-New York, 1970, pp. 18–28.
- [11] Michèle Audin. *The Topology of Torus Actions on Symplectic Manifolds*. Progress in Mathematics, 93. Birkhäuser, Basel, 1991.
- [12] Anton Ayzenberg and Victor Buchstaber. *Nerve complexes and moment-angle spaces of convex polytopes*. Trudy Mat. Inst. Steklova **275** (2011), 22–54 (Russian); Proc. Steklov Inst. Math. **275** (2011), 15–46 (English translation).
- [13] Eric K. Babson, Louis J. Billera and Clara S. Chan. *Neighborly cubical spheres and a cubical lower bound conjecture*. Israel J. Math. **102** (1997), 297–315.
- [14] Anthony Bahri, Martin Bendersky, Frederic R. Cohen, and Samuel Gitler. *The polyhedral product functor: a method of computation for moment-angle complexes, arrangements and related spaces*. Adv. Math. **225** (2010), no. 3, 1634–1668.
- [15] Anthony Bahri, Martin Bendersky, Frederic R. Cohen, and Samuel Gitler. *A new topological construction of infinite families of toric manifolds implying fan reduction*. Preprint (2010); arXiv:1011.0094.
- [16] Anthony Bahri, Martin Bendersky, Frederic R. Cohen, and Samuel Gitler. *Cup-products for the polyhedral product functor*. Math. Proc. Cambridge Philos. Soc. **153** (2012), no. 3, 457–469.
- [17] Anthony Bahri, Matthias Franz, Dietrich Notbohm, and Nigel Ray. *The classification of weighted projective spaces*. Fund. Math. **220** (2013), no. 3, 217–226.
- [18] David Barnette. *Diagrams and Schlegel diagrams*. In: *Combinatorial Structures and Their Applications*. Proc. Calgary Internat. Conference, Calgary 1969. Gordon and Breach, New York, 1970, pp. 1–4.
- [19] David Barnette. *The minimum number of vertices of a simple polytope*. Israel J. Math. **10** (1971), 121–125.
- [20] David Barnette. *A proof of the lower bound conjecture for convex polytopes*. Pacific J. Math. **46** (1973), 349–354.
- [21] David Barnette. *The triangulations of the 3-sphere with up to 8 vertices*. J. Combinatorial Theory. Ser. A **14** (1973), 37–52.

- [22] Iliia V. Baskakov. *Cohomology of  $K$ -powers of spaces and the combinatorics of simplicial subdivisions*. Uspekhi Mat. Nauk **57** (2002), no. 5, 147–148 (Russian); Russian Math. Surveys **57** (2002), no. 5, 989–990 (English translation).
- [23] Iliia V. Baskakov. *Massey triple products in the cohomology of moment-angle complexes*. Uspekhi Mat. Nauk **58** (2003), no. 5, 199–200 (Russian); Russian Math. Surveys **58** (2003), no. 5, 1039–1041 (English translation).
- [24] Iliia V. Baskakov, Victor M. Buchstaber and Taras E. Panov. *Cellular cochain algebras and torus actions*. Uspekhi Mat. Nauk **59** (2004), no. 3, 159–160 (Russian); Russian Math. Surveys **59** (2004), no. 3, 562–563 (English translation).
- [25] Fiammetta Battaglia and Dan Zaffran. *Foliations modelling nonrational simplicial toric varieties*. Preprint (2011); arXiv:1108.1637.
- [26] Victor V. Batyrev. *Quantum cohomology rings of toric manifolds*. In: *Journées de Géométrie Algébrique d’Orsay (Orsay 1992)*. Astérisque No. 218 (1993), 9–34.
- [27] Margaret M. Bayer and Louis J. Billera. *Generalized Dehn–Sommerville relations for polytopes, spheres and Eulerian partially ordered sets*. Invent. Math. **79** (1985), no. 1, 143–157.
- [28] Alexander Berglund and Michael Jöllenbeck. *On the Golod property of Stanley–Reisner rings*. J. Algebra **315** (2007), no. 1, 249–273.
- [29] Louis J. Billera and Carl W. Lee. *Sufficiency of McMullen’s conditions for  $f$ -vectors of simplicial polytopes*. Bull. Amer. Math. Soc. **2** (1980), 181–185.
- [30] Louis J. Billera and Carl W. Lee. *A proof of the sufficiency of McMullen’s conditions for  $f$ -vectors of simplicial polytopes*. J. Comb. Theory, Ser. A **31** (1981), 237–255.
- [31] Anders Björner and Frank Lutz. *Simplicial manifolds, bistellar flips and 16-vertex triangulation of the Poincaré homology 3-sphere*. Experiment. Math. **9** (2000), no. 2, 275–289.
- [32] Anders Björner and Martin Tancer. *Note: Combinatorial Alexander duality—a short and elementary proof*. Discrete Comput. Geom. **42** (2009), no. 4, 586–593.
- [33] Gerd Blind and Roswitha Blind. *Triangle-free polytopes with few facets*. Arch. Math. (Basel) **58** (1992), no. 6, 599–605.
- [34] Armand Borel. *A spectral sequence for complex-analytic bundles*, Appendix Two in: Friedrich Hirzebruch, *Topological methods in algebraic geometry*, 3rd edition, Springer-Verlag, Berlin–Heidelberg, 1966.
- [35] Frédéric Bosio. *Variétés complexes compactes: une généralisation de la construction de Meersseman et López de Medrano–Verjovsky*. Ann. Inst. Fourier **51** (2001), 1259–1297.
- [36] Frédéric Bosio and Laurent Meersseman. *Real quadrics in  $\mathbb{C}^n$ , complex manifolds and convex polytopes*. Acta Math. **197** (2006), no. 1, 53–127.
- [37] Raoul Bott and Hans Samelson. *Application of the theory of Morse to symmetric spaces*. Amer. J. of Math. **80** (1958), 964–1029.
- [38] Raoul Bott and Clifford Taubes. *On the self-linking of knots. Topology and physics*. J. Math. Phys. **35** (1994), no. 10, 5247–5287.
- [39] A. K. Bousfield and Victor K. Gugenheim. *On PL de Rham Theory and Rational Homotopy Type*. Mem. Amer. Math. Soc. **8** (1976), no. 179.
- [40] A. K. Bousfield and Daniel M. Kan. *Homotopy Limits, Completions and Localizations*. Lecture Notes in Math., Vol. 304, Springer-Verlag, Berlin, 1972.
- [41] Glen E. Bredon. *Introduction to Compact Transformation Groups*. Academic Press, New York–London, 1972.
- [42] Arne Brønsted. *An Introduction to Convex Polytopes*. Graduate Texts in Mathematics, 90. Springer-Verlag, New-York, 1983.
- [43] Edward M. Brown. *The Hauptvermutung for 3-complexes*. Trans. Amer. Math. Soc. **140** (1969), 173–196.
- [44] Winfried Bruns and Joseph Gubeladze. *Combinatorial invariance of Stanley–Reisner rings*. Georgian Math. J. **3** (1996), no. 4, 315–318.
- [45] Winfried Bruns and Jürgen Herzog. *Cohen–Macaulay Rings*, revised edition. Cambridge Studies in Adv. Math., 39, Cambridge Univ. Press, Cambridge, 1993.
- [46] David A. Buchsbaum and David Eisenbud. *Algebra structures for finite free resolutions, and some structure theorems for ideals of codimension 3*. Amer. J. Math. **99** (1977), no. 3, 447–485.
- [47] Victor M. Buchstaber [Bukhshtaber]. *The Chern–Dold character in cobordisms I*. Mat. Sbornik **83** (1970), no. 4, 575–595 (Russian); Math. USSR Sbornik **12** (1970), no. , 573–594 (English translation).

- [48] Victor M. Buchstaber. *Ring of simple polytopes and differential equations*. Trudy Mat. Inst. Steklova **263** (2008), 18–43 (Russian); Proc. Steklov Inst. Math. **263** (2008), 1–25 (English translation).
- [49] Victor M. Buchstaber. *Lectures on toric topology*. In *Proceedings of Toric Topology Workshop KAIST 2008*. Information Center for Mathematical Sciences, KAIST. Trends in Math. - New Series **10** (2008), no. 1, 1–64.
- [50] Victor M. Buchstaber and Nickolai Erokhovets. *Polytopes, Fibonacci numbers, Hopf algebras, and quasi-symmetric functions*. Uspehi Mat. Nauk **66** (2011), no. 2, 67–162 (Russian); Russian Math. Surveys **66** (2011), no. 2, 271–367 (English translation).
- [51] Victor M. Buchstaber and Elena V. Koritskaya. *Quasilinear Burgers–Hopf equation and Stasheff polytopes*. Funktsional. Anal. i Prilozhen. **41** (2007), no. 3, 34–47 (Russian); Funct. Anal. and Appl. **41** (2007), no. 3, 196–207 (English translation).
- [52] Victor M. Buchstaber and Taras E. Panov. *Algebraic topology of manifolds defined by simple polyhedra*. Uspehi Mat. Nauk **53** (1998), no. 3, 195–196 (Russian); Russian Math. Surveys **53** (1998), no. 3, 623–625 (English translation).
- [53] Victor M. Buchstaber and Taras E. Panov. *Torus actions and the combinatorics of polytopes*. Trudy Mat. Inst. Steklova **225** (1999), 96–131 (Russian); Proc. Steklov Inst. Math. **225** (1999), 87–120 (English translation).
- [54] Victor M. Buchstaber and Taras E. Panov. *Torus actions, combinatorial topology and homological algebra*. Uspekhi Mat. Nauk **55** (2000), no. 5, 3–106 (Russian). Russian Math. Surveys **55** (2000), no. 5, 825–921 (English translation).
- [55] Victor M. Buchstaber and Taras E. Panov. *Torus Actions and Their Applications in Topology and Combinatorics*. University Lecture Series, 24. American Mathematical Society, Providence, RI, 2002.
- [56] Victor M. Buchstaber and Taras E. Panov. *Combinatorics of simplicial cell complexes and torus action*. Trudy Mat. Inst. Steklova **247** (2004), pp. 41–58 (Russian); Proc. Steklov Inst. Math., vol. **247** (2004), pp. 33–49 (English translation).
- [57] Victor M. Buchstaber and Taras E. Panov. *Torus Actions in Topology and Combinatorics* (in Russian). MCCME, Moscow, 2004.
- [58] Victor M. Buchstaber, Taras E. Panov and Nigel Ray. *Spaces of polytopes and cobordism of quasitoric manifolds*. Moscow Math. J. **7** (2007), no. 2, 219–242.
- [59] Victor M. Buchstaber, Taras E. Panov and Nigel Ray. *Toric genera*. Internat. Math. Research Notices **16** (2010), 3207–3262.
- [60] Victor M. Buchstaber [Bukhshtaber] and Nigel Ray. *Toric manifolds and complex cobordisms*. Uspekhi Mat. Nauk **53** (1998), no. 2, 139–140 (Russian); Russian Math. Surveys **53** (1998), no. 2, 371–373 (English translation).
- [61] Victor M. Buchstaber and Nigel Ray. *Flag manifolds and the Landweber–Novikov algebra*. Geom. Topol. **2** (1998), 79–101.
- [62] Victor M. Buchstaber and Nigel Ray. *Tangential structures on toric manifolds, and connected sums of polytopes*. Internat. Math. Res. Notices **4** (2001), 193–219.
- [63] Victor M. Buchstaber and Nigel Ray. *An invitation to toric topology: vertex four of a remarkable tetrahedron*. In: *Toric Topology* (M. Harada et al., eds.). Contemp. Math., 460, Amer. Math. Soc., Providence, RI, 2008, pp. 1–27.
- [64] Victor M. Buchstaber, Vadim Volodin. *Precise upper and lower bounds for nestohedra*. Izv. Ross. Akad. Nauk, Ser. Mat. **75** (2011), no. 6, 17–46 (Russian); Izv. Math. **75** (2011), no. 6 (English translation).
- [65] James W. Cannon. *Shrinking cell-like decompositions of manifolds. Codimension three*. Ann. of Math. (2) **110** (1979), no. 1, 83–112.
- [66] Xiangyu Cao, Zhi Lü. *Möbius transform, moment-angle complexes and Halperin–Carlsson conjecture*. J. Algebraic Combin. **35** (2012), no. 1, 121–140.
- [67] Michael P. Carr and Satyan L. Devadoss. *Coxeter complexes and graph-associahedra*. Topology Appl. **153** (2006), no. 12, 2155–2168.
- [68] Ildefonso Castro and Francisco Urbano. *Examples of unstable Hamiltonian-minimal Lagrangian tori in  $\mathbb{C}^2$* . Compositio Math. **111** (1998), 1–14.
- [69] Ruth Charney and Michael Davis. *The Euler characteristic of a nonpositively curved, piecewise Euclidean manifold*. Pacific J. Math. **171** (1995), no. 1, 117–137.
- [70] Shiing-Shen Chern. *Complex Manifolds*. University of Chicago, 1956.

- [71] Suyoung Choi. *Classification of Bott manifolds up to dimension eight*. Preprint (2011); arXiv:1112.2321.
- [72] Suyoung Choi and Jang Soo Kim. *A combinatorial proof of a formula for Betti numbers of a stacked polytope*. Electron. J. Combin. **17** (2010), no. 1, Research Paper 9, 8 pp.
- [73] Suyoung Choi, Mikiya Masuda and Sang-il Oum. *Classification of real Bott manifolds and acyclic digraphs*. Preprint (2010); arXiv:1006.4658.
- [74] Suyoung Choi, Mikiya Masuda and Dong Youp Suh. *Quasitoric manifolds over a product of simplices*. Osaka J. Math. **47** (2010), no. 1, 109–129.
- [75] Suyoung Choi, Mikiya Masuda and Dong Youp Suh. *Topological classification of generalized Bott towers*. Trans. Amer. Math. Soc. **362** (2010), no. 2, 1097–1112.
- [76] Suyoung Choi, Mikiya Masuda and Dong Youp Suh. *Rigidity problems in toric topology: a survey*. Proc. Steklov Inst. Math. **275** (2011), 177–190.
- [77] Suyoung Choi, Seonjeong Park and Dong Youp Suh. *Topological classification of quasitoric manifolds with second Betti number 2*. Pacific J. Math. **256** (2012), no. 1, 19–49.
- [78] Yusuf Civan and Nigel Ray. *Homotopy decompositions and K-theory of Bott towers*. K-Theory **34** (2005), no. 1, 1–33.
- [79] George F. Clements and Bernt Lindström. *A generalization of a combinatorial theorem of Macaulay*. J. Combinatorial Theory **7** (1969), 230–238.
- [80] Frederick R. Cohen and Joseph A. Neisendorfer. *A construction of p-local H-spaces*. In: *Algebraic topology, Aarhus 1982*. Lecture Notes in Math., 1051. Springer, Berlin, 1984, pp. 351–359.
- [81] Pierre E. Conner and Edwin E. Floyd. *Differentiable Periodic Maps*. Academic Press Inc., New York, 1964.
- [82] Pierre E. Conner and Edwin E. Floyd. *The Relation of Cobordism to K-theories*. Lecture Notes in Math. **28**, Springer-Verlag, Berlin, 1966.
- [83] David A. Cox. *The homogeneous coordinate ring of a toric variety*. J. Algebraic Geom. **4** (1995), no. 1, 17–50.
- [84] David A. Cox, John B. Little and Henry K. Schenck. *Toric varieties*. Graduate Studies in Mathematics, 124. American Mathematical Society, Providence, RI, 2011.
- [85] H. S. M. Coxeter. *Regular Polytopes*. Third edition. Dover Publications, Inc., New York, 1973.
- [86] Vladimir I. Danilov. *The geometry of toric varieties*. Uspekhi Mat. Nauk **33** (1978), no. 2, 85–134 (Russian); Russian Math. Surveys **33** (1978), no. 2, 97–154 (English translation).
- [87] Michael W. Davis. *Smooth G-manifolds as collections of fiber bundles*. Pacific J. Math., **77** (1978), 315–363.
- [88] Michael W. Davis. *Groups generated by reflections and aspherical manifolds not covered by Euclidean space*. Ann. of Math. (2) **117** (1983), no. 2, 293–324.
- [89] Michael W. Davis. *When are two Coxeter orbifolds diffeomorphic?* Michigan Math. J. **63** (2014), no. 2, 401–421.
- [90] Michael W. Davis and Tadeusz Januszkiewicz. *Convex polytopes, Coxeter orbifolds and torus actions*. Duke Math. J. **62** (1991), no. 2, 417–451.
- [91] Corrado De Concini and C. Procesi. *Wonderful models of subspace arrangements*. Selecta Math. (N.S.) **1** (1995), no. 3, 459–494.
- [92] Mark de Longueville. *The ring structure on the cohomology of coordinate subspace arrangements*. Math. Zeitschrift **233** (2000), no. 3, 553–577.
- [93] Thomas Delzant. *Hamiltoniens périodiques et images convexes de l'application moment*. Bull. Soc. Math. France **116** (1988), no. 3, 315–339 (French).
- [94] Michel Demazure. *Sous-groupes algébriques de rang maximum du groupe de Cremona*. Ann. Sci. École Norm. Sup. (4) **3** (1970), 507–588 (French).
- [95] Graham Denham and Alexander I. Suci. *Moment-angle complexes, monomial ideals, and Massey products*. Pure Appl. Math. Q. **3** (2007), no. 1, 25–60.
- [96] Natalia Dobrinskaya. *The classification problem for quasitoric manifolds over a given simple polytope*. Funktsional. Anal. i Prilozhen. **35** (2001), no. 2, 3–11 (Russian); Funct. Anal. and Appl. **35** (2001), no. 2, 83–89 (English translation).
- [97] Nikolai P. Dolbilin, Mikhail A. Shtan'ko and Mikhail I. Shtogin. *Cubic manifolds in lattices*. Izv. Ross. Akad. Nauk Ser. Mat. **58** (1994), no. 2, 93–107 (Russian); Russian Acad. Sci. Izv. Math. **44** (1995), no. 2, 301–313 (English translation).

- [98] Albrecht Dold. *Geometric cobordism and the fixed point transfer*. In: *Algebraic Topology, Proceedings Vancouver 1977*. Lecture Notes in Math., 673. Springer Verlag, Berlin, 1978, pp. 32–87.
- [99] Yuxin Dong. *Hamiltonian-minimal Lagrangian submanifolds in Kaehler manifolds with symmetries*. *Nonlinear Analysis: Theory, Methods & Applications* **67** (2007), 865–882.
- [100] Johannes J. Duistermaat and G. J. Heckman. *On the variation in the cohomology of the symplectic form of the reduced phase space*. *Invent. Math.* **69** (1982), no. 2, 259–268.
- [101] Art M. Duval. *Free resolutions of simplicial posets*. *J. Algebra* **188** (1997), 363–399.
- [102] William G. Dwyer and J. Spaliński. *Homotopy Theories and Model Categories*. In: *Handbook of Algebraic Topology*, I. M. James, ed. Elsevier, 2001, pp. 73–126.
- [103] Robert D. Edwards. *The double suspension of a certain homology 3-sphere is  $S^5$* . *Notices AMS* **22**, A-334 (1975).
- [104] Robert D. Edwards. *The topology of manifolds and cell-like maps*. In: *Proceedings of the International Congress of Mathematicians (Helsinki, 1978)*. Acad. Sci. Fennica, Helsinki, 1980, pp. 111–127.
- [105] Samuel Eilenberg and John C. Moore. *Homology and fibrations. I*. *Comment. Math. Helv.* **40** (1966), 199–236.
- [106] Davin Eisenbud. *Commutative Algebra with a View Toward Algebraic Geometry*. Graduate Texts in Mathematics, 150. Springer-Verlag, New York, 1995.
- [107] Nickolay Yu. Erokhovets. *The Bukhshtaber invariant of simple polytopes*. *Uspekhi Mat. Nauk* **63** (2008), no. 5, 187–188 (Russian); *Russian Math. Surveys* **63** (2008), no. 5, 962–964 (English translation).
- [108] Günter Ewald. *Combinatorial Convexity and Algebraic Geometry*. Graduate Texts in Mathematics, 168. Springer-Verlag, New-York, 1996.
- [109] Günter Ewald and Christoph Schulz. *Nonstarshaped spheres*. *Arch. Math. (Basel)* **59** (1992), no. 4, 412–416.
- [110] Eva Maria Feichtner and Bernd Sturmfels. *Matroid polytopes, nested sets and Bergman fans*. *Port. Math. (N.S.)* **62** (2005), no. 4, 437–468.
- [111] Yves Felix, Stephen Halperin and Jean-Claude Thomas. Adams’ cobar equivalence. *Transactions Amer. Math. Soc.* **329** (1992), no. 2, 531–549.
- [112] Yves Félix, Stephen Halperin and Jean-Claude Thomas. *Rational Homotopy Theory*. Graduate Texts in Mathematics, 205. Springer-Verlag, New York, 2001.
- [113] Yves Félix, John Oprea and Daniel Tanré. *Algebraic Models in Geometry*. Oxford Graduate Texts in Mathematics, 17. Oxford University Press, Oxford, 2008.
- [114] John Fogarty, Frances Kirwan and David Mumford. *Geometric Invariant Theory*. Third Edition. *Ergebnisse der Mathematik und ihrer Grenzgebiete (2)*, 34. Springer-Verlag, Berlin, 1994.
- [115] Anatoliy T. Fomenko and Dmitriy B. Fuks. *A Course in Homotopic Topology* (in Russian). Nauka, Moscow, 1989.
- [116] Sergey Fomin and Andrei Zelevinsky. *Cluster algebras. I. Foundations*. *J. Amer. Math. Soc.* **15** (2002), no. 2, 497–529.
- [117] Matthias Franz. *On the integral cohomology of smooth toric varieties*. *Proc. Steklov Inst. Math.* **252** (2006), 53–62.
- [118] Michael H. Freedman and Frank Quinn. *Topology of 4-manifolds*. Princeton Mathematical Series, 39. Princeton University Press, Princeton, NJ, 1990.
- [119] Ralph Fröberg. *Determination of a class of Poincaré series*. *Math. Scand.* **37** (1975), no. 1, 29–39.
- [120] Yukiko Fukukawa and Mikiya Masuda. *Buchstaber invariants of skeleta of a simplex*. *Osaka J. Math.* **48** (2011), 549–582.
- [121] D. R. Fulkerson and O. A. Gross. *Incidence matrices and interval graphs*. *Pacific J. Math* **15** (1965), 835–855.
- [122] William Fulton. *Introduction to Toric Varieties*. *Annals of Mathematics Studies*, 131. The William H. Roever Lectures in Geometry. Princeton University Press, Princeton, NJ, 1993.
- [123] Swiatosław R. Gal. *Real root conjecture fails for five and higher dimensional spheres*. *Discrete Comput. Geom.* **34** (2005), no. 2, 260–284.
- [124] Veselin Gasharov, Irena Peeva and Volkmar Welker. *Coordinate subspace arrangements and monomial ideals*. In: *Computational Commutative Algebra and Combinatorics*, T. Hibi, ed. *Adv. Stud. Pure Math.*, 33. Mathematical Society of Japan, Tokyo, 2001, pp. 65–74.

- [125] Israel M. Gelfand, Mikhail M. Kapranov, and Andrei V. Zelevinsky. *Discriminants, Resultants, and Multidimensional Determinants*. Birkhäuser Boston, Inc., Boston, MA, 1994.
- [126] Ezra Getzler and Paul Goerss. *A model category structure for differential graded coalgebras*. Preprint (1999); <http://www.math.northwestern.edu/~pgoerss/>.
- [127] Samuel Gitler and Santiago López de Medrano. *Intersections of quadrics, moment-angle manifolds and connected sums*. *Geom. Topol.* **17** (2013), no. 3, 1497–1534.
- [128] Evgeniy S. Golod. *On the cohomology of some local rings*. *Soviet Math. Dokl.* **3** (1962), 745–749 (Russian).
- [129] Mark Goresky, R. Kottwitz and Robert MacPherson. *Equivariant cohomology, Koszul duality and the localisation theorem*. *Invent. Math.* **131** (1998), no. 1, 25–83.
- [130] Mark Goresky and Robert MacPherson. *Stratified Morse Theory*. Springer-Verlag, Berlin–New York, 1988.
- [131] Jelena Grbić, Taras Panov, Stephen Theriault and Jie Wu. *Homotopy types of moment-angle complexes for flag complexes*. Preprint (2012); arXiv:1211.0873.
- [132] Jelena Grbić and Stephen Theriault. *The homotopy type of the complement of the codimension-two coordinate subspace arrangement*. *Uspekhi Mat. Nauk* **59** (2004), no. 6, 203–204 (Russian); *Russian Math. Surveys* **59** (2004), no. 6, 1207–1209 (English translation).
- [133] Jelena Grbić and Stephen Theriault. *The homotopy type of the complement of a coordinate subspace arrangement*. *Topology* **46** (2007), no. 4, 357–396.
- [134] Jelena Grbić and Stephen Theriault. *The homotopy type of the polyhedral product for shifted complexes*. *Adv. Math.* **245** (2013), 690–715.
- [135] Phillip Griffiths and Joseph Harris. *Principles of algebraic geometry*. Pure and Applied Mathematics. Wiley-Interscience, New York, 1978.
- [136] Mikhail Gromov. *Hyperbolic groups*. In: *Essays in Group Theory*, S. M. Gersten, ed. Math. Sci. Res. Inst. Publ., 8. Springer, New York, 1987, pp. 75–263.
- [137] Michael Grossberg and Yael Karshon. *Bott towers, complete integrability, and the extended character of representations*. *Duke Math. J.* **76** (1994), 23–58.
- [138] Vladimir Grujić, Tanja Stojadinović and Duško Jojić. *Generalized Dehn–Sommerville relations for hypergraphs*. Preprint (2014); arXiv:1402.0421.
- [139] Branko Grünbaum. *Convex Polytopes*. Second edition. Graduate Texts in Mathematics, 221. Springer-Verlag, New York, 2003.
- [140] Branko Grünbaum and V. P. Sreedharan. *An enumeration of simplicial 4-polytopes with 8 vertices*. *J. Combinatorial Theory* **2** (1967), 437–465.
- [141] Victor Guillemin. *Moment Maps and Combinatorial Invariants of Hamiltonian  $T^n$ -spaces*. Progress in Mathematics, 122. Birkhäuser Boston, Inc., Boston, MA, 1994.
- [142] Victor Guillemin, Viktor Ginzburg and Yael Karshon. *Moment maps, cobordisms, and Hamiltonian group actions*. Mathematical Surveys and Monographs, 98. American Mathematical Society, Providence, RI, 2002.
- [143] Victor Guillemin and Shlomo Sternberg. *Convexity properties of the moment mapping*. *Inv. Math.* **67** (1982), no. 3, 491–513.
- [144] Victor Guillemin and Shlomo Sternberg. *Supersymmetry and Equivariant de Rham Theory*. Springer-Verlag, Berlin–Heidelberg–New York, 1999.
- [145] Victor W. Guillemin and Catalin Zara. *Equivariant de Rham theory and graphs*. *Asian J. Math.* **3** (1999), no. 1, 49–76.
- [146] Victor W. Guillemin and Catalin Zara. *One-skeleta, Betti numbers and equivariant cohomology*. *Duke Math. J.* **107** (2001), no. 2, 283–349.
- [147] Tor Gulliksen and Gerson Levin. *Homology of Local Rings*. Queen’s Papers in Pure and Applied Mathematics, 20. Queen’s University, Kingston, Ontario, 1969.
- [148] Stephen Halperin. *Rational homotopy and torus actions*. In: *Aspects of Topology*. London Math. Soc. Lecture Note Series, 93. Cambridge Univ. Press, Cambridge, 1985, pp. 293–306.
- [149] Bernhard Hanke. *Geometric versus homotopy theoretic equivariant bordism*. *Math. Ann.* **332** (2005), 677–696.
- [150] Megumi Harada, Yael Karshon, Mikiya Masuda, and Taras Panov, editors. *Toric Topology. International Conference, May 28–June 3, 2006, Osaka City University, Osaka, Japan*. Contemp. Math., 460. Amer. Math. Soc., Providence, RI, 2008.
- [151] Allen Hatcher. *Algebraic Topology*. Cambridge Univ. Press, Cambridge, 2002.



- [152] Akio Hattori. *Symplectic manifolds with semi-free Hamiltonian  $S^1$ -action*. Tokyo J. Math. **15** (1992), no. 2, 281–296.
- [153] Akio Hattori and Mikiya Masuda, *Theory of multi-fans*. Osaka J. Math. **40** (2003), 1–68.
- [154] Akio Hattori and Mikiya Masuda, *Elliptic genera, torus manifolds and multi-fans*. Internat. J. of Math. **16** (2005), no. 9, 957–998.
- [155] Akio Hattori and Tomoyoshi Yoshida. *Lifting compact group actions in fiber bundles*. Japan. J. Math. **2** (1976), 13–25.
- [156] Frédéric Hélein and Pascal Romon. *Hamiltonian stationary Lagrangian surfaces in  $\mathbb{C}^2$* . Comm. Anal. Geom. **10** (2002), no. 1, 79–126.
- [157] Jürgen Herzog, Victor Reiner and Volkmar Welker. *Componentwise linear ideals and Golod rings*. Michigan Math. J. **46** (1999), no. 2), 211–223.
- [158] Philip S. Hirschhorn. *Model Categories and Their Localizations*. Mathematical Surveys and Monographs, 99. Amer. Math. Soc., Providence, RI, 2003.
- [159] Friedrich Hirzebruch. *Komplexe Mannigfaltigkeiten*. (German) Proc. Internat. Congress Math, 1958. Cambridge Univ. Press, New York, 1960, pp. 119–136.
- [160] Friedrich Hirzebruch. *Topological Methods in Algebraic Geometry*, 3rd edition. Springer-Verlag, Berlin–Heidelberg, 1966.
- [161] Friedrich Hirzebruch, Thomas Berger and Rainer Jung. *Manifolds and Modular Forms*, Second Edition. A Publication from the Max-Planck-Institut für Mathematik, Bonn. Friedr. Vieweg & Sohn, Braunschweig, 1994.
- [162] Melvin Hochster. *Cohen–Macaulay rings, combinatorics, and simplicial complexes*. In: *Ring Theory II (Proc. Second Oklahoma Conference)*. B.R. McDonald and R. Morris, eds. Dekker, New York, 1977, pp. 171–223.
- [163] Mark Hovey. *Model Categories*. Mathematical Surveys and Monographs, 63. Amer. Math. Soc., Providence, RI, 1999.
- [164] W. Y. Hsiang. *Cohomology Theory of Topological Transformation Groups*. Ergeb. Math. Grenzgeb., 85. Springer-Verlag, Berlin–Heidelberg, 1975.
- [165] J. F. P. Hudson. *Piecewise Linear Topology*. W. A. Benjamin, Inc., New York–Amsterdam, 1969.
- [166] Dale Husemoller, John. C. Moore and James Stasheff. *Differential homological algebra and homogeneous spaces*. J. Pure Appl. Algebra **5** (1974), 113–185.
- [167] Dmitri Ilinskii. *On the almost free action of one-dimensional torus on a toric variety*. Mat. Sbornik **197** (2006), no. 5, 51–74 (Russian); Sbornik Math. **197** (2006), no. 5, 681–703 (English translation).
- [168] Kouyemon Iriye and Daisuke Kishimoto. *Decompositions of polyhedral products for shifted complexes*. Adv. Math. **245** (2013), 716–736.
- [169] Hiroaki Ishida. *Complex manifolds with maximal torus actions*. Preprint (2013); arXiv:1302.0633.
- [170] Hiroaki Ishida, Yukiko Fukukawa and Mikiya Masuda. *Topological toric manifolds*. Moscow Math. J. **13** (2013), no. 1, 57–98.
- [171] Hiroaki Ishida and Yael Karshon. *Completely integrable torus actions on complex manifolds with fixed points*. Math. Res. Lett. **19** (2012), no. 6, 1283–1295.
- [172] Hiroaki Ishida and Mikiya Masuda. *Todd genera of complex torus manifolds*. Algebr. Geom. Topol. **12** (2012), no. 3 1777–1788.
- [173] Ilia Itenberg, Grigory Mikhalkin and Eugenii Shustin. *Tropical algebraic geometry*. Second edition. Oberwolfach Seminars, 35. Birkhäuser Verlag, Basel, 2009.
- [174] Ivan Izmistiev. *Geometry of manifolds with a regular action of the torus* (in Russian). Ph.D. thesis, Moscow State University, 2000.
- [175] Klaus Jänich. *Differenzierbare Mannigfaltigkeiten mit Rand als Orbiträume differenzierbarer  $G$ -Mannigfaltigkeiten ohne Rand*. Topology **5** (1966), 301–320 (German).
- [176] John F. Jardine. *A closed model structure for differential graded algebras*. In: *Cyclic cohomology and noncommutative geometry (Waterloo, ON, 1995)*. Fields Inst. Commun. **17**. Amer. Math. Soc., Providence, RI, 1997.
- [177] Gil Kalai. *Rigidity and the lower bound Theorem. I*. Inv. Math. **88** (1987), no. 1, 125–151.
- [178] Yoshinobu Kamishima and Mikiya Masuda. *Cohomological rigidity of real Bott manifolds*. Algebr. Geom. Topol. **9** (2009), no. 4, 2479–2502.
- [179] Kalle Karu. *Hard Lefschetz theorem for nonrational polytopes*. Invent. Math. **157** (2004), no. 2, 419–447.

- [180] Katsuo Kawakubo. *Equivariant Riemann–Roch theorems, localization and formal group law*. Osaka J. Math. **17** (1980), 531–571.
- [181] Tetsuro Kawasaki. *Cohomology of twisted projective spaces and lens complexes*. Math. Ann. **206** (1973), 243–248.
- [182] Askold G. Khovanskii [Hovanskii]. *Newton polyhedra and toric varieties*. Funk. Anal. i Prilozh. **11** (1977), no. 4, 56–64 (Russian); Funct. Anal. Appl. **11** (1977), no. 4, 289–296 (English translation).
- [183] Askold G. Khovanskii. *Hyperplane sections of polyhedra, toric varieties and discrete groups in Lobachevskii space*. Funk. Anal. i Prilozhen. **20** (1986), no. 1, 50–61 (Russian); Funct. Anal. Appl. **20** (1986), no. 1, 41–50 (English translation).
- [184] Ki Hang Kim and Fred W. Roush. *Homology of certain algebras defined by graphs*. J. Pure Appl. Algebra **17** (1980), no. 2, 179–186.
- [185] Robion C. Kirby and Laurent C. Siebenmann. *Foundational Essays on Topological Manifolds, Smoothings, and Triangulations*. Annals of Mathematics Studies, 88. Princeton University Press, Princeton, NJ, 1977.
- [186] Victor Klee. *A combinatorial analogue of Poincaré’s duality theorem*. Canad. J. Math. **16** (1964), 517–531.
- [187] Victor Klee and Peter Kleinschmidt, *Convex polytopes and related complexes*. In *Handbook of Combinatorics, Vol. 1,2*. R.L. Graham et al, eds. Elsevier Science B.V., Amsterdam, 1995, pp. 875–917.
- [188] Igor M. Krichever. *Formal groups and the Atiyah–Hirzebruch formula*. Izv. Akad. Nauk SSSR **38** (1974), no. 6, 1289–1304 (Russian); Math. USSR Izv. **8** (1974), no. 6, 1271–1285 (English translation).
- [189] Igor M. Krichever. *Generalized elliptic genera and Baker–Akhiezer functions*. Mat. Zametki **47** (1990), no. 2, 34–45 (Russian). Math. Notes **47** (1990), no. 1–2, 132–142 (English translation).
- [190] Andrey A. Kustarev. *Equivariant almost complex structures on quasitoric manifolds*. Trudy Mat. Inst. Steklova **266** (2009), 140–148 (Russian); Proc. Steklov Inst. Math. **266** (2008), no. 1, 133–141 (English translation).
- [191] Peter S. Landweber. *Homological properties of comodules over  $MU_*(MU)$  and  $BP_*(BP)$* . Amer. J. Math. **98** (1976), no. 3, 591–610.
- [192] Michel Lazard. *Sur le groupes de Lie formels à un paramètre*. Bull. Soc. Math. France **83** (1955), no. 3, 251–274.
- [193] John M. Lee. *Introduction to Topological Manifolds*. Graduate Texts in Mathematics, 202. Springer-Verlag, New York, 2000.
- [194] Daniel Lehmann. *Théorie homotopique des forms différentielles (d’après D. Sullivan)*. Astérisque, No. 45. Société Mathématique de France, Paris, 1977 (French).
- [195] Ivan Limonchenko. *Bigraded Betti numbers of some simple polytopes*. Math. Notes (2013), to appear; arXiv:1101.0066.
- [196] Peter Löffler. *Bordismengruppen unitärer Torusmannigfaltigkeiten*. Manuscripta Math. **12** (1974), 307–327 (German).
- [197] Santiago López de Medrano. *Topology of the intersection of quadrics in  $\mathbb{R}^n$* . In *Algebraic Topology* (G. Carlsson et al, eds.). Lecture Notes in Math., 1370. Springer-Verlag, Berlin, 1989, pp. 280–292.
- [198] Santiago López de Medrano and Alberto Verjovsky. *A new family of complex, compact, non-symplectic manifolds*. Bol. Soc. Mat. Brasil. **28** (1997), 253–269.
- [199] Zhi Lü and Taras Panov. *Moment-angle complexes from simplicial posets*. Cent. Eur. J. Math. **9** (2011), no. 4, 715–730.
- [200] Frank H. Lutz. *Triangulated manifolds with few vertices and vertex-transitive group actions*. Dissertation, Technischen Universität Berlin, Berlin, 1999. Berichte aus der Mathematik, Shaker Verlag, Aachen, 1999.
- [201] Hui Ma. *Hamiltonian stationary Lagrangian surfaces in  $\mathbb{C}P^2$* . Ann. Global. Anal. and Geom. **27** (2005), no. 1, 1–16.
- [202] F. S. Macaulay. *Some properties of enumeration in the theory of modular systems*. Proc. London Math. Soc. **26** (1927), 531–555.
- [203] Saunders Mac Lane. *Homology*. Springer-Verlag, Berlin, 1963.
- [204] Hiroshi Maeda, Mikiya Masuda and Taras Panov. *Torus graphs and simplicial posets*. Advances in Math. **212** (2007), no. 2, 458–483.

- [205] Peter Mani. *Spheres with few vertices*. J. Combinatorial Theory. Ser. A **13** (1972), 346–352.
- [206] Mikiya Masuda. *Unitary toric manifolds, multi-fans and equivariant index*. Tohoku Math. J. **51** (1999), no. 2, 237–265.
- [207] Mikiya Masuda.  *$h$ -vectors of Gorenstein\* simplicial posets*. Adv. Math. **194** (2005), no. 2, 332–344.
- [208] Mikiya Masuda. *Cohomological non-rigidity of generalised real Bott manifolds of height 2*. Proc. Steklov Inst. Math. **268** (2010), 242–247.
- [209] Mikiya Masuda and Taras Panov. *On the cohomology of torus manifolds*. Osaka J. Math. **43** (2006), 711–746.
- [210] Mikiya Masuda and Taras Panov. *Semifree circle actions, Bott towers, and quasitoric manifolds*. Mat. Sbornik **199** (2008), no. 8, 95–122 (Russian); Sbornik Math. **199** (2008), no. 7–8, 1201–1223 (English translation).
- [211] Mikiya Masuda and Dong Youp Suh. *Classification problems of toric manifolds via topology*. In: *Toric Topology*, M. Harada *et al.*, eds. Contemp. Math., 460. Amer. Math. Soc., Providence, RI, 2008, pp. 273–286.
- [212] Michael Mather. *Pull-backs in homotopy theory*. Canad. J. Math. **28** (1976), no. 2, 225–263.
- [213] Sergei V. Matveev. *Algorithmic Topology and Classification of 3-manifolds*. Algorithms and Computation in Mathematics, 9. Springer-Verlag, Berlin, 2003.
- [214] J. Peter May. *Equivariant Homotopy and Cohomology Theory*. With contributions, by M. Cole, G. Comezana, S. Costenoble, A. D. Elmendorf, J. P. C. Greenlees, L. G. Lewis, Jr., R. J. Piacenza, G. Triantafyllou, and S. Waner. CBMS Regional Conference Series in Mathematics, 91. Amer. Math. Soc., Providence, RI, 1996.
- [215] John McCleary. *A User's Guide to Spectral Sequences*. Second edition. Cambridge Studies in Advanced Mathematics, 58. Cambridge University Press, Cambridge, 2001.
- [216] Dennis McGavran. *Adjacent connected sums and torus actions*. Trans. Amer. Math. Soc. **251** (1979), 235–254.
- [217] Peter McMullen. *The maximum numbers of faces of a convex polytope*. Mathematika **17** (1970), 179–184.
- [218] Peter McMullen. *The numbers of faces of simplicial polytopes*. Israel J. Math. **9** (1971), 559–570.
- [219] Peter McMullen. *On simple polytopes*. Invent. Math. **113** (1993), no. 2, 419–444.
- [220] Peter McMullen. *Weights on polytopes*. Discrete Comput. Geom. **15** (1996), no. 4, 363–388.
- [221] Peter McMullen and G. Shephard. *Convex Polytopes and the Upper Bound Conjecture*. London Math. Soc. Lecture Notes Series, 3. Cambridge Univ. Press, Cambridge, 1971.
- [222] Peter McMullen and David Walkup. *A generalized lower bound conjecture for simplicial polytopes*. Mathematika **18** (1971), 264–273.
- [223] Laurent Meersseman. *A new geometric construction of compact complex manifolds in any dimension*. Math. Ann. **317** (2000), 79–115.
- [224] Laurent Meersseman and Alberto Verjovsky. *Holomorphic principal bundles over projective toric varieties*. J. Reine Angew. Math. **572** (2004), 57–96.
- [225] Ezra Miller and Bernd Sturmfels. *Combinatorial Commutative Algebra*. Graduate Texts in Mathematics, 227. Springer-Verlag, New York, 2005.
- [226] John Milnor. *On the cobordism ring  $\Omega^*$  and a complex analogue. I*. Amer. J. Math. **82** (1960), 505–521.
- [227] John W. Milnor and James D. Stasheff. *Characteristic classes*. Annals of Mathematics Studies, 76. Princeton Univ. Press, Princeton, NJ, 1974.
- [228] Andrey E. Mironov. *On Hamiltonian-minimal Lagrangian tori in  $\mathbb{C}P^2$* . Sibirsk. Mat. Zh. **44** (2003), no. 6, 1324–1328 (Russian); Siberian Math. Journal. **44** (2003), no. 6, 1039–1042 (English translation).
- [229] Andrey E. Mironov. *New examples of Hamilton-minimal and minimal Lagrangian submanifolds in  $\mathbb{C}^n$  and  $\mathbb{C}P^n$* . Mat. Sbornik **195** (2004), no. 1, 89–102 (Russian); Sbornik Math. **195** (2004), no. 1–2, 85–96 (English translation).
- [230] Andrey E. Mironov and Taras Panov. *Intersections of quadrics, moment-angle manifolds, and Hamiltonian-minimal Lagrangian embeddings*. Funktsional. Anal. i Prilozhen. **47** (2013), no. 1, 47–61 (Russian); Funct. Anal. and Appl. **47** (2013), no. 1, 38–49 (English translation).

- [231] Andrey E. Mironov and Taras Panov. *Hamiltonian minimal Lagrangian submanifolds in toric varieties*. Uspekhi Mat. Nauk **68** (2013), no. 2, 203–204 (Russian); Russian Math. Surveys **68** (2013), no. 2, 392–394 (English translation).
- [232] Andrey E. Mironov and Dafeng Zuo. *On a family of conformally flat Hamiltonian–minimal Lagrangian tori in  $\mathbb{C}P^3$* . Internat. Math. Res. Notices (2008), Art. ID rnn 078, 13 pp.
- [233] Edwin E. Moise. *Geometric Topology in Dimensions 2 and 3*. Graduate Texts in Mathematics, 47. Springer-Verlag, New York-Heidelberg, 1977.
- [234] John C. Moore. *Differential homological algebra*. In: *Actes du Congrès International des Mathématiciens, 1970, Nice, France*, volume 1. Gauthier-Villars, Paris, 1971, pp. 335–339.
- [235] James R. Munkres. *Elementary Differential Topology*. Revised edition. Annals of Math. Studies, 54. Princeton Univ. Press, Princeton, NJ, 1966.
- [236] Oleg R. Musin. *Actions of the circle on homotopy complex projective spaces*. Mat. Zametki **28** (1980), no. 1, 139–152 (Russian); Math. Notes **28** (1980), no. 1–2, 533–539 (English translation).
- [237] Oleg R. Musin. *On rigid Hirzebruch genera*. Moscow Math. J. **11** (2011), no. 1, 139–147.
- [238] A. Nabutovsky. *Geometry of the space of triangulations of a compact manifold*. Comm. Math. Phys. **181** (1996), no. 2, 303–330.
- [239] Joseph Neisendorfer. *Lie algebras, coalgebras and rational homotopy theory for nilpotent spaces*. Pacific J. Math. **74** (1978), no. 2, 429–460.
- [240] Joseph Neisendorfer. *Algebraic methods in unstable homotopy theory*. New Mathematical Monographs, 12. Cambridge Univ. Press, Cambridge, 2010.
- [241] Joseph Neisendorfer and Timothy Miller. *Formal and coformal spaces*. Illinois J. Math. **22** (1978), no. 4, 565–580.
- [242] Stefan Nemirovski. *Lagrangian Klein bottles in  $\mathbb{R}^{2n}$* . Geom. Funct. Anal. **19** (2009), no. 3, 902–909.
- [243] Dietrich Notbohm and Nigel Ray. *On Davis–Januszkiewicz homotopy types I; formality and rationalisation*. Alg. Geom. Topol. **5** (2005), 31–51.
- [244] Sergei P. Novikov. *Some problems in the topology of manifolds connected with the theory of Thom spaces*. Dokl. Akad. Nauk SSSR **132** (1960), 1031–1034 (Russian); Soviet Math. Dokl. **1** (1960), 717–720 (English translation).
- [245] Sergei P. Novikov. *Homotopy properties of Thom complexes*. Mat. Sbornik **57(99)** (1962), 407–442 (Russian).
- [246] Sergei P. Novikov. *Methods of algebraic topology from the point of view of cobordism theory*. Izv. Akad. Nauk SSSR, Ser. Mat. **31** (1967), no. 4, 855–951 (Russian); Math. USSR – Izv. **1** (1967), no. 4, 827–913 (English translation).
- [247] Sergei P. Novikov. *Adams operators and fixed points*. Izv. Akad. Nauk SSSR, Ser. Mat. **32** (1968), no. 6, 1245–1263 (Russian); Math. USSR – Izv. **2** (1968), no. 6, 1193–1211 (English translation).
- [248] Sergei P. Novikov. *Topology I*. Encyclopaedia Math. Sci., 12. Springer-Verlag, Berlin, 1996.
- [249] Serge Ochanine. *Sur les genres multiplicatifs définis par des intégrales elliptiques*. Topology **26** 143–151, no. 2, 1987.
- [250] Tadao Oda. *Convex Bodies and Algebraic Geometry. An introduction to the theory of toric varieties*. Ergebnisse der Mathematik und ihrer Grenzgebiete (3), 15. Springer-Verlag, New York, 1988.
- [251] Yong-Geun Oh. *Volume minimization of Lagrangian submanifolds under Hamiltonian deformations*. Math. Zeitschrift **212** (1993), no. 2, 175–192.
- [252] Udo Pachner. *Konstruktionsmethoden und das kombinatorische Homöomorphieproblem für Triangulationen kompakter semilinearer Mannigfaltigkeiten*. Abh. Math. Sem. Univ. Hamburg **57** (1987), 69–86.
- [253] Udo Pachner. *P.L. homeomorphic manifolds are equivalent by elementary shellings*. European J. Combin. **12** (1991), no. 2, 129–145.
- [254] Taras Panov. *Classification up to cobordism of manifolds that carry a simple action of the group  $\mathbb{Z}/p$* . Mat. Zametki **63** (1998), no. 2, 260–268 (Russian); Math. Notes **63** (1998), no. 1–2, 225–232 (English translation).
- [255] Taras Panov. *Calculation of Hirzebruch genera of manifolds with  $\mathbb{Z}/p$  group action in terms of the invariants of the action*. Izv. Ross. Acad. Nauk, Ser. Mat. **62** (1998), no. 3, 87–120 (Russian); Izv. Math. **62** (1998), no. 3, 515–548 (English translation).

- [256] Taras Panov. *Hirzebruch genera of manifolds with torus actions*. Izv. Ross. Akad. Nauk, Ser. Mat. **65** (2001), no. 3, 123–138 (Russian); Izv. Math. **65** (2001), no. 3, 543–556 (English translation).
- [257] Taras Panov. *Cohomology of face rings, and torus actions*. In: *Surveys in Contemporary Mathematics*. London Math. Soc. Lecture Note Series, 347. Cambridge Univ. Press, Cambridge, 2008, pp. 165–201.
- [258] Taras Panov. *Toric Kempf–Ness sets*. Trudy Mat. Inst. Steklova **263** (2008), 159–172 (Russian); Proc. Steklov Inst. Math. **263** (2008), pp. 150–162 (English translation).
- [259] Taras Panov. *Moment-angle manifolds and complexes*. Information Center for Mathematical Sciences, KAIST. Trends in Mathematics - New Series **12** (2010), no. 1, 43–69; arXiv:1008.5047.
- [260] Taras Panov and Nigel Ray. *Categorical aspects of toric topology*. In: *Toric Topology*, M. Harada *et al.*, eds. Contemp. Mathematics, 460. Amer. Math. Soc., Providence, RI, 2008, pp. 293–322.
- [261] Taras Panov, Nigel Ray and Rainer Vogt. *Colimits, Stanley–Reiner algebras, and loop spaces*. In: *Categorical decomposition techniques in algebraic topology (Isle of Skye, 2001)*. Progress in Math., 215, Birkhäuser, Basel, 2004, pp. 261–291.
- [262] Taras Panov and Yuri Ustinovsky. *Complex-analytic structures on moment-angle manifolds*. Moscow Math. J. **12** (2012), no. 1, 149–172.
- [263] Lev S. Pontryagin. *Foundations of Combinatorial Topology*. Graylock Press, Rochester, NY, 1952.
- [264] Gerald J. Porter. *The homotopy groups of wedges of suspensions*. Amer. J. Math. **88** (1966) 655–663.
- [265] Alexander Postnikov. *Permutohedra, associahedra, and beyond*. Int. Math. Res. Not. **2009**, no. 6, 1026–1106.
- [266] Alexander Postnikov, Victor Reiner, L. Williams. *Faces of generalized permutohedra*. Doc. Math. **13** (2008), 207–273.
- [267] Stewart Priddy. *Koszul resolutions*. Trans. Amer. Math. Soc. **151** (1970), no. 1, 39–60.
- [268] J. S. Provan and Louis J. Billera. *Decompositions of simplicial complexes related to diameters of convex polyhedra*. Math. Oper. Res. **5** (1980), no. 4, 576–594.
- [269] Volker Puppe. *Multiplicative aspects of the Halperin–Carlsson conjecture*. Georgian Math. J. **16** (2009), no. 2, 369–379; arXiv:0811.3517.
- [270] Daniel Quillen. *Homotopical Algebra*. Lecture Notes in Mathematics, 43. Springer-Verlag, Berlin, 1967.
- [271] Daniel Quillen. *Rational homotopy theory*. Ann. of Math. (2) **90** (1969), no. 2, 205–295.
- [272] Daniel G. Quillen. *On the formal group laws of unoriented and complex cobordism theory*. Bull. Amer. Math. Soc. **75** (1969), no. 6, 1293–1298.
- [273] Daniel G. Quillen. *Elementary proofs of some results of cobordism theory using steenrod operations*. Adv. Math. **7** (1971), 29–56.
- [274] Andrew Ranicki. *On the Hauptvermutung*. In: *The Hauptvermutung Book*. K-Monogr. Math., 1. Kluwer Acad. Publ., Dordrecht, 1996, pp. 3–31.
- [275] Nigel Ray. *On a construction in bordism theory*. Proc. Edin. Math. Soc. **29** (1986), 413–422.
- [276] Gerald A. Reisner. *Cohen–Macaulay quotients of polynomial rings*, Adv. Math. **21** (1976), no. 1, 30–49.
- [277] Colin P. Rourke and Brian J. Sanderson. *Introduction to Piecewise-Linear Topology*. Springer-Verlag, Berlin, 1972.
- [278] J. Hyam Rubinstein. *An algorithm to recognise the 3-sphere*. Proceedings of the International Congress of Mathematicians, Vol 1, 2 (Zürich, 1994), 601–611; Birkhäuser, Basel, 1995.
- [279] Yuli B. Rudyak. *Piecewise linear structures on topological manifolds*. arXiv:math.AT/0105047 (2001).
- [280] Hans Samelson. *A connection between the Whitehead and the Pontryagin product*. Amer. J. Math. **75** (1953), no. 4, 744–752.
- [281] Roland Schwanzl and Rainer M. Vogt. *The categories of  $A_\infty$ - and  $E_\infty$ -monoids and ring spaces as closed simplicial and topological model categories*. Arch. Math (Basel) **56** (1991), no. 4, 405–411.
- [282] Gerald W. Schwarz. *The topology of algebraic quotients*. In: *Topological Methods in Algebraic Transformation Groups*. Progr. in Math, 80. Birkhäuser, Boston, 1989, pp. 135–151.

- [283] Stefan Schwede and Brooke E. Shipley. *Algebras and modules in monoidal model categories*. Proc. London Math. Soc. (3) **80** (2000), no. 2, 491–511.
- [284] S. A. Seyed Fakhari and Volkmar Welker. *The Golod property for products and high symbolic powers of monomial ideals*. arXiv:1209.2577 (2012).
- [285] Igor R. Shafarevich. *Basic Algebraic Geometry. 2. Schemes and complex manifolds*. Second edition. Translated from the 1988 Russian edition by Miles Reid. Springer-Verlag, Berlin, 1994.
- [286] Vsevolod Shevchishin. *Lagrangian embeddings of the Klein bottle and combinatorial properties of mapping class groups*. Izv. Ross. Akad. Nauk Ser. Mat. **73** (2009), no. 4, 153–224 (Russian); Izv. Math. **73** (2009), no. 4, 797–859 (English translation).
- [287] Larry Smith. *Homological algebra and the Eilenberg–Moore spectral sequence*. Trans. Amer. Math. Soc. **129** (1967), 58–93.
- [288] Richard P. Stanley. *The upper bound conjecture and Cohen–Macaulay rings*. Studies in Appl. Math. **54** (1975), no. 2, 135–142.
- [289] Richard P. Stanley. *The number of faces of simplicial convex polytope*. Adv. Math. **35** (1980), no. 3, 236–238.
- [290] Richard P. Stanley. *Enumerative Combinatorics, Vol. 1*. Wadsworth and Brooks/Cole, Monterey, California, 1986.
- [291] Richard P. Stanley. *Generalized  $H$ -vectors, intersection cohomology of toric varieties, and related results*. In: *Commutative algebra and combinatorics (Kyoto, 1985)*, M. Nagata and H. Matsumure, eds. Adv. Stud. Pure Math., 11, North-Holland, Amsterdam, 1987, pp. 187–213.
- [292] Richard P. Stanley.  *$f$ -vectors and  $h$ -vectors of simplicial posets*. J. Pure Appl. Algebra. **71** (1991), 319–331.
- [293] Richard P. Stanley. *Combinatorics and Commutative Algebra*, second edition. Progr. in Math., 41. Birkhäuser, Boston, 1996.
- [294] Richard P. Stanley. *Positivity problems and conjectures in algebraic combinatorics*. In: *Mathematics: Frontiers and Perspectives*, V. I. Arnold et al, eds. Amer. Math. Soc., Providence, RI, 2000, pp. 295–319.
- [295] James D. Stasheff. *Homotopy associativity of  $H$ -spaces. I*. Transactions Amer. Math. Soc. **108** (1963), 275–292.
- [296] James D. Stasheff. *From operads to “physically” inspired theories*. In: *Operads: Proceedings of Renaissance Conferences (Hartford, CT/Luminy, 1995)*. Contemp. Math., 202, Amer. Math. Soc., Providence, RI, 1997, pp. 53–81.
- [297] Robert E. Stong. *Notes on Cobordism Theory*. Princeton Univ. Press, Princeton, NJ, 1968.
- [298] Dennis Sullivan. *Infinitesimal computations in topology*. Publ. I.H.E.S. **47** (1977), 269–331.
- [299] Yusuke Suyama. *Examples of toric manifolds which are not quasitoric manifolds*. Alg. Geom. Topol., to appear; arXiv:1312.5973.
- [300] R. H. Szczarba. *On tangent bundles of fibre spaces and quotient spaces*. Amer. J. Math. **86** (1964), 685–697.
- [301] Jérôme Tambour. *LVMB manifolds and simplicial spheres*. Annales l’Institut Fourier **62** (2012), no. 4, 1289–1317.
- [302] Clifford H. Taubes.  *$S^1$  actions and elliptic genera*. Comm. Math. Phys. **122** (1989), no. 3, 455–526.
- [303] Naoki Terai and Takayuki Hibi. *Computation of Betti numbers of monomial ideals associated with stacked polytopes*. Manuscripta Math. **92** (1997), no. 4, 447–453.
- [304] Stephen Theriault. *Moment-angle manifolds and Panov’s problem*. Preprint (2014), arXiv:1405.4886.
- [305] René Thom. *Quelques propriétés globales des variétés différentiables*. Comment. Math. Helv. **28** (1954), 17–86.
- [306] Emery Thomas. *Complex structures on real vector bundles*. Amer. J. Math. **89** (1967), 887–908.
- [307] Vladlen Timorin. *An analogue of the Hodge–Riemann relations for simple convex polytopes*. Uspekhi Mat. Nauk **54** (1999), no. 2, 113–162 (Russian); Russian Math. Surveys **54** (1999), no. 2, 381–426 (English translation).
- [308] Valerio Toledano Laredo. *Quasi-Coxeter algebras, Dynkin diagram cohomology, and quantum Weyl groups*. Int. Math. Res. Pap. IMRP **2008**, Article ID rpn009, 167 pp.

- [309] Susan Tolman and Jonathan Weitsman. *On semifree symplectic circle actions with isolated fixed points*. *Topology* **39** (2000), no. 2, 299–309.
- [310] Tammo tom Dieck. *Bordism of  $G$ -manifolds and integrality theorems*. *Topology* **9** (1970), 345–358, 1970.
- [311] Yury Ustinovsky. *Toral rank conjecture for moment-angle complexes*. *Mat. Zametki* **90** (2011), no. 2, 300–305 (Russian); *Math. Notes* **90** (2011), no. 1–2, 279–283 (English translation).
- [312] Yury Ustinovsky. *On almost free torus actions and the Horrocks conjecture*. *Dal’nevost. Mat. Zh.* **12** (2012), no. 1, 98–107 (Russian); arXiv:1203.3685.
- [313] Ernest B. Vinberg. *Discrete linear groups generated by reflections*. *Izv. Akad. Nauk SSSR Ser. Mat.* **35** (1971), 1072–1112 (Russian); *Math. USSR Izvestija* **5** (1971), no. 5, 1083–1119 (English translation).
- [314] Ernest B. Vinberg and Vladimir L. Popov. *Invariant theory*. In: *Algebraic Geometry 4*. VINITI, Moscow, 1989, pp. 137–314 (Russian); *Encyclopaedia Math. Sci.*, 55. Springer, Heidelberg, 1994, pp. 123–284 (English translation).
- [315] Rainer M. Vogt. *Convenient categories of topological spaces for homotopy theory*. *Arch. Math. (Basel)* **22** (1971), no. 1, 545–555.
- [316] Rainer M. Vogt. *Homotopy limits and colimits*. *Math. Zeitschrift* **134** (1973), 11–52.
- [317] Rainer M. Vogt. *Homotopy homomorphisms and the classifying space functor*. Preprint (2012); arXiv:1203.4978.
- [318] I. A. Volodin, V. E. Kuznecov, A. T. Fomenko. *The problem of the algorithmic discrimination of the standard three-dimensional sphere*. Appendix by S. P. Novikov. *Uspekhi Mat. Nauk* **29** (1974), no. 5, 71–168 (Russian); *Russian Math. Surveys* **29** (1974), no. 5, 71–172 (English translation).
- [319] V. A. Yemelichev, M. M. Kovalev and M. K. Kravtsov. *Polytopes, Graphs and Optimisation*. Translated from the Russian by G. H. Lawden. Cambridge Univ. Press, Cambridge, 1984.
- [320] C. T. C. Wall. *Determination of the cobordism ring*. *Ann. of Math. (2)* **72** (1960), 292–311.
- [321] Volkmar Welker, Günter Ziegler and Rade Živaljević. *Homotopy colimits—comparison lemmas for combinatorial applications*. *J. Reine Angew. Math.* **509** (1999), 117–149.
- [322] Andrew Wilfong. *Toric polynomial generators of complex cobordism*. Preprint (2013); arXiv:1308.2010.
- [323] Francis D. Williams. *Higher Samelson products*. *J. Pure Appl. Algebra* **2** (1972), 249–260.
- [324] Edward Witten. *Elliptic genera and quantum field theory*. *Comm. Math. Phys.* **109** (1987), no. 4, 525–536.
- [325] Günter M. Ziegler. *Lectures on Polytopes*. Graduate Texts in Mathematics, 152. Springer-Verlag, New York, 1995.





# Index

- Action (of group), 420
  - almost free, 169, 421
  - effective, 421
  - free, 421
  - proper, 200, 222
  - semifree, 300, 421
  - transitive, 421
- Acyclic (space), 269, 413
- Affine equivalence, 8
- Alexander duality, 74, 118
- Algebra, 387
  - bigraded, 388
  - connected, 387
  - exterior, 388
  - finitely generated, 387
  - graded, 387
  - graded-commutative, 387
    - free, 388
  - polynomial, 387
  - multigraded, 388
  - with straightening law (ASL), 120
- Almost complex structure, 446
  - associated with omniorientation, 252
  - $T$ -invariant, 252, 259, 457
- Ample divisor, 192
- Annihilator (of module), 400
- Arrangement (of subspaces), 101
  - coordinate, 162
- Aspherical (space), 409, 242
- Associahedron, 40
  - generalised, 31
- Atiyah–Hirzebruch formula, 381
- Axial function, 272, 310
  - $n$ -independent, 311
  - 2-independent, 310
- Bar construction, 436
- Barnette sphere, 77, 79, 190
- Barycentre (of simplex), 70
- Barycentric subdivision
  - of polytope, 71
  - of simplicial complex, 70
  - of simplicial poset, 89, 128
- Base (of Schlegel diagram), 77
- Based map, 407
- Based space, 407
- Basepoint, 407
- Basis (of free module), 388
  - minimal, 392
- Betti numbers (algebraic), 103, 124, 180
- Betti numbers (topological), 414
  - bigraded, 149
- Bidegree, 388
- Bistellar equivalence, 85
- Bistellar move, 84
- Blow-down, 317
- Blow-up
  - of  $T$ -graph, 316
  - of  $T$ -manifold, 281
- Boolean lattice, 87
- Bordism, 441
  - complex, 446
  - oriented, 445
  - unoriented, 441
- Borel construction, 422
- Borel spectral sequence, 233
- Bott manifold, 294
  - generalised, 306
- Bott–Taubes polytope, 42
- Bott tower, 294
  - generalised, 306
  - real, 308
  - topologically trivial, 294
- Boundary, 389
- Bounded flag, 290
- Bounded flag manifold, 290, 295, 369
- Bouquet (of spaces), 407
- Brückner sphere, 81
- Buchsbaum complex, 116
- Buchstaber invariant, 171
- Building set, 35
  - graphical, 40
- Calabi–Eckmann manifold, 235
- Canonical line bundle, 424
- Catalan number, 40
- Categorical quotient, 194
- CAT(0) inequality, 72

- Cell complex, 408
- Cellular approximation, 408
- Cellular chain, 415
- Cellular map, 408
- Chain complex, 389
  - augmented, 412, 413
- Chain homotopy, 389
- Characteristic function, 250
  - directed, 253
- Characteristic matrix, 253
  - refined, 254
- Characteristic number, 452
- Characteristic pair, 251
  - combinatorial, 253
  - equivalence of, 252, 253
- Characteristic submanifold, 250, 267, 285
- Charney–Davis Conjecture, 44
- Chern–Dold character, 373
- Chow ring, 191
- CHP (covering homotopy property), 409
- Classifying functor (algebraic), 436
- Classifying space, 421
- Clique, 71, 352
- Cobar construction, 343, 436
- Cobordism, 443, 444
  - complex, 447
  - equivariant
    - geometric, 365, 367
    - homotopic, 365, 366
  - unoriented, 445
- Coboundary, 389
- Cochain complex, 389
- Cochain homotopy, 389
- Cocycle, 389
- Cofibrant (object, replacement, approximation), 428
- Cofibration, 411
  - in model category, 428
- Cofibre, 411
- Coformality, 349, 431, 436
- Cohen–Macaulay
  - algebra, 400
  - module, 400
  - simplicial complex, 112
  - simplicial poset, 127
- Cohomological rigidity, 307
- Cohomology
  - cellular, 416
  - of cochain complex, 389
  - simplicial, 412
    - reduced, 413
  - singular, 414
- Cohomology product, 416
- Cohomology product length, 161
- Colimit, 179, 187, 322, 427
- Combinatorial equivalence
  - of polyhedral complexes, 76
  - of polytopes, 8
- Combinatorial neighbourhood, 69
- Complex orientable map, 447
- Complete intersection algebra, 115
- Cone
  - over simplicial complex, 67
  - over space, 411
- Cone (convex polyhedral), 62
  - dual, 62
  - rational, 62
  - regular, 62
  - simplicial, 62
  - strongly convex, 62
- Connected sum
  - of manifolds, 351, 450
    - equivariant, 360
  - of simple polytopes, 12
  - of simplicial complexes, 68
  - of stably complex manifolds, 451
- Connection (on graph), 310
- Contraction (of building set), 36
- Coordinate subspace, 162
- Coproduct, 427
- Core (of simplicial complex), 69
- Cross-polytope, 10
- Cube, 8
  - standard, 8
  - topological, 89
- Cubical complex
  - abstract, 89
  - polyhedral, 90
  - topological, 89
- Cubical subdivision, 94
- Cup product, 416
- CW complex, 408
- Cycle, 389
- Cyclohedron, 42
- Davis–Januszkiewicz space, 147, 324
- Deformation retraction, 163
- Degree (grading), 387
  - external, 391
  - internal, 391
  - total, 391
- Dehn–Sommerville relations
  - for polytopes, 21, 25
  - for simplicial complexes, 117
  - for simplicial posets, 133
  - for triangulated manifolds, 134
- Depth (of module), 398
- Diagonal approximation, 151
- Diagonal map, 416
- Diagram (functor), 427
- Diagram category, 427
- Differential graded algebra (dg-algebra, dga), 390, 402
  - formal, 403
  - homologically connected, 402
  - minimal, 402

- simply connected, 402
- Dimension
  - of module, 400
  - of polytope, 7
  - of simplicial complex, 65
  - of simplicial poset, 87
- Dolbeault cohomology, 230
- Dolbeault complex, 230, 466
- Double (simplicial), 172
- Edge, 8
- Eilenberg–Mac Lane space, 408
- Eilenberg–Moore spectral sequence, 425
- Elliptic genus, 372
- Equivariant bundle, 423
- Equivariant characteristic class, 423
- Equivariant cohomology, 423
  - of  $T$ -graph, 311
- Equivariant map, 421
- Euler class
  - in cobordism, 449
  - in equivariant cobordism, 368
  - in equivariant cohomology, 267, 423
- Euler formula, 21
- Euler characteristic, 259, 383, 412, 413, 466
- Eulerian poset, 133
- Exact sequence, 389
- Excision, 415
- Exponential (of formal group law), 460
- Face
  - of cubical complex, 89
  - of cone, 62
  - of manifold with corners, 247, 269
  - of manifold with faces, 247
  - of polytope, 7
  - of simplicial complex, 65
  - of simplicial poset, 88
  - of  $T$ -graph, 311
- Face category (of simplicial complex), 88, 322, 427
- Face coalgebra, 342
- Face poset, 8
- Face ring (Stanley–Reisner ring)
  - of manifold with corners, 271
  - of simple polytope, 98
  - of simplicial complex, 98
    - exterior, 148
  - of simplicial poset, 119
- Facet, 8, 247, 311
- Face truncation, 11
- Fan, 62, 79
  - complete, 62
  - normal, 63
  - rational, 62
  - regular, 62
  - simplicial, 62
- Fat wedge, 144
- Fibrant (object, replacement, approximation), 428
- Fibration, 409
  - in model category, 428
  - locally trivial, 408
- Fibre bundle, 408
  - associated (with  $G$ -space), 422
- Fixed point, 421
- Fixed point data, 376
- Flag complex (simplicial), 71, 347
- Flagtope (flag polytope), 44
- Folding map, 88
- Formal group law, 459
  - of geometric cobordisms, 461
  - linearisable, 459
  - universal, 460
- Formality
  - in model category, 431
  - integral, 324
  - of dg-algebra, 403
  - of space 175, 323, 327, 419
- $F$ -polynomial (of polytope), 20
- Frölicher spectral sequence, 233
- Full subcomplex (of simplicial complex), 69
- Fundamental group, 407
- Fundamental homology class, 162
- $f$ -vector (face vector)
  - of cubical complex, 90
  - of polytope, 20
  - of simplicial complex, 66
  - of simplicial poset, 121
- Gal Conjecture, 72
- Gale diagram, 17, 214, 242
  - combinatorial, 19, 213
- Gale duality, 16, 210, 216, 217, 232
- Gale transform, 16
- Ganea’s Theorem, 148
- $g$ -conjecture, 80, 117
- Generalised homology theory, 442
- Generalised Lower Bound Conjecture, 28, 194
- Generating series
  - of face polynomials, 57
  - of polytopes, 55
- Genus, 372, 463
- Geometric cobordism, 449
- Geometric quotient, 195
- Geometric realisation
  - of cubical complex, 90
  - of simplicial complex, 65
  - of simplicial set, 430
- Ghost vertex, 65
- GKM-graph, 309
- GKM-manifold, 309
- Golod
  - ring, 178, 352
  - simplicial complex, 178

- Gorenstein, Gorenstein\*
  - simplicial complex, 115, 159
  - simplicial poset, 131
- Goresky–MacPherson formula, 167
- Graph
  - chordal, 352
  - of polytope, 14
  - simple, 14, 40
- Graph-associahedron, 40
- Graph product, 348
- $g$ -theorem, 29, 193
- $g$ -vector
  - of polytope, 20
  - of simplicial complex, 66
- Gysin homomorphism
  - in equivariant cohomology, 267, 423
  - in cobordism, 369, 449
- Gysin–Thom isomorphism, 377, 452
- Half-smash product (left, right), 329
- Hamiltonian action, 201, 300
- Hamiltonian-minimal submanifold, 237
- Hamiltonian vector field, 236
- Hard Lefschetz Theorem, 30, 193
- Hauptvermutung, 82
- Heisenberg group, 420
- HEP (homotopy extension property), 410
- Hermitian quadric, 208
- Hilton–Milnor Theorem, 144
- Hirzebruch genus, 372, 463
  - equivariant, 373
  - fibre multiplicative, 374
  - rigid, 372, 374
  - universal, 466
- Hirzebruch surface, 188
- $H$ -minimal submanifold, 237
- Hodge algebra, 120
- Hodge number, 230
- Homological dimension (of module), 391
- Homology
  - cellular, 416
  - of chain complex, 389
  - simplicial, 412
    - reduced, 412
  - singular, 413
    - of pair, 414
    - reduced, 413
- Homology polytope, 269
- Homology sphere, 82
- Homotopy, 407
- Homotopy category (of model category), 429
- Homotopy cofibre, 411
- Homotopy colimit, 322, 438
- Homotopy equivalence, 407
- Homotopy fibre, 410
- Homotopy group, 407
- Homotopy Lie algebra, 349, 417, 431
- Homotopy limit, 322, 438
- Homotopy quotient, 422
- Homotopy type, 407
- Hopf Conjecture, 72
- Hopf equation, 56
- Hopf line bundle, 424
- Hopf manifold, 227
- $H$ -polynomial (of polytope), 20
- hsop (homogeneous system of parameters), 400
  - in face rings, 111, 121
- $h$ -vector
  - of polytope, 20
  - of simplicial complex, 66
  - of simplicial poset, 121
- Hyperplane cut, 11
- Intersection homology, 30, 193
- Intersection poset (of arrangement), 167
- Isotropy representation, 422
- Join (least common upper bound), 88, 118
- Join (operation)
  - of simplicial complexes, 67
  - of simplicial posets, 179
  - of spaces, 327
- Klein bottle, 239
- Koszul algebra, 395
- Koszul complex, 395
- Koszul resolution, 392
- Lagrangian immersion, 236
- Lagrangian submanifold, 236
- Landweber Exact Functor Theorem, 466
- Latching functor, 432
- Lattice, 186, 215
- Lefschetz pair, 139
- Left lifting property, 411
- Leibniz identity, 390
- $L$ -genus (signature), 466
- Limit (of diagram), 427
- Link (in simplicial complex), 68, 128
- Link (of intersection of quadrics), 213
- Localisation formula, 376
- Locally standard (torus action), 246, 263
- Logarithm (of formal group law), 460
- Loop functor (algebraic), 436
- Loop space, 338, 409
- Lower Bound Theorem, 27
- lsop (linear system of parameters), 400
  - in face rings, 111, 121
  - integral, 112
- LVM-manifold, 219, 229
- Manifold with corners, 139, 247
  - face-acyclic, 269
  - nice, 247
- Manifold with faces, 247

- Mapping cone, 411
- Mapping cylinder, 411
- Massey product, 175, 404
  - indecomposable, 178
  - indeterminacy of, 404
  - trivial (vanishing), 404
- Matching functor, 432
- Mayer–Vietoris sequence, 415
- Maximal action (of torus), 229
- Meet (greatest common lower bound), 88, 118
- Milnor hypersurface, 454
- Minimal model
  - of dg-algebra, 402, 431
  - of space, 419
- Minimal submanifold, 237
- Minkowski sum, 31
- Missing face, 71, 340, 347
- Model (of dg-algebra), 402
- Model category, 428
- Module, 387
  - finitely generated, 387
  - free, 388
  - graded, 387
  - projective, 388
- Moment-angle complex, 137, 179
  - real, 140
- Moment-angle manifold, 140, 203
  - polytopal, 140, 212
  - non-formal, 176
- Moment map, 201, 215
  - proper, 201, 216
- Monoid, 142
- Monomial ideal, 98
- Moore loops, 338
- Multi-fan, 245, 385
- Multidegree, 388
- Multigrading, 106, 154, 180
- $M$ -vector, 29
  
- Nerve complex, 66
- Nested set, 36
- Nestohedron, 36
- Nilpotent space, 418
- Noether Normalisation Lemma, 400
- Non- $PL$  sphere, 80, 82
- Normal complex structure, 446
  
- Omniorientation, 252, 267, 285, 315
- Opposite category, 427
- Orbifold, 189
- Orbit (of group action), 421
- Orbit space, 421
- Order complex (of poset), 71
- Overcategory, 428
  
- Path space, 409
- Pair (of spaces), 407
- Perfect elimination order, 352
  
- Permutahedron, 34
- Picard group, 201
- $PL$  map, 67
  - homeomorphism, 67
- $PL$  manifold, 82
- $PL$  sphere, 76
- Poincaré algebra, 116
- Poincaré–Atiyah duality, 448
- Poincaré duality, 415
- Poincaré duality space, 159
- Poincaré series 391, 349
  - of face ring, 100
- Poincaré sphere, 82
- Pointed map, 407
- Pointed space, 407
- Polar set, 9
- Polyhedral complex, 76
- Polyhedral product, 141, 179, 321
- Polyhedral smash product, 333
- Polyhedron (convex), 7
  - Delzant, 216
- Polyhedron (simplicial complex), 65
- Polytopal sphere, 79
- Polytope
  - combinatorial, 8
  - convex, 7
  - cyclic, 13
  - Delzant, 63, 190, 204
  - dual, 10
  - generic, 9
  - lattice, 189
  - neighbourly, 13
  - nonrational, 190
  - polar, 9
  - regular, 10
  - self-dual, 10
  - simple, 9, 52
  - simplicial, 9, 52
  - stacked, 27
  - triangle-free, 45
- Polytope algebra, 30
- Pontryagin algebra, 339
- Pontryagin product, 417
- Pontryagin–Thom map, 423, 442
- Poset (partially ordered set), 8
- Poset category, 427
- Positive orthant, 9, 136
- Presentation (of a polytope by inequalities), 8
  - generic, 9
  - irredundant, 8
  - rational, 216
- Primitive (lattice vector), 62
- Principal bundle, 421
- Principal minor (of matrix), 298
- Product
  - of building sets, 53
  - of polytopes, 11

- Product (categorical), 427
- Product (in cobordism), 448
- Projective dimension (of module), 391
- Pseudomanifold, 157, 314
  - orientable, 158
- Pullback, 427
- Pushout, 427
  
- Quadratic algebra, 98, 347
- Quasi-isomorphism, 390, 402, 430
- Quasitoric manifold, 250, 326, 382
  - almost complex structure on, 259
  - canonical smooth structure on, 255
  - complex structure on, 259
  - equivalence of, 252, 253
- Quillen pair (of functors), 429
- Quotient space, 421
  
- Rank function, 87
- Rational equivalence, 418
- Rational homotopy type, 418
- Ray's basis, 371
- Redundant inequality, 8
- Reedy category, 432, 438
- Regular sequence, 397
- Regular subdivision, 127
- Regular value (of moment map), 201, 216
- Reisner Theorem, 114
- Resolution (of module)
  - free, 391
  - minimal, 392
  - projective, 391
- Restriction (of a building set), 32
- Restriction map
  - algebraic, 100, 111, 120, 272
  - in equivariant cohomology, 265
- Right-angled Artin group, 348
- Right-angled Coxeter group, 348
- Right lifting property, 411
- Ring of polytopes, 50
  
- Samelson product, 339, 417
  - higher, 340, 431
- Schlegel diagram, 76
- Segre embedding, 454
- Seifert fibration, 230
- Sign (of fixed point), 257, 382, 457
- Signature, 383, 466
- Simplex, 8, 88
  - abstract, 65
  - regular, 8
  - standard, 8
- Simplicial cell complex, 88
- Simplicial chain, 411
- Simplicial cochain, 412
- Simplicial complex
  - abstract, 65
  - Alexander dual, 73
  - geometric, 65
  - pure, 65
  - shifted, 178, 332
- Simplicial manifold, 82
- Simplicial map, 66
  - isomorphism, 66
  - nondegenerate, 66
- Simplicial object (in category), 427
- Simplicial poset, 87
  - dual (of manifold with corners), 270
- Simplicial set, 427
- Simplicial sphere, 76
- Simplicial subdivision, 67
- Simplicial wedge, 172
- Singular chain, 413
  - of pair, 414
- Singular cochain, 414
- Skeleton (of cell complex), 408
- Slice Theorem, 422
- Small category, 427
- Small cover, 239, 289, 308
- Smash product, 329, 407
- Stabiliser (of group action), 421
- Stably complex structure, 256, 445
  - $T$ -invariant, 457
- Stanley–Reisner ideal, 98
- Star, 68, 128, 224
- Starshaped sphere, 79, 226
- Stasheff polytope, 31
- Stationary subgroup, 421
- Steinitz Problem, 81
- Steinitz Theorem, 77
- Stellahedron, 42
- Stellar subdivision
  - of simplicial complex, 84
  - of simplicial poset, 128
- Straightening relation, 120
- Subcomplex of simplicial complex, 65
- Sullivan algebra (of piecewise polynomial differential forms), 418
- Supporting hyperplane, 7
- Suspension
  - of module, 388
  - of simplicial complex, 67
  - of space, 411
- Suspension isomorphism, 415
- Symplectic manifold, 201
- Symplectic reduction, 201, 215, 242
- Symplectic quotient, 202, 215
- Syzygy, 391
  
- Tangential representation, 422
- Tautological line bundle, 424
- Tensor product (of modules), 388
- $T$ -graph (torus graph), 311
- Thom class, 273, 312, 423
- Thom space, 442
- $T$ -manifold, 245
- Todd genus, 384, 466

- Topological fan, 286
  - complete, 286
- Topological monoid, 430
- Topological toric manifold, 284
- Tor-algebra, 103
- Toral rank, 169
- Toric manifold, 191, 242, 248
  - Hamiltonian, 204, 218
  - over cube, 294
  - projective, 191
- Toric space, 2, 136
- Toric variety, 30, 185
  - affine, 186
  - projective, 189
  - real, 289, 239
- Torus
  - algebraic, 185
  - standard, 136
- Torus manifold, 263
- Triangulated manifold, 82
- Triangulated sphere, 27, 76
- Triangulation, 61, 67
  - neighbourly, 81
- Tropical geometry, 289
- Truncated cube, 46
- Truncated simplex, 44
  
- Undercategory, 428
- Underlying simplicial complex (of fan), 67
- Unipotent (upper triangular matrix), 298
- Universal toric genus, 366, 368
- Upper Bound Theorem, 26
  
- Vector bundle, 422
- Vertex
  - of polytope, 8
  - of simplicial complex, 65
  - of simplicial poset, 87
- Vertex truncation, 11
- Volume polynomial, 30
  
- Weak equivalence
  - of dg-algebras, 402
  - in model category, 428
- Wedge (of spaces), 144, 407
  - of spheres, 178, 328, 352
- Weight (of torus representation), 256, 382, 457
- Weight graph, 308
- Weight lattice (of torus), 215
- Whitehead product, 417
  - higher, 340
  
- Yoneda algebra, 436
  
- Zonotope, 35
  
- $\gamma$ -polynomial, 23
- $\gamma$ -vector
  - of polytope, 23
- of triangulated sphere, 72
- $\chi_{a,b}$ -genus, 380
- $\chi_y$ -genus, 466
- 2-truncated cube, 46
- 24-cell, 10
- 5-lemma, 390