

THE HOMOTOPY THEORY OF SIMPLICIAL PROPS

PHILIP HACKNEY AND MARCY ROBERTSON

ABSTRACT. The category of (colored) props is an enhancement of the category of colored operads, and thus of the category of small categories. In this paper, the second in a series on ‘higher props,’ we show that the category of all small colored simplicial props admits a cofibrantly generated model category structure. With this model structure, the forgetful functor from props to operads is a right Quillen functor.

1. INTRODUCTION

The aim of this paper is to provide a simplicial model for “higher props.” A prop, first introduced by Adams and MacLane [25], is a device which is capable of modeling algebraic, coalgebraic, and bialgebraic structures. Examples of structures which are governed by props include the usual types of (co)algebras (associative, commutative, Lie, Poisson, etc.) and bialgebras (Hopf and Frobenius algebras), but also topological examples such as n -fold loop spaces [5] and topological or conformal field theories [38]. The colored, or multi-sorted, version of prop will be considered here, which allows one to model (among other things) morphisms and families of such structures. A (colored) prop, like a category, has a set of objects $\{x, y, \dots\}$, but we replace arrows $x \rightarrow y$ by multilinear operations $x_1 \otimes \dots \otimes x_n \rightarrow y_1 \otimes \dots \otimes y_m$. Operads [29, 28], categories [26], colored operads [5, 2], and properads [39] are all essentially examples of such props. See the survey paper [27] for more examples and motivation.

The adjective “higher” refers to higher category theory, in the $(\infty, 1)$ -categorical sense [4]. Roughly, an $(\infty, 1)$ -category is to a category as an A_∞ -space is to a monoid. There are many ways to formalize this concept, including simplicial categories [3], complete Segal spaces [35], and quasi-categories [21, 24]. These are all related by chains of Quillen equivalences of model categories (see the survey article [4] for an overview). Similar definitions of ∞ -operads were developed by Moerdijk, Cisniski and Weiss in [31, 32, 6, 7, 8].

This paper is part of a multistage project developing the notion of higher props by extending one of these known models for ∞ -categories to props. More explicitly, we develop the simplicial model for higher props by showing that the category of simplicial props admits a cofibrantly generated model category structure. The main technical effort of this paper is contained in Proposition 5.8 where we analyze pushouts of simplicial props with varying sets of colors. While pushouts of operads can be computed in the category of symmetric sequences, this is not the case for pushouts of props. This complication requires us to provide significantly different

2010 *Mathematics Subject Classification.* Primary 55U35; Secondary 18D10, 18D50, 18G55, 19D23, 55U10.

Key words and phrases. Prop, colored prop, cofibrantly generated model category, model category.

proofs from those in the operad setting [8, 37]. Further, pushouts of simplicial props cannot be computed using the later technology of Batanin and Berger [1].

The model structure developed in this paper is used in the follow-up paper [16] to give a model structure on the category of simplicial *properads*. This is important in a parallel project with Donald Yau, initiated in [17], to understand the homotopy theory of infinity properads. Later papers in this series will develop combinatorial models for up-to-homotopy props, following the dendroidal approach to higher operads [7, 8, 6, 31, 32] as well as Francis and Lurie's approach to ∞ -operads in [10, 23].

1.1. Organization. Sections 2 – 4 are background material, section 5 contains the main theorem and its proof, modulo the proof of Lemma 5.12 which comprises the last four sections.

The paper begins in the next section with the basics of (colored) graphs, mega-graphs (parametrized simplicial sets with Σ -bifunctors) and graph substitution. In section 3 we give a definition of prop, and provide two ways to produce props in 3.1, 3.2. Section 4 recalls two specific previously known model structures: the Bergner model structure on simplicially-enriched categories with varying object sets, and the Johnson-Yau model structure on simplicially-enriched props with a fixed set of colors.

In section 5 we blend these two model structures together to give a model structure on the category of simplicially-enriched props with varying color sets. We describe sets of generating (acyclic) cofibrations (definitions 5.4, 5.5) and in 5.1 compute the orthogonal complements of their saturations (the acyclic fibrations and fibrations, respectively).

At this point we go about showing that pushouts of generating acyclic cofibrations are weak equivalences. Those which come from the generating acyclic cofibrations in **sSet** are relatively straightforward, while the remaining ones constitute a major difficulty. In particular, the proof of Lemma 5.12 takes up the bulk of this paper. It begins in section 6, where we set up a general categorical framework for modeling pushouts of simplicial props. In section 7, we restrict attention to the types of pushout from Lemma 5.12, and are able to make several reductions in our categorical framework. We use this in section 8 to give a filtration of this pushout, while in section 9 we exhibit each filtration inclusion as a pushout of an acyclic cofibration of **sSet**. This section concludes with a proof of Lemma 5.12.

With Lemma 5.12 proved, we show in the remainder of 5.2 that relative J -cell complexes are weak equivalences, and then use this fact as input in the recognition theorem for cofibrantly generated model categories to establish the desired model structure. We conclude by noting, in 5.3, that the model structure on simplicial props is right proper.

1.2. Acknowledgments. The first version of this paper lacked an adequate explanation for Lemma 5.12; the authors would like to thank an anonymous referee for pointing this out and would also like to thank D. Yau and M. Batanin for discussions related to this problem. This paper has had several referees, and we are thankful to all of them for their insightful and useful comments. We also thank F. Wierstra for a useful conversation which helped finish section 9.

2. Graphs and megagraphs

In this paper, we employ the notions of graph and megagraph from [14]. We will use descriptive terminology for graphs here; precise formulations may be found in [1, 22, 40]. For our purposes, a graph is a collection of vertices and directed edges; the tail of each edge is either an input of the graph or is connected to a vertex, and similarly the head of each edge is either an output of the graph or connected to a vertex. In addition, our graphs have no directed cycles. Special examples are the graph j with no vertices and one edge, the graph with one vertex and no edges, and the empty graph.

2.1. Megagraphs. Consider the free monoid monad $M : \text{Set} \rightarrow \text{Set}$ which takes a set C to $M(C) = \coprod_{k \geq 0} C^k$. There are right and left actions of the symmetric groups on the components of $M(C)$. More compactly we could say that there are both right and left actions of the symmetric groupoid $\mathbb{S} = \coprod_{n \geq 0} \mathbb{S}_n$ on $M(C)$. A \mathbb{S} -bimodule is a set with compatible left and right \mathbb{S} -actions. We now describe an extension of the notion of graph, namely one in which edges are permitted to have multiple inputs and outputs.

- Definition 2.1. (1) A megagraph X consists of a set of objects X_0 , a set of arrows X_1 , two functions $s : X_1 \rightarrow M(X_0)$ and $t : X_1 \rightarrow M(X_0)$, and right and left actions on X_1 . These actions should have an interchange property $(x \cdot \sigma) = (\sigma \cdot x)$ and should be compatible with those on $M(X_0)$, so $t(x \cdot \sigma) = \sigma \cdot t(x)$ and $s(\sigma \cdot x) = \sigma \cdot s(x)$, where $\sigma \in \mathbb{S}_2$.
- (2) A map of megagraphs $f : X \rightarrow Y$ is determined by maps $f_0 : X_0 \rightarrow Y_0$ and $f_1 : X_1 \rightarrow Y_1$ so $f_1 \circ s = (Mf_0) \circ s$ and $f_1 \circ t = (Mf_0) \circ t$. The collection of megagraphs determines a category which we call Mega .
- (3) A simplicial megagraph will be a structure with a discrete simplicial set of objects X_0 , a simplicial set of arrows X_1 , along with a compatible structure of a megagraph on each $(X_1)_n$.
- (4) For a map of simplicial megagraphs we require that the function f_1 be a map of simplicial sets; we denote by S Mega the category of simplicial megagraphs.

Remark 2.2. We will often denote the set of objects X_0 of a megagraph X by $X_0 = C$. In this case, we will also call X a megagraph over C .

Definition 2.3. In anticipation of the role played in the definition of prop (3.2, we will call elements of $M(C) \rightarrow M(C)$ input-output profiles of C . We will use underlines to give the shorthand notation

$$(\underline{c}; \underline{d}) = (c_1; \dots; c_m; d_1; \dots; d_n) \in C^m \times C^n \rightarrow M(C) \rightarrow M(C)$$

whenever we write down an input-output profile.

Remark 2.4. If X is a (simplicial) megagraph and $(\underline{c}; \underline{d})$ is an input-output profile of X_0 , we denote by $X(\underline{c}; \underline{d})$ the preimage of $(\underline{c}; \underline{d})$ under $(s; t)$; in other words, the diagram

$$\begin{array}{ccc} X(\underline{c}; \underline{d}) & \xrightarrow{\quad} & f(\underline{c}; \underline{d})g \\ \downarrow & & \downarrow \\ X_1 & \xrightarrow{(s;t)} & M(X_0) \rightarrow M(X_0) \end{array}$$

is a pullback. The induced map

$$\coprod_{(\underline{c}; \underline{d}) \in \mathbb{M}(X_0) \times \mathbb{M}(X_0)} \mathcal{X}(\underline{c}; \underline{d}) \rightarrow X_1$$

is a bijection, hence an isomorphism.

This inspires the following definition of megagraph, which is valid in an arbitrary category \mathcal{E} .

Definition 2.5. Let \mathfrak{C} be a set. An \mathcal{E} -megagraph \mathcal{X} over \mathfrak{C} consists of the data

- an object $\mathcal{X}(\underline{c}; \underline{d})$ of \mathcal{E} for each input-output profile $(\underline{c}; \underline{d})$ of \mathfrak{C} ,
- \mathcal{E} -maps $\tau_* : \mathcal{X}(\underline{c}; \underline{d}) \rightarrow \mathcal{X}(\tau \cdot \underline{c}; \underline{d})$ for each $\tau \in \Sigma_{|\underline{c}|}$, and
- \mathcal{E} -maps $\sigma^* : \mathcal{X}(\underline{c}; \underline{d}) \rightarrow \mathcal{X}(\underline{c}; \underline{d} \cdot \sigma)$ for each $\sigma \in \Sigma_{|\underline{d}|}$.

These data should satisfy $\tau_* \sigma^* = \sigma^* \tau_*$, $\sigma^*(\sigma')^* = (\sigma' \sigma)^*$, and $\tau_* \tau'_* = (\tau \tau')^*$. If \mathcal{X} is an \mathcal{E} -megagraph over \mathfrak{C} and \mathcal{Y} is an \mathcal{E} -megagraph over \mathfrak{D} , then a morphism $\mathcal{X} \rightarrow \mathcal{Y}$ consists of a set map $f : \mathfrak{C} \rightarrow \mathfrak{D}$ and \mathcal{E} -morphisms

$$\mathcal{X}(\underline{c}; \underline{d}) \rightarrow \mathcal{Y}(f\underline{c}; f\underline{d})$$

which are compatible with the Σ actions.

Thus we may think of a megagraph as a family of objects parametrized by $\mathbb{M}(\mathfrak{C}) \times \mathbb{M}(\mathfrak{C})$, together with left and right Σ -actions. A megagraph \mathcal{X} over \mathfrak{C} would be called a \mathfrak{C} -colored Σ -bimodule in [11].

2.2. Graph Substitution. Graph substitution is a powerful notational tool which we employ throughout this paper.

Definition 2.6. Let \mathfrak{C} be a set. A \mathfrak{C} -colored graph is a graph together with the following additional structure.

- An edge coloring function $\zeta : \text{Edge}(G) \rightarrow \mathfrak{C}$,
- for each vertex $v \in \text{Vt}(G)$ a fixed ordering on the input edges $\text{in}(v)$ and the output edges $\text{out}(v)$, and
- an ordering on both $\text{in}(G)$ and $\text{out}(G)$.

Let $\mathbf{G}_{\mathfrak{C}}(\underline{c}; \underline{d})$ be the set of \mathfrak{C} colored graphs so that $\zeta(\text{in}(G)) = \underline{c}$ and $\zeta(\text{out}(G)) = \underline{d}$ (as ordered sets).

This is a subset of the data comprising a ‘decoration of G ’ in [14, Def. 41].

Definition 2.7. If G is a \mathfrak{C} -colored graph and $f : \mathfrak{C} \rightarrow \mathfrak{D}$ is a map of sets, then denote by fG the \mathfrak{D} -colored graph with all of the same structure as G , except that the edge coloring function is changed to the composite

$$\text{Edge}(G) \xrightarrow{\zeta} \mathfrak{C} \xrightarrow{f} \mathfrak{D}.$$

For each $c \in \mathfrak{C}$, write $|_c$ for the graph with one c -colored edge and no vertices. Given an input-output profile $(\underline{c}; \underline{d}) = (c_1, \dots, c_n; d_1, \dots, d_m)$, the *standard corolla* $C_{(\underline{c}; \underline{d})}$ is the graph with edges e_1, \dots, e_{n+m} , a single vertex v adjacent to all edges, and, as ordered lists,

$$(1) \quad \begin{aligned} \text{in}(G) = \text{in}(v) &= e_1, \dots, e_n & \zeta(\text{in}(G)) &= c_1, \dots, c_n \\ \text{out}(G) = \text{out}(v) &= e_{n+1}, \dots, e_{n+m} & \zeta(\text{out}(G)) &= d_1, \dots, d_m. \end{aligned}$$

Suppose now that we have a graph $G \in \mathbf{G}_{\mathfrak{C}}(\underline{c}; \underline{d})$, a vertex $v \in G$, and a graph $K \in \mathbf{G}_{\mathfrak{C}}(\zeta(\text{in}(v)); \zeta(\text{out}(v)))$.

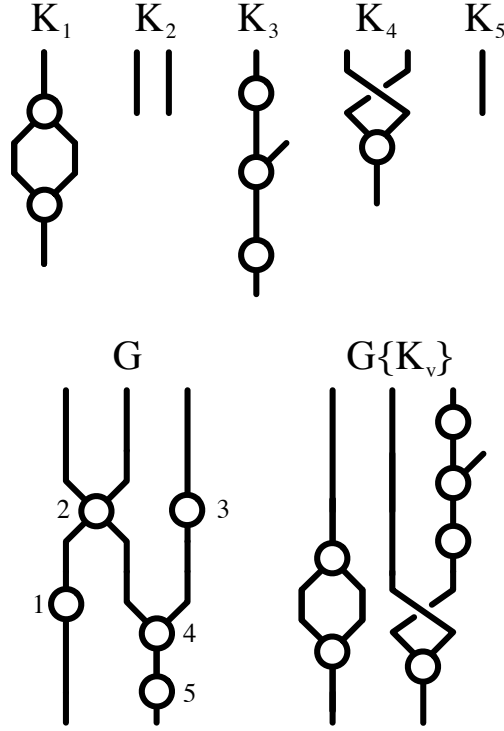

FIGURE 1. A sample graph substitution

Definition 2.8. The *graph substitution* $G(K)$ is the graph with

$$\begin{aligned} \text{Edge}(G(K)) &= (\text{Edge}(G) \amalg \text{Edge}(K)) / (\text{out}(v), \text{in}(v) \sim \text{out}(K), \text{in}(K)) \\ \text{Vt}(G(K)) &= (\text{Vt}(G) \setminus \{v\}) \amalg \text{Vt}(K) \end{aligned}$$

together with all the data of the evident orderings, coloring functions, source, target, etc.

Remark 2.9. We can, in fact, do multiple graph substitutions at once, which we will write as $G\{K_v\}$ where v ranges over some subset of vertices of G . An example is given in figure 1, where the orderings should all be taken as those coming from the plane.

Notation 2.10. We avoid explicitly writing ζ unless absolutely necessary. In particular, we will write $\mathbf{G}_{\mathcal{C}}(\text{in}(v); \text{out}(v))$ instead of $\mathbf{G}_{\mathcal{C}}(\zeta(\text{in}(v)); \zeta(\text{out}(v)))$.

Graph substitution is associative, so $\mathbf{G}_{\mathcal{C}}(\underline{c}; \underline{d})$ is in fact a category, with an arrow

$$G\{K_v\} \rightarrow G$$

for every graph substitution.

Example 2.11. Let $\mathcal{C} = *$, let $G \in \mathbf{G}_{\mathcal{C}}(*; *)$ be the graph with two vertices v, w and four edges depicted in figure 2. Let K_w and K_v be the relevant non-standard corollas. Then up to renaming of edges, $G\{K_v, K_w\} = G$. This is a non-trivial graph substitution, hence is an example of a non-trivial automorphism in $\mathbf{G}_{\mathcal{C}}(*; *)$.

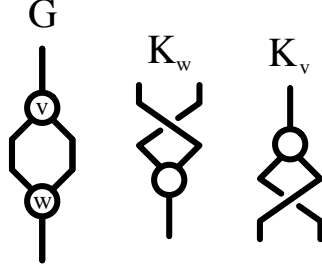

FIGURE 2. Graphs from example 2.11

Proposition 2.12. *The standard corolla $C_{(\underline{c}; \underline{d})}$ is a terminal object in $\mathbf{G}_{\mathfrak{C}}(\underline{c}; \underline{d})$.*

Proof. First notice that if $K \in \mathbf{G}_{\mathfrak{C}}(\underline{c}; \underline{d})$, then $K = C_{(\underline{c}; \underline{d})}(K)$, where K is substituted into the unique vertex of the corolla, whence there is map $K \rightarrow C_{(\underline{c}; \underline{d})}$. We now just need to check that there are no non-identity automorphisms of $C_{(\underline{c}; \underline{d})}$: all maps to $C_{(\underline{c}; \underline{d})}$ are of the form

$$C_{(\underline{c}; \underline{d})}(K_v) \xrightarrow{f} C_{(\underline{c}; \underline{d})},$$

where v is the unique vertex of v and $K_v \in \mathbf{G}_{\mathfrak{C}}(\underline{c}; \underline{d})$ is some graph. But $C_{(\underline{c}; \underline{d})}(K_v) = K_v$, hence if f is an automorphism then f is the identity on $C_{(\underline{c}; \underline{d})}(C_{(\underline{c}; \underline{d})}) = C_{(\underline{c}; \underline{d})}$. \square

3. PROPS

In this section we define props by using graph substitution, give a description of the free prop on a megagraph, and discuss how every colored operad defines a prop. A good reference for this material is [40].

Fix a symmetric monoidal category $(\mathcal{E}, \otimes, I)$ with all small limits and colimits, such that \otimes distributes over colimits in both variables, and let \mathfrak{C} be a set of colors.

Notation 3.1. Suppose \mathcal{X} is a megagraph in $(\mathcal{E}, \otimes, I)$ and G is an X_0 -colored graph. Let

$$\mathcal{X}[G] = \bigotimes_{v \in \text{Vt}(G)} X(\text{in}(v); \text{out}(v))$$

be the space of decorations of the vertices of G by elements of \mathcal{X} . Here we are using the *unordered tensor product*; namely, if S is a finite set with k elements and $\{Z_s\}_{s \in S}$ is an S -indexed family of objects of \mathcal{E} , then the unordered tensor product is defined to be

$$\bigotimes_{s \in S} Z_s := \left(\prod_{\alpha: \{1, \dots, k\} \xrightarrow{\cong} S} Z_{\alpha(1)} \otimes \cdots \otimes Z_{\alpha(k)} \right)_{\Sigma_k}$$

where α ranges over all bijections between $\{1, \dots, k\}$ and S . Note that for any fixed bijection $\alpha: \{1, \dots, k\} \rightarrow S$, the map $\bigotimes_{i=1}^k Z_{\alpha(i)} \rightarrow \bigotimes_{s \in S} Z_s$ is an isomorphism.

Definition 3.2. A \mathfrak{C} -colored prop in \mathcal{E} consists of

- (1) an \mathcal{E} megagraph \mathcal{T} over \mathfrak{C} (definition 2.5), and

(2) for each graph $G \in \mathbf{G}_{\mathfrak{C}}$, a map γ_G

$$\begin{array}{c} \mathcal{T}[G] = \bigotimes_{v \in G} \mathcal{T}(\text{in}(v); \text{out}(v)) \\ \downarrow \gamma_G \\ \mathcal{T}(\text{in}(G); \text{out}(G)) \in \mathcal{E} \end{array}$$

such that the following two conditions hold.

Unity: $\gamma_C = \text{id}$ whenever C is a standard corolla (1).

Associativity: γ is associative with respect to graph substitution, in the sense that the diagram

$$(2) \quad \begin{array}{ccc} \bigotimes_{v \in G} \mathcal{T}[H_v] & \xrightarrow{\otimes \gamma_{H_v}} & \mathcal{T}[G] \\ \cong \uparrow & & \downarrow \gamma_G \\ \mathcal{T}[G\{H_v\}] & \xrightarrow{\gamma_{G\{H_v\}}} & \mathcal{T}(\text{in}(G); \text{out}(G)) \end{array}$$

is commutative whenever it is defined.

Notation 3.3. When we discuss a prop \mathcal{T} we will refer to \mathfrak{C} as the set of colors of \mathcal{T} . When we are dealing with several props it is convenient to denote \mathfrak{C} as $\text{Col}(\mathcal{T})$ so it does not become confusing which set of colors belongs to which prop.

Definition 3.4. A morphism of props $f : \mathcal{R} \rightarrow \mathcal{T}$ is a morphism of megagraphs so that

$$\begin{array}{ccc} \mathcal{R}[G] & \longrightarrow & \mathcal{T}[fG] \\ \downarrow & & \downarrow \\ \mathcal{R}(\underline{c}; \underline{d}) & \longrightarrow & \mathcal{T}(f\underline{c}; f\underline{d}) \end{array}$$

commutes for every $\text{Col}(\mathcal{R})$ -graph G (where fG is defined as in definition 2.7). The category of props and prop morphisms is denoted **Prop**.

In this paper we will be primarily interested when the underlying symmetric monoidal category \mathcal{E} is the category of simplicial sets with monoidal product the Cartesian product. We will write **sProp** for the category of props enriched in simplicial sets. The category **sProp** inherits both colimits and limits from taking the corresponding (co)limits levelwise in **Prop**; further, limits in **sProp** are created componentwise in **sSet**.

Remark 3.5. The definition of (colored) prop we use is weaker than classical definitions à la Adams-MacLane. In the classical definition of prop, the set of operations in bi-arity $(0, 0)$ form an abelian group by an Eckmann-Hilton argument. That is, in the classical setting, there are two separate operations

$$(3) \quad \mathcal{T}(\emptyset; \emptyset) \times \mathcal{T}(\emptyset; \emptyset) \rightarrow \mathcal{T}(\emptyset; \emptyset)$$

given by horizontal and vertical composition; in the graph setting there is but a single graph with two vertices and no edges, so our formalism using graph substitution gives only single morphism (3), which need not be commutative. We are grateful to M. Batanin for pointing this out to us; more details may be found in [1, §10]. This distinction is irrelevant when considering props which come from operads or

properads, or when considering props which only have operations with non-empty output¹ (or input), such as props modeling nonunital field theories.

3.1. The free prop associated to a megagraph.

Definition 3.6. The forgetful functor $U : \mathbf{Prop} \rightarrow \mathbf{Mega}$ applied to a prop \mathcal{T} is defined by

$$(U\mathcal{T})_0 = \text{Col } \mathcal{T} \quad (U\mathcal{T})_1 = \coprod_{\underline{a}, \underline{b} \in \mathbb{M}(\text{Col } \mathcal{T})} \mathcal{T}(\underline{a}; \underline{b})$$

with the induced source and target maps.

Theorem 3.7 ([14, Theorem 14]). *The functor $U : \mathbf{Prop} \rightarrow \mathbf{Mega}$ has a left adjoint $F : \mathbf{Mega} \rightarrow \mathbf{Prop}$.*

For a concrete description of $F\mathcal{X}$, see Proposition 3.12. We will repeatedly use the following class of free props in section 5.

Definition 3.8. The (n, m) -corolla $\mathcal{G}_{n,m}$ is the connected graph with one vertex, n inputs and m outputs, and this graph can be naturally modeled by a megagraph \mathcal{X} by letting

$$\begin{aligned} X_0 &= \{a_1, \dots, a_n, b_1, \dots, b_m\} & s(e, e) &= (a_1, \dots, a_n) \\ X_1 &= \Sigma_n \times \Sigma_m & t(e, e) &= (b_1, \dots, b_m) \end{aligned}$$

together with the evident symmetric group actions on X_1 .

Definition 3.9. If \mathcal{X} is the megagraph described above, which models the (n, m) -corolla $\mathcal{G}_{n,m}$, we will also write $\mathcal{G}_{n,m}$ for the prop $F(\mathcal{X})$.

The prop $\mathcal{G}_{n,m}$ has a single generating operation in $\mathcal{G}_{n,m}(a_1, \dots, a_n; b_1, \dots, b_m)$.

Theorem 3.10. *The collection*

$$\{\mathbf{G}_{\mathfrak{C}}(\underline{c}; \underline{d})\}$$

forms a \mathfrak{C} -colored prop enriched in \mathbf{Cat} , with prop structure obtained from graph substitution.

Proof. The relevant properties are established in [40, §6.3]. □

The free-forgetful adjunction

$$F : \mathbf{Mega} \rightleftarrows \mathbf{Prop} : U$$

from Theorem 3.7 has an associated comonad $\perp = FU : \mathbf{Prop} \rightarrow \mathbf{Prop}$ and an associated monad $\top = UF : \mathbf{Mega} \rightarrow \mathbf{Mega}$. In this section we will describe \mathbf{Prop} as the category of algebras for the monad \top .

If \mathcal{X} is the underlying megagraph of a prop \mathcal{T} and $G \in \mathbf{G}_{\mathfrak{C}}(\underline{c}; \underline{d})$, we have the map

$$\gamma_G : \mathcal{T}[G] \rightarrow (\top\mathcal{T})(\underline{c}; \underline{d}) \rightarrow \mathcal{T}(\underline{c}; \underline{d}) = \mathcal{T}(\text{in}(G); \text{out}(G))$$

since \mathcal{T} is an algebra for the monad \top .

Proposition 3.11. *If \mathcal{T} is a simplicial \mathfrak{C} -prop, then there exists a functor, called the a decoration functor*

$$\partial : \mathbf{G}_{\mathfrak{C}}(\underline{c}; \underline{d}) \rightarrow \mathbf{sSet}$$

which sends a \mathfrak{C} -colored graph G to the simplicial set $\mathcal{T}[G]$. Furthermore, ∂ has the property that $\text{colim } \partial \cong \mathcal{T}(\underline{c}; \underline{d})$.

¹ i.e. props with $\mathcal{T}(\underline{c}; \emptyset) = \emptyset$ for all $\underline{c} \neq \emptyset$ and $\mathcal{T}(\emptyset; \emptyset) = *$.

Proof. For each morphism $f : G\{K_v\} \rightarrow G$ in $\mathbf{G}_{\mathfrak{C}}(\underline{c}; \underline{d})$, we declare $\partial(f)$ to be

$$\begin{aligned} \mathcal{T}[G\{K_v\}] &= \prod_{w \in G\{K_v\}} \mathcal{T}(\text{in}(w); \text{out}(w)) \\ &= \prod_{v \in G} \prod_{w \in K_v} \mathcal{T}(\text{in}(w); \text{out}(w)) \\ &\xrightarrow{\prod \gamma^{K_v}} \prod_{v \in G} \mathcal{T}(\text{in}(K_v); \text{out}(K_v)) = \prod_{v \in G} \mathcal{T}(\text{in}(v); \text{out}(v)) = \mathcal{T}[G]. \end{aligned}$$

To see that $\text{colim } \partial \cong \mathcal{T}(\underline{c}; \underline{d})$, recall from Proposition 2.12 that the standard corolla (1) is the terminal object in $\mathbf{G}_{\mathfrak{C}}(\underline{c}; \underline{d})$, so

$$\text{colim } \partial = \partial(C_{(\underline{c}; \underline{d})}) = \mathcal{T}[C_{(\underline{c}; \underline{d})}] = \mathcal{T}(\underline{c}; \underline{d}).$$

□

Proposition 3.12. *Let \mathcal{X} be a \mathfrak{C} -colored megagraph, $(\underline{c}; \underline{d})$ be a fixed \mathfrak{C} input-output profile, and*

$$I \subset \text{Ob } \mathbf{G}_{\mathfrak{C}}(\underline{c}; \underline{d})$$

be a set of representatives for isomorphism classes of $\mathbf{G}_{\mathfrak{C}}(\underline{c}; \underline{d})$. Then in the free prop $F\mathcal{X}$ we have

$$F\mathcal{X}(\underline{c}; \underline{d}) \cong \prod_{G \in I} \mathcal{X}[G].$$

Proof. This is an unraveling of the description of the free prop given in [14, Appendix]. □

3.2. The prop generated by an operad. Another important family of props are colored operads. Recall that a colored operad, \mathcal{O} , is a structure with a color set $\text{Col } \mathcal{O}$ and hom sets $\mathcal{O}(c_1, \dots, c_n; c)$ for each list of colors c_1, \dots, c_n, c , together with appropriate composition operations. The precise definition is a bit more involved than that of prop since the operadic composition mixes together horizontal and vertical propic compositions (see, for example, [2]). We regard colored operads as a special type of prop, namely those which are completely determined by the components with only one output. Let **Operad** be the category of colored operads, which, following the conventions of [30], we refer to as simply *operads*. There is a forgetful functor

$$U_0 : \mathbf{Prop} \rightarrow \mathbf{Operad}$$

which takes \mathcal{T} to an operad $U_0(\mathcal{T})$ with $\text{Col } U_0(\mathcal{T}) = \text{Col } \mathcal{T}$. The morphism sets are defined by

$$U_0(\mathcal{T})(a_1, \dots, a_n; b) = \mathcal{T}(a_1, \dots, a_n; b)$$

and operadic composition

$$\begin{array}{c} U_0(\mathcal{T})(a_1, \dots, a_n; b) \times \prod_{i=1}^n U_0(\mathcal{T})(c_{i,1}, \dots, c_{i,p_i}; a_i) \\ \downarrow \gamma \\ U_0(\mathcal{T})(c_{1,1}, \dots, c_{1,p_1}, c_{2,1}, \dots, c_{n,p_n}; b) \end{array}$$

is given by

$$\gamma(g, f_1, \dots, f_n) = g \circ_v (f_1 \circ_h \cdots \circ_h f_n).$$

In [14, Proposition 11], we indicate how an operad generates a prop and prove the following result.

Proposition 3.13. *The forgetful functor $U_0 : \mathbf{Prop} \rightarrow \mathbf{Operad}$ has a left adjoint $F_0 : \mathbf{Operad} \rightarrow \mathbf{Prop}$ with $\text{Col } F(\mathcal{O}) = \text{Col } \mathcal{O}$. If \mathcal{O} is an operad then*

$$F_0(\mathcal{O})(a_1, \dots, a_n; b) \cong \mathcal{O}(a_1, \dots, a_n; b).$$

Consequently, $U_0 F_0 \cong \text{id}_{\mathbf{Operad}}$.

The obvious variant holds if one instead considers operads and props enriched in \mathbf{sSet} : there is an adjunction $F_0 : \mathbf{sOperad} \rightleftarrows \mathbf{sProp} : U_0$, cf. Corollary 5.2.

4. A REVIEW OF VARIOUS MODEL CATEGORY STRUCTURES

One of the most basic examples of a model category structure is the so-called ‘natural’ model category structure on \mathbf{Cat} , the category of all small (non-enriched) categories.

Theorem 4.1. *The category \mathbf{Cat} admits a cofibrantly generated model category structure where:*

- *the weak equivalences are the categorical equivalences;*
- *the cofibrations are the functors $F : \mathcal{C} \rightarrow \mathcal{D}$ which are injective on objects;*
- *the fibrations are the isofibrations, i.e. functors $F : \mathcal{C} \rightarrow \mathcal{D}$ with the property that for each object c in \mathcal{C} and each isomorphism $f : Fc \rightarrow d$ in \mathcal{D} there exists a c' in \mathcal{C} and an isomorphism $g : c \rightarrow c'$ in \mathcal{C} such that $F(g) = f$.*

A proof of this theorem, along with a proof that \mathbf{Cat} is a simplicial model category, may be found in [34]. The Bergner model structure on simplicial categories blends the model category structure on \mathbf{Cat} together with the standard model structure on simplicial sets [13, 33].

Let \mathbf{sSet} be the category of simplicial sets with the standard model structure [13, 33], and let \mathbf{sCat} denote the category of *simplicial categories*, by which we mean small categories enriched in \mathbf{sSet} . Given a simplicial category \mathcal{A} , we can form a genuine category $\pi_0(\mathcal{A})$ which has the same set of objects as \mathcal{A} and whose set of morphisms $\pi_0(\mathcal{A})(x, y) := [*, \mathcal{A}(x, y)]$ is the set of path components of the simplicial set $\mathcal{A}(x, y)$. This induces a functor $\pi_0 : \mathbf{sCat} \rightarrow \mathbf{Cat}$, with values in the category of small categories.

Given the conditions from Theorem 4.2, it is immediate that the inclusion $\mathbf{Cat} \rightarrow \mathbf{sCat}$ is a right Quillen functor. Hence π_0 is a left Quillen functor, so once we have established the model structure on \mathbf{sCat} we will have the (total left derived) functor $\text{Ho}(\mathbf{sCat}) \rightarrow \text{Ho}(\mathbf{Cat})$ [18, 8.5.8(1)]. In other words, any $F : \mathcal{C} \rightarrow \mathcal{D}$ in $\text{Ho}(\mathbf{sCat})$ induces a morphism $\pi_0(\mathcal{C}) \rightarrow \pi_0(\mathcal{D})$. Note that this set up implies that the *essential image* of a simplicial functor $F : \mathcal{A} \rightarrow \mathcal{B}$ must be defined as the full simplicial subcategory of \mathcal{B} consisting of all objects whose image in the component category $\pi_0(\mathcal{B})$ are in the essential image of the functor $\pi_0(F)$.

Informally, one can say that inside every simplicial prop lies a simplicial category consisting of the operations with only one input and one output. More formally, there exists a forgetful functor $U_0 : \mathbf{sProp} \rightarrow \mathbf{sCat}$ defined by $\text{Ob } U_0(\mathcal{T}) := \text{Col}(\mathcal{T})$, $U_0(\mathcal{T})(c, d) := \mathcal{T}(c; d)$. Composition is given by the applicable \circ_v operations. The functor U_0 admits a left adjoint, F_0 , which assigns a category \mathcal{C} to an prop $F_0\mathcal{C}$ with $\text{Col}(F_0\mathcal{C}) := \text{Ob}(\mathcal{C})$. This adjunction is factored by the adjunction $\mathbf{sOperad} \rightleftarrows \mathbf{sProp}$ from section 3.2.

We define the *underlying component category* functor to be

$$(4) \quad \mathbf{sProp} \xrightarrow{U_0} \mathbf{sCat} \xrightarrow{\pi_0} \mathbf{Cat}.$$

When there is no ambiguity we will denote $\pi_0(U_0(\mathcal{T}))$ by $\pi_0(\mathcal{T})$.

4.1. The Bergner model structure on \mathbf{sCat} . The following theorem (with ‘proper’ replaced by ‘right proper’) is due to Bergner [3]; left properness was shown by Lurie [24, A.3.2].

Theorem 4.2. *The category of all small simplicial categories, \mathbf{sCat} , supports a proper, cofibrantly generated, model category structure. The weak equivalences (respectively, fibrations) are the \mathbf{sSet} -enriched functors*

$$F : \mathcal{A} \longrightarrow \mathcal{B}$$

such that:

W1 (F1): *for all objects x, y in \mathcal{A} , the \mathbf{sSet} -morphism $F_{x,y} : \mathcal{A}(x, y) \longrightarrow \mathcal{B}(Fx, Fy)$ is a weak equivalence (respectively, fibration) in the model structure on \mathbf{sSet} , and*

W2 (F2): *the induced functor $\pi_0(F) : \pi_0(\mathcal{A}) \longrightarrow \pi_0(\mathcal{B})$ is a weak equivalence (respectively, fibration) in \mathbf{Cat} .*

Note that if $F : \mathcal{A} \rightarrow \mathcal{B}$ satisfies condition (W1), then $\pi_0(F)$ is automatically fully-faithful. Thus, checking that F satisfies condition (W2) is equivalent to checking that the induced functor

$$\pi_0(F) : \pi_0(\mathcal{A}) \rightarrow \pi_0(\mathcal{B})$$

is essentially surjective.

Bergner gives an explicit description of the generating (acyclic) cofibrations of this model structure, which we will generalize in section 5. In order to describe these generating (acyclic) cofibrations we will need some background. Let \emptyset denote the empty category and $\mathcal{I} = \{x\}$ denote the terminal category, which is the category with one object and one identity arrow (viewed as a simplicial category by applying the strong monoidal functor $\mathbf{Set} \rightarrow \mathbf{sSet}$). Given any simplicial set K we can generate a simplicial category $\mathcal{G}_{1,1}[K]$. The category $\mathcal{G}_{1,1}[K]$ has two objects, called a_1 and b_1 , such that $\mathrm{Hom}(a_1, b_1) = K$, $\mathrm{Hom}(a_1, a_1) \cong \mathrm{Hom}(b_1, b_1) \cong *$, and $\mathrm{Hom}(b_1, a_1) = \emptyset$.

For concreteness, we fix a set of generating cofibrations for \mathbf{sSet} to be the boundary inclusions

$$(5) \quad \partial\Delta[n] \rightarrow \Delta[n] \quad n \geq 0,$$

and a set of generating acyclic cofibrations to be the horn inclusions

$$(6) \quad \Lambda[n, k] \rightarrow \Delta[n] \quad n \geq 1, 0 \leq k \leq n$$

(see, for example, [18, 11.1.6] or [33]). The following two propositions appear in [3].

Proposition 4.3. *A functor of simplicial categories $F : \mathcal{A} \rightarrow \mathcal{B}$ is an acyclic fibration if, and only if, F has the right lifting property (RLP) with respect to all the maps*

- $\mathcal{G}_{1,1}[K] \hookrightarrow \mathcal{G}_{1,1}[L]$ where $K \hookrightarrow L$ is a generating cofibration of \mathbf{sSet} , and
- the map $\emptyset \hookrightarrow \mathcal{I}$.

To describe the generating acyclic cofibrations of simplicial categories, Bergner looks at a family of simplicial categories \mathcal{H} which have two objects x and y , weakly contractible function complexes, and only countably many simplices in each function complex. Furthermore, she requires \mathcal{H} to be cofibrant in the Dwyer-Kan model

category structure on $\mathbf{sCat}_{\{x,y\}}$ [9]. Let \mathbf{H} denote a set of representatives of isomorphism classes of such categories.

Proposition 4.4. *A functor of simplicial categories $F : \mathcal{A} \rightarrow \mathcal{B}$ is a fibration if, and only if, F has the right lifting property (RLP) with respect to maps of the form*

- $\mathcal{G}_{1,1}[K] \hookrightarrow \mathcal{G}_{1,1}[L]$ where $K \hookrightarrow L$ is a generating acyclic cofibration of \mathbf{sSet} , and
- the maps $\mathcal{I} \hookrightarrow \mathcal{H}$ for $\mathcal{H} \in \mathbf{H}$ which send x to x .

4.2. Categories of props with a fixed set of colors. Fix a set \mathcal{C} and consider the category of all simplicial props with a *fixed* set of colors \mathcal{C} . We will denote this category by $\mathbf{sProp}_{\mathcal{C}}$. In this category the morphisms are the morphisms of simplicial props $f : \mathcal{R} \rightarrow \mathcal{T}$ such that the induced map on colors $f : \text{Col}(\mathcal{R}) \rightarrow \text{Col}(\mathcal{T})$ is the identity map on \mathcal{C} . In particular, all of the morphisms in $\mathbf{sProp}_{\mathcal{C}}$ are essentially surjective. This category admits a model structure analogous to the Dwyer-Kan model structure on simplicial categories with a fixed object set [9]. The following theorem was established (for more general enrichments) by Fresse in the monochrome case [12] and Johnson and Yau [20, 3.11] in the fixed color case; alternatively it is a special case of [2, 2.1] since $\mathbf{sProp}_{\mathcal{C}}$ is a category of algebras over a $\mathbb{M}\mathcal{C} \times \mathbb{M}\mathcal{C}$ -colored operad.

Theorem 4.5. *The category of simplicial props with fixed color set \mathcal{C} admits a cofibrantly generated model category structure where $f : \mathcal{R} \rightarrow \mathcal{T}$ is a weak equivalence (respectively, fibration) if for each input-output profile $(\underline{a}; \underline{b})$ in \mathcal{C} the map*

$$f : \mathcal{R}(\underline{a}; \underline{b}) \longrightarrow \mathcal{T}(\underline{a}; \underline{b})$$

is a weak equivalence (respectively, fibration) of simplicial sets.

Given a map of sets $\alpha : \mathcal{C} \rightarrow \mathcal{D}$ there is an induced adjoint pair of functors

$$\alpha_! : \mathbf{sProp}_{\mathcal{C}} \rightleftarrows \mathbf{sProp}_{\mathcal{D}} : \alpha^*.$$

If \mathcal{T} is a prop with color set \mathcal{D} , then the prop $\alpha^*\mathcal{T}$ has colors \mathcal{C} and operations

$$\alpha^*\mathcal{T}(\underline{a}; \underline{b}) = \mathcal{T}(\alpha\underline{a}; \alpha\underline{b}).$$

Notice that there is a canonical map $\alpha^*\mathcal{T} \rightarrow \mathcal{T}$ with color function α , and any morphism $\mathcal{R} \rightarrow \mathcal{T}$ with color function α factors uniquely as $\mathcal{R} \rightarrow \alpha^*\mathcal{T} \rightarrow \mathcal{T}$.

Proposition 4.6. [20, 7.5] *The adjunction $(\alpha_!, \alpha^*)$ is a Quillen pair.*

5. THE MODEL STRUCTURE ON \mathbf{sProp}

We now turn to the main result of the paper, namely the model structure on the category of simplicial props.

Definition 5.1. Let \mathcal{R} and \mathcal{T} be simplicial props, and let $f : \mathcal{R} \rightarrow \mathcal{T}$ be a morphism of simplicial props. We say that f is a *weak equivalence* if

W1: for each input-output profile $(\underline{a}; \underline{b})$ in $\text{Col}(\mathcal{R})$ the morphism

$$f : \mathcal{R}(\underline{a}; \underline{b}) \longrightarrow \mathcal{T}(f\underline{a}; f\underline{b})$$

is a weak homotopy equivalence of simplicial sets; and

W2: the functor $\pi_0 f : \pi_0 \mathcal{R} \rightarrow \pi_0 \mathcal{T}$ from (4) is an equivalence of categories.

We say that the morphism f is a *fibration* if

F1: for each input-output profile $(\underline{a}; \underline{b})$ in $\text{Col}(\mathcal{R})$ the morphism

$$f : \mathcal{R}(\underline{a}; \underline{b}) \longrightarrow \mathcal{T}(f\underline{a}; f\underline{b})$$

is a Kan fibration of simplicial sets; and

F2: the functor $\pi_0 f : \pi_0 \mathcal{R} \rightarrow \pi_0 \mathcal{T}$ is an isofibration.

Main Theorem. *The category of simplicial props \mathbf{sProp} admits a cofibrantly generated model category structure with the above classes of weak equivalences and fibrations. Cofibrations are those morphisms which have the left lifting property (LLP) with respect to the acyclic fibrations.*

In the special case where we consider simplicial categories as simplicial props, the conditions (W1) and (W2) are precisely those conditions that give a weak equivalence of simplicial categories in the Bergner model structure. In the case where \mathcal{R} and \mathcal{T} are two simplicial props with the same set \mathfrak{C} of colors and f acts as the *identity* of \mathfrak{C} , then condition (W1) implies (W2). Thus such an f is a weak equivalence if and only if it is a weak equivalence in the Johnson-Yau model structure on $\mathbf{sProp}_{\mathfrak{C}}$ from Theorem 4.5.

We further note that there is a similar model structure on the category of simplicial colored operads, $\mathbf{sOperad}$, which was shown by the second author [37] and independently by Cisinski and Moerdijk [8]. Notice that the model structure on \mathbf{sProp} is *not* lifted from the model structure on $\mathbf{sOperad}$ across the adjunction (F_0, U_0) .

Corollary 5.2. *The adjunction $F_0 : \mathbf{sOperad} \rightleftarrows \mathbf{sProp} : U_0$ is a Quillen adjunction.*

Proof. The forgetful functor U_0 preserves fibrations and acyclic fibrations. \square

We provide an explicit description of the generating cofibrations and generating acyclic cofibrations. For this purpose, we will need the following construction. Each (n, m) -corolla determines a prop $\mathcal{G}_{n,m}$, as described in Definition 3.9. Then, given a simplicial set X and integers $n, m \geq 0$, we denote by $\mathcal{G}_{n,m}[X]$ the free simplicial prop with (n, m) -ary operations decorated by the simplicial set X . In other words, the simplicial prop $\mathcal{G}_{n,m}[X]$ has colors $a_1, \dots, a_n; b_1, \dots, b_m$ and

$$(7) \quad \mathcal{G}_{n,m}[X](a_1, \dots, a_n; b_1, \dots, b_m) = X.$$

This construction is functorial in X .

Remark 5.3. The props $\mathcal{G}_{n,m}[X]$ are characterized by the property that a map $f : \mathcal{G}_{n,m}[X] \rightarrow \mathcal{T}$ consists of a set map

$$\{a_1, \dots, a_n, b_1, \dots, b_m\} \rightarrow \text{Col } \mathcal{T}$$

together with a simplicial set map

$$f : X \rightarrow \mathcal{T}(fa_1, \dots, fa_n, fb_1, \dots, fb_m).$$

Recall that \mathcal{I} is the category with one object x and no non-identity morphisms and that we have fixed a specific set of generating (acyclic) cofibrations for \mathbf{sSet} (5), (6).

Definition 5.4 (Generating cofibrations). The set I of generating cofibrations consists of the following morphisms of simplicial props:

- C1:** Given a generating cofibration $K \hookrightarrow L$ in the model structure on \mathbf{sSet} , the induced morphisms of props $\mathcal{G}_{n,m}[K] \rightarrow \mathcal{G}_{n,m}[L]$ for each $n, m \in \mathbb{N}$.
- C2:** The map $\emptyset \hookrightarrow F_0(\mathcal{I})$; we will usually write this as just $\emptyset \hookrightarrow \mathcal{I}$ when no confusion will result.

As in section 4.1, we consider simplicial categories \mathcal{H} with two objects x and y , weakly contractible function complexes, and only countably many simplices in each function complex. Furthermore, we require that each such \mathcal{H} is cofibrant in the Dwyer-Kan model category structure on $\mathbf{sCat}_{\{x,y\}}$ [9]. Let \mathbf{H} denote a set of representatives of isomorphism classes of such categories.

Definition 5.5 (Generating acyclic cofibrations). The set J of generating acyclic cofibrations consists of the following morphisms of simplicial props:

- A1:** Given a generating acyclic cofibration $K \hookrightarrow L$ of the model structure on \mathbf{sSet} , the morphisms $\mathcal{G}_{n,m}[K] \rightarrow \mathcal{G}_{n,m}[L]$ for each $n, m \in \mathbb{N}$.
- A2:** The maps $F_0(\mathcal{I} \hookrightarrow \mathcal{H})$ for $\mathcal{H} \in \mathbf{H}$ which take x to x ; as in (C2), we will abuse notation and denote this map by $\mathcal{I} \hookrightarrow \mathcal{H}$.

Note that all of the morphisms in (A1) are weak equivalences in the Johnson-Yau model structure on $\mathbf{sProp}_{\{a_1, \dots, a_n; b_1, \dots, b_m\}}$ and thus are weak equivalences in \mathbf{sProp} .

The proof of our main theorem applies Kan's recognition theorem for cofibrantly generated model categories (see [18, 11.2.1] or [19, 2.1.19]). We begin by verifying compatibility of Definitions 5.4 and 5.5 with our (acyclic) fibrations from 5.1.

5.1. Classification of (acyclic) fibrations. As we will show later, the saturation of the set of generating acyclic cofibrations J , denoted by \bar{J} , is the class of acyclic cofibrations in \mathbf{sProp} . Similarly, the saturation of the set of generating cofibrations I , denoted by \bar{I} , is the class of cofibrations in \mathbf{sProp} . In the following two lemmas we show that this is consistent with our choice of fibrations and acyclic fibrations.

Lemma 5.6. *A morphism of simplicial props $f : \mathcal{R} \rightarrow \mathcal{T}$ has the right lifting property with respect to the class \bar{J} if, and only if, f is a fibration of simplicial props.*

Proof. Let $K \hookrightarrow L$ be a generating acyclic cofibration of \mathbf{sSet} . Remark 5.3 implies that a morphism of simplicial props $f : \mathcal{R} \rightarrow \mathcal{T}$ has the right lifting property (RLP) with respect to $j : \mathcal{G}_{n,m}[K] \hookrightarrow \mathcal{G}_{n,m}[L]$ for some $n, m \in \mathbb{N}$ if, and only if, for each input-output profile $c_1, \dots, c_n; d_1, \dots, d_m$ in \mathcal{R} , the map of simplicial sets $f : \mathcal{R}(c; d) \rightarrow \mathcal{T}(f c; f d)$ has the RLP with respect to $K \hookrightarrow L$. Thus f satisfies (F1) if and only if f has the RLP with respect to every map j in (A1).

Assume now that f has the RLP with respect to a prop morphism in the set (A2). To avoid confusion with the simplicial functors $\mathcal{I} \hookrightarrow \mathcal{H}$, we will write $F_0\mathcal{I} \hookrightarrow F_0\mathcal{H}$ when considering maps of simplicial props in (A2) for the remainder of the proof.

If f is a fibration, then $U_0(f)$ is a fibration in \mathbf{sCat} , so $U_0(f)$ has the RLP with respect to all of the simplicial functors $\mathcal{I} \hookrightarrow \mathcal{H}$ from Proposition 4.4. A commutative square

$$\begin{array}{ccc} F_0\mathcal{I} & \longrightarrow & \mathcal{R} \\ \downarrow & & \downarrow \\ F_0\mathcal{H} & \longrightarrow & \mathcal{T} \end{array}$$

factors as

$$\begin{array}{ccccc} F_0\mathcal{I} & \longrightarrow & F_0U_0\mathcal{R} & \longrightarrow & \mathcal{R} \\ \downarrow & & \downarrow & & \downarrow \\ F_0\mathcal{H} & \longrightarrow & F_0U_0\mathcal{T} & \longrightarrow & \mathcal{T} \end{array}$$

(A dotted arrow points from $F_0\mathcal{H}$ to $F_0U_0\mathcal{R}$.)

where the dotted lift exists since $U_0F_0 = \text{id}_{\mathbf{sCat}}$ and $U_0(f)$ has the RLP with respect to $\mathcal{I} \hookrightarrow \mathcal{H}$. Thus f has the RLP with respect to maps in (A2). On the other hand, if f has the RLP with respect to the maps $F_0\mathcal{I} \rightarrow F_0\mathcal{H}$ in (A2) and we have a commutative square

$$\begin{array}{ccc} \mathcal{I} & \longrightarrow & U_0\mathcal{R} \\ \downarrow & & \downarrow \\ \mathcal{H} & \longrightarrow & U_0\mathcal{T}, \end{array}$$

we know that we have a dotted lift in

$$\begin{array}{ccccc} F_0\mathcal{I} & \longrightarrow & F_0U_0\mathcal{R} & \longrightarrow & \mathcal{R} \\ \downarrow & & \downarrow & & \downarrow \\ F_0\mathcal{H} & \longrightarrow & F_0U_0\mathcal{T} & \longrightarrow & \mathcal{T}. \end{array}$$

(A dotted arrow points from $F_0\mathcal{H}$ to \mathcal{R} .)

This map factors through $F_0U_0\mathcal{R}$, and applying U_0 we have the desired lift $\mathcal{H} = U_0F_0\mathcal{H} \rightarrow U_0F_0U_0\mathcal{R} = U_0\mathcal{R}$. Thus $U_0(f)$ has the RLP with respect to maps of the form $\mathcal{I} \rightarrow \mathcal{H}$. If, furthermore, we assume that f has the RLP with respect to maps in (A1), then, in particular, it has the RLP with respect to the maps $\mathcal{G}_{1,1}[K] \rightarrow \mathcal{G}_{1,1}[L]$, and so $U_0(f)$ is a fibration in \mathbf{sCat} by Proposition 4.4. Thus $\pi_0(U_0(f)) = \pi_0(f)$ is a fibration of categories, and we already knew that f satisfied (F1), so f is a fibration in \mathbf{sProp} . \square

Lemma 5.7. *A morphism $f : \mathcal{R} \rightarrow \mathcal{T}$ has the right lifting property with respect to the class \bar{I} if, and only if, f is an acyclic fibration of simplicial props.*

Proof. The proof is nearly identical to that of Lemma 5.6. \square

5.2. Relative J -cell complexes and proof of the main theorem. The subcategory of *relative J -cell complexes* consists of those maps which can be constructed as a transfinite composition of pushouts of elements of J .

Proposition 5.8. *Every relative J -cell complex is a weak equivalence.*

It is enough to show that a pushout of a map in J is a weak equivalence. In this section we will analyze the maps (A1) from Definition 5.5. Analysis of the maps (A2) is considerably more involved, and will be deferred until sections 7–9.

Proposition 5.9. *Let $f : \mathcal{B} \rightarrow \mathcal{R}$ be a morphism of props with color map α . Then there is a unique map $\tilde{f} : \alpha_1\mathcal{B} \rightarrow \mathcal{R}$ so that $\mathcal{B} \rightarrow \mathcal{R}$ factors as $\mathcal{B} \rightarrow \alpha_1\mathcal{B} \rightarrow \mathcal{R}$. This decomposition is functorial.*

Proof. Recall that $\alpha^*\mathcal{R}(a; b) = \mathcal{R}(\alpha a; \alpha b)$ and that the map $\mathcal{B} \rightarrow \alpha_1\mathcal{B}$ is defined by

$$\mathcal{B} \rightarrow \alpha^*\alpha_1\mathcal{B} \rightarrow \alpha_1\mathcal{B}$$

where the first map is the unit of the adjunction. Write

$$\Phi : \text{Hom}(\alpha_1\mathcal{B}, \mathcal{R}) \xrightarrow{\cong} \text{Hom}(\mathcal{B}, \alpha^*\mathcal{R})$$

for the adjunction isomorphism. Existence and uniqueness follow from the diagram

$$\begin{array}{ccccc}
 \mathcal{B} & \xrightarrow{\text{unit}} & \alpha^* \alpha_! \mathcal{B} & \longrightarrow & \alpha_! \mathcal{B} \\
 & \searrow & \downarrow \alpha^* \tilde{f} & & \downarrow \tilde{f} \\
 & & \alpha^* \mathcal{R} & \longrightarrow & \mathcal{R}
 \end{array}$$

and the fact that $\Phi(\tilde{f})$ must be defined by

$$\begin{array}{ccc}
 & & \mathcal{R}(\alpha \underline{a}; \alpha \underline{b}) \\
 & \nearrow f & \cong \downarrow \\
 \mathcal{B}(\underline{a}; \underline{b}) & \xrightarrow[\Phi(\tilde{f})]{} & \alpha^* \mathcal{R}(\underline{a}; \underline{b})
 \end{array}$$

since the composite $\mathcal{B} \xrightarrow{\Phi(\tilde{f})} \alpha^* \mathcal{R} \rightarrow \mathcal{R}$ needs to be f .

□

Proposition 5.10. *Let $j : \mathcal{A} \rightarrow \mathcal{B}$ be a morphism in $\mathbf{sProp}_{\mathcal{C}}$ and $\alpha : \mathcal{C} \rightarrow \mathcal{D}$ a map of sets. Then*

$$\begin{array}{ccc}
 \mathcal{A} & \longrightarrow & \alpha_! \mathcal{A} \\
 \downarrow j & & \downarrow \alpha_! j \\
 \mathcal{B} & \longrightarrow & \alpha_! \mathcal{B}
 \end{array}$$

is a pushout in \mathbf{sProp} .

Proof. Suppose we have a diagram

$$\begin{array}{ccc}
 \mathcal{A} & \longrightarrow & \alpha_! \mathcal{A} \\
 \downarrow & & \downarrow \\
 \mathcal{B} & \longrightarrow & \alpha_! \mathcal{B} \\
 & \searrow x & \downarrow \beta \\
 & & \mathcal{R}
 \end{array}$$

where $\alpha_! \mathcal{A} \rightarrow \mathcal{R}$ has color map β . If $\beta = \text{id}_{\mathcal{D}}$, then the dotted arrow exists and is unique by the previous proposition.

If β is not the identity, then $x : \mathcal{B} \rightarrow \mathcal{R}$ has color map $\beta\alpha$. Consider the diagram

$$\begin{array}{ccccccc}
 \mathcal{A} & \longrightarrow & \alpha_! \mathcal{A} & \longrightarrow & \beta_! \alpha_! \mathcal{A} & & \\
 \downarrow j & & \downarrow \alpha_! j & & \downarrow & \searrow & \\
 \mathcal{B} & \xrightarrow{i} & \alpha_! \mathcal{B} & \xrightarrow{i'} & (\beta\alpha)_! \mathcal{B} & \xrightarrow{\tilde{x}} & \mathcal{R} \\
 & \searrow x & \downarrow & \searrow q & & & \\
 & & & & & &
 \end{array}$$

The arrow $\tilde{x} : (\beta\alpha)_! \mathcal{B} \rightarrow \mathcal{R}$ exists by the previous paragraph, which implies that the dotted arrow q exists as well. If we had some other map, say q_0 , which made

the diagram

$$\begin{array}{ccc}
 \mathcal{A} & \longrightarrow & \alpha_1 \mathcal{A} \\
 \downarrow & & \downarrow \\
 \mathcal{B} & \xrightarrow{i} & \alpha_1 \mathcal{B} \\
 & \searrow x & \swarrow q_0 \\
 & & \mathcal{R}
 \end{array}$$

commute, then we can factor q_0 uniquely as

$$q_0 : \alpha_1 \mathcal{B} \xrightarrow{i'} \beta_1 \alpha_1 \mathcal{B} \xrightarrow{\tilde{q}_0} \mathcal{R}.$$

Thus $x = q_0 i = \tilde{q}_0 i' i$. Of course x factors uniquely as

$$x : \mathcal{B} \xrightarrow{i' i} (\beta \alpha)_1 \mathcal{B} \xrightarrow{\tilde{x}} \mathcal{R},$$

so we see that $\tilde{q}_0 = \tilde{x}$, implying that $q_0 = \tilde{q}_0 i' = \tilde{x} i' = q$. \square

Lemma 5.11. *Consider the following pushout square in the category of simplicial props*

$$\begin{array}{ccc}
 \mathcal{A} & \xrightarrow{f} & \mathcal{A}' \\
 \downarrow j & & \downarrow g \\
 \mathcal{B} & \xrightarrow{k} & \mathcal{B}'
 \end{array}$$

If $j : \mathcal{A} \rightarrow \mathcal{B}$ is an acyclic cofibration of $\mathbf{sProp}_{\mathfrak{C}}$ and $f : \mathcal{A} \rightarrow \mathcal{A}'$ is a morphism of simplicial props, then $g : \mathcal{A}' \rightarrow \mathcal{B}'$ is a weak equivalence in \mathbf{sProp} .

Proof. Let $\alpha := \text{Col}(f) : \mathfrak{C} \rightarrow \mathfrak{D} = \text{Col}(\mathcal{A}')$. Since $j : \mathcal{A} \rightarrow \mathcal{B}$ is an acyclic cofibration in $\mathbf{sProp}_{\mathfrak{C}}$, $\alpha_1 j$ is an acyclic cofibration in $\mathbf{sProp}_{\mathfrak{D}}$ by Proposition 4.6. We know that the left hand square in

$$\begin{array}{ccccc}
 \mathcal{A} & \longrightarrow & \alpha_1 \mathcal{A} & \longrightarrow & \mathcal{A}' \\
 \downarrow j & & \downarrow \alpha_1 j & & \downarrow g \\
 \mathcal{B} & \longrightarrow & \alpha_1 \mathcal{B} & \longrightarrow & \mathcal{B}'
 \end{array}$$

is a pushout by Proposition 5.10 and the full rectangle is a pushout by assumption, so the right rectangle is a pushout in \mathbf{sProp} as well. This implies that the right hand rectangle is a pushout in $\mathbf{sProp}_{\mathfrak{D}}$, proving that g is an acyclic cofibration in $\mathbf{sProp}_{\mathfrak{D}}$. Since g is a weak equivalence in $\mathbf{sProp}_{\mathfrak{D}}$, g is, in particular, a weak equivalence in \mathbf{sProp} . \square

The following proposition is quite subtle, and forms the technical heart of this paper.

Proposition 5.12. *Let \mathcal{T} be a simplicial prop, $f : \mathcal{I} \rightarrow \mathcal{T}$ a morphism of simplicial props, and let $j : \mathcal{I} \rightarrow \mathcal{H}$ be a generating acyclic cofibration. Given the pushout*

diagram

$$\begin{array}{ccc} \mathcal{I} & \xrightarrow{f} & \mathcal{T} \\ j \downarrow & & \downarrow g \\ \mathcal{H} & \longrightarrow & \mathcal{P} \end{array}$$

the map g satisfies (W1).

We will present a proof of Proposition 5.12 beginning in section 6 and continuing until the end of the paper. Here is an alternative suggestion for a method of proof, which we've only been able to work out parts of, and which presents considerable technical difficulties of its own. One would like to be able to adapt the proof of [3, 3.4] to the prop setting, but a major hurdle is that the category of props is not left proper (see [15]). On the other hand, we suspect that this category is 'relatively left proper' in the sense of [15], i.e. that pushouts of weak equivalences between Σ -cofibrant props are again weak equivalences. This is likely enough to modify the proof in [3] to the present setting.

Proof of Proposition 5.8, assuming Proposition 5.12. It is enough to show that the pushout of a generating acyclic cofibration is a weak equivalence. In other words, given $j : \mathcal{A} \rightarrow \mathcal{B}$ which is in either the set (A1) or the set (A2), if

$$\begin{array}{ccc} \mathcal{A} & \xrightarrow{f} & \mathcal{T} \\ j \downarrow & & \downarrow g \\ \mathcal{B} & \xrightarrow{k} & \mathcal{P} \end{array}$$

is a pushout square in \mathbf{sProp} , then g is a weak equivalence. First, let us assume that j is in (A1) and thus is of the form $j : \mathcal{G}_{n,m}[K] \rightarrow \mathcal{G}_{n,m}[L]$ where $K \rightarrow L$ is a generating acyclic cofibration of \mathbf{sSet} (see (6)).

Then $j : \mathcal{G}_{n,m}[K] \rightarrow \mathcal{G}_{n,m}[L]$ is an acyclic cofibration in $\mathbf{sProp}_{\{a_1, \dots, a_n, b_1, \dots, b_m\}}$ (since fibrations are defined levelwise), so g is a weak equivalence by Lemma 5.11.

Now we assume that j is an acyclic cofibration from set (A2) and consider the following pushout square:

$$\begin{array}{ccc} \mathcal{I} & \xrightarrow{f} & \mathcal{T} \\ j \downarrow & & \downarrow g \\ \mathcal{H} & \xrightarrow{k} & \mathcal{P}. \end{array}$$

We know that g satisfies (W1) by Proposition 5.12, which implies that $\pi_0(g)$ is a fully faithful functor. Thus, to show that g satisfies (W2), we must show that $\pi_0(g)$ is essentially surjective. But notice that

$$\mathrm{Ob} \pi_0 \mathcal{P} = \mathrm{Ob} U_0 \mathcal{P} = \mathrm{Col} \mathcal{P} = (\mathrm{Ob} \pi_0 \mathcal{T}) \amalg \{y\},$$

so we just need to show that y is isomorphic to an object in the image of $\pi_0(g)$; we will show that $y \cong \pi_0(g)x$. Let $a \in \mathcal{H}(x, y)_0$ and $b \in \mathcal{H}(y, x)_0$. Then since $\mathcal{H}(x, x)$ and $\mathcal{H}(y, y)$ are weakly contractible, $a \circ b$ is in the same path component as id_x and $b \circ a$ is in the same path component as id_y . Hence $k(a \circ b) = k(a) \circ k(b)$ is in the same path component as $k(\mathrm{id}_x) = \mathrm{id}_{\pi_0(g)x}$ and $k(b) \circ k(a)$ is in the same path component as id_y . Hence $y \cong \pi_0(g)x$ in $\pi_0 \mathcal{P}$. \square

We can now prove the existence of the model category structure on the category of all small simplicial props.

Proof of Main Theorem, assuming Proposition 5.12. To prove the main theorem we will apply Kan’s recognition theorem for cofibrantly generated model categories; we will indicate why the conditions of [19, 2.1.19] are satisfied.

The category **Prop** is bicomplete (see [14]), hence so is **sProp**. Weak equivalences are closed under retracts and satisfy the “2-out-3” property using the corresponding properties from **sSet** and **Cat**. The domains of I and J , namely $\mathcal{G}_{n,m}[\partial\Delta[p]]$, $\mathcal{G}_{n,m}[\Lambda[p,k]]$, \emptyset , and \mathcal{I} , are all small [19, 2.1.3]. Thus (1), (2), and (3) hold. Our classification of fibrations and acyclic cofibrations, Lemmas 5.6 and 5.7, imply (5) and (6). Finally, (4) follows directly from Proposition 5.8 and the classification of fibrations given in Lemma 5.6. \square

5.3. sProp is right proper. The model structure on **sCat** from Theorem 4.2 was right proper, and we now show that the same is true for the model structure on **sProp**. The category **sProp** is not left proper, due to a counterexample of Dwyer given in [15].

Lemma 5.13. *Let*

$$\begin{array}{ccc} \mathcal{A} & \xrightarrow{h} & \mathcal{R} \\ \downarrow f & & \downarrow g \\ \mathcal{B} & \xrightarrow{k} & \mathcal{T} \end{array}$$

be a pullback square in **sProp**. Then, for any input-output profile $(\underline{c}; \underline{d})$ in \mathcal{A} , the diagram

$$\begin{array}{ccc} \mathcal{A}(\underline{c}; \underline{d}) & \xrightarrow{h} & \mathcal{R}(h\underline{c}; h\underline{d}) \\ \downarrow f & & \downarrow g \\ \mathcal{B}(f\underline{c}; f\underline{d}) & \xrightarrow{k} & \mathcal{T}(gh\underline{c}; kf\underline{d}) \end{array}$$

is a pullback in **sSet**.

Proof. A commutative diagram of the form

$$\begin{array}{ccc} X & & \\ & \searrow & \\ & & \mathcal{A}(\underline{c}; \underline{d}) \xrightarrow{h} \mathcal{R}(h\underline{c}; h\underline{d}) \\ & & \downarrow f \qquad \downarrow g \\ & & \mathcal{B}(f\underline{c}; f\underline{d}) \xrightarrow{k} \mathcal{T}(gh\underline{c}; kf\underline{d}) \end{array}$$

gives

$$\begin{array}{ccc} \mathcal{G}_{n,m}[X] & & \\ & \searrow & \\ & & \mathcal{A} \xrightarrow{h} \mathcal{R} \\ & & \downarrow f \qquad \downarrow g \\ & & \mathcal{B} \xrightarrow{k} \mathcal{T} \end{array}$$

and so p induces the necessary map $X \rightarrow \mathcal{A}(\underline{c}; \underline{d})$. \square

Proposition 5.14. *The model category structure on \mathbf{sProp} is right proper. In other words, every pullback of a weak equivalence along a fibration is a weak equivalence.*

Proof. Let

$$\begin{array}{ccc} \mathcal{A} & \xrightarrow{h} & \mathcal{R} \\ \downarrow f & & \downarrow g \\ \mathcal{B} & \xrightarrow{k} & \mathcal{T} \end{array}$$

be a pullback square in \mathbf{sProp} with g a weak equivalence and k a fibration.

Since U_0 is a right adjoint it preserves pullbacks, and, moreover, is a right Quillen functor so preserves fibrations as well. By inspection U_0 preserves weak equivalences. Thus $U_0(f)$ a weak equivalence in the model structure on \mathbf{sCat} , so f satisfies (W2). The previous lemma and the fact that \mathbf{sSet} is right proper [18, 13.1.13] imply that f satisfies (W1). \square

6. A MODEL FOR THE PUSHOUT IN SIMPLICIAL PROPS

Recall, from Theorem 3.10, the \mathbf{Cat} -enriched \mathfrak{C} -colored prop $\mathbf{G}_{\mathfrak{C}} = \{\mathbf{G}_{\mathfrak{C}}(\underline{c}; \underline{d})\}$. The objects of the category $\mathbf{G}_{\mathfrak{C}}(\underline{c}; \underline{d})$ are \mathfrak{C} -colored graphs and morphisms are defined by graph substitution. In this section we introduce a variant of $\mathbf{G}_{\mathfrak{C}}(\underline{c}; \underline{d})$ to obtain a prop enriched in \mathbf{Cat} which models pushouts of props. Suppose that we want to model a pushout

$$\begin{array}{ccc} \mathcal{G} & \xrightarrow{m_b} & \mathcal{B} \\ \downarrow m_w & & \\ \mathcal{W} & & \end{array}$$

where \mathcal{W} , \mathcal{G} and \mathcal{B} are simplicial props. We know that the pushout simplicial prop will have color set $\mathfrak{C} = \text{Col}(\mathcal{W}) \amalg_{\text{Col}(\mathcal{G})} \text{Col}(\mathcal{B})$. The operations, however, are complicated; each operation is represented by a \mathfrak{C} -colored graph where each vertex is labelled by an operation from either \mathcal{W} , \mathcal{G} , or \mathcal{B} . To help visualize these operations, imagine that said vertices are colored by either white, grey, or black. We now introduce a \mathbf{Cat} -enriched \mathfrak{C} -colored prop $\mathbf{B}_{\mathfrak{C}}$ which has \mathfrak{C} -colored graphs with $\{g, w, b\}$ -labelled vertices as objects and morphisms defined by graph substitution.

Definition 6.1. Let \mathfrak{C} be a set and let $(\underline{c}; \underline{d})$ be some fixed input-output profile. Define a category $\mathbf{B}(\underline{c}; \underline{d})$ as follows.

- The objects of $\mathbf{B}(\underline{c}; \underline{d})$ are graphs $G \in \mathbf{G}_{\mathfrak{C}}(\underline{c}; \underline{d})$ together with a partition function $\boxplus : \text{Vt}(G) \rightarrow \{g, w, b\}$, coloring each vertex either grey, white, or black.
- A *gsd map* $(G, \boxplus) \rightarrow (J, \boxplus')$ is a graph substitution decomposition $G = J\{K_v\}_{v \in \text{Vt}(J)}$ of G so that $\boxplus(v') = \boxplus'(v)$ for every $v' \in \text{Vt}(K_v)$.
- Given such a gsd map, there is a map of sets

$$f_{\text{Vt}} : \text{Vt}(G) \rightarrow \text{Vt}(J)$$

which takes every vertex in K_v to v .

- A *transfusion* $q : \boxplus \rightarrow \boxplus'$ of partitions of G turns some grey vertices into either white vertices or black vertices. There is at most one transfusion between any two partitions. The requirement to have a transfusion is that if $\boxplus(v) \in \{w, b\}$, then $\boxplus'(v) = \boxplus(v)$.
- Morphisms of $\mathbf{B}(\underline{c}; \underline{d})$ consist of a transfusion followed by a gsd map. We write such morphisms as (f, q) where $q : \boxplus' \rightarrow \boxplus$ is a transfusion and f is a gsd map on (G, \boxplus) ; if f or q is an identity, we will write (f, q) as just q or f , respectively.

Let us now define the composition in $\mathbf{B}(\underline{c}; \underline{d})$. Given two morphisms of $\mathbf{B}(\underline{c}; \underline{d})$

$$\begin{aligned} (G, \boxplus_1) &\xrightarrow{q'} (G, \boxplus_2) \xrightarrow{f} (J, \boxplus'_2) \\ (J, \boxplus'_2) &\xrightarrow{q} (J, \boxplus_3) \xrightarrow{g} (K, \boxplus'_3), \end{aligned}$$

where q', q are transfusions and f, g are gsd maps, the composition in $\mathbf{B}(\underline{c}; \underline{d})$ is defined by considering the composite

$$(8) \quad f^* \boxplus_3 : \text{Vt}(G) \xrightarrow{f_{\text{Vt}}} \text{Vt}(J) \xrightarrow{\boxplus_3} \{g, w, b\},$$

filling in the diagram (which we do momentarily)

$$(9) \quad \begin{array}{ccccc} (G, \boxplus_1) & \xrightarrow{q'} & (G, \boxplus_2) & \xrightarrow{f^* q} & (G, f^* \boxplus_3) \\ & & \downarrow f & & \downarrow f \\ (J, \boxplus'_2) & \xrightarrow{q} & (J, \boxplus_3) & & \\ & & \downarrow g & & \\ & & (K, \boxplus'_3) & & \end{array}$$

and setting $(g, q) \circ (f, q') = (gf, (f^* q)q')$. To see that there is a transfusion $f^* q : \boxplus_2 \rightarrow f^* \boxplus_3$, note that if $\boxplus_2(v) \in \{w, b\}$, then $\boxplus_2 f_{\text{Vt}}(v) = \boxplus_2(v) \in \{w, b\}$, hence we have the middle equality in

$$(f^* \boxplus_3)(v) = \boxplus_3 f_{\text{Vt}}(v) = \boxplus_2 f_{\text{Vt}}(v) = \boxplus_2(v).$$

Proposition 6.2. *With the composition given above, $\mathbf{B}(\underline{c}; \underline{d})$ is a category.*

Proof. We will show that composition is associative, i.e. that $(f_3, q_3) \circ (f_2, q_2) \circ (f_1, q_1)$ doesn't depend on choice of parenthesization. In the diagram

$$\begin{array}{ccccc} (G, \boxplus_0) & \xrightarrow{q_1} & (G, \boxplus_1) & & \\ & & \downarrow f_1 & & \\ (J, \boxplus'_1) & \xrightarrow{q_2} & (J, \boxplus_2) & & \\ & & \downarrow f_2 & & \\ (K, \boxplus'_2) & \xrightarrow{q_3} & (K, \boxplus_3) & & \\ & & \downarrow f_3 & & \\ & & (L, \boxplus'_3) & & \end{array}$$

only the black portion is relevant for this task. Unraveling, we have

$$\begin{array}{ccccc}
 (G, \boxplus_1) & \xrightarrow{f_1^* q_2} & (G, f_1^* \boxplus_2) & \xrightarrow{(f_2 f_1)^* q_3} & (G, (f_2 f_1)^* \boxplus_3) \\
 \downarrow f_1 & & \downarrow f_1 & & \downarrow f_2 f_1 \\
 (J, \boxplus'_1) & \xrightarrow{q_2} & (J, \boxplus_2) & & \\
 & & \downarrow f_2 & & \\
 & & (K, \boxplus'_2) & \xrightarrow{q_3} & (K, \boxplus_3)
 \end{array}$$

and

$$\begin{array}{ccccc}
 (G, \boxplus_1) & \xrightarrow{f_1^* (f_2^* q_3 \circ q_2)} & (G, f_1^* (f_2^* \boxplus_3)) & & \\
 \downarrow f_1 & & \downarrow f_1 & & \\
 (J, \boxplus'_1) & \xrightarrow{q_2} & (J, \boxplus_2) & \xrightarrow{f_2^* q_3} & (J, f_2^* \boxplus_3) \\
 & & \downarrow f_2 & & \downarrow f_2 \\
 & & (K, \boxplus'_2) & \xrightarrow{q_3} & (K, \boxplus_3)
 \end{array}$$

defining the two ways to compose. But there is at most one transfusion between two partitions, hence we must just show that

$$(f_2 f_1)^* \boxplus_3 = f_1^* (f_2^* \boxplus_3).$$

This follows immediately from the definition (8). \square

Theorem 6.3. *If we allow the input-output profiles $(\underline{c}; \underline{d})$ to vary, graph substitution produces a \mathfrak{C} -colored prop $\mathbf{B} = \mathbf{B}_{\mathfrak{C}}$ enriched in \mathbf{Cat} .*

Proof. This is a variation on Proposition 3.10. If J is a \mathfrak{C} -colored graph and we have a collection of objects $(K_v, \boxplus_v) \in \mathbf{B}(\text{in}(v); \text{out}(v))$ ranging over the vertices of J , then the graph substitution

$$G = J\{K_v\}$$

is an object of $\mathbf{B}(\text{in}(J); \text{out}(J))$ by considering the partition

$$\left(\coprod_{\text{Vt}(J)} \boxplus_v \right) : \text{Vt}(G) = \coprod_{\text{Vt}(J)} \text{Vt}(K_v) \rightarrow \{g, w, b\}.$$

\square

Suppose we are given a pushout diagram in \mathbf{sProp} that we wish to compute. Then we define decoration functors $D_{(\underline{c}; \underline{d})} : \mathbf{B}(\underline{c}; \underline{d}) \rightarrow \mathbf{sSet}$ so that $\{\text{colim } D_{(\underline{c}; \underline{d})}\}$ will be the underlying megagraph of the pushout.

Definition 6.4. Suppose we have two prop morphisms

$$\mathcal{W} \xrightarrow{m_w} \mathcal{G} \xrightarrow{m_b} \mathcal{B},$$

and set $\mathfrak{C} = \text{Col}(\mathcal{W}) \amalg_{\text{Col}(\mathcal{G})} \text{Col}(\mathcal{B})$. For a given input-output profile $(\underline{c}; \underline{d})$ we describe a *decoration functor* $D_{(\underline{c}; \underline{d})} : \mathbf{B}(\underline{c}; \underline{d}) \rightarrow \mathbf{sSet}$ as follows.

(1) On objects of $\mathbf{B}(\underline{c}; \underline{d})$ we define $D_{(\underline{c}; \underline{d})}(G, \boxplus)$ to be

$$\left[\prod_{\boxplus(v)=w} \mathcal{W}(\text{in}(v); \text{out}(v)) \right] \times \left[\prod_{\boxplus(v)=b} \mathcal{B}(\text{in}(v); \text{out}(v)) \right] \times \left[\prod_{\boxplus(v)=g} \mathcal{G}(\text{in}(v); \text{out}(v)) \right].$$

(2) On transfusions $\boxplus \rightarrow \boxplus'$, we define $D_{(\underline{c}; \underline{d})}(G, \boxplus) \rightarrow D_{(\underline{c}; \underline{d})}(G, \boxplus')$ by applying m_w and m_b to the \mathcal{G} -decorations of the grey vertices of G

$$\begin{aligned} & \left[\prod_{\boxplus(v)=g} \mathcal{G}(\text{in}(v); \text{out}(v)) \right] \\ & \cong \left[\prod_{\boxplus'(v)=g} \mathcal{G}(\text{in}(v); \text{out}(v)) \right] \times \left[\prod_{\substack{\boxplus(v)=g \\ \boxplus'(v)=w}} \mathcal{G}(\text{in}(v); \text{out}(v)) \right] \times \left[\prod_{\substack{\boxplus(v)=g \\ \boxplus'(v)=b}} \mathcal{G}(\text{in}(v); \text{out}(v)) \right] \\ & \text{id} \times m_w \times m_b \left[\prod_{\boxplus'(v)=g} \mathcal{G}(\text{in}(v); \text{out}(v)) \right] \times \left[\prod_{\substack{\boxplus(v)=g \\ \boxplus'(v)=w}} \mathcal{W}(\text{in}(v); \text{out}(v)) \right] \times \left[\prod_{\substack{\boxplus(v)=g \\ \boxplus'(v)=b}} \mathcal{B}(\text{in}(v); \text{out}(v)) \right] \end{aligned}$$

and then rearranging to get a map

$$\begin{aligned} & \left[\prod_{\boxplus(v)=w} \mathcal{W}(\text{in}(v); \text{out}(v)) \right] \times \left[\prod_{\boxplus(v)=b} \mathcal{B}(\text{in}(v); \text{out}(v)) \right] \times \left[\prod_{\boxplus(v)=g} \mathcal{G}(\text{in}(v); \text{out}(v)) \right] \\ \rightarrow & \left[\prod_{\boxplus'(v)=w} \mathcal{W}(\text{in}(v); \text{out}(v)) \right] \times \left[\prod_{\boxplus'(v)=b} \mathcal{B}(\text{in}(v); \text{out}(v)) \right] \times \left[\prod_{\boxplus'(v)=g} \mathcal{G}(\text{in}(v); \text{out}(v)) \right]. \end{aligned}$$

(3) On gsd maps $f : (G, \boxplus) \rightarrow (J, \boxplus')$ with $G = J\{K_v\}_{v \in \text{Vt}(J)}$,

$$D_{(\underline{c}; \underline{d})}f : D_{(\underline{c}; \underline{d})}(G, \boxplus) \rightarrow D_{(\underline{c}; \underline{d})}(J, \boxplus')$$

is defined by

$$\begin{aligned} & \left[\prod_{\boxplus(v')=w} \mathcal{W}(\text{in}(v'); \text{out}(v')) \right] \times \left[\prod_{\boxplus(v')=b} \mathcal{B}(\text{in}(v'); \text{out}(v')) \right] \times \left[\prod_{\boxplus(v')=g} \mathcal{G}(\text{in}(v'); \text{out}(v')) \right] \\ & \xrightarrow{\cong} \left[\prod_{\boxplus'(v)=w} \mathcal{W}[K_v] \right] \times \left[\prod_{\boxplus'(v)=b} \mathcal{B}[K_v] \right] \times \left[\prod_{\boxplus'(v)=g} \mathcal{G}[K_v] \right] \\ & \gamma^{\mathcal{W}} \times \gamma^{\mathcal{B}} \times \gamma^{\mathcal{G}} \left[\prod_{\boxplus'(v)=w} \mathcal{W}(\text{in}(K_v); \text{out}(K_v)) \right] \times \left[\prod_{\boxplus'(v)=b} \mathcal{B}(\text{in}(K_v); \text{out}(K_v)) \right] \times \left[\prod_{\boxplus'(v)=g} \mathcal{G}(\text{in}(K_v); \text{out}(K_v)) \right] \end{aligned}$$

where

$$\gamma^{\mathcal{W}} : \mathcal{W}[K] \cong \prod_{v \in K} \mathcal{W}(\text{in}(v); \text{out}(v)) \rightarrow \mathcal{W}(\text{in}(K); \text{out}(K))$$

is the propic composition in \mathcal{W} , and similarly for $\gamma^{\mathcal{B}}$ and $\gamma^{\mathcal{G}}$.

Proposition 6.5. $D_{(\underline{c}; \underline{d})} : \mathbf{B}(\underline{c}; \underline{d}) \rightarrow \mathbf{sSet}$ is a functor.

Proof. Notice that $D_{(\mathcal{C};d)}$ respects compositions when restricted to the subcategory containing only transfusions. Furthermore, when restricted to the subcategory containing only gsd maps, $D_{(\mathcal{C};d)}$ again respects compositions because \mathcal{W} , \mathcal{B} , \mathcal{G} are props. To finish the proof, we must show that

$$\begin{array}{ccc} D(G, \boxplus) & \xrightarrow{D(f^*q)} & D(G, f^*\boxplus') \\ \downarrow D(f) & & \downarrow D(f) \\ D(J, \boxplus'') & \xrightarrow{D(q)} & D(J, \boxplus') \end{array}$$

commutes, which follows from the fact that m_w and m_b are maps of props. \square

6.1. Colimits and Reflexive Coequalizers. In order to show that \mathbf{B} models the pushout

$$\begin{array}{ccc} \mathcal{G} & \xrightarrow{m_b} & \mathcal{B} \\ \downarrow m_w & & \\ \mathcal{W} & & \end{array}$$

we will make use of the following basic facts about reflexive coequalizers. Recall that a *reflexive coequalizer* is a functor out of $\mathbf{sk}_1 \Delta^{\text{op}}$.

Lemma 6.6. *Let X_0, X_1 be two props and $U : \mathbf{Prop} \rightarrow \mathbf{Mega}$ be the forgetful functor. If*

$$X_0 \begin{array}{c} \xleftarrow{d_0} \\ \xleftarrow{s_0} \rightarrow \\ \xleftarrow{d_1} \end{array} X_1$$

is a reflexive coequalizer (i.e. $d_0 s_0 = d_1 s_0 = \text{id}_{X_0}$) then

$$U \text{ colim} \left(\begin{array}{ccc} X_0 & \begin{array}{c} \xleftarrow{d_0} \\ \xleftarrow{s_0} \rightarrow \\ \xleftarrow{d_1} \end{array} & X_1 \end{array} \right) = \text{colim} \left(\begin{array}{ccc} UX_0 & \begin{array}{c} \xleftarrow{Ud_0} \\ \xleftarrow{Us_0} \rightarrow \\ \xleftarrow{Ud_1} \end{array} & UX_1 \end{array} \right).$$

Proof. This follows from [36, 4.3]. \square

Remark 6.7. We will apply Lemma 6.6 to the following case. If \mathcal{P} is a prop, we then have $\epsilon_{\mathcal{P}} : \perp \mathcal{P} \rightarrow \mathcal{P}$ which is the adjoint of the identity $U\mathcal{P} \rightarrow U\mathcal{P}$. Furthermore, for any prop \mathcal{P} we have a map $\sigma_{\mathcal{P}}$

$$\begin{aligned} \perp \mathcal{P} &= F \text{id}_{\mathbf{Mega}} U\mathcal{P} \\ &\xrightarrow{\eta} F\top U\mathcal{P} \\ &= FUFU\mathcal{P} = \perp^2 \mathcal{P} \end{aligned}$$

where $\eta : \text{id}_{\mathbf{Mega}} \Rightarrow \top$ is the unit for the monad \top . We then have a reflexive coequalizer diagram with $X_0 = \perp \mathcal{P}$, $X_1 = \perp^2 \mathcal{P}$, $d_0 = \epsilon_{\perp \mathcal{P}}$, $d_1 = \perp \epsilon_{\mathcal{P}}$, and $s_0 = \sigma_{\mathcal{P}}$. The colimit of this reflexive coequalizer is just \mathcal{P} .

Lemma 6.8. *Let $m_w : \mathcal{G} \rightarrow \mathcal{W}$ and $m_b : \mathcal{G} \rightarrow \mathcal{B}$ be prop maps. Then*

$$\text{colim} \left(\begin{array}{ccc} \perp \mathcal{B} \amalg_{\perp \mathcal{G}} \perp \mathcal{W} & \begin{array}{c} \xleftarrow{d_0} \\ \xleftarrow{s_0} \rightarrow \\ \xleftarrow{d_1} \end{array} & \perp^2 \mathcal{B} \amalg_{\perp^2 \mathcal{G}} \perp^2 \mathcal{W} \end{array} \right) = \mathcal{B} \amalg_{\mathcal{G}} \mathcal{W}.$$

Proof. Interchange of colimits on the product category

$$(\mathbf{sk}_1 \Delta)^{\text{op}} \times (\bullet \leftarrow \bullet \rightarrow \bullet).$$

□

The proof of the following proposition is elementary.

Proposition 6.9. *Suppose that we have a pushout diagram of sets*

$$\begin{array}{ccc} A & \xrightarrow{e} & B \\ \downarrow f & & \downarrow g \\ C & \xrightarrow{h} & D \end{array}$$

with f a monomorphism. Then g is also a monomorphism and

$$D = g(B) \amalg h(C \setminus f(A)) \cong B \amalg (C \setminus A).$$

If $x, y \in C$ have $h(x) = h(y)$, then there are (unique) $\tilde{x}, \tilde{y} \in A$ with $x = f(\tilde{x})$, $y = f(\tilde{y})$ and $e(\tilde{x}) = e(\tilde{y})$. □

For the purposes of the next lemma, fix a graph $G \in \mathbf{G}_{\mathcal{C}}(\underline{c}; \underline{d})$, let $\mathbf{T}_G \subset \mathbf{B}(\underline{c}; \underline{d})$ be the subcategory whose objects are (G, \boxplus) where \boxplus ranges over all partitions of $\text{Vt}(G)$ and whose morphisms are precisely the transfusions.

Lemma 6.10. *Suppose that $m_w : \mathcal{G} \rightarrow \mathcal{W}$ and $m_b : \mathcal{G} \rightarrow \mathcal{B}$ are morphisms of props, that m_w is a monomorphism of megagraphs, and that $D_{(\underline{c}; \underline{d})}$ is the associated functor on $\mathbf{B}(\underline{c}; \underline{d})$. Let*

$$\mathcal{X} = UB \amalg_{U\mathcal{G}} UW$$

be the pushout in **Mega**. Fix a graph $G \in \mathbf{G}_{\mathcal{C}}(\underline{c}; \underline{d})$ and consider the restriction of $D_{(\underline{c}; \underline{d})}$ to the subcategory \mathbf{T}_G . Then

$$\text{colim}_{\mathbf{T}_G} D_{(\underline{c}; \underline{d})} \cong \mathcal{X}[G].$$

Proof. For any partition \boxplus of G , there is an obvious map α_{\boxplus} from $D_{(\underline{c}; \underline{d})}(G, \boxplus)$ to

$$\begin{aligned} \mathcal{X}[G] &= \prod_{v \in \text{Vt}(G)} \mathcal{X}(\text{in}(v); \text{out}(v)) \\ &= \prod_{v \in \text{Vt}(G)} \mathcal{B}(\text{in}(v); \text{out}(v)) \amalg_{\mathcal{G}(\text{in}(v); \text{out}(v))} \mathcal{W}(\text{in}(v); \text{out}(v)). \end{aligned}$$

If $\boxplus \rightarrow \boxplus'$ is a transfusion, then the diagram

$$\begin{array}{ccc} D_{(\underline{c}; \underline{d})}(G, \boxplus) & & \\ \downarrow & \searrow \alpha_{\boxplus} & \\ & & \mathcal{X}[G] \\ & \nearrow \alpha_{\boxplus'} & \\ D_{(\underline{c}; \underline{d})}(G, \boxplus') & & \end{array}$$

commutes, hence there exists a map

$$\alpha : \text{colim}_{\mathbf{T}_G} D_{(\underline{c}; \underline{d})} \rightarrow \mathcal{X}[G].$$

To see that α is a surjection, let $x \in \mathcal{X}[G]$, and, for each vertex $v \in \text{Vt}(G)$, pick y_v above $\pi_v(x)$

$$\begin{array}{ccc} y_v & \in & \mathcal{B}(\text{in}(v); \text{out}(v)) \amalg \mathcal{W}(\text{in}(v); \text{out}(v)) \\ \downarrow & & \downarrow \\ \pi_v(x) & \in & \mathcal{B}(\text{in}(v); \text{out}(v)) \amalg_{\mathcal{G}(\text{in}(v); \text{out}(v))} \mathcal{W}(\text{in}(v); \text{out}(v)); \end{array}$$

this choice of y_v gives a partition of G with

$$\boxplus(v) = \begin{cases} w & y_v \in \mathcal{W}(\text{in}(v); \text{out}(v)) \\ b & y_v \in \mathcal{B}(\text{in}(v); \text{out}(v)) \end{cases}$$

By construction, the element $y = (y_v) \in D(G, \boxplus)$ satisfies $\alpha_{\boxplus}(y) = x$. Hence α is a surjection.

Injectivity is more subtle. Suppose that $x = (x_v) \in D(G, \boxplus^x)_n$, $y = (y_v) \in D(G, \boxplus^y)_n$, and $\alpha_{\boxplus^x}(x) = \alpha_{\boxplus^y}(y)$. We must show that x and y represent the same element in $\text{colim}_{\uparrow G} D(\underline{c}; \underline{d})$.

Fix a vertex v and write

$$A^b = \mathcal{B}(\text{in}(v); \text{out}(v)) \quad A^g = \mathcal{G}(\text{in}(v); \text{out}(v)) \quad A^w = \mathcal{W}(\text{in}(v); \text{out}(v))$$

for the relevant simplicial sets; now we have

$$x_v \in A^{\boxplus^x(v)} \quad \text{and} \quad y_v \in A^{\boxplus^y(v)}.$$

We will write

$$\begin{aligned} \pi_v^{\mathcal{X}} : \mathcal{X}[G] \rightarrow \mathcal{X}(\text{in}(v); \text{out}(v)) &= \mathcal{B}(\text{in}(v); \text{out}(v)) \amalg_{\mathcal{G}(\text{in}(v); \text{out}(v))} \mathcal{W}(\text{in}(v); \text{out}(v)) \\ &= A^b \amalg_{A^g} A^w; \end{aligned}$$

universally writing m for the map $A^{\square} \rightarrow A^b \amalg_{A^g} A^w$ we have $\pi_v^{\mathcal{X}} \alpha_{\boxplus^x}(x) = mx_v$. The equality $\alpha_{\boxplus^x}(x) = \alpha_{\boxplus^y}(y)$ is equivalent to

$$\pi_v^{\mathcal{X}} \alpha_{\boxplus^x}(x) = \pi_v^{\mathcal{X}} \alpha_{\boxplus^y}(y)$$

for all $v \in \text{Vt}(G)$.

Based on x and y , we create an interpolating partition \boxplus^g equipped with transfusions $\boxplus^g \rightarrow \boxplus^x$ and $\boxplus^g \rightarrow \boxplus^y$. We simultaneously construct elements $x' = (x'_v), y' = (y'_v) \in D(G, \boxplus^g)$ satisfying $mx'_v = my'_v$. Finally, we construct a fourth partition \boxplus^b which admits a black transfusion $\boxplus^g \rightarrow \boxplus^b$, so that we have the following schematic.

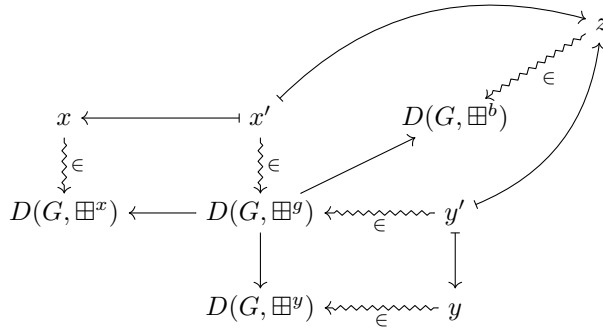

Fix a vertex v ; we will specify a color for v in the partitions \boxplus^g, \boxplus^b and also define the components x'_v, y'_v .

- Suppose $\boxplus^x(v) = \boxplus^y(v)$ and $x_v = y_v$. Then set $\boxplus^b(v) = \boxplus^g(v) = \boxplus^x(v)$ and $x'_v = y'_v = x_v$.
- Suppose $\boxplus^x(v) = \boxplus^y(v)$ and $x_v \neq y_v$. Set $\boxplus^g(v) = g$ and $\boxplus^b(v) = b$.
 - We have $\boxplus^x(v) \neq b$ since

$$A^b \hookrightarrow A^b \amalg_{A^g} A^w$$

is a monomorphism (Proposition 6.9) and $m x_v = \pi_v^{\mathcal{X}}(\alpha_{\boxplus^x} x) = \pi_v^{\mathcal{X}}(\alpha_{\boxplus^y} y) = m y_v$.

- If $\boxplus^x(v) = \boxplus^y(v) = w$, then use Proposition 6.9 to find elements $x'_v, y'_v \in A^g$ which map to $x_v, y_v \in A^w$. Notice that $m_b x'_v = m_b y'_v$.
- If $\boxplus^x(v) = \boxplus^y(v) = g$, then set $x'_v = x_v, y'_v = y_v \in A^g$. Notice that these elements have a common image in A^b .
- If $\boxplus^x(v) \neq \boxplus^y(v)$, then set $\boxplus^g(v) = g$ and $\boxplus^b(v) = b$. There are six cases, but they are symmetric; reverse the roles of x_v and y_v when necessary.
 - If $\boxplus^x(v) = g$ and $\boxplus^y(v) = b$, then since $m x_v = m y_v$ we actually have $m_b x_v = y_v$. Set $x'_v = y'_v = x_v$.
 - If $\boxplus^x(v) = g$ and $\boxplus^y(v) = w$, then set $x'_v = x_v$. We have $m_w x_v = m y_v$, so there is an element $y'_v \in A^g$ with $m_w y'_v = y_v$, and $m_b x'_v = m_b y'_v$.
 - If $\boxplus^x(v) = w$ and $\boxplus^y(v) = b$, then $x_v = m_w(x'_v)$ for some x'_v , and, furthermore, $m_b(x'_v) = y_v$. Set $y'_v = x'_v$.

By construction, x' and y' map to the same element of $D(G, \boxplus^b)$, hence x and y represent the same element of $\text{colim}_{\Gamma_G} D_{(\underline{c}; \underline{d})}$.

□

Theorem 6.11. *Suppose that $m_w : \mathcal{G} \rightarrow \mathcal{W}$ and $m_b : \mathcal{G} \rightarrow \mathcal{B}$ are morphisms of props, that m_w is a monomorphism of megagraphs, and that $D_{(\underline{c}; \underline{d})}$ is the associated functor on $\mathbf{B}(\underline{c}; \underline{d})$. Consider the pushout*

$$\begin{array}{ccc} \mathcal{G} & \xrightarrow{m_b} & \mathcal{B} \\ \downarrow m_w & & \downarrow \\ \mathcal{W} & \longrightarrow & \mathcal{B} \amalg_{\mathcal{G}} \mathcal{W}. \end{array}$$

Then

$$(\mathcal{B} \amalg_{\mathcal{G}} \mathcal{W})(\underline{c}; \underline{d}) \cong \text{colim}_{\mathbf{B}(\underline{c}; \underline{d})} D_{(\underline{c}; \underline{d})}.$$

Proof. By Lemmas 6.6 and 6.8, it is enough to compute

$$\text{colim} \left(U [\perp \mathcal{B} \amalg_{\perp \mathcal{G}} \perp \mathcal{W}] \begin{array}{c} \xleftarrow{U d_0} \\ \xleftarrow{U s_0} \\ \xrightarrow{U d_1} \end{array} U [\perp^2 \mathcal{B} \amalg_{\perp^2 \mathcal{G}} \perp^2 \mathcal{W}] \right)$$

at a profile $(\underline{c}; \underline{d})$. Colimits in **Mega** are computed levelwise, so we're really after

$$\text{colim} \left([\perp \mathcal{B} \amalg_{\perp \mathcal{G}} \perp \mathcal{W}](\underline{c}; \underline{d}) \begin{array}{c} \xleftarrow{d_0} \\ \xleftarrow{s_0} \\ \xrightarrow{d_1} \end{array} [\perp^2 \mathcal{B} \amalg_{\perp^2 \mathcal{G}} \perp^2 \mathcal{W}](\underline{c}; \underline{d}) \right).$$

For notational convenience we will write

$$\begin{aligned}\mathcal{X} &= U\mathcal{B} \amalg_{U\mathcal{G}} U\mathcal{W}, \\ \mathcal{Y} &= U\perp\mathcal{B} \amalg_{U\perp\mathcal{G}} U\perp\mathcal{W};\end{aligned}$$

since left adjoints commute with colimits we have

$$\begin{aligned}\perp\mathcal{B} \amalg_{\perp\mathcal{G}} \perp\mathcal{W} &= F(U\mathcal{B} \amalg_{U\mathcal{G}} U\mathcal{W}) = F\mathcal{X} \\ \perp^2\mathcal{B} \amalg_{\perp^2\mathcal{G}} \perp^2\mathcal{W} &= F\mathcal{Y}.\end{aligned}$$

Let $I \in \mathbf{G}_{\mathcal{E}}(\underline{c}; \underline{d})$ be a set of representatives of isomorphism classes as in Proposition 3.12. For each $(G, \boxplus) \in \mathbf{B}(\underline{c}; \underline{d})$, there is an $H \in I$ which is isomorphic to G , and we have

$$D_{(\underline{c}; \underline{d})}(G, \boxplus) \xrightarrow{\cong} D_{(\underline{c}; \underline{d})}(H, \boxplus') \rightarrow \mathcal{X}[H] \subset F\mathcal{X}(\underline{c}; \underline{d}).$$

The composites

$$D_{(\underline{c}; \underline{d})}(G, \boxplus) \rightarrow F\mathcal{X}(\underline{c}; \underline{d}) \rightarrow (\mathcal{B} \amalg_{\mathcal{G}} \mathcal{W})(\underline{c}; \underline{d})$$

are compatible with maps in $\mathbf{B}(\underline{c}; \underline{d})$ and induce

$$(10) \quad \operatorname{colim}_{\mathbf{B}(\underline{c}; \underline{d})} D_{(\underline{c}; \underline{d})} \rightarrow (\mathcal{B} \amalg_{\mathcal{G}} \mathcal{W})(\underline{c}; \underline{d}).$$

The diagram

$$\begin{array}{ccc} \coprod_{G \in I} \operatorname{colim}_{\top_G} D_{(\underline{c}; \underline{d})}(G, \boxplus) & \xrightarrow{\cong} & \coprod_{G \in I} \mathcal{X}[G] \cong F\mathcal{X}(\underline{c}; \underline{d}) \\ \downarrow & & \\ \operatorname{colim}_{\mathbf{B}(\underline{c}; \underline{d})} D_{(\underline{c}; \underline{d})}(G, \boxplus) & & \end{array}$$

shows that we have a map

$$p : F\mathcal{X}(\underline{c}; \underline{d}) \rightarrow \operatorname{colim}_{\mathbf{B}(\underline{c}; \underline{d})} D_{(\underline{c}; \underline{d})}(G, \boxplus);$$

we need to show that this induces a map out of

$$\mathcal{B} \amalg_{\mathcal{G}} \mathcal{W}(\underline{c}; \underline{d}) = \operatorname{colim} \left(F\mathcal{X}(\underline{c}; \underline{d}) \begin{array}{c} \xleftarrow{d_0} \\ \xleftarrow{s_0} \rightarrow \\ \xrightarrow{d_1} \end{array} F\mathcal{Y}(\underline{c}; \underline{d}) \right).$$

It is enough to show that the two composites

$$(11) \quad F\mathcal{Y}(\underline{c}; \underline{d}) \xrightarrow{d_0} F\mathcal{X}(\underline{c}; \underline{d}) \xrightarrow{p} \operatorname{colim}_{\mathbf{B}(\underline{c}; \underline{d})} D_{(\underline{c}; \underline{d})}(G, \boxplus)$$

$$(12) \quad F\mathcal{Y}(\underline{c}; \underline{d}) \xrightarrow{d_1} F\mathcal{X}(\underline{c}; \underline{d}) \xrightarrow{p} \operatorname{colim}_{\mathbf{B}(\underline{c}; \underline{d})} D_{(\underline{c}; \underline{d})}(G, \boxplus)$$

are equal.

Write

$$D_{(\underline{c}; \underline{d})}^\perp : \mathbf{B}(\underline{c}; \underline{d}) \rightarrow \mathbf{sSet}$$

for the functor associated to the prop maps

$$\perp\mathcal{B} \begin{array}{c} \xleftarrow{\perp m_b} \\ \xleftarrow{\perp m_w} \end{array} \perp\mathcal{G} \begin{array}{c} \xleftarrow{\perp m_\psi} \\ \xleftarrow{\perp m_\varphi} \end{array} \perp\mathcal{W}.$$

Lemma 6.10 applied to $\perp m_w$ and $\perp m_b$ tells us that the natural map

$$(13) \quad \operatorname{colim}_{\top_G} D_{(\underline{c}; \underline{d})}^\perp \xrightarrow{\cong} \mathcal{Y}[G].$$

is an isomorphism.

Fix a graph $G \in I \subset \mathbf{G}_{\mathcal{C}}(\underline{c}; \underline{d})$, and let $\tilde{y} \in \mathcal{Y}[G]$. Pick a representative $y \in D_{(\underline{c}; \underline{d})}^{\perp}(G, \boxplus)$ for \tilde{y} using (13) with $\boxplus^{-1}(g) = \emptyset$.

For each $v \in \text{Vt}(G)$, let $I_v \subset \mathbf{G}_{\mathcal{C}}(\text{in}(v); \text{out}(v))$ be a set of representatives for isomorphism classes. We have

$$\begin{aligned} D_{(\underline{c}; \underline{d})}^{\perp}(G, \boxplus) &= \prod_{\boxplus(v)=b} FUB(\text{in}(v); \text{out}(v)) \times \prod_{\boxplus(v)=w} FUW(\text{in}(v); \text{out}(v)) \\ &= \prod_{\boxplus(v)=b} \left(\prod_{K_v \in I_v} \mathcal{B}[K_v] \right) \times \prod_{\boxplus(v)=w} \left(\prod_{K_v \in I_v} \mathcal{W}[K_v] \right) \\ &= \prod_{\prod_v I_v} \left(\prod_{\boxplus(v)=b} \mathcal{B}[K_v] \times \prod_{\boxplus(v)=w} \mathcal{W}[K_v] \right) \end{aligned}$$

so

$$y \in \left(\prod_{\boxplus(v)=b} \mathcal{B}[K_v] \times \prod_{\boxplus(v)=w} \mathcal{W}[K_v] \right)$$

for some choice of graphs K_v , one for each vertex of G . Let \boxplus' be the partition of $G\{K_v\}$ so that each vertex of K_v has the same color as v .

We have the following commutative diagram

$$\begin{array}{ccc} y & \overset{\in}{\rightsquigarrow} & D_{(\underline{c}; \underline{d})}^{\perp}(G, \boxplus) \\ \downarrow \in & & \downarrow = \\ \prod_{\boxplus(v)=b} \mathcal{B}[K_v] \times \prod_{\boxplus(v)=w} \mathcal{W}[K_v] & \hookrightarrow & \prod_{\prod_v I_v} \left(\prod_{\boxplus(v)=b} \mathcal{B}[K_v] \times \prod_{\boxplus(v)=w} \mathcal{W}[K_v] \right) \\ \downarrow = & & \downarrow \prod (\prod \gamma_{\mathcal{B}} \times \prod \gamma_{\mathcal{W}}) \\ \prod_{\boxplus(v)=b} \mathcal{B}(\text{in}(v); \text{out}(v)) \times \prod_{\boxplus(v)=w} \mathcal{W}(\text{in}(v); \text{out}(v)) & & \prod_{\boxplus(v)=w} \mathcal{W}(\text{in}(v); \text{out}(v)) \\ \downarrow & & \downarrow = \\ D(G\{K_v\}, \boxplus') & \xrightarrow{\quad} & D(G, \boxplus) \\ & \searrow & \downarrow \\ & & \text{colim}_{\mathbf{B}(\underline{c}; \underline{d})} D_{(\underline{c}; \underline{d})}(G, \boxplus). \end{array}$$

Composition along the left is (11) while composition along the right is (12). Hence $pd_0(\tilde{y}) = pd_1(\tilde{y})$. Since \tilde{y} was arbitrary, $pd_0 = pd_1$ and we have that p induces

$$\mathcal{B} \amalg_{\mathcal{G}} \mathcal{W}(\underline{c}; \underline{d}) \rightarrow \text{colim}_{\mathbf{B}(\underline{c}; \underline{d})} D_{(\underline{c}; \underline{d})}(G, \boxplus)$$

which is the inverse to (10). \square

7. SPECIALIZATION TO PUSHOUTS ALONG $\mathcal{I} \rightarrow \mathcal{H}$

At this point we wish to specialize to pushouts where $\mathcal{G} \rightarrow \mathcal{W}$ is one of the maps $\mathcal{I} \rightarrow \mathcal{H}$. To do so, we will look at a subcategory of $\mathbf{B}(\underline{c}; \underline{d})$ called ${}^s\mathbf{B}(\underline{c}; \underline{d})$ whose objects are *simplified* graphs; this subcategory has the property that $\text{colim}_{{}^s\mathbf{B}(\underline{c}; \underline{d})} D = \text{colim}_{\mathbf{B}(\underline{c}; \underline{d})} D$ (Theorem 7.13). First we will reduce to an intermediary class of graphs: the admissible graphs.

Definition 7.1. Fix an input-output profile $(\underline{c}; \underline{d})$.

- An object $(G, \boxplus) \in \mathbf{B}(\underline{c}; \underline{d})$ will be called *admissible* if
 - For each white vertex v ,

$$(\text{in}(v); \text{out}(v)) \in \{(x; x), (x; y), (y; x), (y; y)\},$$
 - For each grey vertex v , $(\text{in}(v); \text{out}(v)) = (x; x)$, and
 - For each black vertex v , $y \notin \text{in}(v) \cup \text{out}(v)$.
- For a fixed input-output profile, $(\underline{c}; \underline{d})$, let ${}^a\mathbf{B}(\underline{c}; \underline{d})$ be the full subcategory of $\mathbf{B}(\underline{c}; \underline{d})$ consisting of those (G, \boxplus) which are admissible.
- For two graphs G, K , a *subgraph structure* $K \leq G$ is a graph J together with a vertex $v_0 \in \text{Vt}(J)$ so that $G = J(K)$, with K substituted at the vertex v_0 .

The functor $F_0 : \mathbf{sCat} \rightarrow \mathbf{sProp}$ takes a simplicial category \mathcal{C} to the simplicial prop with morphism spaces defined by

$$F_0\mathcal{C}(a_1, \dots, a_n; b_1, \dots, b_m) = \begin{cases} \prod_{\theta} \prod_{i=1}^n \mathcal{C}(a_{\theta^{-1}(i)}, b_i) & n = m \geq 0 \\ \emptyset & \text{otherwise} \end{cases}$$

where θ ranges over bijections $\theta : \{1, \dots, n\} \rightarrow \{1, \dots, n\}$ (see [14, Proposition 11]). This implies that if $D(G, \boxplus) \neq \emptyset$, then for each white or grey vertex v we must have $|\text{in}(v)| = |\text{out}(v)| = n \geq 0$. Given such a white or grey vertex v , we can ‘blow-up’ the graph G in $n!$ ways, with the vertex v replaced by n vertices² (of the same color as v). This gives $n!$ objects $(G_\theta, \boxplus_\theta)$, indexed on bijections $\theta : \{1, \dots, n\} \rightarrow \{1, \dots, n\}$ so that the gsd maps give an isomorphism

$$\prod_{\theta} D(G_\theta, \boxplus_\theta) \xrightarrow{\cong} D(G, \boxplus).$$

For example, if $n = 2$ then the $2! = 2$ modifications of a vertex with two inputs and two outputs are as in figure 3; the rest of the graph is left untouched.

The *vertex expansion* of (G, \boxplus) is obtained by iterated blow-ups of all white and grey vertices. We have a collection of gsd maps with

- $(G_\alpha, \boxplus_\alpha) \rightarrow (G, \boxplus)$ is a gsd map

$$G_\alpha = G\{K_v\}_{\boxplus(v) \in \{w, g\}}$$

- each $(G_\alpha, \boxplus_\alpha)$ is admissible in the sense of Definition 7.1,
- each K_v is a (possibly empty) graph whose connected components are linear graphs with at least one vertex, and
- the map

$$(14) \quad \prod_{\alpha} D(G_\alpha, \boxplus_\alpha) \xrightarrow{\cong} D(G, \boxplus).$$

is an isomorphism.

We call (14) the vertex expansion; note that it is the identity if (G, \boxplus) is already admissible.

Definition 7.2. *Atomic morphisms* of $\mathbf{B}(\underline{c}; \underline{d})$ are one of the following:

- An *atomic transfusion* changes precisely one grey vertex to either a white or black vertex. We call these white or black atomic transfusions, respectively.

²If $n = 0$, this blow-up operation is just deletion of the isolated vertex v , while if $n = 1$ the result is the same graph G .

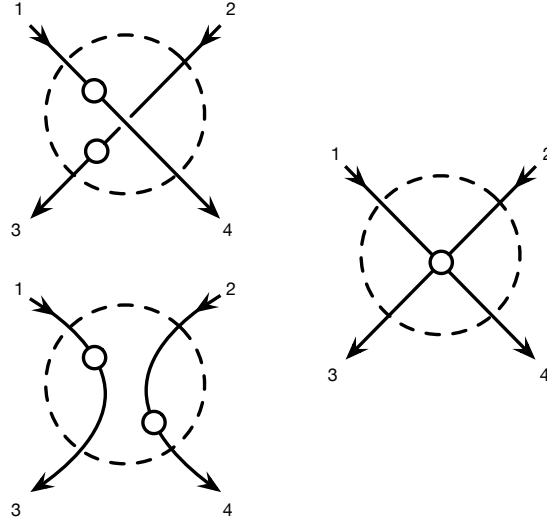

FIGURE 3. Blow-up at a 2-2 corolla

- An *atomic gsd map* is a gsd map of the form

$$(G(K), \boxplus') \rightarrow (G, \boxplus)$$

given by doing a graph substitution at a single vertex $v \in \text{Vt}(G)$. Depending on $\boxplus(v)$, we say this is a white, grey, or black atomic gsd map.

Lemma 7.3. *Suppose that $(G, \boxplus) \rightarrow (J, \boxplus)$ is a map in $\mathbf{B}(\underline{c}; \underline{d})$ with $D(G, \boxplus) \neq \emptyset$, and that*

$$\coprod_{\alpha} D(G_{\alpha}, \boxplus_{\alpha}) \xrightarrow{\cong} D(G, \boxplus) \quad \coprod_{\beta} D(J_{\beta}, \boxplus'_{\beta}) \xrightarrow{\cong} D(J, \boxplus')$$

are the vertex expansions (14). Then, for each α_0 there is a morphism $(G_{\alpha_0}, \boxplus_{\alpha_0}) \rightarrow (J_{\beta_0}, \boxplus'_{\beta_0})$ making the diagram

$$\begin{array}{ccccc} D(G_{\alpha_0}, \boxplus_{\alpha_0}) & \longrightarrow & \coprod_{\alpha} D(G_{\alpha}, \boxplus_{\alpha}) & \xrightarrow{\cong} & D(G, \boxplus) \\ \downarrow & & & & \downarrow \\ D(J_{\beta_0}, \boxplus'_{\beta_0}) & \longrightarrow & \coprod_{\beta} D(J_{\beta}, \boxplus'_{\beta}) & \xrightarrow{\cong} & D(J, \boxplus') \end{array}$$

commute.

Proof. Write $G_{\alpha_0} = G\{H_v\}_{v \in \text{Vt}(G)}$, with H_v a corolla for every black vertex v and H_v has (1,1) corollas as its connected components for each grey or white vertex v . It is enough to prove the lemma when $(G, \boxplus) \rightarrow (J, \boxplus)$ is an atomic morphism. The most trivial case is that of a black atomic gsd map (which we omit), white and grey atomic gsd maps share the same argument, and black atomic transfusions are interesting.

We begin with the case when we have a grey or white atomic gsd map. Suppose that $G = J(K)$, with K substituted into a grey or white vertex v_0 of J . Then the

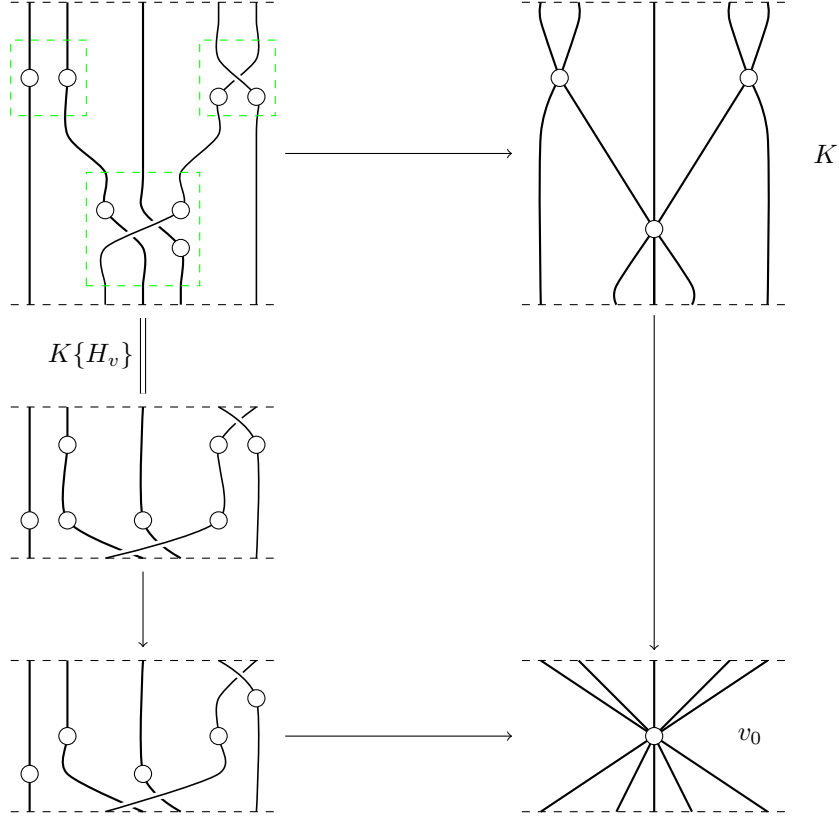

FIGURE 4. White or grey subgraph contraction

graph $K\{H_v\}_{v \in \text{Vt}(K)}$ is a subgraph of G_{α_0} whose connected components are again linear graphs containing at least one vertex.

$$G_{\alpha_0} = G\{H_w\}_{w \in \text{Vt}(G)} = J(K)\{H_v\}_{v \in \text{Vt}(G)} = (J\{H_v\}_{v \in \text{Vt}(G) \setminus \text{Vt}(K)})(K\{H_v\}_{v \in \text{Vt}(K)})$$

Contracting each component of $K\{H_v\}_{v \in \text{Vt}(K)}$ to a (1,1)-corolla gives a blow-up of the vertex v_0 in (J, \boxplus) . See Figure 4.

For the case of a white atomic transfusion, suppose that v_0 is transfused from grey to white. Then the transfusion $\boxplus_{\alpha_0} \rightarrow \boxplus'_{\alpha_0}$ which turns all vertices of H_{v_0} into white vertices gives the commutative diagram

$$\begin{array}{ccc} (G_{\alpha_0}, \boxplus_{\alpha_0}) & \longrightarrow & (G, \boxplus) \\ \downarrow & & \downarrow \\ (G_{\alpha_0}, \boxplus'_{\alpha_0}) & \longrightarrow & (J, \boxplus'), \end{array}$$

and $(G_{\alpha_0}, \boxplus'_{\alpha_0}) \rightarrow (J, \boxplus')$ is a vertex expansion of (J, \boxplus') .

Finally, for case of a black atomic transfusion where we transfuse v_0 from grey to black, we first transfuse all vertices of H_{v_0} to black vertices. We get something that is no longer a vertex expansion of J since a black vertex has been blown up.

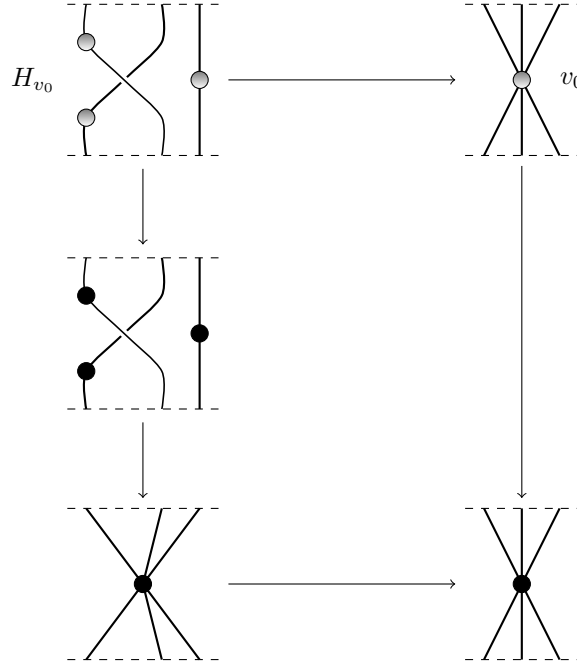

FIGURE 5. Black transfusion

So we follow this by a contraction of the subgraph H_{v_0} to get a vertex expansion of J . See Figure 5.

□

Proposition 7.4. *Let $D_{(\underline{c}; \underline{d})} = D$ be the functor $\mathbf{B}(\underline{c}; \underline{d}) \rightarrow \mathbf{sSet}$ determined by the maps $\mathcal{I} \rightarrow \mathcal{H}$ and $\mathcal{I} \rightarrow \mathcal{P}$. Then the map*

$$\operatorname{colim}_{\mathbf{B}(\underline{c}; \underline{d})} D \rightarrow \operatorname{colim}_{\mathbf{B}(\underline{c}; \underline{d})} D$$

is an isomorphism.

Proof. We construct an inverse. For each $(G, \boxplus) \in \mathbf{B}(\underline{c}; \underline{d})$ with $D(G, \boxplus) \neq \emptyset$, we have the composite

$$D(G, \boxplus) \xleftarrow{\cong} \coprod_{\alpha} D(G_{\alpha}, \boxplus_{\alpha}) \rightarrow \operatorname{colim}_{\mathbf{B}(\underline{c}; \underline{d})} D$$

where the map on the left is vertex expansion (14); we wish to show that this induces a map from $\operatorname{colim}_{\mathbf{B}(\underline{c}; \underline{d})} D$. If $(G, \boxplus) \rightarrow (J, \boxplus')$ is a morphism of $\mathbf{B}(\underline{c}; \underline{d})$,

then for each α_0 we have the commutative diagram

$$\begin{array}{ccc}
D(G, \boxplus) & \longrightarrow & D(J, \boxplus') \\
\cong \uparrow & & \cong \uparrow (14) \\
\coprod_{\alpha} D(G_{\alpha}, \boxplus_{\alpha}) & & \coprod_{\beta} D(J_{\beta}, \boxplus'_{\beta}) \\
\uparrow & & \uparrow \\
D(G_{\alpha_0}, \boxplus_{\alpha_0}) & \xrightarrow{7.3} & D(J_{\beta_0}, \boxplus'_{\beta_0}) \\
\downarrow & & \downarrow \\
\operatorname{colim}_{\mathfrak{B}(\underline{c}; \underline{d})} D & \xrightarrow{=} & \operatorname{colim}_{\mathfrak{B}(\underline{c}; \underline{d})} D
\end{array}$$

Summing over all α shows that we have a well-defined map $\operatorname{colim}_{\mathfrak{B}(\underline{c}; \underline{d})} D \rightarrow \operatorname{colim}_{\mathfrak{B}(\underline{c}; \underline{d})} D$. It is immediate that the composite

$$\operatorname{colim}_{\mathfrak{B}(\underline{c}; \underline{d})} D \rightarrow \operatorname{colim}_{\mathfrak{B}(\underline{c}; \underline{d})} D \rightarrow \operatorname{colim}_{\mathfrak{B}(\underline{c}; \underline{d})} D$$

is the identity.

To show that

$$\operatorname{colim}_{\mathfrak{B}(\underline{c}; \underline{d})} D \rightarrow \operatorname{colim}_{\mathfrak{B}(\underline{c}; \underline{d})} D \rightarrow \operatorname{colim}_{\mathfrak{B}(\underline{c}; \underline{d})} D$$

is the identity, it is enough to show that the diagram

$$\begin{array}{ccccc}
& & & & D(G, \boxplus) \\
& & & & \downarrow a \\
& & & & \operatorname{colim}_{\mathfrak{B}(\underline{c}; \underline{d})} D \\
\operatorname{colim}_{\mathfrak{B}(\underline{c}; \underline{d})} D & \xleftarrow{g} & \operatorname{colim}_{\mathfrak{B}(\underline{c}; \underline{d})} D & \xrightarrow{f} & \operatorname{colim}_{\mathfrak{B}(\underline{c}; \underline{d})} D \\
& & & & \uparrow a
\end{array}$$

commutes for each object $(G, \boxplus) \in \mathfrak{B}(\underline{c}; \underline{d})$. For an admissible (G, \boxplus) we have

$$\begin{array}{ccccccc}
& & & & & & D(G, \boxplus) \\
& & & & & & \downarrow a \\
& & & & & & \operatorname{colim}_{\mathfrak{B}(\underline{c}; \underline{d})} D \\
\operatorname{colim}_{\mathfrak{B}(\underline{c}; \underline{d})} D & \xrightarrow{f} & \operatorname{colim}_{\mathfrak{B}(\underline{c}; \underline{d})} D & \xleftarrow{g} & \operatorname{colim}_{\mathfrak{B}(\underline{c}; \underline{d})} D & \xrightarrow{f} & \operatorname{colim}_{\mathfrak{B}(\underline{c}; \underline{d})} D \\
& & & & & & \uparrow a \\
& & & & & & D(G, \boxplus) \\
& & & & & & \downarrow a \\
& & & & & & \operatorname{colim}_{\mathfrak{B}(\underline{c}; \underline{d})} D
\end{array}$$

and we know that $gfa' = a'$, hence $fga = fgfa' = fa' = a$. But using the decomposition of $D(G, \boxplus)$ into the coproduct over $\coprod_{\alpha} D(G_{\alpha}, \boxplus_{\alpha})$ we have $fga = a$ for an arbitrary (G, \boxplus) . \square

7.1. Grey reduction of admissible graphs. The following definition doesn't need the full notion of *admissibility*, but it *does* need that grey vertices have input-output profile $(x; x)$.

Definition 7.5. If $(G, \boxplus) \in \mathfrak{B}(\underline{c}; \underline{d})$, let $\eta(G, \boxplus) = (G^{\boxplus}, \boxplus^g)$ be the object with

$$G^{\boxplus} = G \setminus \{x\}_{\boxplus(v)=g}$$

and $\boxplus^g = \boxplus|_{\operatorname{Vt}(G) \setminus \boxplus^{-1}(g)}$. Let $gr(G, \boxplus)$ be the gsd map

$$\eta(G, \boxplus) \rightarrow (G, \boxplus).$$

We call $gr(G, \boxplus)$ or $\eta(G, \boxplus)$ the *grey-reduction* of (G, \boxplus) .

Lemma 7.6. *If D is the functor associated with*

$$\mathcal{H} \leftarrow \mathcal{I} \rightarrow \mathcal{P},$$

then

$$D(\text{gr}(G, \boxplus)) : D(G^{\setminus \boxplus}, \boxplus^{\setminus g}) \rightarrow D(G, \boxplus)$$

is an isomorphism.

Proof. This is immediate since $F_0\mathcal{I}(x; x) = \mathcal{I}(x, x) = *$. \square

We wish to show that grey reduction is functorial. In what follows, we will assume that *all objects are admissible*. Suppose that we have a transfusion $q : (G, \boxplus') \rightarrow (G, \boxplus)$. Then

$$\begin{aligned} G^{\setminus \boxplus'} &= G\{ |x \rangle_{\boxplus'(v)=g} \\ &= G\{ |x \rangle_{\boxplus(v)=g} \{ |x \rangle_{\substack{\boxplus'(v)=g \\ \boxplus(v) \neq g}} \\ &= G^{\setminus \boxplus} \{ |x \rangle_{\substack{\boxplus'(v)=g \\ \boxplus(v) \neq g}} \end{aligned} \quad (15)$$

which determines a gsd map $\eta(q)$ which is the top map of the diagram

$$\text{gr}(q) = \left(\begin{array}{ccc} \eta(G, \boxplus') & \xrightarrow{\eta(q)} & \eta(G, \boxplus) \\ \downarrow & & \downarrow \\ (G, \boxplus') & \xrightarrow{q} & (G, \boxplus) \end{array} \right).$$

Suppose that we have a gsd map $f : (G, \boxplus) \rightarrow (H, \boxplus')$; write

$$G = H\{K_v\}_{\boxplus'(v) \in \{b, w\}} \{L_v\}_{\boxplus'(v)=g}$$

where each L_v is connected and linear by admissibility. Setting $G_0 = H\{L_v\}_{\boxplus'(v)=g}$, we then have a factorization of f as

$$(G, \boxplus) \rightarrow (G_0, \boxplus_0) \rightarrow (H, \boxplus')$$

where $G = G_0\{K_v\}_{\boxplus'(v) \in \{b, w\}}$. For the first map we have

$$\begin{aligned} G^{\setminus \boxplus} &= G\{ |x \rangle_{\boxplus(v)=g} \\ &= (G_0\{K_v\}_{\boxplus'(v) \in \{b, w\}}) \{ |x \rangle_{\boxplus(v)=g} \\ &= G_0\{K_v\}_{\boxplus_0(v) \in \{b, w\}} \{ |x \rangle_{\boxplus_0(v)=g} \\ &= G_0\{ |x \rangle_{\boxplus_0(v)=g} \{K_v\}_{\boxplus_0(v) \in \{b, w\}} \\ &= G_0^{\setminus \boxplus_0} \{K_v\}_{\boxplus_0(v) \in \{b, w\}} \end{aligned} \quad (16)$$

hence get a gsd map

$$\eta(G, \boxplus) \rightarrow \eta(G_0, \boxplus_0).$$

By admissibility, each L_v is a connected, linear graph, and we have

$$\begin{aligned} G_0^{\setminus \boxplus_0} &= G_0\{ |x \rangle_{\boxplus_0(v)=g} \\ &= (H\{L_v\}_{\boxplus'(v)=g}) \{ |x \rangle_{\boxplus_0(v)=g} \\ &= H\{L_v\{ |x \rangle_{v' \in \text{vt}(L_v)}\}_{\boxplus'(v)=g} \\ &= H\{ |x \rangle_{\boxplus'(v)=g} = H^{\setminus \boxplus'} \end{aligned} \quad (17)$$

and set

$$gr(f) = \left(\begin{array}{ccccc} \eta(G, \boxplus) & \xrightarrow{gsd} & \eta(G_0, \boxplus_0) & \xrightarrow{=} & \eta(H, \boxplus') \\ \downarrow & & & & \downarrow \\ (G, \boxplus) & \longrightarrow & (G_0, \boxplus_0) & \longrightarrow & (H, \boxplus') \end{array} \right).$$

It is now easy to check that

$$\begin{aligned} gr(f \circ f') &= gr(f) \circ gr(f') \\ gr(q \circ q') &= gr(q) \circ gr(q') \end{aligned}$$

where f, f' are gsd maps and q, q' are transfusions. We then *define*

$$gr(f \circ q) = gr(f) \circ gr(q)$$

whenever f is a gsd map and q is a transfusion.

Proposition 7.7. *Grey reduction $gr : {}^a\mathbb{B}(\underline{c}; \underline{d}) \rightarrow Ar({}^a\mathbb{B}(\underline{c}; \underline{d}))$ is a functor.*

Proof. We need to show that

$$gr(q \circ f) = gr(q) \circ gr(f)$$

when f is a gsd map and q is a transfusion. Consider the situation

$$\begin{array}{ccc} (G, \boxplus_2) & \xrightarrow{f^*q} & (G, f^*\boxplus_3) \\ \downarrow f & & \downarrow f \\ (J, \boxplus'_2) & \xrightarrow{q} & (J, \boxplus_3) \end{array}$$

from (9) on page 21. We must show that

$$gr(f) \circ gr(f^*q) = gr(q) \circ gr(f).$$

It is enough to check that the composites of gsd maps

$$(18) \quad G \setminus^{\boxplus_2} \rightarrow G \setminus^{f^*\boxplus_3} \rightarrow J \setminus^{\boxplus_3}$$

$$(19) \quad G \setminus^{\boxplus_2} \rightarrow J \setminus^{\boxplus'_2} \rightarrow J \setminus^{\boxplus_3}$$

are equal.

The map f is given by a decomposition

$$G = J\{K_v\}_{\boxplus'_2(v) \in \{b,w\}} \{M_v\}_{\boxplus_3(v) \in \{b,w\}} \{L_v\}_{\boxplus_3(v)=g}.$$

By admissibility, each M_v and L_v is a connected linear graph with each edge colored by x .

Set $G_1 = J\{L_v\}$ and $G_0 = J\{M_v, L_v\} = G_1\{M_v\}$; then we have decompositions

$$f : (G, \boxplus_2) \rightarrow (G_0, \boxplus_0) \rightarrow (J, \boxplus'_2) \quad f : (G, f^*\boxplus_3) \rightarrow (G_1, \boxplus_1) \rightarrow (J, \boxplus_3)$$

$$G = G_0\{K_v\}_{\boxplus'_2(v) \in \{b,w\}} \quad G = G_1\{K_v, M_v\}_{\boxplus_3(v) \in \{b,w\}},$$

which gives

$$(20) \quad G \setminus^{\boxplus_2} \stackrel{(16)}{=} G_0 \setminus^{\boxplus_0} \{K_v\}_{\boxplus_0(v) \in \{b,w\}} \stackrel{(17)}{=} J \setminus^{\boxplus'_2} \{K_v\}_{\boxplus'_2(v) \in \{b,w\}}$$

$$(21) \quad G \setminus^{f^*\boxplus_3} \stackrel{(16)}{=} G_1 \setminus^{\boxplus_1} \{K_v, M_v\}_{\boxplus_1(v) \in \{b,w\}} \stackrel{(17)}{=} J \setminus^{\boxplus_3} \{K_v, M_v\}_{\boxplus_3(v) \in \{b,w\}}.$$

Focusing now on the transfusions $q : (J, \boxplus'_2) \rightarrow (J, \boxplus_3)$ and $f^*q : (G, \boxplus_2) \rightarrow (G, f^*\boxplus_3)$, we have by (15)

$$(22) \quad J^{\setminus \boxplus'_2} = J^{\setminus \boxplus_3} \{ |x \rangle \}_{\substack{\boxplus'_2(v)=g \\ \boxplus_3(v) \neq g}}$$

$$(23) \quad G^{\setminus \boxplus_2} = G^{\setminus f^*\boxplus_3} \{ |x \rangle \}_{\substack{\boxplus_2(v)=g \\ f^*\boxplus_3(v) \neq g}}$$

Computing (18), we have

$$\begin{aligned} G^{\setminus \boxplus_2} &\stackrel{(23)}{=} G^{\setminus f^*\boxplus_3} \{ |x \rangle \}_{\substack{\boxplus_2(v')=g \\ f^*\boxplus_3(v') \neq g}} \\ &\stackrel{(21)}{=} \left(J^{\setminus \boxplus_3} \{ K_v, M_v \}_{\boxplus_3(v) \in \{b, w\}} \right) \{ |x \rangle \}_{\substack{\boxplus_2(v')=g \\ f^*\boxplus_3(v') \neq g}} \\ &= J^{\setminus \boxplus_3} \{ K_v \}_{\boxplus'_2(v) \in \{b, w\}} \{ M_v \}_{\substack{\boxplus_3(v) \in \{b, w\} \\ \boxplus'_2(v)=g}} \{ |x \rangle \}_{\substack{\boxplus_2(v')=g \\ f^*\boxplus_3(v') \neq g}} \\ &= J^{\setminus \boxplus_3} \{ K_v \}_{\boxplus'_2(v) \in \{b, w\}} \{ M_v \{ |x \rangle \text{Vt}(M_v) \}_{\substack{\boxplus_3(v) \in \{b, w\} \\ \boxplus'_2(v)=g}} \\ &= J^{\setminus \boxplus_3} \{ K_v \}_{\boxplus'_2(v) \in \{b, w\}} \{ |x \rangle \}_{\substack{\boxplus_3(v) \in \{b, w\} \\ \boxplus'_2(v)=g}} \end{aligned}$$

while computing (19) yields

$$\begin{aligned} G^{\setminus \boxplus_2} &\stackrel{(20)}{=} J^{\setminus \boxplus'_2} \{ K_v \}_{\boxplus'_2(v) \in \{b, w\}} \\ &\stackrel{(22)}{=} J^{\setminus \boxplus_3} \{ |x \rangle \}_{\substack{\boxplus'_2(v)=g \\ \boxplus_3(v) \neq g}} \{ K_v \}_{\boxplus'_2(v) \in \{b, w\}} \end{aligned}$$

so the two composites of gsd maps (18,19) are equal. \square

7.2. Simplification of admissible graphs. We now define the category of simplified graphs; a related category appears in section 9 where we order a subset of vertices.

Definition 7.8. Fix an input-output profile $(\underline{c}; \underline{d})$.

- Define $\varrho : \text{Ob } \mathbf{B}(\underline{c}; \underline{d}) \rightarrow \text{Ob } \mathbf{B}(\underline{c}; \underline{d})$ to be the function that turns all grey vertices to white vertices; notice that ϱ takes admissible objects to admissible objects.
- An admissible object (G, \boxplus) will be called *simplified* if the only white, connected, non-edge subgraphs of $\varrho(G, \boxplus)$ are corollas (which, by admissibility, will be (1,1)-corollas).
- For a fixed input-output profile $(\underline{c}; \underline{d})$, let ${}^s\mathbf{B}(\underline{c}; \underline{d})$ be the full subcategory of $\mathbf{B}(\underline{c}; \underline{d})$ consisting of those (G, \boxplus) which are both admissible and simplified.

Suppose that an admissible object $(G, \boxplus) \in {}^a\mathbf{B}(\underline{c}; \underline{d})$ is not simplified and is grey-free. Consider the set of subgraphs $L \leq G$ with

- L is connected and linear,
- $\boxplus(L) = w$, and
- $|\text{Vt}(L)| \geq 1$

and let L_1, \dots, L_r be the set of subgraphs which are *maximal* with respect to these properties and with $\coprod \text{Vt}(L_i) = \boxplus^{-1}(w)$. By maximality the L_i do not intersect one another, and we can contract each L_i to a single vertex, yielding a new graph

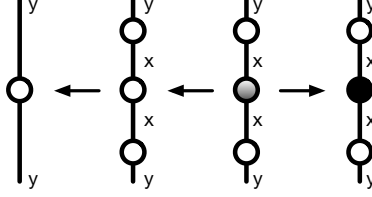

FIGURE 6. No maps between simplified graphs on the ends

\overline{G} . Specifically, we have $G = \overline{G}\{L_i\}_{v_i} \rightarrow \overline{G}$, where $v_1, \dots, v_r \subset \text{Vt}(\overline{G})$ is a set of r vertices. Define a partition on \overline{G}

$$\overline{\boxplus}(v) = \begin{cases} \boxplus(v) & v \in \text{Vt}(\overline{G}) \setminus \{v_1, \dots, v_r\} \subset \text{Vt}(G) \\ w & v \in \{v_1, \dots, v_r\}. \end{cases}$$

The gsd map $(G, \boxplus) \rightarrow (\overline{G}, \overline{\boxplus})$ is called the *simplification* of the grey-free, admissible object (G, \boxplus) .

Notation 7.9. We will decorate our symbols for categories with $\not\downarrow$ when we only consider objects (G, \boxplus) with $\boxplus(v) \in \{b, w\}$ for all v . For example, ${}^s\mathbf{B}^{\not\downarrow}(\underline{c}; \underline{d})$ is the full subcategory of ${}^s\mathbf{B}(\underline{c}; \underline{d})$ consisting of grey-free simplified graphs.

Lemma 7.10. *If $(G, \boxplus) \in {}^a\mathbf{B}^{\not\downarrow}(\underline{c}; \underline{d})$ is admissible and grey-free, then its simplification is a weakly initial object in the comma category $(G, \boxplus) \downarrow {}^s\mathbf{B}(\underline{c}; \underline{d})$.*

Proof. Fix a map

$$(G, \boxplus) \xrightarrow{q} (G, \boxplus_0) \xrightarrow{f} (J, \boxplus_1)$$

with q a transfusion, f a gsd map, and (J, \boxplus_1) simplified. Since (G, \boxplus) is grey-free, q is the identity. Write $G = J\{K_v\}$ and $G = \overline{G}\{L_i\}_{v_i}$. Suppose that $v \in \text{Vt}(J)$ with $\boxplus_1(v) = w$. Since (J, \boxplus_1) is simplified and admissible, we know that

$$|\text{in}(K_v)| = |\text{in}(v)| = 1 = |\text{out}(v)| = |\text{out}(K_v)|,$$

and since (G, \boxplus) is admissible we know that all white vertices v' have $|\text{in}(v')| = |\text{out}(v')| = 1$, so K_v is connected. Then for each vertex v' of K_v , v' is contained in some L_i , but since (J, \boxplus_1) has no adjacent white vertices, all vertices of L_i are contained in K_v ; by maximality of L_i we have $L_i = K_v$. Notice that K_v may just be an edge; write

$$S = \{\bar{v}_1, \dots, \bar{v}_r\} \subset \text{Vt}(J)$$

for the set of vertices so that $K_{\bar{v}_i} \cong L_i$ has at least one vertex. Then we have

$$\overline{G}\{L_i\} = G = J\{K_v\}_{\text{Vt}(J)} = J\{K_v\}_{v \notin S}\{L_i\}$$

showing that $\overline{G} = J\{K_v\}_{v \notin S}$, hence we have a factorization

$$(G, \boxplus) \rightarrow (\overline{G}, \overline{\boxplus}) \rightarrow (J, \boxplus_1)$$

of f . □

Example 7.11. Note that if (G, \boxplus) contains grey vertices adjacent to white vertices, then there may not be a weakly initial object in $(G, \boxplus) \downarrow {}^s\mathbf{B}(\underline{c}; \underline{d})$. For instance, there are no maps in $\mathbf{B}(y; y)$ between the simplified graphs at the left and right ends of Figure 6.

Lemma 7.12. *If D is the functor associated with $\mathcal{H} \leftarrow \mathcal{I} \rightarrow \mathcal{P}$, then the inclusions ${}^s\mathbf{B}^g(\underline{c}; \underline{d}) \rightarrow {}^s\mathbf{B}(\underline{c}; \underline{d})$ and ${}^a\mathbf{B}^g(\underline{c}; \underline{d}) \rightarrow {}^a\mathbf{B}(\underline{c}; \underline{d})$ induce isomorphisms*

$$\begin{aligned} \operatorname{colim}_{{}^s\mathbf{B}^g(\underline{c}; \underline{d})} D &\xrightarrow{\cong} \operatorname{colim}_{{}^s\mathbf{B}(\underline{c}; \underline{d})} D \\ \operatorname{colim}_{{}^a\mathbf{B}^g(\underline{c}; \underline{d})} D &\xrightarrow{\cong} \operatorname{colim}_{{}^a\mathbf{B}(\underline{c}; \underline{d})} D. \end{aligned}$$

Proof. We construct an inverse to

$$(24) \quad \operatorname{colim}_{{}^a\mathbf{B}^g(\underline{c}; \underline{d})} D \rightarrow \operatorname{colim}_{{}^a\mathbf{B}(\underline{c}; \underline{d})} D,$$

the simplified case is similar. If $(G, \boxplus) \in {}^a\mathbf{B}(\underline{c}; \underline{d})$, then by Lemma 7.6 there is a map

$$\varepsilon_{G, \boxplus} : D(G, \boxplus) \xleftarrow{\cong} D(\eta(G, \boxplus)) \rightarrow \operatorname{colim}_{{}^a\mathbf{B}^g(\underline{c}; \underline{d})} D.$$

If $f : (G, \boxplus) \rightarrow (J, \boxplus')$ is a morphism of ${}^a\mathbf{B}(\underline{c}; \underline{d})$, then the diagram

$$\begin{array}{ccc} D(G, \boxplus) & \xrightarrow{Df} & D(J, \boxplus') \\ \cong \uparrow & & \cong \uparrow \\ D\eta(G, \boxplus) & \xrightarrow{D\eta f} & D\eta(J, \boxplus') \\ & \searrow & \swarrow \\ & \operatorname{colim}_{{}^a\mathbf{B}^g(\underline{c}; \underline{d})} D & \end{array}$$

commutes by Proposition 7.7. Hence $D(f)\varepsilon_{G, \boxplus} = \varepsilon_{J, \boxplus'}$ so ε_- induces a map

$$\operatorname{colim}_{{}^a\mathbf{B}(\underline{c}; \underline{d})} D \rightarrow \operatorname{colim}_{{}^a\mathbf{B}^g(\underline{c}; \underline{d})} D.$$

It is routine to check that this is both a left and right inverse to (24). \square

Proposition 7.13. *Let $D_{(\underline{c}; \underline{d})} = D$ be the functor $\mathbf{B}(\underline{c}; \underline{d}) \rightarrow \mathbf{sSet}$ determined by the maps $\mathcal{I} \rightarrow \mathcal{H}$ and $\mathcal{I} \rightarrow \mathcal{P}$. Then*

$$\operatorname{colim}_{{}^s\mathbf{B}(\underline{c}; \underline{d})} D = \operatorname{colim}_{\mathbf{B}(\underline{c}; \underline{d})} D$$

Proof. By Proposition 7.4, it is enough to show that

$$\operatorname{colim}_{{}^s\mathbf{B}(\underline{c}; \underline{d})} D \rightarrow \operatorname{colim}_{{}^a\mathbf{B}(\underline{c}; \underline{d})} D$$

is an isomorphism. In the diagram

$$\begin{array}{ccc} {}^s\mathbf{B}^g(\underline{c}; \underline{d}) & \longrightarrow & {}^s\mathbf{B}(\underline{c}; \underline{d}) \\ \downarrow & & \downarrow \\ {}^a\mathbf{B}^g(\underline{c}; \underline{d}) & \longrightarrow & {}^a\mathbf{B}(\underline{c}; \underline{d}) \end{array}$$

the functor

$${}^s\mathbf{B}^g(\underline{c}; \underline{d}) \rightarrow {}^a\mathbf{B}^g(\underline{c}; \underline{d})$$

is cofinal by Lemma 7.10. Applying Lemma 7.12 implies that the top and bottom maps in the diagram

$$\begin{array}{ccc} \operatorname{colim}_{\mathcal{B}'(\underline{c}; \underline{d})} D & \xrightarrow{\cong} & \operatorname{colim}_{\mathcal{B}(\underline{c}; \underline{d})} D \\ \text{cofinality} \downarrow \cong & & \downarrow \\ \operatorname{colim}_{\mathcal{B}'(\underline{c}; \underline{d})} D & \xrightarrow{\cong} & \operatorname{colim}_{\mathcal{B}(\underline{c}; \underline{d})} D \end{array}$$

are isomorphisms, so the result follows. \square

8. A LOCAL FILTRATION OF THE PUSHOUT

Consider the functions

$$\#_{wx} : \operatorname{Ob} \mathcal{B}(\underline{c}; \underline{d}) \rightarrow \mathbb{N}$$

$$\#_{gwx} : \operatorname{Ob} \mathcal{B}(\underline{c}; \underline{d}) \rightarrow \mathbb{N}$$

with

$$\begin{aligned} \#_{wx}(G, \boxplus) &= |\{v \in \operatorname{Vt}(G) \mid \boxplus(v) = w, \operatorname{in}(v) = \operatorname{out}(v) = x\}| \\ \#_{gwx}(G, \boxplus) &= |\{v \in \operatorname{Vt}(G) \mid \boxplus(v) \in \{g, w\}, \operatorname{in}(v) = \operatorname{out}(v) = x\}|. \end{aligned}$$

Let $\mathcal{B}_{\leq k}(\underline{c}; \underline{d})$ be the full subcategory of $\mathcal{B}(\underline{c}; \underline{d})$ with objects $\#_{wx}^{-1}[0, k]$. Note that all maps of $\mathcal{B}(\underline{c}; \underline{d})$ are non-decreasing with respect to $\#_{wx}$, so $\mathcal{B}_{\leq k}(\underline{c}; \underline{d})$ is a *right ideal* of $\mathcal{B}(\underline{c}; \underline{d})$, meaning it is closed under precomposition with maps from $\mathcal{B}(\underline{c}; \underline{d})$. Evidently $\mathcal{B}(\underline{c}; \underline{d}) = \operatorname{colim}_k \mathcal{B}_{\leq k}(\underline{c}; \underline{d})$.

Definition 8.1. Suppose that $G : \mathcal{C} \rightarrow \mathcal{D}$ and $F : \mathcal{D} \rightarrow \mathbf{sSet}$ are functors. If $c \in \mathcal{C}$ and $z \in FG(c)$, write $[z]_{\mathcal{C}} \in \operatorname{colim}_{\mathcal{C}} F$ for its image. Likewise, if $z \in F(d)$ write $[z]_{\mathcal{D}} \in \operatorname{colim}_{\mathcal{D}} F$. Write

$$\begin{array}{ccc} \operatorname{colim}_{\mathcal{C}} FG & \xrightarrow{g} & \operatorname{colim}_{\mathcal{D}} F \\ [z]_{\mathcal{C}} & \mapsto & [z]_{\mathcal{D}} \end{array}$$

for the induced map on colimits. To study injectivity of g , it is helpful to introduce a sequence of relations \sim_n .

Suppose that $g(x) = g(x')$. A *witness* to $x \sim_n x'$ consists of a zigzag of morphisms

$$(25) \quad G(c) \xrightarrow{f_1} d_1 \xleftarrow{f_2} d_2 \xrightarrow{f_3} \dots \xrightarrow{f_{2n-1}} d_{2n-1} \xleftarrow{f_{2n}} G(c')$$

in \mathcal{D} , representatives $z \in FG(c)$, $z' \in FG(c')$ with $[z]_{\mathcal{C}} = x$, $[z']_{\mathcal{C}} = x'$ (where $c, c' \in \mathcal{C}$), and elements $z_i \in F(d_i)$ so that

$$\begin{aligned} F(f_1)(z) &= z_1 & F(f_{2n})(z') &= z_{2n-1} \\ F(f_{2i})(z_{2i}) &= z_{2i-1} & F(f_{2i+1})(z_{2i}) &= z_{2i+1}. \end{aligned}$$

There is a corresponding function

$$\begin{aligned} \omega &: \left(\operatorname{colim}_{\mathcal{C}} FG \right) \times_g \left(\operatorname{colim}_{\mathcal{C}} FG \right) \rightarrow \mathbb{N} \\ \omega(x, x') &= \min\{n \mid x \sim_n x'\}. \end{aligned}$$

If $x \sim_n x'$ then $x \sim_{n+1} x'$, which is witnessed by extending (25) with $f_{2n+1} = f_{2n+2} = \operatorname{id}_{Gc'}$ and $z_{2n} = z_{2n+1} = z'$.

Remark 8.2. Suppose that \mathcal{C} is a full subcategory of \mathcal{D}

and $F : \mathcal{D} \rightarrow \mathbf{sSet}$ a functor. Consider the relation $x \sim_n x'$ on $\text{colim}_{\mathcal{C}} F$. The case $n = 0$ corresponds to equality in $\text{colim}_{\mathcal{C}} F$, so $x = x'$ if and only if $x \sim_0 x'$. The map $g : \text{colim}_{\mathcal{C}} F \rightarrow \text{colim}_{\mathcal{D}} F$ is injective if and only if $\omega(-, -)$ is identically zero.

Notation 8.3. Let $\mathbb{Y}(G)$ be the set of vertices of G which are incident to y -edges. Notice that if (G, \boxplus) is simplified, then all such vertices are extremal.

Proposition 8.4. *If D is the functor associated with $\mathcal{H} \leftarrow \mathcal{I} \rightarrow \mathcal{P}$, then*

$$\text{colim}_{{}^s\mathbf{B}_{\leq \ell}(\underline{c}; \underline{d})} D \rightarrow \text{colim}_{{}^s\mathbf{B}(\underline{c}; \underline{d})} D$$

is a monomorphism.

Proof. Suppose that $x, x' \in \text{colim}_{{}^s\mathbf{B}_{\leq \ell}} D$ with x and x' mapping to the same element in $\text{colim}_{{}^s\mathbf{B}} D$ and

$$x \neq x' \quad \stackrel{8.2}{\Leftrightarrow} \quad \omega(x, x') = n > 0.$$

Choose a zigzag (25) that witnesses $x \sim_n x'$, which begins as

$$(26) \quad (H, \boxplus') \xrightarrow{f} (G, \boxplus) \xleftarrow{f'} (H', \boxplus'') \xrightarrow{f_3} d_3 \leftarrow \dots \xleftarrow{f_{2n}} c'$$

with $\#_{wx}(H, \boxplus') = k \leq \ell$. There is $z \in D(H, \boxplus')$, $z' \in D(H', \boxplus'')$ so that $[z]_{\mathcal{C}} = x$ and $D(f)(z) = D(f')(z')$. By Lemma 7.6 and the fact that ${}^s\mathbf{B}_{\leq k}(\underline{c}; \underline{d})$ is a right ideal, we may assume that (H, \boxplus') is grey-free.

The morphism

$$f : (H, \boxplus') \rightarrow (G, \boxplus)$$

is in ${}^s\mathbf{B}(\underline{c}; \underline{d})$. Since (H, \boxplus') is grey-free, we have that f is a gsd map. Further, since (H, \boxplus') is simplified, we have

$$H = G\{K_v\}_{\boxplus^{-1}(b) \cup \mathbb{Y}(G)} \{ |x \} _S$$

for some set S of white and grey vertices of (G, \boxplus) with

$$\boxplus^{-1}(g) \subset S \subset \boxplus^{-1}(g) \cup \boxplus^{-1}(w) \setminus \mathbb{Y}(G)$$

and $(\text{in}(v); \text{out}(v)) = (x; x)$ for every $v \in S$. Let \boxplus_S be the partition of G defined by

$$\boxplus_S(v) = \begin{cases} \boxplus(v) & v \notin S \\ g & v \in S; \end{cases}$$

notice that we have

$$\begin{aligned} \boxplus_S^{-1}(w) &= \boxplus^{-1}(w) \setminus S \\ \boxplus_S^{-1}(g) &= \boxplus^{-1}(g) \cup S = S \\ \boxplus_S^{-1}(b) &= \boxplus^{-1}(b). \end{aligned}$$

We have $G^{\boxplus_S} = G\{ |x \} _{\boxplus_S(v)=g} = G\{ |x \} _S$ hence $H = G^{\boxplus_S}\{K_v\}_{\boxplus_S^{-1}(b) \cup \mathbb{Y}(G)}$. Then f factors as

$$(H, \boxplus') \rightarrow \eta(G, \boxplus_S) \rightarrow (G, \boxplus_S) \rightarrow (G, \boxplus);$$

note that $\#_{wx}(H, \boxplus') = \#_{wx}\eta(G, \boxplus_S) = k$. The image of $D(f)$ is equal to $D\eta(G, \boxplus_S) = D(G, \boxplus_S) \subset D(G, \boxplus)$.

We may also assume that (H', \boxplus'') is grey-free and $\#_{wx}(H', \boxplus'') = j \leq \ell$ (otherwise precompose with $gr(H', \boxplus'')$). Factor the map

$$f' : (H', \boxplus'') \rightarrow (G, \boxplus)$$

as before for some $\boxplus^{-1}(g) \subset T \subset \boxplus^{-1}(g) \cup \boxplus^{-1}(w)$

$$(H', \boxplus'') \rightarrow \eta(G, \boxplus_T) \rightarrow (G, \boxplus_T) \rightarrow (G, \boxplus)$$

where the last map is grey-white transfusion on $T \cap \boxplus^{-1}(w)$, the middle map is a gsd map that creates grey vertices, and the first map preserves $\#_{wx}$. The image of $D(f')$ is $D\eta(G, \boxplus_T) = D(G, \boxplus_T) \subset D(G, \boxplus)$. Notice that $D(G, \boxplus_S) \cap D(G, \boxplus_T) = D(G, \boxplus_{S \cup T})$. We have a diagram

$$\begin{array}{ccccccc} \eta(G, \boxplus_S) & \longrightarrow & (G, \boxplus_S) & \longrightarrow & (G, \boxplus) & \longleftarrow & (G, \boxplus_T) \longleftarrow \eta(G, \boxplus_T) \\ & & \swarrow & & \uparrow & & \swarrow \\ & & & & (G, \boxplus_{S \cup T}) & & \\ & \swarrow & & & \uparrow & & \swarrow \\ & & & & \eta(G, \boxplus_{S \cup T}) & & \end{array}$$

gsd *tr* *tr* *gsd*

The outer diagonal maps either create white vertices or are identities.

Notice that $\#_{wx}\eta(G, \boxplus_{S \cup T}) \leq \min(k, j) \leq k \leq \ell$. Write

$$\begin{aligned} \eta(G, \boxplus_T) &= (G^{\setminus \boxplus_T}, \boxplus_T^g) \\ \eta(G, \boxplus_{S \cup T}) &= (G^{\setminus \boxplus_{S \cup T}}, \boxplus_{S \cup T}^g) & G^{\setminus \boxplus_{S \cup T}} &= G^{\setminus \boxplus_T} \{ |x \}_U \\ & & U &= (S \cap \boxplus^{-1}(w)) \setminus T \\ & & &\subset (\boxplus_T^g)^{-1}(w) = \boxplus_T^{-1}(w). \end{aligned}$$

Now $(H', \boxplus'') \rightarrow \eta(G, \boxplus_T)$ is a gsd map, and we write

$$H' = G^{\setminus \boxplus_T} \{K_v\}_{(\boxplus_T^g)^{-1}(b) \cup \mathbb{Y}(G^{\setminus \boxplus_T})},$$

where $\mathbb{Y}(G^{\setminus \boxplus_T}) \cong \mathbb{Y}(G)$. Note that $U \cap \left((\boxplus_T^g)^{-1}(b) \cup \mathbb{Y}(G^{\setminus \boxplus_T}) \right) = \emptyset$, so we can form a new graph H'' with $\text{Vt}(H'') = \text{Vt}(H') \setminus U$ by setting

$$\begin{aligned} H'' &= G^{\setminus \boxplus_T} \{K_v\}_{(\boxplus_T^g)^{-1}(b) \cup \mathbb{Y}(G^{\setminus \boxplus_T})} \{ |x \}_U \\ &= H' \{ |x \}_U \\ &= G^{\setminus \boxplus_{S \cup T}} \{K_v\}_{(\boxplus_T^g)^{-1}(b) \cup \mathbb{Y}(G^{\setminus \boxplus_T})}. \end{aligned}$$

We have the diagram of gsd maps

$$\begin{array}{ccc} \eta(G, \boxplus_T) & \longleftarrow & (H', \boxplus'') \\ \uparrow & & \uparrow g \\ \eta(G, \boxplus_{S \cup T}) & \longleftarrow & (H'', \boxplus''|_{H''}) \end{array}$$

and the objects on the bottom in ${}^*B_{\leq k}^g(c; d)$. Applying D , we have

$$\begin{array}{ccccc}
D(G, \boxplus) & \longleftarrow & D\eta(G, \boxplus_T) & \longleftarrow & D(H', \boxplus'') \\
\uparrow & & \uparrow & & \uparrow^{D(g)} \\
\text{im}(f) \cap \text{im}(f') & \longleftarrow & D\eta(G, \boxplus_{S \cup T}) & \longleftarrow & D(H'', \boxplus''|_{H''})
\end{array}$$

with the right square a pullback.

We've replaced the chain

$$(H, \boxplus') \rightarrow (G, \boxplus) \leftarrow (H', \boxplus'')$$

with the longer chain

$$(H, \boxplus') \rightarrow \eta(G, \boxplus_S) \leftarrow (H'', \boxplus''|_{H''}) \rightarrow (H', \boxplus'')$$

with the three objects on the left in ${}^s\mathbf{B}_{\leq k}$. However, $z' \in D(H'', \boxplus''|_{H''})$, so we can modify the zigzag (26) by looking at

$$(27) \quad (H'', \boxplus''|_{H''}) \xrightarrow{f_3 \circ g} d_3 \leftarrow \dots \xleftarrow{f_{2n}} c'$$

which witnesses that $x = [z]_{s\mathbf{B}_{\leq \ell}} = [z']_{s\mathbf{B}_{\leq \ell}} \sim_{n-1} x'$, contrary to the assumption that $\omega(x, x') = n$.

It follows that $\omega(x, x') = 0$ for all pairs x, x' , so by remark 8.2 the map is injective. \square

Corollary 8.5. *If D is the functor associated with $\mathcal{H} \leftarrow \mathcal{I} \rightarrow \mathcal{P}$, then*

$$\text{colim}_{s\mathbf{B}_{\leq k}(\underline{c}; \underline{d})} D \rightarrow \text{colim}_{s\mathbf{B}_{\leq k+1}(\underline{c}; \underline{d})} D$$

is a monomorphism. \square

Notation 8.6. Write

$$\mathcal{Q}^k(\underline{c}; \underline{d}) = \text{colim}_{s\mathbf{B}_{\leq k}(\underline{c}; \underline{d})} D;$$

then for each $(\underline{c}; \underline{d})$ we have an exhaustive filtration

$$\mathcal{Q}^0(\underline{c}; \underline{d}) \hookrightarrow \mathcal{Q}^1(\underline{c}; \underline{d}) \hookrightarrow \dots \hookrightarrow \mathcal{Q}^k(\underline{c}; \underline{d}) \hookrightarrow \dots \hookrightarrow \text{colim}_n \mathcal{Q}^n(\underline{c}; \underline{d}).$$

9. EXHIBITION OF THE FILTRATION LAYERS AS A PUSHOUT

We will now consider graphs which come equipped with an ordering of a subset of k vertices; by considering maps which preserve these vertices and their ordering we end up with a category $\mathbf{G}_k^M(\underline{c}; \underline{d})$. An object of $\mathbf{G}_k^M(\underline{c}; \underline{d})$ is a pair (G, ℓ) with $G \in \mathbf{G}_{\underline{c}}(\underline{c}; \underline{d})$ and $\ell : \{1, \dots, k\} \rightarrow \text{Vt}(G)$ satisfying

- all y -edges of G are extremal
- the set of vertices incident to y -edges, denoted by $\mathbb{Y}(G)$, has the property that if $v \in \mathbb{Y}(G)$ then $(\text{in}(v); \text{out}(v)) \in \{(x; y), (y; x), (y; y)\}$,
- all vertices $v \in \text{Im } \ell$ have $(\text{in}(v); \text{out}(v)) = (x; x)$
- no two vertices in $\text{Im } \ell \cup \mathbb{Y}(G)$ are adjacent.

For the morphism spaces, we take

$$\text{hom}_{\mathbf{G}_k^M(\underline{c}; \underline{d})}((G, \ell), (H, \ell')) \subset \text{hom}_{\mathbf{G}_{\underline{c}}(\underline{c}; \underline{d})}(G, H)$$

to be those decompositions f of the form

$$\begin{aligned}
G &= H\{K_v\}_{v \notin \text{Im } \ell'} \\
f_{\text{Vt}} \circ \ell &= \ell'.
\end{aligned}$$

There is a functor

$$A : [1]^k \times \mathbf{G}_k^M(\underline{c}; \underline{d}) \rightarrow {}^s\mathbf{B}_{\leq k}(\underline{c}; \underline{d}) \\ (t_1, \dots, t_k, (G, \ell)) \mapsto (G, \boxplus)$$

where \boxplus is defined by

$$\boxplus(v) = \begin{cases} g & v = \ell(i) \text{ and } t_i = 0 \\ w & v = \ell(i) \text{ and } t_i = 1 \\ w & v \in \mathbb{Y}(G) \\ b & \text{otherwise.} \end{cases}$$

The (multi)functor A takes $(\text{constant}, 0 \rightarrow 1, \text{constant})$ to an atomic white trans-fusion and $(\text{constant}, (G, \ell) \rightarrow (H, \ell'))$ to the gsd map given by $G \rightarrow H$. Let $[1]_*^k$ denote the full subcategory of $[1]^k$ without the terminal object 1^k . Notice that the restriction of A to $[1]_*^k \times \mathbf{G}_k^M(\underline{c}; \underline{d})$ lands in ${}^s\mathbf{B}_{\leq k-1}(\underline{c}; \underline{d})$ and that every object of $\#_{gwx}^{-1}(k)$ is in the image of A .

Define

$$\tilde{\mathcal{Q}}_k^+(\underline{c}; \underline{d}) = \operatorname{colim}_{[1]_*^k \times \mathbf{G}_k^M(\underline{c}; \underline{d})} DA \\ \tilde{\mathcal{Q}}_k(\underline{c}; \underline{d}) = \operatorname{colim}_{[1]^k \times \mathbf{G}_k^M(\underline{c}; \underline{d})} DA.$$

We can write the composite

$$[1]^k \times \mathbf{G}_k^M(\underline{c}; \underline{d}) \xrightarrow{A} {}^s\mathbf{B}_{\leq k}(\underline{c}; \underline{d}) \xrightarrow{D} \mathbf{sSet}$$

as a product $DA \cong D_L \times D_R$, where

$$D_L : [1]^k \rightarrow \mathbf{sSet} \quad Z_0 = \mathcal{I}(x; x) = * \\ (t_1, \dots, t_k) \mapsto \prod_{i=1}^k Z_{t_i} \quad Z_1 = \mathcal{H}(x; x) \simeq *$$

and

$$D_R : \mathbf{G}_k^M(\underline{c}; \underline{d}) \rightarrow \mathbf{sSet} \\ D_R(G, \ell) = \left(\prod_{v \notin \mathbb{Y}(G) \cup \operatorname{Im} \ell} \mathcal{P}(\operatorname{in}(v); \operatorname{out}(v)) \right) \times \left(\prod_{v \in \mathbb{Y}(G)} \mathcal{H}(\operatorname{in}(v); \operatorname{out}(v)) \right).$$

Thus we have

$$\tilde{\mathcal{Q}}_k^+(\underline{c}; \underline{d}) = \operatorname{colim}_{[1]_*^k \times \mathbf{G}_k^M(\underline{c}; \underline{d})} DA = \operatorname{colim}_{[1]_*^k \times \mathbf{G}_k^M(\underline{c}; \underline{d})} (D_L \times D_R) = \operatorname{colim}_{[1]_*^k} D_L \times \operatorname{colim}_{\mathbf{G}_k^M(\underline{c}; \underline{d})} D_R$$

and

$$\tilde{\mathcal{Q}}_k(\underline{c}; \underline{d}) = \operatorname{colim}_{[1]^k} D_L \times \operatorname{colim}_{\mathbf{G}_k^M(\underline{c}; \underline{d})} D_R.$$

Note that there is a free Σ_k -action on $[1]^k \times \mathbf{G}_k^M(\underline{c}; \underline{d})$, which induces a free Σ_k -actions on $\tilde{\mathcal{Q}}_k(\underline{c}; \underline{d})$ and $\tilde{\mathcal{Q}}_k^+(\underline{c}; \underline{d})$.

Lemma 9.1 (Pushout-Product Lemma). *Suppose that $F : [1] \rightarrow \mathbf{sSet}$ takes the generating morphism $0 \rightarrow 1$ to a (n acyclic) cofibration.*

Then, for $n \geq 2$, the map

$$\operatorname{colim}_{[1]_*^n} F^{\times n} \rightarrow \operatorname{colim}_{[1]^n} F^{\times n} \cong F(1)^{\times n}$$

is a (n acyclic) cofibration as well.

Proof. A simple induction using the usual pushout-product axiom. \square

Lemma 9.2. *The map*

$$\tilde{\mathcal{Q}}_k^+(\underline{c}; \underline{d}) \rightarrow \tilde{\mathcal{Q}}_k(\underline{c}; \underline{d})$$

is an acyclic cofibration in \mathbf{sSet} . Furthermore, it induces an acyclic cofibration

$$\tilde{\mathcal{Q}}_k^+(\underline{c}; \underline{d})/\Sigma_k \rightarrow \tilde{\mathcal{Q}}_k(\underline{c}; \underline{d})/\Sigma_k.$$

Proof. By assumption, $\mathcal{I}(x; x) \rightarrow \mathcal{H}(x; x)$ is an acyclic cofibration. The pushout-product lemma 9.1 then gives that

$$\operatorname{colim}_{[1]_*^k} D_L \rightarrow \operatorname{colim}_{[1]^k} D_L$$

is an acyclic cofibration as well.

For the second statement, note that the map is Σ_k -equivariant and that the Σ_k -actions on $\tilde{\mathcal{Q}}_k^+(\underline{c}; \underline{d})$ and $\tilde{\mathcal{Q}}_k(\underline{c}; \underline{d})$ are free. \square

The diagram

$$\begin{array}{ccc} \tilde{\mathcal{Q}}_{k+1}^+(\underline{c}; \underline{d}) & \longrightarrow & \mathcal{Q}^k(\underline{c}; \underline{d}) \\ \downarrow & & \downarrow \\ \tilde{\mathcal{Q}}_{k+1}(\underline{c}; \underline{d}) & \longrightarrow & \mathcal{Q}^{k+1}(\underline{c}; \underline{d}). \end{array}$$

factors as

$$\begin{array}{ccccc} \tilde{\mathcal{Q}}_{k+1}^+(\underline{c}; \underline{d}) & \longrightarrow & \tilde{\mathcal{Q}}_{k+1}^+(\underline{c}; \underline{d})/\Sigma_{k+1} & \longrightarrow & \mathcal{Q}^k(\underline{c}; \underline{d}) \\ \downarrow & & \downarrow & & \downarrow \\ \tilde{\mathcal{Q}}_{k+1}(\underline{c}; \underline{d}) & \longrightarrow & \tilde{\mathcal{Q}}_{k+1}(\underline{c}; \underline{d})/\Sigma_{k+1} & \longrightarrow & \mathcal{Q}^{k+1}(\underline{c}; \underline{d}) \end{array}$$

by forgetting the ordering of the marked vertices.

Proposition 9.3. *The diagram*

$$\begin{array}{ccc} \tilde{\mathcal{Q}}_{k+1}^+(\underline{c}; \underline{d})/\Sigma_{k+1} & \longrightarrow & \mathcal{Q}^k(\underline{c}; \underline{d}) \\ \downarrow & & \downarrow \\ \tilde{\mathcal{Q}}_{k+1}(\underline{c}; \underline{d})/\Sigma_{k+1} & \longrightarrow & \mathcal{Q}^{k+1}(\underline{c}; \underline{d}). \end{array}$$

is a pushout.

Proof. Consider the map

$$(28) \quad C : \tilde{\mathcal{Q}}_{k+1}(\underline{c}; \underline{d}) \amalg_{\tilde{\mathcal{Q}}_{k+1}^+(\underline{c}; \underline{d})} \mathcal{Q}^k(\underline{c}; \underline{d}) \rightarrow \mathcal{Q}^{k+1}(\underline{c}; \underline{d}).$$

For each element of $\mathcal{Q}^{k+1}(\underline{c}; \underline{d})$ we can find a representative $z \in D(G, \boxplus)$ for some $(G, \boxplus) \in {}^s\mathbf{B}_{\leq k+1}^{\mathcal{J}}$. If $\#_{w_x}(G, \boxplus) \leq k$, then $[z]$ is in the image of $\mathcal{Q}^k(\underline{c}; \underline{d})$, while if

$\#_{wx}(G, \boxplus) = k + 1$ then $(G, \boxplus) = A(1, \dots, 1, (G, \ell))$ for a choice of ordering ℓ of the white vertices of (G, \boxplus) , so $[z]$ is in the image of $\tilde{\mathcal{Q}}_{k+1}(\underline{c}; \underline{d})$. Thus (28) is surjective.

It is not true that (28) is injective, but we will show that

$$C_{\Sigma_{k+1}} : \tilde{\mathcal{Q}}_{k+1}(\underline{c}; \underline{d}) / \Sigma_{k+1} \amalg_{\tilde{\mathcal{Q}}_{k+1}^+(\underline{c}; \underline{d}) / \Sigma_{k+1}} \mathcal{Q}^k(\underline{c}; \underline{d}) \rightarrow \mathcal{Q}^{k+1}(\underline{c}; \underline{d}).$$

is injective. Suppose that we have

$$x, x' \in \tilde{\mathcal{Q}}_{k+1}(\underline{c}; \underline{d}) \setminus \left(\text{Im } \tilde{\mathcal{Q}}_{k+1}^+(\underline{c}; \underline{d}) \right)$$

with $C(x) = C(x')$. If we can show that this implies $x = x' \pmod{\Sigma_k}$, then $C_{\Sigma_{k+1}}$ is injective.

Suppose that $C(x) = C(x')$ and, using the notation of definition 8.1, that $x \sim_n x'$ for some $n > 0$. Choose a witness to $x \sim_n x'$, i.e. elements

$$\begin{aligned} z &\in DA(c) & z' &\in DA(c') \\ [z] &= x \in \tilde{\mathcal{Q}}_{k+1}(\underline{c}; \underline{d}) & [z'] &= x' \in \tilde{\mathcal{Q}}_{k+1}(\underline{c}; \underline{d}), \end{aligned}$$

a zigzag

$$(29) \quad A(c) \xrightarrow{f_1} d_1 \xleftarrow{f_2} d_2 \xrightarrow{f_3} \dots \xrightarrow{f_{2n-1}} d_{2n-1} \xleftarrow{f_{2n}} A(c')$$

in ${}^s\mathbf{B}_{\leq k+1}(\underline{c}; \underline{d})$, and elements $z_i \in D(d_i)$ so that

$$\begin{aligned} D(f_1)(z) &= z_1 & D(f_{2n})(z') &= z_{2n-1} \\ D(f_{2i})(z_{2i}) &= z_{2i-1} & D(f_{2i+1})(z_{2i}) &= z_{2i+1}. \end{aligned}$$

Note that remark 8.2 does not apply in the present setting; nevertheless, we will show that $\omega(x, x') \leq 1$.

Our goal is to show that if $n > 1$, $x \sim_n x'$ implies $x \sim_{n-1} x'$. Write the beginning of (29) as

$$A(1, \dots, 1, (H, \ell')) = (H, \boxplus') \xrightarrow{f} (G, \boxplus) \xleftarrow{f'} (H', \boxplus'');$$

note that (H, \boxplus') is grey-free, otherwise our x is in the image of $\tilde{\mathcal{Q}}_{k+1}^+(\underline{c}; \underline{d})$. Hence $\#_{wx}(H, \boxplus') = k + 1$ and f is a gsd map. Notice that f cannot increase $\#_{wx}$ (otherwise we leave ${}^s\mathbf{B}_{\leq k+1}$), so f is given by

$$H = G\{K_v\}_{\boxplus^{-1}(b) \cup \mathbb{Y}(G)} \{ |x \}_{\boxplus(v)=g}.$$

We then have a diagram

$$\begin{array}{ccccc} & & \eta(G, \boxplus) & \xleftarrow{\eta(f')} & \eta(H', \boxplus'') \\ & \nearrow \tilde{f} & \downarrow & & \downarrow \\ (H, \boxplus') & \xrightarrow{f} & (G, \boxplus) & \xleftarrow{f'} & (H', \boxplus'') \end{array}$$

where the gsd map \tilde{f} is given by $H = G^{\boxplus} \{K_v\}_{\boxplus^{-1}(b) \cup \mathbb{Y}(G)}$. Notice that \tilde{f} is the image under A of a map

$$\text{id} \times \tilde{f} : (1, \dots, 1, (H, \ell')) \rightarrow (1, \dots, 1, (G^{\boxplus}, \ell)),$$

where $\ell = \tilde{f}_{\text{vt}} \circ \ell'$.

Factor f' as a transfusion q followed by a gsd map h

$$(30) \quad f' : (H', \boxplus'') \xrightarrow{q} (H', \boxplus_0) \xrightarrow{h} (G, \boxplus).$$

Write h to be the decomposition

$$H' = G\{L_v\}_{\boxplus(v)\in\{b,w\}}\{R_v\}_{\boxplus(v)=g};$$

then by (16,17) and the fact that everything is simplified, $\eta(h)$ is the decomposition

$$(31) \quad H'^{\wedge\boxplus_0} = G^{\wedge\boxplus}\{L_v\}_{\boxplus(v)\in\{b,w\}}.$$

Let S be the set of vertices v with $\boxplus(v) = w$, $v \notin \mathbb{Y}(G)$, and $L_v = |_x$. We will argue that $\eta(h)$ is the image under A of a morphism of the form

$$(32) \quad (1, \dots, 1, (H'^{\wedge\boxplus_0}, \ell_0)) \rightarrow (1, \dots, 1, (G^{\wedge\boxplus}, \ell)).$$

Define a new partition \boxplus_S on $G^{\wedge\boxplus}$ by

$$\boxplus_S(v) = \begin{cases} g & v \in S; \\ \boxplus^{\setminus g}(v) & \text{otherwise.} \end{cases}$$

But now

$$\begin{aligned} H'^{\wedge\boxplus_0} &= G^{\wedge\boxplus}\{L_v\}_{\boxplus(v)\in\{b,w\}} \\ &= (G^{\wedge\boxplus})^{\setminus\boxplus_S}\{L_v\}_{\boxplus^{-1}\{b,w\}\setminus S}. \end{aligned}$$

giving the first map in the factorization

$$(33) \quad \eta(H', \boxplus_0) \rightarrow \eta(G^{\wedge\boxplus}, \boxplus_S) \rightarrow (G^{\wedge\boxplus}, \boxplus_S) \rightarrow (G^{\wedge\boxplus}, \boxplus^{\setminus g}) = \eta(G, \boxplus).$$

The map

$$(G^{\wedge\boxplus}, \boxplus_S) \rightarrow (G^{\wedge\boxplus}, \boxplus^{\setminus g})$$

is the image under A of a map

$$(34) \quad (t_1, \dots, t_{k+1}, (G^{\wedge\boxplus}, \ell)) \rightarrow (1, \dots, 1, (G^{\wedge\boxplus}, \ell))$$

$$t_i = \begin{cases} 0 & \ell(i) \in S \\ 1 & \text{otherwise.} \end{cases}$$

If this is *not* the identity then x is represented by an element of $DA(t_1, \dots, t_{k+1}, (G^{\wedge\boxplus}, \ell))$, hence is in the image of $\tilde{\mathcal{Q}}_{k+1}^+(\underline{c}; \underline{d})$, contrary to assumption. Thus (34) is the identity, so $t_i = 1$ for all i and $S = \emptyset$. Now, in (33), we have

$$\begin{array}{ccccccc} \eta(H', \boxplus_0) & \longrightarrow & \eta(G^{\wedge\boxplus}, \boxplus_S) & \longrightarrow & (G^{\wedge\boxplus}, \boxplus_S) & \xrightarrow{=} & (G^{\wedge\boxplus}, \boxplus^{\setminus g}) \\ & & \searrow = & & \uparrow & & \downarrow = \\ & & & & \eta(G^{\wedge\boxplus}, \boxplus_S) & \xrightarrow{=} & \eta(G, \boxplus) \end{array}$$

which shows that the map $\eta(h) : \eta(H', \boxplus_0) \rightarrow \eta(G, \boxplus)$ from (31) is of the form

$$H'^{\wedge\boxplus_0} = G^{\wedge\boxplus}\{L_v\}_{\boxplus^{-1}(b)\cup\mathbb{Y}(G)},$$

hence we have that $\eta(h)$ is the image under A of a morphism of $\text{id} \times \eta(h)$ as in (32).

Next consider $q : (H', \boxplus'') \rightarrow (H', \boxplus_0)$ from (30); by (15) we have that $\eta(q)$ is the decomposition

$$H'^{\wedge\boxplus''} = H'^{\wedge\boxplus_0} \{ |_x \}_{\substack{\boxplus''(v)=g \\ \boxplus_0(v) \neq g}}.$$

So far we know that $\eta(H', \boxplus_0) = A(1, \dots, 1, (H'^{\wedge\boxplus_0}, \ell_0))$. We play the same kind of game as above and let

$$S = \left\{ v \in \text{Vt}(H'^{\wedge\boxplus_0}) \mid \boxplus''(v) = g \ \& \ \boxplus_0(v) \neq g \right\}$$

so that $H^\wedge \boxplus'' = H^\wedge \boxplus_0 \{ \cdot \}_S$. Define a partition on $H^\wedge \boxplus_0$ by

$$\boxplus_S(v) = \begin{cases} g & v \in S \\ \boxplus_0 \setminus g(v) & \text{otherwise,} \end{cases}$$

so we have a factorization

$$(35) \quad \eta(H', \boxplus'') \rightarrow (H^\wedge \boxplus_0, \boxplus_S) \rightarrow \eta(H', \boxplus_0)$$

where the second map is a transfusion and the first map creates grey vertices indexed by S . The transfusion is the image under A of

$$(t_1, \dots, t_{k+1}, (H^\wedge \boxplus_0, \ell_0)) \rightarrow (1, \dots, 1, (H^\wedge \boxplus_0, \ell_0))$$

where $t_i = 0$ if $\ell_0(i) \in S$ and $t_i = 1$ if $\ell_0(i) \notin S$. But if any $t_i = 0$ then x is in the image of $\tilde{\mathcal{Q}}_{k+1}^+(\underline{c}; \underline{d})$, hence $S = \emptyset$ and both maps in (35) are identities.

Let us return now to our witness of $x \sim_n x'$:

$$A(1, \dots, 1, (H, \ell')) = (H, \boxplus') \xrightarrow{f} (G, \boxplus) \xleftarrow{f'} (H', \boxplus'') \xrightarrow{f_3} \dots \xrightarrow{f_{2n-1}} d_{2n-1} \xleftarrow{f_{2n}} A(c')$$

$$\begin{array}{ccccccc} (H, \boxplus') & \xrightarrow{f} & (G, \boxplus) & \xleftarrow{f'} & (H', \boxplus'') & \xrightarrow{f_3} & d_3 \cdots \xrightarrow{f_{2n-1}} d_{2n-1} \xleftarrow{f_{2n}} A(c') \\ \uparrow & \searrow & \uparrow & \longleftarrow & \uparrow & & \uparrow \\ = & & \eta(G, \boxplus) & \longleftarrow & \eta(H', \boxplus'') & & \uparrow \\ & & = & & = & & \uparrow \\ A(1^{k+1}, (H, \ell')) & \rightarrow & A(1^{k+1}, (G^\wedge \boxplus, \ell)) & \leftarrow & A(1^{k+1}, (H^\wedge \boxplus_0, \ell_0)) & & \uparrow \\ & & & & & & \uparrow \\ & & & & & & f'_3 \end{array}$$

Since z_2 actually lives in $D\eta(H', \boxplus'')$ by Lemma 7.6, we get a witness

$$A(1, \dots, 1, (H^\wedge \boxplus_0, \ell_0)) \xrightarrow{f'_3} d_3 \xleftarrow{f_4} \dots \xrightarrow{f_{2n-1}} d_{2n-1} \xleftarrow{f_{2n}} A(c')$$

to $x = [z_2] \sim_{n-1} x'$.

All of the above constructions work when $n = 1$, except now the witness to $x \sim_1 x'$ looks like

$$A(1, \dots, 1, (H, \ell')) = (H, \boxplus') \xrightarrow{f} (G, \boxplus) \xleftarrow{f'} (H', \boxplus'') = A(1, \dots, 1, (H', \ell''))$$

with (H', \boxplus'') grey-free. The diagram above reduces to

$$\begin{array}{ccccc} & & & & A(1^{k+1}, (H', \ell'')) \\ & & & & \downarrow = \\ (H, \boxplus') & \xrightarrow{f} & (G, \boxplus) & \xleftarrow{f'} & (H', \boxplus'') \\ \uparrow & & \uparrow & & \uparrow \\ = & & & & = \\ A(1^{k+1}, (H, \ell')) & \rightarrow & A(1^{k+1}, (G^\wedge \boxplus, \ell)) & \leftarrow & A(1^{k+1}, (H', \ell_0)). \end{array}$$

But of course we don't have control over ℓ_0 , which may be different from ℓ'' , so the composite $A(1, \dots, 1, (H', \ell_0)) \rightarrow A(1, \dots, 1, (H', \ell''))$ does not necessarily come from a map $(1, \dots, 1, (H', \ell_0)) \rightarrow (1, \dots, 1, (H', \ell''))$ in $[1]^k \times \mathbf{G}_{k+1}^M(\underline{c}; \underline{d})$. But $\text{Im}(\ell'') = \boxplus''^{-1}(w) = \text{Im}(\ell_0)$, so $\tilde{z}_2 \in DA(1^{k+1}, (H', \ell_0))$ and $z_2 \in DA(1^{k+1}, (H', \ell''))$

map to the same element in $\tilde{\mathcal{Q}}_{k+1}(\underline{c}; \underline{d})/\Sigma_{k+1}$. Thus $x = [z] = [\tilde{z}_2]$ and $x' = [z_2] = \sigma[\tilde{z}_2]$ give the same element of $\tilde{\mathcal{Q}}_{k+1}(\underline{c}; \underline{d})/\Sigma_{k+1}$, so $C_{\Sigma_{k+1}}$ is injective. \square

Proof of Proposition 5.12. Fix an input-output profile $(\underline{c}; \underline{d})$. Then we have isomorphisms

$$\operatorname{colim}_k \mathcal{Q}^k(\underline{c}; \underline{d}) = \operatorname{colim}_k \operatorname{colim}_{\mathcal{B}_{\leq k}(\underline{c}; \underline{d})} D \cong \operatorname{colim}_{\mathcal{B}(\underline{c}; \underline{d})} D \stackrel{7.13}{\cong} \operatorname{colim}_{\mathcal{B}(\underline{c}; \underline{d})} D \stackrel{6.11}{\cong} \mathcal{H} \amalg_{\mathcal{I}} \mathcal{T}(\underline{c}; \underline{d}).$$

By Lemma 9.2 and Proposition 9.3, each

$$\mathcal{Q}^k(\underline{c}; \underline{d}) \rightarrow \mathcal{Q}^{k+1}(\underline{c}; \underline{d})$$

is an acyclic cofibration of simplicial sets. Hence

$$\mathcal{Q}^0(\underline{c}; \underline{d}) \rightarrow \operatorname{colim}_k \mathcal{Q}^k(\underline{c}; \underline{d}) \cong \mathcal{H} \amalg_{\mathcal{I}} \mathcal{T}(\underline{c}; \underline{d})$$

is an acyclic cofibration as well. If $(\underline{c}; \underline{d})$ is a $\operatorname{Col}(\mathcal{T})$ profile, then $\mathbb{G}_{\operatorname{Col}(\mathcal{T})} = {}^s\mathbb{B}_{\leq 0}(\underline{c}; \underline{d})$, so $\mathcal{T}(\underline{c}; \underline{d}) = \mathcal{Q}^0(\underline{c}; \underline{d})$ by Proposition 3.11. Hence

$$\mathcal{T}(\underline{c}; \underline{d}) \rightarrow \mathcal{H} \amalg_{\mathcal{I}} \mathcal{T}(\underline{c}; \underline{d})$$

is a weak equivalence for all input-output profiles $(\underline{c}; \underline{d})$ in $\operatorname{Col}(\mathcal{T})$, so $\mathcal{T} \rightarrow \mathcal{H} \amalg_{\mathcal{I}} \mathcal{T}$ satisfies (W1). \square

REFERENCES

1. Michael Batanin and Clemens Berger, *Homotopy theory for algebras over polynomial monads*, Preprint, arXiv:1305.0086 [math.CT].
2. Clemens Berger and Ieke Moerdijk, *Resolution of coloured operads and rectification of homotopy algebras*, Categories in algebra, geometry and mathematical physics, Contemp. Math., vol. 431, Amer. Math. Soc., Providence, RI, 2007, pp. 31–58. MR 2342815 (2008k:18008)
3. Julia E. Bergner, *A model category structure on the category of simplicial categories*, Trans. Amer. Math. Soc. **359** (2007), no. 5, 2043–2058. MR 2276611 (2007i:18014)
4. ———, *A survey of $(\infty, 1)$ -categories*, Towards higher categories, IMA Vol. Math. Appl., vol. 152, Springer, New York, 2010, Available at http://dx.doi.org/10.1007/978-1-4419-1524-5_2, pp. 69–83. MR 2664620 (2011e:18001)
5. J. M. Boardman and R. M. Vogt, *Homotopy Invariant Algebraic Structures on Topological Spaces*, Lecture Notes in Mathematics, Vol. 347, Springer-Verlag, Berlin, 1973. MR 0420609 (54 #8623a)
6. Denis-Charles Cisinski and Ieke Moerdijk, *Dendroidal sets as models for homotopy operads*, J. Topol. **4** (2011), no. 2, 257–299, Available at <http://dx.doi.org/10.1112/jtopol/jtq039>. MR 2805991
7. ———, *Dendroidal Segal spaces and ∞ -operads*, J. Topol. **6** (2013), no. 3, 675–704, Available at <http://dx.doi.org/10.1112/jtopol/jtt004>.
8. ———, *Dendroidal sets and simplicial operads*, J. Topol. **6** (2013), no. 3, 705–756, Available at <http://dx.doi.org/10.1112/jtopol/jtt006>.
9. W. G. Dwyer and D. M. Kan, *Simplicial localizations of categories*, J. Pure Appl. Algebra **17** (1980), no. 3, 267–284. MR 579087 (81h:55018)
10. John Francis, *Derived algebraic geometry over E_n -rings*, 2008, Thesis (Ph.D.)–Massachusetts Institute of Technology. MR 2717524
11. Yael Frégier, Martin Markl, and Donald Yau, *The L_∞ -deformation complex of diagrams of algebras*, New York J. Math. **15** (2009), 353–392. MR 2530153 (2011b:16039)
12. Benoit Fresse, *Props in model categories and homotopy invariance of structures*, Georgian Math. J. **17** (2010), no. 1, 79–160. MR 2640648 (2011h:18011)
13. Paul G. Goerss and John F. Jardine, *Simplicial Homotopy Theory*, Progress in Mathematics, vol. 174, Birkhäuser Verlag, Basel, 1999. MR 1711612 (2001d:55012)
14. Philip Hackney and Marcy Robertson, *On the category of props*, Appl. Categ. Structures **23** (2015), no. 4, 543–573. MR 3367131

15. Philip Hackney, Marcy Robertson, and Donald Yau, *Relative left properness of colored operads*, (2014), To appear in Algebraic and Geometric Topology. Preprint, arXiv:1411.4668 [math.AT].
16. ———, *A simplicial model for infinity properads*, (2014), Preprint, arXiv:1502.06522 [math.AT].
17. ———, *Infinity Properads and Infinity Wheeled Properads*, Lecture Notes in Mathematics, vol. 2147, Springer, Cham, 2015, Available at arXiv:1410.6716 [math.AT] and doi:10.1007/978-3-319-20547-2.
18. Philip S. Hirschhorn, *Model Categories and Their Localizations*, Mathematical Surveys and Monographs, vol. 99, American Mathematical Society, Providence, RI, 2003. MR 1944041 (2003j:18018)
19. Mark Hovey, *Model categories*, Mathematical Surveys and Monographs, vol. 63, American Mathematical Society, Providence, RI, 1999. MR 1650134 (99h:55031)
20. Mark W. Johnson and Donald Yau, *On homotopy invariance for algebras over colored PROPs*, J. Homotopy Relat. Struct. **4** (2009), no. 1, 275–315. MR 2559644 (2010j:18014)
21. A. Joyal, *Quasi-categories and Kan complexes*, J. Pure Appl. Algebra **175** (2002), no. 1-3, 207–222, Special volume celebrating the 70th birthday of Professor Max Kelly. MR 1935979 (2003h:55026)
22. Joachim Kock, *Graphs, hypergraphs, and properads*, Preprint, arXiv:1407.3744 [math.QA].
23. Jacob Lurie, *Higher Algebra*, Preprint (May 18, 2011) available at www.math.harvard.edu/~lurie/papers/higheralgebra.pdf.
24. ———, *Higher topos theory*, Annals of Mathematics Studies, vol. 170, Princeton University Press, Princeton, NJ, 2009, Available at <http://www.math.harvard.edu/~lurie/papers/highertopoi.pdf>. MR 2522659 (2010j:18001)
25. Saunders Mac Lane, *Categorical algebra*, Bull. Amer. Math. Soc. **71** (1965), 40–106. MR 0171826 (30 #2053)
26. ———, *Categories for the working mathematician*, second ed., Graduate Texts in Mathematics, vol. 5, Springer-Verlag, New York, 1998. MR 1712872 (2001j:18001)
27. Martin Markl, *Operads and PROPs*, Handbook of algebra. Vol. 5, Handb. Algebr., vol. 5, Elsevier/North-Holland, Amsterdam, 2008, pp. 87–140. MR 2523450 (2010j:18015)
28. Martin Markl, Steve Shnider, and Jim Stasheff, *Operads in algebra, topology and physics*, Mathematical Surveys and Monographs, vol. 96, American Mathematical Society, Providence, RI, 2002. MR 1898414 (2003f:18011)
29. J. Peter May, *The Geometry of Iterated Loop Spaces*, Springer-Verlag, Berlin, 1972, Lectures Notes in Mathematics, Vol. 271. MR 0420610 (54 #8623b)
30. Ieke Moerdijk, *Lectures on dendroidal sets*, Simplicial methods for operads and algebraic geometry, Adv. Courses Math. CRM Barcelona, Birkhäuser/Springer Basel AG, Basel, 2010, Notes written by Javier J. Gutiérrez, pp. 1–118. MR 2778589
31. Ieke Moerdijk and Ittay Weiss, *Dendroidal sets*, Algebr. Geom. Topol. **7** (2007), 1441–1470, Available at <http://dx.doi.org/10.2140/agt.2007.7.1441>. MR 2366165 (2009d:55014)
32. ———, *On inner Kan complexes in the category of dendroidal sets*, Adv. Math. **221** (2009), no. 2, 343–389, Available at <http://dx.doi.org/10.1016/j.aim.2008.12.015>. MR 2508925 (2010a:55021)
33. Daniel G. Quillen, *Homotopical algebra*, Lecture Notes in Mathematics, No. 43, Springer-Verlag, Berlin, 1967. MR 0223432 (36 #6480)
34. Charles Rezk, *A model category for categories*, Available at <http://www.math.uiuc.edu/~rezk/cat-ho.dvi>, 1996.
35. ———, *A model for the homotopy theory of homotopy theory*, Trans. Amer. Math. Soc. **353** (2001), no. 3, 973–1007 (electronic), Available at <http://dx.doi.org/10.1090/S0002-9947-00-02653-2>. MR 1804411 (2002a:55020)
36. ———, *Every homotopy theory of simplicial algebras admits a proper model*, Topology Appl. **119** (2002), no. 1, 65–94. MR 1881711 (2003g:55033)
37. Marcy Robertson, *The homotopy theory of simplicially enriched multicategories*, (2011), Preprint, arXiv:1111.4146 [math.AT].
38. Graeme Segal, *The definition of conformal field theory*, Differential geometrical methods in theoretical physics (Como, 1987), NATO Adv. Sci. Inst. Ser. C Math. Phys. Sci., vol. 250, Kluwer Acad. Publ., Dordrecht, 1988, pp. 165–171. MR 981378 (90d:58026)

39. Bruno Vallette, *A Koszul duality for PROPs*, Trans. Amer. Math. Soc. **359** (2007), no. 10, 4865–4943. MR 2320654 (2008e:18020)
40. Donald Yau and Mark W. Johnson, *A Foundation for PROPs, Algebras, and Modules*, Math. Surveys and Monographs, Vol. 203, Amer. Math. Soc., Providence, RI, 2015.

MATEMATISKA INSTITUTIONEN, STOCKHOLMS UNIVERSITET, 106 91 STOCKHOLM, SWEDEN
E-mail address: `hackney@math.su.se`

DEPARTMENT OF MATHEMATICS, THE UNIVERSITY OF CALIFORNIA LOS ANGELES, LOS ANGELES,
CA
E-mail address: `mrober97@math.ucla.edu`