

5-list-coloring planar graphs with distant precolored vertices

Zdeněk Dvořák* Bernard Lidický† Bojan Mohar‡§
 Luke Postle¶

Abstract

We answer positively the question of Albertson asking whether every planar graph can be 5-list-colored even if it contains precolored vertices, as long as they are sufficiently far apart from each other. In order to prove this claim, we also give bounds on the sizes of graphs critical with respect to 5-list coloring. In particular, if G is a planar graph, H is a connected subgraph of G and L is an assignment of lists of colors to the vertices of G such that $|L(v)| \geq 5$ for every $v \in V(G) \setminus V(H)$ and G is not L -colorable, then G contains a subgraph with $O(|H|^2)$ vertices that is not L -colorable.

*Computer Science Institute of Charles University, Prague, Czech Republic. E-mail: rakdver@iuuk.mff.cuni.cz. Supported by Institute for Theoretical Computer Science (ITI), project 1M0545 of Ministry of Education of Czech Republic, and by project GA201/09/0197 (Graph colorings and flows: structure and applications) of Czech Science Foundation. Further work after these grants finished was supported by the Center of Excellence – Inst. for Theor. Comp. Sci., Prague, project P202/12/G061 of Czech Science Foundation.

†Iowa State University, Ames IA, USA. E-mail: lidicky@iasate.edu.

‡Department of Mathematics, Simon Fraser University, Burnaby, B.C. V5A 1S6. E-mail: mohar@sfu.ca. Supported in part by an NSERC Discovery Grant (Canada), by the Canada Research Chair program, and by the Research Grant P1-0297 of ARRS (Slovenia).

§On leave from: IMFM & FMF, Department of Mathematics, University of Ljubljana, Ljubljana, Slovenia.

¶University of Waterloo. E-mail: lpostle@uwaterloo.ca.

1 List colorings of planar graphs

For a graph G , a *list assignment* is a function L that assigns a set of colors to each vertex of G . For $v \in V(G)$, we say that $L(v)$ is the *list* of v . An L -*coloring* of G is a function φ such that $\varphi(v) \in L(v)$ for every $v \in V(G)$ and $\varphi(u) \neq \varphi(v)$ for any pair of adjacent vertices $u, v \in V(G)$. A graph G is k -*choosable* if G is L -colorable for every list assignment L such that $|L(v)| \geq k$ for each $v \in V(G)$.

A well-known result by Thomassen [13] states that every planar graph is 5-choosable. This implies that planar graphs are 5-colorable. Since planar graphs are known to be 4-colorable [2, 3], a natural question is whether the result can be strengthened. Voigt [17] gave an example of a non-4-choosable planar graph; hence, the vertices with lists of size smaller than 5 must be restricted in some way. For example, Albertson [1] asked the following question.

Problem 1. *Does there exist a constant d such that whenever G is a planar graph with list assignment L that gives lists of size one or five to its vertices and the distance between any pair of vertices with lists of size one is at least d , then G is L -colorable?*

For usual colorings, Albertson [1] proved that if S is a set of vertices in a planar graph G that are precolored with colors 1–5 and are at distance at least 4 from each other, then the precoloring of S can be extended to a 5-coloring of G . This solved a problem asked earlier by Thomassen [14]¹. This result does not generalize to 4-colorings even if we have only two precolored vertices (arbitrarily far apart). Examples are given by triangulations of the plane that have precisely two vertices of odd degree. As proved by Ballantine [5] and Fisk [8], the two vertices of odd degree must have the same color in every 4-coloring. Thus, precoloring them with a different color, we cannot extend the precoloring to a 4-coloring of the whole graph.

Recently, there has been significant progress towards the solution of Albertson’s problem, see [4] and [7]. Let us remark that when the number of precolored vertices is also bounded by some constant, then the answer is positive by the results of Kawarabayashi and Mohar [9] on 5-list-coloring graphs on surfaces. In this paper, we prove that the answer is positive in general.

¹The problem was posted in the preprint version of [14]; the published version refers to it as being solved already.

Theorem 2. *If G is a planar graph with list assignment L that gives lists of size one or five to its vertices and the distance between any pair of vertices with lists of size one is at least 20780, then G is L -colorable.*

In the proof, we need the following result concerning the case that the precolored vertices form a connected subgraph, which is of independent interest.

Theorem 3. *Suppose that G is a planar graph, H is a connected subgraph of G and L is an assignment of lists to the vertices of G such that $|L(v)| \geq 5$ for $v \in V(G) \setminus V(H)$ (and the lists of vertices of H are arbitrary). If G is not L -colorable, then G contains a subgraph F with at most $8|V(H)|^2$ vertices such that F is not L -colorable.*

Let us remark that the existence of such a subgraph of bounded size follows from [9], but our bound on the size of F is much better and gives a better estimate on the required distance in Problem 1. During the publication process of this paper, Postle and Thomas [12] improved the bound of Theorem 3 to linear, and announced a stronger result [10, 11] implying that this bound holds even for disconnected H ; the latter of course gives another proof of Theorem 2 (with a different forbidden distance between precolored vertices).

In order to prove Theorem 2, we instead consider a more general statement allowing some lists of smaller size. For a plane graph G and a face f of G , let the *boundary* of f denote the subgraph of G consisting of vertices and edges incident with f (let us recall that a *face* is a maximal connected subset of the plane after removing the points contained in the drawing of G). Let G be a plane graph, let P be a subpath of the boundary H of the outer face of G , and let X be a subset of $V(G) \setminus V(P)$. For a positive integer M , a list assignment L for G is *M -valid with respect to P and X* if

- $|L(v)| = 5$ for $v \in V(G) \setminus (V(H) \cup X)$,
- $3 \leq |L(v)| \leq 5$ for $v \in V(H) \setminus (V(P) \cup X)$,
- $|L(v)| = 1$ for $v \in X$,
- the subgraph of G induced by $V(P) \cup X$ is L -colorable, and
- for every $v \in X$, the vertices of $V(G) \setminus \{v\}$ at distance at most M from v do not belong to P and have lists of size 5.

If $X = \emptyset$ and L is 0-valid, we simply say that L is *valid with respect to P* .

A key ingredient for our proofs is the following well-known result of Thomassen [13] regarding the coloring of planar graphs from lists of restricted sizes.

Theorem 4 ([13]). *If G is a connected plane graph, xy is an edge incident with the outer face of G , and L is a list assignment that is valid with respect to xy , then G is L -colorable.*

There are arbitrarily large non- L -colorable graphs with this structure if we allow a path of length two to be precolored (throughout the paper, the *length* of the path refers to the number of its edges, i.e., a path of length two has three vertices). Thomassen [15] gave their complete description, see Lemma 12. In Theorem 10, we deal with the more general case when P has fixed length k . In particular, we show that if G is a minimal non- L -colorable graph satisfying the assumptions of Theorem 10, then at most $k - 2$ of its vertices incident with the outer face have lists of size at least four. In conjunction with Theorem 3, this enables us to bound the size of such graphs subject to the additional assumption that no two vertices with lists of size three are adjacent.

Next, we use the new approach to 5-choosability of planar graphs developed in [7] to show that we can reduce the problem to the case that only one internal vertex is precolored. Having established this fact, the following lemma gives the affirmative answer to Problem 1.

Lemma 5. *There exists a constant M with the following property. Let G be a plane graph and let H be the boundary of its outer face. Let P be a (possibly null) subpath of H of length at most one. For every $x \in V(G) \setminus V(P)$ and every list assignment L that is M -valid with respect to P and $\{x\}$ such that no two vertices with lists of size three are adjacent, the graph G is L -colorable.*

We first prove Theorem 3, in Section 2. In Section 3, we prove Theorem 10. In Section 4, we show that Lemma 5 implies our main result, Theorem 2. Finally, in Section 5, we prove Lemma 5.

Let us mention that we could also allow different kinds of “irregularities” other than just precolored vertices, for example, precolored triangles or crossings, as long as the irregularity satisfies the condition analogous to Lemma 5. To keep the presentation manageable, we do not give proofs in this full generality and focus on the case of precolored single vertices.

2 Critical graphs

To avoid dealing with irrelevant subgraphs, we define what a list-coloring critical graph means. Let G be a graph, let T be a (not necessarily induced) subgraph of G and let L be a list assignment to the vertices of $V(G)$. For an L -coloring φ of T , we say that φ *extends to an L -coloring of G* if there exists an L -coloring of G that matches φ on $V(T)$. The graph G is *T -critical with respect to the list assignment L* if $G \neq T$ and for every proper subgraph $G' \subset G$ such that $T \subseteq G'$, there exists a coloring of T that extends to an L -coloring of G' , but does not extend to an L -coloring of G . If the list assignment is clear from the context, we shorten this and say that G is *T -critical*. Note that G is list-critical for the usual definition of criticality if and only if it is \emptyset -critical. Let us also observe that every proper subgraph of a T -critical graph that includes T is L -colorable, and that it may happen that G is also L -colorable.

Let G be a T -critical graph (with respect to some list assignment). For $S \subseteq G$, a graph $G' \subseteq G$ is an *S -component* of G if S is a proper subgraph of G' , $T \cap G' \subseteq S$ and all edges of G incident with vertices of $V(G') \setminus V(S)$ belong to G' . For example, if G is a plane graph with T contained in the boundary of its outer face and S is a cycle in G that does not bound a face, then the subgraph of G drawn inside the closed disk bounded by S (which we denote by $\text{Int}_S(G)$) is an S -component of G .

Another important example of S -components comes from chords. Given a graph G and a cycle $K \subseteq G$, an edge uv is a *chord* of K if $u, v \in V(K)$, but uv is not an edge of K . For an integer $k \geq 2$, a path $v_0v_1 \dots v_k$ is a *k -chord* of K if $v_0, v_k \in V(K)$ and $v_1, \dots, v_{k-1} \notin V(K)$. Suppose that K bounds the outer face of a plane T -critical graph G , where T is a subpath of K . Let the set K' consist of $V(K) \setminus V(T)$ and of the endvertices of T . Let S be a chord or a k -chord of K such that both its endvertices belong to K' , and let c be a simple closed curve in plane consisting of S and a curve in the outer face of G joining the endpoints of S , such that T lies outside the closed disk bounded by c . The subgraph G' of G drawn inside the closed disk bounded by c is an S -component. We say that G' is the subgraph of G *split off* by S .

We are also going to need a generalization of the construction from the preceding paragraph. In the same situation, let $Q \neq T$ be a path in G such that no internal vertex of Q belongs to K' and both endvertices belong to K' (so Q may possibly contain some edges and vertices of T , but $T \not\subseteq Q$). We say that Q is a *span* of G . Let c be a simple closed curve in plane consisting

of Q and a curve in the outer face of G joining the endpoints of Q , such that T is not contained in the closed disk bounded by c . Again, the subgraph G' of G drawn inside the closed disk bounded by c is a Q -component, and we say that G' is the subgraph of G *split off* by Q .

The S -components have the following basic property.

Lemma 6. *Let G be a T -critical graph with respect to a list assignment L . Let G' be an S -component of G , for some $S \subseteq G$. Then G' is S -critical with respect to L .*

Proof. If G contains an isolated vertex v that does not belong to T , then since G is T -critical, we have that $L(v) = \emptyset$ and $T = G - v$. Observe that if G' is an S -component of G , then $S \subseteq T$ and $G' - v = S$, and clearly G' is S -critical.

Therefore, we can assume that every isolated vertex of G belongs to T . Consequently, every isolated vertex of G' belongs to S . Suppose for a contradiction that G' is not S -critical. Then, there exists an edge $e \in E(G') \setminus E(S)$ such that every L -coloring of S that extends to $G' - e$ also extends to G' . Note that $e \notin E(T)$. Since G is T -critical, there exists a coloring ψ of T that extends to an L -coloring φ of $G - e$, but does not extend to an L -coloring of G . However, by the choice of e , the restriction of φ to S extends to an L -coloring φ' of G' . Let φ'' be the coloring that matches φ' on $V(G')$ and φ on $V(G) \setminus V(G')$. Observe that φ'' is an L -coloring of G extending ψ , which is a contradiction. \square

Lemma 6 together with the following reformulation of Theorem 4 enables us to apply induction to critical graphs.

Lemma 7. *Let G be a plane graph with its outer face bounded by a cycle H and let L be a list assignment for G such that $|L(v)| \geq 5$ for $v \in V(G) \setminus V(H)$. If G is H -critical with respect to the list assignment L , then either H has a chord or G contains a vertex with at least three neighbors in H .*

Proof. Suppose that H is an induced cycle. Since G is H -critical, there exists an L -coloring φ of H that does not extend to an L -coloring of G . Let L' be the list assignment for the graph $G' = G - V(H)$ obtained from L by removing the colors of vertices of H given by φ from the lists of their neighbors. Since φ does not extend to G , it follows that G' is not L' -colorable, and by Theorem 4, there exists $v \in V(G')$ with $|L'(v)| \leq 2$. This implies that v has at least three neighbors in H . \square

Clearly, to prove Theorem 3, it suffices to bound the size of critical graphs. It is more convenient to bound the *weight* of such graphs, which is defined as follows.

Definition 1 (Weights of faces and vertices). *Let G be a plane graph, let P be a subgraph of the boundary H of the outer face f_0 of G , and let L be a list assignment. For a face f of G , let $|f|$ denote the length of f (if an edge is incident with the same face f on both sides, it contributes 2 to $|f|$). The weight of f is*

$$\omega_{G,P,L}(f) = \begin{cases} |f| - 3 & \text{if } f \neq f_0 \\ 0 & \text{if } f = f_0. \end{cases}$$

For a vertex v of G , the weight is

$$\omega_{G,P,L}(v) = \begin{cases} 1 & \text{if } v \in V(P) \text{ and } v \text{ is a cut-vertex of } G \\ 0 & \text{if } v \in V(P) \text{ and } v \text{ is not a cut-vertex of } G \\ |L(v)| - 3 & \text{if } v \in V(H) \setminus V(P) \\ 0 & \text{if } v \in V(G) \setminus V(H). \end{cases}$$

In the cases where G , P or L are clear from the context, we drop the corresponding indices in $\omega_{G,P,L}$ notation.

Definition 2 (Weight of a graph). *Let G be a plane graph, let P be a subgraph of the boundary of the outer face of G , and let L be a list assignment. We set*

$$\omega_{P,L}(G) = \sum_{v \in V(G)} \omega_{G,P,L}(v) + \sum_{f \in F(G)} \omega_{G,P,L}(f),$$

where the sums go over the vertices and faces of G , respectively.

Let \mathcal{S} be a set of proper colorings of K . We say that $v \in V(K)$ is *relaxed* in \mathcal{S} if there exist two distinct colorings in \mathcal{S} that differ only in the color of v .

Lemma 8. *Let G be a plane graph with its outer face bounded by a cycle H and let L be a list assignment for G such that $|L(v)| \geq 5$ for $v \in V(G) \setminus V(H)$. If G is H -critical with respect to the list assignment L and G is not equal to H with one added chord, then*

$$\omega_{H,L}(G) + \frac{|V(G) \setminus V(H)|}{2|H| + 2} \leq |H| - 9/2.$$

Proof. We proceed by induction. Assume that the lemma holds for all graphs having fewer edges than G . For a subgraph G' of G with outer face bounded by a cycle C , let

$$\theta(G') = \omega_{C,L}(G') + \frac{|V(G') \setminus V(C)|}{2|H| + 2}.$$

Let $C \neq H$ be a cycle in G such that $|C| \leq |H|$. By Lemma 6, $\text{Int}_C(G)$ is C -critical with respect to L unless C bounds a face. If $\text{Int}_C(G)$ has at least four faces (including the outer one bounded by C), then the induction hypothesis applied to $\text{Int}_C(G)$ implies that

$$\begin{aligned} \theta(\text{Int}_C(G)) &= \omega_{C,L}(\text{Int}_C(G)) + \frac{|V(\text{Int}_C(G)) \setminus V(C)|}{2|H| + 2} \\ &\leq \omega_{C,L}(\text{Int}_C(G)) + \frac{|V(\text{Int}_C(G)) \setminus V(C)|}{2|C| + 2} \\ &\leq |C| - 9/2. \end{aligned}$$

Observe that if $\text{Int}_C(G)$ has three faces (i.e., consists of C and its chord), then $\theta(\text{Int}_C(G)) = \omega_{C,L}(\text{Int}_C(G)) = |C| - 4$, and if C bounds a face of G , then $\theta(\text{Int}_C(G)) = |C| - 3$.

We construct a sequence $G_0 \supset G_1 \supset \dots \supset G_k$ of subgraphs of G with outer faces bounded by cycles H_0, H_1, \dots, H_k such that for $0 \leq i \leq k$, G_i is H_i -critical and

$$\omega_{H_i,L}(G_i) = \omega_{H,L}(G) - (|H| - |H_i|). \quad (1)$$

We set $G_0 = G$ and $H_0 = H$. Suppose that G_i has already been constructed. If H_i has a chord, or a vertex of G_i has at least four neighbors in H_i , then we set $k = i$ and stop. Otherwise, by Lemma 7, there is a vertex $v \in V(G_i)$ with three neighbors v_1, v_2 and v_3 in H_i . Let C_1, C_2 and C_3 be the three cycles of $H_i + \{v_1v, v_2v, v_3v\}$ distinct from H_i , where C_j does not contain the edge vv_j ($j = 1, 2, 3$). If at most one of these cycles bounds a face of G_i , then we set $k = i$ and stop. Otherwise, assume that say C_1 and C_3 bound faces of G_i . Let \mathcal{S}_i be the set of L -colorings of H_i that do not extend to an L -coloring of G_i . If v_2 is relaxed in \mathcal{S}_i , then again set $k = i$ and stop. Otherwise, let $G_{i+1} = \text{Int}_{C_2}(G_i)$ and let $H_{i+1} = C_2$ be the cycle bounding its outer face.

Note that in the last case, we have $|H_{i+1}| \leq |H_i|$ and that

$$|H_i| - |H_{i+1}| = (|C_1| - 3) + (|C_3| - 3). \quad (2)$$

Furthermore, if $w \in V(H_{i+1}) \setminus \{v\}$ is relaxed in \mathcal{S}_i , then it is also relaxed in \mathcal{S}_{i+1} . This is obvious if $w \neq \{v_1, v_3\}$. Suppose that say $w = v_1$ and that $\varphi_1, \varphi_2 \in \mathcal{S}_i$ differ only in the color of v_1 . Since v has a list of size at least 5, there exists a color $c \in L(v) \setminus \{\varphi_1(v_1), \varphi_2(v_1), \varphi_1(v_2), \varphi_1(v_3)\}$. Let φ'_1 and φ'_2 be the L -colorings of H_{i+1} that match φ_1 and φ_2 on H_i and $\varphi'_1(v) = \varphi'_2(v) = c$. Then neither φ'_1 nor φ'_2 extends to an L -coloring of G_{i+1} , showing that v_1 is relaxed in \mathcal{S}_{i+1} . Similarly, v is relaxed in \mathcal{S}_{i+1} , since for an arbitrary $\varphi \in \mathcal{S}_i$ (the set \mathcal{S}_i is nonempty, since G_i is H_i -critical), there exist at least two possible colors for v in $L(v) \setminus \{\varphi(v_1), \varphi(v_2), \varphi(v_3)\}$, giving two elements of \mathcal{S}_{i+1} that differ only in the color of v . We conclude that the number of non-relaxed vertices in \mathcal{S}_{i+1} is smaller than the number of non-relaxed vertices in \mathcal{S}_i for every $i < k$, and consequently, $k \leq |H|$.

Lemma 6 implies that every G_i is H_i -critical. It is also easy to see by induction and using (2) that (1) holds for $0 \leq i \leq k$. In each step in the construction of the sequence $(G_i, H_i)_{i=0}^k$, the number $|V(G_i) \setminus V(H_i)|$ is decreased by 1. Thus, (1) implies that

$$\theta(G) - \theta(G_k) = |H| - |H_k| + \frac{k}{2|H| + 2}. \quad (3)$$

Suppose that there exists a proper subgraph $G' \supset H_k$ of G_k and a coloring $\varphi \in \mathcal{S}_k$ that does not extend to an L -coloring of G' . We may choose G' to be H_k -critical. Note that

$$\begin{aligned} \theta(G) &= \frac{k}{2|H| + 2} + (|H| - |H_k|) + \theta(G_k) \\ &= \frac{k}{2|H| + 2} + (|H| - |H_k|) + \theta(G') + \sum_{f \in F(G') \setminus \{H_k\}} (\theta(\text{Int}_f(G)) - \omega(f)). \end{aligned}$$

By induction, $\theta(G') \leq |H_k| - 4$, since $G' \neq H_k$. This implies that all faces of G' are shorter than $|H|$. Since G' is a proper subgraph of G_k , we have $\theta(\text{Int}_f(G)) \leq \omega(f) - 1$ for at least one face f of G' by induction. It follows that

$$\theta(G) \leq 1/2 + (|H| - |H_k|) + (|H_k| - 4) - 1 = |H| - 9/2,$$

as required. Therefore, we can assume that every coloring in \mathcal{S}_k extends to every proper subgraph of G_k that includes H_k .

Let us now consider various possibilities in the definition of G_k . If $v \in V(G_k) \setminus V(H_k)$ has exactly three neighbors v_1, v_2 and v_3 in H_k and v_2 is

relaxed, then consider colorings $\varphi_1, \varphi_2 \in \mathcal{S}_k$ that differ only in the color of v_2 . The coloring φ_1 extends to an L -coloring ψ_1 of $G_k - vv_2$. Let ψ_2 be obtained from ψ_1 by changing the color of v_2 to $\varphi_2(v_2)$, and note that ψ_2 is an L -coloring of $G_k - vv_2$ extending φ_2 . However, either $\psi_1(v) \neq \varphi_1(v_2)$ or $\psi_2(v) \neq \varphi_2(v_2)$, hence either φ_1 or φ_2 extends to an L -coloring of G_k . This is a contradiction, since they both belong to \mathcal{S}_k .

Suppose now that H_k has a chord $e = xy$ in G_k . If $G_k = H_k + e$, then since G is not H with a single chord, we have $k > 0$. However, that implies that a vertex of G_{k-1} has degree at most four and a list of size 5, which is impossible in a critical graph. It follows that $G_k \neq H_k + e$. Since G_k is H_k -critical, there exists a coloring $\varphi \in \mathcal{S}_k$ that extends to an L -coloring of $H_k + e$, i.e., $\varphi(x) \neq \varphi(y)$. However, every coloring in \mathcal{S}_k extends to every proper subgraph of G_k that includes H_k , and it follows that φ extends to an L -coloring of $G_k - e$. This gives an L -coloring of G_k extending φ , contradicting the assumption that $\varphi \in \mathcal{S}_k$. Therefore, we can assume that H_k is an induced cycle in G_k .

It follows that a vertex $v \in V(G_k) \setminus V(H_k)$ either has at least four neighbors in H_k , or three neighbors v_1, v_2 and v_3 in H_k such that at most one of the cycles of $H_k + \{v_1v, v_2v, v_3v\}$ distinct from H_k bounds a face. Then H_k has a 2-chord Q such that neither of the cycles K_1 and K_2 of $H_k \cup Q$ distinct from H_k bounds a face. For $i \in \{1, 2\}$, let $G'_i = \text{Int}_{K_i}(G)$. Suppose first that it is not possible to choose Q so that neither G'_1 nor G'_2 is a cycle with one chord. Since the middle vertex v of Q has degree at least 5, this can only happen if $V(G_k) \setminus V(H_k) = \{v\}$ and v has degree exactly 5. But then $k = 0$, since otherwise G_{k-1} would contain a vertex of degree at most four with a list of size 5, and we have $\theta(G) = |H| - 5 + \frac{1}{2|H|+2} < |H| - 9/2$.

Finally, suppose that neither G'_1 nor G'_2 is a cycle with a chord. By induction and (3), we have $\theta(G) \leq \frac{k+1}{2|H|+2} + (|H| - |H_k|) + \theta(G'_1) + \theta(G'_2) \leq 1/2 + (|H| - |H_k|) + |K_1| + |K_2| - 9 = 1/2 + (|H| - |H_k|) + |H_k| - 5 = |H| - 9/2$, as required. \square

To prove Theorem 3, we need the following simple observation regarding the sizes of faces in a plane graph.

Lemma 9. *If H is a connected plane graph with n vertices, then*

$$\sum_{f \in F(H)} (|f|^2 - 2) \leq 4n^2 - 8n + 2.$$

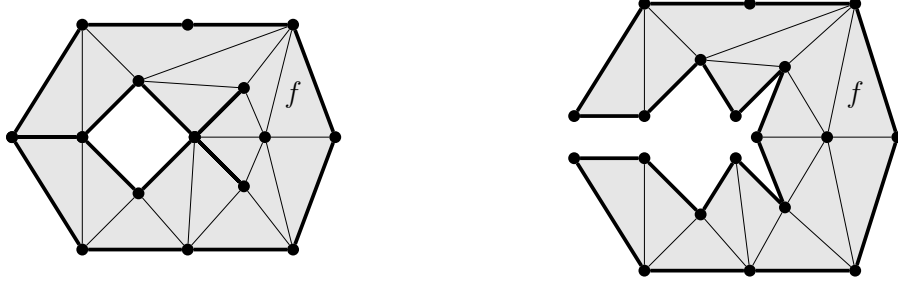

Figure 1: Splitting the boundary of a face of H . The boundaries of f and the split cycle C are shown by bold edges.

Proof. We prove the claim by induction on the number of edges of H . If H is a tree, then it has only one face of length $2n - 2$ and the claim follows. Otherwise, H contains an edge e such that $H - e$ is connected. Let f be the face of $H - e$ corresponding to two faces f_1 and f_2 of H separated by e . We have

$$\begin{aligned} |f|^2 - 2 &= (|f_1| + |f_2| - 2)^2 - 2 = |f_1|^2 + |f_2|^2 + 2|f_1||f_2| - 4|f_1| - 4|f_2| + 2 \\ &\geq (|f_1|^2 - 2) + (|f_2|^2 - 2), \end{aligned}$$

since $|f_1|, |f_2| \geq 3$. Therefore,

$$\sum_{f \in F(H)} (|f|^2 - 2) \leq \sum_{f \in F(H-e)} (|f|^2 - 2) \leq 4n^2 - 8n + 2$$

by the induction hypothesis. \square

Theorem 3 is now an easy corollary of Lemma 8.

Proof of Theorem 3. Let F be a minimal subgraph of G including H that is not L -colorable. If $F = H$, then the conclusion of Theorem 3 clearly holds. Hence, assume that $F \neq H$, and thus F is H -critical. Let f be a face of H and let F'_f be the subgraph of F drawn in the closure of f . In F'_f , split the vertices of f so that the interior of f is unchanged and the boundary of f becomes a cycle C . The notion of “splitting” should be clear from a generic example shown in Figure 1. Let F_f be the resulting graph and note that the

length of C is $|f|$. Observe that if $V(F_f) \neq V(C)$, then F_f is C -critical, and by Lemma 8,

$$|V(F'_f) \setminus V(f)| = |V(F_f) \setminus V(C)| \leq (2|f| + 2)(|f| - 9/2) \leq 2(|f|^2 - 2). \quad (4)$$

Note that the inequality (4) holds when $V(F_f) = V(C)$ as well, since $|f| \geq 3$. Summing (4) over all the faces of H , we conclude using Lemma 9 that F contains at most $8|V(H)|^2 - 16|V(H)| + 4 < 8|V(H)|^2 - |V(H)|$ vertices not belonging to H . Therefore, $|V(F)| \leq 8|V(H)|^2$. \square

2.1 An algorithmic remark

Lemma 8 gives rise to a natural algorithm to enumerate all graphs with lists of size 5 critical with respect to their outer face boundaries. We proceed inductively by the length k of the cycle H ; hence assume that we already know, up to isomorphism, the set \mathcal{G} of all planar graphs with precolored outer cycle of length at most $k - 1$, such that the internal vertices have lists of size at least five. Let \mathcal{H}_A be all graphs consisting of a cycle of length $\leq k$ with a chord and \mathcal{H}_B the graphs consisting of a cycle of length $\leq k$ and a vertex with at least three neighbors in the cycle. Let \mathcal{H}'_0 be the set of all graphs that can be obtained from the graphs in $\mathcal{H}_A \cup \mathcal{H}_B$ by pasting the graphs of \mathcal{G} in some of the faces. Let \mathcal{H}_0 be the subset of \mathcal{H}'_0 consisting of the graphs that are critical with respect to the boundaries of their outer faces. For each graph in \mathcal{H}_0 , keep adding a vertex of degree three adjacent to three consecutive vertices of H , as long as the resulting graph is critical with respect to the boundary of its outer face. This way, we obtain all graphs critical with respect to the boundaries of their outer faces, and these outer faces have length ℓ . Lemma 8 guarantees that this algorithm will finish. Note also that by omitting \mathcal{H}_A in the first step of the algorithm, we can generate such critical graphs whose outer cycle is chordless.

The main difficulty in the implementation is the need to generate all the possible lists in order to test the criticality, which makes the time complexity impractical. However, sometimes it is sufficient to generate a set of graphs that is guaranteed to contain all graphs that are critical (for some choice of the lists), but may contain some non-critical graphs as well. To achieve this, one may replace the criticality testing by a set of simple heuristics that prove that a graph is not critical. For example, in an H -critical graph G , each vertex $v \in V(G) \setminus V(H)$ has degree at least $|L(v)|$, and the vertices

whose degrees match the sizes of the lists induce a subgraph G' such that each block of G' is either a complete graph or an odd cycle [16]. There are similar claims forbidding other kinds of subgraphs with specified sizes of lists. On the positive side, to prove that a graph is H -critical, it is usually sufficient to consider the case that all lists are equal. By combining these two tests, we were able to generate graphs critical with respect to the outer face boundary of length at most 9. If the outer face is bounded by an induced cycle, then there are three of them for length 6, six for length 7, 34 for length 8 and 182 for length 9. The program that we used can be found at <http://atrey.karlin.mff.cuni.cz/~rakdver/5choos/>.

3 Extending a coloring of a path

For a path P , we let $\ell(P)$ denote its length (the number of its edges). A vertex of P is an *inside* vertex if it is not an endvertex of P . The main result of this section follows by using the same basic strategy as in Thomassen's proof of Theorem 4 [13].

Theorem 10. *Let G be a plane graph and let P be a subpath of the boundary H of its outer face. Let L be a list assignment valid with respect to P . If G is P -critical with respect to L , then $\omega_{P,L}(G) \leq \ell(P) - 2$.*

Proof. Suppose for a contradiction that G is a counterexample with the smallest number of edges, and in particular that $\omega_{P,L}(G) \geq \ell - 1$, where $\ell = \ell(P)$. By Theorem 4, we have $\ell \geq 2$. Furthermore, Theorem 4 also implies that if either a vertex or two adjacent vertices form a vertex-cut R in G , then each component of $G - R$ contains a vertex of P . Let $P = p_0 p_1 \dots p_\ell$. If p_i is a cut-vertex for some $1 \leq i \leq \ell - 1$, then $G = G_1 \cup G_2$, where $G_1, G_2 \neq \{p_i\}$ and $G_1 \cap G_2 = \{p_i\}$. Let $P_1 = P \cap G_1$ and $P_2 = P \cap G_2$. Since $G \neq P$, we can assume that $G_1 \neq P_1$. Note that if $G_2 = P_2$, then $\omega_{P_2,L}(G_2) = \ell(P_2) - 1$. If $G_i \neq P_i$, then G_i is P_i -critical by Lemma 6, for $i \in \{1, 2\}$. Furthermore, p_i has weight 1 in G and weight 0 both in G_1 and G_2 . By the minimality of G , we have $\omega_{P,L}(G) = \omega_{P_1,L}(G_1) + \omega_{P_2,L}(G_2) + 1 \leq (\ell(P_1) - 2) + (\ell(P_2) - 1) + 1 = \ell - 2$. Since $\omega_{P,L}(G) \geq \ell - 1$, we conclude that G is 2-connected.

Suppose that there exists a proper subgraph $G' \supsetneq P$ of G and an L -coloring ψ of P does not extend to an L -coloring of G' . We may choose G' to be P -critical. By the minimality of G , we have $\omega_{P,L}(G') \leq \ell - 2$. Let H' be boundary of the outer face of G' and let W' be the walk such that

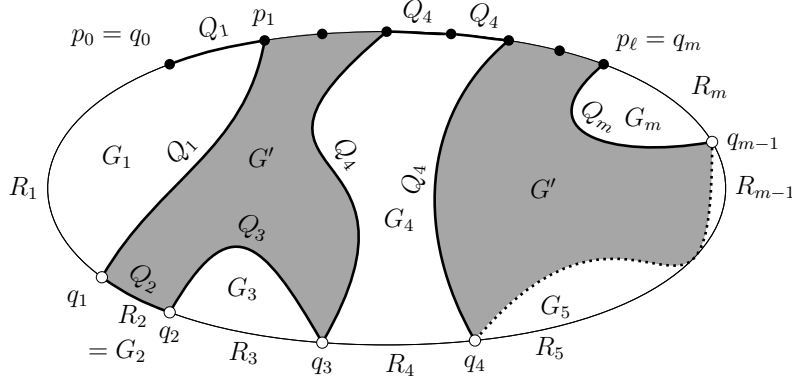

Figure 2: Spans in a graph.

the concatenation of W' and P equals H' . Since G' is P -critical, Theorem 4 implies that W' is a path. Let q_0, \dots, q_m be the vertices of $V(H) \cap V(W')$ that are not internal vertices of the path P , listed in the order as they appear in W' , where q_0 and q_m are the endvertices of P . Observe that q_0, \dots, q_m appear in the same order also in H . Each subwalk Q_i of W' from q_{i-1} to q_i ($i = 1, \dots, m$) is a span, as defined in Section 2. Note that W' is the union of spans Q_1, \dots, Q_m , and each of the spans is a path. For $1 \leq i \leq m$, let R_i be the segment of H from q_{i-1} to q_i , and let G_i be the subgraph of G drawn inside the closed disk bounded by $R_i \cup Q_i$. See Figure 2 for an illustration. Note that if $G_i = Q_i$, then Q_i is an edge of H . Observe that $\omega_{G',P,L}(v) \geq 1$ for each internal vertex v of Q_i , since v either has a list of size 5 or it is a cut-vertex in G' . Hence, the total weight in G' of internal vertices of Q_i is at least $\ell(Q_i) - 1$. On the other hand, their weight in G is 0. By the minimality of G , we have $\omega_{Q_i,L}(G_i) \leq \ell(Q_i) - 2$ if Q_i is not equal to an edge of H . If Q_i is an edge of H , then $\omega_{Q_i,L}(G_i) = 0 = \ell(Q_i) - 1$. Consider now an internal face f of G' with boundary B_f . If f is also a face of G , then $\omega_{B_f,L}(\text{Int}_f(G)) = |f| - 3 = \omega_{G',P,L}(f)$. If f is not a face of G , then Lemma 8 implies that $\omega_{B_f,L}(\text{Int}_f(G)) \leq |f| - \frac{9}{2} < |f| - 3 = \omega_{G',P,L}(f)$. Since

$$G = G' \cup \bigcup_{i=1}^m G_i \cup \bigcup_{f \in F(G')} \text{Int}_f(G),$$

the weight of G can be obtained by summing the weights of the pieces and

adjusting for the different weights of some vertices in G . More precisely,

$$\begin{aligned}\omega_{P,L}(G) &\leq \omega_{P,L}(G') + \sum_{i=1}^m (\omega_{Q_i,L}(G_i) - (\ell(Q_i) - 1)) + \\ &\quad \sum_{f \in F(G')} (\omega_{B_f,L}(\text{Int}_f(G)) - \omega_{G',P,L}(f)) \\ &\leq \omega_{P,L}(G') \leq \ell - 2.\end{aligned}$$

This is a contradiction which proves the following:

Claim 1. *For every proper subgraph G' of G , every L -coloring ψ of P extends to an L -coloring of G' .*

Let ψ be an L -coloring of P that does not extend to G . If L' is the list assignment such that $L'(v) = L(v)$ for $v \notin V(P)$ and $L'(v) = \{\psi(v)\}$ for $v \in V(P)$, Claim 1 implies that G is P -critical with respect to L' . Note that $\omega_{P,L}(G) = \omega_{P,L'}(G)$ as the sizes of the lists of the vertices of P are not affecting ω . Consequently, we can assume henceforth that $|L(v)| = 1$ for every $v \in V(P)$. If $V(H) = V(P)$, then by Lemma 8, $\omega_{P,L}(G) = \omega_{H,L}(G) \leq \ell - 2$. This is a contradiction, hence p_0 has a neighbor $w \in V(H) \setminus V(P)$.

If $|L(w)| \geq 4$, then let L' be the list assignment obtained from L by setting $L'(w) = L(w) \setminus L(p_0)$. Note that $G' = G - p_0w$ is P -critical with respect to L' , and by the minimality of G , $\omega_{P,L'}(G') \leq \ell - 2$. Let f be the internal face of G incident with p_0w . Suppose that $u \in V(f) \setminus \{w, p_0\}$. If u belongs to $V(H)$, then u is a cutvertex in G' , and as shown at the beginning of the proof, u is an internal vertex of P . Therefore, $\omega_{G',P,L'}(u) = 1$ and $\omega_{G,P,L}(u) = 0$. On the other hand, if $u \notin V(H)$, then $\omega_{G',P,L'}(u) = 2$ and $\omega_{G,P,L}(u) = 0$. Using these facts we obtain a contradiction:

$$\begin{aligned}\omega_{P,L}(G) &= \omega_{P,L'}(G') + \omega_{G,P,L}(f) + 1 - \sum_{u \in V(f) \setminus \{w, p_0\}} (\omega_{G',P,L'}(u) - \omega_{G,P,L}(u)) \\ &\leq \omega_{P,L'}(G') + (|f| - 3) + 1 - (|f| - 2) = \omega_{P,L'}(G') \leq \ell - 2.\end{aligned}$$

Next, consider the case that $|L(w)| = 3$ and w is adjacent to a vertex p_i for some $1 \leq i \leq \ell - 1$. Let C be the cycle composed of p_0wp_i and a subpath of P and let G' be the subgraph of G obtained by removing all vertices and edges of $\text{Int}_C(G)$ except for p_iw . Let $P' = (P \cap G') + p_iw$. Note that G' is P' -critical with respect to L . By the minimality of G and Lemma 8, we have

$$\omega_{P,L}(G) = \omega_{P',L}(G') + \omega_{C,L}(\text{Int}_C(G)) \leq \ell(P') - 2 + |C| - 3 = \ell - 2.$$

Suppose now that w is adjacent to p_ℓ . Note that wp_ℓ is an edge of H and $G \neq H$, hence Lemma 8 implies that $\omega_{P,L}(G) = \omega_{H,L}(G) \leq |H| - 4 = \ell - 2$. This is a contradiction.

Finally, suppose that p_0 is the only neighbor of w in P . Note that $L(p_0) \subset L(w)$, since G is P -critical. Furthermore, w has only one neighbor $z \in V(H)$ distinct from p_0 . Let $S = L(w) \setminus L(p_0)$, $G' = G - w$ and let L' be defined by $L'(v) = L(v)$ if v is not a neighbor of w or if $v = p_0$ or $v = z$, and $L'(v) = L(v) \setminus S$ otherwise. Since $|S| = 2$, L' is a valid list assignment with respect to P . Note that G' is not L' -colorable, as every L' -coloring of G' can be extended to an L -coloring of G by coloring w using a color from S different from the color of z . Let G'' be a P -critical subgraph of G' . Let Q_1, \dots, Q_m be the spans in the boundary of the outer face of G'' and let G_i be defined as in the proof of Claim 1, for $1 \leq i \leq m$, where $w \in V(G_1)$. The path Q_1 is an edge-disjoint union of paths M_1, \dots, M_t , where the endvertices of M_j are neighbors of w and the internal vertices of M_j are non-adjacent to w for $1 \leq j \leq t$ (with the exception that one of the endvertices of M_t does not have to be adjacent to w). For $1 \leq j \leq t$, let C_j be the cycle or path formed by M_j and the edges between w and M_j and let H_j be the subgraph of G split off by C_j . Note that if v is an internal vertex of M_j , then $\omega_{G,P,L}(v) = 0$ and $\omega_{G'',P,L'}(v) \geq 1$, while endvertices of M_j have the same weight in G and in G'' . Furthermore, $\omega_{G,P,L}(w) = 0$. By the minimality of G and Lemma 8, we have

$$\omega_{Q_1,L}(G_1) \leq \sum_{j=1}^t \omega_{C_j,L}(H_j) \leq \sum_{j=1}^t (\ell(M_j) - 1).$$

Furthermore,

$$\sum_{v \in V(Q_1)} \omega_{G'',P,L'}(v) - \omega_{G,P,L}(v) \geq \sum_{j=1}^t (\ell(M_j) - 1) \geq \omega_{Q_1,L}(G_1).$$

We analyse the weights of the other pieces of $G - G'$ in the same way as in the proof of Claim 1 and conclude that $\omega_{P,L}(G) \leq \omega_{P,L'}(G'')$. This contradicts the minimality of G and finishes the proof of Theorem 10. \square

We need a more precise description of critical graphs in the case that $\ell(P) = 2$. There are infinitely many such graphs, but their structure is relatively simple and it is described in the sequel.

For an integer $n \geq 0$, a *fan of order n* with *base xyz* is the graph consisting of the path xyz , a path $xv_1 \dots v_n z$ and edges yv_i for $1 \leq i \leq n$. For an integer

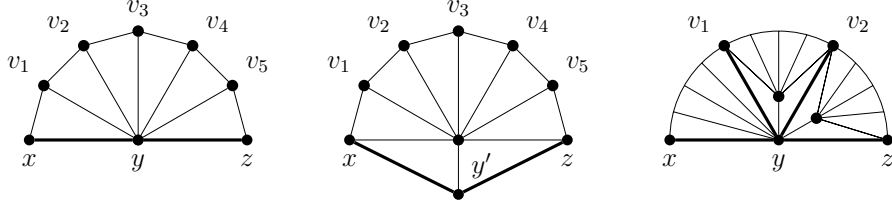

Figure 3: A fan, a fat fan, and a fan procession.

$n \geq 1$, a *fat fan of order n with base xyz* is the graph consisting of the path xyz , a vertex y' adjacent to x , y and z , and a fan of order n with base $xy'z$. A *fan procession with base xyz* is a graph consisting of the path xyz , vertices v_1, \dots, v_{k-1} (for some $k \geq 1$) adjacent to y , and subgraphs G_1, \dots, G_k where for $1 \leq i \leq k$, G_i is either a fan or a fat fan with base $v_{i-1}yv_i$ (where we set $v_0 = x$ and $v_k = z$). Each fan or fan procession is a planar near-triangulation, and we consider its unique face of size ≥ 4 to be the outer face. See Figure 3. A fan procession is *even* if all constituent fat fans have even order. A list assignment L for a fan procession G with base xyz and outer face bounded by H is *dangerous* if $|L(v)| = 3$ for all $v \in V(H) \setminus \{x, y, z\}$ and $|L(v)| = 5$ for all $v \in V(G) \setminus V(H)$.

Consider a fat fan G of order $n > 0$ with base xyz and a valid list assignment L (with respect to the path xyz). Let y' be the common neighbor of x , y and z , and let $v_1v_2 \dots v_n$ be the subpath of the outer face boundary from the definition of a fat fan. Suppose that G is not L -colorable, and let φ be an L -coloring of xyz . It is easy to see that the list assignment L must be dangerous. Let $S = L(y') \setminus \{\varphi(x), \varphi(y), \varphi(z)\}$. If there exists $c \in S$ and $1 \leq i \leq n$ such that $c \notin L(v_i)$, then φ extends to an L -coloring of G assigning the color c to y' . Therefore, we have $S \subseteq L(v_i)$ for $1 \leq i \leq n$. Similarly, we have $\varphi(x) \in L(v_1)$ and $\varphi(z) \in L(v_n)$. Since $\varphi(x) \notin S$ and $S \cup \{\varphi(x)\} \subseteq L(v_1)$, we have $|S| = 2$, $\{\varphi(x), \varphi(y), \varphi(z)\} \subset L(y')$ and $\varphi(x) \neq \varphi(z)$. Observe also that $n \geq 2$, as otherwise y' has degree four. Therefore, $\{\varphi(x)\} = L(v_1) \setminus L(v_n)$, $\{\varphi(z)\} = L(v_n) \setminus L(v_1)$ and $\{\varphi(y)\} = L(y') \setminus (L(v_1) \cup L(v_n))$. Therefore, there exists at most one precoloring of xyz that does not extend to an L -coloring of G . Furthermore, if the order n of G is odd, then we can color y' by a color from S and the vertices v_1, v_3, \dots, v_n by the other color from S and extend this to an L -coloring of G . Therefore, the order of the fat fan G is even.

Using this analysis, it is easy to see that the following holds:

Observation 11. *Let G be a fan procession with base xyz and L a dangerous list assignment for G . If φ_1 and φ_2 are precolorings of xyz that do not extend to an L -coloring of G , and $\varphi_1(x) = \varphi_2(x)$ and $\varphi_1(y) = \varphi_2(y)$, then $\varphi_1 = \varphi_2$. Furthermore, if there exist two different precolorings of xyz that do not extend to an L -coloring of G , then G is a fan.*

Conversely, a result of Thomassen [15] implies that even fan processions with dangerous list assignments are the only plane graphs with valid list assignments that are P -critical for a path P of length two.

Lemma 12. *Let G be a plane graph, let H be the boundary of the outer face of G , and let P a subpath of H of length two. Let L be a list assignment valid with respect to P . If G is P -critical with respect to L , then G is an even fan procession with base P and L is dangerous.*

Proof. By Theorem 10, G is 2-connected, all faces other than the outer one are triangles and all vertices in $V(H) \setminus V(P)$ have lists of size three. Since G is P -critical, there exists an L -coloring of P that does not extend to an L -coloring of G . By Theorem 3 of [15], there exists a fan procession $G' \subseteq G$ with base P and L is a dangerous list assignment for G' . By Lemma 8, every triangle in G bounds a face. Furthermore, Theorem 4 implies that every chord of H is incident with the middle vertex of P . We conclude that $G = G'$, and thus G is a fan procession with base P . Furthermore, since an L -coloring of P does not extend to an L -coloring of G , the fan procession is even, as we have argued before. \square

4 Reducing the precolored vertices

One could hope that the proof of Theorem 10 can be modified to deal with the case that G contains sufficiently distant precolored vertices. Most of the inductive applications deal with the situations which reduce the length of the precolored path, and if the distance between the new precolored path (one of the spans) from the old one is guaranteed to be bounded by a constant, we could ensure that the distance between P and the precolored vertices is at least some function of $\ell(P)$. However, the fact that there are infinitely many critical graphs makes it difficult to prove such a constraint on the distance.

To avoid this problem, we restrict ourselves to working with list assignments such that the vertices with lists of size three form an independent set (almost—for technical reasons, we allow one edge joining vertices with lists of size three). In this setting, we easily conclude by combining Theorem 10 with Lemma 8 that the size of critical graphs is bounded.

Lemma 13. *Let G be a plane graph, let H be the boundary of its outer face, let P be a subpath of H and let L be a list assignment valid with respect to P , such that G contains at most one edge joining vertices with lists of size three. If G is P -critical, then $|V(G)| \leq 8\ell(P)^2 + 4\ell(P)$.*

Proof. By induction, we can assume that no cut-vertex belongs to P , and thus G is 2-connected. The claim is true if $V(G) = V(P)$, thus assume that $V(G) \neq V(P)$. For $i \in \{3, 4, 5\}$, let n_i denote the number of vertices with lists of size i in $V(H) \setminus V(P)$. We have $\omega_{P,L}(G) \geq n_4 + 2n_5$. Let Q be a path of length $n_3 + 2$ whose endvertices coincide with the endvertices of P , but is otherwise disjoint from G , and let G' be the graph obtained from $G \cup Q$ by joining each vertex $v \in V(H) \setminus V(P)$ with $5 - |L(v)|$ vertices of Q in the planar way. Let L_Q be the list assignment to the internal vertices of Q such that each such vertex has a single color that does not appear in any other list (including the lists of vertices of G). Let L' be the list assignment for G' that matches L_Q on the internal vertices of Q and the list of each vertex $v \in V(G) \setminus V(P)$ consists of $L(v)$ and the colors of the adjacent internal vertices of Q . Observe that G' is $(P \cup Q)$ -critical, and by Lemma 8,

$$\frac{|V(G) \setminus V(P)|}{2|P \cup Q| + 2} = \frac{|V(G') \setminus V(P \cup Q)|}{2|P \cup Q| + 2} \leq |P \cup Q| - 9/2.$$

Letting $y = |P \cup Q|$, this implies that $|V(G) \setminus V(P)| \leq 2y^2 - 7y - 9$, and therefore $|V(G)| \leq 2y^2 - 6y - 9$. Since L is valid, since at most one edge joins vertices with lists of size three, and since G is 2-connected, we have $n_3 \leq n_4 + n_5 + 2$. Consequently, $\ell(Q) = n_3 + 2 \leq n_4 + n_5 + 4 \leq \omega_{P,L}(G) + 4$. Since $\omega_{P,L}(G) \leq \ell(P) - 2$ by Theorem 10, we have that $y = |P \cup Q| \leq 2\ell(P) + 2$, and the claim follows. \square

Let us remark that a converse of the transformation described in the proof of Lemma 13 can be used to generate all critical graphs satisfying the assumptions of the lemma with the length of P fixed.

Our aim in this section is to show that Lemma 5 implies a positive answer to Problem 1 (Theorem 2). For technical reasons, we will prove a somewhat

convoluted strengthening of this claim, Lemma 14 below. In the proof of Theorem 2, this Lemma is applied with p being one of the precolored vertices and X consisting of the remaining ones; it gives a conclusion that that $X = \emptyset$, i.e., only one vertex is precolored, and we can finish the proof using Theorem 4 (see the end of the paper for a precise proof). We need to introduce several technical definitions.

Let G be a plane graph, let H be the boundary of its outer face, and let Q be a path in G . Suppose that $Q = q_0q_1 \dots q_k$ and $q_0 \in V(H)$. For $0 < i < k$, let L_i and R_i be the sets of edges of G incident with q_i such that the cyclic clockwise order (according to the drawing of G in the plane) of the edges incident with q_i is q_iq_{i+1} , R_i , q_iq_{i-1} , L_i . We define L_0 and R_0 similarly, except that we consider the outer face instead of the edge q_iq_{i-1} in the order. We define G^Q as the graph obtained from G by splitting the vertices along Q in the natural way, i.e., so that Q corresponds to paths $Q_L = q_0^Lq_1^L \dots q_{k-1}^Lq_k$ and $Q_R = q_0^Rq_1^R \dots q_{k-1}^Rq_k$ and for $0 \leq i < k$, the vertex q_i^L is incident with the edges in L_i and the vertex q_i^R is incident with the edges in R_i . If G is given with a list assignment L , then let L^Q be the list assignment for G^Q such that $L^Q(q_i^L) = L^Q(q_i^R) = L(q_i)$ for $0 \leq i < k$ and $L^Q(v) = L(v)$ for other vertices of G^Q . We say that G^Q and L^Q are *obtained by cutting along Q* .

For integers M and k , let $D(M, k) = M + 2$ if $k \leq 1$ and $D(M, k) = D(M, k - 1) + 16k^2 + 8k$ if $k \geq 2$. Note that there is a simple explicit formula for the values $D(M, k)$, but we shall only use its recursive description. A set X of vertices is *M -scattered* if the distance between any two elements of X is at least $\max\{D(M, 2M + 11), D(M, 2) + D(M, 6) + 1\}$.

Let $Q = q_0q_1 \dots q_k$ be a path of length k . If k is even, then $q_{k/2}$ is said to be the *central vertex* of Q ; if k is odd, then each of the two vertices $q_{(k-1)/2}$ and $q_{(k+1)/2}$ is a *central vertex* of Q .

Lemma 14. *Suppose that there is a positive integer M such that the conclusion of Lemma 5 holds. Let G be a plane graph, let P be a subpath of the boundary H of its outer face and let p be a central vertex of P . Let X be an M -scattered subset of $V(G)$ such that the distance between p and X is at least $D(M, \ell(P))$. Let L be a list assignment for G that is M -valid with respect to P and X . Furthermore, assume that there is at most one edge $uv \in E(G)$ such that $u, v \in V(G) \setminus V(P)$ and $|L(u)| = |L(v)| = 3$, and if such an edge exists, then $\ell(P) \leq 1$, u or v is adjacent to p and the distance between p and X is at least $D(M, 2) - 1$. If G is P -critical with respect to*

L , then $X = \emptyset$.

Proof. For a contradiction, suppose that G is a counterexample to Lemma 14 with the smallest number of edges that do not belong to P , subject to that, with the smallest number of vertices, and subject to that, with the largest number of vertices in P . Since G is P -critical, every vertex $v \in V(G) \setminus V(P)$ satisfies $\deg(v) \geq |L(v)|$. Let $\ell = \ell(P)$ and $P = p_0 p_1 \dots p_\ell$. If ℓ is odd, choose the labels so that $p = p_{(\ell+1)/2}$.

Suppose that G is disconnected. Since G is P -critical, it has two components: one is equal to P and the other one, G' , is not L -colorable. Choose $v \in V(H) \cap V(G')$ arbitrarily, and let P' be the path consisting of v . Note that G' is P' -critical. If G' with the path P' satisfies the assumptions of Lemma 14, then by the minimality of G we have $X \cap V(G') = \emptyset$, and thus $X = \emptyset$. This is a contradiction, and thus the distance from v to the closest vertex $x \in X$ is at most $M + 1$. Let Q be the shortest path between v and x and let G^Q , Q_L and Q_R with the list assignment L^Q be obtained from G' by cutting along Q . Let $Q' = Q_L \cup Q_R$ and $X' = X \setminus \{x\}$. Note that x is the central vertex of Q' and its distance to any $u \in X'$ is at least $D(M, \ell(Q'))$, since X is M -scattered and $\ell(Q') \leq 2M + 2$. In particular, L^Q is M -valid with respect to Q' and X' . Furthermore, G^Q is Q' -critical with respect to L^Q . To see this, consider an arbitrary edge $e \in E(G') \setminus E(Q)$. Since G is P -critical, there exists an L -coloring of P that extends to $G - e$ but not to G . The coloring of $G - e$ induced on Q gives rise to an L^Q -coloring of Q' that extends to $G^Q - e$ but not to G^Q . This shows that G^Q is Q' -critical. Since the distances in G^Q are not shorter than those in G , the graph G^Q satisfies all assumptions of Lemma 14. By the minimality of G , we conclude that $X' = \emptyset$. But then $|X| = 1$ and G' (with no precolored path) contradicts Lemma 5.

Therefore, G is connected. In particular, if $\ell = 0$, then we can include another vertex of H in P ; therefore, we can assume that $\ell \geq 1$. Since G is connected, its outer face has a facial walk, which we write as $p_\ell \dots p_1 p_0 v_1 v_2 v_3 \dots v_s$.

Suppose that the distance between P and X is at most $M + 5$. Then the distance from p to X is at most $M + \ell + 5$. By the assumptions of the lemma, this distance is at least $D(M, \ell)$, which is only possible if $\ell \leq 1$. As assumed above, this means that $\ell = 1$. Moreover, the assumptions of the lemma imply that no two vertices with lists of size three are adjacent. Let Q be a shortest path between P and a vertex $x \in X$. Let G^Q , Q_L

and Q_R with the list assignment L^Q be obtained from G by cutting along Q . Let Q' be the path consisting of $Q_L \cup Q_R$ and of the edge of P , and let $X' = X \setminus \{x\}$. Note that $\ell(Q') \leq 2M + 11$. Since X is M -scattered, so is X' , and the distance in G^Q from the central vertex x of Q' to X' is at least $D(M, 2M + 11) \geq D(M, \ell(Q'))$. As in the previous paragraph, we conclude that since G^Q is Q' -critical with respect to L^Q , we have $X' = \emptyset$. Then $|X| = 1$ and, consequently, G contradicts the postulated property of the constant M . Therefore, we conclude:

Claim 2. *The distance between P and X is at least $M + 6$.*

We say that a cycle T in G is *separating* if $V(\text{Int}_T(G)) \neq V(T)$ and T does not bound the outer face of G . Let $T = t_1 \dots t_k$ be a separating k -cycle in G , where $k \leq 4$. Suppose that the distance from t_1 to P is at most $6 - k$. Let us choose such a cycle with $\text{Int}_T(G)$ minimal; it follows that T is an induced cycle. By Lemma 6, $\text{Int}_T(G)$ is T -critical, and thus there exists an L -coloring ψ of T that does not extend to an L -coloring of $\text{Int}_T(G)$. Let $G' = \text{Int}_T(G) - \{t_3, \dots, t_k\}$. Let L' be the list assignment for G' such that $L'(t_1) = \{\psi(t_1)\}$, $L'(t_2) = \{\psi(t_2)\}$ and $L'(v) = L(v) \setminus \{\psi(t_i) \mid vt_i \in E(G), 3 \leq i \leq k\}$ for other vertices $v \in V(G')$. Note that no two vertices with lists of size three are adjacent in G' , as otherwise we have $k = 4$ and $t_3 t_4$ is incident with a separating triangle contradicting the choice of T . The graph G' is not L' -colorable, hence it contains a $t_1 t_2$ -critical subgraph G'' . By Claim 2, L' is an M -valid list assignment for G'' , and the distance between t_1 and $X \cap V(G')$ is at least $M + 2$. By the minimality of G , it follows that $X \cap V(G'') = \emptyset$. However, then G'' contradicts Theorem 4. We conclude that the following holds:

Claim 3. *If $T \neq H$ is a separating k -cycle in G , where $k \leq 4$, then the distance between T and P is at least $7 - k$.*

Similarly, by applying induction, we obtain the following property.

Claim 4. *If R is either a chord of H that does not contain an internal vertex of P , or R is a cut-vertex of G , then the distance between R and P is at least 4.*

Proof. Suppose first that R does not contain an internal vertex of P . Let G' be the subgraph of G split off by R . By Lemma 6, G' is R -critical, and Theorem 4 implies that $X \cap V(G') \neq \emptyset$. If the distance from P to R is at most 3, then by Claim 2, the distance between R and X is at least

$M+2 = D(M, \ell(R))$. If $G' - V(R)$ does not contain two adjacent vertices with lists of size three, this contradicts the minimality of G . If $uv \in E(G' - V(R))$ and $|L(u)| = |L(v)| = 3$, then by the assumptions, we have $\ell = 1$ and u or v is adjacent to p . Consequently, $p \in V(R)$, and thus the distance between a central vertex p of R and X is at least $D(M, 2) - 1$. Again, we have a contradiction with the minimality of G .

Suppose now that P contains a cut-vertex v of G , and let G_1 and G_2 be the two maximal connected subgraphs of G that intersect in v . For $i \in \{1, 2\}$, let $P_i = P \cap G_i$ and note that either $P_i = G_i$ or G_i is P_i -critical by Lemma 6. By the minimality of G , we conclude that neither G_1 nor G_2 contains a vertex of X , and thus $X = \emptyset$. This contradiction completes the proof. \square

Next, we claim the following.

Claim 5. *Let $C \subset G$ be a cycle of length at most $\ell + 1$ such that $C \neq H$ and the distance between C and p is at most $8\ell^2 + 4\ell$. Then $\text{Int}_C(G)$ contains no vertices of X .*

Proof. The length of C is at least three, and thus $\ell \geq 2$. If $x \in X$ belongs to C , then the distance from x to p is less than $8\ell^2 + 5\ell < D(M, \ell)$, a contradiction. Thus, we may assume that $V(C) \cap X = \emptyset$ and, in particular, that C does not bound a face. If $\ell(C) \leq \ell$, then the claim holds even under a weaker assumption that the distance between C and P is at most $16\ell^2 + 8\ell$. Indeed, consider a spanning subpath Q of C of length $\ell(C) - 1$ such that the distance between p and a central vertex q of Q is at most $16\ell^2 + 8\ell$. The distance of every vertex of X in $\text{Int}_C(G)$ from q is at least $D(M, \ell) - 16\ell^2 - 8\ell \geq D(M, \ell(Q))$. By Lemma 6, we have that $\text{Int}_C(G)$ is Q -critical, and the claim follows by the minimality of G .

Suppose now that $\ell(C) = \ell + 1$ and let $C = c_0c_1 \dots c_\ell$, where $c_{\lceil \ell/2 \rceil}$ is the vertex of C nearest to p . There exists an L -coloring φ of C that does not extend to an L -coloring of $\text{Int}_C(G)$. Let d be a new color that does not appear in any of the lists and let L' be the list assignment obtained from L by replacing $\varphi(c_\ell)$ by d in the lists of c_ℓ and its neighbors and by setting $L'(c_0) = \{\varphi(c_0), \varphi(c_1), d\}$. Let φ' be the coloring of the path $C' = c_1c_2 \dots c_\ell$ such that $\varphi'(c_\ell) = d$ and φ' matches φ on the rest of the vertices. The coloring φ' does not extend to an L' -coloring of $\text{Int}_C(G)$; hence, $\text{Int}_C(G)$ contains a subgraph $F \supset C'$ that is C' -critical with respect to L' . The distance of $X \cap V(F)$ from the central vertex $c_{\lceil \ell/2 \rceil}$ of C' is at least $D(M, \ell) - 8\ell^2 - 4\ell > D(M, \ell(C'))$. By the minimality of G , we conclude that F contains no vertex of X . By

Theorem 10, we have $\omega_{C',L'}(F) \leq \ell - 3$, and in particular, every face of F has length at most ℓ . By Lemma 13, the distance from $c_{\lceil \ell/2 \rceil}$ to every vertex of F is less than $8\ell^2 + 4\ell$, thus the distance between every vertex of F and p is at most $16\ell^2 + 8\ell$. By the previous paragraph, we conclude that no vertex of X appears in the interior of any face of F . Let Q be the path in the boundary of the outer face of F , distinct from C' , joining c_1 with c_ℓ . If $v \neq c_0$ is an internal vertex of Q , then $\omega_{F,C',L'}(v) \geq 1$, hence Q contains at most $\ell - 3$ such internal vertices. It follows that $Q + c_1c_0c_\ell$ is either a cycle of length at most ℓ (if $c_0 \notin V(Q)$) or a union of two cycles of total length at most $\ell + 1$ (if $c_0 \in V(Q)$). In both cases, the interiors of the cycles do not contain any vertex of X by the previous paragraph. Consequently, $X \cap V(\text{Int}_C(G)) = \emptyset$ as claimed. \square

Let ψ be an L -coloring of P that does not extend to an L -coloring of G . We are going to show that ψ extends to all proper subgraphs of G that contain P . To prove this, we use the following claim, which we formulate in greater generality for future use.

Claim 6. *Let G' be a proper subgraph of G with $P \subseteq G'$, and let H' be the boundary of the outer face of G' . Let L' be a list assignment for G' that is M -valid with respect to P and $X \cap V(G')$, such that $L'(v) = L(v)$ for all $v \in V(G') \setminus V(H')$ and $L'(v) \subseteq L(v)$ for all $v \in V(H')$. Furthermore, assume that there is at most one edge $u'v' \in E(G')$ such that $u', v' \in V(G') \setminus V(P)$ and $|L'(u)| = |L'(v)| = 3$, and if such an edge exists, then $\ell(P) \leq 1$, u' or v' is adjacent to p and the distance between p and $X \cap V(G')$ is at least $D(M, 2) - 1$. Suppose that G' is P -critical with respect to L' . Then $X \cap V(G') = \emptyset$ and every internal face f of G' satisfies $X \cap V(\text{Int}_f(G)) = \emptyset$. Furthermore, suppose that Q is a span^2 in G (not necessarily contained in G') with a central vertex in G' . If $\ell(Q) \leq \ell - 1$, then the subgraph of G split off by Q contains no vertices of X . In particular, this is the case if $Q \subset H'$ and $L'(v) = L(v)$ for all internal vertices v of Q .*

Proof. Since G' satisfies the assumptions of Lemma 14, the minimality of G implies that $X \cap V(G') = \emptyset$. By Theorem 10, it follows that $\omega_{P,L'}(G') \leq \ell - 2$, and in particular, $\ell \geq 2$. Let f be a face of G' distinct from the outer one such that $\text{Int}_f(G) \neq f$. Since $\omega(f) \leq \ell - 2$, we have $\ell(f) \leq \ell + 1$. Furthermore, by Lemma 13, the distance in G' between f and p is at most $8\ell^2 + 4\ell$. By Claim 5, no vertex of X appears in $\text{Int}_f(G)$.

²As defined in Section 2.

Consider now a span Q of G with a central vertex q in G' , and let G_Q be the Q -component of G split off by Q . By Lemma 13, the distance between p and q in G' is at most $8\ell^2 + 4\ell$, and thus if $\ell(Q) \leq \ell - 1$, then the distance between q and X in G_Q is at least $D(M, \ell) - 8\ell^2 - 4\ell \geq D(M, \ell(Q))$. Observe that G_Q is Q -critical if $G_Q \neq Q$, and by the minimality of G , G_Q contains no vertices of X .

Suppose that Q happens to be a subpath of H' such that $L'(v) = L(v)$ for all internal vertices v of Q , implying $\omega_{G', P, L'}(v) \geq 1$. Then, $\ell(Q) \leq \omega_{P, L'}(G') + 1 \leq \ell - 1$, and the argument of the previous paragraph applies. \square

Suppose that there exists a proper subgraph $G' \subset G$ such that $P \subset G'$ and ψ cannot be extended to an L -coloring of G' . Let G' be minimal subject to this property. Then G' is a P -critical graph. If G' does not satisfy the assumptions of Claim 6 (with the list assignment L), then $\ell = 1$ and there exist adjacent vertices $u, v \in V(G') \setminus V(P)$ with lists of size three such that neither of them is adjacent to p_1 in G' , while u is adjacent to p_1 in G . Let c be a new color that does not appear in any of the lists. Let L' be the list assignment for G' obtained from L by replacing $\psi(p_1)$ by c in the lists of all vertices adjacent to p_1 in G' and by setting $L'(p_0) = \{\psi(p_0)\}$, $L'(p_1) = \{c\}$, and $L'(u) = L(u) \cup \{c\}$. Each L' -coloring of $G' + up_1$ corresponds to an L -coloring of G' extending ψ , hence $G' + up_1$ is not L' -colorable and it contains a P -critical subgraph G'' . Note that $|L'(u)| = 4$ and hence no two vertices with lists of size three are adjacent in G'' . However, the minimality of G implies that G'' contains no vertices of X , and we obtain a contradiction with Theorem 4.

Hence, Claim 6 applies to G' , showing that no vertex of X is contained in G' , in $\text{Int}_f(G)$ for internal faces f of G' , or in the subgraphs of G split off by the spans contained in the boundary of the outer face of G' . We conclude that $X = \emptyset$. This is a contradiction; therefore, ψ extends to all proper subgraphs of G that contain P . Equivalently, we can restrict the lists of the vertices of P to the singleton lists given by ψ , and G is P -critical with respect to the resulting list assignment. Hence, we can assume the following.

Claim 7. *The vertices of P have lists of size one, G is not L -colorable and every proper subgraph of G that contains P is L -colorable.*

Let us fix ψ as the unique L -coloring of P .

Consider a chord $e = uv$ of H at distance at most three from P . By Claim 4, we can assume that u is an internal vertex of P , and in particular

$\ell \geq 2$. If v belonged to P as well, then by Claim 7 we have $G = P + e$, implying $X = \emptyset$. Hence, v does not belong to P .

Let G_1 and G_2 be the maximal connected subgraphs of G intersecting in uv , such that $G_1 \cup G_2 = G$, $p_\ell \in V(G_1)$, and $p_0 \in V(G_2)$. Let $P_i = (P \cap G_i) + e$. For $i \in \{1, 2\}$, Lemma 6 implies that the graph G_i is P_i -critical. Note that either $\ell(P_i) < \ell(P)$, or $\ell(P_i) = \ell$ and p is a central vertex of P_i . We conclude that the distance between a central vertex of P_i and X is at least $D(M, \ell(P_i))$. By the minimality of G , we have $X \cap V(G_i) = \emptyset$ for $i \in \{1, 2\}$. It follows that $X = \emptyset$, which is a contradiction. Therefore, we have:

Claim 8. *The distance of any chord of H from P is at least four.*

In particular, if $\ell \geq 2$, then p is not incident with a chord, and thus G cannot contain adjacent vertices with lists of size three.

Claim 9. *If $\ell \geq 2$, then no edge $uv \in E(G)$ satisfies $|L(u)| = |L(v)| = 3$.*

Let $s = |V(H) \setminus V(P)|$. A consequence of Claim 7 is that $s \geq 1$ (if s were equal to 0, then $G - p_0 p_\ell$ would contradict the claim). We can say more:

Claim 10. *If $|L(v_1)| > 3$, then $|L(v_1)| = 4$, $s \geq 2$ and $|L(v_2)| = 3$.*

Otherwise, suppose that $|L(v_1)| = 5$, or $|L(v_1)| = 4$ and either $s = 1$ or $|L(v_2)| \geq 4$. Let $G' = G - p_0 v_1$ and let L' be the list assignment obtained from L by removing $\psi(p_0)$ from the list of v_1 . The assumptions together with Claim 8 imply that if $|L'(v_1)| = 3$, then v_1 is not adjacent to any vertex with list of size three in G' . By Claim 7, G' is P -critical with respect to L' , contradicting the minimality of G .

Suppose now that $\ell \geq 2$ and a vertex v is adjacent to p_0, p_1 and p_2 . By Claim 8, we have $v \notin V(H)$. Let $P' = p_0 v p_2 p_3 \dots p_\ell$, $H' = p_0 v p_2 \dots p_\ell v_s \dots v_1$ and $G' = \text{Int}_{H'}(G)$. By Lemma 6, G' is P' -critical. If $\ell \geq 3$, then p is a central vertex of P' and by the minimality of G , we have $X \cap V(G') = \emptyset$. Furthermore, Claim 3 implies that $p_0 p_1 v$ and $p_1 p_2 v$ bound faces of G , and thus $X = \emptyset$. This contradiction shows the following.

Claim 11. *If $\ell \geq 2$ and p_0, p_1 and p_2 have a common neighbor, then $\ell = 2$.*

For a vertex $v \in V(G) \setminus V(P)$, let us define the reduced list $S(v)$ by

$$S(v) = L(v) \setminus \{\psi(r) : r \in V(P), vr \in E(G)\}.$$

Claim 12. *If v is a vertex of $V(G) \setminus V(P)$ with k neighbors in P , then $|S(v)| = |L(v)| - k$.*

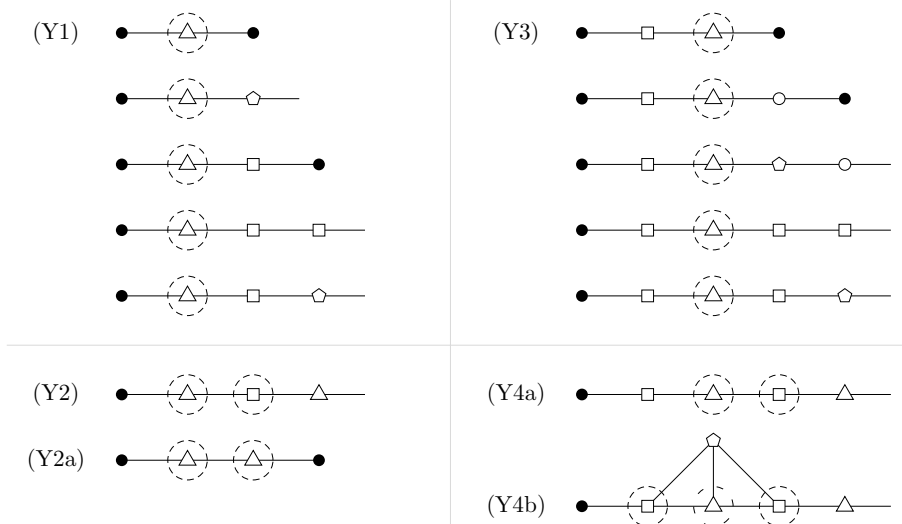

Figure 4: The definition of the set Y . Full-circle vertices belong to P , numbers of sides of polygonal vertices indicate sizes of the lists. Empty-circle vertices do not belong to P , but may have any lists.

To see this, suppose v is adjacent to a vertex $r \in V(P)$ and $\psi(r) \notin L(v)$, or v is adjacent to two vertices $r, r' \in V(P)$ with $\psi(r) = \psi(r')$. Then we can remove the edge vr and obtain a contradiction to the last assertion in Claim 7.

Consider a nonempty set $Y \subseteq V(G) \setminus V(P)$ and a partial coloring φ of the subgraph of G induced by Y from the reduced list assignment S . The domain of this partial coloring is denoted by $\text{dom}(\varphi) \subseteq Y$. We define L_φ as the list assignment such that

$$L_\varphi(z) = L(z) \setminus \{\varphi(y) : y \in \text{dom}(\varphi), yz \in E(G), \varphi(y) \in S(z)\}$$

for every $z \in V(G - Y)$.

We now define a particular set $Y \subseteq V(H) \setminus V(P)$ (see Figure 4 for reference) and a partial L -coloring φ of Y as follows.

Definition 3.

(Y1) If $|L(v_1)| = 3$ and one of the following holds:

- $s = 1$, or

- $s \geq 2$ and $|L(v_2)| = 5$, or
- $s = 2$ and $|L(v_2)| = 4$, or
- $s \geq 3$, $|L(v_2)| = 4$ and $|L(v_3)| \neq 3$,

then $Y = \{v_1\}$ and $\varphi(v_1) \in S(v_1)$ is chosen arbitrarily.

(Y2) If $|L(v_1)| = 3$, $s \geq 3$, $|L(v_2)| = 4$ and $|L(v_3)| = 3$, then $Y = \{v_1, v_2\}$ and φ is chosen so that $\varphi(v_2) \in L(v_2) \setminus L(v_3)$ and $\varphi(v_1) \in S(v_1) \setminus \{\varphi(v_2)\}$.

(Y2a) If $s = 2$ and $|L(v_1)| = |L(v_2)| = 3$, then $Y = \{v_1, v_2\}$ and $\varphi(v_1) \in S(v_1)$ and $\varphi(v_2) \in S(v_2)$ are chosen arbitrarily so that $\varphi(v_1) \neq \varphi(v_2)$.

(Y3) If $|L(v_1)| = 4$, $s \geq 2$, $|L(v_2)| = 3$, and one of the following holds:

- $s \leq 3$, or
- $s \geq 4$ and $|L(v_3)| = 5$, or
- $s \geq 4$, $|L(v_3)| = 4$ and $|L(v_4)| \neq 3$,

then $Y = \{v_2\}$. If $s = 3$ and $|L(v_3)| = 3$, then $\varphi(v_2)$ is chosen in $L(v_2) \setminus S(v_3)$, otherwise $\varphi(v_2) \in S(v_2)$ is chosen arbitrarily.

(Y4) If $s \geq 4$, $|L(v_1)| = 4$, $|L(v_2)| = 3$, $|L(v_3)| = 4$ and $|L(v_4)| = 3$, then:

(Y4a) If v_1, v_2 and v_3 do not have a common neighbor, then $Y = \{v_2, v_3\}$ and φ is chosen so that $\varphi(v_3) \in L(v_3) \setminus L(v_4)$ and $\varphi(v_2) \in L(v_2) \setminus \{\varphi(v_3)\}$.

(Y4b) If v_1, v_2 and v_3 have a common neighbor, then $Y = \{v_1, v_2, v_3\}$ and φ is chosen so that $\varphi(v_3) \in L(v_3) \setminus L(v_4)$, $\varphi(v_1) \in S(v_1)$ and either at least one of $\varphi(v_1)$ and $\varphi(v_3)$ does not belong to $L(v_2)$, or $\varphi(v_1) = \varphi(v_3)$. The vertex v_2 is left uncolored. Note that this is the only case where $\text{dom}(\varphi) \neq Y$.

By using Claim 10 (together with Claim 8 and the condition on adjacent vertices with lists of size 3) it is easy to see that Y and φ are always defined. (Note that in the case of adjacent vertices u, v with lists of size 3, we can assume that u is adjacent to p and $\ell = 1$. Let us recall that if $\ell = 1$, then we have chosen $p = p_1$; hence, $u = v_s$ and $v = v_{s-1}$. Therefore, only (Y2a) and (Y3) are needed to deal with this special case.) We remark that the following is true.

Claim 13. *Every L_φ -coloring of $G - Y$ extends to an L -coloring of G .*

Indeed, this is obviously true if $\text{dom}(\varphi) = Y$. The only case when $\text{dom}(\varphi) \neq Y$ is (Y4b), where $Y = \{v_1, v_2, v_3\}$ and $\text{dom}(\varphi) = \{v_1, v_3\}$. However, $\deg(v_2) = 3$ by Claim 3, and $|L_\varphi(v_2)| \geq 2$ by the choice of $\varphi(v_1)$ and $\varphi(v_3)$. This implies that any L_φ -coloring of $G - Y$ extends to v_2 and proves Claim 13. Consequently, $G - Y$ is not L_φ -colorable. We let G_φ be a P -critical subgraph of $G - Y$.

Using Claim 2 and Claim 8, it is easy to verify that the choice of Y and φ ensures that the list assignment L_φ for $G - Y$ is M -valid with respect to P and X . Let us now distinguish two cases depending on whether G_φ contains two adjacent vertices with lists of size three (that did not have lists of size three in G as well) or not.

- Suppose first that **no two vertices $u, v \in V(G_\varphi)$ such that $|L_\varphi(u)| = |L_\varphi(v)| = 3$ and $\max(|L(u)|, |L(v)|) > 3$ are adjacent.** If G_φ with the list assignment L_φ does not satisfy the assumptions of Lemma 14, this is only because there are adjacent vertices with lists of size 3 that are no longer adjacent to p in G_φ . More precisely, in that case $\ell = 1$, $|L(v_s)| = |L(v_{s-1})| = 3$, $v_s v_{s-1} \in E(G_\varphi)$ and $p_1 v_s \notin E(G_\varphi)$. Let c be a new color that does not appear in any of the lists and let L' be the list assignment obtained from L_φ by replacing $\psi(p_1)$ with c in the lists of vertices adjacent to p_1 in G_φ and by setting $L'(p_1) = \{c\}$ and $L'(v_s) = L(v_s) \cup \{c\}$. Observe that $G_\varphi + p_1 v_s$ is not L' -colorable and thus it contains a P -critical subgraph G' . By the minimality of G , we have $X \cap V(G') = \emptyset$. However, then G' contradicts Theorem 4.

Therefore, G_φ with the list assignment L_φ satisfies the assumptions of Lemma 14. By the minimality of G , we conclude that G_φ does not contain any vertex of X . By Theorem 10, we have $\ell \geq 2$ and $\omega_{P, L_\varphi}(G_\varphi) \leq \ell - 2$. Let Q be the span contained in the boundary of the outer face of G_φ such that the Q -component G_Q split off by Q contains Y . By Claim 6, if f is a face of G_φ , then $\text{Int}_f(G)$ contains no vertex of X , and if Q' is a span different from Q , then the subgraph of G split off by Q' contains no vertex of X . Since $X \neq \emptyset$, it follows that G_Q contains a vertex of X . Also, Claim 6 implies that $\ell(Q) \geq \ell$.

If v is an internal vertex of Q , then $\omega_{P, L_\varphi}(v) \geq 1$, unless $|L_\varphi(v)| = 3$. Since the sum of the weights of the internal vertices of Q is at most $\omega_{P, L_\varphi}(G_\varphi) \leq \ell - 2$, we conclude that at least one internal vertex of Q

has a list of size three. This is only possible in the cases (Y2), (Y4a), and (Y4b); Claim 9 excludes the case (Y2a). Furthermore, observe that only one internal vertex of Q has a list of size three by Claim 3; let v denote this vertex. It also follows that $\ell(Q) = \ell$ and that all internal vertices of Q other than v either belong to P or have lists of size four.

Let y_1 and y_2 be the neighbors of v in $\text{dom}(\varphi)$, where y_1 is closer to p_0 than y_2 . Let Q_1 and Q_2 be the subpaths of Q intersecting in v (where Q_1 is closer to p_0 than Q_2) and let Q'_1 and Q'_2 be the paths obtained from them by adding the edge y_1v . For $i \in \{1, 2\}$, if $\ell(Q_i) < \ell - 1$, then Claim 6 implies that the subgraph of G split off by Q'_i does not contain any vertex of X . Since $X \neq \emptyset$ and $\ell(Q_1) + \ell(Q_2) = \ell(Q) = \ell$, it follows that $\ell(Q_1) = 1$ or $\ell(Q_2) = 1$.

If for some $i \in \{1, 2\}$, we have $\ell(Q_i) > 1$ and an internal vertex z of Q_i is adjacent to y_i (this is only possible when $\ell \geq 3$), then Q_i is an edge-disjoint union of paths $Q_{i,1}$ and $Q_{i,2}$ such that $Q_{i,1}$ together with vy_iz forms a cycle C of length at most ℓ and $Q_{i,2} + zy_i$ is a span of length $k \leq \ell - 1$. By considering the interior of C and the subgraph of G split off by $Q_{i,2} + zy_i$ separately, Claim 6 again implies that the subgraph of G split off by Q does not contain any vertex of X . This is a contradiction. It follows that no internal vertex of Q_i is adjacent to y_i , and thus no internal vertex of Q_i has a list of size four. Therefore, all internal vertices of Q except for v belong to P .

If $\ell(Q_1) > 1$, then let $Q_2 = vw$, where $w \in V(H)$; consider the subgraph F of G split off by y_1vw . Note that $\ell = \ell(Q) \geq 3$ and the distance between v and X is at least $D(M, \ell) - \lceil \ell/2 \rceil - 3 \geq D(M, 2)$. By the minimality of G , it follows that F (which is y_1vw -critical) contains no vertex of X . By Theorem 10, we have $\omega_{y_1vw, L}(F) = 0$. This is a contradiction, since in each of the cases (Y2), (Y4a) and (Y4b), $F - \{y_1, v, w\}$ contains a vertex with a list of size four.

Therefore, $\ell(Q_1) = 1$. In case (Y4a), v is not adjacent to v_1 , and thus v is adjacent to p_0 . Similarly, in case (Y4b), v is adjacent to p_0 , since v_1 belongs to Y . Since v_1 has a list of size four, it has degree at least four, and thus at least one vertex of G is drawn inside the 4-cycle $v_1v_2vp_0$. This contradicts Claim 3. Suppose now that (Y2) holds. Since $\ell(Q_2) = \ell - 1$ and $\deg_{G_\varphi}(v) \geq 3$, we conclude that $Q_2 = vp_2p_3 \dots p_\ell$. Hence, G_φ is the union of P with the graph $G' = G_\varphi - \{p_4, \dots, p_\ell\}$, and

G' is $p_0p_1p_2$ -critical with respect to the list assignment L_φ . Since v is adjacent to p_0 and p_2 , Lemma 12 implies that G' is equal to the 4-cycle $p_0p_1p_2v$ with the chord p_1v , and thus G_φ consists of P and the vertex v adjacent to p_0 , p_1 and p_2 . By Claim 11, $\ell = 2$. Let us postpone the discussion of this case and summarize it in the next claim.

Claim 14. *In the subcase considered, (Y2) holds, $\ell = 2$, and p_0 , p_1 , p_2 , v_1 and v_2 have a common neighbor.*

- Let us now consider the case that **two vertices** $u, v \in V(G_\varphi)$ **with** $|L_\varphi(u)| = |L_\varphi(v)| = 3$ **and** $|L(v)| > 3$ **are adjacent.** By Claim 3, at most one of u and v has two neighbors in $\text{dom}(\varphi)$. If neither u nor v has two neighbors in $\text{dom}(\varphi)$, then $u, v \in V(H)$ and the choice of Y and φ ensures that uv is a chord of H . However, that contradicts Claim 8. Thus, we can assume that v has two neighbors in $\text{dom}(\varphi)$ and $v \notin V(H)$; and in particular, Y was chosen according to one of the cases (Y2), (Y4a) or (Y4b) (the case (Y2a) is excluded, since in that case G_φ would contain at most one vertex with a list of size three). Since u has at most one neighbor in $\text{dom}(\varphi)$ and $|L_\varphi(u)| = 3$, we have $u \in V(H)$. If $|L(u)| = 4$, then u has a neighbor $y \in \text{dom}(\varphi)$, and by Claim 8, we have $uy \in E(H)$. This is not possible (in the case (Y4a), the vertex v_1 has a list of size four, but it is not adjacent to v). Therefore, $|L(u)| = 3$. Furthermore, inspection of cases (Y2), (Y4a), (Y4b) shows that u has no neighbor in Y , as otherwise either H would have a chord contradicting Claim 8, or G would contain a 4-cycle $y'yuv$ with $y, y' \in Y$ and $|L(y)| = 4$; in the latter case, y would have degree at least four, contradicting Claim 3.

Let $y_1, y_2 \in \text{dom}(\varphi)$ be the neighbors of v , where y_1 is closer to p_0 than y_2 . By the previous paragraph, v has a neighbor u' in $V(H) \setminus Y$ with $|L(u')| = 3$; choose such a neighbor u' so that the subgraph F of G split off by $u'vy_1$ is as small as possible. Note that $\omega_{u'vy_1, L}(F) \geq 1$, as $|L(y_2)| = 4$. Since F is $u'vy_1$ -critical with respect to L , Theorem 10 implies that $X \cap V(F) \neq \emptyset$, and by the minimality of G , a vertex $x \in X \cap V(F)$ is at distance at most $D(M, 2) - 1$ from v . Hence, the distance between x and p is at most $D(M, 2) + 1 + \ell$, and since this is at least $D(M, \ell)$ by the assumptions, we have $\ell \leq 2$.

Let Q be the path consisting of P , the subpath of H between p_0 and y_1 and the path y_1vu' . If $|L(v_s)| = |L(v_{s-1})| = 3$ and $u' \neq v_s$, include also

the edge $p_\ell v_s$ in Q . Let G_Q be the subgraph of G such that $G_Q \cup F = G$ and $G_Q \cap F = u'v y_1$. Note that $\ell(Q) \leq 6$ (even if the edge $p_\ell v_s$ has been added to Q , since then $\ell = 1$ by Claim 9). Since the distance between v and a vertex of $X \cap V(F)$ is at most $D(M, 2) - 1$ and X is M -scattered, the distance between a central vertex of Q and $X \cap V(G_Q)$ is at least $D(M, 6)$. Since G_Q is Q -critical with respect to L , the minimality of G implies that G_Q contains no vertex of X .

Consider now the graphs $G'_Q = G_Q - Y$ and $F' = F - Y$ with list assignment L_φ . By the choice of u' so that F is minimal, no two adjacent vertices of F' other than u' and v have lists of size three. Furthermore, the distance between v and X is at least $M+3 > D(M, 1)$ by Claim 2. By the minimality of G , no uv -critical subgraph of F' (with respect to the list assignment L_φ) contains a vertex of X , and by Theorem 4 we conclude that every L_φ -coloring of $u'v$ extends to an L_φ -coloring of F' . Since G_φ is not L_φ -colorable, it follows that G'_Q is not L_φ -colorable. By Theorem 4 this is not possible if $\ell = 1$, and thus $\ell = 2$.

Note that if xy is an edge of G'_Q and $|L_\varphi(x)| = |L_\varphi(y)| = 3$, then x or y is equal to v , and in particular all such edges distinct from vu' are chords of the outer face of G'_Q . Since G'_Q is not L_φ -colorable, it contains a subgraph G''_Q that is P -critical with respect to L_φ . By Lemma 12, G''_Q is an even fan procession with base P and L_φ is dangerous for G''_Q . Note that all chords of the outer face of G''_Q are incident with p_1 , and thus G''_Q contains at most one edge xy satisfying $|L_\varphi(x)| = |L_\varphi(y)| = 3$. Furthermore, using Claim 8 observe that the outer face of G''_Q has at most one chord, namely p_1v . The only even fan processions satisfying these constraints are a fan of order 1 or a fat fan of order 2. In the former case, v is adjacent to all vertices of P . In the latter case, v is adjacent to p_0 and v_s , $|L(v_s)| = 3$ and p_0, p_1, p_2, v and v_s have a common neighbor. This is not possible in the cases (Y4a) and (Y4b), since v_1 cannot have degree less than four. We are left with the case that either the configuration described in Claim 14 appears, or we have the following:

Claim 15. *If the situation of Claim 14 does not occur, then (Y2) holds, $\ell = 2$, the common neighbor v of v_1 and v_2 is adjacent to p_0 and v_s , $|L(v_s)| = 3$, and there exists a vertex w adjacent to $V(P) \cup \{v, v_s\}$.*

Since either Claim 14 or Claim 15 holds, we always have $\ell = 2$ and there exists a vertex w adjacent to all vertices of P , where $w = v$ if Claim 14 holds. In particular, no two vertices with list of size three are adjacent in G by Claim 9, and P has a unique central vertex. Therefore, by symmetry we also have $|L(v_s)| = 3$, $|L(v_{s-1})| = 4$ and w is either adjacent to v_{s-1} and v_s , or adjacent to v_1 and the common neighbor v' of v_{s-1} , v_s and p_2 . Observe that the outcome of Claim 15 contradicts the last conclusion, as w in Claim 15 does not have a neighbor with a list of size four (thus w is not adjacent to v_{s-1}) and v is the only neighbor of w with a list of size five and v is not adjacent to p_2 (excluding the existence of v').

Therefore, Claim 14 holds and v is also adjacent to v_{s-1} and v_s . Let us choose $c_1 \in S(v)$ and $c_2 \in S(v_1)$ arbitrarily so that $c_1 \neq c_2$. Let L' be the list assignment such that $L'(v_2) = L(v_2) \setminus \{c_2\}$, $L'(v) = \{c_1\}$ and $L'(z) = L(z)$ for any other vertex z . Let $G' = G - \{p_1, p_0, v_1\}$ and $P' = p_2v$. Note that each L' -coloring of G' corresponds to an L -coloring of G , and thus G' is not L' -colorable. Let G'' be a P' -critical subgraph of G' . The only possible adjacent vertices of G'' with lists of size three are v_2 and v_3 . Also, the distance between v and X is at least $D(M, 2) - 1$. If $vv_2 \in E(G'')$, then G'' satisfies the assumptions of Lemma 14, and by the minimality of G , we have $X \cap V(G'') = \emptyset$. However, then G'' contradicts Theorem 4.

Finally, suppose that $vv_2 \notin E(G'')$. Let d be a new color that does not appear in any of the lists, and let L'' be the list assignment obtained from L' by replacing c_1 with d in the lists of v and its neighbors in G'' and by setting $L''(v_2) = L(v_2) \cup \{d\}$. Observe that $G'' + vv_2$ is not L'' -colorable, and since no two vertices of $G'' + vv_2$ with lists of size three are adjacent, we again obtain a contradiction with the minimality of G and Theorem 4. \square

5 The conjecture of Albertson

In order to finish the proof of Theorem 2, it remains to show that Lemma 5 holds. We are going to prove a stronger statement, giving a complete list of the critical graphs where we only forbid the precolored vertex x to be adjacent with a vertex with a list of size three. Let us start with a simple observation.

Lemma 15. *Let G be a graph drawn in the plane, let P be a path of length at most one contained in the boundary H of the outer face of G , and let x be a vertex of $V(G) \setminus V(P)$. Let L be a 0-valid list assignment for G and*

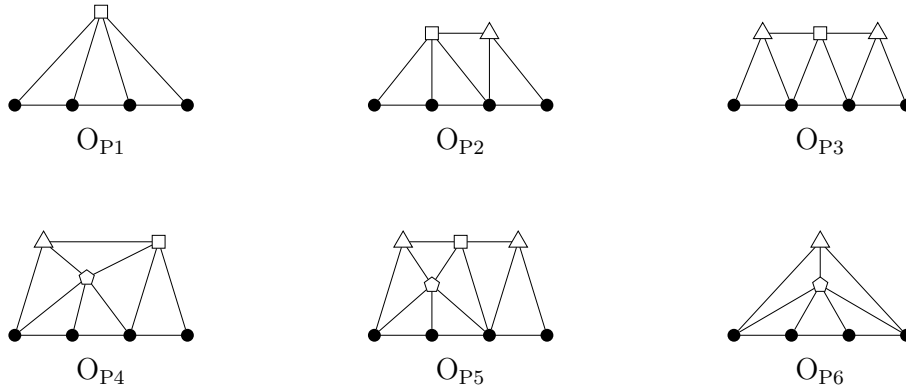

Figure 5: Forbidden configurations of Theorem 16.

X , where $X = \{x\}$, and assume that x is not adjacent to any vertex with a list of size three. If $x \in V(H)$ or x has neighbors only in H , then G is L -colorable.

Proof. Let L' be the list assignment obtained from L by removing $L(x)$ from the list of all its neighbors and let $G' = G - x$. Since x is not adjacent to any vertex with a list of size three, we have $|L'(v)| \geq 3$ for each $v \in V(G) \setminus V(P)$. Since L is a 0-valid assignment, P is L' -colorable. Furthermore, by the assumptions of the lemma, all the vertices with lists of size less than five are incident with the outer face of G' . Hence, G' is L' -colorable by Theorem 4, and this coloring extends to an L -coloring of G . \square

We use a part of a result of Dvořák et al. [7] regarding the case that a path of length three is precolored, but adjacent vertices with lists of size three are forbidden (let us remark that this result can also be easily derived from Theorem 10 and the technique used in the proof of Lemma 13). An *obstruction* is a plane graph with a prescribed subpath of its outer face boundary and prescribed lengths of lists. An obstruction O appears in a graph G with the list assignment L and a specified path P if O is isomorphic to a subgraph of G such that the prescribed subpath of O corresponds to P and the sizes of the lists given by L match those prescribed by O . In figures, the full-circle vertices belong to the prescribed path (and their list sizes are not prescribed), triangle vertices have lists of size three, square vertices have lists of size four and pentagonal vertices have lists of size five.

Theorem 16 (Dvořák et al. [7], Theorem 7). *Let G be a graph drawn in the plane, let P be a path of length at most three contained in the boundary H of the outer face of G and let L be a valid list assignment for G such that no two vertices with lists of size three are adjacent and all vertices of P have lists of size one. If the following conditions hold, then G is L -colorable:*

- *if a vertex v has three neighbors w_1, w_2, w_3 in $V(P)$, then $L(v) \neq L(w_1) \cup L(w_2) \cup L(w_3)$, and*
- *if O is an obstruction depicted in Figure 5 that appears in G , then O is L -colorable.*

Another special case of the result of Dvořák et al. [7] is the following:

Theorem 17 (Dvořák et al. [7], Theorem 7). *Let G be a graph drawn in the plane, let P be a path of length at most one contained in the boundary H of the outer face of G , let w be a vertex in $V(G) \setminus V(H)$ and let L be a list assignment for G such that P is L -colorable, all vertices in $V(G) \setminus V(H)$ other than w have lists of size at least five, all vertices in $V(H) \setminus V(P)$ have lists of size at least three and no two vertices with lists of size three are adjacent. If $|L(w)| = 4$, then G is L -colorable.*

We also use the following characterization of critical graphs with a short precolored face, given in [6] (this can also be easily derived from Lemma 8).

Lemma 18 ([6]). *Let G be a plane graph, let H be the boundary of its outer face, and let L be a list assignment such that $|L(v)| \geq 5$ for $v \in V(G) \setminus V(H)$. If H is an induced cycle of length at most six and G is H -critical with respect to L , then $|H| \geq 5$ and one of the following holds:*

- $|V(G) \setminus V(H)| = 1$, or
- $|H| = 6$ and $V(G) \setminus V(H)$ consists of two adjacent vertices of degree five, or
- $|H| = 6$ and $V(G) \setminus V(H)$ consists of three pairwise adjacent vertices of degree five.

Let us now proceed with a strengthening of Lemma 5.

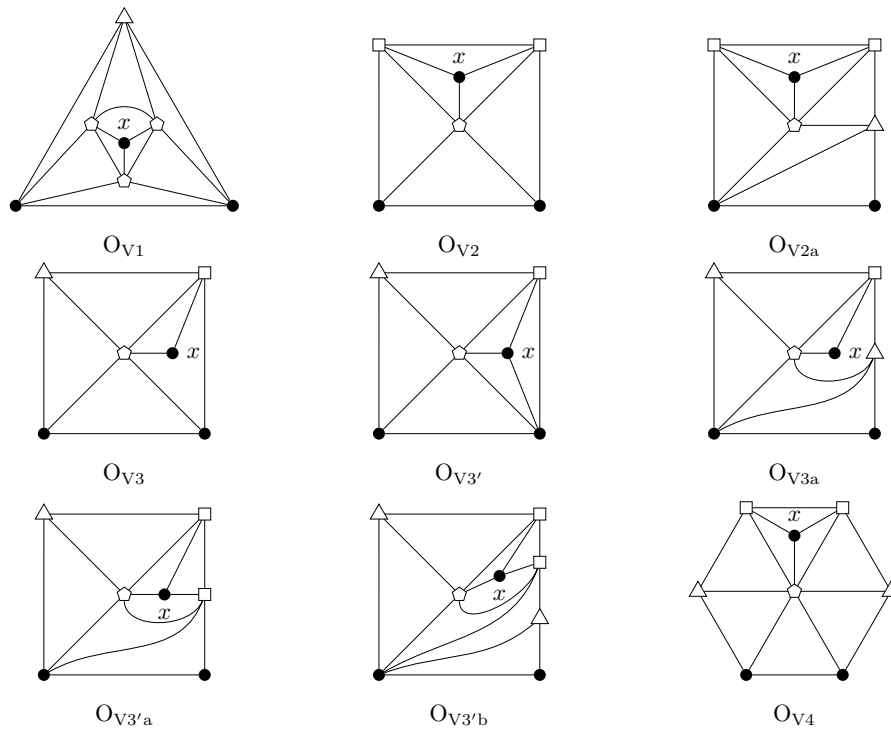

Figure 6: Forbidden configurations of Lemma 19.

Lemma 19. *Let G be a graph drawn in the plane, let P be a path of length at most one contained in the boundary H of the outer face of G and let x be a vertex of $V(G) \setminus V(P)$. Let L be a 0-valid list assignment for G and X , where $X = \{x\}$. If the following conditions hold, then G is L -colorable:*

- *no two vertices with lists of size three are adjacent,*
- *x is not adjacent to any vertex with a list of size three, and*
- *if O is an obstruction drawn in Figure 6 that appears in G (with the marked vertex corresponding to x), then O is L -colorable.*

Proof. We can assume that $|L(p)| = 1$ for $p \in V(P)$ and that $\ell(P) = 1$. Let $P = p_0p_1$. Observe that in the process of reducing lists of vertices in P (in order to be able to assume that $|L(p)| = 1$), we may create a non-colorable obstruction from Figure 6. However, G contains at most one such obstruction O (with the exception of O_{V_3} and $O_{V_{3'}}$, when we consider $O = O_{V_{3'}}$). Therefore, we can always take the lists for vertices in $V(P)$ coming from an L -coloring of O .

For contradiction, assume that G is a counterexample with $|V(G)| + |E(G)|$ the smallest possible. Note that G is P -critical and connected. By Lemma 15, we have $x \notin V(H)$.

By Lemma 6 and Theorem 16, every non-facial triangle in G and every chord of H separates P from x . Furthermore, by applying these results to 2-chords, we obtain the following.

Claim 16. *If a 2-chord $Q = v_1v_2v_3$ of H does not separate P from x , then the subgraph of G split off by Q consists either of the edge v_1v_3 , or of a single vertex with a list of size three adjacent to $v_1v_2v_3$.*

Suppose that G contains a vertex cut of size one, and let G_1 and G_2 be the subgraphs of G such that $G = G_1 \cup G_2$, G_1 and G_2 intersect in a single vertex v and $P \subseteq G_1$. Note that $x \in V(G_2) \setminus \{v\}$, and by the minimality of G and Lemma 6, we conclude that G_2 consists of the edge joining v with x . By Lemma 15, we have $v \notin V(H)$. It follows that H is a cycle.

Let us now consider a chord uv of H and let G_1 and G_2 be the subgraphs of G intersecting in uv , where $P \subseteq G_1$. By Lemma 6 and the minimality of G , either G_2 is one of the graphs drawn in Figure 6, or $V(G_2) = \{u, v, x\}$. The latter is impossible by Lemma 15; hence, assume the former. The inspection of these graphs shows that there exists only one proper L -coloring φ of the

subgraph of G induced by $\{u, v, x\}$ that does not extend to an L -coloring of G_2 (let us recall that $|L(x)| = 1$). By symmetry, we can assume that x is not adjacent to u and that u does not have a list of size three. Let G' be the graph obtained from G_1 by adding a new vertex x' and the edge ux' , and if $vx \in E(G)$, then also the edge vx' . Let c be a new color that does not appear in any of the lists and let L' be a list assignment for G' defined as follows: $L'(x') = \{c\}$, $L'(u) = (L(u) \setminus \{\varphi(u)\}) \cup \{c\}$, if $vx \in E(G)$, then $L'(v) = (L(v) \setminus L(x)) \cup \{c\}$, otherwise $L'(v) = L(v)$, and $L'(w) = L(w)$ for every $w \in V(G_1) \setminus \{u, v\}$. Since each L' -coloring of G' corresponds to an L -coloring of G , it follows that G' is not L' -colorable. By the minimality of G , this is only possible if $u \in V(P)$ and $L(u) = \{\varphi(u)\}$. By Theorem 16 applied to G_1 with respect to the path $P + uv$, we conclude that G_1 either is a triangle, or $V(G_1) = \{p_0, p_1, v, w\}$ for some vertex w with a list of size three adjacent to p_0, p_1 and v . However, it is easy to check that the composition of G_1 with G_2 (an obstruction from Figure 6) is either L -colorable or equal to one of the obstructions in Figure 6. This is a contradiction. Consequently:

Claim 17. *H is an induced cycle.*

Suppose that the distance between x and P is 1, say $xp_0 \in E(G)$. Observe that $xp_1 \notin E(G)$ by Lemma 6 and Theorem 16. Let G' be the graph obtained from G by splitting p_0 to two vertices p'_0 and p''_0 , where both p'_0 and p''_0 are adjacent to x , $P' = p'_0xp''_0p_1$ is a path in G' and other neighbors of p_0 are divided between p'_0 and p''_0 in the planar way. Note that G' is P' -critical and we can apply Theorem 16 for it. Using Claim 17, observe that P' is an induced path and that each vertex with a list of size three has at most two neighbors in P' , hence G' is one of the graphs drawn in Figure 5. Since each vertex distinct from x is adjacent to at most one of p'_0 and p''_0 and x is not adjacent to a vertex with a list of size three, it follows that G' is O_{P_4} . But then G is O_{V_3} . Therefore, we have:

Claim 18. *The distance between x and P is at least 2.*

Consider a separating triangle $C = v_0v_1v_2$ in G , and let $G' = \text{Int}_C(G)$ with the list assignment L . Note that G' is C -critical. By Theorem 4 it follows that $x \in V(G') \setminus V(C)$. If x is adjacent to say v_0 , then G' is bounded by the closed walk $xv_0v_1v_2v_0x$ of length 5. Formally, we split v_0 into two vertices v'_0 and v''_0 as we did with p_0 in the previous paragraph. Observe that $|V(G') \setminus \{x, v_0, v_1, v_2\}| \neq 1$, since no vertex other than x is adjacent to both

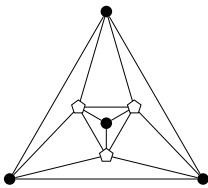

Figure 7: Nontrivial separating triangle.

v'_0 and v''_0 and all vertices in $V(G') \setminus \{x, v_0, v_1, v_2\}$ have degree at least five. Using Lemma 18, we conclude that $V(G') = \{v_0, v_1, v_2, x\}$.

Let us now consider the case that the distance between C and x is at least two. Let φ be an L -coloring of C that is obtained from an L -coloring of $G - x$. Then φ does not extend to an L -coloring of G' . Let L' be the list assignment such that $L'(v_0) = \{\varphi(v_0)\}$, $L'(v_1) = \{\varphi(v_1)\}$, $L'(v_2) = \{\varphi(v_0), \varphi(v_1), \varphi(v_2)\}$ and L' matches L on the remaining vertices of G' . Then G' is not L' -colorable. By the minimality of G , O_{V_1} appears in G' . We conclude that G' is the graph drawn in Figure 7. In that case, every L -coloring of C different from φ extends to an L -coloring of G' . Since G is not O_{V_1} , at least one vertex $w \in V(C) \setminus V(P)$ does not have a list of size three. Let G'' be the graph obtained from $G - (V(G') \setminus V(C))$ by adding a vertex x' and the edge $x'w$. Let L'' be the list assignment such that $L''(x') = \{\varphi(w)\}$ and L'' matches L on other vertices of G'' . Note that G'' is not L'' -colorable, since each such coloring would extend to an L -coloring of G . Furthermore, x' has degree one, hence G'' does not contain any of the obstructions. Therefore, G'' contradicts the minimality of G . This implies:

Claim 19. *If C is a separating triangle in G , then $V(\text{Int}_C(G)) = V(C) \cup \{x\}$.*

Let $p_1 p_0 v_1 \dots v_s$ be the facial walk of H . Note that $s \geq 1$. For $v \in V(G) \setminus (V(P) \cup \{x\})$, let

$$S(v) = L(v) \setminus \bigcup_{\substack{u \in V(P) \cup \{x\} \\ uv \in E(G)}} L(u).$$

Observe that $|S(v)| = |L(v)| - k$, where k is the number of neighbors of v in $V(P) \cup \{x\}$, by the minimality of G .

If $s = 1$, then note that $|S(v_1)| \geq 1$. Choose an arbitrary color $c \in S(v_1)$ and let L' be the list assignment obtained from L by removing c from the lists

of neighbors of v_1 . Note that $G - v_1$ is not L' -colorable, and since it contains no vertices with list of size three, by the minimality of G we conclude that O_{V_2} appears in $G - v_1$. But then G is equal to O_{V_1} , which is a contradiction. Therefore, $s \geq 2$. As we observed before, $x \notin V(H)$, and hence neither v_1 nor v_2 is equal to x .

Suppose that $|L(v_1)| = 5$, or that $|L(v_1)| = 4$ and $|L(v_2)| \geq 4$. If x is not adjacent to v_1 , then let $y = p_0$, otherwise let $y = x$. Let L' be the list assignment obtained from L by removing $L(y)$ from $L(v_1)$ and let $G' = G - yv_1$. Observe that G' is P -critical with respect to L' , and by the minimality of G , it is one of the graphs in Figure 6. This is not possible if $y = p_0$, since then G' either is not 2-connected or contains a vertex (a neighbor of p_1) with a list of size 5 incident with the outer face. If $y = x$, then v_1 and x are not adjacent in G' , but the edge v_1x can be added keeping the graph planar. This is only possible if G' is either O_{V_3} or $O_{V_{3a}}$. However, in such a case G would be isomorphic to O_{V_2} , $O_{V_{2a}}$ or $O_{V_{3'a}}$, and would be L -colorable by assumption. We conclude the following.

Claim 20. *We have $s \geq 2$, $|L(v_1)| \leq 4$, and one of v_1 and v_2 has a list of size three; symmetrically, $|L(v_s)| \leq 4$ and one of v_s and v_{s-1} has a list of size three.*

Next, we claim the following:

Claim 21. *If the vertices p_0, p_1, v_1 and v_2 have a common neighbor w , then w is adjacent to x .*

Proof. By Claim 17 and Claim 18, we have $w \in V(G) \setminus (V(H) \cup \{x\})$. Suppose that w is not adjacent to x . By Lemma 15 and Claim 19, we conclude that wp_1p_0 , wp_0v_1 and wv_1v_2 bound faces. Let G_1 and G_2 be the subgraphs of G intersecting in p_1wv_2 such that $P \subset G_1$. Note that $x \in V(G_2)$, $|L(v_1)| = 3$, $|S(v_1)| = 2$ and $|S(w)| = 3$. Choose $c \in S(w) \setminus S(v_1)$ arbitrarily. Let $L'(w) = \{c\}$ and $L'(v) = L(v)$ for any $v \in V(G_2) \setminus \{w\}$. Note that every L' -coloring of G_2 extends to an L -coloring of G , hence G_2 is not L' -colorable. By the minimality of G and Claim 18, we conclude that one of the obstructions K drawn in Figure 6 appears in G_2 , with the precolored path p_1w . Note that $v_2 \in V(K)$, as otherwise G contains a 2-chord contradicting Claim 16. Also, $|L'(v_2)| \geq 4$, as v_2 is adjacent to v_1 , which has a list of size three. Therefore, K is one of O_{V_2} , $O_{V_{2a}}$, O_{V_3} or $O_{V_{3'a}}$ (the case $O_{V_{3'}}$ is excluded, since x is adjacent neither to w nor to p_1). By Claim 20, K is not O_{V_2} . Furthermore, H is not $O_{V_{3'a}}$, since w has degree at least five. In the remaining two cases,

Claim 17, Claim 19 and the assumption that x is not adjacent to a vertex with a list of size 3 imply that $K = G_2$. It is a simple exercise to check that the combination of G_1 with K is L -colorable. This is a contradiction. \square

Suppose that a vertex of P , say p_0 , has degree two in G . We can assume that the color of p_1 only appears in the lists of its neighbors, by replacing it with a new color if necessary. Let $G' = G - p_0 + p_1v_1$ and let L' be the list assignment such that $L'(v_1) = (L(v_1) \setminus L(p_0)) \cup L(p_1)$ and L' matches L on other vertices. By the minimality of G , we have that G' is L' -colorable; but this gives an L -coloring of G , which is a contradiction. Therefore, both vertices of P have degree at least three.

Claim 22. *The vertex x has no neighbor in H .*

Proof. Suppose that x has a neighbor $v \in V(H)$. By Claim 18, we have $v \notin V(P)$.

Let us first consider the case that p_0, p_1 and x have a common neighbor w . For $i \in \{0, 1\}$, let $Q_i = p_iwxv$ and let G_i be the subgraph of G split off by Q_i . Note that G_i is Q_i -critical, and we can apply Theorem 16 to it. Suppose that each of G_0 and G_1 is among the graphs drawn in Figure 5 different from O_{P_6} , or consists of a vertex with a list of size three adjacent to p_i, w and v , or consists of an edge joining v to p_i . (Note that some configurations of Figure 5 are excluded since x is not adjacent to a vertex with a list of size 3.) A straightforward case analysis shows that for any $c \in S(w)$, there exists at most one color $c' \in S(v)$ such that the L -coloring of Q_i that assigns the color c to w and the color c' to v does not extend to an L -coloring of G_i . Since $|L(v)| \geq 4$, we conclude that G is L -colorable, which is a contradiction. Hence, we can assume that say G_0 does not satisfy this property; by Theorem 16, the following cases are possible:

- G_0 contains the edge vw and either the edge p_0v or a vertex with a list of size three adjacent to p_0, w and v ; or,
- G_0 is O_{P_6} .

In the former case, $vw \notin E(G_1)$, since G does not have parallel edges. In the latter case, if $vw \in E(G_1)$, then G is easily seen to be L colorable. Therefore, we can assume that $vw \notin E(G_1)$. If G_1 is O_{P_6} , then all the combinations with the possible choices for G_0 result in an L -colorable graph. Hence, for any $c \in S(w)$ there exists at most one color $c' \in S(v)$ such that the

corresponding coloring does not extend to an L -coloring of G_1 . If G_0 is O_{P6} , this would imply that G is L -colorable. Therefore, G_0 contains the edge vw . A straightforward case analysis shows that all the remaining combinations of the choices for G_0 and G_1 result in O_{V2} , O_{V3} , O_{V4} or in an L -colorable graph. We conclude that p_0 , p_1 and x do not have a common neighbor.

Let M be the set consisting of $V(P)$ and of all vertices with lists of size three adjacent to P , i.e., $M \subseteq \{v_s, p_1, p_0, v_1\}$. Suppose that a vertex w has at least three neighbors in M ; note that $w \notin V(H)$ by Claim 17. If w is adjacent to v_s and p_0 , then since x has a neighbor in $V(H)$, we have $x \notin V(\text{Int}_{p_0 p_1 v_s w}(G))$, and since p_1 has degree at least three, Lemma 18 implies that w is also adjacent to p_1 . Hence, by symmetry, we can assume that w is adjacent to p_0 , p_1 and v_1 . By the previous paragraph, w is not adjacent to x , and thus $|S(w)| = 3 > |S(v_1)|$. Let c be a color in $S(w) \setminus S(v_1)$. Let $G' = G - p_0$ and let L' be the list assignment such that $L'(w) = \{c\}$, $L'(v_1) = S(v_1) \cup \{c\}$ and L' matches L on all other vertices. Then G' is not L' -colorable, and thus one of the configurations K drawn in Figure 6 appears in G' . Observe that Claim 16, Claim 17, Claim 19 and Claim 21 imply that $G' = K$. Since w has degree at least five and $|L'(v_1)| = 3$, this is only possible if K is O_{V1} , O_{V3a} , $O_{V3'a}$ or $O_{V3'b}$. However, the corresponding graph G is easily seen to be L -colorable, which is a contradiction.

Consequently, every vertex has at most two neighbors in M . Furthermore, each vertex in $V(H)$ other than v has at most one neighbor in M , by Claim 17. Let θ be an L -coloring of the subgraph of G induced by M . If v is the only neighbor of x in $V(H)$, then let G' be the graph obtained from $G - M$ by splitting v into two vertices v' and v'' adjacent to x , with other neighbors of v distributed between v' and v'' in the planar way. Let L' be the list assignment such that $L'(v') = L'(v'')$ consists of a single color in $S(v)$ distinct from the colors of the neighbors of v in M according to θ and $L'(z) = L(z) \setminus \{\theta(t) : t \in M, tz \in E(G)\}$ for any other vertex $z \in V(G')$. If x has at least two neighbors in $V(H)$, then by Claim 16, it has exactly two such neighbors v' and v'' and $v'v'' \in E(G)$. In this case, let $G' = G - M - v'v''$, and let L' be defined as before for vertices other than v' and v'' , with the lists of v' and v'' chosen to consist of a single color distinct from each other and the colors of their neighbors in $M \cup \{x\}$. Let $P' = v'xv''$. Note that each vertex of G' not in P' has a list of size at least three, and all internal vertices have lists of size five. Since any L' -coloring of G' together with θ would give an L -coloring of G , no such L' -coloring exists. By Lemma 12, G' contains an even fan procession F with base P' and L' is a dangerous assignment for it.

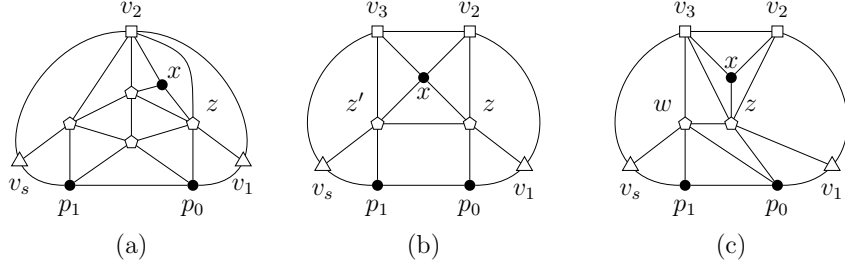

Figure 8: Configurations from Claim 22.

Suppose first that F is not a fan. By Observation 11, there is at most one coloring of P' that does not extend to an L' -coloring of F . If there were at least two choices for the colors of the endvertices of P' , at least one of them would give a coloring of G' extending to an L -coloring of G . Therefore, there is only one choice, which is only possible if v is the only neighbor of x in H and v has two neighbors in M . In this case, v' and v'' have the same color, hence F is not a fat fan and x has a neighbor z with $|L'(z)| = 3$. Since all neighbors of x in $V(H)$ belong to P' , we conclude that z has two neighbors in M . Let C be the cycle formed by z , its neighbors in M and the path between them in M ; by choosing the neighbors of z as close to each other as possible, we can assume that C is an induced cycle. Note that $|C| \leq 5$. Since no vertex has more than two neighbors in M , Lemma 18 applied to $\text{Int}_C(G)$ with the list assignment L implies that C bounds a face of G . Because vertices of P have degree at least three and x , p_0 and p_1 do not have a common neighbor, we conclude that z is adjacent either to p_0 and v_1 , or to p_1 and v_s . By symmetry, we can assume the former. Since there is only one choice for the color of v' and v'' , we have $v = v_2$ and $V(H) = M \cup \{v_2\}$. Since F is not a fan, it has at least three vertices with lists of size three. By planarity, we conclude that it has exactly three, namely the vertex z , a vertex adjacent to p_0 and p_1 , and a vertex adjacent to p_1 and v_s , where $s = 3$. Consequently, F consist of the triangle $xv'z$ and of a fat fan of order two. See Figure 8(a). However, the corresponding graph G is L -colorable.

Therefore, F is a fan. Let z be a neighbor of x with $|L'(z)| = 3$ that is also adjacent to the endvertex v' of P' . Again, z has two neighbors in M and we can assume that they are p_0 and v_1 . Let us now consider the case that F has order at least two. Then, there exists a common neighbor z' of

x and v'' distinct from z , and z' is adjacent to p_1 and v_s . By Claim 16, we have that v' is adjacent to v_1 and v'' is adjacent to v_s . We apply Lemma 18 to the subgraph $\text{Int}_{p_0zxz'p_1}(G)$ with list assignment L . Since p_0 , p_1 and x do not have a common neighbor, we conclude that the 5-cycle $p_0zxz'p_1$ is not induced, and furthermore, that $p_0z', p_1z \notin E(G)$. Since both z and z' have degree at least five, it follows that $zz' \in E(G)$. There are two cases depending on whether $s = 3$ or $s = 4$, but in both of them, the resulting graph G is L -colorable. See Figure 8(b) illustrating the case $s = 4$.

We conclude that F is a fan of order one; hence, z is adjacent to both ends of P' . It follows that x has two neighbors (v_2 and v_3) in H . If we have three possible choices for the list (color) of $v'' = v_3$ in L' , then we can choose the list so that F is L' -colorable and obtain an L -coloring of G . This is a contradiction, hence v_3 has a neighbor in M . Note that $s > 3$; otherwise, since p_1 has degree at least three, the 4-cycle $p_1p_0zv_3$ would by Lemma 18 applied to $\text{Int}_{p_1p_0zv_3}(G)$ have a chord p_1z , contradicting the observation that z has only two neighbors in M . Therefore, we have $s = 4$. Similarly, since p_1 has degree at least three and it is not adjacent to z or v_3 , Lemma 18 applied to the interior of the 5-cycle $p_1p_0zv_3v_4$ implies that there exists a vertex w adjacent to p_0 , p_1 , z , v_3 and v_4 . See Figure 8(c). However, w has three neighbors in M , which we already excluded. This completes the proof of Claim 22. \square

Let the set Y , its partial coloring φ , and the list assignment L_φ be defined according to Definition 3. Note that $G - Y$ is not L_φ -colorable, and thus $G - Y$ contains a P -critical subgraph G_φ (with respect to the list assignment L_φ). Let us note that Claim 17 together with the choice of Y implies that every vertex $v \in V(G_\varphi) \setminus \{p_0, p_1, x\}$ satisfies $|L_\varphi(v)| \geq 3$.

Claim 23. *There exists a neighbor of x adjacent to two vertices of $\text{dom}(\varphi)$.*

Proof. Note that x is not adjacent to Y or any other vertex of H (Claim 22). By excluding the conclusion of the claim, x is not adjacent to a vertex with a list of size three in G_φ . By Theorem 4, we have $x \in V(G_\varphi)$.

- Let us first consider the situation that G_φ contains two adjacent vertices u and v with $|L_\varphi(u)| = |L_\varphi(v)| = 3$. If $u, v \in V(H)$, then Claim 17 implies that $uv \in E(H)$ and the choice of Y would ensure that either $|L_\varphi(u)| > 3$ or $|L_\varphi(v)| > 3$. Hence, by symmetry we can assume that $u \notin V(H)$, and thus u has two neighbors in $\text{dom}(\varphi)$, and one of (Y2),

(Y4a) and (Y4b) occurs. If $v \notin V(H)$, then v is also adjacent to the two vertices $y_1, y_2 \in \text{dom}(\varphi)$. By Claim 19, we have $y_1y_2 \notin E(G)$, hence (Y4b) happens, $y_1 = v_1$ and $y_2 = v_3$. Choose vertices u and v so that the disk bounded by the 4-cycle $C = v_1v_2v_3u$ is as small as possible. By Theorem 16, we have $x \in V(\text{Int}_C(G)) \setminus V(C)$. However, u is not adjacent to x and forms a vertex cut in G_φ . Let G_1 and G_2 be the subgraphs of G_φ such that $G_1 \cap G_2 = u$, $G_1 \cup G_2 = G_\varphi$, both G_1 and G_2 have at least two vertices, $P \subset G_1$ and $x \in V(G_2)$. By Theorem 4, G_1 is L_φ -colorable, and by the minimality of G , the precoloring of u given by this coloring extends to an L_φ -coloring of G_2 (the choice of u ensures that no two vertices with lists of size three are adjacent in G_2). Hence, G_φ is L_φ -colorable. This is a contradiction.

We conclude that there exists a vertex $u \in V(G) \setminus V(H)$ adjacent to two vertices in $\text{dom}(\varphi)$ and all edges joining vertices with lists of size three (according to L_φ) are incident with u . Furthermore, the other ends of these edges belong to H . Choose a neighbor v' of u incident with the outer face of G_φ so that $|L_\varphi(v')| = 3$ and the subgraph G_2 of G_φ split off by uv' is as large as possible. Note that all edges joining u to vertices with lists of size three belong to G_2 . Let G_1 be the subgraph of G_φ such that $G_1 \cup G_2 = G_\varphi$ and $G_1 \cap G_2 = uv'$ (we have $P \subseteq G_1$). Let $P_2 = uv'$. Note that $G_2 \neq uv'$, since otherwise G would contain a 2-chord Q consisting of uv' and a vertex in $\text{dom}(\varphi)$ contradicting Claim 16. By Theorem 4, we have that $x \in V(G_2)$.

Note that G_2 is P_2 -critical with respect to L_φ and x is not adjacent to any vertex of P_2 . Furthermore, no two vertices in $V(G_2) \setminus V(P_2)$ with lists of size three are adjacent. Observe that x is adjacent neither to u nor to v' , thus by the minimality of G , we conclude that G_2 is equal to one of the graphs drawn in Figure 6. In particular, there exists a unique coloring ψ of P_2 that does not extend to an L_φ -coloring of G_2 .

Suppose that u and v' do not have a common neighbor w in G_1 with $|L_\varphi(w)| = 4$. Note that by Claim 16 and Claim 21, u is not adjacent to both vertices of P . Let $c_u \in L_\varphi(u)$ be a color that is different from $\psi(u)$ and different from the color of a neighbor of u in P , if it has any. Let $c_{v'} \in L_\varphi(v')$ be a color different from c_u and different from the color of a neighbor of v' in P , if it has any. Let $G'_1 = G_1 - \{u, v'\}$ with the list L_1 obtained from L_φ by removing c_u from the lists of neighbors of u and $c_{v'}$ from the lists of neighbors of v' . By the choice of v' and

the assumption that u and v' have no common neighbor with a list of size 4, it follows that every vertex of $V(G'_1) \setminus V(P)$ has a list of size at least three. By Theorem 4, we conclude that G_1 has an L -coloring such that the color of u is not $\psi(u)$. However, this coloring extends to an L_φ -coloring of G_φ , which is a contradiction.

Therefore, we can assume that u and v' have a common neighbor $w \in V(G_1)$ with $|L_\varphi(w)| = 4$. If $w \in V(H)$, then Claim 17 and Claim 19 imply that v' has degree two in G_1 . On the other hand, if $w \notin V(H)$, then w has a neighbor in $\text{dom}(\varphi)$ and Claim 19 implies that u has degree two in G_1 . In the former case, let $q_0 = v'$ and $q_1 = u$, in the latter case let $q_0 = u$ and $q_1 = v'$. Note that q_0 has no neighbor in P . Let c be a color in $L_\varphi(q_0) \setminus \{\psi(u), \psi(v')\}$. By Theorem 4, there exists an L -coloring of $G_1 - q_0$ such that the color of w is not c . Observe that this coloring extends to an L_φ -coloring of G_1 such that either q_0 or q_1 is colored by c . This coloring extends to an L_φ -coloring of G_φ , which is a contradiction.

- Therefore, we can assume that no two adjacent vertices of G_φ have lists of size three according to L_φ . By the minimality of G and Claim 18, we conclude that G_φ is one of the graphs drawn in Figure 6 (except $O_{V3'}$ which has vertex x adjacent to P). Let us discuss the possible cases for G_φ separately.
 - If G_φ is O_{V1} , O_{V2a} , O_{V3a} or $O_{V3'b}$, then let w be the vertex with $|L_\varphi(w)| = 3$ that is adjacent to both vertices of P . By Claim 17, we have that $w \in V(G) \setminus V(H)$, and thus w is adjacent to two vertices in $\text{dom}(\varphi)$. By Claim 16, these vertices are v_1 and v_2 . However, that contradicts Claim 21.
 - If G_φ is O_{V2} or O_{V3} , then G contains a path $Q = p_0w_1w_2p_1$ corresponding to the outer face of G_φ . By Claim 17, at most one of w_1 and w_2 belongs to H . If say w_1 belongs to H , then by Claim 16, G consists of G_φ and a vertex with a list of size three adjacent to w_1 , w_2 and p_1 . However, such a graph is L -colorable. Therefore, neither w_1 nor w_2 belongs to H . Let F be the subgraph of G split off by Q . Since $s \geq 2$, F has at least two vertices not belonging to Q , and by Theorem 16, F is O_{P2} , O_{P3} , O_{P4} or O_{P5} . If F is O_{P2} or O_{P4} , then we can assume that $Y = \{v_1\}$ is the vertex with a list of size three; but then v_1 is adjacent to at most one of w_1

and w_2 , contrary to the fact that $|L_\varphi(w_i)| < |L(w_i)|$ for $i \in \{1, 2\}$. Similarly, if F is O_{P_5} , then we can assume that $Y = \{v_1, v_2\}$ is not adjacent to at least one of w_1 and w_2 , which is again a contradiction. If F is O_{P_3} , then G_φ is not O_{V_2} , since we assume that the common neighbor of the two vertices in Y is not adjacent to x . The final possibility, the combination of O_{P_3} and O_{V_3} does not result in a P -critical graph.

- Suppose now that G_φ is $O_{V_3'a}$. Let $p_i w_1 w_2 w_3 p_{1-i}$ (for some $i \in \{0, 1\}$) be the subpath of G corresponding to the outer face of G_φ , where $|L_\varphi(w_1)| = 3$. By Claim 22, we have $w_2, w_3 \notin V(H)$.

Suppose that $w_1 \notin V(H)$. Then w_1 is adjacent to two vertices $y_1, y_2 \in \text{dom}(\varphi)$, and by Claim 16, $p_i y_1 y_2$ is a subpath of H and $|L(y_1)| = 3$. Observe that $Y = \{y_1, y_2\}$, and thus w_2 and w_3 are adjacent to y_2 . By Claim 16 applied to $y_2 w_3 p_{1-i}$, we conclude that y_2, w_3 and p_{1-i} have a common neighbor with a list of size three (if y_2 were adjacent to p_{1-i} , we would have chosen $Y = \{y_1\}$). However, the resulting graph is L -colorable.

Therefore, we have $w_1 \in V(H)$. By Theorem 16, the subgraph F of G split off by $Q = w_1 w_2 w_3 p_{1-i}$ either consists of a vertex z with a list of size three adjacent to all vertices of Q (z cannot be adjacent to only three vertices of Q , since $Y = \{z\}$, $|L_\varphi(w_2)| < |L(w_2)|$, and $|L_\varphi(w_3)| < |L(w_3)|$), or is equal to one of the graphs drawn in Figure 5. In the former case, G is L -colorable. In the latter case, the choice of Y shows that F is not O_{P_1} , and since w_2 and w_3 are adjacent to a vertex in Y , F is not O_{P_4} , O_{P_5} or O_{P_6} . If F is O_{P_3} , then the assumption that no neighbor of x has two neighbors in $\text{dom}(\varphi)$ is violated, and similarly we exclude the case that F is O_{P_2} and $|L(v_1)| = 3$. The case that F is O_{P_2} and $|L(v_1)| = 4$ is excluded as well, since then $Y = \{v_2\}$ and w_3 is not adjacent to any vertex in Y .

- Finally, suppose that G_φ is O_{V_4} and let $p_0 w_1 w_2 w_3 w_4 p_1$ be the subpath of G corresponding to the outer face of G_φ . By Claim 22, we have $w_2, w_3 \notin V(H)$.

If $w_1 \notin V(H)$, then w_1 is adjacent to two vertices $y_1, y_2 \in \text{dom}(\varphi)$ and y_2 is also adjacent to w_2 and w_3 . In this case, w_4 cannot have two neighbors in $\text{dom}(\varphi)$, and since $|L_\varphi(w_4)| = 3$, it follows that w_4 belongs to $V(H)$. By Claim 16, either y_2 is adjacent to w_4 , or

w_4 , w_3 and y_2 have a neighbor with a list of size three. However, in both cases G would be L -colorable.

We conclude that $w_1 \in V(H)$, and symmetrically $w_4 \in V(H)$. Let F be the subgraph of G split off by $w_1w_2w_3w_4$. By Theorem 16, F is either one of the graphs depicted in Figure 5 or (taking into account that $|L_\varphi(w_2)| < |L(w_2)|$ and $|L_\varphi(w_3)| < |L(w_3)|$) consists of a vertex with a list of size three adjacent to w_1 , w_2 , w_3 and w_4 . In the latter case, G is L -colorable; hence, consider the former. Since both w_2 and w_3 are adjacent to a vertex in Y , F is not O_{P_4} , O_{P_5} or O_{P_6} . By the choice of Y , F is not O_{P_1} . And, if F is O_{P_2} or O_{P_3} , then x and two vertices in $\text{dom}(\varphi)$ have a common neighbor.

□

Let us consider a set $Y' \subseteq \{v_s, v_{s-1}, \dots\}$ and its partial coloring φ' chosen on the other side of P by rules symmetric to the ones used to select Y and φ . Clearly, the statement symmetric to Claim 24 holds:

Claim 24. *There exists a neighbor of x adjacent to two vertices of $\text{dom}(\varphi')$.*

Let w be the common neighbor of x and two vertices $y_1, y_2 \in Y$, where $|L(y_2)| = 4$. Let w' be the common neighbor of x and two vertices in $y'_1, y'_2 \in Y'$, where $|L(y'_2)| = 4$.

Claim 25. *We can choose y_1 and y'_1 so that $|L(y_1)| = |L(y'_1)| = 3$ and $y_1y_2, y'_1y'_2 \in E(G)$.*

Proof. This only needs to be discussed in the case (Y4b), where w could be a neighbor of v_1 and v_3 , but not v_2 , and by Claim 16, x would be contained inside the 4-cycle $v_1v_2v_3w$ together with a common neighbor z of v_1 , v_2 and v_3 . In that case, planarity implies that $w = w'$. The choice of Y implies that $Y' \neq Y$ (as we would then have $s = 3$ and we would be in case (Y3)). By Claim 16 (applied to the 2-chord y'_1wv_3 and noting that $|L(y'_2)| = 4$), we have $y'_2 = v_3$, v_4 is adjacent to w , and y'_1 is either v_4 or v_5 .

Let F be the subgraph of G drawn inside the 4-cycle $v_1v_2v_3w$. Let F' be the graph obtained from F by splitting w into two vertices w_1 and w_2 adjacent to x and by distributing the other neighbors of w between w_1 and w_2 in the planar way. Let $K = v_1v_2v_3w_1xw_2$ be the cycle bounding the outer face of F' , and note that F' is K -critical with respect to L . By Claim 22, x is not adjacent to v_1 or v_3 . We conclude that K is an induced cycle. No vertex

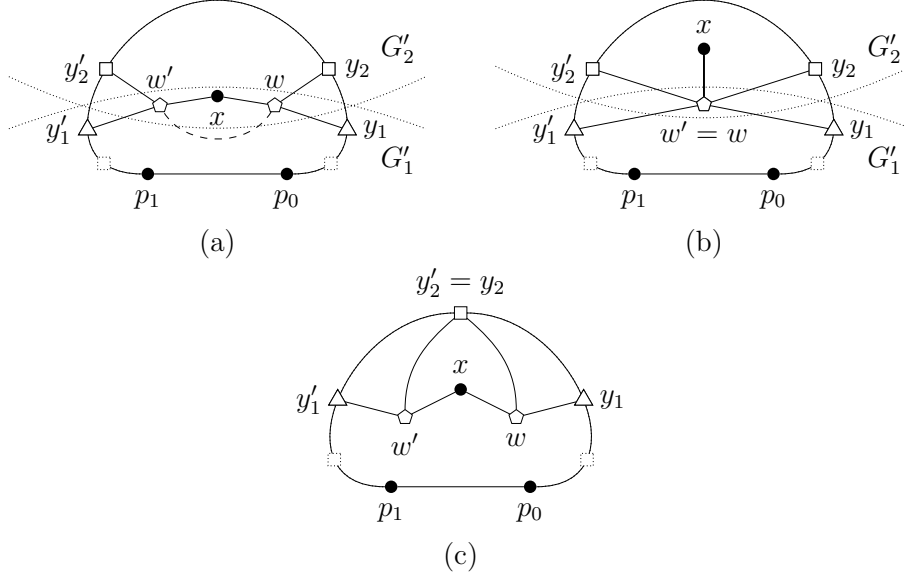

Figure 9: Configurations following Claim 25.

of F' other than x is adjacent to both w_1 and w_2 , hence Lemma 18 implies that $F - V(K)$ consists either of z adjacent to x and one of w_1 or w_2 , or of a triangle zz_1z_2 , where z_1 is adjacent to v_3 , w_1 and x , and z_2 is adjacent to v_1 , w_2 and x .

In the latter case, note that $\deg_G(v_3) = 5$ and observe that every L -coloring of $G - \{v_2, v_3, z, z_1, z_2\}$ extends to an L -coloring of G , contrary to the assumption that G is P -critical. Therefore, assume that z is the only vertex of $V(F) \setminus V(K)$. Choose a color $c \in S(z) \setminus L(v_2)$, let $G' = G - \{z, v_2\}$ and let L' be the list assignment obtained from L by removing c from the lists of v_1 , v_3 and w . Then G' is L' -colorable by Lemma 15 and this coloring extends to an L -coloring of G , which is a contradiction. \square

By the choice of Y and Y' , note that $y_1 \notin \{y_1', y_2'\}$ and $y_1' \notin \{y_1, y_2\}$. Furthermore, if $w = w'$, then Claim 16 implies that x is contained in the subgraph of G split off by y_1wy_1' . If $w \neq w'$, then let $Q = Q_0 = y_1wxw'y_1'$. If $w = w'$, then let Q be the star with center w and rays y_1 , y_1' and x and let $Q_0 = y_1wy_1'$. Let G_2 be the subgraph of G split off by Q_0 and let G_1 be the subgraph of G such that $G_1 \cup G_2 = G$ and $G_1 \cap G_2 = Q_0$ (we have $P \subset G_1$). Note that $y_2 \notin V(G_1)$. If w and w' are adjacent in G_2 , then let

$G'_1 = G_1 + ww'$ and $G'_2 = G_2 - \{y_1, y'_1\} - ww'$, otherwise let $G'_1 = G_1$ and $G'_2 = G_2 - \{y_1, y'_1\}$. See Figure 9(a) and (b). Let $Q' = Q - \{y_1, y'_1\}$. By the minimality of G , there exists an L -coloring θ of G'_1 .

Suppose that $y_2 \neq y'_2$. We let L_2 be the list assignment such that $L_2(q) = \{\theta(q)\}$ for $q \in V(Q)$, $L_2(y_2) = L(y_2) \setminus \{\theta(y_1)\}$, $L_2(y'_2) = L(y'_2) \setminus \{\theta(y'_1)\}$ and $L_2(v) = L(v)$ for all other vertices. Note that all vertices of $G'_2 - V(Q')$ have lists of size at least three. Furthermore, by Claim 22, all neighbors of x not in Q' have lists of size five. Now we apply Lemma 12 to G'_2 and L_2 . (If $w = w'$, we first split the edge wx so that we obtain a precolored path of length 2.) Lemma 12 implies that G'_2 contains an even fan procession for which L_2 is dangerous. In particular, since x has no neighbors in H , we conclude that G'_2 contains a fat fan of even order for which L_2 is a dangerous assignment. Since G does not have parallel edges, it follows that $w \neq w'$. Since no two vertices with lists of size three are adjacent in G and $ww' \notin E(G'_2)$, we conclude that the fat fan has order two and one of its vertices is y_2 (or y'_2). Let $z \neq y_2$ be the vertex of the fat fan with $|L_2(z)| = 3$. By the choice of Y and Y' , we have $z \neq y'_2$. However, the 2-chord $y'_1w'z$ then contradicts Claim 16.

We conclude that $y_2 = y'_2$. If $w = w'$, Claim 19 and Claim 22 imply that w is the only neighbor of x . However, Theorem 17 then implies that G is L -colorable. It follows that $w \neq w'$. By Lemma 18 applied to $\text{Int}_{w'xwy_2}(G)$ with list assignment L , we have $V(\text{Int}_{w'xwy_2}(G)) = \{w', x, w, y_2\}$, and since x is not adjacent to y_2 by Claim 22 and $ww' \notin E(G'_2)$ by the construction of G'_2 , we conclude that hence G'_2 is equal to the 4-cycle $w'xwy_2$ and $\deg_G(y_2) = 4$. See Figure 9(c).

If $S(y_1) \not\subset L(y_2)$, then we can color y_1 by a color in $S(y_1) \setminus L(y_2)$ and remove the color from the lists of neighbors of y_1 , obtaining a list assignment L' for the graph $G' = G - \{y_1, y_2\}$. Observe that G' is not L' -colorable, and by the minimality of G , one of the obstructions Z depicted in Figure 6 appears in G' . However, note that $|L'(w')| = 5$, since $y_1w' \notin E(G)$ by Claim 19 applied to y_1y_2w' . It follows that either a vertex with a list of size five or x is incident with the outer face of Z . However, this does not happen for any of the obstructions in Figure 6.

We conclude that $S(y_1) \subset L(y_2)$, and by symmetry $S(y'_1) \subset L(y_2)$. Suppose that there exists a color $c \in S(y_1) \cap S(y'_1)$. Let L' be the list assignment for $G' = G - \{y_1, y'_1, y_2\}$ obtained by removing c from the lists of neighbors of y_1 and y'_1 . Note that G' is not L' -colorable. By the minimality of G , one of the obstructions Z depicted in Figure 6 appears in G' . Since x is not incident with the outer face of Z , both w and w' belong to Z and

$|L'(w)| = |L'(w')| = 4$. Together with Claim 17 (note that all vertices z with $|L'(z)| = 3$ belong to $V(H)$), this implies that Z is O_{V_2} , $O_{V_3'a}$ or O_{V_4} . In all the cases, Claim 16 uniquely determines G , and the resulting graph is L -colorable. This is a contradiction.

It follows that $S(y_1)$ and $S(y'_1)$ are disjoint. Since $|L(y_2)| = 4$, we conclude that $|S(y_1)| = |S(y_2)| = 2$, and thus $y_1 = v_1$ and $y'_1 = v_s$, where $s = 3$. Suppose that there exists a color $c \in S(w') \cap S(y_1)$. Note that $c \notin S(y'_1)$. Let $G' = G - \{w', y_1, y_2\}$ with the list assignment L' obtained from L by removing c from the lists of neighbors of w' and y_1 , except for the vertex y'_1 where we set $L'(y'_1) = L(y'_1)$. Note that y'_1 is the only vertex with a list of size three and x is incident with the outer face of G' , hence by Lemma 15, G' is L' -colorable. However, this implies that G is L -colorable, which is a contradiction. We conclude that $S(w') \cap S(y_1) = \emptyset$, and symmetrically $S(w) \cap S(y'_1) = \emptyset$.

By symmetry, we can assume that w has at most one neighbor in P , and thus $|S(w)| \geq 3$. Since $S(y'_1)$ and $S(w)$ are disjoint, $S(y'_1) \cup S(y_1) = L(y_2)$, $|S(y'_1)| = 2$ and $|L(y_2)| = 4$, there exists a color $c \in S(w) \setminus L(y_2)$. Clearly, $c \notin S(y_1)$. Let $G' = G - \{w, y_2\}$ with the list assignment L' obtained from L by removing c from the lists of the neighbors of w other than y_1 and y'_1 . Again, Lemma 15 implies that G' is L' -colorable, giving an L -coloring of G . This contradiction completes the proof of Lemma 19. \square

We are now ready to prove the main result.

Proof of Theorem 2. By Lemma 19, Lemma 5 holds with $M = 2$. Let X be the set of vertices with lists of size 1. The distance condition imposed in the theorem says that X is M -scattered (for $M = 2$). Since every planar graph is 5-choosable, we can assume that $X \neq \emptyset$. We may also assume that a vertex $x \in X$ is incident with the outer face. Furthermore, we can assume that G is $\{x\}$ -critical. By Lemma 14, we conclude that all vertices of G except for x have lists of size at least 5. However, Theorem 4 with P consisting of the vertex x then implies that G is L -colorable. \square

References

- [1] ALBERTSON, M. O. You can't paint yourself into a corner. *J. Combin. Theory, Ser. B* 73, 2 (1998), 189–194.

- [2] APPEL, K., AND HAKEN, W. Every planar map is four colorable, Part I: discharging. *Illinois J. of Math.* 21 (1977), 429–490.
- [3] APPEL, K., HAKEN, W., AND KOCH, J. Every planar map is four colorable, Part II: reducibility. *Illinois J. of Math.* 21 (1977), 491–567.
- [4] AXENOVICH, M., HUTCHINSON, J. P., AND LASTRINA, M. A. List precoloring extension in planar graphs. *Discrete Math.* 311, 12 (2011), 1046–1056.
- [5] BALLANTINE, J. P. A postulational introduction to the four color problem. *Publ. in Math., Univ. of Washington, Seattle* (1930), 1–16.
- [6] BÖHME, T., MOHAR, B., AND STIEBITZ, M. Dirac’s map-color theorem for choosability. *J. Graph Theory* 32 (1999), 327–339.
- [7] DVOŘÁK, Z., LIDICKÝ, B., AND MOHAR, B. 5-choosability of graphs with crossings far apart. *ArXiv e-prints 1201.3014v2* (2015).
- [8] FISK, S. The nonexistence of colorings. *J. Combin. Theory, Ser. B* 24 (1978), 247–248.
- [9] KAWARABAYASHI, K., AND MOHAR, B. List-color-critical graphs on a fixed surface. In *Proceedings of the twentieth Annual ACM-SIAM Symposium on Discrete Algorithms* (Philadelphia, PA, USA, 2009), SODA ’09, Society for Industrial and Applied Mathematics, pp. 1156–1165.
- [10] POSTLE, L. *5-List-Coloring Graphs on Surfaces*. PhD thesis, Georgia Institute of Technology, 2012.
- [11] POSTLE, L., AND THOMAS, R. Hyperbolic families and coloring graphs on surfaces. Manuscript, 2013.
- [12] POSTLE, L., AND THOMAS, R. Five-list-coloring graphs on surfaces II. A linear bound for critical graphs in a disk. *Journal of Combinatorial Theory, Series B* (2015). In press.
- [13] THOMASSEN, C. Every planar graph is 5-choosable. *J. Combin. Theory, Ser. B* 62 (1994), 180–181.
- [14] THOMASSEN, C. Color-critical graphs on a fixed surface. *J. Combin. Theory, Ser. B* 70 (1997), 67–100.

- [15] THOMASSEN, C. Exponentially many 5-list-colorings of planar graphs. *J. Combin. Theory, Ser. B* 97 (2007), 571–583.
- [16] VIZING, V. G. Vertex colorings with given colors (in russian). *Metody Diskret. Analiz, Novosibirsk* 29 (1976), 3–10.
- [17] VOIGT, M. List colourings of planar graphs. *Discrete Math.* 120 (1993), 215–219.