

BOUNDARIES OF DISK-LIKE SELF-AFFINE TILES

KING-SHUN LEUNG AND JUN JASON LUO

ABSTRACT. Let $T := T(A, \mathcal{D})$ be a disk-like self-affine tile generated by an integral expanding matrix A and a consecutive collinear digit set \mathcal{D} , and let $f(x) = x^2 + px + q$ be the characteristic polynomial of A . In the paper, we identify the boundary ∂T with a sofic system by constructing a neighbor graph and derive equivalent conditions for the pair (A, \mathcal{D}) to be a number system. Moreover, by using the graph-directed construction and a device of pseudo-norm ω , we find the generalized Hausdorff dimension $\dim_H^\omega(\partial T) = 2 \log \rho(M) / \log |q|$ where $\rho(M)$ is the spectral radius of certain contact matrix M . Especially, when A is a similarity, we obtain the standard Hausdorff dimension $\dim_H(\partial T) = 2 \log \rho / \log |q|$ where ρ is the largest positive zero of the cubic polynomial $x^3 - (|p| - 1)x^2 - (|q| - |p|x - |q|)$, which is simpler than the known result.

1. Introduction

Let $M_n(\mathbb{Z})$ denote the set of $n \times n$ matrices with entries in \mathbb{Z} and let $A \in M_n(\mathbb{Z})$ be expanding (i.e., all eigenvalues of A have moduli > 1). Assume $|\det(A)| = |q|$, and $\mathcal{D} = \{0, d_1, \dots, d_{|q|-1}\} \subset \mathbb{Z}^n$ with $|q|$ distinct vectors. We call \mathcal{D} a *digit set* and (A, \mathcal{D}) a *self-affine pair*. It is well-known that there exists a unique self-affine set $T := T(A, \mathcal{D})$ [LW1] satisfying

$$T = A^{-1}(T + \mathcal{D}) = \left\{ \sum_{i=1}^{\infty} A^{-i} d_{j_i} : d_{j_i} \in \mathcal{D} \right\}.$$

If T has non-void interior, then there exists a subset $\mathcal{J} \subset \mathbb{Z}^n$ such that

$$T + \mathcal{J} = \mathbb{R}^n \quad \text{and} \quad (T + t)^\circ \cap (T + t')^\circ = \emptyset, \quad t \neq t', \quad t, t' \in \mathcal{J},$$

thus T is called a *self-affine tile* and \mathcal{J} a tiling set. $T + \mathcal{J}$ is called a tiling of \mathbb{R}^n , and a lattice tiling if \mathcal{J} is a lattice [LW3].

The topological properties of self-affine tiles and their boundaries, such as connectedness, local connectedness or disk-likeness (i.e., homeomorphic to the closed unit disk), have attracted a lot of interest. A systematical study on the connectedness of self-affine tiles was due to Kirat and Lau [KL], they mainly concerned a class of tiles $T(A, \mathcal{D})$ generated by the *consecutive collinear (CC)* digit sets $\mathcal{D} := \mathcal{D}(v, |q|) = \{0, 1, \dots, |q| - 1\}v, v \in \mathbb{Z}^n \setminus \{0\}$ via the algebraic property of the

Date: November 7, 2018.

Key words and phrases. boundary, self-affine tile, sofic system, number system, neighbor graph, contact matrix, graph-directed set, Hausdorff dimension.

The research is supported by STU Scientific Research Foundation for Talents (no. NTF12016).

characteristic polynomial of the matrix A . More general cases on non-consecutive collinear or non-linear digit sets were considered by [K], [DL], [LLu].

The question of disk-likeness was first investigated by Bandt and Gelbrich [BG] for self-affine tiles in \mathbb{R}^2 with $|\det(A)| = 2$ or 3 . They observed that the characteristic polynomial of $A \in M_2(\mathbb{Z})$ is of the form:

$$f(x) = x^2 + px + q, \text{ with } |p| \leq q, \text{ if } q \geq 2; \quad |p| \leq |q + 2|, \text{ if } q \leq -2.$$

By studying the neighborhood structure of T , Bandt and Wang [BW] proved that a tile T with no more than six neighbors is disk-like if and only if T is connected. A translation of the tile $T + \ell$, $\ell \in \mathcal{J}$ is called a *neighbor* of T if $T \cap (T + \ell) \neq \emptyset$. Making use of this criterion, Leung and Lau [LL] then gave a complete characterization of the disk-likeness of self-affine tiles with CC digit sets. Gmainer and Thuswaldner [GM] considered the disk-likeness of tiles with non-collinear digit sets arising from polyominoes, and Kirat [K] proposed necessary and sufficient conditions for such tiles to be disk-like in general. By using the neighbor map technique, Bandt and Mesing [BM] constructed a kind of finite type self-affine tiles and discussed their disk-likeness as well.

Theorem 1.1. ([LL]) *Let $A \in M_2(\mathbb{Z})$ be an expanding matrix with characteristic polynomial $f(x) = x^2 + px + q$. Then for any CC digit set $\mathcal{D}(v, |q|)$ in \mathbb{Z}^2 such that v, Av are linearly independent, T is a disk-like tile if and only if $2|p| \leq |q + 2|$.*

Moreover, when $p = 0$, T is a square tile; when $p \neq 0$, T is a hexagonal tile.

The boundary of a self-affine tile has more complicated geometric structure than the tile itself, hence it is also of considerable interest. The dimension of the boundary of a self-similar tile (where the expanding matrix A is a similarity) has been studied extensively in the literature. Strichartz and Wang [SW] described the boundary set as a graph-directed set and gave an algorithm for finding the dimension of the boundary, various other methods can be founded in [DKV], [V], [HLR], [LN].

Recently, Akiyama and Loridant ([AL], [AL2]) provided a new method to parameterize the boundary set and reproved Theorem 1.1 by showing that the boundary of T is a simple closed curve. In the present paper, we go further to explore the structure of the boundary of the T defined in Theorem 1.1. For convenience, we call such T a *CC tile*. If it is also disk-like, we call it a *disk-like CC tile*.

First we establish a neighbor graph of T such that the boundary ∂T is identified as the union of all one-sided infinite paths of this graph. Hence ∂T determines a sofic system [Fi]. The neighbor graph technique is classical in the study of tiling theory ([BG], [BM]). However, it will be shown that we use the technique here from a different aspect. As self-affine tiles can be studied in the context of number systems [MTT], it is worth studying the conditions for the self-affine pair (A, \mathcal{D}) to be a number system. We give the answer when $T(A, \mathcal{D})$ is disk-like.

Theorem 1.2. *Let $T = T(A, \mathcal{D})$ be a disk-like CC tile. Then the following are equivalent:*

- (i) (A, \mathcal{D}) is a number system.
- (ii) $0 \in T^\circ$.
- (iii) $f(x) = x^2 + px + q$ with $-1 \leq p$ and $q \geq 2$.
- (iv) For all neighbors $T + \ell$, $\ell = \sum_{i=0}^k a_i A^i v \in \mathcal{D}_{A, k+1}$ for some $k \in \mathbb{Z}$ with $a_k = 1$ and $a_i \in D$ where $0 \leq i < k$.

In [SW], Strichartz and Wang applied the graph-directed iterated function system (GIFS) to represent the boundary of a self-affine tile, but they were not sure whether the GIFS satisfies the open set condition or not. Our second aim is to give a positive answer for the disk-like CC tile and estimate the generalized Hausdorff dimension (\dim_H^ω) of the boundary by using a pseudo-norm ω ([HL],[LY]) instead of Euclidean norm.

Theorem 1.3. *The generalized Hausdorff dimension of the boundary of disk-like CC tile T is*

$$\dim_H^\omega(\partial T) = \frac{2 \log \rho(M)}{\log |q|}$$

where $\rho(M)$ denotes the spectral radius of certain contact matrix M , and the corresponding measure is positive and finite.

When A is a similarity, we can improve the well-known Hausdorff dimension formula of the boundary in the following simpler way.

Theorem 1.4. *Let $A \in M_2(\mathbb{Z})$ be an expanding similarity with characteristic polynomial $f(x) = x^2 + px + q$ and $T = T(A, \mathcal{D})$ be a disk-like CC tile. Then*

$$\dim_H(\partial T) = \frac{2 \log \rho}{\log |q|}$$

where ρ is the largest positive zero of the cubic polynomial $x^3 - (|p| - 1)x^2 - (|q| - |p|)x - |q|$.

The rest of the paper is organized as follows: In Section 2, we identify ∂T with a sofic system by constructing a neighbor graph and prove Theorem 1.2. In Section 3, we consider ∂T as a graph-directed set and prove Theorems 1.3 and 1.4. Finally all neighbor graphs, graph-directed sets and contact matrices corresponding to different characteristic polynomials $f(x)$ are listed in Appendices A, B and C for easy reference.

2. Sofic System and number system

We first introduce some terminology of symbolic dynamics from [LM]. Let $\mathcal{G} = \mathcal{G}(\mathcal{V}, \mathcal{E})$ be a directed graph where \mathcal{V} is the set of vertices and \mathcal{E} the set of edges. Let \mathcal{A} be a finite set (called *alphabet*). If there exists a mapping (called *labeling*) $\mathcal{L} : \mathcal{E} \rightarrow \mathcal{A}$, then the ordered pair $\mathbf{G} = (\mathcal{G}, \mathcal{L})$ is called a *labeled directed graph*. All

the infinite paths $\xi = e_1 e_2 e_3 \dots$ on \mathcal{G} constitute the so-called *edge shift* $\mathbf{X}_{\mathcal{G}}$. Define the *label of the path* ξ by

$$\mathcal{L}_{\infty}(\xi) := \mathcal{L}(e_1)\mathcal{L}(e_2)\mathcal{L}(e_3)\dots \in \mathcal{A}^{\mathbb{N}}.$$

Here $\mathcal{A}^{\mathbb{N}}$ is called the *full shift* of \mathcal{A} . The set of all such labels is denoted by

$$\mathbf{X}_{\mathcal{G}} = \{x \in \mathcal{A}^{\mathbb{N}} : x = \mathcal{L}_{\infty}(\xi) \text{ for some } \xi \in \mathbf{X}_{\mathcal{G}}\}.$$

Any subset of $\mathcal{A}^{\mathbb{N}}$ which can be defined by a labeled directed graph as above, is called a *sofic shift* or *sofic system* ([Fi], [LM]). Weiss [We] coined the term *sofic* which is derived from the Hebrew word for *finite* [LM].

Let $D = \{0, 1, \dots, |q| - 1\}$ and the difference set $\Delta D := D - D$, then the CC digit set $\mathcal{D} = Dv$ and $\Delta \mathcal{D} := \mathcal{D} - \mathcal{D} = \Delta Dv$. Without loss of generality, we assume the digit set \mathcal{D} is primitive, i.e., the lattice \mathcal{J} generated by \mathcal{D} and $A\mathcal{D}$ in \mathbb{Z}^2 is equal to \mathbb{Z}^2 . For otherwise, there exists an invertible $B \in M_2(\mathbb{Z})$ such that $\tilde{\mathcal{D}} = B^{-1}\mathcal{D} \subset \mathbb{Z}^2$ is primitive and $T(A, \mathcal{D}) = BT(\tilde{A}, \tilde{\mathcal{D}})$ where $\tilde{A} = B^{-1}AB \in M_2(\mathbb{Z})$ [LW2] and we can consider $\tilde{A}, \tilde{\mathcal{D}}$ instead. Hence we set $\mathbb{Z}^2 = \{\gamma v + \delta Av : \gamma, \delta \in \mathbb{Z}\}$. It is easy to see that $T + \ell$ where $\ell \in \mathbb{Z}^2$ is a neighbor of T if and only if $\ell \in T - T$. More precisely, ℓ can be expressed as

$$\ell = \sum_{i=1}^{\infty} b_i A^{-i}v \in T - T, \quad b_i \in \Delta D.$$

The following is a neighbor-generating formula which plays a key role in constructing the labeled directed graph for the boundary.

Lemma 2.1. ([LL]) *Suppose $T + \ell$ is a neighbor of T with $\ell = \gamma v + \delta Av = \sum_{i=1}^{\infty} b_i A^{-i}v$, then we get another neighbor $T + \ell'$ satisfying $\ell' = A\ell - b_1 v = \gamma' v + \delta' Av$ with $\gamma' = -(q\delta + b_1)$ and $\delta' = \gamma - p\delta$.*

Inductively, we can construct a sequence of neighbors: $\{T + \ell_n\}_{n=0}^{\infty}$ where $\ell_0 = \ell$ and $\ell_{n+1} = A\ell_n - b_{n+1}v$.

Let T be a disk-like CC tile and $T_{\ell} = T \cap (T + \ell)$ for any $\ell \in \mathbb{Z}^2$. Let $\mathcal{V} = \{\ell \in \mathbb{Z}^2 : \ell \neq 0 \text{ and } T \cap T_{\ell} \neq \emptyset\}$. Then the boundary of T can be written as

$$(2.1) \quad \partial T = \bigcup_{\ell \in \mathcal{V}} T_{\ell}.$$

Define an edge set $\mathcal{E} := \{e = (\ell, \ell') : \ell, \ell' \in \mathcal{V} \text{ and } \ell' = A\ell - b_1 v \text{ for some } b_1 \in \Delta D\}$ and a labeling $\mathcal{L} : \mathcal{E} \rightarrow \mathcal{A}$ by $\mathcal{L}(e) = b_1$ where $\mathcal{A} = \Delta D$. Then by the definition above, $\mathbf{G} = (\mathcal{G}, \mathcal{L})$ is a labeled directed graph and it determines a sofic shift. We call \mathbf{G} the *neighbor graph* of T .

Proposition 2.2. *Let \mathbf{G} be the neighbor graph of a CC disk-like tile T . If $x = \sum_{i=1}^{\infty} a_i A^{-i}v = \ell + \sum_{i=1}^{\infty} a'_i A^{-i}v \in T_{\ell}$ where $a_i, a'_i \in D$, then $\{b_i := a_i - a'_i\}_{i=1}^{\infty}$ is the sequence of labeling of the edges of an infinite path starting at ℓ (or simply called a*

label sequence starting at ℓ). Conversely, any label sequence $\{b_i\}_{i=1}^\infty$ (with $b_i \in \Delta D$) starting at ℓ defines a set

$$\left\{x : x = \sum_{i=1}^{\infty} a_i A^{-i} v = \ell + \sum_{i=1}^{\infty} a'_i A^{-i} v, \ a_i - a'_i = b_i, \ a_i, a'_i \in D \text{ for } i = 1, 2, \dots\right\}$$

of boundary points of T .

Proof. Since $\ell = \sum_{i=1}^{\infty} b_i A^{-i} v$ with $b_i = a_i - a'_i$, by Lemma 2.1, we have a sequence of neighbors $\{T + \ell_n\}_{n=0}^\infty$ where $\ell_0 = \ell$ and $\ell_{n+1} = A\ell_n - b_{n+1}v$, hence $\{b_i\}_{i=1}^\infty$ is a label sequence starting at ℓ by the definition.

Conversely, if $\ell = \sum_{i=1}^{\infty} b_i A^{-i} v$ where $b_i \in \Delta D$, then $b_i = a_i - a'_i$ for $a_i, a'_i \in D$ and $\ell = \sum_{i=1}^{\infty} (a_i - a'_i) A^{-i} v$. It follows that

$$(2.2) \quad x = \sum_{i=1}^{\infty} a_i A^{-i} v = \ell + \sum_{i=1}^{\infty} a'_i A^{-i} v \in T \cap (T + \ell) = T_\ell.$$

□

We can verify whether the origin 0 is a boundary point of T in the following way.

Corollary 2.3. $0 \in \partial T$ if and only if there exists an infinite path in \mathbf{G} with all edge labels either non-positive or non-negative.

Proof. Suppose $0 \in T \cap (T + \ell)$ for some neighbor $T + \ell$. Putting $a_i = 0$ for all i into (2.2), we have

$$\ell = \sum_{i=1}^{\infty} (-a'_i) A^{-i} v.$$

Since $a'_i \in D$, the label sequence $\{b_i = -a'_i\}_{i=1}^\infty$ starting at ℓ has all labels non-positive. Similarly $\{b'_i = a_i\}_{i=1}^\infty$ is a sequence starting at $-\ell$ with all labels non-negative. By reversing the argument, we can prove the converse. □

In fact, we can determine the neighbor graph \mathbf{G} for any disk-like CC tile T . Let us take the case of $f(x) = x^2 + px + q$, $p, q \geq 2$ (excluding $p = q = 2$) as an example. By Theorem 1.1, T is a hexagonal tile with six neighbors [LL] and

$$(2.3) \quad \mathcal{V} = \{\pm v, \pm(Av + (p-1)v), \pm(Av + pv)\}.$$

In view of the definition of \mathcal{E} , if $\ell = v$ we take $b_1 = -p$ and $\ell' = Av + pv$ or $b_1 = -(p-1)$ and $\ell' = Av + (p-1)v$; if $\ell = Av + pv$, using $f(A)v = 0$, we have $b_1 = -(q-1)$ and $\ell' = -v$. Proceeding similarly with all ℓ , we obtain Table 1. Then we establish the neighbor graph (Figure 1). The neighbor graphs corresponding to other $f(x)$ are given in Appendix A.

Following [LW1], we let $\mathcal{D}_{A,k} = \{\sum_{i=0}^{k-1} a_i A^i v : a_i \in D\}$, $\Delta \mathcal{D}_{A,k} = \mathcal{D}_{A,k} - \mathcal{D}_{A,k} = \{\sum_{i=0}^{k-1} b_i A^i v : b_i \in \Delta D\}$ and $\mathcal{D}_{A,\infty} = \cup_{k=1}^\infty \mathcal{D}_{A,k}$.

Proposition 2.4. *Let T be a disk-like CC tile and $T + \ell$ a neighbor. Then $\ell = \sum_{i=0}^k b_i A^i v \in \Delta \mathcal{D}_{A,k+1}$ for some $k \in \mathbb{Z}$ with $b_k \in \{-1, 1\}$, $b_i \in \Delta D$ for $0 \leq i < k$. When $f(x) = x^2 \pm 2x + 2$, $k = 3$; and $k = 1$ otherwise.*

| ℓ | b_1 | ℓ' |
|----------------|------------------------|------------------------------|
| v | $-(p-1)$ $-p$ | $Av + (p-1)v$ $Av + pv$ |
| $Av + (p-1)v$ | $-(q-p)$ $-(q-p+1)$ | $-Av - pv$ $-Av - (p-1)v$ |
| $Av + pv$ | $-(q-1)$ | $-v$ |
| $-v$ | $p-1$ p | $-Av - (p+1)v$ $-Av - pv$ |
| $-Av - (p-1)v$ | $q-p$ $q-p+1$ | $Av + pv$ $Av + (p-1)v$ |
| $-Av - pv$ | $q-1$ | v |

TABLE 1. Relation among all neighbors of T associated with $f(x) = x^2 + px + q$, $p, q \geq 2$, $2p \leq q + 2$ (excluding $p = q = 2$).

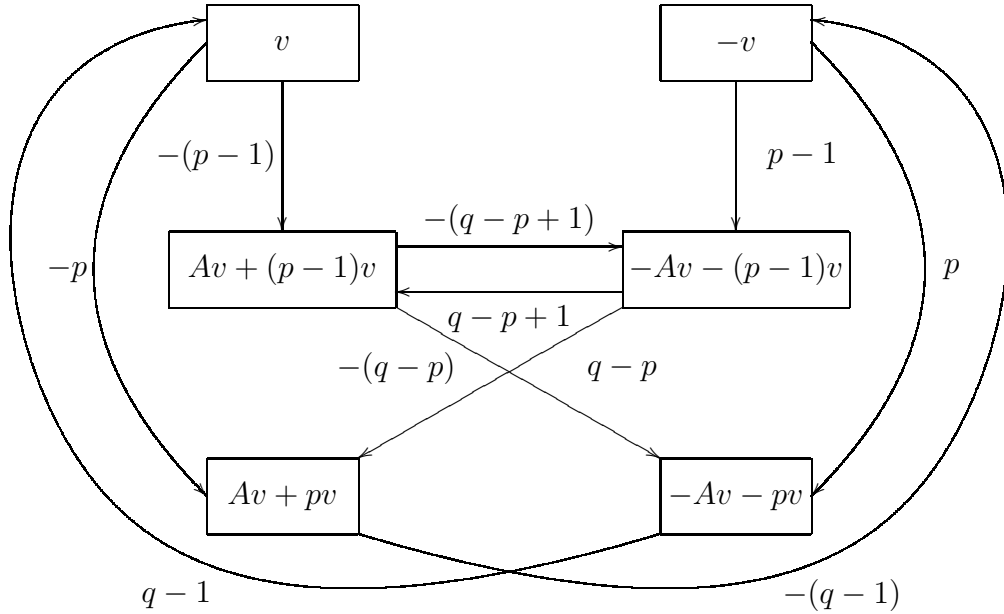

FIGURE 1. The neighbor graph of T associated with $f(x) = x^2 + px + q$, $p, q \geq 2$, $2p \leq q + 2$, (excluding $q = p = 2$).

Proof. It follows from (2.3) that $\ell \in \Delta\mathcal{D}_{A,2}$ excluding the case of $f(x) = x^2 \pm 2x + 2$. For $f(x) = x^2 \pm 2x + 2$, we have $Av \pm 2v = A^3v \pm A^2v + Av \in \Delta\mathcal{D}_{A,4}$ by using $(A \mp I)f(A) = 0$. \square

A more desirable property is that any $\ell \in \mathbb{Z}^2$ can be expressed as $\ell = \sum_{i=0}^k a_i A^i v \in \mathcal{D}_{A,k+1}$ (instead of $\Delta\mathcal{D}_{A,k+1}$) for some $k \in \mathbb{Z}$ with $a_k = 1$ and $a_i \in D$ where $0 \leq i < k$. But this is not always the case. This property is closely related to a *number system* defined below (see also [MTT]).

Definition 2.5. Let $A \in M_2(\mathbb{Z})$ be expanding and \mathcal{D} be a CC digit set. The self-affine pair (A, \mathcal{D}) is said to be a number system if for any $\ell \in \mathbb{Z}^2$, it has a unique representation $\ell = \sum_{i=0}^k A^i v'_i$ with $v'_i \in \mathcal{D}$.

For convenience, we sometimes write a point of the form $x = \sum_{i=1}^{\infty} a_i A^{-i} v \in \mathbb{R}^2$ as *radix expansion*: $0.a_1 a_2 a_3 \dots$. An overbar denotes repeating digits as in $0.12\overline{301} = 0.12301301301\dots$. Likewise, $a_{-2} a_{-1} a_0 . a_1 a_2 a_3 \dots$ represents a point $a_{-2} A^2 v + a_{-1} A v + a_0 v + \sum_{i=1}^{\infty} a_i A^{-i} v$. Note that shifting a radix place to the left means multiplying A to x . When x is on the boundary of T , the radix expansion of x is not unique. Now we give some equivalent conditions for the self-affine pair (A, \mathcal{D}) to be a number system.

Theorem 2.6. Let $T = T(A, \mathcal{D})$ be a disk-like CC tile. Then the following are equivalent:

- (i) (A, \mathcal{D}) is a number system.
- (ii) $0 \in T^\circ$.
- (iii) $f(x) = x^2 + px + q$ with $-1 \leq p$ and $q \geq 2$.
- (iv) For all neighbors $T + \ell$, $\ell = \sum_{i=0}^k a_i A^i v \in \mathcal{D}_{A, k+1}$ for some $k \in \mathbb{Z}$ with $a_k = 1$ and $a_i \in \mathcal{D}$ where $0 \leq i < k$.

Proof. (i) \Rightarrow (ii) Suppose $0 \notin T^\circ$. Then $0 \in T \cap (T + \ell)$ for some $\ell \in \mathbb{Z}^2 \setminus \{0\}$. Since (A, \mathcal{D}) is a number system, $\ell = \sum_{i=-k}^0 a_i A^{-i} v$ with $a_i \in \mathcal{D}$ and $a_{-k} > 0$. Hence $0 = a_{-k} a_{-(k-1)} \dots a_{-1} a_0 . a_1 a_2 a_3 \dots$. Shifting the radix point k places to the left, we get $0 = a_{-k} . a_{-(k-1)} \dots a_{-1} a_0 a_1 a_2 a_3 \dots$. That means $T + a_{-k} v$ is a neighbor of T . By Proposition 2.4, $a_{-k} = 1$. Hence 0 corresponds to an infinite path starting at v with non-positive labels $b_i = -a_i$. But by checking all the neighbor graphs in Appendix A, we find no such path.

(ii) \Rightarrow (i) It suffices to show that $\mathbb{Z}^2 \subset \mathcal{D}_{A, \infty}$. By the lattice tiling property, 0 is the only lattice point in T , i.e., $\mathbb{Z}^2 \cap T = \{0\}$. It follows that $\mathbb{Z}^2 \cap A^n T = \sum_{i=0}^{n-1} A^i \mathcal{D} = \mathcal{D}_{A, n}$ for $n \geq 1$. If $\ell \in \mathbb{Z}^2$, there exists a large integer n such that $\ell \in A^n T$ as $0 \in T^\circ$, then $\ell \in \mathcal{D}_{A, n} \subset \mathcal{D}_{A, \infty}$.

(ii) \Leftrightarrow (iii) By inspecting all neighbor graphs in Appendix A, we find that in each graph corresponding to $f(x) = x^2 + px + q$ with $-1 \leq p$ and $q \geq 2$, there exists no infinite path with edge labels either all non-positive or all non-negative, hence $0 \in T^\circ$ by Corollary 2.3. In every other case, there always exists such a path. All these paths are listed in Table 2.

(iii) \Rightarrow (iv) Let $f(x)$ be one of the cases: $x^2 + q$, $x^2 + x + q$, $x^2 + px + q$ ($p \geq 2$, excluding $p = q = 2$), $x^2 + 2x + 2$, $x^2 - x + q$, where $p \geq 0$ and $q \geq 2$. In each case, we can rewrite their neighbors as the desired form in (iv). By using $0 = f(A)v$, $0 = (A - I)f(A)v$, $0 = (A + I)f(A)v$, we have

Case (1) $f(x) = x^2 + q$. $Av - v = A^2 v + Av + (q - 1)v$, $-v = A^2 v + (q - 1)v$, $-Av = A^3 v + (q - 1)Av$, $-Av + v = A^3 v + (q - 1)Av + v$, $-Av - v = A^3 v + A^2 v + (q - 1)Av + (q - 1)v$.

| $f(x)$ | Neighbor | Path |
|----------------|----------------|---------------------------|
| $x^2 - 2x + 2$ | $Av - v$ | $\overline{(-1)}$ |
| | $-Av + v$ | $\bar{1}$ |
| $x^2 - px - q$ | v | $\overline{p(q-1)}$ |
| | $-v$ | $\overline{(-p)[-(q-1)]}$ |
| $x^2 + px - q$ | $Av + (p+1)v$ | $\overline{(q-p-1)}$ |
| | $-Av - (p+1)v$ | $\overline{[-(q-p-1)]}$ |
| $x^2 - q$ | v | $\overline{0(q-1)}$ |
| | $-v$ | $\overline{0[-(q-1)]}$ |
| | $Av + v$ | $\overline{(q-1)}$ |
| | $-Av - v$ | $\overline{[-(q-1)]}$ |
| $x^2 - px + q$ | $Av - (p-1)v$ | $\overline{[-(q-p+1)]}$ |
| | $-Av + (p-1)v$ | $\overline{(q-p+1)}$ |

TABLE 2. Infinite paths representing a boundary point 0.

Case (2) $f(x) = x^2 + x + q$. $-v = A^2v + Av + (q-1)v$, $-Av = A^3v + A^2v + (q-1)Av$, $-Av - v = A^2v + (q-1)v$.

Case (3) $f(x) = x^2 + px + q$ ($p \geq 2$). $-v = A^2v + pAv + (q-1)v$, $-Av - (p-1)v = A^2v + (p-1)Av + (q-p+1)v$, $-Av - pv = A^2v + (p-1)Av + (q-p)v$.

Case (4) $f(x) = x^2 + 2x + 2$. $Av + 2v = A^3v + A^2v + Av$, $-v = A^4v + A^3v + A^2v + v$, $-Av - v = A^2v + Av + v$, $-Av - 2v = A^2v + Av$.

Case (5) $f(x) = x^2 - x + q$. $Av - v = A^2v + (q-1)v$, $-v = A^3v + (q-1)Av + (q-1)v$, $-Av = A^4v + (q-1)A^2v + (q-1)Av$, $-Av + v = A^4v + (q-1)A^2v + (q-1)Av + v$.

(iv) \Rightarrow (ii) Suppose $0 \notin T^\circ$. By the same argument as in the proof of (i) \Rightarrow (ii) above, there should be an infinite path in the neighbor graph starting at v with edge labels all non-positive. But we find no such path by inspecting all the neighbor graphs in Appendix A. \square

Remark 2.7. Gilbert [Gi] obtained some related results in the context of quadratic number fields. We conjecture that Theorem 2.6 can be extended to non-disk-like tiles.

3. Dimension of the boundary of T

For a directed graph $\mathcal{G} = \mathcal{G}(\mathcal{V}, \mathcal{E})$ where $\mathcal{V} = \{v_1, v_2, \dots, v_m\}$, we write $\mathcal{E}_{i,j}$ for the set of edges from vertex v_i to vertex v_j , and we add a contraction mapping $F_e : \mathbb{R}^2 \rightarrow \mathbb{R}^2$ for each edge $e \in \mathcal{E}$. Then the family of contractions $\{F_e : e \in \mathcal{E}\}$

is called a *graph-directed iterated function system (GIFS)* and there exists a unique family of non-empty compact subsets E_1, \dots, E_m of \mathbb{R}^2 ([Fa2], [MW]) such that

$$(3.1) \quad E_i = \bigcup_{j=1}^m \bigcup_{e \in \mathcal{E}_{i,j}} F_e(E_j).$$

We call $E := \bigcup_{i=1}^m E_i$ a *graph-directed set*. Define $M = (M_{ij})_{1 \leq i, j \leq m}$ as the *contact matrix* [GH] of \mathcal{G} with $M_{ij} = \#\mathcal{E}_{i,j}$ counting the number of edges from v_i to v_j .

The GIFS $\{F_e : e \in \mathcal{E}\}$ is said to satisfy the *open set condition (OSC)* if there exist a family of open sets $\{O_1, \dots, O_m\}$ such that

$$(3.2) \quad O_i \supset \bigcup_{j=1}^m \bigcup_{e \in \mathcal{E}_{i,j}} F_e(O_j) \quad \text{for } i = 1, 2, \dots, m$$

with disjoint unions, i.e., $F_e(O_j) \cap F_{e'}(O_{j'}) = \emptyset$ whenever $(e, j) \neq (e', j')$. With this OSC, we then can compute the dimension of the graph-directed set.

In this section, we first identify the boundary of T with a graph-directed set by making use of the well-known method ([SW], [HLR]), then calculate its dimension in the self-affine case and the self-similar case, respectively.

Proposition 3.1. *Let $\ell = \gamma v + \delta A v$, $\ell' = \gamma' v + \delta' A v \in \mathcal{V}$ such that $\ell' = A\ell - b_1 v$ for some $b_1 \in \Delta D$, then*

$$A^{-1}(T_{\ell'} + jv) \subset T_\ell \quad \text{for all } j \in I_{b_1} := \begin{cases} \{b_1, b_1 + 1, \dots, q - 1\} & \text{if } b_1 \geq 0; \\ \{0, 1, \dots, q - 1 + b_1\} & \text{if } b_1 < 0. \end{cases}$$

Moreover,

$$T_\ell = \bigcup_{\ell' \in B_\ell} \bigcup_{j \in I_{b_1}} A^{-1}(T_{\ell'} + jv)$$

where $B_\ell := \{\ell'' \in \mathcal{V} : \ell'' = A\ell - b'_1 v \text{ for some } b'_1 \in \Delta D\}$. Hence the boundary $\partial T = \bigcup_{\ell \in \mathcal{V}} T_\ell$ is a graph-directed set.

Proof. When $b_1 \geq 0$, if $x \in T_{\ell'}$ then the radix expansion is

$$x = 0.c_1 c_2 c_3 \dots = \delta' \gamma'. c'_1 c'_2 c'_3 \dots$$

It follows from Lemma 2.1 and $0 = A^{-1}f(A)v$ that

$$A^{-1}x + (b_1 + k)A^{-1}v = 0.(b_1 + k)c_1 c_2 c_3 \dots = \delta \gamma. k c'_1 c'_2 c'_3 \dots \in T_\ell$$

for $k = 0, 1, \dots, q - 1 - b_1$. The case when $b_1 < 0$ can be proved similarly.

For the second part, we only need to show

$$T_\ell \subset \bigcup_{\ell' \in B_\ell} \bigcup_{j \in I_{b_1}} A^{-1}(T_{\ell'} + jv).$$

Let $y = 0.a_1 a_2 a_3 \dots = \delta \gamma. a'_1 a'_2 a'_3 \dots \in T_\ell$. It follows that $Ay - a_1 v = 0.a_2 a_3 a_4 \dots = \delta \gamma (a'_1 - a_1). a'_2 a'_3 \dots \in T_{\ell'}$, where $\ell' = A\ell - (a_1 - a'_1)v$. This implies $y \in A^{-1}(T_{\ell'} + a_1 v)$. By definition, we see that $a_1 \in I_{b_1}$ for $b_1 = a_1 - a'_1$. \square

It should be mentioned that the graph for the GIFS comes from the neighbor graph by adding more edges, or equivalently the neighbor graph is a reduced graph for the GIFS. The following example about Figure 1 can illustrate their relationship. All the other cases are given in Appendix B.

Example 3.2. Consider the case $f(x) = x^2 + px + q$ ($p, q \geq 2$, excluding $p = q = 2$). When $\ell = v$, from Table 1 we have $B_\ell = B_v = \{Av + pv, Av + (p-1)v\}$. When $\ell' = Av + pv$, $b_1 = -p$ and $I_{-p} = \{0, 1, 2, \dots, q-1-p\}$; when $\ell' = Av + (p-1)v$, $b_1 = -(p-1)$ and $I_{-(p-1)} = \{0, 1, 2, \dots, q-p\}$. Thus by Proposition 3.1, the first set equation comes out. Similarly the other five can be deduced. For simplicity we let $u_1 = v$, $u_2 = Av + (p-1)v$, $u_3 = Av + pv$. Then the sets $T_{\pm u_1}$, $T_{\pm u_2}$, $T_{\pm u_3}$, representing ∂T satisfy

$$\begin{aligned}
AT_{u_1} &= \bigcup_{j=0}^{q-p} (T_{u_2} + jv) \cup \bigcup_{j=0}^{q-p-1} (T_{u_3} + jv) \\
AT_{u_2} &= \bigcup_{j=0}^{p-2} (T_{-u_2} + jv) \cup \bigcup_{j=0}^{p-1} (T_{-u_3} + jv) \\
AT_{u_3} &= T_{-u_1} \\
AT_{-u_1} &= \bigcup_{j=p-1}^{q-1} (T_{-u_2} + jv) \cup \bigcup_{j=p}^{q-1} (T_{-u_3} + jv) \\
AT_{-u_2} &= \bigcup_{j=q-p+1}^{q-1} (T_{u_2} + jv) \cup \bigcup_{j=q-p}^{q-1} (T_{u_3} + jv) \\
AT_{-u_3} &= T_{u_1} + (q-1)v
\end{aligned}$$

The Hausdorff dimension (\dim_H) (see e.g., [Fa], [Fa2]) is the most common and important dimension in fractal geometry. The case of self-similar sets has been studied extensively with or without separation conditions. However the case of self-affine sets is still hard to handle. Recently, He and Lau [HL] defined the generalized Hausdorff dimension (\dim_H^ω) and Hausdorff measure (\mathcal{H}_ω^s) for self-affine fractals by replacing the Euclidean norm with a pseudo-norm ω for which the expanding matrix A becomes a similarity:

$$\omega(Ax) = |\det A|^{1/2} \omega(x).$$

Under this setting, most of the basic properties for the self-similar sets can be carried to the self-affine sets. Moreover, Luo and Yang [LY] extended this technique to the self-affine GIFS and obtained a dimension formula of the graph-directed set we need.

Proposition 3.3. ([LY]) For the GIFS as in (3.1) with the affine mappings $F_e(x) = A^{-1}(x + d_e)$ where A is an expanding matrix and $|\det A| = |q|$, let $\rho(M)$ be the spectral radius of the contact matrix M . If the OSC holds, then $s = \dim_H^\omega E = 2 \log \rho(M) / \log |q|$ and $0 < \mathcal{H}_\omega^s(E) < \infty$.

By using this, we can establish our first dimensional result about the boundary of T as follows.

Theorem 3.4. *The generalized Hausdorff dimension of the boundary of disk-like CC tile T is*

$$\dim_H^\omega(\partial T) = 2 \log \rho(M) / \log |q|$$

and the corresponding measure is positive and finite.

Proof. From Propositions 3.1 and 3.3, it suffices to show the GIFS representing the boundary of T satisfies the OSC. Replacing T_ℓ by $(T + \ell)^\circ$, we can check the OSC holds case by case. We illustrate the idea by proving the case $f(x) = x^2 + px + q$ ($p \geq 2, q \geq 2$, excluding $p = q = 2$). In view of Example 3.2, we need to show

$$\begin{aligned} A(T + u_1)^\circ &\supset \bigcup_{j=0}^{q-p} ((T + u_2)^\circ + jv) \cup \bigcup_{j=0}^{q-p-1} ((T + u_3)^\circ + jv) \\ A(T + u_2)^\circ &\supset \bigcup_{j=0}^{p-2} ((T - u_2)^\circ + jv) \cup \bigcup_{j=0}^{p-1} ((T - u_3)^\circ + jv) \\ A(T + u_3)^\circ &\supset (T - u_1)^\circ \\ A(T - u_1)^\circ &\supset \bigcup_{j=p-1}^{q-1} ((T - u_2)^\circ + jv) \cup \bigcup_{j=p}^{q-1} ((T - u_3)^\circ + jv) \\ A(T - u_2)^\circ &\supset \bigcup_{j=q-p+1}^{q-1} ((T + u_2)^\circ + jv) \cup \bigcup_{j=q-p}^{q-1} ((T + u_3)^\circ + jv) \\ A(T - u_3)^\circ &\supset (T + u_1)^\circ + (q-1)v \end{aligned}$$

with disjoint unions. Since T is a CC tile, it follows that

$$(3.3) \quad AT^\circ \supset \bigcup_{j=0}^{q-1} (T + jv)^\circ = \bigcup_{j=0}^{q-1} (T^\circ + jv)$$

with disjoint union. By using (3.3) and $0 = f(A)v = A^2v + pAv + qv$ extensively, we prove the first two set inequalities in the following. The remaining four can be verified similarly.

For $j = 0, 1, \dots, q-p$,

$$(T + u_2)^\circ + jv = T^\circ + (p-1+j)v + Av \subset A(T + u_1)^\circ.$$

For $j = 0, 1, \dots, q-p-1$,

$$(T + u_3)^\circ + jv = T^\circ + (p+j)v + Av \subset A(T + u_1)^\circ.$$

For $j = 0, 1, \dots, p-2$,

$$\begin{aligned} (T - u_2)^\circ + jv &= T^\circ + (j-p+1)v - Av \\ &= T^\circ + (q+j-p+1)v + A^2v + (p-1)Av \\ &\subset A(T + u_2)^\circ. \end{aligned}$$

For $j = 0, 1, \dots, p-1$,

$$\begin{aligned} (T - u_3)^\circ + jv &= T^\circ + (j - p)v - Av \\ &= T^\circ + (q + j - p)v + A^2v + (p - 1)Av \\ &\subset A(T + u_2)^\circ. \end{aligned}$$

By the same way, all the other cases follow and hence the theorem is proved. \square

In the rest of this section, we will find the exact value of Hausdorff dimension $\dim_H(\partial T)$ for certain particular cases that A is a similarity. We state the simplest one first.

Proposition 3.5. *Let $A \in M_2(\mathbb{Z})$ be expanding with characteristic polynomial $f(x) = x^2 + q$ ($|q| \geq 2$) and $T(A, \mathcal{D})$ a disk-like CC tile. Then $\dim_H(\partial T) = 1$.*

Proof. By Theorem 1.1, T is a square tile (parallelogram). Hence $\dim_H(\partial T) = 1$. \square

Geometrically, a similarity is a multiple of either a reflection or a rotation. We call the former a *scaled reflection* and the latter a *scaled rotation*; algebraically, a similarity is a multiple of an orthogonal matrix. The case that A is a scaled reflection is solved already as its characteristic polynomial is of the form $f(x) = x^2 - q$ ($q > 0$). So we focus our attention on those A that are scaled rotations.

Lemma 3.6. *Let A be a scaled rotation. Then its characteristic polynomial has positive constant term and A has either two distinct non-real eigenvalues or two equal real eigenvalues.*

Proof. Let $A = \begin{pmatrix} r\cos\theta & -r\sin\theta \\ r\sin\theta & r\cos\theta \end{pmatrix}$. The characteristic polynomial is given by $x^2 - 2r\cos\theta x + r^2$. It has two equal real zeros when $\theta = 0$ or π and two distinct non-real zeros otherwise. \square

The following dimension formula on the boundaries of self-similar tiles has been investigated in the literature by various methods (see [DKV], [SW], [V], [HLR], [LN]). We shall apply this formula to obtain our second dimensional result which is simpler than the known one.

Proposition 3.7. *If A is a similarity with $|\det(A)| = |q| \geq 2$, then the Hausdorff dimension of ∂T is given by*

$$(3.4) \quad \dim_H(\partial T) = \log \rho(M) / \log r = 2 \log \rho(M) / \log |q|,$$

where $\rho(M)$ denotes the spectral radius of the contact matrix M and $r = |q|^{1/2}$ is the expansion ratio of A .

Let ℓ, ℓ', b_1 and B_ℓ be defined as in Proposition 3.1. We first find the contact matrix M . Since \mathcal{D} is a CC digit set, we have the entry $M_{\ell\ell'} = \#I_{b_1} = q - |b_1|$ where I_{b_1} is as in Proposition 3.1. Recall that b_1 is the label of the edge from ℓ to ℓ' . Hence we obtain the contact matrix M of T from its neighbor graph with different edge labels (i.e., replace b_1 by $q - |b_1|$).

| | v | $Av + (p-1)v$ | $Av + pv$ | $-v$ | $-Av - (p-1)v$ | $-Av - pv$ |
|----------------|-----|---------------|-----------|------|----------------|------------|
| v | 0 | $q - p + 1$ | $q - p$ | 0 | 0 | 0 |
| $Av + (p-1)v$ | 0 | 0 | 0 | 0 | $p - 1$ | p |
| $Av + pv$ | 0 | 0 | 0 | 1 | 0 | 0 |
| $-v$ | 0 | 0 | 0 | 0 | $q - p + 1$ | $q - p$ |
| $-Av - (p-1)v$ | 0 | $p - 1$ | p | 0 | 0 | 0 |
| $-Av - pv$ | 1 | 0 | 0 | 0 | 0 | 0 |

TABLE 3. The contact matrix of T associated with $f(x) = x^2 + px + q$, $p, q \geq 2, 2p \leq q + 2$ (excluding $p = q = 2$).

Moreover, it is easy to see that there is a one-to-one correspondence between the contact matrix and the neighbor graph. For example, the contact matrix for the case $f(x) = x^2 + px + q$ ($p, q \geq 2, 2p \leq q + 2$ excluding $p = q = 2$) can be found in Table 3, and the related neighbor graph is shown by Figure 1. The contact matrices for the other cases are given in Appendix C.

If M is irreducible (i.e., for each entry M_{ij} , there exists an integer $n \geq 0$ such that $(M^n)_{ij} > 0$), then the spectral radius $\rho(M) = \lambda_M$ where λ_M is the *Perron-Frobenius eigenvalue* of M as stated in the following simplified version of the Perron-Frobenius Theorem.

Theorem 3.8. ([Ga], [Se]) *Let M be an irreducible non-negative matrix. Then there exists a positive eigenvalue λ_M such that $\lambda_M \geq |\mu|$ for all eigenvalues μ of M . Moreover, λ_M is a simple zero of the characteristic polynomial of M .*

It is known that a contact matrix is irreducible if and only if the neighbor graph it represents is strongly connected. A directed graph is called *strongly connected* if for any two vertices v_i, v_j there exists a path starting at v_i and ending at v_j .

Theorem 3.9. *Let $A \in M_2(\mathbb{Z})$ be an expanding similarity with characteristic polynomial $f(x) = x^2 + px + q$ and $T(A, \mathcal{D})$ be a disk-like CC tile. Then $\rho(M)$ is the largest positive zero of the cubic polynomial*

$$x^3 - (|p| - 1)x^2 - (|q| - |p|x - |q|).$$

Hence $\dim_H(\partial T) = 2 \log \rho(M) / \log |q|$.

Proof. Since $|\det(A)| = |q|$, it is more convenient to work with $f(x) = x^2 \pm px \pm q$ ($p \geq 0, q \geq 2$). Also we ignore those $f(x)$ of the form $f(x) = x^2 \pm px - q$ ($p > 0, q \geq 2$) as they cannot be characteristic polynomials of similarities (Lemma 3.6). We can see from Appendix A or C that the contact matrix is irreducible if and only if $f(x) = x^2 \pm px + q$ where $p > 0$.

Case (1) $f(x) = x^2 + px + q$. The characteristic polynomial of the corresponding M is $(x-1)(x^2 + px + q)[x^3 - (p-1)x^2 - (q-p)x - q]$. Notice that $\rho(M) \neq 1$. Indeed, if $\rho(M) = 1$, then $\dim_H(\partial T) = 0$, which implies ∂T is totally disconnected (Proposition 2.5, [Fa]). This is not possible for the boundary of a topological disk.

The zeros of $x^2 + px + q$ are either both negative or both non-real. Hence $\rho(M)$ is the largest positive real zero of $x^3 - (p-1)x^2 - (q-p)x - q$.

Case (2) $f(x) = x^2 - px + q$. The characteristic polynomial of the corresponding M is $(x+1)(x^2 - px + q)[x^3 - (p-1)x^2 - (q-p)x - q]$. Since $f(x)$ cannot have unequal real zeros (Lemma 3.6), we have $p^2 - 4q \leq 0$. When $p^2 - 4q < 0$, the zeros of $x^2 - px + q$ are non-real. Then $\rho(M)$ is the largest positive real zero of $x^3 - (p-1)x^2 - (q-p)x - q$. When $p^2 - 4q = 0$, the two zeros of $x^2 - px + q$ are equal. But the Perron-Frobenius eigenvalue should be a simple zero of the characteristic polynomial of M (Theorem 3.8), so $\rho(M)$ is also the largest positive real zero of $x^3 - (p-1)x^2 - (q-p)x - q$.

Case (3) $f(x) = x^2 + q$. The contact matrix M is reducible. Its characteristic polynomial is $(x^2 - q)(x^2 + q)(x-1)(x+1)(x^2 + 1)$. We see that $\rho(M) = q^{1/2}$, which is the largest positive zero of $x^3 + x^2 - qx - q = (x^2 - q)(x+1)$.

Case (4) $f(x) = x^2 - q$. The contact matrix M is also reducible and its characteristic polynomial is found to be $(x^2 - q)^2(x+1)(x-1)^3$. As in the previous case, $\rho(M) = q^{1/2}$, which is also the largest positive zero of $x^3 + x^2 - qx - q$. \square

Remark 3.10. *It is interesting to see that the signs of p and q do not matter in the calculation of $\dim_H(\partial T)$ when A is a similarity. Notice also for the last two cases, $f(x) = x^2 + q$ ($|q| \geq 2$), we have $\rho(M) = |q|^{1/2}$. It follows that $\dim_H(\partial T) = 1$, as expected for the boundary of a parallelogram (Proposition 3.5).*

We observe that $\dim_H(\partial T)$ is independent of the choice of the vector v in the following sense.

Corollary 3.11. *Let $A \in M_2(\mathbb{Z})$ be an expanding similarity with characteristic polynomial $f(x) = x^2 + px + q$ ($|q| \geq 2$). Let $\mathcal{D} = \mathcal{D}(v, |q|)$ and $\mathcal{D}' = \mathcal{D}(v', |q|)$ be two CC digit sets such that each of $\{v, Av\}$ and $\{v', Av'\}$ is an independent set. If $2|p| \leq |q+2|$, then*

$$\dim_H(\partial T(A, \mathcal{D})) = \dim_H(\partial T(A, \mathcal{D}')).$$

Proof. As $2|p| \leq |q+2|$, both $T(A, \mathcal{D})$ and $T(A, \mathcal{D}')$ are disk-like CC tiles (Theorem 1.1). Hence the corollary follows from Theorem 3.9. \square

Remark 3.12. *We conjecture that Theorem 3.9 and Corollary 3.11 are also valid when $2|p| > |q+2|$, i.e., T is non-disk-like. The major difficulty in justifying these conjectures is that, in general, there is no upper bound on the number of neighbors of a non-disk-like CC tile [DJN].*

Acknowledgements: The authors would like to thank Professor Ka-Sing Lau for suggesting the question and reading an earlier version of the manuscript carefully. They are also grateful to the anonymous referees for their valuable comments and suggestions.

4. Appendix A: Neighbor Graphs

Let $f(x) = x^2 \pm px \pm q$ ($p \geq 0, q \geq 2$). The neighbor graphs of disk-like tiles are classified by $f(x)$ and listed below.

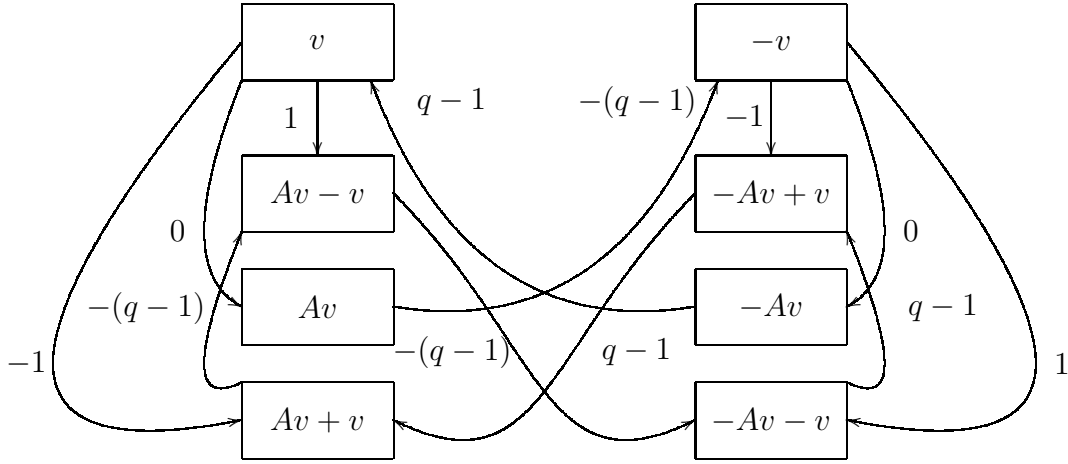

FIGURE 2. The neighbor graph of T associated with $f(x) = x^2 + q$.

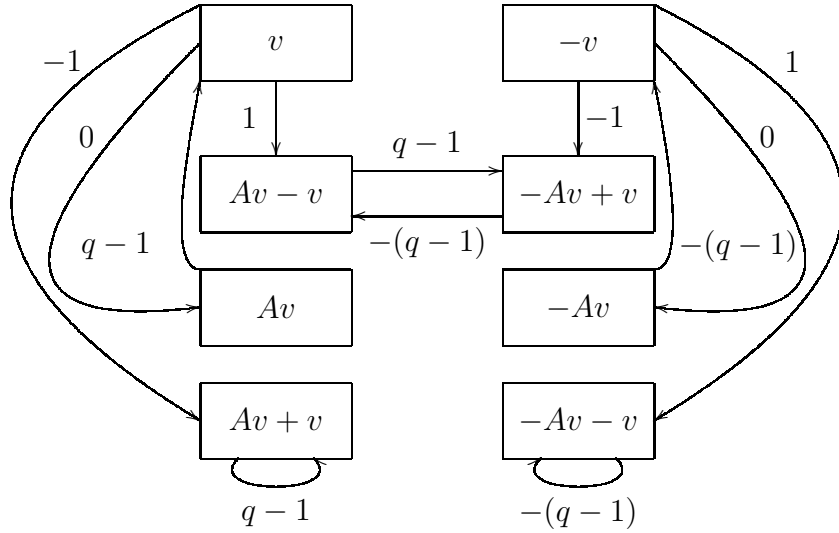

FIGURE 3. The neighbor graph of T associated with $f(x) = x^2 - q$.

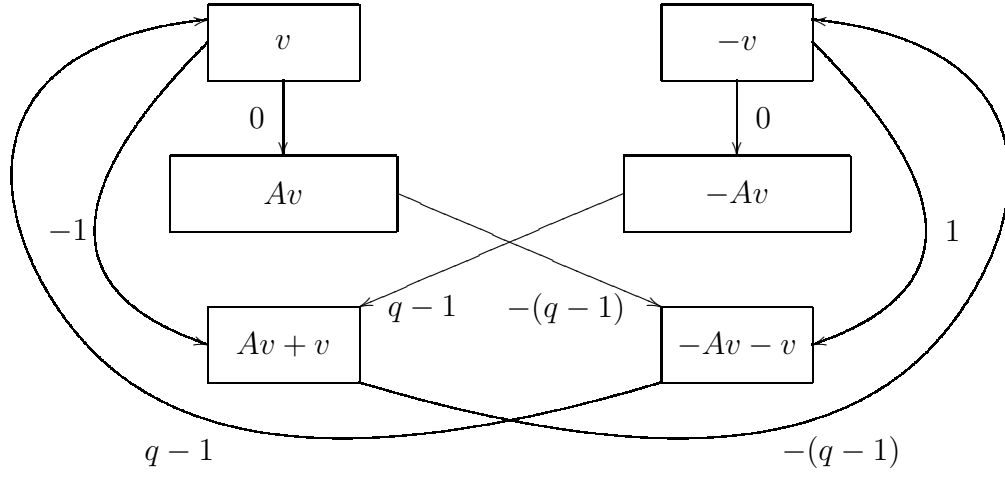

FIGURE 4. The neighbor graph of T associated with $f(x) = x^2 + x + q$.

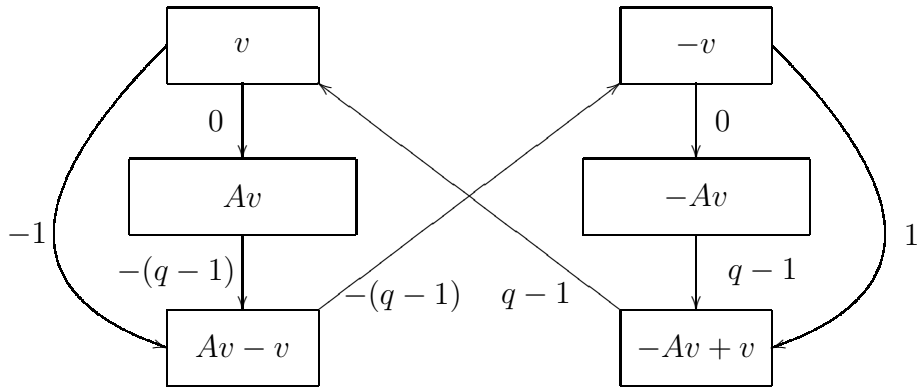

FIGURE 5. The neighbor graph of T associated with $f(x) = x^2 - x + q$.

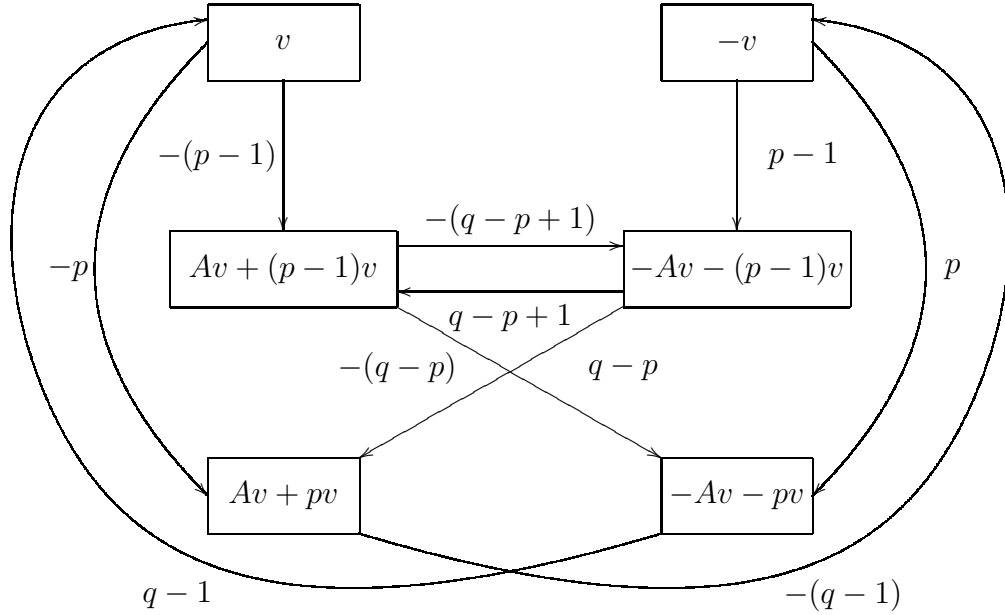

FIGURE 6. The neighbor graph of T associated with $f(x) = x^2 + px + q$, $p \geq 2$, $2p \leq q + 2$ (excluding $q = p = 2$).

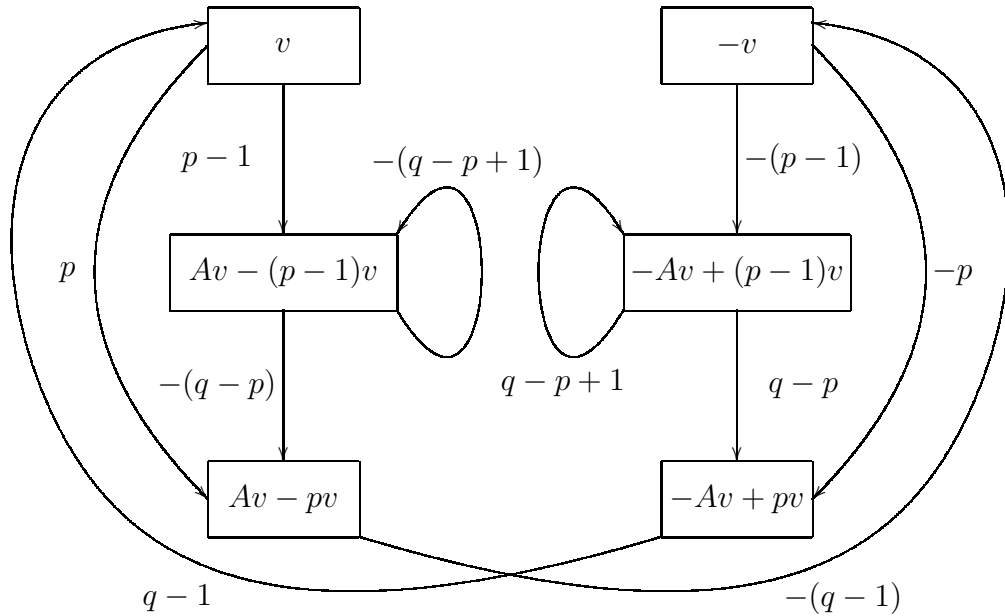

FIGURE 7. The neighbor graph of T associated with $f(x) = x^2 - px + q$, $p \geq 2$, $2p \leq q + 2$ (excluding $q = p = 2$).

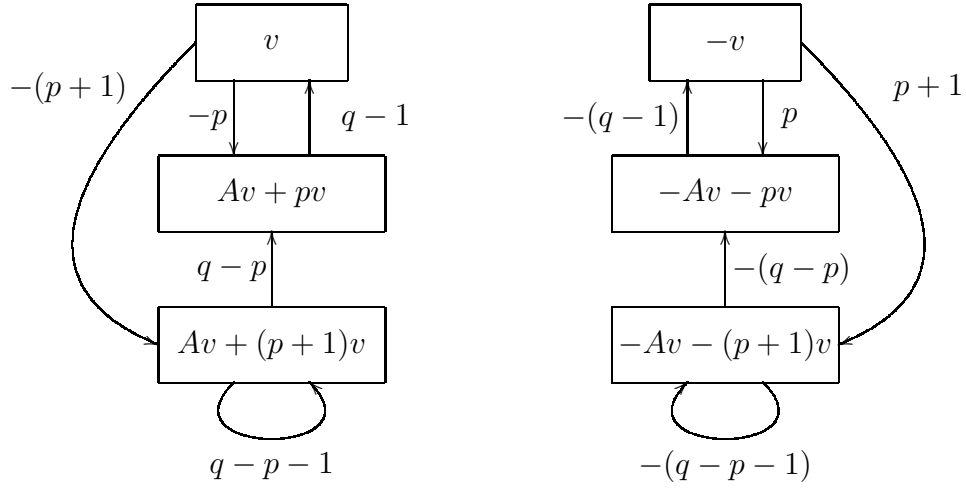

FIGURE 8. The neighbor graph of T associated with $f(x) = x^2 + px - q$, $p \geq 1$, $2p \leq q - 2$

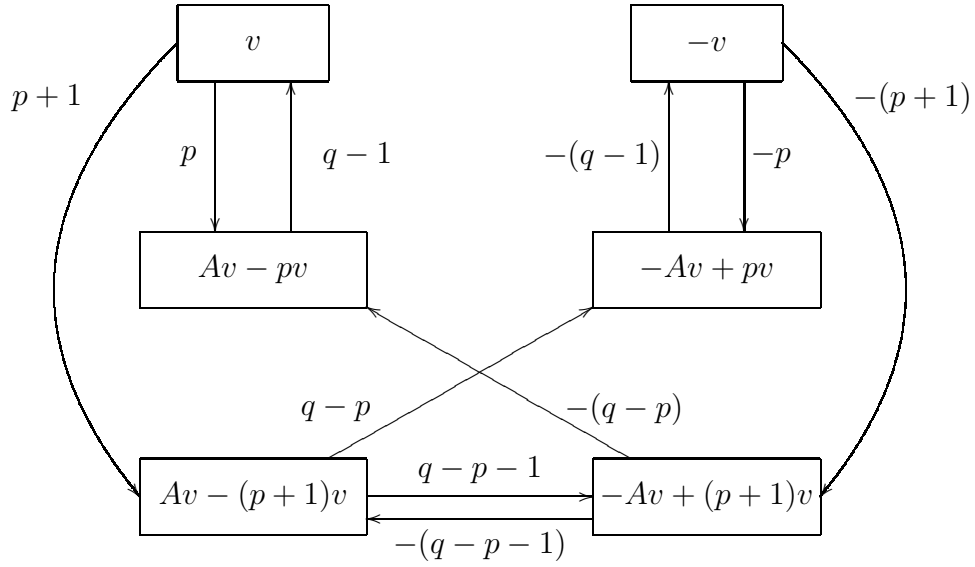

FIGURE 9. The neighbor graph of T associated with $f(x) = x^2 - px - q$, $p \geq 1$, $2p \leq q - 2$

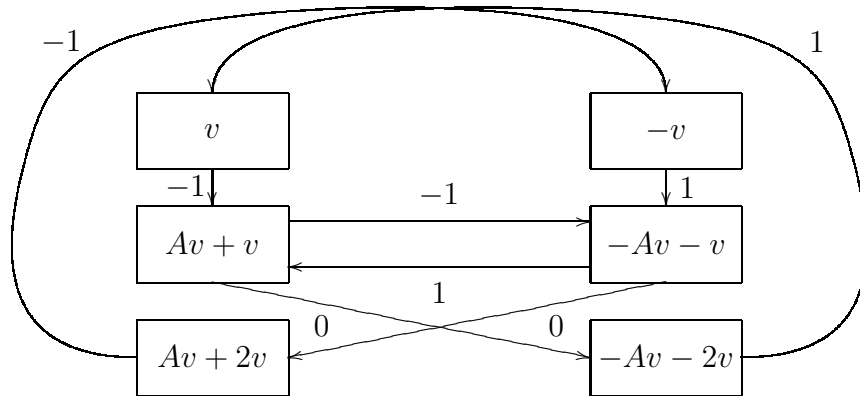

FIGURE 10. The neighbor graph of T associated with $f(x) = x^2 + 2x + 2$

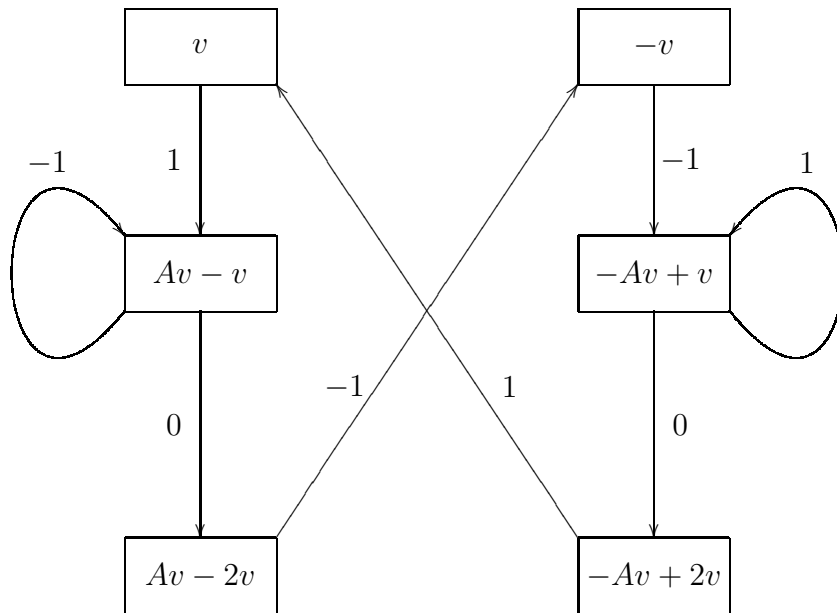

FIGURE 11. The neighbor graph of T associated with $f(x) = x^2 - 2x + 2$

5. Appendix B: Graph-directed Sets

Let $f(x) = x^2 \pm px \pm q$ ($p \geq 0, q \geq 2$). The graph-directed sets representing the boundary ∂T are classified by $f(x)$ and listed below.

(1) $f(x) = x^2 + q$. Convention: $u_1 = v, u_2 = Av - v, u_3 = Av, u_4 = Av + v$.

$$\begin{aligned}
 AT_{u_1} &= \bigcup_{j=1}^{q-1} (T_{u_2} + jv) \cup \bigcup_{j=0}^{q-1} (T_{u_3} + jv) \cup \bigcup_{j=0}^{q-2} (T_{u_4} + jv) \\
 AT_{u_2} &= T_{-u_4} \\
 AT_{u_3} &= T_{-u_1} \\
 AT_{u_4} &= T_{u_2} \\
 AT_{-u_1} &= \bigcup_{j=0}^{q-2} (T_{-u_2} + jv) \cup \bigcup_{j=0}^{q-1} (T_{-u_3} + jv) \cup \bigcup_{j=1}^{q-1} (T_{-u_4} + jv) \\
 AT_{-u_2} &= T_{u_4} + (q-1)v \\
 AT_{-u_3} &= T_{u_1} + (q-1)v \\
 AT_{-u_4} &= T_{-u_2} + (q-1)v
 \end{aligned}$$

(2) $f(x) = x^2 - q$. Convention: $u_1 = v, u_2 = Av - v, u_3 = Av, u_4 = Av + v$.

$$\begin{aligned}
 AT_{u_1} &= \bigcup_{j=1}^{q-1} (T_{u_2} + jv) \cup \bigcup_{j=0}^{q-1} (T_{u_3} + jv) \cup \bigcup_{j=0}^{q-2} (T_{u_4} + jv) \\
 AT_{u_2} &= T_{-u_2} + (q-1)v \\
 AT_{u_3} &= T_{u_1} + (q-1)v \\
 AT_{u_4} &= T_{u_4} + (q-1)v \\
 AT_{-u_1} &= \bigcup_{j=0}^{q-2} (T_{-u_2} + jv) \cup \bigcup_{j=0}^{q-1} (T_{-u_3} + jv) \cup \bigcup_{j=1}^{q-1} (T_{-u_4} + jv) \\
 AT_{-u_2} &= T_{u_2} \\
 AT_{-u_3} &= T_{-u_1} \\
 AT_{-u_4} &= T_{-u_4}
 \end{aligned}$$

(3) $f(x) = x^2 + x + q$. Convention: $u_1 = v, u_2 = Av, u_3 = Av + v$.

$$\begin{aligned}
 AT_{u_1} &= \bigcup_{j=0}^{q-1} (T_{u_2} + jv) \cup \bigcup_{j=0}^{q-2} (T_{u_3} + jv) \\
 AT_{u_2} &= T_{-u_3} \\
 AT_{u_3} &= T_{-u_1} \\
 AT_{-u_1} &= \bigcup_{j=0}^{q-1} (T_{-u_2} + jv) \cup \bigcup_{j=1}^{q-1} (T_{-u_3} + jv) \\
 AT_{-u_2} &= T_{u_3} + (q-1)v \\
 AT_{-u_3} &= T_{u_1} + (q-1)v
 \end{aligned}$$

(4) $f(x) = x^2 - x + q$. Convention: $u_1 = v$, $u_2 = Av$, $u_3 = Av - v$.

$$\begin{aligned}
AT_{u_1} &= \bigcup_{j=0}^{q-1} (T_{u_2} + jv) \cup \bigcup_{j=0}^{q-2} (T_{u_3} + jv) \\
AT_{u_2} &= T_{u_3} \\
AT_{u_3} &= T_{-u_1} \\
AT_{-u_1} &= \bigcup_{j=0}^{q-1} (T_{-u_2} + jv) \cup \bigcup_{j=1}^{q-1} (T_{-u_3} + jv) \\
AT_{-u_2} &= T_{-u_3} + (q-1)v \\
AT_{-u_3} &= T_{u_1} + (q-1)v
\end{aligned}$$

(5) $f(x) = x^2 + px + q$, $p \geq 2$, $2p \leq q + 2$ (excluding $p = q = 2$). Convention: $u_1 = v$, $u_2 = Av + (p-1)v$, $u_3 = Av + pv$.

$$\begin{aligned}
AT_{u_1} &= \bigcup_{j=0}^{q-p} (T_{u_2} + jv) \cup \bigcup_{j=0}^{q-p-1} (T_{u_3} + jv) \\
AT_{u_2} &= \bigcup_{j=0}^{p-2} (T_{-u_2} + jv) \cup \bigcup_{j=0}^{p-1} (T_{-u_3} + jv) \\
AT_{u_3} &= T_{-u_1} \\
AT_{-u_1} &= \bigcup_{j=p-1}^{q-1} (T_{-u_2} + jv) \cup \bigcup_{j=p}^{q-1} (T_{-u_3} + jv) \\
AT_{-u_2} &= \bigcup_{j=q-p+1}^{q-1} (T_{u_2} + jv) \cup \bigcup_{j=q-p}^{q-1} (T_{u_3} + jv) \\
AT_{-u_3} &= T_{u_1} + (q-1)v
\end{aligned}$$

(6) $f(x) = x^2 - px + q$, $p \geq 2$, $2p \leq q + 2$ (excluding $p = q = 2$). Convention: $u_1 = v$, $u_2 = Av - (p-1)v$, $u_3 = Av - pv$.

$$\begin{aligned}
AT_{u_1} &= \bigcup_{j=p-1}^{q-1} (T_{u_2} + jv) \cup \bigcup_{j=p}^{q-1} (T_{u_3} + jv) \\
AT_{u_2} &= \bigcup_{j=0}^p (T_{u_2} + jv) \cup \bigcup_{j=0}^{p-1} (T_{u_3} + jv) \\
AT_{u_3} &= T_{-u_1} \\
AT_{-u_1} &= \bigcup_{j=0}^{q-p} (T_{-u_2} + jv) \cup \bigcup_{j=0}^{q-p-1} (T_{-u_3} + jv) \\
AT_{-u_2} &= \bigcup_{j=q-p+1}^{q-1} (T_{-u_2} + jv) \cup \bigcup_{j=q-p}^{q-1} (T_{-u_3} + jv) \\
AT_{-u_3} &= T_{u_1} + (q-1)v
\end{aligned}$$

(7) $f(x) = x^2 + px - q$, $p \geq 1$, $2p \leq q - 2$. Convention: $u_1 = v$, $u_2 = Av + pv$, $u_3 = Av + (p + 1)v$.

$$\begin{aligned}
AT_{u_1} &= \bigcup_{j=0}^{q-p-1} (T_{u_2} + jv) \cup \bigcup_{j=0}^{q-p-2} (T_{u_3} + jv) \\
AT_{u_2} &= T_{u_1} + (q - 1)v \\
AT_{u_3} &= \bigcup_{j=q-p}^{q-1} (T_{u_2} + jv) \cup \bigcup_{j=q-p-1}^{q-1} (T_{u_3} + jv) \\
AT_{-u_1} &= \bigcup_{j=p}^{q-1} (T_{-u_2} + jv) \cup \bigcup_{j=p+1}^{q-1} (T_{-u_3} + jv) \\
AT_{-u_2} &= T_{u_1} \\
AT_{-u_3} &= \bigcup_{j=0}^{p-1} (T_{-u_2} + jv) \cup \bigcup_{j=0}^p (T_{-u_3} + jv)
\end{aligned}$$

(8) $f(x) = x^2 - px - q$, $p \geq 1$, $2p \leq q - 2$. Convention: $u_1 = v$, $u_2 = Av - pv$, $u_3 = Av - (p + 1)v$.

$$\begin{aligned}
AT_{u_1} &= \bigcup_{j=p}^{q-1} (T_{u_2} + jv) \cup \bigcup_{j=p+1}^{q-1} (T_{u_3} + jv) \\
AT_{u_2} &= T_{u_1} + (q - 1)v \\
AT_{u_3} &= \bigcup_{j=q-p}^{q-1} (T_{-u_2} + jv) \cup \bigcup_{j=q-p-1}^{q-1} (T_{-u_3} + jv) \\
AT_{-u_1} &= \bigcup_{j=0}^{q-p-1} (T_{-u_2} + jv) \cup \bigcup_{j=0}^{q-p-2} (T_{-u_3} + jv) \\
AT_{-u_2} &= T_{-u_1} \\
AT_{-u_3} &= \bigcup_{j=0}^{p-1} (T_{u_2} + jv) \cup \bigcup_{j=0}^{p-2} (T_{u_3} + jv)
\end{aligned}$$

(9) $f(x) = x^2 + 2x + 2$. Convention: $u_1 = v$, $u_2 = Av + v$, $u_3 = Av + 2v$.

$$\begin{aligned}
AT_{u_1} &= T_{u_2} \\
AT_{u_2} &= T_{-u_2} \cup T_{-u_3} \cup (T_{-u_3} + v) \\
AT_{u_3} &= T_{-u_1} \\
AT_{-u_1} &= T_{-u_2} + v \\
AT_{-u_2} &= (T_{u_2} + v) \cup T_{u_3} \cup (T_{u_3} + v) \\
AT_{-u_3} &= T_{u_1} + v
\end{aligned}$$

(10) $f(x) = x^2 - 2x + 2$. Convention: $u_1 = v$, $u_2 = Av - v$, $u_3 = Av - 2v$.

$$\begin{aligned}
AT_{u_1} &= T_{u_2} + v \\
AT_{u_2} &= T_{u_2} \cup T_{u_3} \cup (T_{u_3} + v) \\
AT_{u_3} &= T_{-u_1} \\
AT_{-u_1} &= T_{-u_2} \\
AT_{-u_2} &= (T_{-u_2} + v) \cup T_{-u_3} \cup (T_{-u_3} + v) \\
AT_{-u_3} &= T_{u_1} + v
\end{aligned}$$

6. Appendix C: Contact Matrices

Let $f(x) = x^2 \pm px \pm q$ ($p \geq 0$, $q \geq 2$). The contact matrices (in table form) of disk-like tiles are classified by $f(x)$ and listed below.

| | v | Av | $-v$ | $-Av$ | $Av - v$ | $-Av - v$ | $-Av + v$ | $Av + v$ |
|-----------|-----|------|------|-------|----------|-----------|-----------|----------|
| v | 0 | q | 0 | 0 | $q - 1$ | 0 | 0 | $q - 1$ |
| Av | 0 | 0 | 1 | 0 | 0 | 0 | 0 | 0 |
| $-v$ | 0 | 0 | 0 | q | 0 | $q - 1$ | $q - 1$ | 0 |
| $-Av$ | 1 | 0 | 0 | 0 | 0 | 0 | 0 | 0 |
| $Av - v$ | 0 | 0 | 0 | 0 | 0 | 1 | 0 | 0 |
| $-Av - v$ | 0 | 0 | 0 | 0 | 0 | 0 | 1 | 0 |
| $-Av + v$ | 0 | 0 | 0 | 0 | 0 | 0 | 0 | 1 |
| $Av + v$ | 0 | 0 | 0 | 0 | 1 | 0 | 0 | 0 |

TABLE 4. $f(x) = x^2 + q$.

| | v | Av | $-v$ | $-Av$ | $Av - v$ | $-Av + v$ | $Av + v$ | $-Av - v$ |
|-----------|-----|------|------|-------|----------|-----------|----------|-----------|
| v | 0 | q | 0 | 0 | $q - 1$ | 0 | $q - 1$ | 0 |
| Av | 1 | 0 | 0 | 0 | 0 | 0 | 0 | 0 |
| $-v$ | 0 | 0 | 0 | q | 0 | $q - 1$ | 0 | $q - 1$ |
| $-Av$ | 0 | 0 | 1 | 0 | 0 | 0 | 0 | 0 |
| $Av - v$ | 0 | 0 | 0 | 0 | 0 | 1 | 0 | 0 |
| $-Av + v$ | 0 | 0 | 0 | 0 | 1 | 0 | 0 | 0 |
| $Av + v$ | 0 | 0 | 0 | 0 | 0 | 0 | 1 | 0 |
| $-Av - v$ | 0 | 0 | 0 | 0 | 0 | 0 | 0 | 1 |

TABLE 5. $f(x) = x^2 - q$.

| | v | Av | $Av + v$ | $-v$ | $-Av$ | $-Av - v$ |
|-----------|-----|------|----------|------|-------|-----------|
| v | 0 | q | $q - 1$ | 0 | 0 | 0 |
| Av | 0 | 0 | 0 | 0 | 0 | 1 |
| $Av + v$ | 0 | 0 | 0 | 1 | 0 | 0 |
| $-v$ | 0 | 0 | 0 | 0 | q | $q - 1$ |
| $-Av$ | 0 | 0 | 1 | 0 | 0 | 0 |
| $-Av - v$ | 1 | 0 | 0 | 0 | 0 | 0 |

TABLE 6. $f(x) = x^2 + x + q$.

| | v | Av | $Av - v$ | $-v$ | $-Av$ | $-Av + v$ |
|-----------|-----|------|----------|------|-------|-----------|
| v | 0 | q | $q - 1$ | 0 | 0 | 0 |
| Av | 0 | 0 | 1 | 0 | 0 | 0 |
| $Av - v$ | 0 | 0 | 0 | 1 | 0 | 0 |
| $-v$ | 0 | 0 | 0 | 0 | q | $q - 1$ |
| $-Av$ | 0 | 0 | 0 | 0 | 0 | 1 |
| $-Av + v$ | 1 | 0 | 0 | 0 | 0 | 0 |

TABLE 7. $f(x) = x^2 - x + q$.

| | v | $Av + (p-1)v$ | $Av + pv$ | $-v$ | $-Av - (p-1)v$ | $-Av - pv$ |
|----------------|-----|---------------|-----------|------|----------------|------------|
| v | 0 | $q - p + 1$ | $q - p$ | 0 | 0 | 0 |
| $Av + (p-1)v$ | 0 | 0 | 0 | 0 | $p - 1$ | p |
| $Av + pv$ | 0 | 0 | 0 | 1 | 0 | 0 |
| $-v$ | 0 | 0 | 0 | 0 | $q - p + 1$ | $q - p$ |
| $-Av - (p-1)v$ | 0 | $p - 1$ | p | 0 | 0 | 0 |
| $-Av - pv$ | 1 | 0 | 0 | 0 | 0 | 0 |

TABLE 8. $f(x) = x^2 + px + q$, $p \geq 2$, $2p \leq q + 2$ (excluding $p = q = 2$).

| | v | $Av - (p-1)v$ | $Av - pv$ | $-v$ | $-Av + (p-1)v$ | $-Av + pv$ |
|----------------|-----|---------------|-----------|------|----------------|------------|
| v | 0 | $q - p + 1$ | $q - p$ | 0 | 0 | 0 |
| $Av - (p-1)v$ | 0 | $p - 1$ | p | 0 | 0 | 0 |
| $Av - pv$ | 0 | 0 | 0 | 1 | 0 | 0 |
| $-v$ | 0 | 0 | 0 | 0 | $q - p + 1$ | $q - p$ |
| $-Av + (p-1)v$ | 0 | 0 | 0 | 0 | $p - 1$ | p |
| $-Av + pv$ | 1 | 0 | 0 | 0 | 0 | 0 |

TABLE 9. $f(x) = x^2 - px + q$, $p \geq 2$, $2p \leq q + 2$ (excluding $p = q = 2$).

| | v | $Av + pv$ | $Av + (p+1)v$ | $-v$ | $-Av - pv$ | $-Av - (p+1)v$ |
|----------------|-----|-----------|---------------|------|------------|----------------|
| v | 0 | $q - p$ | $q - p - 1$ | 0 | 0 | 0 |
| $Av + pv$ | 1 | 0 | 0 | 0 | 0 | 0 |
| $Av + (p+1)v$ | 0 | p | $p + 1$ | 0 | 0 | 0 |
| $-v$ | 0 | 0 | 0 | 0 | $q - p$ | $q - p - 1$ |
| $-Av - pv$ | 0 | 0 | 0 | 1 | 0 | 0 |
| $-Av - (p+1)v$ | 0 | 0 | 0 | 0 | p | $p + 1$ |

TABLE 10. $f(x) = x^2 + px - q$, $p \geq 1$, $2p \leq q - 2$.

| | v | $Av - pv$ | $Av - (p+1)v$ | $-v$ | $-Av + pv$ | $-Av + (p+1)v$ |
|----------------|-----|-----------|---------------|------|------------|----------------|
| v | 0 | $q - p$ | $q - p - 1$ | 0 | 0 | 0 |
| $Av - pv$ | 1 | 0 | 0 | 0 | 0 | 0 |
| $Av - (p+1)v$ | 0 | 0 | 0 | 0 | p | $p + 1$ |
| $-v$ | 0 | 0 | 0 | 0 | $q - p$ | $q - p - 1$ |
| $-Av + pv$ | 0 | 0 | 0 | 1 | 0 | 0 |
| $-Av + (p+1)v$ | 0 | p | $p + 1$ | 0 | 0 | 0 |

TABLE 11. $f(x) = x^2 - px - q$, $p \geq 1$, $2p \leq q - 2$.

| | v | $Av + v$ | $Av + 2v$ | $-v$ | $-Av - v$ | $-Av - 2v$ |
|------------|-----|----------|-----------|------|-----------|------------|
| v | 0 | 1 | 0 | 0 | 0 | 0 |
| $Av + v$ | 0 | 0 | 0 | 0 | 1 | 2 |
| $Av + 2v$ | 0 | 0 | 0 | 1 | 0 | 0 |
| $-v$ | 0 | 0 | 0 | 0 | 1 | 0 |
| $-Av - v$ | 0 | 1 | 2 | 0 | 0 | 0 |
| $-Av - 2v$ | 1 | 0 | 0 | 0 | 0 | 0 |

TABLE 12. $f(x) = x^2 + 2x + 2$.

| | v | $Av - v$ | $Av - 2v$ | $-v$ | $-Av + v$ | $-Av + 2v$ |
|------------|-----|----------|-----------|------|-----------|------------|
| v | 0 | 1 | 0 | 0 | 0 | 0 |
| $Av - v$ | 0 | 1 | 2 | 0 | 0 | 0 |
| $Av - 2v$ | 0 | 0 | 0 | 1 | 0 | 0 |
| $-v$ | 0 | 0 | 0 | 0 | 1 | 0 |
| $-Av + v$ | 0 | 0 | 0 | 0 | 1 | 2 |
| $-Av + 2v$ | 1 | 0 | 0 | 0 | 0 | 0 |

TABLE 13. $f(x) = x^2 - 2x + 2$.

REFERENCES

- [AL] S. AKIYAMA AND B. LORIDANT, *Boundary parametrization of planar self-affine tiles with collinear digit set*, Sci. China Math. **53(9)** (2010), 2173-2194.
- [AL2] S. AKIYAMA AND B. LORIDANT, *Boundary parametrization of self-affine tiles*, J. Math. Soc. Japan **63** no.2 (2011), 525-579.
- [BG] C. BANDT AND G. GELBRICH, *Classification of self-affine lattice tilings*, J. London Math. Soc. **50** (1994), 581-593.
- [BM] C. BANDT AND M. MESING, *Self-affine fractals of finite type*, Banach Center Publications, Vol.84 (2009), 131-148.
- [BW] C. BANDT AND Y. WANG, *Disk-like self-affine tiles in \mathbb{R}^2* , Discrete Comput.Geom. **26** (2001), 591-601.
- [DJN] D.-W. DENG, T. JIANG, AND S.-M. NGAI, *Structure of planar integral self-affine tilings*, Math. Nachr. **285** (2012), 447-475.
- [DL] Q.R. DENG AND K.S. LAU, *Connectedness of a class of planar self-affine tiles*, J. Math. Anal. Appl. **380** (2011), 493-500.
- [DKV] P. DUVAL, J. KEESLING, AND A. VINCE, *The Hausdorff dimension of the boundary of a self-similar tile*, J. London Math. Soc. **61** (2000), 748-760.
- [Fa] K.J. FALCONER, *Fractal Geometry: Mathematical Foundations and Applications*, John Wiley & Sons, 2003.
- [Fa2] K.J. FALCONER, *Techniques in fractal geometry*, John Wiley & Sons, 1997.
- [Fi] R. FISCHER, *Sofic systems and graphs*, Monatsh. Math. **80** (1975), 179-186.
- [Ga] F.R. GANTMACHER, *Matrix theory*, Volume II. Chelsea Publishing Company, New York, 1960.
- [Gi] W.G. GILBERT, *Radix representataions of quadratic fields*, J. Math. Anal. Appl. **83** (1981), 264-274.
- [GM] J. GMAINER AND J.M. THUSWALDNER *On disk-like self-affine tiles arising from polyominoes*, Methods Appl. Anal. Vol.13, No.4 (2006), 351-372.
- [GH] K. GRÖCHENIG AND A. HAAS, *Self-similar lattice tilings*, J. Fourier Anal. Appl. **1** (1994), 131-170.

- [HL] X.G. HE AND K.S. LAU, *On a generalized dimension of self-affine fractals*, Math. Nachr. **281** (2008) No.8, 1142-1158.
- [HLR] X.G. HE, K.S. LAU, AND H. RAO, *Self-affine sets and graph-directed systems*, Constr. Approx. **19** (2003), 373-397.
- [K] I. KIRAT, *Disk-like tiles and self-affine curves with non-collinear digits*, Math. Comp. **79** (2010), 1019-1045.
- [KL] I. KIRAT AND K.S. LAU, *On the connectedness of self-affine tiles*, J. London Math. Soc. **62** (2000), 291-304.
- [LW1] J. C. LAGARIAS AND Y. WANG, *Self-affine tiles in \mathbb{R}^n* , Adv. Math. **121** (1996), 21-49.
- [LW2] J. C. LAGARIAS AND Y. WANG, *Integral Self-affine tiles in \mathbb{R}^n I. Standard and non-standard digit sets*, J. London Math. Soc. **54** (1996), 161-179.
- [LW3] J. C. LAGARIAS AND Y. WANG, *Integral Self-affine tiles in \mathbb{R}^n II. Lattice tilings*, J. Fourier Anal. Appl. **3** (1997), 84-102.
- [LN] K.S. LAU AND S.M. NGAI, *Dimensions of the boundaries of self-similar sets*, Experiment. Math. **12** (2003), 13-26.
- [LL] K.S. LEUNG AND K.S. LAU, *Disk-likeness of planar self-affine tiles*, Trans. Amer. Math. Soc. **359** (2007), 3337-3355.
- [LLu] K.S. LEUNG AND J.J. LUO, *Connectedness of planar self-affine sets associated with non-consecutive collinear digit sets*, J. Math. Anal. Appl. **395**(2012), 208-217.
- [LY] J.J. LUO AND Y.M. YANG, *On single-matrix graph-directed iterated function systems*, J. Math. Anal. Appl. **372**(2010), 8-18.
- [LM] D. LIND AND B. MARCUS, *An introduction to symbolic dynamics and coding*, Cambridge University Press, 1995.
- [MW] R.D. MAULDIN AND S.C. WILLIAMS, *Hausdorff dimension in graph-directed constructions*, Trans. Amer. Math. Soc. **309** (1988), 811-829.
- [MTT] W. MÜLLER, J.M. THUSWALDNER, AND R.T. TICHY, *Fractal properties of number system*, Period. Math. Hungar. **42** (2001), 51-68.
- [Se] E. SENETA, *Non-negative matrices and Markov chains*, Springer, New York, second edition, 1980.
- [SW] R.S. STRICHARTZ AND Y. WANG, *Geometry of self-affine tiles I*, Indiana U. Math. J. **48** (1999), 1-23.
- [V] J. VEERMAN, *Hausdorff dimension of boundaries of self-affine tiles in \mathbb{R}^n* , Bol. Soc. Mat. Mexicana (3) **4** (1998), no. 2, 159C182.
- [We] B. WEISS, *Subshifts of finite type and sofic systems*, Monatsh. Math. **77** (1973), 462-474.

DEPARTMENT OF MATHEMATICS AND INFORMATION TECHNOLOGY, THE HONG KONG INSTITUTE OF EDUCATION, HONG KONG

E-mail address: ksleung@ied.edu.hk

DEPARTMENT OF MATHEMATICS, SHANTOU UNIVERSITY, SHANTOU, GUANGDONG 515063, CHINA

E-mail address: luojun2011@yahoo.com.cn