

# VOGAN DIAGRAMS OF SOME HYPERBOLIC KAC-MOODY ALGEBRAS

B RANSINGH AND K C PATI

Department of Mathematics  
National Institute of Technology  
Rourkela (India)  
email- bransingh@gmail.com

ABSTRACT. This paper constructs the Vogan diagrams for hyperbolic Kac-Moody algebras, which have potential physical applications in cosmological billiards.

PACS numbers: 02.20.Sv, 04.65.+e

2010 AMS Subject classification: 81R10, 17B67, 22E60, 22E65

Keywords - Vogan diagram; Kac-Moody algebras

## 1. INTRODUCTION

For a complex semi-simple Lie algebra  $\mathfrak{g}$ , it is well known that the conjugacy classes of real forms of  $\mathfrak{g}$  are in one to one correspondence with the conjugacy classes of involutions of  $\mathfrak{g}$ , if we associate to a real form  $\mathfrak{g}_{\mathbb{R}}$  one of its Cartan involutions  $\theta$ . Using a suited pair  $(\mathfrak{h}, \Pi)$  of a Cartan subalgebra  $\mathfrak{h}$  and a basis  $\Pi$  of the associated root system, an involution is described by a "Vogan diagram"; the equivalences of Vogan diagrams describe how such a diagram changes when one changes  $(\mathfrak{h}, \Pi)$ .

When  $\mathfrak{g}$  is now an affine Kac-Moody algebra, the one to one correspondence  $\mathfrak{g}_{\mathbb{R}} \leftrightarrow \theta$  was established by Ben Messaoud and Rousseau (Theorem 3.1 and reference [15]).

The last two decades shows a gradual advancement in classification of real form of semisimple Lie algebras via Kac-Moody algebras to Lie superalgebras by Satake diagrams and Vogan diagrams. Splits Cartan subalgebra based on Satake diagram where as Vogan diagram based on maximally compact Cartan subalgebra. Kac-Moody algebras have played an increasingly crucial role in various areas of mathematics as well as theoretical physics. The hyperbolic Kac-Moody algebras which constitute a subclass of Lorentzian Kac-Moody algebras and some of their (almost split) real forms have appeared in a variety of problems in the realms of string field theory and supergravity theories. The almost split real forms have been classified by Tits-Satake diagrams [3].

Knapp [11] brought Vogan diagram into the light to represent the real forms of the complex simple Lie algebras. Batra [1, 2] developed a corresponding theory of Vogan diagrams for real forms of nontwisted affine Kac-Moody Lie algebras, where the author used the involution of the Kobashi's article automorphism of finite order of the affine Lie algebra  $A_l^{(1)}$ . The sequel of the Batra's article gives a broad sense of classification of invariants of real forms of affine Kac-Moody algebras. Tanushree [13] developed the theory of Vogan diagrams for almost compact real forms of twisted affine Kac-Moody Lie algebras. In that article the author exploit the involution in classification of finite order involution of affine Kac-Moody algebras by Leivstein. Hyperbolic Kac-Moody algebras among all types of Kac-Moody algebras is least understood. However these types of algebras have led to many potential physical applications.

In space like singularity, at each spatial point, the degree of freedom that carry the essential dynamics are the logarithms  $\beta^i \equiv -\ln a_i$  of the scale factors  $a_i$  along a set of (special) independent spatial directions ( $ds^2 = -dt^2 + \sum_i a_i^2(t, x)(w^i)^2$ ). The billiard analysis refers to the dynamics, in the vicinity of a spacelike singularity, of a gravitational model described by the Lagrangian[17]

$$\begin{aligned} \mathcal{L}_D &= {}^{(D)}R\sqrt{|^{(D)}g|}dx^0 \wedge \dots \wedge dx^{D-1} - \sum_{\alpha} \star d\phi^{\alpha} \wedge d\phi^{\alpha} - \\ &\quad - \frac{1}{2} \sum_p e^{\sum_{\alpha} \lambda_{\alpha}^{(p)} \phi^{\alpha}} \star F^{(p+1)} \wedge F^{(p+1)}, \quad D \geq 3 \end{aligned}$$

, where  $R$  is the spatial curvature scalar and  $\star$  is the Hodge star operator.

The real parameter  $\lambda_{\alpha}^{(p)}$  measures the strength of the coupling to the dilaton. Field strength is  $F^{(p)}$ . The dilatons are denoted by  $\phi^{\alpha}$ , ( $\alpha = 1, \dots, N$ ); their kinetic terms are normalized with a weight 1 with

respect to the Ricci scalar. The Einstein metric has Lorentz signature  $(-, +, \dots, +)$ ; its determinant is  $(D)g$ .

The light-like wall and the walls bounding the billiard have different origins: some arise from the Einstein-Hilbert action and involve only the scale factors  $\beta^i$ , ( $i = 1, \dots, d$ ), introduced through the Iwasawa decomposition of the space metric. For example a criterion for gravitational dynamics to be chaotic is that the billiard has finite volume. This in turn stems from the remarkable property that the billiard can be identified with the fundamental Weyl chamber of an hyperbolic Kac-Moody algebra. In this paper we have obtained the Vogan diagrams of some of the hyperbolic Kac-Moody algebras which have been discussed in paper [16], so that these diagrams can lead to more interesting studies related to billiard, M-theory etc. More particularly we have also obtained Vogan diagram of hyperbolic Kac-Moody algebra  $E_{10}$ . The  $E_{10}$  hyperbolic Kac-Moody algebras play a fundamental role in small tension expansion of M-theory and airthmatic chaos in superstring cosmology[7].

A Vogan diagram is a Dynkin diagram with some additional information as follows. The 2-elements orbits under  $\theta$  (Cartan Involution) are exhibited by joining the correponding simple roots by a double arrow and the 1-element orbit is painted in black (respectively, not painted), if the corresponding imaginary simple root is noncompact (respectively compact). The Vogan diagrams provide us to handle the problem of classification of compact real form of Lie algebra [11] in a quicker way.

## 2. PRELIMINARIES

The following definitions are useful tools in our work.

**Definition 2.1.** (*Generalised Cartan Matrix (GCM)*) [10] An integral matrix  $A = (a_{ij})_{i,j=1}^r$  is said to be *GCM* if

$$a_{ij} = \begin{cases} 2 & i = j \\ \leq 0 & i \neq j \end{cases}$$

and

$$a_{ij} = 0 \Rightarrow a_{ji} = 0$$

**Definition 2.2.** (*Kac-Moody Algebra*)[10] Let  $e_i$ ,  $f_i$  and  $h_i$  denote the  $3r$  Chevalley generators. The *Kac-Moody algebra* is defined as the algebra  $\mathfrak{g}$  together with the following relations

- (a)  $[h_i, h_j] = 0$ ,
- (b)  $[e_i, f_i] = h_i$ ,
- (c)  $[e_i, f_j] = 0$  if  $i \neq j$ ,
- (d)  $[h_i, e_j] = a_{ij}e_j$ ,
- (e)  $[h_i, f_j] = -a_{ij}f_j$ ,
- (f)  $(\text{ad } e_i)^{1-a_{ij}} e_j = 0$ ,
- (g)  $(\text{ad } f_i)^{1-a_{ij}} f_j = 0$  if  $i \neq j$ .

**Definition 2.3.** (*Dynkin Diagram*) [10] A Dynkin diagram associated with a *GCM*  $A$  is a graph with the following properties:

- (a) The Dynkin diagram has  $r$  vertices.
- (b) When  $a_{ij}a_{ji} = n \leq 4$ , the vertices  $i$  and  $j$  are joined by  $n$  lines.
- (c) if  $a_{ij}a_{ji} \leq 4$  and  $|a_{ij}| \geq |a_{ji}|$ , the vertices  $i$  and  $j$  are connected by  $|a_{ij}|$  lines and these lines are equipped with an arrow pointing towards  $i$  if  $|a_{ij}| > 1$ .
- (d) If  $a_{ij}a_{ji} > 4$ . the vertices  $i$  and  $j$  are connected by a bold-faced line equipped with an ordered pair of integers  $|a_{ij}|, |a_{ji}|$ .
- (e) If  $n > 4$ ,  $i$  and  $j$  are joined by a thick line on which we write  $|A_{ij}|, |A_{ji}|$  with  $|A_{ij}| \geq |A_{ji}|$ . This  $n > 4$  case will only concern us when we discuss rank-2 hyperbolic algebras.

*Remark 2.4.* It is clear that  $A$  is indcomposable if and only if Dynkin diagram is a connected graph.

The the relationship between a *GCM*, a *Dynkin diagram* and an *algebra* as in above relations is one to one.

**Definition 2.5.** (*Hyperbolic Kac-Moody Algebra*) [10] A generalised Cartan matrix (GCM)  $A$  is called a *matrix of hyperbolic type* if it is indecomposable, symmetrizable of indefinite type and if every proper connected subdiagram of Dynkin diagram of  $A$  is of finite or affine type. The Kac-Moody algebra is called *hyperbolic Kac-Moody Algebra* if the GCM is of hyperbolic type.

**Definition 2.6.** (*Dynkin diagram of hyperbolic Kac-Moody Algebras*) The general strategy in searching for hyperbolic Dynkin diagrams of rank  $r + 1$  is as follows:

- (i) Draw all possible Lie and / or affine (including semisimple) diagrams of rank  $r$
- (ii) Add an extra root, trying all possible lengths
- (iii) Try connecting the new root to the old ones in all ways consistent with a symmetrizable GCM.
- (iv) Test the resulting diagram by removing any point to see whether it reduces to (perhaps a disconnected combinations of) known finite or affine algebras, the twisted ones being included among the latter. A diagram that survives the test is of the hyperbolic type.

### 3. ROOT SYSTEM AND RELATIVE ROOT SYSTEM

Let  $\omega'$  is the standard Cartan semi-involution,  $\omega$  Chevalley Cartan involution  $\mathfrak{g}$ , s.t.  $w(h) = -h$ , and  $w(e_i) = -f_i$  and  $\tau$  is a involutive diagram automorphism. Let  $\sigma'$  be a semi-involution of the first kind and  $\mathfrak{g}_{\mathbb{R}}$  be the corresponding almost compact real form. and thus  $\sigma = \sigma'\omega' = \omega'\sigma'$  is the Cartan involution of  $\mathfrak{g}_{\mathbb{R}}$ . Hence  $\mathfrak{h}_{\mathbb{R}}$  is a  $\sigma$ -stable maximally split Cartan subalgebra of  $\mathfrak{g}_{\mathbb{R}}$  and  $\mathfrak{t}_{\mathbb{R}} = \mathfrak{h}_{\mathbb{R}}^{-\sigma}$  is a  $\sigma$  stable maximal compact toral subalgebra. The group  $K = G_{\mathbb{R}}^{\sigma}$  is transitive on the set of  $\sigma$  stable maximally compact Cartan subalgebra (respectively  $\sigma$ -stable maximally compact toral subalgebra) of  $\mathfrak{g}_{\mathbb{R}}$ . The root space decomposition becomes

$$\mathfrak{g} = \mathfrak{h} \oplus \bigoplus_{\alpha \in \Delta} \mathfrak{g}_{\alpha}$$

$$Z_{\mathfrak{g}}(\mathfrak{t}_0) = \mathfrak{h} \oplus \bigoplus_{\alpha \in \Delta, \alpha \text{ real}} \mathfrak{g}_{\alpha}$$

and  $\mathfrak{k}_0 \cap Z_{\mathfrak{g}}(\mathfrak{t}_0) = \mathfrak{k}_0 \cap \mathfrak{h} = \mathfrak{t}_0$ . Therefore  $\mathfrak{t}_0$  is maximal abelian in  $\mathfrak{k}_0$  and  $\mathfrak{h}_0$  is maximally compact.

We get the relative or restricted root system for  $\alpha \in \Delta(\mathfrak{g}, \mathfrak{h})$  by denoting  $\alpha' = \alpha|_{\mathfrak{t}_{\mathbb{R}}}$  the restriction of  $\alpha$  to  $\mathfrak{t}_{\mathbb{R}}$ . The (infinite) relative (or restricted) root system  $\Delta' = \Delta(\mathfrak{g}_{\mathbb{R}}, \mathfrak{t}_{\mathbb{R}}) = \{\alpha'; \alpha \in \Delta(\mathfrak{g}, \mathfrak{h})\} \setminus \{0\}$  and

$$\mathfrak{h}_{\mathbb{R}} = \mathfrak{h} \cap \mathfrak{g}^{\sigma'} = \mathfrak{h} \cap \mathfrak{g}_{\mathbb{R}}$$

$$\mathfrak{t}_{\mathbb{R}} = \bigoplus_{i \in \Omega} \mathbb{R}(p_i + p_{\tau_i})$$

where  $\Omega$  is the simple root corresponding to maximally compact Cartan subalgebras.

**3.1. The relative Kac-Moody matrix and Dynkin diagram.** A relative Kac-Moody matrix  $B' = (\alpha'_j, \alpha'_i) = (b'_{i,j})$  which satisfies  $b'_{i,j} \in \mathbb{Z}$ ,  $b'_{i,j} \leq 2$ ,  $b'_{i,j} \in \mathbb{Z}^-$  for  $i \neq j$ ,  $b'_{i,j} = 0$  iff  $b'_{j,i} = 0$ . The relative Kac-Moody matrix is associated a graph  $S(B')$ , with  $|I'|$  vertices, called the relative Dynkin diagram as follows; we associate each  $i$  a vertex equipped with a cross if  $b'_{i,i} = 1$ , with a  $-$  sign if  $b'_{i,i} < 0$  and with  $0$  if  $b'_{i,i} = 0$ . Two vertices  $i$  and  $j$  are linked iff  $b'_{i,j} < 0$ ; if  $b'_{i,i}$  and  $b'_{j,j}$  are positive and  $a'_{i,j}a'_{j,i} = n_{i,j} \leq 4$ , the vertices  $i$  and  $j$  are joined by  $m_{i,j} = \max(|a'_{i,j}|, |a'_{j,i}|)$  line(s) with an arrow pointing towards the vertex  $i$  if  $|a'_{i,j}| > 1$ . If  $n_{i,j} \geq 5$  or one of the two coefficient  $b'_{i,i}$  or  $b'_{j,j}$  is non-positive, the vertices  $i$  and  $j$  are joined by by a thick line on which we write  $|a'_{i,j}|$  (besides the vertex  $i$ ) and  $|a'_{j,i}|$  (beside the vertex  $j$ ). We use the same nomenclature as in [3] namely  $Z_-$  stands for  $\bullet_-$

### 4. REAL FORM OF HYPERBOLIC KAC-MOODY ALGEBRAS AND VOGAN DIAGRAM

We now recall some terms associated with Kac-Moody algebras.

A real form of  $\mathfrak{g}$  is an algebra  $\mathfrak{g}_{\mathbb{R}}$  over  $\mathbb{R}$  such that there exists an isomorphism from  $\mathfrak{g}$  to  $\mathfrak{g}_{\mathbb{R}} \otimes \mathbb{C}$ . If we replace  $\mathbb{C}$  with  $\mathbb{R}$  in the definition of  $\mathfrak{g}$ , we obtain a real form  $\mathfrak{g}_{\mathbb{R}}$  which is called split. A real form of  $\mathfrak{g}$  corresponds to a semi-linear involution of  $\mathfrak{g}$ . A semi-linear involution is an automorphism  $\tau$  of  $\mathfrak{g}$  such that  $\tau^2 = Id$  and  $\tau(\lambda x) = \bar{\lambda}\tau(x)$  for  $\lambda \in \mathbb{C}$ .

A Borel subalgebra of  $\mathfrak{g}$  is a maximal completely solvable subalgebra. There are two types of Borel subalgebra (positive or negative).

A linear or semi-linear automorphism of  $\mathfrak{g}$  is said to be of the first kind if it transforms a Borel subalgebra in  $\mathfrak{g}$  to a Borel subalgebra of the same sign. A linear or semilinear automorphism of  $\mathfrak{g}$  is said to be of the second kind if it transforms a Borel subalgebra into a Borel subalgebra of the opposite sign.

Let  $\mathfrak{g}_{\mathbb{R}}$  be a real form of  $\mathfrak{g}$  and fix an isomorphism from  $\mathfrak{g}$  to  $\mathfrak{g}_{\mathbb{R} \otimes \mathbb{C}}$ . Then the Galois group  $\Gamma = Gal(\mathbb{C}/\mathbb{R})$  acts on  $\mathfrak{g}$  and the corresponding group  $G$ . A real form is the fixed point set  $\mathfrak{g}^{\Gamma}$ . If  $\Gamma$  consists of first kind of automorphism then  $\mathfrak{g}_{\mathbb{R}}$  is almost split, otherwise if the non-trivial element of  $\Gamma$  is a second kind automorphism the  $\mathfrak{g}_{\mathbb{R}}$  is almost compact. We consider

- (1) The semiinvolutions  $\sigma'$ , of the second kind of  $\mathfrak{g}$ .
- (2) The involution  $\theta$ , of the first kind of  $\mathfrak{g}$ .

**Theorem 4.1.** [15] *The relation  $\sigma \approx \theta$  if and only if*

- (a)  $\omega' = \theta\sigma' = \sigma'\theta$  is a Cartan semiinvolution.
- (b)  $\theta$  and  $\sigma'$  stabilize the same Cartan subalgebra  $\mathfrak{h}$ .
- (c)  $\mathfrak{h}$  is contained in a minimal  $\sigma'$ -stable positive parabolic subalgebra.

*Remark 4.2.* The above theorem is proved in affine Kac-Moody algebras. Since the minimal parabolic subalgebra  $\mathfrak{p}$ , satisfy  $\sigma'(\mathfrak{p}) \cap \mathfrak{p} = \mathfrak{h}$ . The condition (c) in the theorem is equivalent to require that  $\mathfrak{h}^{\sigma'}$  is a maximally compact Cartan subalgebras. Then this relation induces a bijection between the conjugacy classes under  $Aut(\mathfrak{g})$  of semiinvolutions of the second kind and conjugacy classes of involutions of the first kind.

## 5. VOGAN DIAGRAM

Let  $\mathfrak{g}_{\mathbb{R}}$  be an almost compact real form of  $\mathfrak{g}$ . Let  $\sigma$  be the Cartan involution and  $\mathfrak{g}_{\mathbb{R}} = \mathfrak{k}_0 \oplus \mathfrak{p}_0$  be the corresponding Cartan decomposition. Let  $\mathfrak{h}_0 = \mathfrak{t}_0 \oplus \mathfrak{a}_0$  be a maximally compact  $\sigma$ -stable Cartan subalgebra of  $\mathfrak{g}_{\mathbb{R}}$ , with complexification  $\mathfrak{h} = \mathfrak{t} \oplus \mathfrak{a}$

The roots of  $(\mathfrak{g}, \mathfrak{h})$  are imaginary on  $\mathfrak{t}_0$  and real on  $\mathfrak{a}_0$ . A root is real if it takes real values on  $\mathfrak{a}_0$ . A root is real if it takes real values on  $\mathfrak{h}_0$  (i.e., vanishes on  $\mathfrak{t}_0$ ), imaginary if it takes purely imaginary values on  $\mathfrak{h}_0$  (i.e., vanishes on  $\mathfrak{a}_0$ ) and complex otherwise.

For any root  $\alpha$ ,  $\sigma\alpha$  is the root  $\sigma\alpha(H) = \alpha(\sigma^{-1}H)$ . If  $\alpha$  is imaginary, then  $\sigma\alpha = \alpha$ . Thus  $\mathfrak{g}_{\alpha}$  is  $\sigma$ -stable, and we have  $\mathfrak{g}_{\alpha} = (\mathfrak{g}_{\alpha} \cap \mathfrak{t}) \oplus (\mathfrak{g}_{\alpha} \cap \mathfrak{p})$ . Since  $\mathfrak{g}_{\alpha}$  is one dimensional,  $\mathfrak{g}_{\alpha} \subseteq \mathfrak{t}$  or  $\mathfrak{g}_{\alpha} \subseteq \mathfrak{p}$ . We call an imaginary root  $\alpha$  compact if  $\mathfrak{g}_{\alpha} \subseteq \mathfrak{t}$ , noncompact if  $\mathfrak{g}_{\alpha} \subseteq \mathfrak{p}$ . Let  $\mathfrak{h}_0$  be a  $\sigma$ -stable Cartan subalgebra of  $\mathfrak{g}_{\mathbb{R}}$ . Then there are no real roots if and only if  $\mathfrak{h}_0$  is maximally compact [1, Proposition 3.8].

Let  $\Delta = \Delta(\mathfrak{g}, \mathfrak{h})$  be the set of roots. There are no real roots, i.e., no roots that vanishes on  $\mathfrak{t}$ . We choose a positive system  $\Delta^+$  for  $\Delta$  that takes  $i\mathfrak{t}_0$  before  $\mathfrak{a}_0$ . Since  $\sigma$  is  $+1$  on  $\mathfrak{t}_0$  and  $-1$  on  $\mathfrak{a}_0$  and since there are no real roots,  $\sigma(\Delta^+) = \Delta^+$ . Therefore  $\sigma$  permutes the simple roots. It must fix the simple roots that are imaginary and permutes in two cycles the simple roots that are complex.

By the Vogan diagram of the triple  $(\mathfrak{g}, \mathfrak{h}_0, \Delta^+)$ , we mean the Dynkin diagram of  $\Delta^+$  with the two-element orbits under  $\sigma$  (*diagram automorphism*) labeled by an arrow and with the one-element orbits painted or not, according to the corresponding imaginary simple root, noncompact or compact.

**Theorem 5.1.** *Every over extended Vogan diagram represents an almost compact real form of an hyperbolic Kac-Moody Lie algebra. Two overextended Vogan diagrams are equivalent if and only if their corresponding algebras are isomorphic.*

Here we reformulate the Borel and de Siebenthal Theorem for hyperbolic Kac-Moody algebras.

**Theorem 5.2.** (*Borel and de Siebenthal*) *Every equivalence class of very extended (hyperbolic) Vogan diagrams has a representative with at most one vertex painted.*

*Proof.* The Borel and de Siebenthal theorem says that every real form of a complex simple Lie algebra can be represented by a Vogan diagram with at most one painted vertex and this was verified by using algorithm  $F(i)$  in [4] and diagram automorphisms to explicitly reduce every painting on a Dynkin diagram  $D$  to another painting with at most one painted vertex.

In [6], it is shown that the equivalence class of Vogan diagram of an extended Dynkin diagram  $D$ , with an extra vertex  $p$  with extra edge consist of at most two painted vertices.

The very extended Dynkin diagram consists of a very extra vertex with very extra edge with at most two painted vertices, we obtain a painting with at most three painted vertices. But using the same  $F(i)$  algorithm we get a painting with at most one painted vertex.  $\square$

The following Corollary is immediate.

**Corollary 5.3.** *If a connected graph  $D$  is a hyperbolic Dynkin diagram, then*

- (a) *every painting on  $D$  can be simplified via a sequence of  $F < i >$  to a painting with single painted vertex.*
- (b) *every connected subgraph of  $D$  satisfies property (a).*

*Proof.* The proof of the corollary is straightforward using the  $F < i >$  sequences. □

The Vogan diagrams  $HA^{(2)}$  is a results of Theorem 6.2 and Corollary 6.3.

Using the Theorem 6.2 without the  $F(i)$  algorithm we get at most three painted vertices Vogan diagrams.

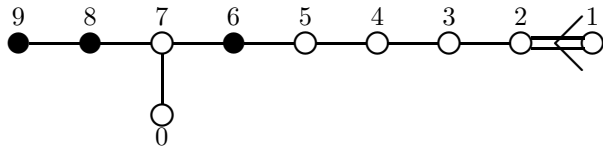

The above Vogan diagram with vertices painted  $(9, 8, 6)$  is equivalent to single painted Vogan diagram by using theorem 4.1 and we get  $(9, 8, 6) \sim (8, 7) \sim (0, 7) \sim (0)$  by  $F < 8, 7, 0 >$  So the equivalent diagram becomes

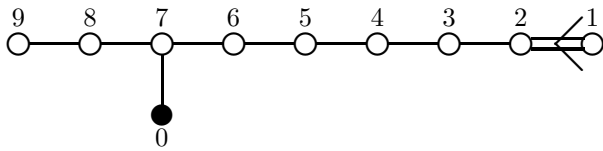

Similarly One can get single painted Vogan diagram using Theorem 4.1 using the three painted diagrams below

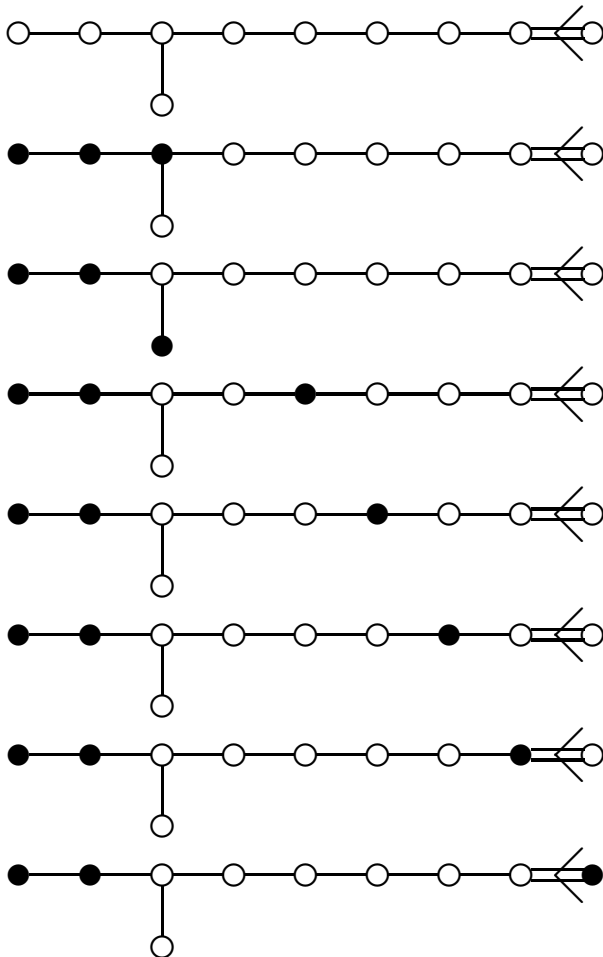

**5.1. Equivalence classes of Vogan diagrams.** Batra [1] defined equivalence of Vogan diagrams by defining equivalence relations generated by the following two operations:

- (a) Application of an automorphism of the Dynkin diagram.
- (b) Change in the positive system by reflection in a simple, noncompact root, i.e., by a vertex which is colored in the Vogan diagram.

As a consequence of reflection by a simple, noncompact root  $\alpha$ , the rule for single and triple lines is that we leave  $\alpha$  colored and its immediate neighbour is changed to the opposite color. The rule for double lines is that if  $\alpha$  is the smaller root, then there is no change in the color of its immediate neighbour, but we leave  $\alpha$  colored. If  $\alpha$  is the larger root, then we leave  $\alpha$  colored and its immediate neighbour is changed to the opposite color. If two Vogan diagrams are not equivalent to each other, they are called nonequivalent.

By labeling vertices with  $1, \dots, n$  as in [4, 5] a Vogan diagram with painted vertices  $i_1, \dots, i_k$ ,  $1 \leq i_1 \leq \dots < i_k \leq n$ , is denoted by  $(i_1, \dots, i_k)$ . Suppose  $i \in \{i_1, \dots, i_k\}$ , so that  $i$  is a painted vertices. The  $F\langle i \rangle$  operates on the Vogan diagram as follows. It acts on the root system by reflection corresponding to the noncompact simple root  $i$ , as a result it leads an equivalent Vogan diagram. A combinatorial description for two Vogan diagrams to be equivalent with  $F\langle i \rangle$  operation is as follows

- (i) The color of  $i$  and all vertices not adjacent to  $i$  remain unchanged.
- (ii) If  $j$  is joined to  $i$  by a double edge and  $j$ 's long, the color of  $j$  remains unchanged.
- (iii) Apart from the above exceptions, the colors of all vertices adjacent to  $i$ , are reversed.

For Exceptional Dynkin diagram like  $E_{10}$ , we get the following Lemma from [6]

**Lemma 5.4.** ([6], Lemma 3.8 )

- (a) For  $q \geq 4$  and  $p = 2, 3$ , we get  $(p, q) \sim (0, p-1, q-1)$  and  $(0, p, q) \sim (p-1, q-1)$
- (b) For  $q \geq 4$ ,  $(1, q) \sim (0, q-1)$  and  $(0, 1, q) \sim (q-1)$

Applying all these technique in our hand, now we proceed to find the Vogan diagrams of some algebras which are important in respect of physical applications in string theory, High energy physics etc. We start with  $E_{10}$ .

**Example-1** Dynkin diagram of hyperbolic Kac-Moody algebra  $E_{10}$ .

The Dynkin diagram of  $E_{10}$  is given as.

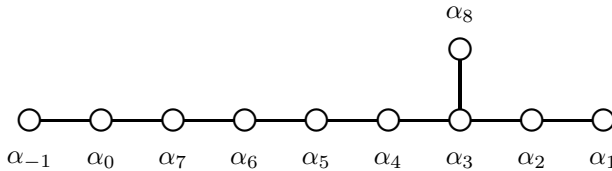

$\alpha_0$  and  $\alpha_{-1}$  roots correspond to affine and hyperbolic extension of simple Lie algebra  $E_8$  respectively. Enumerating the vertices of  $E_{10}$  differently as shown below we get the Dynkin diagram and the following proposition.

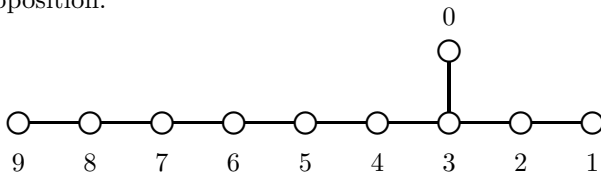

**Proposition 5.5.** The equivalence classes of Vogan diagram of  $E_{10}$  are given by

- (1)  $1 \sim 5 \sim (0, 4) \sim (0, 9) \sim (0, 8)$
- (2)  $2 \sim 3 \sim 7 \sim 8 \sim (0, 7) \sim (0, 6) \sim 0 \sim 4 \sim 6 \sim 9 \sim (0, 3) \sim (0, 1) \sim (0, 2) \sim (0, 5) \sim (0, 7)$

*Proof.* The proposition can be proved by using Lemma 5.4, switching the sequences as follows

- (0, 7)  $\sim$  (1, 8) by Lemma 5.4(b)
- $\sim$  (0, 2, 9) by Lemma 5.4(a)
- $\sim$  (8)  $F \langle 0, 3, 4, 5, 6, 7, 8 \rangle$
- $\sim$  (0, 1, 9) by Lemma 5.4(b)
- $\sim$  (2) by  $F \langle 9, 8, 7, 6, 5, 4, 3, 2 \rangle$
- $\sim$  (0, 1, 4) by  $F \langle 2, 3, 0 \rangle$
- $\sim$  (3) by Lemma 5.4(b)
  
- (0, 5)  $\sim$  (1, 6) by Lemma 5.4(b)
- $\sim$  (0, 2, 7) by Lemma 5.4(a)
- $\sim$  (6) by  $F \langle 0, 3, 4, 5, 6 \rangle$
- $\sim$  (0, 1, 7) by Lemma 5.4(b)
- $\sim$  (2, 8) by Lemma 5.4(a)
- $\sim$  (0)  $F \langle 8, 7, 6, 5, 4, 3, 0 \rangle$
- $\sim$  (0, 3)  $F \langle 0 \rangle$
- $\sim$  (1, 4) by Lemma 5.4(b)
- $\sim$  (0, 2, 5)  $\sim$  (4)  $F \langle 0, 3, 4 \rangle$
- $\sim$  (0, 1, 5) by Lemma 5.4(b)
- $\sim$  (2, 6) by Lemma 5.4(b)
- $\sim$  (0, 7)  $F \langle 6, 5, 4, 3, 0 \rangle$
- $\sim$  (1, 8) by Lemma 5.4(b)
- $\sim$  (0, 2)  $F \langle 8, 7, 6, 5, 4, 3, 2 \rangle$
- $\sim$  (0, 1)  $F \langle 0, 2, 1 \rangle$
- $\sim$  (9) by  $F \langle 1, 2, 3, 4, 5, 6, 7, 8, 9 \rangle$
  
- (5)  $\sim$  (0, 1, 6) by Lemma 5.4(b)
- $\sim$  (1, 5)  $F \langle 0, 1, 3, 4, 5 \rangle$
- $\sim$  (0, 4) by Lemma 5.4(b)  $\sim$  (1) by  $F \langle 0, 3, 2, 1 \rangle$
- $\sim$  (0, 9)  $F \langle 1, 2, 3, 4, 5, 6, 7, 8, 9 \rangle$
  
- (0, 6)  $\sim$  (1, 7) by Lemma 5.4(b)
- $\sim$  (0, 2, 8) by Lemma 5.4(a)
- $\sim$  (7) by  $F \langle 0, 3, 4, 5, 6 \rangle$
- $\sim$  (0, 1, 8) by Lemma 5.4(b)
- $\sim$  (2) by  $F \langle 8, 7, 6, 5, 4, 3, 2 \rangle$
- $\sim$  (0, 1, 4) by  $F \langle 2, 3, 0 \rangle$
- $\sim$  (3) by Lemma 5.4(b)

□

Remark 5.6. The two Vogan diagrams of hyperbolic Kac-Moody  $E_{10}$  are given below.

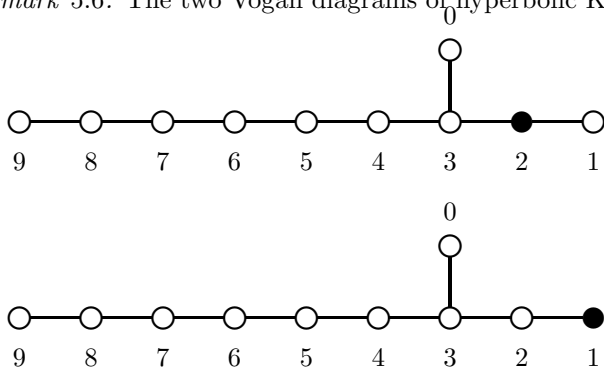

Now we consider some more examples.

**Example-2** Dynkin diagram of a rank 4 hyperbolic algebra  
 Consider the Dynkin diagram

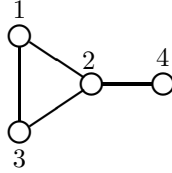

**Proposition 5.7.** *The equivalence classes of Vogan diagram of the above hyperbolic Kac-Moody algebra are given by*

- (a)  $1 \sim 3 \sim 4$
- (b) 2

*Proof.* By applying Lemma 5.4 [6]

$$\begin{aligned}
 (1) \quad & \sim (1, 2, 3) && \text{by } F\langle 1 \rangle \\
 & \sim (2, 4) && \text{by } F\langle 2 \rangle \\
 & \sim (4) && \text{by } F\langle 4 \rangle \\
 (1, 2, 3) & \sim (3) && \text{by } F\langle 3 \rangle
 \end{aligned}$$

Also we have

$$\begin{aligned}
 (2) \quad & \sim (1, 2, 3, 4) && F\langle 2 \rangle \\
 & \sim (1, 3, 4) && F\langle 4 \rangle
 \end{aligned}$$

Vogan diagram of this algebra is given by

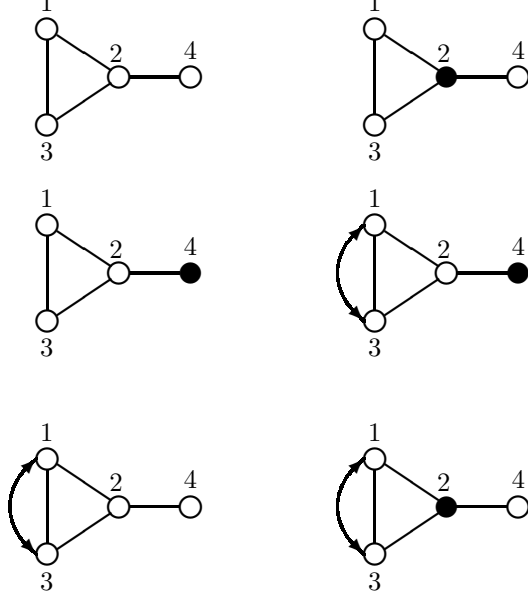

□

**Example-3** The Dynkin diagram of another rank 4 hyperbolic Kac-Moody algebra is given by

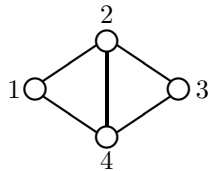

**Proposition 5.8.** *The equivalence classes of another rank 4 hyperbolic Kac-Moody algebra are given by*

- (a)  $3 \sim 1$  (by symmetry)  $\sim (1, 2, 4) \sim (3, 4)$
- (b)  $4 \sim 2$  by symmetry

*Proof.* By symmetry (diagram automorphism) and  $F_i$  algorithm, we get .

- (a)  $1 \sim (1, 2, 4)$  by  $F\langle 1 \rangle \sim (3, 4)$  by  $F\langle 4 \rangle$
- (b)  $4 \sim (1, 3, 4)$  by  $F\langle 4 \rangle \sim (2, 3)$  by  $F\langle 1 \rangle$

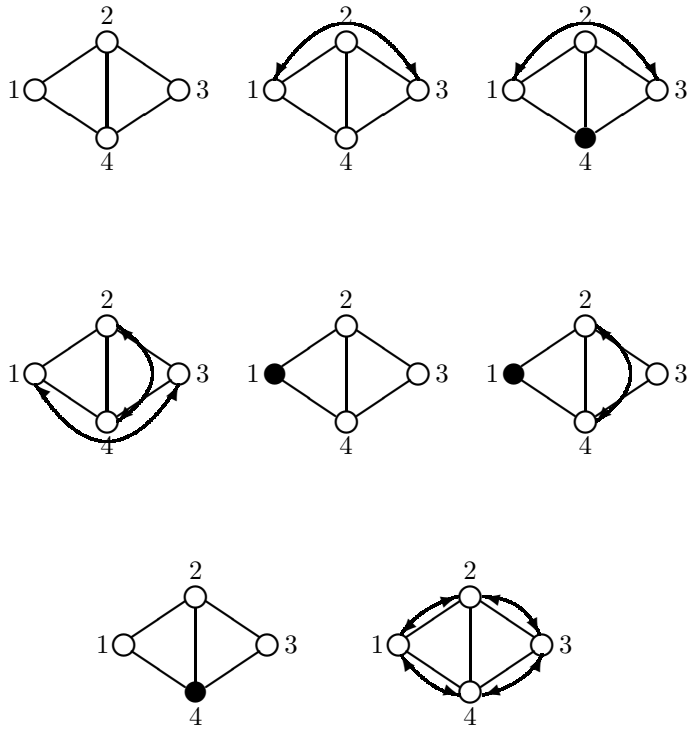

□

**Example-4** The dynkin diagram of a rank 5 hyperbolic Kac-Moody algebra is given by

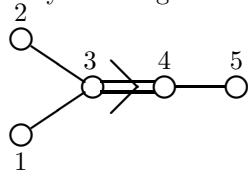

**Proposition 5.9.** *The equivalence classes of Vogan diagram of this rank 5 hyperbolic Kac-Moody algebra are given by*

- (a)  $1 \sim 2 \sim 3$
- (b)  $4 \sim (4, 5) \sim 5$

*Proof.* By using  $F_i$  algorithm

$$\begin{aligned} 2 &\sim (2, 3) && \text{by } F\langle 2 \rangle \\ &\sim (1, 2, 3, 4) && \text{by } F\langle 3 \rangle \end{aligned}$$

and

$$\begin{aligned} 1 &\sim (1, 3) && \text{by } F\langle 1 \rangle \\ &\sim (1, 2, 3, 4) && \text{by } F\langle 3 \rangle \\ &\sim (1, 2, 3, 4, 5) && \text{by } F\langle 4 \rangle \end{aligned}$$

from above we get  $1 \sim 2$

$$3 \sim (1, 2, 3, 4) \text{ by } F\langle 3 \rangle \sim (1, 2, 4) \text{ by } F\langle 1 \rangle$$

So  $1 \sim 2 \sim 3$

$$4 \sim (4, 5) \text{ by } F\langle 4 \rangle \sim 5 \text{ by } F\langle 5 \rangle$$

So the Vogan Diagrams of the above dynkin diagram with diagram automorphism become

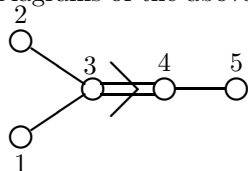

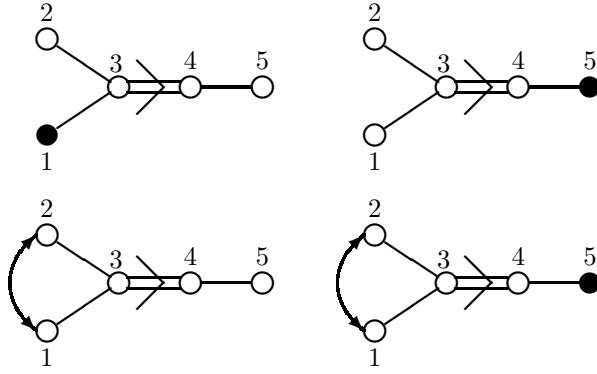

□

**Example-5** The dynkin diagram of another rank 5 hyperbolic Kac-Moody algebra is given by

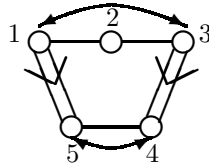

**Proposition 5.10.** *The equivalence classes of this rank 5 hyperbolic Kac-Moody algebra are given by*

- (a)  $2 \sim (1, 2, 3)$
- (b)  $5 \sim (4, 5) \sim (2, 3, 4, 5) \sim 4 \sim (4, 5)$
- (c)  $1 \sim (1, 2, 5) \sim (2, 3, 5) \sim 3 \sim (2, 3, 4) \sim (1, 2, 4)$

*Proof.* (a)  $(2) \sim (1, 2, 3)$  by  $F(2) \sim (1, 4, 5)$   
 (b)  $(5) \sim (4, 5)$  by  $F(5) \sim (2, 3, 4, 5)$  by  $F(3)$   
 and  $(4) \sim (4, 5)$  by  $F(4)$   
 (c)  $(1) \sim (1, 2, 5)$  by  $F(1) \sim (2, 3, 5)$  by  $F(2) \sim (2, 3, 4)$  by  $F(4)$   
 and  $3 \sim (2, 3, 4)$  by  $F(3) \sim (1, 2, 4)$  by  $F(2)$

□

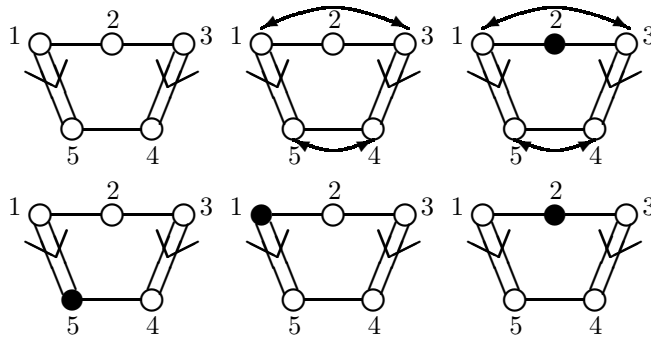

**Example-6** The Dynkin diagram of another rank 5 hyperbolic Kac-Moody algebra is given by

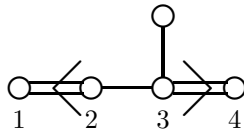

**Proposition 5.11.** *The equivalence classes of this rank 5 hyperbolic Kac-Moody algebra are given by*

- (a) 1
- (b) 4
- (c) 5
- (d) 3
- (e) 2

- Proof.* (a)  $1 \sim 1$  by  $F\langle 1 \rangle$   
 (b)  $4 \sim 4$  by  $F\langle 4 \rangle$   
 (c)  $5 \sim (5, 3)$  by  $F\langle 5 \rangle \sim (2, 3, 4)$  by  $F\langle 3 \rangle$   
 (d)  $3 \sim (2, 3, 4, 5)$  by  $F\langle 5 \rangle$   
 (e)  $2 \sim (1, 2, 3)$  by  $F\langle 2 \rangle$

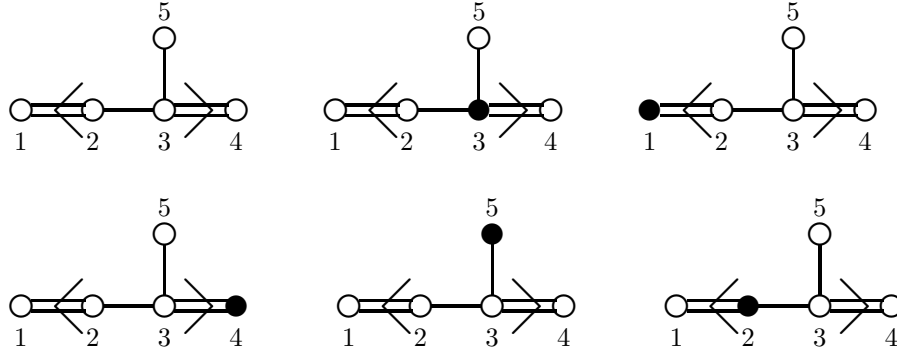

□

6. VOGAN DIAGRAMS OF SOME MORE HYPERBOLIC KAC-MOODY ALGEBRAS AND ITS RELATIVE DIAGRAMMS

We will construct few relative Dynkin diagrams, we can find similarly the relative diagrams of all Vogan diagrams.

The Vogan diagrams of  $GG_3$

- $1 \sim 1$  by  $F\langle 1 \rangle$   
 $2 \sim (1, 2, 3)$   
 $1 \sim 3$  by symmetry

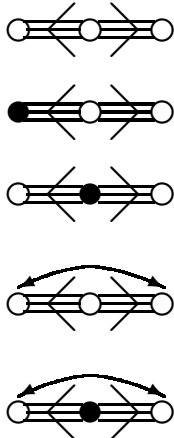

From the above diagrams we get the relative Dynkin diagrams

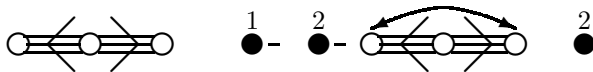

The Vogan diagrams of  $G'G_3$

**Proposition 6.1.** *The equivalence classes of this rank 3 hyperbolic Kac-Moody algebra are given by*

- (a)  $1 \sim 2$   
 (b) 3

*Proof.*  $1 \sim (1, 2) \sim (2, 3) \sim (1, 2, 3)$  by  $F\langle 1, 2, 3 \rangle$  and  $2 \sim (2, 3)$  by  $F\langle 2 \rangle$ . Hence  $1 \sim 2$ .

□

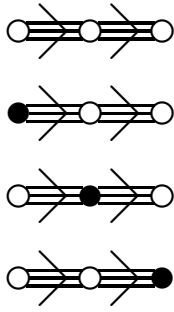

Its relative Dynkin diagrams are



The Vogan diagrams of  $G'G'_3$

**Proposition 6.2.** *The equivalence classes of this rank 3 hyperbolic Kac-Moody algebra are given by*

- (a)  $1 \sim 3$
- (b)  $2 \sim 2$

*Proof.*

- (a) By symmetry  $1 \sim 3$
- (b)  $2 \sim 2$

□

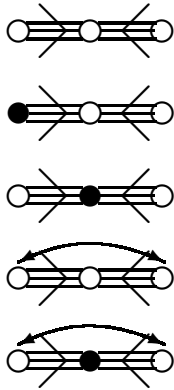

We have the relative Dynkin diagrams for restricted roots

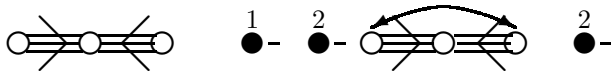

The Vogan diagrams of  $AC_2^{(1)}$

**Proposition 6.3.** *The equivalence classes of this rank 3 hyperbolic Kac-Moody algebra are given by*

- (a) 1
- (b) 3

- Proof.*
- (a)  $1 \sim (1, 2, 3) \sim 2$  by  $F(1, 2)$
  - (b)  $3 \sim 3$  by  $F(3)$

□

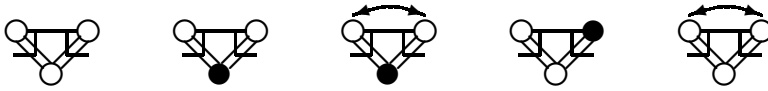

The Vogan diagrams of  $AD_3^{(2)}$

**Proposition 6.4.** *The equivalence classes of this rank 3 hyperbolic Kac-Moody algebra are given by*

- (a) 1
- (b) 3

*Proof.* (a)  $1 \sim (1, 2) \sim 2$  by  $F\langle 1, 2 \rangle$  also by symmetry  
 (b)  $3 \sim (1, 2, 3)$

□

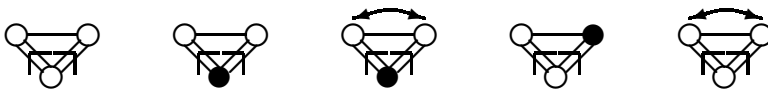

The Vogan diagrams of  $AGG_3$

**Proposition 6.5.** *The equivalence classes of this rank 3 hyperbolic Kac-Moody algebra are given by*

- (a) 1
- (b) 3

*Proof.* (a)  $1 \sim (1, 2) \sim 2$  by  $F\langle 1, 2 \rangle$  also by symmetry  
 (b)  $3 \sim (1, 2, 3)$

□

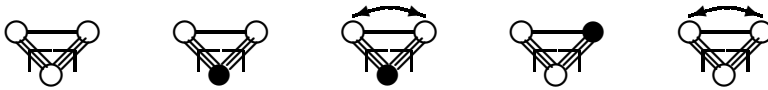

The Vogan diagrams of  $AG'G'_3$

**Proposition 6.6.** *The equivalence classes of this rank 3 hyperbolic Kac-Moody algebra are given by*

- (a) 1
- (b) 3

*Proof.* (a)  $1 \sim (1, 2, 3) \sim 2$  by  $F\langle 1, 2 \rangle$   
 (b)  $3 \sim 3$  by  $F\langle 3 \rangle$

□

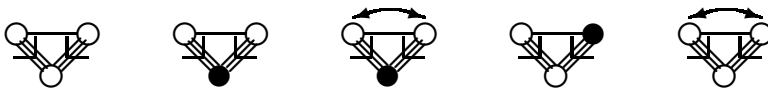

The Vogan diagram of  $AC_{3,4}^{(1)}$

**Proposition 6.7.** *The equivalence classes of this rank 4 hyperbolic Kac-Moody algebra are given by*

- (a) 1
- (b) 2

*Proof.* (a) By symmetry  $1 \sim 4$   
 (b) By symmetry  $2 \sim 3$

□

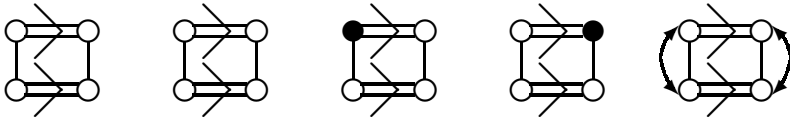

Vogan diagrams of  $HG_2^{(1)}$

**Proposition 6.8.** *The equivalence classes of this rank 4 hyperbolic Kac-Moody algebra are given by*

- (a) 1
- (b)  $2 \sim 4$
- (c) 3
- (d) 4

*Proof.* (a)  $1 \sim 1$  by  $F\langle 1 \rangle$   
 (b)  $2 \sim (1, 2, 3) \sim (1, 3, 4) \sim 4$  by  $F\langle 2, 3, 4 \rangle$   
 (c)  $3 \sim (2, 3, 4) \sim (2, 4)$  by  $F\langle 3, 4 \rangle$   
 (d)  $4 \sim (3, 4) \sim (2, 3) \sim (1, 2)$

□

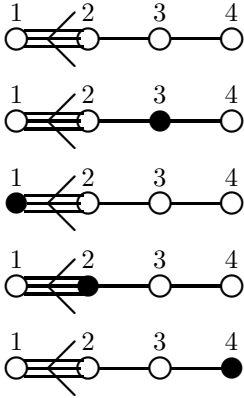

The Vogan diagram of  $HF_4^{(1)}$

**Proposition 6.9.** *The equivalence classes of this rank 6 hyperbolic Kac-Moody algebra are given by*

- (a) 1
- (b) 2
- (c) 3
- (d) 4
- (e) 5

*Proof.* (a)  $1 \sim (1, 2) \sim (2, 3) \sim (3, 4) \sim (4, 5) \sim (4, 5, 6) \sim (4, 6)$  by  $F\langle 1, 2, 3, 4, 5, 6 \rangle$   
 (b)  $2 \sim (1, 2, 3) \sim (1, 3, 4) \sim (1, 4, 5) \sim (1, 4, 5, 6) \sim (1, 4, 6)$  by  $F\langle 2, 3, 4, 5, 6 \rangle$   
 (c)  $3 \sim (2, 3, 4) \sim (2, 4, 5) \sim (2, 4, 5, 6) \sim (2, 4, 5, 6) \sim (2, 4, 6)$  by  $F\langle 3, 4, 5, 6 \rangle$   
 (d)  $4 \sim (3, 4, 5) \sim (3, 4, 5, 6) \sim (3, 4, 6)$  by  $F\langle 4, 5, 6 \rangle$   
 (e)  $5 \sim (5, 6) \sim 6$  by  $F\langle 5, 6 \rangle$

□

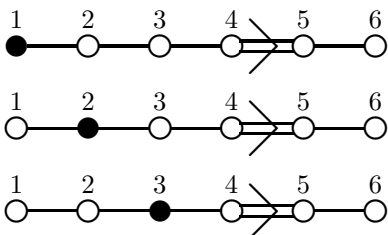

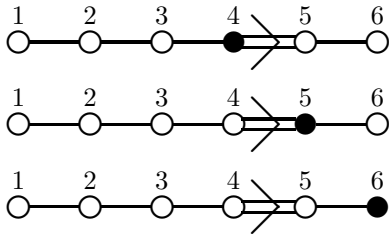

The Vogan diagram of  $HA_2^{(2)}$

**Proposition 6.10.** *The equivalence classes of Vogan diagrams on rank 3 hyperbolic Kac-Moody algebra are given by*

- (a)  $1 \sim 2$
- (b) 3

*Proof.* (a)  $1 \sim (1, 2) \sim (1, 2, 3) \sim 2$  by  $F\langle 1, 2, 2 \rangle$   
 (b)  $3 \sim 3$  by  $F\langle 3 \rangle$

□



The Vogan diagrams of  $H'A_2^{(2)}$

**Proposition 6.11.** *The equivalence classes of Vogan diagrams on rank 3 hyperbolic Kac-Moody algebra are given by*

- (a)  $1 \sim 2$
- (b) 3

*Proof.* (a)  $1 \sim (1, 2) \sim 2$  by  $F\langle 1, 2, 2 \rangle$   
 (b)  $3 \sim (2, 3) \sim (1, 2, 3) \sim (1, 3)$  by  $F\langle 3, 2, 1 \rangle$

□

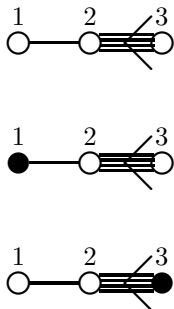

The Vogan diagrams of  $HC_n^1$

**Proposition 6.12.** *The equivalence classes of this rank 6 hyperbolic Kac-Moody algebra are given by*

- (a)  $1 \sim 2$
- (b)  $3 \sim 5$
- (c) 4
- (d) 5

*Proof.* (a)  $1 \sim (1, 2) \sim (1, 2, 3)$  by  $F\langle 1, 2 \rangle$  and  $2 \sim (1, 2, 3)$ . So  $1 \sim 2$

- (b)  $3 \sim (3, 4) \sim (4, 5) \sim 5$  by  $F\langle 2, 3, 4, 5 \rangle$
- (c)  $4 \sim (3, 4, 5) \sim (3, 5)$  by  $F\langle 4, 5 \rangle$
- (d)  $5 \sim (4, 5) \sim (5, 6)$  by  $F\langle 6, 5 \rangle$

□

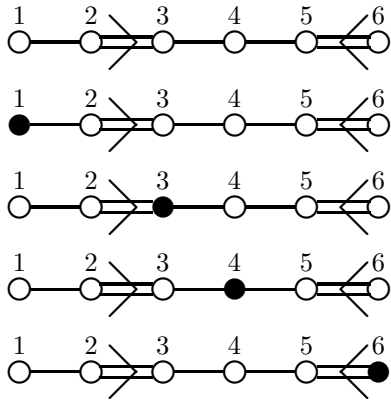

The Vogan diagrams of  $HD_{n,n+2}^{(1)}$

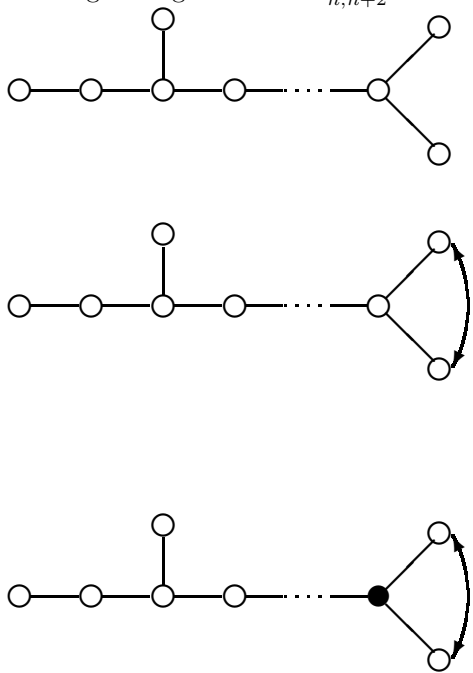

Vogan diagrams of  $H^2D_4^{(1)}$

**Proposition 6.13.** *The equivalence classes of this rank 6 hyperbolic Kac-Moody algebra are given by*

- (a)  $1 \sim 2$
- (b)  $4 \sim 5 \sim 6$
- (c)  $3$

*Proof.*

- (a)  $1 \sim 2$  by  $F\langle 1, 2 \rangle$
- (b) From the symmetry of the diagram we get  $4 \sim 5 \sim 6$
- (c)  $3 \sim (2, 3, 4, 5, 6)$  by  $F\langle 3 \rangle$

□

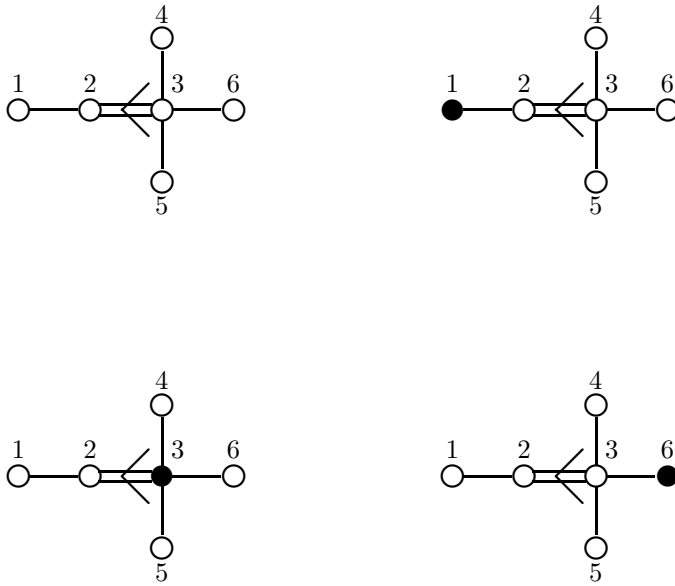

**Acknowledgement**

The authors thank National Board of Higher Mathematics, India (Project Grant No. 48/3/2008-R&D II/196-R) for financial support.

REFERENCES

[1] Batra P., *Invariant of Real forms of Affine Kac-Moody Lie algebras*, Journal of Algebra 223, 208 - 236 (2000).  
 [2] Batra P., *Vogan diagrams of affine kac-Moody algebras*, Journal of Algebras 251, 80 - 97 (2002).  
 [3] Ben Messaud H., *Almost split real forms for Hyperbolic Kac-Moody Lie algebras*, J.Phys. A: Math.Gen.39 (2006) 13659 - 13690.  
 [4] Chuah Meng-Kiat, Hu Chu-Chin, *Equivalence classes of Vogan diagrams*, Journal of Algebra 279 (2004) 22 - 37.  
 [5] Chuah Meng-Kiat, Hu Chu-Chin, *A Quick Proof on the Equvalence classes of Extended Vogan diagrams*, Journal of Algebra 313 (2007) 624-927.  
 [6] Chuah Meng-Kiat, Hu Chu-Chin, *Extended Vogan diagrams*, Journal of Algebra, 301 (2006) 112 - 147.  
 [7] Damour T., Henneaux M., and Nicolai H.,  *$E_{10}$  and a small tension expansion of M-theory*, Physc. Rev. Lett., 89(22): 221601 - 4, (2002).  
 [8] Damour T. and Marc Henneaux,  *$E_{10}$ ,  $BE_{10}$  and Arithmetical Chaos in Superstring Cosmology*, arxiv:hep-th0012172v2, 12 April (2001).  
 [9] Helgason Sigurdur, *Differential Geometry, Lie Groups and Symmetric Spaces*, Academic Press (1994).  
 [10] Kac V. G., *Infinite dimensional Lie algebra*, Cambridge University Press (1994).  
 [11] Knapp A. W., *Lie groups beyond an Introduction*, Second Edition, Birkhauser (2005).  
 Vol. 10, No.2 (1986), 269-283.  
 [12] Pati K. C., Parashar D. and Kaushal R. S., *Involutive automorphisms and Iwasawa decomposition of some hyperbolic Kac-Moody algebras* J. Math. Phy. 40 (1) (1999).  
 [13] Paul Tanushree, *Vogan diagram of twisted Affine Kac-Moody lie algebras*, Pacific Journal of Mathematics, Vol 239, No 1, January (2009).  
 [14] Sacligu Cihan, *String vertex operators and Dynkin diagrams for Hyperbolic Kac-Moody algebras*, CERN-TH.4854/87  
 [15] Rousseau G. and Messaoud H. Ben, J.Algebra 267 (2003) 443-513  
 [16] Sophie de Buyl, *Kac-Moody algebras in M-theory*, hep-th/0608161.  
 [17] Damour, T., S. De Buyl, and M. Henneaux. *Einstein Billiards and Overextensions of Finite-dimensional Simple Lie Algebras*, arXiv:hep-th/0206125v1.