

On Approximation Lower Bounds for TSP with Bounded Metrics

Marek Karpinski*

Richard Schmied†

Abstract

We develop a new method for proving explicit approximation lower bounds for TSP problems with bounded metrics improving on the best up to now known bounds. They almost match the best known bounds for unbounded metric TSP problems. In particular, we prove the best known lower bound for TSP with bounded metrics for the metric bound equal to 4.

1 Introduction

We give first the basic definitions and an overview of the known results.

Traveling Salesperson (TSP) Problem

We are given a metric space (V, d) and the task consists of constructing a shortest tour visiting each vertex exactly once.

The TSP problem in metric spaces is one of the most fundamental NP-hard optimization problems. The decision version of this problem was shown early to be NP-complete by Karp [K72]. Christofides [C76] gave an algorithm approximating the TSP problem within $3/2$, i.e., an algorithm that produces a tour with length being at most a factor $3/2$ from the optimum.

As for lower bounds, a reduction due to Papadimitriou and Yannakakis [PY93] and the PCP Theorem [ALM⁺98] together imply that there exists some constant, not better than $1 + 10^{-6}$, such that it is NP-hard to approximate the TSP problem with distances either one or two. For discussion of bounded metrics TSP, see also [T00]. This hardness result was improved by Engebretsen [E03], who proved that it is NP-hard to approximate the TSP problem restricted to distances one and two with an approximation factor better than $5381/5380$ (1.00018). Böckenhauer and Seibert [BS00] studied the TSP problem with distances one, two and three, and

*Dept. of Computer Science and the Hausdorff Center for Mathematics, University of Bonn. Supported in part by DFG grants and the Hausdorff Center grant EXC59-1. Email: marek@cs.uni-bonn.de

†Dept. of Computer Science, University of Bonn. Work supported by Hausdorff Doctoral Fellowship. Email: schmied@cs.uni-bonn.de

obtained an approximation lower bound of $3813/3812$ (1.00026). Then, Papadimitriou and Vempala [PV06] showed that approximating the general problem with a constant approximation factor better than $220/219$ (1.00456) is NP-hard. Recently, this bound was improved to $185/184$ (1.00543) by Lampis [L12].

The restricted version of the TSP problem, in which the distance function takes values in $\{1, \dots, B\}$, is referred to as the $(1, B)$ -TSP problem.

The $(1, 2)$ -TSP problem can be approximated in polynomial time with an approximation factor $8/7$ due to Berman and Karpinski [BK06].

On the other hand, Engebretsen and Karpinski [EK06] proved that it is NP-hard to approximate the $(1, B)$ -TSP problem with an approximation factor less than $741/740$ (1.00135) for $B = 2$ and $389/388$ (1.00257) for $B = 8$.

In this paper, we prove that the $(1, 2)$ -TSP and the $(1, 4)$ -TSP problem are NP-hard to approximate with an approximation factor less than $535/534$ and $337/336$, respectively.

Asymmetric Traveling Salesperson (ATSP) Problem

We are given an asymmetric metric space (V, d) , i.e., d is not necessarily symmetric, and we would like to construct a shortest tour visiting every vertex exactly once.

The best known algorithm for the ATSP problem approximates the solution within $O(\log n / \log \log n)$, where n is the number of vertices in the metric space [AGM⁺10].

On the other hand, Papadimitriou and Vempala [PV06] proved that the ATSP problem is NP-hard to approximate with an approximation factor less than $117/116$ (1.00862).

It is conceivable that the special cases with bounded metric are easier to approximate than the cases when the distance between two points grows with the size of the instance. Clearly, the $(1, B)$ -ATSP problem, in which the distance function is taking values in the set $\{1, \dots, B\}$, can be approximated within B by just picking any tour as the solution.

When we restrict the problem to distances one and two, it can be approximated within $5/4$ due to Bläser [B04].

Furthermore, it is NP-hard to approximate this problem with an approximation factor better than $321/320$ [BK06].

For the case $B = 8$, Engebretsen and Karpinski [EK06] constructed a reduction yielding the approximation lower bound $135/134$ for the $(1, 8)$ -ATSP problem.

In this paper, we prove that it is NP-hard to approximate the $(1, 2)$ -ATSP and the $(1, 4)$ -ATSP problem with an approximation factor less than $207/206$ and $141/140$, respectively.

Maximum Asymmetric Traveling Salesperson (MAX-ATSP) Problem

We are given a complete directed graph G and a weight function w assigning each edge of G a nonnegative weight. The task is to find a tour of maximum weight visiting every vertex of G exactly once.

This problem is well-known and motivated by several applications (cf. [BGS02]). A good approximation algorithm for the MAX-ATSP problem yields

a good approximation algorithm for many other optimization problems such as the Shortest Superstring problem, the Maximum Compression problem and the $(1, 2)$ -ATSP problem.

The MAX- $(0, 1)$ -ATSP problem is the restricted version of the MAX-ATSP problem, in which the weight function w takes values in the set $\{0, 1\}$.

Vishwanathan [V92] constructed an approximation preserving reduction proving that any $(1/\alpha)$ -approximation algorithm for the MAX- $(0, 1)$ -ATSP problem transforms in a $(2-\alpha)$ -approximation algorithm for the $(1, 2)$ -ATSP problem. Due to this reduction, all negative results concerning the approximation of the $(1, 2)$ -ATSP problem imply hardness results for the MAX- $(0, 1)$ -ATSP problem.

Since the $(1, 2)$ -ATSP problem is APX-hard [PY93], there is little hope for polynomial time approximation algorithms with arbitrary good precision for the MAX- $(0, 1)$ -ATSP problem. Due to the explicit approximation lower bound for the $(1, 2)$ -ATSP problem given in [EK06], it is NP-hard to approximate the MAX- $(0, 1)$ -ATSP problem with an approximation factor less than $320/319$.

The best known approximation algorithm for the restricted version of this problem is due to Bläser [B04] and achieves an approximation ratio $5/4$.

For the general problem, Kaplan et al. [KLS⁺05] designed an algorithm for the MAX-ATSP problem yielding the best known approximation upper bound of $3/2$.

On the approximation hardness side, Karpinski and Schmied [KS11] constructed a reduction yielding the approximation lower bound $208/207$ for the MAX-ATSP problem.

In this paper, we prove that approximating the MAX- $(0, 1)$ -ATSP problem with an approximation ratio less than $206/205$ is NP-hard.

Overview of Known Explicit Approximation Lower Bounds and Our Results

$(1, B)$ -ATSP problem	$B = 2$	$B = 4$	$B = 8$	unbounded
Previously known results	$321/320$ (1.00312) [EK06]	$321/320$ (1.00312) [EK06]	$135/134$ (1.00746) [EK06]	$117/116$ (1.00862) [PV06]
Our results	$207/206$ (1.00485)	$141/140$ (1.00714)		
$(1, B)$ -TSP problem	$B = 2$	$B = 4$	$B = 8$	unbounded
Previously known results	$741/740$ (1.00135) [EK06]	$741/740$ (1.00135) [EK06]	$389/388$ (1.00257) [EK06]	$220/219$ (1.00456) [PV06]
Our results	$535/534$ (1.00187)	$337/336$ (1.00297)	$337/336$ (1.00297)	

Figure 1: Known explicit approximation lower bounds and the new results.

	MAX-(0, 1)-ATSP problem	MAX-ATSP problem
Previously known results	320/319 (1.00314) [EK06]	208/207 (1.00483) [KS11]
Our results	206/205 (1.00487)	206/205 (1.00487)

Figure 2: Known explicit approximation lower bounds and the new results.

2 Preliminaries

In this section, we define the abbreviations and notations used in this paper.

Given a natural number k and a finite set V , we use the abbreviation $[k]$ for $\{1, \dots, k\}$ and $\binom{V}{2}$ for the set $\{S \subseteq V \mid |S| = 2\}$.

Given an asymmetric metric space (V, d) with $V = \{v_1, \dots, v_n\}$ and $d: V \times V \rightarrow \mathbb{R}_{\geq 0}$, a *Hamiltonian cycle* in V or a *tour* in V is a cycle visiting each vertex v_i in V exactly once.

In the remainder, we specify a tour σ in V by $\sigma = \{(v_1, v_{i_1}), \dots, (v_{i_{n-1}}, v_1)\} \subseteq V \times V$ or explicitly by $\sigma = v_1 \rightarrow v_{i_1} \rightarrow \dots \rightarrow v_{i_{n-1}} \rightarrow v_1$.

Given a tour σ in (V, d) , the length of a tour $\ell(\sigma)$ is defined by

$$\ell(\sigma) = \sum_{a \in \sigma} d(a).$$

Analogously, given a metric space (V, d) with $V = \{v_1, \dots, v_n\}$ and $d: \binom{V}{2} \rightarrow \mathbb{R}_{>0}$, we specify a tour σ in V by $\sigma = \{\{v_1, v_{i_1}\}, \dots, \{v_{i_{n-1}}, v_1\}\} \subseteq \binom{V}{2}$ or explicitly by $\sigma = v_1 - v_{i_1} - \dots - v_{i_{n-1}} - v_1$.

In order to specify, an instance (V, d) of the (1, 2)-ATSP problem, it suffices to identify the arcs $a \in V \times V$ with weight one. The same instance is specified by a directed graph $D = (V, A)$, where $a \in A$ if and only if $d(a) = 1$. Analogously, in the (1, 2)-TSP problem, an instance is completely specified by a graph $G = (V, E)$.

In the remainder, we refer to an arc and an edge with weight $x \in \mathbb{N}$ as a x -arc and x -edge, respectively.

3 Related Work

3.1 Hybrid Problem

Berman and Karpinski [BK99], see also [BK01] and [BK03] introduced the following Hybrid problem and proved that this problem is NP-hard to approximate with some constant.

Definition 1 (Hybrid problem). *Given a system of linear equations mod 2 containing n variables, m_2 equations with exactly two variables, and m_3 equations with exactly*

three variables, find an assignment to the variables that satisfies as many equations as possible.

In [BK99], Berman and Karpinski constructed special instances of the Hybrid problem with bounded occurrences of variables, for which they proved the following hardness result.

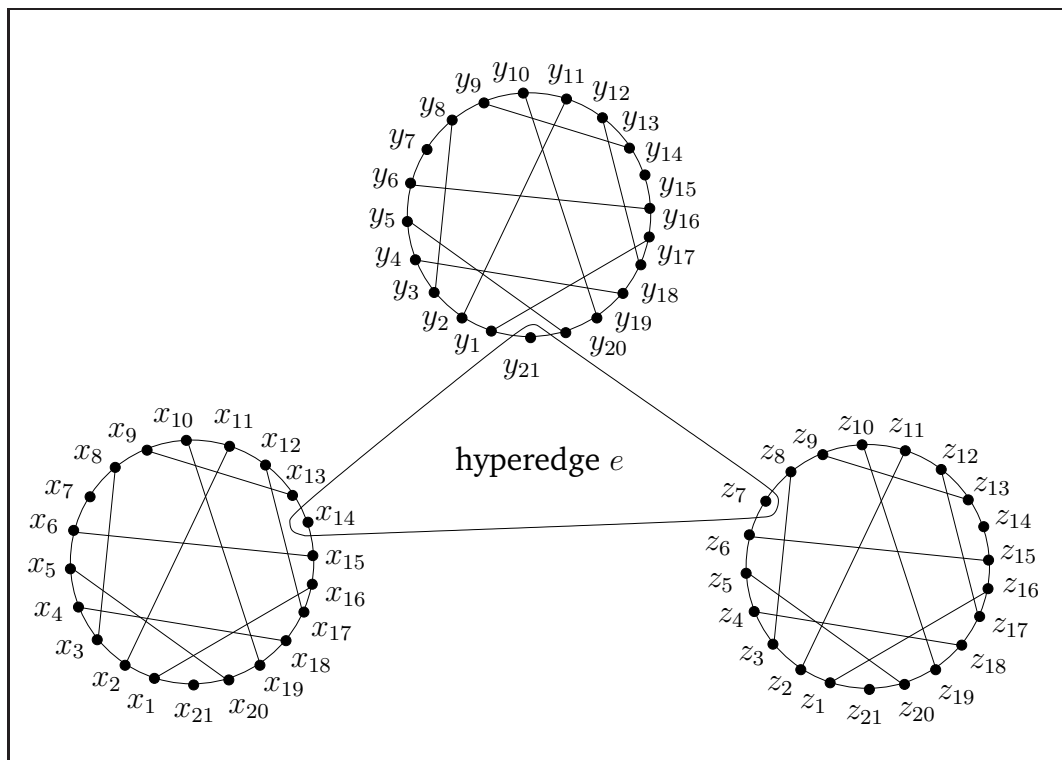

Figure 3: An example of a Hybrid instance with circles C^x , C^y , C^z , and hyperedge $e = \{z_7, y_{21}, x_{14}\}$.

Theorem 1 ([BK99]). *For any constant $\epsilon > 0$, there exists instances of the Hybrid problem with 42ν variables, 60ν equations with exactly two variables, and 2ν equations with exactly three variables such that:*

- (i) *Each variable occurs exactly three times.*
- (ii) *Either there is an assignment to the variables that leaves at most $\epsilon\nu$ equations unsatisfied, or else every assignment to the variables leaves at least $(1 - \epsilon)\nu$ equations unsatisfied.*
- (iii) *It is NP-hard to decide which of the two cases in item (ii) above holds.*

The instances of the Hybrid problem produced in Theorem 1 have an even more special structure, which we are going to describe.

The equations containing three variables are of the form $x \oplus y \oplus z = \{0, 1\}$. These equations stem from the Theorem of Håstad [H01] dealing with the hardness of approximating equations with exactly three variables. We refer to it as the MAX-E3-LIN problem, which can be seen as a special instance of the Hybrid problem.

Theorem 2 (Håstad [H01]). *For any constant $\delta \in (0, \frac{1}{2})$, there exists systems of linear equations mod 2 with $2m$ equations and exactly three unknowns in each equation such that:*

- (i) *Each variable in the instance occurs a constant number of times, half of them negated and half of them unnegated. This constant grows as $\Omega(2^{1/\delta})$.*
- (ii) *Either there is an assignment satisfying all but at most $\delta \cdot m$ equations, or every assignment leaves at least $(1 - \delta)m$ equations unsatisfied.*
- (iii) *It is NP-hard to distinguish between these two cases.*

For every variable x of the original instance \mathcal{E}_3 of the MAX-E3-LIN problem, Berman and Karpinski introduced a corresponding set of variables V_x . If the variable x occurs t_x times in \mathcal{E}_3 , then, V_x contains $7t_x$ variables x_1, \dots, x_{7t_x} . The variables contained in $\text{Con}(V_x) = \{x_i \mid i \in \{7\nu \mid \nu \in [t_x]\}\}$ are called *contact variables*, whereas the variables in $C(V_x) = V_x \setminus \text{Con}(V_x)$ are called *checker variables*.

All variables in V_x are connected by equations of the form $x_i \oplus x_{i+1} = 0$ with $i \in [7t_x - 1]$ and $x_1 \oplus x_{7t_x} = 0$. In addition to it, there exists equations of the form $x_i \oplus x_j = 0$ with $\{i, j\} \in M^x$, where M^x defines a perfect matching on the set of checker variables. In the remainder, we refer to this construction as the circle \mathcal{C}^x containing the variables $x \in V_x$.

Let \mathcal{E}_3 be an instance of the MAX-E3-LIN problem and \mathcal{H} be its corresponding instance of the Hybrid problem. We denote by $V(\mathcal{E}_3)$ the set of variables which occur in the instance \mathcal{E}_3 . Then, \mathcal{H} can be represented graphically by $|V(\mathcal{E}_3)|$ circles \mathcal{C}^x with $x \in V(\mathcal{E}_3)$ containing the variables $V(\mathcal{C}^x) = \{x_1, \dots, x_{t_x}\}$ as vertices.

The edges are identified by the equations included in \mathcal{H} . The equations with exactly three variables are represented by hyperedges e with cardinality $|e| = 3$. The equations $x_i \oplus x_{i+1} = 0$ induce a cycle containing the vertices $\{x_1, \dots, x_{t_x}\}$ and the matching equations $x_i \oplus x_j = 0$ with $\{i, j\} \in M^x$ induce a perfect matching on the set of checker variables. An example of an instance of the Hybrid problem is depicted in Figure 3.

In summary, we notice that there are four type of equations in the Hybrid problem (i) the circle equations $x_i \oplus x_{i+1} = 0$ with $i \in [7t_x - 1]$, (ii) circle border equations $x_1 \oplus x_{7t_x}$, (iii) matching equations $x_i \oplus x_j = 0$ with $\{i, j\} \in M^x$, and (iv) equations with three variables of the form $x \oplus y \oplus z = \{0, 1\}$.

In the remainder, we may assume that equations with three variables are of the form $x \oplus y \oplus z = 0$ or $\bar{x} \oplus y \oplus z = 0$ due to the transformation $\bar{x} \oplus y \oplus z = 0 \equiv x \oplus y \oplus z = 1$.

3.2 Approximation Hardness of TSP Problems

Reducing the Hybrid Problem to the (1, 2)–(A)TSP Problem

Engebretsen and Karpinski [EK06] constructed an approximation preserving reduction from the Hybrid problem to the (1, 2)–ATSP problem to prove explicit approximation lower bounds for the latter problem. They introduced graphs (gadgets), which simulate variables, equations with two variables and equations with three variables. In particular, the graphs corresponding to equations of the form $x \oplus y \oplus z = 0$ and to variables are displayed in Figure 4 (a) and (b), respectively.

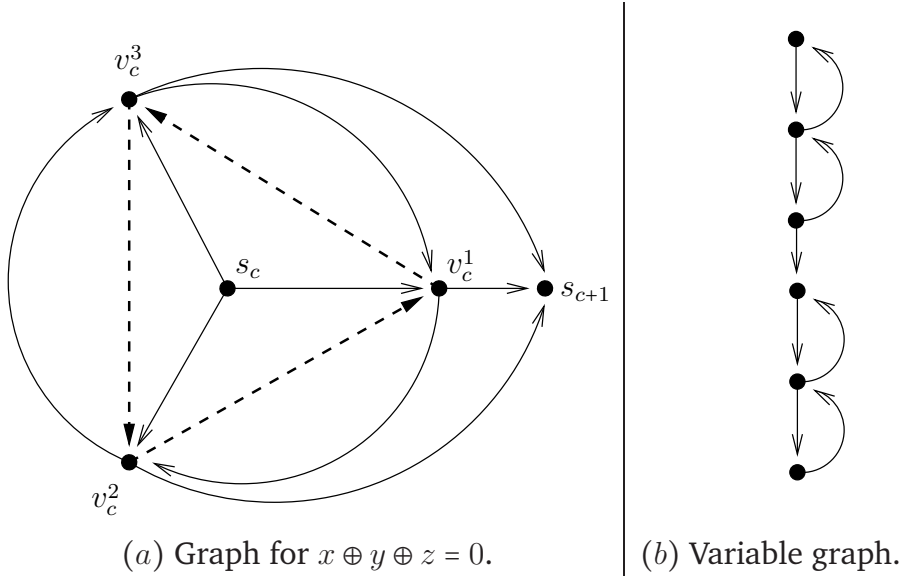

Figure 4: Gadgets used in [EK06].

For the graph corresponding to an equation with three variables, they proved the following statement.

Proposition 1 ([EK06]). *There is a Hamiltonian path from s_c to s_{c+1} in Figure 4 (a) if and only if an even number of ticked edges is traversed.*

A similar reduction was constructed in order to prove explicit approximation lower bounds for the $(1, 2)$ -TSP problem. The corresponding graphs are depicted in Figure 5. The graph contained in the dashed box in Figure 5 (b) will play a crucial role in our reduction and we refer to it as *parity graph*. In particular, our variable gadget consists only of a parity graph.

In the reduction of the $(1, 2)$ -TSP problem, the following statement was proved for the graph corresponding to equations of the form $x \oplus y \oplus z = 0$.

Proposition 2 ([EK06]). *There is a simple path from s_c to s_{c+1} in Figure 5 (a) containing the vertices $v \in \{v_c^1, v_c^2\}$ if and only if an even number of parity graphs is traversed.*

The former mentioned reductions combined with Theorem 1 yield the following explicit approximation lower bounds.

Theorem 3 ([EK06]). *It is NP-hard to approximate the $(1, 2)$ -ATSP and the $(1, 2)$ -TSP problem with an approximation ratio less than $321/320$ (1.00312) and $741/740$ (1.00135), respectively.*

Explicit Approximation Lower Bounds for the MAX-ATSP problem

By replacing all edges with weight two of an instance of the $(1, 2)$ -ATSP problem by edges of weight zero, we obtain an instance of the MAX- $(0, 1)$ -ATSP problem, which relates the $(1, 2)$ -ATSP problem to the MAX-ATSP problem in the following sense.

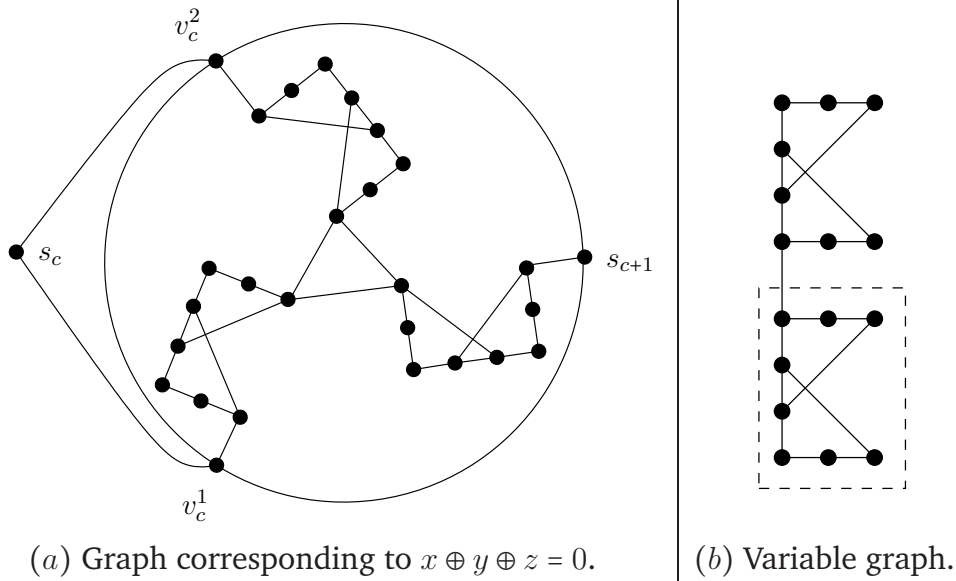

Figure 5: Gadgets used in [EK06] to prove approximation hardness of the $(1, 2)$ -TSP problem.

Theorem 4 ([V92]). *An $(1/\alpha)$ -approximation algorithm for the MAX- $(0, 1)$ -ATSP problem implies an $(2 - \alpha)$ -approximation algorithm for the $(1, 2)$ -ATSP problem.*

This reduction transforms every hardness result addressing the $(1, 2)$ -ATSP problem into a hardness result for the MAX- $(0, 1)$ -ATSP problem. In particular, Theorem 3 implies the best known explicit approximation lower bound for the MAX- $(0, 1)$ -ATSP problem.

Corollary 1. *It is NP-hard to approximate the MAX- $(0, 1)$ -ATSP problem within any better than $320/319$ (1.00314).*

4 Our Contribution

We now formulate our main results.

Theorem 5. *Suppose we are given an instance \mathcal{H} of the Hybrid problem with n circles, m_2 equations with two variables and m_3 equations with exactly three variables with the properties described in Theorem 1.*

(i) *Then, it is possible to construct in polynomial time an instance $D_{\mathcal{H}}$ of the $(1, 2)$ -ATSP problem with the following properties:*

(a) *If there exists an assignment ϕ to the variables of \mathcal{H} which leaves at most u equations unsatisfied, then, there exist a tour σ_{ϕ} in $D_{\mathcal{H}}$ with length at most $\ell(\sigma_{\phi}) = 3m_2 + 13m_3 + n + 1 + u$.*

- (b) From every tour σ in $D_{\mathcal{H}}$ with length $\ell(\sigma) = 3m_2 + 13m_3 + n + 1 + u$, we can construct in polynomial time an assignment ψ_σ to the variables of \mathcal{H} that leaves at most u equations in \mathcal{H} unsatisfied.
- (ii) Furthermore, it is possible to construct in polynomial time an instance $(V_{\mathcal{H}}, d_{\mathcal{H}})$ of the (1, 4)–ATSP problem with the following properties:
- (a) If there exists an assignment ϕ to the variables of \mathcal{H} which leaves at most u equations unsatisfied, then, there exist a tour σ_ϕ in $(V_{\mathcal{H}}, d_{\mathcal{H}})$ with length at most $\ell(\sigma_\phi) = 4m_2 + 20m_3 + 2n + 2u + 2$.
- (b) From every tour σ in $(V_{\mathcal{H}}, d_{\mathcal{H}})$ with length $\ell(\sigma) = 4m_2 + 20m_3 + 2n + 2u + 2$, we can construct in polynomial time an assignment ψ_σ to the variables of \mathcal{H} that leaves at most u equations in \mathcal{H} unsatisfied.

The former theorem can be used to derive an explicit approximation lower bound for the (1, 2)–ATSP problem by reducing instances of the Hybrid problem of the form described in Theorem 1 to the (1, 2)–ATSP problem.

Corollary 2. *It is NP-hard to approximate the (1, 2)–ATSP problem with an approximation factor less than $207/206$ (1.00485).*

Proof. Let \mathcal{E}_3 be an instance of the MAX–E3–LIN problem. We define k to be the minimum number of occurrences of a variable in \mathcal{E}_3 . According to Theorem 2, we may choose $\delta > 0$ such that $\frac{207-\delta}{206+\delta+\frac{\delta}{k}} \geq \frac{207}{206} - \epsilon$ holds. Given an instance \mathcal{E}_3 of the MAX–E3–LIN problem with $\delta' \in (0, \delta)$, we generate the corresponding instance \mathcal{H} of the Hybrid problem. Then, we construct the corresponding instance $D_{\mathcal{H}}$ of the (1, 2)–ATSP problem with the properties described in Theorem 5. We conclude according to Theorem 1 that there exist a tour in $D_{\mathcal{H}}$ with length at most

$$3 \cdot 60\nu + 13 \cdot 2\nu + \delta'\nu + n + 1 \leq (206 + \delta' + \frac{n+1}{\nu})\nu \leq (206 + \delta' + \frac{6+1}{k})\nu$$

or the length of a tour in $D_{\mathcal{H}}$ is bounded from below by

$$3 \cdot 60\nu + 13 \cdot 2\nu + (1 - \delta')\nu + n + 1 \geq (206 + (1 - \delta'))\nu \geq (207 - \delta')\nu.$$

From Theorem 1, we know that the two cases above are NP-hard to distinguish. Hence, for every $\epsilon > 0$, it is NP-hard to find a solution to the (1, 2)–ATSP problem with an approximation ratio $\frac{207-\delta'}{206+\delta'+\frac{\delta'}{k}} \geq \frac{207}{206} - \epsilon$. \square

Analogously, we derive the following statement.

Corollary 3. *It is NP-hard to approximate the (1, 4)–ATSP problem with an approximation factor less than $141/140$ (1.00714).*

For the symmetric version of the problems, we construct reductions from the Hybrid problem with similar properties.

Theorem 6. *Suppose we are given an instance \mathcal{H} of the Hybrid problem with n circles, m_2 equations with two variables and m_3 equations with exactly three variables with the properties described in Theorem 1.*

- (i) Then, it is possible to construct in polynomial time an instance $G_{\mathcal{H}}$ of the $(1, 2)$ -TSP problem with the following properties:
- (a) If there exists an assignment ϕ to the variables of \mathcal{H} which leaves at most u equations unsatisfied, then, there exist a tour σ_ϕ in $G_{\mathcal{H}}$ with length at most $\ell(\sigma_\phi) = 8m_2 + 27m_3 + 3n + 1 + u$.
 - (b) From every tour σ in $G_{\mathcal{H}}$ with length $\ell(\sigma) = 8m_2 + 27m_3 + 3n + 1 + u$, we can construct in polynomial time an assignment ψ_σ to the variables of \mathcal{H} that leaves at most u equations in \mathcal{H} unsatisfied.
- (ii) Furthermore, it is possible to construct in polynomial time an instance $(V_{\mathcal{H}}, d_{\mathcal{H}})$ of the $(1, 4)$ -TSP problem with the following properties:
- (a) If there exists an assignment ϕ to the variables of \mathcal{H} which leaves at most u equations unsatisfied, then, there exist a tour σ_ϕ in $(V_{\mathcal{H}}, d_{\mathcal{H}})$ with length at most $\ell(\sigma_\phi) = 10m_2 + 36m_3 + 6n + 2 + 2u$.
 - (b) From every tour σ in $(V_{\mathcal{H}}, d_{\mathcal{H}})$ with length $\ell(\sigma) = 10m_2 + 36m_3 + 6n + 2 + 2u$, we can construct in polynomial time an assignment ψ_σ to the variables of \mathcal{H} that leaves at most u equations in \mathcal{H} unsatisfied.

Analogously, we combine the former theorem with the explicit approximation lower bound for the Hybrid problem of the form described in Theorem 1 yielding the following approximation hardness result.

Corollary 4. *It is NP-hard to approximate the $(1, 2)$ -TSP and the $(1, 4)$ -TSP problem with an approximation factor less than $535/534$ (1.00187) and $337/336$ (1.00297), respectively.*

From Theorem 4 and Corollary 2, we obtain the following explicit approximation lower bound.

Corollary 5. *It is NP-hard to approximate the MAX- $(0, 1)$ -ATSP problem with an approximation factor less than $206/205$ (1.00487).*

5 Approximation Hardness of the $(1, 2)$ -ATSP problem

Before we proceed to the proof of Theorem 5 (i), we describe the reduction from a high-level view and try to build some intuition.

5.1 Main Ideas

As mentioned above, we prove our hardness results by a reduction from the Hybrid problem. Let \mathcal{E}_3 be an instance of the MAX-E3-LIN problem and \mathcal{H} the corresponding instance of the Hybrid problem. Every variable x^l in the original instance \mathcal{E}_3 introduces an associated circle \mathcal{C}_l in the instance \mathcal{H} as illustrated in Figure 3.

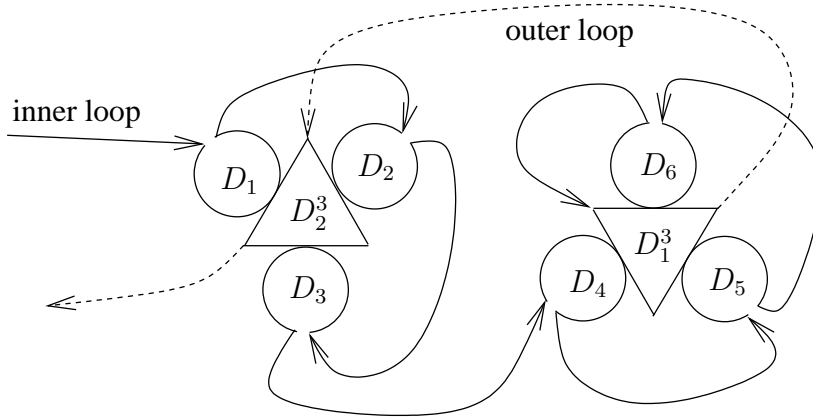

Figure 6: An illustration of the instance $D_{\mathcal{H}}$ and a tour in $D_{\mathcal{H}}$.

The main idea of our reduction is to make use of the special structure of the circles in \mathcal{H} . Every circle \mathcal{C}_l in \mathcal{H} corresponds to a graph D_l in the instance $D_{\mathcal{H}}$ of the $(1, 2)$ -ATSP problem. Moreover, D_l is a subgraph of $D_{\mathcal{H}}$, which builds almost a cycle. An assignment to the variable x^l will have a natural interpretation in this reduction. The parity of x_l corresponds to the direction of movement in D_l of the underlying tour.

The circle graphs of $D_{\mathcal{H}}$ are connected and build together the *inner loop* of $D_{\mathcal{H}}$. Every variable x_i^l in a circle \mathcal{C}_l possesses an associated parity graph P_i^l (Figure 7) in D_l as a subgraph. The two natural ways to traverse a parity graph will be called 0/1-traversals and correspond to the parity of the variable x_i^l . Some of the parity graphs in D_l are also contained in graphs D_c^3 (Figure 4(a) and Figure 9 for a more detailed view) corresponding to equations with three variables of the form $g_c^3 \equiv x \oplus y \oplus z = 0$.

These graphs are connected and build the *outer loop* of $D_{\mathcal{H}}$. The whole construction is illustrated in Figure 6. The outer loop of the tour checks whether the 0/1-traversals of the parity graphs correspond to an satisfying assignment of the equations with three variables. If an underlying equation is not satisfied by the assignment defined via 0/1-traversal of the associated parity graph, it will be punished by using a costly 2-arc.

5.2 Constructing $D_{\mathcal{H}}$ from a Hybrid Instance \mathcal{H}

Given a instance of the Hybrid problem \mathcal{H} , we are going to construct the corresponding instance $D_{\mathcal{H}} = (V(D_{\mathcal{H}}), A(D_{\mathcal{H}}))$ of the $(1, 2)$ -ATSP problem.

For every type of equation in \mathcal{H} , we will introduce a specific graph or a specific way to connect the so far constructed subgraphs. In particular, we will distinguish between graphs corresponding to circle equations, matching equations, circle border equations and equations with three variables. First of all, we introduce graphs corresponding to the variables in \mathcal{H} .

Variable Graphs

Let \mathcal{H} be an instance of the hybrid problem and \mathcal{C}_l a circle in \mathcal{H} . For every variable x_i^l in the circle \mathcal{C}_l , we introduce the parity graph P_i^l consisting of the vertices v_i^{l1} , $v_i^{l\perp}$ and v_i^{l0} depicted in Figure 7.

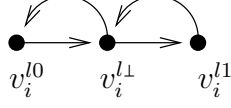

Figure 7: Parity graph P_i^l corresponding to the variable x_i^l in circle \mathcal{C}_l .

Matching and Circle Equations

Let \mathcal{H} be an instance of the hybrid problem, \mathcal{C}_l a circle in \mathcal{H} and M_l the associated perfect matching. Furthermore, let $x_i^l \oplus x_j^l = 0$ with $e = \{i, j\} \in M_l$ and $i < j$ be a matching equation. Due to the construction of \mathcal{H} , the circle equations $x_i^l \oplus x_{i+1}^l = 0$ and $x_j^l \oplus x_{j+1}^l = 0$ are both contained in \mathcal{C}_l . Then, we introduce the associated parity

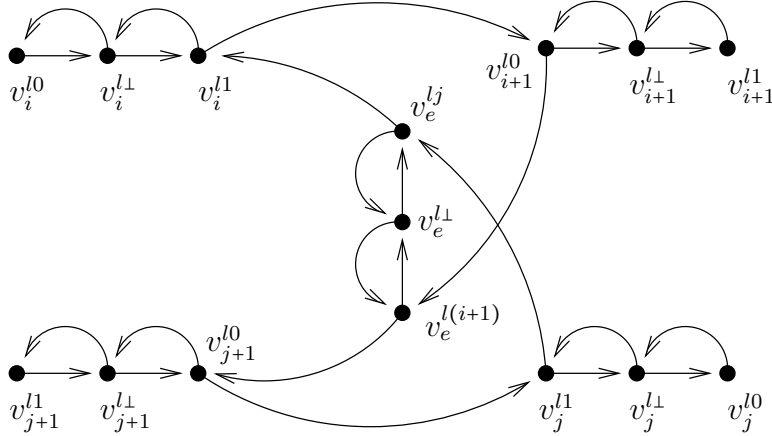

Figure 8: Connecting the parity graph P_e^l

graph P_e^l consisting of the vertices v_e^{lj} , $v_e^{l\perp}$ and $v_e^{l(i+1)}$. In addition to it, we connect the parity graphs P_i^l , P_{i+1}^l , P_j^l , P_{j+1}^l and P_e^l as depicted in Figure 8.

Graphs Corresponding to Equations with Three Variables

Let $g_c^3 \equiv x_i^l \oplus x_j^s \oplus x_t^k = 0$ be an equation with three variables in \mathcal{H} . Then, we introduce the graph D_c^3 (Figure 4) corresponding to the equation g_c^3 . The graph D_c^3 includes the vertices s_c , v_c^1 , v_c^2 , v_c^3 and s_{c+1} . Furthermore, it contains the parity graphs P_e^l , P_b^s and P_a^k as subgraphs, where $e = \{i, i+1\}$, $b = \{j, j+1\}$ and $a = \{t, t+1\}$. Exemplary, we display D_c^3 with its connections to the graph corresponding to the circle equation $x_i^l \oplus x_{i+1}^l = 0$ in Figure 9.

In case of $g_c^3 \equiv \bar{x}_i^l \oplus x_j^s \oplus x_k^u = 0$, we connect the parity graphs with arcs (v_i^{l1}, v_e^{l0}) , (v_{i+1}^{l0}, v_i^{l1}) and (v_e^{l1}, v_{i+1}^{l0}) .

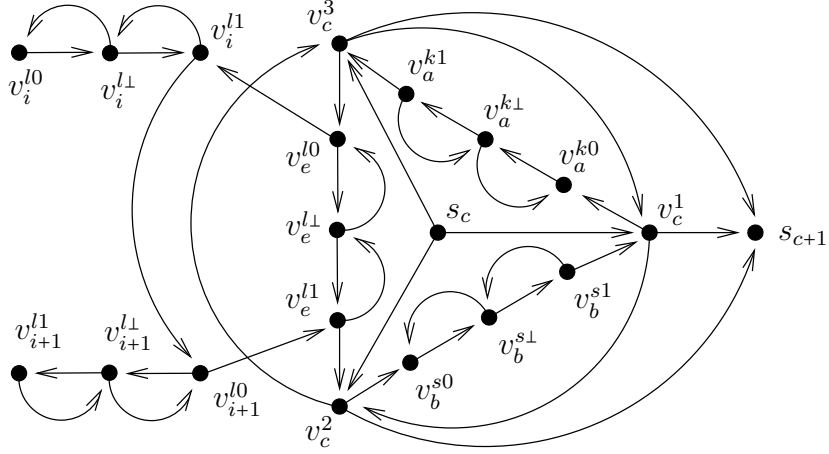

Figure 9: The graph D_c^3 corresponding to $g_c^3 \equiv x_i^l \oplus x_j^s \oplus x_k^u = 0$ connected to graphs corresponding to $x_i^l \oplus x_{i+1}^l = 0$.

Graphs Corresponding to Circle Border Equations

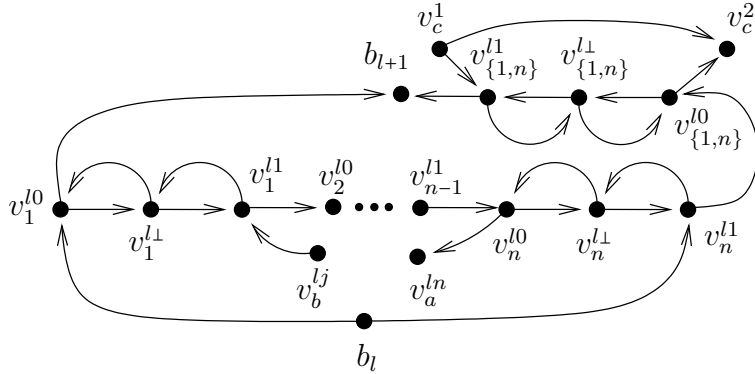

Figure 10: The graph corresponding to $x_1^l \oplus x_n^l = 0$

Let \mathcal{C}_l and \mathcal{C}_{l+1} be circles in \mathcal{H} . In addition, let $x_1^l \oplus x_n^l = 0$ be the circle border equation of \mathcal{C}_l . Then, we introduce the vertex b_l and connect it to v_1^{l0} and v_n^{l1} . Let b_{l+1} be the vertex corresponding to the circle \mathcal{C}_{l+1} . We draw an arc from v_1^{l0} to b_{l+1} . Finally, we connect the vertex $v_{\{1,n\}}^{l0}$ to b_{l+1} . Recall that x_n also occurs in the equation g_c^3 , which is an equation with three variables in \mathcal{H} . This construction is illustrated in Figure 10, where only a part of the corresponding graph D_c^3 is depicted.

Let \mathcal{C}_n be the last circle in \mathcal{H} . Then, we set $b_{n+1} = s_1$ as s_1 is the starting vertex of the graph D_1^3 corresponding to the equation g_1^3 . This is the whole description of the graph $D_{\mathcal{H}}$.

Next, we are going to describe the associated tour σ_ϕ in $D_{\mathcal{H}}$ given an assignment to the variables in \mathcal{H} .

5.3 Constructing the Tour σ_ϕ from an Assignment ϕ

Let \mathcal{H} be an instance of the Hybrid problem and $D_{\mathcal{H}} = (V_{\mathcal{H}}, A_{\mathcal{H}})$ the corresponding instance of the $(1, 2)$ -ATSP problem as defined in Section 5.2. Given an assignment $\phi : V(\mathcal{H}) \rightarrow \{1, 0\}$ to the variables of \mathcal{H} , we are going to construct the associated Hamiltonian tour σ_ϕ in $D_{\mathcal{H}}$. In addition to it, we analyze the relation between the length of the tour σ_ϕ and the number of satisfied equations by ϕ .

Let \mathcal{H} be an instance of the Hybrid problem consisting of circles $\mathcal{C}_1, \mathcal{C}_2, \dots, \mathcal{C}_m$ and equations with three variables g_j^3 with $j \in [m_3]$. The associated Hamiltonian tour σ_ϕ in $D_{\mathcal{H}}$ starts at the vertex b_1 . From a high level view, σ_ϕ traverses all graphs corresponding to the equations associated with the circle \mathcal{C}_1 ending with the vertex b_2 . Successively, it passes all graphs for each circle in \mathcal{H} until it reaches the vertex $b_m = s_1$ as s_1 is the starting vertex of the graph D_1^3 .

At this point, the tour begins to traverse the remaining graphs D_c^3 which are simulating the equations with three variables in \mathcal{H} . By now, some of the parity graphs appearing in graphs D_c^3 already have been traversed in the *inner loop* of σ_ϕ . The *outer loop* checks whether for each graph D_c^3 , an even number of parity graphs has been traversed in the inner loop. In every situation, in which ϕ does not satisfy the underlying equation, the tour needs to use a 2-arc. This paths, consisting of 1-arcs, will be aligned by means of 2-arcs in order to build a Hamiltonian tour in $D_{\mathcal{H}}$. For each circle \mathcal{C}_l , we will have to use 2-arcs in order to obtain a Hamiltonian path from b_l to b_{l+1} traversing all graphs associated with \mathcal{C}_l in some order except in the case when all variables in the circle have the same parity. Since we specify only a part of the tour σ_ϕ we rather refer to a representative tour from a set of tours having the same length and the same specification.

In order to analyze the length of the tour in relation to the number of satisfied equation, we are going to examine the part of σ_ϕ passing the graphs corresponding to the underlying equation and account the local length to the analyzed parts of the tour. Let us begin to describe σ_ϕ passing through parity graphs associated to variables in \mathcal{H} .

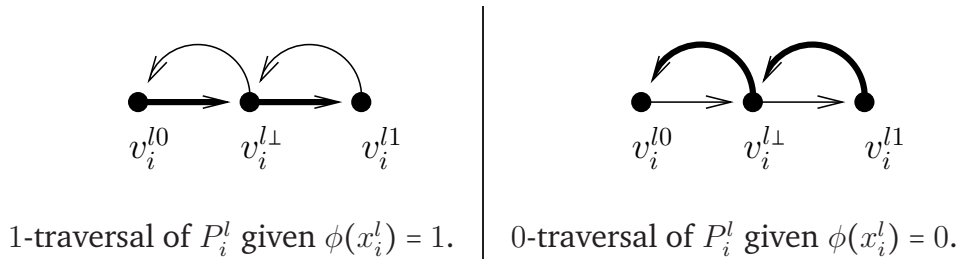

Figure 11: Traversal of the graph P_i^l given the assignment ϕ .

Traversing Parity Graphs

Let x_i^l be a variable in \mathcal{H} . Then, the tour σ_ϕ traverses the parity graph P_i^l using the path $v_i^{l[1-\phi(x_i^l)]} \rightarrow v_i^{l1} \rightarrow v_i^{l\phi(x_i^l)}$. In the remainder, we call this part of the tour a

$\phi(x_i^l)$ -traversal of the parity graph. In Figure 11, we depicted the corresponding traversals of the graph P_i^l given the assignment $\phi(x_i^l)$, where the traversed arcs are illustrated by thick arrows. In both cases, we associate the local length 2 with this part of the tour.

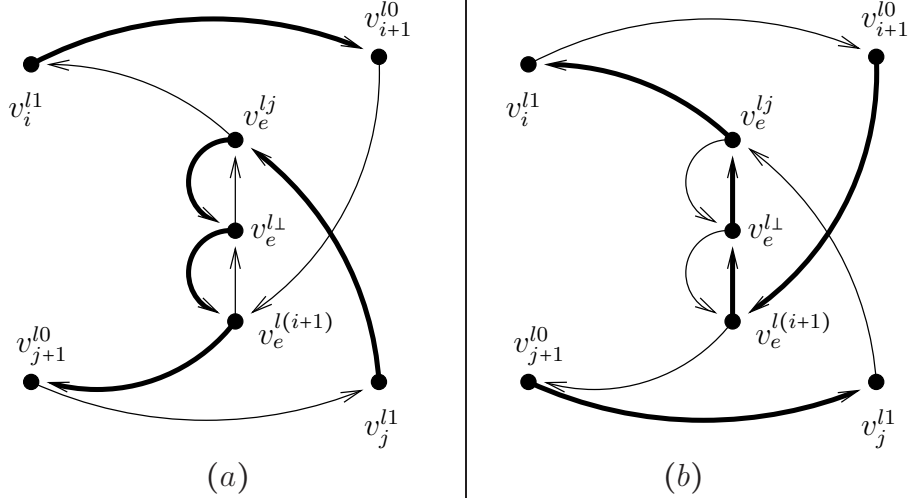

Figure 12: 1. Case $\phi(x_i) \oplus \phi(x_{i+1}) = 0$, $\phi(x_i) \oplus \phi(x_j) = 0$ and $\phi(x_j) \oplus \phi(x_{j+1}) = 0$.

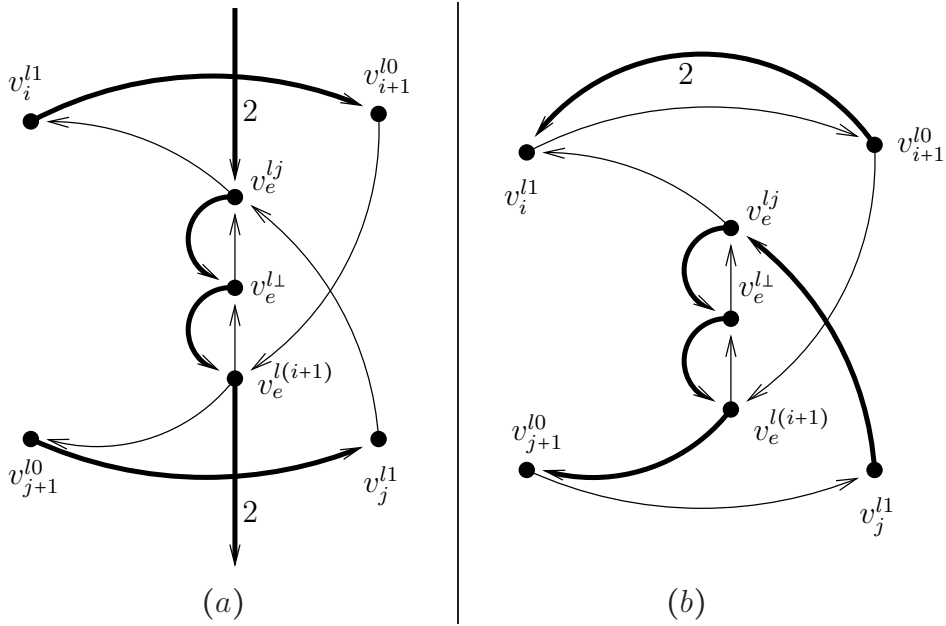

Figure 13: 2. Case $\phi(x_i) \oplus \phi(x_{i+1}) = 0$, $\phi(x_i) \oplus \phi(x_j) = 1$ and $\phi(x_j) \oplus \phi(x_{j+1}) = 0$.

Traversing Graphs Corresponding to Matching Equations

Let \mathcal{C}_l be a circle in \mathcal{H} and $x_i^l \oplus x_j^l = 0$ with $e = \{i, j\} \in M_l$ a matching equation. Given $x_i \oplus x_{i+1} = 0$, $x_i \oplus x_j = 0$, $x_j \oplus x_{j+1} = 0$ and the assignment ϕ , we are going

to construct a tour through the corresponding parity graphs in dependence of ϕ . We begin with the case $\phi(x_i) \oplus \phi(x_{i+1}) = 0$, $\phi(x_i) \oplus \phi(x_j) = 0$ and $\phi(x_j) \oplus \phi(x_{j+1}) = 0$.

1. Case $\phi(x_i) \oplus \phi(x_{i+1}) = 0$, $\phi(x_i) \oplus \phi(x_j) = 0$ and $\phi(x_j) \oplus \phi(x_{j+1}) = 0$:

In this case, we traverse the corresponding parity graphs as depicted in Figure 12. In Figure 12 (a), we have $\phi(x_i) = \phi(x_{i+1}) = \phi(x_j) = \phi(x_{j+1}) = 1$, whereas in Figure 12 (b), we have $\phi(x_i) = \phi(x_{i+1}) = \phi(x_j) = \phi(x_{j+1}) = 0$. In both cases, this part of the tour has local length 5.

2. Case $\phi(x_i) \oplus \phi(x_{i+1}) = 0$, $\phi(x_i) \oplus \phi(x_j) = 1$ and $\phi(x_j) \oplus \phi(x_{j+1}) = 0$:

The tour σ_ϕ is pictured in Figure 13 (a) and (b).

In the case $\phi(x_i) = \phi(x_{i+1}) = 0$ and $\phi(x_j) = \phi(x_{j+1}) = 1$ depicted in Figure 13 (a), we are forced to enter and leave the parity graph P_e^l via 2-arcs. So far, we associate the local length 6 with this part of the tour.

In Figure 13 (b), we have $\phi(x_i) = \phi(x_{i+1}) = 1$ and $\phi(x_j) = \phi(x_{j+1}) = 0$. This part of the tour σ_ϕ contains one 2-arc yielding the local length 6.

3. Case $\phi(x_i) \oplus \phi(x_{i+1}) = 0$, $\phi(x_i) \oplus \phi(x_j) = 0$ and $\phi(x_j) \oplus \phi(x_{j+1}) = 1$:

In dependence of ϕ , we traverse the corresponding parity graphs in the way as depicted in Figure 14.

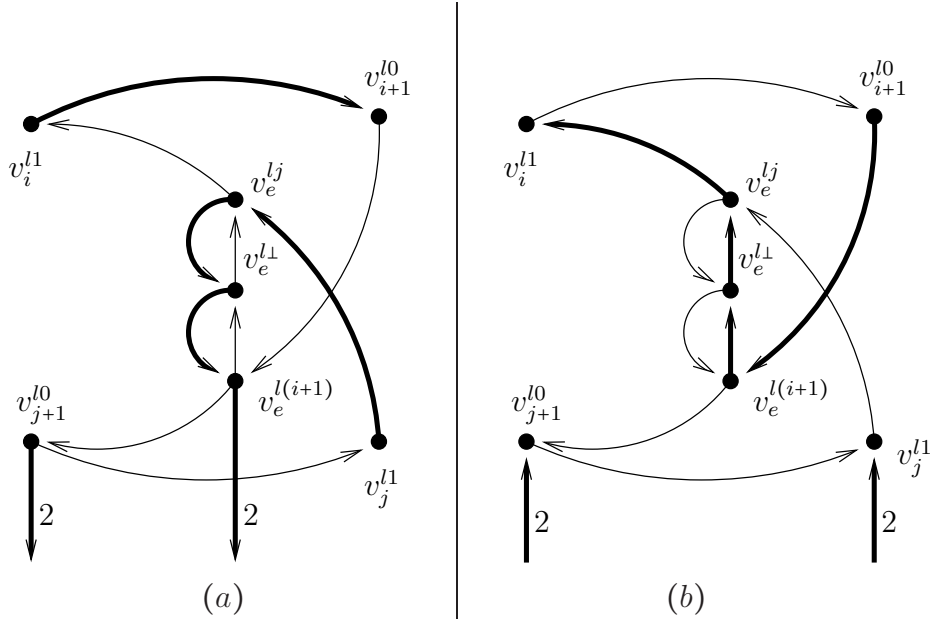

Figure 14: 3. Case $\phi(x_i) \oplus \phi(x_{i+1}) = 0$, $\phi(x_i) \oplus \phi(x_j) = 0$ and $\phi(x_j) \oplus \phi(x_{j+1}) = 1$.

The situation, in which $\phi(x_i) = \phi(x_{i+1}) = 1$ and $\phi(x_j) = 1 \neq \phi(x_{j+1})$ holds, is depicted in Figure 14 (a). On the other hand, if we have $\phi(x_i) = \phi(x_{i+1}) = 0$ and $\phi(x_j) = 0 \neq \phi(x_{j+1})$, the tour is pictured in Figure 14 (b). In both cases, we associate the local length 6.

4. Case $\phi(x_i) \oplus \phi(x_{i+1}) = 0$, $\phi(x_i) \oplus \phi(x_j) = 1$ and $\phi(x_j) \oplus \phi(x_{j+1}) = 1$:

The tour σ_ϕ is displayed in Figure 15. In Figure 15 (a), we are given $\phi(x_i) =$

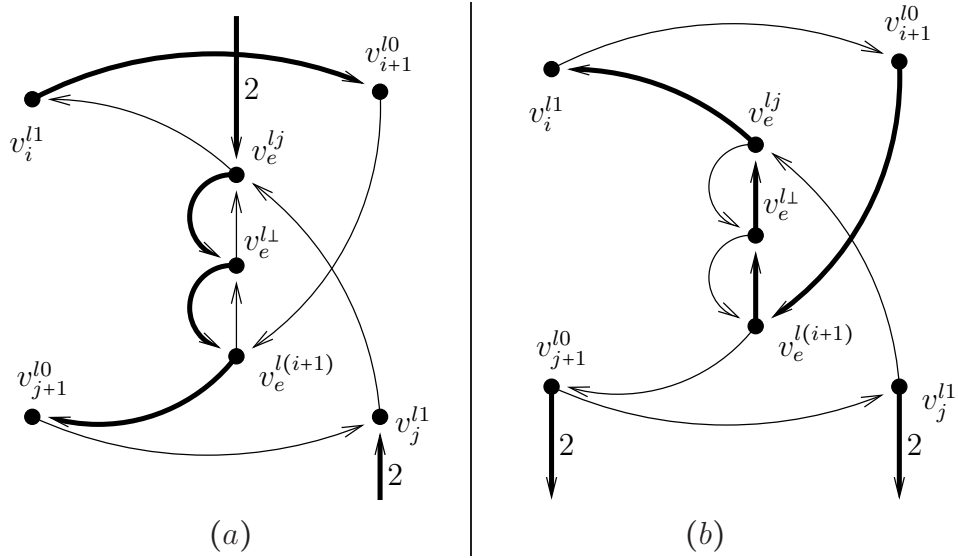

Figure 15: 4. Case $\phi(x_i) \oplus \phi(x_{i+1}) = 0$, $\phi(x_i) \oplus \phi(x_j) = 1$ and $\phi(x_j) \oplus \phi(x_{j+1}) = 1$.

$\phi(x_{i+1}) = 1$ and $\phi(x_j) \neq \phi(x_{j+1}) = 1$, whereas in Figure 15 (b), we have $\phi(x_i) = \phi(x_{i+1}) = 0$ and $\phi(x_j) \neq \phi(x_{j+1}) = 0$. In both cases, we associate the local length 6 with this part of the tour.

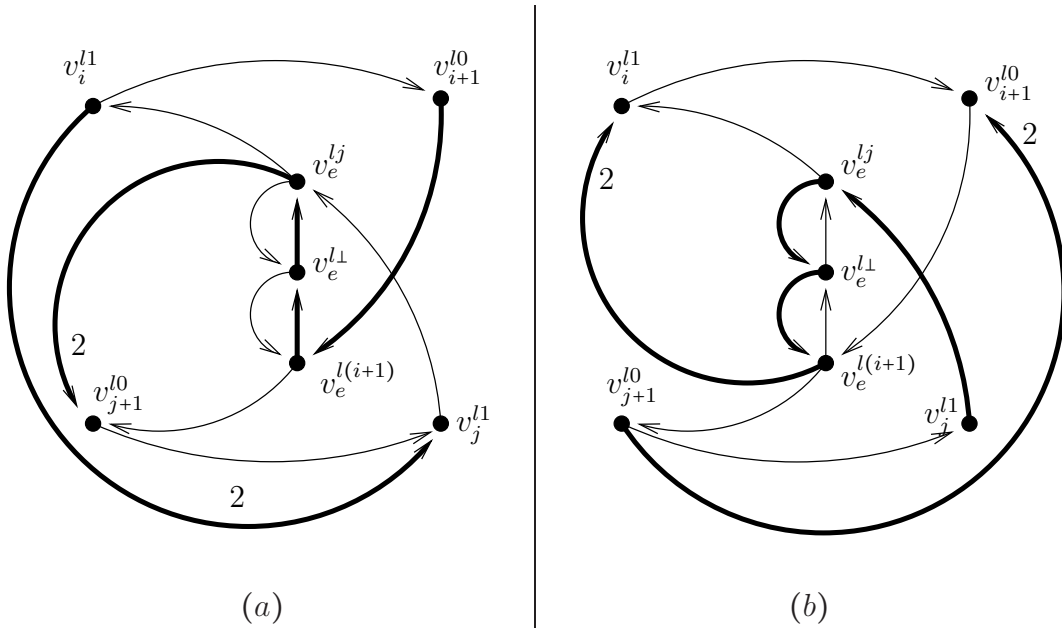

Figure 16: 5. Case $\phi(x_i) \oplus \phi(x_{i+1}) = 1$, $\phi(x_i) \oplus \phi(x_j) = 1$, $\phi(x_j) \oplus \phi(x_{j+1}) = 1$.

5. Case $\phi(x_i) \oplus \phi(x_{i+1}) = 1$, $\phi(x_i) \oplus \phi(x_j) = 1$ and $\phi(x_j) \oplus \phi(x_{j+1}) = 1$:
 In this case, we traverse the corresponding parity graphs as depicted in Figure 16. In Figure 16 (a), we notice that $\phi(x_i) \neq \phi(x_{i+1}) = 0$ and $\phi(x_j) \neq \phi(x_{j+1}) = 1$, whereas in (b), we have $\phi(x_i) \neq \phi(x_{i+1}) = 1$ and $\phi(x_j) \neq \phi(x_{j+1}) = 0$. This part of the tour has local length 7.

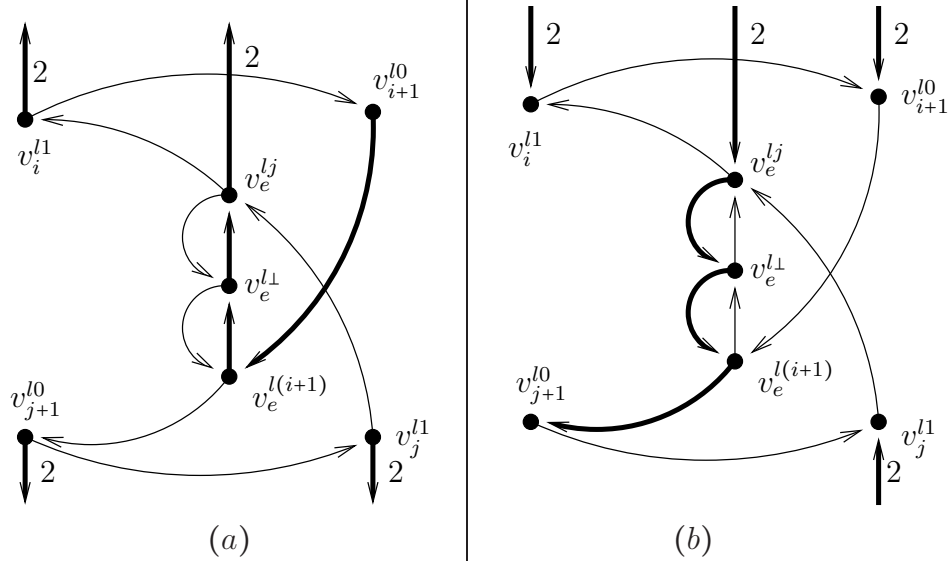

Figure 17: 6. Case $\phi(x_i) \oplus \phi(x_{i+1}) = 1$, $\phi(x_i) \oplus \phi(x_j) = 0$, and $\phi(x_j) \oplus \phi(x_{j+1}) = 1$.

6. Case $\phi(x_i) \oplus \phi(x_{i+1}) = 1$, $\phi(x_i) \oplus \phi(x_j) = 0$ and $\phi(x_j) \oplus \phi(x_{j+1}) = 1$:

In this case, we traverse the corresponding parity graphs as depicted in Figure 17. In Figure 17 (a), we have $\phi(x_i) \neq \phi(x_{i+1}) = 0$ and $\phi(x_j) \neq \phi(x_{j+1}) = 0$, whereas in (b), we have $\phi(x_i) \neq \phi(x_{i+1}) = 1$ and $\phi(x_j) \neq \phi(x_{j+1}) = 1$. This part of the tour has local length 7.

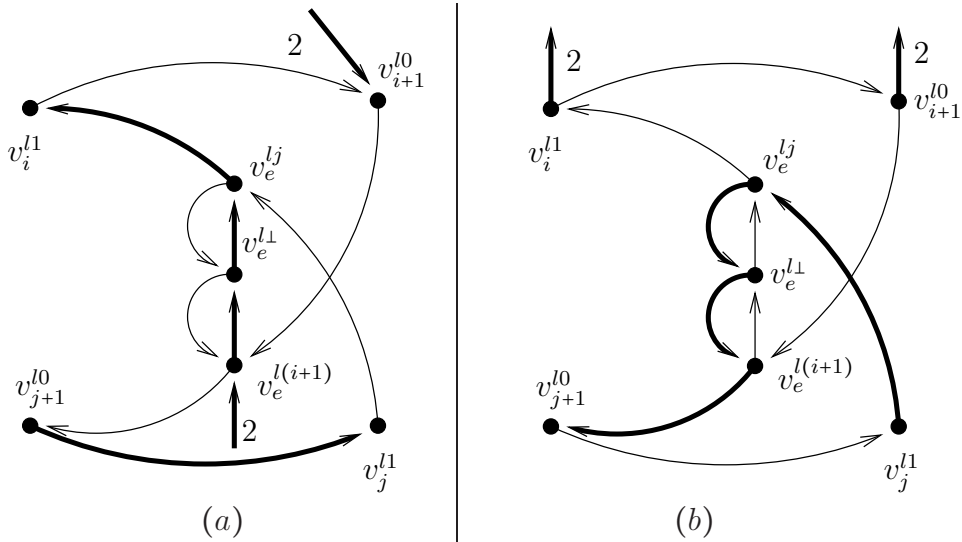

Figure 18: 7. Case $\phi(x_i) \oplus \phi(x_{i+1}) = 1$, $\phi(x_i) \oplus \phi(x_j) = 0$ and $\phi(x_j) \oplus \phi(x_{j+1}) = 0$.

7. Case $\phi(x_i) \oplus \phi(x_{i+1}) = 1$, $\phi(x_i) \oplus \phi(x_j) = 0$ and $\phi(x_j) \oplus \phi(x_{j+1}) = 0$:

In this case, we traverse the corresponding parity graphs as depicted in Figure 18. In Figure 18 (a), we have $\phi(x_i) \neq \phi(x_{i+1}) = 1$ and $\phi(x_j) = \phi(x_{j+1}) = 0$, whereas in (b), we have $\phi(x_i) \neq \phi(x_{i+1}) = 0$ and $\phi(x_j) = \phi(x_{j+1}) = 1$. This part of the tour has local length 7.

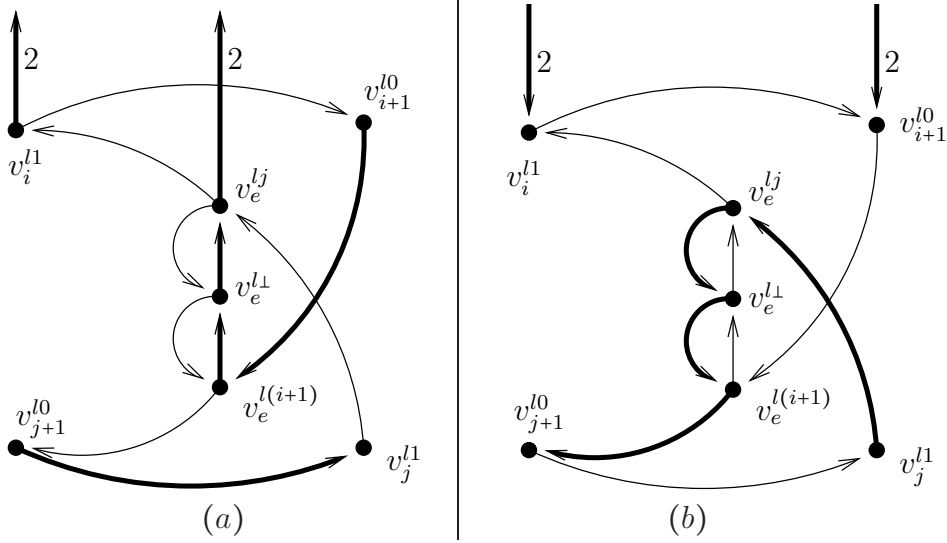

Figure 19: 8. Case $\phi(x_i) \oplus \phi(x_{i+1}) = 1$, $\phi(x_i) \oplus \phi(x_j) = 1$ and $\phi(x_j) \oplus \phi(x_{j+1}) = 0$.

local length 6.

8. Case $\phi(x_i) \oplus \phi(x_{i+1}) = 1$, $\phi(x_i) \oplus \phi(x_j) = 1$ and $\phi(x_j) \oplus \phi(x_{j+1}) = 0$:

In the final case, we traverse the corresponding parity graphs as depicted in Figure 19. In Figure 19 (a), we notice that $\phi(x_i) \neq \phi(x_{i+1}) = 0$ and $\phi(x_j) = \phi(x_{j+1}) = 0$, whereas in (b), we have $\phi(x_i) \neq \phi(x_{i+1}) = 1$ and $\phi(x_j) = \phi(x_{j+1}) = 1$. This part of the tour has local length 6.

Our analysis yields the following proposition.

Proposition 3. Let $x_i^l \oplus x_{i+1}^l = 0$, $x_i^l \oplus x_j^l = 0$ and $x_j^l \oplus x_{j+1}^l = 0$ be equations in \mathcal{H} . Given an assignment ϕ to the variables in \mathcal{H} , the associated tour σ_ϕ has local length at most $5 + u$, where u denotes the number of unsatisfied equations in $\{x_i^l \oplus x_{i+1}^l = 0, x_i^l \oplus x_j^l = 0, x_j^l \oplus x_{j+1}^l = 0\}$ by ϕ .

Traversing Graphs Corresponding to Equations with Three Variables

Let $g_c^3 \equiv x_i^l \oplus x_j^s \oplus x_t^k = 0$ be an equation with three variables in \mathcal{H} . Furthermore, let $x_i^l \oplus x_{i+1}^l = 0$, $x_j^s \oplus x_{j+1}^s = 0$ and $x_t^k \oplus x_{t+1}^k = 0$ be circle equations in \mathcal{H} . For notational simplicity, we introduce $e = \{i, i + 1\}$, $a = \{t, t + 1\}$ and $b = \{j, j + 1\}$. In Figure 20, we display the construction involving the graphs D_c^3 , P_a^k , P_b^s , P_e^l , P_i^l and P_{i+1}^l . Exemplary, we depicted the connections of the graphs D_c^3 , P_e^l , P_i^l and P_{i+1}^l in this figure. We are going to construct the tour σ_ϕ traversing the corresponding graphs and analyze the dependency of the local length of σ_ϕ and the number of satisfied participating equations.

Recall from Proposition 1 that there is a Hamiltonian path from s_c to s_{c+1} containing the vertices v_c^1 , v_c^2 and v_c^3 in D_c^3 if and only if an even number of parity graphs $P \in \{P_a^k, P_b^s, P_e^l\}$ is traversed.

The outer loop traverses the graph D_c^3 starting at s_c and ending at s_{c+1} . Further-

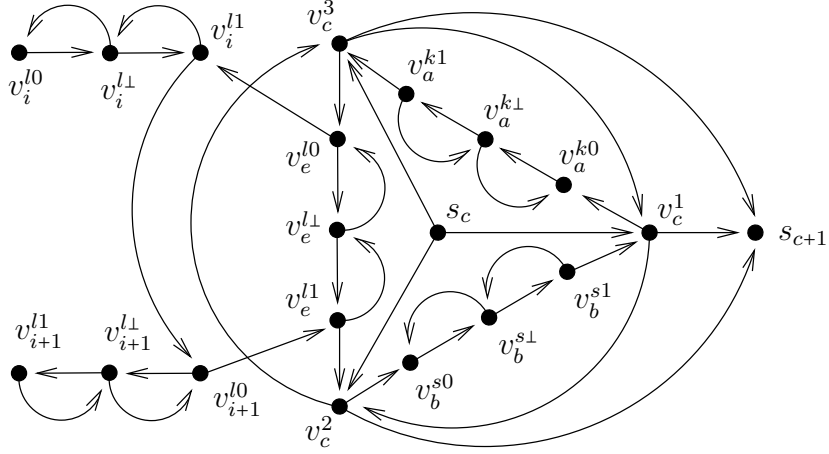

Figure 20: The graph D_c^3 with its connections to P_i^l and P_{i+1}^l .

more, it contains the vertices v_c^1 , v_c^2 and v_c^3 in some order. If σ_ϕ traverses an even number of parity graphs $P \in \{P_a^k, P_b^s, P_e^l\}$ in the inner loop, it is possible to construct a Hamiltonian path with associated local length $3 \cdot 3 + 4$. In the other case, we have to use a 2-arc yielding the local length 14.

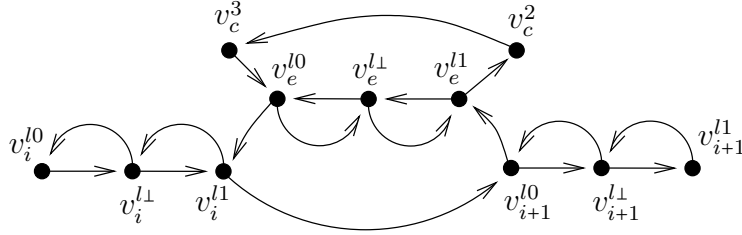

Figure 21: A part of the graphs corresponding to $x_i^l \oplus x_{i+1}^l = 0$ and $x_i^l \oplus x_j^s \oplus x_t^k = 0$.

Let us analyze the part of σ_ϕ traversing graphs corresponding to $x_i^l \oplus x_{i+1}^l = 0$. For this reason, we will examine the situation depicted in Figure 21. Let us begin with the case $\phi(x_i^l) \oplus \phi(x_{i+1}^l) = 0$.

1. Case $\phi(x_i^l) \oplus \phi(x_{i+1}^l) = 0$:

If $\phi(x_i^l) = \phi(x_{i+1}^l) = 1$ holds, the tour σ_ϕ uses the arc (v_i^{l1}, v_{i+1}^{l0}) . Afterwards, the parity graph P_e^l will be traversed when the tour leads through the graph D_c^3 . More precisely, it will use the path $v_c^3 \rightarrow v_e^{l0} \rightarrow v_e^{l1} \rightarrow v_e^{l1} \rightarrow v_c^2$. In Figure 22, we illustrated this part of the tour.

In the other case $\phi(x_i^l) = \phi(x_{i+1}^l) = 0$, we use the path $v_{i+1}^{l0} \rightarrow v_e^{l1} \rightarrow v_e^{l1} \rightarrow v_e^{l0} \rightarrow v_i^{l1}$. Afterwards, the tour σ_ϕ contains the arc (v_c^2, v_c^3) .

In both cases, we associate the local length 1 with this part of the tour.

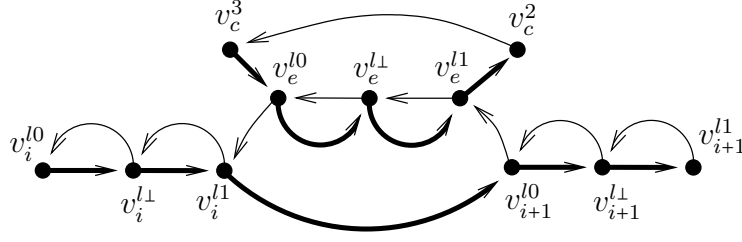

Figure 22: Case $\phi(x_i^l) = \phi(x_{i+1}^l) = 1$.

2. Case $\phi(x_{i+1}^l) \oplus \phi(x_i^l) = 1$:

Assuming $\phi(x_i^l) \neq \phi(x_{i+1}^l) = 1$, the tour σ_ϕ uses a 2-arc entering v_e^{l1} and the path $v_e^{l1} \rightarrow v_e^{l1} \rightarrow v_e^{l0} \rightarrow v_i^{l1}$. Furthermore, we need another 2-arc in order to reach v_{i+1}^{l0} . The situation is depicted in Figure 23.

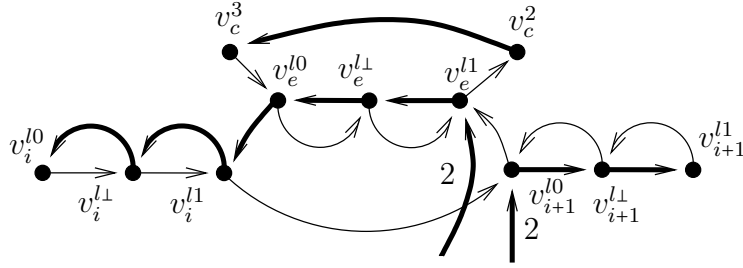

Figure 23: Case $\phi(x_i^l) \neq \phi(x_{i+1}^l) = 1$.

In the other case, namely $\phi(x_i^l) \neq \phi(x_{i+1}^l) = 0$, we use 2-arcs leaving v_{i+1}^{l0} and v_i^{l1} . Afterwards, the tour uses the path $v_c^3 \rightarrow v_e^{l0} \rightarrow v_e^{l1} \rightarrow v_c^2$ while traversing the graph D_c^3 .

In both cases, we associate the local length 2 with this part of the tour.

We obtain the following proposition.

Proposition 4. *Let $x_i^l \oplus x_j^s \oplus x_t^k = 0$ be an equation with three variables in \mathcal{H} . Furthermore, let $x_i^l \oplus x_{i+1}^l = 0$, $x_j^s \oplus x_{j+1}^s = 0$ and $x_t^k \oplus x_{t+1}^k = 0$ be circle equations in \mathcal{H} . Given an assignment ϕ to the variables in \mathcal{H} , the associated tour σ_ϕ has local length at most $3 \cdot 3 + 4 + 3 + u$, where u denotes the number of unsatisfied equations in $\{x_i^l \oplus x_j^s \oplus x_t^k = 0, x_i^l \oplus x_{i+1}^l = 0, x_j^s \oplus x_{j+1}^s = 0, x_t^k \oplus x_{t+1}^k = 0\}$ by ϕ .*

Traversing Graphs Corresponding to Circle Border Equations

Let \mathcal{C}_l be a circle in \mathcal{H} and $x_1^l \oplus x_n^l = 0$ its circle border equation. Recall that the variable x_n^l is also included in an equation with three variables. We are going to describe the part of the tour passing through the graphs depicted in Figure 24 in dependence of the assigned values to the variables x_1^l and x_n^l . Let us start with the case $\phi(x_1^l) \oplus \phi(x_n^l) = 0$.

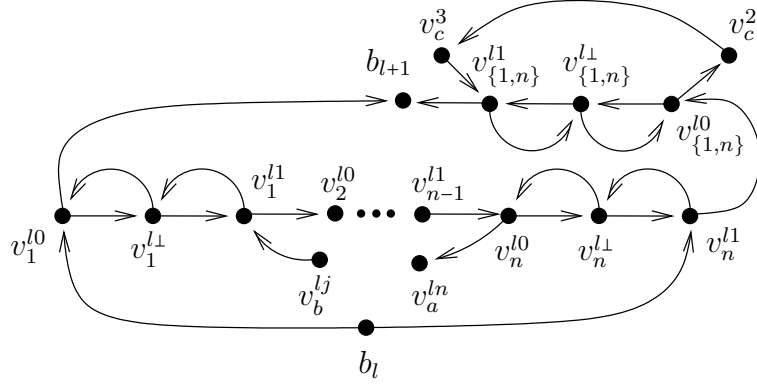

Figure 24: Traversing Graphs Corresponding To Circle Border Equations.

1. Case $\phi(x_1^l) \oplus \phi(x_n^l) = 0$

The starting point of the tour σ_ϕ passing through the graph corresponding to $x_1^l \oplus x_n^l = 0$ is the vertex b_l . Given the values $\phi(x_1^l) = \phi(x_n^l)$, we use in each case the $\phi(x_1^l)$ -traversal of the parity graphs P_1^l and P_n^l ending in b_{l+1}^l . Note that in the case $\phi(x_1^l) = \phi(x_n^l) = 0$, we use the 1-traversal of the parity graph $P_{\{1,n\}}^l$. Exemplary, we display the situation $\phi(x_1^l) = \phi(x_n^l) = 1$ in Figure 25.

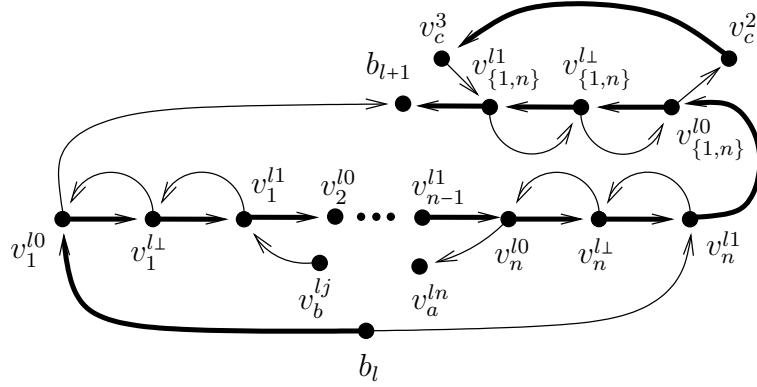

Figure 25: Case $\phi(x_1^l) = \phi(x_n^l) = 1$.

In both cases, we associated the local length 2 with this part of the tour.

2. Case $\phi(x_1^l) \oplus \phi(x_n^l) = 1$

Given the assignment $\phi(x_1^l) \neq \phi(x_n^l) = 0$, we traverse the arc (b_l, v_1^{l0}) . Due to the construction, we have to use 2-arcs to enter b_{l+1} and v_n^{l1} as depicted in Figure 26.

In the other case, we have to use a 2-arc in order to leave the vertex b_l . In addition, the tour contains the path $v_n^{l1} \rightarrow v_{\{1,n\}}^{l0} \rightarrow v_{\{1,n\}}^{l\perp} \rightarrow v_{\{1,n\}}^{l1} \rightarrow b_{l+1}$.

Hence, in both cases, we associate the local length 3 with this part of σ_ϕ .

We obtain the following proposition.

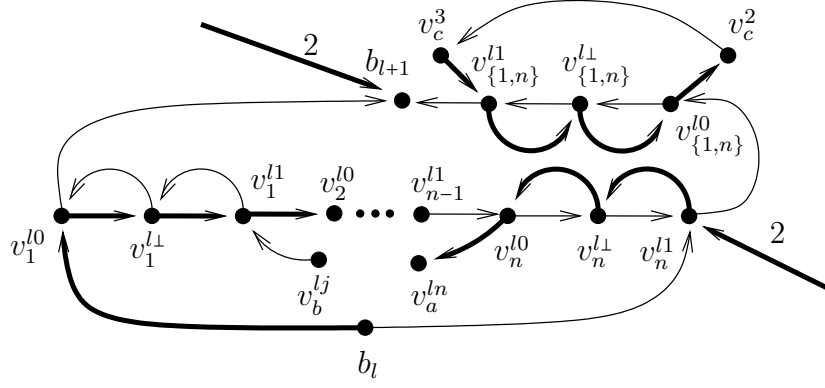

Figure 26: Case $\phi(x_1^l) \neq \phi(x_n^l) = 0$.

Proposition 5. Let $x_1^l \oplus x_n^l = 0$ be an circle border equations in \mathcal{H} . Given an assignment ϕ to the variables in \mathcal{H} , the associated tour σ_ϕ has local length 2 if the equation $x_1^l \oplus x_n^l = 0$ is satisfied by ϕ and 3, otherwise.

5.4 Constructing the Assignment ψ_σ from a Tour σ

Let \mathcal{H} be an instance of the Hybrid problem, $D_{\mathcal{H}} = (V_{\mathcal{H}}, A_{\mathcal{H}})$ the associated instance of the $(1, 2)$ -ATSP problem and σ a tour in $D_{\mathcal{H}}$. We are going to define the corresponding assignment $\psi_\sigma : V(\mathcal{H}) \rightarrow \{0, 1\}$ to the variables in \mathcal{H} . In addition to it, we establish a connection between the length of σ and the number of satisfied equations by ψ_σ .

In order to define an assignment, we first introduce the notion of consistent tours in $D_{\mathcal{H}}$.

Definition 2 (Consistent Tour). Let \mathcal{H} be an instance of the Hybrid problem and $D_{\mathcal{H}}$ the associated instance of the $(1, 2)$ -ATSP problem. A tour in $D_{\mathcal{H}}$ is called consistent if the tour uses only 0/1-traversals of all in $D_{\mathcal{H}}$ contained parity graphs.

Due to the following proposition, we may assume that the underlying tour is consistent.

Proposition 6. Let \mathcal{H} be an instance of the Hybrid problem and $D_{\mathcal{H}}$ the associated instance of the $(1, 2)$ -ATSP problem. Any tour σ in $D_{\mathcal{H}}$ can be transformed in polynomial time into a consistent tour σ' with $\ell(\sigma') \leq \ell(\sigma)$.

Proof. For every parity graph contained in $D_{\mathcal{H}}$, it can be seen by considering all possibilities exhaustively that any tour in $D_{\mathcal{H}}$ that is not using the corresponding 0/1-traversals can be modified into a tour with at most the same number of 2-arcs. The less obvious cases are shown in Figure 51 (see 10. Figure Appendix). \square

In the remainder, we assume that the underlying tour σ is consistent with all parity graphs in $D_{\mathcal{H}}$. Let us now define the corresponding assignment ψ_σ given σ .

Definition 3 (Assignment ψ_σ). Let \mathcal{H} be an instance of the Hybrid problem, $D_{\mathcal{H}} = (V_{\mathcal{H}}, A_{\mathcal{H}})$ the associated instance of the $(1, 2)$ -ATSP problem. Given a tour σ in $D_{\mathcal{H}}$, in which all parity graphs are consistent with respect to σ , the corresponding assignment $\psi_\sigma : V(\mathcal{H}) \rightarrow \{0, 1\}$ is defined as follows.

$$\begin{aligned} \psi_\sigma(x_i^l) &= 1 && \text{if } \sigma \text{ uses a 1-traversal of } P_i^l \\ &= 0 && \text{otherwise} \end{aligned}$$

We are going to analyze the local length of σ in dependence of the number of corresponding satisfied equations by ψ_σ . In some cases, we will have to modify the underlying tour improving in this way on the number of satisfied equations by the corresponding assignment ψ_σ . Let us start with the analysis.

Transforming σ in Graphs Corresponding to Matching Equations

Given the equations $x_i \oplus x_{i+1} = 0$, $x_i \oplus x_j = 0$, $x_j \oplus x_{j+1} = 0$ and a tour σ , we are going to construct an assignment in dependence of σ . In particular, we analyze the relation between the length of the tour and the number of satisfied equations by ψ_σ .

1. Case $\psi_\sigma(x_i) \oplus \psi_\sigma(x_{i+1}) = 0$, $\psi_\sigma(x_i) \oplus \psi_\sigma(x_j) = 0$ and $\psi_\sigma(x_j) \oplus \psi_\sigma(x_{j+1}) = 0$:

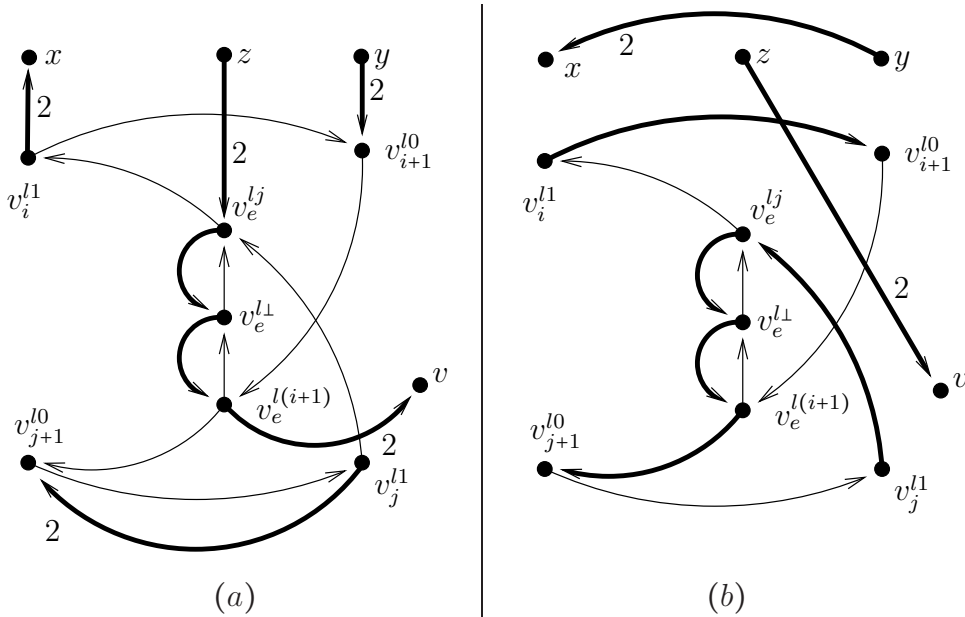

Figure 27: 1. Case $\psi_\sigma(x_i) \oplus \psi_\sigma(x_{i+1}) = 0$, $\psi_\sigma(x_i) \oplus \psi_\sigma(x_j) = 0$ & $\psi_\sigma(x_j) \oplus \psi_\sigma(x_{j+1}) = 0$.

Given $\psi_\sigma(x_i) = \psi_\sigma(x_j) = \psi_\sigma(x_{i+1}) = \psi_\sigma(x_{j+1}) = 1$, it is possible to transform the underlying tour such that no 2-arcs enter or leave the vertices v_i^{l1} , v_{i+1}^{l0} , v_{j+1}^{l0} , v_e^{lj} , $v_e^{l(i+1)}$ and v_j^{l1} . Exemplary, we display in Figure 27 such an transformation, where Figure 27 (a) and Figure 27 (b) illustrate the underlying tour σ and the transformed tour σ' , respectively. The case $\psi_\sigma(x_i) = \psi_\sigma(x_{i+1}) = \psi_\sigma(x_j) = \psi_\sigma(x_{j+1}) = 0$

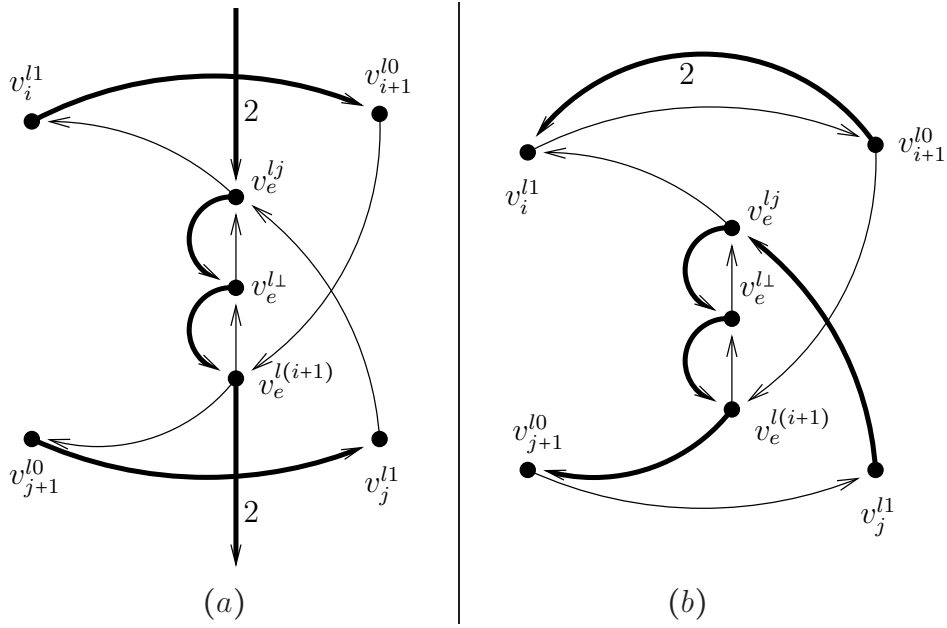

Figure 28: 2. Case $\psi_\sigma(x_i) \oplus \psi_\sigma(x_{i+1}) = 0$, $\psi_\sigma(x_i) \oplus \psi_\sigma(x_j) = 1$ & $\psi_\sigma(x_j) \oplus \psi_\sigma(x_{j+1}) = 0$.

can be discussed analogously.

In both cases, we obtain the local length 5 for this part of σ while ψ_σ satisfies all 3 equations.

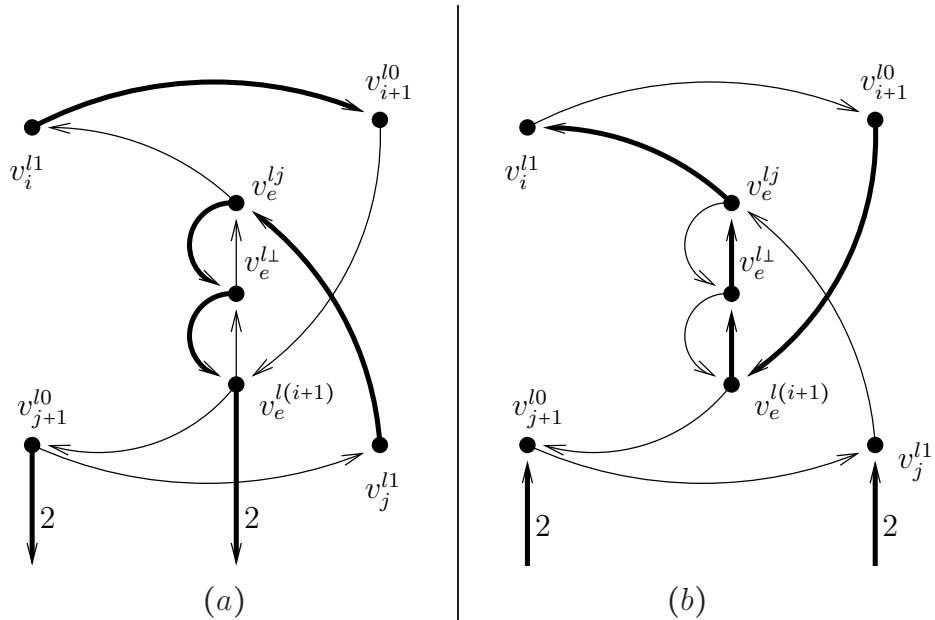

Figure 29: 3. Case $\psi_\sigma(x_i) \oplus \psi_\sigma(x_{i+1}) = 0$, $\psi_\sigma(x_i) \oplus \psi_\sigma(x_j) = 0$ & $\psi_\sigma(x_j) \oplus \psi_\sigma(x_{j+1}) = 1$.

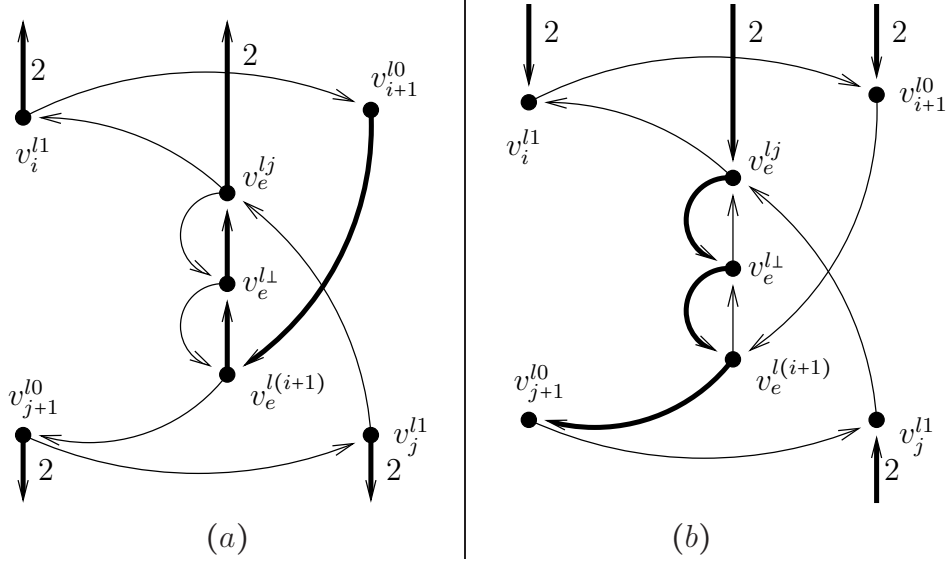

Figure 30: 4. Case $\psi_\sigma(x_i) \oplus \psi_\sigma(x_{i+1}) = 1$, $\psi_\sigma(x_i) \oplus \psi_\sigma(x_j) = 0$ & $\psi_\sigma(x_j) \oplus \psi_\sigma(x_{j+1}) = 1$.

2. Case $\psi_\sigma(x_i) \oplus \psi_\sigma(x_{i+1}) = 0$, $\psi_\sigma(x_i) \oplus \psi_\sigma(x_j) = 1$ and $\psi_\sigma(x_j) \oplus \psi_\sigma(x_{j+1}) = 0$:
Assuming $\psi_\sigma(x_i) = \psi_\sigma(x_{i+1}) = 1$ and $\psi_\sigma(x_j) = \psi_\sigma(x_{j+1}) = 0$, we are able to transform the tour such that it uses the arcs (v_i^{l1}, v_{i+1}^{l0}) and (v_{j+1}^{l0}, v_j^{l1}) . Due to the construction and our assumption, the tour cannot traverse the arcs (v_j^{l1}, v_e^{lj}) , (v_e^{lj}, v_i^{l1}) , $(v_e^{l(i+1)}, v_{j+1}^{l0})$ and $(v_{i+1}^{l0}, v_e^{l(i+1)})$. Consequently, we have to use 2-arcs entering and leaving the parity graph P_e^l . The situation is displayed in Figure 28 (a). We associate only the cost of one 2-arc yielding the local length 6, which corresponds to the fact that ψ_σ leaves the equation $x_i \oplus x_j = 0$ unsatisfied.

Note that a similar situation holds in case of $\psi_\sigma(x_i) = \psi_\sigma(x_{i+1}) = 0$ and $\psi_\sigma(x_j) = \psi_\sigma(x_{j+1}) = 1$ (cf. Figure 28 (b)).

3. Case $\psi_\sigma(x_i) \oplus \psi_\sigma(x_{i+1}) = 0$, $\psi_\sigma(x_i) \oplus \psi_\sigma(x_j) = 0$ and $\psi_\sigma(x_j) \oplus \psi_\sigma(x_{j+1}) = 1$:
Let us start with the case $\psi_\sigma(x_i) = \psi_\sigma(x_{i+1}) = 1$ and $\psi_\sigma(x_j) \neq \psi_\sigma(x_{j+1}) = 0$. The situation is displayed in Figure 29 (a). Due to the construction, we are able to transform σ such that it uses the arc (v_i^{l1}, v_{i+1}^{l0}) . Note that the tour cannot traverse the arcs $(v_e^{l(i+1)}, v_{j+1}^{l0})$ and (v_{j+1}^{l0}, v_j^{l1}) . Hence, we are forced to use two 2-arcs increasing the cost by 2. All in all, we obtain the local length 6. The case $\psi_\sigma(x_i) = \psi_\sigma(x_{i+1}) = 0$ and $\psi_\sigma(x_j) \neq \psi_\sigma(x_{j+1}) = 1$ can be analyzed analogously (cf. Figure 29 (b)). A similar argumentation holds for $\psi_\sigma(x_i) \oplus \psi_\sigma(x_{i+1}) = 1$, $\psi_\sigma(x_i) \oplus \psi_\sigma(x_j) = 0$ and $\psi_\sigma(x_j) \oplus \psi_\sigma(x_{j+1}) = 0$.

4. Case $\psi_\sigma(x_i) \oplus \psi_\sigma(x_{i+1}) = 1$, $\psi_\sigma(x_i) \oplus \psi_\sigma(x_j) = 0$ and $\psi_\sigma(x_j) \oplus \psi_\sigma(x_{j+1}) = 1$:
Given $\psi_\sigma(x_i) \neq \psi_\sigma(x_{i+1}) = 0$ and $\psi_\sigma(x_j) \neq \psi_\sigma(x_{j+1}) = 0$, we are able to transform the tour such that it uses the arc $(v_{i+1}^{l0}, v_e^{l(i+1)})$. This situation is depicted in Figure 30 (a). Notice that we are forced to use four 2-arcs in order to connect all vertices. Consequently, it yields the local length 7.

The case, in which $\psi_\sigma(x_i) \neq \psi_\sigma(x_{i+1}) = 0$ and $\psi_\sigma(x_j) \neq \psi_\sigma(x_{j+1}) = 0$ holds,

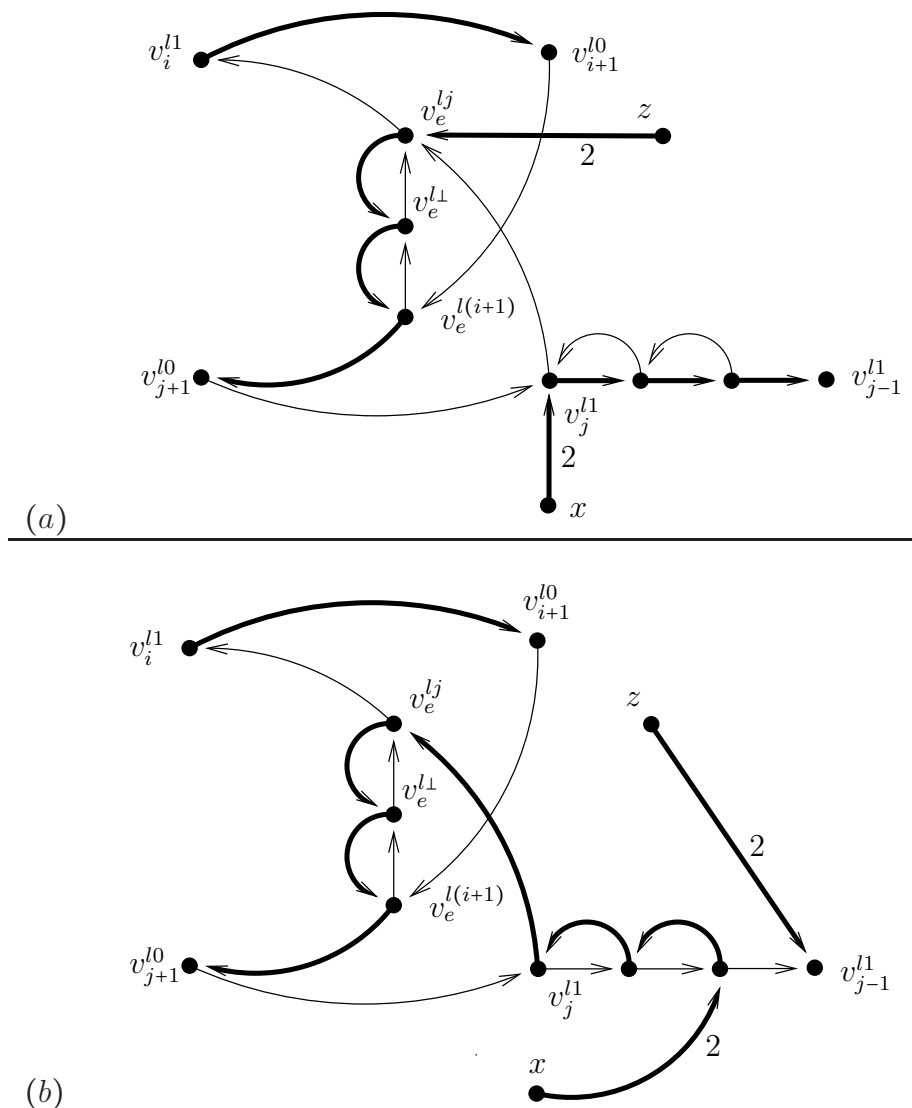

Figure 31: 5. Case with $\psi_\sigma(x_i) = \psi_\sigma(x_{i+1}) = 1$ and $\psi_\sigma(x_j) \neq \psi_\sigma(x_{j+1}) = 1$.

is displayed in Figure 30 (b) and can be discussed analogously.

5. Case $\psi_\sigma(x_i) \oplus \psi_\sigma(x_{i+1}) = 0$, $\psi_\sigma(x_i) \oplus \psi_\sigma(x_j) = 1$ and $\psi_\sigma(x_j) \oplus \psi_\sigma(x_{j+1}) = 1$:
Let the tour σ be characterized by $\psi_\sigma(x_i) = \psi_\sigma(x_{i+1}) = 1$ and $\psi_\sigma(x_j) \neq \psi_\sigma(x_{j+1}) = 1$. Then, we transform σ in such a way that we are able to use the arc (v_i^{l1}, v_{i+1}^{l0}) . The corresponding situation is illustrated in Figure 31 (a). In order to change the value of $\psi_\sigma(x_j)$, we transform the tour by traversing the parity graph P_j^l in the other direction and obtain $\psi_\sigma(x_j) = 1$. This transformation induces a tour with at most the same cost. On the other hand, the corresponding assignment ψ_σ satisfies at least $2 - 1$ more equations since $x_j^l \oplus x_{j-1}^l = 0$ might get unsatisfied. In this case, we associate the local costs of 6 with σ .

In the other case, in which $\psi_\sigma(x_i) = \psi_\sigma(x_{i+1}) = 0$ and $\psi_\sigma(x_j) \neq \psi_\sigma(x_{j+1}) = 0$

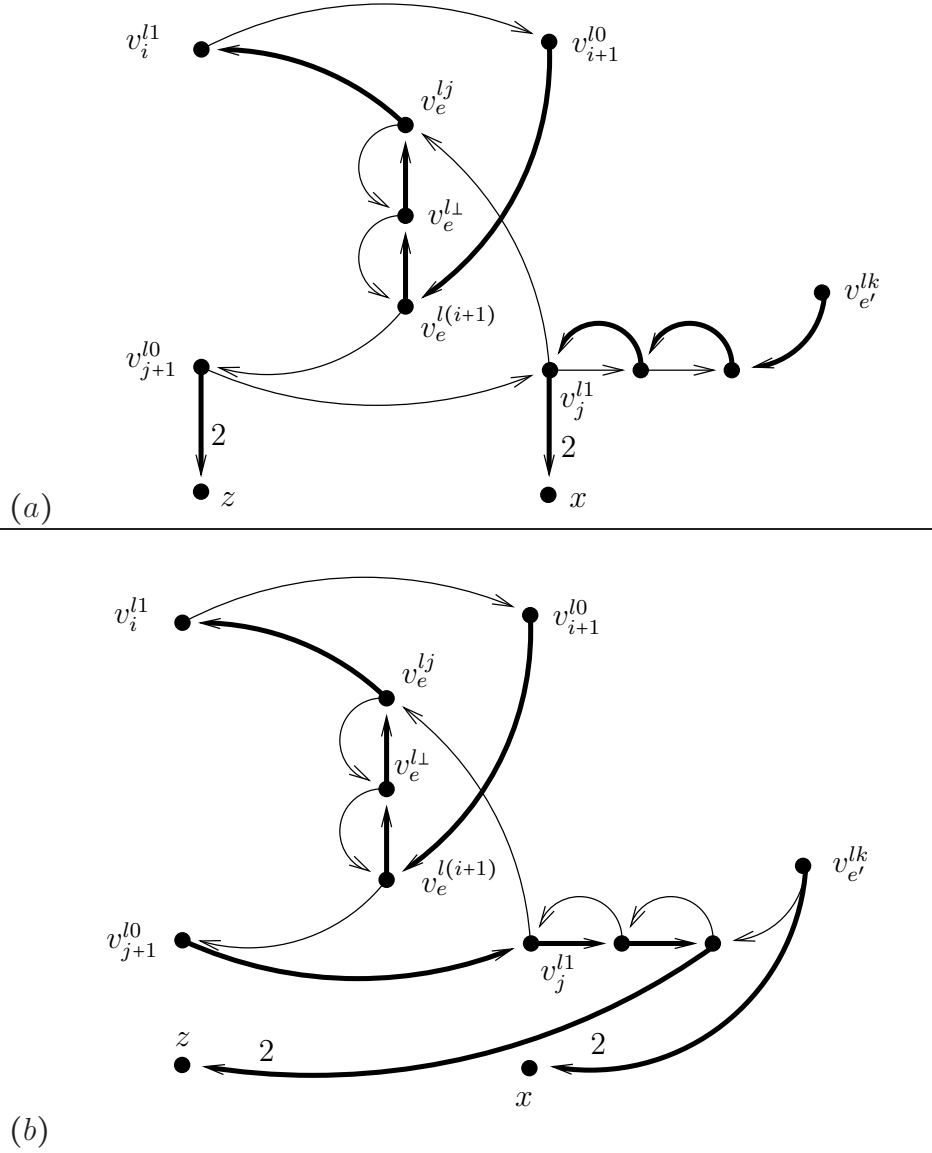

Figure 32: 5. Case with $\psi_\sigma(x_i) = \psi_\sigma(x_{i+1}) = 0$ and $\psi_\sigma(x_j) \neq \psi_\sigma(x_{j+1}) = 0$.

holds, we may argue similarly. The transformation is depicted in Figure 32 (a) – (b).

6. Case $\psi_\sigma(x_i) \oplus \psi_\sigma(x_{i+1}) = 1$, $\psi_\sigma(x_i) \oplus \psi_\sigma(x_j) = 1$ and $\psi_\sigma(x_j) \oplus \psi_\sigma(x_{j+1}) = 1$:
 Given a tour σ with $\psi_\sigma(x_i) \neq \psi_\sigma(x_{i+1}) = 1$ and $\psi_\sigma(x_j) \neq \psi_\sigma(x_{j+1}) = 0$, we transform σ such that it traverses the parity graph P_j^l in the opposite direction meaning $\psi_\sigma(x_j) = 0$ (cf. Figure 33). This transformation enables us to use the arc (v_{j+1}^{l0}, v_j^{l1}) . Furthermore, it yields at least one more satisfied equation in \mathcal{H} . In order to connect the remaining vertices, we are forced to use at least two 2-arcs. In summary, we associate the local length 7 with this situation in conformity with the at most 2 unsatisfied equations by ψ_σ .

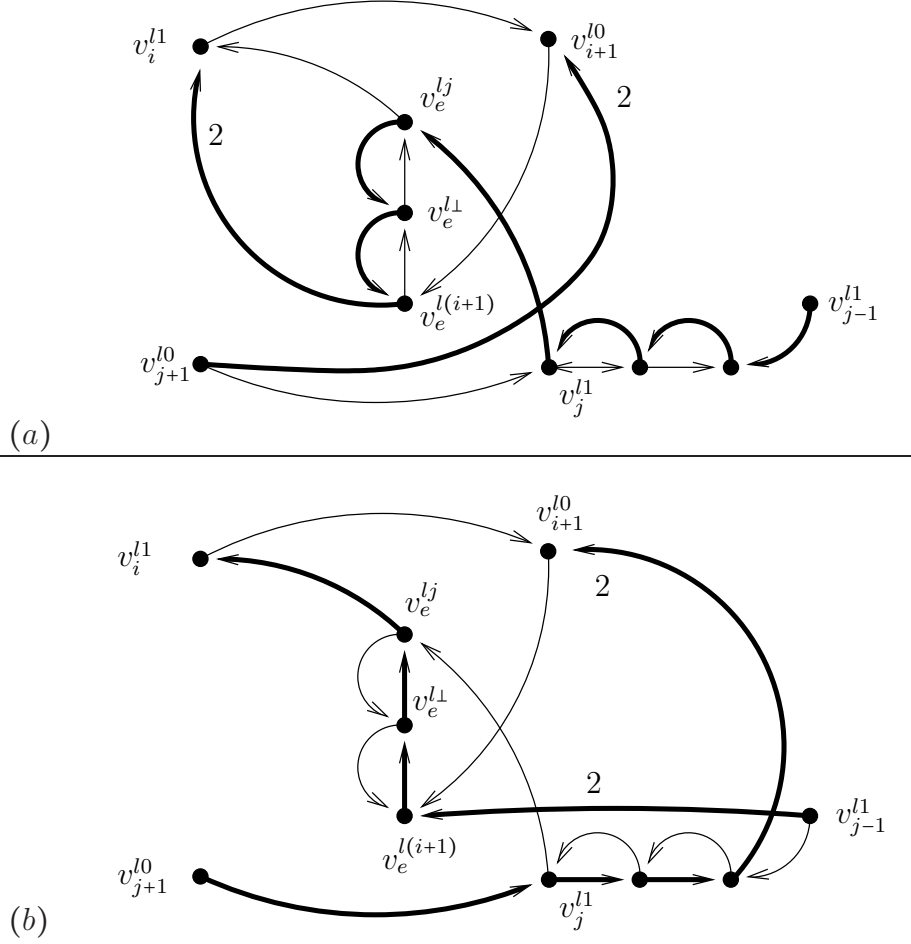

Figure 33: 6. Case with $\psi_\sigma(x_i) \neq \psi_\sigma(x_{i+1}) = 1$ and $\psi_\sigma(x_j) \neq \psi_\sigma(x_{j+1}) = 0$.

If we are given a tour σ with $\psi_\sigma(x_i) \neq \psi_\sigma(x_{i+1}) = 0$ and $\psi_\sigma(x_j) \neq \psi_\sigma(x_{j+1}) = 1$, we obtain the situation displayed in Figure 34 (a). By applying local transformations without increasing the length of the underlying tour, we achieve the scenario depicted in Figure 34 (b). We argue that the associated local length of the tour is 7.

The case, in which $\psi_\sigma(x_i) \oplus \psi_\sigma(x_{i+1}) = 1$, $\psi_\sigma(x_i) \oplus \psi_\sigma(x_j) = 1$ and $\psi_\sigma(x_j) \oplus \psi_\sigma(x_{j+1}) = 0$ holds, can be discussed analogously.

We obtain the following proposition.

Proposition 7. *Let $x_i^l \oplus x_{i+1}^l = 0$, $x_i^l \oplus x_j^l = 0$ and $x_j^l \oplus x_{j+1}^l = 0$ be equations in \mathcal{H} . Then, it is possible to transform in polynomial time the given tour σ passing through the graphs corresponding to $x_i^l \oplus x_{i+1}^l = 0$, $x_i^l \oplus x_j^l = 0$ and $x_j^l \oplus x_{j+1}^l = 0$ such that it has local length $5 + u$ and the number of unsatisfied equations in $\{x_i^l \oplus x_{i+1}^l = 0, x_i^l \oplus x_j^l = 0, x_j^l \oplus x_{j+1}^l = 0\}$ by ψ_σ is bounded from above by u .*

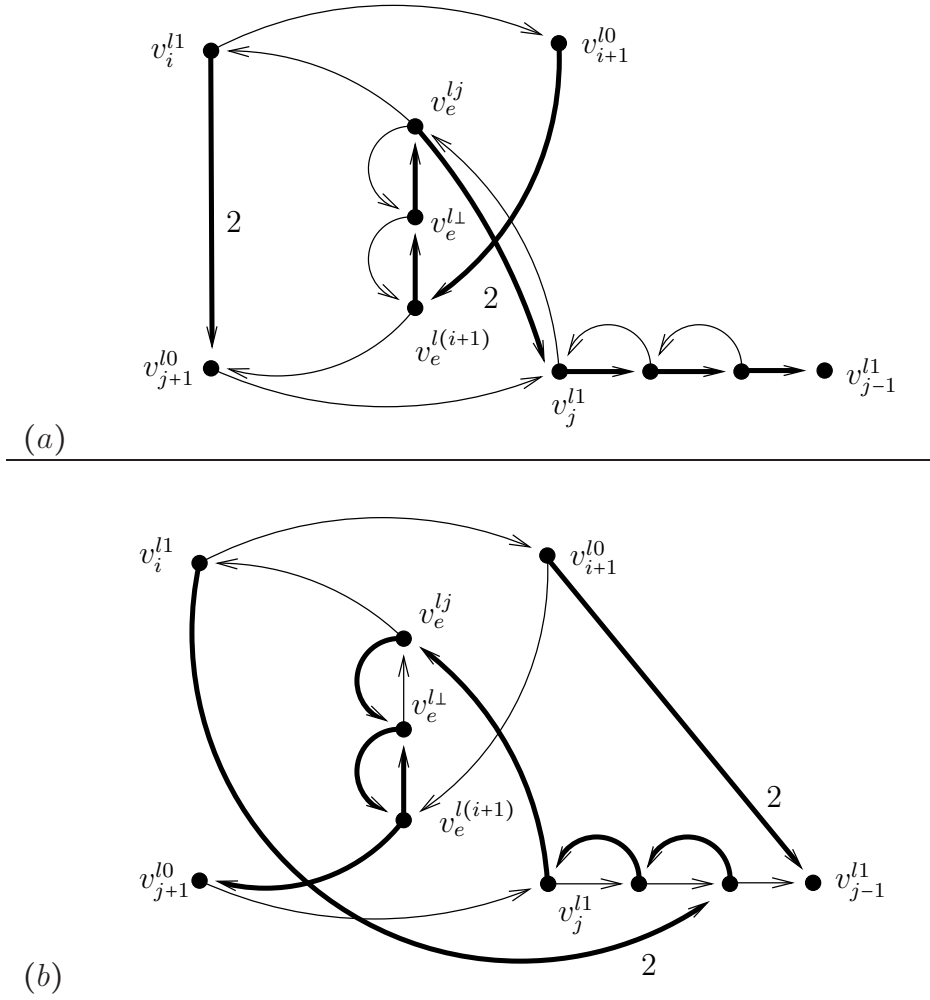

Figure 34: 6. Case with $\psi_\sigma(x_i) \neq \psi_\sigma(x_{i+1}) = 0$ and $\psi_\sigma(x_j) \neq \psi_\sigma(x_{j+1}) = 1$.

Transforming σ in Graphs Corresponding to Equations With Three Variables

Let $g_c^3 \equiv x_i^l \oplus x_j^s \oplus x_k^r = 0$ be an equation with three variables in \mathcal{H} . Furthermore, let C_l be a circle in \mathcal{H} and $x_i^l \oplus x_{i+1}^l = 0$ a circle equation. For notational simplicity, we set $e = \{i, i + 1\}$. We are going to analyze the the number of satisfied equations by ψ_σ in relation to the local length of σ in the graphs P_i^l , P_{i+1}^l , P_e^l and D_c^3 . First, we transform the tour traversing the graphs P_i^l , P_{i+1}^l and P_e^l such that it uses the $\psi_\sigma(x_i^l)$ -traversal of P_e^l . Afterwards, due to the construction of D_c^3 and Proposition 1, the tour can be transformed such that it has local length $3 \cdot 3 + 4$ if it passes an even number of parity graphs $P \in \{P_e^l, P_a^k, P_b^s\}$ by using a simple path through D_c^3 , otherwise, it yields a local length of $13 + 1$. Let us start with the case $\psi_\sigma(x_i^l) = 1$ and $\psi_\sigma(x_{i+1}^l) = 1$.

1. Case $\psi_\sigma(x_i^l) = 1$ and $\psi_\sigma(x_{i+1}^l) = 1$:

In Figure 35 (a) and (b), we display the tour passing through P_i^l , P_{i+1}^l and P_e^l with

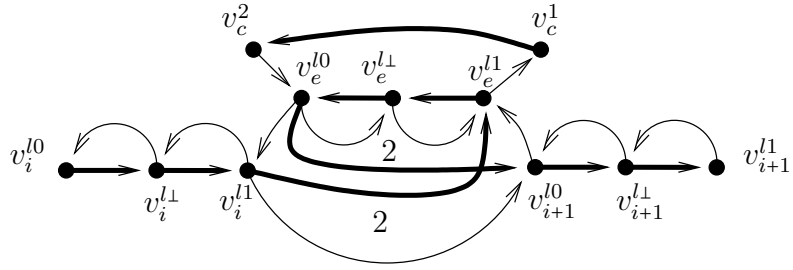

(a)

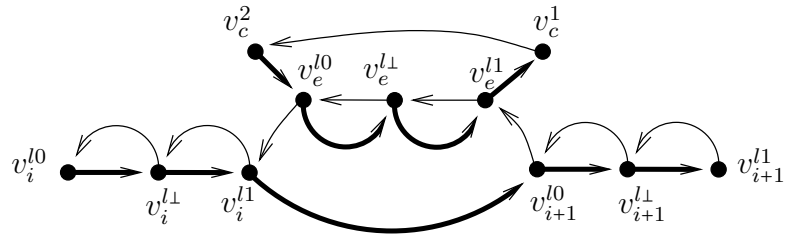

(b)

Figure 35: 1. Case $\psi_\sigma(x_i^l) = 1$ and $\psi_\sigma(x_{i+1}^l) = 1$

$\psi_\sigma(x_i^l) = 1$ and $\psi_\sigma(x_{i+1}^l) = 1$ before and after the transformation, respectively.

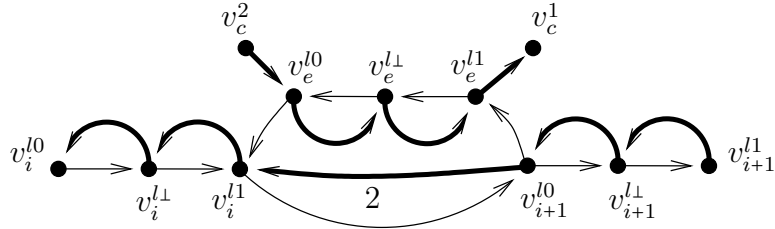

(a)

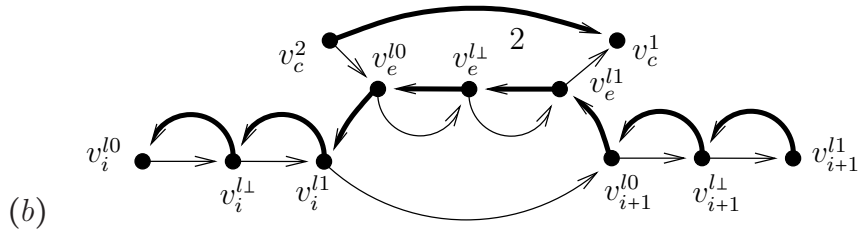

(b)

Figure 36: 2. Case $\psi_\sigma(x_i^l) = 0$ and $\psi_\sigma(x_{i+1}^l) = 0$

It is possible to transform the tour σ without increasing the length such that it

traverses the arc (v_i^{l1}, v_{i+1}^{l0}) . In the outer loop, the tour may use at least one of the arcs (v_c^2, v_e^{l0}) and (v_e^{l1}, v_c^1) depending on the parity check in D_c^3 . We associate the local length 1 with this part of the tour.

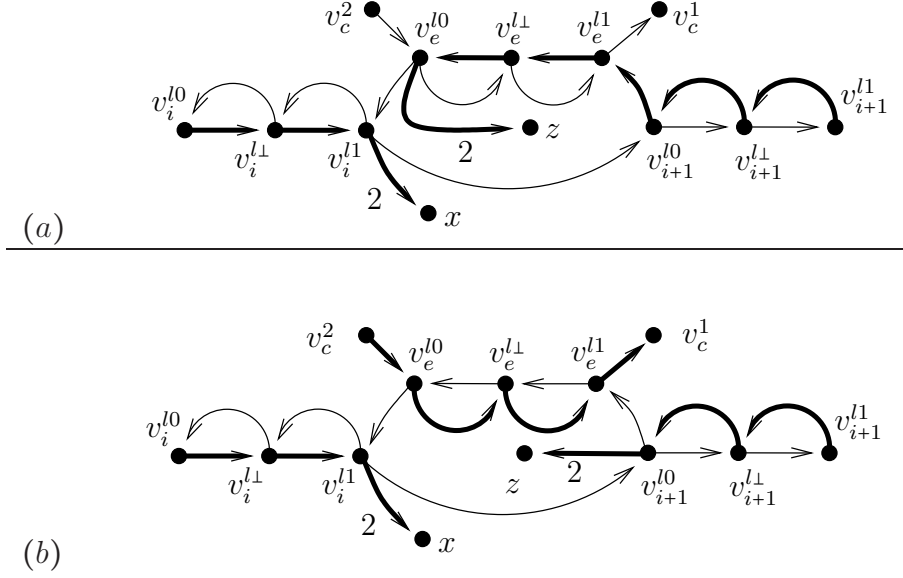

Figure 37: 3. Case $\psi_\sigma(x_i^l) = 1$, $\psi_\sigma(x_{i+1}^l) = 0$ and $\psi_\sigma(x_i^l) \oplus \psi_\sigma(x_j^s) \oplus \psi_\sigma(x_k^r) = 0$

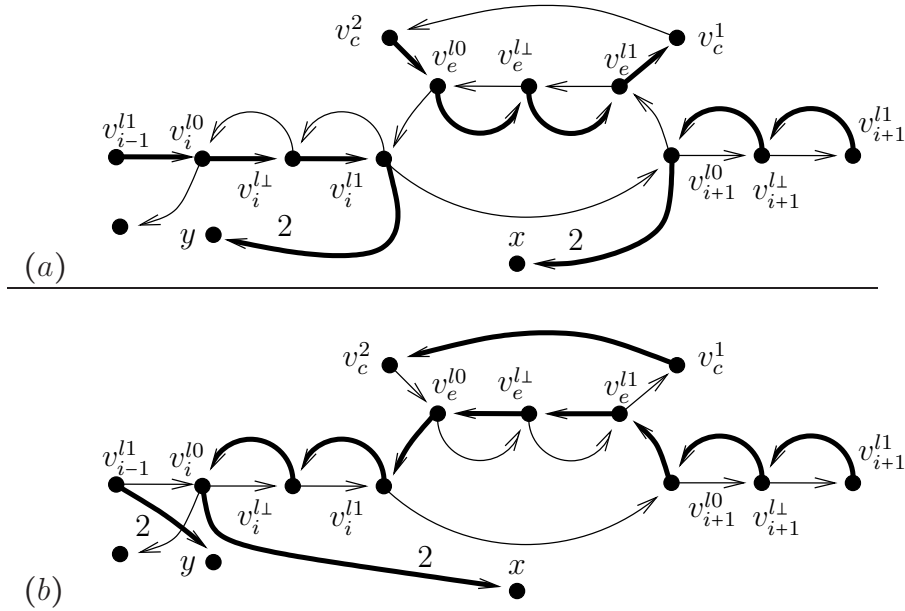

Figure 38: 3. Case $\psi_\sigma(x_i^l) = 1$, $\psi_\sigma(x_{i+1}^l) = 0$ and $\psi_\sigma(x_i^l) \oplus \psi_\sigma(x_j^s) \oplus \psi_\sigma(x_k^r) = 1$.

2. Case $\psi_\sigma(x_i^l) = 0$ and $\psi_\sigma(x_{i+1}^l) = 0$:

In Figure 36, we display the underlying scenario with $\psi_\sigma(x_i^l) = 0$ and $\psi_\sigma(x_{i+1}^l) = 0$.

The transformed tour uses the 0-traversal of the parity graph P_e^l . The vertices v_c^2 and v_c^1 are connected via a 2-arc. We assign the local length 1 to this part of the tour.

3. Case $\psi_\sigma(x_i^l) = 1$ and $\psi_\sigma(x_{i+1}^l) = 0$:

Let us assume that $\psi_\sigma(x_i^l) \oplus \psi_\sigma(x_j^s) \oplus \psi_\sigma(x_k^r) = 0$ holds. Hence, it is possible to transform the tour such that it uses the path $v_c^2 \rightarrow v_e^{l0} \rightarrow v_e^{l1} \rightarrow v_c^1$ and thus, the 0-traversal of the parity graph P_e^l as displayed in Figure 37.

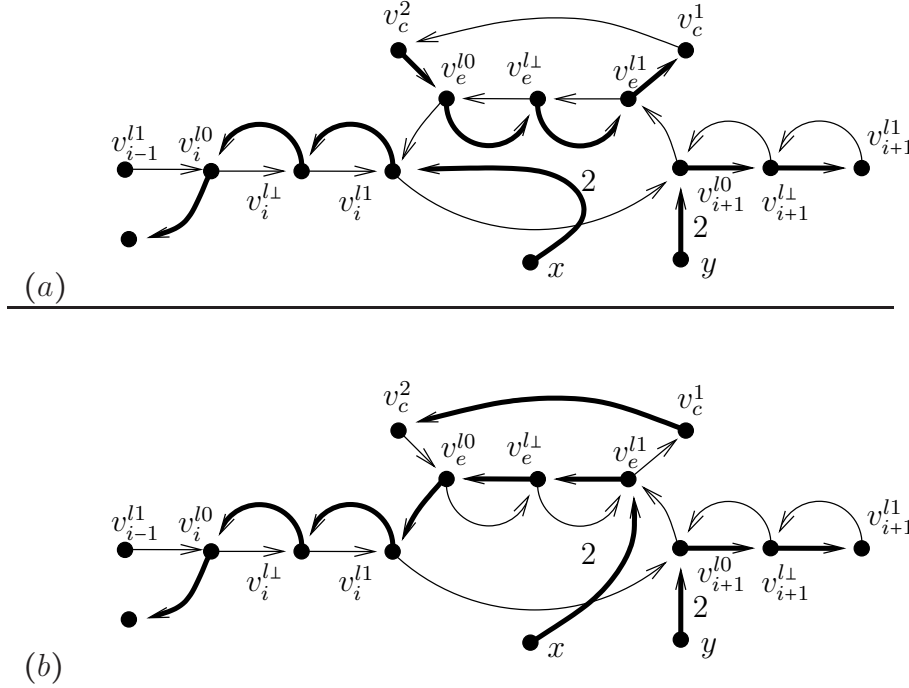

Figure 39: 4. Case $\psi_\sigma(x_i^l) = 0$, $\psi_\sigma(x_{i+1}^l) = 1$ and $\psi_\sigma(x_i^l) \oplus \psi_\sigma(x_j^s) \oplus \psi_\sigma(x_k^r) = 0$

In the other case, namely $\psi_\sigma(x_i^l) \oplus \psi_\sigma(x_j^s) \oplus \psi_\sigma(x_k^r) = 1$, we will change the value of $\psi_\sigma(x_i^l)$ achieving in this way at least $2 - 1$ more satisfied equation. Let us examine the scenario in Figure 38. The tour uses the 0-traversal of the parity graph P_e^l , which enables σ to pass the parity check in D_c^3 .

In both cases, we obtain the local length 2 in conformity with the at most one unsatisfied equation by ψ_σ .

4. Case $\psi_\sigma(x_i^l) = 0$ and $\psi_\sigma(x_{i+1}^l) = 1$:

Assuming $\psi_\sigma(x_i^l) \oplus \psi_\sigma(x_j^s) \oplus \psi_\sigma(x_k^r) = 0$ and the scenario depicted in Figure 39 (a), the tour will be modified such that the parity graphs P_i^l and P_e^l are traversed in the same direction. Since we have $\psi_\sigma(x_i^l) \oplus \psi_\sigma(x_j^s) \oplus \psi_\sigma(x_k^r) = 0$, we are able to uncouple the parity graph P_e^l from the tour through D_c^3 without increasing its length. We display the transformed tour in Figure 39 (b).

Assuming $\psi_\sigma(x_i^l) \oplus \psi_\sigma(x_j^s) \oplus \psi_\sigma(x_k^r) = 1$ and the scenario depicted in Figure 40 (a), we transform σ such that the parity graph P_e^l is traversed when σ is passing through D_c^3 meaning $v_c^2 \rightarrow v_e^{l0} \rightarrow v_e^{l1} \rightarrow v_c^1$ is a part of the tour. In addition,

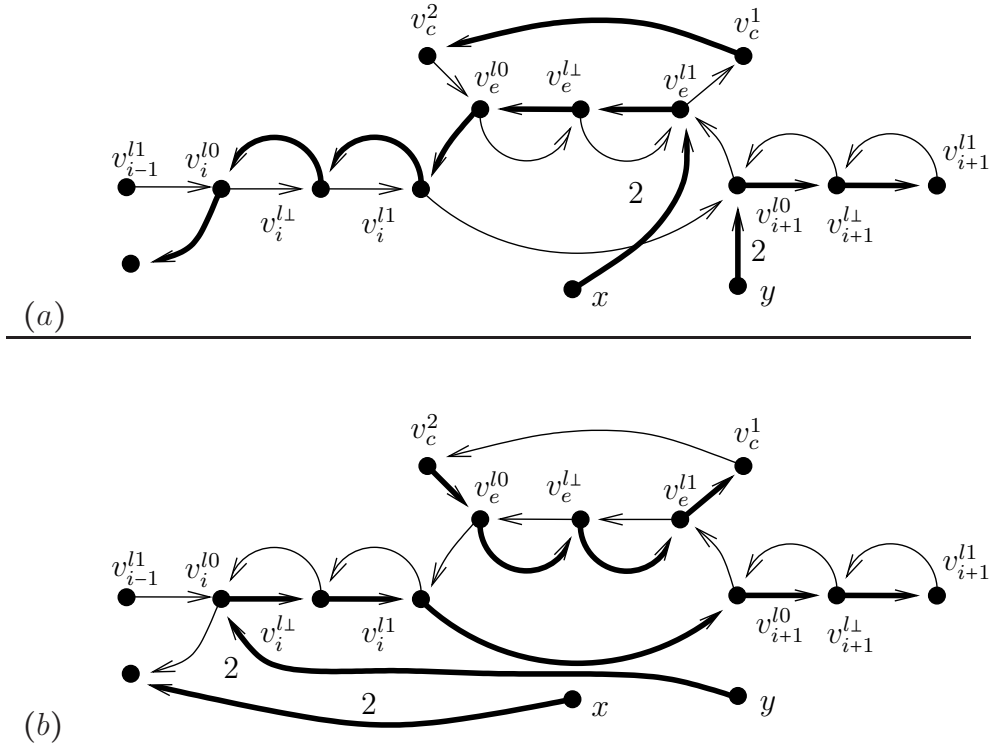

Figure 40: 4. Case $\psi_\sigma(x_i^l) = 0$, $\psi_\sigma(x_{i+1}^l) = 1$ and $\psi_\sigma(x_i^l) \oplus \psi_\sigma(x_j^s) \oplus \psi_\sigma(x_k^r) = 1$

we change the value of $\psi_\sigma(x_i^l)$ yielding at least $2 - 1$ more satisfied equations. The transformed tour is displayed in Figure 40 (b).

In both cases, we associate the local length 2 with σ . On the other hand, ψ_σ leaves at most one equation unsatisfied.

We obtain the following proposition.

Proposition 8. Let $g_c^3 \equiv x_i^l \oplus x_j^s \oplus x_k^r = 0$ be an equation with three variables in \mathcal{H} . Furthermore, let $x_i^l \oplus x_{i+1}^l = 0$, $x_j^s \oplus x_{j+1}^s = 0$ and $x_k^r \oplus x_{k+1}^r = 0$ be circle equations in \mathcal{H} . Then, it is possible to transform in polynomial time the given tour σ passing through the graph corresponding to $x_i^l \oplus x_{i+1}^l = 0$, $x_j^s \oplus x_{j+1}^s = 0$, $x_k^r \oplus x_{k+1}^r = 0$ and g_c^3 such that it has local length $4 + 3 \cdot 3 + 3 + u$ and the number of unsatisfied equations in $\{x_i^l \oplus x_{i+1}^l = 0, x_j^s \oplus x_{j+1}^s = 0, x_k^r \oplus x_{k+1}^r = 0, g_c^3\}$ by ψ_σ is at most u .

Transforming σ in Graphs Corresponding to Circle Border Equations

Let C_l be a circle in \mathcal{H} and $x_1^l \oplus x_n^l = 0$ its circle border equation. Furthermore, let $g_c^3 \equiv x_n^l \oplus x_j^s \oplus x_k^r = 0$ be an equation with three variables contained in \mathcal{H} . We are going to transform a given tour σ passing through the graph corresponding to $x_1^l \oplus x_n^l = 0$ such that it will have the local length 2 if $x_1^l \oplus x_n^l = 0$ is satisfied by ψ_σ and 3, otherwise. In each case, we modify σ such that it uses a $\psi(x_n^l)$ -traversal of $P_{\{1,n\}}^l$. Afterwards, σ will be checked in D_c^3 whether it passes the parity test. Let us begin with the analysis starting with the case $\psi_\sigma(x_1) = 0$ and $\psi_\sigma(x_n) = 0$.

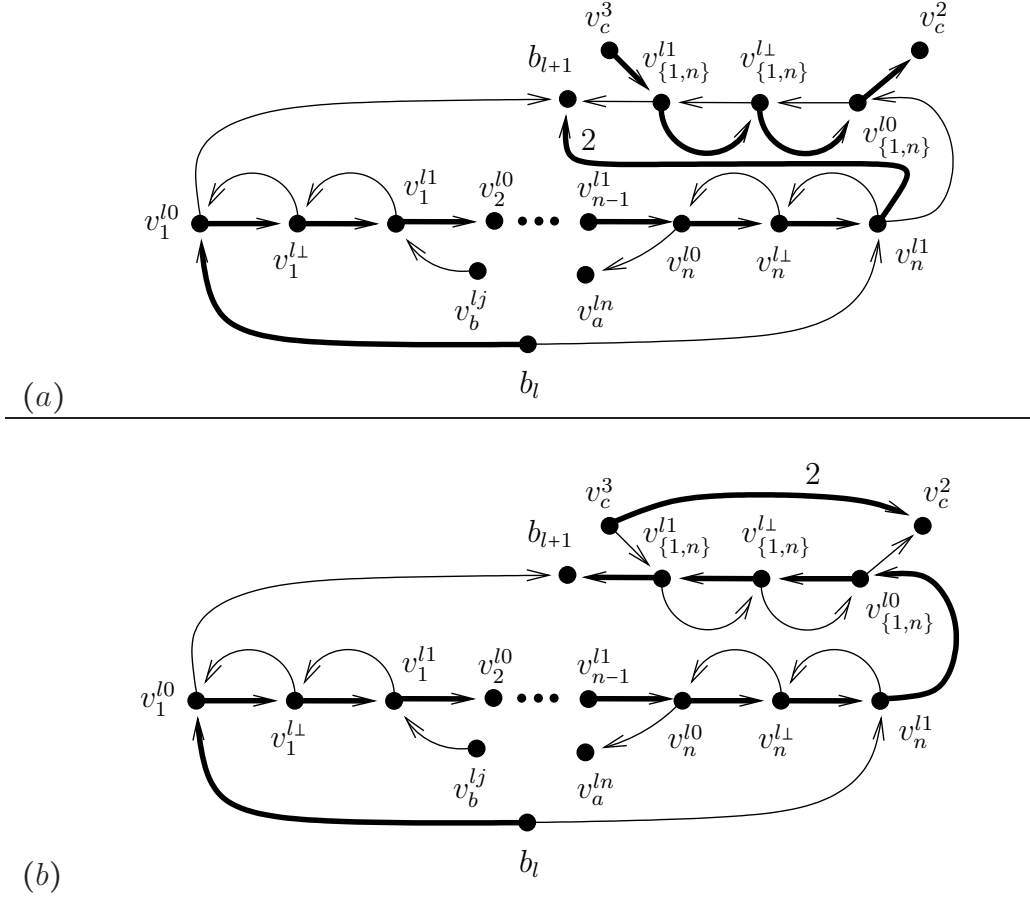

Figure 41: Case $\psi_\sigma(x_1) = 0$ and $\psi_\sigma(x_n) = 0$

1. Case $\psi_\sigma(x_1) = 0$ and $\psi_\sigma(x_n) = 0$:

Let us assume that ψ_σ leaves g_c^3 unsatisfied meaning $\psi_\sigma(x_n^l) \oplus \psi_\sigma(x_j^s) \oplus \psi_\sigma(x_k^r) = 1$. In addition to it, we assume that the path $v_c^3 \rightarrow v_{\{1,n\}}^{l_1} \rightarrow v_{\{1,n\}}^{l_1} \rightarrow v_{\{1,n\}}^{l_0} \rightarrow v_c^2$ is a part of σ . Notice that σ fails the parity check in D_c^3 if $v_c^3 \rightarrow v_{\{1,n\}}^{l_1} \rightarrow v_{\{1,n\}}^{l_1} \rightarrow v_{\{1,n\}}^{l_0} \rightarrow v_c^2$ is not used by σ . First, we modify the tour such that it includes the arc $(b_l, v_1^{l_0})$. For the same reason, we may assume that $v_n^{l_1}$ and b_{l+1} is connected via a 2-arc. We obtain the scenario depicted in Figure 41 (a). As for the next step, we transform σ such that it contains the arcs $(v_n^{l_1}, v_{\{1,n\}}^{l_0})$ and $(v_{\{1,n\}}^{l_1}, b_{l+1})$. Consequently, we use the 1-traversal of the parity graph $P_{\{1,n\}}^l$ and connect v_c^3 and v_c^2 via a 2-arc. The modified tour is depicted in Figure 41 (b).

If ψ_σ satisfies g_c^3 and σ contains the path $v_c^3 \rightarrow v_{\{1,n\}}^{l_1} \rightarrow v_{\{1,n\}}^{l_1} \rightarrow v_{\{1,n\}}^{l_0} \rightarrow v_c^2$, we modify σ in D_c^3 such that it passes the parity test in D_c^3 and contains the arc (v_c^2, v_c^3) .

In both cases, we associate the local length 2 with this part of σ .

2. Case $\psi_\sigma(x_1) = 1$ and $\psi_\sigma(x_n) = 1$:

Let us assume that $\psi_\sigma(x_n^l) \oplus \psi_\sigma(x_j^s) \oplus \psi_\sigma(x_k^r) = 1$ holds and σ contains the arc

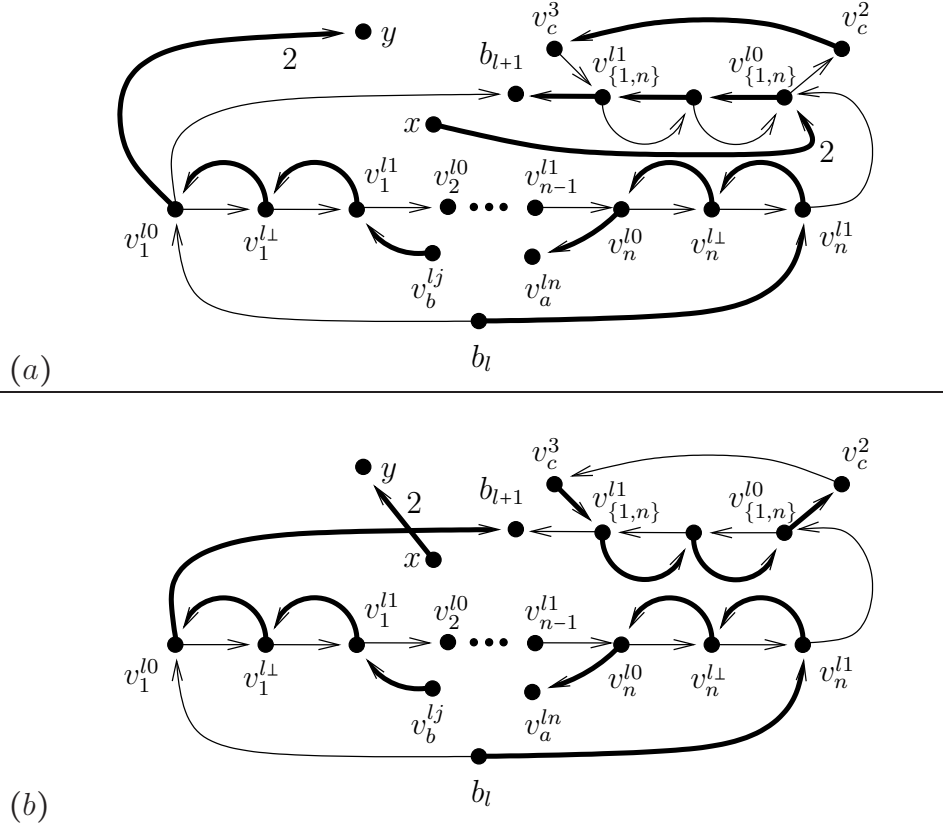

Figure 42: 2. Case $\psi_\sigma(x_1) = 1$ and $\psi_\sigma(x_n) = 1$

(v_c^2, v_c^3) . Given this scenario, we may assume that $(b_l, v_n^{l_1})$ is contained in σ due to a simple modification. Then, we are going to analyze the situation depicted in Figure 42 (a). We transform σ in the way described in Figure 42 (b). Afterwards, σ will be modified in D_c^3 such that it uses a simple path in D_c^3 failing the parity check.

The case, in which $\psi_\sigma(x_i^l) \oplus \psi_\sigma(x_j^l) \oplus \psi_\sigma(x_k^l) = 0$ holds and σ contains the arc (v_c^2, v_c^3) , can be discussed similarly since σ passes the parity check by including the path $v_c^3 \rightarrow v_{\{1,n\}}^{l_1} \rightarrow v_{\{1,n\}}^{l_1} \rightarrow v_{\{1,n\}}^{l_0} \rightarrow v_c^2$.

In both cases, we associate the length 2 with this part of σ .

3. Case $\psi_\sigma(x_1) = 0$ and $\psi_\sigma(x_n) = 1$:

Let us assume that $\psi_\sigma(x_n^l) \oplus \psi_\sigma(x_j^s) \oplus \psi_\sigma(x_k^r) = 1$ holds and σ traverses the path $v_c^3 \rightarrow v_{\{1,n\}}^{l_1} \rightarrow v_{\{1,n\}}^{l_1} \rightarrow v_{\{1,n\}}^{l_0} \rightarrow v_c^2$. Then, we transform the tour σ such that it contains the arc $(v_1^{l_0}, b_{l+1})$. Note that neither $(b_l, v_1^{l_0})$ nor $(b_l, v_n^{l_1})$ is included in the tour. Hence, σ contains a 2-arc to connect b_l . The same holds for the vertex $v_n^{l_1}$. This situation is displayed in Figure 43 (a).

We are going to invert the value of $\psi_\sigma(x_n^l)$ such that ψ_σ satisfies g_c^3 and $x_1^l \oplus x_n^l = 0$. In this way, we gain at least 2 - 1 more satisfied equations. The corresponding transformation is pictured in Figure 43 (b).

On the other hand, if we assume that $\psi_\sigma(x_n^l) \oplus \psi_\sigma(x_j^s) \oplus \psi_\sigma(x_k^r) = 0$ holds and σ

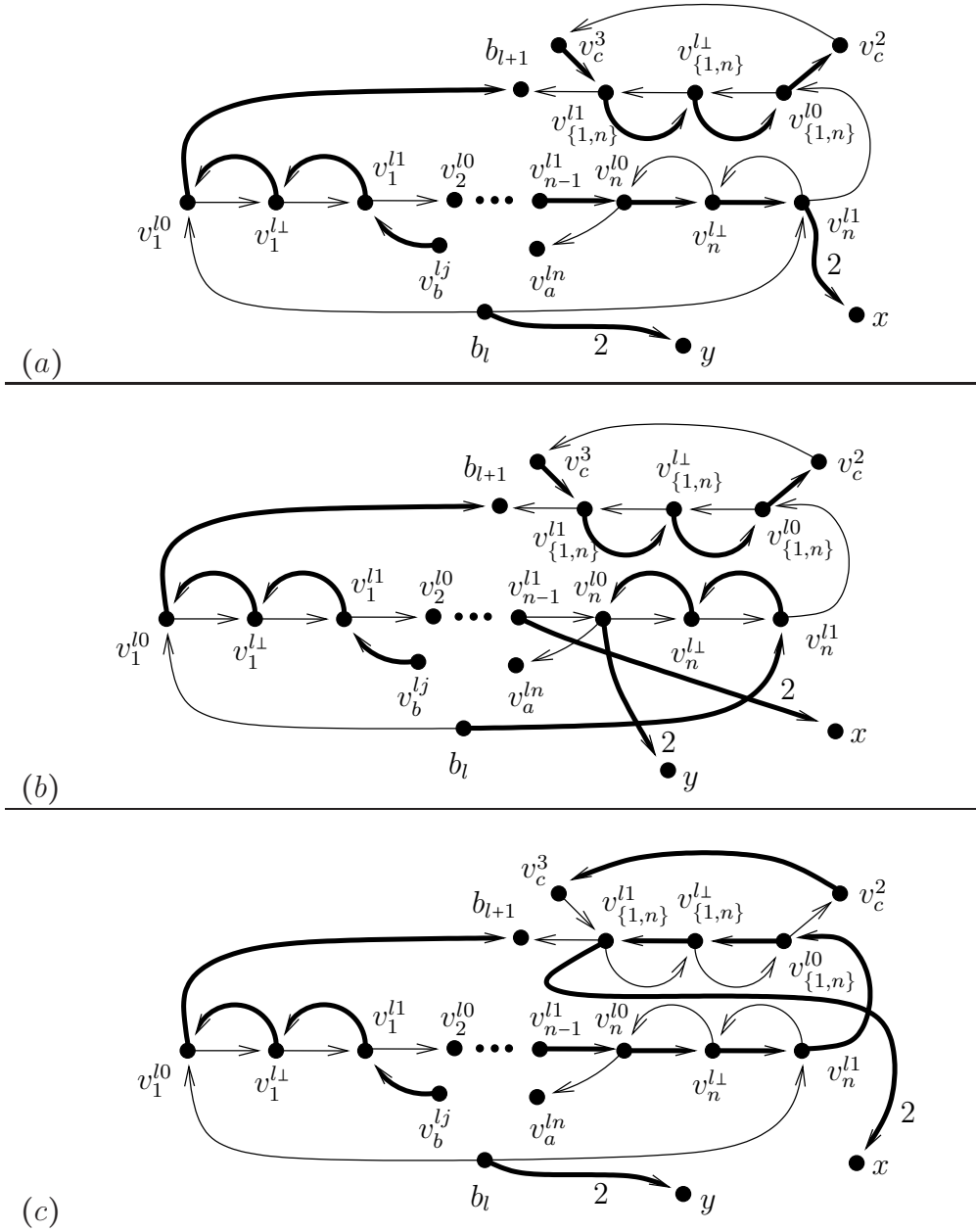

Figure 43: 3. Case $\psi_\sigma(x_1) = 0$ and $\psi_\sigma(x_n) = 1$

traverses the path $v_c^3 \rightarrow v_{1,n}^{l_1} \rightarrow v_{1,n}^{l_1} \rightarrow v_{1,n}^{l_0} \rightarrow v_c^2$, we modify the tour as depicted in Figure 43 (c). Note that σ passes the parity check in D_c^3 and therefore, the tour may use a simple path in D_c^3 .

We associate the local length 3 with σ in this case.

4. Case $\psi_\sigma(x_1) = 1$ and $\psi_\sigma(x_n) = 0$:

Let us assume that $\psi_\sigma(x_n^l) \oplus \psi_\sigma(x_j^s) \oplus \psi_\sigma(x_k^r) = 1$ holds and σ uses the arc (v_c^2, v_c^3) .

Then, we transform the tour σ such that it contains the arc $(b_l, v_n^{l_1})$. We note that neither $(v_1^{l_0}, b_{l+1})$ nor $(v_n^{l_1}, v_{1,n}^{l_0})$ is included in the tour. For this reason, σ must

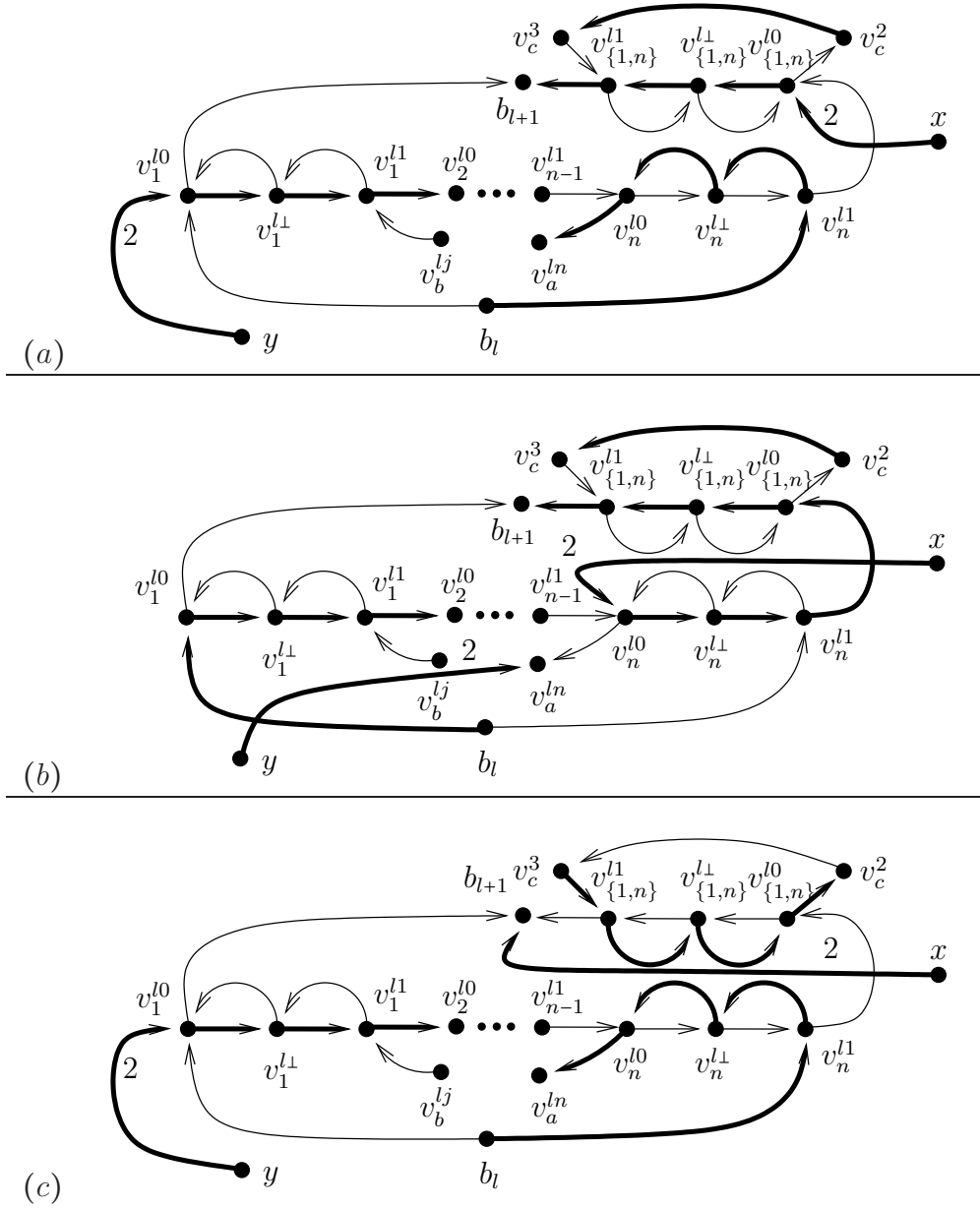

Figure 44: 4. Case $\psi_\sigma(x_1) = 1$ and $\psi_\sigma(x_n) = 0$

use a 2-arc to connect $v_{\{1,n\}}^{l_0}$. The same holds for the vertex $v_1^{l_0}$. The corresponding situation is displayed in Figure 44 (a).

We modify the tour as displayed in Figure 44 (b) and obtain at least 2 - 1 more satisfied equations.

On the other hand, if we assume that $\psi_\sigma(x_n^l) \oplus \psi_\sigma(x_j^s) \oplus \psi_\sigma(x_k^r) = 0$ holds, we need to include the path $v_c^3 \rightarrow v_{\{1,n\}}^{l_1} \rightarrow v_{\{1,n\}}^{l_1} \rightarrow v_{\{1,n\}}^{l_0} \rightarrow v_c^2$ as depicted in Figure 44 (c).

In both cases, we associate the local length 3 with this part of the tour.

We obtain the following statement.

Proposition 9. *Let C_l be a circle in \mathcal{H} and $x_1^l \oplus x_n^l = 0$ its circle border equation. Then, it is possible to transform in polynomial time the given tour σ passing through the graph corresponding to $x_1^l \oplus x_n^l = 0$ such that it has local length 2 if $x_1^l \oplus x_n^l = 0$ is satisfied by ψ_σ and 3, otherwise.*

Thus far, we are ready to give the proof of Theorem 5(i).

5.5 Proof of Theorem 5(i)

Let \mathcal{H} be an instance of the Hybrid problem consisting of n circles $\mathcal{C}_1, \dots, \mathcal{C}_n$, m_2 equations with two variables and m_3 equations with three variables g_c^3 with $c \in [m_3]$. Then, we construct in polynomial time the corresponding instance $D_{\mathcal{H}} = (V(D_{\mathcal{H}}), A(D_{\mathcal{H}}))$ of the (1,2)-ATSP problem as described in Section 5.2.

(a) Let ϕ be an assignment to the variables in \mathcal{H} leaving u equations in \mathcal{H} unsatisfied. According to Proposition 3 – 5, it is possible to construct in polynomial time the tour σ_ϕ with length

$$\ell(\sigma_\phi) \leq 3 \cdot m_2 + (4 + 3 \cdot 3) \cdot m_3 + n + 1 + u.$$

(b) Let σ be a tour in $D_{\mathcal{H}}$ with length $\ell(\sigma) = 3 \cdot m_2 + 13 \cdot m_3 + n + 1 + u$. Due to Proposition 6 we may assume that σ uses only 0/1-traversals of every parity graph included in $D_{\mathcal{H}}$. According to Definition 3, we associate the corresponding assignment ψ_σ with the underlying tour σ . Recall from Proposition 7 – 9 that it is possible to convert σ in polynomial time into a tour σ' without increasing the length such that $\psi_{\sigma'}$ leaves at most u equations in \mathcal{H} unsatisfied. \square

6 Approximation Hardness of the (1,4)-ATSP Problem

In order to prove the claimed hardness results for the (1,4)-ATSP problem, we use the same construction described in Section 5.2 with the difference that all arcs in parity graphs have weight 1, whereas all other arcs contained in the directed graph $D_{\mathcal{H}}$ obtain the weight 2. The induced asymmetric metric space $(V_{\mathcal{H}}, d_{\mathcal{H}})$ is given by $V_{\mathcal{H}} = V(D_{\mathcal{H}})$ and distance function defined by the shortest path metric in $D_{\mathcal{H}}$ bounded by the value 4. In other words, given $x, y \in V_{\mathcal{H}}$, the distance between x and y in $V_{\mathcal{H}}$ is

$$d_{\mathcal{H}}(x, y) = \min\{\text{length of a shortest path from } x \text{ to } y \text{ in } D_{\mathcal{H}}, 4\}.$$

The only difficulty that remains is to prove that tours remain consistent. Thus, we have to prove that given a tour σ in $V_{\mathcal{H}}$, we are able to transform σ in polynomial time into a tour σ' , which uses only 0/1-traversals in parity graphs contained in $D_{\mathcal{H}}$, without increasing $\ell(\sigma)$. This statement can be proved by considering all possibilities exhaustively. Some cases are displayed in Figure 52 – Figure 54.

We are ready to give the proof of Theorem 5 (ii).

6.1 Proof of Theorem 5 (ii)

Given \mathcal{H} an instance of the Hybrid problem consisting of n circles $\mathcal{C}_1, \dots, \mathcal{C}_n$, m_2 equations with two variables and m_3 equations with three variables g_c^3 with $c \in [m_3]$, we construct in polynomial time the associated instance $(V_{\mathcal{H}}, d)$ of the $(1, 4)$ -ATSP problem.

Given an assignment ϕ to the variables of \mathcal{H} leaving u equations unsatisfied in \mathcal{H} , then there exists a tour with length at most $m_2 \cdot (2+2) + m_3 \cdot (3 \cdot 4 + 2 \cdot 4) + 2 \cdot u + 2(n+1)$. On the other hand, if we are given a tour σ in $V_{\mathcal{H}}$ with length $4m_2 + 20m_3 + 2n + 2 + 2 \cdot u$, it is possible to transform σ in polynomial time into a tour σ' without increasing the length such that the associated assignment $\psi_{\sigma'}$ leaves at most u equations in \mathcal{H} unsatisfied. \square

7 Approximation Hardness of the $(1, 2)$ -TSP Problem

In order to prove Theorem 6 (i), we apply the reduction method used in Section 5 to the $(1, 2)$ -TSP problem. As for the parity gadget, we use the graph depicted in Figure 45 with its corresponding traversals. The traversed edges are pictured by thick lines.

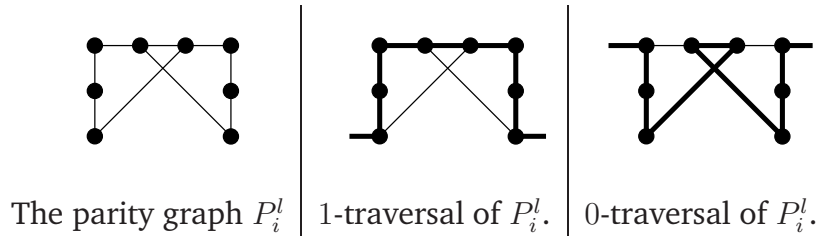

Figure 45: Traversal of the graph P_i^l given the assignment ϕ .

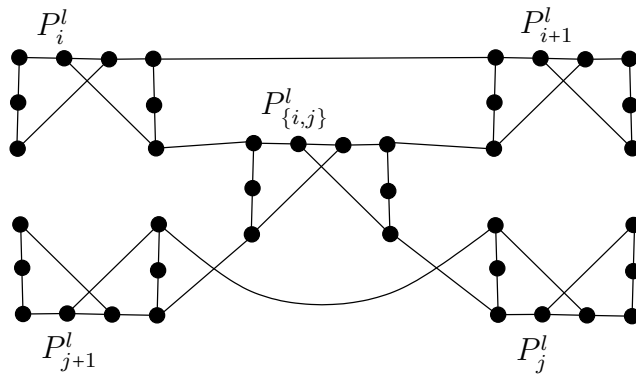

Figure 46: Graphs corresponding to equations $x_i^l \oplus x_j^l = 0$, $x_i^l \oplus x_{i+1}^l = 0$ & $x_j^l \oplus x_{j+1}^l = 0$.

Let \mathcal{H} be an instance of the hybrid problem. Given a matching equation $x_i^l \oplus x_j^l = 0$ in \mathcal{H} and the corresponding circle equations $x_i^l \oplus x_{i+1}^l = 0$ and $x_j^l \oplus x_{j+1}^l = 0$, we connect the associated parity graphs P_i^l , P_{i+1}^l , $P_{\{i,j\}}^l$, P_j^l and P_{j+1}^l as displayed in Figure 46.

For equations with three variables $g_c^3 \equiv x \oplus y \oplus z = 0$ in \mathcal{H} , we use the graph G_c^3 depicted in Figure 47. Recall from Proposition 2 that there is a simple path from s_c to s_{c+1} in Figure 47 containing the vertices $v \in \{v_c^1, v_c^2\}$ if and only if an even number of parity graphs is traversed.

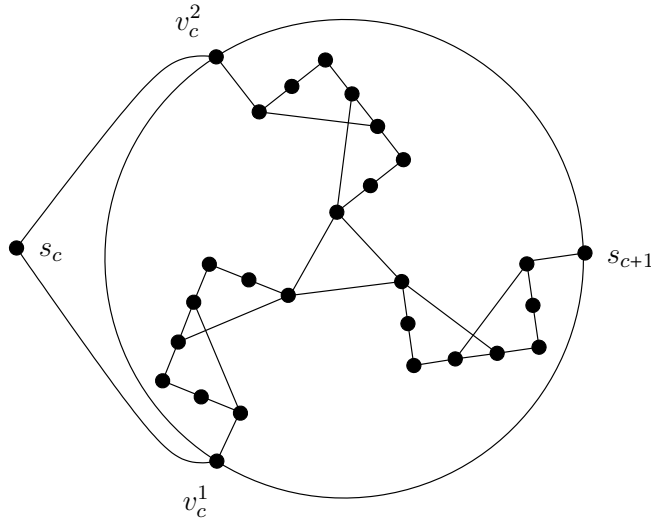

Figure 47: The graph G_c^3 corresponding to $x \oplus y \oplus z = 0$.

Let \mathcal{C}_l be a circle in \mathcal{H} with variables $\{x_1^l, \dots, x_n^l\}$. For the circle border equation of \mathcal{C}_l , we introduce the path $p_l = b_l^1 - b_l^2 - b_l^3$. In addition, we connect b_l^3 and b_{l+1}^1 to the parity graphs P_1^l and P_n^l in a similar way as in the reduction from the Hybrid problem to the (1,2)-ATSP problem. This is the whole description of the corresponding graph $G_{\mathcal{H}} = (V(G_{\mathcal{H}}), E(G_{\mathcal{H}}))$.

We are ready to give the proof of Theorem 6 (i).

7.1 Proof of Theorem 6 (i)

Given \mathcal{H} an instance of the Hybrid problem consisting of n circles $\mathcal{C}_1, \dots, \mathcal{C}_n$, m_2 equations with two variables and m_3 equations with three variables g_c^3 with $c \in [m_3]$, we construct in polynomial time the associated instance $G_{\mathcal{H}}$ of the (1,2)-TSP problem.

Given an assignment ϕ to the variables of \mathcal{H} leaving u equations unsatisfied in \mathcal{H} , then, there is a tour with length at most $8 \cdot m_2 + (3 \cdot 8 + 3) \cdot m_3 + 3n + 1$.

On the other hand, if we are given a tour σ in $G_{\mathcal{H}}$ with length $8 \cdot m_2 + (3 \cdot 8 + 3) \cdot m_3 + 3n + 1$, it is possible to transform σ in polynomial time into a tour σ' such that it uses 0/1-traversals of all contained parity graphs in $G_{\mathcal{H}}$ without increasing the length. Some cases are displayed in Figure 50. Moreover, we are able to construct in polynomial time an assignment to the variables of \mathcal{H} , which leaves at most u equations in \mathcal{H} unsatisfied. \square

8 Approximation Hardness of the $(1, 4)$ -TSP Problem

In order to prove the claimed approximation hardness for the $(1, 4)$ -TSP problem, we cannot use the same parity graphs as in the construction in the previous section since tours are not necessarily consistent in this metric. For this reason, we introduce the parity graph depicted in Figure 48 with the corresponding traversals.

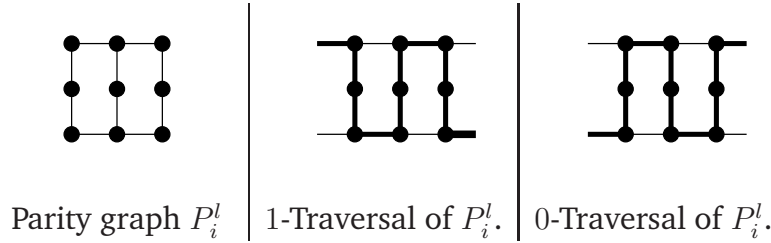

Figure 48: 0/1-Traversals of the graph P_i^l .

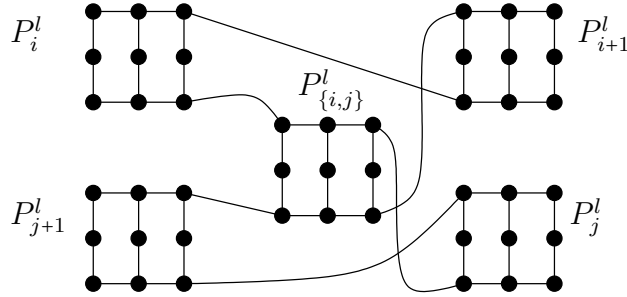

Figure 49: Graphs corresponding to $x_i^l \oplus x_j^l = 0$, $x_i^l \oplus x_{i+1}^l = 0$ and $x_j^l \oplus x_{j+1}^l = 0$.

Given a matching equation $x_i^l \oplus x_j^l = 0$ in \mathcal{H} and the circle equations $x_i^l \oplus x_{i+1}^l = 0$ and $x_j^l \oplus x_{j+1}^l = 0$, we connect the corresponding graphs as displayed in Figure 49. In order to define the new instance of the $(1, 4)$ -TSP problem, we replace all parity graphs in $G_{\mathcal{H}}$ by graphs displayed in Figure 48. In the remainder, we refer to this graph as $H_{\mathcal{H}}$. All edges contained in a parity graph have weight 1, whereas all other edges have weight 2. The remaining distances in the associated metric space $V_{\mathcal{H}}$ are induced by the graphical metric in $H_{\mathcal{H}}$ bounded by the value 4 meaning

$$d_{\mathcal{H}}(\{x, y\}) = \min\{\text{length of a shortest path from } x \text{ to } y \text{ in } H_{\mathcal{H}}, 4\}.$$

This is the whole description of the associated instance $(V_{\mathcal{H}}, d_{\mathcal{H}})$ of the $(1, 4)$ -TSP problem. We are ready to give the proof of Theorem 6 (ii).

8.1 Proof of Theorem 6 (ii)

Given \mathcal{H} an instance of the Hybrid problem consisting of n circles $\mathcal{C}_1, \dots, \mathcal{C}_n$, m_2 equations with two variables and m_3 equations with three variables g_c^3 with $c \in [m_3]$, we construct in polynomial time the associated instance $(V_{\mathcal{H}}, d_{\mathcal{H}})$ of the $(1, 4)$ -TSP problem.

Given an assignment ϕ to the variables of \mathcal{H} leaving u equations unsatisfied in \mathcal{H} , there is a tour in $V_{\mathcal{H}}$ with length at most $m_2 \cdot (2+8) + m_3 \cdot (3 \cdot 10 + 2 \cdot 3) + 6n + 2 + 2 \cdot u$.

On the other hand, if we are given a tour σ in $(V_{\mathcal{H}}, d_{\mathcal{H}})$ with length $10m_2 + 36m_3 + 6n + 2 + 2 \cdot u$, it is possible to transform σ in polynomial time into a tour σ' such that it uses 0/1-traversals of all contained parity graphs in $G_{\mathcal{H}}$ without increasing the length. Some cases are displayed in Figure 55. Then, we are able to construct in polynomial time an assignment to the variables of \mathcal{H} , which leaves at most u equations in \mathcal{H} unsatisfied. \square

9 Further Research

We have improved (modestly) the best known approximation lower bounds for TSP with bounded metrics problems. They almost match the best known bounds for the general (unbounded) metrics TSP problems. Because of a lack of the good definability properties of metric TSP, further improvements seem to be very difficult. A new less *local* method seems now to be necessary to achieve much stronger results.

References

- [ALM⁺98] S. Arora, C. Lund, R. Motwani, M. Sudan and M. Szegedy, *Proof Verification and the Hardness of Approximation Problems*, J. ACM 45 (1998), pp. 501–555.
- [AGM⁺10] A. Asadpour, M. Goemans, A. Madry, S. Gharan and A. Saberi, *An $O(\log n / \log \log n)$ -Approximation Algorithm for the Asymmetric Traveling Salesman Problem*, Proc. 21st SODA (2010), pp. 379–389.
- [BGS02] A. Barvinok, E. Gimadi and A. Serdyukov, *The Maximum Traveling Salesman Problem*, in: *The Traveling Salesman Problem and Its Variations*, pp. 585–607, G. Gutin and A. Punnen, eds., Kluwer, 2002.
- [BK99] P. Berman and M. Karpinski, *On Some Tighter Inapproximability Results*, Proc. 26th ICALP (1999), LNCS 1644, Springer, 1999, pp. 200–209.
- [BK01] P. Berman and M. Karpinski, *Efficient Amplifiers and Bounded Degree Optimization*, ECCO TR01-053, 2001.

- [BK03] P. Berman and M. Karpinski, *Improved Approximation Lower Bounds on Small Occurrence Optimization*, ECCC TR03-008, 2003.
- [BK06] P. Berman and M. Karpinski, *8/7-approximation algorithm for (1, 2)-TSP*, 17th SODA (2006), pp. 641–648.
- [B04] M. Bläser, *A 3/4-Approximation Algorithm for Maximum ATSP with Weights Zero and One*, Proc. 8th APPROX-RANDOM (2004), pp. 61–71.
- [BS00] H.-J. Böckenhauer and S. Seibert, *Improved Lower Bounds on the Approximability of the Traveling Salesman Problem*, Theor. Inform. Appl. 34 (2000), pp. 213–255.
- [C76] N. Christofides, *Worst-Case Analysis of a New Heuristic for the Traveling Salesman Problem*, Technical Report CS-93-13, Carnegie Mellon University, Pittsburgh, 1976.
- [E03] L. Engebretsen, *An Explicit Lower Bound for TSP with Distances One and Two*, Algorithmica 35 (2003), pp. 301–318.
- [EK06] L. Engebretsen and M. Karpinski, *TSP with Bounded Metrics*, J. Comput. Syst. Sci. 72 (2006), pp. 509–546.
- [H01] J. Håstad, *Some Optimal Inapproximability Results*, J. ACM 48 (2001), pp. 798–859.
- [KLS⁺05] H. Kaplan, M. Lewenstein, N. Shafir and M. Sviridenko, *Approximation Algorithms for Asymmetric TSP by Decomposing Directed Regular Multigraphs*, J. ACM 52 (2005), pp. 602–626.
- [K72] R. Karp, *Reducibility Among Combinatorial Problems*, Compl. of Computer Computations, pp. 85–103, 1972.
- [KS11] M. Karpinski and R. Schmied, *Improved Lower Bounds for the Shortest Superstring and Related Problems*, ECCC TR11-156, 2011.
- [L12] M. Lampis, *Improved Inapproximability for TSP*, CoRR abs/1206.2497, 2012.
- [PV06] C. Papadimitriou and S. Vempala, *On the Approximability of the Traveling Salesman Problem*, Combinatorica 26 (2006), pp. 101–120.
- [PY93] C. Papadimitriou and M. Yannakakis, *The Traveling Salesman Problem with Distances One and Two*, Math. Oper. Res. 18 (1993), pp. 1–11.
- [T00] L. Trevisan, *When Hamming Meets Euclid: The Approximability of Geometric TSP and Steiner Tree*, SIAM J. Comput. 30 (2000), pp. 475–485.
- [V92] S. Vishwanathan, *An Approximation Algorithm for the Asymmetric Traveling Salesman Problem with Distances One and Two*, Inf. Process. Lett. 44 (1992), pp. 297–302.

10 Figure Appendix

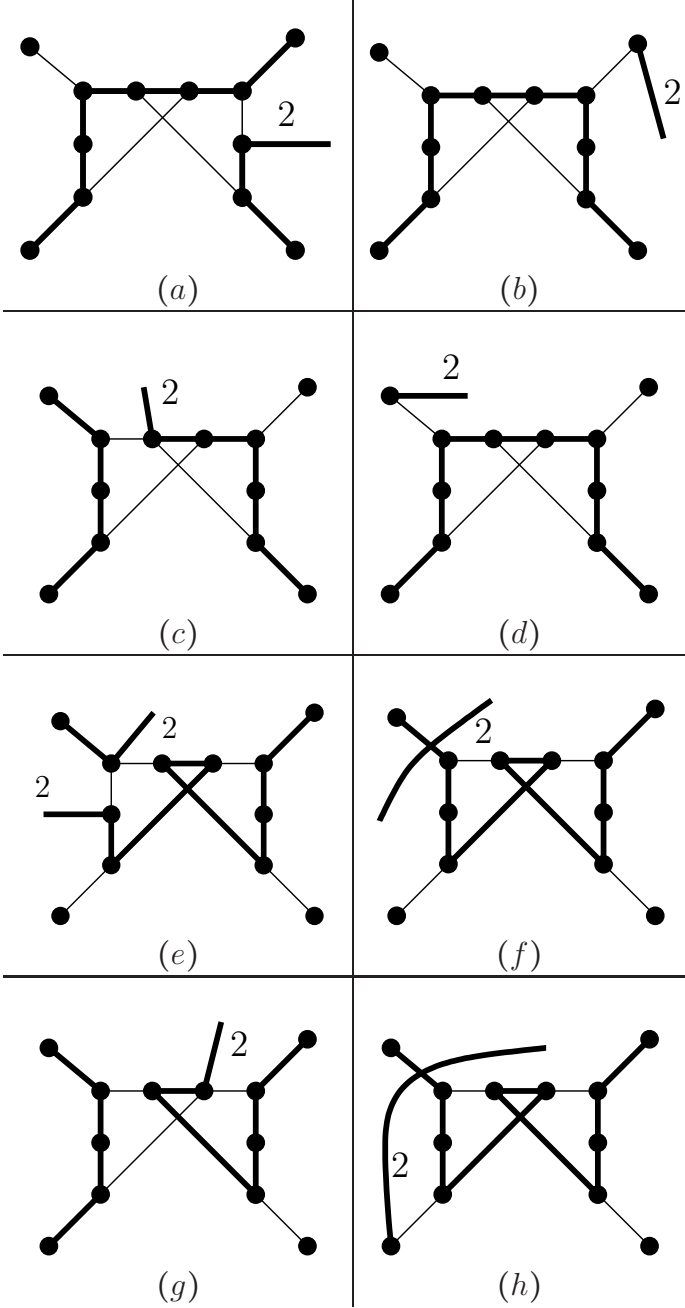

Figure 50: Transformations yielding a consistent tour.

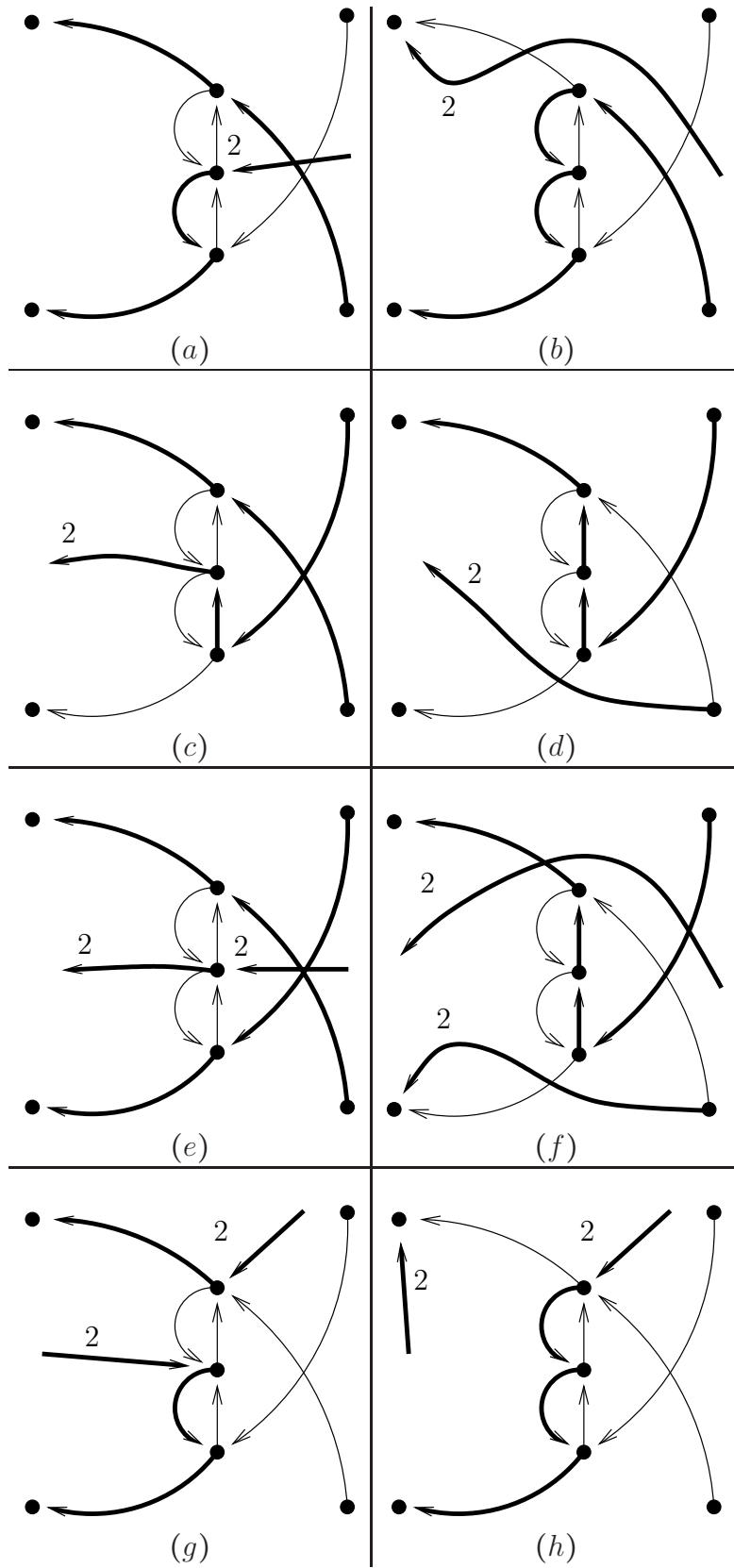

Figure 51: Transformations yielding a consistent tour.

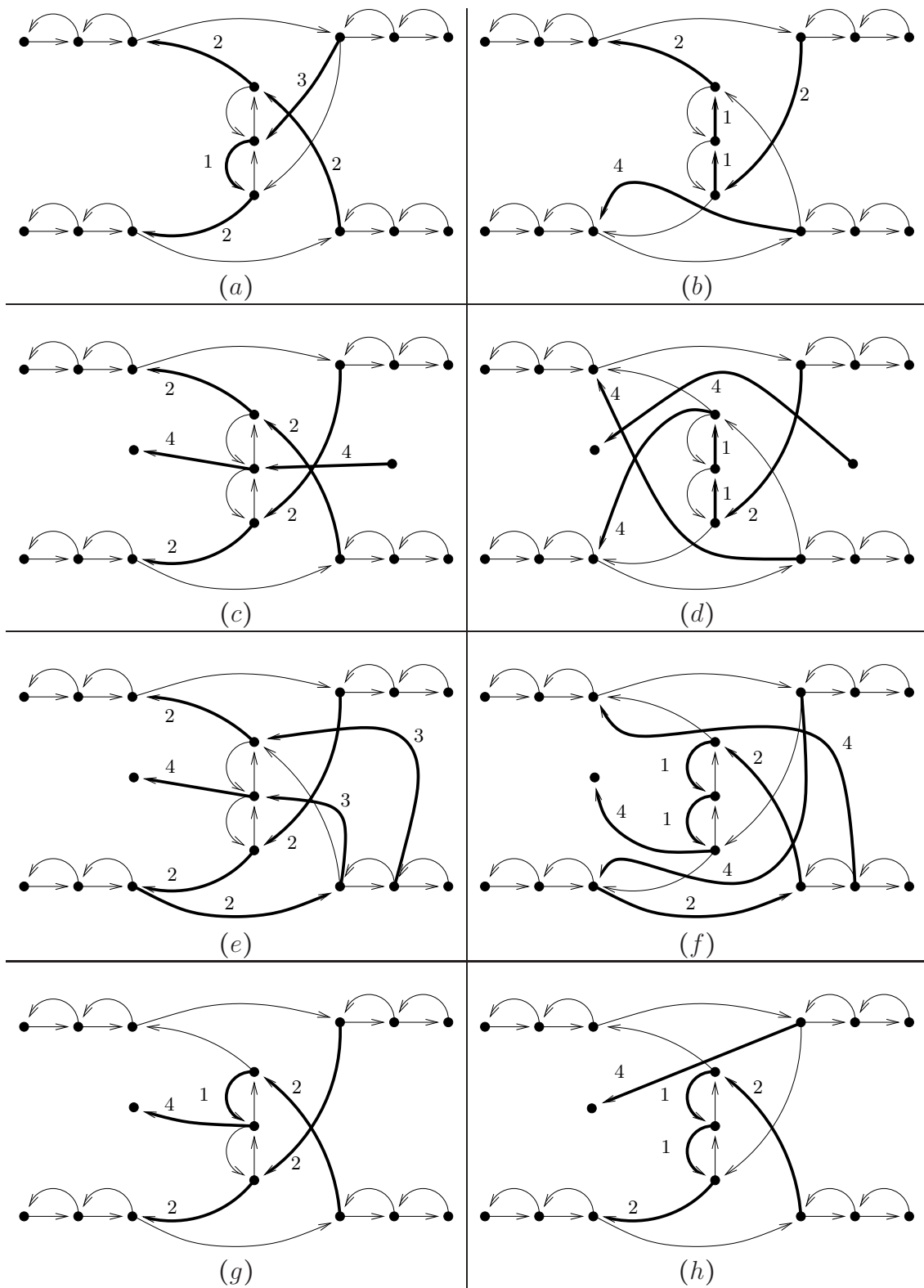

Figure 52: Transformations yielding a consistent tour.

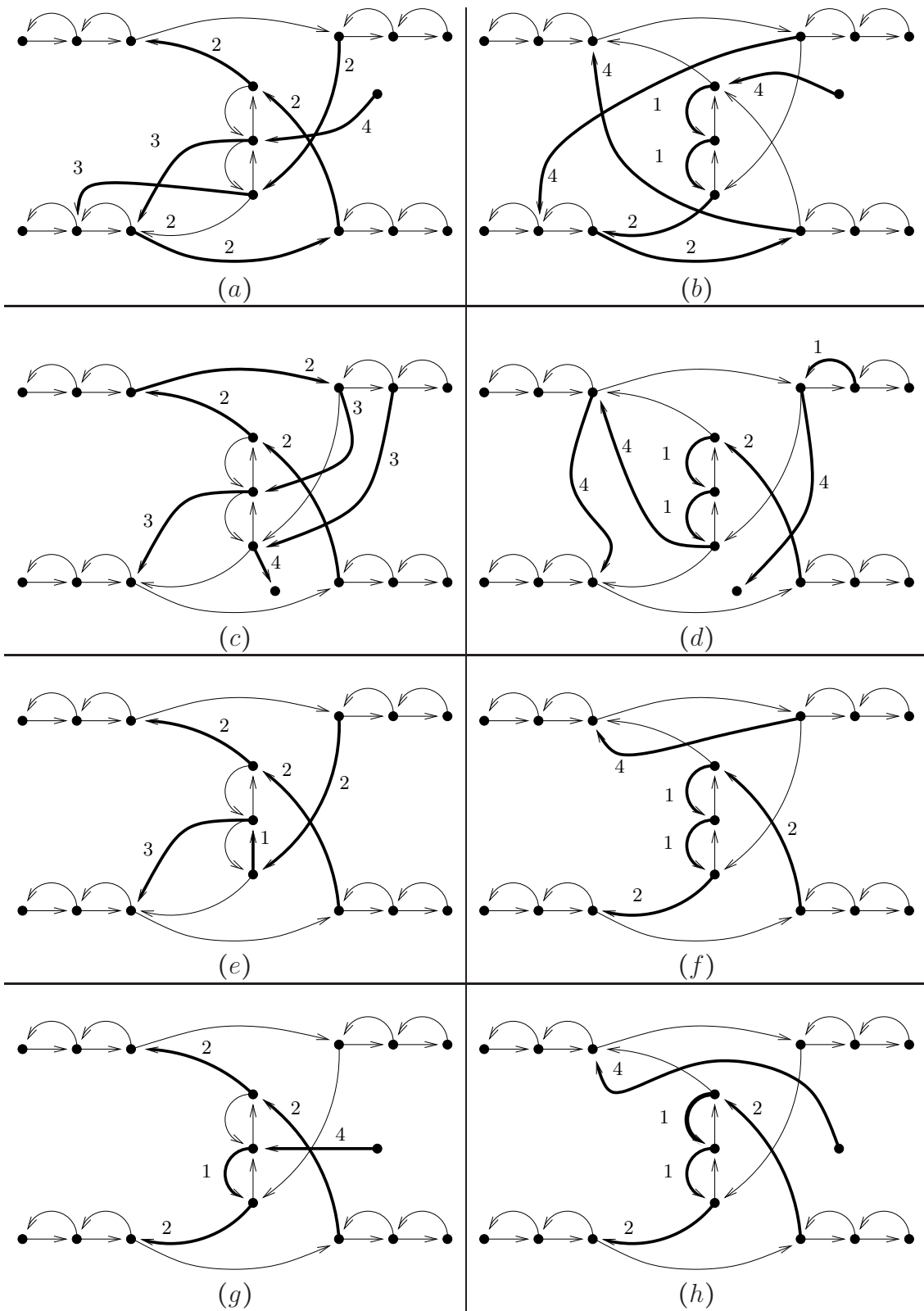

Figure 53: Transformations yielding a consistent tour.

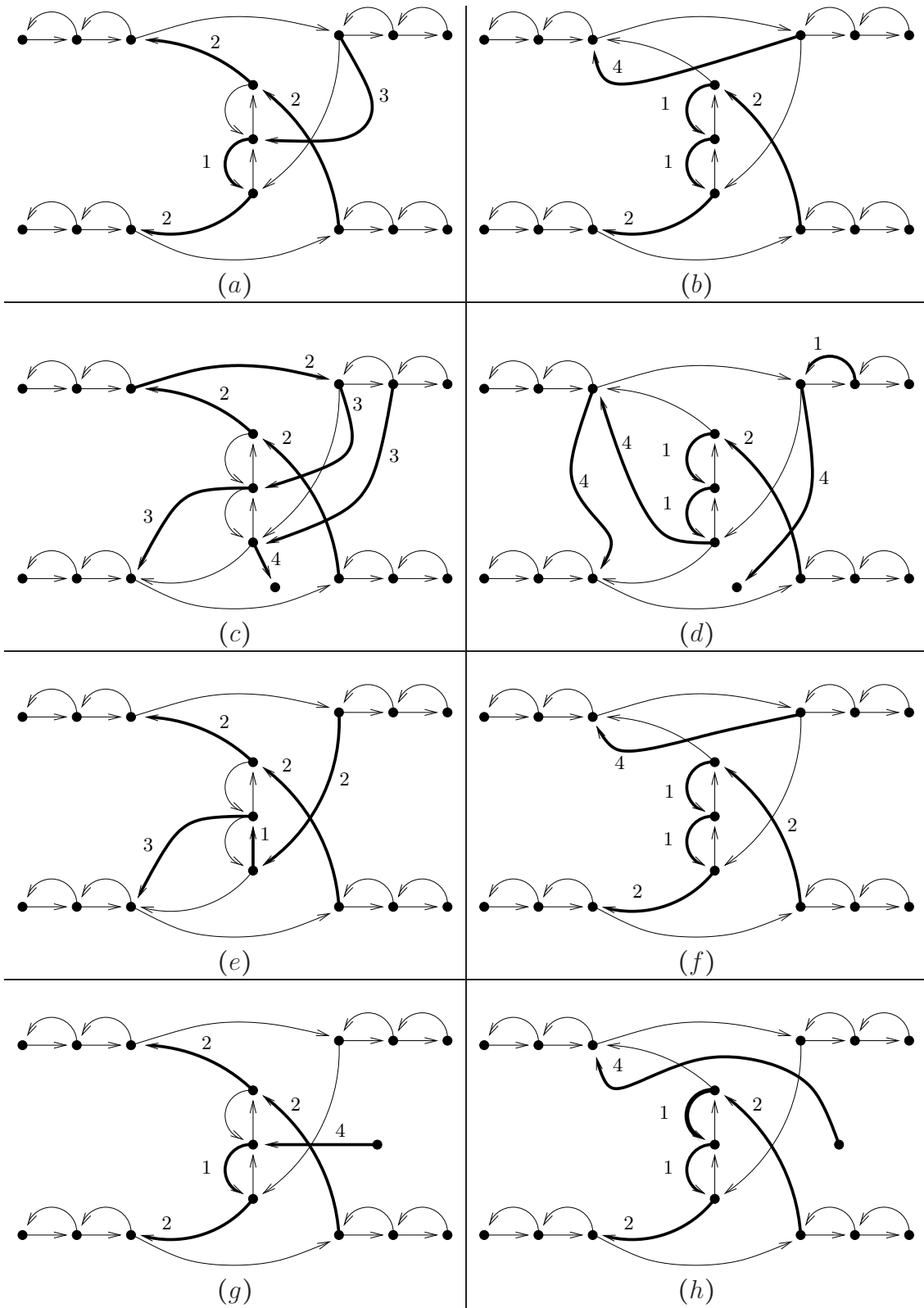

Figure 54: Transformations yielding a consistent tour.

