

On Vulnerability of Banking Networks

Piotr Berman

Department of Computer Science & Engineering
Pennsylvania State University
University Park, PA 16802
Email: berman@cse.psu.edu

Bhaskar DasGupta & Lakshmi Kaligounder

Department of Computer Science
University of Illinois at Chicago
Chicago, IL 60607-7053
Email: dasgupta@cs.uic.edu, lkalig2@uic.edu

Marek Karpinski

Department of Computer Science
University of Bonn
53117 Bonn, Germany
Email: marek@cs.uni-bonn.de

Second Revision (12 point font, November 28, 2018)

Abstract

Threats on the stability of a financial system may severely affect the functioning of the entire economy, and thus considerable emphasis is placed on the analyzing the cause and effect of such threats. The financial crisis in the current and past decade has shown that one important cause of instability in global markets is the so-called *financial contagion*, namely the spreadings of instabilities or failures of *individual* components of the network to other, perhaps healthier, components. This leads to a natural question of whether the regulatory authorities could have predicted and perhaps mitigated the current economic crisis by effective computations of some stability measure of the banking networks. Motivated by such observations, we consider the problem of defining and evaluating stabilities of both homogeneous and heterogeneous banking networks against propagation of *synchronous idiosyncratic shocks* given to a subset of banks. We formalize the homogeneous banking network model of Nier *et al.* [38] and its corresponding heterogeneous version, formalize the synchronous shock propagation procedures outlined in [19, 38], define two appropriate stability measures and investigate the computational complexities of evaluating these measures for various network topologies and parameters of interest. Our results and proofs also shed some light on the properties of topologies and parameters of the network that may lead to higher or lower stabilities.

1 Introduction and Motivation

In market-based economies, financial systems perform important financial intermediation functions of borrowing from surplus units and lending to deficit units. Financial stability is the ability of the financial systems to absorb shocks and perform its key functions, even in stressful situations. Threats on the stability of a financial system may severely affect the functioning of the entire economy, and thus considerable emphasis is placed on the analyzing the cause and effect of such threats. The concept of instability of a market-based financial system due to factors such as debt financing of investments can be traced back to earlier works of the economists such as Irving Fisher [23] and John Keynes [30] during the 1930's Great Depression era. Subsequently, some economists such as Hyman Minsky [37] have argued that:

such instabilities are inherent in many modern capitalist economies.

In this paper, we investigate systemic instabilities of the banking networks, an important component of modern capitalist economies of many countries. The financial crisis in the current and past decade has shown that an important component of instability in global financial markets is the so-called *financial contagion*, namely the spreadings of instabilities or failures of *individual* components of the network to other, perhaps healthier, components. The general topic of interest in this paper, motivated by the global economic crisis in the current and the past decade, is the phenomenon of financial contagion in the context of *banking networks*, and is philosophically related to the following natural extension of the question posed by Minsky and others:

Are the instabilities of the banking networks systemic? Could one have predicted, assuming access to all necessary data, the current economic crisis by effective computations of the stability of the relevant banking networks ?

To investigate these types of questions, one must first settle the following issues:

- What is the *precise* model of the banking network that is studied?
- How *exactly* failures of individual banks propagated through the network to other banks?
- What is an *appropriate stability measure* and what are the computational properties of such a measure?

As prior researchers such as Allen and Babus [1] pointed out, graph-theoretic concepts provide a conceptual framework within which various patterns of connections between banks can be described and analyzed in a meaningful way by modeling banking networks as a *directed* network in which nodes represent the banks and the links represent the direct exposures between banks. Such a network-based approach to studying financial systems is particularly important for assessing financial stability, and in capturing the externalities that the risk associated with a single or small group of institutions may create for the entire system. Conceptually, links between banks have two *opposing* effects on contagion:

- More interbank links increase the opportunity for spreading failures to other banks [25]: when one region of the network suffers from a crisis, another region also incurs a loss because their claims on the troubled region fall in value and, if this spillover effect is strong enough, it can cause a crisis in adjacent regions.

- More interbank links provide banks with a form of *coinsurance* against uncertain liquidity flows [2], *i.e.*, banks can insure against the liquidity shocks by exchanging deposits through links in the network.

2 The Banking Network Model

2.1 Homogeneous Networks: Balance Sheets and Parameters for Banks

We provide a precise abstraction of the model as outlined in [38] which builds up on the works of Eboli [19]. The network is modeled by a weighted directed graph $G = (V, F)$ of n nodes and m directed edges, where each node $v \in V$ corresponds to a bank (Bank_v) and each directed edge $(v, v') \in F$ indicates that Bank_v has an agreement to lend money to $\text{Bank}_{v'}$. Let $\text{deg}_{\text{in}}(v)$ and $\text{deg}_{\text{out}}(v)$ denote the in-degree and the out-degree of node v . The model has the following parameters:

$$E = \text{total external asset}, \quad I = \text{total inter-bank exposure}, \quad A = I + E = \text{total asset}$$

$$[0, 1] \ni \gamma = \text{percentage of equity to asset}, \quad w = w(e) = \frac{I}{m} = \text{weight of edge } e \in F, \quad \Phi = \text{severity of shock } (1 \geq \Phi > \gamma)$$

Now, we describe the balance sheet for a node $v \in V$ (*i.e.*, for Bank_v):

Assets		Liabilities	
$l_v = \text{deg}_{\text{out}}(v) \times w = \text{interbank asset}$		$b_v = \text{deg}_{\text{in}}(v) \times w = \text{interbank borrowing}$	
$e_v = (b_v - l_v) + \frac{E - \sum_{v \in V} (b_v - l_v)}{n} = (b_v - l_v) + \frac{E}{n}$		$c_v = \gamma \times a_v = \text{net worth (equity)}$	
$= \text{share of total external asset } E$		$d_v = \text{customer deposits}$	
$a_v = e_v + l_v = b_v + \frac{E}{n} = \text{total asset}$		$l_v = b_v + c_v + d_v = \text{total liability}$	
$a_v = l_v$ (balance sheet equation)			

Note that the homogeneous model is completely described by the 4-tuple of parameters $\langle G, \gamma, I, E \rangle$.

2.2 Balance Sheets and Parameters for Heterogeneous Networks

The heterogeneous version of the model is the same as its' homogeneous counterpart as described above, except that the shares of interbank exposures and external assets for different banks may be different. Formally, the following modifications are done in the homogeneous model:

- $w(e) > 0$ denotes the weight of the edge $e \in E$ along with the constraint that $\sum_{e \in F} w(e) = I$.
- $l_v = \sum_{e=(v,v') \in F} w(e)$, and $b_v = \sum_{e=(v',v) \in F} w(e)$.
- $e_v = (b_v - l_v) + \alpha_v \times (E - \sum_{v \in V} (b_v - l_v))$ for some $\alpha_v > 0$ along with the constraint $\sum_{v \in V} \alpha_v = 1$. Since $\sum_{v \in V} (b_v - l_v) = 0$, this gives $e_v = (b_v - l_v) + \alpha_v E$. Consequently, a_v now equals $b_v + \alpha_v E$.

Denoting the m -dimensional vector of $w(e)$'s by \mathbf{w} and the n -dimensional vector of α_v 's by $\boldsymbol{\alpha}$, the heterogeneous model is completely described by the 6-tuple of parameters $\langle G, \gamma, I, E, \mathbf{w}, \boldsymbol{\alpha} \rangle$.

2.3 Idiosyncratic Shock [19, 38]

As in [38], our initial failures are caused by *idiosyncratic shocks* which can occur due to *operations risks* (frauds) or *credit risks*, and has the effect of reducing the external assets of a selected subset of banks perhaps causing them to default. While *aggregated* or *correlated* shocks affecting all banks simultaneously is relevant in practice, idiosyncratic shocks are a cleaner way to study the *stability* of the topology of the banking network. Formally, we select a non-empty subset of nodes (banks) $\emptyset \subset V_{\text{shock}} \subseteq V$. For all nodes $v \in V_{\text{shock}}$, we si-

multaneously decrease their external assets from e_v by $s_v = \Phi e_v$, where the parameter $\Phi \in (0, 1]$ determines the “severity” of the shock. As a result, the new net worth of Bank_v becomes $c'_v = c_v - s_v$. The effect of this shock is as follows:

- If $c'_v \geq 0$, Bank_v continues to operate but with a lower net worth of c'_v .
- If $c'_v < 0$, Bank_v *defaults* (i.e., stops functioning).

2.4 Propagation of an Idiosyncratic Shock [19, 38]

We use the notation $c_v(t)$ to denote c_v at time t , and t_0^+ to denote any $t > t_0$. Let $V_{\text{alive}}(t) \subseteq V$ be the set of nodes that have not failed at time t and let $G_{\text{alive}}(t) = (V_{\text{alive}}(t), E_{\text{alive}}(t))$ be the corresponding node-induced subgraph of G at time t with $\deg_{\text{in}}(v, t)$ and $\deg_{\text{out}}(v, t)$ denote the in-degree and out-degree of a node $v \in V_{\text{alive}}(t)$ in the graph $G_{\text{alive}}(t)$. In a continuous-time model, the shock propagates as follows:

- $V_{\text{alive}}(1) = V$, $c_v(1) = c_v - s_v$ if $v \in V_{\text{shock}}$, and $c_v(1) = c_v$ otherwise.
- If a banks equity ever becomes negative, it fails subsequently, i.e., $\forall t_0 \geq 1: c_v(t_0) < 0 \Rightarrow v \notin V_{\text{alive}}(t_0^+)$.
- A failed bank Bank_v at time $t = t_0$ affects the net worth (equity) of all banks that gave loan to Bank_v in the following manner. For each edge $(u, v) \in E_{\text{alive}}(t_0)$ in the network at time t_0 , the equity $c_u(t_0)$ is decreased by an amount¹ of $\frac{\min\{|c_v(t_0)|, b_v\}}{\deg_{\text{in}}(v, t_0)}$. Thus, the shock propagation

¹If $|c_v(t_0)| > b_v$ then the depositors incur a loss of $b_v - |c_v(t_0)|$, but this model assumes that all the depositors are insured for their deposits, e.g., in United States the Federal Deposit Insurance Corporation provides such an insurance up to a maximum level.

```

t = 1 ; Valive(1) = V
(* start the shock at t = 1 on nodes in Vshock *)
∀ v ∈ V : if v ∈ Vshock then cv(1) = cv - Φ ev else cv(1) = cv

(* shock propagation at times t = 2, 3, ..., T *)
while (t ≤ T) ∧ (Valive(t) ≠ ∅) do

    (* transmit loss to next time step *)
    ∀ u ∈ Valive(t) : cu(t + 1) = cu(t) - ∑v: cv(t) < 0 & (u,v) ∈ Ealive(t)  $\frac{\min\{|c_v(t)|, b_v\}}{\deg_{\text{in}}(v, t)}$ 

    (* remove Bankv from network if it is to fail at this step *)
    Valive(t + 1) = Valive(t) \ { v | v ∈ Valive(t) & cv(t) < 0 }

    t = t + 1
endwhile

```

Table 1: Discrete-time idiosyncratic shock propagation for T steps.

is defined by the following partial differential equation:

$$\forall \mathbf{t} \geq \mathbf{1} \quad \forall \mathbf{u} \in \mathbf{V}_{\text{alive}}(\mathbf{t}): \quad \frac{\partial \mathbf{c}_{\mathbf{u}}(\mathbf{t})}{\partial \mathbf{t}} = \sum_{\mathbf{v}: \mathbf{c}_{\mathbf{v}}(\mathbf{t}) < \mathbf{0} \ \& \ (\mathbf{u}, \mathbf{v}) \in \mathbf{E}_{\text{alive}}(\mathbf{t})} \frac{\min \{ |\mathbf{c}_{\mathbf{v}}(\mathbf{t})|, \mathbf{b}_{\mathbf{v}} \}}{\text{deg}_{\text{in}}(\mathbf{v}, \mathbf{t})}$$

A *discrete-time* version of the above can be obtained by the obvious method of quantizing time and replacing the partial differential equations by “difference equations”. With appropriate normalizations, the discrete-time model for shock propagation is described by a synchronous iterative procedure shown in Table 1 where $t = 1, 2, \dots, T$ denotes the discrete time step at which the synchronous update is done ($T \leq n$).

Parameter Simplification We can assume without loss of generality that in the homogeneous shock propagation model $w = 1$. To observe this, if $w = I/m \neq 1$, then we can divide each of the quantities t_v , b_v , E and d_v by w ; it is easy to see that the outcome of the shock propagation procedure in Table 1 remains the same. Moreover, we will ignore the balance sheet equation since d_v has no effect in shock propagation.

3 Related Prior Works on Financial Networks

Although there is a large amount of literature on stability of financial systems in general and banking systems in particular, much of the prior research is on the empirical side or applicable to small-size networks. Two main categories of prior researches can be summarized as follows. The particular model used in this paper is the model of Nier *et al.* [38]. As stated before, definition of a precise stability measure and analysis of its computational complexity issues for stability calculation were not provided for these models before.

Network formation Babus [6] proposed a model in which banks form links with each other as an insurance mechanism to reduce the risk of contagion. In contrast, Castiglionesi and Navarro [11] studied decentralization of the network of banks that is optimal from the perspective of a social planner. In a setting in which banks invest on behalf of depositors and there are positive network externalities on the investment returns, fragility arises when “not sufficiently capitalized” banks gamble with depositors’ money. When the probability of bankruptcy is low, the decentralized solution well-approximates the first objective of Babus.

Contagion spread in networks Although ordinarily one would expect the risk of contagion to be larger in a highly interconnected banking system, some empirical simulations indicate that shocks have an *extremely complex* effect on the network stability in the sense that higher connectivity among banks may sometimes lead to *lower* risk of contagion. Allen and Gale [2] studied how a banking system may respond to contagion when banks are connected under different network structures, and found that, in a setting where consumers have the liquidity preferences as introduced by Diamond and Dybvig [17] and have random liquidity needs, banks perfectly insure against liquidity fluctuations by exchanging interbank deposits, but the connections created by swapping deposits expose the *entire system* to contagion. Allen and Gale concluded that incomplete networks are *more* prone to contagion than networks with maximum connectivity since

better-connected networks are more resilient via transfer of proportion of the losses in one bank's portfolio to more banks through interbank agreements. Freixas *et al.* [24] explored the case of banks that face liquidity fluctuations due to the uncertainty about consumers withdrawing funds. Gai and Kapadia [25] argued that the higher is the connectivity among banks the more will be the contagion effect during crisis. Haldane [27] suggested that contagion should be measured based on the interconnectedness of each institution within the financial system. Liedorp *et al.* [35] investigated if interconnectedness in the interbank market is a channel through which banks affect each others riskiness, and argued that both large lending and borrowing shares in interbank markets increase the riskiness of banks active in the *dutch* banking market. Dasgupta [16] explored how linkages between banks, represented by cross-holding of deposits, can be a source of contagious breakdowns by investigating how depositors, who receive a private signal about fundamentals of banks, may want to withdraw their deposits if they believe that enough other depositors will do the same. Lagunoff and Schreft [34] considered a model in which agents are linked in the sense that the return on an agents' portfolio depends on the portfolio allocations of other agents. Iazzetta and Manna [28] used network topology analysis on monthly data on deposits exchange to gain more insight into the way a liquidity crisis spreads. Nier *et al.* [38] explored the dependency of systemic risks on the structure of the banking system via network theoretic approach and the resilience of such a system to contagious defaults. Kleindorfer *et al.* [32] argued that network analyses can play a crucial role in understanding many important phenomena in finance. Corbo and Demange [15] explored, given the exogenous default of set of banks, the relationship of the structure of interbank connections to the contagion risk of defaults. Babus [7] studied how the trade-off between the benefits and the costs of being linked changes depending on the network structure, and observed that, when the network is maximal, liquidity can be redistributed in the system to make the risk of contagion minimal.

4 The Stability and Dual Stability Indices

A banking network is called *dead* if all the banks in the network have failed. Consider a given homogeneous or heterogeneous banking network $\langle G, \gamma, I, E, \Phi \rangle$ or $\langle G, \gamma, I, E, \Phi, \mathbf{w}, \boldsymbol{\alpha} \rangle$. For $\emptyset \subset V' \subseteq V$, let

$$\text{infl}(V') = \{v \in V \mid v \text{ fails if all nodes in } V' \text{ are shocked}\}$$

$$\text{SI}(G, V', T) = \begin{cases} |V'|/n, & \text{if } \text{infl}(V') = V \\ \infty, & \text{otherwise} \end{cases}$$

The Stability Index The optimal *stability index* of a network G is defined as

$$\text{SI}^*(G, T) = \text{SI}(G, V_{\text{shock}}, T) = \min_{V'} \{ \text{SI}(G, V', T) \}$$

For estimation of this measure, we assume that it is possible for the network to fail, *i.e.*, $\text{SI}^*(G, T) < \infty$. Thus, $0 < \text{SI}^*(G, T) \leq 1$, and the higher the stability index is, the better is the stability of the network against an idiosyncratic shock. We thus arrive at the natural computational problem $\text{STAB}_{T, \Phi}$. We denote an optimal subset of nodes that is a solution of Problem $\text{STAB}_{T, \Phi}$ by V_{shock} , *i.e.*, $\text{SI}^*(G, T) = \text{SI}(G, V_{\text{shock}}, T)$. Note that if $T \geq n$ then the $\text{STAB}_{T, \Phi}$ finds a minimum subset of

nodes which, when shocked, will *eventually* cause the death of the network in an arbitrary number of time steps.

Input: a banking network with shocking parameter Φ , and an integer $T > 1$ Valid solution: A subset $V' \subseteq V$ such that $\text{SI}(G, V', T) < \infty$ Objective: <i>minimize</i> $ V' $	Input: a banking network with shocking parameter Φ , and two integers $T, \kappa > 1$ Valid solution: A subset $V' \subseteq V$ such that $ V' = \kappa$ Objective: <i>maximize</i> $ \text{infl}(V')/\kappa $
Stability of banking network ($\text{STAB}_{T,\Phi}$)	Dual Stability of banking network ($\text{DUAL-STAB}_{T,\Phi,\kappa}$)

The Dual Stability Index Many covering-type minimization problems in combinatorics have a natural maximization dual in which one fixes a-priori the number of covering sets and then finds a maximum number of elements that can be covered with these many sets. For example, the usual dual of the minimum set covering problem is the maximum coverage problem [31]. Analogously, we define a dual stability problem $\text{DUAL-STAB}_{T,\Phi,\kappa}$. The *dual stability index* of a network G can then be defined as

$$\text{DSI}^*(G, T, \kappa) = \max_{V' \subseteq V: |V'|=\kappa} |\text{infl}(V')/\kappa|$$

The dual stability measure is of particular interest when $\text{SI}^*(G, T) = \infty$, *i.e.*, the entire network cannot be made to fail. In this case, a natural goal is to find out if a significant portion of the nodes in the network can be failed by shocking a limited number of nodes of G ; this is captured by the definition of $\text{DSI}^*(G, T, \kappa)$.

Violent Death vs. Slow Poisoning In our results, we distinguish two cases of death of a network: *violent death* ($T = 2$) in which the network is dead by the very next step after the shock, and *slow poisoning* (*any* $T \geq 2$) in which the network may not be dead immediately but dies *eventually*.

5 Comparison with Other Models for Attribute Propagation in Networks

Models for propagation of beneficial or harmful attributes have been investigated in the past in several other contexts such as influence maximization in social networks [10, 12, 13, 29], disease spreading in urban networks [14, 20, 21], and percolation models in physics and mathematics [40]. However, the model for shock propagation in financial network discussed in this paper is *fundamentally* very different from all these models. Some distinguishing features of our model include:

(a) Almost all of these models include a trivial solution in which the attribute spreads to the entire network if we inject each node individually with the attribute. This is not the case with our model: *a node may not fail when shocked, and the network may not be dead if all nodes are shocked*. For example, consider the network in Fig. 1(i).

- Suppose that all the nodes are shocked. Then, the following events happen.

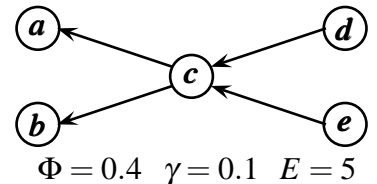

Figure 1: A homogeneous network used in the discussion in Section 5.

- Node a (and similarly node b) fails at $t = 1$ since $\Phi(\deg_{\text{in}}(a) + \frac{E}{5}) > \gamma(\deg_{\text{in}}(a) + \frac{E}{5})$.
 - Node c also fails at $t = 1$ since $\Phi(\deg_{\text{in}}(c) - \deg_{\text{out}}(c) + \frac{E}{5}) = 0.4 > \gamma(\deg_{\text{in}}(c) + \frac{E}{5}) = 0.3$.
 - Node d (and similarly node e) do not fail at $t = 1$ since $\Phi(-\deg_{\text{out}}(d) + \frac{E}{5}) = 0 < \gamma \times \frac{E}{5} = 0.1$ and its equity stays at $0.1 - 0 = 0.1$.
 - At $t = 2$, node d (and similarly node e) receives a shock from node c of the amount $\frac{0.4-0.3}{2} = 0.05 < 0.1$. Thus, nodes d and e do not fail. Since no new nodes fail during $t > 2$, the network does not become dead.
- However, suppose that only nodes a and b are shocked. Then, the following events happen.
 - Node a (and similarly node b) fails at $t = 1$ since $\Phi(\deg_{\text{in}}(a) + \frac{E}{5}) = 0.8 > \gamma(\deg_{\text{in}}(a) + \frac{E}{5}) = 0.2$.
 - At $t = 2$, node c receives a shock of the amount $2 \times (0.8 - 0.2) = 1.2 > \gamma(\deg_{\text{in}}(c) + \frac{E}{5}) = 0.3$. Thus, node c fails at $t = 2$.
 - At $t = 3$, node d (and similarly node e) receives a shock of the amount $\frac{1.2-0.3}{2} = 0.45 > \gamma \times \frac{E}{5} = 0.1$. Thus, both these nodes fail at $t = 3$ and the entire network is dead.

As the above example shows, if shocking a subset of nodes makes a network dead, adding more nodes to this subset may *not* necessarily lead to the death of the network, and the stability measure is *neither monotone nor sub-modular*. Similarly, it is also possible to exhibit banking networks such that to make the entire network fail:

- it may be necessary to shock a node even if it does not fail since shocking such a node “weakens” it by decreasing its equity, and
- it may be necessary to shock a node even if it fails due to shocks given to other nodes.

(b) The complexity of the computational aspects of many previous attribute propagation models arise due to the presence of cycles in the graph; for example, see [12] for polynomial-time solutions of some of these problems when the underlying graph does not have a cycle. In contrast, our computational problems are may be hard *even when the given graph is acyclic*; instead, a key component of computational complexity arises due to two or more directed paths sharing a node.

6 Overview of Our Results and Their Implications on Banking Networks

Table 2 summarizes our results, where the notation $\text{poly}(x_1, x_2, \dots, x_k)$ denotes a constant-degree polynomial in variables x_1, x_2, \dots, x_k . Our results for heterogeneous networks show that the problem of computing stability indices for them is harder than that for homogeneous networks, as one would naturally expect.

	Network type, result type	Stability $SI^*(G, T)$ bound, assumption (if any), corresponding theorem	Dual Stability $DSI^*(G, T, \kappa)$ bound, assumption (if any), corresponding theorem
Homogeneous	$T = 2$ approximation hardness	$(1 - \varepsilon) \ln n$, $NP \not\subseteq DTIME(n^{\log \log n})$, Theorem 8.1	
	$T = 2$, approximation ratio	$O\left(\log\left(\frac{n \Phi E}{\gamma(\Phi - \gamma) E - \Phi }\right)\right)$, Theorem 9.1	
	Acyclic, $\forall T > 1$, approximation hardness	APX-hard, Theorem 10.1	$(1 - e^{-1} + \varepsilon)^{-1}$, $P \neq NP$, Theorem 15.1(a)
	In-arborescence, $\forall T > 1$, exact solution	$O(n^2)$ time, every node fails when shocked, Theorem 11.1	$O(n^3)$ time, every node fails when shocked, Theorem 15.1(b)
Heterogeneous	Acyclic, $\forall T > 1$, approximation hardness	$(1 - \varepsilon) \ln n$, $NP \not\subseteq DTIME(n^{\log \log n})$, Theorem 12.1	$(1 - e^{-1} + \varepsilon)^{-1}$, $P \neq NP$, Theorem 15.1(a)
	Acyclic, $T = 2$, approximation hardness		n^δ , assumption $(*)^\dagger$, Theorem 16.1
	Acyclic, $\forall T > 3$, approximation hardness	$2^{\log^{1-\varepsilon} n}$, $NP \not\subseteq DTIME(n^{\text{poly}(\log n)})$, Theorem 14.1	
	Acyclic, $T = 2$, approximation ratio [‡]	$O\left(\log\left(\frac{n \bar{E} \overline{w_{\max}} \overline{w_{\min}} \overline{\alpha_{\max}}}{\Phi \gamma(\Phi - \gamma) \underline{E} \underline{w_{\min}} \underline{\alpha_{\min}} \overline{w_{\max}}}\right)\right)$, Theorem 13.1	

[‡]See Theorem 13.1 for definitions of some parameters in the approximation ratio.

[†]See page 42 for statement of assumption $(*)$, which is weaker than the assumption $P \neq NP$.

Table 2: A summary of our results; $\varepsilon > 0$ is any arbitrary constant and $0 < \delta < 1$ is some constant.

6.1 Brief Overview of Proof Techniques

6.1.1 Homogeneous Networks, $STAB_{T, \Phi}$

$T = 2$, approximation hardness and approximation algorithm The reduction for approximation hardness is from a corresponding inapproximability result for the dominating set problem for graphs. The logarithmic approximation *almost* matches the lower bound. Even though this algorithmic problem can be cast as a covering problem, one *cannot* explicitly enumerate *exponentially many* covering sets in polynomial time. Instead, we reformulate the problem to that of computing an optimal solution of a polynomial-size integer linear programming (ILP), and then use the greedy approach of [18] for approximation. A careful calculation of the size of the coefficients of the ILP ensures that we have the desired approximation bound.

Any $T > 1$, approximation hardness and exact algorithm The APX-hardness result, which holds even if the degrees of all nodes are *small* constants, is via a reduction from the node cover problem for 3-regular graphs. Technical complications in the reduction arise from making sure that the generated graph instance of $STAB_{T, \Phi}$ is *acyclic*, no new nodes fail for any $t > 3$, but the network can be dead without each node being individually shocked. If the network is a rooted in-arborescence and every node can be individually shocked to fail, then we design an $O(n^2)$ time *exact* algorithm via dynamic programming; as a by product it also follows that the value of the stability index of this kind of network with *bounded* node degrees is *large*.

6.1.2 Homogeneous Networks, $\text{DUAL-STAB}_{T,\Phi,\kappa}$

Any T , approximation hardness and exact algorithm For hardness, we translate a lower bound for the *maximum coverage* problem [22]. The reduction relies on the fact that in dual stability measure every node of the network need *not* fail. If the given graph is a rooted in-arborescence and every node can be individually shocked to fail, we provide an $O(n^3)$ time exact algorithm via dynamic programming.

6.1.3 Heterogeneous Networks, $\text{STAB}_{T,\Phi}$

Any T , approximation hardness The reduction is from a corresponding inapproximability result for the minimum set covering problem. Unlike homogeneous networks, unequal shares of the total external assets by various banks allows us to encode an instance of set cover by “equalizing” effects of nodes.

$T = 2$ The **approximation algorithm** uses linear program in Theorem 9.1 with more careful calculations.

Any $T > 2$, approximation hardness This stronger poly-logarithmic inapproximability result than that in Theorem 12.1 is obtained by a reduction from MINREP , a graph-theoretic abstraction of two prover multi-round protocol for any problem in NP . Many technical complications in the reduction, culminating to a set of 22 symbolic linear equations between the parameters that we must satisfy. Intuitively, the two provers in MINREP correspond to two nodes in the network that cooperate to fail to another specified set of nodes.

6.1.4 Heterogeneous Networks, $\text{DUAL-STAB}_{2,\Phi,\kappa}$, approximation hardness The reduction for this stronger inapproximability result is from the *densest hyper-graph* problem.

6.2 Implications of Our Results on Banking Networks

Effects of Topological Connectivity Though researchers agree that the connectivity of banking networks affects its stability [2, 25], the conclusions drawn are mixed, namely some researchers conclude that lesser connectivity implies more susceptibility to contagion whereas other researchers conclude in the opposite. Based on our results and their proofs, we found that topological connectivity does play a significant role in stability of the network in the following complex manner.

Even acyclic networks display complex stability behavior: Sometimes a cause of the instability of a banking network is attributed to *cyclical* dependencies of borrowing and lending mechanisms among major banks, *e.g.*, banks v_1 , v_2 and v_3 borrowing from banks v_2 , v_3 and v_1 , respectively. Our results show that computing the stability measures may be difficult even without the presence of such cycles. Indeed, larger inapproximability results, especially for heterogeneous networks, are possible because slight change in network parameters can cause a large change in the stability measure. On the other hand, acyclic small-degree rooted in-arborescence networks exhibit higher values of the stability measure, *e.g.*, if the maximum in-degree of any

node in a rooted in-arborescence is 5 and the shock parameter Φ is no more than twice the value of the percentage of equity to assets γ , then by Theorem 11.1 $SI^*(G, T) > 0.1$.

Intersection of borrowing chains may cause lower stability: By a *borrowing chain* we mean a directed path from a node v_1 to another node v_2 , indicating that bank v_2 effectively borrowed from bank v_1 through a sequence of successive intermediaries. Now, assume that there is another directed path from v_1 to another node v_3 . Then, failure of v_2 and v_3 propagates the resulting shocks to v_1 and, if the shocks arrive at the same step, then the total shock received by bank v_1 is the addition of these two shocks, which in turn passes this “amplified” shock to other nodes in the network.

Effects of Ratio of External to Internal Assets (E/I) and percentage of equity to assets (γ) for Homogeneous Networks As our relevant results and their proofs show, lower values of E/I and γ may cause the network stability to be extremely sensitive with respect to variations of other parameters of a homogeneous network. For example, in the proof of Theorem 8.1 we have $\lim_{n \rightarrow \infty} E/I = \lim_{n \rightarrow \infty} \gamma = 0$, leading to variation of the stability index by a logarithmic factor; however, in the proof of Theorem 10.1 we have $E/I = 0.25$ and $\gamma = 0.23$ leading to much smaller variation of the stability index.

Homogeneous vs. Heterogeneous Networks Our results and proofs show that heterogeneous networks of banks with diverse equities tend to exhibit wider fluctuations of the stability index with respect to parameters, *e.g.*, Theorem 14.1 shows a polylogarithmic fluctuation even if the ratio E/I is large.

7 Preliminary Observations on Shock Propagation

Proposition 7.1. *Let $\langle G = (V, F), \gamma, \beta, E \rangle$ be the given (homogeneous or heterogeneous) banking network. Then, the following are true:*

- (a) *If $\deg_{\text{out}}(v) = 0$ for some $v \in V$, then node v must be given a shock (and, must fail due to this shock) for the entire network to fail.*
- (b) *Let α be the number of edges in the longest directed simple path in G . Then, no new node fails at any time $t > \alpha$.*
- (c) *We can assume without loss of generality that G is weakly connected, i.e., the un-oriented version of G is connected.*

Proof.

(a) Since $\deg_{\text{out}}(v) = 0$, no part of any shock given to any other nodes in the network can reach v . Thus, the network of v , namely $c_v = \gamma a_v$ stays strictly positive (since $\gamma > 0$) and node v never fails.

(b) Let t_{last} be the latest time a node of G failed, and let $V(t)$ be the set of nodes that failed at time $t = 1, 2, \dots, t_{\text{last}}$. Then, $V(1), V(2), \dots, V(t_{\text{last}})$ is a partition of V . For every $i = 1, 2, \dots, t_{\text{last}} - 1$, add directed edges (u, v) from a node $u \in V(i)$ to a node $v \in V(i + 1)$ if u was last node that transmitted any part of the shock to v before v failed. Note that (u, v) is also an edge of G and for

every node $v \in V(i+1)$ there must be an edge (u, v) for some node $u \in V(i)$. Thus, G has a path of length at least t_{last} .

(c) This holds since otherwise the stability measures can be computed separately on each weakly connected component. \square

8 Homogeneous Networks, $\text{STAB}_{2,\Phi}$, Logarithmic Inapproximability

Theorem 8.1. $\text{Sl}^*(G, 2)$ cannot be approximated in polynomial time within a factor of $(1 - \varepsilon) \ln n$, for any constant $\varepsilon > 0$, unless $\text{NP} \subseteq \text{DTIME}(n^{\log \log n})$.

Proof. The dominating set problem for an undirected graph (DOMIN-SET) is defined as follows: given an undirected graph $G = (V, F)$ with $n = |V|$ nodes, find a minimum cardinality subset of nodes $V' \subset V$ such that every node in $V \setminus V'$ is incident on at least one edge whose other endpoint is in V' . It is known that DOMIN-SAT is equivalent to the minimum set-cover problem under L-reduction [8], and thus cannot be approximated within a factor of $(1 - \varepsilon) \ln n$ unless $\text{NP} \subseteq \text{DTIME}(n^{\log \log n})$ [22].

Consider an instance $G = (V, F)$ of DOMIN-SET with n nodes and m edges, and let OPT denote the size of an optimal solution for this instance. Our (directed) banking network $\vec{G} = (\vec{V}, \vec{F})$ is obtained from G by replacing each undirected edge $\{u, v\}$ by two directed edges (u, v) and (v, u) . Thus we have $0 < \deg_{\text{in}}(v) = \deg_{\text{out}}(v) < n$ for every node $v \in V$. We set the global parameters as follows: $E = 10n$, $\gamma = n^{-2}$ and $\Phi = 1$.

For a node v , let $\text{Nbr}(v) = \{u \mid \{u, v\} \in E\}$ be the set of neighbors of v in G . We claim that if a node v is shocked at time $t = 1$, then all nodes in $\{v\} \cup \text{Nbr}(v)$ fail at time $t = 2$. Indeed, suppose that v is shocked at $t = 1$. Then, v surely fails because

$$\Phi e_v = \deg_{\text{in}}(v) - \deg_{\text{out}}(v) + \frac{E}{n} = 10 > \frac{2}{n} > \frac{\deg_{\text{in}}(v) + \frac{E}{n}}{n^2} = \gamma a_v$$

Now, consider $t = 2$ and consider a node v such that v has not failed but a node $u \in \text{Nbr}(v)$ failed at time $t = 1$. Then, node v surely fails because

$$\begin{aligned} s_{v,2} &\geq \frac{\min\{s_{u,1} - c_u, b_u\}}{\deg_{\text{in}}(u, 2)} = \frac{\min\{\Phi e_u - \gamma a_u, \deg_{\text{in}}(u)\}}{\deg_{\text{in}}(u)} > \min \left\{ \frac{10 - \frac{2}{n}}{\deg_{\text{in}}(u)}, 1 \right\} \\ &> \frac{2}{n} > \frac{\deg_{\text{in}}(v) + \frac{E}{n}}{n^2} = \gamma a_v \end{aligned}$$

Thus, we have a 1–1 correspondence between the solutions of DOMIN-SET and death of \vec{G} , namely $V' \subset V$ is a solution of DOMIN-SET if and only if shocking the nodes in V' makes \vec{G} fail at time $t = 2$. \square

9 Homogeneous Networks, $\text{STAB}_{2,\Phi}$, Logarithmic Approximation

Theorem 9.1. $\text{STAB}_{2,\Phi}$ admits a polynomial-time algorithm with approximation ratio $O\left(\log\left(\frac{n\Phi E}{\gamma(\Phi-\gamma)|E-\Phi|}\right)\right)$.

Proof. Suppose that $\Phi e_u < 0$ for some node $u \in V$. Then, there exists an optimal solution in which we do not shock the node u . Indeed, if u was shocked, the equity of u increases from c_u to $c_u + |\Phi e_u|$ and u does not propagate any shock to other nodes. Thus, if u still fails at $t = 2$, then it also fails at $t = 2$ if it was not shocked.

Let V_{shock} denote the set of nodes that we will select for shocking, and, for every node $v \in V$, let $\delta_{v,u}$ be defined as: $\delta_{v,u} = \begin{cases} \max\{0, \Phi e_v\}, & \text{if } u = v \\ \frac{\min\{\Phi e_v - c_v, b_v\}}{\deg_{\text{in}}(v)}, & \text{if } \Phi e_v > c_v \text{ and } (u, v) \in F. \\ 0, & \text{otherwise} \end{cases}$. Then, our problem reduces to a covering problem of the following type:

find a minimum cardinality subset $V_{\text{shock}} \subseteq V$ such that, for every node u , $\sum_{v \in V_{\text{shock}}} \delta_{v,u} > c_u$.

Note that we cannot even explicitly enumerate, for a node $u \in V$, all subsets $V' \subseteq V \setminus \{u\}$ such that $\sum_{v \in V'} \delta_{v,u} > c_u$, since there are exponentially many such subsets. Let the binary variable $x_v \in \{0, 1\}$ be the indicator variable for a node $v \in V$ for inclusion in V_{shock} . However, we can reformulate our problem as the following integer linear programming problem:

$$\begin{aligned} & \text{minimize } \sum_{v \in V} x_v \\ & \text{subject to } \forall u \in V: \sum_{v \in V} \delta_{v,u} x_v > c_u \\ & x_u \in \{0, 1\} \end{aligned} \tag{1}$$

Let $\zeta = \min_{u \in V} \{ \min_{v \in V} \{ \delta_{u,v} \}, c_u \}$. We can rewrite each constraint $\sum_{v \in V} \delta_{v,u} x_v > c_u$ as $\sum_{v \in V} \frac{\delta_{v,u}}{\zeta} x_v > \frac{c_u}{\zeta}$ to ensure that every non-zero entry is at least 1. Since the coefficients of the constraints and the objective function are all positive real numbers, (1) can be approximated by the greedy algorithm described in [18, Theorem 4.1] with an approximation ratio of $2 + \ln n + \ln\left(\max_{v \in V} \left\{ \sum_{u \in V} \frac{\delta_{v,u}}{\zeta} \right\}\right)$. Now, observe that:

$$\begin{aligned} \min_{\substack{u \in V \\ \delta_{u,u} > 0}} \{ \delta_{u,u} \} &= \min_{\substack{u \in V \\ \delta_{u,u} > 0}} \left\{ \Phi \left(\deg_{\text{in}}(u) - \deg_{\text{out}}(u) + \frac{E}{n} \right) \right\} = \Omega \left(\frac{|E - \Phi|}{n} \right) \\ \min_{u \in V} \min_{\substack{v \in V \\ \delta_{u,v} > 0}} \{ \delta_{u,v} \} &= \min_{u \in V} \min_{\substack{v \in V \\ \Phi e_v > c_v}} \left\{ (\Phi - \gamma) \left(1 + \frac{E}{\deg_{\text{in}}(v)} \right) - \Phi \frac{\deg_{\text{out}}(v)}{\deg_{\text{in}}(v)} \right\} = \Omega \left(\frac{(\Phi - \gamma)E}{n} \right) \end{aligned}$$

$$\min_{u \in V} \{c_u\} = \min_{u \in V} \left\{ \gamma \left(\deg_{\text{in}}(u) + \frac{E}{n} \right) \right\} = \Omega \left(\frac{\gamma E}{n} \right)$$

$$\zeta = \min \left\{ \min_{u \in V} \min_{v \in V} \{ \delta_{u,v} \}, \min_{u \in V} \{c_u\} \right\} = \Omega \left(\min \left\{ \frac{|E - \Phi|}{n}, \frac{(\Phi - \gamma)E}{n}, \frac{\gamma E}{n} \right\} \right)$$

$$\max_{v \in V} \sum_{u \in V} \delta_{v,u} \leq n \max_{u \in V} \left\{ (\Phi - \gamma) \left(1 + \frac{E}{\deg_{\text{in}}(u)} \right) - \Phi \frac{\deg_{\text{out}}(u)}{\deg_{\text{in}}(u)} \right\} = O(n(\Phi - \gamma)E)$$

and thus, $\max_{v \in V} \left\{ \sum_{u \in V} \frac{\delta_{v,u}}{\zeta} \right\} = O \left(\text{poly} \left(n, \frac{\Phi}{\gamma}, \frac{1}{\Phi - \gamma}, \frac{E}{|E - \Phi|} \right) \right)$, giving the approximation bound. \square

10 Homogeneous Networks, $\text{STAB}_{T,\Phi}$, any T , APX-hardness

Theorem 10.1. *For any T , computing $\text{SI}^*(G, T)$ is APX-hard even if the banking network G is a DAG with $\deg_{\text{in}}(v) \leq 3$ and $\deg_{\text{out}}(v) \leq 2$ for every node v .*

Proof. We reduce the 3-MIN-NODE-COVER problem to $\text{STAB}_{T,\Phi}$. 3-MIN-NODE-COVER is defined as follows. We are given an undirected 3-regular graph G , *i.e.*, an undirected graph $G = (V, F)$ in which the degree of every node is exactly 3 (and thus $|F| = 1.5|V|$). A valid solution (node cover) is a subset of nodes $V' \subseteq V$ such that every edge is incident to at least one node in V' . The goal is then to find a node cover $V' \subseteq V$ such that $|V'|$ is *minimized*. This problem is known to be APX-hard [9].

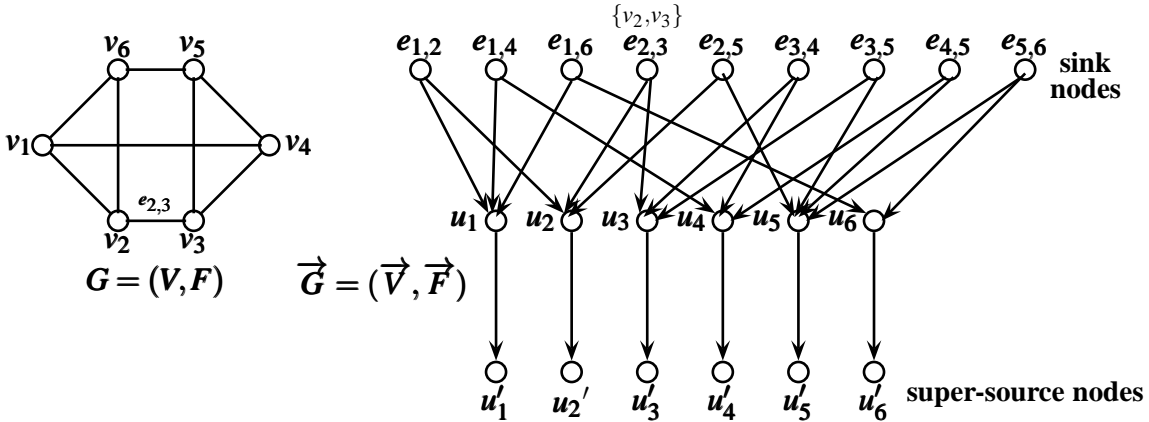

Figure 2: A 3-regular graph $G = (V, F)$ and its corresponding banking network $\vec{G} = (\vec{V}, \vec{F})$.

Given such an instance $G = (V, F)$ of 3-MIN-NODE-COVER, we construct an instance of the banking network $\vec{G} = (\vec{V}, \vec{F})$ as follows:

- For every node $v_i \in V$, we have two nodes u_i, u'_i in \vec{V} , and a directed edge (u_i, u'_i) . We refer to u'_i as a “super-source” node.

- For every edge $\{v_i, v_j\} \in F$ with $i < j$, we have a (“sink”) node $e_{i,j}$ in \vec{V} and two directed edges $(e_{i,j}, u_i)$ and $(e_{i,j}, u_j)$ in \vec{F} . For notational convenience, the node $e_{i,j}$ is also sometimes referred to as the node $e_{j,i}$.

Thus, $|\vec{V}| = 3.5|V|$, and $|\vec{F}| = 4|V|$. See Fig. 2 for an illustration. Observe that:

- $\deg_{\text{in}}(u_i) = 3$ and $\deg_{\text{out}}(u_i) = 1$ for all $i = 1, 2, \dots, |V|$.
- $\deg_{\text{in}}(u'_i) = 1$ and $\deg_{\text{out}}(u'_i) = 0$ for all $i = 1, 2, \dots, |V|$. Thus, by Proposition 7.1(a), every node u'_i must be shocked to make the network fail.
- $\deg_{\text{in}}(e_{i,j}) = 0$ and $\deg_{\text{out}}(e_{i,j}) = 2$ for all i and j . Since $\deg_{\text{in}}(e_{i,j}) = 0$, if a node $e_{i,j}$ is shocked, no part of the shock is propagated to any other node in the network.
- Since the longest path in \vec{G} has 2 edges, by Proposition 7.1(b) no new node fails at any $t > 3$.

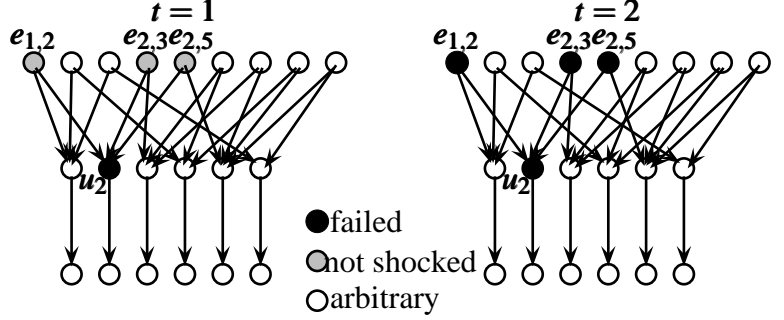

Figure 3: Case (III): if node u_2 is shocked then the nodes $e_{1,2}$, $e_{2,3}$ and $e_{2,5}$ must fail at $t = 2$.

For notational convenience, let $n = |V|$, $\mathcal{E} = E/n$, and e_{i,j_1} , e_{i,j_2} and e_{i,j_3} be the three edges $\{v_i, v_{j_1}\}$, $\{v_i, v_{j_2}\}$ and $\{v_i, v_{j_3}\}$ in G that are incident on the node v_i . We will select the remaining network parameters, namely γ , Φ and \mathcal{E} , based on the following desirable properties.

(I) If a node u'_i is shocked at $t = 1$, it fails:

$$\Phi (\deg_{\text{in}}(u'_i) - \deg_{\text{out}}(u'_i) + \mathcal{E}) > \gamma (\deg_{\text{in}}(u'_i) + \mathcal{E}) \equiv \Phi (1 + \mathcal{E}) > \gamma (1 + \mathcal{E}) \equiv \Phi > \gamma \quad (2)$$

(II) If a node $e_{i,j}$ is shocked, it does not fail:

$$\deg_{\text{in}}(e_{i,j}) - \deg_{\text{out}}(e_{i,j}) + \mathcal{E} < 0 \equiv \mathcal{E} < 2 \quad (3)$$

(III) If a node u_i is shocked at $t = 1$, then u_i fails at $t = 1$, and the nodes e_{i,j_1} , e_{i,j_2} and e_{i,j_3} fail at time $t = 2$ if they were not shocked (see Fig. 3 for an illustration):

$$\begin{aligned} & \frac{\min \{ \Phi (\deg_{\text{in}}(u_i) - \deg_{\text{out}}(u_i) + \mathcal{E}) - \gamma (\deg_{\text{in}}(u_i) + \mathcal{E}), \deg_{\text{in}}(u_i) \}}{\deg_{\text{in}}(u_i)} > \gamma (\deg_{\text{in}}(e_{i,j_1}) + \mathcal{E}) \\ & \equiv \frac{\min \{ \Phi (2 + \mathcal{E}) - \gamma (3 + \mathcal{E}), 3 \}}{3} > \gamma \mathcal{E} \end{aligned}$$

The above inequality is satisfied provided:

$$\Phi (2 + \mathcal{E}) > \gamma (3 + 4\mathcal{E}) \quad (4)$$

$$1 > \gamma \mathcal{E} \equiv \gamma < \frac{1}{\mathcal{E}} \quad (5)$$

(IV) Consider a sink node $e_{i,j}$. Then, we require that if one or both of the super-source node u'_i and u'_j are shocked at $t = 1$ but the none of the nodes u_i , u_j and $e_{i,j}$ were shocked, then we require that one or both of the corresponding nodes u_i and u_j fail at $t = 2$, but the node $e_{i,j}$ never fails. Pictorially, we want a situation as depicted in Fig. 4. This is satisfied provided the following inequalities hold:

(IV-1) u_i fails at $t = 2$ if u'_i was shocked (the case of u_j and u'_j is similar):

$$\frac{\min \{ \Phi (\deg_{\text{in}}(u'_i) - \deg_{\text{out}}(u'_i) + \mathcal{E}) - \gamma (\deg_{\text{in}}(u'_i) + \mathcal{E}), \deg_{\text{in}}(u'_i) \}}{\deg_{\text{in}}(u'_i)} > \gamma (\deg_{\text{in}}(u_i) + \mathcal{E})$$

$$\equiv \frac{\min \{ (\Phi - \gamma)(1 + \mathcal{E}), 1 \}}{1} > \gamma(3 + \mathcal{E})$$

The above inequality is satisfied provided:

$$(\Phi - \gamma)(1 + \mathcal{E}) > \gamma(3 + \mathcal{E}) \equiv \Phi(1 + \mathcal{E}) > \gamma(4 + 2\mathcal{E}) \quad (6)$$

$$1 > \gamma(3 + \mathcal{E}) \equiv \gamma < \frac{1}{3 + \mathcal{E}} \quad (7)$$

(IV-2) $e_{i,j}$ never fails even if both u_i and u_j have failed:

$$\frac{\min \{ (\Phi - \gamma)(1 + \mathcal{E}), 1 \}}{1} - \gamma(3 + \mathcal{E}) \leq \frac{\gamma \mathcal{E}}{2} \equiv \min \{ (\Phi - \gamma)(1 + \mathcal{E}), 1 \} \leq 3\gamma \left(1 + \frac{\mathcal{E}}{2} \right)$$

The above inequality is satisfied provided:

$$(\Phi - \gamma)(1 + \mathcal{E}) \leq 3\gamma \left(1 + \frac{\mathcal{E}}{2} \right) \equiv \Phi(1 + \mathcal{E}) \leq \gamma \left(4 + \frac{5\mathcal{E}}{2} \right) \quad (8)$$

$$1 \leq 3\gamma \left(1 + \frac{\mathcal{E}}{2} \right) \equiv \gamma \geq \frac{2}{6 + 3\mathcal{E}} \quad (9)$$

There are obviously many choices of parameters γ , Φ and \mathcal{E} that satisfy Equations (2)–(9); here we exhibit just one. Let $\mathcal{E} = 1$ which satisfied Equation (3). Choosing $\gamma = 0.23$ satisfies Equations (5), (7) and (9). Letting $\Phi = 0.7$ satisfies Equations (2), (4), (6) and (8).

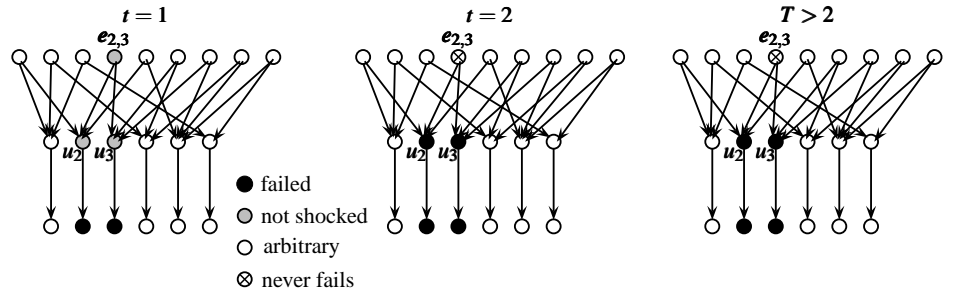

Figure 4: Case (IV): to make $e_{2,3}$ fail, at least one of u_2 or u_3 must be shocked.

Suppose that $V' \subset V$ is a solution of 3-MIN-NODE-COVER. Then, we shock all the super-nodes, and the nodes in V' . By (I) and (III) all the super-nodes and the nodes in $(\cup_{v_i \in V \setminus V'} \{v_i\})$

fails at $t = 1$, and by **(III)** the nodes in $\cup_{\substack{\{v_i, v_j\} \in E \\ i < j}} \{e_{i,j}\}$ fails $t = 2$. Thus, we obtain a solution of \vec{G} by shocking $|V'| + n$ nodes.

Conversely, consider a solution of the $\text{STAB}_{T,\Phi}$ problem on \vec{G} . Remember that all the super-nodes must be shocked, which ensures that we need to shock $n + a$ nodes for some integer $a \geq 0$, and that any node v_i that is not shocked will fail at $t = 2$. By **(II)** it is of no use to shock the sink nodes. Thus, the shocked nodes consist of all super-nodes and a subset V' of cardinality a of the nodes u_1, u_2, \dots, u_n . By **(IV)** for every node $e_{i,j}$ at least one of the nodes u_i or u_j must be in U . Thus, the set of nodes $\{v_i \mid u_i \in U\}$ form a node cover of G of size a .

That the reduction is an L-reduction follows from the observation that any locally improvable solution of 3-MIN-NODE-COVER has between $n/3$ and n nodes. \square

11 Restricted Homogeneous Networks, $\text{STAB}_{T,\Phi}$, Any T , Exact Solution

The APX-hardness result of Theorem 10.1 has constant values for both Φ and γ , and requires $\deg_{\text{out}}(v) = 2$ for some nodes v . We show that if $\deg_{\text{out}}(v) \leq 1$ for every node v then under mild technical assumptions $\text{SI}^*(G, T)$ can be computed in polynomial time for any T and, in addition, if $\deg_{\text{in}}(v)$ is bounded by a constant for every node v then the network is highly stable (*i.e.*, $\text{SI}^*(G, T)$ is large). Recall that an in-arborescence is a directed rooted tree where all edges are oriented towards the root.

Theorem 11.1. *If the banking network G is a rooted in-arborescence then $\text{SI}^*(G, T) > \gamma/\Phi \deg_{\text{in}}^{\max}$, where $\deg_{\text{in}}^{\max} = \max_{v \in V} \{\deg_{\text{in}}(v)\}$. Moreover, under the assumption that every node of G can be individually failed by shocking, $\text{SI}^*(G, T)$ can be computed exactly in $O(n^2)$ time.*

Remark 11.2. *Thus, for example, when $\deg_{\text{in}}^{\max} = 3$, $\gamma = 0.1$ and $\Phi = 0.15$, we get $\text{SI}^*(G, T) > 0.22$ and the network cannot be put to death without shocking more than 22% of the nodes. The proof gives an example for which the lower bound is tight.*

In the rest of this section, we prove the above theorem. Let $G = (V, F)$ be the given in-arborescence rooted at node r . We will use the following notations and terminologies:

- $u \rightarrow v$ and $u \rightsquigarrow v$ denote a directed edge and a directed path of one or more edges, respectively, from node u to node v .
- If $(u, v) \in F$ then v is the *parent* of u and u is a *child* of v . Similarly, if $u \rightsquigarrow v$ exists in G then v is an *ancestor* of u and u is a *descendent* of v .
- Let $\nabla(u) = \{v \mid u \rightsquigarrow v \text{ exists in } G\}$ denote the set of all proper ancestors of u , and $\Delta(u) = \{v \mid v \rightsquigarrow u \text{ exists in } G\} \cup \{u\}$ denote the set of all descendents of u (including the node u itself). Note that for the network G to fail, at least one node in $\nabla(u) \cup \{u\}$ must be shocked for every node u .

Suppose that we shock a node u of G (and shock no other nodes in $\Delta(u)$). If u fails, then the shock splits and propagates to a subset of nodes in $\Delta(u)$ until each split part of the shock terminates because of one of the following reasons:

- the component of the shock reaches a “leaf” node v with $\deg_{\text{in}}(v) = 0$, or
- the component of the shock reaches a node v with a sufficiently high c_v such that v does not fail.

Based on the above observations, we define the following quantities.

Definition 11.3 (see Fig. 5 for illustrations). *The influence zone of a shock on u , denoted by $\text{iz}(u)$, is the set of all failed nodes $v \in \Delta(u)$ within time T when u is shocked (and, no other node in $\Delta(u)$ is shocked). Note that $u \in \text{iz}(u)$.*

Note that, for any node u , $\text{iz}(u)$ can be computed in $O(n)$ time.

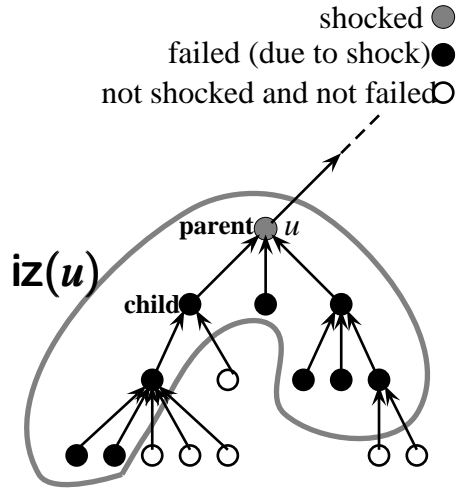

Figure 5: Influence zone of a shock on u .

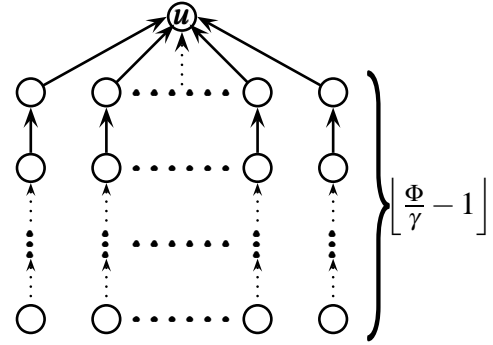

Figure 6: A tight example for the bound in Lemma 11.4 ($\mathcal{E} = 0$).

Lemma 11.4. *For any node u , $|\text{iz}(u)| < 1 + \deg_{\text{in}}(u) \left(\frac{\Phi}{\gamma} - 1 \right)$.*

Proof. For notational simplicity, let $\mathcal{E} = E/n$. If the node u does not fail when shocked, or u fails but it has no child, then $|\text{iz}(u)| \leq 1$ and our claim holds since $\Phi > \gamma$. Otherwise, u fails and each of its $\deg_{\text{in}}(u)$ children at level 2 receives a part of the shock given by

$$\begin{aligned} \mathcal{D} &= \min \left\{ \frac{\Phi(\deg_{\text{in}}(u) - 1 + \mathcal{E}) - \gamma(\deg_{\text{in}}(u) + \mathcal{E})}{\deg_{\text{in}}(u)}, 1 \right\} \\ &< \Phi \left(1 + \frac{\mathcal{E}}{\deg_{\text{in}}(u)} \right) - \gamma \left(1 + \frac{\mathcal{E}}{\deg_{\text{in}}(u)} \right) \leq \Phi(1 + \mathcal{E}) - \gamma(1 + \mathcal{E}) \end{aligned}$$

Consider a child v of u . Each node $v' \in \Delta(v)$ that fails due to the shock subtracts an amount of $\gamma(\deg_{\text{in}}(v') + \mathcal{E}) \geq \gamma(1 + \mathcal{E})$ from \mathcal{D} provided this subtraction does not result in a negative value. Thus, the total number of failed nodes is strictly less than $1 + \deg_{\text{in}}(u) \frac{\Phi(1 + \mathcal{E}) - \gamma(1 + \mathcal{E})}{\gamma(1 + \mathcal{E})} = 1 + \deg_{\text{in}}(u) \left(\frac{\Phi}{\gamma} - 1 \right)$. \square

Remark 11.5. *The bound in Lemma 11.4 is tight as shown in Fig. 6.*

Lemma 11.4 immediately implies that $\text{SI}^*(G, T) > \frac{n / \left(1 + \deg_{\text{in}}^{\max} \left(\frac{\Phi}{\gamma} - 1\right)\right)}{n} \geq \frac{\gamma}{\Phi \deg_{\text{in}}^{\max}}$. We now provide a polynomial time algorithm to compute $\text{SI}^*(G, T)$ exactly *assuming each node can be shocked to fail individually*. For a node u , define the following:

- For every node $u' \in \nabla(u)$, $\text{SI}_{\text{SANS}}^*(G, T, u, u')$ is the number of nodes in an optimal solution of $\text{STAB}_{T, \Phi}$ for the subgraph induced by the nodes in $\Delta(u)$ (or ∞ , if there is no feasible solution of $\text{STAB}_{T, \Phi}$ for this subgraph under the stated conditions) assuming the following:
 - u' was shocked,
 - u was *not* shocked, and
 - no node in the path $u' \rightsquigarrow u$ excluding u' was shocked.
- $\text{SI}_{\text{SAS}}^*(G, T, u)$ is the number of nodes in an optimal solution of $\text{STAB}_{T, \Phi}$ for the subgraph induced by the nodes in $\Delta(u)$ (or ∞ , if there is no feasible solution of $\text{STAB}_{T, \Phi}$ under the stated conditions)² assuming that the node u was shocked (and therefore failed).

We consider the usual partition of the nodes of G into *levels*: $\text{level}(r) = 1$ and $\text{level}(u) = \text{level}(v) + 1$ if u is a child of v . We will compute $\text{SI}_{\text{SAS}}^*(G, T, u)$ and $\text{SI}_{\text{SANS}}^*(G, T, u, v)$ for the nodes u level by level, starting with the highest level and proceeding to successive lower levels. By Observation 7.1(a), the root r must be shocked to fail for the entire network to fail, and thus $\text{SI}_{\text{SAS}}^*(G, T, r)$ will provide us with our required optimal solution.

Every node u at the highest level has $\deg_{\text{in}}(u) = 0$. In general, $\text{SI}_{\text{SAS}}^*(G, T, u)$ and $\text{SI}_{\text{SANS}}^*(G, T, u, u')$ can be computed for any node u with $\deg_{\text{in}}(u) = 0$ as follows:

Computing $\text{SI}_{\text{SAS}}^*(G, T, u)$ when $\deg_{\text{in}}(u) = 0$: $\text{SI}_{\text{SAS}}^*(G, T, u) = 1$ by our assumption that every node can be shocked to fail.

Computing $\text{SI}_{\text{SANS}}^*(G, T, u, u')$ when $\deg_{\text{in}}(u) = 0$:

- If $u \in \text{iz}(u')$ then shocking node v makes node u fail. Since node u fails without being shocked, we have $\text{SI}_{\text{SANS}}^*(G, T, u, u') = 0$.
- Otherwise, node u does not fail. Thus, there is no feasible solution and $\text{SI}_{\text{SANS}}^*(G, T, u, u') = \infty$.

Note that we only count the number of nodes in $\Delta(u)$ in the calculations of $\text{SI}_{\text{SANS}}^*(G, T, u, u')$ and $\text{SI}_{\text{SAS}}^*(G, T, u)$.

Now, consider a node u at some level ℓ with $\deg_{\text{in}}(u) > 0$. Let $v_1, v_2, \dots, v_{\deg_{\text{in}}(u)}$ be the children of u at level $\ell + 1$. Note that $\nabla(v_1) = \nabla(v_2) = \dots = \nabla(v_{\deg_{\text{in}}(u)})$.

Computing $\text{SI}_{\text{SAS}}^*(G, T, u)$ when $\deg_{\text{in}}(u) > 0$: By our assumption, u fails when shocked. Note that no node in $\Delta(u) \setminus \{u\}$ can receive any component of a shock given to a node in $V \setminus \Delta(u)$ since u failed. For each child v_i of u we have two choices: v_i is shocked and (and, therefore, fails), or v_i is not shocked. Thus, in this case we have $\text{SI}_{\text{SAS}}^*(G, T, u) = 1 + \sum_{i=1}^{\deg_{\text{in}}(u)} \min \left\{ \text{SI}_{\text{SAS}}^*(G, T, v_i), \text{SI}_{\text{SANS}}^*(G, T, v_i, u) \right\}$.

²Intuitively, a value of ∞ signifies that the corresponding quantity is undefined.

```

(* preprocessing *)
 $\forall u \in V$ : compute  $\text{iz}(u)$ 
(* dynamic programming *)
for  $\ell = \ell_{\max}, \ell_{\max} - 1, \dots, 1$  do
  for each node  $u$  at level  $\ell$  do
    if  $\text{deg}_{\text{in}}(u) = 0$  then
       $\text{Sl}_{\text{SAS}}^*(G, T, u) = 1$ 
       $\forall u' \in \nabla(u)$ : if  $u \in \text{iz}(u')$  then  $\text{Sl}_{\text{SANS}}^*(G, T, u, u') = 0$  else  $\text{Sl}_{\text{SANS}}^{\text{st}}(G, T, u, u') = \infty$ 
    else (*  $\text{deg}_{\text{in}}(u) > 0$  *)
       $\text{Sl}_{\text{SAS}}^*(G, T, u) = 1 + \sum_{i=1}^{\text{deg}_{\text{in}}(u)} \min \left\{ \text{Sl}_{\text{SAS}}^*(G, T, v_i), \text{Sl}_{\text{SANS}}^*(G, T, v_i, u) \right\}$ 
       $\forall u' \in \nabla(u)$ : if  $u \notin \text{iz}(u')$  then  $\text{Sl}_{\text{SANS}}^*(G, T, u, u') = \infty$ 
      else
         $\text{Sl}_{\text{SANS}}^*(G, T, u, u') = \sum_{i=1}^{\text{deg}_{\text{in}}(u)} \min \left\{ \text{Sl}_{\text{SAS}}^*(G, T, v_i), \text{Sl}_{\text{SANS}}^*(G, T, v_i, u') \right\}$ 
      endif
    endif
  endif
endfor
endfor
return  $\text{Sl}_{\text{SAS}}^*(G, T, r)$  as the solution

```

Figure 7: A polynomial time algorithm to compute $\text{Sl}^*(G, T)$ when G is a rooted in-arborescence and each node of G fails individually when shocked.

Computing $\text{Sl}_{\text{SANS}}^*(G, T, u, u')$ when $\text{deg}_{\text{in}}(u) > 0$: Since u' is shocked and u is not shocked, the following cases arise:

- If $u \notin \text{iz}(u')$ then u does not fail. Thus, there is no feasible solution for the subgraph induced by the nodes in $\Delta(u)$ under this condition, and $\text{Sl}_{\text{SANS}}^*(G, T, u, u') = \infty$.
- Otherwise, $u \in \text{iz}(u')$, and therefore u fails when u' is shocked. For each child v_i of u , there are two options: v_i is shocked and fails, or v_i is not shocked. Thus, in this case we have $\text{Sl}_{\text{SANS}}^*(G, T, u, u') = \sum_{i=1}^{\text{deg}_{\text{in}}(u)} \min \left\{ \text{Sl}_{\text{SAS}}^*(G, T, v_i), \text{Sl}_{\text{SANS}}^*(G, T, v_i, u') \right\}$.

Let ℓ_{\max} be the maximum level number of any node in G . Based on the above observations, we can design the dynamic programming algorithm as shown in Fig. 7 to compute an optimal solution of $\text{STAB}_{T, \Phi}$ on G . It is easy to check that the running time of our algorithm is $O(n^2)$.

12 Heterogeneous Networks, $\text{STAB}_{T, \Phi}$, Any T , Logarithmic In-approximability

Theorem 12.1. *Assuming $\text{NP} \not\subseteq \text{DTIME}(n^{\log \log n})$, for any constant $0 < \varepsilon < 1$ and any T , it is impossible to approximate $\text{Sl}^*(G, T)$ within a factor of $(1 - \varepsilon) \ln n$ in polynomial time even if G is a DAG.*

$$\begin{aligned}\mathcal{U} &= \{u_1, u_2, u_3, u_4\} \\ \mathcal{S} &= \{S_1, S_2, S_3, S_4\} \\ S_1 &= \{u_1, u_2, u_3\} \\ S_2 &= \{u_3, u_4\} \\ S_3 &= \{u_3\} \\ S_4 &= \{u_1, u_2\}\end{aligned}$$

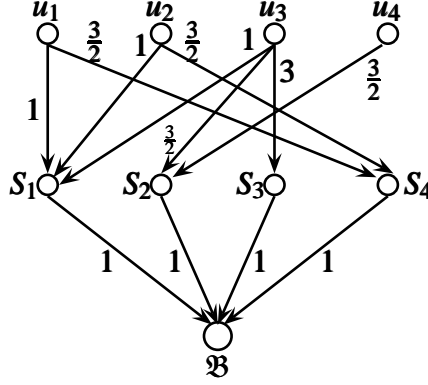

Figure 8: An instance $\langle \mathcal{U}, \mathcal{S} \rangle$ of SET-COVER and its corresponding banking network $G = (V, F)$.

Proof. The (unweighted) SET-COVER problem is defined as follows. We have an universe \mathcal{U} of n elements, a collection of m sets \mathcal{S} over \mathcal{U} . The goal is to pick a sub-collection $\mathcal{S}' \subseteq \mathcal{S}$ containing a *minimum* number of sets such that these sets “cover” \mathcal{U} , i.e., $\cup_{S \in \mathcal{S}'} S = \mathcal{U}$. It is known that there exists instances of SET-COVER that cannot be approximated within a factor of $(1 - \delta) \ln n$, for any constant $0 < \delta < 1$, unless $\text{NP} \subseteq \text{DTIME}(n^{\log \log n})$ [22]. Without any loss of generality, one may assume that every element $u \in \mathcal{U}$ belongs to at least two sets in \mathcal{S} since otherwise the only set containing u must be selected in any solution.

Given such an instance $\langle \mathcal{U}, \mathcal{S} \rangle$ of SET-COVER, we now construct an instance of the banking network $G = (V, F)$ as follows:

- We have a special node \mathfrak{B} .
- For every set $S \in \mathcal{S}$, we have a node S , and a directed edge (S, \mathfrak{B}) .
- For every element $u \in \mathcal{U}$, we have a node u , and directed edges (u, S) for every set S that contains u .

Thus, $|V| = n + m + 1$, and $|F| < nm + m$. See Fig. 8 for an illustration. We set the shares of internal assets for each bank as follows:

- For each set $S \in \mathcal{S}$, if S contains $k > 1$ elements then, for each element $u \in S$, we set the weight of the edge $e = (u, S)$ as $w(e) = \frac{3}{k}$.
- For each set $S \in \mathcal{S}$, we set the weight of the edge (S, \mathfrak{B}) as 1.

Thus, $I = 4m$. Also, observe that:

- For any $S \in \mathcal{S}$, $b_S = 3$, and $t_S = 1$.
- For any $u \in \mathcal{U}$, $b_u = 0$. Also, since u belongs to at least two sets in \mathcal{S} and any set has at most $n - 1$ elements, $\frac{2}{n} \leq t_u < \frac{3n}{2}$.
- $b_{\mathfrak{B}} = m$ and $t_{\mathfrak{B}} = 0$.
- Since $\text{deg}_{\text{in}}(u) = 0$ for any element $u \in \mathcal{U}$, if a node u is shocked, no part of the shock is propagated to any other node in the network.
- Since the longest path in G has 2 edges, by Proposition 7.1(b) no new node in G fails for $T > 3$.

Let the share of external assets for a node (bank) y be denoted by E_y (thus, $\sum_{y \in V} E_y = E$). We will select the remaining network parameters, namely γ , Φ and the E_y values, based on the following properties.

(I) If the node \mathfrak{B} is shocked at $t = 1$, it fails:

$$\Phi(b_{\mathfrak{B}} - \iota_{\mathfrak{B}} + E_{\mathfrak{B}}) > \gamma(b_{\mathfrak{B}} + E_{\mathfrak{B}}) \equiv \Phi(m + E_{\mathfrak{B}}) > \gamma(m + E_{\mathfrak{B}}) \equiv \Phi > \gamma \quad (10)$$

(II) For any $S \in \mathcal{S}$, if node S is shocked at $t = 1$, then S fails at $t = 1$, and, for every $u \in S$, node u fails at time $t = 2$:

$$\begin{aligned} & \frac{\min \{ \Phi(b_S - \iota_S + E_S) - \gamma(b_S + E_S), b_S \}}{\deg_{\text{in}}(S)} > \gamma(b_u + E_u) \\ & \equiv \frac{\min \{ \Phi(2 + E_S) - \gamma(3 + E_S), 3 \}}{|S|} > \gamma E_u \end{aligned}$$

The above inequality is satisfied if:

$$\Phi(2 + E_S) > \gamma(3 + E_S + |S|E_u) \quad (11)$$

$$\Phi(2 + E_S) - \gamma(3 + E_S) \leq 3 \quad (12)$$

(III) For any $u \in \mathcal{U}$, consider the node u , and let $S_1, S_2, \dots, S_p \in \mathcal{S}$ be the p sets that contain u . Then, we require that if the node \mathfrak{B} is shocked at $t = 1$ then \mathfrak{B} fails at $t = 1$, every node among the set of nodes $\{S_1, S_2, \dots, S_p\}$ that was not shocked at $t = 1$ fails at $t = 2$, but the node u does not fail if the none of the nodes u, S_1, S_2, \dots, S_p were shocked, This is satisfied provided the following inequalities hold:

(III-1) Any node among the set of nodes $\{S_1, S_2, \dots, S_p\}$ that was not shocked at $t = 1$ fails at $t = 2$. This is satisfies provided for any set $S \in \mathcal{S}$ the following holds:

$$\begin{aligned} & \frac{\min \{ \Phi(b_{\mathfrak{B}} - \iota_{\mathfrak{B}} + E_{\mathfrak{B}}) - \gamma(b_{\mathfrak{B}} + E_{\mathfrak{B}}), b_{\mathfrak{B}} \}}{\deg_{\text{in}}(\mathfrak{B})} > \gamma(b_S + E_S) \\ & \equiv \min \left\{ (\Phi - \gamma) \left(1 + \frac{E_{\mathfrak{B}}}{m} \right), 1 \right\} > \gamma(3 + E_S) \end{aligned}$$

The above inequality is satisfied provided:

$$(\Phi - \gamma) \left(1 + \frac{E_{\mathfrak{B}}}{m} \right) > \gamma(3 + E_S) \equiv \Phi \left(1 + \frac{E_{\mathfrak{B}}}{m} \right) > \gamma \left(4 + E_S + \frac{E_{\mathfrak{B}}}{m} \right) \quad (13)$$

$$1 > \gamma(3 + E_S) \equiv \gamma < \frac{1}{3 + E_S} \quad (14)$$

(III-2) u does not fail if the none of the nodes u, S_1, S_2, \dots, S_p were shocked:

$$\begin{aligned} & \min \left\{ (\Phi - \gamma) \left(1 + \frac{E_{\mathfrak{B}}}{m} \right), 1 \right\} - \gamma(3 + E_S) \leq \frac{\gamma E_u}{n} \\ & \equiv \min \left\{ (\Phi - \gamma) \left(1 + \frac{E_{\mathfrak{B}}}{m} \right), 1 \right\} \leq \gamma \left(3 + E_S + \frac{E_u}{n} \right) \end{aligned}$$

The above inequality is satisfied provided:

$$(\Phi - \gamma) \left(1 + \frac{E_{\mathfrak{B}}}{m}\right) \leq \gamma \left(3 + E_S + \frac{E_u}{n}\right) \equiv \Phi \left(1 + \frac{E_{\mathfrak{B}}}{m}\right) \leq \gamma \left(4 + E_S + \frac{E_{\mathfrak{B}}}{m} + \frac{E_u}{n}\right) \quad (15)$$

$$(\Phi - \gamma) \left(1 + \frac{E_{\mathfrak{B}}}{m}\right) \leq 1 \equiv \gamma \geq \Phi - \frac{1}{1 + \frac{E_{\mathfrak{B}}}{m}} \quad (16)$$

There are many choices of parameters γ , Φ and E_y 's satisfying Equations (10)–(16); we exhibit just one:

$$\forall S \in \mathcal{S} : E_S = 0 \quad E_{\mathfrak{B}} = 0 \quad \forall u \in \mathcal{U} : E_u = \frac{1}{100n} \quad \gamma = 0.1 \quad \Phi = 0.4 + \frac{1}{n^{10000}}$$

Suppose that $\mathcal{S}' \subset \mathcal{S}$ is a solution of SET-COVER. Then, we shock the node \mathfrak{B} and the nodes S for each $S \in \mathcal{S}'$. By **(I)** and **(II)** the node \mathfrak{B} and the nodes S for each $S \in \mathcal{S}'$ fails at $t = 1$, and by **(II)** the nodes u for every $u \in \mathcal{U}$ fails $t = 2$. Thus, we obtain a solution of G by shocking $|\mathcal{S}'| + 1$ nodes.

Conversely, consider a solution of the $\text{STAB}_{T,\Phi}$ problem on G . If a node u for some $u \in \mathcal{U}$ was shocked, we can instead shock the node S for any set S that contains u , which by **(II)** still fails all the nodes in the network and does not increase the number of shocked nodes. Thus, after such normalizations, we may assume that the shocked nodes consist of \mathfrak{B} and a subset $\mathcal{S}' \subseteq \mathcal{S}$ of nodes. By **(II)** and **(III)** for every node $u \in \mathcal{U}$ at least one set that contains u must be in \mathcal{S}' . Thus, the collection of sets in \mathcal{S}' form a cover of \mathcal{U} of size $|\mathcal{S}'|$. \square

13 Heterogeneous Networks, $\text{STAB}_{2,\Phi}$, Logarithmic Approximation

For any positive real $x > 0$, let $\bar{x} = \max\{x, 1/x\}$ and $\underline{x} = \min\{x, 1/x\}$. Let $w_{\min} = \min_{e: w(e)>0} \{w(e)\}$, $w_{\max} = \max_e \{w(e)\}$, $\alpha_{\min} = \min_{v: \alpha_v>0} \{\alpha_v\}$, and $\alpha_{\max} = \max_v \{\alpha_v\}$.

Theorem 13.1. $\text{STAB}_{2,\Phi}$ admits a poly-time algorithm with approximation ratio $O\left(\log \frac{n \bar{E} \overline{w_{\max}} \overline{w_{\min}} \overline{\alpha_{\max}}}{\Phi \gamma (\Phi - \gamma) \underline{E} \underline{w_{\min}} \underline{\alpha_{\min}} \underline{w_{\max}}}\right)$.

Proof. We can reuse the proof of the corresponding approximation for homogeneous networks in Theorem 9.1 to obtain an approximation ratio of $2 + \ln n + \ln\left(\max_{v \in V} \left\{\sum_{u \in V} \frac{\delta_{v,u}}{\zeta}\right\}\right)$, where $\zeta = \min_{u \in V} \left\{\min_{v \in V} \{\delta_{u,v}\}, c_u\right\}$, provided we recalculate $\max_{v \in V} \left\{\sum_{u \in V} \frac{\delta_{v,u}}{\zeta}\right\}$. Then,

$$\min_{\substack{u \in V \\ \delta_{u,u}>0}} \{\delta_{u,u}\} = \min_{\substack{u \in V \\ \delta_{u,u}>0}} \left\{ \Phi \left(\sum_{e=(v',u) \in F} w(e) - \sum_{e=(u,v') \in F} w(e) + \alpha_v E \right) \right\} = \Omega\left(\text{poly}(s, \Phi, \underline{E}, \underline{\alpha_{\min}})\right)$$

$$\begin{aligned} \min_{u \in V} \min_{\substack{v \in V \\ \delta_{u,v} > 0}} \{\delta_{u,v}\} &= \min_{u \in V} \min_{\substack{v \in V \\ \Phi_{e_v > c_v}}} \left\{ (\Phi - \gamma) \left(1 + \frac{\alpha_v E}{\sum_{e=(v',v) \in F} w(e)} \right) - \Phi \frac{\sum_{e=(v,v') \in F} w(e)}{\sum_{e=(v',v) \in F} w(e)} \right\} \\ &= \Omega \left(\text{poly} \left(n^{-1}, \Phi - \gamma, \Phi, \underline{E}, \underline{w_{\max}}, \underline{w_{\min}}, \underline{\alpha_{\min}} \right) \right) \end{aligned}$$

$$\min_{u \in V} \{c_u\} = \min_{u \in V} \left\{ \gamma \left(\sum_{e=(v',u) \in F} w(e) + \alpha_u E \right) \right\} = \Omega \left(\text{poly} \left(n^{-1}, \gamma, \underline{E}, \underline{\alpha_{\min}}, \underline{w_{\min}} \right) \right)$$

$$\zeta = \min \left\{ \min_{u \in V} \min_{v \in V} \{\delta_{u,v}\}, \min_{u \in V} \{c_u\} \right\} = \Omega \left(\text{poly} \left(n^{-1}, \Phi - \gamma, \Phi, \gamma, \underline{E}, \underline{w_{\min}}, \underline{\alpha_{\min}}, \underline{w_{\max}} \right) \right)$$

$$\max_{v \in V} \sum_{u \in V} \delta_{v,u} \leq n \max_{u \in V} \left\{ (\Phi - \gamma) \left(1 + \frac{\alpha_v E}{\sum_{e=(v',v) \in F} w(e)} \right) - \Phi \frac{\sum_{e=(v,v') \in F} w(e)}{\sum_{e=(v',v) \in F} w(e)} \right\} = O \left(\text{poly} \left(n, \bar{E}, \overline{w_{\max}}, \overline{w_{\min}}, \overline{\alpha_{\max}} \right) \right)$$

and thus,

$$\max_{v \in V} \left\{ \sum_{u \in V} \frac{\delta_{v,u}}{\zeta} \right\} = O \left(\text{poly} \left(n, \Phi^{-1}, \gamma^{-1}, (\Phi - \gamma)^{-1}, \bar{E}, \underline{E}^{-1}, \overline{w_{\max}}, \overline{w_{\min}}, \overline{\alpha_{\max}}, \underline{w_{\min}}^{-1}, \underline{\alpha_{\min}}^{-1}, \underline{w_{\max}}^{-1} \right) \right)$$

giving the desired approximation bound. \square

14 Heterogeneous Networks, $\text{STAB}_{T,\Phi}$, $T > 3$, Poly-logarithmic Inapproximability

Theorem 14.1. *Assuming $\text{NP} \not\subseteq \text{DTIME} \left(n^{\text{poly}(\log n)} \right)$, for any constant $0 < \varepsilon < 1$ and any $T > 3$, it is impossible to approximate $\text{SI}^*(G, T)$ within a factor of $2^{\log^{1-\varepsilon} n}$ in polynomial time even if G is a DAG.*

Proof. The MINREP problem (with minor modifications from the original setup) is defined as follows. We are given a bipartite graph $G = (V^{\text{left}}, V^{\text{right}}, F)$ such that the degree of every node of G is at least 10, a partition of V^{left} into $\frac{|V^{\text{left}}|}{\alpha}$ equal-size subsets $V_1^{\text{left}}, V_2^{\text{left}}, \dots, V_\alpha^{\text{left}}$, and a partition of V^{right} into $\frac{|V^{\text{right}}|}{\beta}$ equal-size subsets $V_1^{\text{right}}, V_2^{\text{right}}, \dots, V_\beta^{\text{right}}$.

These partitions define a natural “bipartite super-graph” $G_{\text{super}} = (V_{\text{super}}, F_{\text{super}})$ in the following manner. G_{super} has a “super-node” for every V_i^{left} (for $i = 1, 2, \dots, \alpha$) and for every V_j^{right} (for $j = 1, 2, \dots, \beta$). There exists an “super-edge” $h_{i,j}$ between the super-node for V_i^{left} and the super-node for V_j^{right} if and only if there exists $u \in V_i^{\text{left}}$ and $v \in V_j^{\text{right}}$ such that $\{u, v\}$ is an edge of G . A pair of nodes u and v of G “witnesses” the super-edge $h_{i,j}$ of H provided u is in V_i^{left} , v is in V_j^{right} and the edge $\{u, v\}$ exists in G , and a set of nodes $V' \subseteq V$ of G witnesses a super-edge if and only if there exists at least one pair of nodes in S that witnesses the super-edge.

The goal of MINREP is to find $V_1 \subseteq V^{\text{left}}$ and $V_2 \subseteq V^{\text{right}}$ such that $V_1 \cup V_2$ witnesses *every* super-edge of H and the *size* of the solution, namely $|V_1| + |V_2|$, is *minimum*. For notational simplicity, let $n = |V^{\text{left}}| + |V^{\text{right}}|$. The following result is a consequence of Raz's parallel repetition theorem [33, 39].

Theorem 14.2. [33] *Let L be any language in NP and $0 < \delta < 1$ be any constant. Then, there exists a reduction running in $n^{\text{poly}(\log n)}$ time that, given an input instance x of L , produces an instance of MINREP such that:*

- if $x \in L$ then MINREP has a solution of size $\alpha + \beta$;
- if $x \notin L$ then MINREP has a solution of size at least $(\alpha + \beta) \cdot 2^{\log^{1-\delta} n}$.

Thus, the above theorem provides a $2^{\log^{1-\delta} n}$ -inapproximability for MINREP under the complexity-theoretic assumption of $\text{NP} \not\subseteq \text{DTIME}(n^{\text{polylog}(n)})$.

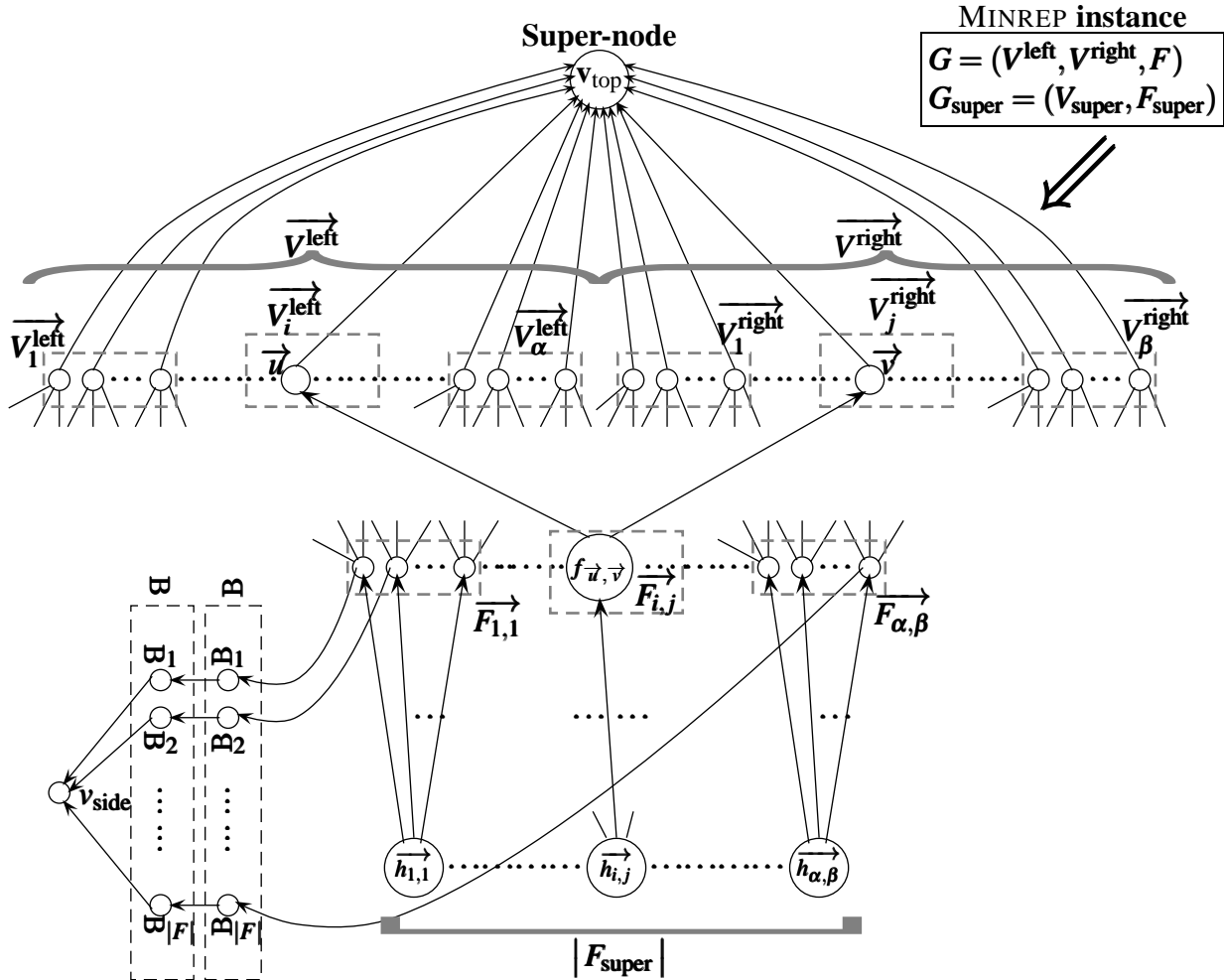

Figure 9: Reduction of an instance of MINREP to $\text{STAB}_{T, \Phi}$ for heterogeneous networks.

Let $F_{i,j} = \left\{ \{u, v\} \mid u \in V_i^{\text{left}}, v \in V_j^{\text{right}}, \{u, v\} \in F \right\}$. We now show our construction of an instance of $\text{STAB}_{T, \Phi}$ from an instance of MINREP. Our directed graph $\vec{G} = (\vec{V}, \vec{F})$ for $\text{STAB}_{T, \Phi}$ is

constructed as follows (see Fig. 9 for an illustration):

Nodes:

- For every node $u \in V_i^{\text{left}}$ of G we have a corresponding node \vec{u} in the set of nodes \vec{V}_i^{left} in \vec{G} , and for every node $v \in V_j^{\text{right}}$ of G we have a corresponding node \vec{v} in the set of nodes \vec{V}_j^{right} in \vec{G} . The total number of such nodes is n .
- For every edge $\{u, v\}$ of G with $u \in V_i^{\text{left}}$ and $v \in V_j^{\text{right}}$, we have a corresponding node $f_{\vec{u}, \vec{v}}$ in the set of nodes $\vec{F}_{i,j}$ in \vec{G} . There are $|F|$ such nodes.
- For every super-edge $h_{i,j}$ of G_{super} , we have a node $\vec{h}_{i,j}$ in \vec{G} . There are $|F_{\text{super}}|$ such nodes.
- We have one “top super-node” v_{top} , one “side super-node” v_{side} , and $2|F|$ additional nodes $\varpi_1, \varpi_2, \dots, \varpi_{|F|}, \mathfrak{m}_1, \mathfrak{m}_2, \dots, \mathfrak{m}_{|F|}$. Let $\varpi = \cup_{j=1}^{|F|} \varpi_j$ and $\mathfrak{m} = \cup_{j=1}^{|F|} \mathfrak{m}_j$.

Thus, $n + 3|F| + 2 < |\vec{V}| = n + |F| + |F_{\text{super}}| + 2 + 2|F| < n + 4|F| + 2$.

Edges:

- For every node u of G , we have an edge (u, v_{top}) in \vec{G} . There are n such edges.
- For every edge $\{u, v\}$ of G , we have two edges $(f_{\vec{u}, \vec{v}}, \vec{u})$ and $(f_{\vec{u}, \vec{v}}, \vec{v})$ in \vec{G} . There are $2|F|$ such edges.
- For every super-edge $h_{i,j}$ of G_{super} and for every edge $f_{u,v}$ in $F_{i,j}$, we have an edge $(\vec{h}_{i,j}, f_{\vec{u}, \vec{v}})$ in \vec{G} . There are $|F|$ such edges.
- Let $p_1, p_2, \dots, p_{|F|}$ be any arbitrary ordering of the edges in F . Then, for every $j = 1, 2, \dots, |F|$, we have the edges $(v_{\text{side}}, \varpi_j)$, $(\varpi_j, \mathfrak{m}_j)$ and (\mathfrak{m}_j, p_j) . The total number of such edges is $3|F|$.

Thus, $|\vec{E}| = n + 6|F|$.

Distribution of internal assets: We set the weight of every edge to 1, Thus, $I = n + \sum_{u \in V^{\text{left}} \cup V^{\text{right}}} \deg(u) + 4|F| = n + 6|F|$.

Let $\deg(u) \geq 10$ be the degree of node $u \in V^{\text{left}} \cup V^{\text{right}}$. Observe that:

- $b_{v_{\text{top}}} = n$, and $t_{v_{\text{top}}} = 0$. Since $\deg_{\text{out}}(v_{\text{top}}) = 0$, by Proposition 7.1(a) the node v_{top} must be shocked to make the network fail.
- $b_{v_{\text{side}}} = |F|$, and $t_{v_{\text{side}}} = 0$. Since $\deg_{\text{out}}(v_{\text{side}}) = 0$, by Proposition 7.1(a) the node v_{side} must be shocked to make the network fail.
- For any $u \in V^{\text{left}} \cup V^{\text{right}}$, $b_{\vec{u}} = \deg(u)$ and $t_{\vec{u}} = 1$.
- For any node $f_{\vec{u}, \vec{v}}$, $b_{f_{\vec{u}, \vec{v}}} = 1$ and $t_{f_{\vec{u}, \vec{v}}} = 2$.

- For every node $\vec{h}_{i,j}$, $b_{\vec{h}_{i,j}} = 0$ and $\iota_{\vec{h}_{i,j}} = |F_{i,j}|$. Since $\deg_{\text{in}}(\vec{h}_{i,j}) = 0$ for any node $\vec{h}_{i,j}$, if such a node is shocked, no part of the shock is propagated to any other node in the network.
- For every j , $b_{\varpi_j} = \iota_{\varpi_j} = b_{\varpi_j} = \iota_{\varpi_j} = 1$.
- Since the longest directed path in G has 4 edges, by Proposition 7.1(b) no new node in G fails for $t > 4$.

Let the share of external assets for a node (bank) y be denoted by E_y (thus, $\sum_{y \in V} E_y = E$). We will select the remaining network parameters, namely γ , Φ and the set of E_y values, based on the following desirable properties and events. For the convenience of the readers, all the relevant constraints are also summarized in Table 3. Assume that no nodes in $\left(\cup_{i,j} \vec{F}_{i,j}\right) \cup \left(\cup_{i,j} \{\vec{h}_{i,j}\}\right)$ were shocked at $t = 1$.

(I) Suppose that the node v_{top} is shocked at $t = 1$. Then, the following happens.

(I-a) v_{top} fails at $t = 1$:

$$\Phi(b_{v_{\text{top}}} - \iota_{v_{\text{top}}} + E_{v_{\text{top}}}) > \gamma(b_{v_{\text{top}}} + E_{v_{\text{top}}}) \equiv \Phi(n + E_{v_{\text{top}}}) > \gamma(n + E_{v_{\text{top}}}) \equiv \boxed{\Phi > \gamma} \quad (17)$$

(I-b) Each node $\vec{u} \in \vec{V}^{\text{left}} \cup \vec{V}^{\text{right}}$ that was not shocked at $t = 1$ fails at $t = 2$:

$$\begin{aligned} \frac{\min\{\Phi(b_{v_{\text{top}}} - \iota_{v_{\text{top}}} + E_{v_{\text{top}}}) - \gamma(b_{v_{\text{top}}} + E_{v_{\text{top}}}), b_{v_{\text{top}}}\}}{\deg_{\text{in}}(v_{\text{top}})} &> \gamma(b_{\vec{u}} + E_{\vec{u}}) \\ &\equiv \frac{\min\{\Phi(n + E_{v_{\text{top}}}) - \gamma(n + E_{v_{\text{top}}}), n\}}{n} > \gamma(\deg(u) + E_{\vec{u}}) \end{aligned}$$

These constraints are satisfied provided:

$$\frac{\Phi(n + E_{v_{\text{top}}}) - \gamma(n + E_{v_{\text{top}}})}{n} > \gamma(\deg(u) + E_{\vec{u}}) \equiv \boxed{\Phi > \gamma \left(1 + \frac{\deg(u) + E_{\vec{u}}}{1 + \frac{E_{v_{\text{top}}}}{n}}\right)} \quad (18)$$

$$\Phi(n + E_{v_{\text{top}}}) - \gamma(n + E_{v_{\text{top}}}) \leq n \equiv \boxed{\Phi \leq \gamma + \frac{1}{1 + \frac{E_{v_{\text{top}}}}{n}}} \quad (19)$$

(I-c) If the nodes \vec{u} , \vec{v} and $f_{\vec{u}, \vec{v}}$ were *not* shocked at $t = 1$, then the part of the shock, say

$\Phi > \gamma$ (17)	$\Phi > \gamma \left(1 + \frac{\deg(u) + E_{\vec{u}}}{1 + \frac{E_{v_{\text{top}}}}{n}} \right)$ (18)	$\Phi \leq \gamma + \frac{1}{1 + \frac{E_{v_{\text{top}}}}{n}}$ (19)	$\Phi > \gamma \left(1 + \frac{1}{\deg(u) - 1 + E_{\vec{u}}} \right)$ (20)
$\frac{\Phi(\deg(u) - 1 + E_{\vec{u}}) - \gamma(\deg(u) + E_{\vec{u}})}{\deg(u)} + \frac{\Phi(\deg(v) - 1 + E_{\vec{v}}) - \gamma(\deg(v) + E_{\vec{v}})}{\deg(v)} > \gamma \left(1 + E_{f_{\vec{u}, \vec{v}}} \right)$ (21)			
$\Phi \leq \gamma \left(\frac{\deg(u) + E_{\vec{u}}}{\deg(u) - 1 + E_{\vec{u}}} \right) + \frac{\deg(u)}{\deg(u) - 1 + E_{\vec{u}}}$ (22)			
$\frac{\Phi(\deg(u) - 1 + E_{\vec{u}}) - \gamma(\deg(u) + E_{\vec{u}})}{\deg(u)} + \frac{\Phi(\deg(v) - 1 + E_{\vec{v}}) - \gamma(\deg(v) + E_{\vec{v}})}{\deg(v)} - \gamma \left(1 + E_{f_{\vec{u}, \vec{v}}} \right) > \gamma E_{h_{i,j}^{\rightarrow}}$ (23)			
$\gamma E_{h_{i,j}^{\rightarrow}} < 1$ (24)	$\Phi \leq \gamma \left(1 + \frac{1}{E_{\varpi_j}} \right)$ (25)	$\Phi > \frac{\gamma \left(2 + \frac{E_{v_{\text{side}}}}{ F } + E_{\varpi_j} \right)}{\left(1 + \frac{E_{v_{\text{side}}}}{ F } \right)}$ (26)	
$\Phi > \gamma \left(\frac{(F + E_{v_{\text{side}}})}{3 F + F E_{\varpi_j} + F E_{\varpi_j} + E_{v_{\text{side}}}} \right)$ (29)		$\Phi \leq \gamma + \frac{1}{1 + \frac{E_{v_{\text{side}}}}{ F }}$ (27)	$\Phi \leq \gamma \left(1 + \frac{1}{E_{\varpi_j}} \right)$ (28)
$\Phi \leq \gamma \left(1 + \frac{1 + E_{\varpi_j}}{1 + \frac{E_{v_{\text{side}}}}{ F }} \right) + \frac{1}{1 + \frac{E_{v_{\text{side}}}}{ F }}$ (30)		$\Phi \leq \gamma \left(\frac{3 + \frac{E_{v_{\text{side}}}}{ F } + E_{\varpi_j} + E_{\varpi_j}}{1 + \frac{E_{v_{\text{side}}}}{ F }} \right) + \frac{1}{1 + \frac{E_{v_{\text{side}}}}{ F }}$ (32)	
$\Phi > \gamma \left(\frac{6 + \frac{1}{\deg(u)} + \frac{E_{v_{\text{top}}}}{n \deg(u)} + \frac{E_{\vec{u}}}{\deg(u)} + \frac{1}{\deg(v)} + \frac{E_{v_{\text{top}}}}{n \deg(v)} + \frac{E_{\vec{v}}}{\deg(v)} + E_{f_{\vec{u}, \vec{v}}} + \frac{E_{v_{\text{side}}}}{ F } + E_{\varpi_j} + E_{\varpi_j}}{1 + \frac{E_{v_{\text{side}}}}{ F } + \frac{1}{\deg(u)} + \frac{E_{v_{\text{top}}}}{n \deg(u)} + \frac{1}{\deg(v)} + \frac{E_{v_{\text{top}}}}{n \deg(v)}} \right)$ (31)			
$\Phi \leq \gamma \left(\frac{1 + \frac{E_{v_{\text{top}}}}{n} + \deg(u) + E_{\vec{u}}}{1 + \frac{E_{v_{\text{top}}}}{n}} \right) + \frac{\deg(u)}{1 + \frac{E_{v_{\text{top}}}}{n}}$ (33)		$\Phi > \gamma \left(\frac{6 + \frac{E_{v_{\text{side}}}}{ F } + E_{\varpi_j} + E_{\varpi_j} + \frac{E_{v_{\text{top}}}}{n \deg(u)} + \frac{E_{\vec{u}} + 1}{\deg(u)} + \frac{E_{\vec{v}}}{\deg(v)} + E_{f_{\vec{u}, \vec{v}}}}{2 + \frac{E_{v_{\text{side}}}}{ F } + \frac{1}{\deg(u)} + \frac{E_{v_{\text{top}}}}{n \deg(u)} + \frac{E_{\vec{v}} - 1}{\deg(v)}} \right)$ (34)	
$\Phi \leq \gamma \left(\frac{3 + \frac{E_{v_{\text{side}}}}{ F } + E_{\varpi_j} + E_{\varpi_j}}{1 + \frac{E_{v_{\text{side}}}}{ F } - E_{\varpi_j} + E_{\varpi_j}} \right) + \frac{1}{1 + \frac{E_{v_{\text{side}}}}{ F } - E_{\varpi_j} + E_{\varpi_j}}$ (35)			
$\Phi \leq \gamma \left(\frac{6 + \frac{1}{\deg(u)} + \frac{E_{v_{\text{top}}}}{n \deg(u)} + \frac{E_{\vec{u}}}{\deg(u)} + \frac{1}{\deg(v)} + \frac{E_{v_{\text{top}}}}{n \deg(v)} + \frac{E_{\vec{v}}}{\deg(v)} + E_{f_{\vec{u}, \vec{v}}} + \frac{E_{v_{\text{side}}}}{ F } + E_{\varpi_j} + E_{\varpi_j}}{1 + \frac{1}{\deg(u)} + \frac{E_{v_{\text{top}}}}{n \deg(u)} + \frac{1}{\deg(v)} + \frac{E_{v_{\text{top}}}}{n \deg(v)} + \frac{E_{v_{\text{side}}}}{ F } - E_{\varpi_j} + E_{\varpi_j}} \right) + \frac{1}{1 + \frac{1}{\deg(u)} + \frac{E_{v_{\text{top}}}}{n \deg(u)} + \frac{1}{\deg(v)} + \frac{E_{v_{\text{top}}}}{n \deg(v)} + \frac{E_{v_{\text{side}}}}{ F } - E_{\varpi_j} + E_{\varpi_j}}$ (36)			
$\Phi \leq \gamma \left(\frac{6 + \frac{1}{\deg(u)} + \frac{E_{v_{\text{top}}}}{n \deg(u)} + \frac{E_{\vec{u}}}{\deg(u)} + \frac{1}{\deg(v)} + \frac{E_{v_{\text{top}}}}{n \deg(v)} + \frac{E_{\vec{v}}}{\deg(v)} + E_{f_{\vec{u}, \vec{v}}} + \frac{E_{v_{\text{side}}}}{ F } + E_{\varpi_j} + E_{\varpi_j} + \frac{E_{h_{i,j}^{\rightarrow}}}{ F_{i,j} }}{1 + \frac{1}{\deg(u)} + \frac{E_{v_{\text{top}}}}{n \deg(u)} + \frac{1}{\deg(v)} + \frac{E_{v_{\text{top}}}}{n \deg(v)} + \frac{E_{v_{\text{side}}}}{ F } - E_{\varpi_j} + E_{\varpi_j}} \right)$ (37)			
$\Phi \leq \gamma \left(\frac{2 + \frac{E_{v_{\text{side}}}}{ F } + E_{\varpi_j}}{1 + \frac{E_{v_{\text{side}}}}{ F } - E_{\varpi_j}} \right) + \frac{1}{1 + \frac{E_{v_{\text{side}}}}{ F } - E_{\varpi_j}}$ (38)		$\Phi \leq \gamma \left(\frac{2 + \frac{E_{v_{\text{side}}}}{ F } + E_{\varpi_j} + 1 + E_{\varpi_j}}{1 + \frac{E_{v_{\text{side}}}}{ F } - E_{\varpi_j} + E_{\varpi_j}} \right) + \frac{1}{1 + \frac{E_{v_{\text{side}}}}{ F } - E_{\varpi_j} + E_{\varpi_j}}$ (39)	
$\Phi \leq \gamma \left(\frac{6 + \frac{1}{\deg(u)} + \frac{E_{v_{\text{top}}}}{n \deg(u)} + \frac{E_{\vec{u}}}{\deg(u)} + \frac{E_{\vec{v}}}{\deg(v)} + \frac{E_{v_{\text{side}}}}{ F } + E_{\varpi_j} + E_{f_{\vec{u}, \vec{v}}} + E_{\varpi_j} + \frac{\gamma E_{h_{i,j}^{\rightarrow}}}{ F_{i,j} }}{2 + \frac{1}{\deg(u)} + \frac{E_{v_{\text{top}}}}{n \deg(u)} - \frac{1}{\deg(v)} + \frac{E_{\vec{v}}}{\deg(v)} + \frac{E_{v_{\text{side}}}}{ F } - E_{\varpi_j} + E_{\varpi_j}} \right)$ (40)			
$\Phi \leq \gamma \left(\frac{6 + \frac{1}{\deg(u)} + \frac{E_{v_{\text{top}}}}{n \deg(u)} + \frac{E_{\vec{u}}}{\deg(u)} + \frac{E_{\vec{v}}}{\deg(v)} + \frac{E_{v_{\text{side}}}}{ F } + E_{\varpi_j} + E_{f_{\vec{u}, \vec{v}}} + E_{\varpi_j}}{2 + \frac{1}{\deg(u)} + \frac{E_{v_{\text{top}}}}{n \deg(u)} - \frac{1}{\deg(v)} + \frac{E_{\vec{v}}}{\deg(v)} + \frac{E_{v_{\text{side}}}}{ F } - E_{\varpi_j} + E_{\varpi_j}} \right) + \frac{1}{2 + \frac{1}{\deg(u)} + \frac{E_{v_{\text{top}}}}{n \deg(u)} - \frac{1}{\deg(v)} + \frac{E_{\vec{v}}}{\deg(v)} + \frac{E_{v_{\text{side}}}}{ F } - E_{\varpi_j} + E_{\varpi_j}}$ (42)			

Table 3: List of all inequalities to be satisfied in the proof of Theorem 14.1.

σ_1 , given to v_{top} that is received by node $f_{\vec{u}, \vec{v}}$ at $t = 3$ is:

$$\begin{aligned} \sigma_1 &= \frac{\min \left\{ \frac{\min \{ \Phi(b_{v_{\text{top}}} - \iota_{v_{\text{top}}} + E_{v_{\text{top}}}) - \gamma(b_{v_{\text{top}}} + E_{v_{\text{top}}}), b_{v_{\text{top}}} \}}{\deg_{\text{in}}(v_{\text{top}})} - \gamma(b_{\vec{u}} + E_{\vec{u}}), b_{\vec{u}} \right\}}{\deg_{\text{in}}(\vec{u})} \\ &+ \frac{\min \left\{ \frac{\min \{ \Phi(b_{v_{\text{top}}} - \iota_{v_{\text{top}}} + E_{v_{\text{top}}}) - \gamma(b_{v_{\text{top}}} + E_{v_{\text{top}}}), b_{v_{\text{top}}} \}}{\deg_{\text{in}}(v_{\text{top}})} - \gamma(b_{\vec{v}} + E_{\vec{v}}), b_{\vec{v}} \right\}}{\deg_{\text{in}}(\vec{v})} \\ &= \frac{\min \left\{ \frac{\min \{ \Phi(n + E_{v_{\text{top}}}) - \gamma(n + E_{v_{\text{top}}}), n \}}{n} - \gamma(\deg(u) + E_{\vec{u}}), \deg(u) \right\}}{\deg(u)} \\ &+ \frac{\min \left\{ \frac{\min \{ \Phi(n + E_{v_{\text{top}}}) - \gamma(n + E_{v_{\text{top}}}), n \}}{n} - \gamma(\deg(v) + E_{\vec{v}}), \deg(v) \right\}}{\deg(v)} \end{aligned}$$

On the other hand, if the node $f_{\vec{u}, \vec{v}}$ and *exactly* one of the nodes \vec{u} and \vec{v} , say \vec{u} , were *not* shocked at $t = 1$, then the part of the shock, say σ'_1 , given to v_{top} that is received by node $f_{\vec{u}, \vec{v}}$ at $t = 3$ is:

$$\sigma'_1 = \frac{\min \left\{ \frac{\min \{ \Phi(n + E_{v_{\text{top}}}) - \gamma(n + E_{v_{\text{top}}}), n \}}{n} - \gamma(\deg(u) + E_{\vec{u}}), \deg(u) \right\}}{\deg(u)}$$

(II) Suppose that some node \vec{u} is shocked at $t = 1$. Then, the following happens.

(II-a) Node \vec{u} fails at $t = 1$:

$$\Phi(b_{\vec{u}} - \iota_{\vec{u}} + E_{\vec{u}}) > \gamma(b_{\vec{u}} + E_{\vec{u}}) \equiv \boxed{\Phi > \gamma \left(1 + \frac{1}{\deg(u) - 1 + E_{\vec{u}}} \right)} \quad (20)$$

(II-b) Node $f_{\vec{u}, \vec{v}} \in \vec{F}_{i,j}$ fails at $t = 2$ and node $h_{i,j}$ fails at $t = 3$ if both \vec{u} and \vec{v} were shocked at $t = 1$:

$$\begin{aligned} &\frac{\min \{ \Phi(b_{\vec{u}} - \iota_{\vec{u}} + E_{\vec{u}}) - \gamma(b_{\vec{u}} + E_{\vec{u}}), b_{\vec{u}} \}}{\deg_{\text{in}}(\vec{u})} \\ &+ \frac{\min \{ \Phi(b_{\vec{v}} - \iota_{\vec{v}} + E_{\vec{v}}) - \gamma(b_{\vec{v}} + E_{\vec{v}}), b_{\vec{v}} \}}{\deg_{\text{in}}(\vec{v})} > \gamma(b_{f_{\vec{u}, \vec{v}}} + E_{f_{\vec{u}, \vec{v}}}) \\ &\equiv \frac{\min \{ \Phi(\deg(u) - 1 + E_{\vec{u}}) - \gamma(\deg(u) + E_{\vec{u}}), \deg(u) \}}{\deg(u)} \\ &+ \frac{\min \{ \Phi(\deg(v) - 1 + E_{\vec{v}}) - \gamma(\deg(v) + E_{\vec{v}}), \deg(v) \}}{\deg(v)} > \gamma(1 + E_{f_{\vec{u}, \vec{v}}}) \end{aligned}$$

$$\min \left\{ \frac{\min \{ \Phi(b_{\vec{u}} - \iota_{\vec{u}} + E_{\vec{u}}) - \gamma(b_{\vec{u}} + E_{\vec{u}}), b_{\vec{u}} \}}{\deg_{\text{in}}(\vec{u})} + \frac{\min \{ \Phi(b_{\vec{v}} - \iota_{\vec{v}} + E_{\vec{v}}) - \gamma(b_{\vec{v}} + E_{\vec{v}}), b_{\vec{v}} \}}{\deg_{\text{in}}(\vec{v})} - \gamma(b_{f_{\vec{u}, \vec{v}}} + E_{f_{\vec{u}, \vec{v}}}), b_{f_{\vec{u}, \vec{v}}} \right\}$$

$$\deg_{\text{in}}(f_{\vec{u}, \vec{v}})$$

$$> \gamma(b_{h_{i,j}} + E_{h_{i,j}})$$

≡

$$\min \left\{ \frac{\min \{ \Phi(\deg(u) - 1 + E_{\vec{u}}) - \gamma(\deg(u) + E_{\vec{u}}), \deg(u) \}}{\deg(u)} + \frac{\min \{ \Phi(\deg(v) - 1 + E_{\vec{v}}) - \gamma(\deg(v) + E_{\vec{v}}), \deg(v) \}}{\deg(v)} - \gamma(1 + E_{f_{\vec{u}, \vec{v}}}), 1 \right\}$$

$$> \gamma E_{h_{i,j}}^{\rightarrow}$$

These constraints are satisfied provided the inequalities (17)–(20) are satisfied, and the following holds:

$$\boxed{\frac{\Phi(\deg(u) - 1 + E_{\vec{u}}) - \gamma(\deg(u) + E_{\vec{u}})}{\deg(u)} + \frac{\Phi(\deg(v) - 1 + E_{\vec{v}}) - \gamma(\deg(v) + E_{\vec{v}})}{\deg(v)} > \gamma(1 + E_{f_{\vec{u}, \vec{v}}})} \quad (21)$$

$$\Phi(\deg(u) - 1 + E_{\vec{u}}) - \gamma(\deg(u) + E_{\vec{u}}) \leq \deg(u) \equiv \boxed{\Phi \leq \gamma \left(\frac{\deg(u) + E_{\vec{u}}}{\deg(u) - 1 + E_{\vec{u}}} \right) + \frac{\deg(u)}{\deg(u) - 1 + E_{\vec{u}}}} \quad (22)$$

$$\boxed{\frac{\Phi(\deg(u) - 1 + E_{\vec{u}}) - \gamma(\deg(u) + E_{\vec{u}})}{\deg(u)} + \frac{\Phi(\deg(v) - 1 + E_{\vec{v}}) - \gamma(\deg(v) + E_{\vec{v}})}{\deg(v)} - \gamma(1 + E_{f_{\vec{u}, \vec{v}}}) > \gamma E_{h_{i,j}}^{\rightarrow}} \quad (23)$$

$$\boxed{\gamma E_{h_{i,j}}^{\rightarrow} < 1} \quad (24)$$

(III) When the node v_{side} is shocked at $t = 1$, the following happens.

(III-a) v_{side} fails at $t = 1$:

$$\Phi(b_{v_{\text{side}}} - \iota_{v_{\text{side}}} + E_{v_{\text{side}}}) > \gamma(b_{v_{\text{side}}} + E_{v_{\text{side}}}) \equiv \Phi(|F| + E_{v_{\text{side}}}) > \gamma(|F| + E_{v_{\text{side}}}) \equiv \Phi > \gamma$$

which is same as (17).

(III-b) If a node $\varpi_j \in \varpi$ is shocked at $t = 1$, it does not fail:

$$\Phi(b_{\varpi_j} - \iota_{\varpi_j} + E_{\varpi_j}) \leq \gamma(b_{\varpi_j} + E_{\varpi_j}) \equiv \boxed{\Phi \leq \gamma \left(1 + \frac{1}{E_{\varpi_j}} \right)} \quad (25)$$

(III-c) Any node $\varpi_j \in \varpi$ fails at $t = 2$ irrespective of whether ϖ_j was shocked or not:

$$\frac{\min\{\Phi(b_{v_{\text{side}}} - \iota_{v_{\text{side}}} + E_{v_{\text{side}}}) - \gamma(b_{v_{\text{side}}} + E_{v_{\text{side}}}), b_{v_{\text{side}}}\}}{\deg_{\text{in}}(v_{\text{side}})} > \gamma(b_{\varpi_j} + E_{\varpi_j})$$

These constraints are satisfied provided:

$$\frac{\Phi(b_{v_{\text{side}}} - \iota_{v_{\text{side}}} + E_{v_{\text{side}}}) - \gamma(b_{v_{\text{side}}} + E_{v_{\text{side}}})}{\deg_{\text{in}}(v_{\text{side}})} > \gamma(b_{\varpi_j} + E_{\varpi_j}) \equiv \boxed{\Phi > \frac{\gamma\left(2 + \frac{E_{v_{\text{side}}}}{|F|} + E_{\varpi_j}\right)}{\left(1 + \frac{E_{v_{\text{side}}}}{|F|}\right)}} \quad (26)$$

$$\Phi(b_{v_{\text{side}}} - \iota_{v_{\text{side}}} + E_{v_{\text{side}}}) - \gamma(b_{v_{\text{side}}} + E_{v_{\text{side}}}) \leq b_{v_{\text{side}}} \equiv \boxed{\Phi \leq \gamma + \frac{1}{1 + \frac{E_{v_{\text{side}}}}{|F|}}} \quad (27)$$

(III-d) If a node $\varpi_j \in \varpi$ is shocked at $t = 1$, it does not fail (and thus, by **(III-b)**, it does not fail at $t = 2$ also):

$$\Phi(b_{\varpi_j} - \iota_{\varpi_j} + E_{\varpi_j}) \leq \gamma(b_{\varpi_j} + E_{\varpi_j}) \equiv \boxed{\Phi \leq \gamma\left(1 + \frac{1}{E_{\varpi_j}}\right)} \quad (28)$$

(III-e) Any node $\varpi_j \in \varpi$ fails at $t = 3$ irrespective of whether ϖ_j was shocked or not:

$$\frac{\min\left\{\frac{\min\{\Phi(b_{v_{\text{side}}} - \iota_{v_{\text{side}}} + E_{v_{\text{side}}}) - \gamma(b_{v_{\text{side}}} + E_{v_{\text{side}}}), b_{v_{\text{side}}}\}}{\deg_{\text{in}}(v_{\text{side}})} - \gamma(b_{\varpi_j} + E_{\varpi_j}), b_{\varpi_j}\right\}}{\deg_{\text{in}}(\varpi_j)} > \gamma(b_{\varpi_j} + E_{\varpi_j}) \equiv$$

$$\min\left\{\frac{\min\{\Phi(|F| + E_{v_{\text{side}}}) - \gamma(|F| + E_{v_{\text{side}}}), |F|\}}{|F|} - \gamma(1 + E_{\varpi_j}), 1\right\} > \gamma(1 + E_{\varpi_j})$$

These constraints are satisfied provided all the previous constraints hold and the following holds:

$$\frac{\Phi(|F| + E_{v_{\text{side}}}) - \gamma(|F| + E_{v_{\text{side}}})}{|F|} - \gamma(1 + E_{\varpi_j}) > \gamma(1 + E_{\varpi_j}) \equiv \boxed{\Phi > \gamma\left(\frac{(|F| + E_{v_{\text{side}}})}{3|F| + |F|E_{\varpi_j} + |F|E_{\varpi_j} + E_{v_{\text{side}}}}\right)} \quad (29)$$

$$\frac{\Phi(|F| + E_{v_{\text{side}}}) - \gamma(|F| + E_{v_{\text{side}}})}{|F|} - \gamma(1 + E_{\varpi_j}) \leq 1 \equiv \boxed{\Phi \leq \gamma\left(1 + \frac{1 + E_{\varpi_j}}{1 + \frac{E_{v_{\text{side}}}}{|F|}}\right) + \frac{1}{1 + \frac{E_{v_{\text{side}}}}{|F|}}} \quad (30)$$

(III-f) Consider a directed path $(v_{\text{side}}) \leftarrow (\varpi_j) \leftarrow (\varpi_j) \leftarrow (p_j)$ from $p_j = f_{\vec{u}, \vec{v}}$ to v_{side} . The maximum value of its proportion of shock receive by p_j from this path, say σ_2 , is obtained

by shocking all the nodes $v_{\text{side}}, \varpi_j, \varpi_j$ and is given by (assuming all previous inequalities hold):

$$\sigma_2 = \frac{\min \left\{ \frac{\min \left\{ \frac{\Phi(b_{v_{\text{side}}} - \iota_{v_{\text{side}}} + E_{v_{\text{side}}}) - \gamma(b_{v_{\text{side}}} + E_{v_{\text{side}}})}{\deg_{\text{in}}(v_{\text{side}})} - (\gamma(b_{\varpi_j} + E_{\varpi_j}) - \Phi(b_{\varpi_j} - \iota_{\varpi_j} + E_{\varpi_j})), b_{\varpi_j} \right\}}{\deg_{\text{in}}(\varpi_j)} - (\gamma(b_{\varpi_j} + E_{\varpi_j}) - \Phi(b_{\varpi_j} - \iota_{\varpi_j} + E_{\varpi_j})), b_{\varpi_j} \right\}}{\deg_{\text{in}}(\varpi_j)}$$

$$= \min \left\{ \min \left\{ \Phi \left(1 + \frac{E_{v_{\text{side}}}}{|F|} - E_{\varpi_j} \right) - \gamma \left(2 + \frac{E_{v_{\text{side}}}}{|F|} + E_{\varpi_j} \right), 1 \right\} - (\gamma(1 + E_{\varpi_j}) - \Phi E_{\varpi_j}), 1 \right\}$$

Similarly, the minimum value of its proportion of shock receive by p_j from this path, say σ_2 , is obtained by shocking only the node v_{side} and is given by (assuming all previous inequalities hold):

$$\sigma_2' = \frac{\min \left\{ \frac{\Phi(b_{v_{\text{side}}} - \iota_{v_{\text{side}}} + E_{v_{\text{side}}}) - \gamma(b_{v_{\text{side}}} + E_{v_{\text{side}}})}{\deg_{\text{in}}(v_{\text{side}})} - \gamma(b_{\varpi_j} + E_{\varpi_j})}{\deg_{\text{in}}(\varpi_j)} - \gamma(b_{\varpi_j} + E_{\varpi_j}), b_{\varpi_j} \right\}}{\deg_{\text{in}}(\varpi_j)}$$

$$= \min \left\{ \Phi \left(1 + \frac{E_{v_{\text{side}}}}{|F|} \right) - \gamma \left(2 + \frac{E_{v_{\text{side}}}}{|F|} + E_{\varpi_j} \right) - \gamma(1 + E_{\varpi_j}), 1 \right\}$$

We want node $f_{\vec{u}, \vec{v}}$ to fail at $t = 4$ assuming it did not fail already. Since $f_{\vec{u}, \vec{v}}$ did not fail at $t = 2$, at most one of the nodes \vec{u} and \vec{v} was shocked. There are two cases to consider: when neither \vec{u} nor \vec{v} was shocked, or when exactly one of these nodes, say \vec{v} , was shocked (assuming all previous inequalities hold):

$$\sigma_2' + \sigma_1 = \min \left\{ \Phi \left(1 + \frac{E_{v_{\text{side}}}}{|F|} \right) - \gamma \left(2 + \frac{E_{v_{\text{side}}}}{|F|} + E_{\varpi_j} \right) - \gamma(1 + E_{\varpi_j}), 1 \right\}$$

$$+ \frac{\min \left\{ \frac{\min \left\{ \Phi(n + E_{v_{\text{top}}}) - \gamma(n + E_{v_{\text{top}}}), n \right\}}{n} - \gamma(\deg(u) + E_{\vec{u}}), \deg(u) \right\}}{\deg(u)}$$

$$+ \frac{\min \left\{ \frac{\min \left\{ \Phi(n + E_{v_{\text{top}}}) - \gamma(n + E_{v_{\text{top}}}), n \right\}}{n} - \gamma(\deg(v) + E_{\vec{v}}), \deg(v) \right\}}{\deg(v)}$$

$$> \gamma(b_{f_{\vec{u}, \vec{v}}} + E_{f_{\vec{u}, \vec{v}}})$$

≡

$$\min \left\{ \Phi \left(1 + \frac{E_{v_{\text{side}}}}{|F|} \right) - \gamma \left(2 + \frac{E_{v_{\text{side}}}}{|F|} + E_{\varpi_j} \right) - \gamma(1 + E_{\varpi_j}), 1 \right\}$$

$$+ \frac{\min \left\{ \Phi \left(1 + \frac{E_{v_{\text{top}}}}{n} \right) - \gamma \left(1 + \frac{E_{v_{\text{top}}}}{n} \right) - \gamma(\deg(u) + E_{\vec{u}}), \deg(u) \right\}}{\deg(u)}$$

$$\begin{aligned}
& + \frac{\min \left\{ \Phi \left(1 + \frac{E_{v_{\text{top}}}}{n} \right) - \gamma \left(1 + \frac{E_{v_{\text{top}}}}{n} \right) - \gamma (\deg(v) + E_{\vec{v}}), \deg(v) \right\}}{\deg(v)} \\
& > \gamma \left(1 + E_{f_{\vec{u}, \vec{v}}} \right)
\end{aligned}$$

$$\sigma'_2 + \sigma'_1 + \frac{\min \{ \Phi(b_{\vec{v}} - \iota_{\vec{v}} + E_{\vec{v}}) - \gamma(b_{\vec{v}} + E_{\vec{v}}), b_{\vec{v}} \}}{\deg_{\text{in}}(\vec{v})} > \gamma(b_{f_{\vec{u}, \vec{v}}} + E_{f_{\vec{u}, \vec{v}}})$$

≡

$$\begin{aligned}
& \min \left\{ \Phi \left(1 + \frac{E_{v_{\text{side}}}}{|F|} \right) - \gamma \left(2 + \frac{E_{v_{\text{side}}}}{|F|} + E_{\varpi_j} \right) - \gamma(1 + E_{\varpi_j}), 1 \right\} \\
& \min \left\{ \frac{\min \{ \Phi(n + E_{v_{\text{top}}}) - \gamma(n + E_{v_{\text{top}}}), n \}}{n} - \gamma(\deg(u) + E_{\vec{u}}), \deg(u) \right\} \\
& + \frac{\deg(u)}{\deg_{\text{in}}(\vec{v})} \\
& + \frac{\min \{ \Phi(b_{\vec{v}} - \iota_{\vec{v}} + E_{\vec{v}}) - \gamma(b_{\vec{v}} + E_{\vec{v}}), b_{\vec{v}} \}}{\deg_{\text{in}}(\vec{v})} \\
& > \gamma(b_{f_{\vec{u}, \vec{v}}} + E_{f_{\vec{u}, \vec{v}}})
\end{aligned}$$

≡

$$\begin{aligned}
& \min \left\{ \Phi \left(1 + \frac{E_{v_{\text{side}}}}{|F|} \right) - \gamma \left(2 + \frac{E_{v_{\text{side}}}}{|F|} + E_{\varpi_j} \right) - \gamma(1 + E_{\varpi_j}), 1 \right\} \\
& \min \left\{ \Phi \left(1 + \frac{E_{v_{\text{top}}}}{n} \right) - \gamma \left(1 + \frac{E_{v_{\text{top}}}}{n} \right) - \gamma(\deg(u) + E_{\vec{u}}), \deg(u) \right\} \\
& + \frac{\deg(u)}{\deg_{\text{in}}(\vec{v})} \\
& + \frac{\min \{ \Phi(\deg(\vec{v}) - 1 + E_{\vec{v}}) - \gamma(\deg(\vec{v}) + E_{\vec{v}}), \deg(\vec{v}) \}}{\deg_{\text{in}}(\vec{v})} \\
& > \gamma(1 + E_{f_{\vec{u}, \vec{v}}})
\end{aligned}$$

These constraints are satisfied provided all the previous constraints hold and the following holds:

$$\begin{aligned}
& \Phi \left(1 + \frac{E_{v_{\text{side}}}}{|F|} \right) - \gamma \left(2 + \frac{E_{v_{\text{side}}}}{|F|} + E_{\varpi_j} \right) - \gamma(1 + E_{\varpi_j}) \\
& \Phi \left(1 + \frac{E_{v_{\text{top}}}}{n} \right) - \gamma \left(1 + \frac{E_{v_{\text{top}}}}{n} \right) - \gamma(\deg(u) + E_{\vec{u}}) \\
& + \frac{\deg(u)}{\deg_{\text{in}}(\vec{v})} \\
& \Phi \left(1 + \frac{E_{v_{\text{top}}}}{n} \right) - \gamma \left(1 + \frac{E_{v_{\text{top}}}}{n} \right) - \gamma(\deg(v) + E_{\vec{v}}) \\
& + \frac{\deg(v)}{\deg_{\text{in}}(\vec{v})} > \gamma(1 + E_{f_{\vec{u}, \vec{v}}})
\end{aligned}$$

$$\equiv \Phi > \gamma \left(\frac{6 + \frac{1}{\deg(u)} + \frac{E_{v_{\text{top}}}}{n \deg(u)} + \frac{E_{\vec{u}}}{\deg(u)} + \frac{1}{\deg(v)} + \frac{E_{v_{\text{top}}}}{n \deg(v)} + \frac{E_{\vec{v}}}{\deg(v)} + E_{f_{\vec{u}, \vec{v}}} + \frac{E_{v_{\text{side}}}}{|F|} + E_{\varpi_j} + E_{\varrho_j}}{1 + \frac{E_{v_{\text{side}}}}{|F|} + \frac{1}{\deg(u)} + \frac{E_{v_{\text{top}}}}{n \deg(u)} + \frac{1}{\deg(v)} + \frac{E_{v_{\text{top}}}}{n \deg(v)}} \right) \quad (31)$$

$$\Phi \left(1 + \frac{E_{v_{\text{side}}}}{|F|} \right) - \gamma \left(2 + \frac{E_{v_{\text{side}}}}{|F|} + E_{\varpi_j} \right) - \gamma(1 + E_{\varrho_j}) \leq 1 \equiv \Phi \leq \gamma \left(\frac{3 + \frac{E_{v_{\text{side}}}}{|F|} + E_{\varpi_j} + E_{\varrho_j}}{1 + \frac{E_{v_{\text{side}}}}{|F|}} \right) + \frac{1}{1 + \frac{E_{v_{\text{side}}}}{|F|}} \quad (32)$$

$$\Phi \left(1 + \frac{E_{v_{\text{top}}}}{n} \right) - \gamma \left(1 + \frac{E_{v_{\text{top}}}}{n} \right) - \gamma(\deg(u) + E_{\vec{u}}) \leq \deg(u) \equiv \Phi \leq \gamma \left(\frac{1 + \frac{E_{v_{\text{top}}}}{n} + \deg(u) + E_{\vec{u}}}{1 + \frac{E_{v_{\text{top}}}}{n}} \right) + \frac{\deg(u)}{1 + \frac{E_{v_{\text{top}}}}{n}} \quad (33)$$

$$\begin{aligned} & \Phi \left(1 + \frac{E_{v_{\text{side}}}}{|F|} \right) - \gamma \left(2 + \frac{E_{v_{\text{side}}}}{|F|} + E_{\varpi_j} \right) - \gamma(1 + E_{\varrho_j}) + \frac{\Phi \left(1 + \frac{E_{v_{\text{top}}}}{n} \right) - \gamma \left(1 + \frac{E_{v_{\text{top}}}}{n} \right) - \gamma(\deg(u) + E_{\vec{u}})}{\deg(u)} \\ & + \frac{\Phi(\deg(\vec{v}) - 1 + E_{\vec{v}}) - \gamma(\deg(\vec{v}) + E_{\vec{v}})}{\deg_{\text{in}}(\vec{v})} > \gamma \left(1 + E_{f_{\vec{u}, \vec{v}}} \right) \\ & \equiv \\ & \Phi > \gamma \left(\frac{6 + \frac{E_{v_{\text{side}}}}{|F|} + E_{\varpi_j} + E_{\varrho_j} + \frac{E_{v_{\text{top}}}}{n \deg(u)} + \frac{E_{\vec{u}} + 1}{\deg(u)} + \frac{E_{\vec{v}}}{\deg(v)} + E_{f_{\vec{u}, \vec{v}}}}{2 + \frac{E_{v_{\text{side}}}}{|F|} + \frac{1}{\deg(u)} + \frac{E_{v_{\text{top}}}}{n \deg(u)} + \frac{E_{\vec{v}} - 1}{\deg(v)}} \right) \quad (34) \end{aligned}$$

(IV) By (II-b) node $\vec{h}_{i,j}$ fails at $t = 3$ provided both the nodes \vec{u} and \vec{v} were shocked at $t = 1$. Our goal is to make sure that node $\vec{h}_{i,j}$ does not fail in any other condition (assuming the node itself was not shocked). Assuming the nodes \vec{u} , \vec{v} and $f_{\vec{u}, \vec{v}}$ were not shocked, the maximum amount of shock that $f_{\vec{u}, \vec{v}} \in \vec{F}_{i,j}$ can receive is when all the nodes before $f_{\vec{u}, \vec{v}}$ in the path $\overset{v_{\text{side}}}{\circ} \leftarrow \overset{\varpi_j}{\circ} \leftarrow \overset{\varrho_j}{\circ} \leftarrow \overset{\rho_j}{\circ} \leftarrow \overset{f_{\vec{u}, \vec{v}}}{\circ}$ were shocked and no more than one of the nodes \vec{u} or \vec{v} was shocked. Based on this, the following

constraints must hold for $\vec{h}_{i,j}$ not to fail.

$$\begin{aligned}
& \frac{\min \left\{ \sigma_1 + \sigma_2 - \gamma \left(b_{f_{\vec{u}, \vec{v}}} + E_{f_{\vec{u}, \vec{v}}} \right), b_{f_{\vec{u}, \vec{v}}} \right\}}{\deg_{\text{in}}(f_{\vec{u}, \vec{v}})} \leq \frac{\gamma \left(b_{\vec{h}_{i,j}} + E_{\vec{h}_{i,j}} \right)}{|F_{i,j}|} \\
& \equiv \\
& \min \left\{ \frac{\min \left\{ \frac{\min \left\{ \Phi(n + E_{v_{\text{top}}}) - \gamma(n + E_{v_{\text{top}}}), n \right\}}{n} - \gamma(\deg(u) + E_{\vec{u}}), \deg(u) \right\}}{\deg(u)} \right. \\
& \quad \left. + \frac{\min \left\{ \frac{\min \left\{ \Phi(n + E_{v_{\text{top}}}) - \gamma(n + E_{v_{\text{top}}}), n \right\}}{n} - \gamma(\deg(v) + E_{\vec{v}}), \deg(v) \right\}}{\deg(v)} \right. \\
& \quad \left. + \min \left\{ \min \left\{ \Phi \left(1 + \frac{E_{v_{\text{side}}}}{|F|} - E_{\varpi_j} \right) - \gamma \left(2 + \frac{E_{v_{\text{side}}}}{|F|} + E_{\varpi_j} \right), 1 \right\} - (\gamma(1 + E_{\varpi_j}) - \Phi E_{\varpi_j}), 1 \right\} \right. \\
& \quad \left. - \gamma(1 + E_{f_{\vec{u}, \vec{v}}}), 1 \right\} \leq \frac{\gamma E_{\vec{h}_{i,j}}}{|F_{i,j}|} \\
& \equiv \\
& \min \left\{ \Phi \left(\frac{1}{\deg(u)} + \frac{E_{v_{\text{top}}}}{n \deg(u)} + \frac{1}{\deg(v)} + \frac{E_{v_{\text{top}}}}{n \deg(v)} \right) \right. \\
& \quad \left. - \gamma \left(3 + \frac{1}{\deg(u)} + \frac{E_{v_{\text{top}}}}{n \deg(u)} + \frac{E_{\vec{u}}}{\deg(u)} + \frac{1}{\deg(v)} + \frac{E_{v_{\text{top}}}}{n \deg(v)} + \frac{E_{\vec{v}}}{\deg(v)} + E_{f_{\vec{u}, \vec{v}}} \right) \right. \\
& \quad \left. + \min \left\{ \Phi \left(1 + \frac{E_{v_{\text{side}}}}{|F|} - E_{\varpi_j} + E_{\varpi_j} \right) - \gamma \left(3 + \frac{E_{v_{\text{side}}}}{|F|} + E_{\varpi_j} + E_{\varpi_j} \right), 1 \right\}, 1 \right\} \leq \frac{\gamma E_{\vec{h}_{i,j}}}{|F_{i,j}|}
\end{aligned}$$

These constraints are satisfied provided all the previous constraints hold and the following holds:

$$\begin{aligned}
& \Phi \left(1 + \frac{E_{v_{\text{side}}}}{|F|} - E_{\varpi_j} + E_{\varpi_j} \right) - \gamma \left(3 + \frac{E_{v_{\text{side}}}}{|F|} + E_{\varpi_j} + E_{\varpi_j} \right) \leq 1 \\
& \equiv \boxed{\Phi \leq \gamma \left(\frac{3 + \frac{E_{v_{\text{side}}}}{|F|} + E_{\varpi_j} + E_{\varpi_j}}{1 + \frac{E_{v_{\text{side}}}}{|F|} - E_{\varpi_j} + E_{\varpi_j}} \right) + \frac{1}{1 + \frac{E_{v_{\text{side}}}}{|F|} - E_{\varpi_j} + E_{\varpi_j}}} \quad (35)
\end{aligned}$$

$$\Phi \leq \gamma \left(\frac{6 + \frac{1}{\deg(u)} + \frac{E_{v_{\text{top}}}}{n \deg(u)} + \frac{E_{\vec{u}}}{\deg(u)} + \frac{1}{\deg(v)} + \frac{E_{v_{\text{top}}}}{n \deg(v)} + \frac{E_{\vec{v}}}{\deg(v)} + E_{f_{\vec{u}, \vec{v}}} + \frac{E_{v_{\text{side}}}}{|F|} + E_{\varpi_j} + E_{\varpi_j}}{1 + \frac{1}{\deg(u)} + \frac{E_{v_{\text{top}}}}{n \deg(u)} + \frac{1}{\deg(v)} + \frac{E_{v_{\text{top}}}}{n \deg(v)} + \frac{E_{v_{\text{side}}}}{|F|} - E_{\varpi_j} + E_{\varpi_j}} \right) + \frac{1}{1 + \frac{1}{\deg(u)} + \frac{E_{v_{\text{top}}}}{n \deg(u)} + \frac{1}{\deg(v)} + \frac{E_{v_{\text{top}}}}{n \deg(v)} + \frac{E_{v_{\text{side}}}}{|F|} - E_{\varpi_j} + E_{\varpi_j}} \quad (36)$$

$$\Phi \leq \gamma \left(\frac{6 + \frac{1}{\deg(u)} + \frac{E_{v_{\text{top}}}}{n \deg(u)} + \frac{E_{\vec{u}}}{\deg(u)} + \frac{1}{\deg(v)} + \frac{E_{v_{\text{top}}}}{n \deg(v)} + \frac{E_{\vec{v}}}{\deg(v)} + E_{f_{\vec{u}, \vec{v}}} + \frac{E_{v_{\text{side}}}}{|F|} + E_{\varpi_j} + E_{\varpi_j} + \frac{E_{\vec{h}_{i,j}}}{|F_{i,j}|}}{1 + \frac{1}{\deg(u)} + \frac{E_{v_{\text{top}}}}{n \deg(u)} + \frac{1}{\deg(v)} + \frac{E_{v_{\text{top}}}}{n \deg(v)} + \frac{E_{v_{\text{side}}}}{|F|} - E_{\varpi_j} + E_{\varpi_j}} \right) \quad (37)$$

On the other hand, if exactly one of the nodes \vec{u} or \vec{v} , say \vec{u} , was shocked at $t = 1$, then the maximum amount of shock that $f_{\vec{u}, \vec{v}} \in \vec{F}_{i,j}$ can receive is modified, and the new conditions for our desired goal become as follows.

$$\begin{aligned} & \min \left\{ \sigma'_1 + \frac{\min \{ \Phi(b_{\vec{v}} - t_{\vec{v}} + E_{\vec{v}}) - \gamma(b_{\vec{v}} + E_{\vec{v}}), b_{\vec{v}} \}}{\deg_{\text{in}}(\vec{v})} + \sigma_2 - \gamma(b_{f_{\vec{u}, \vec{v}}} + E_{f_{\vec{u}, \vec{v}}}), b_{f_{\vec{u}, \vec{v}}} \right\} \leq \frac{\gamma(b_{\vec{h}_{i,j}} + E_{\vec{h}_{i,j}})}{|F_{i,j}|} \\ & \quad \equiv \\ & \min \left\{ \frac{\min \left\{ \frac{\min \{ \Phi(n + E_{v_{\text{top}}}) - \gamma(n + E_{v_{\text{top}}}), n \}}{n} - \gamma(\deg(u) + E_{\vec{u}}), \deg(u) \right\}}{\deg(u)} \right. \\ & \quad + \frac{\min \{ \Phi(b_{\vec{v}} - t_{\vec{v}} + E_{\vec{v}}) - \gamma(b_{\vec{v}} + E_{\vec{v}}), b_{\vec{v}} \}}{\deg_{\text{in}}(\vec{v})} \\ & \quad + \min \left\{ \min \left\{ \Phi \left(1 + \frac{E_{v_{\text{side}}}}{|F|} - E_{\varpi_j} \right) - \gamma \left(2 + \frac{E_{v_{\text{side}}}}{|F|} + E_{\varpi_j} \right), 1 \right\} - \left(\gamma(1 + E_{\varpi_j}) - \Phi E_{\varpi_j} \right), 1 \right\} \\ & \quad \left. - \gamma(1 + E_{f_{\vec{u}, \vec{v}}}), 1 \right\} \leq \frac{\gamma E_{\vec{h}_{i,j}}}{|F_{i,j}|} \\ & \quad \equiv \\ & \min \left\{ \Phi \left(1 + \frac{1}{\deg(u)} + \frac{E_{v_{\text{top}}}}{n \deg(u)} - \frac{1}{\deg(v)} + \frac{E_{\vec{v}}}{\deg(v)} \right) - \gamma \left(2 + \frac{1}{\deg(u)} + \frac{E_{v_{\text{top}}}}{n \deg(u)} + \frac{E_{\vec{u}}}{\deg(u)} + \frac{E_{\vec{v}}}{\deg(v)} \right) \right. \\ & \quad \left. + \min \left\{ \min \left\{ \Phi \left(1 + \frac{E_{v_{\text{side}}}}{|F|} - E_{\varpi_j} \right) - \gamma \left(2 + \frac{E_{v_{\text{side}}}}{|F|} + E_{\varpi_j} \right), 1 \right\} - \left(\gamma(1 + E_{\varpi_j}) - \Phi E_{\varpi_j} \right), 1 \right\} \right\} \end{aligned}$$

$$\left. -\gamma \left(1 + E_{f_{\vec{u}, \vec{v}}} \right), 1 \right\} \leq \frac{\gamma E_{h_{i,j}}^{\rightarrow}}{|F_{i,j}|}$$

These constraints are satisfied provided all the previous constraints hold and the following holds:

$$\Phi \left(1 + \frac{E_{v_{\text{side}}}}{|F|} - E_{\varpi_j} \right) - \gamma \left(2 + \frac{E_{v_{\text{side}}}}{|F|} + E_{\varpi_j} \right) \leq 1 \equiv \Phi \leq \gamma \left(\frac{2 + \frac{E_{v_{\text{side}}}}{|F|} + E_{\varpi_j}}{1 + \frac{E_{v_{\text{side}}}}{|F|} - E_{\varpi_j}} \right) + \frac{1}{1 + \frac{E_{v_{\text{side}}}}{|F|} - E_{\varpi_j}} \quad (38)$$

$$\begin{aligned} & \Phi \left(1 + \frac{E_{v_{\text{side}}}}{|F|} - E_{\varpi_j} \right) - \gamma \left(2 + \frac{E_{v_{\text{side}}}}{|F|} + E_{\varpi_j} \right) - (\gamma(1 + E_{\varpi_j}) - \Phi E_{\varpi_j}) \leq 1 \\ & \equiv \Phi \leq \gamma \left(\frac{2 + \frac{E_{v_{\text{side}}}}{|F|} + E_{\varpi_j} + 1 + E_{\varpi_j}}{1 + \frac{E_{v_{\text{side}}}}{|F|} - E_{\varpi_j} + E_{\varpi_j}} \right) + \frac{1}{1 + \frac{E_{v_{\text{side}}}}{|F|} - E_{\varpi_j} + E_{\varpi_j}} \quad (39) \end{aligned}$$

$$\begin{aligned} & \Phi \left(1 + \frac{1}{\deg(u)} + \frac{E_{v_{\text{top}}}}{n \deg(u)} - \frac{1}{\deg(v)} + \frac{E_{\vec{v}}}{\deg(v)} \right) - \gamma \left(2 + \frac{1}{\deg(u)} + \frac{E_{v_{\text{top}}}}{n \deg(u)} + \frac{E_{\vec{u}}}{\deg(u)} + \frac{E_{\vec{v}}}{\deg(v)} \right) \\ & + \Phi \left(1 + \frac{E_{v_{\text{side}}}}{|F|} - E_{\varpi_j} \right) - \gamma \left(2 + \frac{E_{v_{\text{side}}}}{|F|} + E_{\varpi_j} \right) - (\gamma(1 + E_{\varpi_j}) - \Phi E_{\varpi_j}) - \gamma \left(1 + E_{f_{\vec{u}, \vec{v}}} \right) \leq \frac{\gamma E_{h_{i,j}}^{\rightarrow}}{|F_{i,j}|} \\ & \equiv \\ & \Phi \leq \gamma \left(\frac{6 + \frac{1}{\deg(u)} + \frac{E_{v_{\text{top}}}}{n \deg(u)} + \frac{E_{\vec{u}}}{\deg(u)} + \frac{E_{\vec{v}}}{\deg(v)} + \frac{E_{v_{\text{side}}}}{|F|} + E_{\varpi_j} + E_{f_{\vec{u}, \vec{v}}} + E_{\varpi_j} + \frac{\gamma E_{h_{i,j}}^{\rightarrow}}{|F_{i,j}|}}{2 + \frac{1}{\deg(u)} + \frac{E_{v_{\text{top}}}}{n \deg(u)} - \frac{1}{\deg(v)} + \frac{E_{\vec{v}}}{\deg(v)} + \frac{E_{v_{\text{side}}}}{|F|} - E_{\varpi_j} + E_{\varpi_j}} \right) \quad (40) \end{aligned}$$

$$\begin{aligned} & \Phi \left(1 + \frac{1}{\deg(u)} + \frac{E_{v_{\text{top}}}}{n \deg(u)} - \frac{1}{\deg(v)} + \frac{E_{\vec{v}}}{\deg(v)} \right) - \gamma \left(2 + \frac{1}{\deg(u)} + \frac{E_{v_{\text{top}}}}{n \deg(u)} + \frac{E_{\vec{u}}}{\deg(u)} + \frac{E_{\vec{v}}}{\deg(v)} \right) \\ & + \Phi \left(1 + \frac{E_{v_{\text{side}}}}{|F|} - E_{\varpi_j} \right) - \gamma \left(2 + \frac{E_{v_{\text{side}}}}{|F|} + E_{\varpi_j} \right) - (\gamma(1 + E_{\varpi_j}) - \Phi E_{\varpi_j}) - \gamma \left(1 + E_{f_{\vec{u}, \vec{v}}} \right) \leq 1 \quad (41) \end{aligned}$$

$$\begin{aligned} & \equiv \Phi \leq \gamma \left(\frac{6 + \frac{1}{\deg(u)} + \frac{E_{v_{\text{top}}}}{n \deg(u)} + \frac{E_{\vec{u}}}{\deg(u)} + \frac{E_{\vec{v}}}{\deg(v)} + \frac{E_{v_{\text{side}}}}{|F|} + E_{\varpi_j} + E_{f_{\vec{u}, \vec{v}}} + E_{\varpi_j}}{2 + \frac{1}{\deg(u)} + \frac{E_{v_{\text{top}}}}{n \deg(u)} - \frac{1}{\deg(v)} + \frac{E_{\vec{v}}}{\deg(v)} + \frac{E_{v_{\text{side}}}}{|F|} - E_{\varpi_j} + E_{\varpi_j}} \right) \\ & + \frac{1}{2 + \frac{1}{\deg(u)} + \frac{E_{v_{\text{top}}}}{n \deg(u)} - \frac{1}{\deg(v)} + \frac{E_{\vec{v}}}{\deg(v)} + \frac{E_{v_{\text{side}}}}{|F|} - E_{\varpi_j} + E_{\varpi_j}} \quad (42) \end{aligned}$$

There are many choices of parameters γ , Φ and E_y 's satisfying inequalities (17)–(26); we exhibit just one:

$$\begin{aligned} \gamma &= 4n^{-1000} & \Phi &= n^{-1000} & \forall u \in V^{\text{left}} \cup V^{\text{right}}: E_{\vec{u}} &= 1 & E_{v_{\text{top}}} &= n^3 & E_{v_{\text{side}}} &= n^2 |F| \\ \forall u \in V^{\text{left}} \forall v \in V^{\text{right}}: E_{f_{\vec{u}, \vec{v}}} &= 1 & \forall h_{i,j} \in F_{\text{super}} \forall f_{u,v} \in F_{i,j}: E_{\vec{h}_{i,j}} &= 1 & \forall j: E_{\varpi_j} &= E_{\omega_j} &= \frac{1}{4} \end{aligned}$$

Remembering that $10 \leq \deg(u) < n$ for any node $u \in V^{\text{left}} \cup V^{\text{right}}$ and $|F_{i,j}| < |F|$, it is relatively straightforward to verify that all the inequalities are satisfied for all sufficiently large n . Note that

$$\begin{aligned} E &= E_{v_{\text{top}}} + E_{v_{\text{side}}} + \sum_{u \in V^{\text{left}} \cup V^{\text{right}}} E_{\vec{u}} + \sum_{\{u,v\} \in F} E_{f_{\vec{u}, \vec{v}}} + \sum_{h_{i,j} \in F_{\text{super}}} E_{\vec{h}_{i,j}} + \sum_{j=1}^{|F|} (E_{\varpi_j} + \sum E_{\omega_j}) \\ &= n^3 + n^2 |F| + n + \frac{3}{2} |F| + |F_{\text{super}}| \end{aligned}$$

and thus the ratio of total external assets to total internal assets E/I is large. We can now finish our proof by selecting δ such that $\log^{1-\delta} n = \log^{1-\varepsilon} |\vec{V}| - 1$ and showing the following:

(completeness) If MINREP has a solution of size $\alpha + \beta$ on G then $\text{Sl}^* \left(\vec{G}, T \right) \leq \alpha + \beta + 2$.

(soundness) If every solution of MINREP on G is of size at least $(\alpha + \beta) 2^{\log^{1-\delta} n}$ then $\text{Sl}^* \left(\vec{G}, T \right) \geq \frac{\alpha + \beta}{2} 2^{\log^{1-\delta} n}$.

Proof of Completeness (MINREP has a solution of size $\alpha + \beta$)

Let $V_1 \subseteq V^{\text{left}}$ and $V_2 \subseteq V^{\text{right}}$ be a solution of MINREP such that $|V_1| + |V_2| = \alpha + \beta$. We shock the nodes v_{top} and v_{side} , and every node \vec{u} for every $u \in V^{\text{left}} \cup V^{\text{right}}$. By **(I-a)** v_{top} fails at $t = 1$, and by **(I-b)** and **(II-a)** every node in $\cup_{i=1}^{\alpha} V_i^{\text{left}} \cup \cup_{j=1}^{\beta} V_j^{\text{right}}$ fails on or before $t = 2$. By **(III-a)**, **(III-b)** and **(III-c)** every node in $\{V_{\text{shock}}\} \cup \varpi \cup \omega$ fails on or before $t = 3$. Since V_1 and V_2 are a valid solution of MINREP, for every super-edge $h_{i,j}$ there exists $u \in V_1$ and $v \in V_2$ such that $u \in V_i^{\text{left}}$, $v \in V_j^{\text{right}}$ and $\{u, v\} \in F$; since we shock the nodes \vec{u} and \vec{v} , by **(II-a)** both \vec{u} and \vec{v} fail at $t = 1$, by **(II-b)** the node $f_{\vec{u}, \vec{v}}$ fails at $t = 2$, and by **(II-c)** the node $\vec{h}_{i,j}$ fails at $t = 3$. Thus, the network \vec{G} fails at $t = 3$ and $\text{Sl}^* \left(\vec{G}, T \right) = \alpha + \beta + 1$ for $t \geq 4$.

Proof of Soundness (every solution of MINREP is of size at least $(\alpha + \beta) 2^{\log^{1-\delta} n}$)

We will prove the logically equivalent contrapositive of our claim, *i.e.*, we will show that if $\text{Sl}^* \left(\vec{G}, T \right) < \frac{\alpha + \beta}{2} 2^{\log^{1-\delta} n}$ then MINREP has a solution of size strictly less than $(\alpha + \beta) 2^{\log^{1-\delta} n}$.

Consider a solution of $\text{STAB}_{T, \Phi}$ on \vec{G} that shocks at most $z = \frac{\alpha + \beta}{2} 2^{\log^{1-\delta} n}$ nodes. Note that the nodes v_{top} and v_{side} must be shocked at $t = 1$ by Proposition 7.1(a). By **(I-a)** and **(III-a)**, the nodes v_{top} and v_{side} fails at $t = 1$, by **(I-b)** and **(III-c)** every node in $\overrightarrow{V^{\text{left}}} \cup \overrightarrow{V^{\text{right}}} \cup \varpi$ fails at $t = 2$, by

(III-e) every node in \mathfrak{m} fails at $t = 3$, by (III-f) every node $f_{\vec{u}, \vec{u}}$ fails at $t = 4$ unless it was shocked at $t = 1$ and by (IV) a node $\vec{h}_{i,j}$ fails only if $\vec{h}_{i,j}, f_{\text{ovru,ovru}} \in \vec{F}_{i,j}$ or both the nodes \vec{u} and \vec{v} were shocked at $t = 1$. We “normalize” this given solution in the following manner (each step of the normalization assumes that the previous steps have been already carried out):

- If a node from $\mathfrak{m} \cup \mathfrak{w}$ was shocked at $t = 1$, we do not shock it. By (III) this has no effect on the failure of the network.
- If a node $f_{\vec{u}, \vec{v}} \in \vec{F}_{i,j}$ was shocked, we do not shock it but instead shock the nodes \vec{u} and \vec{v} if they were not already shocked in the given solution. This at most doubles the number of nodes shocked and, by (II-b), the node $f_{u,v}$ fails at $t = 2$ and the node $\vec{h}_{i,j}$ fails at $t = 3$ if it was not shocked at $t = 1$. Thus, after this sequence of normalization steps, we may assume that no $f_{\vec{u}, \vec{v}}$ node was shocked.
- If a node $\vec{h}_{i,j}$ was shocked at $t = 1$, we do not shock it but instead shock the nodes \vec{u} and \vec{v} (for some u and v such that $\{u, v\} \in F_{i,j}$) if they were not already shocked in the given solution. This at most doubles the number of nodes shocked and, by (II-b), the node $f_{u,v}$ fails at $t = 2$ and the node $\vec{h}_{i,j}$ fails at $t = 3$. Thus, after this sequence of normalization steps, we may assume that no $\vec{h}_{i,j}$ node was shocked.

These normalizations result in a solution of $\text{STAB}_{T,\Phi}$ of size at most $2z$ in which the nodes v_{top} , v_{side} , a subset $\vec{V}_1 \subseteq \vec{V}^{\text{left}}$ and a subset $\vec{V}_2 \subseteq \vec{V}^{\text{right}}$ of nodes. Our solution of MINREP is $V_1 \equiv \{v \mid \vec{v} \in \vec{V}_1\} \subseteq V^{\text{left}}$ and $V_2 = \{v \mid \vec{v} \in \vec{V}_2\} \subseteq V^{\text{right}}$ of size $2z - 2 < 2z$. Since failure of every $\vec{h}_{i,j}$ is attributed to shocking two nodes \vec{u} and \vec{v} such that $f_{\vec{u}, \vec{v}} \in \vec{F}_{i,j}$, every super-edge $h_{i,j}$ of G is witnessed by the two nodes u and v . \square

15 Homogeneous Networks, $\text{DUAL-STAB}_{T,\Phi,\kappa}$, any T , hardness and exact algorithm

Theorem 15.1.

(a) Assuming $\text{P} \neq \text{NP}$, $\text{DSI}^*(G, T, \kappa)$ cannot be approximated within a factor of $(1 - e^{-1} + \delta)^{-1}$, for any $\delta > 0$, even if G is a DAG (e is the base of natural logarithm).

(b) If G is a rooted in-arborescence then $\text{DSI}^*(G, T, \kappa) < 1 + \deg_{\text{in}}^{\text{max}}((\Phi/\gamma) - 1)$, where $\deg_{\text{in}}^{\text{max}} = \max_{v \in V} \{\deg_{\text{in}}(v)\}$ is the maximum in-degree over all nodes of G . Moreover, under the assumption that any individual node of the network can be failed by shocking, $\text{DSI}^*(G, T, \kappa)$ can be computed exactly in $O(n^3)$ time.

Proof.

(a) The max κ -cover problem is defined as follows. An instance of the problem is an universe \mathcal{U} of n elements, a collection of m sets \mathcal{S} over \mathcal{U} , and a positive integer κ . The goal is to pick a sub-collection $\mathcal{S}' \subseteq \mathcal{S}$ of κ sets such that the number of elements covered, namely $|\cup_{S \in \mathcal{S}'} S|$, is maximized. Let OPT denote the maximum number of elements covered by an optimal solution of the max κ -cover problem. It was shown in [22] that, assuming $\text{P} \neq \text{NP}$, the max κ -cover

problem cannot be approximated within a factor of $\frac{1}{(1 - \frac{1}{e} + \delta)}$ for any constant $\delta > 0$. More precisely, [22] provides a polynomial-time reduction for a restricted but still NP-hard version of the Boolean satisfiability problem (3-CNF5) instances of max κ -cover with $\kappa = |\mathcal{U}|^\alpha$, for some constant $0 < \alpha < 1$, and shows that

- (1) if the CNF formula is satisfiable, then $\text{OPT} = |\mathcal{U}|$;
- (2) if the CNF formula is not satisfiable, then $\text{OPT} < \left(1 - \frac{1}{e} + g(\kappa)\right) |\mathcal{U}|$, where $g(\kappa) \rightarrow 0$ as $\kappa \rightarrow \infty$.

Our reduction from max κ -cover to $\text{DUAL-STAB}_{T,\kappa}$ is as follows³. In our graph $G = (V, F)$, we have an element node \tilde{u} for every element $u \in \mathcal{U}$, a set node \tilde{S} for every set $S \in \mathcal{S}$, and directed edges (\tilde{u}, \tilde{S}) for every element $u \in \mathcal{U}$ and set $S \in \mathcal{S}$ such that $u \in S$. Thus, $n = |V| = |\mathcal{U}| + |\mathcal{S}|$ and $|F| = \sum_{S \in \mathcal{S}} |S|$. We now set the remaining parameters as follows: $E = n$, $\gamma = n^{-2}$ and $\Phi = 1$. Now, we observe the following:

- If an element node \tilde{u} is shocked, it does not fail since $\Phi (\deg_{\text{in}}(\tilde{u}) - \deg_{\text{out}}(\tilde{u}) + \frac{E}{n}) \leq 0$ whereas $\gamma (\deg_{\text{in}}(\tilde{u}) + \frac{E}{n}) = n^{-2} > 0$.
- If a set node \tilde{S} is shocked, it fails since $\Phi (\deg_{\text{in}}(\tilde{S}) - \deg_{\text{out}}(\tilde{S}) + \frac{E}{n}) \geq 2$ whereas $\gamma (\deg_{\text{in}}(\tilde{S}) + \frac{E}{n}) \leq \frac{n+1}{n^2} < 1$.
- If a set node \tilde{S} is shocked, then every element node \tilde{u} for $u \in S$ fails at $t = 2$. To observe this, note that

$$\begin{aligned} & \frac{\min \left\{ \Phi (\deg_{\text{in}}(\tilde{S}) - \deg_{\text{out}}(\tilde{S}) + \frac{E}{n}) - \gamma (\deg_{\text{in}}(\tilde{u}) + \frac{E}{n}), \deg_{\text{in}}(\tilde{S}) \right\}}{\deg_{\text{in}}(\tilde{S})} \\ & \geq \frac{2 - \frac{n+1}{n^2}}{n} > \frac{n+1}{n^2} \geq \gamma \left(\deg_{\text{in}}(\tilde{S}) + \frac{E}{n} \right) \end{aligned}$$

- Since the longest directed path in G has one edge, no new nodes fails during $t > 2$.

Based on the above observations, one can identify the sets selected in max k -cover with the set nodes selected for shocking in $\text{DUAL-STAB}_{T,\kappa}$ on G to conclude that $\text{DSI}^*(G, T, \kappa) = \text{OPT} + \kappa$. Thus, using (1) and (2), inapproximability gap is

$$\frac{|\mathcal{U}| + \kappa}{\left(1 - \frac{1}{e} + g(\kappa)\right) |\mathcal{U}| + \kappa} = \frac{|\mathcal{U}| + |\mathcal{U}|^\alpha}{\left(1 - \frac{1}{e} + g(\kappa)\right) |\mathcal{U}| + |\mathcal{U}|^\alpha} \rightarrow \frac{1}{1 - \frac{1}{e} + \delta} \text{ as } |\mathcal{U}| \rightarrow \infty \text{ for any } \delta > 0$$

(b) The bound $\text{DSI}^*(G, T, \kappa) < 1 + \deg_{\text{in}}^{\max} \left(\frac{\Phi}{\gamma} - 1 \right)$ follows directly using Lemma 11.4 and the definition of $\text{DSI}^*(G, T, \kappa)$. To provide a polynomial time algorithm for $\text{DSI}^*(G, T, \kappa)$, we suitably modify the algorithm described in the proof of Theorem 11.1. We redefine $\text{SI}_{\text{SANS}}^*(G, T, u, v)$ and $\text{SI}_{\text{SAS}}^*(G, T, u)$ in the following manner:

³However, this exact construction will not work in the proof of Theorem 8.1 since the entire network needs to fail in that proof.

- For every node $u' \in \nabla(u)$ and every integer $0 \leq k \leq \kappa$, $\text{DSI}_{\text{SANS}}^*(G, T, u, u', k)$ is the number of nodes in an optimal solution of $\text{DUAL-STAB}_{T, \Phi, \kappa}$ (or ∞ if there is no feasible solution of $\text{DUAL-STAB}_{T, \Phi, \kappa}$) for the subgraph induced by the nodes in $\Delta(u)$ assuming the following:
 - u' was shocked,
 - u was not shocked,
 - no node in the path $u' \rightsquigarrow u$ except u' was shocked, and
 - total number of shocked nodes in $\Delta(u)$ is exactly k .
- For every integer $0 \leq k \leq \kappa$, $\text{DSI}_{\text{SAS}}^*(G, T, u, k)$ is the number of nodes in an optimal solution of $\text{DUAL-STAB}_{T, \Phi, \kappa}$ for the subgraph induced by the nodes in $\Delta(u)$ (or ∞ , if there is no feasible solution of $\text{STAB}_{T, \Phi}$ under the stated conditions) assuming that the node u was shocked (and therefore failed), and the number of shocked nodes in $\Delta(u)$ is exactly k .

Computing these quantities becomes slightly more computationally involved as shown below.

Computing $\text{DSI}_{\text{SAS}}^*(G, T, u, k)$ when $\text{deg}_{\text{in}}(u) = 0$:

$$\text{DSI}_{\text{SAS}}^*(G, T, u, 1) = 1 \text{ and } \text{DSI}_{\text{SAS}}^*(G, T, u, k) = -\infty \text{ for any } k \neq 1.$$

Computing $\text{DSI}_{\text{SANS}}^*(G, T, u, u', k)$ when $\text{deg}_{\text{in}}(u) = 0$:

- If $u \in \text{iz}(u')$ then shocking node v makes node u fail. Thus, $\text{SI}_{\text{SANS}}^*(G, T, u, u', 1) = 1$ and $\text{SI}_{\text{SANS}}^*(G, T, u, u', k) = -\infty$ for any $k \neq 1$.
- Otherwise, node u does not fail. Thus, $\text{DSI}_{\text{SANS}}^*(G, T, u, u') = -\infty$.

Computing $\text{DSI}_{\text{SAS}}^*(G, T, u)$ when $\text{deg}_{\text{in}}(u) > 0$: In this case we have

$$\text{DSI}_{\text{SAS}}^*(G, T, u, k) = 1 + \min_{k_1+k_2+\dots+k_{\text{deg}_{\text{in}}(u)}=k-1} \left\{ \sum_{i=1}^k \min \left\{ \text{DSI}_{\text{SAS}}^*(G, T, v_i, k_i), \text{DSI}_{\text{SANS}}^*(G, T, v_i, u, k_i) \right\} \right\}$$

Computing $\text{DSI}_{\text{SANS}}^*(G, T, u, u', k)$ when $\text{deg}_{\text{in}}(u) > 0$: Since u' is shocked and u is not shocked, the following cases arise:

- If $u \notin \text{iz}(u')$ then u does not fail. Then,

$$\text{DSI}_{\text{SANS}}^*(G, T, u, u', k) = \min_{k_1+k_2+\dots+k_{\text{deg}_{\text{in}}(u)}=k} \left\{ \sum_{i=1}^{\text{deg}_{\text{in}}(u)} \min \left\{ \text{DSI}_{\text{SAS}}^*(G, T, v_i, k_i), \text{SI}_{\text{SANS}}^*(G, T, v_i, u', k_i) \right\} \right\}$$

- Otherwise, $u \in \text{iz}(u')$, and therefore u fails when u' is shocked. Then,

$$\text{DSI}_{\text{SANS}}^*(G, T, u, u', k) = 1 + \min_{k_1+k_2+\dots+k_{\text{deg}_{\text{in}}(u)}=k} \left\{ \sum_{i=1}^{\text{deg}_{\text{in}}(u)} \min \left\{ \text{DSI}_{\text{SAS}}^*(G, T, v_i, k_i), \text{DSI}_{\text{SANS}}^*(G, T, v_i, u', k_i) \right\} \right\}$$

It only remains to show how we compute

$$\min_{k_1+k_2+\dots+k_{\deg_{\text{in}}(u)}=F} \left\{ \sum_{i=1}^{\deg_{\text{in}}(u)} \min \left\{ \text{DSI}_{\text{SAS}}^*(G, T, v_i, k_i), \text{DSI}_{\text{SANS}}^*(G, T, v_i, u', k_i) \right\} \right\} \text{ for } F \in \{k-1, k\}$$

in polynomial time. It is easy to cast this problem as an instance of the unbounded integral knapsack problem in the following manner:

- We have $\deg_{\text{in}}(u)$ objects $\mathcal{O}_1, \mathcal{O}_2, \dots, \mathcal{O}_{\deg_{\text{in}}(u)}$, each of *unlimited* supply and *weight* 1.
- The *cost* of selecting k_i objects of the type \mathcal{O}_i is

$$\min \left\{ \text{DSI}_{\text{SAS}}^*(G, T, v_i, k_i), \text{DSI}_{\text{SANS}}^*(G, T, v_i, u', k_i) \right\}$$

- The *goal* is to select a total of *exactly* F objects such that the total cost is *minimum*.

The standard pseudo-polynomial time dynamic programming algorithm for Knapsack can be used to solve the above instance in $O(k \deg_{\text{in}}(u)) = O(n^2)$ time. Thus, the total running time of our algorithm is $O(n^3)$. \square

16 Heterogeneous Networks, DUAL-STAB_{2,Φ,κ}, Stronger Inapproximability

We show that $\text{DSI}^*(G, 2, \kappa)$ cannot be approximated within a large approximation factor provided a complexity-theoretic assumption is satisfied. To understand this assumption, we recall the following definitions from [5].

A random (m, n, d) hyper-graph H is a random hyper-graph of n nodes, m hyper-edges each having exactly d nodes obtained by choosing each hyper-edge independently and uniformly at random. For our purpose, assume that d is a constant, and $m \geq n^c$ for some constant $c > 3$. Let $Q: \{0, 1\}^d \mapsto \{0, 1\}$ denote a d -ary predicate, and let $\mathcal{F}_{Q,m}$ be a distribution over d -local functions from $\{0, 1\}^n$ to $\{0, 1\}^m$ by defining the random d -local function $f_{H,Q}: \{0, 1\}^n \mapsto \{0, 1\}^m$ to be the function whose i^{th} output is computed by applying the predicate Q to the d inputs that are indexed by the i^{th} hyper-edge of H . Finally, the κ densest sub-hypergraph problem (DS_κ) is defined as follows: *given an hyper-graph $G = (V, F)$ with $n = |V|$ and $m = |F|$ such that every hyper-edge contains exactly d nodes and an integer $\kappa > 0$, select a subset $V' \subseteq V$ of exactly κ nodes which maximizes $|\{ \{u_1, u_2, \dots, u_d\} \in F \mid u_1, u_2, \dots, u_d \in V' \}|$.*

The essence of the complexity-theoretic assumption is that if, for a suitable choice of Q , $\mathcal{F}_{Q,m}$ is a collection of one-way functions, then DS_κ is hard to approximate. More precisely, the assumption is:

- (★) If $\mathcal{F}_{Q,m}$ is $1/o(1/\sqrt{n} \log n)$ -pseudorandom, then for $\kappa = n^{1-\frac{c-3}{2d}}$ for some constant $c > 3$ there exists instances $G = (V, F)$ of DS_κ with $m \geq n^c$ such that it is not possible to decide in polynomial time if there is a solution of DS_κ with at least $\frac{(1+o(1))m}{n^{\frac{c-3}{2}(1-\frac{1}{d})}}$ edges (the “yes” instance), or if every solution of DS_κ has at most $\frac{(1-o(1))m}{n^{\frac{c-3}{2}}}$ edges (the “no” instance).

Theorem 16.1. *Under the technical assumption (\star) , $\text{DSI}^*(G, 2, \kappa)$ cannot be approximated within a ratio of n^δ for some constant $\delta > 0$ even if G is a DAG.*

Proof. Given an instance $G = (V, F)$ of DS_κ as stated in (\star) , we construct an instance graph $\vec{G} = (\vec{V}, \vec{F})$ as follows:

- For every node $u \in V$, we have a node $\vec{u} \in \vec{V}$, and for every edge $e = \{u_1, u_2, \dots, u_d\} \in F$, we have a node \vec{e} (also denoted by $\overline{\{u_1, u_2, \dots, u_d\}}$) in \vec{V} . Thus, the total number of nodes of \vec{G} is $|\vec{V}| = m + n$.
- For every hyper-edge $e = (u_1, u_2, \dots, u_d) \in F$, we have d edges $(e, u_1), (e, u_2), \dots, (e, u_d) \in \vec{F}$. We set the weight (share of internal asset) of every edge (e, u_i) to 2. Thus, $|I| = 2dm$.

Let the share of external assets for a node (bank) $\vec{y} \in \vec{V}$ be denoted by $E_{\vec{y}}$ (thus, $\sum_{\vec{y} \in \vec{V}} E_{\vec{y}} = E$). We will select the remaining network parameters as follows. For each $e \in F$, $E_{\vec{e}} = 1.99d$, and for each $u \in V$, $E_{\vec{u}} = 0$. Thus, $E = 1.99dm$. Finally, we set $\Phi = 1$ and $\gamma = 1/2$. We prove the following:

(completeness) If DS_κ has a solution with $\alpha \geq \frac{(1+o(1))m}{n^{\frac{c-3}{2}(1-\frac{1}{d})}}$ hyper-edges then then

$$\text{DSI}^*(\vec{G}, 2, \kappa) \geq \kappa + \alpha.$$

(soundness) If every solution of DS_κ has at most $\beta = \frac{(1-o(1))m}{n^{\frac{c-3}{2}}}$ hyper-edges then

$$\text{DSI}^*(\vec{G}, 2, \kappa) \leq \kappa + \beta.$$

Note that with $c = 5$ (and, thus $m \geq n^5$), and sufficiently large d and n , we have

$$\frac{\kappa + \alpha}{\kappa + \beta} = \frac{n^{1-\frac{c-3}{2d}} + \frac{(1+o(1))m}{n^{\frac{c-3}{2}(1-\frac{1}{d})}}}{n^{1-\frac{c-3}{2d}} + \frac{(1-o(1))m}{n^{\frac{c-3}{2}}}} = \frac{n^{1-\frac{1}{d}} + \frac{(1+o(1))m}{n^{1-\frac{1}{d}}}}{n^{1-\frac{1}{d}} + \frac{(1-o(1))m}{n}} \geq (1-o(1))n^{1/d}$$

which proves the theorem with $\delta = 1/d$.

Proof of Completeness (DS_κ has a solution with α hyper-edges)

Let $V' \subseteq V$ be a solution of DS_κ with at least α hyper-edges. We shock all the nodes in $V_{\text{shock}} = \{\vec{u} \mid u \in V'\}$. Every shocked node \vec{u} fails at $t = 1$ since $\Phi(b_{\vec{u}} - \iota_{\vec{u}} + E_{\vec{u}}) = 2 \deg_{\text{in}}(\vec{u}) > \deg_{\text{in}}(\vec{u}) = \gamma(b_{\vec{u}} + E_{\vec{u}})$. Now, consider a hyper-edge $e = (u_1, u_2, \dots, u_d) \in F$ such that $u_1, u_2, \dots, u_d \in V'$. Then, the node \vec{e} fails at $t = 2$ since

$$\sum_{i=1}^d \frac{\min\{\Phi(b_{\vec{u}_i} - \iota_{\vec{u}_i} + E_{\vec{u}_i}) - \gamma(b_{\vec{u}_i} + E_{\vec{u}_i}), b_{\vec{u}_i}\}}{\deg_{\text{in}}(\vec{u}_i)} = d > 0.995d = \gamma(b_{\vec{e}} + E_{\vec{e}})$$

Proof of Soundness (every solution of DS_κ has at most β hyper-edges)

We will prove the logically equivalent contrapositive of our claim, *i.e.*, we will show that if $DSI^*(\vec{G}, 2, \kappa) > \beta + \kappa$ then DS_κ has a solution of with strictly more than β hyper-edges. First, note that we can assume without loss of generality that, for any hyper-edge $e \in F$, the node \vec{e} is not shocked. Otherwise, if we shock node \vec{e} , then it does not fail since at $t = 1$ since $\Phi(b_{\vec{e}} - t_{\vec{e}} + E_{\vec{e}}) = -0.01d < 0.995d = \gamma(b_{\vec{e}} + E_{\vec{e}})$, and in fact doing so increases its equity to $1.005d$. Since the equity of \vec{e} increased by shocking it, if this node failed in the given solution then it would also fail if it was not shocked. So, we can instead shock a node \vec{u} that was not shocked in the given solution; such a node must exist since $\kappa < n$.

Note that we have already shown in the proof of the completeness part that, for any $e = (u_1, u_2, \dots, u_d) \in F$, if the d nodes $\vec{u}_1, \vec{u}_2, \dots, \vec{u}_d$ are shocked then \vec{e} fails at $t = 2$. Thus, our proof is complete provided we show that such a node \vec{e} does *not* fail at $t = 2$ if *at least* one of the nodes $\vec{u}_1, \vec{u}_2, \dots, \vec{u}_d$ is *not* shocked. Let $S \subset \{\vec{u}_1, \vec{u}_2, \dots, \vec{u}_d\}$ be the set of shocked nodes among these d nodes. Then, \vec{e} does not fail at $t = 2$ since

$$\sum_{u_i \in S} \frac{\min\{\Phi(b_{\vec{u}_i} - t_{\vec{u}_i} + E_{\vec{u}_i}) - \gamma(b_{\vec{u}_i} + E_{\vec{u}_i}), b_{\vec{u}_i}\}}{\deg_{\text{in}}(\vec{u}_i)} \leq d - 1 \leq 0.995d = \gamma(b_{\vec{e}} + E_{\vec{e}})$$

for all sufficiently large d . □

References

- [1] F. Allen and A. Babus. *Networks in Finance*, in *Network-based Strategies and Competencies*, P. Kleindorfer and J. Wind (eds.), 367-382, Wharton School Publishing, 2009.
- [2] F. Allen and D. Gale. *Financial Contagion*, *Journal of Political Economy*, 108 (1), 1-33, 2000.
- [3] P. Alimonti and V. Kann. *Some APX-completeness results for cubic graphs*, *Theoretical Computer Science*, 237 (1-2), 123-134, 2000.
- [4] F. Allen and D. Gale. *Financial contagion*, *Journal of Political Economy*, 108 (1), 1-33, 2001.
- [5] B. Applebaum. *Pseudorandom Generators with Long Stretch and Low locality from Random Local One-Way Functions*, *Electronic Colloquium on Computational Complexity*, Technical Report 11-007, 2011, available from <http://eccc.hpi-web.de/report/2011/007/>.
- [6] A. Babus. *The Formation of Financial Networks*, Tinbergen Institute Discussion Paper No. 2006-093/2; FEEM Working Paper No. 69.2007, 2007, available at <http://ssrn.com/abstract=939754>.
- [7] A. Babus. *Contagion Risk in Financial Networks*, in K. Liebscher (ed.), *Financial Development, Integration and Stability*, 423-440, 2006.
- [8] R. Bar-Yehuda and S. Moran. *On approximation problems related to the independent set and vertex cover problems*, *Discrete Applied Mathematics*, 9, 1-10, 1984.

- [9] P. Berman and M. Karpinski. *On some tighter inapproximability results, Further Improvements*, Electronic Colloquium on Computational Complexity, Technical Report TR98-029, 1998.
- [10] A. Borodin, Y. Filmus and J. Oren. *Threshold models for competitive influence in social networks*, 6th international conference on Internet and network economics, 539-550, 2010.
- [11] F. Castiglionesi and N. Navarro. *Optimal Fragile Financial Networks*, Tilburg University Discussion Paper no. 2007-100. Tilburg, The Netherlands: Tilburg University, 2007, available at <http://ssrn.com/abstract=1089357>.
- [12] N. Chen. *On the approximability of influence in social networks*, 19th annual ACM-SIAM symposium on Discrete algorithms, 1029-1037, 2008.
- [13] W. Chen, Y. Wang and S. Yang. *Efficient influence maximization in social networks*, 15th ACM SIGKDD international conference on Knowledge discovery and data mining, 199-208, 2009.
- [14] F. C. Coelho, O. G Cruz and C. T Codeo *Epigrass: a tool to study disease spread in complex networks*, Source Code for Biology and Medicine, 3 (3), 2008.
- [15] J. Corbo and G. Demange. *Contagion in Financial Networks: A Random Graph Model*, 3rd financial Risks International Forum, Paris, France, 2010.
- [16] B. Dasgupta. *Capital Accumulation in the Presence of Informal Credit Contracts: Does the Incentive Mechanism Work Better than Credit Rationing Under Asymmetric Information?*, Working papers 2004-32, University of Connecticut, Department of Economics, 2004.
- [17] D. W. Diamond and P. H. Dybvig. *Bank runs, deposit insurance and liquidity*, Journal of Political Economy, 91, 401-419, 1983.
- [18] G. Dobson. *Worst-Case Analysis of Greedy Heuristics for Integer Programming with Non-negative Data*, Mathematics of Operations Research, 7 (4), 515-531, 1982.
- [19] M. Eboli. *Systemic Risk in Financial Network: a Graph Theoretical Approach*, Mimeo, Univ. di Chieti, Pescara, 2004.
- [20] S. Eubank. *Network based models of infectious disease spread*, Japanese Journal of Infectious Diseases, 58, S19-S13, 2005.
- [21] S. Eubank, H. Guclu, V. S. A. Kumar, M. V. Marathe, A. Srinivasan, Z. Toroczkai, and N. Wang. *Modeling Disease Outbreaks in Realistic Urban Social Networks*, Nature, 429, 180-183, 2004.
- [22] U. Feige. *A threshold of $\ln n$ for approximating set cover*, Journal of the ACM, 45, 634-652, 1998.
- [23] I. Fisher. *The Debt-Deflation Theory of Great Depressions*, Econometrica, 1, 337-357, 1933.

- [24] X. Freixas, B. M. Parigi and J.-C. Rochet. *Systemic risk, interbank relations, and liquidity provision by the central bank*, Journal of Money, Credit and Banking, 32(3), 611-638, 2000.
- [25] P. Gai and S. Kapadia. *Contagion in financial networks*, Proc. R. Soc. A, 466 (2120), 2401-2423, 2010.
- [26] D. Gale and S. Kariv. *Financial networks*, American Economic Review, 99-103, 2007.
- [27] A. Haldane. *Why Banks Failed the Stress Test*, speech given at the Marcus-Evans Conference on Stress-Testing, 9-10 February 2009, available at <http://www.bankofengland.co.uk/publications/speeches/2009/speech374.pdf>.
- [28] C. Iazzetta and M. Manna. *The Topology of the Interbank Market Developments in Italy Since 1990*, Bank of Italy Temi di Discussione (Working Paper) No. 711, 2009, available at <http://ssrn.com/abstract=1478472>.
- [29] D. Kempe, J. Kleinberg and E. Tardos. *Maximizing the spread of influence through a social network*, 9th ACM SIGKDD international conference on Knowledge discovery and data mining, 137-146, 2003.
- [30] J. M. Keynes. *The General Theory of Employment, Interest, and Money*, New York: Harcourt, Brace and Company, 1936.
- [31] S. Khuller, A. Moss and J. Naor. *The budgeted maximum coverage problem*, Information Processing Letters, 70 (1), 39-45, 1999.
- [32] P. R. Kleindorfer, Y. Wind and R. E. Gunther. *The Network Challenge: Strategy, Profit and Risk in an Interlinked World*, Pearson Prentice Hall, 2009.
- [33] G. Kortsarz, R. Krauthgamer and J. R. Lee. *Hardness of Approximating Vertex-Connectivity Network Design Problems*, SIAM Journal of Computing, 33 (3), 704-720, 2004.
- [34] R. Lagunoff and S. Schreft. *A Model of Financial Fragility*, Journal of Economic Theory, 99 (1-2), 220-264, 2001.
- [35] F. R. Liedorp, L. Medema, M. Koetter, R. H. Koning and I. van Lelyveld. *Peer monitoring or contagion? Interbank market exposure and bank risk*, DNB working paper No. 248, 2010.
- [36] Y. Leitner. *Financial Networks: Contagion, Commitment, and Private Sector Bailouts*, Journal of Finance, 60, 2925-2953, 2005.
- [37] H. Minsky. *A Theory of Systemic Fragility*, in Financial Crises: Institutions and Markets in a Fragile Environment, E. I. Altman & A. W. Sametz (eds.), John Wiley & Sons, 1977.
- [38] E. Nier, J. Yang, T. Yorulmazer and A. Alentorn. *Network models and financial stability*, Journal of Economics Dynamics and Control, 31, 2033-2060, 2007.
- [39] R. Raz. *A parallel repetition theorem*, SIAM Journal of Computing, 27 (3), 763-803, 1998.
- [40] D. Stauffer and A. Aharony. *Introduction to Percolation Theory*, 2nd edition, CRC Press, 1994.