

# GRAPH-COMPLEXES COMPUTING THE RATIONAL HOMOTOPY OF HIGH DIMENSIONAL ANALOGUES OF SPACES OF LONG KNOTS

GREGORY ARONE AND VICTOR TURCHIN

**ABSTRACT.** We continue our investigation of spaces of long embeddings (long embeddings are high-dimensional analogues of long knots). In previous work we showed that when the dimensions are in the stable range, the rational *homology* groups of these spaces can be calculated as the homology of a direct sum of certain finite graph-complexes, which we described explicitly. In this paper, we establish a similar result for the rational *homotopy* groups of these spaces. We also put emphasis on different ways how the calculations can be done. In particular we describe three different graph-complexes computing these rational homotopy groups. We also compute the generating functions of the Euler characteristics of the summands in the homological splitting.

## CONTENTS

1. Introduction	1
2. Graph-complexes	11
3. Rational homotopy of $\overline{\text{Emb}}_c(\mathbb{R}^m, \mathbb{R}^n)$ in small dimensions	19
4. Rational homotopy of $\text{Emb}_c(\mathbb{R}^m, \mathbb{R}^n)$	25
5. Koszul complexes	30
6. Euler characteristics of the double splitting	37
References	42
Appendix A. Tables of Euler characteristics	43

## 1. INTRODUCTION

**1.1. Overview.** In this paper we continue the study of spaces of high-dimensional long knots that we began in [4]. Let  $\text{Emb}_c(\mathbb{R}^m, \mathbb{R}^n)$  be the space of smooth embeddings  $\mathbb{R}^m \hookrightarrow \mathbb{R}^n$  that coincide with a fixed linear embedding  $i: \mathbb{R}^m \hookrightarrow \mathbb{R}^n$  outside a compact subset of  $\mathbb{R}^m$ . For  $m = 1$  this space is usually called the *space of long knots*, and for a general  $m$  we will be calling it the *space of long embeddings*. Let  $\text{Imm}_c(\mathbb{R}^m, \mathbb{R}^n)$  be the analogous space of immersions  $\mathbb{R}^m \looparrowright \mathbb{R}^n$  with the same behavior at infinity. The space  $\text{Emb}_c(\mathbb{R}^m, \mathbb{R}^n)$  is

---

2010 *Mathematics Subject Classification.* Primary: 57R40, 57R42; Secondary: 55P48, 55P62, 18D50.

*Key words and phrases.* Spaces of embeddings, little discs operad, rational homotopy, graph-complexes.

Both authors gratefully acknowledge NSF support via collaborative grant DMS 0967649 and via Midwest Topology Network grant DMS 0844249.

an open subset of  $\text{Imm}_c(\mathbb{R}^m, \mathbb{R}^n)$ ; in case  $n \geq 2m + 1$ , this subset is dense. Denote by  $\overline{\text{Emb}}_c(\mathbb{R}^m, \mathbb{R}^n)$  the homotopy fiber of the inclusion  $\text{Emb}_c(\mathbb{R}^m, \mathbb{R}^n) \hookrightarrow \text{Imm}_c(\mathbb{R}^m, \mathbb{R}^n)$  over the fixed linear embedding  $i$ . The subject of this paper is the rational homotopy type of  $\text{Emb}_c(\mathbb{R}^m, \mathbb{R}^n)$  and  $\overline{\text{Emb}}_c(\mathbb{R}^m, \mathbb{R}^n)$ , when  $n \geq 2m + 2$ .

The case  $m = 1$  (which is the case of usual long knots) has been studied extensively, see [2, 20, 21, 40]. Our goal is to achieve the same level of understanding of the rational homology and homotopy of these spaces in cases  $m > 1$ . Our methods do apply to the case  $m = 1$ , but in this case all our results are known.

Our point of departure is Theorem 0.2 of [4] (first part of Theorem 1.1 below). This theorem describes the rational homology groups  $H_*(\overline{\text{Emb}}_c(\mathbb{R}^m, \mathbb{R}^n), \mathbb{Q})$  as the homology of a “space of derived maps” of certain right  $\Omega$ -modules (right  $\Omega$ -modules are the same thing as right modules over the commutative operad without unit). In Subsection 1.3 we briefly explain how [4, Theorem 0.2] was obtained. Using this theorem in Sections 2 and 5 we define two explicit complexes computing the homology  $H_*(\overline{\text{Emb}}_c(\mathbb{R}^m, \mathbb{R}^n), \mathbb{Q})$ . The complex from Section 2 is obtained by taking a fibrant replacement (in the injective model structure) for the target  $\Omega$ -module and the one from Section 5 is obtained by taking a cofibrant replacement (in the projective model structure) of the source  $\Omega$ -module. Actually the latter complex appeared already in [4]. It is given here for completeness of exposition and also because it is used in computations of the Euler characteristics of the double splitting, see Section 6. We also compare this latter complex with a certain deformation complex of a morphism of operads. In Section 2 we obtain that the rational homotopy  $\mathbb{Q} \otimes \pi_*(\overline{\text{Emb}}_c(\mathbb{R}^m, \mathbb{R}^n))$  can also be described as the homology of a space of derived maps between certain  $\Omega$ -modules. This result is equivalent to saying that the spectral sequence computing  $\mathbb{Q} \otimes \pi_*(\overline{\text{Emb}}_c(\mathbb{R}^m, \mathbb{R}^n))$  and associated with the Goodwillie-Weiss tower collapses at the second term. Similarly we obtain two different complexes computing  $\mathbb{Q} \otimes \pi_*(\overline{\text{Emb}}_c(\mathbb{R}^m, \mathbb{R}^n))$ , see Section 2 and 5. It is quite interesting that all the obtained complexes computing the rational homology and homotopy of  $\overline{\text{Emb}}_c(\mathbb{R}^m, \mathbb{R}^n)$  look very similar to the graph-complexes arising in the Bott-Taubes integration for the space of long knots and their higher dimensional analogues [8, 9, 32, 33, 42]. In the paper we also determine how the rational homotopy type of  $\text{Emb}_c(\mathbb{R}^m, \mathbb{R}^n)$  is related to that of  $\overline{\text{Emb}}_c(\mathbb{R}^m, \mathbb{R}^n)$ , see Section 4.

As it follows from [4, Theorem 0.2] the rational homology  $H_*(\overline{\text{Emb}}_c(\mathbb{R}^m, \mathbb{R}^n), \mathbb{Q})$ ,  $n \geq 2m + 2$ , has a natural double splitting and the terms of the splitting depend only on the parities of  $m$  and  $n$  (but the homological degree in which these terms appear do depend on  $m$  and  $n$ ). In other words up to a certain regrading this homology is the same for spaces  $\overline{\text{Emb}}_c(\mathbb{R}^m, \mathbb{R}^n)$  with  $m$  and  $n$  of the same parities. In particular if we know this splitting in the homology of  $\overline{\text{Emb}}_c(\mathbb{R}^1, \mathbb{R}^n)$ , we can determine the homology of any space  $\overline{\text{Emb}}_c(\mathbb{R}^m, \mathbb{R}^n)$  with  $m$  odd. This *biperiodicity* is quite surprising. Notice it does not hold for the initial spaces of long embeddings  $\text{Emb}_c(\mathbb{R}^m, \mathbb{R}^n)$  since it is false for  $\text{Imm}_c(\mathbb{R}^m, \mathbb{R}^n)$ . In Section 6 we produce generating functions of the Euler characteristics of this splitting. We mention that in the case  $m = 1$  this splitting was earlier considered by the second author in [40]. Our computations are completely analogous. In Appendix we present results of

computer calculations of the Euler characteristics of the splitting in small degrees both for the homology and homotopy.

**1.2. Rational homology and homotopy of  $\overline{\text{Emb}}_c(\mathbb{R}^m, \mathbb{R}^n)$  in terms of maps between  $\Omega$ -modules.** As we mentioned in the previous subsection, our starting point for this paper is [4, Theorem 0.2]. In order to formulate this result we need to evoke some terminology. Let  $\Omega$  be the category of finite (possibly empty) sets with morphisms - surjective mappings. Let  $\Gamma$  be the category of finite pointed sets with morphisms - maps preserving the based point. For a small category  $\mathcal{C}$  we will call a right  $\mathcal{C}$ -module a contravariant functor whose source category is  $\mathcal{C}$ . Similarly a left  $\mathcal{C}$ -module is a covariant functor with source  $\mathcal{C}$ . The target category usually is going to be the category of vector spaces over  $\mathbb{Q}$  or the category of non-negatively graded chain complexes over  $\mathbb{Q}$ . The category of right  $\mathcal{C}$ -modules in  $\mathbb{Q}$ -vector spaces will be denoted  $\text{mod-}\mathcal{C}$ . In [29] Pirashvili constructs a functor

$$\text{cr}: \text{mod-}\Gamma \longrightarrow \text{mod-}\Omega \quad (1.1)$$

which defines an equivalence of categories. The functor  $\text{cr}$  is defined in the following way. Let  $F$  be a right  $\Gamma$ -module. Let  $k$  denote the set  $\{1, 2, \dots, k\}$  and  $k_+$  denote the set  $\{0, 1, 2, \dots, k\}$ , pointed at 0. The component  $\text{cr}F(k)$  is the quotient of  $F(k_+)$  by the images of the maps

$$\alpha_i^*: F((k-1)_+) \rightarrow F(k_+)$$

induced by the maps  $\alpha_i: k_+ \rightarrow (k-1)_+$ ,  $i = 1 \dots k$ , defined as

$$\alpha_i(j) = \begin{cases} j, & j < i; \\ 0, & j = i; \\ j-1, & j > i. \end{cases}$$

The  $\Omega$ -module  $\text{cr}F$  is called *cross-effect* of  $F$ .

For any  $m \geq 1$  we can consider a contravariant functor

$$S^{m\bullet}: \Omega \rightarrow \text{Top}$$

that sends a set  $k$  to the sphere  $S^{mk}$ . On morphisms this functor is defined by means of the diagonal maps (here  $S^{mk}$  is viewed as a one-point compactification of  $\mathbb{R}^{mk} = \underbrace{\mathbb{R}^m \times \dots \times \mathbb{R}^m}_k$ ). Composing with the reduced homology functor produces the graded

right  $\Omega$ -module  $\tilde{H}_*(S^{m\bullet}, \mathbb{Q})$ . It is easy to see that this  $\Omega$ -module is the cross-effect of the  $\Gamma$ -module  $H_*((S^m)^\bullet, \mathbb{Q})$  that assigns to a pointed set  $k_+$  the homology of the space  $(S^m)^k$  of pointed maps  $k_+ \rightarrow S^m$ .

It is not hard to see that for  $n \geq 2$  the assignment

$$k_+ \rightsquigarrow \text{Emb}_*(k_+, S^n),$$

where  $\text{Emb}_*(k_+, S^n)$  is the space of pointed embeddings  $k_+ \hookrightarrow S^n$ , defines a contravariant functor

$$\text{Emb}_*(\bullet, S^n): \Gamma \rightarrow \text{hTop}$$

where  $\mathbf{hTop}$  is the *homotopy* category of topological spaces (whose morphisms are homotopy classes of maps). Notice that  $\mathbf{Emb}_*(k_+, S^n)$  is homeomorphic to the configuration space  $C(k, \mathbb{R}^n)$  of  $k$  labeled points in  $\mathbb{R}^n$ . Composing with the homology functor one gets a right  $\Gamma$ -module (again with trivial differential)  $H_*(\mathbf{Emb}_*(\bullet, S^n), \mathbb{Q})$ . In case  $n \geq 3$  these configuration spaces are simply connected which allows us to define a  $\Gamma$ -module  $\mathbb{Q} \otimes \pi_*(\mathbf{Emb}_*(\bullet, S^n))$ . The cross-effect of these two functors will be denoted by  $\hat{H}_*(C(\bullet, \mathbb{R}^n), \mathbb{Q})$  and  $\mathbb{Q} \otimes \hat{\pi}_*(C(\bullet, \mathbb{R}^n))$  respectively. The corresponding groups are sometimes called the normalized (rational) homology and homotopy of configuration spaces.

The differential non-negatively graded right  $\Omega$ -modules form a category  $\mathbf{Ch}_{\geq 0}(\text{mod-}\Omega)$  with a natural *projective* model structure enriched over chain complexes. In this model structure weak equivalences are quasi-isomorphisms, fibrations are surjective maps in all strictly positive degrees, cofibrations are inclusions with degree-wise projective cokernels. For a pair of  $\Omega$ -modules  $F$  and  $G$ , we will denote by  $\mathbf{hRmod}_{\Omega}(F, G)$  the corresponding derived hom object, which is a chain complex.<sup>1</sup>

**Theorem 1.1.** *For  $n \geq 2m + 2$ , one has natural isomorphisms*

$$(i) \quad H_*(\overline{\mathbf{Emb}}_c(\mathbb{R}^m, \mathbb{R}^n), \mathbb{Q}) \simeq H \left( \mathbf{hRmod}_{\Omega} \left( \tilde{H}_*(S^{m\bullet}, \mathbb{Q}), \hat{H}_*(C(\bullet, \mathbb{R}^n), \mathbb{Q}) \right) \right); \quad (1.2)$$

$$(ii) \quad \mathbb{Q} \otimes \pi_*(\overline{\mathbf{Emb}}_c(\mathbb{R}^m, \mathbb{R}^n)) \simeq H \left( \mathbf{hRmod}_{\Omega} \left( \tilde{H}_*(S^{m\bullet}, \mathbb{Q}), \mathbb{Q} \otimes \hat{\pi}_*(C(\bullet, \mathbb{R}^n)) \right) \right). \quad (1.3)$$

The first part of this theorem is the main result [4, Theorem 0.2] of our previous paper. The second part of this theorem is proved in Section 2. It is a consequence of Theorems 2.1-2.2.

Notice that the source and the target objects in (1.2) and (1.3) have trivial differential. This means that the right-hand sides are just products of certain Ext groups in the abelian category  $\text{mod-}\Omega$  of  $\Omega$ -modules in  $\mathbb{Q}$ -vector spaces.

Another way to understand the theorem above is that it describes the rational homology and homotopy of  $\overline{\mathbf{Emb}}_c(\mathbb{R}^m, \mathbb{R}^n)$  in terms of the higher order Hochschild homology defined by Pirashvili [29].

**1.3. Theorem 1.1 (i).** To make the presentation self-contained we present below the main ideas behind the proof of Theorem 1.1 (i) (a.k.a. [4, Theorem 0.2]). In short this result is a combination of the Goodwillie-Weiss manifold calculus of functors and a result about the relative formality of the little discs operads [22, Theorem 1.4]. By *standard discs* in  $\mathbb{R}^m$  we will understand discs obtained from the unit disc by translations and rescaling. Let  $\tilde{\mathcal{O}}_{\infty}^{st}(\mathbb{R}^m)$  denote the subcategory of open subsets of  $\mathbb{R}^m$  which are finite unions of open *standard discs* union a complement of a closed standard disc (we call it the *anti-disc*). All the discs and the anti-disc are supposed to be disjoint. We will view  $\mathbb{R}^m$  as a subset of  $\mathbb{R}^n$  via inclusion  $i$ . By a *standard embedding* of a subset  $X$  of  $\mathbb{R}^m$  in  $\mathbb{R}^n$  we will understand

<sup>1</sup>One could choose instead to work with the category of unbounded complexes of  $\Omega$ -modules. The theorem below would still be true. But it just takes a little bit more work to define a model structure.

an embedding which is a composition of the inclusion, translation, and rescaling on each connected component of  $X$ . Consider the cofunctor

$$\text{Emb}_c^{st}(\bullet, \mathbb{R}^n): \tilde{\mathcal{O}}_\infty^{st}(\mathbb{R}^m) \rightarrow \text{Top},$$

that assigns to an open set  $U$  the space of standard embeddings  $U \hookrightarrow \mathbb{R}^n$ . It follows from the Goodwillie-Weiss manifold calculus of functors [44], that in the range  $n \geq 2m + 2$  one has a quasi-isomorphism

$$\mathbf{C}_*(\overline{\text{Emb}}_c(\mathbb{R}^m, \mathbb{R}^n)) \simeq \text{holim}_{\tilde{\mathcal{O}}_\infty^{st}(\mathbb{R}^m)} \mathbf{C}_*(\text{Emb}_c^{st}(\bullet, \mathbb{R}^n)),$$

where  $\mathbf{C}_*(-)$  is the functor of singular chains and the homotopy limit is taken in the model category of non-negatively graded chain complexes of abelian groups, see [4, Lemmas 4.4 and 5.1].

Let  $\mathbf{B}_m$  and  $\mathbf{B}_n$  be the operads of little  $m$ -discs and  $n$ -discs respectively. One can define a natural inclusion  $i: \mathbf{B}_m \hookrightarrow \mathbf{B}_n$  induced by the fixed linear inclusion  $i: \mathbb{R}^m \hookrightarrow \mathbb{R}^n$  (we are abusing notation by denoting both inclusions by  $i$ ). It was shown in [22] that the morphism of operads

$$i_*: \mathbf{C}_*^{\mathbb{R}}(\mathbf{B}_m) \rightarrow \mathbf{C}_*^{\mathbb{R}}(\mathbf{B}_n)$$

is a formal map of operads when  $n \geq 2m$ . This means that the morphism of operads  $i_*$  is connected by a zig-zag of quasi-isomorphisms to the morphism  $\mathbf{H}_*(\mathbf{B}_m, \mathbb{R}) \rightarrow \mathbf{H}_*(\mathbf{B}_n, \mathbb{R})$ . Using this result one can show that the functor  $\mathbf{C}_*^{\mathbb{R}}(\text{Emb}_c^{st}(\bullet, \mathbb{R}^n))$  is formal, i.e. quasi-isomorphic to the functor  $\mathbf{H}_*(\text{Emb}_c^{st}(\bullet, \mathbb{R}^n), \mathbb{R})$ . One gets

$$\mathbf{C}_*^{\mathbb{R}}(\overline{\text{Emb}}_c(\mathbb{R}^m, \mathbb{R}^n)) \simeq \text{holim}_{\tilde{\mathcal{O}}_\infty^{st}(\mathbb{R}^m)} \mathbf{H}_*(\text{Emb}_c^{st}(\bullet, \mathbb{R}^n), \mathbb{R}).$$

Over a field any complex is quasi-isomorphic to its homology (viewed as a complex with zero differential). On the other hand, a tensor product of a  $\mathbb{Q}$ -complex with  $\mathbb{R}$  preserves the dimensions of the homology groups, thus the above quasi-isomorphism also (non-naturally) holds over  $\mathbb{Q}$ :

$$\mathbf{C}_*^{\mathbb{Q}}(\overline{\text{Emb}}_c(\mathbb{R}^m, \mathbb{R}^n)) \simeq \text{holim}_{\tilde{\mathcal{O}}_\infty^{st}(\mathbb{R}^m)} \mathbf{H}_*(\text{Emb}_c^{st}(\bullet, \mathbb{R}^n), \mathbb{Q}).$$

We prefer to use the singular chains rather than homology for the left-hand side to stress the fact that the right-hand side in the above quasi-isomorphism is viewed as a complex.

It is easy to see that the functor

$$\mathbf{H}_*(\text{Emb}_c^{st}(\bullet, \mathbb{R}^n), \mathbb{Q}): \tilde{\mathcal{O}}_\infty^{st}(\mathbb{R}^m) \longrightarrow \text{Ch}_{\geq 0}^{\mathbb{Q}}$$

can be factored through the category  $\Gamma$ . Indeed, the above functor is the composition of the functor  $\mathbf{H}_*(\text{Emb}_*(\bullet, S^n), \mathbb{Q})$  considered in Subsection 1.2 and the functor

$$\pi_0: \tilde{\mathcal{O}}_\infty^{st}(\mathbb{R}^m) \longrightarrow \Gamma,$$

that assigns the set of connected components based in the anti-disc. In case  $m = 1$  the anti-disc has two connected components, thus we modify a little bit  $\pi_0$  so that it assigns only one point to an anti-disc.

Intuitively the Goodwillie-Weiss manifold calculus is a machinery that scans a manifold (in our case  $\mathbb{R}^m$  or rather its one-point compactification  $S^m$ ) with finitely many discs, evaluate the functor on these collections of discs, and then extrapolate the functor from these data on the entire manifold. The fact that the functor  $H_*(\text{Emb}_c^{st}(\bullet, \mathbb{R}^n), \mathbb{Q})$  factors through  $\Gamma$  means that instead of scanning our manifold  $S^m$  with finitely many discs we can scan it with finitely many points and extrapolate from there. More precisely in [4] we proved the following:

$$\mathfrak{C}_*^{\mathbb{Q}}(\overline{\text{Emb}}_c(\mathbb{R}^m, \mathbb{R}^n)) \simeq \text{hRmod}_{\Gamma} \left( \mathfrak{C}_*^{\mathbb{Q}}((S^m)^{\bullet}), H_*(\text{Emb}_*(\bullet, S^n), \mathbb{Q}) \right), \quad (1.4)$$

see [4, Proposition 6.3].

It turns out that the  $\Gamma$ -module  $\mathfrak{C}_*^{\mathbb{Q}}((S^m)^{\bullet})$  is formal, see [4, Lemma 6.5]. Thus we can replace  $\mathfrak{C}_*^{\mathbb{Q}}((S^m)^{\bullet})$  in (1.4) by  $H_*((S^m)^{\bullet}, \mathbb{Q})$ .<sup>2</sup> Applying Pirashvili's cross-effect functor (1.1) we obtain exactly the statement of [4, Theorem 0.2]. The reason we use  $\Omega$ -modules instead of  $\Gamma$ -modules is that working with  $\Omega$ -modules considerably reduces computations.

**1.4. Double splitting.** It turns out that in the rational homology and homotopy of  $\overline{\text{Emb}}_c(\mathbb{R}^m, \mathbb{R}^n)$  one can introduce two additional gradings that we consider below. One obviously has

$$\begin{aligned} \tilde{H}_*(S^{m\bullet}, \mathbb{Q}) &= \bigoplus_{s=0}^{+\infty} \tilde{H}_{ms}(S^{m\bullet}); \\ \hat{H}_*(C(\bullet, \mathbb{R}^n), \mathbb{Q}) &= \prod_{t=0}^{+\infty} \hat{H}_{t(n-1)}(C(\bullet, \mathbb{R}^n), \mathbb{Q}); \\ \mathbb{Q} \otimes \hat{\pi}_*(C(\bullet, \mathbb{R}^n)) &= \prod_{t=0}^{+\infty} \mathbb{Q} \otimes \hat{\pi}_{t(n-2)+1}(C(\bullet, \mathbb{R}^n)). \end{aligned}$$

In the above each summand/factor is viewed as a chain complex concentrated in a single homological degree. Obviously in the above the infinite direct sum can be replaced by a direct product and vice versa. We need the sum for the first decomposition and the product for the second and third ones to obtain the following factorizations:

$$\text{hRmod}_{\Omega} \left( \tilde{H}_*(S^{m\bullet}, \mathbb{Q}), \hat{H}_*(C(\bullet, \mathbb{R}^n), \mathbb{Q}) \right) = \prod_{s,t} \text{hRmod}_{\Omega} \left( \tilde{H}_{ms}(S^{m\bullet}, \mathbb{Q}), \hat{H}_{t(n-1)}(C(\bullet, \mathbb{R}^n), \mathbb{Q}) \right); \quad (1.5)$$

$$\text{hRmod}_{\Omega} \left( \tilde{H}_*(S^{m\bullet}, \mathbb{Q}), \mathbb{Q} \otimes \hat{\pi}_*(C(\bullet, \mathbb{R}^n)) \right) = \prod_{s,t} \text{hRmod}_{\Omega} \left( \tilde{H}_{ms}(S^{m\bullet}, \mathbb{Q}), \mathbb{Q} \otimes \hat{\pi}_{t(n-2)+1}(C(\bullet, \mathbb{R}^n)) \right). \quad (1.6)$$

It is not hard to show that when the dimensions are in the stable range, that is when  $n \geq 2m + 2$ , the product in (1.5) can be replaced by a direct sum, see [4]. Again this is

<sup>2</sup>The formality of  $\mathfrak{C}_*^{\mathbb{Q}}((S^m)^{\bullet})$  is in fact the main reason for the Hodge splitting in the higher order Hochschild homology [29] for which our case is a particular example. This splitting (by Hodge degree  $s$ ) is discussed in the next subsection.

equivalent to saying that only finitely many factors are non-trivial in any given homological degree. We show in Section 5 that the same is true for the second equation (1.6). Thus Theorem 1.1 naturally defines a double splitting in the rational homology and homotopy of  $\overline{\text{Emb}}_c(\mathbb{R}^m, \mathbb{R}^n)$ :

$$H_*(\overline{\text{Emb}}_c(\mathbb{R}^m, \mathbb{R}^n), \mathbb{Q}) \cong \bigoplus_{s,t} hR_{\Omega} \text{mod} \left( \tilde{H}_{ms}(S^{m\bullet}, \mathbb{Q}), \hat{H}_{t(n-1)}(C(\bullet, \mathbb{R}^n), \mathbb{Q}) \right); \quad (1.7)$$

$$\mathbb{Q} \otimes \pi_*(\overline{\text{Emb}}_c(\mathbb{R}^m, \mathbb{R}^n)) \cong \bigoplus_{s,t} hR_{\Omega} \text{mod} \left( \tilde{H}_{ms}(S^{m\bullet}, \mathbb{Q}), \mathbb{Q} \otimes \hat{\pi}_{t(n-2)+1}(C(\bullet, \mathbb{R}^n)) \right). \quad (1.8)$$

The additional grading  $t$  will be called *complexity*. It is related with the Vassiliev filtration in the homology by complexity of strata in the discriminant [41]. The grading  $s$  will be called *Hodge degree*. It comes from the Hodge type decomposition in the Hochschild cohomology of a commutative algebra and more generally in the (higher order) homology of  $\Gamma$ -modules [15, 25, 29].

We expect that the bialgebra structure of  $H_*(\overline{\text{Emb}}_c(\mathbb{R}^m, \mathbb{R}^n), \mathbb{Q})$  does not respect this splitting as a bigrading (we know this is false for  $m = 1$ ), but it must respect the splitting as a bifiltration. And the ranks of the terms of the splitting still behave in a way as if the splitting was respected as a bigrading. This follows from the fact that the graph-complex  $\mathcal{E}_H^{m,n}$  computing  $H_*(\overline{\text{Emb}}_c(\mathbb{R}^m, \mathbb{R}^n), \mathbb{Q})$  is naturally a polynomial bialgebra generated by the graph-complex  $\mathcal{E}_\pi^{m,n}$  computing  $\mathbb{Q} \otimes \pi_*(\overline{\text{Emb}}_c(\mathbb{R}^m, \mathbb{R}^n))$ , see Section 2. This fact is used in Lemma A.1.

**1.5. Operads.** In recent years it became clear that manifold calculus is deeply related to the theory of operads [35, 3, 4]. This paper continues this tradition. We will now review briefly some relevant notions about operads. A good introduction to the theory of operads can be found in [26].

**1.5.1. Operads as monoids.** Let  $(\mathcal{C}, \otimes, \mathbb{1})$  be a cocomplete symmetric monoidal category, where  $\otimes$  distributes over colimits, and let  $\mathbb{S}$  be the category of finite sets with morphisms bijective maps. A *right  $\mathbb{S}$ -module* with values in  $\mathcal{C}$  is a contravariant functor  $M: \mathbb{S} \rightarrow \mathcal{C}$ . This functor can be viewed as a sequence of objects  $\{M(n), n \geq 0\}$  with a right action of  $\Sigma_n$  on each  $M(n)$ . We view elements of  $M(n)$  as something that have  $n$  inputs and one output. The symmetric group action permutes the inputs. With a right  $\mathbb{S}$ -module one can assign a *power series functor*  $F_M: \mathcal{C} \rightarrow \mathcal{C}$ , that is a functor of the form

$$F_M(V) = \bigoplus_n M(n) \otimes_{\Sigma_n} V^{\otimes n}.$$

It turns out that a composition of two power series functors is again a power series functor. And we define composition  $M \circ N$  of two  $\mathbb{S}$ -modules  $M$  and  $N$  in such a way that  $F_{M \circ N} = F_M \circ F_N$ . For an explicit definition of  $M \circ N$ , see [26, Chapter 5]. Intuitively elements of  $M \circ N$  are objects of the form:

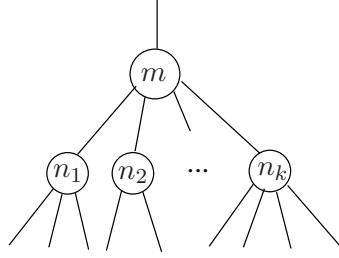

In each input of some element of  $M$  we insert elements of  $N$ . The operation  $\circ$  turns the category of right  $\mathbb{S}$ -modules into a monoidal category with unit  $\text{id}$ :

$$\text{id}(n) = \begin{cases} 0, & n \neq 1; \\ \mathbb{1}, & n = 1, \end{cases}$$

where  $0$  is the initial object of  $\mathcal{C}$ . The symmetric group action is trivial for all components of  $\text{id}$ . An *operad* is a monoid in the category of  $\mathbb{S}$ -modules: it is an  $\mathbb{S}$ -module  $\mathcal{P}$  endowed with morphisms  $\mathcal{P} \circ \mathcal{P} \rightarrow \mathcal{P}$ , and  $\text{id} \rightarrow \mathcal{P}$  which satisfy natural associativity and unit axioms. *Left* and *right modules* over an operad are defined in an expected way.

Let now  $\mathcal{C}$  be the category of chain complexes over  $\mathbb{Q}$ . Let  $\Sigma$  be a suspension functor that shifts a complex in degree by  $+1$ . An *operadic suspension* is an endofunctor of the category of right  $\mathbb{S}$ -modules, that assigns to an  $\mathbb{S}$ -module  $M$  an  $\mathbb{S}$ -module  $M[1]$  defined as

$$M[1](n) = \Sigma^{n-1} M \otimes \text{sign}_n,$$

where  $\text{sign}_n$  is the sign representation of  $\Sigma_n$ . One can view this operation as a suspension of each input and desuspension of the output for every element of  $M$ . One can also define  $M[1]$  as a symmetric sequence such that  $F_{M[1]} = \Sigma^{-1} \circ F_M \circ \Sigma$ . It is easy to see that the operadic suspension respects the monoidal structure:

$$\text{id}[1] = \text{id};$$

$$(M \circ N)[1] = (M[1]) \circ (N[1]).$$

Thus an operadic suspension of an operad is again an operad.

1.5.2. *Operads  $\text{Com}$ ,  $\text{Lie}$ ,  $\text{Assoc}$ ,  $\text{Poiss}$ ,  $\mathbb{B}_n$ ,  $\mathbb{H}_*(\mathbb{B}_n)$ .* The main classical operads we make use of are the operads  $\text{Com}$  of commutative unital algebras,  $\text{Com}_+$  of commutative non-unital algebras,  $\text{Lie}$  of Lie algebras,  $\text{Assoc}$  of associative unital algebras,  $\text{Poiss}$  of Poisson algebras. We will also need the topological operad  $\mathbb{B}_n$  of little  $n$ -discs. The latter operad is central for the manifold calculus of functors. It was shown by F. Cohen [10] that the homology operad  $\mathbb{H}_*(\mathbb{B}_n)$  is the associative operad  $\text{Assoc}$  if  $n = 1$  and is the operad  $\text{Poiss}_{n-1}$  of graded Poisson algebras with a commutative product of degree zero and a Lie bracket of degree  $(n - 1)$  in case  $n \geq 2$ , see also [16, 37]. For  $n \geq 2$ , one has  $\mathbb{H}_0(\mathbb{B}_n)$  is the operad  $\text{Com}$ , and  $\mathbb{H}_{(\bullet-1)(n-1)}(\mathbb{B}_n(\bullet))$  is the operad  $\text{Lie}[n - 1]$  – the  $(n - 1)$ -fold operadic suspension of the operad  $\text{Lie}$ .

Each component  $B_n(k)$  is homotopy equivalent to the configuration space  $C(k, \mathbb{R}^n)$  whose cohomology algebra is generated by the elements  $\alpha_{ij}$ ,  $1 \leq i \neq j \leq k$ , of degree  $(n-1)$ . The relations are

$$\begin{cases} \alpha_{ij} = (-1)^n \alpha_{ji}, & \alpha_{ij}^2 = 0; \\ \alpha_{ij}\alpha_{jk} + \alpha_{jk}\alpha_{ki} + \alpha_{ki}\alpha_{ij} = 0, \end{cases}$$

see [1, 10]. The last relation is often called *Arnol'd relation*. To every monomial of this algebra one can assign a directed graph putting an edge from vertex  $i$  to  $j$  for every factor  $\alpha_{ij}$ . Using the above relations one can show that a monomial is non-zero if and only if the corresponding graph is a forest. Thus  $H^*(B_n(k))$  can be described as a certain space of forests on  $k$  vertices modulo orientation and Arnol'd relations. Notice that the top cohomology group  $H^{(k-1)(n-1)}(B_n(k))$  is the space of trees (forests with exactly one component). They form an  $\mathbb{S}$ -module  $H^{(\bullet-1)(n-1)}(B_n(\bullet))$  which is naturally isomorphic to the cooperad  $co\mathcal{L}ie[n-1]$  dual to the operad  $\mathcal{L}ie[n-1]$ . We refer to [36] where the reader can find how exactly this duality works and how exactly the cooperad structure on  $H^*(B_n(\bullet))$  looks.

1.5.3. *Infinitesimal bimodules.* It is almost straightforward to see that the structure of a right  $\Omega$ -module is equivalent to the structure of a right module over the operad  $Com_+$  of commutative algebras without unit. The structure of a right  $\Gamma$ -module is also intimately related to the commutative operad, more precisely we have seen in [40, 4] that a right  $\Gamma$ -module is the same thing as a *weak bimodule* over  $Com$ . In this paper we adopt the terminology of Merkulov-Vallette-Loday [27, 26] and call them *infinitesimal bimodules*. This term is more appropriate here since we are using this notion only for the abelian category of chain complexes. Let us recall that an *infinitesimal* (or *weak*) bimodule over an operad  $\mathcal{O}$  is a right  $\mathbb{S}$ -module  $M$  endowed with a family of maps:

$$\bar{\circ}_i: \mathcal{O}(n) \otimes M(k) \rightarrow M(n+k-1), \quad i = 1 \dots n, \quad (\text{left action}); \quad (1.9)$$

$$\underline{\circ}_i: M(k) \otimes \mathcal{O}(n) \rightarrow M(k+n-1), \quad i = 1 \dots k, \quad (\text{right action}), \quad (1.10)$$

satisfying natural unity, associativity, and compatibility with the  $\Sigma_n$ -group action conditions, see [27, 40, 4]. Each element of  $\mathcal{O}$  and of  $M$  is viewed as an object with some number of inputs and one output. The composition is obtained by inserting an output in one of the inputs, see Figure 1 below. The result of composition  $\bar{\circ}_i(o, m)$ , and  $\underline{\circ}_i(m, o)$ , for  $o \in \mathcal{O}(n)$ , and  $m \in M(k)$ , will be denoted by  $o \circ_i m$ , and  $m \circ_i o$ .

For example, if  $\mathcal{P}$  is an operad endowed with a morphism  $\mathcal{O} \rightarrow \mathcal{P}$ , then  $\mathcal{P}$  is naturally an infinitesimal bimodule over  $\mathcal{O}$ . Applying this construction to the map

$$H_0(B_n(\bullet), \mathbb{Q}) \rightarrow H_*(B_n(\bullet), \mathbb{Q}), \quad n \geq 2,$$

we obtain that  $H_*(B_n(\bullet), \mathbb{Q})$  is automatically an infinitesimal bimodule over  $Com$ , thus  $H_*(B_n(\bullet), \mathbb{Q})$  is naturally a right  $\Gamma$ -module. One can easily see that this  $\Gamma$ -module is exactly  $H_*(\text{Emb}_*(\bullet, S^n), \mathbb{Q})$  considered in Subsection 1.2. We will use both  $\hat{H}_*(C(\bullet, \mathbb{R}^n), \mathbb{Q})$  and  $\hat{H}_*(B_n(\bullet), \mathbb{Q})$  to denote its cross-effect  $\Omega$ -module. Notice that its dual left  $\Omega$ -module

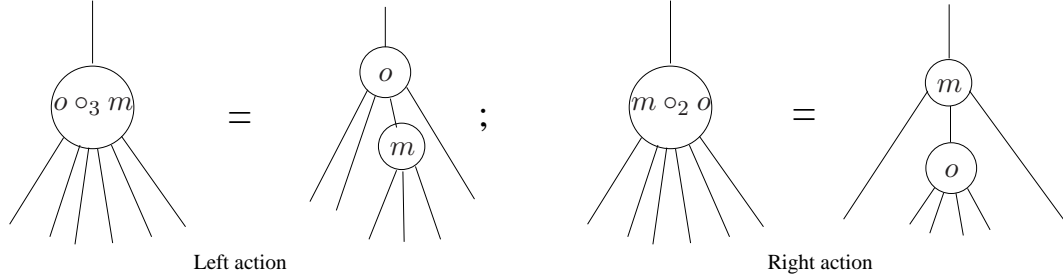

FIGURE 1.

$\hat{H}^*(\mathcal{B}_n(\bullet), \mathbb{Q})$  in degree  $k$  is the subspace of  $H^*(\mathcal{B}_n(k), \mathbb{Q})$  spanned by forests with the property that all connected components have at least two vertices.

**1.6. A section by section outline.** In Section 2 we construct a graph-complex  $\mathcal{E}_H^{m,n}$  computing the rational homology  $H_*(\overline{\text{Emb}}_c(\mathbb{R}^m, \mathbb{R}^n), \mathbb{Q})$ . This construction is obtained by replacing the target  $\Omega$ -module  $\hat{H}_*(C(\bullet, \mathbb{R}^n), \mathbb{Q})$  in (1.2) by a quasi-isomorphic complex of injective  $\Omega$ -modules. Similarly we construct a graph-complex  $\mathcal{E}_\pi^{m,n}$  computing the right-hand side of (1.3). It turns out that  $\mathcal{E}_H^{m,n}$  is a polynomial bialgebra whose subcomplex of primitives is its subcomplex of connected graphs which is exactly  $\mathcal{E}_\pi^{m,n}$ . This immediately implies Theorem 1.1 (ii). In Section 3 we compute the rational homotopy of  $\overline{\text{Emb}}_c(\mathbb{R}^m, \mathbb{R}^n)$  in small dimensions. In Section 4 we compare the rational homotopy of  $\overline{\text{Emb}}_c(\mathbb{R}^m, \mathbb{R}^n)$  with that of  $\text{Emb}_c(\mathbb{R}^m, \mathbb{R}^n)$  assuming as usual  $n \geq 2m + 2$ . By the Smale-Hirsch theorem [17] the space  $\text{Imm}_c(\mathbb{R}^m, \mathbb{R}^n)$ ,  $n \geq 2m$ , is weakly equivalent to the  $m$ -fold loop space  $\Omega^m \text{Inj}(\mathbb{R}^m, \mathbb{R}^n)$ , where  $\text{Inj}(\mathbb{R}^m, \mathbb{R}^n)$  is the Stiefel manifold of isometric linear injections  $\mathbb{R}^m \hookrightarrow \mathbb{R}^n$ . One has a fibration

$$\Omega^{m+1} \text{Inj}(\mathbb{R}^m, \mathbb{R}^n) \xrightarrow{\iota} \overline{\text{Emb}}_c(\mathbb{R}^m, \mathbb{R}^n) \longrightarrow \text{Emb}_c(\mathbb{R}^m, \mathbb{R}^n).$$

Since the rational homotopy of the Stiefel manifold  $\text{Inj}(\mathbb{R}^m, \mathbb{R}^n)$  is finite-dimensional, it follows that up to a finite-dimensional correction the rational homotopy of  $\overline{\text{Emb}}_c(\mathbb{R}^m, \mathbb{R}^n)$  is the same as that of  $\text{Emb}_c(\mathbb{R}^m, \mathbb{R}^n)$ . In Section 4 we determine this correction. It is again quite surprising that the image of the induced map  $\iota_*$  in rational homotopy depends on the parities of  $m$  and  $n$  only.

In Section 5 we construct an explicit cofibrant replacement (in the projective model structure) of the right  $\Omega$ -module  $\tilde{H}_*(S^{m\bullet}, \mathbb{Q})$ . This allows us to construct another type of complexes computing  $H_*(\overline{\text{Emb}}_c(\mathbb{R}^m, \mathbb{R}^n), \mathbb{Q})$  and  $\mathbb{Q} \otimes \pi_*(\overline{\text{Emb}}_c(\mathbb{R}^m, \mathbb{R}^n))$ . The corresponding complexes are denoted  $\mathcal{K}_H^{m,n}$  and  $\mathcal{K}_\pi^{m,n}$ . We are calling them Koszul complexes, since the main ingredient in the construction of the cofibrant replacement is the Koszul duality between the commutative and Lie operads.<sup>3</sup> In Subsection 5.3 we describe the complex  $\text{HH}^{m,n}$  dual to  $\mathcal{K}_H^{m,n}$  as a certain complex of graphs whose edges can have two colors. Its subcomplex  $\text{HH}_\pi^{m,n}$  of connected graphs is our third complex computing  $\mathbb{Q} \otimes \pi_*(\overline{\text{Emb}}_c(\mathbb{R}^m, \mathbb{R}^n))$ . In

<sup>3</sup>This construction can actually be used to compute the Hochschild-Pirashvili homology [29] in any general situation.

Subsection 5.4 we interpret  $\mathcal{K}_H^{m,n}$  as the deformation complex of the morphism of operads

$$H_*(\mathbf{B}_m, \mathbb{Q}) \xrightarrow{i_*} H_*(\mathbf{B}_n, \mathbb{Q}),$$

where  $i: \mathbf{B}_m \hookrightarrow \mathbf{B}_n$  is the inclusion of the operad of little  $m$ -discs into the operad of little  $n$ -discs (induced by our fixed linear embedding  $\mathbb{R}^m \hookrightarrow \mathbb{R}^n$ ). This gives a connection between the homology of a certain deformation complex of a morphism of operads with the homology of the space of long embeddings — a connection earlier conjectured by Kontsevich.

In Section 6 we compute the generating function of the Euler characteristics of the double splitting in  $H_*(\overline{\text{Emb}}_c(\mathbb{R}^m, \mathbb{R}^n), \mathbb{Q})$ . In Appendix we present results of computer calculations of these Euler characteristics in small dimensions for the splitting both in homology and in homotopy.

## 2. GRAPH-COMPLEXES

**2.1. Complexes of uni- $\geq 3$ -valent graphs.** In this section we introduce complexes  $\mathcal{E}_H^{m,n}$ ,  $\mathcal{E}_\pi^{m,n}$  calculating the rational homology and rational homotopy of  $\overline{\text{Emb}}_c(\mathbb{R}^m, \mathbb{R}^n)$ . The starting point for the derivation of the complex  $\mathcal{E}_H^{m,n}$  is Theorem 1.1 (i), which presents  $\mathbb{C}_*^{\mathbb{Q}}(\overline{\text{Emb}}_c(\mathbb{R}^m, \mathbb{R}^n))$  as the derived “space” of maps between right  $\Omega$ -modules  $\tilde{H}_*(S^{m\bullet}, \mathbb{Q})$  and  $\hat{H}_*(\mathbf{B}_n(\bullet); \mathbb{Q})$ . The complex  $\mathcal{E}_H^{m,n}$  will be obtained by taking an injective resolution of  $\hat{H}_*(\mathbf{B}_n(\bullet); \mathbb{Q})$ .

The main attraction of the complex  $\mathcal{E}_H^{m,n}$  is that it will enable us to construct another complex, denoted  $\mathcal{E}_\pi^{m,n}$ , which calculates the rational *homotopy* groups of the space  $\overline{\text{Emb}}_c(\mathbb{R}^m, \mathbb{R}^n)$ . In particular, this will enable us to prove the homotopical part of Theorem 1.1.

The complex  $\mathcal{E}_\pi^{m,n}$  is defined as a *complex of connected uni- $\geq 3$ -valent graphs*. We mention that such graph-complexes appeared earlier in the study of the Hodge decomposition of the homology groups of the space of long knots  $\overline{\text{Emb}}_c(\mathbb{R}, \mathbb{R}^n)$ , see [40, Section 11]. Our Theorem 2.1 below is exactly [40, Conjecture 11.1] from the above reference. The construction of  $\mathcal{E}_\pi^{m,n}$  was inspired by a work of Bar-Natan [5] where he studies the bialgebra of chord diagrams — an object that combinatorially encodes finite type invariants of classical knots in  $\mathbb{R}^3$ . He shows that the space of primitive elements of this bialgebra is naturally isomorphic to a certain *space of uni-trivalent graphs* quotiented out by some orientation and *IHX* relations. One can easily see that this space is precisely the degree zero homology of our complex  $\mathcal{E}_\pi^{1,3}$  that we define below.

Let us define the complex  $\mathcal{E}_\pi^{m,n}$ . It is spanned by abstract connected graphs having a non-empty set of non-labeled *external vertices* of valence 1, and a possibly empty set of non-labeled *internal vertices* of valence  $\geq 3$ . The graphs are allowed to have loops (edges joining a vertex to itself) and multiple edges. For such graph define its *orientation set* as the union of the set of its external vertices (considered as elements of degree  $-m$ ), the set of its internal vertices (considered as elements of degree  $-n$ ), and the set of its edges (considered as elements of degree  $(n-1)$ ). By an *orientation* of a graph we will understand ordering of its orientation set together with an orientation of all its edges. Two such graphs are *equivalent* if there is a bijection between their sets of vertices and edges respecting the

adjacency structure of the graphs, orientation of the edges, and the order of the orientation sets. The space of  $\mathcal{E}_\pi^{m,n}$  is the quotient space of the vector space freely spanned by such graphs modulo the orientation relations:

(1)  $\Upsilon_1 = (-1)^n \Upsilon_2$  if  $\Upsilon_1$  differs from  $\Upsilon_2$  by an orientation of an edge.

(2)  $\Upsilon_1 = \pm \Upsilon_2$ , where  $\Upsilon_2$  is obtained from  $\Upsilon_1$  by a permutation of the orientation set. The sign here is the Koszul sign of permutation taking into account the degrees of the elements.

The differential  $\partial\Upsilon$  of a graph  $\Upsilon \in \mathcal{E}_\pi^{m,n}$  is defined as the sum of expansions of its internal vertices. An expanded vertex is replaced by an edge. The set of edges adjacent to the expanded vertex splits into two sets – one containing the edges that go to one vertex of the new edge and the other set containing the edges that go to the other vertex. An expansion of a vertex of valence  $\ell$  is a sum of  $\frac{2^\ell - 2\ell - 2}{2} = 2^{\ell-1} - \ell - 1$  graphs obtained in such way. One subtracts  $2\ell + 2$  to exclude graphs with internal vertices of valence  $< 3$ , and one divides by 2 because of the symmetry. The orientation set of a new graph is obtained by adding the new vertex and the new edge as the first and second elements to the orientation set, and by orienting the new edge from the old vertex to the new one. There is a freedom which of 2 vertices of the new edge is considered as a new one and which as an old one, but regardless of this choice, the orientation of the boundary graph is the same. All the graphs in the differential appear with positive sign (the sign is hidden in the way we order the orientation set and orient the new edge).

Finally define the graph-complex  $\mathcal{E}_H^{m,n}$  as the free polynomial bialgebra generated by  $\mathcal{E}_\pi^{m,n}$ . In other words  $\mathcal{E}_H^{m,n}$  can be viewed as a graph-complex spanned by possibly empty or disconnected graphs with each connected component from  $\mathcal{E}_\pi^{m,n}$ .

In addition to the total grading (which is the sum of the degrees of the elements in the orientation set of a graph), we define two other gradings: *complexity* — the first Betti number of the graph obtained from initial graph by gluing together all univalent vertices, and *Hodge degree* — the number of external vertices. Notice that the differential preserves both the complexity and the Hodge degree. Section 3 describes  $\mathcal{E}_\pi^{m,n}$  in complexities  $\leq 3$ . We will denote the part of  $\mathcal{E}_H^{m,n}$ ,  $\mathcal{E}_\pi^{m,n}$  concentrated in complexity  $t$  and Hodge degree  $s$  by  $\mathcal{E}_H^{m,n}(s, t)$ ,  $\mathcal{E}_\pi^{m,n}(s, t)$  respectively.

**Theorem 2.1.** *For  $n \geq 2m + 2$ , the homology of the graph-complex  $\mathcal{E}_H^{m,n}$  (respectively  $\mathcal{E}_\pi^{m,n}$ ) is isomorphic to the rational homology (respectively homotopy) of  $\overline{\text{Emb}}_c(\mathbb{R}^m, \mathbb{R}^n)$ :*

$$H(\mathcal{E}_H^{m,n}) \simeq H_*(\overline{\text{Emb}}_c(\mathbb{R}^m, \mathbb{R}^n), \mathbb{Q}); \quad (2.1)$$

$$H(\mathcal{E}_\pi^{m,n}) \simeq \pi_*(\overline{\text{Emb}}_c(\mathbb{R}^m, \mathbb{R}^n)) \otimes \mathbb{Q}. \quad (2.2)$$

It is well-known that the space  $\overline{\text{Emb}}_c(\mathbb{R}^m, \mathbb{R}^n)$ ,  $n \geq 2m + 2$ , is a connected  $(m + 1)$ -loop space [6, 40]. This implies that its rational homology is a graded polynomial bialgebra generated by its rational homotopy groups. As a consequence the statements (2.1) and (2.2) of the previous theorem are equivalent. The statement (2.1) follows from Theorem 1.1 (i) and the statement (2.3) of Theorem 2.2 below.

**Theorem 2.2.** *For  $n \geq 2m + 2$ , one has weak equivalences of chain complexes*

$$\mathcal{E}_H^{m,n} \simeq \text{hRmod}_{\Omega} \left( \tilde{H}_*(S^{m\bullet}, \mathbb{Q}), \hat{H}_*(\mathbb{B}_n(\bullet), \mathbb{Q}) \right). \quad (2.3)$$

$$\mathcal{E}_{\pi}^{m,n} \simeq \text{hRmod}_{\Omega} \left( \tilde{H}_*(S^{m\bullet}, \mathbb{Q}), \hat{\pi}_*(\mathbb{B}_n(\bullet)) \otimes \mathbb{Q} \right), \quad (2.4)$$

Moreover the above isomorphisms preserve both the complexity and the Hodge degree, which means

$$\mathcal{E}_H^{m,n}(s, t) \simeq \text{hRmod}_{\Omega} \left( \tilde{H}_{ms}(S^{m\bullet}), \hat{H}_{(n-1)t}(\mathbb{B}_n(\bullet), \mathbb{Q}) \right). \quad (2.5)$$

$$\mathcal{E}_{\pi}^{m,n}(s, t) \simeq \text{hRmod}_{\Omega} \left( \tilde{H}_{ms}(S^{m\bullet}), \hat{\pi}_{1+(n-2)t}(\mathbb{B}_n(\bullet)) \otimes \mathbb{Q} \right), \quad (2.6)$$

This theorem will be proved in Subsection 2.1.2. The idea of the proof is to replace the right  $\Omega$ -modules  $\hat{\pi}_*(\mathbb{B}_n(\bullet)) \otimes \mathbb{Q}$  and  $\hat{H}_*(\mathbb{B}_n(\bullet), \mathbb{Q})$  by quasi-isomorphic differential graded right  $\Omega$ -modules  $\hat{P}_n^{\bullet}, \hat{D}_n^{\bullet}$ , which happen to be injective in each homological degree. All their components  $\hat{P}_n^k, \hat{D}_n^k, k \geq 0$ , are certain graph-complexes, see Subsections 2.1.1-2.1.2.

Notice that the second statement of Theorem 2.1 together with the statement (2.4) of Theorem 2.2 imply Theorem 1.1 (ii).

2.1.1. *Right  $\Gamma$ -modules  $D_n^{\bullet}, P_n^{\bullet}$ .* The right  $\Gamma$ -modules that we define in this section were introduced in [40]. The  $k$ -th component  $D_n^k$  is a vector space spanned by the graphs with  $k$  external vertices labeled by  $1, 2, \dots, k$ , and a bunch of non-labeled internal vertices. The external vertex can have any valence (including zero), the internal vertices are of valence  $\geq 3$ . The graphs are allowed to be disconnected, but each connected component of a graph should have at least one external vertex. The graphs can have loops and multiple edges. *Orientation set* of such graph consists of the set of its internal vertices (having degree  $-n$ ), and edges (having degree  $(n-1)$ ). By an *orientation* of a graph we understand an ordering of its orientation set and a choice of orientation made for each one of its edges. Two graphs are equivalent if there is a bijection between their sets of internal vertices and edges respecting the adjacency structure of the graphs, orientation of the edges, and the order of their orientation sets. The orientation relations are the same as in Subsection 2.1. The differential is the sum of expansions of vertices. An expansion of an external vertex produces one external vertex with the same label and one internal one. An expansion of external vertices of valence  $\ell$  is a sum of  $2^{\ell} - \ell - 1$  graphs. We excluded  $\ell + 1$  cases to make sure that the new internal vertex has valence  $\geq 3$ . The sequence of differential graded vector spaces  $D_n^k, k \geq 0$ , forms an operad. The composition  $\Upsilon_1 \circ_i \Upsilon_2$  of two graphs is defined as insertion of  $\Upsilon_2$  into the  $i$ -th vertex of  $\Upsilon_1$ , see Figure 2. The orientation set of each graph in the sum is obtained by concatenation of the orientation set of  $\Upsilon_1$  and that of  $\Upsilon_2$ . With this definition all signs are positive in this figure.

Recall that  $\{H_*(\mathbb{B}_n(\bullet), \mathbb{Q})\}$  is the homology operad of  $n$ -dimensional little cubes. This homology operad is the operad of  $(n-1)$ -Poisson algebras, i.e. operad of graded Poisson algebras with a commutative product of degree zero and a Lie bracket of degree  $(n-1)$ .

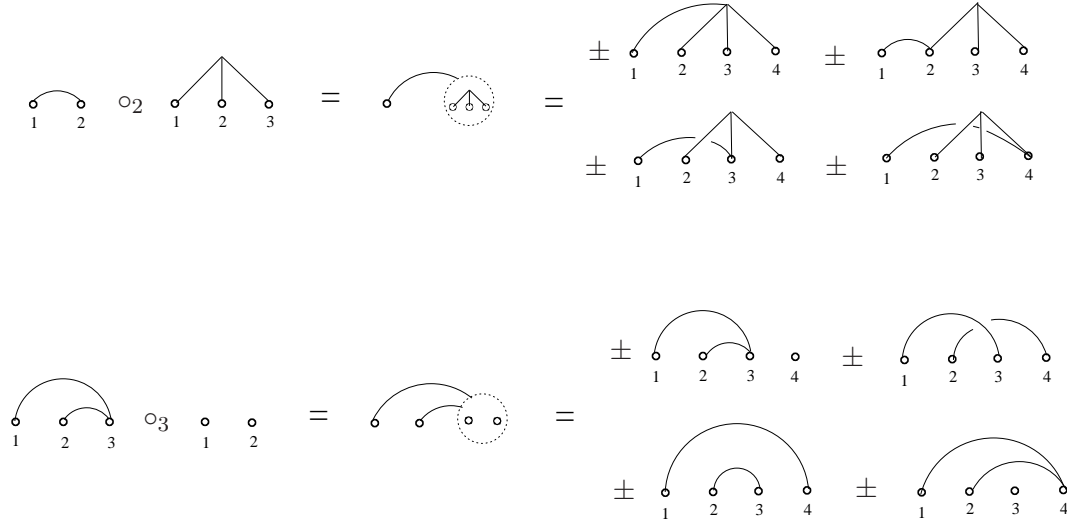

FIGURE 2. Examples of composition

**Proposition 2.3** ([22, 20, 40]). *For  $n \geq 2$ , the assignment*

$$x_1x_2 \mapsto \begin{array}{c} \bullet \\ \downarrow \\ \begin{array}{cc} \bullet & \bullet \\ \hline \end{array} \end{array}, \quad [x_1, x_2] \mapsto \begin{array}{c} \bullet \\ \downarrow \\ \begin{array}{cc} \bullet & \bullet \\ \hline \end{array} \end{array},$$

where  $x_1x_2, [x_1, x_2] \in H_*(\mathcal{B}_n(2), \mathbb{Q})$  are the product and the bracket of the operad of  $(n-1)$ -Poisson algebras, defines an inclusion of operads

$$H_*(\mathcal{B}_n(\bullet); \mathbb{Q}) \hookrightarrow D_n^\bullet \tag{2.7}$$

that turns out to be a quasi-isomorphism ( $H_*(\mathcal{B}_n(\bullet), \mathbb{Q})$  is considered to have a zero differential).

The operad  $D_n^\bullet$  is an operad in the category of differential graded cocommutative coalgebras. The coproduct in each component is given by cosuperimposing, see Figure 3.

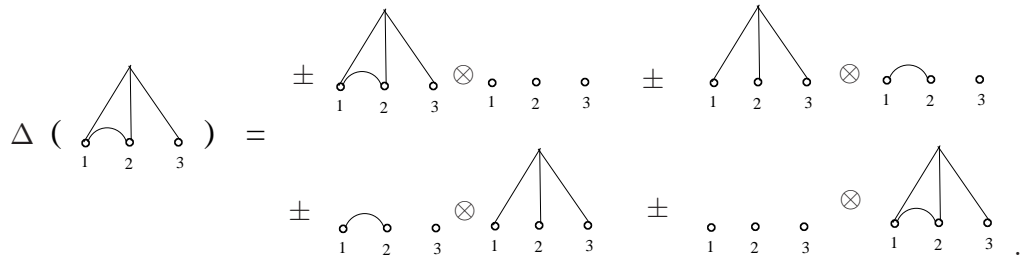

FIGURE 3. Example of a coproduct in  $D_n^3$

In general for a graph  $\Gamma \in D_n^k$  its coproduct  $\Delta(\Gamma) \in D_n^k \otimes D_n^k$  is a sum of  $2^c$  summands, where  $c$  is the number of the connected components of the graph obtained from  $\Gamma$  by removing its labeled vertices together with their small vicinities. For the graph from the above figure  $c = 2$ . Its first connected component corresponds to the edge 12, the second connected component corresponds to the subgraph consisting of the only internal vertex and its 3 adjacent edges. The counit is defined as 1 on the trivial diagram without edges and internal vertices and as 0 on all the others. The morphism (2.7) is a morphism of operads in coalgebras. Due to this morphism,  $D_n^\bullet$  is an infinitesimal bimodule over  $H_*(\mathbf{B}_n(\bullet), \mathbb{Q})$  and therefore over  $H_0(\mathbf{B}_n(\bullet), \mathbb{Q}) = \mathcal{C}om$  as well, see Subsection 1.5.3. Thus  $D_n^\bullet$  is a right  $\Gamma$ -module. Explicitly  $\mathcal{C}om$  in  $D_n^\bullet$  is spanned by the diagrams without edges (and without internal vertices). The infinitesimal left  $\mathcal{C}om$  action adds isolated label vertices. The infinitesimal right action is given by insertion of the product as in the lower part of Figure 2. It is easy to see that the  $\Gamma$  structure maps respect the coalgebra structure, therefore  $D_n^\bullet$  is a right  $\Gamma$ -module in the category of coalgebras.

Let  $P_n^k$  denote the primitive part of  $D_n^k$ . The space  $P_n^k$  is spanned by the graphs with  $k$  labeled external vertices that become connected if one removes all the external vertices together with their small vicinities. The family of spaces  $P_n^\bullet = \{P_n^k, k \geq 0\}$  is preserved by the  $\Gamma$  structure maps, simply because these maps respect the coalgebra structure of  $D_n^k, k \geq 0$ .

**Proposition 2.4** ([40, 34]). *For  $n \geq 3$ , the right  $\Gamma$ -modules  $\pi_*(\mathbf{B}_n(\bullet)) \otimes \mathbb{Q}$  and  $P_n^\bullet$  are quasi-isomorphic (by a zigzag of quasi-isomorphisms), where  $\pi_*(\mathbf{B}_n(\bullet)) \otimes \mathbb{Q}$  is considered to have a zero differential.*

For each  $\bullet = k$ , the morphism (2.7) is a quasi-isomorphism of differential graded commutative coalgebras. The configuration spaces  $\mathbf{B}_n(k)$  are known to be formal, thus the dual of  $D_n^k$  is a rational model for  $\mathbf{B}_n(k)$ . On the other hand the coalgebras  $D_n^k$  are quasi-cofree with the space of cogenerators  $P_n^k$ . This explains why the homology of  $P_n^k$  is  $\mathbb{Q} \otimes \pi_* \mathbf{B}_n(k)$ . The precise zigzag of quasi-isomorphisms is given in the proof of [20, Theorem 9.3], see also [40, Proposition 9.5]. The same construction was independently discovered and described in [34, Section 3].

*Remark 2.5.* One can easily see that this zigzag respects the *complexity*  $t$ , which is the first Betti number of the graphs obtained by gluing all external vertices for the graphs from  $P_n^\bullet$ . For  $\pi_*(\mathbf{B}_n(\bullet)) \otimes \mathbb{Q}$ , the part of complexity  $t$  is simply  $\mathbb{Q} \otimes \pi_{t(n-2)+1}(\mathbf{B}_n(\bullet))$ . Moreover, for any given complexity one can also check that the zigzag of quasi-isomorphisms given in [20] goes always through the bounded above non-negatively graded complexes.

2.1.2. *Right  $\Omega$ -modules  $\hat{D}_n^\bullet, \hat{P}_n^\bullet$ .* Recall that in [29] Pirashvili defines a functor

$$\text{cr}: \text{mod-}\Gamma \longrightarrow \text{mod-}\Omega,$$

that turns out to be an equivalence of abelian categories, see Subsection 1.2. Denote by  $\hat{D}_n^\bullet$  and  $\hat{P}_n^\bullet$  the right  $\Omega$ -modules  $\text{cr}(D_n^\bullet)$  and  $\text{cr}(P_n^\bullet)$  respectively. In each degree  $\hat{D}_n^k$  and  $\hat{P}_n^k$  are spanned by the same graphs as  $D_n^k, P_n^k$  with the only restriction that all the

external vertices in these graphs are of valence  $\geq 1$ . According to the definition of the cross-effect,  $\hat{D}_n^k$  and  $\hat{P}_n^k$  should be viewed as quotient spaces of  $D_n^k$  and  $P_n^k$ , respectively (by the subspace spanned by the graphs having external vertices of valence 0). The category  $\Omega$  can be viewed as a subcategory  $\Gamma$  by adding to any finite set a base-point  $*$ . The right action of  $\Omega$  is the restriction action of  $\Gamma$  on these quotient spaces. For example, in the second composition in Figure 2 one has to throw away the 2 graphs with external vertices of valence 0 to get the corresponding picture of the  $\Omega$ -action.

**Proposition 2.6.** *The right  $\Omega$ -modules  $\hat{D}_n^\bullet$  and  $\hat{P}_n^\bullet$  are finite-dimensional and injective in each homological degree.*

*Proof.* We show first that they are finite-dimensional in each homological degree, which in particular means that all except a finite number of components of the right  $\Omega$ -modules are trivial for any given homological degree. Let  $\Upsilon \in \hat{D}_n^k$  be a graph with  $E$  edges,  $I$  internal vertices, and  $k$  external vertices. To recall the complexity  $t$  of  $\Upsilon$  is the first Betti number of the graph obtained from  $\Upsilon$  by gluing together all external vertices. So, one has

$$t = E - I. \quad (2.8)$$

The total degree of  $\Upsilon$  is  $(n-1)E - n \cdot I = (n-1)t - I$ . Since the valence of any internal vertex is  $\geq 3$ , and the valence of any external one is  $\geq 1$ , one gets

$$3I + k \leq 2E.$$

Which implies  $I \leq \frac{2}{3}E$ ,  $k \leq 2E$ . From (2.8) one has  $E = t + I \leq t + \frac{2}{3}E$ , so  $E \leq 3t$ ,  $I \leq 2t$ ,  $k \leq 6t$ . This very rough estimation shows that the set of graphs  $\Upsilon$  in any given complexity  $t$  is finite. On the other hand for a given complexity  $t$  the total homological degree of any graph is  $(n-1)t - I \geq (n-3)t$ . Therefore there are finitely many complexities  $t$  that can produce non-trivial graphs in a given homological degree.

Before proving the injectivity, recall [29] that the category  $\text{mod-}\Omega$  of right  $\Omega$ -modules in  $\mathbb{Q}$ -vector spaces has injective cogenerators  $\Omega_k^*$ ,  $k \geq 0$ . First one defines the left  $\Omega$ -modules  $\Omega_k$ ,  $k \geq 0$ , as

$$\Omega_k(\bullet) = \mathbb{Q}[\text{Mor}_\Omega(k, \bullet)],$$

which are projective generators of the category  $\Omega\text{-mod}$  of left  $\Omega$ -modules in  $\mathbb{Q}$ -vector spaces. Their duals  $\Omega_k^*$  are therefore injective right  $\Omega$ -modules. For any right  $\Omega$ -module  $F$  one has

$$\text{Rmod}_\Omega(F, \Omega_k^*) \simeq (F(k))^*,$$

where  $(-)^*$  denote the dual vector space. This isomorphism is due to the Yoneda lemma. Notice that  $\Omega_k^*$  has a natural action of the symmetric group  $\Sigma_k$  that comes from the automorphisms of  $k \in \text{Obj}(\Omega)$ . Given any representation  $V$  of  $\Sigma_k$  one can define a right  $\Omega$ -module  $\Omega_k^* \otimes_{\Sigma_k} V$  whose  $\ell$ -th component is  $\mathbb{Q}[\text{Mor}_\Omega(k, \ell)] \otimes_{\Sigma_k} V$ .

**Lemma 2.7.** *For any finite-dimensional representation  $V$  of  $\Sigma_k$ , the right  $\Omega$ -module  $\Omega_k^* \otimes_{\Sigma_k} V$  is injective. Moreover for any right  $\Omega$ -module  $F$ , one has  $\text{Rmod}_\Omega(F, \Omega_k^* \otimes_{\Sigma_k} V) \simeq \text{hom}_{\Sigma_k}(F(k), V)$ .*

*Proof of Lemma 2.7.* Since the ground field is  $\mathbb{Q}$ , any finite-dimensional  $\Sigma_k$ -module  $V$  is a direct summand of a finitely generated free  $\Sigma_k$ -module. Thus  $V \otimes_{\Sigma_k} \Omega_k^*$  is a direct summand of a finite sum of copies of  $\Omega_k^*$  and therefore is also injective. For the second statement, since  $V$  is finite-dimensional, one has:

$$\mathrm{Rmod}_{\Omega}(F, \Omega_k^* \otimes_{\Sigma_k} V) \simeq \mathrm{Rmod}_{\Omega}(F, \Omega_k^*) \otimes_{\Sigma_k} V \simeq (F(k))^* \otimes_{\Sigma_k} V \simeq \mathrm{hom}_{\Sigma_k}(F(k), V).$$

□

Now let us show that  $\hat{D}_n^\bullet, \hat{P}_n^\bullet$  are injective in each degree. Denote by  $M(D_n^k), M(P_n^k)$  the subspaces (which are actually subcomplexes) of  $\hat{D}_n^\bullet, \hat{P}_n^\bullet$  respectively spanned by the graphs whose external vertices are all univalent. This notation comes from the fact that these spaces are spaces of *multiderivations* in  $D_n^k, P_n^k$ , see [40, Section 10]. Each  $M(D_n^k), M(P_n^k)$  has a natural  $\Sigma_k$  action given by relabeling the external vertices. The following lemma finishes the proof of Proposition 2.6. □

**Lemma 2.8.** *The graded right  $\Omega$ -modules  $\hat{D}_n^\bullet, \hat{P}_n^\bullet$  are isomorphic to  $\bigoplus_{k=0}^{+\infty} \Omega_k^* \otimes_{\Sigma_k} M(D_n^k)$ , and  $\bigoplus_{k=1}^{+\infty} \Omega_k^* \otimes_{\Sigma_k} M(P_n^k)$ , respectively.*

*Proof.* Below we construct isomorphisms

$$(2.9) \quad \bigoplus_{k=0}^{+\infty} \Omega_k^* \otimes_{\Sigma_k} M(D_n^k) \xrightarrow{\simeq} \hat{D}_n^\bullet,$$

$$(2.10) \quad \bigoplus_{k=0}^{+\infty} \Omega_k^* \otimes_{\Sigma_k} M(P_n^k) \xrightarrow{\simeq} \hat{P}_n^\bullet.$$

To recall  $\Omega_k^*$  in degree  $\ell$  is a vector space whose basis is the set of surjective maps  $k \rightarrow \ell$ .<sup>4</sup> Given a surjective map  $\alpha: k \rightarrow \ell$ , viewed as an element of  $\Omega_k^*$ , and a graph  $\Upsilon \in M(D_n^k)$ , which means  $\Upsilon$  has  $k$  external vertices all of valence 1, one can construct a graph in  $D_n^\ell$  as follows: take  $\Upsilon$  and take  $\ell$  vertices labeled by  $1 \dots \ell$ , and then join each external vertex  $i$  of  $\Upsilon$  with the labeled vertex  $\alpha(i)$ :

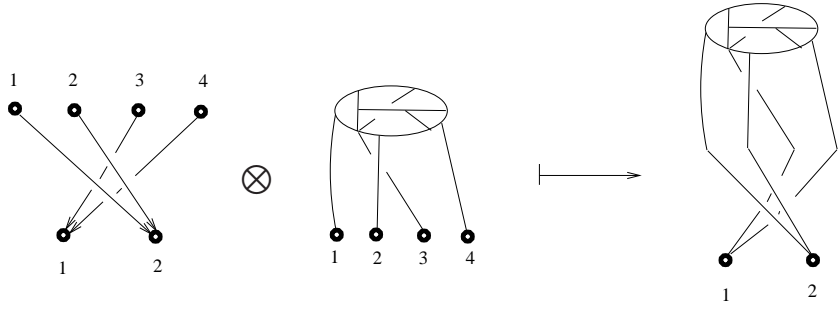

<sup>4</sup>The right action of  $\Omega$  on  $\Omega_k^*$  is as follows. Given a basis element  $\alpha: k \rightarrow \ell$  of  $\Omega_k^*$  and a morphism  $f: \ell' \rightarrow \ell$  in  $\Omega$ , the result of the action of  $f$  on  $\alpha$  is the sum (with all positive signs) of all surjections  $\alpha': k \rightarrow \ell'$ , such that  $\alpha = f \circ \alpha'$ .

It is easy to see that the maps (2.9)-(2.10) defined as above are isomorphisms of  $\Omega$ -modules.  $\square$

We warn the reader that the isomorphisms (2.9), (2.10) send the differential of the source to the sum of expansions of internal vertices, which is only a part of the differential in  $\hat{D}_n^\bullet$ ,  $\hat{P}_n^\bullet$ . The other part is the sum of expansion of external vertices. In other words, they are not morphisms of right  $\Omega$ -modules of chain complexes, but only of right modules of graded vector spaces. But the right hand sides of (2.9) and (2.10) do admit filtrations whose associated graded modules are isomorphic to the left hand sides. The  $r$ -th term of such filtration is spanned by the graphs whose sum of valences of external vertices is  $\leq r$ .

*Remark 2.9.* If  $n$  is odd, the graphs with loops (edges connecting a vertex to itself) are canceled out by the orientation relations. For even  $n$  if we quotient out  $P_n^\bullet$  by the graphs with loops, the isomorphism (2.10) fails to be true only in complexity 1, since there is only one graph  in  $M(P_n^\bullet)$  that can produce a loop by gluing external vertices. Because of that in complexity  $\geq 2$  the graph-complex  $\mathcal{E}_\pi^{m,n}$  can be reduced to a quasi-isomorphic complex consisting of graphs without loops.

Now we finish the proof of Theorem 2.2.

*Proof of Theorem 2.2.* One has

$$\begin{aligned} \mathrm{hRmod}_\Omega \left( \tilde{H}_*(S^{m^\bullet}, \mathbb{Q}), \hat{H}_*(\mathbf{B}_n(\bullet), \mathbb{Q}) \right) &\simeq \mathrm{Rmod}_\Omega \left( \tilde{H}_*(S^{m^\bullet}, \mathbb{Q}), \hat{D}_n^\bullet \right) \simeq \\ &\bigoplus_{k=0}^{\infty} \mathrm{hom}_{\Sigma_k} \left( \tilde{H}_*(S^{mk}), M(D_n^k) \right). \end{aligned}$$

To recall the derived hom is taken in the model category  $\mathrm{Ch}_{\geq 0}(\mathrm{mod}-\Omega)$ . The first isomorphism is due to the fact that the left-hand side can be written as a product of Ext groups (in the abelian category  $\mathrm{mod}-\Omega$  of right  $\Omega$  modules in  $\mathbb{Q}$  vector spaces) since it is a space of derived maps between objects with trivial differential and  $\hat{D}_n^\bullet$  in any complexity  $t$  is an injective resolution of the right  $\Omega$ -module  $\hat{H}_{t(n-1)}(\mathbf{B}_n(\bullet), \mathbb{Q})$ . Indeed it follows from Proposition 2.3 that the inclusion (2.7) is a quasi-isomorphic inclusion of right  $\Omega$ -modules. On the other hand Proposition 2.6 tells us that  $\hat{D}_n^\bullet$  is injective in any homological degree. The second isomorphism is due to Lemmas 2.7 and 2.8. Finally one can notice that the graded vector space  $\bigoplus_k \mathrm{hom}_{\Sigma_k}(\tilde{H}_*(S^{mk}), M(D_n^k)) = \bigoplus_s \mathrm{hom}_{\Sigma_s}(\tilde{H}_{ms}(S^{ms}), M(D_n^s))$  is exactly  $\mathcal{E}_H^{m,n}$  defined at the beginning of Subsection 2.1. We only need to check that the differentials are the same. Any element  $\phi \in \mathrm{hom}_{\Sigma_s}(\tilde{H}_{ms}(S^{ms}), M(D_n^s))$  in the above direct sum should be understood as an  $\Omega$ -module map  $\phi: \bigoplus_k \tilde{H}_{mk}(S^{m^\bullet}) \rightarrow \hat{D}_n^\bullet$  that sends all the summands to zero except the  $s$ -th one  $\tilde{H}_{ms}(S^{m^\bullet})$ . The latter  $\Omega$ -module is one dimensional and is concentrated in the  $s$ -th component. By Lemmas 2.7 and 2.8 the map  $\phi$  must send the generator of the one dimensional space  $\tilde{H}_{ms}(S^{ms})$  to some element  $\psi \in M(D_n^s) \subset \hat{D}_n^s$ . But the part of the differential in  $\hat{D}_n^\bullet$  that expands the external vertices must act trivially on  $\psi$  (since all the external vertices in any graph from  $M(D_n^s)$  are univalent). The other

part of the differential corresponds to the expansion of internal vertices, which produces exactly the differential on  $\mathcal{E}_H^{m,n}$ .

The proof of (2.4) goes in the same way:

$$\begin{aligned} \mathrm{hRmod}_{\Omega} \left( \tilde{H}_*(S^{m\bullet}, \mathbb{Q}), \hat{\pi}_*(\mathcal{B}_n(\bullet)) \otimes \mathbb{Q} \right) &\simeq \mathrm{Rmod}_{\Omega}(\tilde{H}_*(S^{m\bullet}, \mathbb{Q}), \hat{P}_n\bullet) \simeq \\ &\bigoplus_{k=0}^{\infty} \mathrm{hom}_{\Sigma_k}(\tilde{H}_*(S^{mk}), M(P_n^k)). \end{aligned}$$

But in this case even though  $\hat{P}_n\bullet$  is still a complex of injective  $\Omega$ -modules it is no more an injective resolution of  $\pi_*(\mathcal{B}_n(\bullet)) \otimes \mathbb{Q}$ , but is only quasi-isomorphic to it, see Proposition 2.4. However for any given complexity this quasi-isomorphism is a zigzag that goes through bounded above complexes, see Remark 2.5. Thus the standard “balancing Ext” argument can still be applied, see the proof of [43, Theorem 2.7.6] and also [43, Exercise 10.7.1]. The second isomorphism and the fact that the obtained complex coincides with  $\mathcal{E}_{\pi}^{m,n}$  are proven in the same way.

A scrupulous reader might prefer to see a product instead of a direct sum in (2.9), (2.10) and also in the two formulas above. But  $\hat{D}_n\bullet$  and  $\hat{P}_n\bullet$  are finite-dimensional in any homological degree (by Proposition 2.6) and so are complexes  $\mathcal{E}_H^{m,n}$ ,  $\mathcal{E}_{\pi}^{m,n}$ ,  $n \geq 2m + 2$  (by a similar argument). Thus in all these expressions the direct sum can be considered as a product.  $\square$

### 3. RATIONAL HOMOTOPY OF $\overline{\mathrm{Emb}}_c(\mathbb{R}^m, \mathbb{R}^n)$ IN SMALL DIMENSIONS

In this section we describe the rational homotopy of  $\overline{\mathrm{Emb}}_c(\mathbb{R}^m, \mathbb{R}^n)$  in complexities  $t \leq 3$ . The table in Subsection 3.7 summarizes these computations. Recall that we defined graph-complexes  $\mathcal{E}_{\pi}^{m,n}$  computing the rational homotopy of  $\overline{\mathrm{Emb}}_c(\mathbb{R}^m, \mathbb{R}^n)$ , see Theorem 2.1. It is clear from the definition that up to a regrading the graph-complexes  $\mathcal{E}_{\pi}^{m,n}$  depend on the parities of  $m$  and  $n$  only. The case  $m = 1$  was considered in [40, Section 9] which by a regrading describes the situation when  $m$  is odd. Notice that for even  $n$  the graphs with multiple edges cancel out by the orientation relations. For odd  $n$  the graphs with loops disappear by the same reason. Due to Remark 2.9 in complexities  $\geq 2$  even when  $n$  is even one can consider the reduced version of  $\mathcal{E}_{\pi}^{m,n}$  spanned only by the graphs without loops.

We only give a brief summary of our computations that gives an idea of how these graph-complexes look like in small degrees. In most of the cases the sign matters only when we check weather the corresponding graphs survive their symmetries. As for the differential in small complexities often the sign is not important — for any choice of sign the resulting homology is the same. For this reason we do not specify how exactly the graphs are oriented, see Subsection 2.1 for the definition of the orientation of a graph and the differential in the graph-complex.

**3.1. Complexity 1.** There are only two graphs in this complexity:



These graphs are in Hodge degrees 2 and 1 respectively. They survive the orientation relations and define non-trivial generators in rational homotopy according to Table A.



Cycle	appear when	degree
	$n - m$ even	$n - 2m - 1$
	$n$ even	$n - m - 2$

TABLE A. Rational homotopy generators in complexity 1

**3.2. Complexity 2.** Due to Remark 2.9 one should consider only graphs without loops. Among those graphs there are only three that might survive the orientation relations, with only one graph in each of the Hodge degrees 3, 2, and 1. These graphs define non-trivial generators in rational homotopy according to Table B.



Cycle	appear when	degree
	$n - m$ odd	$2n - 3m - 3$
	$m$ odd, $n$ odd	$2n - 2m - 4$
	$n$ odd	$2n - m - 4$

TABLE B. Rational homotopy generators in complexity 2

Notice that only the last graph is not uni-trivalent. The uni-trivalent graphs for all parities of  $m$  and  $n$  cancel out by the orientation relations in Hodge degree 1.

**3.3. Image of the connecting homomorphism.** One has a homotopy fibration

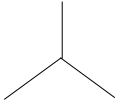
$$\overline{\text{Emb}}_c(\mathbb{R}^m, \mathbb{R}^n) \rightarrow \text{Emb}_c(\mathbb{R}^m, \mathbb{R}^n) \rightarrow \Omega^m \text{Inj}(\mathbb{R}^m, \mathbb{R}^n),$$

that produces a long exact sequence of homotopy groups:

$$(3.1) \quad \dots \rightarrow \pi_{*+1} \Omega^m \text{Inj}(\mathbb{R}^m, \mathbb{R}^n) \xrightarrow{\partial_*} \pi_* \overline{\text{Emb}}_c(\mathbb{R}^m, \mathbb{R}^n) \rightarrow \pi_* \text{Emb}_c(\mathbb{R}^m, \mathbb{R}^n) \rightarrow \pi_* \Omega^m \text{Inj}(\mathbb{R}^m, \mathbb{R}^n) \rightarrow \dots$$

Perhaps surprisingly for  $n \geq 2m + 2$  the image of  $\partial_*$  in rational homotopy depends on the parities of  $m$  and  $n$  only. The following is an equivalent reformulation of Theorem 4.1 or of Corollary 4.3.



**Theorem 3.1.** For  $n \geq 2m + 2$ , the image of the connecting homomorphism

$$\partial_* : \mathbb{Q} \otimes \pi_{*+1} \Omega^m \text{Inj}(\mathbb{R}^m, \mathbb{R}^n) \rightarrow \mathbb{Q} \otimes \pi_* \overline{\text{Emb}}_c(\mathbb{R}^m, \mathbb{R}^n) \tag{3.2}$$

in rational homotopy is described by the homology of  $\mathcal{E}_\pi^{m,n}$  spanned by the following graphs



These classes are non-zero according to the following table:

Cycle	appear when	degree	complexity
	$n - m$ even	$n - 2m - 1$	1
	$n$ even	$n - m - 2$	1
	$n$ odd	$2n - m - 4$	2

We don't prove this result now. This theorem is equivalent to Theorem 4.1. We will also see in Section 4 that the first and the second cycles come from the Euler classes of  $\mathbb{Q} \otimes \pi_* \text{Inj}(\mathbb{R}^m, \mathbb{R}^n)$ , and the last one comes from the top Pontryagin class of  $\mathbb{Q} \otimes \pi_* \text{Inj}(\mathbb{R}^m, \mathbb{R}^n)$ .

**3.4. Complexity 3.** The rank of the homology of  $\mathcal{E}_\pi^{m,n}$  in complexity 3 is always two. The homology generators are represented by the graphs shown in Table C.

Cycle	appear when	degree
	$m$ even	$3n - 3m - 6$
	$m$ odd	$3n - 2m - 7$
	always	$3n - m - 7$

TABLE C. Rational homotopy generators in complexity 3

Notice that the cycles depend only on the parity of  $m$ . The graph-complexes actually do depend on the parity of  $n$ . As it follows from Remark 2.9, when  $n$  is even one can consider a quasi-isomorphic complex consisting of graphs without loops. It turns out that for even  $n$  the only such graphs that are not canceled out by the orientation relations are those that appear in the above table. When  $n$  is odd the complex is more complicated because of the presence of graphs with multiple edges. For the case  $m$  odd,  $n$  odd, see [40, Section 11]. The case  $m$  even,  $n$  odd is considered below.

$m$  even,  $n$  odd. For the Hodge degree 4 one has two non-trivial graphs:

$$\begin{array}{ccc}
 \begin{array}{c} \diagup \quad \diagdown \\ \text{---} \\ \diagdown \quad \diagup \end{array} & \xleftarrow{\partial} & \begin{array}{c} \diagup \quad \diagdown \\ \diagdown \quad \diagup \end{array} \\
 & & (3.4)
 \end{array}$$

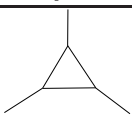
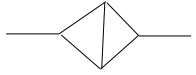
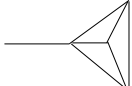
The homology is still trivial, since  $\partial(\times) = 3 \begin{array}{c} \diagup \quad \diagdown \\ \text{---} \\ \diagdown \quad \diagup \end{array}$ .

In the Hodge degree 3 one has the complex

$$\begin{array}{ccc}
 \begin{array}{c} \diagup \\ \text{---} \\ \diagdown \end{array} & \xleftarrow{\partial} & \begin{array}{c} \diagup \quad \diagdown \\ \diagdown \quad \diagup \end{array} \\
 \begin{array}{c} \text{---} \\ \diagdown \quad \diagup \end{array} & & \begin{array}{c} \diagup \quad \diagdown \\ \diagdown \quad \diagup \end{array}
 \end{array}$$

with the differential

$$\partial \left( \begin{array}{c} \diagup \quad \diagdown \\ \diagdown \quad \diagup \end{array} \right) = 2 \begin{array}{c} \diagup \\ \text{---} \\ \diagdown \end{array} + \begin{array}{c} \text{---} \\ \diagdown \quad \diagup \end{array} .$$

This part of  $\mathcal{E}_\pi^{m,n}$  produces only one-dimensional homology group spanned by the first graph from Table C.

In Hodge degree 2 one has the complex

$$\begin{array}{ccc}
 \begin{array}{c} \diagup \quad \diagdown \\ \text{---} \\ \diagdown \quad \diagup \end{array} & \xleftarrow{\partial} & \begin{array}{c} \diagup \quad \diagdown \\ \diagdown \quad \diagup \end{array} \\
 \begin{array}{c} \diagup \\ \text{---} \\ \diagdown \end{array} & & \begin{array}{c} \text{---} \\ \diagdown \quad \diagup \end{array}
 \end{array}$$

Which is acyclic.

In the Hodge degree 1, one has the complex

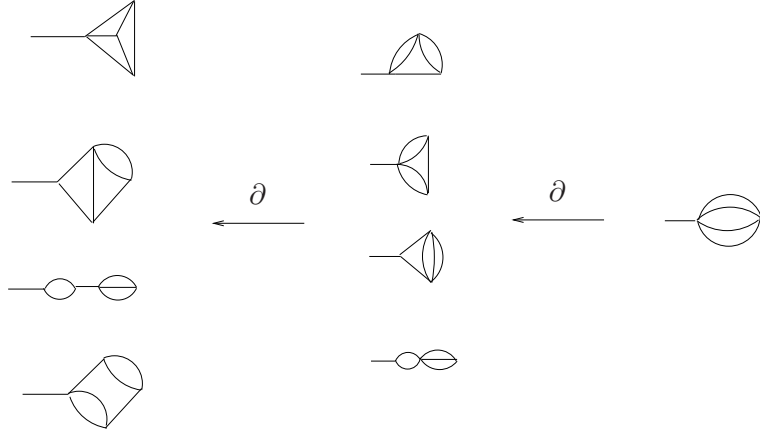

Which produces the last cycle from Table C.

**3.5. Subcomplex of trees or  $s = t + 1$ .** Denote by  $\pi_*^{(s,t)}(\overline{\text{Emb}}_c(\mathbb{R}^m, \mathbb{R}^n))$  the part of the rational homotopy of  $\overline{\text{Emb}}_c(\mathbb{R}^m, \mathbb{R}^n)$  which lies in Hodge degree  $s$  and complexity  $t$ . The summand  $\mathcal{E}_\pi^{m,n}(s, t)$  in Hodge degree  $s$  and complexity  $t$  is non-trivial only if  $s \leq t + 1$ . The case  $s = t + 1$  corresponds to the subcomplex of trees or graphs without cycles.

**Proposition 3.2.** *For  $t \geq 3$ , one has  $\pi_*^{(t+1,t)}(\overline{\text{Emb}}_c(\mathbb{R}^m, \mathbb{R}^n)) = 0$  (with the usual assumption  $n \geq 2m + 2$ ).*

*Proof.* Let  $M_t(P_n^{t+1})$  denote the subcomplex of  $M(P_n^{t+1})$ , see Section 2.1.2, spanned by the trees. It is well known that the homology of this graph-complex is concentrated in the lowest degree and is described as the space of binary trees modulo  $IHX$  relations [45]. Up to a sign representation  $\text{sign}_{t+1}$  of the symmetric group  $\Sigma_{t+1}$  this homology is isomorphic to the  $t$ -th component  $\mathcal{L}ie(t)$  of the cyclic Lie operad. The subcomplex of  $\mathcal{E}_\pi^{m,n}$  is isomorphic to

$$M_t(P_n^{t+1}) \otimes_{\Sigma_{t+1}} (\text{sign}_{t+1})^{\otimes m}.$$

But it is well known, see for example [18, 30], that both the invariants and anti-invariants of  $\mathcal{L}ie(t)$  are trivial for  $t \geq 3$ . The result thus follows.  $\square$

As an example illustrating this result, the complex (3.4) has trivial homology. Notice however that for the complexity  $t = 1$  and  $2$  one has non-trivial classes in Hodge degree  $t + 1$ , see Tables A-B.

**3.6. Subcomplex of graphs with one cycle or  $s = t$ .** It turns out that the homology of  $\mathcal{E}_\pi^{m,n}$  can also be easily understood when the complexity  $t$  equals the Hodge degree  $s$ , or in other words the homology of the subcomplex  $\bigoplus_{t \geq 1} \mathcal{E}_\pi^{m,n}(t, t)$  spanned by graphs with exactly one cycle. For any  $k \geq 1$ , define a  $k$ -wheel as a graph with  $k$  univalent external vertices and  $k$  trivalent internal vertices, which is obtained from a  $k$ -gon by adding an edge from each vertex. As an example a 5-wheel is pictured below:

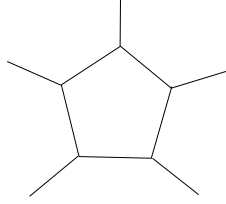

**Proposition 3.3.** *The homology of  $\mathcal{E}_\pi^{m,n}(t,t)$  has rank 0 or 1 and is generated by the  $t$ -wheel, which is non-zero*

- for  $m$  odd,  $n$  odd, if  $t = 2k$ ,  $k \in \mathbb{N}$ ;
- for  $m$  odd,  $n$  even, if  $t = 4k - 3$ ,  $k \in \mathbb{N}$ ;
- for  $m$  even,  $n$  odd, if  $t = 4k - 1$ ,  $k \in \mathbb{N}$ ;
- for  $m$  even,  $n$  even, if  $t = 2k - 1$ ,  $k \in \mathbb{N}$ .

Notice that 1, 2, and 3-wheels appeared already in our computations. Since we are not going to use this result, we explain very briefly the way it can be proved.

*Idea of the proof.* The idea is that one can reduce  $\mathcal{E}_\pi^{m,n}$  to a smaller complex of graphs without cut-vertices [12]. The argument is similar to the one given in the above reference. For the case  $s = t$  the only such graph is the  $t$ -wheel. One only needs to check when this  $t$ -wheel survives the dihedral symmetries.  $\square$

*Remark 3.4.* The results of Subsections 3.1-3.6 are consistent with the computations of the Euler characteristics presented in Appendix in Tables 1, 3, 5, 7. All these computations are also consistent with the previous computations of the rational homotopy of  $\overline{\text{Emb}}_c(\mathbb{R}, \mathbb{R}^n)$ , see [39, Appendix B, Tables 5-6].

Recently the second author together with Baltazar Chavez-Diaz, James Conant, Jean Costello, and Patrick Weed computed the homology of the subcomplex of  $\mathcal{E}_\pi^{m,n}$  of graphs with two cycles ( $s = t - 1$ ). The results of these computations show that the ranks of the homology of this part of the graph-complex grow linearly with  $t$ . We believe the following is true.

**Conjecture 3.5.** *For  $\ell$  fixed, the rank of  $\pi_*^{(t-\ell,t)}(\overline{\text{Emb}}_c(\mathbb{R}^m, \mathbb{R}^n))$  has asymptotic  $t^\ell$  when  $t \rightarrow +\infty$ .*

As another confirmation for this conjecture, the ranks of the spaces of 3-loop uni-trivalent graphs modulo  $IHX$  relations (see Subsection 2.1) grow quadratically with the number of univalent vertices in the graphs [13].<sup>5</sup>

**3.7. Recollecting results of computations.** The table below resumes the results of computations from 3.1-3.6 and describes the dimensions of the first few linearly independent generators of  $\mathbb{Q} \otimes \pi_*(\overline{\text{Emb}}_c(\mathbb{R}^m, \mathbb{R}^n))$ ,  $n > 2m + 1$ . To obtain a similar description of

<sup>5</sup>These spaces are non-trivial only when the number of univalent vertices in 3-loop graphs is even [28].

the rational homotopy of  $\text{Emb}_c(\mathbb{R}^m, \mathbb{R}^n)$ ,  $n > 2m + 1$ , in small dimensions one can use Corollary 4.3.

Case	Dimensions of rational homotopy generators	Other generators have dimension
$m$ odd, $n$ odd	$n - 2m - 1, 2n - 2m - 4, 2n - m - 4, 3n - 2m - 7, 3n - m - 7, 4n - 4m - 8$	$\geq 4n - 3m - 9$
$m$ odd, $n$ even	$n - m - 2, 2n - 3m - 3, 3n - 2m - 7, 3n - m - 7$	$\geq 4n - 3m - 9,$
$m$ even, $n$ odd	$2n - 3m - 3, 2n - m - 4, 3n - 3m - 6, 3n - m - 7$	$\geq 4n - 3m - 9$
$m$ even, $n$ even	$n - 2m - 1, n - m - 2, 3n - 3m - 6, 3n - m - 7$	$\geq 4n - 3m - 9$

#### 4. RATIONAL HOMOTOPY OF $\text{Emb}_c(\mathbb{R}^m, \mathbb{R}^n)$

It is natural to ask ourselves: “Is it possible to reconstruct from  $\mathbb{Q} \otimes \pi_*(\overline{\text{Emb}}_c(\mathbb{R}^m, \mathbb{R}^n))$  the rational homotopy of the initial embedding space  $\text{Emb}_c(\mathbb{R}^m, \mathbb{R}^n)$ ?” To answer this question it is enough to know the rational homotopy of  $\Omega^m \text{Inj}(\mathbb{R}^m, \mathbb{R}^n)$  (which is the homotopy of  $\text{Inj}(\mathbb{R}^m, \mathbb{R}^n)$  shifted by  $m$ ), and the image of the morphism

$$\mathbb{Q} \otimes \pi_* \text{Emb}_c(\mathbb{R}^m, \mathbb{R}^n) \xrightarrow{D_*} \mathbb{Q} \otimes \pi_* \Omega^m \text{Inj}(\mathbb{R}^m, \mathbb{R}^n) \quad (4.1)$$

induced by the Smale-Hirsch map  $D$ . The space  $\text{Inj}(\mathbb{R}^m, \mathbb{R}^n)$  is the Stiefel variety of isometric linear injections of  $\mathbb{R}^m$  into  $\mathbb{R}^n$ . The rational homotopy of  $\text{Inj}(\mathbb{R}^m, \mathbb{R}^n)$  is finite-dimensional, see Theorem 4.2. As a consequence up to a finite-dimensional correction the rational homotopy of  $\text{Emb}_c(\mathbb{R}^m, \mathbb{R}^n)$  and of  $\overline{\text{Emb}}_c(\mathbb{R}^m, \mathbb{R}^n)$  is the same. We mention also that the rational homology of  $\text{Emb}_c(\mathbb{R}^m, \mathbb{R}^n)$ ,  $n \geq 2m + 2$ , is a polynomial bialgebra generated by the rational homotopy. This follows from the fact that  $\text{Emb}_c(\mathbb{R}^m, \mathbb{R}^n)$ ,  $n \geq 2m + 2$ , is a double loop space. For  $m \geq 2$  it is straightforward, since the spaces  $\text{Emb}_c(\mathbb{R}^m, \mathbb{R}^n)$ ,  $n \geq 2m + 2$ , are connected and have an obvious action of the operad of  $m$ -cubes. For  $m = 1$  this result is due to Salvatore [31].

**Theorem 4.1.** *Let  $n \geq 2m + 2$ . A non-zero element of  $\mathbb{Q} \otimes \pi_* \Omega^m \text{Inj}(\mathbb{R}^m, \mathbb{R}^n)$  is in the image of (4.1) if and only if it is both of degree  $> 2n - 3m - 4$  and in the image of  $(\Omega^m i)_*$ , where  $i$  is the natural inclusion*

$$\text{Inj}(\mathbb{R}^{m-1}, \mathbb{R}^{n-1}) \xrightarrow{i} \text{Inj}(\mathbb{R}^m, \mathbb{R}^n). \quad (4.2)$$

*Proof.* R. Budney proved that  $\text{Emb}_c(\mathbb{R}^m, \mathbb{R}^n)$  is  $(2n - 3m - 4)$ -connected [7, Proposition 3.9]. In the same paper he showed that the map  $D$  up to homotopy factors through

$\Omega^m \text{Inj}(\mathbb{R}^{m-1}, \mathbb{R}^{n-1})$  [7, Theorem 2.5]:

$$\begin{array}{ccc} \text{Emb}_c(\mathbb{R}^m, \mathbb{R}^n) & \xrightarrow{D} & \Omega^m \text{Inj}(\mathbb{R}^m, \mathbb{R}^n) \\ & \searrow \text{hol} & \nearrow \Omega^m i \\ & & \Omega^m \text{Inj}(\mathbb{R}^{m-1}, \mathbb{R}^{n-1}) \end{array}$$

Thus to prove the above theorem, one only needs to show that every class  $\omega \in \mathbb{Q} \otimes \pi_* \Omega^m \text{Inj}(\mathbb{R}^m, \mathbb{R}^n)$ , such that  $\deg \omega > 2n - 3m - 4$  and  $\omega \in \text{Im}(\Omega^m i)_*$ , does appear in  $\text{Im} D_*$ . Notice that if  $\omega \notin \text{Im} D_*$ , then  $\partial_* \omega \neq 0$ , where  $\partial_*$  is the connecting homomorphism (3.2). One also has

$$\deg \partial_* \omega = \deg \omega - 1.$$

The end of the proof will go as follows. Assuming  $\partial_* \omega \neq 0$  we will show that  $\deg \partial_* \omega$  is too big to make  $\partial_* \omega$  appear in complexity 1, too small to make it appear in complexity  $\geq 3$ , and its parity does not match to appear in complexity 2. The space  $\text{Inj}(\mathbb{R}^m, \mathbb{R}^n)$  is a fibered product  $S^{n-1} \times S^{n-2} \times \dots \times S^{n-m}$ , and moreover the inclusion (4.2) is

$$\begin{array}{ccc} \text{Inj}(\mathbb{R}^{m-1}, \mathbb{R}^{n-1}) & \hookrightarrow & \text{Inj}(\mathbb{R}^m, \mathbb{R}^n) \\ \parallel & & \parallel \\ S^{n-2} \times \dots \times S^{n-m} & \hookrightarrow & S^{n-1} \times S^{n-2} \times \dots \times S^{n-m} \end{array}$$

The rational homotopy of  $\text{Inj}(\mathbb{R}^m, \mathbb{R}^n)$  is described by the following well known result whose proof we will sketch.

**Theorem 4.2.** *Assuming  $n > 2m \geq 2$ , one has*

- for  $m$  odd,  $n$  odd:

$$\mathbb{Q} \otimes \pi_* \text{Inj}(\mathbb{R}^m, \mathbb{R}^n) = \begin{cases} \mathbb{Q}, & * = n - m \text{ or } 2n - 3 - 4k, 0 \leq k \leq \frac{m-1}{2}; \\ 0, & \text{otherwise.} \end{cases}$$

- for  $m$  odd,  $n$  even:

$$\mathbb{Q} \otimes \pi_* \text{Inj}(\mathbb{R}^m, \mathbb{R}^n) = \begin{cases} \mathbb{Q}, & * = n - 1 \text{ or } 2n - 5 - 4k, 0 \leq k \leq \frac{m-3}{2}; \\ 0, & \text{otherwise.} \end{cases}$$

- for  $m$  even,  $n$  odd:

$$\mathbb{Q} \otimes \pi_* \text{Inj}(\mathbb{R}^m, \mathbb{R}^n) = \begin{cases} \mathbb{Q}, & * = 2n - 3 - 4k, 0 \leq k \leq \frac{m-2}{2}; \\ 0, & \text{otherwise.} \end{cases}$$

- for  $m$  even,  $n$  even:

$$\mathbb{Q} \otimes \pi_* \text{Inj}(\mathbb{R}^m, \mathbb{R}^n) = \begin{cases} \mathbb{Q}, & * = n - 1, n - m, \text{ or } 2n - 5 - 4k, 0 \leq k \leq \frac{m-2}{2}; \\ 0, & \text{otherwise.} \end{cases}$$

The classes of degree  $n - 1$  and  $n - m$  will be called Euler classes, the other classes will be called Pontryagin classes. Notice that Pontryagin classes have degrees  $4\ell - 1$ ,  $\ell \in \mathbb{N}$ . A similar statement is true in the range  $n > m \geq 1$ , but if  $n \leq 2m$  the Euler and Pontryagin classes can lie in the same degrees, which makes more difficult to formulate the result.

*Sketch of the proof.* One has a fibration

$$SO(n - m) \xrightarrow{L} SO(n) \xrightarrow{p} \text{Inj}(\mathbb{R}^m, \mathbb{R}^n).$$

The rational homotopy of  $\text{Inj}(\mathbb{R}^m, \mathbb{R}^n)$  can be split into a direct sum of the image of  $p_*$  (containing all the Pontryagin classes of  $\text{Inj}(\mathbb{R}^m, \mathbb{R}^n)$  and the Euler class of degree  $n - 1$ , appearing if  $n$  is even) and a space transversal to  $\text{Im } p_*$  which gets mapped by a connecting homomorphism  $\partial_*$  isomorphically on  $\text{Im } \partial_*$  (this space has dimension zero or one and is generated by the Euler class of degree  $n - m$ , appearing if  $n - m$  is even). Theorem 4.2 is easily proved by a careful study of the map  $\iota_*$  in rational homotopy. As we already mentioned  $\text{Inj}(\mathbb{R}^m, \mathbb{R}^n)$  is a fibered product of spheres:

$$\text{Inj}(\mathbb{R}^m, \mathbb{R}^n) = S^{n-1} \times S^{n-2} \times \dots \times S^{n-m} \tag{4.3}$$

The Pontryagin class of degree  $4\ell - 1$  appears either from the factor  $S^{2\ell} \times S^{2\ell-1}$  of (4.3) or from the Hopf class of the last sphere if  $n - m = 2\ell$ . The Euler class of degree  $n - 1$  comes from the first sphere of (4.3) and it appears only if  $n$  is even. The Euler class of degree  $n - m$  corresponds to the last sphere of (4.3) and it appears only if  $n - m$  is even. The case  $m = 1$  fits into Theorem 4.2: when  $n$  is even the only sphere  $S^{n-1}$  is treated as the first sphere in (4.3); when  $n$  is odd it is treated as the last one.  $\square$

We now return to the proof of Theorem 4.1. We first list the classes in  $\mathbb{Q} \otimes \pi_* \Omega^m \text{Inj}(\mathbb{R}^m, \mathbb{R}^n)$  that can not lie in  $\text{Im } D_*$  by Budney's result. Basically these are the Euler classes (since their dimensions are too small) and the top Pontryagin class when  $n$  is odd (since it is not in the image of  $i_*$ ). When  $n$  is even the only class which is not in the image of  $i_*: \mathbb{Q} \otimes \pi_* \text{Inj}(\mathbb{R}^{m-1}, \mathbb{R}^{n-1}) \rightarrow \mathbb{Q} \otimes \pi_* \text{Inj}(\mathbb{R}^m, \mathbb{R}^n)$  is the Euler class of degree  $n - 1$ . Via the image of  $\partial_*$  it appears as a class of degree  $n - m - 2$  in  $\mathbb{Q} \otimes \pi_* \overline{\text{Emb}}_c(\mathbb{R}^m, \mathbb{R}^n)$ . The shift of degree by  $m$  comes from  $m$  loops. This class corresponds to the graph



from (3.3).

When  $n$  is odd and  $m \geq 2$  there is only one class not lying in  $\text{Im } i_*$  which is the top Pontryagin class whose degree is  $2n - 3$ . Via the connecting homomorphism it appears as a class of degree  $2n - m - 4$  in  $\mathbb{Q} \otimes \pi_* \overline{\text{Emb}}_c(\mathbb{R}^m, \mathbb{R}^n)$ . The corresponding graph from (3.3) is



For  $n$  odd and  $m = 1$ , there are two classes not in the image of  $i_*$  (which is a zero map since the source is zero): the Pontryagin class of degree  $2n - 1$  and the Euler class of degree

$n - 1$ . The corresponding graphs are



Assuming  $n \geq 2m + 2$ , the Euler class of degree  $n - 2m$  in  $\mathbb{Q} \otimes \pi_* \Omega^m \text{Inj}(\mathbb{R}^m, \mathbb{R}^n)$  can not lie in  $\text{Im } D_*$  since by Budney's result [7, Proposition 3.9] the space  $\text{Emb}_c(\mathbb{R}^m, \mathbb{R}^n)$  is  $(2n - 3m - 4)$ -connected and

$$n - 2m > 2n - 3m - 4$$

is possible only if  $n = 4$  and  $m = 1$ , but the case  $m = 1$  excludes the Euler class from the image of  $D_*$  by the previous argument. Via the connecting homomorphism this class produces a generator of degree  $n - 2m - 1$  in  $\mathbb{Q} \otimes \pi_* \overline{\text{Emb}}_c(\mathbb{R}^m, \mathbb{R}^n)$ . The corresponding graph from (3.3) is



The degree of the bottom Pontryagin class of  $\text{Inj}(\mathbb{R}^m, \mathbb{R}^n)$  is  $2n - 2m - 1$  or  $2n - 2m + 1$  depending on the parity of  $n - m$ . Shifted by  $m$  it appears in degree  $\geq 2n - 3m - 1$  of  $\mathbb{Q} \otimes \pi_* \Omega^m \text{Inj}(\mathbb{R}^m, \mathbb{R}^n)$ . But  $2n - 3m - 1 > 2n - 3m - 4$ , so neither of the other Pontryagin classes are excluded from  $\text{Im } D_*$  by Budney's results.

Notice that the above analysis shows that Theorem 4.1 is equivalent to Theorem 3.1.

To finish the proof of Theorem 4.1 one has to show that all the Pontryagin classes except the top one (when  $n$  is odd) lie in  $\text{Im } D_*$ . Notice that the degree of such class  $\omega \in \mathbb{Q} \otimes \pi_* \Omega^m \text{Inj}(\mathbb{R}^m, \mathbb{R}^n)$  is  $4\ell - 1 - m$  for some  $\ell > 0$ . If  $\omega$  does not lie in  $\text{Im } D_*$ , then  $\partial_* \omega \neq 0$  and the degree of  $\partial_* \omega$  is  $4\ell - m - 2$ . One has  $\partial_* \omega$  can not lie in complexity 1, since complexity one is already taken by the image of the Euler classes. It can not lie in complexity 2, since the parity of its degree is  $m$ , and there are no classes other than  of this parity in complexity 2, see Table B, which is also already taken by the image of the top Pontryagin class. Finally let us check that  $\partial_* \omega$  can not lie in complexity  $\geq 3$ . Assuming that  $\partial_* \omega$  corresponds to a cycle in graph-homology of  $\mathcal{E}_\pi^{m,n}$  in complexity  $t$  and Hodge degree  $s$ , let  $I$  denote the number of internal vertices of one of the graphs in the linear combination representing  $\partial_* \omega$ , and  $E$  be the number of edges in this graph. One has

$$E \geq \frac{3I + s}{2}.$$

One also has that the complexity  $t$  is

$$t = E - I.$$

From the above

$$E \leq 3t - s.$$

The total degree is

$$\deg \partial_* \omega = (n - 1)E - n \cdot I - ms = nt - ms - E \geq (n - 3)t - (m - 1)s.$$

Since for  $t \geq 3$  one has  $s \leq t$  (Proposition 3.2), the total degree can be estimated as

$$\deg \partial_* \omega \geq (n-3)t - (m-1)s \geq (n-m-2)t \geq 3(n-m-2).$$

On the other hand the degree of the highest Pontryagin class, which is in the image of  $(\Omega^m i)_*$ , is  $2n-5-m$  or  $2n-7-m$  depending on the parity of  $n$ . One can easily check that  $n > 2m+1$  implies

$$3(n-m-2) > 2n-5-m,$$

which finishes the proof of Theorem 4.1.  $\square$

Theorem 3.1 is an equivalent reformulation of Theorem 4.1. Another equivalent reformulation is given below.

**Corollary 4.3.** *Assuming  $n \geq 2m+2$ , the ranks of the rational homotopy of  $\text{Emb}_c(\mathbb{R}^m, \mathbb{R}^n)$  are related to that of  $\overline{\text{Emb}}_c(\mathbb{R}^m, \mathbb{R}^n)$  as follows:*

- for  $m$  odd,  $n$  odd:

$$\begin{aligned} \text{rank } \mathbb{Q} \otimes \pi_* \text{Emb}_c(\mathbb{R}^m, \mathbb{R}^n) = \\ \begin{cases} \text{rank } \mathbb{Q} \otimes \pi_* \overline{\text{Emb}}_c(\mathbb{R}^m, \mathbb{R}^n) + 1, & * = 2n - m - 7 - 4k, \quad 0 \leq k \leq \frac{m-3}{2}; \\ \text{rank } \mathbb{Q} \otimes \pi_* \overline{\text{Emb}}_c(\mathbb{R}^m, \mathbb{R}^n) - 1, & * = 2n - m - 4, \quad n - 2m - 1; \\ \text{rank } \mathbb{Q} \otimes \pi_* \overline{\text{Emb}}_c(\mathbb{R}^m, \mathbb{R}^n), & \text{otherwise.} \end{cases} \end{aligned}$$

- for  $m$  odd,  $n$  even:

$$\begin{aligned} \text{rank } \mathbb{Q} \otimes \pi_* \text{Emb}_c(\mathbb{R}^m, \mathbb{R}^n) = \\ \begin{cases} \text{rank } \mathbb{Q} \otimes \pi_* \overline{\text{Emb}}_c(\mathbb{R}^m, \mathbb{R}^n) + 1, & * = 2n - m - 5 - 4k, \quad 0 \leq k \leq \frac{m-3}{2}; \\ \text{rank } \mathbb{Q} \otimes \pi_* \overline{\text{Emb}}_c(\mathbb{R}^m, \mathbb{R}^n) - 1, & * = n - m - 2; \\ \text{rank } \mathbb{Q} \otimes \pi_* \overline{\text{Emb}}_c(\mathbb{R}^m, \mathbb{R}^n), & \text{otherwise.} \end{cases} \end{aligned}$$

- for  $m$  even,  $n$  odd:

$$\begin{aligned} \text{rank } \mathbb{Q} \otimes \pi_* \text{Emb}_c(\mathbb{R}^m, \mathbb{R}^n) = \\ \begin{cases} \text{rank } \mathbb{Q} \otimes \pi_* \overline{\text{Emb}}_c(\mathbb{R}^m, \mathbb{R}^n) + 1, & * = 2n - m - 7 - 4k, \quad 0 \leq k \leq \frac{m-4}{2}; \\ \text{rank } \mathbb{Q} \otimes \pi_* \overline{\text{Emb}}_c(\mathbb{R}^m, \mathbb{R}^n) - 1, & * = 2n - m - 4; \\ \text{rank } \mathbb{Q} \otimes \pi_* \overline{\text{Emb}}_c(\mathbb{R}^m, \mathbb{R}^n), & \text{otherwise.} \end{cases} \end{aligned}$$

- for  $m$  even,  $n$  even:

$$\begin{aligned} \text{rank } \mathbb{Q} \otimes \pi_* \text{Emb}_c(\mathbb{R}^m, \mathbb{R}^n) = \\ \begin{cases} \text{rank } \mathbb{Q} \otimes \pi_* \overline{\text{Emb}}_c(\mathbb{R}^m, \mathbb{R}^n) + 1, & * = 2n - m - 5 - 4k, \quad 0 \leq k \leq \frac{m-2}{2}; \\ \text{rank } \mathbb{Q} \otimes \pi_* \overline{\text{Emb}}_c(\mathbb{R}^m, \mathbb{R}^n) - 1, & * = n - m - 2, \quad n - 2m - 1; \\ \text{rank } \mathbb{Q} \otimes \pi_* \overline{\text{Emb}}_c(\mathbb{R}^m, \mathbb{R}^n), & \text{otherwise.} \end{cases} \end{aligned}$$

## 5. KOSZUL COMPLEXES

**5.1. Cofibrant model for  $\tilde{H}_*(S^{m\bullet}, \mathbb{Q})$ .** In this section we introduce an explicit cofibrant model (in the projective model structure) of the right  $\Omega$ -module  $\tilde{H}_*(S^{m\bullet}, \mathbb{Q})$ . In Subsection 5.2 using this cofibrant replacement we produce another model for the complex of derived maps  $\text{hRmod}(\tilde{H}_*(S^{m\bullet}, \mathbb{Q}), N)$ , where  $N$  is any right  $\Omega$ -module. Applying this to the case  $N = \hat{H}_*(C(\bullet, \mathbb{R}^n), \mathbb{Q})$  or  $N = \mathbb{Q} \otimes \hat{\pi}_*(C(\bullet, \mathbb{R}^n))$  one obtains complexes  $\mathcal{K}_H^{m,n}$  and  $\mathcal{K}_\pi^{m,n}$  computing respectively  $H_*(\overline{\text{Emb}}_c(\mathbb{R}^m, \mathbb{R}^n), \mathbb{Q})$  and  $\mathbb{Q} \otimes \pi_*(\overline{\text{Emb}}_c(\mathbb{R}^m, \mathbb{R}^n))$ .

One has  $\tilde{H}_*(S^{m\bullet}, \mathbb{Q}) = \bigoplus_{s \geq 0} \tilde{H}_{ms}(S^{m\bullet}, \mathbb{Q})$ . Denote by  $Q_s^m$  the  $\Omega$ -module  $\tilde{H}_{ms}(S^{m\bullet}, \mathbb{Q})$ . It is concentrated in a single component

$$Q_s^m(k) = \begin{cases} \Sigma^{ms} \mathbb{Q}, & k = s; \\ 0, & k \neq s. \end{cases}$$

In the above expression  $\Sigma^{ms}$  means that the corresponding 1-dimensional vector space lies in the grading  $ms$ . The symmetric group action on this component coincides with the sign representation in case  $m$  is odd and is trivial in case  $m$  is even.

Below we describe explicitly a cofibrant replacement  $CQ_s^m$  of  $Q_s^m$ . This construction comes from the theory of operads. As we explained in Subsection 1.5 the structure of a right  $\Omega$ -module is the same thing as the structure of a right module over the operad  $Com_+$  of commutative non-unital algebras. In [14, Section 5.3] Fresse defines a cofibrant replacement of a right module  $M$  over any Koszul operad  $\mathcal{P}$ . He denotes such replacement  $CM$  by  $K(M, P, P)$ . As a symmetric sequence it is  $CM = M \circ \mathcal{P}^i[1] \circ \mathcal{P}$ , where  $\mathcal{P}^i$  is the cooperad Koszul dual to  $\mathcal{P}$ , and “[1]” denotes the operadic suspension, see Subsection 1.5. The differential in  $M \circ \mathcal{P}^i[1] \circ \mathcal{P}$  comes from two ingredients: when a cooperation from  $\mathcal{P}^i[1]$  acts from the right on  $M$  or when it acts from the left on  $\mathcal{P}$ . For the precise definition and construction, see [14]. Below we explain this construction in the case of  $CQ_s^m = K(Q_s^m, Com_+, Com_+)$ . Notice that the action of  $Com_+$  on  $Q_s^m$  is trivial. Because of that only the second part of the differential is non-trivial for  $CQ_s^m$ . The operad  $Com_+$  is well known to be Koszul whose Koszul dual is the operad  $\mathcal{L}ie$  of Lie algebras. We will use the description of the cooperad  $co\mathcal{L}ie = Com_+^i$  of Lie algebras that interprets the components of the cooperad as spaces of trees modulo Arnol'd relations. This description arises from the duality between the homology and cohomology of configuration spaces, see for example [36] or [39, Section 5], see also Subsection 1.5.2.

For a finite set  $K$  with  $k$  elements, the component  $CQ_s^m(K)$  of  $CQ_s^m = Q_s^m \circ co\mathcal{L}ie[1] \circ Com_+$  is a chain complex spanned by *oriented forests* with  $s$  connected components. The vertices of the forests are disjoint subsets of  $K$  so that all the vertices of any such forest define a partition of  $K$ . An *orientation set* of a forest is the union of the set of its connected components (considered as elements of degree  $m$ ) and the set of edges (considered as elements of degree 1). An *orientation* of a forest is an ordering of its orientation set. The relations in  $CQ_s^m$  are the orientation relations and the Arnol'd relations. More precisely one has  $T_1 = \pm T_2$  if the forest  $T_1$  differs from  $T_2$  only in reordering of the orientation set.

The sign is the corresponding Koszul sign of permutation. The Arnol'd relations have the form:

$$\begin{array}{c} \textcircled{S_2} \\ / \quad \backslash \\ 1 \quad 2 \\ \textcircled{S_1} \quad \textcircled{S_3} \end{array} + \begin{array}{c} \textcircled{S_2} \\ \backslash \\ 1 \\ \textcircled{S_1} \text{---} \textcircled{S_3} \\ 2 \end{array} + \begin{array}{c} \textcircled{S_2} \\ / \\ 2 \\ \textcircled{S_1} \text{---} \textcircled{S_3} \\ 1 \end{array} = 0$$

where  $S_i$ ,  $i = 1, 2, 3$ , are disjoint subsets of  $K$ . All the other edges (and vertices) in each of the three forests are the same. The differential in  $CQ_s^m$  is the sum (with appropriate signs) of contractions of edges. The new vertex is labeled by the union of two sets corresponding to the vertices that bounded the collapsed edge. The sign is obtained by pulling the edge that is contracted to the first place in the orientation set and then forgetting it since it is no more present in the orientation set of the new forest:

$$\partial \left( \begin{array}{c} \textcircled{1,2} \text{---} \textcircled{4} \text{---} \textcircled{6,7} \\ | \\ \textcircled{3,5} \end{array} \right) = \begin{array}{c} \textcircled{1,2,4} \text{---} \textcircled{6,7} \\ | \\ \textcircled{3,5} \end{array} - \begin{array}{c} \textcircled{1,2} \text{---} \textcircled{4,6,7} \\ | \\ \textcircled{3,5} \end{array}$$

For a surjective map  $g: K_1 \rightarrow K_2$  between two finite sets, one has the induced map

$$g^*: CQ_s^m(K_2) \rightarrow CQ_s^m(K_1),$$

that sends any forest  $T \in CQ_s^m(K_2)$  to the forest  $g^*(T)$  obtained from  $T$  by replacing each vertex  $S_i \subset K_2$  with  $g^{-1}(S_i)$ .

The map  $CQ_s^m \rightarrow Q_s^m$  sends everything to zero except the forest without edges and whose all vertices are singletons. The latter forest gets mapped to a generator of  $Q_s^m(s)$ .

From the definition it is clear that  $CQ_s^m$  as a right  $\text{Com}_+$  module is freely generated by a certain symmetric sequence  $KQ_s^m = Q_s^m \circ \text{coLie}[1]$  that we call the *Koszul dual* of  $Q_s^m$ . Notice that  $KQ_s^m$  is naturally a (cofree) right comodule over the cooperad  $\text{coLie}[1]$ . Explicitly  $KQ_s^m(K)$  is a subspace of  $CQ_s^m(K)$  spanned by forests whose all vertices are singletons. Notice also that  $KQ_s^m(K)$  is concentrated in the single homological degree  $ms + (k - s) = (m - 1)s + k$  (such forests have  $s$  connected components and  $k - s$  edges).

It is easy to show that for  $m \geq 2$  one has a natural isomorphism of symmetric sequences:

$$KQ_s^m(\bullet) \simeq \tilde{H}_{(m-1)s+\bullet}(S^{m\bullet}/\Delta^\bullet S^m, \mathbb{Q}), \quad (5.1)$$

where  $\Delta^k S^m$  denotes the ‘‘fat diagonal’’ in  $S^{mk}$  — the union of subspaces  $x_i = x_j$ ,  $1 \leq i \neq j \leq k$ , in the smash product  $S^m \wedge \dots \wedge S^m = S^{mk}$ .

To see this isomorphism one can notice first that

$$\tilde{H}_*(S^{mk}/\Delta^k S^m, \mathbb{Q}) = \overline{H}_*(C(k, \mathbb{R}^m), \mathbb{Q}), \quad (5.2)$$

where  $\overline{H}_*(-)$  denotes the locally compact singular homology. Then one should use the Poincaré duality together with the description of the cohomology groups of  $C(k, \mathbb{R}^m)$  in terms of spaces of trees modulo Arnol'd relations [1]. We leave it as an exercise to the reader. In [4] we gave a more geometric explanation for the isomorphism (5.1).

To finish this section we mention that the Koszul dual of  $\tilde{H}_*(S^{m\bullet}, \mathbb{Q})$  is the sum of Koszul duals to  $Q_s^m$ ,  $s \geq 0$ , and is exactly the symmetric sequence  $\overline{H}_*(C(\bullet, \mathbb{R}^m), \mathbb{Q})$ .

**5.2. Koszul complex of derived maps.** Let  $N$  be a right  $\Omega$ -module. For simplicity we will be assuming that  $N$  has a trivial differential, as is the case with  $\hat{H}_*(C(\bullet, \mathbb{R}^n), \mathbb{Q})$  and  $\mathbb{Q} \otimes \hat{\pi}_*(C(\bullet, \mathbb{R}^n))$ . We will now describe explicitly the complex of derived maps

$$\mathrm{hRmod}(\tilde{H}_*(S^{m\bullet}, \mathbb{Q}), N) = \prod_{s \geq 0} \prod_{\Omega} \mathrm{Rmod}(CQ_s^m, N). \quad (5.3)$$

Since  $CQ_s^m$  is freely generated by the symmetric sequence  $KQ_s^m$ , one has that the space of the above complex is the product

$$\prod_{s \geq 0} \prod_{k \geq s} \mathrm{hom}_{\Sigma_k}(KQ_s^m(k), N(k)). \quad (5.4)$$

In the case  $N = \hat{H}_*(C(\bullet, \mathbb{R}^n), \mathbb{Q})$  or  $N = \mathbb{Q} \otimes \hat{\pi}_*(C(\bullet, \mathbb{R}^n))$ ,  $n \geq 2m + 2$ , the product above can be replaced by a direct sum. Indeed, the homological degree of  $KQ_s^m(k)$  is  $(m-1)s + k$ . The spaces  $\hat{H}_*(B_n(k), \mathbb{Q})$  and  $\mathbb{Q} \otimes \hat{\pi}_*(B_n(k))$  are concentrated in the degrees  $\geq \frac{k}{2}(n-1)$  and  $\geq (k-1)(n-2) + 1$  respectively. Therefore  $\mathrm{hom}_{\Sigma_k}(KQ_s^m(k), \hat{H}_*(B_n(k), \mathbb{Q}))$  and  $\mathrm{hom}_{\Sigma_k}(KQ_s^m(k), \mathbb{Q} \otimes \hat{\pi}_*(B_n(k)))$  are concentrated in the degrees  $\geq \frac{k}{2}(n-3) - (m-1)s$  and  $\geq k(n-3) - (m-1)s - n + 3$  respectively. Notice that when  $s$  is fixed this gradings go to infinity with  $k$ . As a consequence the second product in (5.4) can be replaced by a direct sum in these two cases. On the other hand since  $k \geq s$ , we obtain

$$\begin{aligned} \frac{k}{2}(n-3) - (m-1)s &\geq \frac{n-2m-1}{2}s, \\ k(n-3) - (m-1)s - n + 3 &\geq (n-m-2)s - n + 3. \end{aligned}$$

Since  $n \geq 2m + 2$  we obtain that this minimal grading goes to infinity with  $s$ , and therefore the first product in (5.4) can also be replaced by a direct sum. A similar argument shows that  $\mathrm{hom}_{\Sigma_k}(KQ_s^m(k), N(k))$  is also a direct sum of spaces taken by the homological degree of  $N(k)$ . Thus the complexes of derived maps we are interested in can be written as direct sums of complexes

$$(5.5) \quad \mathcal{K}_H^{m,n} = \mathrm{hRmod}_{\Omega} \left( \tilde{H}_*(S^{m\bullet}, \mathbb{Q}), \hat{H}_*(C(\bullet, \mathbb{R}^n), \mathbb{Q}) \right) = \bigoplus_{s,t} \left( \bigoplus_{k \geq s} \mathrm{hom}_{\Sigma_k} \left( KQ_s^m(k), \hat{H}_{t(n-1)}(B_n(k), \mathbb{Q}) \right), \partial \right);$$

$$(5.6) \quad \mathcal{K}_{\pi}^{m,n} = \mathrm{hRmod}_{\Omega} \left( \tilde{H}_*(S^{m\bullet}, \mathbb{Q}), \mathbb{Q} \otimes \hat{\pi}_*(C(\bullet, \mathbb{R}^n)) \right) = \bigoplus_{s,t} \left( \bigoplus_{k \geq s} \mathrm{hom}_{\Sigma_k} \left( KQ_s^m(k), \mathbb{Q} \otimes \hat{\pi}_{1+t(n-2)}(B_n(k)) \right), \partial \right).$$

In the first case one has a restriction  $k \leq 2t$ . In the second case one has restriction  $k \leq t + 1$ .

Now let us describe the differential in the complex  $\text{Rmod}_{\Omega}(CQ_s^m, N)$ . Let  $f$  be a pure element in this complex lying in  $\text{hom}_{\Sigma_k}(KQ_s^m(k), N(k))$ . The element  $\partial f$  is also pure and lies in  $\text{hom}_{\Sigma_{k+1}}(KQ_s^m(k+1), N(k+1))$  (here we are using the fact that  $N$  has trivial differential). Let  $T$  be a forest in  $KQ_s^m(k+1)$ . One has

$$(\partial f)(T) = \partial(f(T)) - (-1)^{|f|} f(\partial T).$$

Since we assume that  $N$  has trivial differential the first summand can be ignored, and one has

$$(\partial f)(T) = (-1)^{|f|-1} f(\partial T).$$

On the other hand,

$$\partial T = \sum_{e \in E(T)} \pm \gamma_e^*(T/e),$$

where  $E(T)$  is the set of edges of  $T$ ;  $T/e$  is the forest obtained from  $T$  by contracting edge  $e$ . We view  $T/e$  as an element of  $KQ_s^m((k+1)/e)$  with  $(k+1)/e$  being the set obtained from  $\{1, 2, \dots, k+1\}$  by identifying the endpoints of  $e$ . The map

$$\gamma_e^*: CQ_s^m((k+1)/e) \rightarrow CQ_s^m(k+1)$$

above is induced by the surjective map

$$\gamma_e: k+1 \rightarrow (k+1)/e.$$

(Abusing notation  $\gamma_e^*$  also denotes below the induced map  $\gamma_e^*: N((k+1)/e) \rightarrow N(k+1)$ .) Since  $f$  is a morphism of  $\Omega$ -modules, we finally get

$$(\partial f)(T) = \sum_{e \in E(T)} \pm \gamma_e^*(f(T/e)). \quad (5.7)$$

The sign is  $(-1)^{|f|-1}$  times the sign obtained by pulling the edge  $e$  on the first place of the orientation set of  $T$ .

**5.3. Complex of bicolored graphs.** In this subsection we will describe a complex  $\text{HH}^{m,n}$  dual to  $\mathcal{K}_{\mathbb{H}}^{m,n}$ . The construction is a straightforward application of the duality between the homology and cohomology of configuration spaces [36] to the description of  $\mathcal{K}_{\mathbb{H}}^{m,n}$  that we gave in the previous subsection. This dual complex  $\text{HH}^{m,n}$  was already described in our previous paper [4, Section 11], but it was constructed using a slightly different approach. The complex  $\text{HH}^{m,n}$  computes the rational cohomology  $\text{H}^*(\overline{\text{Emb}}_c(\mathbb{R}^m, \mathbb{R}^n), \mathbb{Q})$ . Applying (5.1), (5.2), (5.5), (5.6) one gets that this dual complex has the form

$$\text{HH}^{m,n} = \left( \bigoplus_k \overline{\text{H}}_{-*}(C(k, \mathbb{R}^m), \mathbb{Q}) \otimes_{\Sigma_k} \hat{\text{H}}^*(C(k, \mathbb{R}^n), \mathbb{Q}), d \right). \quad (5.8)$$

To recall Subsections 1.5.2-1.5.3,  $\hat{H}^*(C(k, \mathbb{R}^n), \mathbb{Q})$  and  $H^*(C(k, \mathbb{R}^m), \mathbb{Q})$  are described as certain spaces of forests modulo Arnol'd relations. Finally applying Poincaré duality

$$\bar{H}_*(C(k, \mathbb{R}^m), \mathbb{Q}) \simeq H^{mn-*}(C(k, \mathbb{R}^m), \mathbb{Q}) \otimes (\text{sign}_k)^{\otimes m} \quad (5.9)$$

we can describe  $\text{HH}^{m,n}$  as a complex of graphs that have two types of edges: dotted and full. The dotted edges correspond to the generators of  $H^*(C(\bullet, \mathbb{R}^m), \mathbb{Q})$  and the full edges correspond to the generators of  $H^*(C(\bullet, \mathbb{R}^n), \mathbb{Q})$ . The vertices of the graphs are non-labeled (this corresponds to the fact that in (5.8) the tensor product is taken over  $\Sigma_k$ ). There are two restrictions on the graphs. If we remove the dotted edges the resulting graph is a forest whose all connected components have at least two vertices. If we remove the full edges the resulting graph is a forest with any type of connected components. The number of full edges in a graph is its *complexity*, the number of connected components obtained by removing full edges is its *Hodge degree*. The space of graphs is taken modulo Arnol'd relations with respect to both types of edges. The differential is the sum of contractions of dotted edges. There are two equivalent ways to define the *orientation set* of a graph. In the first way, see (5.8), (5.9), it consists of











- full edges (of degree  $(n - 1)$ )
- dotted edges (of degree  $(m - 1)$ )
- vertices (of degree  $-m$ )

It is easy to see that equivalently we can define an orientation set as a union of

- full edges (of degree  $(n - 1)$ )
- dotted edges (of degree  $-1$ )
- connected components with respect to dotted edges (of degree  $-m$ )

The edges are oriented. Changing orientation of an edge produces the sign  $(-1)^n$  in the case of a full edge and  $(-1)^m$  in the case of a dotted edge (assuming we choose the first way to define an orientation set, otherwise there is no sign). The latter way is more natural to the operadic approach, see Subsections 5.1, 5.2 in which we describe  $KQ_s^m = Q_s^m \circ \text{coLie}[1]$ .

The complex  $\text{HH}^{m,n}$  naturally carries a structure of a polynomial bialgebra (with respect to the operation of connected sum). The space of generators is given by its subcomplex  $\text{HH}_\pi^{m,n}$  of connected graphs. Obviously  $\text{HH}_\pi^{m,n}$  computes the dual of the rational homotopy of  $\bar{\text{Emb}}_c(\mathbb{R}^m, \mathbb{R}^n)$ . The table below describes the homology generators of  $\text{HH}_\pi^{m,n}$  in complexities  $\leq 2$  and the corresponding to them generators of  $\mathcal{E}_\pi^{m,n}$ .

$\text{HH}_\pi^{m,n}$					
$\mathcal{E}_\pi^{m,n}$					

As we mentioned earlier all our graph-complexes look very similar to the graph-complexes that appear in the Bott-Taubes type integration construction for spaces of long embeddings [9, 32, 33, 42]. The latter construction produces a map from a certain graph-complex to the de Rham complex of differential forms on  $\text{Emb}_c(\mathbb{R}^m, \mathbb{R}^n)$ . Unfortunately for  $m \geq 2$

this construction works nicely only on the level of graphs with no more than one cycle. As example if we look at the classes from the previous table, only the third and the fourth ones are proper to  $\text{Emb}_c(\mathbb{R}^m, \mathbb{R}^n)$ , see Theorem 3.1. Both classes are recovered by Sakai in his construction [32]. The third class from our table is the Haefliger class. It is the only class proper to  $\text{Emb}_c(\mathbb{R}^m, \mathbb{R}^n)$  and appearing on the level of graphs without loops. The corresponding cycle in Sakai's graph-complex is

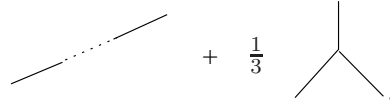

It is quite interesting that both graphs appear in our computations but in two different complexes. As another example, most of the wheel-type cocycles considered in Proposition 3.3 are constructed in [33].

**5.4. Complex of deformations.** It turns out that the complex  $\mathcal{K}_H^{m,n}$  has a natural interpretation from the point of view of the deformation theory of operads. This theory was initiated by Kontsevich and Soibelman [19] and was further developed by Merkulov and Vallette [27]. Given  $m < n$ , one has inclusion of the operads of little discs:

$$\mathbf{B}_m \xrightarrow{i} \mathbf{B}_n.$$

inducing morphism in the homology

$$H_*(\mathbf{B}_m, \mathbb{Q}) \xrightarrow{i_*} H_*(\mathbf{B}_n, \mathbb{Q}). \tag{5.10}$$

The operad  $H_*(\mathbf{B}_m, \mathbb{Q})$  is the associative operad  $Assoc$  if  $m = 1$  and is the operad  $\mathcal{Pois}_{m-1}$  of graded Poisson algebras with bracket  $[x_1, x_2]$  of degree  $(m-1)$  and commutative product  $x_1x_2$  of degree 0. The map (5.10) sends the product to the product and the bracket to zero. We notice that  $i_*$  factors through the commutative operad.

**Theorem 5.1.** *For  $n \geq 2m + 2$ , one has*

$$\mathcal{C}_*^{\mathbb{Q}} \overline{\text{Emb}}_c(\mathbb{R}^m, \mathbb{R}^n) \simeq \Sigma^{m+1} \text{Def} \left( H_*(\mathbf{B}_m, \mathbb{Q}) \xrightarrow{i_*} H_*(\mathbf{B}_n, \mathbb{Q}) \right).$$

In the above  $\text{Def}(\bullet \rightarrow \bullet)$  states for a deformation complex of a morphism of operads as defined in [19, 27]. For simplicity the operads  $\mathbf{B}_m, \mathbf{B}_n$  in the above theorem are taken without the degree zero component.<sup>6</sup> The case  $m = 1$  of this theorem is well known. Indeed, the complex  $\text{Def} \left( Assoc \xrightarrow{i_*} H_*(\mathbf{B}_m, \mathbb{Q}) \right)$  is the usual Hochschild complex of the operad  $H_*(\mathbf{B}_n, \mathbb{Q}) = \mathcal{Pois}_{n-1}$ , see [19, 38, 21]. For  $m \geq 2$  this relation between the homology of higher dimensional long knots and the deformation homology of the morphism (5.10) was conjectured earlier by Kontsevich.

We should also mention that the deformation complex of the map (5.10) in case  $m = n$ , i.e. when  $i_*$  is the identity map, was studied by Willwacher in [46]. In the latter work several graph-complexes similar to those appearing in our paper are produced. Moreover

<sup>6</sup>We believe that the result is still true even if one includes the degree zero components, but technically it is more complicated, since one has to find a cofibrant model of the unital Poisson and associative operads.

in [46, Section 4], the author considers a filtration in one of his graph-complexes whose associated graded quotient up to a regrading is quasi-isomorphic to our deformation complex (assuming  $m$  and  $n$  are of the same parity), see [46, Remark 4.7]. One of the interesting consequences of Willwacher's work for us is that in case  $n$  is even, the Hodge degree one part of the rational homotopy of  $\overline{\text{Emb}}_c(\mathbb{R}^m, \mathbb{R}^n)$  always contains the non-completed Grothendieck-Teichmüller Lie algebra, see [46, Proposition 7.2]. Since the Hodge degree one part of the complex  $\mathcal{E}_\pi^{m,n}$  depends only on the parity of  $n$  the latter result holds for either parity of  $m$ , but of course always assuming the stable range  $n \geq 2m + 2$ . Besides that a careful reader might also find several overlaps between our paper and the one of Willwacher [46] in the way of working with graph-complexes.

Let  $\mathcal{P}oiss_{m-1}^\infty$  be a cofibrant model of  $\mathcal{P}oiss_{m-1}$ , that is a quasi-free operad quasi-isomorphic to  $\mathcal{P}oiss_{m-1}$  via a projection

$$\mathcal{P}oiss_{m-1}^\infty \xrightarrow{p} \mathcal{P}oiss_{m-1}.$$

The operad  $\mathcal{P}oiss_{m-1}$  is known to be Koszul [16]. Its Koszul dual  $\mathcal{P}oiss_{m-1}^!$  is the operad of graded Poisson algebras with bracket of degree zero and commutative product of degree  $(m-1)$ . The cofibrant model  $\mathcal{P}oiss_{m-1}^\infty$  can be chosen as the quasi-free operad  $\mathcal{F}(\Sigma^{-1}\mathcal{P}oiss_{m-1}^i[1])$  generated by the symmetric sequence  $\Sigma^{-1}\mathcal{P}oiss_{m-1}^i[1]$ , where  $\mathcal{P}oiss_{m-1}^i[1]$  is the cooperad whose dual is the operad  $\mathcal{P}oiss_{m-1}^!$  of graded Poisson algebras with bracket of degree 1 and commutative product of degree  $m$ ,<sup>7</sup> and  $\Sigma^{-1}$  is the desuspension of each component in the symmetric sequence. The differential in  $\mathcal{F}(\Sigma^{-1}\mathcal{P}oiss_{m-1}^i[1])$  comes from the cooperadic structure of  $\mathcal{P}oiss_{m-1}^i[1]$ . We refer to [27] for a better account on the deformation theory of Koszul objects. The space of the complex  $\text{Def}\left(\mathcal{P}oiss_{m-1} \xrightarrow{i_*} \mathcal{P}oiss_{n-1}\right)$  is the space of infinitesimal deformations (derivations) of the morphism of operads:

$$\mathcal{F}(\Sigma^{-1}\mathcal{P}oiss_{m-1}^i[1]) \xrightarrow{poi_*} \mathcal{P}oiss_{n-1},$$

that is

$$\text{Def}\left(\mathcal{P}oiss_{m-1} \xrightarrow{i_*} \mathcal{P}oiss_{n-1}\right) = \bigoplus_{k \geq 2} \text{hom}_{\Sigma_k}\left(\Sigma^{-1}\mathcal{P}oiss_{m-1}^i[1](k), \mathcal{P}oiss_{n-1}(k)\right). \quad (5.11)$$

One has a natural isomorphism of graded  $\Sigma_k$ -modules

$$\tilde{\text{H}}_*(S^{mk}/\Delta^k S^m, \mathbb{Q}) \simeq \Sigma^m \mathcal{P}oiss_{m-1}^i[1](k),$$

that one can see for example from the forest description of  $\tilde{\text{H}}_*(S^{mk}/\Delta^k S^m, \mathbb{Q}) = \overline{\text{H}}_*(\text{C}(k, \mathbb{R}^m), \mathbb{Q})$  given above and a similar forest description of the cooperad of Poisson algebras given in [36] (here  $\overline{\text{H}}$  denotes singular locally finite homology). The differential in (5.11) is the pre-Lie commutator with  $\mu = x_1 x_2$ , see [27]:<sup>8</sup>

$$df = \mu \circ f - (-1)^{|f|-1} f \circ \mu.$$

<sup>7</sup>The operad  $\mathcal{P}oiss_{m-1}^!$  is obtained from  $\mathcal{P}oiss_{m-1}^i$  by an operadic suspension, see Subsection 1.5.1.

<sup>8</sup>Here we use the fact that  $i_*$  sends  $[x_1, x_2]$  to zero.

The second summand is exactly the right-hand side of (5.7). The first summand can be written as follows

$$(\mu \circ f)(T) = \sum_v (-1)^\delta x_v \cdot f(T \setminus v), \quad (5.12)$$

where the sum is taken over the univalent vertices of the forest  $T$ . The sign  $(-1)^\delta$  is the Koszul sign of permutation taking the only edge adjacent to  $v$  on the first place of the orientation set of  $T$ , and  $T \setminus v$  denotes the forest obtained from  $T$  by removing the vertex  $v$  and the edge adjacent to it. The total complex (5.11) can be written as

$$\bigoplus_{k \geq 2} \Sigma^{m+1} \text{hom}_{\Sigma_k}(\overline{\mathbb{H}}_*(\mathbb{C}(k, \mathbb{R}^m), \mathbb{Q}), \mathbb{H}_*(\mathbb{C}(k, \mathbb{R}^n), \mathbb{Q})).$$

This complex contains an acyclic complex spanned by degeneracies. The quotient-complex is exactly the (shifted by  $m + 1$  gradings) complex  $\mathcal{K}_H^{m,n}$ :

$$\bigoplus_{k \geq 2} \Sigma^{m+1} \text{hom}_{\Sigma_k}(\overline{\mathbb{H}}_*(\mathbb{C}(k, \mathbb{R}^m), \mathbb{Q}), \hat{\mathbb{H}}_*(\mathbb{C}(k, \mathbb{R}^n), \mathbb{Q})), \quad (5.13)$$

computing the reduced rational homology of  $\overline{\text{Emb}}_c(\mathbb{R}^m, \mathbb{R}^n)$ . This is straightforward and similar to the fact that the Hochschild complex of the Poisson operad is a direct sum of its normalized subcomplex and an acyclic one spanned by degeneracies. The complex (5.13) can also be interpreted as the complex of unital deformations of the morphism  $\mathcal{P}oiss_{m-1} \xrightarrow{i_*} \mathcal{P}oiss_{n-1}$ . By *unital* we mean deformations preserving the zero-ary operation  $\mathbb{1} \in \mathcal{P}oiss_{m-1}(0)$  (the deformation of higher operations are annihilated when applied to  $\mathbb{1}$ ) if the latter one is added to the operad  $\mathcal{P}oiss_{m-1}$ .

## 6. EULER CHARACTERISTICS OF THE DOUBLE SPLITTING

In this section we investigate the generating function of the Euler characteristics of the double splitting in the rational homology of  $\overline{\text{Emb}}_c(\mathbb{R}^m, \mathbb{R}^n)$ . Let  $\chi_{st}$  denote the Euler characteristic of the summand  $\mathcal{K}_H^{m,n}(s, t)$  of complexity  $t$  and Hodge degree  $s$ , see (5.5). This summand is finite dimensional, so the homology should also be finite dimensional and the Euler characteristic is well defined. Let

$$F_{mn}(x, u) = \sum_{st} \chi_{st} x^s u^t \quad (6.1)$$

denote the generating function of the Euler characteristics of the double splitting in  $\mathbb{H}_*(\overline{\text{Emb}}_c(\mathbb{R}^m, \mathbb{R}^n); \mathbb{Q})$ . It is clear that this function depends only on the parities of  $m$  and  $n$ .

**Theorem 6.1.** *One has*

$$F_{mn}(x, u) = \prod_{\ell \geq 1} \frac{\Gamma((-1)^{n-1} E_\ell(\frac{1}{u}) - (-1)^{m-1} E_\ell(x))}{((-1)^{n-1} \ell u^\ell)^{(-1)^{m-1} E_\ell(x)} \Gamma((-1)^{n-1} E_\ell(\frac{1}{u}))}, \quad (6.2)$$

where each factor in the product is understood as the asymptotic expansion of the underlying function when  $u$  is complex and  $(-1)^{n-1} u^\ell \rightarrow +0$  and  $x$  is considered as a fixed parameter.

In the above  $\Gamma(y)$  is the gamma function which is  $(y-1)!$  on positive integers,  $E_\ell(y) = \frac{1}{\ell} \sum_{d|\ell} \mu(d) y^{\ell/d}$  (where  $\mu(-)$  is the standard Möbius function).

Tables 2, 4, 6, 8 describe  $\chi_{st}$  for complexities  $t \leq 23$ . From these tables the above generating functions start as follows:

$$F_{oo}(x, u) = 1 + x^2u + (x^4 + x^2 - x)u^2 + (x^6 + x^4 - x^3 + x^2 - x)u^3 + \dots$$

$$F_{oe}(x, u) = 1 - xu + x^3u^2 + (-x^4 - x^2 + x)u^3 + \dots$$

$$F_{eo}(x, u) = 1 + (-x^3 + x)u^2 + (-x^3 + x)u^3 + \dots$$

$$F_{ee}(x, u) = 1 + (-x^2 + x)u + (-x^3 + x^2)u^2 + (-x^4 + 2x^3 - x)u^3 + \dots$$

The subscript  $o$  refers to the case when the corresponding variable  $m$  or  $n$  is odd, and the subscript  $e$  refers to the situation when  $m$  or  $n$  is even.

The case  $m = 1$  of this formula was proved in [40]. We refer the reader to this paper which explains this formula in more details. In the rest of the section we sketch the main steps of the computations.

From Subsection 5.2 the complex computing  $H_*(\overline{\text{Emb}}_c(\mathbb{R}^m, \mathbb{R}^n), \mathbb{Q})$  in complexity  $t$  and Hodge degree  $s$  is

$$\left( \bigoplus_{k=s}^{2t} \text{hom}_{\Sigma_k} \left( KQ_s^m(k), \hat{H}_{t(n-1)}(C(k, \mathbb{R}^n); \mathbb{Q}) \right), \partial \right).$$

To recall (5.1), the  $\Sigma_k$ -module  $KQ_s^m(k)$  is  $\tilde{H}_{k+s(m-1)}(S^{mk}/\Delta^k S^m; \mathbb{Q}) = \overline{H}_{k+s(m-1)}(C(k, \mathbb{R}^m); \mathbb{Q})$  (assuming  $m \geq 2$ ), where  $\overline{H}$  denotes the locally compact singular homology. The entire complex computing  $H_*(\overline{\text{Emb}}_c(\mathbb{R}^m, \mathbb{R}^n); \mathbb{Q})$  is

$$\left( \bigoplus_{k \geq 0} \text{hom}_{\Sigma_k} \left( \overline{H}_*(C(k, \mathbb{R}^m); \mathbb{Q}), \hat{H}_*(C(k, \mathbb{R}^n), \mathbb{Q}) \right), \partial \right).$$

The above formula is also true for  $m = 1$ , but in that case the splitting over the Hodge degree can not be defined in the same way. For  $m = 1$  this splitting is similar to the Hodge-type splitting in the Hochschild (co)homology of a commutative algebra [40]. As we mentioned earlier the case  $m = 1$  of Theorem 6.1 was done in [40, Theorem 13.1]. For simplicity of exposition we will be assuming below that  $m \geq 2$ .

We start by introducing some standard notation. For each permutation  $\sigma \in \Sigma_k$  define  $Z(\sigma)$ , the *cycle indicator* of  $\sigma$ , by

$$Z(\sigma) = \prod_{\ell} a_{\ell}^{j_{\ell}(\sigma)},$$

where  $j_{\ell}(\sigma)$  is the number of  $\ell$ -cycles of  $\sigma$  and where  $a_1, a_2, a_3, \dots$  is an infinite family of commuting variables.

Let  $\rho^V : S_k \rightarrow GL(V)$  be a representation of  $\Sigma_k$ . Define  $Z_V(a_1, a_2, \dots)$  the *cycle index* of  $V$ , by

$$Z_V(a_1, a_2, \dots) = \frac{1}{n!} \sum_{\sigma \in \Sigma_k} \text{tr } \rho^V(\sigma) \cdot Z(\sigma).$$

Similarly for a symmetric sequence  $W = \{W(k), k \geq 0\}$  — sequence of  $\Sigma_k$ -modules, one defines its *cycle index sum*  $Z_W$  by

$$Z_W(a_1, a_2, \dots) = \sum_{k=0}^{+\infty} Z_{W(k)}(a_1, a_2, \dots).$$

The following lemma is well known [40, Lemma 15.4].

**Lemma 6.2.** *Let  $V$  and  $W$  be two  $\Sigma_k$ -modules, then*

$$\dim \text{hom}_{\Sigma_k}(V, W) = (Z_V(a_\ell \leftarrow \partial/\partial a_\ell, \ell \in \mathbb{N}) Z_W(a_\ell \leftarrow \ell a_\ell, \ell \in \mathbb{N})) \Big|_{\substack{a_\ell=0, \\ \ell \in \mathbb{N}}}.$$

In the above formula  $Z_W(a_\ell \leftarrow \ell a_\ell, \ell \in \mathbb{N})$  is a polynomial obtained from  $Z_W(a_1, a_2, \dots)$  by replacing each variable  $a_\ell$  by  $\ell a_\ell$ . The expression  $Z_V(a_\ell \leftarrow \partial/\partial a_\ell, \ell \in \mathbb{N})$  is a differential operator obtained from the polynomial  $Z_V(a_1, a_2, \dots)$  by replacing each  $a_\ell$  by  $\partial/\partial a_\ell$ . The differential operator is applied to the polynomial and at the end one takes all the variables  $a_\ell, \ell \in \mathbb{N}$ , to be zero.

In case  $V = \bigoplus_i V_i$ ,  $W = \bigoplus_i W_i$  are graded  $S_k$ -modules, and  $\dim \text{hom}_{\Sigma_k}(V, W)$  is the graded dimension:

$$\dim \text{hom}_{\Sigma_k}(V, W) = \sum_{i, j \in \mathbb{Z}} \dim \text{hom}_{\Sigma_k}(V_i, W_j) z^{j-i},$$

and  $Z_V, Z_W$  are *graded cycle indices*:

$$\begin{aligned} Z_V(z; a_1, a_2, \dots) &= \sum_{i \in \mathbb{Z}} Z_{V_i}(a_1, a_2, \dots) z^i, \\ Z_W(z; a_1, a_2, \dots) &= \sum_{i \in \mathbb{Z}} Z_{W_i}(a_1, a_2, \dots) z^i. \end{aligned}$$

Then

$$\dim \text{hom}_{\Sigma_k}(V, W) = Z_V(1/z; a_\ell \leftarrow \partial/\partial a_\ell, \ell \in \mathbb{N}) Z_W(z; a_\ell \leftarrow \ell a_\ell, \ell \in \mathbb{N}) \Big|_{\substack{a_\ell=0, \\ \ell \in \mathbb{N}}}. \quad (6.3)$$

We will be considering bigraded symmetric sequences. Similarly in our computations we will add one more variable  $x$  or  $u$  responsible for the second grading.

Next step is to find the graded cycle index sum of the symmetric sequences  $\overline{H}_*(C(\bullet, \mathbb{R}^m); \mathbb{Q})$ , and  $\hat{H}_*(\mathbf{B}_n(\bullet), \mathbb{Q})$ . The symmetric group action on the homology of configuration spaces  $C(k, \mathbb{R}^n)$  is well understood [11, 23, 24].

**Proposition 6.3.** *The graded cycle index sum for the symmetric sequence*

$$H_*(C(\bullet, \mathbb{R}^n), \mathbb{Q}) = \{H_*(C(k, \mathbb{R}^n), \mathbb{Q}) \mid k \geq 0\}$$

is given by the following formula:

$$Z_{H_*(C(\bullet, \mathbb{R}^n), \mathbb{Q})}(z; a_1, a_2, \dots) = \prod_{\ell=1}^{+\infty} \left( 1 + (-1)^n (-z)^{(n-1)\ell} a_\ell \right)^{(-1)^n E_\ell \left( \frac{1}{(-z)^{n-1}} \right)}, \quad (6.4)$$

where  $E_\ell(y) = \frac{1}{\ell} \sum_{d|\ell} \mu(d) y^{\frac{\ell}{d}}$ .

*Proof.* It is an easy consequence of [23, Theorem B].  $\square$

Let us add another variable  $u$  that will be responsible for the complexity, which is the homology degree divided by  $(n-1)$ . Thus the  $u$ -degree is the  $z$ -degree divided by  $(n-1)$ :

$$Z_{H_*(C(\bullet, \mathbb{R}^n), \mathbb{Q})}(z, u; a_1, a_2, \dots) = \prod_{\ell=1}^{+\infty} \left( 1 + (-1)^n ((-z)^{(n-1)} u)^\ell a_\ell \right)^{(-1)^n E_\ell \left( \frac{1}{(-z)^{n-1} u} \right)}. \quad (6.5)$$

The following result is easily obtained from (6.5), see [40, Section 15.2].

**Proposition 6.4** ([40]). *One has*

$$Z_{\hat{H}_*(C(\bullet, \mathbb{R}^n), \mathbb{Q})}(z, u; a_1, a_2, \dots) = \prod_{\ell=1}^{+\infty} e^{-\frac{a_\ell}{\ell}} \left( 1 + (-1)^n ((-z)^{(n-1)} u)^\ell a_\ell \right)^{(-1)^n E_\ell \left( \frac{1}{(-z)^{n-1} u} \right)}, \quad (6.6)$$

where the variable  $u$  is responsible for the complexity and  $z$  for the homology degree.

**Proposition 6.5.** *One has*

$$(6.7) \quad Z_{\overline{H}_*(C(\bullet, \mathbb{R}^m), \mathbb{Q})}(z, x; a_\ell, \ell \in \mathbb{N}) = \prod_{\ell=1}^{+\infty} \left( 1 + (-z)^\ell a_\ell \right)^{(-1)^m E_\ell((-z)^{m-1} x)},$$

where the variable  $x$  is responsible for the Hodge degree and  $z$  is responsible for the homology degree.

*Proof.* From the Poincaré duality one has an isomorphism of  $\Sigma_\ell$ -modules:

$$\overline{H}_*(C(\ell, \mathbb{R}^m), \mathbb{Q}) \simeq H^{\ell m - *}(C(\ell, \mathbb{R}^m), \mathbb{Q}) \otimes (\text{sign}_\ell)^{\otimes m}. \quad (6.8)$$

The sign representation appears due to the fact that the Poincaré duality uses the orientation of the variety. From the above one has

$$\overline{H}_{i(m-1)+\ell}(C(\ell, \mathbb{R}^m), \mathbb{Q}) \simeq H^{(\ell m - i)(m-1)}(C(\ell, \mathbb{R}^m), \mathbb{Q}) \otimes (\text{sign}_\ell)^{\otimes m}.$$

So, the part of  $H_*(C(\ell, \mathbb{R}^m), \mathbb{Q})$  lying in Hodge degree  $s$  corresponds to the part of  $H^*(C(\ell, \mathbb{R}^m), \mathbb{Q})$  lying in complexity  $(\ell - i)$ .

It follows from this, that

$$(6.9) \quad Z_{\overline{H}_*(C(\bullet, \mathbb{R}^m), \mathbb{Q})}(z, x; a_\ell, \ell \in \mathbb{N}) = Z_{H_*(C(\bullet, \mathbb{R}^m), \mathbb{Q})}(z \leftarrow 1/z; u \leftarrow 1/x; a_\ell \leftarrow (-1)^{(\ell-1)m} x^\ell z^{m\ell} a_\ell, \ell \in \mathbb{N}).$$

Indeed, the sign  $(-1)^{(\ell-1)m}$  arises because of the factor  $(\text{sign}_\ell)^{\otimes m}$  in (6.8). The isomorphism (6.8) sends the complexity  $t$  to the Hodge degree  $s = \ell - t$ , which explains why  $u$

is replaced by  $1/x$ , and also the presence of the factor  $x^\ell$  in  $a_\ell \leftarrow (-1)^{(\ell-1)m} x^\ell z^{m\ell} a_\ell$ . The total homological degree  $*$  of the left-hand side corresponds to  $(m\ell - *)$  of the right-hand side in (6.8): this explains why  $z$  is replaced by  $1/z$ , and also the presence of the factor  $z^{m\ell}$  in  $a_\ell \leftarrow (-1)^{(\ell-1)m} x^\ell z^{m\ell} a_\ell$ .

The equation (6.7) follows immediately from (6.9) and (6.4).  $\square$

*Proof of Theorem 6.1.* Define  $\Psi_{mn}(x, u, z)$  as the following generating function:

$$\Psi_{mn}(x, u, z) = \sum_{s,t,k} \dim \left( \text{hom}_{\Sigma_k} \left( \overline{\mathbb{H}}_{s(m-1)+k}(C(k, \mathbb{R}^m); \mathbb{Q}), \hat{\mathbb{H}}_{t(n-1)}(C(k, \mathbb{R}^n); \mathbb{Q}) \right) \right) x^s u^t z^{t(n-1)-s(m-1)-k}.$$

The variable  $x$  is responsible for the Hodge degree; the variable  $u$  is responsible for the complexity; and the variable  $z$  for the total homological degree. It follows from (6.3), and Propositions 6.4-6.5 that

$$\begin{aligned} \Psi_{mn}(x, u, z) &= \\ & \left( \prod_{\ell=1}^{+\infty} (1 + (-1/z)^\ell \partial / \partial a_\ell)^{(-1)^m E_\ell \left( \frac{x}{(-z)^{m-1}} \right)} \prod_{\ell=1}^{+\infty} e^{-a_\ell} (1 + (-1)^n \ell ((-z)^{(n-1)} u)^\ell a_\ell)^{(-1)^n E_\ell \left( \frac{1}{(-z)^{n-1} u} \right)} \right) \Bigg|_{\substack{a_\ell=0 \\ \ell \in \mathbb{N}}} = \\ & \prod_{\ell=1}^{+\infty} \left( (1 + (-1/z)^\ell \partial / \partial a_\ell)^{(-1)^m E_\ell \left( \frac{x}{(-z)^{m-1}} \right)} e^{-a_\ell} (1 + (-1)^n \ell ((-z)^{(n-1)} u)^\ell a_\ell)^{(-1)^n E_\ell \left( \frac{1}{(-z)^{n-1} u} \right)} \right) \Bigg|_{a_\ell=0}. \end{aligned}$$

Since  $F_{mn}(x, u) = \Phi_{mn}(x, u, -1)$  we get

$$F_{mn}(x, u) = \prod_{\ell=1}^{+\infty} \left( (1 + \partial / \partial a)^{(-1)^m E_\ell(x)} e^{-a} \left( 1 + (-1)^n \ell u^\ell a \right)^{(-1)^n E_\ell \left( \frac{1}{u} \right)} \right) \Bigg|_{a=0}.$$

Notice that in the above formula we replaced  $a_\ell$  by  $a$ . We could do so because each factor uses only one variable  $a_\ell$  which is anyway taken to be zero.

The rest follows from the formula

$$\begin{aligned} & \left( (1 + \partial / \partial a)^{(-1)^m E_\ell(x)} e^{-a} \left( 1 + (-1)^n \ell u^\ell a \right)^{(-1)^n E_\ell \left( \frac{1}{u} \right)} \right) \Bigg|_{a=0} = \\ & = \frac{\Gamma((-1)^{n-1} E_\ell \left( \frac{1}{u} \right) - (-1)^n E_\ell(x))}{((-1)^{n-1} \ell u^\ell)^{(-1)^{m-1} E_\ell(x)} \Gamma((-1)^{n-1} E_\ell \left( \frac{1}{u} \right))}, \end{aligned}$$

which is proved in [40, Proposition 15.7].  $\square$

**Acknowledgement.** The authors are grateful to P. Lambrechts and the Université Catholique de Louvain for hospitality. It was actually at the UCL where the idea for this paper first appeared.

## REFERENCES

- [1] V. Arnol'd. The cohomology ring of the group of colored braids. (Russian) *Mat. Zametki* 5, 1969, pp 227–231.
- [2] G. Arone, P. Lambrechts, V. Turchin, and I. Volić. Coformality and rational homotopy groups of spaces of long knots. *Math. Res. Lett.* 15 (2008), no. 1, 1–14.
- [3] G. Arone, P. Lambrechts, and I. Volić. Calculus of functors, operad formality, and rational homology of embedding spaces. *Acta Math.* 199 (2007), no. 2, 153–198.
- [4] G. Arone, V. Turchin. On the rational homology of high dimensional analogues of spaces of long knots. arXiv:1105.1576.
- [5] Dr. Bar-Natan. On the Vassiliev knot invariants. *Topology* 34 (1995), no. 2, 423–472.
- [6] R. Budney. Little cubes and long knots. *Topology* 46 (2007), no. 1, 1–27.
- [7] R. Budney, A family of embedding spaces. *Groups, homotopy and configuration spaces*, 41–83, *Geom. Topol. Monogr.*, 13, Geom. Topol. Publ., Coventry, 2008.
- [8] A. Cattaneo, P. Cotta-Ramusino, and R. Longoni. Configuration spaces and Vassiliev classes in any dimension. *Algeb. Geom. Topol.*, 2: 949–1000, 2002.
- [9] A. Cattaneo, C. Rossi. Wilson surfaces and higher dimensional knot invariants. *Comm. Math. Phys.* 256 (2005), no. 3, 513–537.
- [10] F. Cohen. The homology of  $C_{n+1}$  spaces. In *Lecture Notes in Mathematics*, Vol. 533, 1976.
- [11] F. R. Cohen, L. R. Taylor. On the representation theory associated to the cohomology of configuration spaces, In: Algebraic Topology (Oaxtepec, 1991), *Contemp. Math.* 146, Amer. Math. Soc., Providence, RI, 1993, pp. 91–109.
- [12] J. Conant, F. Gerlits, K. Vogtmann. Cut vertices in commutative graphs. *Q. J. Math.* 56 (2005), no. 3, pp 321–336.
- [13] O. Dasbach, On the combinatorial structure of primitive Vassiliev invariants II, *J. Combin. Theory Ser. A* 81 (2) (1998) 127–139.
- [14] B. Fresse. Koszul duality of operads and homology of partition posets. In: Homotopy theory: relations with algebraic geometry, group cohomology, and algebraic  $K$ -theory, *Contemp. Math.*, 346, Amer. Math. Soc. Providence, RI, 2004, pp 115–215.
- [15] M. Gerstenhaber, S. D. Schack. A Hodge-type decomposition for commutative algebra cohomology. *J. Pure Appl. Algebra* 48 (1987), no. 3, 229–247.
- [16] E. Getzler, J. D. S. Jones. Operads, homotopy algebra and iterated integrals for double loop spaces. arXiv:hep-th/9403055.
- [17] M. Hirsch. Immersions of manifolds. *Trans. Amer. Math. Soc.* 93, 1959, 242–276.
- [18] A. A. Klyachko, Lie elements in the tensor algebra, *Siberian Math. J.* 15 (1974), 914–920.
- [19] M. Kontsevich, Ya. Soibelman, Deformations of algebras over operads and the Deligne conjecture. In *Conférence Moshé Flato 1999, Vol. I (Dijon)*, volume 21 of *Math. Phys. Stud.*, pages 255–307. Kluwer Acad. Publ., Dordrecht, 2000.
- [20] P. Lambrechts, V. Turchin. Homotopy graph-complex for configuration and knot spaces. *Trans. Amer. Math. Soc.* 361 (2009), no. 1, 207–222.
- [21] P. Lambrechts, V. Turchin, I. Volić. The rational homology of spaces of long knots in codimension  $> 2$ . *Geom. Topol.* 14 (2010), no. 4, 2151–2187.
- [22] P. Lambrechts, I. Volić. Formality of the little  $N$ -disks operad. To appear in *Memoirs of the AMS*. Preprint arXiv:0808.0457.
- [23] G. I. Lehrer. Equivariant Cohomology of Configurations in  $\mathbb{R}^d$ . Special issue dedicated to Klaus Roggenkamp on the occasion of his 60th birthday. *Algebr. Represent. Theory* 3 (2000), no. 4, 377–384.
- [24] G. I. Lehrer, L. Solomon. On the action of the symmetric group on the cohomology of the complement of its reflecting hyperplanes, *J. Algebra* 104 (1986), 410–424.
- [25] J.-L. Loday. Opérations sur l’homologie cyclique des algèbres commutatives. *Invent. Math.* 96 (1989), no. 1, 205–230.

- [26] J.-L. Loday, B. Vallette. Algebraic Operads. Grundlehren der Mathematischen Wissenschaften [Fundamental Principles of Mathematical Sciences], 346. Springer, Heidelberg, 2012. xxiv+634 pp.
- [27] V. Merkulov, B. Vallette. Deformation theory of representation of prop(erad)s I. *J. Reine Angew. Math.*, Issue 634 (2009), pp 51-106.
- [28] D. Moskovich, T. Ohtsuki, Vanishing of 3-loop Jacobi diagrams of odd degree. *J. Combin. Theory Ser. A* 114 (2007), no. 5, 919–930.
- [29] T. Pirashvili, Hodge decomposition for higher order Hochschild homology. *Ann. Sci. Ecole Norm. Sup.* (4) 33 (2000), no. 2, 151–179.
- [30] C. A. Robinson, S. Whitehouse, The tree representation of  $\Sigma_{n+1}$ . *Journal of Pure and Applied Algebra*, 1996, 111 (1-3), 245-253.
- [31] P. Salvatore. Knots, operads, and double loop spaces. *Int. Math. Res. Not.* 2006, Art. ID 13628, 22 pp.
- [32] K. Sakai. Configuration space integrals for embedding spaces and the Haefliger invariant. *J. Knot Theory Ramifications* 19 (2010), no. 12, 1597-1644.
- [33] K. Sakai, T. Watanabe. 1-loop graphs and configuration space integral for embedding spaces. *Math. Proc. Cambridge Philos. Soc.* 152 (2012), no. 3, 497–533.
- [34] P. Severa, T. Willwacher. Equivalence of formalities of the little discs operad. *Duke Math. J.*, 160(1):175-206, 2011.
- [35] D. Sinha. Operads and knot spaces. *J. Am. Math. Soc.* 19(2): 461–486, 2006.
- [36] D. Sinha. A pairing between graphs and trees. arXiv:math/0502547.
- [37] D. Sinha. The homology of the little discs operad. Preprint arXiv:math/0610236.
- [38] V. Turchin (Tourchine). On the homology of the spaces of long knots. *Advances in topological quantum field theory*, 23–52, NATO Sci. Ser. II Math. Phys. Chem., 179, Kluwer Acad. Publ., Dordrecht, 2004.
- [39] V. Turchin (Tourchine). On the other side of the bialgebra of chord diagrams. *Journal of Knot Theory and its Ramifications*. Vol. 16 (5), May 2007, pp. 575-629.
- [40] V. Turchin, Hodge-type decomposition in the homology of long knots. *J. Topol.* 3 (2010), no. 3, 487–534.
- [41] V. Vassiliev. Complements of Discriminants of Smooth Maps: Topology and Applications. Revised ed. Providence, R.I.: AMS, 1994 (*Translation of Mathem. Monographs*, 98).
- [42] T. Watanabe. Configuration space integral for long  $n$ -knots and the Alexander polynomial. *Algebr. Geom. Topol.* 7 (2007), 47–92.
- [43] Ch. A. Weibel. An introduction to homological algebra. *Cambridge Studies in Advanced Mathematics*, 38. Cambridge University Press, Cambridge, 1994. xiv+450 pp.
- [44] M. Weiss, Homology of spaces of smooth embeddings. *Q. J. Math.* 55 (2004), no. 4, 499-504.
- [45] S. Whitehouse. Gamma Homology of Commutative Algebras and Some Related Representations of the Symmetric Group, thesis. Warwick University, 1994.
- [46] T. Willwacher. M. Kontsevich’s graph complex and the Grothendieck-Teichmueller Lie algebra. Preprint arXiv:1009.1654.

#### APPENDIX A. TABLES OF EULER CHARACTERISTICS

We present below results of computer calculations which were produced using Maple. These results appeared partially in [40]. We add here the case of even  $m$ . For completeness of presentation we keep the case of odd  $m$  as well. To recall  $\chi_{st}$  denotes the Euler characteristic of  $H_*(\overline{\text{Emb}}_c(\mathbb{R}^m, \mathbb{R}^n), \mathbb{Q})$  in complexity  $t$  and Hodge degree  $s$ . Let  $\chi_{st}^\pi$  denote the Euler characteristic of an analogous component of  $\mathbb{Q} \otimes \pi_* \overline{\text{Emb}}_c(\mathbb{R}^m, \mathbb{R}^n)$ .

**Lemma A.1.**

$$F_{mn}(x, u) = \sum_{st} \chi_{st} x^s u^t = \prod_{st} \frac{1}{(1 - x^s u^t)^{\chi_{st}^\pi}}. \quad (\text{A.1})$$

*Proof.* See [40, Lemma 16.1]. □

This formula was used to fill Tables 1, 3, 5, 7. The last column “total” stays for the sum of absolute values of the Euler characteristics of the terms in a given complexity. This gives a lower bound estimation for the rank of the rational homotopy in a given complexity.

$t$	Hodge degree $s$																							total
	1	2	3	4	5	6	7	8	9	10	11	12	13	14	15	16	17	18	19	20	21	22	23	
1	1	1	1	0	0	0	0	0	0	0	0	0	0	0	0	0	0	0	0	0	0	0	0	1
2	-1	1	1	0	0	0	0	0	0	0	0	0	0	0	0	0	0	0	0	0	0	0	0	2
3	-1	1	0	0	0	0	0	0	0	0	0	0	0	0	0	0	0	0	0	0	0	0	0	2
4	-1	1	0	0	0	0	0	0	0	0	0	0	0	0	0	0	0	0	0	0	0	0	0	4
5	-2	2	1	1	0	0	0	0	0	0	0	0	0	0	0	0	0	0	0	0	0	0	0	6
6	-2	2	2	2	-3	1	0	0	0	0	0	0	0	0	0	0	0	0	0	0	0	0	0	10
7	-2	4	3	2	-4	2	1	0	0	0	0	0	0	0	0	0	0	0	0	0	0	0	0	18
8	-2	4	-4	7	-6	4	2	0	0	0	0	0	0	0	0	0	0	0	0	0	0	0	0	32
9	-2	5	-10	12	-11	9	4	2	1	0	0	0	0	0	0	0	0	0	0	0	0	0	0	56
10	-1	5	-14	20	-22	19	9	6	2	0	0	0	0	0	0	0	0	0	0	0	0	0	0	102
11	-2	7	-17	30	-39	38	19	16	6	2	0	0	0	0	0	0	0	0	0	0	0	0	0	186
12	0	5	-22	45	-66	72	38	40	16	7	2	1	0	0	0	0	0	0	0	0	0	0	0	340
13	0	4	-25	60	-104	133	72	91	40	24	9	3	1	0	0	0	0	0	0	0	0	0	0	630
14	-1	2	-22	79	-155	221	-244	203	91	68	24	11	3	1	0	0	0	0	0	0	0	0	0	1170
15	-1	3	-17	81	-217	368	-445	413	203	186	68	37	-12	-3	0	0	0	0	0	0	0	0	0	2182
16	-4	3	-12	83	-275	549	-769	823	413	455	186	121	-45	13	1	0	0	0	0	0	0	0	0	4096
17	-18	19	-12	79	-307	751	-1258	1528	823	1071	455	351	-152	53	3	0	0	0	0	0	0	0	0	7710
18	-20	59	-83	65	-257	964	-1943	2651	1528	2369	1071	969	-465	186	16	0	0	0	0	0	0	0	0	14560
19	-13	124	-188	59	-298	1234	-2646	4224	2651	4983	2369	2486	-1353	613	70	3	0	0	0	0	0	0	0	27594
20	12	115	-225	442	-807	1202	-3068	6527	4224	9707	4983	6075	-3672	1847	278	0	0	0	0	0	0	0	0	52452
21	158	-281	-607	1998	-1171	378	-4068	9921	6527	17558	9707	14053	-9307	5204	999	0	0	0	0	0	0	0	0	100736
22	638	-457	-2294	2080	613	3026	-8531	11888	-20247	30923	17558	30247	-22186	13900	3287	0	0	0	0	0	0	0	0	194066
23	480	1706	967	-7614	-6392	20835	-8447	5974	-31163	54026	-61977	60522	-50681	35146	10068	-4302	1570	-484	124	-25	4	0	0	382844

TABLE 1. Table for Euler characteristics  $\chi_{st}^{\pi}$  by complexity  $t$  and Hodge degree  $s$  of  $\pi_* \overline{\text{Emb}}_c(\mathbb{R}^m, \mathbb{R}^n) \otimes \mathbb{Q}$  for both  $m$  and  $n$  odd.

DEPARTMENT OF MATHEMATICS, UNIVERSITY OF VIRGINIA, CHARLOTTESVILLE, VA 22904, USA  
*E-mail address:* zga2m@virginia.edu

DEPARTMENT OF MATHEMATICS, KANSAS STATE UNIVERSITY, MANHATTAN, KS 66506, USA  
*E-mail address:* turchin@ksu.edu

$t$	Hodge degree $s$																						
	1	2	3	4	5	6	7	8	9	10	11	12	13	14	15	16	17	18	19	20	21	22	23
23	480	1619	1446	-5648	-17669	45575	-61584	130666	-271978	436507	-591664	702289	-731813	678875	-570539	441262	-318509	217419	-142337	90568	-56797	35263	-21798
22	638	-391	-2652	3573	-5265	20670	-48875	94966	-171890	262183	-334105	368926	-360657	316730	-253621	187909	-130721	86694	-55715	35034	-21798	13448	-8322
21	158	-217	-956	3381	-5196	11975	-32592	66403	-109135	152157	-181121	187515	-172652	143782	-109800	78122	-52716	34181	-21600	13392	-8322	5173	-3172
20	12	164	-461	1415	-3897	9561	-22616	43567	-66750	85597	-94842	92332	-80218	63394	-46401	31900	-20912	13236	-8322	5173	-3172	1960	-1211
19	-13	155	-348	726	-2645	7467	-15913	27513	-39089	46618	-48051	43930	-36222	27330	-19176	12706	-8187	5131	-3172	1960	-1211	758	-460
18	-20	72	-205	600	-2016	5418	-10793	16931	-21970	24380	-23612	20356	-15886	11412	-7761	5026	-3172	1960	-1211	758	-460	286	-173
17	-18	29	-105	510	-1646	3858	-6917	9960	-11959	12375	-11226	9101	-6791	4701	-3082	1930	-1211	758	-460	286	-173	113	-65
16	-4	14	-97	435	-1256	2628	-4264	5662	-6288	6027	-5164	3991	-2826	1862	-1211	758	-460	286	-173	113	-65	41	-25
15	-1	13	-88	355	-919	1730	-2529	3065	-3190	2882	-2308	1673	-1152	736	-460	286	-173	113	-65	41	-25	18	-8
14	-1	12	-83	290	-633	1063	-1449	1629	-1557	1307	-1003	692	-460	286	-173	113	-65	41	-25	18	-8	6	-3
13	0	15	-74	210	-421	648	-795	820	-743	584	-422	271	-173	113	-65	41	-25	18	-8	6	-3	1	-1
12	0	14	-61	153	-267	367	-422	405	-340	244	-173	113	-65	41	-25	18	-8	6	-3	1	-1	1	0
11	-2	15	-45	101	-166	207	-217	188	-150	102	-65	41	-25	18	-8	6	-3	1	0	0	0	0	0
10	-1	11	-36	67	-95	108	-107	86	-65	41	-25	18	-8	6	-3	1	0	0	0	0	0	0	0
9	-2	10	-25	41	-55	57	-51	34	-25	18	-8	6	-3	1	0	0	0	0	0	0	0	0	0
8	-2	7	-16	25	-30	25	-8	18	-8	6	-3	1	-1	0	0	0	0	0	0	0	0	0	0
7	-2	6	-11	13	-17	13	-8	6	-3	1	-1	0	0	0	0	0	0	0	0	0	0	0	0
6	-1	3	-8	8	-8	6	-3	3	-1	1	0	0	0	0	0	0	0	0	0	0	0	0	0
5	-2	3	-4	3	-3	3	-1	1	-1	0	0	0	0	0	0	0	0	0	0	0	0	0	0
4	-1	1	-3	1	-1	1	0	0	0	0	0	0	0	0	0	0	0	0	0	0	0	0	0
3	-1	1	-1	1	0	0	0	0	0	0	0	0	0	0	0	0	0	0	0	0	0	0	0
2	-1	1	0	1	0	0	0	0	0	0	0	0	0	0	0	0	0	0	0	0	0	0	0
1	0	1	0	1	0	0	0	0	0	0	0	0	0	0	0	0	0	0	0	0	0	0	0

TABLE 2. Table for Euler characteristics  $\chi_{s,t}$  by complexity  $t$  and Hodge degree  $s$  of  $H_*(\text{Emb}_c(\mathbb{R}^m, \mathbb{R}^n); \mathbb{Q})$  for both  $m$  and  $n$  odd.

$t$	Hodge degree $s$																								
	1	2	3	4	5	6	7	8	9	10	11	12	13	14	15	16	17	18	19	20	21	22	23	total	
1	1	2	3	4	5	6	7	8	9	10	11	12	13	14	15	16	17	18	19	20	21	22	23		
2	0	0	1	0	0	0	0	0	0	0	0	0	0	0	0	0	0	0	0	0	0	0	0	0	1
3	1	-1	0	0	0	0	0	0	0	0	0	0	0	0	0	0	0	0	0	0	0	0	0	0	2
4	0	0	0	0	1	0	0	0	0	0	0	0	0	0	0	0	0	0	0	0	0	0	0	0	0
5	1	0	-1	0	-1	0	0	0	0	0	0	0	0	0	0	0	0	0	0	0	0	0	0	0	4
6	-1	1	0	0	1	0	0	0	0	0	0	0	0	0	0	0	0	0	0	0	0	0	0	0	2
7	1	0	-1	0	0	-1	0	0	0	0	0	0	0	0	0	0	0	0	0	0	0	0	0	0	4
8	-1	1	1	-2	0	-1	0	0	0	0	0	0	0	0	0	0	0	0	0	0	0	0	0	0	8
9	0	0	2	-1	0	0	-1	1	-1	0	0	0	0	0	0	0	0	0	0	0	0	0	0	0	6
10	-2	0	3	-2	0	0	-1	2	1	0	0	0	0	0	0	0	0	0	0	0	0	0	0	0	16
11	2	-3	1	3	-6	4	-1	-2	1	0	0	0	0	0	0	0	0	0	0	0	0	0	0	0	24
12	0	-1	0	0	-6	4	2	-1	2	1	0	0	0	0	0	0	0	0	0	0	0	0	0	0	32
13	3	-2	-3	12	-10	-6	15	-13	-6	5	5	1	0	0	0	0	0	0	0	0	0	0	0	0	74
14	0	3	-13	8	-10	-20	19	-8	-4	1	-3	-1	0	0	0	0	0	0	0	0	0	0	0	0	108
15	0	5	-15	5	23	-36	23	11	-32	25	-11	4	3	-1	0	0	0	0	0	0	0	0	0	0	192
16	-7	18	-9	-30	59	-38	-21	68	-59	17	11	-16	1	0	0	0	0	0	0	0	0	0	0	0	370
17	-14	19	23	-82	64	34	-100	96	-43	-21	56	-49	21	-5	-2	2	0	0	0	0	0	0	0	0	630
18	-16	-1	52	-120	78	152	-268	122	85	-168	126	-45	21	-2	0	0	0	0	0	0	0	0	0	0	1294
19	-12	-88	176	-8	-186	290	-265	-30	346	-339	100	76	-108	26	-3	-1	-1	0	0	0	0	0	0	0	2142
20	7	-167	393	-8	-937	558	-265	-611	85	-168	126	-45	21	-2	0	0	0	0	0	0	0	0	0	0	4932
21	168	-37	13	-108	-1151	1472	327	-611	531	-312	-98	363	-294	101	17	-33	3	-2	0	0	0	0	0	0	10338
22	638	-241	-2676	1806	2506	-1378	-349	-2171	1510	718	-984	667	-238	-748	206	-132	45	-6	-7	1	0	0	0	0	20920
23	468	-2644	-2607	12686	1016	-18755	5351	8867	-4274	1079	-2353	228	2389	-2042	537	261	-351	201	-66	8	3	-2	0	0	66188

TABLE 3. Table of Euler characteristics  $\chi_{st}^\pi$  by complexity  $t$  and Hodge degree  $s$  of  $\pi_* \overline{\text{Emb}}_c(\mathbb{R}^m, \mathbb{R}^n) \otimes \mathbb{Q}$  for  $m$  odd and  $n$  even.

$t$	Hodge degree $s$																						
	1	2	3	4	5	6	7	8	9	10	11	12	13	14	15	16	17	18	19	20	21	22	23
23	468	-3290	-2544	16300	-1620	-21938	8761	5388	1424	1676	-11716	9157	-435	-4214	4986	-3974	2252	-794	35	259	-329	263	-171
22	638	-425	-2710	2145	2011	404	-1311	-5578	6395	632	-4769	4616	-3318	1372	602	-1566	1455	-944	498	-209	69	-13	-13
21	168	-74	245	-495	-1705	3209	117	-3475	3050	-1416	-96	1624	-2223	1691	-832	214	141	-285	255	-169	93	-43	19
20	7	-165	519	-77	-991	1031	-444	-27	951	-1739	1332	-232	-616	871	-725	452	-210	73	-16	-13	27	-22	17
19	-12	-84	216	-136	-38	368	-761	556	184	-721	814	-622	318	-4	-193	219	-161	94	-43	19	-14	3	1
18	-16	20	31	-188	266	29	-425	526	-326	-42	332	-413	330	-188	80	-22	-13	27	-22	17	-7	4	-2
17	-14	22	10	-86	126	-74	-33	190	-295	257	-91	-79	148	-135	90	-42	19	-14	3	1	-3	2	-2
16	-7	25	-27	-11	88	-139	67	60	-147	165	-127	75	-30	-9	25	-22	17	-7	4	-2	2	0	0
15	0	2	-20	33	3	-60	105	-83	2	65	-88	72	-38	20	-14	3	1	-3	2	0	0	0	0
14	0	4	-16	15	-5	-16	45	-59	51	-30	0	19	-22	17	-7	4	-2	0	0	0	1	0	0
13	3	-6	3	20	-33	14	15	-36	41	-28	19	-13	3	1	-3	2	0	0	-1	0	0	0	0
12	0	-2	3	1	-11	21	-23	6	11	-18	15	-7	4	-2	0	0	0	1	0	0	0	0	0
11	2	-3	3	1	-8	14	-12	12	-11	4	1	-3	2	-2	1	-1	0	0	0	0	0	0	0
10	-2	2	3	-10	6	3	-10	11	-7	4	-2	0	0	0	0	0	0	0	0	0	0	0	0
9	0	0	3	-2	4	-7	4	1	-3	2	-2	0	-1	0	0	0	0	0	0	0	0	0	0
8	-1	1	0	-3	5	-5	3	-2	0	0	0	1	0	0	0	0	0	0	0	0	0	0	0
7	1	1	-3	2	1	-2	0	-2	0	-1	0	0	0	0	0	0	0	0	0	0	0	0	0
6	-1	1	-1	1	-2	0	0	0	1	0	0	0	0	0	0	0	0	0	0	0	0	0	0
5	1	0	-1	2	-2	0	-1	0	0	0	0	0	0	0	0	0	0	0	0	0	0	0	0
4	1	-1	0	0	0	1	0	0	0	0	0	0	0	0	0	0	0	0	0	0	0	0	0
3	1	-1	0	-1	0	0	0	0	0	0	0	0	0	0	0	0	0	0	0	0	0	0	0
2	0	0	1	0	0	0	0	0	0	0	0	0	0	0	0	0	0	0	0	0	0	0	0
1	-1	0	0	0	0	0	0	0	0	0	0	0	0	0	0	0	0	0	0	0	0	0	0

TABLE 4. Table for Euler characteristics  $\chi_{st}$  by complexity  $t$  and Hodge degree  $s$  of  $H_*(\overline{\text{Emb}}_c(\mathbb{R}^m, \mathbb{R}^n); \mathbb{Q})$  for  $m$  odd and  $n$  even.

$t$	Hodge degree $s$																							
	1	2	3	4	5	6	7	8	9	10	11	12	13	14	15	16	17	18	19	20	21	22	23	total
1	1	0	0	0	0	0	0	0	0	0	0	0	0	0	0	0	0	0	0	0	0	0	0	0
2	1	0	-1	0	0	0	0	0	0	0	0	0	0	0	0	0	0	0	0	0	0	0	0	0
3	1	0	-1	0	0	0	0	0	0	0	0	0	0	0	0	0	0	0	0	0	0	0	0	0
4	1	0	-1	0	0	0	0	0	0	0	0	0	0	0	0	0	0	0	0	0	0	0	0	0
5	2	0	-2	0	0	0	0	0	0	0	0	0	0	0	0	0	0	0	0	0	0	0	0	0
6	1	1	-3	-1	1	0	0	0	0	0	0	0	0	0	0	0	0	0	0	0	0	0	0	0
7	2	2	-4	-3	2	1	0	0	0	0	0	0	0	0	0	0	0	0	0	0	0	0	0	0
8	2	2	-4	-3	2	1	0	0	0	0	0	0	0	0	0	0	0	0	0	0	0	0	0	0
9	2	3	-4	-5	4	2	-2	0	0	0	0	0	0	0	0	0	0	0	0	0	0	0	0	0
10	1	6	-4	-10	6	5	-4	-1	1	0	0	0	0	0	0	0	0	0	0	0	0	0	0	0
11	2	5	-3	-15	6	14	-6	-4	3	0	0	0	0	0	0	0	0	0	0	0	0	0	0	0
12	0	8	0	-22	3	24	-7	-12	6	0	0	0	0	0	0	0	0	0	0	0	0	0	0	0
13	0	8	8	-29	-10	42	-2	-28	8	7	2	0	0	0	0	0	0	0	0	0	0	0	0	0
14	1	5	16	-30	-35	61	17	-55	7	8	-8	-4	0	0	0	0	0	0	0	0	0	0	0	0
15	1	1	22	-25	-69	83	64	-102	-11	54	-11	-12	5	2	0	0	0	0	0	0	0	0	0	0
16	4	-4	20	8	-114	63	156	-147	-70	112	-4	-36	10	4	0	0	0	0	0	0	0	0	0	0
17	18	-14	-5	67	-157	-19	308	-152	-216	193	46	-92	12	18	0	0	0	0	0	0	0	0	0	0
18	20	10	-45	107	-170	63	543	-187	-535	287	212	-200	17	57	0	0	0	0	0	0	0	0	0	0
19	13	101	-152	-1	57	-363	613	-68	-987	278	587	-361	-129	153	0	0	0	0	0	0	0	0	0	0
20	-12	184	-363	-138	800	-740	1101	218	-1370	-198	1301	-474	-17	47	0	0	0	0	0	0	0	0	0	0
21	-158	37	17	125	976	-1707	3204	63	-1737	-1955	2594	-474	-1373	325	0	0	0	0	0	0	0	0	0	0
22	-638	265	2692	-1778	-2654	977	3462	750	-2360	-4510	4592	-50	-3317	584	-489	-3	10	8	1	0	0	0	0	0
23	-480	2668	2671	-12646	-1205	18262	-5099	-7079	3934	-4918	3808	4485	-5937	-227	2845	-822	-561	317	18	-41	7	1	-1	78032

TABLE 5. Table of Euler characteristics  $\chi_{s,t}^\pi$  by complexity  $t$  and Hodge degree  $s$  of  $\pi_* \overline{\text{Emb}}_c(\mathbb{R}^m, \mathbb{R}^n) \otimes \mathbb{Q}$  for  $m$  even and  $n$  odd.

$t$	Hodge degree $s$																						
	1	2	3	4	5	6	7	8	9	10	11	12	13	14	15	16	17	18	19	20	21	22	23
23	-480	2581	3195	-12377	-765	17280	-13802	-1468	24753	-20043	-19152	25227	7322	-16381	-663	6690	-706	-1769	375	280	-84	-21	7
22	-638	333	3111	-1797	-2542	-619	-3755	10105	7017	-17039	-3718	14520	-90	-7577	1088	2562	-638	-551	195	64	-30	-1	0
21	-158	101	250	368	1110	-4072	-2751	9579	1742	-10895	550	7360	-1393	-3206	931	906	-349	-151	76	9	-8	1	0
20	-12	234	-253	199	829	-2859	-622	5706	-631	-5574	1446	3257	-1158	-1204	528	270	-149	-30	24	1	-2	0	0
19	13	132	-56	291	-124	-1900	779	3096	-1377	-2563	1271	1270	-711	-386	255	63	-55	-3	5	0	0	0	0
18	20	25	57	343	-489	-1192	1061	1557	-1203	-1092	840	456	-375	-107	105	8	-16	2	0	0	0	0	0
17	18	-4	93	216	-491	-612	849	699	-794	-412	460	134	-169	-21	39	-1	-5	1	0	0	0	0	0
16	4	9	101	89	-398	-253	588	248	-459	-122	221	31	-68	-1	12	-1	-1	0	0	0	0	0	0
15	1	11	94	3	-294	-54	364	62	-244	-23	101	-2	-24	3	2	0	0	0	0	0	0	0	0
14	1	17	67	-28	-192	11	209	-4	-119	7	42	-5	-8	2	0	0	0	0	0	0	0	0	0
13	0	19	45	-44	-115	36	112	-16	-55	7	15	-3	-2	1	0	0	0	0	0	0	0	0	0
12	0	18	26	-39	-64	33	55	-17	-21	6	5	-1	-1	0	0	0	0	0	0	0	0	0	0
11	2	13	13	-32	-34	26	26	-9	-8	2	1	0	0	0	0	0	0	0	0	0	0	0	0
10	1	14	5	-25	-15	15	12	-6	-3	2	0	0	0	0	0	0	0	0	0	0	0	0	0
9	2	8	2	-16	-8	10	5	-3	-1	0	0	0	0	0	0	0	0	0	0	0	0	0	0
8	2	6	-1	-2	-3	5	2	-1	0	0	0	0	0	0	0	0	0	0	0	0	0	0	0
7	2	4	-2	-7	0	3	0	0	0	0	0	0	0	0	0	0	0	0	0	0	0	0	0
6	1	3	-1	-4	0	1	0	0	0	0	0	0	0	0	0	0	0	0	0	0	0	0	0
5	2	1	-2	-2	0	1	0	0	0	0	0	0	0	0	0	0	0	0	0	0	0	0	0
4	1	1	-1	-1	0	0	0	0	0	0	0	0	0	0	0	0	0	0	0	0	0	0	0
3	1	0	-1	0	0	0	0	0	0	0	0	0	0	0	0	0	0	0	0	0	0	0	0
2	1	0	-1	0	0	0	0	0	0	0	0	0	0	0	0	0	0	0	0	0	0	0	0
1	1	0	0	0	0	0	0	0	0	0	0	0	0	0	0	0	0	0	0	0	0	0	0

TABLE 6. Table for Euler characteristics  $\chi_{st}$  by complexity  $t$  and Hodge degree  $s$  of  $H_*(\overline{\text{Emb}}_c(\mathbb{R}^m, \mathbb{R}^n); \mathbb{Q})$  for  $m$  even and  $n$  odd.

$t$	Hodge degree $s$																								
	1	2	3	4	5	6	7	8	9	10	11	12	13	14	15	16	17	18	19	20	21	22	23	total	
1	1	2	3	4	5	6	7	8	9	10	11	12	13	14	15	16	17	18	19	20	21	22	23		
2	0	-1	0	0	0	0	0	0	0	0	0	0	0	0	0	0	0	0	0	0	0	0	0	0	2
3	-1	0	1	0	0	0	0	0	0	0	0	0	0	0	0	0	0	0	0	0	0	0	0	0	0
4	0	0	0	0	0	0	0	0	0	0	0	0	0	0	0	0	0	0	0	0	0	0	0	0	2
5	-1	0	0	0	1	0	0	0	0	0	0	0	0	0	0	0	0	0	0	0	0	0	0	0	0
6	0	0	-1	0	0	0	0	0	0	0	0	0	0	0	0	0	0	0	0	0	0	0	0	0	2
7	-1	0	0	0	0	0	1	1	0	0	0	0	0	0	0	0	0	0	0	0	0	0	0	0	4
8	1	0	-1	0	-1	0	1	1	0	0	0	0	0	0	0	0	0	0	0	0	0	0	0	0	4
9	0	-2	0	0	-1	2	0	-1	-1	0	0	0	0	0	0	0	0	0	0	0	0	0	0	0	8
10	2	0	1	-1	-4	-1	0	-1	1	0	0	0	0	0	0	0	0	0	0	0	0	0	0	0	12
11	-2	-1	0	0	-4	2	-4	-1	1	-1	0	0	0	0	0	0	0	0	0	0	0	0	0	0	18
12	0	2	3	0	1	3	0	4	1	0	1	0	0	0	0	0	0	0	0	0	0	0	0	0	32
13	-3	0	0	-5	-8	1	-5	8	-1	-3	3	-2	0	0	0	0	0	0	0	0	0	0	0	0	50
14	0	9	-3	-10	12	-14	-2	19	-13	-1	4	-3	-2	0	0	0	0	0	0	0	0	0	0	0	92
15	0	5	-18	9	27	-35	10	-14	-25	-1	1	-4	6	-2	1	0	0	0	0	0	0	0	0	0	172
16	7	4	-29	27	4	-54	56	14	-32	15	-18	-6	4	-2	0	0	0	0	0	0	0	0	0	0	284
17	14	-12	-30	62	-44	-24	102	-96	-32	32	-18	-3	10	-6	0	0	0	0	0	0	0	0	0	0	556
18	16	-40	40	102	-217	41	178	-187	-11	73	-46	12	7	-13	2	0	0	0	0	0	0	0	0	0	1156
19	12	-115	120	142	-289	201	-2	-252	75	38	-100	70	-90	-16	0	0	0	0	0	0	0	0	0	0	1988
20	-7	-107	165	-197	28	702	178	-169	312	-122	-101	169	-204	-3	3	1	0	0	0	0	0	0	0	0	4126
21	-168	297	545	-1715	222	2201	-810	-229	813	-501	-18	221	-204	5	11	3	0	0	0	0	0	0	0	0	9950
22	-638	481	2210	-1750	-1795	319	794	-229	-2385	-765	715	-880	-410	-30	40	40	0	0	0	0	0	0	0	0	19798
23	-468	-1710	-1071	8002	4949	-16438	-2173	15344	-4481	-4279	3298	-1739	901	387	-997	591	-66	-108	92	-47	15	-3	1	0	67160

TABLE 7. Table of Euler characteristics  $\chi_{st}^{\pi}$  by complexity  $t$  and Hodge degree  $s$  of  $\pi_* \overline{\text{Emb}}_c(\mathbb{R}^m, \mathbb{R}^n) \otimes \mathbb{Q}$  for both  $m$  and  $n$  even.

$t$	Hodge degree $s$																						
	1	2	3	4	5	6	7	8	9	10	11	12	13	14	15	16	17	18	19	20	21	22	23
23	-468	-2356	-21	10045	995	-18299	1395	18535	-5178	-11047	5413	3500	-2695	-314	611	-70	-34	5	-64	51	-78	38	125
22	-638	295	2797	-1627	-4280	2443	3324	-1267	-2147	172	1684	-221	-1092	408	399	-238	-32	-9	26	-60	34	105	-76
21	-168	260	468	-1546	-61	2736	-975	-1986	1258	438	-614	150	95	-28	5	-32	-44	46	-52	25	89	-64	0
20	-7	-103	70	61	41	234	-486	-239	701	-38	-436	184	106	-116	33	-16	7	-41	24	75	-54	0	0
19	12	-111	58	237	-227	-100	270	-106	-100	66	-29	49	23	-39	-33	29	52	20	63	0	0	0	0
18	16	-19	20	96	-157	-87	201	-47	-92	112	-4	-61	27	-20	11	-25	15	52	-38	0	0	0	0
17	14	-9	-41	31	23	-33	49	-8	-60	31	15	-8	-16	13	-27	14	44	-32	0	0	0	0	0
16	7	12	-22	2	19	-49	-2	57	-11	-16	16	-26	8	-15	11	36	0	0	0	0	0	0	0
15	0	2	-15	-5	34	-4	-14	15	-12	-6	-5	10	-17	9	30	-22	0	0	0	0	0	0	0
14	0	9	0	-11	4	-1	-10	8	-5	-19	3	-10	7	25	-18	0	0	0	0	0	0	0	0
13	-3	-4	2	-1	7	10	2	0	7	2	-10	3	20	-15	0	0	0	0	0	0	0	0	0
12	0	2	5	-4	-7	5	-6	-8	-6	-7	3	-10	-12	0	0	0	0	0	0	0	0	0	0
11	-2	-1	2	1	0	-6	4	-1	3	5	13	0	0	0	0	0	0	0	0	0	0	0	0
10	2	1	-1	0	-1	1	4	-5	8	11	-8	0	0	0	0	0	0	0	0	0	0	0	0
9	0	-2	-1	4	-3	1	-3	2	-5	0	0	0	0	0	0	0	0	0	0	0	0	0	0
8	-1	1	-2	-3	1	-3	2	7	0	0	0	0	0	0	0	0	0	0	0	0	0	0	0
7	1	0	0	-1	-1	4	5	-4	0	0	0	0	0	0	0	0	0	0	0	0	0	0	0
6	1	-1	0	-2	1	4	-3	0	0	0	0	0	0	0	0	0	0	0	0	0	0	0	0
5	-1	0	-1	1	3	-2	0	0	0	0	0	0	0	0	0	0	0	0	0	0	0	0	0
4	0	-1	2	2	-2	0	0	0	0	0	0	0	0	0	0	0	0	0	0	0	0	0	0
3	-1	0	1	-1	0	0	0	0	0	0	0	0	0	0	0	0	0	0	0	0	0	0	0
2	0	1	-1	0	0	0	0	0	0	0	0	0	0	0	0	0	0	0	0	0	0	0	0
1	1	-1	0	0	0	0	0	0	0	0	0	0	0	0	0	0	0	0	0	0	0	0	0

TABLE 8. Table for Euler characteristics  $\chi_{s,t}$  by complexity  $t$  and Hodge degree  $s$  of  $H_*(\overline{\text{Emb}}_c(\mathbb{R}^m, \mathbb{R}^n); \mathbb{Q})$  for both  $m$  and  $n$  even.

# ON THE RATIONAL HOMOTOPY TYPE OF HIGH DIMENSIONAL ANALOGUES OF SPACES OF LONG KNOTS

GREGORY ARONE AND VICTOR TURCHIN

ABSTRACT. We study high-dimensional analogues of spaces of long knots. These are spaces of compactly-supported embeddings between Euclidean spaces (modulo immersions). We show that when the dimensions are in the stable range, the rational homology and homotopy groups of these spaces of embeddings can be calculated as the homology of a direct sum of certain finite graph complexes, which we describe explicitly. The proof uses the calculus of embeddings, the theory of operads, and some homological algebra of diagrams.

## CONTENTS

Introduction	2
<b>Part 1. General theory</b>	11
1. Operads, modules and weak bimodules	11
2. Operads as categories, modules as functors	18
3. The little balls operad	28
4. Embedding tower as the space of module maps	34
5. Applying the formality theorem	39
6. From the little balls operad to the commutative operad	42
<b>Part 2. Explicit complexes</b>	47
7. The splitting by homological degree	47
8. The Koszul spectral sequence for $\Omega$ -modules	49
9. The Koszul complex	53
10. A complex of forests	62
11. Complex of deformations	64
12. Graph-complexes	66
12.1. Rational homotopy of $\overline{\text{Emb}}_c(\mathbb{R}^m, \mathbb{R}^n)$ in small dimensions	73
13. Rational homotopy type of $\text{Emb}_c(\mathbb{R}^m, \mathbb{R}^n)$	78
14. Euler characteristics of the double splitting	83
References	87
Appendix A. Tables of Euler characteristics	88

---

Supported by the NSF.

## INTRODUCTION

Let  $\mathbb{R}^m, \mathbb{R}^n$  be Euclidean spaces, and let  $i: \mathbb{R}^m \hookrightarrow \mathbb{R}^n$  be a fixed linear inclusion. Let  $\text{Emb}_c(\mathbb{R}^m, \mathbb{R}^n)$  be the space of smooth embeddings of  $\mathbb{R}^m$  into  $\mathbb{R}^n$  that agree with  $i$  outside a compact subset of  $\mathbb{R}^m$ . In the case when  $m = 1$  this is sometimes called the space of long knots in  $\mathbb{R}^n$ . We call the elements of  $\text{Emb}_c(\mathbb{R}^m, \mathbb{R}^n)$  “long embeddings” of  $\mathbb{R}^m$  into  $\mathbb{R}^n$ .

Let  $\text{Imm}_c(\mathbb{R}^m, \mathbb{R}^n)$  be the space of smooth immersions of  $\mathbb{R}^m$  into  $\mathbb{R}^n$  that agree with  $i$  outside a compact set. It follows easily from the Smale-Hirsch theory that there is a homotopy equivalence (assuming that  $n \geq m + 1$ )  $\text{Imm}_c(\mathbb{R}^m, \mathbb{R}^n) \simeq \Omega^m \text{Inj}(\mathbb{R}^m, \mathbb{R}^n)$  where  $\Omega^m$  denotes  $m$ -fold loop space, and  $\text{Inj}(\mathbb{R}^m, \mathbb{R}^n)$  is the Stiefel manifold of linear isometric injections of  $\mathbb{R}^m$  into  $\mathbb{R}^n$ . Thus, the homotopy type of  $\text{Imm}_c(\mathbb{R}^m, \mathbb{R}^n)$  is (in some sense) well-understood, and we view it as “the easy part of  $\text{Emb}_c(\mathbb{R}^m, \mathbb{R}^n)$ ”.

Let  $\overline{\text{Emb}}_c(\mathbb{R}^m, \mathbb{R}^n)$  be the homotopy fiber of the inclusion map  $\text{Emb}_c(\mathbb{R}^m, \mathbb{R}^n) \rightarrow \text{Imm}_c(\mathbb{R}^m, \mathbb{R}^n)$ , with  $i$  serving as the basepoint. This paper is concerned with the rational homotopy type of  $\overline{\text{Emb}}_c(\mathbb{R}^m, \mathbb{R}^n)$  and  $\text{Emb}_c(\mathbb{R}^m, \mathbb{R}^n)$ . For technical reasons we work mostly with the former space, but we make some conclusions about the latter as well. Our main computational result (Theorem 0.2 below) gives a rather explicit algebraic model for the rational homology and homotopy groups of  $\overline{\text{Emb}}_c(\mathbb{R}^m, \mathbb{R}^n)$  in the case when  $n > 2m + 1$ . Our results may be viewed as extending the results of [16, 5, 26] on  $\overline{\text{Emb}}_c(\mathbb{R}^1, \mathbb{R}^n)$  to more general spaces of long embeddings. We also draw heavily on the methods of [6], which is concerned with space of embedding  $\overline{\text{Emb}}(M, \mathbb{R}^n)$ , where  $M$  is an open submanifold of  $\mathbb{R}^m$ .

Before we can state the result, we have to define a few terms. Let  $\mathcal{C}$  be a small category and let  $\mathcal{D}$  be any category. A right  $\mathcal{C}$ -module (resp. left  $\mathcal{C}$ -module) with values in  $\mathcal{D}$  is a contravariant (resp. covariant) functor from  $\mathcal{C}$  to  $\mathcal{D}$ . As example any group or monoid  $G$  can be viewed as a category with a single object. Right (resp. left) modules over such category are exactly right (resp. left)  $G$ -modules. We will sometimes omit to mention explicitly the category  $\mathcal{D}$  and just speak of right or left  $\mathcal{C}$ -modules.

Let  $\Gamma$  be the category of pointed finite sets and pointed functions between them, and let  $\Omega$  be the category of unpointed finite sets and surjective functions between them. Our main result is formulated in terms of certain right- $\Omega$ -modules. Let us first introduce a  $\Gamma$ -module that will play an important role.

Let  $i$  be a natural number. By a slight abuse of notation, we will use the same symbol  $i$  to denote the stanard set with  $i$  elements  $\{1, \dots, i\}$ . Also, let  $i_+$  be the pointed set  $\{0, 1, \dots, i\}$ , with 0 serving as the basepoint. Let  $D^n$  be the unit open ball in  $\mathbb{R}^n$ . Let  $\mathbf{B}_n(i) := \text{sEmb}(i \times D^n, D^n)$  be the space of *standard embeddings* from the disjoint union of  $i$  copies of  $D^n$  into  $D^n$ , where a standard embedding is an embedding that on each connected component amounts to multiplication by a positive scalar followed by a translation. The spaces  $\{\mathbf{B}_n(i)\}_{i=0}^\infty$  make up the (unframed) little balls operad. The reader may want to keep in mind that the space  $\mathbf{B}_n(i)$  is homotopy equivalent to the space of ordered  $i$ -tuples of distinct points in  $\mathbb{R}^n$ .

It turns out that for  $n \geq 2$  there is a well-defined right  $\Gamma$ -module *with values in the homotopy category of spaces*, whose values on the objects of  $\Gamma$  are given by the formula

$$i_+ \mapsto \mathbf{B}_n(i).$$

*Remark 0.1.* Let us emphasize that the above module is not a module with values in the category of spaces. The assignment  $i_+ \mapsto \mathbf{B}_n(i)$  is only functorial up to homotopy. This could make many readers suspicious, for diagrams in the homotopy category are often useless. Nevertheless it turns out that this module can do useful work for us.

Let  $H(X)$  denote the (unreduced) homology of  $X$ , considered as a graded group. It follows from the discussion above that we have a well-defined right  $\Gamma$ -modules with values in graded Abelian groups, defined on the objects of  $\Gamma$  by the formula

$$i_+ \mapsto H(\mathbf{B}_n(i)).$$

Furthermore, let  $\pi(X)$  denote the collection of homotopy groups of  $X$ , also considered as a graded group. It turns out that if  $n \geq 3$  then the spaces  $\mathbf{B}_n(i)$  are simply connected, and there is a well-defined right  $\Gamma$ -module

$$i_+ \mapsto \pi(\mathbf{B}_n(i)).$$

We will denote these right modules by  $H(\mathbf{B}_n(\bullet))$  and  $\pi(\mathbf{B}_n(\bullet))$ .

We really want to work with right  $\Omega$ -modules rather than  $\Gamma$ -modules. Let  $\Gamma\text{-mod}$  and  $\Omega\text{-mod}$  be the categories of right  $\Gamma$ -modules and right  $\Omega$ -modules with values in some Abelian category. In [21] Pirashvili defined a certain cross-effect functor

$$cr: \Gamma\text{-mod} \longrightarrow \Omega\text{-mod}$$

and showed that it induces an equivalence of categories. Let  $\hat{\pi}(\mathbf{B}_n(\bullet))$  and  $\hat{H}(\mathbf{B}_n(\bullet))$  be Pirashvili's cross-effects of the  $\Gamma$ -modules  $\pi(\mathbf{B}_n(\bullet))$  and  $H(\mathbf{B}_n(\bullet))$ . By construction,  $\hat{\pi}(\mathbf{B}_n(\bullet))$  and  $\hat{H}(\mathbf{B}_n(\bullet))$  are right  $\Omega$ -modules with values in the category of graded Abelian groups. These groups are sometimes called *normalized* homology and homotopy of configuration spaces or in other words it is a part of the homology and homotopy which in some sense does not come from configurations with smaller number of points.

We need to define another family of right  $\Omega$ -modules. Fix an integer  $m \geq 1$ , and consider the sequence of spaces  $S^0, S^m, S^{2m}, \dots, S^{im}, \dots$ . It is well-known that the diagonal maps endow this sequence with the structure of a right  $\Omega$ -module with values in  $\text{Top}_*$ . We denote this right module by  $S^{m\bullet}$ . Applying reduced homology to it, we obtain the right module  $\tilde{H}(S^{m\bullet})$ .

We often think of graded Abelian groups as chain complexes with zero differential. In this way, we may consider  $\tilde{H}(S^{m\bullet})$ ,  $\hat{\pi}(\mathbf{B}_n(\bullet))$  and  $\hat{H}(\mathbf{B}_n(\bullet))$  to be right  $\Omega$ -modules with values in chain complexes. The category of chain complexes has a (cofibrantly generated) Quillen closed model structure. It follows that the category of right  $\Omega$ -modules with values in chain complexes has a model structure. In fact, it has an internal derived hom object. Let  $F$  and  $G$  be right  $\Omega$ -modules with values of chain complexes. We define

$$\text{hRmod}_{\Omega}(F, G)$$

to be the internal derived hom object. It can be defined as the strict hom object between a cofibrant replacement of  $F$  and a fibrant replacement of  $G$ .

The following then is our main theorem. We view it as giving an algebraic model for the rational homology and homotopy groups of  $\overline{\text{Emb}}_c(\mathbb{R}^m, \mathbb{R}^n)$ .

**Theorem 0.2.** *Assume that  $n > 2m + 1$ . There is a weak equivalence of chain complexes*

$$(0.1) \quad \mathbf{C}^{\mathbb{Q}}(\overline{\text{Emb}}_c(\mathbb{R}^m, \mathbb{R}^n)) \simeq \text{hRmod}_{\Omega} \left( \tilde{\text{H}}(S^{m\bullet}), \hat{\text{H}}(\mathbf{B}_n(\bullet)); \mathbb{Q} \right).$$

Here  $\mathbf{C}^{\mathbb{Q}}(X)$  denotes the rationalization of the singular chain complex of  $X$ . It follows that there is an isomorphism of rational homology groups

$$\text{H}(\overline{\text{Emb}}_c(\mathbb{R}^m, \mathbb{R}^n); \mathbb{Q}) \cong \text{H} \left( \text{hRmod}_{\Omega} \left( \tilde{\text{H}}(S^{m\bullet}), \hat{\text{H}}(\mathbf{B}_n(\bullet)); \mathbb{Q} \right) \right).$$

There also is an isomorphism

$$(0.2) \quad \pi(\overline{\text{Emb}}_c(\mathbb{R}^m, \mathbb{R}^n)) \otimes \mathbb{Q} \cong \text{H} \left( \text{hRmod}_{\Omega} \left( \tilde{\text{H}}(S^{m\bullet}), \hat{\pi}(\mathbf{B}_n(\bullet)) \otimes \mathbb{Q} \right) \right).$$

We will first discuss some consequences of the theorem, and then outline the proof. Note that if  $X(\bullet)$  is a right  $\Omega$ -module with values in  $\text{Top}$ , or even just the homotopy category of  $\text{Top}$ , then  $\text{H}(X(\bullet))$  splits as a direct sum, as well as a direct product of right-modules concentrated in a single homological degree. Namely, there are obvious isomorphisms of  $\Omega$ -modules

$$\text{H}(X(\bullet)) \cong \bigoplus_{n=0}^{\infty} \text{H}_n(X(\bullet)) \cong \prod_{n=0}^{\infty} \text{H}_n(X(\bullet)).$$

Here we view  $\text{H}_n(X)$  as a chain complex concentrated in dimension  $n$ . There is a similar decomposition of  $\pi(X(\bullet))$ . It follows that the right hand sides of (0.1) and (0.2) split as products of mapping spaces between right modules with values in chain complexes concentrated in a single degree. More specifically, there are weak equivalence of chain complexes

$$\text{hRmod}_{\Omega} \left( \tilde{\text{H}}(S^{m\bullet}), \hat{\text{H}}(\mathbf{B}_n(\bullet)); \mathbb{Q} \right) \simeq \prod_{i,j \geq 0} \text{hRmod}_{\Omega} \left( \tilde{\text{H}}_i(S^{m\bullet}), \hat{\text{H}}_j(\mathbf{B}_n(\bullet)); \mathbb{Q} \right)$$

and

$$\text{hRmod}_{\Omega} \left( \tilde{\text{H}}(S^{m\bullet}), \hat{\pi}(\mathbf{B}_n(\bullet)) \otimes \mathbb{Q} \right) \simeq \prod_{i,j \geq 0} \text{hRmod}_{\Omega} \left( \tilde{\text{H}}_i(S^{m\bullet}), \hat{\pi}_j(\mathbf{B}_n(\bullet)) \otimes \mathbb{Q} \right).$$

In fact, one can show that in case  $n > 2m + 1$ , the direct products on the right side can be replaced with direct sums. Also, note that the decomposition is unnecessarily wasteful, because  $\tilde{\text{H}}_i(S^{m\bullet})$  is non-zero only if  $i$  is a multiple of  $m$ . Similarly,  $\hat{\text{H}}_j(\mathbf{B}_n(\bullet))$  is non-zero only if  $j$  is a multiple of  $n - 1$ , and  $\hat{\pi}_j(\mathbf{B}_n(\bullet)) \otimes \mathbb{Q}$  is non zero only if  $j = 1 + (n - 1)t$

for some integer  $t$ . Therefore, the decompositions above can be rewritten in the following more economic form.

$$(0.3) \quad \mathrm{hRmod}_{\Omega} \left( \tilde{\mathrm{H}}(S^{m\bullet}), \hat{\mathrm{H}}(\mathbf{B}_n(\bullet); \mathbb{Q}) \right) \simeq \bigoplus_{s,t \geq 0} \mathrm{hRmod}_{\Omega} \left( \tilde{\mathrm{H}}_{ms}(S^{m\bullet}), \hat{\mathrm{H}}_{(n-1)t}(\mathbf{B}_n(\bullet); \mathbb{Q}) \right)$$

and

$$(0.4) \quad \mathrm{hRmod}_{\Omega} \left( \tilde{\mathrm{H}}(S^{m\bullet}), \hat{\pi}(\mathbf{B}_n(\bullet)) \otimes \mathbb{Q} \right) \simeq \bigoplus_{s,t \geq 0} \mathrm{hRmod}_{\Omega} \left( \tilde{\mathrm{H}}_{ms}(S^{m\bullet}), \hat{\pi}_{1+(n-2)t}(\mathbf{B}_n(\bullet)) \otimes \mathbb{Q} \right).$$

In fact, the decomposition can be reduced even further. For example, we will see that the terms on the right hand side of (0.3) are non-zero only if  $s \leq 2t$ ; for (0.4) one has a stronger restriction  $s \leq t + 1$ . This actually produces a double splitting in the rational homology and homotopy of  $\overline{\mathrm{Emb}}_c(\mathbb{R}^m, \mathbb{R}^n)$ . Throughout the paper the grading  $s$  of the splitting will be called *Hodge degree* and the grading  $t$  will be called *complexity*.

We will describe several explicit models for the summands in the right hand sides of (0.3) and (0.4). In Sections 8 and 9 we will analyze the mapping objects

$$\mathrm{hRmod}_{\Omega} \left( \tilde{\mathrm{H}}_{ms}(S^{m\bullet}), \hat{\mathrm{H}}_{(n-1)t}(\mathbf{B}_n(\bullet); \mathbb{Q}) \right)$$

by filtering the category  $\Omega$  by cardinality. Analysing this filtration leads us to a certain explicit complex that is weakly equivalent to this “space” of module maps. We call it the Koszul complex, because it can be viewed as a kind of Koszul resolution. Indeed, right modules over  $\Omega$  are the same thing as right modules over the non-unital commutative operad. The Koszul dual of this operad is the non-unital Lie operad. The Koszul dual of the  $\Omega$ -module  $\tilde{\mathrm{H}}_{ms}(S^{m\bullet})$  is a module over the Lie operad, and it makes an explicit appearance in the Koszul complex. We give an explicit description of the Koszul complex in terms of certain spaces of forests.

We do not write an explicit description of the Koszul complex of

$$\mathrm{hRmod}_{\Omega} \left( \tilde{\mathrm{H}}_{ms}(S^{m\bullet}), \hat{\pi}_{1+(n-2)t}(\mathbf{B}_n(\bullet)) \otimes \mathbb{Q} \right)$$

but we do think that it would be interesting to do.

We do not emphasize this point of view, but one can obtain the Koszul complex by taking a cofibrant approximation of the right  $\Omega$ -module  $\tilde{\mathrm{H}}_{ms}(S^{m\bullet})$  in the projective Quillen model structure on the category of right modules, and then studying the strict mapping object from the cofibrant approximation. In Section 12 we pursue the dual approach. Namely, we use certain explicit fibrant approximations in the injective module structure of the right modules  $\hat{\mathrm{H}}_{(n-1)t}(\mathbf{B}_n(\bullet); \mathbb{Q})$  and  $\hat{\pi}_{1+(n-2)t}(\mathbf{B}_n(\bullet)) \otimes \mathbb{Q}$  to write different complexes that model the right hand side of (0.3) and (0.4). These complexes are described in terms of certain spaces of graphs.

It also is worth noting that the right  $\Omega$ -modules  $\tilde{\mathrm{H}}(S^{m\bullet})$ ,  $\hat{\mathrm{H}}(\mathbf{B}_n(\bullet); \mathbb{Q})$ , and  $\hat{\pi}(\mathbf{B}_n(\bullet)) \otimes \mathbb{Q}$  are, up to shifts of degree, almost independent of  $m$  and  $n$ . More precisely, they only depend on the parity of  $m$  and  $n$ . It follows that the total groups  $\mathrm{H}(\overline{\mathrm{Emb}}_c(\mathbb{R}^m, \mathbb{R}^n); \mathbb{Q})$  and  $\pi(\overline{\mathrm{Emb}}_c(\mathbb{R}^m, \mathbb{R}^n)) \otimes \mathbb{Q}$  depend, in some sense, only on the parities of  $m$  and  $n$ . For all

$m$  and  $n$  of a fixed parity (and satisfying  $n > 2m + 1$ ), the total groups are built of the same ingredients, but the topological dimensions of the different ingredients depend on  $m$  and  $n$ . It is quite interesting that the graph-complexes that we obtain at this point look similar to those obtained from the Bott-Taubes generalized construction used to study the De Rham cohomology of higher dimensional knot spaces [8, 23].

We will now discuss the proof of Theorem 0.2. We mentioned already that there is an analogy between the argument in this paper and the proof of the main theorem of [6]. We will recall the set-up in that paper, both in order to put the current paper in context, and because we can offer a somewhat alternative perspective on the results of [6]. Let  $M$  be an open submanifold of  $\mathbb{R}^m$  (where  $\mathbb{R}^m$  is still a subspace of  $\mathbb{R}^n$ ). Define  $\overline{\text{Emb}}(M, \mathbb{R}^n)$  to be the homotopy fiber of the inclusion map  $\text{Emb}(M, \mathbb{R}^n) \rightarrow \text{Imm}(M, \mathbb{R}^n)$  (note that now we are looking at the space of all embeddings, rather than embeddings with compact support). This space is the subject of [6]. In this paper we show that analysis of [op. cit.] can be extended to the space  $\overline{\text{Emb}}_c(\mathbb{R}^m, \mathbb{R}^n)$ , and that in fact one can say more about the latter than about  $\overline{\text{Emb}}(M, \mathbb{R}^n)$ .

Our first step in analyzing  $\overline{\text{Emb}}(M, \mathbb{R}^n)$  and  $\overline{\text{Emb}}_c(\mathbb{R}^m, \mathbb{R}^n)$  is to express the ‘‘Taylor towers’’ of these spaces arising from Weiss’ embedding calculus [27] as (roughly speaking) spaces of maps between certain modules over the little balls operad. Let  $\mathcal{O}(M)$  be the category of open subsets of  $M$  and inclusions. Embedding calculus is, essentially, the theory of contravariant isotopy functors on  $\mathcal{O}(M)$ . The main construction of embedding calculus approximates such a functor  $F$  with another functor  $T_\infty F$ , which is determined by the restriction of  $F$  to the poset of subsets of  $M$  that are diffeomorphic to a finite disjoint union of open balls. Under favorable circumstances, the map  $F \rightarrow T_\infty F$  is a weak equivalence. We will focus on the case when  $M$  is an open submanifold of  $\mathbb{R}^m$ . It turns out that in this case  $T_\infty F$  can often be expressed in terms of derived space of maps between right modules over the little balls operad  $\mathbf{B}_m$ .

As before, let  $\text{sEmb}(i \times D^m, M)$  be the space (or set) of ‘‘standard embeddings’’ of a disjoint union of  $i$  copies of the open unit ball in  $\mathbb{R}^m$  into  $M$ . This is well defined if  $M$  is a subset of  $\mathbb{R}^m$ . Let  $\mathbf{B}_m = \{\mathbf{B}_m(i)\}_{i=0}^\infty$  be the little  $m$ -balls operad. We will sometimes write  $\mathbf{B}_m(\bullet)$  when we want to emphasize that  $\mathbf{B}_m$  really stands for a sequence of spaces. It is easy to see that the sequence  $\{\text{sEmb}(i \times D^m, M)\}_{i=0}^\infty$  is a right module over  $\mathbf{B}_m$ . Note also that since we assume that  $\mathbb{R}^n$  contains  $\mathbb{R}^m$  as a subspace, the operad  $\mathbf{B}_n$  is endowed with the structure of a right module over  $\mathbf{B}_m$ . It turns out that the embedding tower of the functor  $\overline{\text{Emb}}(M, \mathbb{R}^n)$  is equivalent to the space of derived maps between these modules. Let  $\text{hRmod}(-, -)$  denote the derived space of maps between right modules. There is a natural equivalence

$$T_\infty \overline{\text{Emb}}(M, \mathbb{R}^n) \simeq \text{hRmod}_{\mathbf{B}_m}(\text{sEmb}(\bullet, M), \mathbf{B}_n(\bullet)).$$

In fact, for technical reasons we will work with discrete versions of  $\mathbf{B}_m$  and  $\text{sEmb}(\bullet, M)$ , rather than with the topological versions, but let us not worry about this too much during the introduction.

Let  $\mathbf{C}(X)$  be the singular chain complex on  $X$ . Since  $\mathbf{C}(-)$  is a lax monoidal functor, applying it to the little balls operad yields an operad in chain complexes -  $\mathbf{C}(\mathbf{B}_m)$ . The sequences  $\{\mathbf{C}(\text{sEmb}(\bullet, M))\}$  and  $\{\mathbf{C}(\mathbf{B}_n(\bullet))\}$  are right modules over  $\mathbf{C}(\mathbf{B}_m)$ . We have the following model for  $T_\infty \mathbf{C}(\overline{\text{Emb}}(M, \mathbb{R}^n))$

$$T_\infty \mathbf{C}(\overline{\text{Emb}}(M, \mathbb{R}^n)) \simeq \underset{\mathbf{C}(\mathbf{B}_m)}{\text{hRmod}}(\mathbf{C}(\text{sEmb}(\bullet, M)), \mathbf{C}(\mathbf{B}_n(\bullet))).$$

Once again, we only prove, and use the version of the above identity where  $\mathbf{B}_m$ , and  $\text{sEmb}(\bullet, M)$  are replaced with their underlying discrete sets. But this is a technical point that we will disregard in the introduction.

The main observation of [6] is that Kontsevich's formality theorem, together with some formal manipulations, implies that if we work rationally then  $\mathbf{C}^\mathbb{Q}(\mathbf{B}_n)$  can be replaced in the above formula with  $\text{H}(\mathbf{B}_n; \mathbb{Q})$ , where  $\text{H}$  is considered as a chain complex with zero differential. Thus, assuming that  $M$  is an open submanifold of  $\mathbb{R}^m$  and  $2m + 1 \leq n$ , we have an equivalence of chain complexes

$$\mathbf{C}^\mathbb{Q}(\overline{\text{Emb}}(M, \mathbb{R}^n)) \simeq \underset{\mathbf{C}(\mathbf{B}_m)}{\text{hRmod}}(\mathbf{C}(\text{sEmb}(\bullet, M)), \text{H}(\mathbf{B}_n(\bullet); \mathbb{Q})).$$

Here the action of  $\mathbf{C}(\mathbf{B}_m)$  on  $\text{H}(\mathbf{B}_n(\bullet))$  is defined as follows. There is a canonical morphism of operads  $\mathbf{C}(\mathbf{B}_m) \rightarrow \text{Com}$  obtained from the usual augmentation morphism, where  $\text{Com}$  is the commutative operad (with unit) in chain complexes. There also is a canonical action of  $\text{Com} = \text{H}_0(\mathbf{B}_n)$  on  $\text{H}(\mathbf{B}_n)$ , and we pull this action back to  $\mathbf{C}(\mathbf{B}_m)$ . It follows, by a "change of operads isomorphism" that there is an equivalence

$$\underset{\mathbf{C}(\mathbf{B}_m)}{\text{hRmod}}(\mathbf{C}(\text{sEmb}(\bullet, M)), \text{H}(\mathbf{B}_n(\bullet); \mathbb{Q})) \simeq \underset{\text{Com}}{\text{hRmod}}(\text{ind}(\mathbf{C}(\text{sEmb}(\bullet, M))), \text{H}(\mathbf{B}_n(\bullet); \mathbb{Q}))$$

where  $\text{ind}(-)$  is a derived left adjoint of the restriction functor from the category of right  $\text{Com}$ -modules to the category of right  $\mathbf{C}(\mathbf{B}_m)$ -modules. Next, we would like to describe explicitly the right  $\text{Com}$ -module  $\text{ind}(\mathbf{C}(\text{sEmb}(\bullet, M)))$ . A right  $\text{Com}$ -module is the same thing as a contravariant functor from the category of finite sets to the category of chain complexes. In particular, the sequence  $\{\mathbf{C}(M^\bullet)\}$  gives a right module. We have the following proposition (this is essentially the first part of Proposition 6.2, except that in the body of the paper we use the discretized version of  $\text{sEmb}$ )

**Proposition 0.3.** *The right  $\text{Com}$ -module  $\text{ind}(\mathbf{C}(\text{sEmb}(\bullet, M)))$  is equivalent to  $\{\mathbf{C}(M^\bullet)\}$ .*

As a consequence, we have the following theorem

**Theorem 0.4.** *Suppose that  $M$  is an open submanifold of  $\mathbb{R}^m$  and  $2m + 1 \leq n$ . There is an equivalence of rational chain complexes*

$$\mathbf{C}^\mathbb{Q}(\overline{\text{Emb}}(M, \mathbb{R}^n)) \simeq \underset{\text{Com}}{\text{hRmod}}\left(\mathbf{C}^\mathbb{Q}(M^\bullet), \text{H}(\mathbf{B}_n(\bullet); \mathbb{Q})\right).$$

This theorem can be viewed as an alternative formulation of the main result of [6] (a formulation that avoids an explicit mention of orthogonal calculus). In particular, the following statement, which is one of the main consequences of [op. cit.], is an immediate consequence of the above theorem

**Corollary 0.5.** *Let  $M_1, M_2$  be two manifolds satisfying the assumption of the theorem. Suppose that  $M_1$  and  $M_2$  are related by a chain of maps inducing an isomorphism in rational homology. Then there is an isomorphism*

$$H(\overline{\text{Emb}}(M_1, \mathbb{R}^n); \mathbb{Q}) \cong H(\overline{\text{Emb}}(M_2, \mathbb{R}^n); \mathbb{Q}).$$

*Proof.* If  $M_1$  and  $M_2$  are related by a chain of rational homology equivalences, then the right Com-modules  $\mathcal{C}^{\mathbb{Q}}(M_1^{\bullet})$  and  $\mathcal{C}^{\mathbb{Q}}(M_2^{\bullet})$  are weakly equivalent (in the category of right Com-modules with values in rational chain complexes). By the theorem, the homotopy type of the right Com-module  $\mathcal{C}(M^{\bullet})$  determines  $H(\overline{\text{Emb}}(M, \mathbb{R}^n); \mathbb{Q})$ .  $\square$

Now we would like to carry out a similar analysis for the space  $\overline{\text{Emb}}_c(\mathbb{R}^m, \mathbb{R}^n)$ . There is a version of the Taylor tower that applies to this functor (the relative Taylor tower of [27]). Our first task is to express this Taylor tower in terms of operads and their modules. To this end, we use the concept of a “weak bimodule” over an operad, which was first introduced by the second author in [26]<sup>1</sup>. It turns out that weak bimodules can play the same role in the study of  $\overline{\text{Emb}}_c(\mathbb{R}^m, \mathbb{R}^n)$  as right modules do for  $\overline{\text{Emb}}(M, \mathbb{R}^n)$ . This is one of the key insights of the paper. The category of weak bimodules is a kind of linearization of the category of bimodules over an operad. It has many of the pleasant formal properties of the category of right modules. For example, the category of weak bimodules is (in contrast with the category of honest bimodules) equivalent to a certain category of diagrams. In particular, the category of weak bimodules with values in an Abelian category is again an Abelian category. Let  $\text{WBimod}(-, -)$  denote the (derived) internal object of derived morphisms between weak bimodules. We prove the following proposition (with the usual proviso that we replace  $\mathbf{B}_m$  with its discretization and in fact, in the body of the paper we replace  $\mathbf{B}_m$  at the source of the mapping spaces with the discretization of a bimodule equivalent to  $\mathbf{B}_m$ )

**Proposition 0.6.**

$$T_{\infty} \overline{\text{Emb}}_c(\mathbb{R}^m, \mathbb{R}^n) \simeq \text{WBimod}_{\mathbf{B}_m}(\mathbf{B}_m, \mathbf{B}_n)$$

and

$$T_{\infty} \mathcal{C}(\overline{\text{Emb}}_c(\mathbb{R}^m, \mathbb{R}^n)) \simeq \text{WBimod}_{\mathcal{C}(\mathbf{B}_m)}(\mathcal{C}(\mathbf{B}_m), \mathcal{C}(\mathbf{B}_n))$$

Because weak bimodules are similar to right modules, the formal manipulations that were done in [6] for right modules can be repeated, and we may conclude, using the formality theorem, the following

**Corollary 0.7.** *Suppose that  $2m + 1 \leq n$ . Then there is an equivalence*

$$T_{\infty} \mathcal{C}^{\mathbb{Q}}(\overline{\text{Emb}}_c(\mathbb{R}^m, \mathbb{R}^n)) \simeq \text{WBimod}_{\mathcal{C}(\mathbf{B}_m)}(\mathcal{C}^{\mathbb{Q}}(\mathbf{B}_m), H(\mathbf{B}_n; \mathbb{Q}))$$

where the weak bimodule structure on  $H(\mathbf{B}_n)$  is defined via the map of operads  $\mathcal{C}(\mathbf{B}_m) \rightarrow \text{Com}$  and the evident action of  $\text{Com} = H_0(\mathbf{B}_n)$  on  $H(\mathbf{B}_n; \mathbb{Q})$ .

<sup>1</sup>After writing the first draft of this paper, we discovered that our notion of a weak bimodule is equivalent to the notion of an “infinitesimal bimodule” introduced by Merkulov and Vallette [20]. We decided not to change our terminology.

Thus, the action of  $\mathcal{C}(\mathbb{B}_m)$  on  $\mathbb{H}(\mathbb{B}_n; \mathbb{Q})$  factors through an action of  $\text{Com}$ . It turns out that the restriction functor for weak bimodules has a derived left adjoint, which we will denote by  $\widetilde{\text{ind}}$ . Thus, we have the following corollary

**Corollary 0.8.** *Suppose that  $2m + 1 \leq n$ . Then there is an equivalence*

$$T_\infty \mathcal{C}^{\mathbb{Q}}(\overline{\text{Emb}}_c(\mathbb{R}^m, \mathbb{R}^n)) \simeq \text{WBimod}_{\text{Com}} \left( \widetilde{\text{ind}}(\mathcal{C}(\mathbb{B}_m)), \mathbb{H}(\mathbb{B}_n; \mathbb{Q}) \right).$$

Our next task is, naturally, to describe explicitly the weak  $\text{Com}$ -bimodule  $\widetilde{\text{ind}}(\mathcal{C}(\mathbb{B}_m))$ . It turns out that a weak  $\text{Com}$ -bimodule is the same thing as a *right*  $\Gamma$ -module. That is, a contravariant functor on the category of pointed sets (a.k.a  $\Gamma$ ). For example, if  $X$  is a *pointed space*, then the sequence of chain complexes  $\{\mathcal{C}(X^n)\}_{n=0}^\infty$  defines a weak  $\text{Com}$ -bimodule. We will denote this  $\text{Com}$ -bimodule by  $\mathcal{C}(X^\bullet)$ . We will prove the following proposition.

**Proposition 0.9.** *The weak  $\text{Com}$ -bimodule  $\widetilde{\text{ind}}(\mathcal{C}(\mathbb{B}_m))$  is equivalent to the  $\text{Com}$ -bimodule  $\mathcal{C}((S^m)^\bullet)$ .*

We have the following corollary. The right  $\Gamma$ -module structure on  $\mathbb{H}(\mathbb{B}_n(\bullet); \mathbb{Q})$  that is implied by the statement is the same as the one alluded to earlier in the introduction.

**Corollary 0.10.** *Suppose that  $2m + 1 \leq n$ . Then there is an equivalence*

$$T_\infty \mathcal{C}(\overline{\text{Emb}}_c(\mathbb{R}^m, \mathbb{R}^n)) \simeq \text{hRmod}_{\Gamma}(\mathcal{C}((S^m)^\bullet), \mathbb{H}(\mathbb{B}_n(\bullet); \mathbb{Q})).$$

Until now, our analysis of  $\overline{\text{Emb}}_c(\mathbb{R}^m, \mathbb{R}^n)$  proceeded exactly in parallel with the analysis of  $\overline{\text{Emb}}(M, \mathbb{R}^n)$  that we did earlier. But now we can go further. To begin with, recall that there is an equivalence of categories between right  $\Gamma$ -modules and right  $\Omega$ -modules (when the values are in an Abelian category) given by Pirashvili's cross-effects functor

$$\text{cr}: \Gamma\text{-mod} \longrightarrow \Omega\text{-mod}.$$

It follows that for any two right  $\Gamma$ -modules with values in chain complexes  $P$  and  $Q$ , there is an equivalence of chain complexes

$$\text{hRmod}_{\Gamma}(P, Q) \simeq \text{hRmod}_{\Omega}(\text{cr } P, \text{cr } Q).$$

The  $\Omega$ -module  $\text{cr } \mathbb{H}(\mathbb{B}_n(\bullet); \mathbb{Q})$  is the module  $\hat{\mathbb{H}}(\mathbb{B}_n(\bullet); \mathbb{Q})$  that we defined earlier in the introduction. It is easy to see that  $\text{cr } \mathcal{C}((S^m)^\bullet)$  is equivalent to  $\tilde{\mathcal{C}}(S^{m\bullet})$ , where  $\tilde{\mathcal{C}}(-)$  stands for the reduced chain complex. We obtain the following corollary

**Corollary 0.11.** *Suppose that  $2m + 1 \leq n$ . Then there is an equivalence*

$$T_\infty \mathcal{C}^{\mathbb{Q}}(\overline{\text{Emb}}_c(\mathbb{R}^m, \mathbb{R}^n)) \simeq \text{hRmod}_{\Omega} \left( \tilde{\mathcal{C}}(S^{m\bullet}), \hat{\mathbb{H}}(\mathbb{C}(\bullet, \mathbb{R}); \mathbb{Q}) \right).$$

We can still go a step further. Namely, we will prove the following lemma

**Lemma 0.12.** *The right  $\Omega$ -module  $\tilde{\mathcal{C}}(S^{m\bullet})$  is rationally formal. That is, there exists a quasi-isomorphism of right  $\Omega$ -modules*

$$\tilde{\mathcal{C}}^{\mathbb{Q}}(S^{m\bullet}) \simeq \hat{\mathbb{H}}(S^{m\bullet}; \mathbb{Q}).$$

And we have the following corollary

**Corollary 0.13.** *Suppose that  $2m + 1 \leq n$ . Then there is an equivalence*

$$T_\infty \mathcal{C}^\mathbb{Q}(\overline{\text{Emb}}_c(\mathbb{R}^m, \mathbb{R}^n)) \simeq \text{hRmod}_\Omega \left( \tilde{\mathcal{H}}(S^{m\bullet}), \hat{\mathcal{H}}(C(\bullet, \mathbb{R}); \mathbb{Q}) \right).$$

It is well known that the natural map

$$\mathcal{C}^\mathbb{Q}(\overline{\text{Emb}}_c(\mathbb{R}^m, \mathbb{R}^n)) \longrightarrow T_\infty \mathcal{C}^\mathbb{Q}(\overline{\text{Emb}}_c(\mathbb{R}^m, \mathbb{R}^n))$$

is an equivalence if  $2m + 1 < n$ . Therefore, the above corollary is equivalent to the first part of Theorem 0.2, namely equation (0.1). For the second half of the theorem, we show that there is a chain complex  $\mathcal{E}_{m,n}^H$  that is (a) quasi-isomorphic to the right hand side of (0.1) and (b) is equivalent to the free graded cocommutative coalgebra generated by another chain complex,  $\mathcal{E}_{m,n}^\pi$ . Since  $\overline{\text{Emb}}_c(\mathbb{R}^m, \mathbb{R}^n)$  is a loop space (in fact an  $m + 1$ -fold loop space) it follows that the complex  $\mathcal{E}_{m,n}^\pi$  calculates the rational homotopy groups of  $\overline{\text{Emb}}_c(\mathbb{R}^m, \mathbb{R}^n)$ . Moreover, we show that  $\mathcal{E}_{m,n}^\pi$  is quasi-isomorphic to the complex whose homology appears on the right side of equation (0.2). This proves the theorem.

0.0.1. *A section by section outline of the paper.* In Sections 1 and 2 we review some basics about operads and their modules. In particular, we recall the concept of a weak bimodule over an operad, which is not very well-known. We show that the category of right modules over an operad, as well as the category of weak bimodules, are equivalent to a certain category of diagrams. In Sections 3 we apply the general theory to obtain a convenient description of the categories of right modules and of weak bimodules over the little balls operad as certain diagram categories. In Section 4 we show how the Taylor towers for  $\mathcal{C}(\overline{\text{Emb}}(M, \mathbb{R}^n))$  and  $\mathcal{C}(\overline{\text{Emb}}_c(\mathbb{R}^m, \mathbb{R}^n))$  can be described in terms of maps between, respectively, right modules and weak bimodules over the little balls operad. In Section 5 we start working over the rationals, and we show how Kontsevich's theorem on the formality of the little balls operad can be used to drastically simplify our models for  $\mathcal{C}^\mathbb{Q}(\overline{\text{Emb}}(M, \mathbb{R}^n))$  and  $\mathcal{C}^\mathbb{Q}(\overline{\text{Emb}}_c(\mathbb{R}^m, \mathbb{R}^n))$ . In Section 6 we show that the model for  $\mathcal{C}^\mathbb{Q}(\overline{\text{Emb}}_c(\mathbb{R}^m, \mathbb{R}^n))$  can be simplified even further, and rewritten in terms of maps between right  $\Omega$ -modules. This allows us to prove the homological part of the main theorem.

In the second part of the paper we use the general results of the first part to write down explicit complexes calculating the rational homology and homotopy groups of  $\overline{\text{Emb}}_c(\mathbb{R}^m, \mathbb{R}^n)$ . In the process, we also complete the proof of the homotopical part of the main theorem. After reviewing, in the easy Section 7, how (0.1) and (0.2) imply (0.3) and (0.4) respectively, we begin to analyze the terms on the right hand side of (0.3). In Section 8 we show how filtering the category  $\Omega$  by cardinality gives rise to a spectral sequence (which we call the Koszul spectral sequence) for calculating the homology groups of the space of maps between right  $\Omega$ -modules. In Section 9 we show that in the case of interest to us, the first term of the Koszul spectral sequence consists of a single chain complex, which we call the Koszul complex. We describe the Koszul complex explicitly in Section 10 as a complex generated by certain types of forests. In Section 12 we write a different family of complexes modelling the right hand sides of the terms in (0.3) and (0.4). These complexes

are generated by certain types of graphs, as opposed to forests. We use these complexes to prove the homotopical part of the main theorem. In Section 13 we analyze the long exact sequence in rational homotopy associated with the fibration sequence

$$\overline{\text{Emb}}_c(\mathbb{R}^m, \mathbb{R}^n) \longrightarrow \text{Emb}_c(\mathbb{R}^m, \mathbb{R}^n) \longrightarrow \text{Imm}_c(\mathbb{R}^m, \mathbb{R}^n)$$

and describe the relationship between the rational homotopy groups of  $\overline{\text{Emb}}_c(\mathbb{R}^m, \mathbb{R}^n)$  and  $\text{Emb}_c(\mathbb{R}^m, \mathbb{R}^n)$ . In Section 14 we calculate generating functions of the Euler characteristics of the double splitting in the rational homology of  $\overline{\text{Emb}}_c(\mathbb{R}^m, \mathbb{R}^n)$ , and in the Appendix we give tables for these Euler characteristics.

## Part 1. General theory

### 1. OPERADS, MODULES AND WEAK BIMODULES

1.0.2. *Definition of operads.* In this section we will review the (very well-known) notions of an operad and a right module over an operad. We also will review the concept of a weak bimodule over an operad, which is not so well-known.

There is more than one standard way to define an operad. Our exposition follows that of Ching [9], with the important difference that Ching only considers non-unital operads, while we make no such restriction.

**Definition 1.1.** Let  $\Sigma$  be the category of finite sets and isomorphisms between them. Let  $\mathcal{C}$  be any category. A *symmetric sequence*  $P$  in  $\mathcal{C}$  is a functor  $P: \Sigma \rightarrow \mathcal{C}$ .

We will write  $P(n)$  for  $P(\{1, \dots, n\})$  (and  $P(0)$  for  $P(\emptyset)$ ). In practice, a symmetric sequence is determined by the sequence  $P(0), P(1), \dots$  of objects in  $\mathcal{C}$  together with an action of the symmetric group  $\Sigma_n$  on  $P(n)$  for each  $n$ .

**Definition 1.2.** Let  $(\mathcal{C}, \otimes, 1)$  be a symmetric monoidal category. An *operad*  $O$  in  $\mathcal{C}$  is a symmetric sequence  $O$  in  $\mathcal{C}$  equipped with a *unit map*  $\eta: 1 \rightarrow O(1)$  and *partial composition maps*

$$- \circ_a -: O(A) \otimes O(B) \longrightarrow O(A \cup_a B)$$

for each pair of sets  $A$  and  $B$  and each  $a \in A$  where  $A \cup_a B := (A \setminus \{a\}) \amalg B$ . The composition maps must be natural with respect to isomorphisms of  $(A, a)$  and of  $B$ , and must satisfy certain axioms that say that

- (1) the composition is associative in the sense that for all sets  $A, B$  and  $C$ , and elements  $a \in A, b \in B$ , the two compositions  $(- \circ_a -) \circ_b -$  and  $- \circ_a (- \circ_b -)$  define the same map

$$O(A) \otimes O(B) \otimes O(C) \longrightarrow O(A \cup_a B \cup_b C).$$

- (2) for two distinct elements  $a, a' \in A$ , the operations  $- \circ_a -$  and  $- \circ_{a'} -$  commute.
- (3)  $\eta$  acts as both a right unit and a left unit with respect to the composition maps.

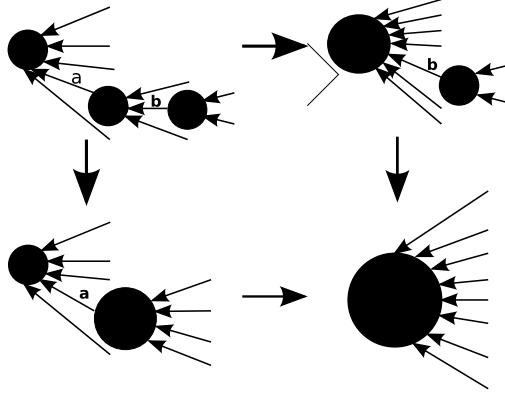

FIGURE 1. The associative law for operads

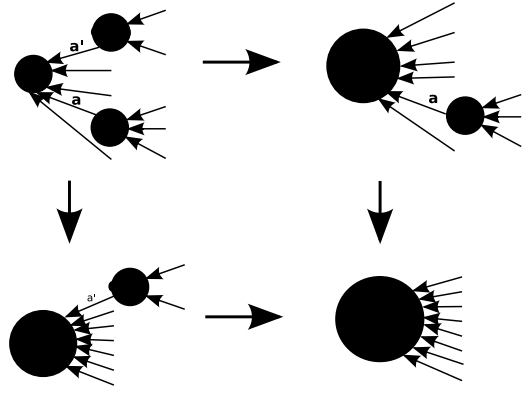

FIGURE 2. The “commutative law” for operads.

The axioms are spelled out fully in [9, Definition 2.2]. A little below, we will spell out the analogous axioms for a module over an operad. In the meantime, we offer a graphic representation of Axioms (1) and (2) in Figure 1 and Figure 2 respectively. Thus, we represent  $O(A)$  as a circle with incoming arrows, labeled by elements of  $A$ . The input for the operation  $\circ_a$  is represented by a tree with two internal vertices and one internal edge, and the operation itself is represented by the collapse of the internal edge. Two operations that can be composed are represented by a bigger tree, with two internal edges. The operad axioms (1) and (2) then say that the composite operation obtained by the collapse of two internal edges is independent of the order in which the edges are collapsed. We will now develop this viewpoint more systematically.

1.0.3. *Trees.* The use of trees in connection with operads is a familiar theme. Again, our approach is largely inspired by [9, Section 3], but since we do not restrict ourselves to non-unital operads, there are some differences. For us, a *rooted tree* is a finite connected acyclic graph with one marked vertex, called the root. The edges of a rooted tree have a preferred orientation. Namely, we orient the edges so that they point towards the root. Thus each vertex except the root has exactly one outgoing edge and any number of incoming edges. A *leaf* of a rooted tree is a vertex, other than the root, with no incoming edges.

Let  $T$  be a rooted tree. For a finite set  $A$ , an  $A$ -*labeling* of  $T$  is an injective function from  $A$  to the set of leaves of  $T$ . A rooted tree equipped with a labeling will be called a labeled tree. The vertices of a labeled tree  $T$  that are not in the image of the labeling function (including the root) will be called the unlabeled vertices of  $T$ . Note that there may be unlabeled leaves. See Figure 3.

The outgoing edge of a labeled leaf will be called a *labeled edge*. All other edges will be called *internal edges*. Given an  $A$ -labeled tree  $T$ , and an internal edge  $e$ , define  $T/e$  to be the tree obtained from  $T$  by collapsing the edge  $e$  to a point and identifying the endpoints of  $e$ . It is easy to see that  $T/e$  is again an  $A$ -labeled tree. There is a canonical map of trees  $T \rightarrow T/e$ .

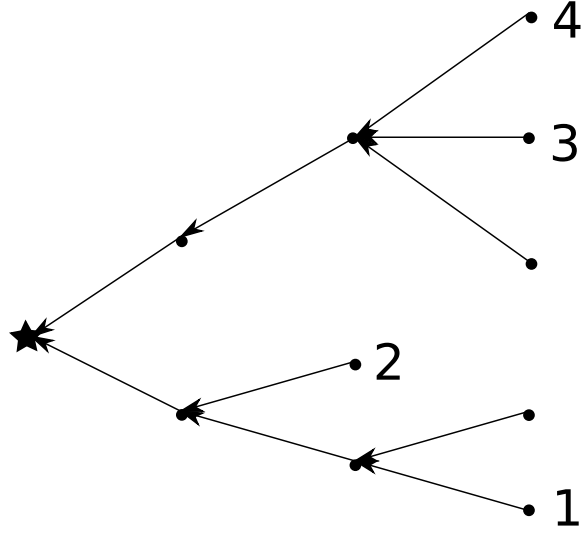

FIGURE 3. A rooted tree labeled by the set  $\{1, 2, 3, 4\}$ . Note that since the orientation of edges is marked, the root can be recognized as the vertex with no outgoing edges. In subsequent drawings we will indicate the orientation of the edges, but will not use a special symbol to distinguish the root from other vertices. Note that we allow unlabeled leaves, as well as vertices with just one incoming edge.

**Definition 1.3.** Let  $A$  be a finite set.  $\mathbb{T}(A)$  is the following subcategory of the category of trees and edge-wise linear functions between them. Its objects are rooted  $A$ -labeled trees, and it is generated by collapses of internal edges, and isomorphisms of trees that preserve the root and the labeling.

The category  $\mathbb{T}(A)$  has a final object, which is the  $A$ -labeled tree with no internal edges. This is the star-shaped tree with  $|A| + 1$  vertices, where one is the root and the rest are the labeled leaves. We will denote it by  $T_A$ .

Let  $O$  be an operad in  $\mathcal{C}$ . Then  $O$  determines a functor from  $\mathbb{T}(A)$  to  $\mathcal{C}$ , which we will denote with the same letter  $O$ . On objects, the functor is defined as follows. Let  $T$  be an  $A$ -labeled tree.

$$O(T) := \bigotimes_{\text{unlabeled vertices } v \text{ of } T} O(i(v)).$$

Here  $i(v)$  is the set of incoming edges of  $v$ . To describe how  $O$  acts on morphisms in  $\mathbb{T}(A)$ , we first consider isomorphisms and edge collapses, which by definition generate  $\mathbb{T}(A)$ . Clearly, an isomorphism of trees  $T \xrightarrow{\cong} T'$  induces a bijection between the unlabeled vertices of  $T$  and of  $T'$ , and thus induces a natural isomorphism  $O(T) \xrightarrow{\cong} O(T')$ . Now let  $e$  be an internal edge of  $T$  from  $u$  to  $v$ . Then  $e \in i(v)$ . Let  $v \circ u$  be the vertex in  $T/e$  obtained

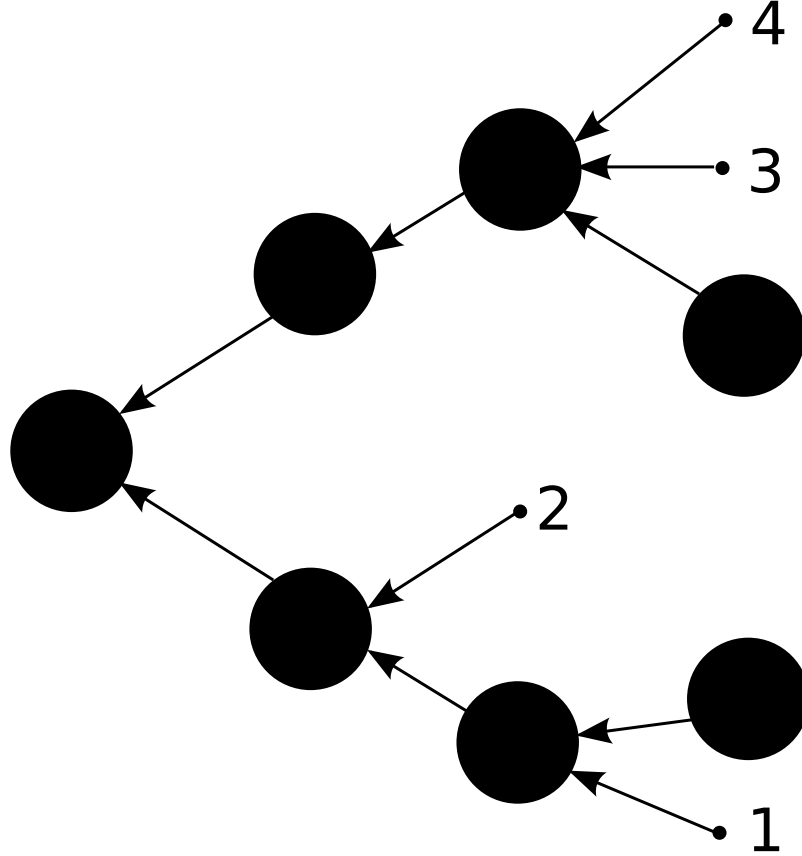

FIGURE 4. This picture represents the tensor product  $O(2) \otimes O(1) \otimes O(2) \otimes O(3) \otimes O(2) \otimes O(0) \otimes O(0)$ , which the operad/functor  $O$  associates to the tree in Figure 3. Internal edges indicate the composition maps that can be applied to this tensor product. The axioms of an operad guarantee that the composed operation resulting from the collapse of several edges is independent of the order in which the edges are collapsed.

from  $u$  and  $v$ . Then  $i(v \circ u) = i(v) \cup_e i(u)$  and we have a natural morphism

$$- \circ_e -: O(i(v)) \otimes O(i(u)) \longrightarrow O(i(v) \cup_e i(u)) = O(i(v \circ u)).$$

This morphism induces a morphism  $O(T) \longrightarrow O(T/e)$ . A look at Figures 1 and 2 should convince the reader that the operad axioms guarantee that the operation resulting from the collapse of several edges is independent of the order in which the edges are collapsed. From here it follows that this operation determines a well-defined functor from  $\mathbf{T}(A)$  to  $\mathcal{C}$ . See figure 4 for an illustration.

In particular, let  $T_A$  be the final object in the category  $\mathbf{T}(A)$ . Clearly,  $O(T_A) = O(A)$ , and thus we have a natural morphism  $O(T) \longrightarrow O(A)$  for every  $A$ -labeled tree  $T$ .

1.0.4. *Modules.* Let  $\mathcal{C}$  be a symmetric monoidal category. Let  $\mathcal{D}$  be a category tensored over  $\mathcal{C}$ . In practice,  $\mathcal{D}$  will often be the same as  $\mathcal{C}$ , but not always.

**Definition 1.4.** Let  $O$  be an operad in  $\mathcal{C}$ . A *right module* over  $O$  with values in  $\mathcal{D}$  is a symmetric sequence  $M$  in  $\mathcal{D}$  together with partial composition maps

$$-\circ_a -: M(A) \otimes O(B) \longrightarrow M(A \cup_a B)$$

where  $A$  and  $B$  are finite sets and  $a \in A$ . The composition maps are required to be natural in isomorphisms of  $(A, a)$  and  $B$ , and satisfy the following axioms

- (1) For all finite sets  $A, B$  and  $C$  and for all  $a \in A$  and  $b \in B$  the following diagram commutes

$$\begin{array}{ccc} M(A) \otimes O(B) \otimes O(C) & \xrightarrow{1 \otimes (-\circ_b -)} & M(A) \otimes O(B \cup_b C) \\ (-\circ_a -) \otimes 1 \downarrow & & \downarrow -\circ_a - \\ M(A \cup_a B) \otimes O(C) & \xrightarrow[-\circ_b -]{} & M(A \cup_a B \cup_b C) \end{array} .$$

- (2) For all finite sets  $A, B$  and  $B'$  and all  $a, a' \in A$  where  $a \neq a'$ , the following diagram commutes

$$\begin{array}{ccc} M(A) \otimes O(B) \otimes O(B') & \xrightarrow{(-\otimes_{a'} -) \otimes 1} & M(A \cup_{a'} B') \otimes O(B) \\ (-\otimes_a -) \otimes 1 \downarrow & & \downarrow -\otimes_a - \\ M(A \cup_a B) \otimes O(B') & \xrightarrow[-\otimes_{a'} -]{} & M(A \cup_a B \cup_{a'} B') \end{array}$$

(more precisely, the top arrow in this square needs to be preceded by the map switching the second and third factors).

- (3) For all finite sets  $A$  and for all  $a \in A$  the following morphism is the identity

$$M(A) = M(A) \otimes \mathbf{1} \xrightarrow{1 \otimes \eta} M(A) \otimes O(1) \xrightarrow{-\circ_a -} M(A).$$

Here we have used the identification of  $\{1\}$  with  $\{a\}$ .

Let  $O$  be an operad in  $\mathcal{C}$  and let  $M$  be a right module over  $O$  with values in  $\mathcal{D}$ . Let  $A$  be a finite set.  $O$  and  $M$  define a functor from  $\mathbf{T}(A)$  to  $\mathcal{D}$  that we will now describe. On objects, it is defined as follows. Let  $r$  be the root of  $T$ .

$$M(T) := M(i(r)) \otimes \bigotimes_{\substack{\text{unlabeled vertices } v \text{ of } T \\ \text{other than the root}}} O(i(v)).$$

The functoriality of  $M$  with respect to  $T$  is defined similarly to that of  $O(T)$ . Isomorphisms of trees induces permutation of factors in the above tensor product. The map  $M(T) \longrightarrow M(T/e)$ , where  $e$  is an internal edge is defined as follows. If  $e$  is an edge  $u \longrightarrow v$  where neither  $u$  nor  $v$  is the root, then the map induced by the operad structure map  $-\circ_e -: O(i(v)) \otimes$

$O(i(u)) \longrightarrow O(i(u \circ v))$ . If  $e$  is an edge  $u \longrightarrow r$ , where  $r$  is the root, then the map is induced by the module structure map

$$- \circ_e -: M(i(r)) \otimes O(i(u)) \longrightarrow M(i(r \circ v)).$$

Once again, the axioms for a right module, together with those of an operad, guarantee that  $M(T)$  is functorial with respect to morphisms in  $\mathbf{T}(A)$ .

The definitions above are well known. Now we will introduce a few definitions that are not so standard. As before, let  $O$  be an operad in a symmetric monoidal category  $\mathcal{C}$ , and let  $\mathcal{D}$  be a category tensored over  $\mathcal{C}$ .

**Definition 1.5.** A *weak left module* over  $O$  with values in  $\mathcal{D}$  is a symmetric sequence  $M$  in  $\mathcal{D}$  together with partial composition maps, defined for all finite sets  $A, B$  and all  $a \in A$

$$- \circ_a -: O(A) \otimes M(B) \longrightarrow M(A \cup_a B).$$

The composition maps are required to be natural in isomorphisms of  $(A, a)$  and  $B$ , and satisfy the following axioms

- (1) For all finite sets  $A, B$  and  $C$  and for all  $a \in A$  and  $b \in B$  the following diagram commutes

$$\begin{array}{ccc} O(A) \otimes O(B) \otimes M(C) & \xrightarrow{1 \otimes (- \circ_b -)} & O(A) \otimes M(B \cup_b C) \\ (- \circ_a -) \otimes 1 \downarrow & & \downarrow - \circ_a - \\ O(A \cup_a B) \otimes M(C) & \xrightarrow{- \circ_b -} & M(A \cup_a B \cup_b C) \end{array} .$$

- (2) For all finite sets  $A$  the following morphism is the identity

$$M(A) = \mathbf{1} \otimes M(A) \xrightarrow{\eta \otimes 1} O(\mathbf{1}) \otimes M(A) \xrightarrow{- \circ_{\mathbf{1}} -} M(A).$$

*Remark 1.6.* The concept of a weak left module is different from the regular concept of a left module over an operad that is more commonly found in literature. A left module is usually defined to be a symmetric sequence  $M$ , equipped with structure maps

$$O(A) \otimes M(B_1) \otimes \dots \otimes M(B_k) \longrightarrow M(A \cup_{a_1} B_1 \cup_{a_2} \dots \cup_{a_k} B_k) = M(B_1 \amalg \dots \amalg B_k)$$

where  $A = \{a_1, \dots, a_k\}$ . Note that a left module structure does not automatically give rise to a weak left module structure.

Finally, we are ready for the key definition of this section. Let  $O$  be an operad in  $\mathcal{C}$  and let  $\mathcal{D}$  be a category tensored over  $\mathcal{C}$

**Definition 1.7.** A *weak bimodule* over  $O$  with values in  $\mathcal{D}$  is a symmetric sequence  $M$  in  $\mathcal{D}$  endowed with the structure of a right module over  $O$  and of a weak left module over  $O$ . The right and left composition maps are required to satisfy the following axioms.

- (1) For all finite sets  $A, B$ , and  $C$  and for all  $a \in A, b \in B$ , the following diagram commutes.

$$\begin{array}{ccc} O(A) \otimes M(B) \otimes O(C) & \xrightarrow{(-\circ_a-) \otimes 1} & M(A \cup_a B) \otimes O(C) \\ \downarrow 1 \otimes (-\circ_b-) & & \downarrow -\circ_b- \\ O(A) \otimes M(B \cup_b C) & \xrightarrow{-\cup_a-} & M(A \cup_a B \cup_b C) \end{array} .$$

- (2) For all finite sets  $A, B, B'$  and for all distinct elements  $a, a' \in A$ , the following diagram commutes

$$\begin{array}{ccc} O(A) \otimes O(B) \otimes M(B') & \xrightarrow{(-\circ_{a'}-) \otimes 1} & M(A \cup_{a'} B) \otimes O(B) \\ \downarrow (-\circ_a-) \otimes 1 & & \downarrow -\circ_a- \\ O(A \cup_a B) \otimes M(B') & \xrightarrow{-\circ_{a'}-} & M(A \cup_a B \cup_{a'} B') \end{array} .$$

More precisely, the top map in the above diagram needs to be preceded by switching the second and third factors.

**Example 1.8.** Let  $O$  and  $P$  be operads. Let  $f: O \rightarrow P$  be a morphism of operads. Then  $P$  is a weak bimodule over  $O$ . For example, the weak left module structure is defined as follows. Let  $A, B$  be finite sets, and let  $a \in A$ . Then the map  $-\circ_a -: O(A) \otimes P(B) \rightarrow P(A \cup_a B)$  is the composite

$$O(A) \otimes P(B) \xrightarrow{f(A) \otimes 1} P(A) \otimes P(B) \xrightarrow{-\circ_a-} P(A \cup_a B).$$

In particular,  $O$  is a weak bimodule over itself.

Similarly to operads and right modules, a weak bimodule determines a functor from a certain category of trees to  $\mathcal{D}$ .

**Definition 1.9.** Let  $A$  be a finite set. A *marked  $A$ -labeled tree* is a pair  $(T, u_0)$  where  $T$  is a rooted  $A$ -labeled tree and  $u_0$  is an unlabeled vertex of  $T$  ( $u_0$  may or may not coincide with the root of  $T$ ). Let  $\mathbf{T}_*(A)$  denote the category of marked  $A$ -labeled trees. Morphisms in  $\mathbf{T}_*(A)$  are morphisms between underlying unmarked trees in  $\mathbf{T}(A)$  that preserve the marked point.

*Remark 1.10.* Note that  $\mathbf{T}(A)$  can be embedded into  $\mathbf{T}_*(A)$  as the full subcategory of those trees for which the marked point coincides with the root. There also is an evident forgetful functor from  $\mathbf{T}_*(A)$  to  $\mathbf{T}(A)$ .

**Definition 1.11.** Let  $O$  be an operad in  $\mathcal{C}$  and let  $M$  be a weak bimodule over  $O$  with values in  $\mathcal{D}$ . Then  $O$  and  $M$  define a functor from  $M: \mathbf{T}_*(A) \rightarrow \mathcal{D}$  as follows. On objects,  $M$  is defined by the formula

$$M(T, u_0) = M(i(u_0)) \otimes \bigotimes_{v \neq u_0} O(i(v))$$

where the big tensor product on the right hand side is indexed over unlabeled vertices of  $T$  different from the marked vertex. To define the action of  $M$  on morphisms in  $\mathbf{T}_*(A)$ , we have to describe the maps  $M(T, u_0) \rightarrow M(T/e, u'_0)$ , where  $e$  is an internal edge of  $T$ . Let  $e$  be an edge from  $u$  to  $v$ . We distinguish between three cases. If neither  $u$  nor  $v$  coincides with the marked vertex  $u_0$ , then the map is defined using the operad structure on  $O$  in the usual way. If  $v = u_0$  then the map is defined using the right module structure. If  $u = u_0$  then the map is defined using the weak left module structure. The axioms for operad and weak bimodule guarantee that this gives rise to a well-defined functor.

**1.0.5. Forests.** The above constructions can be extended from trees to forests. For us, a *forest* is a disjoint union of rooted trees. Let  $A$  be a finite set. We define an  $A$ -labeling of a forest  $F$  in the same way as an  $A$ -labeling of a tree: as an injective function from  $A$  to the set of leaves of  $F$ . We let  $\mathbf{F}(A)$  be the category of forests labeled by  $A$ , where morphisms are generated by isomorphisms of forests and by collapses of internal edges.  $\mathbf{T}(A)$  embeds into  $\mathbf{F}(A)$  as the full subcategory of forests with just one connected components (i.e., trees). Let  $O$  be an operad. We can extend the definition of the functor determined by  $O$  from the category of trees to the category of forests. For example, suppose  $F$  is a forest with connected components  $T_1 \dots T_k$ . Then we define

$$O(F) := \bigotimes_{\text{unlabeled vertices of } F} O(i(v)) = \bigotimes_{j=1}^k O(T_k)$$

Clearly, these formulas defines a functor on  $\mathbf{F}(A)$ , extending the definition we had previously for a functor on  $\mathbf{T}(A)$ .

## 2. OPERADS AS CATEGORIES, MODULES AS FUNCTORS

It is well known that the category of right modules over an operad is equivalent to a certain category of diagrams. In this section we review this construction and introduce an analogous construction for the category of weak bimodules (by contrast, the category of honest bimodules, or even of left modules over an operad is not equivalent to a category of diagrams).

To begin with, recall that for a finite set  $B$ ,  $T_B$  is the minimal rooted  $B$ -labeled tree (Figure 5). Next we will see how to associate a certain tree and a certain forest with a map (or more generally a chain of maps) of sets.

**Definition 2.1.** Let  $\alpha: A \rightarrow B$  be a function between finite sets. We define  $F_\alpha$  to be the mapping cylinder of  $\alpha$ .  $F_\alpha$  will be considered as a rooted  $A$ -labeled forest. The set of vertices of  $F_\alpha$  is a disjoint union  $A \amalg B$ . For every  $a \in A$  there is an edge  $a \rightarrow \alpha(a)$ . Each element  $b \in B$  is the root of its connected component. See Figure 6.

$B$  is a subset of  $T_B$  and of  $F_\alpha$ . We define  $T_B \cup_B F_\alpha$  to be their union along  $B$ . We consider it as an  $A$ -labeled rooted tree, with the root of  $T_B$  serving as the root of  $T_B \cup_B F_\alpha$  (Figure 7).

Given another function  $\beta: B \rightarrow C$ , we define  $F_\beta \cup_B F_\alpha$  to be the union of the two forests along  $B$ , considered as an  $A$ -labeled forest. The roots of  $F_\beta \cup_B F_\alpha$  are the elements of  $C$

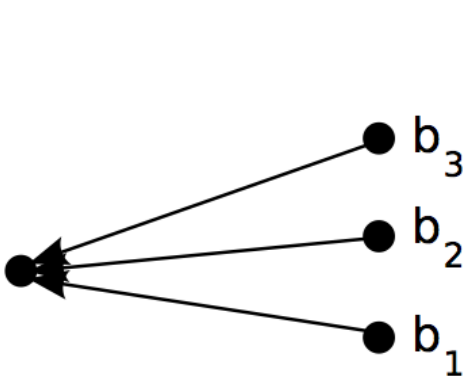

FIGURE 5.  $T_B$  - the minimal  $B$ -labeled tree

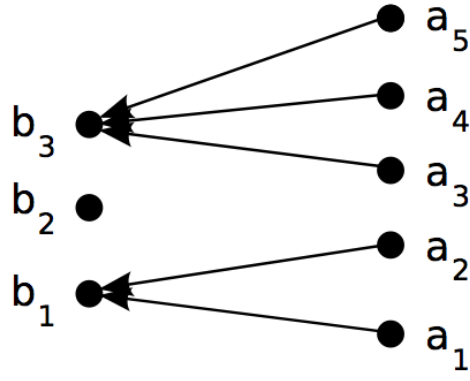

FIGURE 6.  $F_\alpha$  - the mapping cylinder of a function  $\alpha : A \rightarrow B$ , considered as an  $A$ -labeled forest

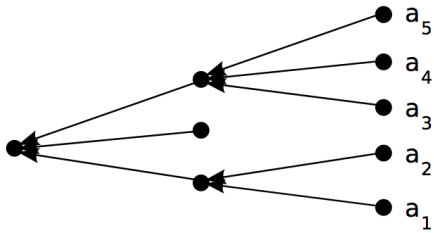

FIGURE 7. The union  $T_B \cup_B F_\alpha$ , considered as an  $A$ -labeled tree

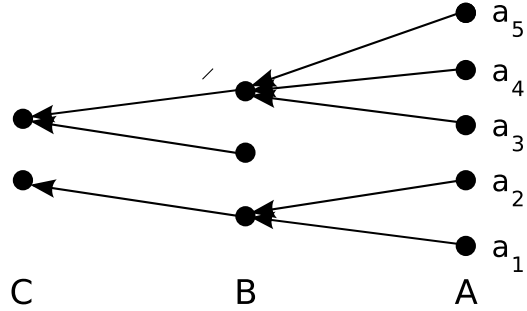

FIGURE 8. The union  $F_\beta \cup_B F_\alpha$ , considered as an  $A$ -labeled forest

(See Figure 8 for an illustration). More generally, let  $\alpha_i : A_i \rightarrow A_{i+1}$  where  $i = 1, \dots, k$  be  $k$  composable functions between sets. We form the corresponding union  $F_{\alpha_1} \cup_{A_2} F_{\alpha_2} \cup \dots \cup_{A_k} F_{\alpha_k}$ . It is easy to check that this union is a forest. We view it as an  $A_1$ -labeled forest. The roots of its components are given by elements of  $A_{k+1}$ .

A look at Figures 7 and 8 should convince the reader of the correctness of the following elementary lemma.

**Lemma 2.2.** *The tree obtained from  $T_B \cup_B F_\alpha$  by collapsing all internal edges is canonically isomorphic to  $T_A$ . The forest obtained from  $F_\beta \cup_B F_\alpha$  by collapsing all internal edges is*

canonically isomorphic to  $F_{\beta\circ\alpha}$ . In particular there is a canonical morphism in  $\mathbf{T}(A)$

$$T_B \cup_B F_\alpha \longrightarrow T_A$$

and a canonical morphism in  $\mathbf{F}(A)$ .

$$F_\beta \cup_B F_\alpha \longrightarrow F_{\beta\circ\alpha}$$

Let  $O$  be an operad and  $M$  a right module. Recall that  $O$  and  $M$  induce functors on  $\mathbf{F}(A)$  and  $\mathbf{T}(A)$  respectively, which we denote with the same letters. Note that  $O(F_\alpha) = \bigotimes_{b \in B} O(\alpha^{-1}(b))$  and  $M(T_B) = M(B)$ . Note also for future reference that there are canonical associative isomorphisms

$$(2.1) \quad M(T_B) \otimes O(F_\alpha) \cong M(T_B \cup_B F_\alpha)$$

and

$$(2.2) \quad O(F_\beta) \otimes O(F_\alpha) \cong O(F_\beta \cup_B F_\alpha).$$

The category  $\mathcal{F}(O)$  of the following definition is equivalent to the category defined in [6, Section 5.1].

**Definition 2.3.** Let  $O$  be an operad in a closed symmetric monoidal category  $\mathcal{C}$ . Define  $\mathcal{F}(O)$  to be the following category, enriched over  $\mathcal{C}$ . The objects of  $\mathcal{F}(O)$  are finite sets. For two finite sets  $A, B$ ,  $\text{Map}_{\mathcal{F}(O)}(A, B)$  is the object of  $\mathcal{C}$ , defined by the following formula

$$\text{Map}_{\mathcal{F}(O)}(A, B) = \coprod_{\alpha: A \rightarrow B} O(F_\alpha)$$

(the coproduct on the right hand side is indexed by all functions from  $A$  to  $B$ ).

To define the unit morphisms, we need to describe a morphism  $1 \longrightarrow \text{Map}_{\mathcal{F}(O)}(A, A)$ . It is defined to be the following composite

$$1 \xrightarrow{\cong} 1^{\otimes A} \xrightarrow{\eta^{\otimes A}} O(1)^{\otimes A} \xrightarrow{\cong} O(F_{1_A}) \hookrightarrow \coprod_{\alpha: A \rightarrow A} O(F_\alpha) = \text{Map}_{\mathcal{F}(O)}(A, A).$$

The composition of morphisms is defined as follows. As usual, let  $\alpha: A \rightarrow B$  and  $\beta: B \rightarrow C$  be functions. Since we assume that  $\mathcal{C}$  is a *closed* symmetric monoidal category, it follows that  $\otimes$  commutes with coproducts in  $\mathcal{C}$ . From this, it follows easily that all we need to do is define morphisms in  $\mathcal{C}$  that are natural, associative, and unital

$$O(F_\beta) \otimes O(F_\alpha) \longrightarrow O(F_{\beta\circ\alpha}).$$

This morphism is defined using the composition

$$O(F_\beta) \otimes O(F_\alpha) \xrightarrow{\cong} O(F_\beta \cup_B F_\alpha) \longrightarrow O(F_{\beta\circ\alpha})$$

where the first map is the isomorphism (2.2), and the second morphism is induced by the collapse map  $F_\beta \cup_B F_\alpha \longrightarrow F_{\beta\circ\alpha}$  (Lemma 2.2). The associativity of this map follows from the fact that taking union of trees is an associative operation, together with the fact that  $O$  is functorial with respect to collapses of internal edges. The unit axiom is easily verified

**Example 2.4.** Let  $\text{Com}$  be the commutative operad in  $\text{Top}$ . This is the operad whose value at every set  $A$  is the one point space  $*$ . All its structure maps are, necessarily, the identity function on  $*$ . It is the final object in the category of operads in  $\text{Top}$ . It is easy to see that  $\mathcal{F}(\text{Com})$  is the category of finite sets and functions between them. We will denote this category simply by  $\mathcal{F}$ .

**Lemma 2.5.** *Let  $O$  be an operad in a closed symmetric monoidal category  $\mathcal{C}$ . Let  $\mathcal{D}$  be a category enriched, tensored and cotensored over  $\mathcal{C}$ . Then the category of right modules over  $O$  with values in  $\mathcal{D}$  is equivalent to the category of enriched contravariant functors from  $\mathcal{F}(O)$  to  $\mathcal{D}$ .*

*Proof.* The lemma is well known, but we will give our own proof. Later we will use the same approach to prove a version of the lemma for weak bimodules.

Let  $M$  be a right module over  $O$ . In particular,  $M$  associates to every finite set  $A$  an object  $M(A)$  of  $\mathcal{D}$ . Our goal is to associate with  $M$  a contravariant functor from  $\mathcal{F}(O)$  to  $\mathcal{D}$ . This functor will be “the same as  $M$ ”, since its value on a finite set  $A$  (an object of  $\mathcal{F}(O)$ ) will be the object  $M(A)$ . By abuse of notation we will denote this functor by  $M$  - that is we will not distinguish notationally between  $M$  the right module and  $M$  the associated functor. To endow  $M$  with the structure of an enriched contravariant functors from  $\mathcal{F}(O)$  to  $\mathcal{D}$ , we need to construct morphisms in  $\mathcal{D}$

$$M(B) \otimes \text{Map}_{\mathcal{F}(O)}(A, B) \longrightarrow M(A)$$

that are associative and unital with respect to composition in  $\mathcal{F}(O)$ . Since we assumed that  $\mathcal{D}$  is enriched, tensored and cotensored over  $\mathcal{C}$ , it follows that the tensoring of  $\mathcal{D}$  over  $\mathcal{C}$  commutes with coproducts in  $\mathcal{C}$ , and so our task is equivalent to constructing morphisms

$$M(B) \otimes O(F_\alpha) \longrightarrow M(A).$$

Here  $\alpha$  is a function from  $A$  to  $B$ . The morphism needs to be natural, associative and unital with respect to  $\alpha$ . We define the morphism to be the following composition

$$M(B) \otimes O(F_\alpha) \xrightarrow{\cong} M(T_B \cup_B F_\alpha) \longrightarrow M(T_A) = M(A).$$

Here the first map is the isomorphism in equation (2.1), and the second map is induced by the canonical collapse map  $T_B \cup_B F_\alpha \longrightarrow T_A$  whose existence follows from Lemma 2.2. It is easy to check that the resulting map is associative and unital, because all its ingredients are.

Conversely, suppose  $M$  is an enriched contravariant functor from  $\mathcal{F}(O)$  to  $\mathcal{D}$ . Then  $M$  can be endowed with the structure of a right module over  $O$  as follows. Let  $A, B$  be finite sets, and let  $b \in B$ . We will define the map  $- \circ_b -: M(B) \otimes O(A) \longrightarrow M(B \cup_b A)$ . Let  $q: B \cup_b A \longrightarrow B$  be the canonical quotient map. Let  $F_q$  be the associated  $B \cup_b A$ -labeled rooted forest. Since  $M$  is a functor on  $\mathcal{F}(O)$ , we have the following composed morphism

$$M(B) \otimes O(F_q) \xrightarrow{\cong} M(T_B \cup_B F_q) \longrightarrow M(T_{B \cup_b A}) = M(B \cup_b A).$$

It is easy to see that

$$O(F_q) \cong \left( \bigotimes_{b' \in B \setminus \{b\}} O(1) \right) \otimes O(A).$$

Using the unit map  $\eta: 1 \rightarrow O(1)$  for each element of  $B \setminus \{b\}$ , we obtain a morphism  $O(A) \rightarrow O(T_q)$ . Combining, we obtain the following composition of morphisms

$$M(B) \otimes O(A) \longrightarrow M(B) \otimes O(T_q) \longrightarrow M(B \cup_b A).$$

$- \circ_b -$  is defined to be this composed map. Thus we defined the right module structure map on  $M$ . It is straightforward to check that it satisfies the axioms of a right module. The above procedures are inverse to each other, and they establish the required equivalence of categories.  $\square$

**Corollary 2.6.** *The category of right Com-modules with values in  $\mathcal{D}$  is equivalent to the category of contravariant functors from  $\mathcal{F}$  (the category of finite sets) to  $\mathcal{D}$ .*

Now we will introduce a variation of the category  $\mathcal{F}(O)$  that will do for weak bimodules over  $O$  what  $\mathcal{F}(O)$  did for right modules. To begin with, let  $\Gamma$  be the category of *pointed* finite sets. We will adopt the convention that if  $A, B$ , etc. denotes a pointed set, then the basepoint is denoted by  $a_0, b_0$ , etc.

**Definition 2.7.** If  $A$  is an unpointed set, then  $A_+$  is the pointed set obtained by adding a basepoint  $a_0$  to  $A$ . If  $A$  is a pointed set, then  $A_-$  is the unpointed set obtained from  $A$  by removing the basepoint.

We will want to use a certain twisted version of  $\Gamma$ .

**Definition 2.8.** Let  $\tilde{\Gamma}$  be the following category. The objects of  $\tilde{\Gamma}$  are finite pointed sets. A morphism  $\tilde{\alpha}$  from  $A$  to  $B$  in  $\tilde{\Gamma}$  is a pointed function, which we denote with the same symbol

$$\tilde{\alpha}: A_- \coprod \{b_0\} \longrightarrow B_- \coprod \{a_0\}$$

where  $b_0$  and  $a_0$  are, as usual, the basepoints of  $B$  and  $A$  respectively, and are the designated basepoints of  $A_- \coprod \{b_0\}$  and  $B_- \coprod \{a_0\}$  respectively. Given a morphism  $\tilde{\beta}$  from  $B$  to  $C$  in  $\tilde{\Gamma}$ , their composition  $\tilde{\beta} * \tilde{\alpha}$  is defined, as a function from  $A_- \coprod \{c_0\}$  to  $C_- \coprod \{a_0\}$  to be the following composition (here every map marked with  $\cong$  is the canonical isomorphism that takes basepoint to basepoint and is the identity away from the basepoint)

$$\begin{aligned} A_- \coprod \{c_0\} &\xrightarrow{\cong} A_- \coprod \{b_0\} \xrightarrow{\tilde{\alpha}} B_- \coprod \{a_0\} \xrightarrow{\cong} \\ &\longrightarrow B_- \coprod \{c_0\} \xrightarrow{\tilde{\beta}} C_- \coprod \{b_0\} \xrightarrow{\cong} C_- \coprod \{a_0\}. \end{aligned}$$

It is not difficult to check that  $\tilde{\Gamma}$  is a well-defined category. Roughly speaking,  $\tilde{\Gamma}$  is similar to  $\Gamma$ , except in the definition of morphisms the source and the target swap their basepoints. It may be helpful to consider an illustration. Figure 10 depicts the mapping cylinder of a morphism  $\tilde{\alpha}$  in  $\tilde{\Gamma}$ . Because of the twist in the definition, the arrows that point to the basepoint, point to the basepoint of the source.

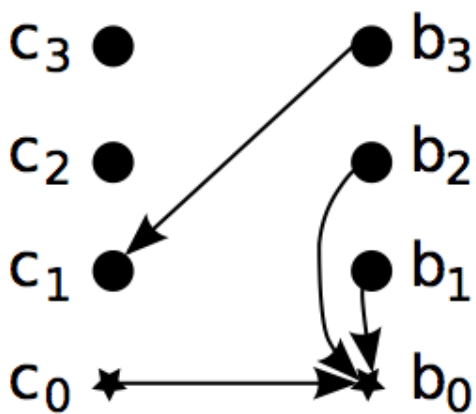

FIGURE 9.  $F_{\tilde{\beta}}$  - the mapping cylinder of a pointed function  $\tilde{\beta} : B_- \amalg \{c_0\} \rightarrow C_- \amalg \{b_0\}$

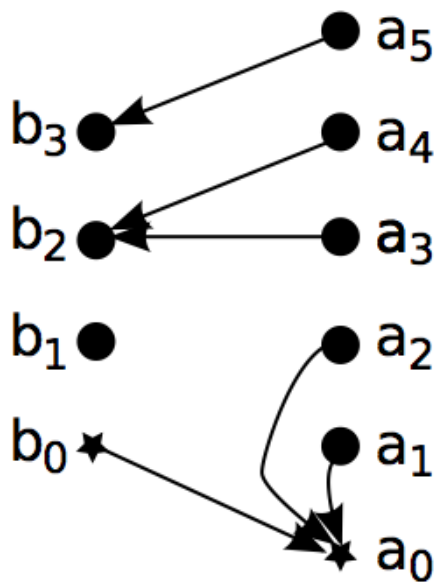

FIGURE 10.  $F_{\tilde{\alpha}}$  - the mapping cylinder of a pointed function  $\tilde{\alpha} : A_- \amalg \{b_0\} \rightarrow B_- \amalg \{a_0\}$ .

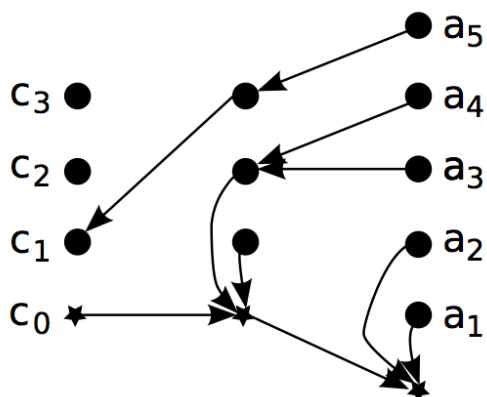

FIGURE 11. The union  $F_{\tilde{\beta}} \cup_B F_{\tilde{\alpha}}$ , considered as an  $A_- \amalg \{c_0\}$ -labeled forest

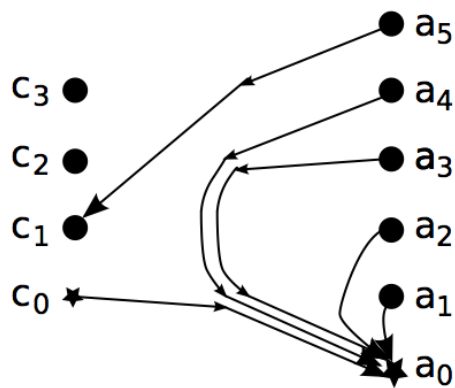

FIGURE 12. The mapping cylinder  $F_{\tilde{\beta} * \tilde{\alpha}}$  is obtained from  $F_{\tilde{\beta}} \cup_B F_{\tilde{\alpha}}$  by collapsing all internal edges.

*Remark 2.9.* In fact there is an equivalence of categories  $\Gamma \xrightarrow{\cong} \tilde{\Gamma}$ , which sends every object to itself and sends a function  $\alpha: A \rightarrow B$  to the function  $\tilde{\alpha}$ , which is defined to be the composite

$$A_- \coprod \{b_0\} \xrightarrow{\cong} A \xrightarrow{\alpha} B \xrightarrow{\cong} B_- \coprod \{a_0\}.$$

Nevertheless, it will be convenient for us to work with  $\tilde{\Gamma}$  instead of  $\Gamma$  for reasons that should become apparent shortly.

Now we will discuss how to associate to objects, morphisms, and chains of morphisms in  $\tilde{\Gamma}$  certain forests and *marked* rooted trees. Let

$$\tilde{\alpha}: A_- \coprod \{b_0\} \rightarrow B_- \coprod \{a_0\}$$

and

$$\tilde{\beta}: B_- \coprod \{c_0\} \rightarrow C_- \coprod \{b_0\}$$

be composable morphisms in  $\tilde{\Gamma}$ . Let  $F_{\tilde{\alpha}}$  be the mapping cylinder of  $\tilde{\alpha}$  (Figure 10). Note that it can be considered as an  $A_- \coprod \{b_0\}$ -labeled forest whose set of roots is  $B_- \coprod \{a_0\}$ . Similarly, let  $F_{\tilde{\beta}}$  be the mapping cylinder of  $\tilde{\beta}$ , considered as a  $B_- \coprod \{c_0\}$ -labeled forest (Figure 9). Let  $F_{\tilde{\beta}} \cup_B F_{\tilde{\alpha}}$  be the union of the forests along  $B$  (Figure 11). Note that it may be considered as an  $A_- \coprod \{c_0\}$ -labeled forest. Collapsing all the internal edges of this forest yields the mapping cylinder of  $\tilde{\alpha} * \tilde{\beta}$  (Figure 12).

**Definition 2.10.** Let  $B$  be a pointed set. We define  $\tilde{T}_B$  to be the minimal  $B_-$ -labeled rooted tree, whose root is identified with  $b_0$ . We consider  $\tilde{T}_B$  to be a *marked*  $B_-$ -labeled rooted tree, where the marked vertex coincides with the root. See Figure 13.

The following lemma is easily verified, but it is of key importance.

**Lemma 2.11.** *Let  $A, B, C$  be pointed sets. Let  $\tilde{\alpha}: A_- \coprod \{b_0\} \rightarrow B_- \coprod \{a_0\}$  and  $\beta: B_- \coprod \{c_0\} \rightarrow C_- \coprod \{b_0\}$  be pointed functions. Then  $\tilde{T}_B \cup_B F_{\tilde{\alpha}}$  is an  $A_-$ -labeled marked tree with root  $a_0$  and marked point  $b_0$  (see Figure 14). The tree obtained by collapsing all the internal edges of  $\tilde{T}_B \cup_B F_{\tilde{\alpha}}$  is canonically isomorphic, as a marked tree, to  $\tilde{T}_A$ .*

*Similarly,  $F_{\tilde{\beta}} \cup_B F_{\tilde{\alpha}}$  is an  $A_-$ -labeled rooted forest. The forest obtained by collapsing all the internal edges of  $F_{\tilde{\beta}} \cup_B F_{\tilde{\alpha}}$  is canonically isomorphic to  $F_{\tilde{\beta} * \tilde{\alpha}}$  (see again Figures 11 and 12).*

*Let  $O$  be an operad and  $M$  a weak bimodule. There are canonical isomorphisms*

$$M(\tilde{T}_B) \otimes O(F_{\tilde{\alpha}}) \cong M(\tilde{T}_B \cup_B F_{\tilde{\alpha}})$$

and

$$O(F_{\tilde{\beta}}) \otimes O(F_{\tilde{\alpha}}) \cong O(F_{\tilde{\beta}} \cup_B F_{\tilde{\alpha}}).$$

Now we are ready to introduce the main definition and the main result of this section.

**Definition 2.12.** Let  $O$  be an operad in a closed symmetric monoidal category  $\mathcal{C}$ . Define  $\tilde{\Gamma}(O)$  to be the following category, enriched over  $\mathcal{C}$ . The objects of  $\tilde{\Gamma}(O)$  are pointed finite

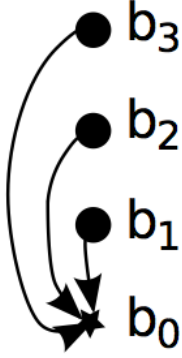

FIGURE 13. The tree  $\tilde{T}_B$ . We consider it as a *marked B*-labeled tree, where the marked point coincides with the root, which is  $b_0$ .

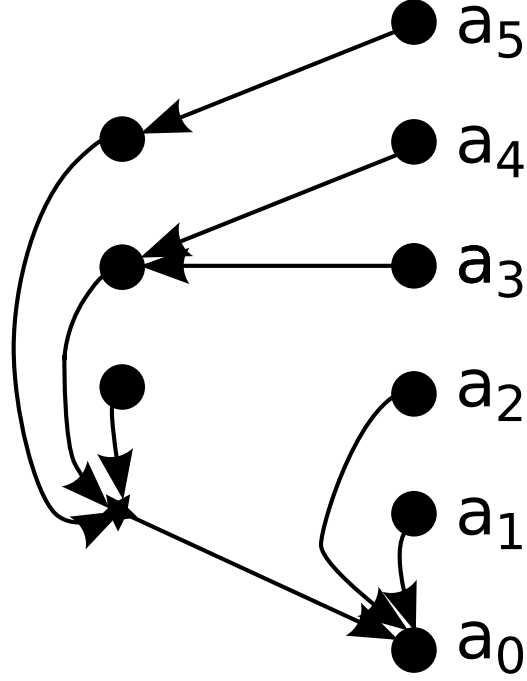

FIGURE 14. The union  $\tilde{T}_B \cup_B F_{\tilde{\alpha}}$ . This is a *marked A*-labeled tree, whose marked point is  $b_0$  and whose root is  $a_0$ . Note that the three obtained from it by collapsing all internal edges is canonically isomorphic to  $\tilde{T}_A$ .

sets. For two pointed finite sets  $A, B$ ,  $\text{Map}_{\tilde{\Gamma}(O)}(A, B)$  is the object of  $\mathcal{C}$ , defined by the following formula

$$\text{Map}_{\tilde{\Gamma}(O)}(A, B) = \coprod_{\tilde{\alpha}: A - \coprod\{b_0\} \rightarrow B - \coprod\{a_0\}} O(F_{\tilde{\alpha}}).$$

Here the coproduct is indexed over *pointed* functions.

To define the unit morphisms, we need to describe a morphism  $1 \rightarrow \text{Map}_{\tilde{\Gamma}(O)}(A, A)$ . It is defined to be the following composite

$$1 \xrightarrow{\cong} 1^{\otimes A} \xrightarrow{\eta^{\otimes A}} O(1)^{\otimes A} \xrightarrow{\cong} O(F_{1_A}) \hookrightarrow \coprod_{\alpha: A \rightarrow A} O(F_{\alpha}) = \text{Map}_{\tilde{\Gamma}(O)}(A, A).$$

The composition of morphisms is defined as follows. As usual, let  $\tilde{\alpha}: A_- \coprod\{b_0\} \rightarrow B_- \coprod\{a_0\}$  and  $\tilde{\beta}: B_- \coprod\{c_0\} \rightarrow C_- \coprod\{b_0\}$  be functions. Since we assume that  $\mathcal{C}$  is a *closed* symmetric monoidal category, it follows that  $\otimes$  commutes with coproducts in  $\mathcal{C}$ . From this, it follows easily that all we need to do is define morphisms in  $\mathcal{C}$  that are natural, associative, and unital

$$O(F_{\tilde{\beta}}) \otimes O(F_{\tilde{\alpha}}) \longrightarrow O(F_{\tilde{\beta}*\tilde{\alpha}}).$$

This morphism is defined using the composition

$$O(F_{\tilde{\beta}}) \otimes O(F_{\tilde{\alpha}}) \xrightarrow{\cong} O(F_{\tilde{\beta}} \cup_B F_{\tilde{\alpha}}) \longrightarrow O(F_{\tilde{\beta}*\tilde{\alpha}})$$

where the first map is the evident isomorphism, and the second morphism is induced by the collapse map  $F_{\tilde{\beta}} \cup_B F_{\tilde{\alpha}} \rightarrow F_{\tilde{\beta}*\tilde{\alpha}}$ , as per Lemma 2.11. The associativity of this map follows from the fact that taking union of trees is an associative operation, together with the fact that  $O$  is functorial with respect to collapses of internal edges. The unit axiom is easily verified.

**Example 2.13.** It is easy to see that  $\tilde{\Gamma}(\text{Com}) \cong \tilde{\Gamma}$ . But, since  $\tilde{\Gamma} \cong \Gamma$ , we conclude that  $\tilde{\Gamma}(\text{Com}) \cong \Gamma$ .

*Remark 2.14.* One can define the category  $\Gamma(O)$  (where  $O$  is an operad) analogously to  $\tilde{\Gamma}(O)$  (since we will not need to use the construction  $\Gamma(O)$ , we will omit the formal definition). We would like to emphasize that even though the category  $\tilde{\Gamma}(\text{Com})$  is equivalent to  $\Gamma(\text{Com})$ , for most operads  $O$  the category  $\tilde{\Gamma}(O)$  is not equivalent to  $\Gamma(O)$ . For example, the two categories are not equivalent when  $O$  is the little balls operad, which will play a central role in later sections of this paper. We suspect that  $\tilde{\Gamma}(O)$  is equivalent to  $\Gamma(O)$  whenever  $O$  is a cyclic operad.

The following proposition is the main result of this section. It generalizes Lemma 2.5.

**Proposition 2.15.** *Let  $O$  be an operad in a closed symmetric monoidal category  $\mathcal{C}$ . Let  $\mathcal{D}$  be a category enriched, tensored and cotensored over  $\mathcal{C}$ . Then the category of weak bimodules over  $O$  with values in  $\mathcal{D}$  is equivalent to the category of enriched contravariant functors from  $\tilde{\Gamma}(O)$  to  $\mathcal{D}$ .*

*Proof.* Let  $M$  be a weak bimodule over  $O$ . We will associate with  $M$  an enriched contravariant functor  $\tilde{M}$  from  $\tilde{\Gamma}(O)$  to  $\mathcal{D}$ . It is defined on objects of  $\tilde{\Gamma}(O)$  by the formula

$$\tilde{M}(A) := M(A_-).$$

To describe the action of  $\tilde{M}$  on morphisms, we need to construct morphisms in  $\mathcal{D}$

$$\tilde{M}(B) \otimes \text{Map}_{\tilde{\Gamma}(O)}(A, B) \longrightarrow \tilde{M}(A)$$

that are associative and unital with respect to composition in  $\tilde{\Gamma}(O)$ . Since we assumed that  $\mathcal{D}$  is enriched, tensored and cotensored over  $\mathcal{C}$ , it follows that tensor product commutes with direct sums, and so our task is equivalent to constructing morphisms

$$M(B_-) \otimes O(F_{\tilde{\alpha}}) \longrightarrow M(A_-).$$

Here  $\tilde{\alpha}$  is a pointed function from  $A_- \coprod \{b_0\}$  to  $B_- \coprod \{a_0\}$ . The morphism needs to be natural, associative and unital with respect to  $\tilde{\alpha}$ . We define the morphism to be the following composition (recall from Definition 1.11 that  $M$ , being a weak bimodule, defines a functor on the category  $\mathbf{T}_*(A)$  of marked rooted trees)

$$\begin{aligned} M(B_-) \otimes O(F_{\tilde{\alpha}}) &\xrightarrow{\cong} M(\tilde{T}_B, b_0) \otimes O(F_{\tilde{\alpha}}) \xrightarrow{\cong} \\ &\longrightarrow M(\tilde{T}_B \cup_B F_{\tilde{\alpha}}, b_0) \longrightarrow M(\tilde{T}_A, a_0) \xrightarrow{\cong} M(A_-). \end{aligned}$$

Here the first and the last map are induced by the canonical isomorphisms  $M(B_-) \cong M(\tilde{T}_B, b_0)$  and  $M(A_-) \cong M(\tilde{T}_A, a_0)$ . The second map is also a canonical isomorphism, given in Lemma 2.11. The third map is induced by the canonical collapse map of marked trees  $\tilde{T}_B \cup_B F_{\tilde{\alpha}} \rightarrow \tilde{T}_A$  (also described in Lemma 2.11). It is easy to check that the resulting map is associative and unital, because all its ingredients are.

Conversely, suppose  $\tilde{M}$  is an enriched contravariant functor from  $\tilde{\Gamma}(O)$  to  $\mathcal{D}$ . We associate with  $\tilde{M}$  a weak bimodule  $M$  over  $O$  as follows. As a symmetric sequence,  $M$  is defined by the formula  $M(A) = \tilde{M}(A_+)$  (here  $A$  is an unpointed set). To describe the right module and the weak left module structure on  $M$ , let  $A, B$  be finite sets, and let  $a \in A$ . We need to describe natural maps  $\tilde{M}(A_+) \otimes O(B) \rightarrow \tilde{M}(A \cup_a B_+)$  and  $O(A) \otimes \tilde{M}(B_+) \rightarrow \tilde{M}(A \cup_a B_+)$ . Let  $a_0$  be the basepoint of  $A_+$  and let  $x_0$  be the basepoint of  $A \cup_a B_+$ . We will construct two morphisms in  $\tilde{\Gamma}$ . One is  $\tilde{r}$  from  $A \cup_a B_+$  to  $A_+$  and the other is  $\tilde{l}$  from  $A \cup_a B_+$  to  $B_+$ . By definition  $\tilde{r}$  needs to be a pointed function from  $A \cup_a B \coprod \{a_0\}$  to  $A \coprod \{x_0\}$ . We define  $\tilde{r}$  to be the function that collapses  $A \cup_a B$  onto  $A$  and sends  $a_0$  to  $x_0$ . On the other hand,  $\tilde{l}$  is the pointed function from  $A \cup_a B \coprod \{b_0\}$  to  $B \coprod \{x_0\}$  that sends elements of  $B$  to themselves, and sends  $A \setminus \{a\} \coprod \{b_0\}$  to the basepoint  $\{x_0\}$ . It is easy to see that  $O(F_{\tilde{r}}) \cong O(1)^{\otimes A} \otimes O(B)$  and  $O(F_{\tilde{l}}) \cong O(1)^{\otimes B} \otimes O(A)$ . We now define the right module structure map on  $M$  to be the composite

$$\tilde{M}(A_+) \otimes O(B) \longrightarrow \tilde{M}(A_+) \otimes O(F_{\tilde{r}}) \longrightarrow \tilde{M}(A \cup_a B_+)$$

where the first map uses the unit  $|A|$  times and the second map uses the functoriality of  $\tilde{M}$  with respect to  $\tilde{\Gamma}(O)$ . The left module structure is defined to be the composite

$$O(A) \otimes \tilde{M}(B_+) \longrightarrow O(F_{\tilde{l}}) \otimes \tilde{M}(B_+) \longrightarrow \tilde{M}(A \cup_a B_+)$$

where, again, the first map uses the unit  $|B|$  times and the second map uses the functoriality of  $\tilde{M}$ . It is a little tedious, but straightforward to check that all the axioms of a weak bimodule are satisfied and that the above constructions are inverse to each other and so establish an equivalence of categories as desired.  $\square$

The following corollary follows from Proposition 2.15 together with Example 2.13

**Corollary 2.16.** *The category of weak Com-bimodules with values in  $\mathcal{D}$  is equivalent to the category of contravariant functors from  $\Gamma$  (the category of pointed finite sets) to  $\mathcal{D}$ .*

**Example 2.17.** Let  $X$  be a pointed topological space. Such an  $X$  gives rise to a contravariant functor from  $\Gamma$  to  $\text{Top}$

$$S \mapsto \text{Map}_*(S, X) \cong X^{S-}$$

(where  $S$  is a pointed set). By the above corollary, this contravariant functor gives rise to a weak Com-bimodule. Indeed, as a symmetric sequence it is given by the formula

$$A \mapsto X^A$$

(where  $A$  is an unpointed set). The right module structure is given by increasing (or decreasing) the multiplicities of points in  $X$ . The weak left module structure is given by adding a suitable multiple of the basepoint in  $X$ .

### 3. THE LITTLE BALLS OPERAD

In this section we apply the theory of previous section to the little balls operad. Inevitably, we have to begin with a few definitions.

**Definition 3.1.** Let  $\mathbb{R}^m$  be a Euclidean space. A *standard isomorphism* of  $\mathbb{R}^m$  is a self homeomorphism of  $\mathbb{R}^m$  that is the composition of a translation and a multiplication by a positive scalar.

Let  $A$  be a connected subspace of  $\mathbb{R}^m$ . A map  $f: A \rightarrow \mathbb{R}^m$  is called a *standard embedding* if  $f$  equals the inclusion followed by a standard isomorphism of  $\mathbb{R}^m$ .

More generally, if  $X$  is another connected subset of  $\mathbb{R}^m$ , then a standard embedding of  $A$  into  $X$  is a standard embedding of  $A$  into  $\mathbb{R}^m$  whose image lies in  $X$ .

Even more generally, we define the following category  $\mathcal{SM}^m$  of spaces and standard embeddings between them. An object of  $\mathcal{SM}^m$  is a locally connected topological space  $X$ , each of whose connected components is identified with an open subset of  $\mathbb{R}^m$ . Given two objects  $A$  and  $X$  of this category, a morphism from  $A$  to  $X$  is an embedding  $f: A \hookrightarrow X$  having the property that the restriction of  $f$  to each connected component of  $A$  (which by assumption is a subset of  $\mathbb{R}^m$ ) is a standard embedding into a component of  $X$  (which, by assumption, is also a subset of  $\mathbb{R}^m$ ). We call such maps standard embeddings of  $A$  into  $X$ . The space of standard embedding of  $A$  into  $X$  will be denoted  $\text{sEmb}(A, X)$ . It is easy to see that a composition of standard embeddings is again a standard embedding, and so we really have a (topologically enriched) category. The abbreviation SM here stays for *standard manifold*.

**Definition 3.2.** Let  $\mathbb{R}^m$  be a fixed Euclidean space. Let  $D^m$  be the unit open ball in  $\mathbb{R}^m$ . The  $m$ -dimensional little balls operad, denoted by  $\mathbf{B}_m$ , is defined as follows. As a symmetric sequence,  $\mathbf{B}_m(A) := \text{sEmb}(A \times D^m, D^m)$ . The unit is given by the identity map in  $\mathbf{B}_m(1) \cong \text{sEmb}(D^m, D^m)$ . To define the composition maps, let  $a \in A$ , and let  $B$  be another finite set. The composition map

$$- \circ_a -: \text{sEmb}(A \times D^m, D^m) \times \text{sEmb}(B \times D^m, D^m) \longrightarrow \text{sEmb}((A \cup_a B) \times D^m, D^m)$$

is defined by identifying the target of the mapping space  $\text{sEmb}(B \times D^m, D^m)$  with  $\{a\} \times D^m$  and substituting the second map into the first one in the evident way.

It is easy to see that  $\mathbf{B}_m$  is the *endomorphism operad* of the unit disc  $D^m$  in this category  $\mathcal{SM}^m$  which is viewed as a symmetric monoidal category with disjoint union as symmetric product and empty set as unit.

Our main goal in this section is to describe the right modules, and especially the weak bimodules over  $\mathbf{B}_m$  (and the discretization of  $\mathbf{B}_m$ ), using the theory of the previous section. Our first task is to describe explicitly the categories  $\mathcal{F}(\mathbf{B}_m)$  and  $\tilde{\Gamma}(\mathbf{B}_m)$ . We begin with the category  $\mathcal{F}(\mathbf{B}_m)$  and the associated category of right modules over  $\mathbf{B}_m$ . The following lemma is an immediate consequence of the definitions.

**Lemma 3.3.** *The category  $\mathcal{F}(\mathbf{B}_m)$  can be identified with the topological category whose objects are finite sets (or, equivalently, finite disjoint unions of copies of  $D^m$ ) and where the space of morphisms from  $A$  to  $B$  is  $\text{sEmb}(A \times D^m, B \times D^m)$ .*

We will refer to  $\mathcal{F}(\mathbf{B}_m)$  as the category of disjoint unions of standard balls and standard embeddings between them. The following lemma is a special case of Lemma 2.5. It certainly is "well known" (e.g., [6]), but we include it here as a warm-up towards introducing the analogous statements about weak bimodules.

**Lemma 3.4.** *The category of right modules over  $\mathbf{B}_m$  with values in  $\text{Top}$  is equivalent to the category of contravariant topological functors from  $\mathcal{F}(\mathbf{B}_m)$  to  $\text{Top}$ .*

**Example 3.5.** Let  $M$  be an open submanifold of  $\mathbb{R}^m$ . We associate with  $M$  a right module  $\mathbf{B}^M$  defined by  $\mathbf{B}^M(A) := \text{sEmb}(A \times D^m, M)$ . Obviously, this defines a contravariant functor from  $\mathcal{F}(\mathbf{B}_m)$  to  $\text{Top}$  and thus a right module over the little balls operad.

To perform a similar analysis of weak bimodules over  $\mathbf{B}_m$  we need to describe the category  $\tilde{\Gamma}(\mathbf{B}_m)$ . It follows immediately from the definition that  $\tilde{\Gamma}(\mathbf{B}_m)$  can be identified with the category whose objects are pointed finite sets and where the space of morphisms from  $A$  to  $B$  (where  $A$  and  $B$  are pointed finite sets) is the space

$$\left\{ \tilde{\alpha} \in \text{sEmb} \left( (A_- \coprod \{b_0\}) \times D^m, (B_- \coprod \{a_0\}) \times D^m \right) \mid \tilde{\alpha}(\{b_0\} \times D^m) \subset \{a_0\} \times D^m \right\}.$$

In words, a morphism from  $A$  to  $B$  is a standard embedding of  $(A_- \coprod \{b_0\}) \times D^m$  into  $(B_- \coprod \{a_0\}) \times D^m$  that takes the basepoint component into the basepoint component. Composition is defined analogously to composition in  $\tilde{\Gamma}$ . See Figures 15, 16 and 17 for an illustration of morphisms in  $\tilde{\Gamma}(\mathbf{B})$ . By Proposition 2.15, the category of weak bimodules over  $\mathbf{B}$  in a topologically enriched category  $\mathcal{D}$  is equivalent to the category of contravariant topological functors from  $\tilde{\Gamma}(\mathbf{B})$  to  $\mathcal{D}$ .

We would like to present an alternative description of the category  $\tilde{\Gamma}(\mathbf{B})$  that we find convenient to use.

Let  $D_0$  and  $D$  be two copies of  $D^m$ . Let  $i: D_0 \rightarrow D$  be a standard embedding. The map  $i$  is the restriction of a standard isomorphism of  $\mathbb{R}^m$ , which we will also denote by  $i$ . Let  $i^{-1}$  be the inverse isomorphism of  $\mathbb{R}^m$ . Then  $i^{-1}$  defines a standard embedding of the complement of  $D$  in  $\mathbb{R}^m$  into the complement of  $D_0$ . This procedure establishes a homeomorphism

$$\text{sEmb}(D_0, D) \cong \text{sEmb}(\mathbb{R}^m \setminus \overline{D}, \mathbb{R}^m \setminus \overline{D_0}).$$

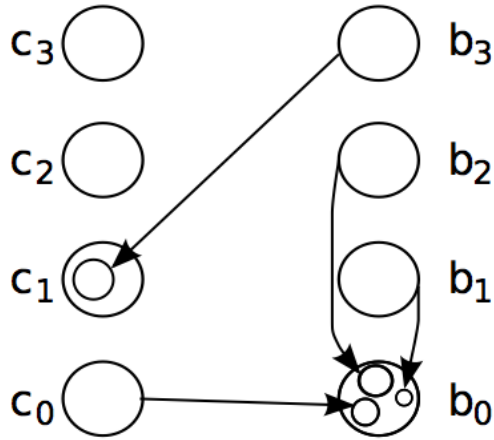

FIGURE 15. A morphism  $\tilde{\beta}$  from  $B$  to  $C$  in  $\tilde{\Gamma}(B)$ .

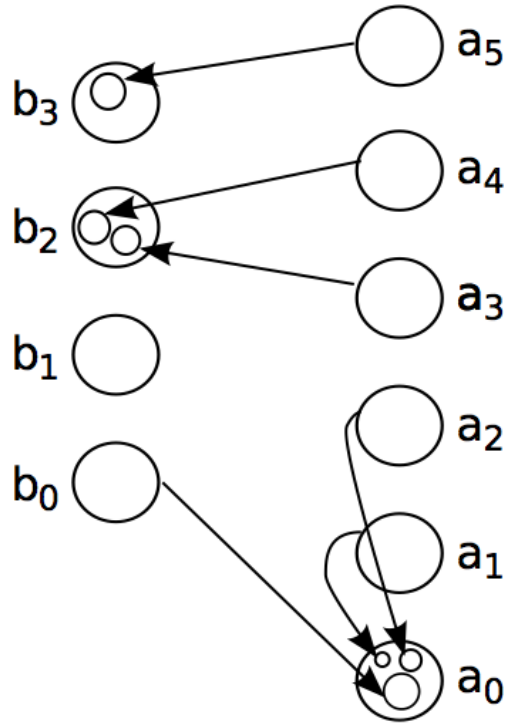

FIGURE 16. A morphism  $\tilde{\alpha}$  from  $A$  to  $B$  in  $\tilde{\Gamma}(B)$ .

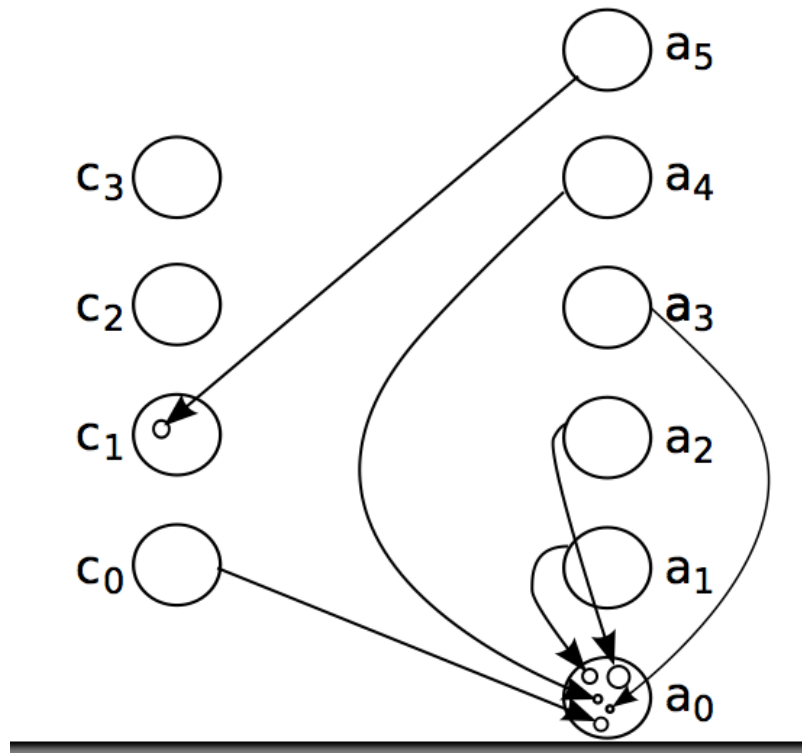

FIGURE 17. The composition  $\tilde{\beta} * \tilde{\alpha}$

In the above  $\overline{D}$ ,  $\overline{D}_0$  denote the closure of  $D$  and  $D_0$  respectively. The above homeomorphism is also true if we took complements of  $D$  and  $D_0$  instead, but since we are going to apply our construction in the manifold calculus of functors we need all the sets to be open. Now let  $D_1, \dots, D_k$  be  $k$  more copies of  $D^m$ . Let  $i$  be a standard embedding

$$i: \coprod_{l=0}^k D_l \hookrightarrow D.$$

For each  $l$ , let  $i_l$  be the restriction of  $i$  to  $D_l$ . Then, as before,  $i_0$  is a restriction of a standard isomorphism of  $\mathbb{R}^m$ , and its inverse, denoted  $i_0^{-1}$ , defines a standard embedding of the complement of  $D$  into the complement of  $D_0$ . Moreover, for each  $l = 1, \dots, k$ ,  $i_0^{-1} \circ i_l$  defines a standard embedding of  $D_l$  into the complement of  $D_0$ , and together, the maps  $i_0^{-1}, i_0^{-1} \circ i_1, \dots, i_0^{-1} \circ i_k$  define a standard embedding

$$(\mathbb{R}^m \setminus \overline{D}) \coprod D_1 \coprod \dots \coprod D_k \hookrightarrow \mathbb{R}^m \setminus \overline{D}_0.$$

Again, the above procedure defines a natural homeomorphism

$$(3.1) \quad \text{sEmb} \left( \coprod_{l=0}^k D_l, D \right) \cong \text{sEmb} \left( (\mathbb{R}^m \setminus \overline{D}) \coprod D_1 \coprod \dots \coprod D_k, \mathbb{R}^m \setminus \overline{D}_0 \right).$$

Now let

$$\tilde{\alpha}: (A_- \coprod \{b_0\}) \times D^m \longrightarrow (B_- \coprod \{a_0\}) \times D^m$$

be a morphism in  $\tilde{\Gamma}(\mathbf{B})$ .  $\tilde{\alpha}$  takes some components of  $A_- \times D^m$  to components of  $B_- \times D^m$ , and it takes the remaining (if there are any) components of  $A_- \times D^m$ , as well as  $\{b_0\} \times D^m$ , into  $\{a_0\} \times D^m$ . By (3.1), the latter part of the data is equivalent to a standard embedding of the disjoint union of  $\mathbb{R}^m \setminus (\{a_0\} \times \overline{D}^m)$  with those components of  $A_- \times D^m$  that are sent by  $\tilde{\alpha}$  into  $\{a_0\} \times D^m$  into  $\mathbb{R}^m \setminus (\{b_0\} \times \overline{D}^m)$ . We can conclude that  $\tilde{\alpha}$  determines, and is determined by a standard embedding

$$(A_- \times D^m) \coprod (\mathbb{R}^m \setminus \overline{D}^m) \hookrightarrow (B_- \times D^m) \coprod (\mathbb{R}^m \setminus \overline{D}^m).$$

The following lemma follows easily from the above discussion

**Lemma 3.6.**  $\tilde{\Gamma}(\mathbf{B}_m)$  can be identified with the topologically enriched category whose objects are pointed finite sets, and where the space of morphisms from  $A$  to  $B$  is the space of standard embeddings

$$\text{sEmb} \left( (A_- \times D^m) \coprod (\mathbb{R}^m \setminus \overline{D}^m), (B_- \times D^m) \coprod (\mathbb{R}^m \setminus \overline{D}^m) \right).$$

With this point of view, composition in  $\tilde{\Gamma}(\mathbf{B}_m)$  is just ordinary composition of standard embeddings.

We will call the space  $\mathbb{R}^m \setminus \overline{D}^m$  the ‘‘antiball’’. With this point of view, an object of  $\tilde{\Gamma}(\mathbf{B}_m)$  can be thought of as a disjoint union of standard balls, together with one antiball.

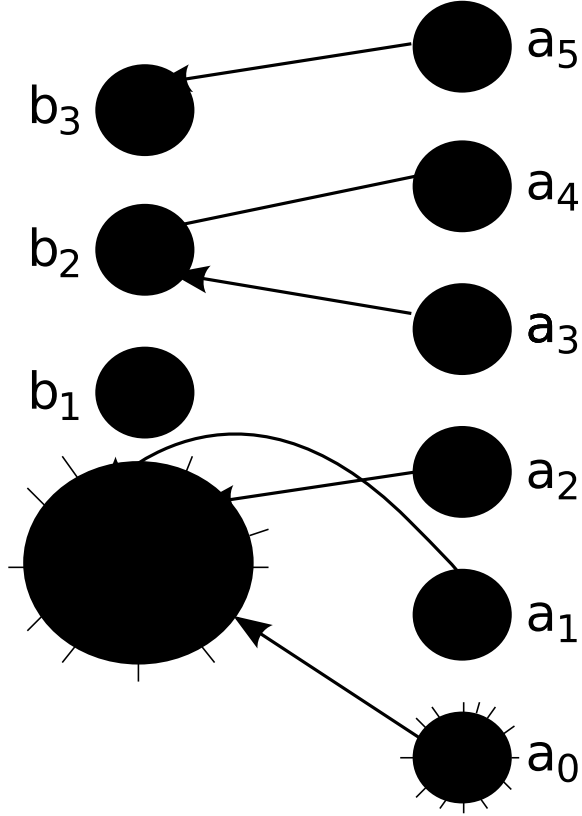

FIGURE 18. A reinterpretation of the morphism  $\tilde{\alpha}$  from Figure 16. Instead of sending the balls  $b_0$ ,  $a_1$  and  $a_2$  into the ball  $a_0$ , we send the “antiball”  $a_0$ , together with balls  $a_1$  and  $a_2$ , into the antiball  $b_0$ .

Morphisms are standard embeddings between such spaces. Figure 18 gives a graphic representation of a morphism from this point of view. From now on we will switch freely between the two points of view on  $\tilde{\Gamma}(\mathcal{B}_m)$ .

We conclude the section with some examples of weak bimodules over  $\tilde{\Gamma}(\mathcal{B}_m)$ .

As with every operad,  $\mathcal{B}_m$  is a weak bimodule over itself. The corresponding contravariant functor from  $\tilde{\Gamma}(\mathcal{B}_m)$  to  $\text{Top}$  is defined on objects by the formula

$$A \mapsto \text{sEmb}(A_- \times D^m, D^m).$$

To understand the functoriality with respect to morphisms in  $\tilde{\Gamma}(\mathcal{B}_m)$ , let us first notice that  $\text{sEmb}(A_- \times D^m, D^m)$  can be identified with the subspace of

$$\text{sEmb}\left((A_- \times D^m) \amalg (\mathbb{R}^m \setminus \overline{D^m}), \mathbb{R}^m\right)$$

consisting of those standard embeddings whose restriction to  $\mathbb{R}^m \setminus \overline{D}^m$  is the inclusion. Let  $f$  be such an embedding, and let

$$\tilde{\alpha}: (B_- \times D^m) \coprod (\mathbb{R}^m \setminus \overline{D}^m) \longrightarrow (A_- \times D^m) \coprod (\mathbb{R}^m \setminus \overline{D}^m)$$

be a morphism in  $\tilde{\Gamma}(\mathbf{B}_m)$ . Then  $f \circ \tilde{\alpha}$  is a standard embedding of  $(B_- \times D^m) \coprod (\mathbb{R}^m \setminus \overline{D}^m)$  into  $\mathbb{R}^m$ , which may not restrict to the inclusion on  $\mathbb{R}^m \setminus \overline{D}^m$ , and so may not represent an element of  $\text{sEmb}(B_- \times D^m, D^m)$ . Let  $r_{\tilde{\alpha}}$  be the unique standard isomorphism of  $\mathbb{R}^m$  for which  $r_{\tilde{\alpha}} \circ f \circ \tilde{\alpha}$  restricts to the inclusion on  $\mathbb{R}^m \setminus \overline{D}^m$ . It is elementary that  $r_{\tilde{\alpha}}$  is well-defined and depends continuously on  $\tilde{\alpha}$ . We define the functoriality by sending  $f$  to  $r_{\tilde{\alpha}} \circ f \circ \tilde{\alpha}$ . It is easy to check that this is the correct definition.

A perhaps even more natural example of a contravariant functor from  $\tilde{\Gamma}(\mathbf{B}_m)$  to  $\text{Top}$  is the functor that sends  $A$  to the space of standard embeddings

$$\text{sEmb}\left((A_- \times D^m) \coprod (\mathbb{R}^m \setminus \overline{D}^m), \mathbb{R}^m\right).$$

This is obviously a functor of  $\tilde{\Gamma}(\mathbf{B}_m)$ . In fact, it is weakly equivalent to the previous functor.

**Lemma 3.7.** *There is a natural transformation of functors*

$$\text{sEmb}\left((A_- \times D^m) \coprod (\mathbb{R}^m \setminus \overline{D}^m), \mathbb{R}^m\right) \longrightarrow \text{sEmb}(A_- \times D^m, D^m)$$

which is a homotopy equivalence for each  $A$ .

*Proof.* As before, let us identify  $\text{sEmb}(A_- \times D^m, D^m)$  with the subspace of

$$\text{sEmb}\left((A_- \times D^m) \coprod (\mathbb{R}^m \setminus \overline{D}^m), \mathbb{R}^m\right)$$

consisting of those embeddings that restrict to the inclusion on  $\mathbb{R}^m \setminus \overline{D}^m$ . As before, given an

$$f \in \text{sEmb}\left((A_- \times D^m) \coprod (\mathbb{R}^m \setminus \overline{D}^m), \mathbb{R}^m\right),$$

there exists a unique standard isomorphism  $r_f$  of  $\mathbb{R}^m$ , depending continuously on  $f$ , for which  $r_f \circ f$  restricts to the inclusion on  $\mathbb{R}^m \setminus \overline{D}^m$ . Our map sends  $f$  to  $r_f \circ f$ . It is easy to see that it is natural with respect to morphisms in  $\tilde{\Gamma}(\mathbf{B}_m)$ . This map is in fact a fiber bundle with contractible fibers (the fiber is the space of standard isomorphisms of  $\mathbb{R}^m$ ). Thus it is a homotopy equivalence.  $\square$

We will also need the following observation. Let  $i: \mathbb{R}^m \hookrightarrow \mathbb{R}^n$  be a linear isometric inclusion of Euclidean spaces. Then  $i$  induces a map of operads  $\mathbf{B}_m \longrightarrow \mathbf{B}_n$  and also a functor  $\tilde{\Gamma}(\mathbf{B}_m) \longrightarrow \tilde{\Gamma}(\mathbf{B}_n)$ . It follows that there is a forgetful functor from the category of weak bimodules over  $\mathbf{B}_n$  to the category of weak bimodules over  $\mathbf{B}_m$ . Of course, there also is such a forgetful functor for right modules. It turns out that these forgetful functors have left adjoints, which play a rather important role in this paper. VICTOR: IS THE LAST SENTENCE REALLY NECESSARY?

## 4. EMBEDDING TOWER AS THE SPACE OF MODULE MAPS

We will now recall the basic setup of M. Weiss's Embedding calculus [27]. Let  $M$  be a smooth  $m$ -dimensional manifold without boundary. Embedding calculus is concerned with contravariant isotopy functors on the category of open subsets of  $M$ . There are several versions of the category of subsets that we will want to use.

**Definition 4.1.** Let  $\mathcal{O}(M)$  be the poset/category of all open subsets of  $M$  ordered by inclusion. Let  $\mathcal{O}_\infty(M)$  be the subposet of  $\mathcal{O}(M)$  consisting of subsets homeomorphic to a finite disjoint union of copies of an open ball in  $\mathbb{R}^m$ . For  $k = 0, 1, \dots$  let  $\mathcal{O}_k(M)$  be the subposet consisting of sets homeomorphic to the union of at most  $k$  open balls.

Let  $F: \mathcal{O}(M) \rightarrow \mathcal{D}$  be a contravariant isotopy functor. In this paper  $\mathcal{D}$  will be the category of either spaces, (rational) spectra, or (rational) chain complexes. For  $k = 0, 1, \dots$  Weiss defines the functor  $T_k F: \mathcal{O}(M) \rightarrow \mathcal{D}$  by the formula

$$T_k F(U) = \operatorname{holim}_{A \in \mathcal{O}_k(U)} F(A).$$

In other words  $T_k F$  is the homotopy right Kan extension of  $F$  from  $\mathcal{O}_k(M)$  to  $\mathcal{O}(M)$ . Restriction from  $\mathcal{O}_k$  to  $\mathcal{O}_{k-1}$  gives rise to a natural map  $T_k F \rightarrow T_{k-1} F$ , and thus the functors  $T_k F$  fit into a tower of fibrations. We call it *the embedding tower of  $F$* .  $T_k F$  plays the role of the  $k$ -th Taylor polynomial of  $F$  in embedding calculus.

Weiss also introduced a relative version of the construction for manifolds with boundary. If  $M$  is a manifold with boundary, he defines  $\mathcal{O}(M, \partial M)$  as the subposet of  $\mathcal{O}(M)$  consisting of open sets that contain  $\partial M$ . The relative version of manifold calculus constructs polynomial approximations to contravariant isotopy functors whose source category is  $\mathcal{O}(M, \partial M)$ . The  $k$ -th approximation is defined as the homotopy right Kan extension of the restriction to the category  $\mathcal{O}_k(M, \partial M)$ , which is the subposet of  $\mathcal{O}(M, \partial M)$  consisting of sets that are the disjoint union of a tubular neighborhood of  $\partial M$  and at most  $k$  open balls in  $M \setminus \partial M$ . The rest of the theory remains unchanged.

In this paper, instead of using the relative version we will want to use a ‘‘compactly supported’’ variation of it in the case when  $M = \mathbb{R}^m$ .

**Definition 4.2.** We define  $\tilde{\mathcal{O}}(\mathbb{R}^m)$  to be the subcategory of  $\mathcal{O}(\mathbb{R}^m)$  consisting of open sets whose complement is compact. We also define  $\tilde{\mathcal{O}}_k(\mathbb{R}^m)$  to be the following subposet of  $\tilde{\mathcal{O}}(\mathbb{R}^m)$ . An open subset is in  $\tilde{\mathcal{O}}_k(\mathbb{R}^m)$  if it is the union of two disjoint subsets  $U_0$  and  $U_1$  where  $U_0$  is isotopic to the complement of a closed ball, and  $U_1$  is isotopic to the disjoint union of at most  $k$  open balls.

Our next goal is to recast the embedding tower as a space of maps between modules over an operad, in some special cases. To begin with, from now on we will only consider the case where  $M$  is an open submanifold of  $\mathbb{R}^m$ . Moreover,  $M$  will be either a bounded submanifold (in which case we are interested in the absolute theory) or all of  $\mathbb{R}^m$  (in which case we will consider the relative theory). In this case, it makes sense to speak of standard balls in  $M$ . We say that a subset of  $M$  is a standard ball if it is the image of a standard

embedding  $D^m \hookrightarrow M$ . Similarly, a disjoint union of standard balls in  $M$  is the image of a standard embedding  $A \times D^m \hookrightarrow M$  where  $A$  is a finite set.

**Definition 4.3.** When  $M$  is a bounded open submanifold of  $\mathbb{R}^m$ , we define  $\mathcal{O}_k^s(M)$  (where  $k = 0, 1, 2, \dots, \infty$ ) to be the subposet of  $\mathcal{O}_k(M)$  consisting of disjoint unions of at most  $k$  standard balls. In the case when  $M = \mathbb{R}^m$ , we define  $\tilde{\mathcal{O}}_k^s(\mathbb{R}^m)$  to be the subposet of  $\tilde{\mathcal{O}}_k(\mathbb{R}^m)$  consisting of sets that are the image of a standard embedding

$$(A \times D^m) \coprod (\mathbb{R}^m \setminus \bar{D}^m) \hookrightarrow \mathbb{R}^m$$

where  $A$  is a finite set with at most  $k$  elements.

We need to be a little careful about the topology present in our posets. Weiss defines  $\mathcal{O}(M)$  to be a discrete poset. However, there is a natural topology that can be put on it. This topology is all the more naturally present in the posets  $\mathcal{O}_k^s(M)$  and  $\tilde{\mathcal{O}}_k^s(\mathbb{R}^m)$ , and we will view them as topological posets. For example, the space of objects of  $\mathcal{O}_k^s(M)$  can be identified with

$$\prod_{i=0}^k \text{sEmb}(\{1, \dots, i\} \times D^m, M) / \Sigma_i.$$

The space of morphisms is topologized accordingly. In order to relate the topological poset  $\mathcal{O}_k^s(M)$  with the discrete poset  $\mathcal{O}_k(M)$ , we need to also consider the poset  ${}^\delta\mathcal{O}_k^s(M)$ , which is the discrete poset underlying  $\mathcal{O}_k^s(M)$ . This notation is taken from [6]. We will use the decoration  ${}^\delta$  to denote “discretization” in other contexts as well.

We have a diagram of posets and continuous maps between them

$$\mathcal{O}_k^s(M) \longleftarrow {}^\delta\mathcal{O}_k^s(M) \longrightarrow \mathcal{O}_k(M).$$

There also is a “tilde-ed” analogue of this diagram in the case  $M = \mathbb{R}^m$ . Using the methods of [27], especially Section 3, it is not difficult to prove the following lemma.

**Lemma 4.4.** *Let  $M$  be an open submanifold of  $\mathbb{R}^m$ . Let  $F: \mathcal{O}(M) \rightarrow \mathcal{D}$  be a contravariant isotopy functor. Then the inclusion of posets  ${}^\delta\mathcal{O}_k^s(M) \rightarrow \mathcal{O}_k(M)$  induces an equivalence of homotopy limits*

$$(4.1) \quad \text{holim}_{U \in \mathcal{O}_k(M)} F(U) \xrightarrow{\cong} \text{holim}_{U \in {}^\delta\mathcal{O}_k^s(M)} F(U).$$

Similarly, if  $F$  is a contravariant isotopy functor from  $\tilde{\mathcal{O}}(\mathbb{R}^m)$  to  $\mathcal{D}$ , then the inclusion of posets  ${}^\delta\tilde{\mathcal{O}}_k^s(\mathbb{R}^m) \rightarrow \tilde{\mathcal{O}}_k(\mathbb{R}^m)$  induces an equivalence of homotopy limits of  $F$ .

In [27],  $\text{holim}_{U \in \mathcal{O}_k(M)} F(U)$  was used to define  $T_k F$ , the  $k$ -th Taylor polynomial of  $F$ . In view of the above lemma, we may replace  $\mathcal{O}_k(M)$  with  ${}^\delta\mathcal{O}_k^s(M)$ , which is what we will do from now on.

**Definition 4.5.** Let  $M$  be either a bounded open submanifold of a Euclidean space  $\mathbb{R}^m$ , or all of  $\mathbb{R}^m$ . Let  $F$  be a contravariant isotopy functor from  $\mathcal{O}_\infty^s(M)$  (or from  $\tilde{\mathcal{O}}_\infty^s(\mathbb{R}^m)$ ) to

$\mathcal{D}$ . We define

$$\mathbb{T}_k F(M) := \operatorname{holim}_{U \in \delta \mathcal{O}_k^s(M)} F(U).$$

In the case  $M = \mathbb{R}^m$ , the definition is amended to

$$\mathbb{T}_k F(\mathbb{R}^m) := \operatorname{holim}_{U \in \delta \tilde{\mathcal{O}}_k^s(\mathbb{R}^m)} F(U).$$

Now we are ready to relate

$$\mathbb{T}_k F(-)$$

to maps of modules over the little balls operad  $\mathbf{B}_m$ . We want to relate the categories  $\mathcal{O}_k^s(M)$  and  $\tilde{\mathcal{O}}_k^s(\mathbb{R}^m)$  to, respectively, the categories  $\mathcal{F}(\mathbf{B}_m)$  and  $\tilde{\Gamma}(\mathbf{B}_m)$  that were defined in the previous section. To begin with, let us introduce truncated versions of  $\mathcal{F}(\mathbf{B}_m)$  and  $\tilde{\Gamma}(\mathbf{B}_m)$ .

**Definition 4.6.** For  $k = 0, 1, \dots, \infty$ , let  $\mathcal{F}_k(\mathbf{B}_m)$  be the full subcategory of  $\mathcal{F}(\mathbf{B}_m)$  consisting of sets of cardinality at most  $k$ . In particular,  $\mathcal{F}_\infty(\mathbf{B}_m) = \mathcal{F}(\mathbf{B}_m)$ . Thus, it is the category of unions of at most  $k$  standard  $m$ -dimensional balls and standard embeddings between them. Similarly, let  $\tilde{\Gamma}_k(\mathbf{B}_m)$  be the full subcategory of  $\tilde{\Gamma}(\mathbf{B}_m)$  consisting of sets of cardinality at most  $k + 1$ . Thus it is equivalent to the category where an object is the union of at most  $k$  standard  $m$ -balls, together with one anti-ball, and morphisms are standard embeddings between such objects.

Next, let us recall the well-known construction that associates to a category and a functor a new category, that represents a kind of homotopy colimit of the functor.

**Definition 4.7.** Let  $\mathcal{C}$  be a category and let  $F: \mathcal{C} \rightarrow \operatorname{Top}$  be a *contravariant* functor (we focus on the contravariant case, because it arises in the examples of relevance to us). We define  $\mathcal{C} \times F$  to be the following topological category. An object of  $\mathcal{C} \times F$  is a pair  $(c, x)$  where  $c$  is an object of  $\mathcal{C}$  and  $x \in F(c)$ . A morphism  $(c, x) \rightarrow (c', x')$  in  $\mathcal{C} \times F$  is given by a morphism  $\alpha: c \rightarrow c'$  in  $\mathcal{C}$  such that  $F(\alpha)(x') = x$ . Composition of morphisms is defined in the evident way. As mentioned already,  $\mathcal{C} \times F$  is a topological category, where both the space of objects and the space of morphisms have a topology. More precisely, the space of objects is topologized as the disjoint union

$$\coprod_{c \in \operatorname{Ob}(\mathcal{C})} F(c)$$

and the space of morphisms is topologized as the disjoint union

$$\coprod_{(c, c') \in \operatorname{Ob}(\mathcal{C}) \times \operatorname{Ob}(\mathcal{C})} \operatorname{Map}_{\mathcal{C}}(c, c') \times F(c').$$

Note that this definition makes sense if  $\mathcal{C}$  is a topologically enriched category whose set of objects is discrete, but whose spaces of morphisms have a topology. In this case, the topology of  $\mathcal{C}$  is accounted for in the topology of the morphism space of  $\mathcal{C} \times F$ .

For example, consider the construction  $\operatorname{sEmb}(\bullet, M)$  as a contravariant functor either from  $\mathcal{F}(\mathbf{B}_m)$  (if  $M$  is a bounded open submanifold of  $\mathbb{R}^m$ ) or from  $\tilde{\Gamma}(\mathbf{B}_m)$  (if  $M = \mathbb{R}^m$ ) to

Top, and consider the associated categories  $\mathcal{F}(\mathbb{B}_m) \times \text{sEmb}(\bullet, M)$  and  $\tilde{\Gamma}(\mathbb{B}_m) \times \text{sEmb}(\bullet, \mathbb{R}^m)$ . An object in either category is given by an ordered pair  $(U, f)$ , where  $U$  is a finite union of standard balls (together with an anti-ball in the second case), and  $f$  is a standard embedding of  $U$  into  $M$  (or into  $\mathbb{R}^m$ ). There are natural evaluation functors, which we denote with the same symbol  $\text{ev}$

$$\text{ev}: \mathcal{F}_k(\mathbb{B}_m) \times \text{sEmb}(\bullet, M) \longrightarrow \mathcal{O}_k^s(M)$$

and

$$\text{ev}: \tilde{\Gamma}_k(\mathbb{B}_m) \times \text{sEmb}(\bullet, \mathbb{R}^m) \longrightarrow \tilde{\mathcal{O}}_k^s(\mathbb{R}^m)$$

which send a pair  $(U, f)$  to the image of  $f$ .

We also would like to consider discretized versions of the evaluation functor. We adopt the convention from [6] that for a topological space  $X$ ,  $\delta X$  denotes the discrete set underlying  $X$ , and similarly for a topological category  $\mathcal{C}$ ,  $\delta \mathcal{C}$  denotes the underlying discrete category. Thus we have discrete versions of the evaluation functors

$$(4.2) \quad \delta \text{ev}: \delta \mathcal{F}_k(\mathbb{B}_m) \times \delta \text{sEmb}(\bullet, M) \longrightarrow \delta \mathcal{O}_k^s(M)$$

$$(4.3) \quad \delta \text{ev}: \delta \tilde{\Gamma}_k(\mathbb{B}_m) \times \delta \text{sEmb}(\bullet, \mathbb{R}^m) \longrightarrow \delta \tilde{\mathcal{O}}_k^s(\mathbb{R}^m)$$

We have the following easy lemma, whose proof relies on the fact that there is a unique standard isomorphism between two standard  $m$ -balls, as well as between two standard anti-balls.

**Lemma 4.8.** *The discretized evaluation functors (4.2) and (4.3) are equivalences of categories. It follows, in particular, that pulling back along these functors induces an equivalence of homotopy limits.*

The lemma tells us that one can replace homotopy limits over  $\delta \mathcal{O}_k^s(M)$  (resp.  $\delta \tilde{\mathcal{O}}_k^s(\mathbb{R}^m)$ ) with homotopy limits over  $\delta \mathcal{F}_k(\mathbb{B}_m) \times \delta \text{sEmb}(\bullet, M)$  (resp.  $\delta \tilde{\Gamma}_k(\mathbb{B}_m) \times \delta \text{sEmb}(\bullet, \mathbb{R}^m)$ ). Next, we observe that homotopy limits over these categories can, for an important class of functors, be viewed as spaces of maps between modules. Note that for a category  $\mathcal{C}$  and a functor  $F$  for which  $\mathcal{C} \times F$  is defined, there is a canonical projection functor  $p: \mathcal{C} \times F \longrightarrow \mathcal{C}$ .

**Definition 4.9.** Let  $F: \delta \mathcal{F}(\mathbb{B}) \times \delta \text{sEmb}(\bullet, M) \longrightarrow \mathcal{D}$  be a contravariant functor. We call  $F$  *context-free* if  $F$  factors, up to a natural equivalence, through the projection functor. That is, if there exists a contravariant functor  $F': \delta \mathcal{F}(\mathbb{B}) \longrightarrow \mathcal{D}$  such that  $F$  is naturally equivalent to  $F' \circ p$ . If  $F$  is context free, we will generally not distinguish in notation between  $F$  and  $F'$ .

We will say that a functor  $F: \delta \mathcal{O}_\infty^s(M) \longrightarrow \mathcal{D}$  is context-free if the functor  $F \circ \delta \text{ev}$  is context-free. In a similar way we define what it means to be context-free for a functor whose domain is  $\delta \tilde{\Gamma}(\mathbb{B}) \times \delta \text{sEmb}(\bullet, V)$  or  $\delta \tilde{\mathcal{O}}_\infty^s(V)$ . Informally speaking, a functor on  $\delta \mathcal{O}_\infty^s(M)$  or a similar category is context-free if it does not depend on the embedding of the balls in  $M$ .

**Example 4.10.** The functor  $U \mapsto \text{sEmb}(U, M)$  is a context-free functor on  $\delta \mathcal{O}_\infty^s(M)$ . Here is an example of a functor that is not context-free. Let  $h: M \looparrowright N$  be a fixed immersion. Recall that  $\overline{\text{Emb}}(U, N)$  is the homotopy fiber of the inclusion map  $\text{Emb}(U, N) \longrightarrow \text{Imm}(U, N)$ .

The functor  $U \mapsto \overline{\text{Emb}}(U, N)$  is not context-free, because it depends on the basepoint of  $\text{Imm}(U, N)$ , which is the restriction of  $h$  to  $U$ , which in turn depends on the embedding of  $U$  into  $M$ . However, if  $N = M$ ,  $h$  is the identity, and  $M$  is a contractible open subset of  $\mathbb{R}^m$  (e.g., an open ball, or all of  $\mathbb{R}^m$ ), then it is not hard to show that  $\overline{\text{Emb}}(U, N)$  is naturally weakly equivalent to  $\text{sEmb}(U, M)$  (the proof is very similar to [6, Proposition 7.1]). See also Lemma 5.1 below). Thus, in this case the functor  $\overline{\text{Emb}}(U, N)$  is context free.

Recall that a contravariant functor on  $\mathcal{F}(\mathbf{B}_m)$  is essentially the same thing as a right module over  $\mathbf{B}_m$  (Lemma 2.5). Thus a context-free functor on  $\mathcal{O}_\infty^s(M)$  is essentially the same as a right module over  $\mathbf{B}_m$ . Similarly, a context-free functor on  $\widetilde{\mathcal{O}}_\infty^s(\mathbb{R}^m)$  is essentially the same as a weak bimodule over  $\mathbf{B}_m$  (Proposition 2.15). The same holds true after discretization.

**Lemma 4.11.** *Let  $F: \delta\mathcal{O}_\infty^s(M) \rightarrow \mathcal{D}$  be a context free functor, where  $\mathcal{D}$  is one of the following categories: (pointed) topological spaces, spectra, or (rational) chain complexes. Then there is a natural equivalence*

$$\mathbb{T}_k F(M) := \text{holim}_{\delta\mathcal{O}_k^s(M)} F(-) \simeq \text{hNat}_{\delta\mathcal{F}_k(\mathbf{B}_m)}(\delta\text{sEmb}(-, M), F(-)).$$

Similarly, if  $F$  is a context-free functor on  $\widetilde{\mathcal{O}}_k^s(\mathbb{R}^m)$  then

$$\mathbb{T}_k F(\mathbb{R}^m) := \text{holim}_{\delta\widetilde{\mathcal{O}}_k^s(V)} F(-) \simeq \text{hNat}_{\delta\widetilde{\Gamma}_k(\mathbf{B}_m)}(\delta\text{sEmb}(-, \mathbb{R}^m), F(-)).$$

Here  $\text{hNat}(F, G)$  stands for the derived object of natural transformations. One way to define is by taking the strict object of natural transformations between a cofibrant replacement of  $F$  and a fibrant replacement of  $G$ .

*Proof.* By Lemma 4.8,

$$\text{holim}_{U \in \delta\mathcal{O}_k^s(M)} F(U) \simeq \text{holim}_{(A, f) \in \delta\mathcal{F}_k(\mathbf{B}_m) \times \text{sEmb}(\bullet, M)} F(f(A)).$$

Since  $F$  is context-free, we can rewrite the right hand side as

$$\text{holim}_{(A, f) \in \delta\mathcal{F}_k(\mathbf{B}_m) \times \text{sEmb}(\bullet, M)} F(A)$$

the point being that  $F$  only depends on  $A$  and not on  $f(A)$ . On the other hand, by [4, Lemma 3.3]

$$\text{holim}_{(A, f) \in \delta\mathcal{F}_k(\mathbf{B}_m) \times \text{sEmb}(\bullet, M)} F(A) \simeq \text{hNat}_{A \in \delta\mathcal{F}_k(\mathbf{B}_m)}(\delta\text{sEmb}(A, M), F(A)).$$

This proves the first equivalence. The second one is proved similarly.  $\square$

*Remark 4.12.* The categories of contravariant functors on  $\delta\mathcal{F}_k(\mathbf{B}_m)$  and  $\delta\widetilde{\Gamma}_k(\mathbf{B}_m)$  are equivalent to the categories of, respectively, truncated right modules and truncated weak bimodules over the discretized little balls operad  $\delta\mathbf{B}_m$ . Thus the above lemma can be interpreted as giving models for  $\mathbb{T}_k F(M)$  and  $\mathbb{T}_k F(\mathbb{R}^m)$  as derived space of maps between truncated right modules and truncated weak bimodules over  $\delta\mathbf{B}_k$ .

*Remark 4.13.* In the statement and proof of Lemma 4.11 we have, obviously, used the fact that the categories in which  $F$  may take values are cotensored (as well as tensored and enriched) over the category of sets. In fact, the main reason that we chose to work so much with the discretized categories  ${}^\delta\mathcal{F}_k(\mathbf{B}_m)$  and  ${}^\delta\mathcal{F}_k(\mathbf{B}_m) \times {}^\delta\text{sEmb}(\bullet, M)$  rather than with the topological categories is that the category of chain complexes is not cotensored over the category of spaces, and thus Lemma 4.11 would not even make sense as stated without discretization. However, we strongly believe that this is a technical issue that could be overcome. In particular, we believe in the following conjecture

**Conjecture 4.14.** *Let  $F: \mathcal{O}_\infty^s(M) \rightarrow \text{Ch}$  be a context-free functor with values in the category of chain complexes. Let  $\mathbf{C}: \text{Top} \rightarrow \text{Ch}$  be the singular chains functor. Then there is a natural equivalence*

$$\mathbb{T}_k F(M) := \text{holim}_{{}^\delta\mathcal{O}_k^s(M)} F(-) \simeq \text{hNat}_{\mathbf{C}(\mathcal{F}_k(\mathbf{B}_m))}(\mathbf{C}(\text{sEmb}(-, M)), F(-)).$$

Similarly, if  $F$  is a context-free functor from  $\tilde{\mathcal{O}}_k^s(\mathbb{R}^m)$  to  $\text{Top}$  then

$$\mathbb{T}_k F(\mathbb{R}^m) := \text{holim}_{{}^\delta\tilde{\mathcal{O}}_k^s(\mathbb{R}^m)} F(-) \simeq \text{hNat}_{\mathbf{C}(\tilde{\Gamma}_k(\mathbf{B}_m))}(\mathbf{C}(\text{sEmb}(-, \mathbb{R}^m)), F(-)).$$

Note, again, that the above objects of natural transformations can be interpreted in terms of mapping objects between truncated modules. Namely

$$\text{hNat}_{\mathbf{C}(\mathcal{F}_k(\mathbf{B}_m))}(\mathbf{C}(\text{sEmb}(-, M)), F(-)) \simeq \text{hRmod}_{\leq k}(\mathbf{C}(\text{sEmb}(-, M)), F)$$

and

$$\text{hNat}_{\mathbf{C}(\tilde{\Gamma}_k(\mathbf{B}_m))}(\mathbf{C}(\text{sEmb}(-, \mathbb{R}^m)), F(-)) \simeq \text{WBimod}_{\leq k}(\mathbf{C}(\mathbf{B}_m), F)$$

Where  $\text{hRmod}_{\leq k}(-, -)$  (resp.  $\text{WBimod}_{\leq k}(-, -)$ ) stands for the chain complex of derived morphisms between truncated right modules (resp. weak bimodules) over the operad  $\mathbf{C}(\mathbf{B}_m)$ .

## 5. APPLYING THE FORMALITY THEOREM

Let  $M$  be an open submanifold of  $\mathbb{R}^m$  (as usual, we assume that  $M$  is either bounded or is all of  $\mathbb{R}^m$ ) and let us suppose that  $\mathbb{R}^m$  is a subspace of another Euclidean space  $\mathbb{R}^n$  such that  $n \geq 2m + 1$ . Thus we have a fixed embedding of  $M$  into  $\mathbb{R}^n$ , and we use this embedding to define the functors  $\overline{\text{Emb}}(-, \mathbb{R}^n): \mathcal{O}(M) \rightarrow \text{Top}$ . Similarly, we use the inclusion of  $\mathbb{R}^m$  into  $\mathbb{R}^n$  to define the functor  $\overline{\text{Emb}}_c(-, \mathbb{R}^n): \tilde{\mathcal{O}}(\mathbb{R}^m) \rightarrow \text{Top}$ . In this section, we would like to apply Lemma 4.11 to the functors  $\mathbf{C}^{\mathbb{Q}}(\overline{\text{Emb}}(-, \mathbb{R}^n))$  and  $\mathbf{C}^{\mathbb{Q}}(\overline{\text{Emb}}_c(-, \mathbb{R}^n))$ . To begin with, we have the following lemma, which says that these functors are context-free

**Lemma 5.1.** *The functor  $\overline{\text{Emb}}(-, \mathbb{R}^n)$ , considered as a functor either from  $\mathcal{O}_\infty^s(M)$  to  $\text{Top}$  or from  $\tilde{\mathcal{O}}_\infty^s(\mathbb{R}^m)$  to  $\text{Top}$  is equivalent to the functor  $\text{sEmb}(-, \mathbb{R}^n)$ .*

*Proof.* The first case is exactly [6, Proposition 7.1]. The second case is proved in the same way.  $\square$

Since  $\text{sEmb}(-, \mathbb{R}^n)$  is a context-free functor, we can apply Lemma 4.11 to obtain the following formulas

$$T_k \mathcal{C}(\overline{\text{Emb}}(M, \mathbb{R}^n)) \simeq \underset{\delta \mathcal{F}_k(\mathbf{B}_m)}{\text{hNat}}(\delta \text{sEmb}(-, M), \mathcal{C}(\text{sEmb}(-, \mathbb{R}^n)))$$

and

$$T_k \mathcal{C}(\overline{\text{Emb}}_c(\mathbb{R}^m, \mathbb{R}^n)) \simeq \underset{\delta \tilde{\Gamma}_k(\mathbf{B}_m)}{\text{hNat}}(\delta \text{sEmb}(-, \mathbb{R}^m), \mathcal{C}(\text{sEmb}(-, \mathbb{R}^n))).$$

We will now write this as maps of right modules and weak bimodules over the (discretized) little balls operad respectively. Clearly, in the first formula,  $\text{sEmb}(-, \mathbb{R}^n)$  is equivalent to  $\mathbf{B}_n$  as a right module over  $\mathbf{B}_m$  (or  $\delta \mathbf{B}_m$ ). By Lemma 3.7, the same is true in the second formula. Thus we may rewrite the formulas as follows

$$(5.1) \quad T_k \mathcal{C}(\overline{\text{Emb}}(M, \mathbb{R}^n)) \simeq \underset{\delta \mathbf{B}_m}{\text{hRmod}_{\leq k}}(\delta \text{sEmb}(-, M), \mathcal{C}(\mathbf{B}_n))$$

and

$$(5.2) \quad T_k \mathcal{C}(\overline{\text{Emb}}_c(\mathbb{R}^m, \mathbb{R}^n)) \simeq \underset{\delta \mathbf{B}_m}{\text{WBimod}_{\leq k}}(\delta \text{sEmb}(-, \mathbb{R}^m), \mathcal{C}(\mathbf{B}_n)).$$

Here  $\text{hRmod}_{\leq k}$  and  $\text{WBimod}_{\leq k}$  denote derived spaces of maps between truncated right modules and truncated weak bimodules respectively.

Next, we use Kontsevich's formality theorem, very much in the spirit of [6] to deduce that in characteristic zero  $\mathcal{C}(\mathbf{B}_n)$  can be replaced with  $\text{H}(\mathbf{B}_n)$  in the above formulas.

**Proposition 5.2.** *Suppose that  $2m + 1 \leq n$ . There are equivalences*

$$T_k \mathcal{C}^{\mathbb{Q}}(\overline{\text{Emb}}(M, \mathbb{R}^n)) \simeq \underset{\delta \mathbf{B}_m}{\text{hRmod}_{\leq k}}(\delta \text{sEmb}(-, M), \text{H}(\mathbf{B}_n; \mathbb{Q}))$$

and

$$T_k \mathcal{C}^{\mathbb{Q}}(\overline{\text{Emb}}_c(\mathbb{R}^m, \mathbb{R}^n)) \simeq \underset{\delta \mathbf{B}_m}{\text{WBimod}_{\leq k}}(\delta \text{sEmb}(-, \mathbb{R}^m), \text{H}(\mathbf{B}_n; \mathbb{Q})).$$

*Proof.* The first assertion is essentially the same as [6, Theorem 9.2]. The proof of the second assertion is similar. The main point is that since the category of weak bimodules over an operad is equivalent to a category of diagrams (Proposition 2.15), just like the category of right modules, all the formal manipulations that were done in [6] for the first case can also be done for the second case. For the reader's convenience, we will go over the main steps of the argument. For the rest of the proof, each occurrence of the word "module" may be read either as "right module" or "weak bi-module".

To begin with, it follows from Kontsevich's formality theorem [15], or more precisely from the "relative" version of the theorem, introduced by Lambrechts and Volic ([17], and see also [6]), that (under the assumption  $2m + 1 \leq n$ ) the map of operads

$$\mathcal{C}^{\mathbb{R}}(\mathbf{B}_m) \longrightarrow \mathcal{C}^{\mathbb{R}}(\mathbf{B}_n)$$

is equivalent, via a chain of quasi-isomorphisms between maps of operads, to the maps of operads

$$\text{H}(\mathbf{B}_m; \mathbb{R}) \longrightarrow \text{H}(\mathbf{B}_n; \mathbb{R}).$$

This means that there is a diagram of operads, where  $\mathcal{D}_m, \mathcal{D}_n$  are some intermediate operads, and the horizontal homomorphisms are quasi-isomorphisms

$$\begin{array}{ccccc} \mathcal{C}^{\mathbb{R}}(\mathcal{B}_m) & \xleftarrow{\simeq} & \mathcal{D}_m & \xrightarrow{\simeq} & \mathbf{H}(\mathcal{B}_m; \mathbb{R}) \\ \downarrow & & \downarrow & & \downarrow \\ \mathcal{C}^{\mathbb{R}}(\mathcal{B}_n) & \xleftarrow{\simeq} & \mathcal{D}_n & \xrightarrow{\simeq} & \mathbf{H}(\mathcal{B}_n; \mathbb{R}) \end{array}$$

Considering  $\mathbf{H}(\mathcal{B}_n; \mathbb{R})$  as a module over  $\mathbf{H}(\mathcal{B}_m; \mathbb{R})$ , we can consider it as a module over  $\mathcal{D}_m$  via the pull-back functor. Then, using the identification of the category of modules with a category of diagrams, we can use the derived left Kan extension (which is the derived left adjoint to the pull-back functor) along the map of operads  $\mathcal{D}_m \rightarrow \mathcal{C}^{\mathbb{R}}(\mathcal{B}_m)$  to get a module over  $\mathcal{C}^{\mathbb{R}}(\mathcal{B}_m)$ . Let us denote this module  $\mathbf{LH}(\mathcal{B}_n; \mathbb{R})$ . This construction was explained in detail in [6] for the case of right modules, and the point here is that since the category of weak bimodules is equivalent to a certain category of diagrams of chain complexes just like the category of right modules, the same constructions and arguments apply to weak bimodules. It follows from the formality theorem that  $\mathbf{LH}(\mathcal{B}_n; \mathbb{R})$  is weakly equivalent to  $\mathcal{C}^{\mathbb{R}}(\mathcal{B}_n)$  as module over  $\mathcal{C}^{\mathbb{R}}(\mathcal{B}_m)$ . On the other hand, since  $\mathbf{H}(\mathcal{B}_n; \mathbb{R})$  splits, in the category of modules over  $\mathbf{H}(\mathcal{B}_m; \mathbb{R})$ , as a direct sum of modules each concentrated in a single homological degree (here we use that  $m < n$ ), it follows that  $\mathbf{LH}(\mathcal{B}_n; \mathbb{R})$  also splits as a direct sum of modules, with each summand concentrated in a single homological degree. Restricting from the operad  $\mathcal{C}^{\mathbb{R}}(\mathcal{B}_m)$  to  $\mathcal{C}_0^{\mathbb{R}}(\mathcal{B}_m) = \mathcal{C}_0^{\mathbb{R}}(\delta\mathcal{B}_m)$ , we obtain that  $\mathbf{LH}(\mathcal{B}_n; \mathbb{R})$ , and therefore also  $\mathcal{C}^{\mathbb{R}}(\mathcal{B}_n)$ , splits in this way as a module over  $\mathcal{C}_0^{\mathbb{R}}(\delta\mathcal{B}_m)$ , or equivalently over  $\delta\mathcal{B}_m$ . Since the latter is a discrete operad, this means that  $\mathcal{C}^{\mathbb{R}}(\mathcal{B}_n)$  splits, as a module over  $\delta\mathcal{B}_m$ , as a product of layers in its Postnikov tower. This means that  $\mathcal{C}^{\mathbb{R}}(\mathcal{B}_n)$  is in fact equivalent to  $\mathbf{H}(\mathcal{B}_n; \mathbb{R})$  as a module over  $\mathcal{C}_0^{\mathbb{R}}(\delta\mathcal{B}_m)$ , where the action of  $\mathcal{C}_0^{\mathbb{R}}(\delta\mathcal{B}_m)$  on  $\mathbf{H}(\mathcal{B}_n; \mathbb{R})$  is defined using the natural map of operads  $\mathcal{C}_0(\delta\mathcal{B}_m) \rightarrow \mathcal{C}(\mathcal{B}_m) \rightarrow \mathbf{Com}$  and the action of  $\mathbf{Com} = \mathbf{H}_0(\mathcal{B}_n)$  on  $\mathbf{H}(\mathcal{B}_n)$ . Again, a detailed proof of all these implications was given in [6] for right modules, and the same proof works for weak bimodules.

Substituting this equivalence into (5.1) and (5.2), we obtain the equivalences

$$\mathrm{T}_k \mathcal{C}^{\mathbb{R}}(\overline{\mathbf{Emb}}(M, \mathbb{R}^n)) \simeq \mathrm{hRmod}_{\leq k}^{\delta\mathcal{B}_m}(\delta\mathrm{sEmb}(-, M), \mathbf{H}(\mathcal{B}_n; \mathbb{R}))$$

and

$$\mathrm{T}_k \mathcal{C}^{\mathbb{R}}(\overline{\mathbf{Emb}}_c(\mathbb{R}^m, \mathbb{R}^n)) \simeq \mathrm{WBimod}_{\leq k}^{\delta\mathcal{B}_m}(\delta\mathrm{sEmb}(-, \mathbb{R}^m), \mathbf{H}(\mathcal{B}_n; \mathbb{R})).$$

It remains to show that  $\mathbb{R}$  can be replaced with  $\mathbb{Q}$  in the above equivalences. This was proved in [6] for the first equivalence, and the proof for the second one is similar. By a compactness argument similar to the proof of [6, Proposition 8.3], one can show that there are quasi-isomorphisms

$$\mathrm{T}_k \mathcal{C}^{\mathbb{R}}(\overline{\mathbf{Emb}}_c(\mathbb{R}^m, \mathbb{R}^n)) \simeq \left( \mathrm{T}_k \mathcal{C}^{\mathbb{Q}}(\overline{\mathbf{Emb}}(\mathbb{R}^m, \mathbb{R}^n)) \right) \otimes \mathbb{R}$$

and

$$\mathrm{hRmod}_{\leq k}^{\delta_{\mathbf{B}_m}}(\delta_{\mathbf{B}_m} \mathrm{sEmb}(-, \mathbb{R}^m), \mathrm{H}(\mathbf{B}_n; \mathbb{R})) \simeq \left( \mathrm{hRmod}_{\leq k}^{\delta_{\mathbf{B}_m}}(\delta_{\mathbf{B}_m} \mathrm{sEmb}(-, \mathbb{R}^m), \mathrm{H}(\mathbf{B}_n; \mathbb{Q})) \right) \otimes \mathbb{R}.$$

Thus the rational chain complexes

$$\mathrm{T}_k \mathcal{C}^{\mathbb{Q}}(\overline{\mathrm{Emb}}_c(\mathbb{R}^m, \mathbb{R}^n)) \quad \text{and} \quad \mathrm{hRmod}_{\leq k}^{\delta_{\mathbf{B}_m}}(\delta_{\mathbf{B}_m} \mathrm{sEmb}(-, \mathbb{R}^m), \mathrm{H}(\mathbf{B}_n; \mathbb{Q}))$$

become quasi-isomorphic after tensoring with  $\mathbb{R}$ . It is easy to show that both complexes are of finite type. It follows that they are quasi-isomorphic also before tensoring with  $\mathbb{R}$ .  $\square$

## 6. FROM THE LITTLE BALLS OPERAD TO THE COMMUTATIVE OPERAD

Let  $A$  be a set and  $C$  a chain complex. Then there is a tautological isomorphism

$$C^A \cong \mathrm{hom}(\mathcal{C}(A), C)$$

where the  $\mathrm{hom}$  on the right hand stands for internal mapping object in the category of chain complexes. It follows that we can rewrite the formulas of Proposition 5.2 in the following form.

$$\mathrm{T}_k \mathcal{C}^{\mathbb{Q}}(\overline{\mathrm{Emb}}(M, \mathbb{R}^n)) \simeq \mathrm{hRmod}_{\leq k}^{\mathcal{C}(\delta_{\mathbf{B}_m})}(\mathcal{C}(\delta_{\mathbf{B}_m} \mathrm{sEmb}(-, M)), \mathrm{H}(\mathbf{B}_n; \mathbb{Q}))$$

and

$$\mathrm{T}_k \mathcal{C}^{\mathbb{Q}}(\overline{\mathrm{Emb}}_c(\mathbb{R}^m, \mathbb{R}^n)) \simeq \mathrm{WBimod}_{\leq k}^{\mathcal{C}(\delta_{\mathbf{B}_m})}(\mathcal{C}(\delta_{\mathbf{B}_m} \mathrm{sEmb}(-, \mathbb{R}^m)), \mathrm{H}(\mathbf{B}_n; \mathbb{Q})).$$

Furthermore, recall that the action of  $\mathcal{C}(\delta_{\mathbf{B}_m})$  on  $\mathrm{H}(\mathbf{B}_n; \mathbb{Q})$  factors through the natural map of operads  $\mathcal{C}(\delta_{\mathbf{B}_m}) \rightarrow \mathrm{Com}$ , where  $\mathrm{Com}$  is the commutative operad in chain complexes. Thus  $\mathrm{H}(\mathbf{B}_n; \mathbb{Q})$  is in the image of the restriction functor from (weak bi-)modules over  $\mathrm{Com}$  to (weak bi-)modules over  $\mathcal{C}(\delta_{\mathbf{B}_m})$ . Since the categories of right modules and weak bi-modules are equivalent to certain diagram categories, both restriction functors have a derived left adjoint, defined using the derived left Kan extension. Let  $\mathrm{ind}$  denote the derived induction functor from right modules over  $\mathcal{C}(\delta_{\mathbf{B}_m})$  to right modules over  $\mathrm{Com}$ , and let  $\widetilde{\mathrm{ind}}$  denote the analogous induction functor for weak bimodules. We have the following tautological consequence of Proposition 5.2.

**Corollary 6.1.** *Suppose that  $2m + 1 \leq n$ ,  $M$  is a bounded open submanifold of  $\mathbb{R}^m$ , and  $\mathbb{R}^m$  is a subspace of  $\mathbb{R}^n$ . Then there are equivalences*

$$\mathrm{T}_k \mathcal{C}^{\mathbb{Q}}(\overline{\mathrm{Emb}}(M, \mathbb{R}^n)) \simeq \mathrm{hRmod}_{\leq k}^{\mathrm{Com}} \left( \mathrm{ind} \left( \mathcal{C}(\delta_{\mathbf{B}_m} \mathrm{sEmb}(-, M)) \right), \mathrm{H}(\mathbf{B}_n; \mathbb{Q}) \right)$$

and

$$\mathrm{T}_k \mathcal{C}^{\mathbb{Q}}(\overline{\mathrm{Emb}}_c(\mathbb{R}^m, \mathbb{R}^n)) \simeq \mathrm{WBimod}_{\leq k}^{\mathrm{Com}} \left( \widetilde{\mathrm{ind}} \left( \mathcal{C}(\delta_{\mathbf{B}_m} \mathrm{sEmb}(-, \mathbb{R}^m)) \right), \mathrm{H}(\mathbf{B}_n; \mathbb{Q}) \right).$$

Our next task is to describe explicitly the right Com-module  $\text{ind}(\mathbf{C}(\delta\text{sEmb}(-, M)))$ , and the weak Com-bimodule  $\widetilde{\text{ind}}(\mathbf{C}(\delta\text{sEmb}(-, \mathbb{R}^m)))$ . Recall that a right Com-module is the same thing as a contravariant functor on the category  $\mathcal{F}$  of unpointed finite sets, and a weak Com-bimodule is the same thing as a contravariant functor on the category  $\Gamma$  of pointed finite sets (Corollaries 2.6 and 2.16 respectively). Let  $\mathbf{C}(M^\bullet)$  be the right Com-module corresponding to the functor from  $\mathcal{F}$  to chain complexes  $U \mapsto \mathbf{C}(\text{Map}(U, M))$ . Let  $\mathbf{C}((S^m)^\bullet)$  be the weak Com-bimodule corresponding to the functor from  $\Gamma$  to chain complexes  $A \mapsto \text{Map}_*(A, S^m)$ . Here  $S^m$  is the one-point compactification of  $\mathbb{R}^m$ , considered as a pointed space with  $\infty$  being the basepoint.

**Proposition 6.2.** *There is an equivalence of right Com-modules.*

$$\text{ind}(\mathbf{C}(\delta\text{sEmb}(-, M))) \simeq \mathbf{C}(M^\bullet),$$

and an equivalence of weak Com-bimodules

$$\widetilde{\text{ind}}(\mathbf{C}(\delta\text{sEmb}(-, \mathbb{R}^m))) \simeq \mathbf{C}((S^m)^\bullet).$$

*Proof.* Let us prove the first assertion first. The induction functor is defined as the derived left Kan extension along the functor  $H_0: \mathbf{C}(\mathcal{F}(\delta\mathbb{B}_m)) \rightarrow \mathbf{C}(\mathcal{F})$ . The chains functor  $\mathbf{C}$  from Top to chain complexes commutes with homotopy colimits. Therefore we may consider instead the functor  $\pi_0: \mathcal{F}(\delta\mathbb{B}_m) \rightarrow \mathcal{F}$ , and it is enough to show that the homotopy left Kan extension of  $\delta\text{sEmb}(\bullet, M)$  along this functor is equivalent to  $M^\bullet$ .

Let us consider first the case when  $M$  is itself an object of  $\mathcal{F}(\delta\mathbb{B}_m)$ . That is, when  $M$  is the disjoint union of standard balls in  $\mathbb{R}^m$ . Let us relabel  $M = U$  in this case. Thus  $\delta\text{sEmb}(V, U)$  is the set of morphisms from  $V$  to  $U$  in  $\mathcal{F}(\delta\mathbb{B}_m)$ . Thus, in this case  $\delta\text{sEmb}(\bullet, U)$  is the free contravariant functor from  $\mathcal{F}(\delta\mathbb{B}_m)$  to Top generated by  $U$ . Since free functors are cofibrant in the standard model structure on the category of diagrams, the derived left Kan extension of a free functor is equivalent to the strict left Kan extension. It follows easily from a version of Yoneda Lemma that the left Kan extension of a free functor is again the corresponding free functor. Thus the homotopy left Kan extension  $\delta\text{sEmb}(\bullet, U)$  is equivalent to  $\pi_0(U)^\bullet := \text{Map}(\bullet, \pi_0(U))$ . This in turn is equivalent to  $U^\bullet := \text{Map}(\bullet, U)$ , because  $U$  is the disjoint union of contractible spaces.

Now let  $M$  be a general open submanifold of  $\mathbb{R}^m$ . Recall that  $\delta\mathcal{O}_\infty^s(M)$  is the poset of subsets of  $M$  that are the unions of copies of the standard ball. Consider the homotopy colimit of functors

$$\text{hocolim}_{U \in \delta\mathcal{O}_\infty^s(M)} \delta\text{sEmb}(\bullet, U).$$

We claim that this homotopy colimit is equivalent to  $\delta\text{sEmb}(\bullet, M)$ . To see this, observe first that the diagram  $U \mapsto \delta\text{sEmb}(\bullet, U)$  is cofibrant in the sense that for all  $V \in \mathcal{O}_\infty^s(M)$  the map

$$\text{colim}_{U_0 \subsetneq U} \delta\text{sEmb}(V, U_0) \longrightarrow \delta\text{sEmb}(V, U)$$

is a cofibration. Indeed, it is a homeomorphism if  $V$  is not homeomorphic to  $U$ , and it is the inclusion of a subset of a discrete set if  $V$  is homeomorphic to  $U$ . More precisely, the

colimit on the left hand side is the set of non-surjective standard embeddings of  $V$  into  $U$ . It follows that the following natural map is an equivalence

$$\operatorname{hocolim}_{U \in \mathcal{O}_\infty^s(M)} \delta\text{sEmb}(\bullet, U) \simeq \operatorname{colim}_{U \in \delta\mathcal{O}_\infty^s(M)} \delta\text{sEmb}(\bullet, U).$$

The target of this map is clearly the same  $\delta\text{sEmb}(\bullet, M)$ , since every standard embedding of a union of balls into  $M$  factors through some  $U \in \delta\mathcal{O}_\infty^s(M)$ .

Since homotopy left Kan extension commutes with homotopy colimits, it follows that  $\operatorname{ind}(\delta\text{sEmb}(\bullet, M))$  is equivalent to homotopy colimit, over  $U$  in  $\delta\mathcal{O}_\infty^s(M)$ , of the homotopy left Kan extensions of  $\delta\text{sEmb}(\bullet, U)$ , which is equivalent, by the first part of the proof, to

$$\operatorname{hocolim}_{U \in \delta\mathcal{O}_\infty^s(M)} U^\bullet,$$

which is easily seen to be equivalent to  $M^\bullet$ .

Now let us consider the second assertion. The idea of the proof is similar. We want to show that the homotopy left Kan extension of  $\delta\text{sEmb}(-, \mathbb{R}^m)$  along the functor

$$\pi_0: \tilde{\Gamma}(\delta\mathbb{B}_m) \longrightarrow \Gamma$$

is equivalent to  $(S^m)^\bullet$ . Let us recall the picture of the category  $\tilde{\Gamma}(\delta\mathbb{B}_m)$  that we are working with. An object of this category is a disjoint union of standard balls in  $\mathbb{R}^m$ , together with one ‘‘anti-ball’’, that is a copy of the complement of the unit open ball in  $\mathbb{R}^m$ . Morphisms are standard embeddings between such objects. Again, let us consider first the homotopy left Kan extension of the functor  $\delta\text{sEmb}(\bullet, U)$ , where  $U$  is an object of  $\tilde{\Gamma}(\delta\mathbb{B}_m)$ . As before, this is a free functor, and so its derived left Kan extension is the functor  $\pi_0(U)^\bullet := \operatorname{Map}_*(-, \pi_0(U))$ . Here we view  $\pi_0(U)$  as a pointed set, the basepoint being the path component of the anti-ball. Now we can not say, as we did in the first part of the proof, that  $\operatorname{Map}_*(-, \pi_0(U)) \simeq \operatorname{Map}_*(-, U)$ , because the components of  $U$  are not contractible. More specifically, the anti-ball is not contractible. On the other hand, if we let  $\bar{U}$  be the space obtained from  $U$  by replacing the anti-ball with its one-point compactification, and consider the added point of  $\bar{U}$  as the basepoint, then it is true that  $\operatorname{Map}_*(-, \pi_0(U)) \simeq \operatorname{Map}_*(-, \bar{U})$ . Now we can argue, exactly as in the first part of the proof, that

$$\delta\text{sEmb}(\bullet, \mathbb{R}^m) \simeq \operatorname{hocolim}_{U \in \delta\tilde{\mathcal{O}}_\infty^s(\mathbb{R}^m)} \delta\text{sEmb}(\bullet, U)$$

and therefore the homotopy Kan extension of  $\delta\text{sEmb}(\bullet, \mathbb{R}^m)$  is equivalent to

$$\operatorname{hocolim}_{U \in \delta\tilde{\mathcal{O}}_\infty^s(\mathbb{R}^m)} \operatorname{Map}_*(-, \bar{U}).$$

It is easy to see that the spaces  $\bar{U}$  are, naturally, subsets of  $S^m$  (= the one-point compactification of  $\mathbb{R}^m$ ), and that the above homotopy colimit is equivalent to  $\operatorname{Map}_*(-, S^m) = (S^m)^\bullet$ . Thus, the homotopy left Kan extension of  $\delta\text{sEmb}(\bullet, \mathbb{R}^m)$  is equivalent to  $\operatorname{Map}_*(-, S^m)$ , which is what we wanted to prove.  $\square$

We have the following consequence of Corollary 6.1 and Proposition 6.2

**Proposition 6.3.** *Under the same assumptions as in Corollary 6.1 there are weak equivalences of rational chain complexes*

$$T_k \mathcal{C}^{\mathbb{Q}}(\overline{\text{Emb}}(M, \mathbb{R}^n)) \simeq \text{hRmod}_{\leq k}^{\text{Com}}(\mathcal{C}(M^{\bullet}), \text{H}(\mathbb{B}_n; \mathbb{Q}))$$

and

$$T_k \mathcal{C}^{\mathbb{Q}}(\overline{\text{Emb}}_c(\mathbb{R}^m, \mathbb{R}^n)) \simeq \text{WBimod}_{\leq k}^{\text{Com}}(\mathcal{C}((S^m)^{\bullet}), \text{H}(\mathbb{B}_n; \mathbb{Q})).$$

The first part of the proposition may be viewed as an alternative formulation of the main result of [6]. As to the second part of the proposition, it can be simplified further, using Pirashvili's "Dold-Kan" correspondence between right  $\Gamma$ -modules and right  $\Omega$ -modules [21]. Recall that weak Com-bimodules are the same as right  $\Gamma$ -modules (Corollary 2.16). By [21, Theorem 3.1], the category of reduced right  $\Gamma$ -modules (with values in an Abelian category) is equivalent to the category of right  $\Omega$ -modules, where  $\Omega$  is the category of (unpointed) finite sets and surjective maps between them. Given a right  $\Gamma$ -module  $F$ , the corresponding  $\Omega$ -module is defined using the cross-effect, so it may be denoted  $\text{cr } F$ . For an unpointed finite set  $i$ ,  $\text{cr } F(i)$  is defined to be the cokernel of the natural homomorphism

$$\bigoplus_{j=1}^i F((i-1)_+) \longrightarrow F(i_+).$$

Here the  $i$  maps  $F((i-1)_+) \longrightarrow F(i_+)$  are induced by the  $i$  maps  $i_+ \longrightarrow (i-1)_+$  where the  $j$ -th map sends  $j$  to the basepoint and is otherwise an order preserving isomorphism. Equivalently, it can be defined as the total cokernel of a certain evident cubical diagram of objects of the form  $F(j_+)$ , where  $j$  ranges over subsets of  $i$ . In the case when  $i$  is empty,  $\text{cr } F(\emptyset) = F(*)$ . It is easy to see that the  $\Omega$ -module  $\text{cr } \mathcal{C}((S^m)^{\bullet})$  is equivalent to the  $\Omega$ -module  $\tilde{\mathcal{C}}(S^{m\bullet})$  which associates to a set  $i$  the complex  $\tilde{\mathcal{C}}(S^{mi}) = \mathcal{C}(S^{mi}, *)$  and where the  $\Omega$ -module structure is defined by the diagonal maps associated with surjective maps of sets. The  $\Omega$ -module  $\text{cr } \text{H}(\mathbb{B}_n; \mathbb{Q})$  is the module  $\hat{\text{H}}(\mathbb{B}_n; \mathbb{Q})$  defined in the introduction. Thus, the second assertion of Proposition 6.3 translates, via Pirashvili's correspondence, into an equivalence

$$(6.1) \quad T_k \mathcal{C}^{\mathbb{Q}}(\overline{\text{Emb}}_c(\mathbb{R}^m, \mathbb{R}^n)) \simeq \text{hRmod}_{\leq k}^{\Omega}(\tilde{\mathcal{C}}(S^{m\bullet}), \hat{\text{H}}(\mathbb{B}_n; \mathbb{Q})).$$

In fact, things can be simplified even further, as shown in the following lemma

**Lemma 6.4.** *The right  $\Omega$ -module  $\tilde{\mathcal{C}}(S^{m\bullet})$  is rationally formal. That is, there is a weak equivalence of modules*

$$\tilde{\mathcal{C}}^{\mathbb{Q}}(S^{m\bullet}) \simeq \tilde{\text{H}}(S^{m\bullet}; \mathbb{Q}).$$

*Proof.* Let us assume that  $m \geq 1$  (the case  $m = 0$  is trivial, but the forthcoming proof does not apply to it). Let us consider truncated modules first. For a right  $\Omega$ -module  $M$ , let  $M_{\leq k}$  be the module that agrees with  $M$  in places less or equal to  $k$ , and is 0 in places greater than  $k$ . Clearly, this is well-defined, and there is a canonical surjective map of right  $\Omega$ -modules  $M_{\leq k} \rightarrow M_{\leq k-1}$ . Let  $M^k$  be the kernel of the homomorphism. Clearly,  $M^k$  is

the right module that agrees with  $M$  in place  $k$  and is zero elsewhere. There is a natural cofibration sequence

$$0 \longrightarrow M^k \longrightarrow M_{\leq k} \longrightarrow M_{\leq k-1} \longrightarrow 0.$$

This sequence can be viewed as a homotopy cofibration sequence of right  $\Omega$ -modules. It is classified by a map (in the homotopy category of right modules)

$$M_{\leq k-1} \longrightarrow \Sigma M^k$$

where  $\Sigma M^k$  is the point-wise shift of  $M^k$ .

Now let us apply this to the module  $M = \tilde{\mathcal{C}}^{\mathbb{Q}}(S^{m\bullet})$ . We have the cofibration sequence

$$\tilde{\mathcal{C}}^{\mathbb{Q}}(S^{m\bullet})^k \longrightarrow \tilde{\mathcal{C}}^{\mathbb{Q}}(S^{m\bullet})_{\leq k} \longrightarrow \tilde{\mathcal{C}}^{\mathbb{Q}}(S^{m\bullet})_{\leq k-1} \longrightarrow \Sigma \tilde{\mathcal{C}}^{\mathbb{Q}}(S^{m\bullet})^k.$$

Let us calculate the derived mapping object, in the category of right modules, from  $\tilde{\mathcal{C}}^{\mathbb{Q}}(S^{m\bullet})_{\leq k-1}$  to  $\Sigma \tilde{\mathcal{C}}^{\mathbb{Q}}(S^{m\bullet})^k$ . This is a chain complex whose  $H_0$  gives the set of homotopy classes of maps between these objects. Recall that  $\tilde{\mathcal{C}}^{\mathbb{Q}}(S^{m\bullet})_{\leq k-1}$  is a module concentrated in places 0 to  $k-1$ , while  $\Sigma \tilde{\mathcal{C}}^{\mathbb{Q}}(S^{m\bullet})^k$  is concentrated in place  $k$ . In the next section we will prove some general results about morphisms between right  $\Omega$ -modules. In particular, we will prove Corollary 8.8, which implies that

$$\mathrm{hRmod}_{\Omega} \left( \tilde{\mathcal{C}}^{\mathbb{Q}}(S^{m\bullet})_{\leq k-1}, \Sigma \tilde{\mathcal{C}}^{\mathbb{Q}}(S^{m\bullet})^k \right) \simeq \mathrm{hom}_{\Sigma_k} \left( \tilde{\mathcal{C}}^{\mathbb{Q}}(\Delta^k S^m), \tilde{\mathcal{C}}^{\mathbb{Q}}(S^{mk}) \right).$$

Here  $\mathrm{hom}_{\Sigma_k}$  stands for derived homomorphism in the category of chain complexes with an action of  $\Sigma_k$  and  $\Delta^k S^m$  is the fat diagonal in  $S^{mk}$ . By Alexander duality, this is quasi-isomorphic to  $\tilde{\mathcal{C}}^{\mathbb{Q}}(\Sigma C(k, \mathbb{R}^m))^{\Sigma_k}$  (here we have used that over the rationals, invariants are equivalent to derived invariants), which is an  $m$ -connected, and therefore zero-connected complex. It follows that there are no homotopically non-trivial maps of modules from  $\tilde{\mathcal{C}}^{\mathbb{Q}}(S^{m\bullet})_{\leq k-1}$  to  $\Sigma \tilde{\mathcal{C}}^{\mathbb{Q}}(S^{m\bullet})^k$ , and therefore there is a weak equivalence of right  $\Omega$ -modules

$$\tilde{\mathcal{C}}^{\mathbb{Q}}(S^{m\bullet})_{\leq k} \simeq \tilde{\mathcal{C}}^{\mathbb{Q}}(S^{m\bullet})_{\leq k-1} \oplus \tilde{\mathcal{C}}^{\mathbb{Q}}(S^{m\bullet})^k.$$

The right module  $\tilde{\mathcal{C}}^{\mathbb{Q}}(S^{m\bullet})^k$  is essentially determined by the chain complex  $\tilde{\mathcal{C}}^{\mathbb{Q}}(S^{mk})$ , together with an action of  $\Sigma_k$ . It is clear that there is a  $\Sigma_k$ -equivariant equivalence of  $\Sigma_k$  complexes  $\tilde{\mathcal{C}}^{\mathbb{Q}}(S^{mk}) \simeq \tilde{H}(S^{mk}; \mathbb{Q})$  (this is in fact true integrally). Thus there is an equivalence of right  $\Omega$ -modules

$$\tilde{\mathcal{C}}^{\mathbb{Q}}(S^{m\bullet})_{\leq k} \simeq \tilde{\mathcal{C}}^{\mathbb{Q}}(S^{m\bullet})_{\leq k-1} \oplus \tilde{H}(S^{m\bullet}; \mathbb{Q})^k,$$

and by induction we get an equivalence

$$\tilde{\mathcal{C}}^{\mathbb{Q}}(S^{m\bullet})_{\leq k} \simeq \bigoplus_{i=1}^k \tilde{H}(S^{m\bullet}; \mathbb{Q})^i.$$

It is easy to see that the right hand side is isomorphic to  $\tilde{H}(S^{m\bullet}; \mathbb{Q})_{\leq k}$  and so we have an equivalence

$$\tilde{\mathcal{C}}^{\mathbb{Q}}(S^{m\bullet})_{\leq k} \simeq \tilde{H}(S^{m\bullet}; \mathbb{Q})_{\leq k}$$

for each  $k$ , with the restriction map  $\tilde{\mathcal{C}}^{\mathbb{Q}}(S^{m\bullet})_{\leq k} \longrightarrow \tilde{\mathcal{C}}^{\mathbb{Q}}(S^{m\bullet})_{\leq k-1}$  corresponding to the restriction map  $\tilde{H}(S^{m\bullet}; \mathbb{Q})_{\leq k} \longrightarrow \tilde{H}(S^{m\bullet}; \mathbb{Q})_{\leq k-1}$ . Finally,  $\tilde{\mathcal{C}}^{\mathbb{Q}}(S^{m\bullet})$  may be identified with

the inverse limit (which is also the homotopy inverse limit) of  $\tilde{\mathcal{C}}^{\mathbb{Q}}(S^{m\bullet})_{\leq k}$ , and similarly for the homological version, which implies that

$$\tilde{\mathcal{C}}^{\mathbb{Q}}(S^{m\bullet}) \simeq \tilde{H}(S^{m\bullet}; \mathbb{Q})$$

□

We are finally ready to state and prove the homological part of our main theorem (first part of Corollary 0.13 in the introduction).

**Theorem 6.5.** *Suppose that  $2m + 1 \leq n$ . Then there are weak equivalences for all  $k$*

$$T_k \mathcal{C}^{\mathbb{Q}}(\overline{\text{Emb}}_c(\mathbb{R}^m, \mathbb{R}^n)) \simeq \text{hRmod}_{\leq k}^{\Omega} \left( \tilde{H}(S^{m\bullet}), \hat{H}(\mathbb{B}_n(\bullet); \mathbb{Q}) \right).$$

*This includes the case  $k = \infty$ :*

$$T_{\infty} \mathcal{C}^{\mathbb{Q}}(\overline{\text{Emb}}_c(\mathbb{R}^m, \mathbb{R}^n)) \simeq \text{hRmod}_{\Omega} \left( \tilde{H}(S^{m\bullet}), \hat{H}(\mathbb{B}_n(\bullet); \mathbb{Q}) \right).$$

*It follows that if  $2m + 1 < n$  then there is an equivalence of chain complexes*

$$\mathcal{C}^{\mathbb{Q}}(\overline{\text{Emb}}_c(\mathbb{R}^m, \mathbb{R}^n)) \simeq \text{hRmod}_{\Omega} \left( \tilde{H}(S^{m\bullet}), \hat{H}(\mathbb{B}_n(\bullet); \mathbb{Q}) \right).$$

*Proof.* Our starting point is (6.1), which says that

$$T_k \mathcal{C}^{\mathbb{Q}}(\overline{\text{Emb}}_c(\mathbb{R}^m, \mathbb{R}^n)) \simeq \text{hRmod}_{\leq k}^{\Omega} \left( \tilde{\mathcal{C}}(S^{m\bullet}), \hat{H}(\mathbb{B}_n(\bullet); \mathbb{Q}) \right).$$

Since the  $\Omega$ -module  $\hat{H}(\mathbb{B}_n(\bullet); \mathbb{Q})$  takes values in rational chain complexes, there is an equivalence

$$\text{hRmod}_{\leq k}^{\Omega} \left( \tilde{\mathcal{C}}^{\mathbb{Q}}(S^{m\bullet}), \hat{H}(\mathbb{B}_n(\bullet); \mathbb{Q}) \right) \simeq \text{hRmod}_{\leq k}^{\Omega} \left( \tilde{\mathcal{C}}(S^{m\bullet}), \hat{H}(\mathbb{B}_n(\bullet); \mathbb{Q}) \right).$$

By Lemma 6.4,  $\tilde{\mathcal{C}}^{\mathbb{Q}}(S^{m\bullet})$  can be replaced with  $\tilde{H}(S^{m\bullet}; \mathbb{Q})$ . Then again, since the target of the mapping space consists of rational chain complexes, we may replace the rational homology groups  $\tilde{H}(S^{m\bullet}; \mathbb{Q})$  with the corresponding integral homology. □

## Part 2. Explicit complexes

### 7. THE SPLITTING BY HOMOLOGICAL DEGREE

Our goal in the second part of the paper is to analyze the consequences of Theorem 6.5 (as well as its homotopical counterpart, which is proved below), and to use it to write explicit chain complexes for computing the rational homology and homotopy groups of  $\overline{\text{Emb}}_c(\mathbb{R}^m, \mathbb{R}^n)$ . Theorem 6.5 expresses  $\mathcal{C}^{\mathbb{Q}}(\overline{\text{Emb}}_c(\mathbb{R}^m, \mathbb{R}^n))$  as a space of morphisms between right  $\Omega$ -modules  $\tilde{H}(S^{m\bullet})$  and  $\hat{H}(\mathbb{B}_n(\bullet); \mathbb{Q})$ . Obviously, these  $\Omega$ -modules splits as direct sums of  $\Omega$ -modules concentrated in a single homological degree. For example, there is an isomorphism of  $\Omega$ -modules

$$\tilde{H}(S^{m\bullet}) \cong \bigoplus_{i=0}^{\infty} \tilde{H}_i(S^{m\bullet}).$$

We remind the reader that by  $\tilde{H}_i(X)$  we really mean the chain complex that has the  $i$ -th reduced homology of  $X$  in degree  $i$  and is zero otherwise. In fact, this decomposition is unnecessarily wasteful, because one need not consider all values of  $i$ , but only multiples of  $m$ .

**Definition 7.1.** We define, for each  $m \geq 1$  and for each  $s \geq 0$  the right  $\Omega$ -module  $Q_s^m(\bullet)$  by the formula  $Q_s^m(\bullet) = \tilde{H}_{ms}(S^{m\bullet})$ .

Clearly,  $Q_s^m(\bullet)$  is given by the following formula

$$Q_s^m(k) = \begin{cases} 0 & k \neq s \\ \mathbb{Z}[ms] & k = s \end{cases}$$

where  $\mathbb{Z}[ms] = \tilde{H}_{ms}(S^{ms})$  is the chain complex that has  $\mathbb{Z}$  in dimension  $ms$  and is zero otherwise. Note that  $\Sigma_s$  acts trivially on  $\mathbb{Z}[ms]$  if  $m$  is even and acts by sign representation if  $m$  is odd.  $Q_s^m(\bullet)$  is in some sense a minimal non-zero right  $\Omega$ -module concentrated in degree  $\bullet = s$ . It is obvious that there is an isomorphism of right  $\Omega$ -modules (assuming always that  $m \geq 1$ )

$$\tilde{H}(S^{m\bullet}) \cong \bigoplus_{s=0}^{\infty} Q_s^m(\bullet).$$

There is a similar splitting for the right module  $\hat{H}(\mathbb{B}_n(\bullet); \mathbb{Q})$  and (for future reference)  $\hat{\pi}(\mathbb{B}_n(\bullet); \mathbb{Q})$

**Definition 7.2.** For each  $n \geq 3$  and  $t \geq 0$  define the right  $\Omega$ -modules  $\hat{H}_t^n(\bullet)$  and  $\hat{\Pi}_t^n(\bullet)$  by the formulas

$$\hat{H}_t^n(\bullet) = \hat{H}_{(n-1)t}(\mathbb{B}_n(\bullet); \mathbb{Q})$$

and

$$\hat{\Pi}_t^n(\bullet) = \hat{\pi}_{1+(n-2)t}(\mathbb{B}_n(\bullet)) \otimes \mathbb{Q}.$$

It is well known that  $H(\mathbb{B}_n(k))$  is concentrated in dimensions of the form  $(n-1)t$  and  $\pi(\mathbb{B}_n(k)) \otimes \mathbb{Q}$  is concentrated in dimensions  $1 + (n-2)t$  (we generally assume that  $n \geq 3$  so that the spaces  $\mathbb{B}_n(k)$  are simply connected, and their homotopy groups are defined independently of basepoint). It follows that there are isomorphisms of  $\Omega$ -modules (assuming  $n \geq 3$ )

$$\hat{H}(\mathbb{B}_n(\bullet); \mathbb{Q}) \cong \bigoplus_{t=0}^{\infty} \hat{H}_t^n(\bullet)$$

and

$$\hat{\pi}(\mathbb{B}_n(\bullet)) \otimes \mathbb{Q} \cong \bigoplus_{t=0}^{\infty} \hat{\Pi}_t^n(\bullet).$$

It is obvious that each one of the direct sums above is isomorphic to a direct product. It follows that there are isomorphisms

$$\mathrm{hR}_{\Omega}\mathrm{mod}\left(\widetilde{\mathrm{H}}(S^{m\bullet}), \widehat{\mathrm{H}}(\mathbb{B}_n(\bullet); \mathbb{Q})\right) \cong \prod_{s,t=0}^{\infty} \mathrm{hR}_{\Omega}\mathrm{mod}\left(Q_s^m(\bullet), \widehat{\mathrm{H}}_t^n(\bullet)\right)$$

and

$$\mathrm{hR}_{\Omega}\mathrm{mod}\left(\widetilde{\mathrm{H}}(S^{m\bullet}), \widehat{\pi}(\mathbb{B}_n(\bullet)) \otimes \mathbb{Q}\right) \cong \prod_{s,t=0}^{\infty} \mathrm{hR}_{\Omega}\mathrm{mod}\left(Q_s^m(\bullet), \widehat{\Pi}_t^n(\bullet)\right).$$

Thus we have the following immediate consequence of Theorem 6.5

**Corollary 7.3.** *Suppose that  $2m + 1 \leq n$ . Then there are weak equivalences for all  $k \leq \infty$*

$$\mathrm{T}_k \mathcal{C}^{\mathbb{Q}}(\overline{\mathrm{Emb}}_c(\mathbb{R}^m, \mathbb{R}^n)) \simeq \prod_{s,t=0}^{\infty} \mathrm{hR}_{\Omega}\mathrm{mod}_{\leq k}\left(Q_s^m(\bullet), \widehat{\mathrm{H}}_t^n(\bullet)\right).$$

It follows that

$$\mathrm{T}_{\infty} \mathcal{C}^{\mathbb{Q}}(\overline{\mathrm{Emb}}_c(\mathbb{R}^m, \mathbb{R}^n)) \simeq \prod_{s,t=0}^{\infty} \mathrm{hR}_{\Omega}\mathrm{mod}\left(Q_s^m(\bullet), \widehat{\mathrm{H}}_t^n(\bullet)\right).$$

If  $2m + 1 < n$  then the embedding tower converges, and so we have an equivalence

$$\mathcal{C}^{\mathbb{Q}}(\overline{\mathrm{Emb}}_c(\mathbb{R}^m, \mathbb{R}^n)) \simeq \prod_{s,t=0}^{\infty} \mathrm{hR}_{\Omega}\mathrm{mod}\left(Q_s^m(\bullet), \widehat{\mathrm{H}}_t^n(\bullet)\right).$$

## 8. THE KOSZUL SPECTRAL SEQUENCE FOR $\Omega$ -MODULES

Our next task is to analyze derived morphisms between right  $\Omega$ -modules, in order to understand better the consequences of Theorem 6.5 and Corollary 7.3. In this section we will review some generalities about the space of morphisms between right  $\Omega$ -modules. In the next section we will apply this analysis to the modules  $Q_s^m(\bullet)$  and  $\widehat{\mathrm{H}}_t^n(\bullet)$ .

In fact, we will focus on a slightly special situation, which is of relevance to us: we will assume most of the time that the target right module is the dual of a left module. Recall that a left  $\Omega$ -module is a *covariant* functor from  $\Omega$  to a background category<sup>2</sup>. We will mostly consider modules with values in the category of (rational) chain complexes or, occasionally, spectra. In this situation, we have the notion of a dual object. Let  $C$  be a chain complex of  $k$ -modules, or a spectrum, or more generally a module spectrum over a ring-spectrum  $R$ . We define  $D(C)$  to be the dual object. In the case of chain complexes over  $k$ ,  $D(C)$  is the chain complex  $\mathrm{hom}(C, k)$ . We recall that the grading of the dual complex is defined by  $\mathrm{hom}(C, k)_n = \mathrm{hom}(C_{-n}, k)$ . In the case when  $C$  is a spectrum,  $D(C)$  is the Spanier-Whitehead dual of  $C$ .

---

<sup>2</sup>To avoid possible confusion, we remind the reader that while a right  $\Omega$ -module is the same thing as a right module over the non-unital commutative operad, a left  $\Omega$ -module is not the same thing as a left module over the operad

Let  $G$  be a left  $\Omega$ -module with values in chain complexes, or spectra. Let  $D(G)$  be the objectwise dual of  $G$ . Then  $D(G)$  is a right  $\Omega$ -module. Let  $F$  be another right  $\Omega$ -module. We are interested in the derived morphism object  $(F, D(G))$ . Let  $F \overset{h}{\otimes} G$  be the derived coend of the contravariant functor  $F$  and the covariant functor  $G$ . It is well known that derived coend is adjoint (up to homotopy) to derived hom, so we have the following proposition.

**Proposition 8.1.** *There is a natural weak equivalence  $\text{hRmod}(F, D(G)) \simeq D(F \overset{h}{\otimes} G)$ .*

For the rest of the section, we will focus on analyzing the homology of  $F \overset{h}{\otimes} G$ . Ultimately we will work with rational chain complexes, so the homology groups of  $D(F \overset{h}{\otimes} G)$  are just the vector space duals of the homology of  $F \overset{h}{\otimes} G$ .

One standard approach to analyzing  $F \overset{h}{\otimes} G$  is to filter the category  $\Omega$  by cardinality, use this to construct a filtration of  $F \overset{h}{\otimes} G$ , and thus obtain a spectral sequence for calculating its homology groups.

**Definition 8.2.** For each  $k \geq 0$ , let  $\Omega_{\leq k}$  be the full subcategory of  $\Omega$  consisting of objects of cardinality  $\leq k$ . Let  $F$  and  $G$  be a right and a left  $\Omega$ -module respectively. By restriction,  $F$  and  $G$  may also be considered as  $\Omega_{\leq k}$ -modules. Let  $F \overset{h}{\otimes}_{\leq k} G$  be the derived coend between  $\Omega_{\leq k}$ -modules.

One obtains a filtration of  $F \overset{h}{\otimes} G$  by truncated homotopy coends.

$$(8.1) \quad F \overset{h}{\otimes}_{\leq 0} G \longrightarrow F \overset{h}{\otimes}_{\leq 1} G \longrightarrow \cdots \longrightarrow F \overset{h}{\otimes} G.$$

We would like to analyze the homotopy cofiber of the map

$$F \overset{h}{\otimes}_{\leq k-1} G \longrightarrow F \overset{h}{\otimes}_{\leq k} G.$$

Let  $k \downarrow \Omega_{< k}$  be the category whose objects are surjective maps  $k \rightarrow i$ , where  $i$  is a set that is strictly smaller than  $k$ , and whose morphisms are the evident commuting triangles. Thus, since  $F$  is a contravariant functor from  $\Omega$  to the category of chain complexes, it gives rise to a contravariant functor from  $k \downarrow \Omega_{< k}$  to chain complexes, given on objects by the formula

$$(k \rightarrow i) \mapsto F(i).$$

Define  $\Delta^k F$  to be the homotopy colimit of this functor. Note that  $\Delta^k F$  has a natural action of the symmetric group  $\Sigma_k$  and that there is a natural  $\Sigma_k$ -equivariant map  $\Delta^k F \rightarrow F(k)$ . The following lemma is elementary and well-known.

**Lemma 8.3.** *For each  $k$ , there is a homotopy pushout square*

$$\begin{array}{ccc} \Delta^k F \otimes_{h\Sigma_k} G(k) & \longrightarrow & F \overset{h}{\otimes}_{\leq k-1} G \\ \downarrow & & \downarrow \\ F(k) \otimes_{h\Sigma_k} G(k) & \longrightarrow & F \overset{h}{\otimes}_{\leq k} G. \end{array}$$

Here the symbol  $\otimes_{h\Sigma_k}$  denotes the derived balanced product of two objects with an action of  $\Sigma_k$ . The left vertical map is induced from the map  $\Delta^k F \rightarrow F(k)$ .

**Definition 8.4.** Let  $F$  be a right  $\Omega$ -module. For  $k \geq 0$ , let  $KF(k)$  be the homotopy cofiber of the natural map  $\Delta^k F \rightarrow F(k)$ . We call the sequence  $\{KF(k)\}_{k=0}^\infty$  the Koszul dual of  $F$ .

**Corollary 8.5.** *The homotopy cofiber of the map*

$$F \overset{h}{\otimes}_{\leq k-1} G \longrightarrow F \overset{h}{\otimes}_{\leq k} G$$

is equivalent to

$$KF(k) \otimes_{h\Sigma_k} G(k).$$

*Remark 8.6.* We will point out that in the case when  $F$  and  $G$  are two right  $\Omega$ -modules, one can analyze the derived “space” of morphisms  $\text{hRmod}(F, G)$  in an analogous way. Namely, one can filter the category  $\Omega$  by cardinality, and obtain a “tower” of fibrations converging to  $\text{hRmod}(F, G)$ :

$$\text{hRmod}(F, G) \longrightarrow \cdots \longrightarrow \text{hRmod}_{\leq k}(F, G) \longrightarrow \cdots$$

There is a description of the homotopy fiber of the restriction map  $\text{hRmod}_{\leq k}(F, G) \rightarrow \text{hRmod}_{\leq k-1}(F, G)$  that is analogous to Corollary 8.5, and is proved in the same way.

**Lemma 8.7.** *Let  $F, G$  be right  $\Omega$ -modules. The homotopy fiber of the map*

$$\text{hRmod}_{\leq k}(F, G) \longrightarrow \text{hRmod}_{\leq k-1}(F, G)$$

is equivalent to

$$\text{hom}(KF(k), G(k))^{h\Sigma_k}.$$

**Corollary 8.8.** *Let  $n \geq 0$  be an integer. Let  $F$  and  $G$  be right  $\Omega$ -modules satisfying  $F(i) \simeq 0$  for  $i < n$  and  $G(i) \simeq 0$  for  $i > n$  then*

$$\text{hRmod}_{\Omega}(F, G) \simeq \text{hom}(F(n), G(n))^{h\Sigma_n}.$$

*Proof.* It follows easily from the assumptions that  $KF(i) \simeq 0$  for  $i < n$  and  $KF(n) \simeq F(n)$ . Therefore,  $\text{hom}(KF(i), G(i))^{h\Sigma_i} \simeq 0$  for  $i < n$ . The same holds for  $i > n$  since  $G(i) \simeq 0$  in those cases. It follows that all the fibers in the tower of fibrations

$$\cdots \longrightarrow \text{hRmod}_{\leq i}(F, G) \longrightarrow \text{hRmod}_{\leq i-1}(F, G) \longrightarrow \cdots$$

are trivial, except for the  $n$ -th fiber. It follows that the inverse homotopy limit of the tower, which is equivalent to  $\mathop{\mathrm{hRmod}}(F, G)$ , is equivalent to the  $n$ -th fiber. But the  $n$ -th fiber is equivalent to

$$\mathrm{hom}(F(n), G(n))^{h\Sigma_n}$$

since  $\mathrm{K}F(n) \simeq F(n)$ . □

Now we go back to assuming that  $F$  is a right  $\Omega$ -module and  $G$  is a left module.

**Definition 8.9.** Corollary 8.5 gives rise to a first quadrant spectral sequence converging to the homology groups of  $F \otimes^h G$ . The  $k$ -th column of the spectral sequence is given by the homology groups of  $\mathrm{K}F(k) \otimes_{h\Sigma_k} G(k)$ , shifted up by  $k$ . We will call it the *Koszul spectral sequence*.

The first differential in the Koszul spectral sequence is induced by maps, for each  $k \geq 1$

$$(8.2) \quad \mathrm{K}F(k) \otimes_{h\Sigma_k} G(k) \longrightarrow \Sigma \mathrm{K}F(k-1) \otimes_{h\Sigma_{k-1}} G(k-1)$$

which are the connecting maps associated with the filtration (8.1). Our next task is to describe these maps explicitly. For this, we need to describe certain structure maps present in Koszul duals of right  $\Omega$ -modules. Consider the homotopy cofibration sequence

$$F(k) \longrightarrow \mathrm{K}F(k) \longrightarrow \Sigma \Delta^k F.$$

Note that the maps in this sequence are  $\Sigma_k$ -equivariant. Recall that, by definition

$$\Delta^k F = \mathop{\mathrm{hocolim}}_{k \rightarrow i \in k \downarrow \Omega_{<k}} F(i).$$

Let  $(k \downarrow \Omega_{<k-1}) \subset (k \downarrow \Omega_{<k})$  be the full subcategory consisting of arrows  $k \rightarrow i$  where  $i < k-1$ . There is a natural inclusion

$$\mathop{\mathrm{hocolim}}_{k \rightarrow i \in k \downarrow \Omega_{<k-1}} F(i) \hookrightarrow \mathop{\mathrm{hocolim}}_{k \rightarrow i \in k \downarrow \Omega_{<k}} F(i).$$

It is not difficult to show that the quotient of this inclusion is naturally equivalent to  $\mathrm{Sur}(k, k-1)_+ \wedge_{\Sigma_{k-1}} \mathrm{K}F(k-1)$ . Here  $\mathrm{Sur}(m, n)$  denotes the set of surjective functions from the standard set with  $m$  elements to the standard set with  $n$  elements. Thus we obtain a natural map

$$\Delta^k F \longrightarrow \mathrm{Sur}(k, k-1)_+ \wedge_{\Sigma_{k-1}} \mathrm{K}F(k-1).$$

From here, we obtain the following composite map

$$(8.3) \quad \mathrm{K}F(k) \longrightarrow \Sigma \Delta^k F \longrightarrow \mathrm{Sur}(k, k-1)_+ \wedge_{\Sigma_{k-1}} \Sigma \mathrm{K}F(k-1).$$

*Remark 8.10.* It follows from (8.3) that for each surjective function  $\beta \in \mathrm{Sur}(k, k-1)$  there is a map  $\mathrm{K}F(k) \rightarrow \Sigma \mathrm{K}F(k-1)$ . A surjective function from  $k$  to  $k-1$  is the same as a choice of two elements  $i, j$  in  $\{1, \dots, k\}$  together with a bijection of the set  $\{1, \dots, k\}_{i \sim j}$  with  $\{1, \dots, k-1\}$ . Thus, for each choice of two distinct elements  $i, j$  there is an equivalence class of maps  $\delta_{i,j}: \mathrm{K}F(k) \rightarrow \Sigma \mathrm{K}F(k-1)$ , where different representatives of  $\delta_{i,j}$  differ by the action of an element of  $\Sigma_{k-1}$  on  $\Sigma \mathrm{K}F(k-1)$ . Together the maps  $\delta_{i,j}$  determine the structure map (8.3).

*Remark 8.11.* The existence of the map (8.3) is closely related to the fact that  $KF$  is the Koszul dual of a right  $\Omega$ -module  $F$ , and therefore is a right comodule over a suitable version of the Lie cooperad. See, for example, Ching's paper [9] for more detail.

The following lemma is an elementary exercise in manipulating colimits.

**Lemma 8.12.** *The connecting map (8.2) is equivalent to the following composition of maps*

$$\begin{aligned} KF(k) \otimes_{h\Sigma_k} G(k) &\longrightarrow (\text{Sur}(k, k-1)_+ \wedge_{\Sigma_{k-1}} \Sigma KF(k-1)) \otimes_{h\Sigma_k} G(k) \xrightarrow{\cong} \\ &\longrightarrow F(k-1)_{h\Sigma_{k-1}} (G(k) \otimes_{h\Sigma_k} \text{Sur}(k, k-1)_+) \longrightarrow \Sigma KF(k-1) \otimes_{h\Sigma_{k-1}} G(k-1) \end{aligned}$$

Here the first map is induced by the composed map (8.3), the second map is just regrouping, and the last map is induced by the  $\Sigma_{k-1}$ -equivariant map  $G(k) \otimes_{h\Sigma_k} \text{Sur}(k, k-1)_+ \longrightarrow G(k-1)$  which arises from the left  $\Omega$ -module structure on  $G$ .

If  $F$  and  $G$  take values in a category where suspension is invertible, such as chain complexes or spectra, then the connecting map can also be written as having the form

$$\Sigma^{-1} KF(k) \otimes_{h\Sigma_k} G(k) \longrightarrow KF(k-1) \otimes_{h\Sigma_{k-1}} G(k-1).$$

We obtain the following proposition.

**Proposition 8.13.** *Filtration by cardinality gives rise to a spectral sequence (the Koszul spectral sequence), calculating  $H(F \overset{h}{\otimes} G)$ . The first page of the Koszul spectral sequence has the following form.*

$$(8.4) \quad \begin{aligned} H(KF(0) \otimes G(0)) &\longleftarrow H(\Sigma^{-1} KF(1) \otimes G(1)) \longleftarrow \\ &\longleftarrow H(\Sigma^{-2} KF(2) \otimes_{h\Sigma_2} G(2)) \longleftarrow \cdots \longleftarrow H(\Sigma^{-k} KF(k) \otimes_{h\Sigma_k} G(k)) \longleftarrow \cdots \end{aligned}$$

Here each term describes a column in the spectral sequence page, the homomorphisms constitute the first differential, and they are induced by the map described in Lemma 8.12

We will sometimes like to think of the first page of the Koszul spectral sequence, together with the first differential, as a chain complex of graded groups.

## 9. THE KOSZUL COMPLEX

In this section we apply the theory of the previous section to the calculation of the homology of the mapping complexes  $\text{hRmod} \left( Q_s^m(\bullet), \hat{H}_t^n(\bullet) \right)$  that appear in Corollary 7.3.

Our next task is to describe the module  $\hat{H}_t^n(\bullet)$ , as well as the Koszul dual of the module  $Q_s^m(\bullet)$ , as explicitly as possible.

We will begin with  $Q_s^m(\bullet)$ . Recall that this right  $\Omega$ -module is defined by the formula

$$Q_s^m(\bullet) = \tilde{H}_{ms}(S^{m\bullet}).$$

Let us consider a few more general versions of this definition.

**Definition 9.1.** Let  $X$  be a pointed topological space. Let  $\Sigma^\infty X^{\wedge \bullet}$  be the right  $\Omega$ -module defined by the formula  $i \mapsto \Sigma^\infty X^{\wedge i}$ . The convention is that  $X^{\wedge 0} = S^0$ . Given a surjective map  $i \twoheadrightarrow j$ , the corresponding map  $\Sigma^\infty X^{\wedge j} \rightarrow \Sigma^\infty X^{\wedge i}$  is defined using the diagonal inclusion.

For a fixed  $X$ ,  $\Sigma^\infty X^{\wedge \bullet}$  is a right module with values in Spectra. One can also let  $X$  vary and consider it as a right  $\Omega$ -module with values in the functor category  $[\text{Top}_*, \text{Spectra}]$ . Suppose that  $X$  is a pointed CW complex but not a finite set. It is easy to see that in this case,  $\Delta^k \Sigma^\infty X^{\wedge \bullet}$  is equivalent to the suspension spectrum of the usual fat diagonal in  $X^{\wedge k}$ , which we denote by  $\Delta^k X$ . Therefore  $K(\Sigma^\infty X^{\wedge \bullet})$  is given, up to a natural homotopy equivalence, by the formula  $n \mapsto \Sigma^\infty X^{\wedge n} / \Delta^n X$ .

For another example that is relevant, let  $\mathbf{1}$  be the right  $\Omega$ -module defined by the formula

$$\mathbf{1}(i) = \begin{cases} S^0 & i = 1 \\ * & i \neq 1 \end{cases}$$

(there is only one way to endow this sequence with the structure of an  $\Omega$ -module).

**Definition 9.2.** For each  $k \geq 1$  let  $T_k$  be the  $k$ -th space of the Koszul dual of  $\mathbf{1}$ .

It is easy to see that  $T_k$  is the standard topological space that one associates with the poset of partitions of a set with  $k$  elements. One way to describe  $T_k$  is as the quotient of the geometric realization of the poset of all partitions of the set with  $k$  elements (a contractible simplicial complex) by its boundary. The space  $T_k$  often appears in the context of the calculus of functors. It is well-known that  $T_k$  is homotopy equivalent to a wedge sum of  $(k-1)!$  copies of  $S^{k-1}$ .

The structure maps (8.3) amount, in this case, to maps of the form

$$(9.1) \quad T_k \longrightarrow \text{Sur}(k, k-1)_+ \wedge_{\Sigma_{k-1}} \Sigma T_{k-1}.$$

It is not difficult to see that this map is induced by collapsing to a point the subcomplex of  $T_k$  spanned by all the partitions that are not of type  $2-1-\dots-1$ . The quotient space of this collapse is canonically homeomorphic to  $\text{Sur}(k, k-1)_+ \wedge_{\Sigma_{k-1}} \Sigma T_{k-1}$ . These maps are closely related to the cooperad structure on the sequence of spaces  $T_1, T_2, \dots$  discovered by Ching [9]. In fact, the suspension space  $\Sigma T_{k-1}$  in the target of this map really should be thought of as  $T_2 \wedge T_1 \wedge \dots \wedge T_1 \wedge T_{k-1}$ , where  $T_2 \cong S^1$  and  $T_1 \cong S^0$ .

For any finite set  $S$ , we define  $T_S$  to be the space constructed out of the poset of partitions of  $S$  in the same way as  $T_n$  is constructed out of  $\{1, \dots, n\}$ . Clearly, this construction is functorial with respect to isomorphisms of finite sets.

**Definition 9.3.** Fix an integer  $s \geq 0$ , and Let  $I_{X,s}$  be the evident right  $\Omega$ -module defined by the formula

$$I_{X,s}(k) = \begin{cases} \Sigma^\infty X^{\wedge s} & k = s \\ * & k \neq s \end{cases}$$

The Koszul dual of  $I_{X,s}$  is quite easy to calculate. To describe the result, we need another definition

**Definition 9.4.** Suppose  $\alpha \in \text{Sur}(k, s)$  is a surjective function. Define

$$T_\alpha = T_{\alpha^{-1}(1)} \wedge \dots \wedge T_{\alpha^{-1}(s)}.$$

Using a calculation similar to one done in [3] it is easy to show that the Koszul dual of  $I_{X,s}$  is given by the formula

$$(9.2) \quad \mathbb{K} I_{X,s}(k) = \left( \bigvee_{\alpha \in \text{Sur}(k,s)} \Sigma^\infty T_\alpha \wedge X^{\wedge s} \right)_{\Sigma_s}.$$

Here  $\Sigma_s$  acts freely on the wedge sum by permuting the summands in the evident way.

*Remark 9.5.* It is worth noting that the module  $I_{X,s}(\bullet)$  can be obtained from the module  $\Sigma^\infty X^{\wedge \bullet}$  by taking the  $s$ -th layer in the Goodwillie tower of the functors  $\Sigma^\infty X^{\wedge \bullet}$ . In other words, for all  $k \geq 0$

$$I_{X,s}(k) = D_s(\Sigma^\infty X^{\wedge k})$$

(where  $D_s$  denotes the  $s$ -th layer in the Goodwillie tower). Since the Koszul dual of a right  $\Omega$ -module is defined using only homotopy colimits, and taking a layer in the Goodwillie tower is an operation that commutes with homotopy colimits of spectrum-valued functors, it follows that the Koszul dual of  $I_{X,s}(\bullet)$  can be obtained by taking the  $s$ -th layer of the Koszul dual of  $\Sigma^\infty X^{\wedge \bullet}$ , which is defined by the formula  $\Sigma^\infty X^{\wedge \bullet} / \Delta^\bullet X$ . In other words, we have natural equivalences

$$\mathbb{K} I_{X,s}(\bullet) \simeq \mathbb{K} D_s(\Sigma^\infty X^{\wedge \bullet}) \simeq D_s(\mathbb{K} \Sigma^\infty X^{\wedge \bullet}) \simeq D_s(\Sigma^\infty X^{\wedge \bullet} / \Delta^\bullet X).$$

Furthermore, it is worth noting that when  $X = S^m$ ,  $m > 1$ , the layers in the Goodwillie tower of  $\Sigma^\infty X^{\wedge \bullet} / \Delta^\bullet X$  exactly detect homology groups. By this we mean that the homology of each layer is concentrated in a single dimension, and this dimension is different for each layer. More precisely, there is an isomorphism

$$(9.3) \quad \tilde{\mathbb{H}}_{k+s(m-1)}(S^{mk} / \Delta^k S^m) \cong \tilde{\mathbb{H}}(\mathbb{K} I_{S^m,s}(k)).$$

This is closely related to the fact that the layers in the orthogonal tower of the configuration space functor  $\mathbb{R}^n \mapsto \Sigma^\infty C(k, \mathbb{R}^n)$  exactly detect the homology groups of the configuration space (for  $n > 1$ ). This fact was exploited in [6], and we are exploiting it again in this paper in a similar way, although we are packaging it a little differently.

For the module  $\mathbb{K} I_{X,s}$  one obtains structure maps for each  $k$

$$\mathbb{K} I_{X,s}(k) \longrightarrow \text{Sur}(k, k-1)_+ \wedge_{\Sigma_{k-1}} \Sigma \mathbb{K} I_{X,s}(k-1)$$

(see (8.3)). Unraveling the description of  $\mathbb{K} I_{X,s}(k)$  in (9.2), it is not difficult to see that the map really has the following form

$$\left( \bigvee_{\alpha \in \text{Sur}(k,s)} \Sigma^\infty T_\alpha \wedge X^{\wedge s} \right)_{\Sigma_s} \longrightarrow \left( \bigvee_{[\beta, \gamma] \in \text{Sur}(k, k-1) \times_{\Sigma_{k-1}} \text{Sur}(k-1, s)} \Sigma^\infty \Sigma T_\gamma \wedge X^{\wedge s} \right)_{\Sigma_s}.$$

Recall that for  $\alpha \in \text{Sur}(k, s)$ ,  $T_\alpha \cong T_{\alpha^{-1}(1)} \wedge \dots \wedge T_{\alpha^{-1}(s)}$ . It is not difficult to check that the structure map is defined in the following way. For each  $\alpha \in \text{Sur}(k, s)$ , the map sends the wedge summand  $\Sigma^\infty T_\alpha \wedge X^{\wedge s}$  to the wedge sum of terms indexed by those (equivalence classes of) pairs  $[\beta, \gamma] \in \text{Sur}(k, k-1) \times_{\Sigma_{k-1}} \text{Sur}(k-1, s)$  for which  $\alpha = \gamma\beta$ . If one thinks of a surjection  $\alpha \in \text{Sur}(k, s)$  as defining a partition of the standard set with  $k$  elements, then (equivalence classes of) factorizations  $\alpha = \gamma\beta$  correspond to all the ways to bring together two elements in *the same component* of the partition defined by  $\alpha$ . For each such pair, the map is induced by the structure map (9.1) on one of the factors  $T_{\alpha^{-1}(i)}$  that make up  $T_\alpha$ .

Next, let us analyze the Koszul duals  $\mathbf{K} Q_s^m(\bullet)$ . We noted already that the chain complex  $\tilde{\mathbf{H}}(S^{ms}) = Q_s^m(s)$  is  $\Sigma_s$ -equivariantly quasi-isomorphic to the complex  $\tilde{\mathbf{C}}(S^{ms})$ . Since  $\bullet = s$  is the only value of  $\bullet$  for which  $Q_s^m(\bullet)$  is not zero, it follows by an easy argument that the right  $\Omega$ -module  $Q_s^m(\bullet)$  is weakly equivalent to the right  $\Omega$ -module that has value  $\tilde{\mathbf{C}}(S^{ms})$  at  $\bullet = s$ , and is zero otherwise. This is the same as the module that has value  $\tilde{\mathbf{C}}(\Sigma^\infty S^{ms})$  at  $\bullet = s$ , and is zero otherwise. Since the singular chains functor preserves homotopy colimits, we just need to calculate the Koszul dual of the spectrum-valued  $\Omega$ -module that has value  $\Sigma^\infty S^{ms}$  at  $\bullet = s$  and is  $*$  otherwise. This is exactly the module  $I_{S^m, s}(\bullet)$ , a special case of the module  $I_{X, s}(\bullet)$  of Definition 9.3. We saw that its Koszul dual  $\mathbf{K} I_{S^m, s}(\bullet)$  is given by the following formula (it is a special case of (9.2))

$$\mathbf{K} I_{S^m, s}(k) \simeq \left( \bigvee_{\alpha \in \text{Sur}(k, s)} \Sigma^\infty T_\alpha \wedge S^{ms} \right)_{\Sigma_s}.$$

It follows that the module  $\mathbf{K} Q_s^m(\bullet)$ , which is equivalent to  $\tilde{\mathbf{C}}(\mathbf{K} I_{S^m, s}(\bullet))$  is given by the following formula

$$\mathbf{K} Q_s^m(k) \simeq \left( \bigoplus_{\alpha \in \text{Sur}(k, s)} \tilde{\mathbf{C}}(T_\alpha \wedge S^{ms}) \right)_{\Sigma_s}.$$

It is obvious from the above formulas that  $\mathbf{K} I_{S^m, s}(k) \simeq *$  for  $k < s$  and therefore  $\mathbf{K} Q_s^m(k) \simeq 0$  in those cases. Furthermore, note that for all  $\alpha \in \text{Sur}(k, s)$  the space  $T_\alpha \wedge S^{ms}$  is homotopy equivalent to a wedge sum of spheres of dimension  $k + (m-1)s$ . It follows that the chain complex  $\tilde{\mathbf{C}}(T_\alpha \wedge S^{ms})$  is naturally equivalent to  $\tilde{\mathbf{H}}(T_\alpha \wedge S^{ms})$ , which is a chain complex concentrated in dimension  $k + (m-1)s$ . Thus,  $\mathbf{K} Q_s^m(k)$  is equivalent to a complex concentrated in dimension  $k + (m-1)s$ . From now on, when we write  $\mathbf{K} Q_s^m(k)$  we really mean the complex concentrated in a single dimension equivalent to it. In other words,  $\mathbf{K} Q_s^m(k) = \tilde{\mathbf{H}}(\mathbf{K}(I_{S^m, s}(k)))$ .

*Remark 9.6.* It follows by Equation 9.3 that

$$\mathbf{K} Q_s^m(k) \cong \tilde{\mathbf{H}}_{k+s(m-1)}(S^{mk} / \Delta^k S^m).$$

We can describe the complex  $\mathbf{K} Q_s^m(k)$  even more explicitly.

**Definition 9.7.** Let  $L_k := \widetilde{\mathbb{H}}(T_k)$ . Thus,  $L_k$  is a complex concentrated in degree  $k - 1$  and it is isomorphic in this degree to  $\mathbb{Z}^{(k-1)!}$ . For  $\alpha \in \text{Sur}(k, s)$ , define

$$L_\alpha = \widetilde{\mathbb{H}}(T_\alpha) = L_{\alpha^{-1}(1)} \otimes \cdots \otimes L_{\alpha^{-1}(s)}.$$

Also recall that we define  $\mathbb{Z}[n] = \widetilde{\mathbb{H}}(S^n)$ .

For any  $\alpha \in \text{Sur}(k, s)$  there is a quasi-isomorphism

$$\widetilde{\mathbb{C}}(T_\alpha \wedge S^{ms}) \simeq L_\alpha \otimes \mathbb{Z}[ms].$$

We obtain the following formula

$$(9.4) \quad \mathbb{K}Q_s^m(k) \simeq \left( \bigoplus_{\alpha \in \text{Sur}(k, s)} L_\alpha \otimes \mathbb{Z}[ms] \right)_{\Sigma_s}$$

Next we describe more explicitly the right  $\Omega$ -module  $\widehat{\mathbb{H}}_t^n(\bullet)$ . We remind the reader that  $\widehat{\mathbb{H}}_t^n(k)$  is  $\widehat{\mathbb{H}}_{(n-1)t}(B_n(k))$ , where the decoration  $\widehat{\phantom{x}}$  denotes Pirashvili's cross-effect of a right  $\Gamma$ -module. Thus  $\widehat{\mathbb{H}}_t^n(\bullet)$  is closely related to the homology of the configuration space of  $k$  points in  $\mathbb{R}^n$ . Let  $\widehat{\text{Sur}}(k, k-t)$  be the set of functions from  $k$  to  $k-t$  for which the inverse image of every point of  $k-t$  has at least two elements. Elements of  $\widehat{\text{Sur}}(k, k-t)$  correspond to partitions of  $k$  with  $k-t$  components which do not have singletons for components. In [6, 4] partitions of  $k$  with  $k-t$  components were said to have excess  $t$ , and partitions without singletons were called irreducible partitions. Thus elements  $\widehat{\text{Sur}}(k, k-t)$  correspond to irreducible partitions of  $k$  of excess  $t$ . The following formula follows easily from the results of [6, 4]

$$(9.5) \quad \widehat{\mathbb{H}}_t^n(k) \cong \left( \bigoplus_{\beta \in \widehat{\text{Sur}}(k, k-t)} \text{hom}(L_\beta, \mathbb{Q}[nt]) \right)_{\Sigma_{k-t}}.$$

where  $\mathbb{Q}[nt]$  denotes, as usual, the chain complex  $\widetilde{\mathbb{H}}(S^{nt}; \mathbb{Q})$ . It is worth noting that  $S^{nt}$  (and therefore also  $\mathbb{Q}[nt]$ ) depends, in a sense, on the surjection  $\beta$ . Namely,  $\beta$  induces an injective homomorphism  $\mathbb{R}^{n(k-t)} \hookrightarrow \mathbb{R}^{nk}$ . The quotient of this homomorphism is non-canonically isomorphic to  $\mathbb{R}^{nt}$ , and  $S^{nt}$  is the one-point compactification of this  $\mathbb{R}^{nt}$ . In particular, this identification plays a role in the action of  $\Sigma_{k-t}$  on the direct sum.

Let us use the notation  $\mathbb{Q}[-nt] = \text{hom}(\mathbb{Q}[nt], \mathbb{Q})$ . This is, again, a chain complex concentrated in dimension  $-nt$ . Note that we are dealing with actions of finite groups on rational chain complexes, so in our context derived quotients, strict quotients, derived fixed points and strict fixed points are all naturally equivalent to each other. Elementary

manipulations show that the above formula for  $\hat{H}_t^n(k)$  is equivalent to the following one

$$(9.6) \quad \hat{H}_t^n(k) \cong \text{hom} \left( \left( \bigoplus_{\beta \in \widehat{\text{Sur}}(k, k-t)} L_\beta \otimes \mathbb{Q}[-nt] \right)_{\Sigma_{k-t}}, \mathbb{Q} \right).$$

We need to describe the right  $\Omega$ -module structure on  $\hat{H}_t^n(k)$  in terms of this description. It is in fact dual to a left  $\Omega$ -module structure on the symmetric sequence

$$k \mapsto \left( \bigoplus_{\beta \in \widehat{\text{Sur}}(k, k-t)} L_\beta \otimes \mathbb{Q}[-nt] \right)_{\Sigma_{k-t}}.$$

The left module structure was essentially described in [6, 4]. We review it here. Let  $h \in \text{Sur}(k, k-1)$  be a surjective function. We need to describe the induced homomorphism

$$\left( \bigoplus_{\beta \in \widehat{\text{Sur}}(k, k-t)} L_\beta \otimes \mathbb{Q}[-nt] \right)_{\Sigma_{k-t}} \longrightarrow \left( \bigoplus_{\beta \in \widehat{\text{Sur}}(k-1, k-1-t)} L_\beta \otimes \mathbb{Q}[-nt] \right)_{\Sigma_{k-1-t}}$$

(we will focus on this part of the left module structure because this is what we need to describe the differential in the Koszul complex). For a more complete description of the structure we refer the reader to [op. cit.]). Fix a surjection  $\beta \in \widehat{\text{Sur}}(k, k-t)$ . We will describe the homomorphism on the summand  $L_\beta \otimes \mathbb{Q}[-nt]$  corresponding to the equivalence class of  $\beta$ . Since  $h$  is a surjective function from  $\{1, \dots, k\}$  to  $\{1, \dots, k-1\}$ ,  $h$  identifies two elements  $i, j$ , and is otherwise a bijection. If  $\beta(i) = \beta(j)$ , in other words if  $i$  and  $j$  belong to the same component of  $\beta$ , then  $h$  is the zero homomorphism on the summand corresponding to  $\beta$ . On the other hand, if  $\beta(i) \neq \beta(j)$ , then we think of  $h$  as “glueing two components of  $\beta$  together”. In this case, there is a commutative diagram

$$\begin{array}{ccc} k & \xrightarrow{\beta} & k-t \\ h \downarrow & & \downarrow \\ k-1 & \xrightarrow{\beta'} & k-1-t \end{array}.$$

Here the right vertical map is any function that brings together  $\beta(i)$  and  $\beta(j)$ , and is otherwise a bijection. A choice of such a function determines  $\beta'$  uniquely. Thus,  $\beta'$  is defined up to an element of  $\Sigma_{k-1-t}$ . In this situation, there is a canonical homomorphism  $L_\beta \rightarrow L_{\beta'}$ . This homomorphism is induced by a natural map of partition complexes

$$T_U \wedge T_V \longrightarrow T_{U \vee V}.$$

Here  $U, V$  are finite sets with a marked point, and the map is induced by “glueing  $U$  and  $V$  along the marked points”. Again, this map was discussed in detail in [6, 4]. The homomorphism extends canonically to a homomorphism

$$L_\beta \otimes \mathbb{Q}[-nt] \longrightarrow L_{\beta'} \otimes \mathbb{Q}[-nt]$$

and the left module structure is determined by homomorphisms of this type.

Now we are ready to describe the Koszul complex for  $\text{hRmod}\left(Q_s^m(\bullet), \hat{H}_t^n(\bullet)\right)$ . Since right  $\Omega$ -module  $\hat{H}_t^n(\bullet)$  is the dual of a left  $\Omega$ -module, we can use the results of Section 8, and in particular (8.4). By (8.4), (9.4) and (9.6), the Koszul complex has the following form

$$\dots \longleftarrow \Sigma^{-k} \left( \bigoplus_{\alpha \in \text{Sur}(k,s)} L_\alpha \otimes \mathbb{Z}[ms] \right)_{\Sigma_s} \otimes_{h\Sigma_k} \left( \bigoplus_{\beta \in \widehat{\text{Sur}}(k,k-t)} L_\beta \otimes \mathbb{Q}[-nt] \right)_{\Sigma_{k-t}} \longleftarrow \dots$$

To shorten notation, let us introduce some abbreviations. For  $\alpha \in \text{Sur}(k,s), \beta \in \widehat{\text{Sur}}(k,k-t)$ , let  $L_{\alpha,\beta} = L_\alpha \otimes L_\beta$ . Also, let us abbreviate  $\Sigma^{-k} L_{\alpha,\beta} \otimes \mathbb{Z}[ms] \otimes \mathbb{Q}[-nt]$  as  $L_{\alpha,\beta}[ms-nt-k]$ . Then the Koszul complex can be written in the following form

$$(9.7) \quad \dots \longleftarrow \left( \bigoplus_{\substack{\alpha, \beta \in \\ \text{Sur}(k,s) \times \widehat{\text{Sur}}(k,k-t)}} L_{\alpha,\beta}[ms-nt-k] \right)_{\Sigma_k \times \Sigma_s \times \Sigma_{k-t}} \longleftarrow \dots$$

*Remark 9.8.* Recall that for  $\alpha \in \text{Sur}(k,s)$ ,  $L_\alpha$  is a chain complex concentrated in degree  $k-s$ . Similarly  $L_\beta$  is concentrated in degree  $k-(k-t)$ , i.e.,  $t$ . It follows that the  $k$ -th term in the complex (9.7) is a chain complex concentrated in degree  $(k-s)+t+(ms-nt-k)$ , which is  $(m-1)s-(n-1)t$ . In particular, *the degree is independent of  $k$* . It follows that (9.7), which a-priori is a chain complex of graded vector spaces, is in fact an ordinary chain complex of rational vector spaces, where all the spaces have an internal degree  $(m-1)s-(n-1)t$ .

**Definition 9.9.** We let  $\text{HH}_{s,t}^{m,n}$  denote the chain complex (9.7). We call  $\text{HH}_{s,t}^{m,n}$  the Koszul complex of  $\text{hRmod}\left(Q_s^m, \hat{H}_t^n\right)$ .

We saw that  $\text{HH}_{s,t}^{m,n}$  is a chain complex of rational vector spaces, which have an internal grading  $(m-1)s-(n-1)t$ . It follows that the dual complex  $\text{hom}\left(\text{HH}_{s,t}^{m,n}, \mathbb{Q}\right)$  is a chain complex of vector spaces with internal grading  $(n-1)t-(m-1)s$ . We define the cohomology groups  $\text{HH}_{s,t}^{m,n}$  to be the homology groups of the dual complex. More precisely we have isomorphisms (the last of which is not natural)

$$\text{H}^k(\text{HH}_{s,t}^{m,n}) := \text{H}_{-k}(\text{hom}(\text{HH}_{s,t}^{m,n}, \mathbb{Q})) \cong \text{hom}(\text{H}_k(\text{HH}_{s,t}^{m,n}), \mathbb{Q}) \cong \text{H}_k(\text{HH}_{s,t}^{m,n}),$$

where in calculation of homology we forget about the internal grading. Combining Proposition 8.1, Proposition 8.13 and Remark 9.8 we obtain that the cohomology groups of  $\text{HH}_{s,t}^{m,n}$  are the homology groups of  $\text{hRmod}(Q_s^m, \hat{H}_t^n)$ . More explicitly, we have an isomorphism for each  $k \geq 0$ .

$$(9.8) \quad \text{H}^k(\text{HH}_{s,t}^{m,n}) \cong \text{H}_{(n-1)t-(m-1)s-k}(\text{hRmod}(Q_s^m, \hat{H}_t^n)).$$

*Remark 9.10.* Suppose that  $s, t > 0$ . Then  $\text{Sur}(k, s) \neq \emptyset$  only if  $k \geq s$ . Similarly  $\widehat{\text{Sur}}(k, k-t) \neq \emptyset$  only if  $k-t > 0$  and  $k \geq 2(k-t)$ . It follows that the complex  $\text{HH}_{s,t}^{m,n}$  is non-zero only in degrees  $\max\{s, t+1\} \leq k \leq 2t$ . It follows that  $H_j\left(\text{hRmod}\left(Q_s^m, \hat{H}_t^n\right)\right)$  can be non-zero only when

$$(n-3)t - (m-1)s \leq j \leq (n-2)t - (m-1)s - 1.$$

Moreover,  $\text{hRmod}\left(Q_s^m, \hat{H}_t^n\right)$  is non-trivial only if  $s \leq 2t$ . It follows easily that for fixed  $m, n$  satisfying  $m \geq 1$  and  $n > 2m+1$ , and for each  $j \geq 0$ ,  $H_j\left(\text{hRmod}\left(Q_s^m, \hat{H}_t^n\right)\right)$  is non-zero only for finitely many values of  $s, t$ . It follows that, assuming that  $n > 2m+1$ , the direct product on the right hand side of the formulas in Corollary 7.3 are equivalent to direct sums. We obtain the following corollary

**Corollary 9.11.** *Suppose that  $n > 2m+1$ . Then there are isomorphisms*

$$(9.9) \quad \tilde{H}(\overline{\text{Emb}}_c(\mathbb{R}^m, \mathbb{R}^n); \mathbb{Q}) \cong \bigoplus_{1 \leq s \leq 2t} H\left(\text{Rmod}(Q_s^m, \hat{H}_t^n)\right) \cong \bigoplus_{1 \leq s \leq 2t} H_{(n-1)t - (m-1)s - *}\left(\text{HH}_{s,t}^{m,n}\right).$$

*Remark 9.12.* The module

$$\bigoplus_{\substack{\alpha, \beta \in \\ \text{Sur}(k, s) \times \widehat{\text{Sur}}(k, k-t)}} L_{\alpha, \beta}[ms - nt - k]$$

is independent of  $m$  and  $n$ , except for the internal shift of degree. The action of the group  $\Sigma_k \times \Sigma_s \times \Sigma_{k-t}$  on this module is also almost independent of  $m$  and  $n$ , except that if  $m$  is odd, the action of  $\Sigma_s$  on  $\mathbb{Z}[ms]$  is the sign, rather than the trivial action. Similarly, if  $n$  is odd, there is a certain twist in the action of  $\Sigma_k \times \Sigma_{k-t}$  on  $\bigoplus_{\widehat{\text{Sur}}(k, k-t)} \mathbb{Q}[nt]$ . In particular,

the action of  $\Sigma_k \times \Sigma_s \times \Sigma_{k-t}$  depends only on the parities of  $m$  and  $n$ . The boundary homomorphism in the complex only depends on the factor  $\Sigma^k L_{\alpha, \beta}$ , and is independent of  $m, n$ . It follows that the entire complex  $\text{HH}_{s,t}^{m,n}$  depends, except for the internal shift of degree, only on the parities of  $m$  and  $n$ . It follows (by Corollary 9.11) that if  $n > 2m+1$  then the rational homology of  $\overline{\text{Emb}}_c(\mathbb{R}^m, \mathbb{R}^n)$  depends, in a sense, only on the parities of  $m$  and  $n$ . More precisely, for a given parity of  $(m, n)$  the homology groups are built of ingredients that are independent of  $m$  and  $n$ , but the topological dimension in which the different ingredients occur does depend on  $m$  and  $n$ .

*Remark 9.13.* Let  $\mathcal{P}(k, s) = \text{Sur}(k, s)/\Sigma_s$  and let  $\widehat{\mathcal{P}}(k, k-t) = \widehat{\text{Sur}}(k, k-t)/\Sigma_{k-t}$ . Then  $\mathcal{P}(k, s)$  can be identified with the set of partitions of the set  $\{1, \dots, k\}$  with exactly  $s$  components. Similarly  $\widehat{\mathcal{P}}(k, k-t)$  is the set of partitions of  $\{1, \dots, k\}$  with exactly  $k-t$  components, with no singleton components (in [4] these were called irreducible partitions of excess  $t$ ). Consider the quotient set  $\mathcal{P}(k) := \Sigma_k \backslash (\mathcal{P}(k, s) \times \widehat{\mathcal{P}}(k, k-t))$ . This is the set of isomorphism classes of pairs of partitions of  $\{1, \dots, k\}$  where the first partition has  $s$  components, and the second partition is an irreducible partition of excess  $t$ . For an an

isomorphism class  $[\alpha, \beta] \in \mathcal{P}(k)$ , let  $\Sigma_{\alpha, \beta} \subset \Sigma_k \times \Sigma_s \times \Sigma_{k-t}$  be the isotropy group of  $(\alpha, \beta)$ . The group  $\Sigma_{\alpha, \beta}$  is well-defined up to conjugation in  $\Sigma_k \times \Sigma_s \times \Sigma_{k-t}$ . It is easy to see that the composed homomorphism

$$\Sigma_{\alpha, \beta} \longrightarrow \Sigma_k \times \Sigma_s \times \Sigma_{k-t} \longrightarrow \Sigma_k$$

is injective, and therefore  $\Sigma_{\alpha, \beta}$  may be thought of as a subgroup of  $\Sigma_k$ . The Koszul chain complex (9.7) can be rewritten in the following form

$$\cdots \leftarrow \bigoplus_{[\alpha', \beta'] \in \mathcal{P}(k-1)} L_{\alpha', \beta'}[ms - nt - k + 1] / \Sigma_{\alpha', \beta'} \leftarrow \bigoplus_{[\alpha, \beta] \in \mathcal{P}(k)} L_{\alpha, \beta}[ms - nt - k] / \Sigma_{\alpha, \beta} \leftarrow \cdots$$

The boundary homomorphism  $d_k$  is induced by a sum of  $\binom{k}{2}$  maps, where the summands correspond to all possible ways to glue two elements of  $\{1, \dots, k\}$  together. To be more concrete, pick an element  $(\alpha, \beta) \in \mathcal{P}(k, s) \times \widehat{\mathcal{P}}(k, k-t)$  and consider the restriction of  $d_k$  to  $L_{\alpha, \beta}[ms - nt - k] / \Sigma_{\alpha, \beta}$ . For  $1 \leq i < j \leq k$ , the homomorphism induced by glueing  $i$  and  $j$  is zero unless  $i, j$  belong to the same component of  $\alpha$  and to distinct components of  $\beta$ . When the homomorphism is not zero, it is induced by the Lie-comodule structure on  $L_\alpha$  and the left  $\Omega$ -module structure on  $L_\beta$ .

**Examples 9.14.** When  $s = t = 0$ ,  $\mathrm{HH}_{s,t}^{m,n}$  is the trivial complex which has  $\mathbb{Q}$  in degree zero and nothing else. It detects the unreduced zero-dimensional homology of  $\overline{\mathrm{Emb}}_c(\mathbb{R}^m, \mathbb{R}^n)$ . In all other cases  $\mathrm{HH}_{s,t}^{m,n}$  is non-trivial only if  $s, t > 0$ . Furthermore it follows from Remark 9.10 that  $\mathrm{HH}_{s,t}^{m,n}$  is non-zero only if  $s \leq 2t$ .

Let us consider the case  $s = 1$ . Clearly, in this case  $s \leq t + 1$  and, again by remark 9.10, the Koszul complex  $\mathrm{HH}_{1,t}^{m,n}$  is non-trivial only in degrees  $t + 1 \leq k \leq 2t$ . The non-zero portion of  $\mathrm{HH}_{1,t}^{m,n}$  has  $t$  terms, and it has the following form

$$0 \leftarrow L_{t+1} \otimes L_{t+1}[m - (n+1)t - 1] / \Sigma_{t+1} \leftarrow \cdots \leftarrow L_{2t} \otimes L_2^{\otimes t}[m - (n+2)t] / \Sigma_t \Sigma_2 \leftarrow 0.$$

For a general  $k$  the  $k$ -th term of  $\mathrm{HH}_{1,t}^{m,n}$  has the form

$$\left( \bigoplus_{[\beta] \in \widehat{\mathrm{Sur}}(k, k-t) / \Sigma_{k-t}} L_k \otimes L_\beta[m - nt - k] \right)_{\Sigma_k}.$$

This is so because  $\mathrm{Sur}(k, 1)$  consists of just one point, and there is just one partition of  $k$  with 1 component. Thus the sum is indexed by irreducible partitions of  $\{1, \dots, k\}$  of excess  $t$ . When  $k = t + 1$  there is one such partition, namely the partition with one component. At the other extreme, when  $k = 2t$ , there is again just one type of irreducible partition of excess  $t$ , namely the partition of type  $2 - 2 - \dots - 2$ . We remark that partitions of this type are closely related to ‘‘chord diagrams’’, familiar from knot theory.

In particular, when  $t = 1$  the complex  $\mathrm{HH}_{1,1}^{m,n}$  has only one (possibly) non-zero term, corresponding to  $k = 2$ . The non-zero term is

$$(L_2 \otimes L_2[m - n - 2])_{\Sigma_2}.$$

$L_2 \otimes L_2[m - n - 2]$  is really just  $\mathbb{Q}$  concentrated in dimension  $m - n$ . It is easy to see that the action of  $\Sigma_2$  on  $L_2 \otimes L_2[m - n - 2]$  is trivial if  $n$  is even and is multiplication by  $-1$  if  $n$  is odd. It follows that if  $n$  is odd then  $\mathrm{HH}_{1,1}^{m,n}$  is the zero complex. If  $n$  is even then  $\mathrm{HH}_{1,1}^{m,n}$  consists of a single copy of  $\mathbb{Q}$  in degree  $k = 2$  and of internal dimension  $m - n$ . It follows that when  $n$  is even  $\mathrm{HH}_{1,1}^{m,n}$  contributes a class of dimension  $n - m - 2$  to  $\mathrm{H}(\overline{\mathrm{Emb}}_c(\mathbb{R}^m, \mathbb{R}^n); \mathbb{Q})$ .

Let us also consider briefly the case  $s = 1, t = 2$ . In this case, the complex  $\mathrm{HH}_{1,2}^{m,n}$  has two non-zero terms, corresponding to  $k = 3, 4$ . It has the following form

$$0 \leftarrow (L_3 \otimes L_3[m - 2n - 3])_{\Sigma_3} \leftarrow (L_4 \otimes L_2 \otimes L_2[m - 2n - 4])_{\Sigma_2 \wr \Sigma_2} \leftarrow 0.$$

The complexity of  $\mathrm{HH}_{s,t}^{m,n}$  grows rapidly with  $s$  and  $t$ .

## 10. A COMPLEX OF FORESTS

In this section we will show how the Koszul complex  $\mathrm{HH}_{s,t}^{m,n}$  (see (9.7)) can be described more explicitly as a complex of forests.

The basic ingredient in the construction of  $\mathrm{HH}_{s,t}^{m,n}$  is the graded module (concentrated in degree  $k - 1$ )  $L_k = \tilde{\mathrm{H}}(T_k)$ . It is well known that  $L_k$  can be described as the free  $\mathbb{Z}$ -module spanned by trees with vertex set  $\{1, \dots, k\}$ , modulo the Arnold relation. More precisely, let  $\mathcal{A}_k$  be the free graded commutative algebra on  $\binom{k}{2}$  one-dimensional generators. Thus  $\mathcal{A}_k$  has a one-dimensional generator  $u_{i,j}$  for each unordered pair  $\{i, j\}$  of distinct indices between 1 and  $k$  (so  $u_{i,j} = u_{j,i}$ ). Note that the generators anti-commute and their squares are zero. Let  $I$  be the ideal of  $\mathcal{A}_k$  generated by the *Arnold relation*

$$u_{i,j}u_{j,k} + u_{j,k}u_{k,i} + u_{k,i}u_{i,j} = 0$$

for all  $i, j, k$ .  $I$  is generated by homogeneous elements so  $\mathcal{A}_k/I$  is a graded algebra. It is well known that there is an isomorphism of graded algebras [2, 10]

$$\mathcal{A}_k/I \cong \mathrm{H}^*(\mathrm{C}(k, \mathbb{R}^2)).$$

This has the following consequence, which is also well-known.

**Proposition 10.1.**  *$L_k$  is naturally isomorphic to the homogeneous degree  $k - 1$  part of  $\mathcal{A}_k/I$ . Moreover, the degree  $k - 1$  part is generated by monomials of the form  $u_{i_1, j_1} \cdots u_{i_{k-1}, j_{k-1}}$  for which the graph with vertex set  $\{1, \dots, k\}$  and edge set  $\{i_1, j_1\}, \dots, \{i_{k-1}, j_{k-1}\}$  is connected and acyclic (i.e., a tree).*

Indeed, one way to obtain the first part of the proposition is to use the natural isomorphisms

$$L_k \cong \mathrm{H}_{k-1}(T_k) \cong \mathrm{H}_{k+1}(S^{2k}/\Delta^k S^2) \cong \mathrm{H}^{k-1}(\mathrm{C}(k, \mathbb{R}^2))$$

and the identification of  $\mathcal{A}_k/I$  with the cohomology of the configuration space  $\mathrm{C}(k, \mathbb{R}^2)$ . The second part of the proposition is proved, for example, in [11].

Next we describe the Lie-comodule structure on the sequence  $L_1, \dots, L_k, \dots$  in terms of this ‘‘tree basis’’. Recall that for every surjective function  $\beta \in \mathrm{Sur}(k, k - 1)$  there is a map

$T_k \longrightarrow \Sigma T_{k-1}$  associated with  $\beta$ . This map induces a homomorphism in homology

$$L_k \longrightarrow \mathbb{Z}\langle v \rangle \otimes L_{k-1}.$$

Here  $v$  is a one-dimensional generator and  $\mathbb{Z}\langle v \rangle$  is the free Abelian group with generator  $v$ . To describe this homomorphism, we need to tell what it does on a generic element of the form  $u_{i_1, j_1} \cdots u_{i_{k-1}, j_{k-1}}$ . Since  $\beta$  is a surjective function from the standard set with  $k$  elements to the one with  $k-1$  elements, there exist two elements  $i, j$  such that  $\beta(i) = \beta(j)$  and otherwise  $\beta$  is a bijection. Roughly speaking the effect of  $\beta$  on the tree basis for homology is determined by the following rule: if  $\{i, j\}$  is not among the edges of a tree, then this tree is sent to zero. If  $\{i, j\}$  is among the edges, then the tree is sent to another tree, obtained by contracting the edge  $\{i, j\}$ , and the edge  $\{i, j\}$  is mapped to the suspension coordinate. More precisely, the rule is as follows: if  $\beta(i) \neq \beta(j)$  then  $u_{i, j}$  is sent to  $u_{\beta(i), \beta(j)}$ . If  $\beta(i) = \beta(j)$  then  $u_{i, j}$  is sent to  $v$ . This induces the following function on the generators of  $L_k$ : if the unordered pair  $\{i, j\}$  is not among the pairs  $\{i_1, j_1\}, \dots, \{i_{k-1}, j_{k-1}\}$ , then the element  $u_{i_1, j_1} \cdots u_{i_{k-1}, j_{k-1}}$  is sent to zero. Otherwise, suppose that  $\{i, j\} = \{i_l, j_l\}$ . Then the element  $u_{i_1, j_1} \cdots u_{i_{k-1}, j_{k-1}}$  is sent to

$$u_{\beta(i_1), \beta(j_1)} \cdots u_{\beta(i_{l-1}), \beta(j_{l-1})} v u_{\beta(i_{l+1}), \beta(j_{l+1})} \cdots u_{\beta(i_{k-1}), \beta(j_{k-1})},$$

which is the same as

$$(-1)^{l-1} v \otimes u_{\beta(i_1), \beta(j_1)} \cdots u_{\beta(i_{l-1}), \beta(j_{l-1})} u_{\beta(i_{l+1}), \beta(j_{l+1})} \cdots u_{\beta(i_{k-1}), \beta(j_{k-1})}.$$

One can desuspend the above homomorphism, to obtain a homomorphism

$$\mathbb{Z}\langle v^{-1} \rangle \otimes L_k \longrightarrow L_{k-1}$$

where  $v^{-1}$  is a generator of degree  $-1$ . This homomorphism sends  $v^{-1} \otimes u_{i_1, j_1} \cdots u_{i_{k-1}, j_{k-1}}$  to  $(-1)^{l-1} u_{\beta(i_1), \beta(j_1)} \cdots \hat{u}_{\beta(i_l), \beta(j_l)} \cdots u_{\beta(i_{k-1}), \beta(j_{k-1})}$  if  $\{i, j\} = \{i_l, j_l\}$ , and to zero if  $\{i, j\}$  is not equal to any of the unordered pairs  $\{i_1, j_1\}, \dots, \{i_k, j_k\}$ .

Now let  $\alpha \in \text{Sur}(k, s)$  be a surjective function. Recall that we define  $L_\alpha = L_{\alpha^{-1}(1)} \otimes \cdots \otimes L_{\alpha^{-1}(s)}$ . It follows that the module  $L_\alpha$  is generated by *forests* with vertex set  $\{1, \dots, k\}$ , whose connected components are labeled by  $1, \dots, s$ , subject to the Arnold relation. Finally recall that the  $k$ -th term of the complex  $\text{HH}_{s,t}^{m,n}$  is isomorphic to the following graded rational vector space

$$\Sigma^{-k} \left( \bigoplus_{(\alpha\beta) \in \text{Sur}(k,s) \times \widehat{\text{Sur}}(k,k-t)} L_\alpha \otimes L_\beta \otimes \mathbb{Z}[ms] \otimes \mathbb{Q}[-nk] \otimes \mathbb{Q}[n(k-t)] \right)_{\Sigma_k \times \Sigma_s \times \Sigma_{k-t}}.$$

It follows that the  $k$ -th term of the Koszul complex  $\text{HH}_{s,t}^{m,n}$  can be described as a quotient (by the Arnold relation) of a direct sum of rational vector spaces, indexed by equivalence classes (with respect to the action of  $\Sigma_k$ ) of pairs of forests with vertex set  $\{1, \dots, k\}$ , where the first forest has  $s$  components and the second forest has  $k-t$  components, all bigger than a point. Each summand is generated by equivalence classes (with respect to the action of the stabilizer group of the pair of forests) of monomials that are products of the following generators:

- a one-dimensional generator for each edge of the two forests,
- $s$  generators of dimension  $m$  (corresponding to  $\mathbb{Z}[ms]$ ),
- $k$  generators of dimension  $-n$  and  $k - t$  generators of dimension  $n$  to account for  $\mathbb{Q}[-nk]$  and  $\mathbb{Q}[n(k - t)]$ ,
- and finally  $k$  more generators of dimension  $-1$ , to account for the  $k$ -fold de-suspension.

The order of generators can be interchanged as prescribed by graded commutativity.

The boundary homomorphism is defined as follows: fix a pair of forests with vertex set  $\{1, \dots, k\}$  (representing an equivalence class of such pairs), where the two forests have  $s$  components and  $k - t$  non-singleton components respectively. The boundary homomorphism on the summand corresponding to this pair is given by a sum of  $\binom{k}{2}$  homomorphisms, corresponding to all the ways to glue together two elements of  $\{1, \dots, k\}$  the only summands that are not zero are the ones that contract an edge in the first forest (and so preserve the number of components in this forest) and glue together two components of the second forest (and so preserve the difference between the number of points and the number of components). The contracted edge is used to cancel one of the de-suspension coordinates, as explained above.

## 11. COMPLEX OF DEFORMATIONS

It turns out that the complexes from Lemma ?? have a natural interpretation from the point of view of the deformation theory of operads (in case  $M$  is an operad). This theory was initiated by Kontsevich and Soibelman [15] and was further developed by Merkulov and Vallette [20]. Given  $m < n$ , one has inclusion of the operads of little discs:

$$\mathbf{B}_m \xrightarrow{i} \mathbf{B}_n.$$

inducing morphism in the homology

$$H(\mathbf{B}_m, \mathbb{Q}) \xrightarrow{i_*} H(\mathbf{B}_n, \mathbb{Q}). \quad (11.1)$$

The operad  $H(\mathbf{B}_m, \mathbb{Q})$  is the associative operad  $\mathcal{A}ssoc$  if  $m = 1$  and is the operad  $\mathcal{P}oiss_{m-1}$  of graded Poisson algebras with bracket  $[x_1, x_2]$  of degree  $(m - 1)$  and commutative product  $x_1 x_2$  of degree 0. The map (11.1) sends the product to the product and the bracket to zero. We notice that  $i_*$  factors through the commutative operad.

**Theorem 11.1.** *For  $n \geq 2m + 2$ , one has*

$$\mathcal{C}^{\mathbb{Q}}\overline{\text{Emb}}_c(\mathbb{R}^m, \mathbb{R}^n) \simeq \Sigma^{m+1} \text{Der} \left( H(\mathbf{B}_m, \mathbb{Q}) \xrightarrow{i_*} H(\mathbf{B}_n, \mathbb{Q}) \right).$$

In the above  $\text{Der}(\bullet \rightarrow \bullet)$  states for a deformation complex of a morphism of operads as defined in [15, 20]. For simplicity the operads  $\mathbf{B}_m, \mathbf{B}_n$  in the above theorem are taken without the degree zero component.<sup>3</sup> The case  $m = 1$  of this theorem is well known. Indeed, the complex  $\text{Der} \left( \mathcal{A}ssoc \xrightarrow{i_*} H(\mathbf{B}_m, \mathbb{Q}) \right)$  is the usual Hochschild complex of the operad

<sup>3</sup>We believe that the result is still true even if one includes the degree zero components, but technically it is more complicated, since one has to find a cofibrant model of the unital Poisson and associative operads.

$H(\mathbb{B}_n, \mathbb{Q}) = \mathcal{P}oiss_{n-1}$ , see [15, 25, 16]. For  $m \geq 2$  this relation between the homology of higher dimensional long knots and the deformation homology of the morphism (11.1) was conjectured earlier by Kontsevich.

Let  $\mathcal{P}oiss_{m-1}^\infty$  be a cofibrant model of  $\mathcal{P}oiss_{m-1}$ , that is a quasi-free operad quasi-isomorphic to  $\mathcal{P}oiss_{m-1}$  via a projection

$$\mathcal{P}oiss_{m-1}^\infty \xrightarrow{p} \mathcal{P}oiss_{m-1}.$$

The operad  $\mathcal{P}oiss_{m-1}$  is known to be Koszul [14]. Its Koszul dual  $\mathcal{P}oiss_{m-1}^!$  is the operad of graded Poisson algebras with bracket of degree zero and commutative product of degree  $(m-1)$ . The cofibrant model  $\mathcal{P}oiss_{m-1}^\infty$  can be chosen as the quasi-free operad  $\mathcal{F}(\Sigma^{-1}\mathcal{P}oiss_{m-1}^i[1])$  generated by the symmetric sequence  $\Sigma^{-1}\mathcal{P}oiss_{m-1}^i[1]$ , where  $\mathcal{P}oiss_{m-1}^i[1]$  is the cooperad whose dual is the operad  $\mathcal{P}oiss_{m-1}^i[1]$  of graded Poisson algebras with bracket of degree 1 and commutative product of degree  $m$ ,<sup>4</sup> and  $\Sigma^{-1}$  is the desuspension of each component in the symmetric sequence. The differential in  $\mathcal{F}(\Sigma^{-1}\mathcal{P}oiss_{m-1}^i[1])$  comes from the cooperadic structure of  $\mathcal{P}oiss_{m-1}^i[1]$ . We refer to [20] for a better account on the deformation theory of Koszul objects. The space of the complex  $\text{Der}(\mathcal{P}oiss_{m-1} \xrightarrow{i_*} \mathcal{P}oiss_{n-1})$  is the space of infinitesimal deformations (derivations) of the morphism of operads:

$$\mathcal{F}(\Sigma^{-1}\mathcal{P}oiss_{m-1}^i[1]) \xrightarrow{poi_*} \mathcal{P}oiss_{n-1},$$

that is

$$\text{Der}(\mathcal{P}oiss_{m-1} \xrightarrow{i_*} \mathcal{P}oiss_{n-1}) = \bigoplus_{k \geq 2} \text{hom}_{\Sigma_k}(\Sigma^{-1}\mathcal{P}oiss_{m-1}^i[1](k), \mathcal{P}oiss_{n-1}(k)). \quad (11.2)$$

One has a natural isomorphism of graded  $\Sigma_k$ -modules

$$\tilde{H}(S^{mk}/\Delta^k S^m, \mathbb{Q}) \simeq \Sigma^m \mathcal{P}oiss_{m-1}^i[1](k),$$

that one can see for example from the forest description of  $\tilde{H}(S^{mk}/\Delta^k S^m, \mathbb{Q}) = \overline{H}(C(k, \mathbb{R}^m), \mathbb{Q})$  given above and a similar forest description of the cooperad of Poisson algebras given in [24] (here  $\overline{H}$  denotes singular locally finite homology). The differential in (11.2) is the pre-Lie commutator with  $\mu = x_1 x_2$ , see [20]:

$$df = f \circ \mu - (-1)^{|f|-1} \mu \circ f.$$

The first summand is exactly the right-hand side of (??). The second summand can be written as follows

$$(\mu \circ f)(T) = \sum_v (-1)^\delta x_v \cdot f(T \setminus v), \quad (11.3)$$

where the sum is taken over the univalent vertices of the forest  $T$ . The sign  $(-1)^\delta$  is the Koszul sign of permutation taking the only edge adjacent to  $v$  on the first place of the

<sup>4</sup>The operad  $\mathcal{P}oiss_{m-1}^i[1]$  is obtained from  $\mathcal{P}oiss_{m-1}^!$  by an operadic suspension.

orientation set of  $T$ , and  $T \setminus v$  denotes the forest obtained from  $T$  by removing the vertex  $v$  and the edge adjacent to it. The total complex (11.2) can be written as

$$\bigoplus_{k \geq 2} \Sigma^{m+1} \text{hom}_{\Sigma_k}(\overline{\mathbb{H}}(C(k, \mathbb{R}^m), \mathbb{Q}), \mathbb{H}(C(k, \mathbb{R}^n), \mathbb{Q})).$$

This complex is a direct sum of the (shifted by  $m + 1$  gradings) complex from Lemma ??:

$$\bigoplus_{k \geq 2} \Sigma^{m+1} \text{hom}_{\Sigma_k} \left( \overline{\mathbb{H}}(C(k, \mathbb{R}^m), \mathbb{Q}), \hat{\mathbb{H}}(C(k, \mathbb{R}^n), \mathbb{Q}) \right), \quad (11.4)$$

computing the reduced rational homology of  $\overline{\text{Emb}}_c(\mathbb{R}^m, \mathbb{R}^n)$  and an acyclic complex. This is straightforward and similar to the fact that the Hochschild complex of the Poisson operad is a direct sum of its normalized subcomplex and an acyclic one spanned by degeneracies. For the normalized complex (11.4) the second summand of the differential described by (11.3) is absent since it produces only elements lying in the image of (?). The complex (11.4) can also be interpreted as the complex of unital deformations of the morphism  $\mathcal{P}oiss_{m-1} \xrightarrow{i_*} \mathcal{P}oiss_{n-1}$ . By *unital* we mean deformations preserving the zero-ary operation  $\mathbb{1} \in \mathcal{P}oiss_{m-1}(0)$  (the deformation of higher operations are annihilated when applied to  $\mathbb{1}$ ) if the latter one is added to the operad  $\mathcal{P}oiss_{m-1}$ .

## 12. GRAPH-COMPLEXES

12.0.6. *Complexes of uni- $\geq 3$ -valent graphs.* In this section we will introduce a new complex, denoted  $\mathcal{E}_{m,n}^H$ , calculating the rational homology of  $\overline{\text{Emb}}_c(\mathbb{R}^m, \mathbb{R}^n)$ . The complex  $\mathcal{E}_{m,n}^H$  is quasi-isomorphic to the direct sum of dual complexes of  $\mathbb{H}H_{s,t}^{m,n}$  defined previously, but the two complexes look different and are derived in a different way. The starting point for the derivation of both complexes is Theorem 6.5, which presents  $\mathbb{C}^{\mathbb{Q}}(\overline{\text{Emb}}_c(\mathbb{R}^m, \mathbb{R}^n))$  as the derived “space” of maps between right  $\Omega$ -modules  $\tilde{\mathbb{H}}(S^{m\bullet})$  and  $\hat{\mathbb{H}}(\mathbb{B}_n(\bullet); \mathbb{Q})$ . Roughly speaking, the complexes  $\mathbb{H}H_{s,t}^{m,n}$  were obtained by taking a cofibrant approximation of the module  $\tilde{\mathbb{H}}(S^{m\bullet})$  in the projective model structure (even though we did not phrase things in this way explicitly). The complex  $\mathcal{E}_{m,n}^H$  will be obtained by taking a *fibrant* approximation of the module  $\hat{\mathbb{H}}(\mathbb{B}_n(\bullet); \mathbb{Q})$  in the *injective* model structure.

The main attraction of the complex  $\mathcal{E}_{m,n}^H$  is that it will enable us to construct another complex, denoted  $\mathcal{E}_{m,n}^\pi$ , which calculates the rational *homotopy* groups of the space  $\overline{\text{Emb}}_c(\mathbb{R}^m, \mathbb{R}^n)$ . In particular, this will enable us to prove the homotopical part of the main theorem.

The complex  $\mathcal{E}_{m,n}^\pi$  is defined as a certain complex of graphs. We mention that such graph-complexes appeared earlier in the study of the Hodge decomposition of the homology groups of the space of long knots  $\overline{\text{Emb}}_c(\mathbb{R}, \mathbb{R}^n)$ , see [26, Section 11]. Our Theorem 12.1 below is exactly [26, Conjecture 11.1] from the above reference.

We will now define the complex  $\mathcal{E}_{m,n}^\pi$ . It is spanned by abstract connected graphs having some non-empty set of non-labeled *external vertices* of valence 1, and some possibly empty set of non-labeled *internal vertices* of valence  $\geq 3$ . The graphs are allowed to have loops

(edges joining a vertex to itself) and multiple edges. For such graph define its *orientation set* as the union of the set of its external vertices (considered as elements of degree  $-m$ ), the set of its internal vertices (considered as elements of degree  $-n$ ), and the set of its edges (considered as elements of degree  $(n-1)$ ). By an *orientation* of a graph we will understand ordering of its orientation set together with an orientation of all its edges. Two such graphs are *equivalent* if there is a bijection between their sets of vertices and edges respecting the adjacency structure of the graphs, orientation of the edges, and the order of the orientation sets. The space of  $\mathcal{E}_{m,n}^\pi$  is the quotient space of the vector space freely spanned by such graphs modulo the orientation relations:

(1)  $\Upsilon_1 = (-1)^n \Upsilon_2$  if  $\Upsilon_1$  differs from  $\Upsilon_2$  by an orientation of an edge.

(2)  $\Upsilon_1 = \pm \Upsilon_2$ , where  $\Upsilon_2$  is obtained from  $\Upsilon_1$  by a permutation of the orientation set. The sign here is the Koszul sign of permutation taking into account the degrees of the elements.

The differential  $\partial\Upsilon$  of a graph  $\Upsilon \in \mathcal{E}_{m,n}^\pi$  is defined as the sum of expansions of its internal vertices. An expansion of a vertex of valence  $k$  is a sum of  $\frac{2^k - 2k - 2}{2} = 2^{k-1} - k - 1$  graphs. One subtracts  $2k + 2$  to exclude graphs with internal vertices of valence  $< 3$ , and one divides by 2 because of the symmetry. The orientation set of a new graph is obtained by adding the new vertex and the new edge as the first and second elements to the orientation set, and by orienting the new edge from the old vertex to the new one. There is a freedom which of 2 vertices of the new edge is considered as a new one and which as an old one, but regardless of this choice, the orientation of the boundary graph is the same.

Finally define the graph-complex  $\mathcal{E}_{m,n}^H$  as the cofree graded cocommutative coalgebra cogenerated by  $\mathcal{E}_{m,n}^\pi$ . In other words  $\mathcal{E}_{m,n}^H$  can be viewed as a graph-complex spanned by possibly empty or disconnected graphs with each connected component from  $\mathcal{E}_{m,n}^\pi$ .

In addition to the total grading (which is the sum of the degrees of the elements in the orientation set of a graph), we define two other gradings: *complexity* — the first Betti number of the graph obtained from initial graph by gluing together all univalent vertices, and *Hodge degree* — the number of external vertices. Notice that the differential preserves both the complexity and the Hodge degree. Section 12.1 describes  $\mathcal{E}_{m,n}^\pi$  in complexities  $\leq 3$ . We will denote the part of  $\mathcal{E}_{m,n}^H, \mathcal{E}_{m,n}^\pi$  concentrated in complexity  $t$  and Hodge degree  $s$  by  $\mathcal{E}_{m,n}^H(s, t), \mathcal{E}_{m,n}^\pi(s, t)$  respectively.

**Theorem 12.1.** *For  $n > 2m + 1$ , the homology of the graph-complex  $\mathcal{E}_{m,n}^H$  (respectively  $\mathcal{E}_{m,n}^\pi$ ) is isomorphic to the rational homology (respectively homotopy) of  $\overline{\text{Emb}}_c(\mathbb{R}^m, \mathbb{R}^n)$ :*

$$H(\mathcal{E}_{m,n}^H) \simeq H(\overline{\text{Emb}}_c(\mathbb{R}^m, \mathbb{R}^n), \mathbb{Q}); \quad (12.1)$$

$$H(\mathcal{E}_{m,n}^\pi) \simeq \pi(\overline{\text{Emb}}_c(\mathbb{R}^m, \mathbb{R}^n)) \otimes \mathbb{Q}. \quad (12.2)$$

It is well-known that the space  $\overline{\text{Emb}}_c(\mathbb{R}^m, \mathbb{R}^n)$ ,  $n \geq 2m + 2$ , is a connected  $(m+1)$ -loop space. This implies that its rational homology is a graded polynomial bialgebra generated, as a coalgebra, by its rational homotopy groups, and this property determines the rational homotopy groups. As a consequence the statements (12.1) and (12.2) of the

previous theorem are equivalent. The statement (12.1) follows from the second statement of Proposition 6.3 above and the first statement of Theorem 12.2 below.

**Theorem 12.2.** *For  $n \geq 2m + 2$ , one has weak equivalences of chain complexes*

$$\mathcal{E}_{m,n}^H \simeq \mathrm{hRmod}_{\Omega} \left( \tilde{H}(S^{m\bullet}), \hat{H}(\mathbb{B}_n(\bullet), \mathbb{Q}) \right). \quad (12.3)$$

$$\mathcal{E}_{m,n}^{\pi} \simeq \mathrm{hRmod}_{\Omega} \left( \tilde{H}(S^{m\bullet}), \hat{\pi}(\mathbb{B}_n(\bullet)) \otimes \mathbb{Q} \right), \quad (12.4)$$

Moreover the above isomorphisms preserve both the complexity and the Hodge degree, which means

$$\mathcal{E}_{m,n}^H(s, t) \simeq \mathrm{hRmod}_{\Omega} \left( \tilde{H}_{ms}(S^{m\bullet}), \hat{H}_{(n-1)t}(\mathbb{B}_n(\bullet), \mathbb{Q}) \right). \quad (12.5)$$

$$\mathcal{E}_{m,n}^{\pi}(s, t) \simeq \mathrm{hRmod}_{\Omega} \left( \tilde{H}_{ms}(S^{m\bullet}), \hat{\pi}_{1+(n-2)t}(\mathbb{B}_n(\bullet)) \otimes \mathbb{Q} \right), \quad (12.6)$$

This theorem will be proved in Section 12.0.8. The idea of the proof is to replace the right  $\Omega$ -modules  $\hat{\pi}(\mathbb{B}_n(\bullet)) \otimes \mathbb{Q}$  and  $\hat{H}(\mathbb{B}_n(\bullet), \mathbb{Q})$  by quasi-isomorphic injective differential graded right  $\Omega$ -modules  $\hat{P}_n^{\bullet}$ ,  $\hat{D}_n^{\bullet}$ . In each degree  $\hat{P}_n^k$ ,  $\hat{D}_n^k$  are certain graph-complexes, see Sections 12.0.7-12.0.8.

12.0.7. *Right  $\Gamma$ -modules  $D_n^{\bullet}$ ,  $P_n^{\bullet}$ .* We mention that the right  $\Gamma$ -modules that we define in this section were introduced in [26]. For a completeness of exposition we repeat this construction here. The  $k$ -th component  $D_n^k$  is a vector space spanned by the graphs with  $k$  external vertices labeled by  $1, 2, \dots, k$ , and a bunch of non-labeled internal vertices. The external vertex can have any valence (including zero), the internal vertices are of valence  $\geq 3$ . The graphs are allowed to be disconnected, but each connected component of a graph should have at least one external vertex (no pieces flying in air). The graphs can have loops and multiple edges. *Orientation set* of such graph consists of the set of its internal vertices (having degree  $-n$ ), and edges (having degree  $(n-1)$ ). By an *orientation* of a graph we understand an ordering of its orientation set and a choice of orientation made for each one of its edges. Two graphs are equivalent if there is a bijection between their sets of internal vertices and edges respecting the adjacency structure of the graphs, orientation of the edges, and the order of their orientation sets. The orientation relations are the same as in Section 12.0.6. The differential is the sum of expansions of vertices. An expansion of an external vertex produces one external vertex with the same label and one internal one. An expansion of external vertices of valence  $n$  is a sum of  $2^n - n - 1$  graphs. The sequence of differential graded vector spaces  $D_n^k$ ,  $k \geq 0$  forms an operad. The composition  $\Upsilon_1 \circ_i \Upsilon_2$  of two graphs is defined as insertion of  $\Upsilon_2$  into the  $i$ -th vertex of  $\Upsilon_1$ , see Figure 19. The orientation set of each graph in the sum is obtained by concatenation of the orientation set of  $\Upsilon_1$  and that of  $\Upsilon_2$ . With this definition all signs are positive in this figure.

Recall that  $\{H(\mathbb{B}_n(\bullet))\}$  is the homology operad of  $n$ -dimensional little cubes. This homology operad is the operad of  $(n-1)$ -Poisson algebras, i.e. operad of graded Poisson algebras with bracket of degree  $(n-1)$ .

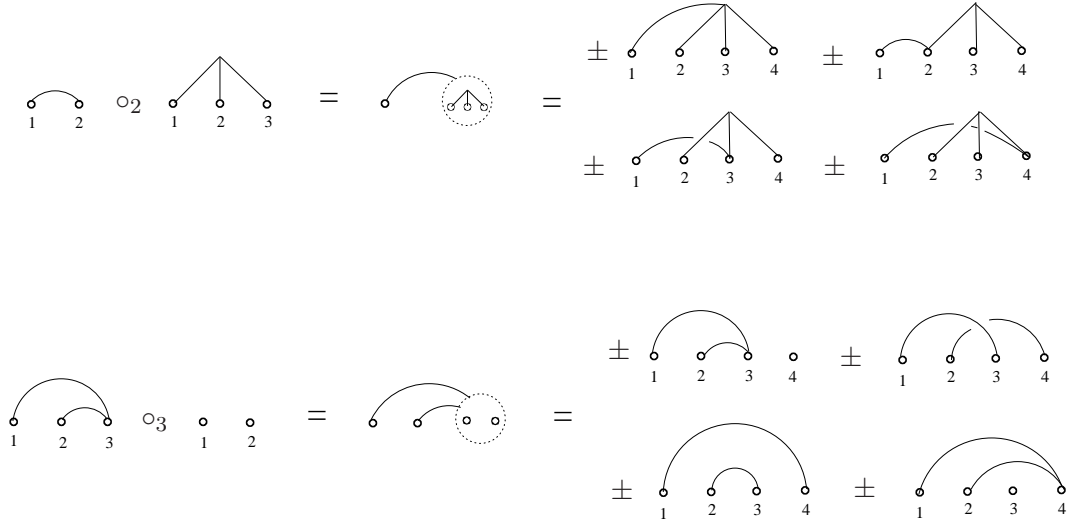

FIGURE 19. Examples of composition

**Proposition 12.3** ([17, 26]). *The assignment*

$$x_1x_2 \mapsto \text{diagram with nodes 1, 2}, \quad [x_1, x_2] \mapsto \text{diagram with arc between nodes 1, 2},$$

where  $x_1x_2, [x_1, x_2] \in H(\mathbb{B}_n(2), \mathbb{Q})$  are the product and the bracket of the operad of  $(n - 1)$ -Poisson algebras, defines an inclusion of operads

$$H(\mathbb{B}_n(\bullet); \mathbb{Q}) \xrightarrow{\cong} D_n^\bullet \tag{12.7}$$

that turns out to be a quasi-isomorphism ( $H(\mathbb{B}_n(\bullet), \mathbb{Q})$  is considered to have a zero differential).

The operad  $D_n^\bullet$  is an operad in the category of differential graded cocommutative coalgebras. The coproduct in each component is given by cosuperimposing:

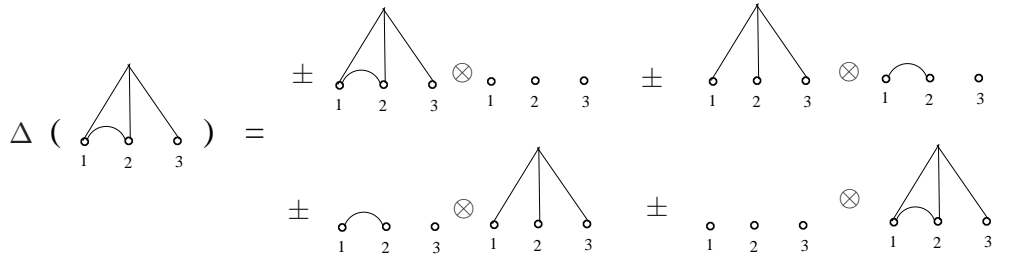

The counit is defined as 1 on the trivial diagram without edges and internal vertices and as 0 on all the others. The morphism (12.7) is a morphism of such operads. Due to this morphism,  $D_n^\bullet$  is a weak bimodule over  $H(\mathbb{B}_n(\bullet), \mathbb{Q})$  and therefore over  $H_0(\mathbb{B}_n(\bullet), \mathbb{Q}) =$

Com as well. Thus  $D_n^\bullet$  is a right  $\Gamma$  module. It is easy to see that the  $\Gamma$  structure maps respect the coalgebra structure, therefore  $D_n^\bullet$  is a right  $\Gamma$ -module in the category of coalgebras.

Let  $P_n^k$  denote the primitive part of  $D_n^k$ . The space  $P_n^k$  is spanned by the graphs with  $k$  labeled external vertices that become connected if one removes all the external vertices together with their small vicinities. The family of spaces  $P_n^\bullet = \{P_n^k, k \geq 0\}$  is preserved by the  $\Gamma$  structure maps, simply because these maps respect the coalgebra structure of  $D_n^k, k \geq 0$ .

**Proposition 12.4** ([26]). *The dg right  $\Gamma$  modules  $\pi(\mathbf{B}_n(\bullet)) \otimes \mathbb{Q}$  and  $P_n^\bullet$  are quasi-isomorphic (by a zig-zag of quasi-isomorphisms), where  $\pi(\mathbf{B}_n(\bullet)) \otimes \mathbb{Q}$  is considered to have a zero differential.*

12.0.8. *Right  $\Omega$ -modules  $\hat{D}_n^\bullet, \hat{P}_n^\bullet$ .* Recall that in [21] Pirashvili defines a functor

$$\text{cr}: \Gamma\text{-mod} \longrightarrow \Omega\text{-mod},$$

that turns out to be an equivalence of abelian categories. Denote by  $\hat{D}_n^\bullet$  and  $\hat{P}_n^\bullet$  the right  $\Omega$ -modules  $\text{cr}(D_n^\bullet)$  and  $\text{cr}(P_n^\bullet)$  respectively. In each degree  $\hat{D}_n^k$  and  $\hat{P}_n^k$  are spanned by the same graphs as  $D_n^k, P_n^k$  except that all the external vertices in these graphs are of valence  $\geq 1$ .

**Proposition 12.5.** *The dg right  $\Omega$ -modules  $\hat{D}_n^\bullet$  and  $\hat{P}_n^\bullet$  are finite-dimensional and injective in each homological degree.*

*Proof.* We show first that they are finite-dimensional in each homological degree, which in particular means that all except a finite number of components of the right  $\Omega$ -modules are trivial for any given homological degree. Let  $\Upsilon \in \hat{D}_n^k$  be a graph with  $E$  edges,  $I$  internal vertices, and  $k$  external vertices. To recall the complexity  $t$  of  $\Upsilon$  is the first Betti number of the graph obtained from  $\Upsilon$  by gluing together all external vertices. So, one has

$$t = E - I. \tag{12.8}$$

The total degree of  $\Upsilon$  is  $(n-1)E - n \cdot I = (n-1)t - I$ . Since the valence of any internal vertex is  $\geq 3$ , and the valence of any external one is  $\geq 1$ , one gets

$$3I + k \leq 2E.$$

Which implies  $I \leq \frac{2}{3}E, k \leq 2E$ . From (12.8) one has  $E = t + I \leq t + \frac{2}{3}E$ , so  $E \leq 3t, I \leq 2t, k \leq 6t$ . This very rough estimation shows that the set of graphs  $\Upsilon$  in any given complexity is finite. On the other hand for a given complexity  $t$  the total homological degree of any graph is  $(n-1)t - I \geq (n-3)t$ . Therefore there are finitely many complexities  $t$  that can produce non-trivial graphs in a given homological degree.

Before proving the injectivity, recall [21] that the category of right  $\Omega$ -modules has injective cogenerators  $\Omega_k^*, k \geq 0$ . First one defines the left  $\Omega$ -modules  $\Omega_k, k \geq 0$ , as

$$\Omega_k(\bullet) = \mathbb{Q}[\text{Mor}_\Omega(k, \bullet)],$$

which are projective generators of the category  $\Omega\text{-mod}$  of left  $\Omega$ -modules. Their duals  $\Omega_k^*$  are therefore injective right  $\Omega$ -modules. For any right  $\Omega$ -module  $F$  one has

$$\text{hRmod}_{\Omega}(F, \Omega_k^*) \simeq \text{Rmod}_{\Omega}(F, \Omega_k^*) \simeq (F(k))^*,$$

where  $(-)^*$  denote the dual vector space. The first isomorphism follows from injectivity, the second one is due to the Yoneda lemma. Notice that  $\Omega_k^*$  has a natural action of the symmetric group  $\Sigma_k$  that comes from the automorphisms of  $k \in \text{Obj}(\Omega)$ . Given any representation  $V$  of  $\Sigma_k$  one can define a right  $\Omega$  module  $\Omega_k^* \otimes_{\Sigma_k} V$  whose  $\ell$ -th component is  $\mathbb{Q}[\text{Mor}_{\Omega}(k, \ell)] \otimes_{\Sigma_k} V$ .

**Lemma 12.6.** *Let the ground field be  $\mathbb{Q}$ . For any finite-dimensional representation  $V$  of  $\Sigma_k$ , the right  $\Omega$ -module  $\Omega_k^* \otimes_{\Sigma_k} V$  is injective. Moreover for any right  $\Omega$ -module  $F$ , one has  $\text{hRmod}_{\Omega}(F, \Omega_k^* \otimes_{\Sigma_k} V) \simeq \text{hom}_{\Sigma_k}(F(k), V)$ .*

*Proof of Lemma 12.6.* Since the ground field is  $\mathbb{Q}$ , any finite-dimensional  $\Sigma_k$ -module  $V$  is a direct summand of a finitely generated free  $\Sigma_k$ -module. Thus  $V \otimes_{\Sigma_k} \Omega_k^*$  is a direct summand of a finite sum of copies of  $\Omega_k^*$  and therefore is also injective. For the second statement, since  $V$  is finite-dimensional, one has:

$$\text{Rmod}_{\Omega}(F, \Omega_k^* \otimes_{\Sigma_k} V) \simeq \text{Rmod}_{\Omega}(F, \Omega_k^*) \otimes_{\Sigma_k} V \simeq (F(k))^* \otimes_{\Sigma_k} V \simeq \text{hom}_{\Sigma_k}(F(k), V).$$

□

Now let us show that  $\hat{D}_n^\bullet, \hat{P}_n^\bullet$  are injective in each degree. Denote by  $M(D_n^k), M(P_n^k)$  the subspaces (which are actually subcomplexes) of  $\hat{D}_n^\bullet, \hat{P}_n^\bullet$  respectively spanned by the graphs whose all external vertices are univalent. This notation comes from the fact that these spaces are spaces of multiderivations in  $D_n^k, P_n^k$ , see [26, Section 10]. Each  $M(D_n^k), M(P_n^k)$  has a natural  $\Sigma_k$  action given by relabeling the external vertices. The following lemma finishes the proof of Proposition 12.5. □

**Lemma 12.7.** *The graded right  $\Omega$ -modules  $\hat{D}_n^\bullet, \hat{P}_n^\bullet$  are isomorphic to  $\bigoplus_{k=0}^{+\infty} \Omega_k^* \otimes_{\Sigma_k} M(D_n^k)$ , and  $\bigoplus_{k=1}^{+\infty} \Omega_k^* \otimes_{\Sigma_k} M(P_n^k)$ , respectively.*

*Proof.* Below we construct isomorphisms

$$\bigoplus_{k=0}^{+\infty} \Omega_k^* \otimes_{\Sigma_k} M(D_n^k) \xrightarrow{\simeq} \hat{D}_n^\bullet, \quad (12.9)$$

$$\bigoplus_{k=0}^{+\infty} \Omega_k^* \otimes_{\Sigma_k} M(P_n^k) \xrightarrow{\simeq} \hat{P}_n^\bullet. \quad (12.10)$$

Given a surjective map  $\alpha: k \rightarrow \ell$  and a graph  $\Upsilon \in M(D_n^k)$ , which means  $\Upsilon$  has  $k$  external vertices all of valence 1, one can construct a graph in  $D_n^\ell$  as follows: take  $\Upsilon$  and take  $\ell$  vertices labeled by  $1 \dots \ell$ , and then join each external vertex  $i$  of  $\Upsilon$  with the labeled vertex  $\alpha(i)$ :

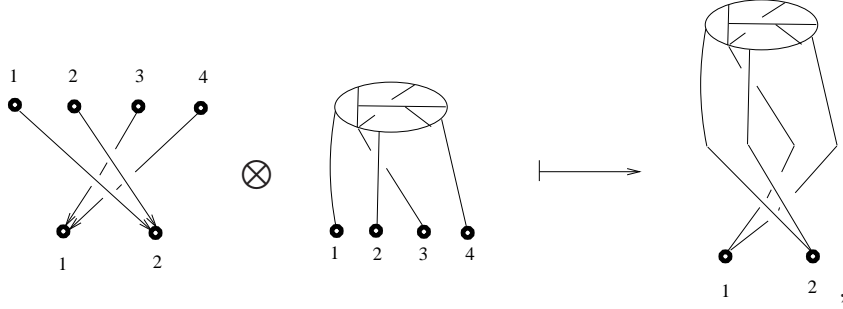

It is easy to see that the maps (12.9)-(12.10) defined as above are isomorphisms.  $\square$

We warn the reader that the isomorphisms (12.9), (12.10) send the differential of the source to the sum of expansions of internal vertices, which is only a part of the differential in  $\hat{D}_n^\bullet$ ,  $\hat{P}_n^\bullet$ . The other part is the sum of expansion of external vertices.

*Remark 12.8.* If  $n$  is odd, the graphs with loops (edges connecting a vertex to itself) are canceled out by the orientation relations. For even  $n$  if we quotient out  $P_n^\bullet$  by the graphs with loops, the isomorphism (12.10) fails to be true only in complexity 1, since there is only one graph  $\overset{1}{\curvearrowright} \overset{2}{\curvearrowright}$  in  $M(P_n^\bullet)$  that can produce a loop by gluing external vertices. Because of that in complexity  $\geq 2$  the graph-complex  $\mathcal{E}_{m,n}^\pi$  can be reduced to a quasi-isomorphic complex consisting of graphs without loops, see the argument below.

Below we finish the proof of Theorem 12.2.

*Proof of Theorem 12.2.* One has

$$\mathrm{hR}_{\Omega} \mathrm{mod} \left( \tilde{H}(S^{m\bullet}), \hat{H}(\mathbf{B}_n(\bullet), \mathbb{Q}) \right) \simeq \mathrm{R}_{\Omega} \mathrm{mod}(\tilde{H}(S^{m\bullet}), \hat{D}_n^\bullet) \simeq \bigoplus_{k=0}^{\infty} \mathrm{hom}_{\Sigma_k}(\tilde{H}(S^{mk}), M(D_n^k)).$$

The first isomorphism is due to the fact that  $\hat{D}_n^\bullet$  is an injective resolution of the right  $\Omega$ -module  $\hat{H}(\mathbf{B}_n(\bullet), \mathbb{Q})$ . Indeed it follows from Proposition 12.3 that the inclusion (12.7) is a quasi-isomorphic inclusion of right  $\Omega$ -modules. On the other hand Proposition 12.5 tells us that all the components in  $\hat{D}_n^\bullet$  are injective. The second isomorphism is due to Lemmas 12.6 and 12.7. Finally one can easily notice that the complex  $\bigoplus_k \mathrm{hom}_{\Sigma_k}(\tilde{H}(S^{mk}), M(D_n^k))$  is exactly  $\mathcal{E}_{m,n}^H$  defined in Section 12.0.6.

The proof of (12.6) goes in the same way:

$$\mathrm{hR}_{\Omega} \mathrm{mod} \left( \tilde{H}(S^{m\bullet}), \hat{\pi}(\mathbf{B}_n(\bullet)) \otimes \mathbb{Q} \right) \simeq \mathrm{R}_{\Omega} \mathrm{mod}(\tilde{H}(S^{m\bullet}), \hat{P}_n^\bullet) \simeq \bigoplus_{k=0}^{\infty} \mathrm{hom}_{\Sigma_k}(\tilde{H}(S^{mk}), M(P_n^k)).$$

But in this case  $\hat{P}_n^\bullet$  is no more a resolution of  $\pi(\mathbf{B}_n(\bullet)) \otimes \mathbb{Q}$ , but is only quasi-isomorphic to it, see Proposition 12.4. To prove the first isomorphism one has to evoke the model category structure [13] on the category of negatively graded chain complexes of right  $\Omega$ -modules. The weak equivalences for this structure are as usual quasi-isomorphisms of complexes.

The fibrations are epic maps in each degree with injective kernels. The cofibrations are maps monic in every strictly negative degree. To get the negative grading we subtract from the total grading the complexity times  $(n - 1)$ , since with a given complexity the maximal grading happens to the graphs without internal vertices. With this model category structure a result similar to [13, Proposition 7.3] finishes the proof of the first isomorphism. The second isomorphism is proven in the same way.  $\square$

**12.1. Rational homotopy of  $\overline{\text{Emb}}_c(\mathbb{R}^m, \mathbb{R}^n)$  in small dimensions.** In this section we describe the rational homotopy of  $\overline{\text{Emb}}_c(\mathbb{R}^m, \mathbb{R}^n)$  in complexity  $\leq 3$ . The table in Subsection 12.1.7 resumes these computations. Recall that we defined graph-complexes  $\mathcal{E}_{m,n}^\pi$  computing the rational homotopy of  $\overline{\text{Emb}}_c(\mathbb{R}^m, \mathbb{R}^n)$ , see Theorem 12.1. It is clear from the definition that up to a regrading the graph-complexes  $\mathcal{E}_{m,n}^\pi$  depend on the parities of  $m$  and  $n$  only. The case  $m = 1$  was considered in [26, Section 9] which by a regrading describes the situation when  $m$  is odd. Notice that for even  $n$  the graphs with multiple edges cancel out by the orientation relations. For odd  $n$  the graphs with loops disappear by the same reason. Due to Remark 12.8 in complexities  $\geq 2$  even when  $n$  is even one can consider the reduced version of  $\mathcal{E}_{m,n}^\pi$  spanned only by the graphs without loops.

12.1.1. *Complexity 1.* There are only two graphs in this complexity:



These graphs are in Hodge degrees 1 and 2 respectively. They survive the orientation relations and define non-trivial generators in rational homotopy according to the Table A.



Cycle	appear when	degree	parity
	$n - m$ even	$n - 2m - 1$	$n - 1$
	$n$ even	$n - m - 2$	$n - m$

TABLE A. Rational homotopy generators in complexity 1

12.1.2. *Complexity 2.* Due to Remark 12.8 one should consider only graphs without loops. Among those graphs there are only three that might survive the orientation relations, with only one graph in each of the Hodge degrees 1, 2, and 3. These graphs define non-trivial generators in rational homotopy according to the Table B.

Notice that only the last graph is not uni-trivalent. The uni-trivalent graphs for all parities of  $m$  and  $n$  cancel out by the orientation relations in Hodge degree 1.



Cycle	appear when	degree	parity
	$n - m$ odd	$2n - 3m - 3$	$m - 1$
	$m$ odd, $n$ odd	$2n - 2m - 4$	even
	$n$ odd	$2n - m - 4$	$m$

TABLE B. Rational homotopy generators in complexity 2

12.1.3. *Image of the connecting homomorphism.* One has a homotopy fibration

$$\overline{\text{Emb}}_c(\mathbb{R}^m, \mathbb{R}^n) \rightarrow \text{Emb}_c(\mathbb{R}^m, \mathbb{R}^n) \rightarrow \Omega^m \text{Inj}(\mathbb{R}^m, \mathbb{R}^n),$$

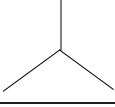
that produces a long exact sequence of homotopy groups:

$$(12.11) \quad \dots \rightarrow \pi_{*+1} \Omega^m \text{Inj}(\mathbb{R}^m, \mathbb{R}^n) \xrightarrow{\partial} \pi_* \overline{\text{Emb}}_c(\mathbb{R}^m, \mathbb{R}^n) \rightarrow \pi_* \text{Emb}_c(\mathbb{R}^m, \mathbb{R}^n) \rightarrow \pi_* \Omega^m \text{Inj}(\mathbb{R}^m, \mathbb{R}^n) \rightarrow \dots$$

Perhaps surprisingly for  $n \geq 2m + 2$  the image of  $\partial$  in rational homotopy depends on the parities of  $m$  and  $n$  only. The following is an equivalent reformulation of Theorem 13.1 or of Corollary 13.3.



**Theorem 12.9.** *For  $n \geq 2m + 2$ , the image of the connecting homomorphism*

$$\partial: \mathbb{Q} \otimes \pi_{*+1} \Omega^m \text{Inj}(\mathbb{R}^m, \mathbb{R}^n) \rightarrow \mathbb{Q} \otimes \pi_* \overline{\text{Emb}}_c(\mathbb{R}^m, \mathbb{R}^n) \quad (12.12)$$

*in rational homotopy is described by the homology of  $\mathcal{E}_{m,n}^\pi$  spanned by the following graphs*

$$\begin{array}{c} \diagup \quad \bigcirc \quad \text{leaf} \end{array} \quad (12.13)$$

*These classes are non-zero according to the following table:*

Cycle	appear when	degree	parity	complexity
	$n - m$ even	$n - 2m - 1$	$n - 1$	1
	$n$ even	$n - m - 2$	$m$	1
	$n$ odd	$2n - m - 4$	$m$	2

We will see later in Section 13 that the first and the second cycles come from the Euler classes of  $\mathbb{Q} \otimes \pi_* \text{Inj}(\mathbb{R}^m, \mathbb{R}^n)$ , and the last one comes from the top Pontryagin class of  $\mathbb{Q} \otimes \pi_* \text{Inj}(\mathbb{R}^m, \mathbb{R}^n)$ .

12.1.4. *Complexity 3.* The rank of the homology of  $\mathcal{E}_{m,n}^\pi$  in complexity 3 is always two. The homology generators are represented by the graphs shown in Table C.

Cycle	appear when	degree	parity
	$m$ even	$3n - 3m - 6$	$n$
	$m$ odd	$3n - 2m - 7$	$n - 1$
	always	$3n - m - 7$	$n - m - 1$

TABLE C. Rational homotopy generators in complexity 3

Notice that the cycles depend only on the parity of  $m$ . The graph-complexes actually do depend on the parity of  $n$ . As it follows from Remark 12.8, when  $n$  is even one can consider a quasi-isomorphic complex consisting of graphs without loops. It turns out that for even  $n$  the only such graphs that are not canceled out by the orientation relations are those that appear in the above table. When  $n$  is odd the complex is more complicated because of the presence of graphs with multiple edges. For the case  $m$  odd,  $n$  odd, see [26, Section 11]. The case  $m$  even,  $n$  odd is considered below.

$m$  even,  $n$  odd. For the Hodge degree 4 one has two non-trivial graphs:

$$\begin{array}{ccc}
 \begin{array}{c} \diagup \quad \diagdown \\ \diagdown \quad \diagup \end{array} & \xleftarrow{\partial} & \begin{array}{c} \diagup \quad \diagdown \\ \diagdown \quad \diagup \end{array} \\
 & & \text{(12.14)}
 \end{array}$$

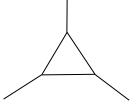
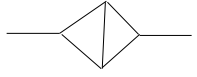
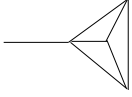
The homology is still trivial, since  $\partial(\text{X}) = 3 \text{Y}$ .

In the Hodge degree 3 one has the complex

$$\begin{array}{ccc}
 \begin{array}{c} \diagup \quad \diagdown \\ \diagdown \quad \diagup \end{array} & \xleftarrow{\partial} & \begin{array}{c} \diagup \quad \diagdown \\ \diagdown \quad \diagup \end{array} \\
 \begin{array}{c} \diagup \quad \diagdown \\ \diagdown \quad \diagup \end{array} & & \begin{array}{c} \diagup \quad \diagdown \\ \diagdown \quad \diagup \end{array}
 \end{array}$$

with the differential

$$\partial \left( \begin{array}{c} \diagup \quad \diagdown \\ \diagdown \quad \diagup \end{array} \right) = 2 \begin{array}{c} \diagup \quad \diagdown \\ \diagdown \quad \diagup \end{array} + \begin{array}{c} \diagup \quad \diagdown \\ \diagdown \quad \diagup \end{array} .$$

This part of  $\mathcal{E}_{m,n}^\pi$  produces only one-dimensional homology group spanned by the first graph from the Table C.

In Hodge degree 2 one has the complex

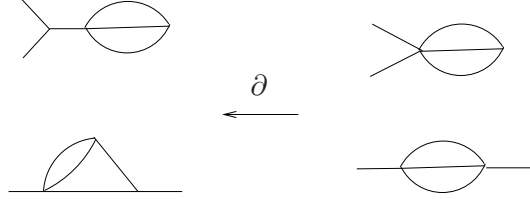

Which produces no cycles.

In the Hodge degree 1, one has the complex

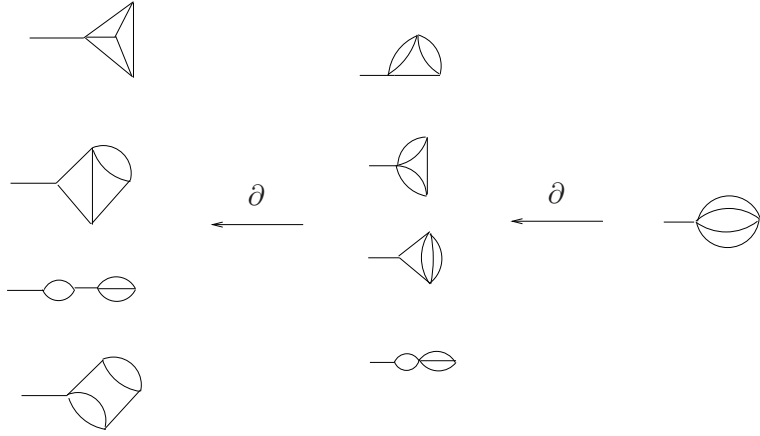

Which produces the last cycle from Table C.

12.1.5. *Subcomplex of trees or  $s = t + 1$ .* Denote by  $\pi_*^{(s,t)}(\overline{\text{Emb}}_c(\mathbb{R}^m, \mathbb{R}^n))$  the part of the rational homotopy of  $\overline{\text{Emb}}_c(\mathbb{R}^m, \mathbb{R}^n)$  which lies in Hodge degree  $s$  and complexity  $t$ . The summand  $\mathcal{E}_{m,n}^\pi(s, t)$  in Hodge degree  $s$  and complexity  $t$  is non-trivial only if  $s \leq t + 1$ . The case  $s = t + 1$  corresponds to the subcomplex of trees or graphs without cycles.

**Proposition 12.10.** *For  $t \geq 3$ , one has  $\pi_*^{(t+1,t)}(\overline{\text{Emb}}_c(\mathbb{R}^m, \mathbb{R}^n)) = 0$  (with the usual assumption  $n \geq 2m + 2$ ).*

*Proof.* Let  $M_t(P_n^{t+1})$  denote the subcomplex of  $M(P_n^{t+1})$ , see Section 12.0.8, spanned by the trees. It is well known that the homology of this graph-complex is concentrated in the lowest degree and is described as the space of binary trees modulo  $IHX$  relations. Up to a sign representation  $sign_{t+1}$  of the symmetric group  $\Sigma_{t+1}$  this homology is isomorphic to the  $t$ -th component  $Lie(t)$  of the cyclic  $Lie$  operad. The subcomplex of  $\mathcal{E}_{m,n}^\pi$  is isomorphic to

$$M_t(P_n^{t+1}) \otimes_{\Sigma_{t+1}} (sign_{t+1})^{\otimes m}.$$

But it is well known that both the invariants and anti-invariants of  $Lie(t)$  are trivial for  $t \geq 3$ . The result thus follows.  $\square$

As an example illustrating this result, the complex (12.14) has trivial homology. Notice however that for the complexity  $t = 1$  and 2 one has non-trivial classes in Hodge degree  $t + 1$ , see Tables A-B.

12.1.6. *Subcomplex of graphs with one cycle or  $s = t$ .* It turns out that the homology of  $\mathcal{E}_{m,n}^\pi$  can also be easily understood when the complexity  $t$  equals the Hodge degree  $s$ , or in other words the homology of the subcomplex  $\oplus_{t \geq 1} \mathcal{E}_{m,n}^\pi(t, t)$  spanned by graphs with exactly one cycle. For any  $k \geq 1$ , define a  $k$ -wheel as a graph with  $k$  univalent external vertices and  $k$  trivalent internal vertices, which is obtained from a  $k$ -gon by adding an edge from each vertex. As an example a 5-wheel is pictured below:

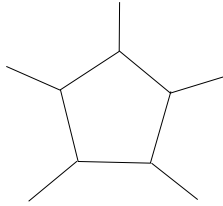

**Proposition 12.11.** *The homology of  $\mathcal{E}_{m,n}^\pi(t, t)$  has rank 0 or 1 and is generated by the  $t$ -wheel, which is non-zero*

- for  $m$  odd,  $n$  odd, if  $t = 2k$ ,  $k \in \mathbb{N}$ ;
- for  $m$  odd,  $n$  even, if  $t = 4k - 3$ ,  $k \in \mathbb{N}$ ;
- for  $m$  even,  $n$  odd, if  $t = 4k - 1$ ,  $k \in \mathbb{N}$ ;
- for  $m$  even,  $n$  even, if  $t = 2k - 1$ ,  $k \in \mathbb{N}$ .

Notice that 1, 2, and 3-wheels appeared already in our computations. Since we are not going to use this result, we explain very briefly the way it can be proved.

*Idea of the proof.* The idea is that one can reduce  $\mathcal{E}_{m,n}^\pi$  to a smaller complex of graphs without cut-vertices [12]. The argument is similar to the one given in the above reference. For the case  $s = t$  the only such graph is the  $t$ -wheel. One only needs to check when this  $t$ -wheel survives the dihedral symmetries.  $\square$

*Remark 12.12.* The results of Sections 12.1, 12.1.5, 12.1.6 are consistent with the computations of the Euler characteristics presented in Tables 1, 3, 5, 7. All these computations are also consistent with the previous computations of the rational homotopy of  $\overline{\text{Emb}}_c(\mathbb{R}, \mathbb{R}^n)$ , see [?, Appendix B, Tables 5-6].

**Conjecture 12.13.** *For  $\ell$  fixed, the rank of  $\pi_*^{(t-\ell, t)}(\overline{\text{Emb}}_c(\mathbb{R}^m, \mathbb{R}^n))$  has asymptotic  $t^\ell$  when  $t \rightarrow +\infty$ .*

12.1.7. *Recollecting results of computations.* The table below resumes the results of computations from 12.1.1-12.1.6 and describes the dimensions of the first few linearly independent generators of  $\mathbb{Q} \otimes \pi(\overline{\text{Emb}}_c(\mathbb{R}^m, \mathbb{R}^n))$ ,  $n > 2m + 1$ . To obtain a similar description of the rational homotopy of  $\text{Emb}_c(\mathbb{R}^m, \mathbb{R}^n)$ ,  $n > 2m + 1$ , in small dimensions one can use Corollary 13.3.

Case	Dimensions of rational homotopy generators	Other generators have dimension
$m$ odd, $n$ odd	$n - 2m - 1, 2n - 2m - 4, 2n - m - 4, 3n - 2m - 7, 3n - m - 7, 4n - 4m - 8$	$\geq 4n - 3m - 9$
$m$ odd, $n$ even	$n - m - 2, 2n - 3m - 3, 3n - 2m - 7, 3n - m - 7$	$\geq 4n - 3m - 9,$
$m$ even, $n$ odd	$2n - 3m - 3, 2n - m - 4, 3n - 3m - 6, 3n - m - 7$	$\geq 4n - 3m - 9$
$m$ even, $n$ even	$n - 2m - 1, n - m - 2, 3n - 3m - 6, 3n - m - 7$	$\geq 4n - 3m - 9$

### 13. RATIONAL HOMOTOPY TYPE OF $\text{Emb}_c(\mathbb{R}^m, \mathbb{R}^n)$

It is natural to ask ourselves: “Is it possible to reconstruct from  $\mathbb{Q} \otimes \pi_*(\overline{\text{Emb}}_c(\mathbb{R}^m, \mathbb{R}^n))$  the rational homotopy of the initial embedding space  $\text{Emb}_c(\mathbb{R}^m, \mathbb{R}^n)$ .” To answer this question it is enough to know the rational homotopy of  $\Omega^m \text{Inj}(\mathbb{R}^m, \mathbb{R}^n)$  (which is shifted by  $m$  the homotopy of  $\text{Inj}(\mathbb{R}^m, \mathbb{R}^n)$ ), and the image of the morphism

$$\mathbb{Q} \otimes \pi_* \text{Emb}_c(\mathbb{R}^m, \mathbb{R}^n) \xrightarrow{D_*} \mathbb{Q} \otimes \pi_* \Omega^m \text{Inj}(\mathbb{R}^m, \mathbb{R}^n) \quad (13.1)$$

induced by the Smale-Hirsch map  $D$ . The space  $\text{Inj}(\mathbb{R}^m, \mathbb{R}^n)$  is the Steifel variety of isometric linear injections of  $\mathbb{R}^m$  into  $\mathbb{R}^n$ . The rational homotopy of  $\text{Inj}(\mathbb{R}^m, \mathbb{R}^n)$  is finite-dimensional, see Theorem 13.2. As a consequence up to a finite-dimensional correction the rational homotopy of  $\text{Emb}_c(\mathbb{R}^m, \mathbb{R}^n)$  and of  $\overline{\text{Emb}}_c(\mathbb{R}^m, \mathbb{R}^n)$  is the same. We mention also that the rational homology of  $\text{Emb}_c(\mathbb{R}^m, \mathbb{R}^n)$  is a polynomial bialgebra generated by the rational homotopy. This follows from the fact that  $\text{Emb}_c(\mathbb{R}^m, \mathbb{R}^n)$  is a double loop space. For  $m \geq 2$  it is straightforward. For  $m = 1$  this result is due to Salvatore [22].

**Theorem 13.1.** *Let  $n \geq m + 2$ . A non-zero element of  $\mathbb{Q} \otimes \pi_* \Omega^m \text{Inj}(\mathbb{R}^m, \mathbb{R}^n)$  is in the image of (13.1) if and only if its degree  $> 2n - 3m - 4$  and also it is in the image of  $(\Omega^m i)_*$ , where  $i$  is the natural inclusion*

$$\text{Inj}(\mathbb{R}^{m-1}, \mathbb{R}^{n-1}) \xrightarrow{i} \text{Inj}(\mathbb{R}^m, \mathbb{R}^n). \quad (13.2)$$

*Proof.* R. Budney proved that  $\text{Emb}_c(\mathbb{R}^m, \mathbb{R}^n)$  is  $(2n - 3m - 4)$ -connected [7, Proposition 3.9]. In the same paper he shows that the map  $D$  up to homotopy factors through

$\Omega^m \text{Inj}(\mathbb{R}^{m-1}, \mathbb{R}^{n-1})$  [7, Theorem 2.5]:

$$\begin{array}{ccc} \text{Emb}_c(\mathbb{R}^m, \mathbb{R}^n) & \xrightarrow{D} & \Omega^m \text{Inj}(\mathbb{R}^m, \mathbb{R}^n) \\ & \searrow \text{hol} & \nearrow \Omega^m i \\ & \Omega^m \text{Inj}(\mathbb{R}^{m-1}, \mathbb{R}^{n-1}) & \end{array}$$

Thus to prove the above theorem, one only needs to show that every class  $\omega \in \mathbb{Q} \otimes \pi_* \Omega^m \text{Inj}(\mathbb{R}^m, \mathbb{R}^n)$ , such that  $\deg \omega > 2n - 3m - 4$  and  $\omega \in \text{Im}(\Omega^m i)_*$ , does appear in  $\text{Im} D_*$ . Notice that if  $\omega \notin \text{Im} D_*$ , then  $\partial\omega \neq 0$ , where  $\partial$  is the connecting homomorphism (12.12). One also has

$$\deg \partial\omega = \deg \omega - 1.$$

The end of the proof will go as follows. Assuming  $\partial\omega \neq 0$  we will show that  $\deg \partial\omega$  is too big to make  $\partial\omega$  appear in complexity 1, too small to make it appear in complexity  $\geq 3$ , and its parity does not match to appear in complexity 2. The space  $\text{Inj}(\mathbb{R}^m, \mathbb{R}^n)$  is a fibered product  $S^{n-1} \times S^{n-2} \times \dots \times S^{n-m}$ , and moreover the inclusion (13.2) is

$$\begin{array}{ccc} \text{Inj}(\mathbb{R}^{m-1}, \mathbb{R}^{n-1}) & \hookrightarrow & \text{Inj}(\mathbb{R}^m, \mathbb{R}^n) \\ \parallel & & \parallel \\ S^{n-2} \times \dots \times S^{n-m} & \hookrightarrow & S^{n-1} \times S^{n-2} \times \dots \times S^{n-m} \end{array}$$

The rational homotopy of  $\text{Inj}(\mathbb{R}^m, \mathbb{R}^n)$  is described by the following well known result whose proof is sketched afterwards.

**Theorem 13.2.** *Assuming  $n > 2m \geq 2$ , one has*

- for  $m$  odd,  $n$  odd:

$$\mathbb{Q} \otimes \pi_* \text{Inj}(\mathbb{R}^m, \mathbb{R}^n) = \begin{cases} \mathbb{Q}, & * = n - m \text{ or } 2n - 3 - 4k, 0 \leq k \leq \frac{m-1}{2}; \\ 0, & \text{otherwise.} \end{cases}$$

- for  $m$  odd,  $n$  even:

$$\mathbb{Q} \otimes \pi_* \text{Inj}(\mathbb{R}^m, \mathbb{R}^n) = \begin{cases} \mathbb{Q}, & * = n - 1 \text{ or } 2n - 5 - 4k, 0 \leq k \leq \frac{m-3}{2}; \\ 0, & \text{otherwise.} \end{cases}$$

- for  $m$  even,  $n$  odd:

$$\mathbb{Q} \otimes \pi_* \text{Inj}(\mathbb{R}^m, \mathbb{R}^n) = \begin{cases} \mathbb{Q}, & * = 2n - 3 - 4k, 0 \leq k \leq \frac{m-2}{2}; \\ 0, & \text{otherwise.} \end{cases}$$

- for  $m$  even,  $n$  even:

$$\mathbb{Q} \otimes \pi_* \text{Inj}(\mathbb{R}^m, \mathbb{R}^n) = \begin{cases} \mathbb{Q}, & * = n - 1, n - m, \text{ or } 2n - 5 - 4k, 0 \leq k \leq \frac{m-2}{2}; \\ 0, & \text{otherwise.} \end{cases}$$

The classes of degree  $n - 1$  and  $n - m$  will be called Euler classes, the other classes will be called Pontryagin classes. Notice that Pontryagin classes have degrees  $4\ell - 1$ ,  $\ell \in \mathbb{N}$ . A similar statement is true in the range  $n > m \geq 1$ , but if  $n \leq 2m$  the Euler and Pontryagin classes can lie in the same degrees, which makes more difficult to formulate the result.

*Sketch of the proof.* One has a fibration

$$SO(n - m) \xrightarrow{\iota} SO(n) \xrightarrow{p} \text{Inj}(\mathbb{R}^m, \mathbb{R}^n).$$

The rational homotopy of  $\text{Inj}(\mathbb{R}^m, \mathbb{R}^n)$  can be split into a direct sum of the image of  $p_*$  (containing all the Pontryagin classes of  $\text{Inj}(\mathbb{R}^m, \mathbb{R}^n)$  and the Euler class of degree  $n - 1$ , appearing if  $n$  is even) and a space transversal to  $\text{Im } p_*$  which gets mapped by a connecting homomorphism  $\partial$  isomorphically on  $\text{Im } \partial$  (this space has dimension zero or one and is generated by the Euler class of degree  $n - m$ , appearing if  $n - m$  is even). Theorem 13.2 is easily proved by a careful study of the map  $\iota_*$  in rational homotopy. As we already mentioned  $\text{Inj}(\mathbb{R}^m, \mathbb{R}^n)$  is a fibered product of spheres:

$$\text{Inj}(\mathbb{R}^m, \mathbb{R}^n) = S^{n-1} \times S^{n-2} \times \dots \times S^{n-m} \quad (13.3)$$

The Pontryagin class of degree  $4\ell - 1$  appears either from the factor  $S^{2\ell} \times S^{2\ell-1}$  of (13.3) or from the Hopf class of the last sphere if  $n - m = 2\ell$ . The Euler class of degree  $n - 1$  comes from the first sphere of (13.3) and it appears only if  $n$  is even. The Euler class of degree  $n - m$  corresponds to the last sphere of (13.3) and it appears only if  $n - m$  is even. The case  $m = 1$  fits into Theorem 13.2: when  $n$  is even the only sphere  $S^{n-1}$  is treated as the first sphere in (13.3); when  $n$  is odd it is treated as the last one.  $\square$

We now return to the proof of Theorem 13.1. We first list the classes in  $\mathbb{Q} \otimes \pi_* \Omega^m \text{Inj}(\mathbb{R}^m, \mathbb{R}^n)$  that can not lie in  $\mathfrak{S}D_*$  by Budney's result. Basically these are the Euler classes (since their dimensions are too small) and the top Pontryagin class when  $n$  is odd (since it is not in the image of  $i_*$ ). When  $n$  is even the only class which is not in the image of  $i_*: \mathbb{Q} \otimes \pi_* \text{Inj}(\mathbb{R}^{m-1}, \mathbb{R}^{n-1}) \rightarrow \mathbb{Q} \otimes \pi_* \text{Inj}(\mathbb{R}^m, \mathbb{R}^n)$  is the Euler class of degree  $n - 1$ . Via the image of  $\partial$  it appears as a class of degree  $n - m - 2$  in  $\mathbb{Q} \otimes \pi_* \overline{\text{Emb}}_c(\mathbb{R}^m, \mathbb{R}^n)$ . The shift of degree by  $m$  comes from  $m$  loops. This class corresponds to the graph



from (12.13).

When  $n$  is odd and  $m \geq 2$  there is only one class not lying in  $\text{Im } i_*$  which is the top Pontryagin class whose degree is  $2n - 3$ . Via the connecting homomorphism it appears as a class of degree  $2n - m - 4$  in  $\mathbb{Q} \otimes \pi_* \overline{\text{Emb}}_c(\mathbb{R}^m, \mathbb{R}^n)$ . The corresponding graph from (12.13) is



For  $n$  odd and  $m = 1$ , there are two classes not in the image of  $i_*$  (which is a zero map since the source is zero): the Pontryagin class of degree  $2n - 1$  and the Euler class of degree

$n - 1$ . The corresponding graphs are



Assuming  $n \geq 2m + 2$ , the Euler class of degree  $n - 2m$  in  $\mathbb{Q} \otimes \pi_* \Omega^m \text{Inj}(\mathbb{R}^m, \mathbb{R}^n)$  can not lie in  $\text{Im } D_*$  since by Budney's result [7, Proposition 3.9] the space  $\text{Emb}_c(\mathbb{R}^m, \mathbb{R}^n)$  is  $(2n - 3m - 4)$ -connected and

$$n - 2m > 2n - 3m - 4$$

is possible only if  $n = 4$  and  $m = 1$ , but the case  $m = 1$  excludes the Euler class from the image of  $D_*$  by the previous argument. Via the connecting homomorphism this class produces a generator of degree  $n - 2m - 1$  in  $\mathbb{Q} \otimes \pi_* \overline{\text{Emb}}_c(\mathbb{R}^m, \mathbb{R}^n)$ . The corresponding graph from (12.13) is



The degree of the bottom Pontryagin class of  $\text{Inj}(\mathbb{R}^m, \mathbb{R}^n)$  is  $2n - 2m - 1$  or  $2n - 2m + 1$  depending on the parity of  $n - m$ . Shifted by  $m$  it appears in degree  $\geq 2n - 3m - 1$  of  $\mathbb{Q} \otimes \pi_* \Omega^m \text{Inj}(\mathbb{R}^m, \mathbb{R}^n)$ . But  $2n - 3m - 1 > 2n - 3m - 4$ , so neither of the other Pontryagin classes are excluded from  $\text{Im } D_*$  by Budney's results.

Notice that the above analysis shows that Theorem 13.1 is equivalent to Theorem 12.9.

To finish the proof of Theorem 13.1 one has to show that all the Pontryagin classes except the top one (when  $n$  is odd) lie in  $\text{Im } D_*$ . Notice that the degree of such class  $\omega \in \mathbb{Q} \otimes \pi_* \Omega^m \text{Inj}(\mathbb{R}^m, \mathbb{R}^n)$  is  $4\ell - 1 - m$  for some  $\ell > 0$ . If  $\omega$  does not lie in  $\mathfrak{S}D_*$ , then  $\partial\omega \neq 0$  and the degree of  $\partial\omega$  is  $4\ell - m - 2$ . One has  $\partial\omega$  can not lie in complexity 1, since complexity one is already taken by the image of the Euler classes. It can not lie in complexity 2, since the parity of its degree is  $m$ , and there are no classes other than  of this parity in complexity 2, see Table B, which is also already taken by the image of the top Pontryagin class. Finally let us check that  $\partial\omega$  can not lie in complexity  $\geq 3$ . Assuming that  $\partial\omega$  corresponds to a cycle in graph-homology of  $\mathcal{E}_{m,n}^\pi$  in complexity  $t$  and Hodge degree  $s$ , let  $I$  denote the number of internal vertices of one of the graphs in the linear combination representing  $\partial\omega$ , and  $E$  be the number of edges in this graph. One has

$$E \geq \frac{3I + s}{2}.$$

One also has that the complexity  $t$  is

$$t = E - I.$$

From the above

$$E \leq 3t - s.$$

The total degree is

$$\deg \partial\omega = (n - 1)E - n \cdot I - ms = nt - ms - E \geq (n - 3)t - (m - 1)s.$$

Since for  $t \geq 3$  one has  $s \leq t$  (Proposition 12.10), the total degree can be estimated as

$$\deg \partial\omega \geq (n-3)t - (m-1)s \geq (n-m-2)t \geq 3(n-m-2).$$

On the other hand the degree of the highest Pontryagin class, which is in the image of  $(\Omega^{mi})_*$  is  $2n-5-m$  or  $2n-7-m$  depending on the parity of  $n$ . One can easily check that  $n > 2m+1$  implies

$$3(n-m-2) > 2n-5-m,$$

which finishes the proof of Theorem 13.1.  $\square$

Theorem 12.9 is an equivalent reformulation of Theorem 13.1. Another equivalent reformulation is given below.

**Corollary 13.3.** *Assuming  $n \geq 2m+2$ , the ranks of the rational homotopy of  $\text{Emb}_c(\mathbb{R}^m, \mathbb{R}^n)$  are related to that of  $\overline{\text{Emb}}_c(\mathbb{R}^m, \mathbb{R}^n)$  as follows:*

- for  $m$  odd,  $n$  odd:

$$\begin{aligned} \text{rank } \mathbb{Q} \otimes \pi_* \text{Emb}_c(\mathbb{R}^m, \mathbb{R}^n) = & \\ & \begin{cases} \text{rank } \mathbb{Q} \otimes \pi_* \overline{\text{Emb}}_c(\mathbb{R}^m, \mathbb{R}^n) + 1, & * = 2n - m - 7 - 4k, \quad 0 \leq k \leq \frac{m-3}{2}; \\ \text{rank } \mathbb{Q} \otimes \pi_* \overline{\text{Emb}}_c(\mathbb{R}^m, \mathbb{R}^n) - 1, & * = 2n - m - 4, \quad n - 2m - 1; \\ \text{rank } \mathbb{Q} \otimes \pi_* \overline{\text{Emb}}_c(\mathbb{R}^m, \mathbb{R}^n), & \text{otherwise.} \end{cases} \end{aligned}$$

- for  $m$  odd,  $n$  even:

$$\begin{aligned} \text{rank } \mathbb{Q} \otimes \pi_* \text{Emb}_c(\mathbb{R}^m, \mathbb{R}^n) = & \\ & \begin{cases} \text{rank } \mathbb{Q} \otimes \pi_* \overline{\text{Emb}}_c(\mathbb{R}^m, \mathbb{R}^n) + 1, & * = 2n - m - 5 - 4k, \quad 0 \leq k \leq \frac{m-3}{2}; \\ \text{rank } \mathbb{Q} \otimes \pi_* \overline{\text{Emb}}_c(\mathbb{R}^m, \mathbb{R}^n) - 1, & * = n - m - 2; \\ \text{rank } \mathbb{Q} \otimes \pi_* \overline{\text{Emb}}_c(\mathbb{R}^m, \mathbb{R}^n), & \text{otherwise.} \end{cases} \end{aligned}$$

- for  $m$  even,  $n$  odd:

$$\begin{aligned} \text{rank } \mathbb{Q} \otimes \pi_* \text{Emb}_c(\mathbb{R}^m, \mathbb{R}^n) = & \\ & \begin{cases} \text{rank } \mathbb{Q} \otimes \pi_* \overline{\text{Emb}}_c(\mathbb{R}^m, \mathbb{R}^n) + 1, & * = 2n - m - 7 - 4k, \quad 0 \leq k \leq \frac{m-4}{2}; \\ \text{rank } \mathbb{Q} \otimes \pi_* \overline{\text{Emb}}_c(\mathbb{R}^m, \mathbb{R}^n) - 1, & * = 2n - m - 4; \\ \text{rank } \mathbb{Q} \otimes \pi_* \overline{\text{Emb}}_c(\mathbb{R}^m, \mathbb{R}^n), & \text{otherwise.} \end{cases} \end{aligned}$$

- for  $m$  even,  $n$  even:

$$\begin{aligned} \text{rank } \mathbb{Q} \otimes \pi_* \text{Emb}_c(\mathbb{R}^m, \mathbb{R}^n) = & \\ & \begin{cases} \text{rank } \mathbb{Q} \otimes \pi_* \overline{\text{Emb}}_c(\mathbb{R}^m, \mathbb{R}^n) + 1, & * = 2n - m - 5 - 4k, \quad 0 \leq k \leq \frac{m-2}{2}; \\ \text{rank } \mathbb{Q} \otimes \pi_* \overline{\text{Emb}}_c(\mathbb{R}^m, \mathbb{R}^n) - 1, & * = n - m - 2, \quad n - 2m - 1; \\ \text{rank } \mathbb{Q} \otimes \pi_* \overline{\text{Emb}}_c(\mathbb{R}^m, \mathbb{R}^n), & \text{otherwise.} \end{cases} \end{aligned}$$

## 14. EULER CHARACTERISTICS OF THE DOUBLE SPLITTING

In this section we investigate the generating function of the Euler characteristics of the double splitting in the rational homology of  $\overline{\text{Emb}}_c(\mathbb{R}^m, \mathbb{R}^n)$ . Let  $\chi_{st}$  denote the Euler characteristic of the summand in (9.9) of complexity  $t$  and Hodge degree  $s$ . This summand is finite dimensional, so the homology should also be finite dimensional and the Euler characteristic is well defined. Let

$$F_{mn}(x, u) = \sum_{st} \chi_{st} x^s u^t \quad (14.1)$$

denote the generating function of the Euler characteristics of the double splitting in  $\text{H}(\overline{\text{Emb}}_c(\mathbb{R}^m, \mathbb{R}^n); \mathbb{Q})$ . From (9.9) it is clear the this function depends only on the parities of  $m$  and  $n$ .

**Theorem 14.1.** *One has*

$$F_{mn}(x, u) = \prod_{\ell \geq 1} \frac{\Gamma((-1)^{n-1} E_\ell(\frac{1}{u}) - (-1)^{m-1} E_\ell(x))}{((-1)^{n-1} \ell u^\ell)^{(-1)^{m-1} E_\ell(x)} \Gamma((-1)^{n-1} E_\ell(\frac{1}{u}))}, \quad (14.2)$$

where each factor in the product is understood as the asymptotic expansion of the underlying function when  $u$  is complex and  $(-1)^{n-1} u^\ell \rightarrow +0$  and  $x$  is considered as a fixed parameter. In the above  $\Gamma(y)$  is the gamma function which is  $(y-1)!$  on positive integers,  $E_\ell(y) = \frac{1}{\ell} \sum_{d|\ell} \mu(d) y^{\ell/d}$  (where  $\mu(-)$  is the standard Möbius function).

Tables 2, 4, 6, 8 describe  $\chi_{st}$  for complexities  $\leq 23$ . From these tables the above generating functions start as follows:

$$\begin{aligned} F_{oo}(x, u) &= 1 + x^2 u && +(x^4 + x^2 - x)u^2 + (x^6 + x^4 - x^3 + x^2 - x)u^3 && + \dots \\ F_{oe}(x, u) &= 1 - xu && +x^3 u^2 + (-x^4 - x^2 + x)u^3 && + \dots \\ F_{eo}(x, u) &= 1 && +(-x^3 + x)u^2 + (-x^3 + x)u^3 && + \dots \\ F_{ee}(x, u) &= 1 + (-x^2 + x)u && +(-x^3 + x^2)u^2 + (-x^4 + 2x^3 - x)u^3 && + \dots \end{aligned}$$

The subscript  $o$  refers to the case when the corresponding variable  $m$  or  $n$  is odd, and the subscript  $e$  refers to the situation when  $m$  or  $n$  is even.

The case  $m = 1$  of this formula was introduced and proved in [26]. We refer the reader to this paper which explains this formula in more details. In the rest of the section we sketch the main steps of the computations.

Using Proposition 8.13 the complex computing  $\text{H}(\overline{\text{Emb}}_c(\mathbb{R}^m, \mathbb{R}^n), \mathbb{Q})$  in complexity  $t$  and Hodge degree  $s$  is

$$\left( \oplus_{k=s}^{2t} \text{hom}_{\Sigma_k} \left( KQ_s^m(k), \hat{\text{H}}_{t(n-1)}(C(k, \mathbb{R}^n); \mathbb{Q}) \right), d \right).$$

To recall Remark 9.6 the  $\Sigma_k$ -module  $KQ_s^m(k)$  is  $\tilde{\text{H}}_{k+s(m-1)}(S^{mk}/\Delta^k S^m; \mathbb{Q}) = \overline{\text{H}}_{k+s(m-1)}(C(k, \mathbb{R}^m); \mathbb{Q})$  (assuming  $m \geq 2$ ), where  $\overline{\text{H}}$  denotes the locally compact singular

homology. The entire complex computing  $H(\overline{\text{Emb}}_c(\mathbb{R}^m, \mathbb{R}^n); \mathbb{Q})$  is

$$\left( \bigoplus_{k \geq 0} \text{hom}_{\Sigma_k} \left( \overline{H}(C(k, \mathbb{R}^m); \mathbb{Q}), \hat{H}(C(k, \mathbb{R}^n), \mathbb{Q}) \right), d \right).$$

The above formula is also true for  $m = 1$ , but in that case the splitting over the Hodge degree can not be defined in the same way. For  $m = 1$  this splitting is similar to the Hodge-type splitting in the Hochschild (co)homology of a commutative algebra [26]. As we mentioned earlier the case  $m = 1$  of Theorem 14.1 was done in [26, Theorem 13.1]. For simplicity of exposition we will be assuming below that  $m \geq 2$ .

We start by introducing some standard notation. For each permutation  $\sigma \in \Sigma_k$  define  $Z(\sigma)$ , the *cycle indicator* of  $\sigma$ , by

$$Z(\sigma) = \prod_{\ell} a_{\ell}^{j_{\ell}(\sigma)},$$

where  $j_{\ell}(\sigma)$  is the number of  $\ell$ -cycles of  $\sigma$  and where  $a_1, a_2, a_3, \dots$  is an infinite family of commuting variables.

Let  $\rho^V: S_k \rightarrow GL(V)$  be a representation of  $\Sigma_k$ . Define  $Z_V(a_1, a_2, \dots)$  the *cycle index* of  $V$ , by

$$Z_V(a_1, a_2, \dots) = \frac{1}{k!} \sum_{\sigma \in \Sigma_k} \text{tr} \rho^V(\sigma) \cdot Z(\sigma).$$

Similarly for a symmetric sequence  $W = \{W(k), k \geq 0\}$  — sequence of  $\Sigma_k$ -modules, one defines its *cycle index sum*  $Z_W$  by

$$Z_W(a_1, a_2, \dots) = \sum_{k=0}^{+\infty} Z_{W(k)}(a_1, a_2, \dots).$$

The following lemma is well known [26, Lemma 15.4].

**Lemma 14.2.** *Let  $V$  and  $W$  be two  $\Sigma_k$ -modules, then*

$$\dim \text{hom}_{\Sigma_k}(V, W) = \left( Z_V(a_{\ell} \leftarrow \partial/\partial a_{\ell}, \ell \in \mathbb{N}) Z_W(a_{\ell} \leftarrow \ell a_{\ell}, \ell \in \mathbb{N}) \right) \Big|_{\substack{a_{\ell}=0, \\ \ell \in \mathbb{N}}}.$$

In the above formula  $Z_W(a_{\ell} \leftarrow \ell a_{\ell}, \ell \in \mathbb{N})$  is a polynomial obtained from  $Z_W(a_1, a_2, \dots)$  by replacing each variable  $a_{\ell}$  by  $\ell a_{\ell}$ . The expression  $Z_V(a_{\ell} \leftarrow \partial/\partial a_{\ell}, \ell \in \mathbb{N})$  is a differential operator obtained from the polynomial  $Z_V(a_1, a_2, \dots)$  by replacing each  $a_{\ell}$  by  $\partial/\partial a_{\ell}$ . The differential operator is applied to the polynomial and at the end one takes all the variables  $a_{\ell}, \ell \in \mathbb{N}$ , to be zero.

In case  $V = \bigoplus_i V_i$ ,  $W = \bigoplus_i W_i$  are graded  $S_k$ -modules, and  $\dim \text{hom}_{\Sigma_k}(V, W)$  is the graded dimension:

$$\dim \text{hom}_{\Sigma_k}(V, W) = \sum_{i, j \in \mathbb{Z}} \dim \text{hom}_{\Sigma_k}(V_i, W_j) z^{j-i},$$

and  $Z_V, Z_W$  are graded cycle indices:

$$\begin{aligned} Z_V(z; a_1, a_2, \dots) &= \sum_{i \in \mathbb{Z}} Z_{V_i}(a_1, a_2, \dots) z^i, \\ Z_W(z; a_1, a_2, \dots) &= \sum_{i \in \mathbb{Z}} Z_{W_i}(a_1, a_2, \dots) z^i. \end{aligned}$$

Then

$$\dim \operatorname{hom}_{\Sigma_k}(V, W) = Z_V(1/z; a_\ell \leftarrow \partial/\partial a_\ell, \ell \in \mathbb{N}) Z_W(z; a_\ell \leftarrow \ell a_\ell, \ell \in \mathbb{N}) \Big|_{\substack{a_\ell=0, \\ \ell \in \mathbb{N}}}. \quad (14.3)$$

We will be considering bigraded symmetric sequences. Similarly in our computations we will add one more variable  $x$  or  $u$  responsible for the second grading.

Next step is to find the graded cycle index sum of the symmetric sequences  $\overline{H}_*(C(\bullet, \mathbb{R}^m); \mathbb{Q})$ , and  $\hat{H}(\mathbf{B}_n(\bullet), \mathbb{Q})$ . The symmetric group action on the homology of configuration spaces  $C(k, \mathbb{R}^n)$  is well studied [11, 18, 19].

**Proposition 14.3.** *The graded cycle index sum for the symmetric sequence*

$$\mathbf{H}(\mathbf{B}_n(\bullet), \mathbb{Q}) = \{\mathbf{H}(C(k, \mathbb{R}^n), \mathbb{Q}) \mid k \geq 0\}$$

is given by the following formula:

$$Z_{\mathbf{H}(\mathbf{B}_n(\bullet), \mathbb{Q})}(z; a_1, a_2, \dots) = \prod_{\ell=1}^{+\infty} \left( 1 + (-1)^n (-z)^{(n-1)\ell} a_\ell \right)^{(-1)^n E_\ell\left(\frac{1}{(-z)^{n-1}}\right)}, \quad (14.4)$$

where  $E_\ell(y) = \frac{1}{\ell} \sum_{d|\ell} \mu(d) y^{\frac{\ell}{d}}$ .

*Proof.* It is an easy consequence of [18, Theorem B].  $\square$

Let us add another variable  $u$  that will be responsible for the complexity, which is the homology degree divided by  $(n-1)$ . Thus the  $u$ -degree is the  $z$ -degree divided by  $(n-1)$ :

$$Z_{\mathbf{H}(\mathbf{B}_n(\bullet), \mathbb{Q})}(z, u; a_1, a_2, \dots) = \prod_{\ell=1}^{+\infty} \left( 1 + (-1)^n ((-z)^{(n-1)u})^\ell a_\ell \right)^{(-1)^n E_\ell\left(\frac{1}{(-z)^{n-1}u}\right)}. \quad (14.5)$$

The following result is easily obtained from (14.5), see [26, Section 15.2].

**Proposition 14.4** ([26]). *One has*

(14.6)

$$Z_{\hat{\mathbf{H}}(\mathbf{B}_n(\bullet), \mathbb{Q})}(z, u; a_1, a_2, \dots) = \prod_{\ell=1}^{+\infty} e^{-\frac{a_\ell}{\ell}} \left( 1 + (-1)^n ((-z)^{(n-1)u})^\ell a_\ell \right)^{(-1)^n E_\ell\left(\frac{1}{(-z)^{n-1}u}\right)},$$

where the variable  $u$  is responsible for the complexity and  $z$  for the homology degree.

**Proposition 14.5.** *One has*

$$(14.7) \quad Z_{\overline{\mathbf{H}}(C(\bullet, \mathbb{R}^m), \mathbb{Q})}(z, x; a_\ell, \ell \in \mathbb{N}) = \prod_{\ell=1}^{+\infty} (1 + (-z)^\ell a_\ell)^{(-1)^m E_\ell((-z)^{m-1}x)},$$

where the variable  $x$  is responsible for the Hodge degree and  $z$  is responsible for the homology degree.

*Proof.* From the Poincaré duality one has an isomorphism of  $\Sigma_k$ -modules:

$$\bar{H}_*(C(k, \mathbb{R}^m), \mathbb{Q}) \simeq H^{km-*}(C(k, \mathbb{R}^m), \mathbb{Q}) \otimes (\text{sign})^{\otimes m}. \quad (14.8)$$

The sign representation appears due to the fact that the Poincaré duality uses the orientation of the variety. From the above one has

$$\bar{H}_{i(m-1)+k}(C(k, \mathbb{R}^m), \mathbb{Q}) \simeq H^{(k-i)(m-1)}(C(k, \mathbb{R}^m), \mathbb{Q}) \otimes (\text{sign})^{\otimes m}.$$

So, the part of  $H_*(C(k, \mathbb{R}^m), \mathbb{Q})$  lying in Hodge degree  $s$  corresponds to the part of  $H^*(C(k, \mathbb{R}^m), \mathbb{Q})$  lying in complexity  $(k-i)$ .

It follows from this, that

$$(14.9) \quad Z_{\bar{H}(C(\bullet, \mathbb{R}^m), \mathbb{Q})}(z, x; a_\ell, \ell \in \mathbb{N}) = \\ Z_{H(C(\bullet, \mathbb{R}^m), \mathbb{Q})}(z \leftarrow 1/z; u \leftarrow 1/x; a_\ell \leftarrow (-1)^{(\ell-1)m} x^\ell z^{m\ell} a_\ell, \ell \in \mathbb{N}).$$

Indeed, the sign  $(-1)^{(\ell-1)m}$  arises because of the factor  $(\text{sign})^{\otimes m}$  in (14.8). The isomorphism (14.8) sends the complexity  $t$  to the Hodge degree  $s = k - t$ , which explains why  $u$  is replaced by  $1/x$ , and also the presence of the factor  $x^\ell$  in  $a_\ell \leftarrow (-1)^{(\ell-1)m} x^\ell z^{m\ell} a_\ell$ . The total homological degree  $*$  of the left-hand side corresponds to  $(km - *)$  of the right-hand side in (14.8): this explains why  $z$  is replaced by  $1/z$ , and also the presence of the factor  $z^{m\ell}$  in  $a_\ell \leftarrow (-1)^{(\ell-1)m} x^\ell z^{m\ell} a_\ell$ .

The equation (14.7) follows immediately from (14.9) and (14.4).  $\square$

Define  $\Psi_{mn}(x, u, z)$  as the following generating function:

$$\Psi_{mn}(x, u, z) = \\ \sum_{s,t,k} \dim \left( \text{hom}_{\Sigma_k} \left( \bar{H}_{s(m-1)+k}(C(k, \mathbb{R}^m); \mathbb{Q}), \hat{H}_{t(n-1)}(C(k, \mathbb{R}^n); \mathbb{Q}) \right) \right) x^s u^t z^{t(n-1)-s(m-1)-k}.$$

The variable  $x$  is responsible for the Hodge degree; the variable  $u$  is responsible for the complexity; and the variable  $z$  for the total homological degree. It follows from (14.3), and Propositions 14.4-14.5 that

$$\Psi_{mn}(x, u, z) = \\ \left( \prod_{\ell=1}^{+\infty} (1 + (-1/z)^\ell \partial / \partial a_\ell)^{(-1)^m E_\ell \left( \frac{x}{(-z)^{m-1}} \right)} \prod_{\ell=1}^{+\infty} e^{-a_\ell} (1 + (-1)^n \ell ((-z)^{(n-1)} u)^\ell a_\ell)^{(-1)^n E_\ell \left( \frac{1}{(-z)^{n-1} u} \right)} \right) \Bigg|_{\substack{a_\ell=0 \\ \ell \in \mathbb{N}}} = \\ \prod_{\ell=1}^{+\infty} \left( (1 + (-1/z)^\ell \partial / \partial a_\ell)^{(-1)^m E_\ell \left( \frac{x}{(-z)^{m-1}} \right)} e^{-a_\ell} (1 + (-1)^n \ell ((-z)^{(n-1)} u)^\ell a_\ell)^{(-1)^n E_\ell \left( \frac{1}{(-z)^{n-1} u} \right)} \right) \Bigg|_{a_\ell=0}.$$

Since  $F_{mn}(x, u) = \Phi_{mn}(x, u, -1)$  we get

$$F_{mn}(x, u) = \prod_{\ell=1}^{+\infty} \left( (1 + \partial/\partial a)^{(-1)^m E_\ell(x)} e^{-a} \left( 1 + (-1)^n \ell u^\ell a \right)^{(-1)^n E_\ell(\frac{1}{u})} \right) \Big|_{a=0}.$$

Notice that in the above formula we replaced  $a_\ell$  by  $a$ . We could do so because each factor uses only one variable  $a_\ell$  which is anyway taken to be zero.

The rest follows from the formula

$$\begin{aligned} \left( (1 + \partial/\partial a)^{(-1)^m E_\ell(x)} e^{-a} \left( 1 + (-1)^n \ell u^\ell a \right)^{(-1)^n E_\ell(\frac{1}{u})} \right) \Big|_{a=0} &= \\ &= \frac{\Gamma((-1)^{n-1} E_\ell(\frac{1}{u}) - (-1)^{m-1} E_\ell(x))}{((-1)^{n-1} \ell u^\ell)^{(-1)^{m-1} E_\ell(x)} \Gamma((-1)^{n-1} E_\ell(\frac{1}{u}))}, \end{aligned}$$

which is proved in [26, Proposition 15.7].

## REFERENCES

- [1] S. Ahearn and N. Kuhn. Product and other fine structure in polynomial resolutions of mapping spaces. *Algebr. Geom. Topol.* 2 (2002), 591–647.
- [2] V. Arnol'd. The cohomology ring of the group of colored braids. (Russian) *Mat. Zametki* 5, 1969, pp 227–231.
- [3] G. Arone. A note on the homology of  $\Sigma_n$ , the Schwartz genus, and solving polynomial equations. *An alpine anthology of homotopy theory*, 1–10, Contemp. Math., 399, Amer. Math. Soc., Providence, RI, 2006.
- [4] G. Arone, Derivatives of embedding functors. I. The stable case. *J. Topol.* 2 (2009), no. 3, 461–516.
- [5] G. Arone, P. Lambrechts, V. Turchin, and I. Volič. Coformality and rational homotopy groups of spaces of long knots. *Math. Res. Lett.* 15 (2008), no. 1, 1–14.
- [6] G. Arone, P. Lambrechts, and I. Volič. Calculus of functors, operad formality, and rational homology of embedding spaces. *Acta Math.* 199 (2007), no. 2, 153–198.
- [7] R. Budney. Little cubes and long knots. *Topology* 46 (2007), no. 1, 1–27.
- [8] A. Cattaneo, P. Cotta-Ramusino, and R. Longoni. Configuration spaces and Vassiliev classes in any dimension. *Algeb. Geom. Topol.*, 2: 949–1000, 2002.
- [9] M. Ching. Bar constructions for topological operads and the Goodwillie derivatives of the identity. *Geom. Topol.* 9 (2005), 833–933.
- [10] F. Cohen. The homology of  $C_{n+1}$  spaces. In *Lecture Notes in Mathematics*, Vol. 533, 1976.
- [11] F. R. Cohen, L. R. Taylor. On the representation theory associated to the cohomology of configuration spaces, In: Algebraic Topology (Oaxtepec, 1991), *Contemp. Math.* 146, Amer. Math. Soc., Providence, RI, 1993, pp. 91–109.
- [12] J. Conant. K. Vogtmann. Graph-complexes without cut-vertices.
- [13] W. Dwyer, Spalinski. Homotopy theories and model categories. *Handbook of algebraic topology*, 73–126, North-Holland, Amsterdam.
- [14] E. Getzler, J. D. S. Jones. Operads, homotopy algebra and iterated integrals for double loop spaces.
- [15] M. Kontsevich, Ya. Soibelman, Deformations of algebras over operads and the Deligne conjecture. In *Conférence Moshé Flato 1999, Vol. I (Dijon)*, volume 21 of *Math. Phys. Stud.*, pages 255–307. Kluwer Acad. Publ., Dordrecht, 2000.
- [16] Lambrechts, Turchin, Volic. The rational homology of spaces of long knots in codimension  $> 2$ . arXiv:math/0703649.
- [17] Lambrechts, Volic. Formality of the little  $N$ -disks operad. arXiv:0808.0457.

- [18] G. I. Lehrer. Equivariant Cohomology of Configurations in  $\mathbb{R}^d$ . Special issue dedicated to Klaus Rogenkamp on the occasion of his 60th birthday. *Algebr. Represent. Theory* 3 (2000), no. 4, 377–384.
- [19] G. I. Lehrer, L. Solomon. On the action of the symmetric group on the cohomology of the complement of its reflecting hyperplanes, *J. Algebra* 104 (1986), 410–424.
- [20] V. Merkulov, B. Vallette. Deformation theory of representation of prop(erad)s I–II.
- [21] T. Pirashvili, Dold-Kan type theorem for  $\Gamma$ -groups. *Math. Ann.* 318 (2000), no. 2, 277–298.
- [22] P. Salvatore. Knots, operads, and double loop spaces. *Int. Math. Res. Not.* 2006, Art. ID 13628, 22 pp.
- [23] S. Keiichi. Configuration space integrals for embedding spaces and the Haefliger invariant. arXiv:0811.3726.
- [24] D. Sinha. A pairing between graphs and trees. arXiv:math/0502547.
- [25] V. Turchin. On the homology of the spaces of long knots. *Advances in topological quantum field theory*, 23–52, NATO Sci. Ser. II Math. Phys. Chem., 179, Kluwer Acad. Publ., Dordrecht, 2004.
- [26] V. Turchin, Hodge-type decomposition in the homology of long knots. *J. Topol.* 3 (2010), no. 3, 487–534.
- [27] M. Weiss, Embeddings from the point of view of immersion theory. I. *Geom. Topol.* 3 (1999), 67–101

#### APPENDIX A. TABLES OF EULER CHARACTERISTICS

We present below results of computer computations which were produced using Maples. These results appeared partially in [26]. We add here the case of even  $m$ . For completeness of presentation we keep the case of odd  $m$  as well. To recall  $\chi_{st}$  denotes the Euler characteristic of  $H(\overline{\text{Emb}}_c(\mathbb{R}^m, \mathbb{R}^n), \mathbb{Q})$  in complexity  $t$  and Hodge degree  $s$ . Let  $\chi_{st}^\pi$  denote the Euler characteristic of an analogous component of  $\mathbb{Q} \otimes \pi_* \overline{\text{Emb}}_c(\mathbb{R}^m, \mathbb{R}^n)$ .

**Lemma A.1.**

$$F_{mn}(x, u) = \sum_{ij} \chi_{st} x^s u^t = \prod_{ij} \frac{1}{(1 - x^s u^t) \chi_{st}^\pi}. \quad (\text{A.1})$$

*Proof.* See [26, Lemma 16.1]. □

This formula was used to fill Tables 1, 3, 5, 7.

DEPARTMENT OF MATHEMATICS, UNIVERSITY OF VIRGINIA, CHARLOTTESVILLE, VA 22904, USA  
*E-mail address:* `zga2m@virginia.edu`

DEPARTMENT OF MATHEMATICS, KANSAS STATE UNIVERSITY, MANHATTAN, KS 66506, USA  
*E-mail address:* `turchin@ksu.edu`

	Hodge degree $s$																							total	
	$t$	1	2	3	4	5	6	7	8	9	10	11	12	13	14	15	16	17	18	19	20	21	22		23
1	0	1	1	0	0	0	0	0	0	0	0	0	0	0	0	0	0	0	0	0	0	0	0	0	1
2	1	2	2	1	1	0	0	0	0	0	0	0	0	0	0	0	0	0	0	0	0	0	0	0	2
3	0	3	3	2	1	0	0	0	0	0	0	0	0	0	0	0	0	0	0	0	0	0	0	0	2
4	0	4	4	3	2	1	0	0	0	0	0	0	0	0	0	0	0	0	0	0	0	0	0	0	4
5	-1	2	2	-1	1	0	0	0	0	0	0	0	0	0	0	0	0	0	0	0	0	0	0	0	6
6	-2	1	1	-1	0	0	0	0	0	0	0	0	0	0	0	0	0	0	0	0	0	0	0	0	10
7	-2	4	3	-4	2	1	0	0	0	0	0	0	0	0	0	0	0	0	0	0	0	0	0	0	18
8	-2	4	3	-6	4	2	1	0	0	0	0	0	0	0	0	0	0	0	0	0	0	0	0	0	32
9	-2	5	5	-10	7	4	2	1	0	0	0	0	0	0	0	0	0	0	0	0	0	0	0	0	56
10	-1	5	5	-14	12	9	6	2	1	0	0	0	0	0	0	0	0	0	0	0	0	0	0	0	102
11	-2	7	7	-17	14	10	7	3	2	1	0	0	0	0	0	0	0	0	0	0	0	0	0	0	186
12	0	5	5	-22	17	12	8	4	3	2	1	0	0	0	0	0	0	0	0	0	0	0	0	0	340
13	0	4	4	-25	19	13	9	5	4	3	2	1	0	0	0	0	0	0	0	0	0	0	0	0	630
14	-1	2	2	-22	15	10	7	4	3	2	1	0	0	0	0	0	0	0	0	0	0	0	0	0	1170
15	-1	3	3	-17	11	8	5	3	2	1	0	0	0	0	0	0	0	0	0	0	0	0	0	0	2182
16	-4	3	3	-12	8	6	5	3	2	1	0	0	0	0	0	0	0	0	0	0	0	0	0	0	4096
17	-18	19	19	-12	7	8	7	5	4	3	2	1	0	0	0	0	0	0	0	0	0	0	0	0	7710
18	-20	59	59	-83	65	79	65	49	36	22	13	7	4	3	2	1	0	0	0	0	0	0	0	0	14560
19	-13	124	124	-188	123	152	107	75	54	36	22	13	7	4	3	2	1	0	0	0	0	0	0	0	27594
20	12	115	115	-225	188	257	188	123	83	54	36	22	13	7	4	3	2	1	0	0	0	0	0	0	52452
21	158	-281	-281	-607	442	599	424	265	152	83	54	36	22	13	7	4	3	2	1	0	0	0	0	0	100736
22	638	-457	-457	-2294	2080	1998	1171	613	378	202	123	64	36	22	13	7	4	3	2	1	0	0	0	0	194066
23	480	1706	1706	-2294	2080	1998	-1171	613	378	202	123	64	36	22	13	7	4	3	2	1	0	0	0	0	382844

TABLE 1. Table for Euler characteristics  $\chi_{st}^\pi$  by complexity  $t$  and Hodge degree  $s$  of  $\pi_* \overline{\text{Emb}}_c(\mathbb{R}^m, \mathbb{R}^n) \otimes \mathbb{Q}$  for both  $m$  and  $n$  odd.

	Hodge degree $s$																						
	1	2	3	4	5	6	7	8	9	10	11	12	13	14	15	16	17	18	19	20	21	22	23
23	480	1619	1446	-5648	-17669	45575	-61584	130666	-271978	436507	-591664	702289	-731813	678875	-570539	441262	-318509	217419	-142337	90568	-56797	35263	-21798
22	638	-391	-2652	3573	-5265	20670	-48875	94966	-171890	262183	-334105	368926	-360657	316730	-253621	187909	-130721	86694	-55715	35034	-21798	13448	-8322
21	158	-217	-956	3381	-5196	11975	-32592	66403	-109135	152157	-181121	187515	-172652	143782	-109800	78122	-52716	34181	-21600	13392	-8322	5173	-3172
20	12	164	-461	1415	-3897	9561	-22616	43567	-66750	85597	-94842	92332	-80218	63394	-46401	31900	-20912	13236	-8322	5173	-3172	1960	-1211
19	-13	155	-348	726	-2645	7467	-15913	27513	-39089	46618	-48051	43930	-36222	27330	-19176	12706	-8187	5131	-3172	1960	-1211	758	-460
18	-20	72	-205	600	-2016	5418	-10793	16931	-21970	24380	-23612	20356	-15886	11412	-7761	5026	-3172	1960	-1211	758	-460	286	-173
17	-18	29	-105	510	-1646	3858	-6917	9960	-11959	12375	-11226	9101	-6791	4701	-3082	1930	-1211	758	-460	286	-173	113	-65
16	-4	14	-97	435	-1256	2628	-4264	5662	-6288	6027	-5164	3991	-2826	1862	-1211	758	-460	286	-173	113	-65	41	-25
15	-1	13	-88	355	-919	1730	-2529	3065	-3190	2882	-2308	1673	-1152	736	-460	286	-173	113	-65	41	-25	18	-8
14	-1	12	-83	290	-633	1063	-1449	1629	-1557	1307	-1003	692	-460	286	-173	113	-65	41	-25	18	-8	6	-3
13	0	15	-74	210	-421	648	-795	820	-743	584	-422	271	-173	113	-65	41	-25	18	-8	6	-3	3	-1
12	0	14	-61	153	-267	367	-422	405	-340	244	-173	113	-65	41	-25	18	-8	6	-3	3	-1	1	0
11	-2	15	-45	101	-166	207	-217	188	-150	102	-65	41	-25	18	-6	3	-1	1	0	0	0	0	0
10	-1	11	-36	67	-95	108	-107	86	-65	41	-25	18	-6	3	-1	1	0	0	0	0	0	0	0
9	-2	10	-25	41	-55	57	-51	34	-25	18	-6	3	-1	1	0	0	0	0	0	0	0	0	0
8	-2	7	-16	25	-30	25	-8	18	-8	6	-3	1	-1	0	0	0	0	0	0	0	0	0	0
7	-2	6	-11	13	-17	13	-8	6	-3	1	-1	0	0	0	0	0	0	0	0	0	0	0	0
6	-1	3	-8	8	-8	6	-3	3	-1	1	0	0	0	0	0	0	0	0	0	0	0	0	0
5	-2	3	-4	3	-3	3	-1	1	0	0	0	0	0	0	0	0	0	0	0	0	0	0	0
4	-1	1	-3	1	-1	1	0	0	0	0	0	0	0	0	0	0	0	0	0	0	0	0	0
3	-1	1	-1	1	0	1	0	0	0	0	0	0	0	0	0	0	0	0	0	0	0	0	0
2	-1	1	0	1	0	1	0	0	0	0	0	0	0	0	0	0	0	0	0	0	0	0	0
1	0	2	3	4	5	6	7	8	9	10	11	12	13	14	15	16	17	18	19	20	21	22	23

TABLE 2. Table for Euler characteristics  $\chi_{st}$  by complexity  $t$  and Hodge degree  $s$  of  $H_*(\text{Emb}_c(\mathbb{R}^m, \mathbb{R}^n); \mathbb{Q})$  for both  $m$  and  $n$  odd.

$t$	Hodge degree $s$																							total
	1	2	3	4	5	6	7	8	9	10	11	12	13	14	15	16	17	18	19	20	21	22	23	
1	-1	0	0	0	0	0	0	0	0	0	0	0	0	0	0	0	0	0	0	0	0	0	0	1
2	0	0	1	0	0	0	0	0	0	0	0	0	0	0	0	0	0	0	0	0	0	0	0	1
3	0	0	0	0	0	0	0	0	0	0	0	0	0	0	0	0	0	0	0	0	0	0	0	2
4	0	-1	0	0	0	0	0	0	0	0	0	0	0	0	0	0	0	0	0	0	0	0	0	0
5	0	0	0	0	0	0	0	0	0	0	0	0	0	0	0	0	0	0	0	0	0	0	0	0
6	0	0	0	0	0	0	0	0	0	0	0	0	0	0	0	0	0	0	0	0	0	0	0	0
7	1	0	-1	0	0	0	0	0	0	0	0	0	0	0	0	0	0	0	0	0	0	0	0	0
8	-1	0	1	-2	0	0	0	0	0	0	0	0	0	0	0	0	0	0	0	0	0	0	0	0
9	0	0	2	-1	0	0	0	0	0	0	0	0	0	0	0	0	0	0	0	0	0	0	0	6
10	-2	0	3	-2	0	0	0	0	0	0	0	0	0	0	0	0	0	0	0	0	0	0	0	16
11	2	-3	0	-2	0	0	0	0	0	0	0	0	0	0	0	0	0	0	0	0	0	0	0	24
12	0	-1	0	3	-6	0	0	0	0	0	0	0	0	0	0	0	0	0	0	0	0	0	0	32
13	3	-2	-3	0	-6	4	5	3	0	-1	-4	-1	0	0	0	0	0	0	0	0	0	0	0	74
14	0	3	-13	8	12	4	12	-10	-6	4	5	3	0	0	0	0	0	0	0	0	0	0	0	108
15	0	5	-15	-13	23	10	23	-10	-36	-20	19	15	2	-1	-4	-1	0	0	0	0	0	0	0	192
16	-7	18	5	3	-30	5	8	59	-30	-36	-21	23	11	-8	-13	-6	68	11	-8	-13	-6	1	0	370
17	-14	19	-9	-15	23	-8	-82	64	-30	5	8	59	23	-10	-36	-20	19	15	2	-1	-4	-1	0	630
18	-16	-1	23	52	64	34	-120	82	-82	64	34	-120	82	-82	64	34	-120	82	-82	64	34	-120	82	1294
19	-12	-88	176	52	78	152	-8	78	-186	78	152	-8	78	-186	78	152	-8	78	-186	78	152	-8	78	2142
20	7	-167	393	176	145	290	-88	145	-937	145	290	-88	145	-937	145	290	-88	145	-937	145	290	-88	145	4932
21	168	-37	13	-108	-1151	1472	-37	13	-108	-1151	1472	-37	13	-108	-1151	1472	-37	13	-108	-1151	1472	-37	13	10338
22	638	-241	-2676	1806	2506	-1378	-241	-2676	1806	2506	-1378	-241	-2676	1806	2506	-1378	-241	-2676	1806	2506	-1378	-241	-2676	20920
23	468	-2644	-2607	12686	1016	-18755	-2644	-2607	12686	1016	-18755	-2644	-2607	12686	1016	-18755	-2644	-2607	12686	1016	-18755	-2644	-2607	66188

TABLE 3. Table of Euler characteristics  $\chi_{s,t}$  by complexity  $t$  and Hodge degree  $s$  of  $\pi_* \text{Emb}_c(\mathbb{R}^m, \mathbb{R}^n) \otimes \mathbb{Q}$  for  $m$  odd and  $n$  even.

$t$	Hodge degree $s$																						
	1	2	3	4	5	6	7	8	9	10	11	12	13	14	15	16	17	18	19	20	21	22	23
23	468	-3290	-2544	16300	-1620	-21938	8761	5388	1424	1676	-11716	9157	-435	-4214	4986	-3974	2252	-794	35	259	-329	263	-171
22	638	-425	-2710	2145	2011	404	-1311	-5578	6395	632	-4769	4616	-3318	1372	602	-1566	1455	-944	498	-209	69	-13	-13
21	168	-74	245	-495	-1705	3209	117	-3475	3050	-1416	-96	1624	-2223	1691	-832	214	141	-285	255	-169	93	-43	19
20	7	-165	519	-77	-991	1031	-444	-27	951	-1739	1332	-232	-616	871	-725	452	-210	73	-16	-13	27	-22	17
19	-12	-84	216	-136	-38	368	-761	556	184	-721	814	-622	318	-4	-193	219	-161	94	-43	19	-14	3	1
18	-16	20	31	-188	266	29	-425	526	-326	-42	332	-413	330	-188	80	-22	-13	27	-22	17	-7	4	-2
17	-14	22	10	-86	126	-74	-33	190	-295	257	-91	-79	148	-135	90	-42	19	-14	3	1	-3	2	-2
16	-7	25	-27	-11	88	-139	67	60	-147	165	-127	75	-30	-9	25	-22	17	-7	4	-2	2	0	0
15	0	2	-20	33	3	-60	105	-83	2	65	-88	72	-38	20	-14	3	1	-3	2	0	0	-1	0
14	0	4	-16	15	-5	-16	45	-59	51	-30	0	19	-22	17	-7	4	-2	0	0	0	1	0	0
13	3	-6	3	20	-33	14	15	-36	41	-28	19	-13	3	1	-3	2	0	1	0	0	0	0	0
12	0	-2	3	1	-11	21	-23	6	11	-18	1	-7	4	-2	0	0	0	0	0	0	0	0	0
11	2	-3	3	1	-8	14	-12	12	-11	4	-2	-3	2	0	1	0	0	0	0	0	0	0	0
10	-2	2	3	-10	6	3	-10	11	-7	4	-2	2	0	0	0	0	0	0	0	0	0	0	0
9	0	0	3	-2	4	-7	4	1	-3	2	0	0	-1	0	0	0	0	0	0	0	0	0	0
8	-1	1	0	-3	5	-5	3	-2	0	0	0	1	0	0	0	0	0	0	0	0	0	0	0
7	1	1	-3	2	1	-2	2	0	1	-1	0	0	0	0	0	0	0	0	0	0	0	0	0
6	-1	0	-1	1	-2	0	-1	0	0	0	0	0	0	0	0	0	0	0	0	0	0	0	0
5	1	0	1	2	-2	0	0	0	0	0	0	0	0	0	0	0	0	0	0	0	0	0	0
4	0	-1	1	0	0	1	0	0	0	0	0	0	0	0	0	0	0	0	0	0	0	0	0
3	1	-1	0	-1	0	0	0	0	0	0	0	0	0	0	0	0	0	0	0	0	0	0	0
2	0	0	1	0	0	0	0	0	0	0	0	0	0	0	0	0	0	0	0	0	0	0	0
1	-1	0	0	0	0	0	0	0	0	0	0	0	0	0	0	0	0	0	0	0	0	0	0

TABLE 4. Table for Euler characteristics  $\chi_{s,t}$  by complexity  $t$  and Hodge degree  $s$  of  $H_*(\text{Emb}_c(\mathbb{R}^m, \mathbb{R}^n); \mathbb{Q})$  for  $m$  odd and  $n$  even.



	Hodge degree $s$																						
	1	2	3	4	5	6	7	8	9	10	11	12	13	14	15	16	17	18	19	20	21	22	23
23	-480	2581	3195	-12377	-765	17280	-13802	-1468	24753	-20043	-19152	25227	7322	-16381	-663	6690	-706	-1769	375	280	-84	-21	7
22	-638	333	3111	-1797	-2542	-619	-3755	10105	7017	-17039	-3718	14520	-90	-7577	1088	2562	-638	-551	195	64	-30	-1	0
21	-158	101	250	368	1110	-4072	-2751	9579	1742	-10895	550	7360	-1393	-3206	931	906	-349	-151	76	9	-8	1	0
20	-12	234	-253	199	829	-2859	-622	5706	-631	-5574	1446	3257	-1158	-1204	528	270	-149	-30	24	1	-2	0	0
19	13	132	-56	291	-124	-1900	779	3096	-1377	-2563	1271	1270	-711	-386	255	63	-55	-3	5	0	0	0	0
18	20	25	57	343	-489	-1192	1061	1557	-1203	-1092	840	456	-375	-107	105	8	-16	2	0	0	0	0	0
17	18	-4	93	216	-491	-612	849	699	-794	-412	460	134	-169	-21	39	-1	-5	1	0	0	0	0	0
16	4	9	101	89	-398	-253	588	248	-459	-122	221	31	-68	-1	12	-1	-1	0	0	0	0	0	0
15	1	11	94	3	-294	-54	364	62	-244	-23	101	-2	-24	3	2	0	0	0	0	0	0	0	0
14	1	17	67	-28	-192	11	209	-4	-119	7	42	-5	-8	2	0	0	0	0	0	0	0	0	0
13	0	19	45	-44	-115	36	112	-16	-55	7	15	-3	-2	1	0	0	0	0	0	0	0	0	0
12	0	18	26	-39	-64	33	55	-17	-21	6	5	-1	-1	0	0	0	0	0	0	0	0	0	0
11	2	13	13	-32	-34	26	26	-9	-8	2	1	0	0	0	0	0	0	0	0	0	0	0	0
10	1	14	5	-25	-15	15	12	-6	-3	1	0	0	0	0	0	0	0	0	0	0	0	0	0
9	2	8	2	-16	-8	10	5	-3	-1	0	0	0	0	0	0	0	0	0	0	0	0	0	0
8	2	6	-1	-10	-3	5	2	-1	0	0	0	0	0	0	0	0	0	0	0	0	0	0	0
7	2	4	-2	-7	0	3	0	0	0	0	0	0	0	0	0	0	0	0	0	0	0	0	0
6	1	3	-1	-4	0	1	0	0	0	0	0	0	0	0	0	0	0	0	0	0	0	0	0
5	2	1	-2	-2	0	1	0	0	0	0	0	0	0	0	0	0	0	0	0	0	0	0	0
4	1	1	-1	-1	0	0	0	0	0	0	0	0	0	0	0	0	0	0	0	0	0	0	0
3	1	0	-1	0	0	0	0	0	0	0	0	0	0	0	0	0	0	0	0	0	0	0	0
2	1	0	-1	0	0	0	0	0	0	0	0	0	0	0	0	0	0	0	0	0	0	0	0
1	1	0	0	0	0	0	0	0	0	0	0	0	0	0	0	0	0	0	0	0	0	0	0
t	1	2	3	4	5	6	7	8	9	10	11	12	13	14	15	16	17	18	19	20	21	22	23

TABLE 6. Table for Euler characteristics  $\chi_{s,t}$  by complexity  $t$  and Hodge degree  $s$  of  $H_*(\overline{\text{Emb}}_c(\mathbb{R}^m, \mathbb{R}^n); \mathbb{Q})$  for  $m$  even and  $n$  odd.



$t$	1	2	3	4	5	6	7	8	9	10	11	12	13	14	15	16	17	18	19	20	21	22	23	
-468	-638	-168	-7	12	16	14	7	0	0	-3	0	-2	2	0	1	0	0	0	0	0	0	0	0	0
-2356	295	260	-103	-111	-19	-9	12	2	9	-4	2	-1	1	-2	0	1	-2	0	0	0	0	0	0	0
-21	2797	468	70	58	20	-41	-22	-15	0	2	5	2	-1	-1	1	-2	0	-1	1	2	-1	0	0	0
10045	-1627	-1546	61	237	96	31	2	-5	-11	-1	-4	1	0	4	-3	1	-2	1	2	-1	0	0	0	0
995	-4280	-61	41	-227	-157	23	19	34	4	7	-7	0	-1	-3	0	-1	1	3	-2	0	0	0	0	0
-18299	2443	2736	234	-100	-87	-33	-49	-4	-1	10	2	5	-6	1	-3	1	4	-2	0	0	0	0	0	0
1395	3324	-975	-486	270	201	49	-2	-14	-10	-10	3	-6	4	-3	2	5	-3	0	0	0	0	0	0	0
18535	-1267	-1986	-239	-106	-47	-8	57	15	8	0	-8	-1	-5	2	7	-4	0	0	0	0	0	0	0	0
-5178	-2147	1258	701	-100	-92	-60	-11	-12	13	-5	7	-6	3	8	-5	0	0	0	0	0	0	0	0	0
-11047	172	438	-38	66	112	31	-16	-6	-19	2	-7	5	11	-6	0	0	0	0	0	0	0	0	0	0
5413	1684	-614	-436	-29	-4	15	16	-5	3	-10	3	13	-8	0	0	0	0	0	0	0	0	0	0	0
3500	-221	150	184	49	-61	-8	-26	10	-10	7	16	-10	0	0	0	0	0	0	0	0	0	0	0	0
-2695	-1092	95	106	23	27	-16	8	-17	7	20	-12	0	0	0	0	0	0	0	0	0	0	0	0	0
-314	408	-28	-116	-39	-20	13	-15	9	25	-15	0	0	0	0	0	0	0	0	0	0	0	0	0	0
611	399	5	33	-33	11	-27	11	30	-18	0	0	0	0	0	0	0	0	0	0	0	0	0	0	0
-70	-238	-32	-16	29	-25	14	36	-22	0	0	0	0	0	0	0	0	0	0	0	0	0	0	0	0
-34	-32	-44	7	-36	15	44	-27	0	0	0	0	0	0	0	0	0	0	0	0	0	0	0	0	0
5	-9	46	-41	20	52	-32	0	0	0	0	0	0	0	0	0	0	0	0	0	0	0	0	0	0
-64	26	-52	24	63	-38	0	0	0	0	0	0	0	0	0	0	0	0	0	0	0	0	0	0	0
51	-60	25	75	-46	0	0	0	0	0	0	0	0	0	0	0	0	0	0	0	0	0	0	0	0
-78	34	89	-54	0	0	0	0	0	0	0	0	0	0	0	0	0	0	0	0	0	0	0	0	0
38	105	-64	0	0	0	0	0	0	0	0	0	0	0	0	0	0	0	0	0	0	0	0	0	0
125	-76	0	0	0	0	0	0	0	0	0	0	0	0	0	0	0	0	0	0	0	0	0	0	0

TABLE 8. Table for Euler characteristics  $\chi_{s,t}$  by complexity  $t$  and Hodge degree  $s$  of  $H_*(\text{Emb}_c(\mathbb{R}^m, \mathbb{R}^n); \mathbb{Q})$  for both  $m$  and  $n$  even.

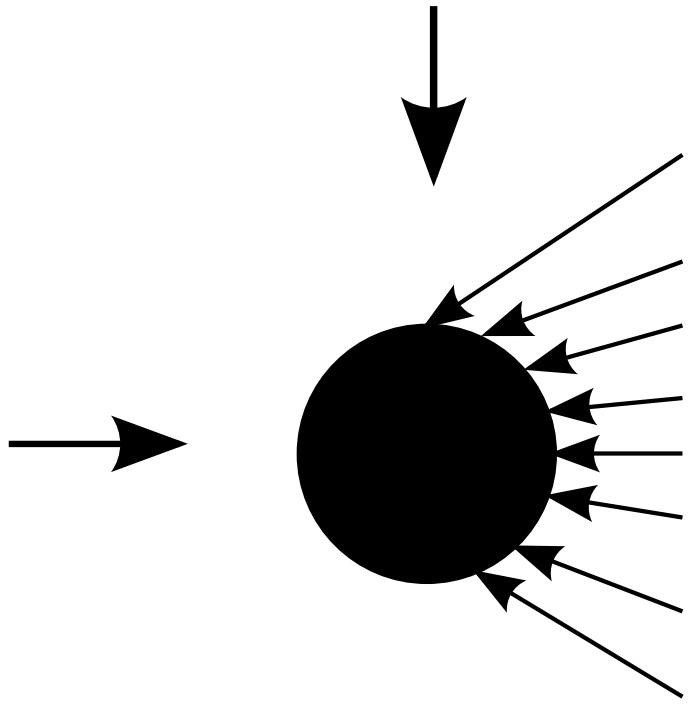
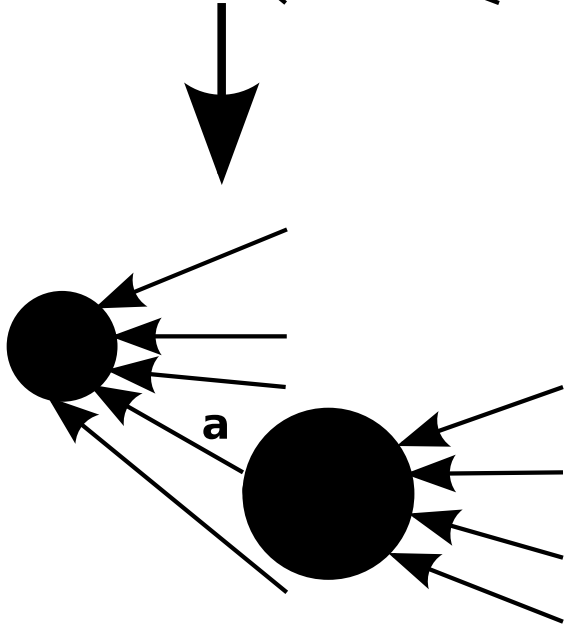
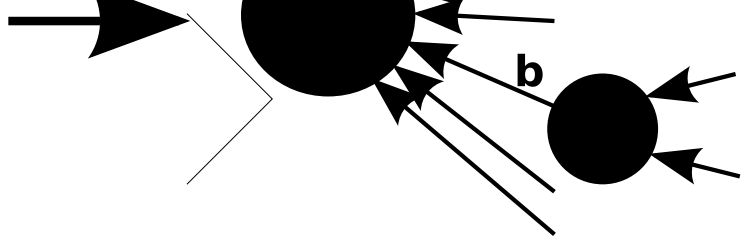
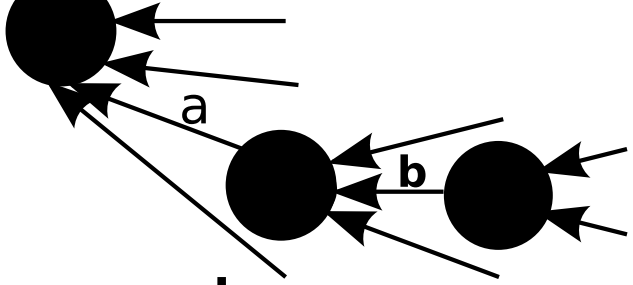

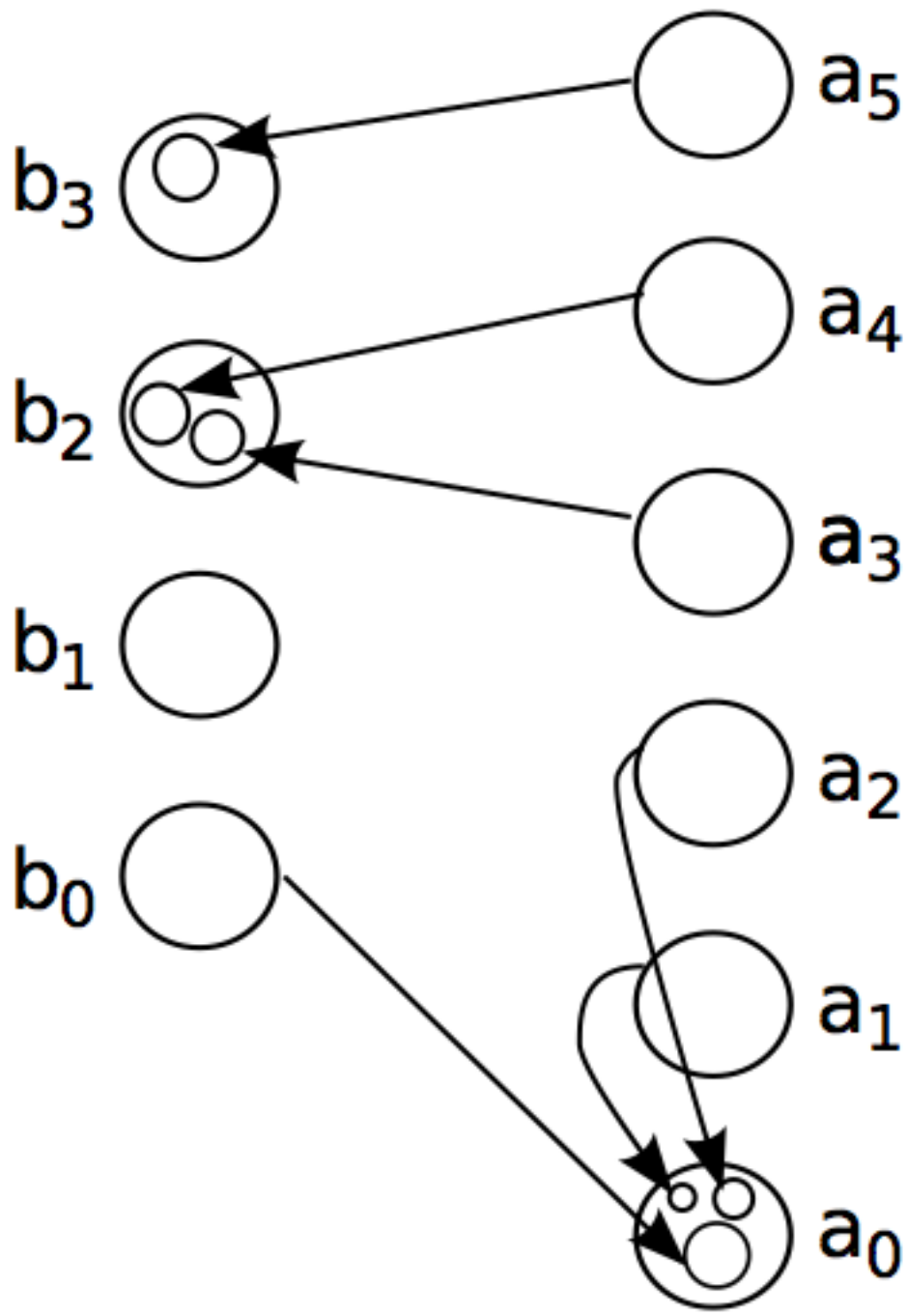

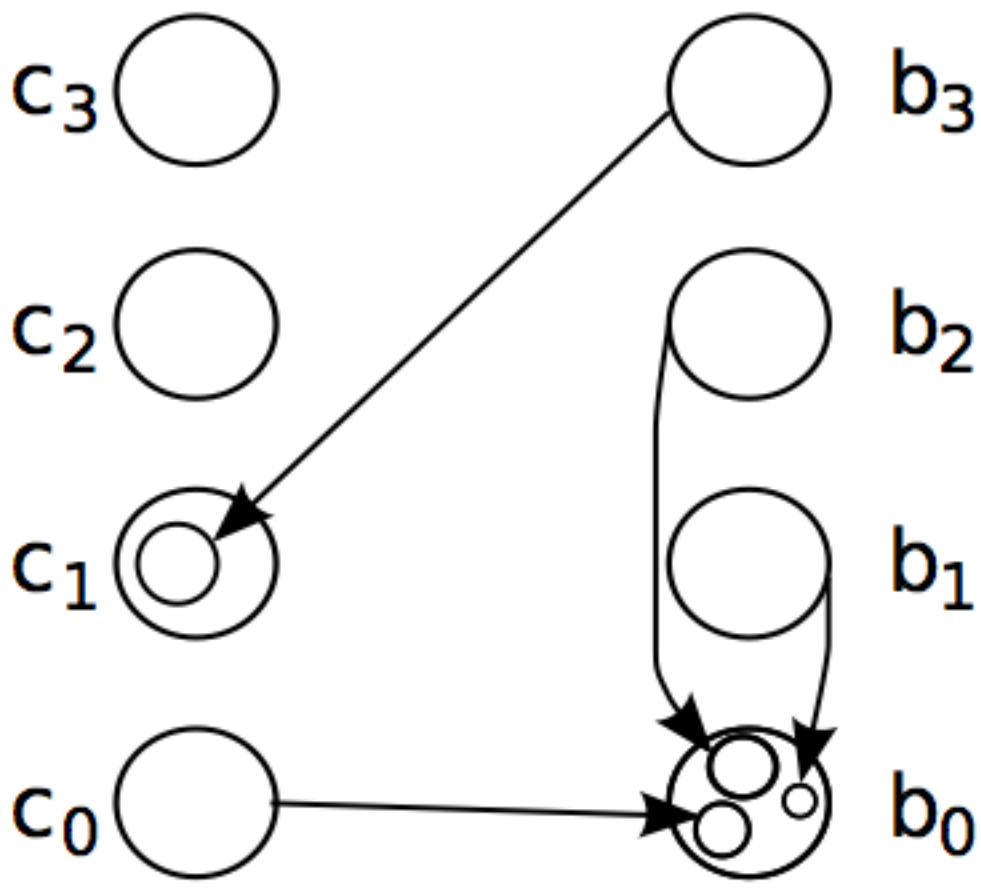

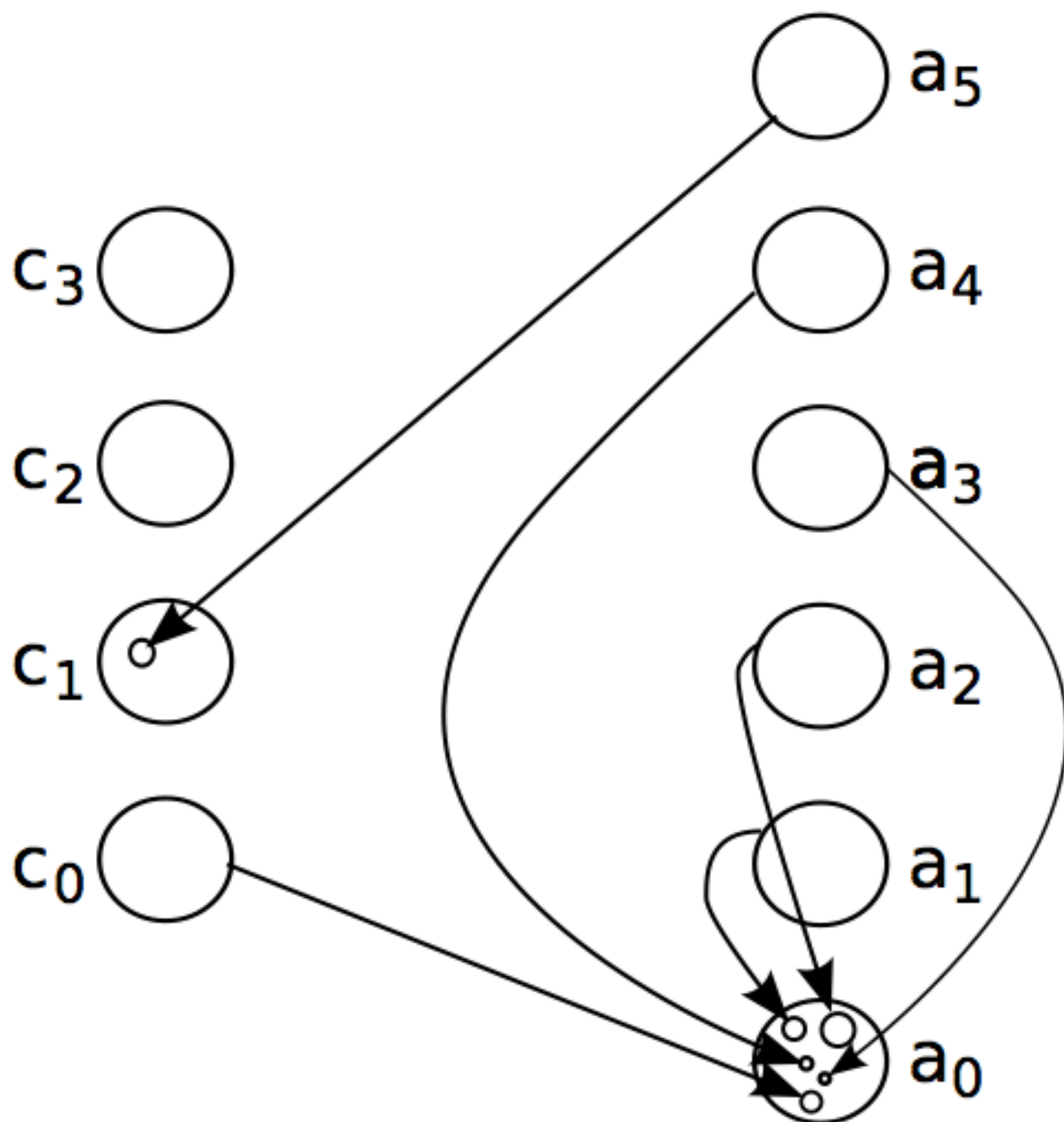

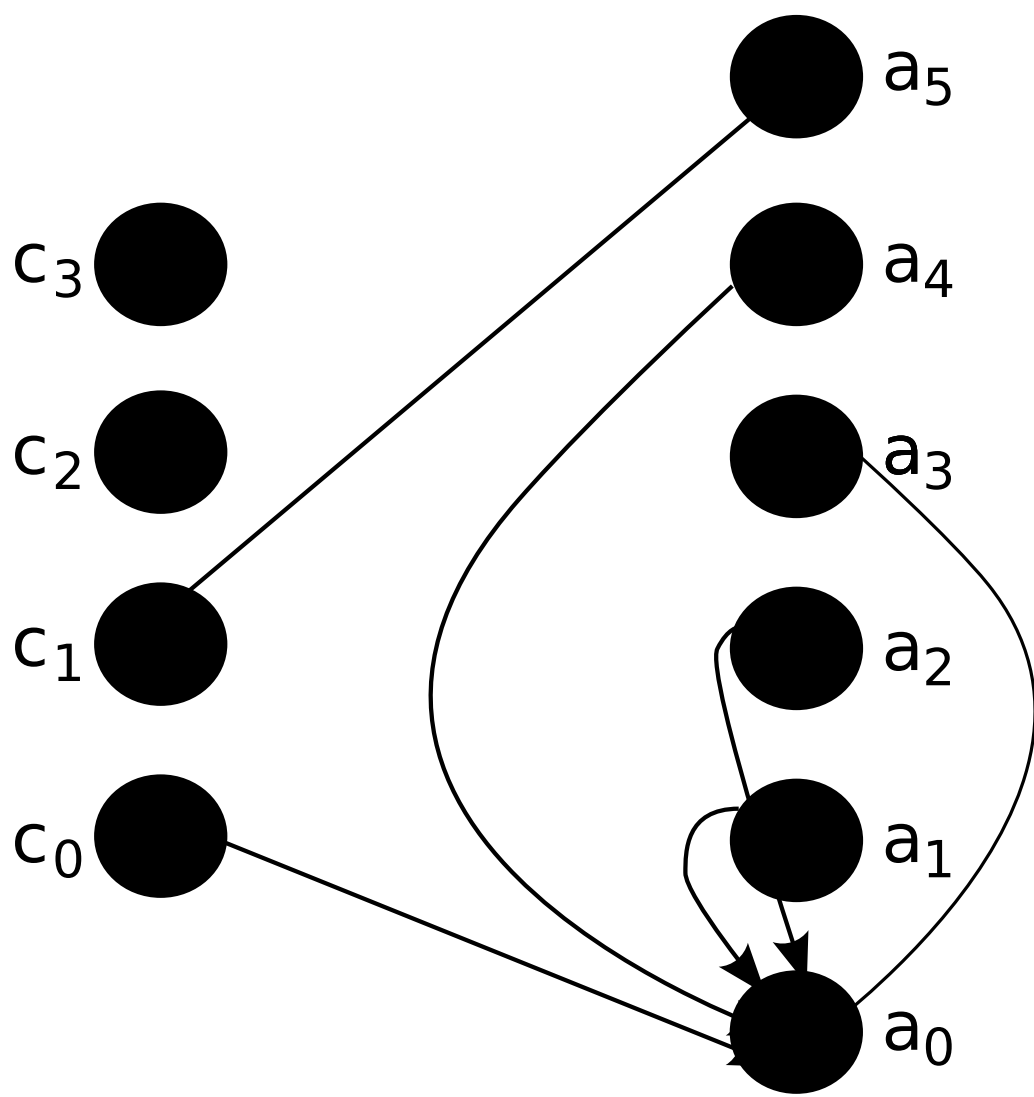
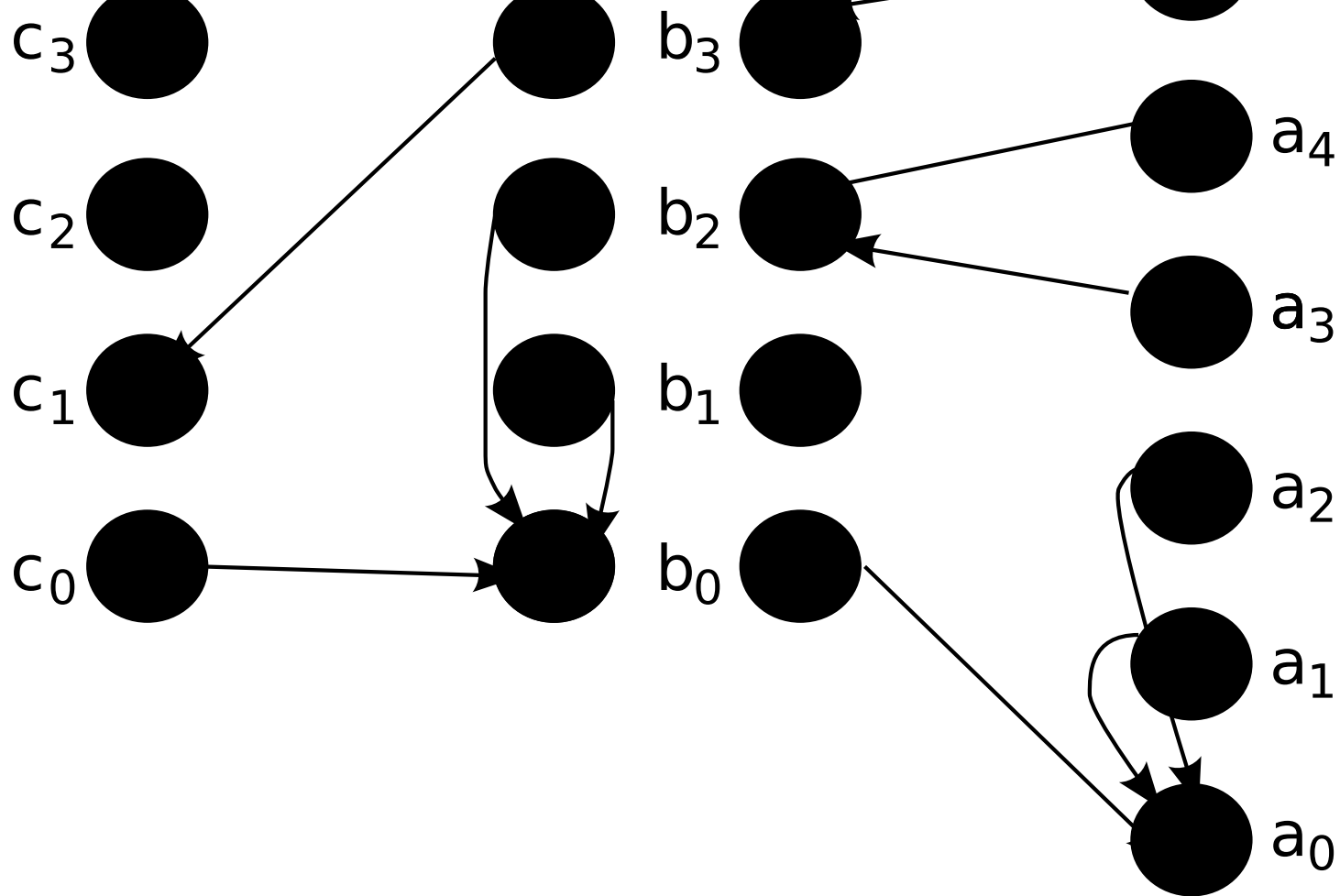

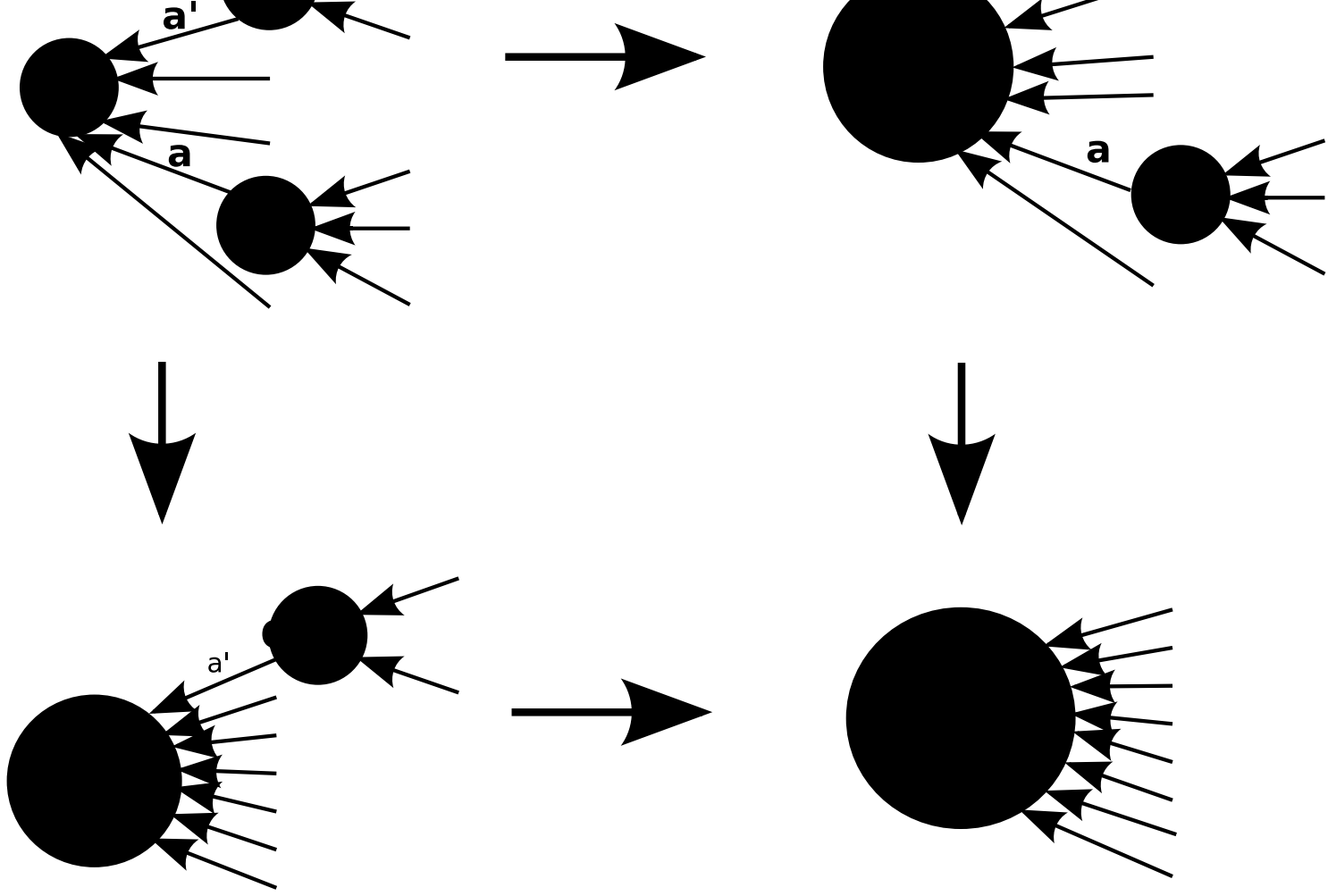

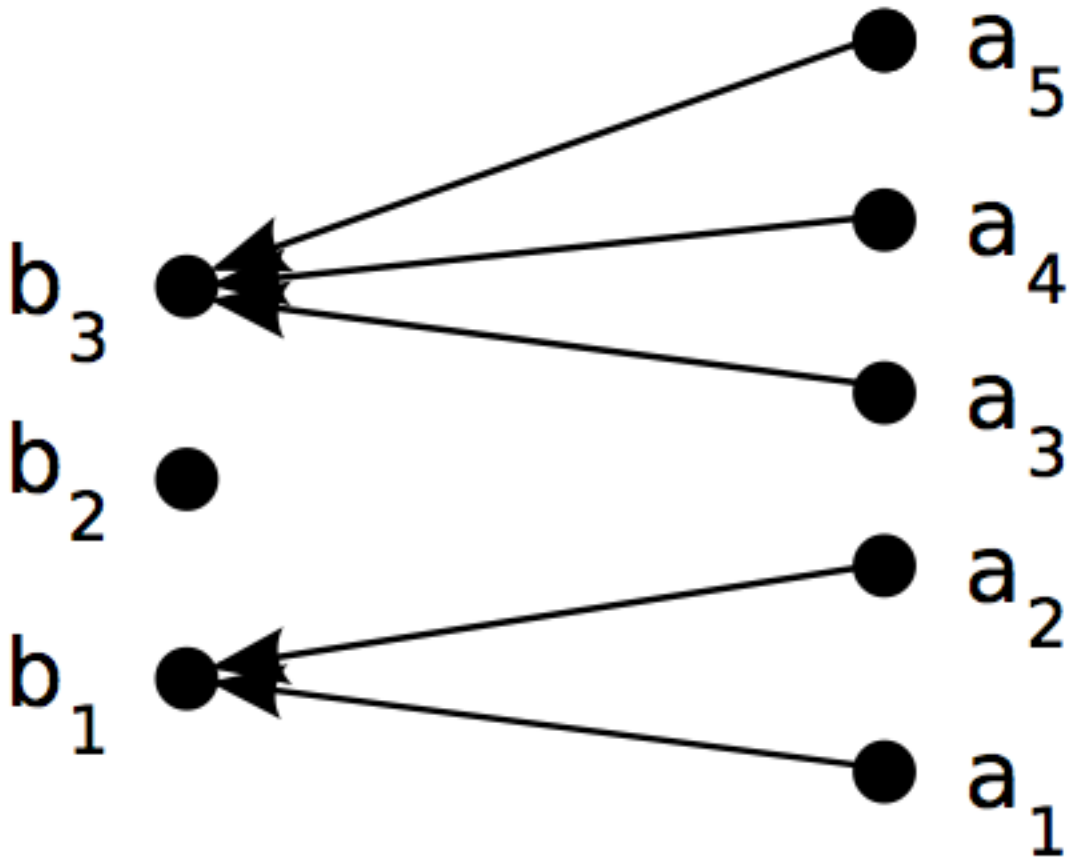

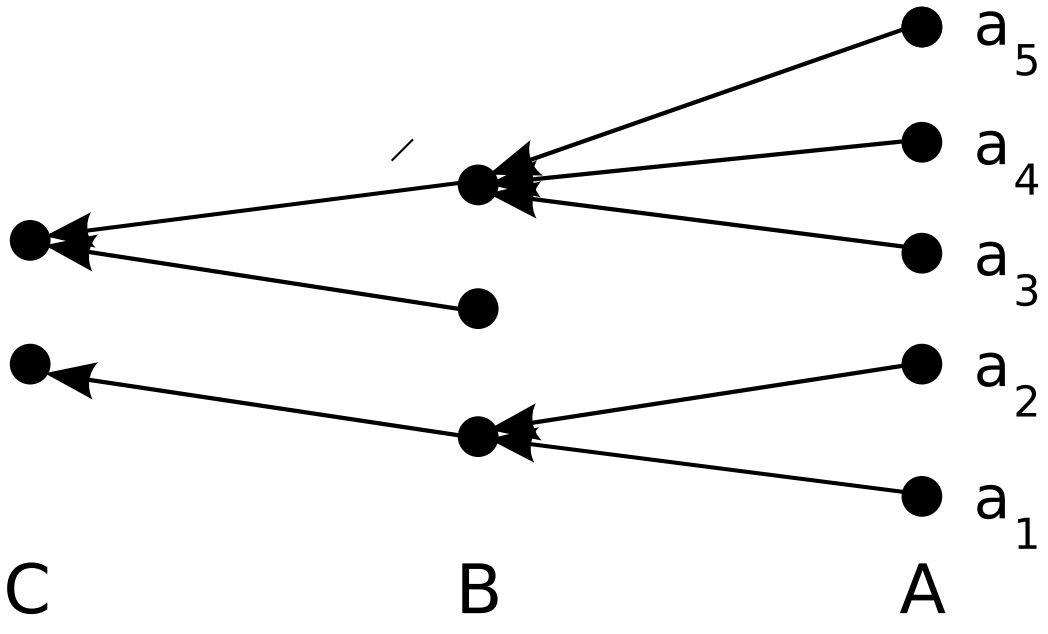

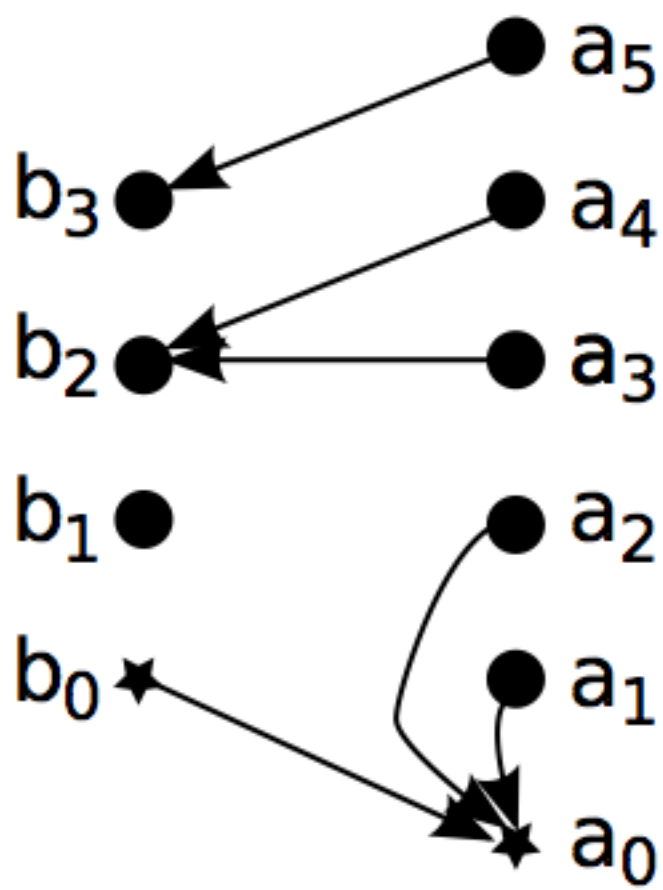

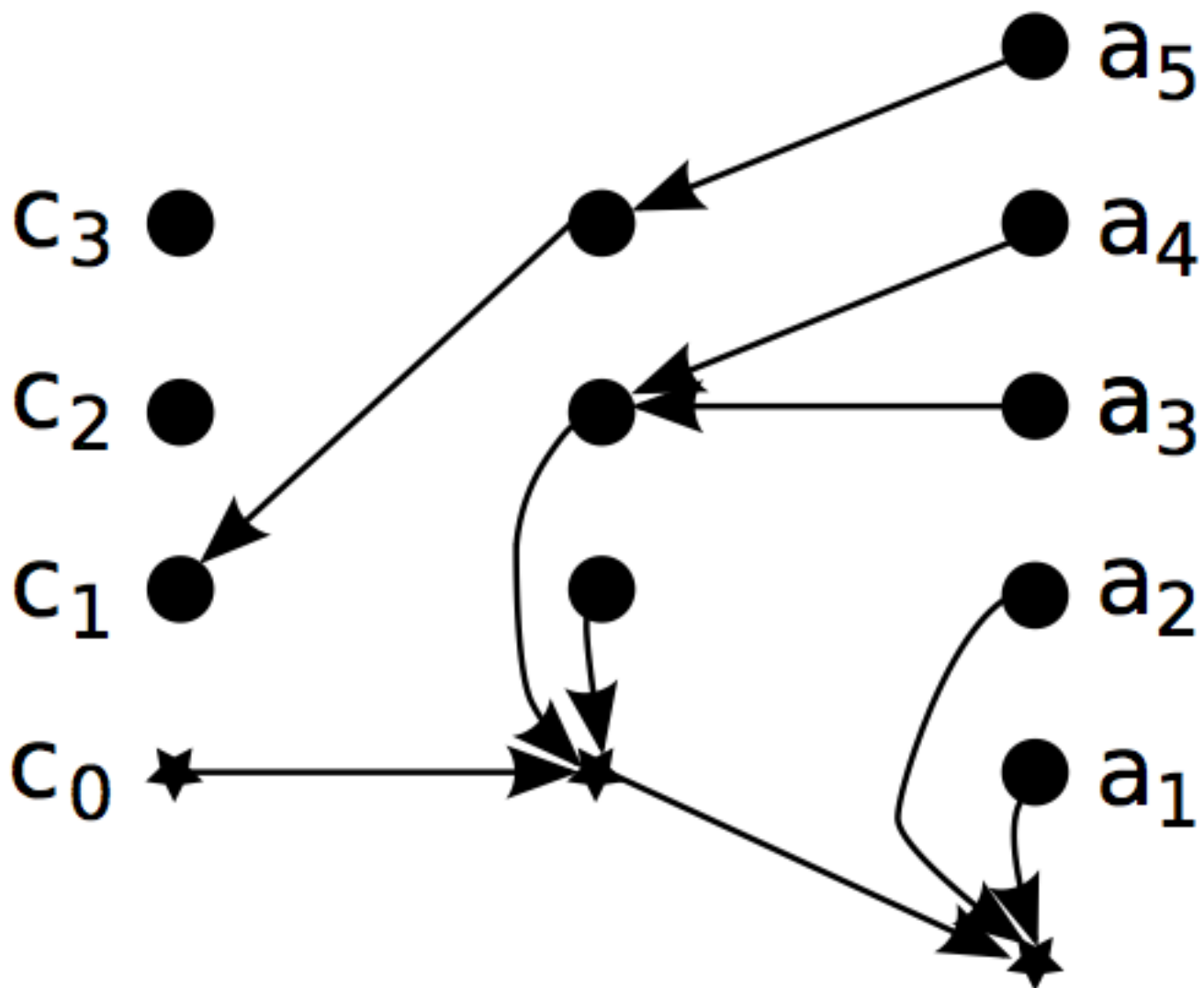

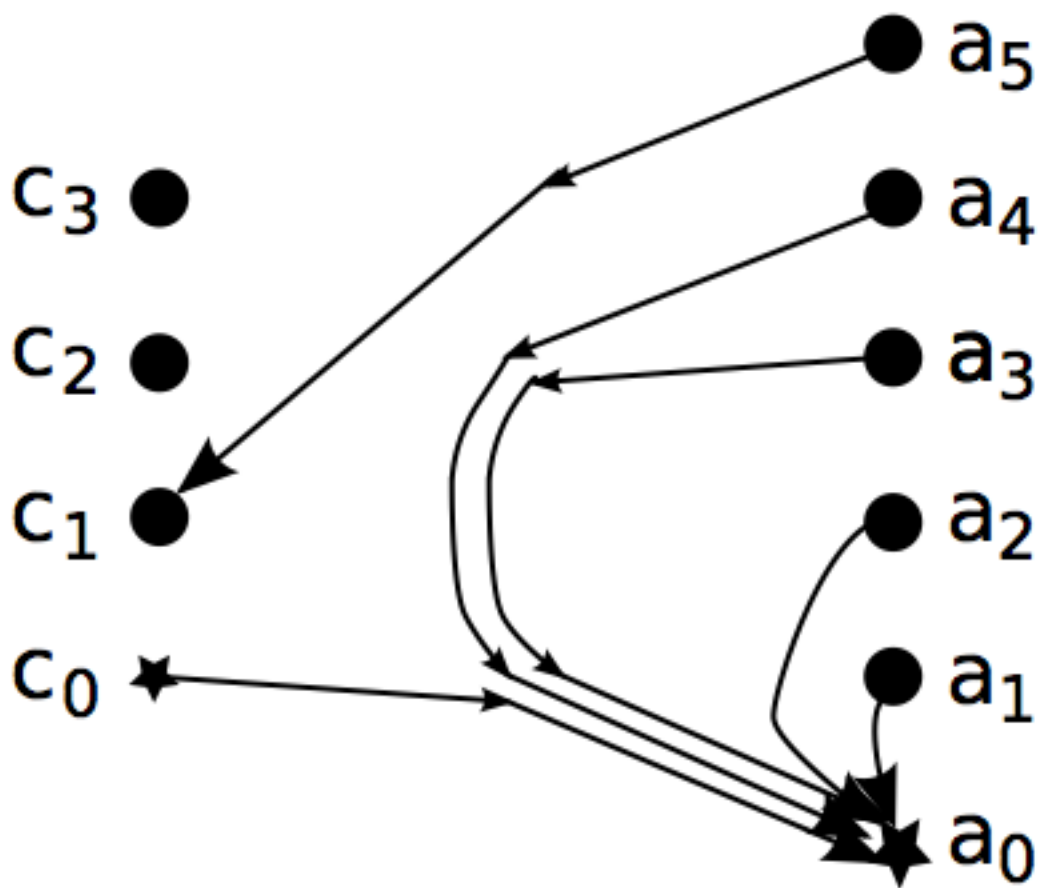

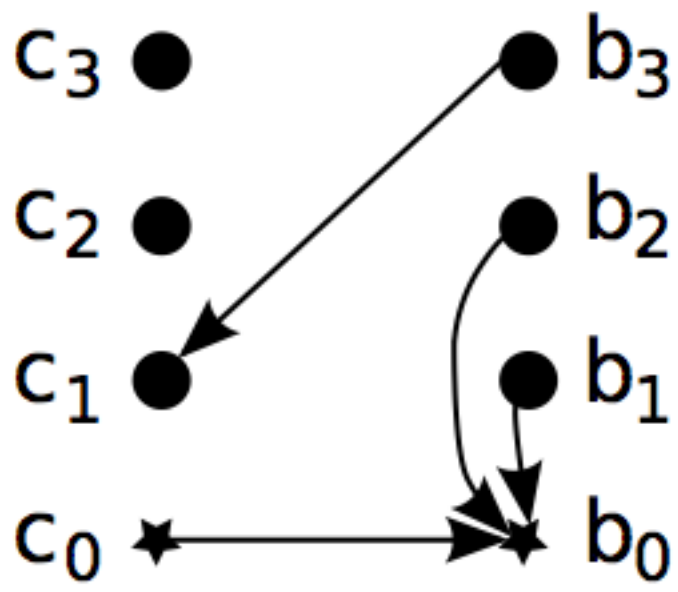

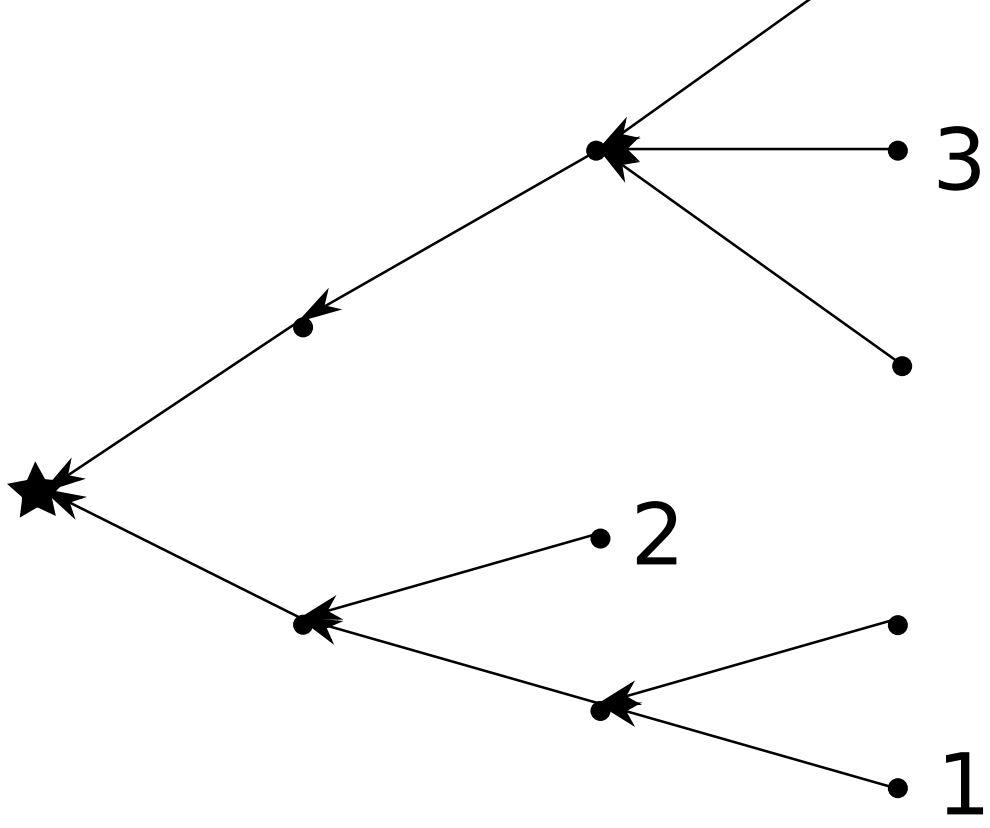

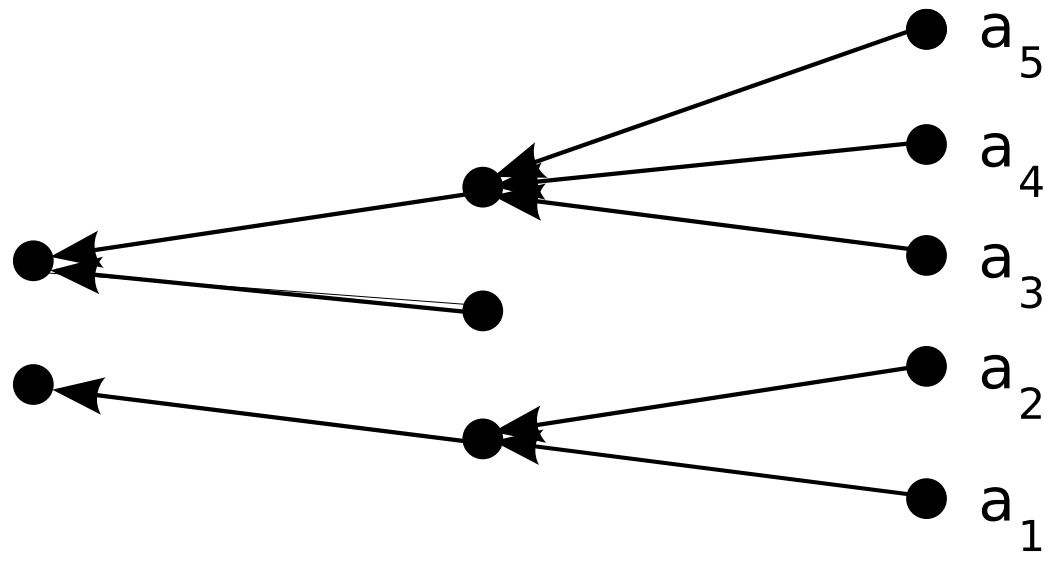
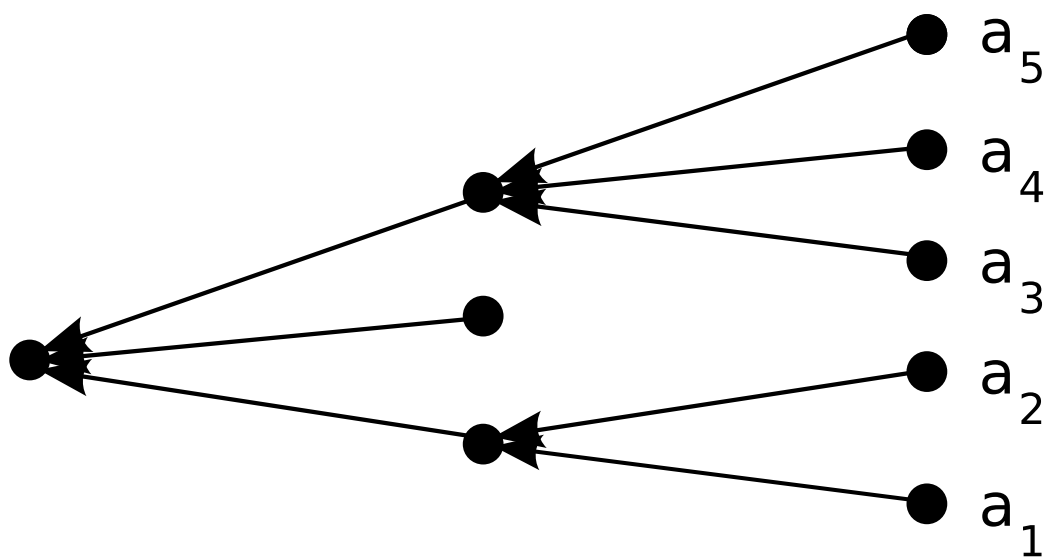
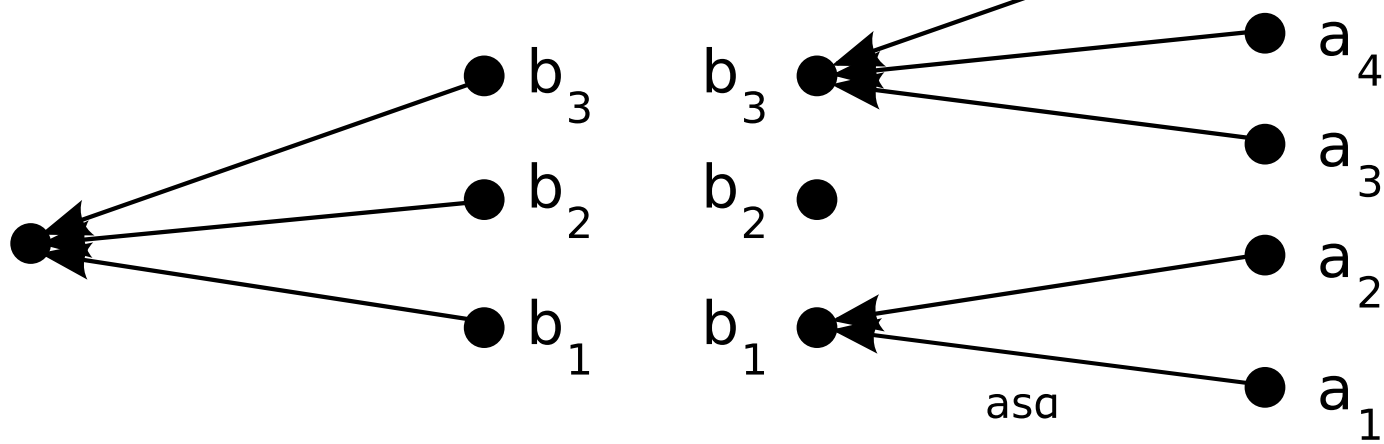

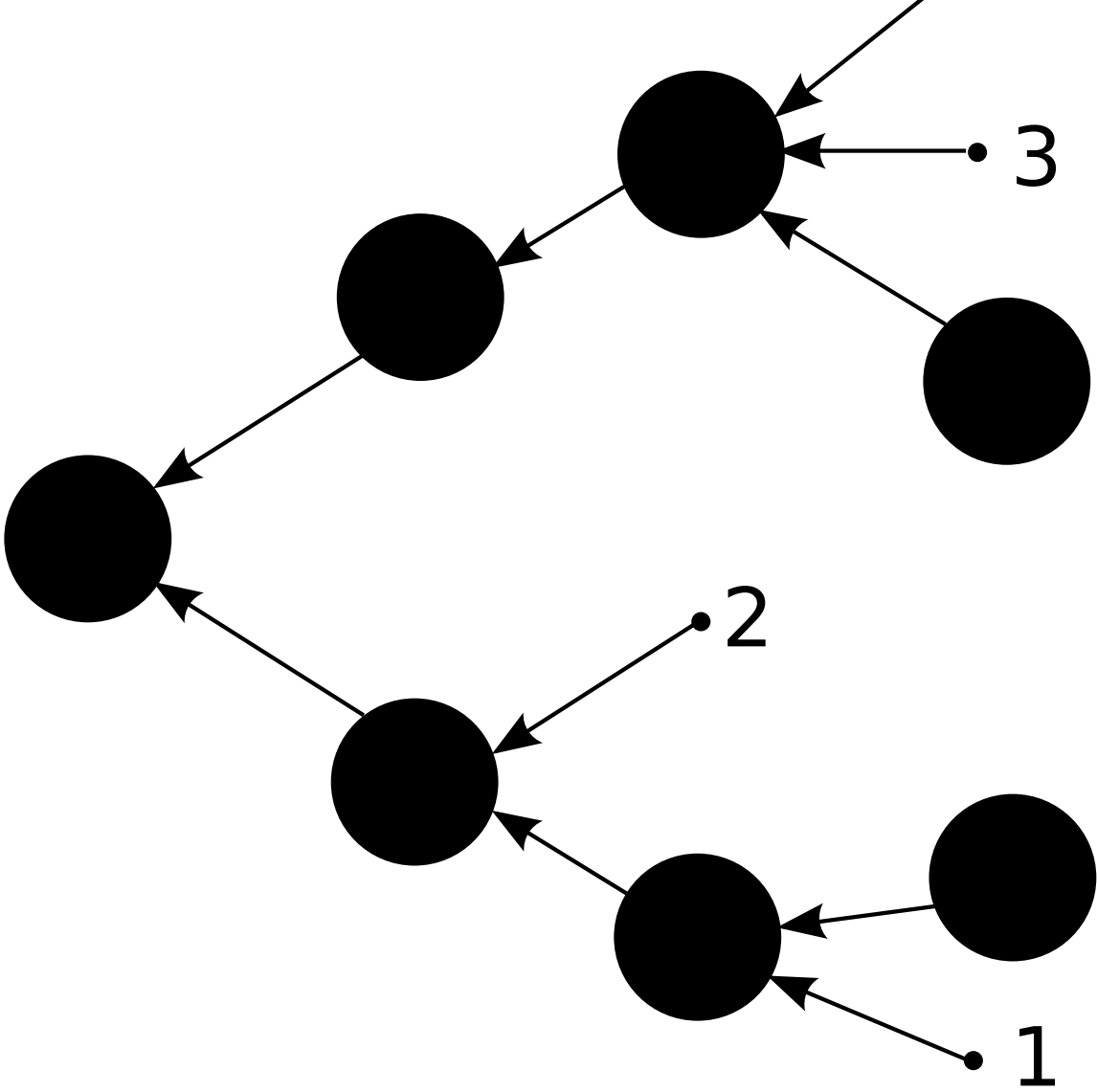

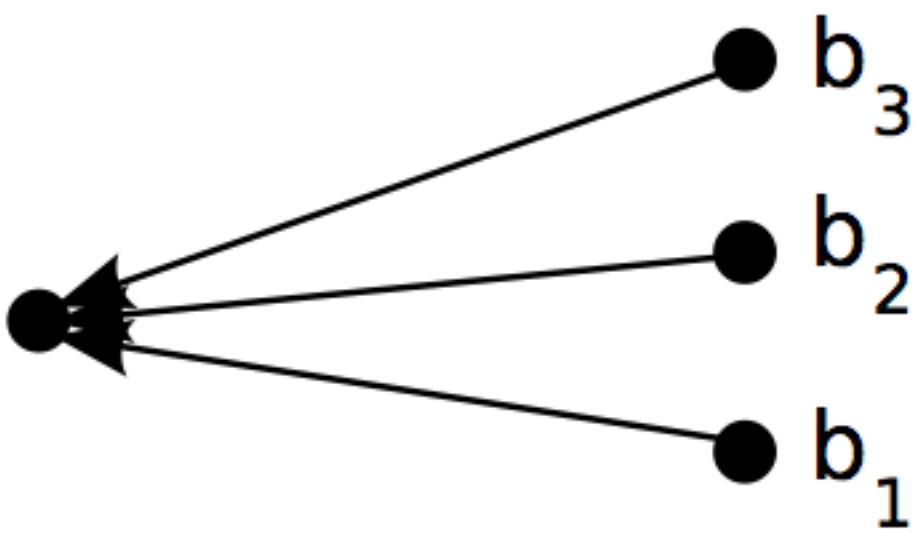

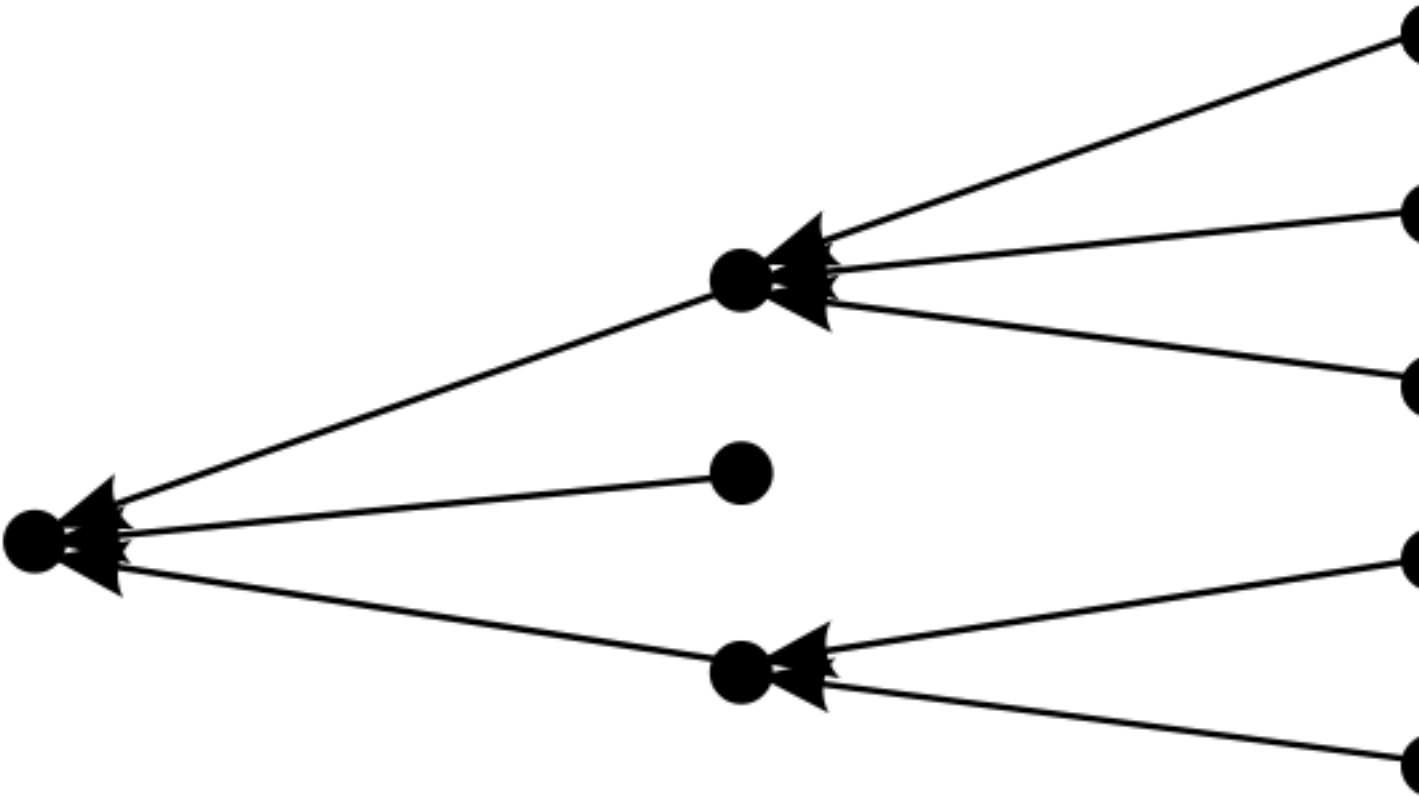

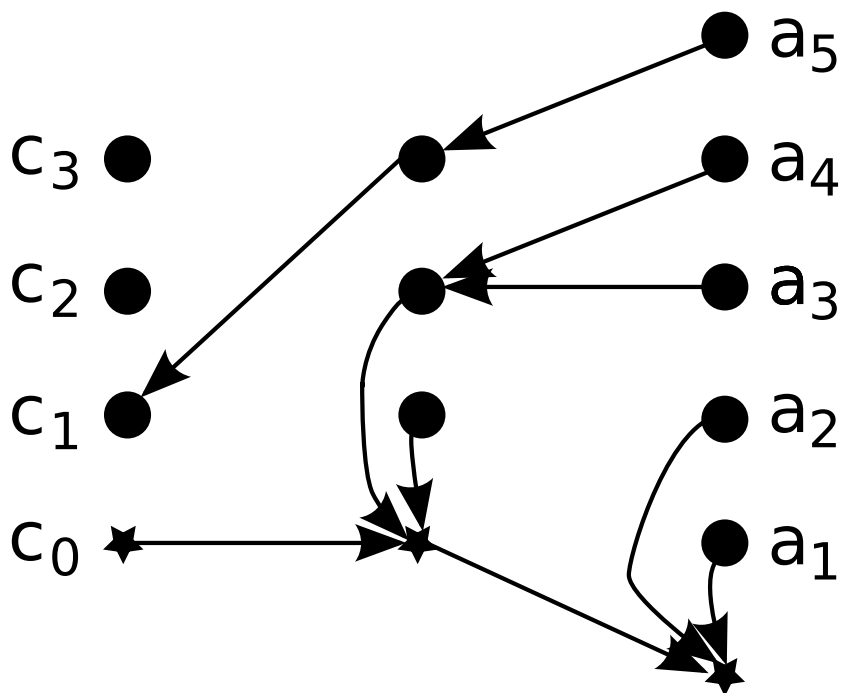
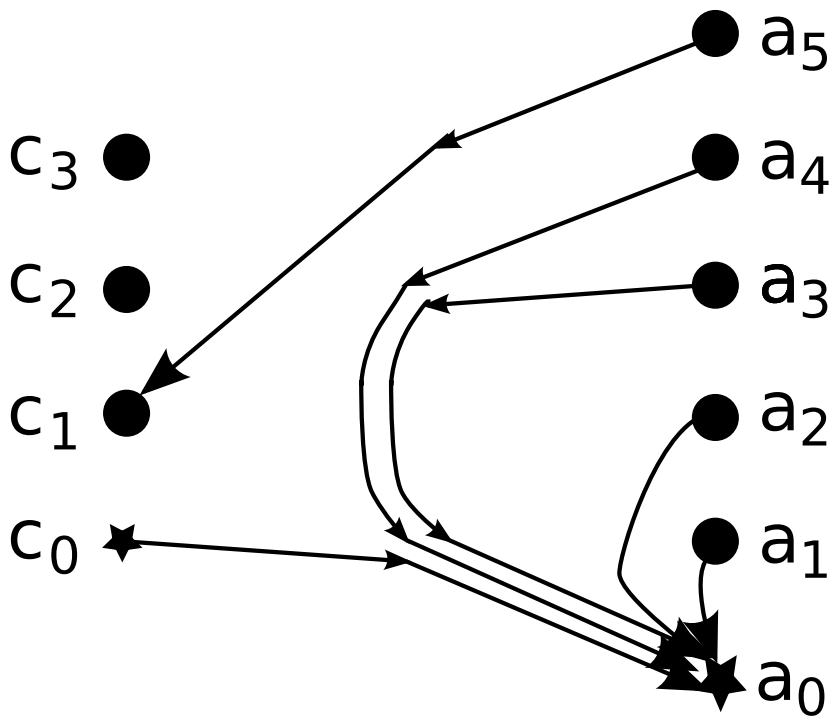
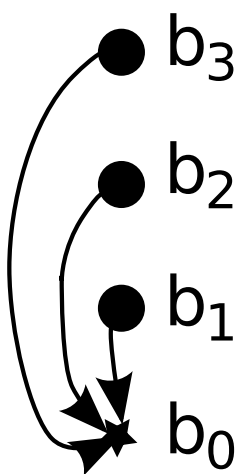
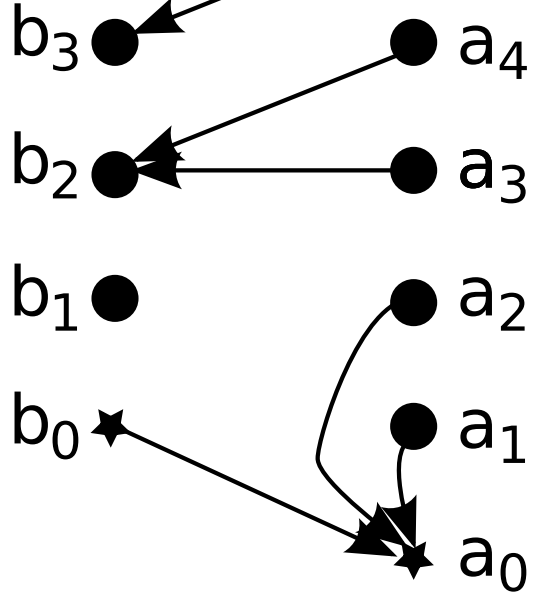
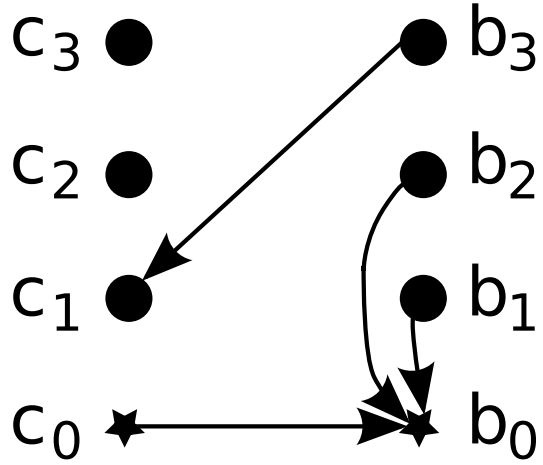

The diagram illustrates a sum of three configurations of nodes  $i$ ,  $j$ , and  $k$  with directed edges and labels 1 and 2, equated to zero.

- Configuration 1:** Node  $j$  is at the top,  $i$  is at the bottom left, and  $k$  is at the bottom right. An arrow labeled 1 points from  $i$  to  $j$ , and an arrow labeled 2 points from  $j$  to  $k$ .
- Configuration 2:** Node  $j$  is at the top,  $i$  is at the bottom left, and  $k$  is at the bottom right. An arrow labeled 1 points from  $j$  to  $k$ , and an arrow labeled 2 points from  $k$  to  $i$ .
- Configuration 3:** Node  $j$  is at the top,  $i$  is at the bottom left, and  $k$  is at the bottom right. An arrow labeled 2 points from  $i$  to  $j$ , and an arrow labeled 1 points from  $k$  to  $i$ .

The equation is:  $\text{Configuration 1} + \text{Configuration 2} + \text{Configuration 3} = 0$

