

Minimum diameter and cycle-diameter orientations on planar graphs*

Nili Guttman-Beck[†]

Refael Hassin[‡]

October 2005

Abstract

Let G be an edge weighted undirected graph. For every pair of nodes consider the shortest cycle containing these nodes in G . The cycle diameter of G is the maximum length of a cycle in this set. Let H be a directed graph obtained by directing the edges of G . The cycle diameter of H is similarly defined except for that cycles are replaced by directed closed walks. Is there always an orientation H of G whose cycle diameter is bounded by a constant times the cycle diameter of G ? We prove this property for planar graphs. These results have implications on the problem of approximating an orientation with minimum diameter.

1 Hereditary order on cycles

Let $G = (V, E)$ be a 2-edge connected undirected graph. Choose one of its nodes, mark it as z . For every node $v \in V \setminus \{z\}$ find the shortest undirected cycle connecting v and z , mark this cycle as $C(v)$, we say that v is served by $C(v)$. Let $\mathcal{C} = \{C(v) | v \in V\}$ and let $G_{\mathcal{C}}$ be the graph induced by the edges in \mathcal{C} . Let V_1, \dots, V_l be the node sets of the connected components of $G_{\mathcal{C}}$ induced by $V \setminus \{z\}$. Let G_i $i = 1, \dots, l$ be the subgraphs of $G_{\mathcal{C}}$ induced by $V_i \cup \{z\}$. Each of these subgraphs will be oriented independently of the others. Clearly, the bound holds for the whole graph if it holds for every component. Hence w.l.o.g we can assume that $l = 1$.

In Figure 1 G_1, G_2 and G_3 are illustrated.

For every edge $e \in E$ let $l(e) \geq 0$ be the length of the edge.

1. A path P is an ordered set of nodes (v_1, \dots, v_n) and distinct edges $(v_1, v_2), (v_2, v_3), \dots, (v_{n-1}, v_n)$. When $v_1 = v_n$, P is a cycle.
2. For every G' a subgraph of G , let $E(G')$ ($V(G')$) be the subgraph's edge set (node set).
3. For every path P , $l(P) = \sum_{e \in E(P)} l(e)$.

*This is part of the Ph.D. dissertation "Approximation algorithms for three optimization problems on graphs" by Nili Guttman-Beck, 2005. The special case of series-parallel graphs is solved in [1].

[†]Department of Computer Science, The Academic College of Tel-Aviv Yaffo, Yaffo, Israel. Email: beck-nili@mta.ac.il ;

[‡]School of Mathematical Sciences, Tel-Aviv University, Tel-Aviv 69978, Israel. Email: hassin@post.tau.ac.il.

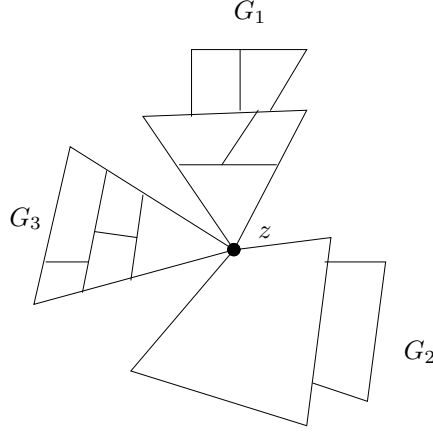

Figure 1: G_1, G_2 and G_3 .

4. For every two subgraphs P and Q , $P \setminus Q$ is the subgraph induces by $E(P) \setminus E(Q)$.
5. For every two nodes a, b on a given path P , let $[a, b]$ be the subpath between them (the identity of P will be clear from the context).

Also assume w.l.o.g that for every $C_1, C_2 \in \mathcal{C}$, $l(C_1) \neq l(C_2)$.

Let C_0 be the shortest cycle in \mathcal{C} .

Lemma 1.1 *Let $C \in \mathcal{C}$.*

- $C_0 \setminus C$ is a path (or a cycle) with at most two nodes in $C_0 \cap C$.
- $C \setminus C_0$ is a path (or a cycle) with at most two nodes in $C_0 \cap C$.

Proof: Similar to the proof of Lemma 1.7. ■

Definition 1.2 Given two nodes $u \neq v \in V(C_0)$ let P be the $v - u$ path in C_0 which includes z . Define $S_{u,v} := \{C \in \mathcal{C} | C \cap C_0 = P\}$. If $S_{u,v} \neq \emptyset$ then the shortest cycle in $S_{u,v}$ is the *son* of C_0 defined by $S_{u,v}$. Given a node $v \in V(C_0)$, define $S_{v,v}$ to be the set $\{C \in \mathcal{C}, C \neq C_0 | C \setminus C_0$ is a cycle touching C_0 in the node $v\}$. If $S_{v,v} \neq \emptyset$ then the shortest cycle in $S_{v,v}$ is the *son* of C_0 defined by $S_{v,v}$.

Observation 1.3 *According to Lemma 1.1, $\{S_{u,v} : u, v \in C_0\}$ is a partition of $\mathcal{C} \setminus C_0$.*

Definition 1.4 Let C' be a son of C'' , defined by the set $S_{k,l}$. Mark $P = C' \setminus C''$ (this is a path as we will prove in Lemma 1.7). Given nodes $u \neq v \in V(P)$ let P' be the $u - v$ path in C' which includes z (clearly $(C' \setminus P') \subseteq P$) . Define $S'_{u,v} := \{C \in S_{k,l} \setminus \{C'\} | C \cap C' = P'\}$. If $S'_{u,v} \neq \emptyset$ then the shortest cycle in $S'_{u,v}$ is the *son* of C' defined by $S'_{u,v}$. Similarly, given a node $v \in V(P)$, define $S'_{v,v} := \{C \in S_{k,l}, C \neq C' | C \supset C', C \setminus C'$ is a cycle touching C' in the node $v\}$. If $S'_{v,v} \neq \emptyset$ then the shortest cycle in $S'_{v,v}$ is the *son* of C' defined by $S'_{v,v}$ (See Figure 2).

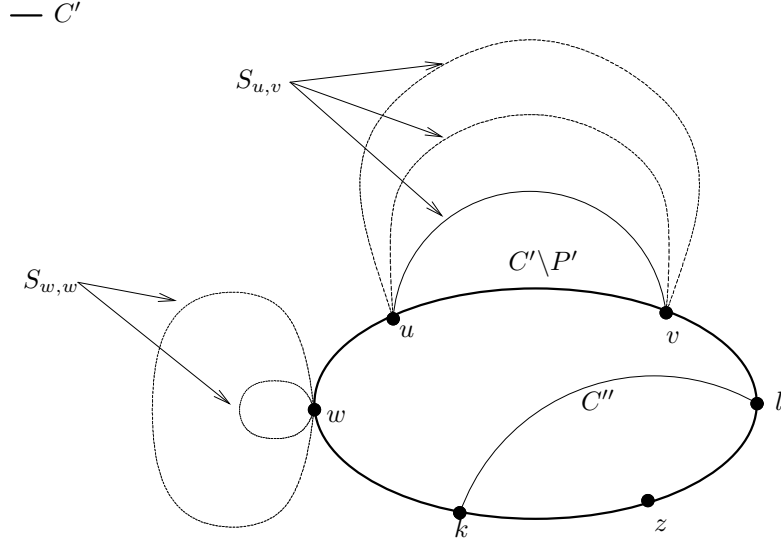

Figure 2: $S_{u,v}$ and $S_{w,w}$.

Definition 1.5 If C_1 is a son of C_2 then C_2 is a *father* of C_1 .

Observation 1.6 A father is shorter than its sons.

Lemma 1.7 If \hat{C} is the son of C' defined by $S_{k,l}$, and $C^* \in S_{k,l}$ then

- $\hat{C} \setminus C^*$ is a path (or a cycle).
- $C^* \setminus \hat{C}$ is a path (or a cycle).

Proof: Mark $\hat{P} = \hat{C} \setminus C'$ and $P^* = C^* \setminus C'$. From Observation (1.6), $l(C' \setminus \hat{C}) < l(\hat{P}) < l(P^*)$. Therefore $U(\hat{C}) \subseteq V(\hat{P})$ and $U(C^*) \subseteq V(P^*)$.

When $\hat{P} \cap P^*$ contains no edges then the claim is obvious. Suppose otherwise, then $\hat{P} \cap P^*$ contains a path, mark this path as P ($P \subset (\hat{C} \cap C^*) \setminus C'$). Mark the end points of P by g and h (see Figure 3). Let \hat{Q} (respectively Q^*) be the $k - g$ path in \hat{C} (C^*), and let \hat{T} (respectively T^*) be the $h - l$ path in \hat{C} (C^*). Let $v \in U(\hat{C})$, w.l.o.g suppose that $v \in \hat{Q}$. Since $\hat{C} \in \mathcal{C}$ $l(\hat{T}) < l(T^*)$, indicating that $U(C^*) \subseteq T^*$. But then since $C^* \in \mathcal{C}$, $l(Q^*) < l(\hat{Q})$. In this case the cycle $\hat{C} \setminus \hat{Q} \cup Q^*$ is shorter than \hat{C} and in S , contradiction the fact that \hat{C} was defined as a son by $S_{k,l}$. ■

Observation 1.8 According to Lemma 1.7, using the notation of Definition 1.4, $\{S'_{u,v} : u, v \in V(P)\}$ is a partition of $S_{k,l} \setminus C'$.

Corollary 1.9 Every cycle $C \in \mathcal{C} \setminus \{C_0\}$ has a unique father.

Definition 1.10 If C_1 is a father of C_2 we mark $C_1 \prec C_2$. If $C_1 \prec C_2$ and $C_2 \prec C_3$ then $C_1 \prec C_3$. \prec defines a hereditary order on \mathcal{C} whose root is C_0 . If $C_1 \prec C_2$ we say that C_1 is an *ancestor* of C_2 , and C_2 is a *descendant* of C_1 .

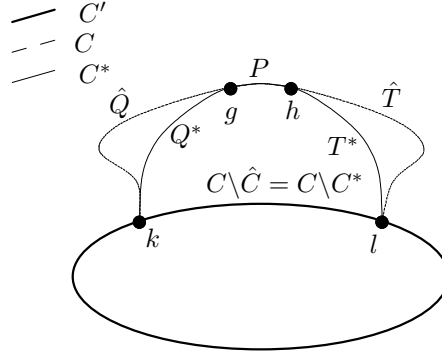

Figure 3: Figure for Lemma 1.7.

Definition 1.11 For every cycle $C \in \mathcal{C} \setminus \{C_0\}$ define (see Figure 2 (right)):

1. $F(C)$, the father of C .
2. $P_f(C) = F(C) \setminus C$ (the *father path*).
3. $P_s(C) = C \setminus F(C)$ (the *son path*).
4. $P_c(C) = C \cap F(C)$ (the *common path*).

Definition 1.12 If C_1 is a father of C_2 we mark $C_1 \prec C_2$. If $C_1 \prec C_2$ and $C_2 \prec C_3$ then $C_1 \prec C_3$. \prec defines a hereditary order on \mathcal{C} whose root is C_0 . If $C_1 \prec C_2$ we say that C_1 is an *ancestor* of C_2 , and C_2 is a *descendant* of C_1 .

Property 1.13 For every cycle $C \in \mathcal{C}$, $U(C)$ induces a path $\subseteq P_s(C)$ (since nodes in $P_c(C)$ are in a shorter cycle for example $F(C)$).

Property 1.14 For every cycle $C \in \mathcal{C} \setminus \{C_0\}$, $z \in P_c(C)$ (since $z \in C \cap F(C)$).

Definition 1.15 Suppose that $C_1, C_2 \in \mathcal{C}$ $C_1 \not\prec C_2$ and $C_2 \not\prec C_1$. C_a is the *lowest common ancestor* of C_1 and C_2 if:

- $C_a \prec C_1$.
- $C_a \prec C_2$.
- There is no cycle $C \in \mathcal{C}$ such that $C \prec C_1, C \prec C_2$, and $C_a \prec C$.

For example in Figure 4 C_0 is the lowest common ancestor of C_1 and C_4 , C_0 is also the lowest common ancestor of C_2 and C_4 , and C_1 is the lowest common ancestor of C_2 and C_3 .

Definition 1.16 Suppose that $C_1, C_2 \in \mathcal{C}$ $C_1 \not\prec C_2$ and $C_2 \not\prec C_1$. Let C_a be the lowest common ancestor of C_1 and C_2 . Set $P_1 = C_a \setminus C_1$, $P_2 = C_a \setminus C_2$. C_1 and C_2 are *crossing* (with respect to C_a) if $E(P_1 \cap P_2)$, $E(P_1 \setminus P_2)$, $E(P_2 \setminus P_1)$ are all nonempty.

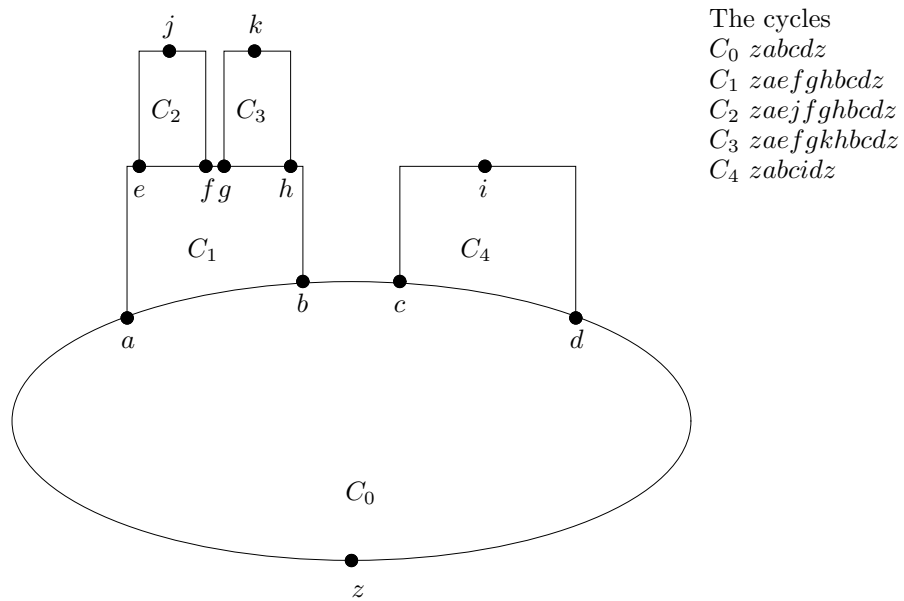

Figure 4: Examples of lowest common ancestor.

C $zkgllhz$
 C' $zkxllhz$
 C'' $zkgxhz$
 \hat{C} $zkxgllhz$
 The shortcut xg

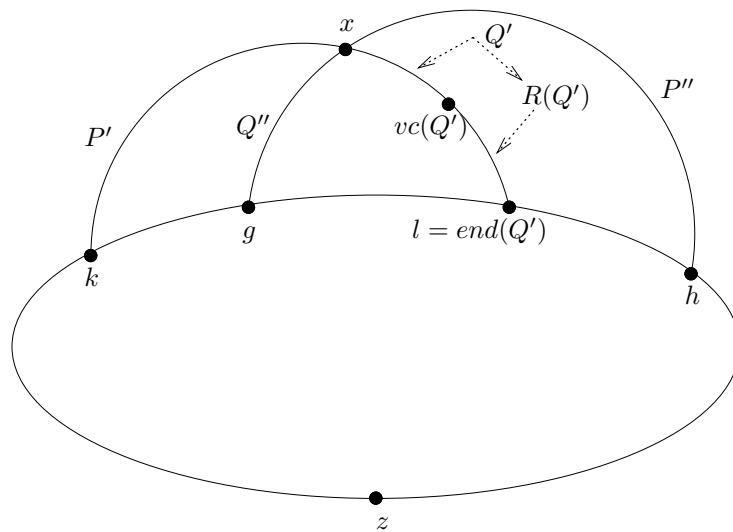

Figure 5: Figure for definitions 1.17, 1.18 and 1.19.

Figure 5 illustrates the following three definitions:

Definition 1.17 The algorithm CANCEL-CROSSING described in section 2.2 replaces cycles. Suppose that the algorithm replaces the cycle $C' = C(v)$, which crossed another cycle C'' with respect to a common ancestor C . Let \hat{C} be the cycle serving v after the change. The path $\hat{C} \setminus (C' \cup C)$ is a *shortcut*.

Definition 1.18 Let $C \in \mathcal{C}$ be a cycle. Suppose that C contains four nodes in $P_s(C)$ ordered k, g, l, h , such that $S_{k,l}$ and $S_{g,h}$ are non empty. In this case, every $C' \in S_{k,l}$ and $C'' \in S_{g,h}$ are crossing with respect to C . Since the graph is planar this means that $(C' \cap C'') \setminus C$ contains at least one node. Choose such a node x (if there is more than one select one arbitrarily). We call such a node a *cross-node* of C' and C'' (with respect to C).

Definition 1.19 Using the notation of Definition 1.18, for a path P between x and $[g, l]$, let $end(P) = P \cap [g, l]$. Note that $end(P)$ is a node in P . Let $R(P) = [vc(P), end(P)]$ be the maximal subpath of P contained in a shortcut defined before the processing of C . ($vc(P) = end(P)$ is possible).

Definition 1.20 For a cycle $C \in \mathcal{C}$ and nodes $v_1, v_2 \in C$ let $P^{v_1, v_2}(C)$ be the $v_1 - v_2$ subpath of C which includes z .

Definition 1.21 Let (P_1, \dots, P_n) be the concatenation of paths P_1, \dots, P_n , in this order.

Definition 1.22 Using the notation of Definition 1.18, if $U(C') \subset [k, x]$, $U(C'') \subset [x, h]$, and $\frac{2}{3}l(P_s(C)) \geq \max\{l(k, l), l(g, h)\}$, then C' and C'' are *not-very-heavy-outer-crossing*¹.

¹ According to Lemma 2.12 bellow either $((U(C') \subset [k, x]) \wedge (U(C'') \subset [x, h]))$ or $((U(C') \subset [x, l]) \wedge (U(C'') \subset [g, x]))$.

2 Cancellation of Crossings

We suggest now a way to change the cycles to avoid some cases of crossing.

2.1 Outline of the algorithm

The algorithm builds the hereditary structure in order of generations. During the process it cancels all not-very-heavy-outer-crossings. In each stage the algorithm considers a generation, and cancels all not-very-heavy-outer-crossing with respect to cycles in this generation. Afterwards, the next generation is defined and the algorithm proceeds to handle crossings with respect to the new generation. We note that once a cycle has been defined as a son of another (already processed) cycle, it will not be changed.

We denote by $SC(C)$ the set of edges contained in shortcuts used by a cycle $C \in \mathcal{C}$. Before the first application of CANCEL-CROSSING, $SC(C) = \phi$ for every $C \in \mathcal{C}$.

2.2 The algorithm

```
CANCEL-CROSSING
input
  1. An undirected graph  $G = (V, E)$ .
  2. A set of cycles  $\mathcal{C}$ .
returns
  A new set of cycles  $\mathcal{C}$  with some crossings removed.
begin
   $D := \{C_0\}$ .
  while ( $D \neq \phi$ )
     $NG := \phi$  [NG is the next generation.]
    for every cycle  $C \in D$  [Processing of C.]
      Find the partition  $\{S_{u,v} : u, v \in P_s(C)\}$  described in
      Observations 1.3 and 1.8.
      while ( $\exists$  cycles  $C'$  and  $C''$  that are not-very-heavy-outer-crossing
        with respect to  $C$ )
        UNCROSS-CYCLES( $C', C''$ ).
      end while
      for every  $S_{u,v} \neq \phi$ 
         $C_{u,v} :=$  the son of  $C$  defined by  $S_{u,v}$ .
         $NG := NG \cup C_{u,v}$ .
      end for
      [C is considered Processed ].
    end for
     $D := NG$ 
  end while
end CANCEL-CROSSING
```

Figure 6: Procedure CANCEL-CROSSING

UNCROSS-CYCLES

input

Not-very-heavy-outer-crossing cycles $C' \in S_{k,l}$ and $C'' \in S_{g,h}$ (see Definition 1.22).

begin

$x :=$ the cross-node.

$P' :=$ the $x - k$ path in C' .

$P'' :=$ the $x - h$ path in C'' .

$Q' :=$ the $x - l$ path in C' .

$Q'' :=$ the $x - g$ path in C'' .

[See Figure 8 .]

$U^* := \{Q'\}$.

$B'(1) := \{c | c \text{ creates n.v.h.c (not very heavy crossing) with } C' \text{ and } c \text{ is the right cycle } \}$.

$X'(1) := \{x(c) | x(c) \text{ is the cross-node between } C' \text{ and } c, c \in B'(1)\}$.

$P'(1) := \{p(c) = [x, x(c)] \cup [x(c), y] | x(c) \in X'(1), [x(c), y] \text{ is the left path between } x(c) \text{ and } [g, l]\}$.

For every $p(c) \in P'(1)$ $R(p(c)) = (R(Q') \cap [x, x(c)]) \cup (R(c) \cap [x(c), y])$.

$U^* = U^* \cup P'(1)$.

while $(B'(i) \neq \phi)$

if $(i \% 2)$

then

$B'(i+1) := \{c | c \text{ creates n.v.h.v with } c_i(c) \in B'(i) \text{ and } c \text{ is the left cycle } \}$.

$X'(i+1) := \{x(c) | x(c) \text{ is the cross-node between } c_i(c) \text{ and } c, c \in B'(i+1)\}$.

$P'(i+1) := \{p(c) | \text{the sub-path of } p(c_i(c)) \text{ till } x(c) \cup [x(c), y]$

$[x(c), y]$ is the right path between $x(c)$ and $[g, l]\}$.

 For every $p(c) \in P'(i+1)$ $R(p(c)) = ((R(c_i(c)) \cap p(c_i(c))) \cup (R(c) \cap [x(c), y]))$.

$U^* = U^* \cup P'(i+1)$.

else

$B'(i+1) := \{c | c \text{ creates n.v.h.c with } c_i(c) \in B'(i) \text{ and } c \text{ is the right cycle } \}$.

$X'(i+1) := \{x(c) | x(c) \text{ is the cross-node between } c_i(c) \text{ and } c, c \in B'(i+1)\}$.

$P'(i+1) := \{p(c) | \text{the sub-path of } p(c_i(c)) \text{ till } x(c) \cup [x(c), y]$

$[x(c), y]$ is the left path between $x(c)$ and $[g, l]\}$.

 For every $p(c) \in P'(i+1)$ $R(p(c)) = ((R(c_i(c)) \cap p(c_i(c))) \cup (R(c) \cap [x(c), y]))$.

$U^* = U^* \cup P'(i+1)$.

end if

end while

$P^* := \arg \min_{P \in U^*} \{l(P) + l(P \setminus R(P))\}$.

U^{**} and P^{**} are defined in a similar way for C'' .

if $(l(P^*) + l(P^* \setminus R(P^*)) < l(P^{**}) + l(P^{**} \setminus R(P^{**})))$

then

$SP :=$ the shortest path between x and $\text{end}(P^*)$.

for every $v \in U(C'')$

$C(v) := (P'', SP, P^{\text{end}(P^*), h}(C))$. $SC(C(v)) := (SC(C'') \setminus Q'') \cup SP$.

end for

for every $v \in U(C')$

$C(v) := (P', SP, P^{k, \text{end}(P^*)}(C))$. $SC(C(v)) := (SC(C') \setminus (Q' \setminus SP)) \cup (SP \setminus Q')$.

end for

 [When $P^* = Q'$ the cycle for nodes in $U_{P'}$ doesn't change .]

else

$SP :=$ the shortest path between x and $\text{end}(P^{**})$.

for every $v \in U(C')$

$C(v) := (P', SP, P^{\text{end}(P^{**}), h}(\emptyset))$. $SC(C(v)) := (SC(C') \setminus Q') \cup SP$.

end for

for every $v \in U(C'')$

$C(v) := (P'', SP, P^{k, \text{end}(P^{**})}(C))$. $SC(C(v)) := (SC(C'') \setminus (Q'' \setminus SP)) \cup (SP \setminus Q'')$.

end for

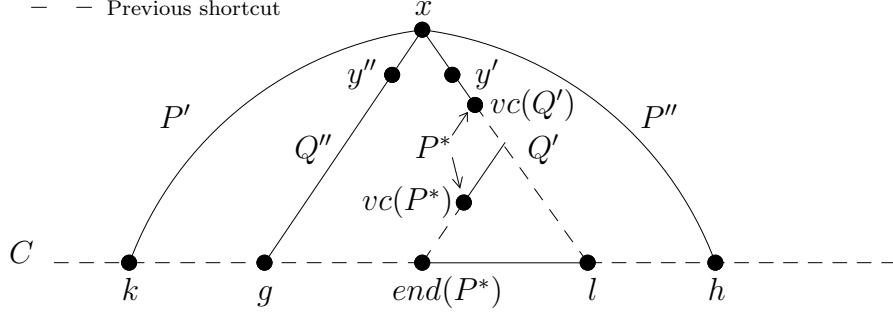

Figure 8: Figure for UNCROSS-CYCLES.

2.3 Analysis

Throughout this section we use the notation of Algorithm UNCROSS-CYCLES.

Property 2.1 Consider the beginning of the processing step of $C \in \mathcal{C}$. For every two nodes $u, v \in P_s(C)$, the $u - v$ subpath of $P_s(C)$ is shorter than any path between these two nodes used by a descendant of C .

Observation 2.2 A shortcut is always the shortest path between its ends.

Definition 2.3 For every node v define C_v^* to be the original cycle serving v . For a set of nodes U such that $C_v^* = C_u^* \forall u, v \in U$, define C_U^* as their common original cycle.

Observation 2.4 $[x, vc(Q')] \subset C_{U(C')}^*$ and symmetrically $[x, vc(Q'')] \subset C_{U(C'')}^*$. (see Figure 8).

Observation 2.5 From the way the algorithm works at any stage of the algorithm, all the nodes in $U(C^*)$ of an original cycle C^* are served by the same cycle.

Lemma 2.6 The set of crossing after the processing of a cycle C by CANCEL-CROSSING does not contain any crossing that did not exist before this step.

Moreover, if C' is a descendant of C which outer-crosses more than one not-very-heavy cycle (with respect to C), and C' is the left cycle in all these crossings (and similarly if it is in the right side in all these crossings), then the total effect of applying UNCROSS-CYCLES to all these crossings is the same as if it is only called once with the crossing point which is closest to $U(C')$ on the right side of $U(C')$.

Proof: Suppose that UNCROSS-CYCLES creates a new crossing. Let C' and C'' be two cycles which crossed with respect to C (before C was processed) and suppose that when UNCROSS-CYCLES is activated on them, C'' is changed. W.l.o.g suppose that $SP = P^* = Q'$ is the shortcut (a similar proof applies when $SP = P^* \neq Q'$). Suppose that the new C'' creates a crossing with a cycle \tilde{C} (see Figure 9). Since \tilde{C} and C'' didn't cross before the processing of C and they are crossing now: $(C \setminus \tilde{C}) \subseteq [g, h]$ and $l \in (C \setminus \tilde{C})$. Therefore \tilde{C} and C' were crossing with respect to C

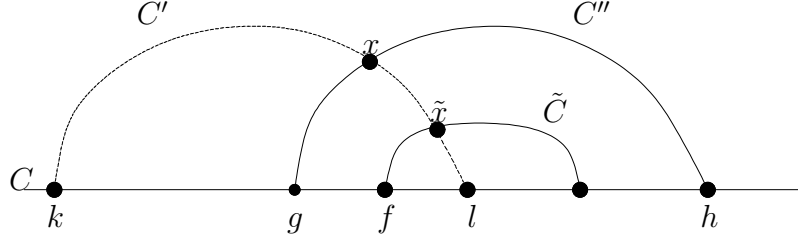

Figure 9: Figure for Lemma 2.6.

before the processing of C . Moreover since C'' is not-very-heavy and $\tilde{C} \subset C''$, \tilde{C} is not-very-heavy. Since C' was outer-crossing with C'' , $U_{C'} \subseteq [x, k]$ so C' and \tilde{C} are outer-crossing. Altogether we get that C' and \tilde{C} were not-very-heavy-outer-crossing with respect to C before the processing of C . Let \tilde{x} be a cross-node of \tilde{C} and C' and let f be the endpoint of $(C \setminus \tilde{C})$ such that $f \in [g, l]$. When UNCROSS-CYCLES is activated on C' and \tilde{C} it compares among other also the paths $[\tilde{x}, f]$ and $[\tilde{x}, l]$, and chooses the latter as the shortcut. Hence, the cycle for the nodes in $U_{\tilde{C}}$ will also be changed during the processing of C , and the new cycle does not cross the new C'' .

Also note that if UNCROSS-CYCLES was first activated on C' and \tilde{C} then C' and C'' are still not-very-heavy-outer-crossing, and then UNCROSS-CYCLES will be activated on them, resulting in the same change of cycles that would have happened if UNCROSS-CYCLES was first activated on C' and C'' . ■

Theorem 2.7 *Consider the beginning of the processing step of a cycle C by CANCEL-CROSSING. Let E' be the set of edges contained in cycles which have been processed before C . Let C^* be an original cycle and let $\check{C} \in \mathcal{C}$ be the cycle which currently serves $U(C^*)$ (see Corollary 2.5). Let A be the set of edges in the (processed) ancestors cycles of \check{C} . Consider \check{P} a subpath of $(\check{C} \cap C^*) \setminus (E' \cap A)$ which contains $U(C^*)$. Define*

- $N(\check{P}) := \check{C} \setminus \check{P}$.
- $O(\check{P}) := C^* \setminus \check{P}$.
- $S(\check{P}) := SC(\check{C})$.
- $T(\check{P}) := S(\check{P}) \cap E'$.
- $A(\check{P}) := S(\check{P}) \setminus E' = S(\check{P}) \setminus T(\check{P})$ (The shortcuts that are in cycles which have not yet been processed).

Then:

$$l(N(\check{P})) + 2l(A(\check{P})) \leq 9l(O(\check{P})).$$

Proof: Denote by C the cycle processed during a given execution of CANCEL-CROSSING. Let $\hat{N}(\check{P})$, $\hat{S}(\check{P})$, and $\hat{T}(\check{P})$ be the path and sets of shortcuts at the beginning of this step. Let $N(\check{P})$, $S(\check{P})$, and $T(\check{P})$ be the path and sets of shortcuts at the end of it. We will show that if the claim of the theorem holds at the beginning of the given step, it still holds at the end of it.

W.l.o.g we consider \check{C} which is a descendant of C (other cycles are not changed while processing C).

Consider a call to UNCROSS-CYCLES to process not-very-heavy-outer-crossing cycles C' and C'' (see Figure 8). By Lemma 2.6 we can assume that UNCROSS-CYCLES is not activated again on the right side of C' and that it is activated at most once on the left side of C' (similarly for C''). The possibility of another activation of UNCROSS-CYCLES on C' (similarly on C'') affects the analysis at only one specific place and we will relate to it during the proof. Since we assume that $\check{P} \subset C^* \cap \check{C}$ all the applied changes are outside of \check{P} . Since this theorem considers the changes in the cycles, it is enough to prove it on any \check{P} which is out of the changing part in each one of the cycles. To simplify the notation we will consider $\check{P} = P'$ and $\check{P} = P''$.

The proof is given for the case that P^* is the shortcut (similar proof follows for the case P^{**} is the shortcut) thus $(l(P^*) + l(P^* \setminus (R(P^*) \cup R(Q')))) < l(P^{**}) + l(P^{**} \setminus (R(P^{**}) \cup R(Q'')))$. Since we use P^* as the left hand side of the inequality the claim clearly holds since the algorithm uses SC which is not longer. A similar proof follows when P^{**} is the shortcut.

Denote: $v' = vc(Q')$ ($v' = l$ when Q' doesn't intersect previous shortcuts and $v' = x$ when Q' is contained in previous shortcuts), and $v'' = vc(Q'')$.

We first consider the case $P^* = Q'$ In this case P' doesn't change so we only need to prove the theorem for P'' . Since $Q'' \in U^{**}$: $l(Q') + l(Q' \setminus R(Q')) < l(Q'') + l(Q'' \setminus R(Q''))$, giving:

$$2l(x, v') + l(v', l) < 2l(x, v'') + l(v'', g). \quad (1)$$

Consider the possible locations of v' and v'' :

1. $v' \neq l$. By definition of v' : $Q' \cap \hat{S}(P') \neq \emptyset$.

(a) $v'' \neq g$ ($Q'' \cap \hat{S}(P'') \neq \emptyset$).

Let $w \in P_s(C)$ be the node for which $[h, w] \subset O(P'')$ and $[h, w]$ is maximal ($h = w$ is possible).

By definition $[x, v''] \subset O(P'')$ giving that

$$l(O(P'')) = l(x, v'') + l(O([x, v''], P'', [h, w])) + l(x, v'') + l(h, w). \quad (2)$$

According to the induction hypothesis

$$l(\hat{N}([x, v''], P'', [h, w])) + 2l(\hat{A}([x, v''], P'', [h, w])) \leq 9l(O([x, v''], P'', [h, w])),$$

Note that $\hat{A}([x, v''], P'', [h, w]) = \hat{A}(P'')$, therefore

$$l(\hat{N}([x, v''], P'', [h, w])) + 2l(\hat{A}(P'')) \leq 9l(O([x, v''], P'', [h, w])). \quad (3)$$

From the way the algorithm works

$$l(N(P'')) = l(\hat{N}([x, v''], P'', [h, w])) - l(v'', g) + l(x, v') + l(v', l) + l(g, l) + l(h, w). \quad (4)$$

Mark the endpoints of $P_s(C)$ as a, b (the nodes on $P_s(C)$ are ordered a, k, g, l, h, b).

In this case since we are processing C $[a, g] \cup [w, b]$ is removed from $A(P'')$ and since P'' is not using the path $[v'', g]$ any more:

$$\hat{A}(P'') \setminus A(P'') = [a, g] \cup [w, b] \cup [v'', g].$$

On the other end $[x, v'] \cup [v', l]$ is the new shortcut so:

$$A(P'') \setminus \hat{A}(P'') = [x, v'] \cup [v', l].$$

Altogether

$$l(A(P'')) = l(\hat{A}(P'')) + l(x, v') + l(v', l) - (l(a, g) + l(w, b) + l(v'', g)). \quad (5)$$

Since $l(g, h) \leq \frac{2}{3}l(P_s(C))$

$$l(g, l) \leq l(g, h) \leq 2[l(a, g) + l(h, w) + l(w, b)] \quad (6)$$

Using (4), (5), (1), (3),(6), and (2) in this order:

$$\begin{aligned} l(N(P'')) + 2l(A(P'')) &= [l(\hat{N}([x, v''], P'', [h, w])) - l(v'', g) + l(x, v') + l(v', l) + l(g, l) + l(h, w)] + \\ &\quad 2[l(\hat{A}(P'')) + l(x, v') + l(v', l) - (l(a, g) + l(w, b) + l(v'', g))] \\ &= l(\hat{N}([x, v''], P'', [h, w])) + 2l(\hat{A}(P'')) - 3l(v'', g) + 3l(x, v') + 3l(v', l) + \\ &\quad l(g, l) + l(h, w) - 2l(a, g) - 2l(w, b) \\ &\leq l(\hat{N}([x, v''], P'', [h, w])) + 2l(\hat{A}(P'')) + 6l(x, v'') + l(g, l) + l(h, w) - \\ &\quad 2l(a, g) - 2l(w, b) \\ &\leq 9l(O([x, v''], P'', [h, w])) + 6l(x, v'') + l(g, l) + l(h, w) - 2l(a, g) - 2l(w, b) \\ &\leq 9l(O([x, v''], P'', [h, w])) + 6l(x, v'') + 3l(h, w) \\ &\leq 9l(O(P'')). \end{aligned}$$

Suppose that C'' participates in not-very-heavy-outer-crossings on both its sides (see Figure 10). Moreover, suppose that both crossings satisfy the assumption of this case (using shortcuts from previous steps). Note that in this case

$$l(g, l) + l(q, h) \leq l(g, h) \leq \frac{2}{3}l(P_s(C)).$$

Therefore, even if both applications of UNCROSS-CYCLES result in changing C'' the inequality $l(N(P'')) + 2l(A(P'')) \leq 9l(O(P''))$ is proven in a similar way.

(b) $v'' = g$ ($Q'' \subset O(P'')$). Let $u \in [k, g]$ such that $[u, g] \subset O(P'')$ and $[u, g]$ is maximal. We get:

$$l(O(P'')) = l(O(P'', Q'', [u, g])) + l(Q'') + l(g, u). \quad (7)$$

According to the induction hypothesis

$$l(\hat{N}(P'', Q'', [u, g])) + 2l(\hat{A}(P'', Q'', [u, g])) \leq 9l(O(P'', Q'', [g, u])). \quad (8)$$

From the way the algorithm works:

$$l(A(P'')) \leq l(\hat{A}(P'', Q'', [u, g])) + l(Q'), \quad (9)$$

it is possible that P'' used shortcuts contained in $P_s(C)$, during the processing of C these paths are removed from $A(P'')$ and then the inequality above is strict. Also:

$$l(N(P'')) = l(\hat{N}(P'', Q'', [u, g])) + l(Q') + l(g, l) + l(g, u). \quad (10)$$

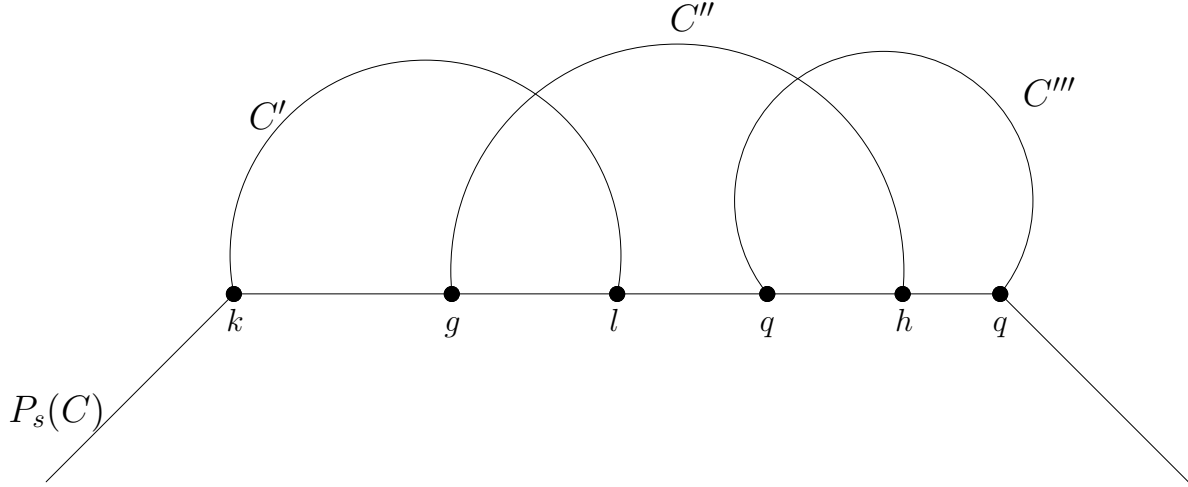

Figure 10: Figure for the case C'' participates in two crossings on both its sides.

Since $[x, v'] \cup [v', l] = Q'$ and using (1):

$$2l(x, v') + l(v', l) \leq 2l(x, v'') + l(v'', g) \leq 2l(Q').$$

Hence we get

$$l(Q') = l(x, v') + l(v', l) \leq 2l(Q''). \quad (11)$$

From Property 2.1 and 11

$$l(g, l) \leq l(Q') + l(Q'') \leq 3l(Q''). \quad (12)$$

Using (10), (9), (11), (12), (8), and (7) in this order:

$$\begin{aligned} l(N(P'')) + 2l(A(P'')) &\leq [l(\hat{N}(P'', Q'', [u, g])) + l(Q') + l(g, l)] + l(g, u) + \\ &\quad 2[l(\hat{A}(P'', Q'', [u, g])) + l(Q')] \\ &= l(\hat{N}(P'', Q'', [u, g])) + 2l(\hat{A}(P'', Q'', [u, g])) + 3l(Q') + l(g, l) + l(g, u) \\ &\leq l(\hat{N}(P'', Q'', [u, g])) + 2l(\hat{A}(P'', Q'', [u, g])) + 6l(Q'') + l(g, l) + l(g, u) \\ &\leq l(\hat{N}(P'', Q'', [u, g])) + 2l(\hat{A}(P'', Q'', [u, g])) + 9l(Q'') + l(g, u) \\ &\leq 9l(O(P'', Q'', [g, u])) + 9l(Q'') + l(g, u) \\ &\leq 9l(O(P'')). \end{aligned}$$

2. $v' = l$ ($Q' \subset O(P')$).

By (1)

$$2l(Q') = 2l(x, v') \leq 2l(x, v'') + l(v'', g). \quad (13)$$

By definition

$$l(O(P'')) = l(O(P'', [x, v''])) + l(x, v''). \quad (14)$$

According to the induction hypothesis

$$l(\hat{N}(P'', [x, v''])) + 2l(\hat{A}(P'', [x, v''])) \leq 9l(O(P'', [x, v''])). \quad (15)$$

From the way the algorithm works

$$l(A(P'')) \leq l(\hat{A}(P'', [x, v''])) + l(Q') - l(v'', g), \quad (16)$$

(again if $P_s(C)$ contains shortcuts used by P'' the inequality is strict) and

$$l(N(P'')) = l(\hat{N}(P'', [x, v''])) + l(Q') - l(v'', g) + l(g, l). \quad (17)$$

From Property 2.1 and Equation (13)

$$l(g, l) \leq l(x, v'') + l(v'', g) + l(Q') < 2l(x, v'') + 1.5l(v'', g). \quad (18)$$

Using (17),(16), (13), (18),(15), and (14) in this order:

$$\begin{aligned} l(N(P'')) + 2l(A(P'')) &\leq [l(\hat{N}(P'', [x, v''])) + l(Q') - l(v'', g) + l(g, l)] + 2[l(\hat{A}(P'', [x, v''])) + \\ &\quad l(Q') - l(v'', g)] \\ &= l(\hat{N}(P'', [x, v''])) + 2l(\hat{A}(P'', [x, v''])) + 3l(Q') - 3l(v'', g) + l(g, l) \\ &\leq l(\hat{N}(P'', [x, v''])) + 2l(\hat{A}(P'', [x, v''])) + 3l(x, v'') - 1.5l(v'', g) + l(g, l) \\ &\leq l(\hat{N}(P'', [x, v''])) + 2l(\hat{A}(P'', [x, v''])) + 5l(x, v'') \\ &\leq 9l(O(P'', [x, v''])) + 5l(x, v'') \\ &\leq 9l(O(P'')). \end{aligned}$$

When $P^* \neq Q'$. The proof for P' is similar to the proof we have seen before (the cross-node moves to the other end of $P^* \cap Q'$). For P'' there are two cases to be considered:

- $v'' \neq g$. Same proof as in Case (1a) since in this case also we can bound $l(g, \text{end}(P^*))$ with respect to $l(T(P'') \setminus \hat{T}(P''))$.
- $v'' = g$. Same proof as in Case (1b) since here also $l(P^*) < 2l(Q'')$ and $Q'' \subset O(P'')$.

■

Corollary 2.8 *For every node v , let C^* be the original cycle which served v and let C be the cycle which serves v after the application of CANCEL-CROSSING. Then*

$$l(C) \leq 9l(C^*).$$

Proof: Let \check{P} be the path induced by $E(U(C^*))$. From Theorem 2.7

$$l(N(\check{P})) + 2l(S(\check{P})) \leq 9l(O(\check{P})) + 2l(T(\check{P})).$$

Since $T(\check{P}) \subset S(\check{P})$ we get $l(N(\check{P})) \leq 9l(O(\check{P}))$, giving

$$l(C) = l(N(\check{P})) + l(\check{P}) \leq 9l(O(\check{P})) + l(\check{P}) \leq 9l(O(\check{P})) + 9l(\check{P}) = 9l(C^*).$$

■

2.4 In-out

During the processing of C let C' and C'' be two crossing cycles with respect to C such that $P_s(C') = [k, x] \cup [x, l]$ and $P_s(C'') = [g, x] \cup [x, h]$, where x is the cross-node and k, g, l, h are nodes in $P_s(C)$ arranged in that order.

Definition 2.9 Define $OUT(C') = [k, x]$, $IN(C') = [x, l]$, $OUT(C'') = [x, h]$ and $IN(C'') = [g, x]$.

Definition 2.10 Define $U_{IN(C')} = \{v \in IN(C') | C(v) = C'\}$, $U_{OUT(C')} = \{v \in OUT(C') | C(v) = C'\}$, $U_{IN(C'')} = \{v \in IN(C'') | C(v) = C''\}$, and $U_{OUT(C'')} = \{v \in OUT(C'') | C(v) = C''\}$.

Lemma 2.11 *Before UNCROSS-CYCLES is applied on C' and C'' , if $U_{OUT(C')} \neq \phi$ then $U_{IN(C'')} = \phi$. (Similarly, if $U_{OUT(C'')} \neq \phi$ then $U_{IN(C')} = \phi$.)*

Proof: Suppose that $U_{OUT(C')} \neq \phi$. If $IN(C')$ is part of the original cycle serving $U_{OUT(C')}$ then obviously

$$l(IN(C')) + l(l, h) < l(OUT(C'')). \quad (19)$$

If $IN(C')$ is not part of the original cycle then $IN(C')$ and $[l, h]$ are part of a previous shortcut, and by Property 2.2 Equation 19 holds.

In both cases Equation 19 holds, therefore the nodes in $V(IN(C''))$ must use $(IN(C'), [l, h])$ as part of their cycle (and not $OUT(C'')$), giving that $U_{IN(C'')} = \phi$. ■

Lemma 2.12 *Either $U_{OUT(C')} = U(C')$ and $U_{OUT(C'')} = U(C'')$ or $U_{OUT(C')} = U_{OUT(C'')} = \phi$. In the first case we say that C' and C'' are Outer-crossing. In the second case we say that C' and C'' are Inner-crossing.*

Proof: If $U_{OUT(C')} \neq \phi$ then by Lemma 2.11 $U_{IN(C'')} = \phi$ and $U_{OUT(C'')} = U(C'')$. Since there are nodes which use the cycle C'' we get that $U_{OUT(C'')} \neq \phi$, and by Lemma 2.11 $U_{IN(C')} = \phi$, giving that $U_{OUT(C')} = U(C')$.

If $U_{IN(C')} \neq \phi$ then by Lemma 2.11 $U_{OUT(C'')} = \phi$ and $U_{IN(C'')} = U(C'')$. Since there are nodes which use the cycle C'' we get that $U_{IN(C'')} \neq \phi$, and by Lemma 2.11 $U_{OUT(C')} = \phi$, giving that $U_{IN(C')} = U(C')$. ■

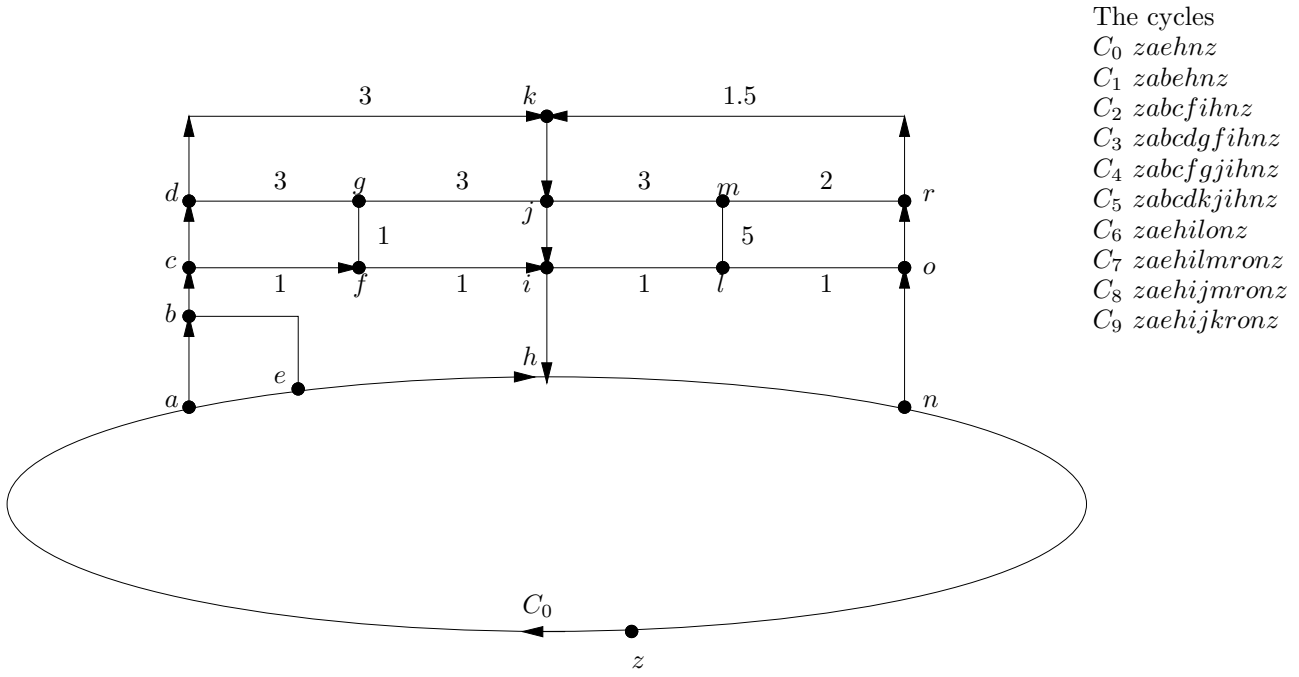

$$S_{ae} = \{C_1\} \quad S_{ah} = \{C_2, C_3, C_4, C_5\} \quad S_{hn} = \{C_6, C_7, C_8, C_9\}$$

Figure 11: An example.

3 Orienting the graph

After all the changes described in the previous section, we are given \mathcal{C} , a set of unoriented cycles with hereditary order.

In Figure 11 an example of a partial oriented graph, in intermediate stage of the algorithm, is given with its corresponding $\mathcal{C} = \{C_0, \dots, C_9\}$. An edge whose length is not indicated is of zero length. In this graph:

- C_1, C_2 and C_9 are sons of C_0 .
- C_3, C_4 and C_5 are sons of C_2 .
- C_6, C_7 and C_8 are sons of C_9 .

Definition 3.1 For a cycle $C \in \mathcal{C}$ define its *generation level* $g(C)$ as the distance in the hereditary tree from C_0 . In Figure 12 we see that $g(C_0) = 0$, $g(C_2) = 1$ and $g(C_3) = 2$.

Definition 3.2 If C' is a contained brother of C we mark it $C' \sqsubseteq C$. If C is not a contained brother of any cycle then it is *uncontained*. In Figure 11 C_2 and C_9 are uncontained. C_3, C_4 are contained brothers of C_5 .

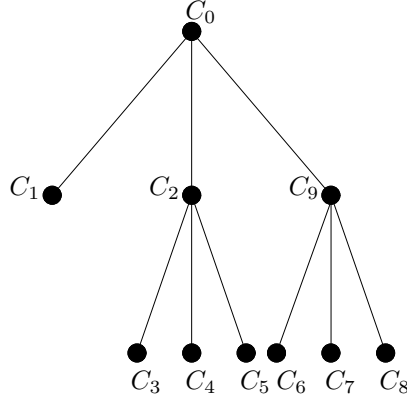

Figure 12: The hereditary tree for Figure 11.

Definition 3.3 For a cycle $C \in \mathcal{C} \setminus \{C_0\}$ define *the level of containment* $lc(C)$ in the following manner:

- $lc(C) = 0$ if C is uncontained.
- $lc(C) = i$ if C is a maximal contained brother of a cycle C' and $lc(C') = i - 1$.

In Figure 11 $lc(C_6) = 0$, $lc(C_7) = 1$ and $lc(C_8) = 2$.

The algorithm described below orients the P_s of cycles in order of their generation level. Starting by orienting C_0 then orienting all the cycles with generation level 1, and continuing with higher generation level. In each generation the orientation is performed in order of level of containment. Again, starting by orienting the cycles with level of containment zero and continuing by increasing level of containment.

Definition 3.4 For every $v \in V$ we mark with $C_v \in \mathcal{C}$ the shortest cycle in \mathcal{C} containing v . For every cycle $C \in \mathcal{C}$, let $U(C) = \{v \in V : C_v = C\}$. By construction $U(C) \neq \emptyset$.

Observation 3.5 $U(C)$ induces a path.

Definition 3.6 The algorithm will orient the edges in $U(C)$ to form a directed path. We call the orientation induced on C *the orientation of C* .

Definition 3.7 A cycle C is *oriented backwards (forwards)* if $U(C)$ and $U(F(C))$ induce different (identical) directions on $P_c(C)$. In Figure 11 C_2 is oriented forwards ($U(C_2) = [a, b, c, f, i, h]$) and C_9 is oriented backwards ($U(C_9) = [n, o, r, k, j, i, h]$).

Definition 3.8 C' , a contained brother of C is *maximal contained* when there is no \hat{C} such that $C' \sqsubseteq \hat{C} \sqsubseteq C$. In Figure 11 C_1 is a maximal contained brother of C_2 .

Definition 3.9 We say that brothers C_l, \dots, C_k ($l \leq k$) create a *block* (C_l, \dots, C_k) when:

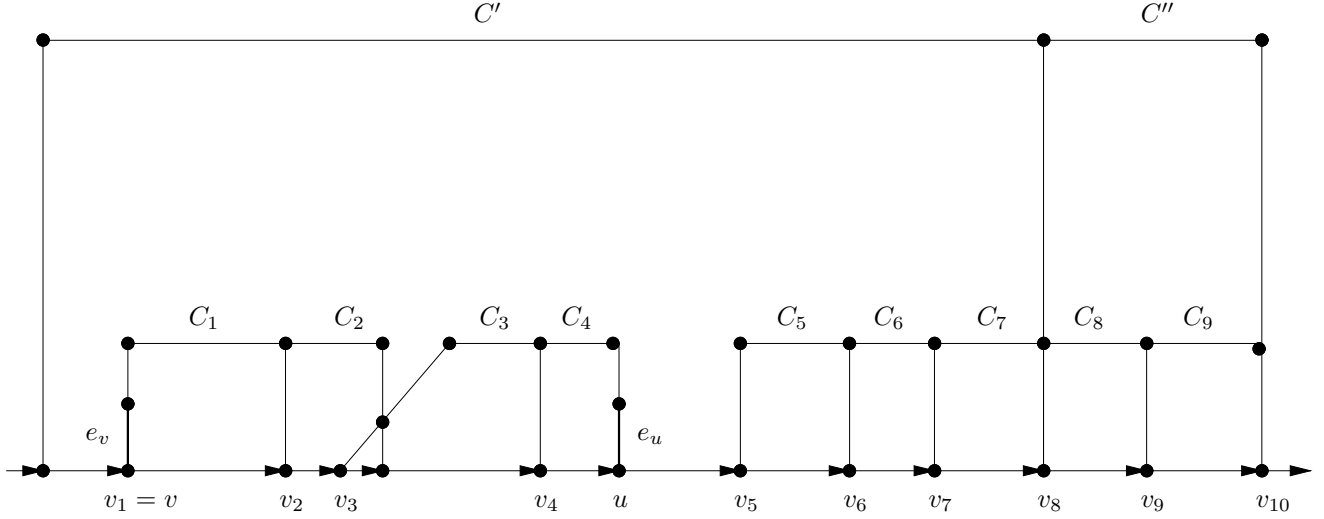

Figure 13: Three blocks.

- $lc(C_1) = lc(C_{l+1}) = \dots = lc(C_k)$.
- If $lc(C_1) > 0$ then there is C' such that (for $l \leq i \leq k$) $lc(C') = lc(C_i) - 1$ and $C_i \sqsubseteq C'$.
- C_i and C_{i+1} are neighbor or crossing brothers (for $l \leq i \leq k - 1$).

In Figure 13 we see three blocks, (C_1, C_2, C_3, C_4) , (C_5, C_6, C_7) and (C_8, C_9) . The cycles C_5, \dots, C_9 are divided into two blocks since C_5, C_6, C_7 are contained brothers of C' and C_8, C_9 are contained brothers of C'' .

Definition 3.10 Let C_1, C_2, \dots, C_m be sons of C . Mark with v_i the "left" end node of $P_f(C_i)$. C_1, C_2, \dots, C_m are ordered according to the direction of C if v_1, v_2, \dots, v_m are ordered in this way. Whenever we write C_1, C_2, \dots, C_m we assume the cycles are ordered according to direction of their father. In Figure 13 the nodes v_1, \dots, v_9 are marked, the cycles C_1, \dots, C_9 are ordered according to the direction of their father.

Observation 3.11 For every cycle C , $P_f(C) \subseteq P_s(F(C))$.

Definition 3.12 If $l(P_f(C)) > \frac{1}{3}l(P_s(F(C)))$ C is heavy, if $l(P_f(C)) > \frac{2}{3}l(P_s(F(C)))$ C is very heavy, if $l(P_f(C)) \leq \frac{1}{3}l(P_s(F(C)))$ C is light.

Definition 3.13 A cycle sets the orientation of an edge when it gives the first orientation of the edge or when it changes a previous orientation of this edge.

Observation 3.14 If C_1 and C_2 are crossing brothers with $lc(C_1) = lc(C_2)$ then either:

- C_1 and C_2 are inner crossing. The cross-node's cycle C' is a containing brother of C_1 and C_2 ($C_1 \sqsubseteq C'$, $C_2 \sqsubseteq C'$), C_1, C_2 are the only maximal uncontained brothers of C' and $l(C') < \min\{l(C_1), l(C_2)\}$. In this case we say that C' is the closest containing brother of C_1 and C_2 . (In Figure 26 C_1, C_2 and C' are illustrated). Or

- C_1 and C_2 are outer crossing and at least one of them is very heavy (otherwise C_1 and C_2 were not-very-heavy-outer-crossing and were changed in previous section). In this work we handle the case when at most one such crossing can exist in each level of containment ².

Definition 3.15 Suppose that:

- $C \sqsubseteq B$,
- $P_s(C) \cap P_s(B) \neq \phi$,
- C is the only contained brother of B in its level of containment,
- B is oriented forwards.

Then C is a *special contained brother* of B . In Figure 11 C_1 is a special contained brother of C_2 .

3.1 General description

The algorithm orients the cycles of G according to generation order. In each application of the procedure DIRECT-BROTHERS, it orients $P_s(C)$ for all the cycles C which belong to a certain generation. The algorithm may change a previously defined direction but only in the procedure DIRECT-ONE.

In the following proofs we define for every $C \in \mathcal{C} \setminus \{C_0\}$ several directed paths. The concatenation of these paths creates a directed cycle connecting z and $U(C)$. We prove that the length of these paths is bounded with respect to the length of C .

In the algorithm there are cycles whose undirected cycle (the one that connects them to z) is changed. Again the length of the new cycle is bounded with respect to the original cycle's length.

Ideally we would like to orient the P_s of cycles alternately (see Figure 21(a) and (b)). However, there are limitations implied by containing brothers and previous generations which were oriented before. Hence, some neighbor brothers will have to be oriented in the same direction (forwards or backwards). Consider Figure 14. In this figure D_i is the oriented cycle connecting $U(C_i)$ and z for $i = 1, \dots, 11$. D_8, \dots, D_{11} in this figure are all oriented in the same direction. We use the notation *directed cycle* for a directed walk that starts and ends in z . In this notation a directed cycle may use an edge twice.

In Figure 14 D_1, D_2 and D_3, D_4, D_5 are oriented alternately. In this figure we can see how the orientation changed the undirected cycles.

We sometimes use the same name C for the undirected cycle and the directed cycle which connects $U(C)$ and z . From the context it will always be clear which cycle is referred to.

The algorithm orients the paths to satisfy the following properties:

Property 3.16 *A heavy cycle is oriented forwards.*

Property 3.17 *In a block with more than two brothers, the first two are not both oriented backwards. The same holds for the last two brothers.*

²A special procedure can be written for the case when two such crossing exist.

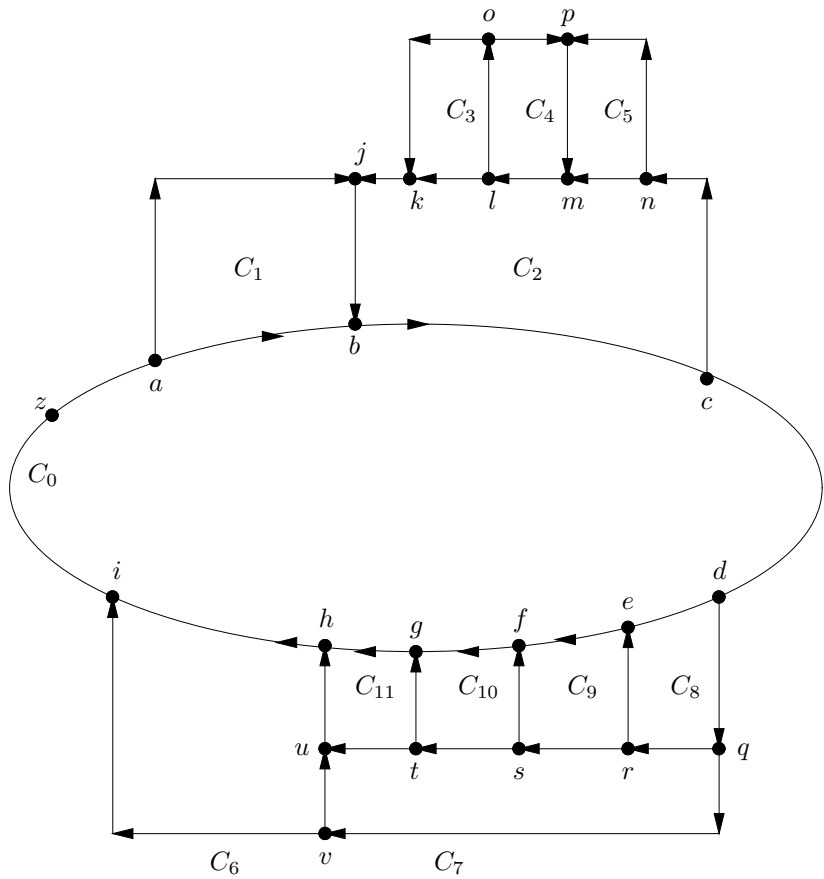

Undirected cycles

- C_0 $zabcde fghiz$
- C_1 $zajbcde fghiz$
- C_2 $zabjklmncde fghiz$
- C_3 $zabjklolmncde fghiz$
- C_4 $zabjklompncde fghiz$
- C_5 $zabjklmpncde fghiz$
- C_6 $abcdqviz$
- C_7 $abcdqvuhiz$
- C_8 $abcdqrefghiz$
- C_9 $abcders fghiz$
- C_{10} $abcde fstghiz$
- C_{11} $abcde fgtuhiz$

Directed cycles

- D_0 $zabcde fghiz$
- D_1 $zajbcde fghiz$
- D_2 $zabcnmlkjbcde fghiz$
- D_3 $zabcnmlokjbcde fghiz$
- D_4 $zabcnmlpmlkjbcde fghiz$
- D_5 $zabcnpmlkjbcde fghiz$
- D_6 $abcdqviz$
- D_7 $abcdqvuhiz$
- D_8 $abcdqrefghiz$
- D_9 $abcdqrs fghiz$
- D_{10} $abcdqrstghiz$
- D_{11} $abcdqrstuhiz$

Figure 14: An example orientation.

Property 3.18 *Inner-crossing cycles are oriented in the same direction (forwards or backwards) like their closest containing brother (see Definition 3.14).*

Property 3.19 *Outer-crossing cycles are oriented forwards.*

Property 3.20 *If C is a special contained brother, it is oriented forwards. Its containing brother B with $lc(C) = lc(B) + 1$ is also oriented forwards (see Definition 3.15).*

Definition 3.21 Consider an oriented cycle C such that $U(C)$ is already oriented. Define the following paths (see Figure 15):

1. Let $I(C)$ be the maximal directed path in $P_s(C)$ which contains $U(C)$.
2. Let $t(C)$, $h(C)$ be the tail and head of $I(C)$, respectively.
3. Let $M_t(C)$ be a directed path from z to $t(C)$ ($M_t(C)$ is constructed during the proof).
4. Let $M_h(C)$ be a directed path from $h(C)$ to z ($M_h(C)$ is constructed during the proof).
5. Let $M(C) = M_t(C) \cup M_h(C)$.
6. Let $J_t(C)$ be the maximal directed subpath of $P_s(C) \setminus I(C)$ with tail $t(C)$. $J_t(C) = \phi$ if $t(C) \in F(C)$.
7. Let $J_h(C)$ be the maximal directed subpath of $P_s(C) \setminus I(C)$ with head $h(C)$. $J_h(C) = \phi$ if $h(C) \in F(C)$.

Definition 3.22 When $I(C) \neq P_s(C)$ we define $B_t(C)$ and $B_h(C)$ the *bypasses* of C in the following manner (these paths will be constructed during the proof):

1. When $h(C) \notin F(C)$, $B_h(C)$ is a path from z to $h(C)$ containing $J_h(C)$.
2. When $t(C) \notin F(C)$, $B_t(C)$ is a path from $t(C)$ to z containing $J_t(C)$.

Definition 3.23 C_1 is preferred to C_2 if any of the following holds:

1. C_1 and C_2 both oriented forwards or both oriented backwards, and $l(C_1) < l(C_2)$.
2. C_1 is oriented forwards, C_2 is oriented backwards and $l(C_1) < l(C_2) + 2l(P_c(C_2) \setminus C_1)$.
3. C_1 is oriented backwards, C_2 is oriented forwards and $l(C_1) + 2l(P_c(C_1) \setminus C_2) < l(C_2)$.

Definition 3.24 Two cycles C_1 and C_2 are *competing on a path P* when $P \subseteq (P_s(C_1) \cap P_s(C_2))$ and $I(C_1)$, $I(C_2)$ induce different orientations on P . C_1 is the *winner* of the competition if the final orientation of P is the one induced by $I(C_1)$.

To motivate the last two definitions consider the comparison between C and C' performed in DIRECT-ONE and Figure 27. In this procedure, the cycles C and C' compete over the path $[x, v_1]$. The preferred cycle sets the orientation of this path.

Observation 3.25 *When two cycles compete the preferred cycle is the winner.*

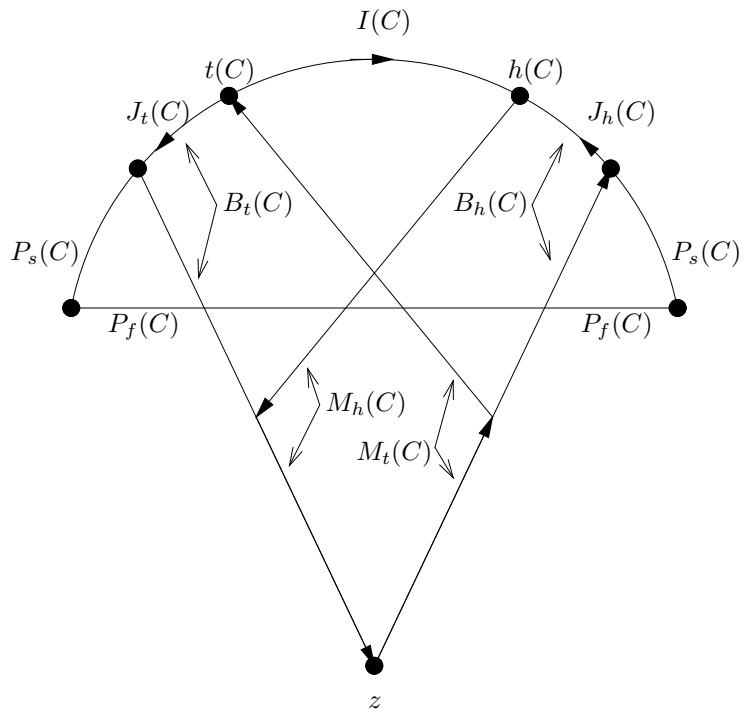

Figure 15: Paths associated with C .

3.2 The algorithm

```

Main
  input
    1. An undirected planar graph  $G = (V, E)$ .
    2. A set of cycles  $\mathcal{C}$  and its hereditary order, with  $g_{max}$  generations.
    [ $\mathcal{C}$  doesn't contain not-very-heavy-outer-crossing cycles.]
  returns
    An orientation of  $G$ 
  begin
    Orient  $C_0$  in arbitrary orientation . (*)
    for ( $i = 1, \dots, g_{max}$ )
      for every cycle  $C$  such that  $g(C) = i$ 
         $C'_1, C'_2, \dots, C'_m :=$  the uncontained sons of  $C$ .
        DIRECT-BROTHERS( $C'_1, C'_2, \dots, C'_m$ ).
      end for
    end for
  end Main

* The orientation of edges in  $E$  is a global variable, seen by all procedures.

```

Figure 16: Procedure *Main*

```

DIRECT-BROTHERS
  input
    An ordered set of brothers  $C_1, C_2, \dots, C_m$  from the same level of containment.
  begin
    for every block  $(C_l, \dots, C_k)$  [see Definition 3.9.]
      DIRECT( $C_l, \dots, C_k$ ).
      for ( $i = l, \dots, k$ )
         $\hat{C}_1, \dots, \hat{C}_p :=$  the maximal contained brothers of  $C_i$ .
        DIRECT-BROTHERS( $\hat{C}_1, \hat{C}_2, \dots, \hat{C}_p$ ).
      end for
    end for
  end DIRECT-BROTHERS

```

Figure 17: Procedure *DIRECT-BROTHERS*

```

DIRECT
  input
  A block  $(C_1, \dots, C_n)$ .
  begin
  if  $(n = 1)$ 
    then  $\{v, u\} = P_f(C_1) \cap P_s(C_1)$  ordered according to the orientation of  $F(C_1)$ .
    else
       $v := (P_f(C_1) \cap P_s(C_1)) \setminus P_f(C_2)$ .
       $u := (P_f(C_{n-1}) \cap P_s(C_n)) \setminus P_f(C_{n-1})$ .
    end if
     $e_v :=$  edge in  $P_s(C_1)$  incident to  $v$ .
     $e_u :=$  edge in  $P_s(C_n)$  incident to  $u$ .
    [ $v, u, e_v$  and  $e_u$  are described in Figure 13 for  $(C_1, C_2, C_3, C_4)$ .]
    if ( $e_v$  is undirected )
      then  $l_1 := 0$ .
    elseif ( $e_v$  is oriented from  $v$ )
      then  $l_1 := 1$ .
      else  $l_1 := -1$ .
    end if
    if ( $e_u$  is undirected )
      then  $l_2 := 0$ .
    elseif ( $e_u$  is oriented into  $u$ )
      then  $l_2 := 1$ .
      else  $l_2 := -1$ .
    end if
    if  $((n = 2) \wedge (C_1, C_2 \text{ are inner-crossing}))$ 
      then DIRECT-INNER-CROSSING $(C_1, C_2, l_1, l_2)$ 
      else DIRECT-K $(C_1, \dots, C_n, l_1, l_2)$ .
    end if
  end DIRECT

```

```

DIRECT-K
  input
  1. A block  $(C_1, \dots, C_n)$ . [There is no inner-crossing in this block.]
  2. Parameters  $l_1, l_2$ .
  begin
  if  $(n = 1)$ 
    then DIRECT-ONE $(C_1, l_1, l_2)$ .
  elseif  $(n = 2)$ 
    then DIRECT-TWO $(C_1, C_2, l_1, l_2)$ .
    else  $(n > 2)$  DIRECT-MANY $(C_1, \dots, C_n, l_1, l_2)$ .
  end if
  end DIRECT-K

```

Figure 18: Procedures DIRECT and DIRECT-K

DIRECT-MANY

input

1. A block (C_1, \dots, C_n) , $n > 2$. [There is no inner-crossing in this block.]
2. Parameters l_1, l_2 .

[According to Observation 3.14 there may be at most one outer-crossing.]

begin

$m_1 := \arg \max\{l(P_f(C_i)) : i = 1, \dots, n\}$.

$m_2 := \arg \max\{l(P_f(C_i)) : i = 1, \dots, n, i \neq m_1\}$.

if $(C_{m_1}$ is light)

then [According to Observation 3.14 also no outer-crossing in this case.]

if $((l_1 \neq -1) \wedge (((n \text{ is even}) \wedge (l_2 \neq 1)) \vee ((n \text{ is odd}) \wedge (l_2 \neq -1))))$

then *DIRECT-FORWARDS* (C_1, \dots, C_n) . [See Figure 21(a) and (b).]

elseif $((l_1 \neq 1) \wedge (((n \text{ is even}) \wedge (l_2 \neq -1)) \vee ((n \text{ is odd}) \wedge (l_2 \neq 1))))$

then *DIRECT-BACKWARDS* (C_1, \dots, C_n) . [See Figure 21(c) and (d).]

elseif $((l_1 = 1) \wedge (((n \text{ is even}) \wedge (l_2 = 1)) \vee ((n \text{ is odd}) \wedge (l_2 = -1))))$.

then [see Figure 21(e) and (f)]

DIRECT-TWO $(C_1, C_2, 1, 1)$.

DIRECT-BACKWARDS (C_3, \dots, C_n) .

elseif $((n \text{ is odd}) \wedge (l_1 = -1) \wedge (l_2 = 1))$.

then [See Figure 21(g).]

DIRECT-TWO $(C_{n-1}, C_n, 1, 1)$.

DIRECT-BACKWARDS (C_1, \dots, C_{n-2}) .

elseif $((n \text{ is even}) \wedge (l_1 = -1) \wedge (l_2 = -1))$.

then [See Figure 21(h).] (*)

DIRECT-ONE $(C_1, -1, -1)$.

DIRECT-TWO $(C_2, C_3, 1, 1)$.

DIRECT-BACKWARDS (C_4, \dots, C_n) .

end if

else $(C_{m_1}$ is heavy)

if $((C_{m_2}$ is light) \wedge $(C_{m_1}$ is not crossing))

then

if $(m_1 = 1)$

then *DIRECT-ONE* $(C_1, l_1, +1)$.

DIRECT-K $(C_2, \dots, C_n, -1, l_2)$.

elseif $(m_1 = n)$

then *DIRECT-ONE* $(C_n, +1, l_2)$.

DIRECT-K $(C_1, \dots, C_{n-1}, l_1, -1)$.

else $(1 < m_1 < n)$

DIRECT-ONE $(C_{m_1}, +1, +1)$.

DIRECT-K $(C_1, \dots, C_{m_1-1}, l_1, -1)$.

DIRECT-K $(C_{m_1+1}, \dots, C_n, -1, l_2)$.

end if

end if

* *Special treatment to satisfy Property 3.17.*

Figure 19: Procedure *DIRECT-MANY*, first part

```

DIRECT-MANY (cont.)
else (( $C_{m_2}$  is heavy)  $\vee$  ( $C_{m_1}$  is crossing))
  [When  $C_{m_1}$  is crossing, it is outer-crossing and very heavy, see Observation 3.14]
  [In this case  $C_{m_2}$  is either the crossing brother or light.]
  if ( $C_{m_1}$  is crossing)
    then  $\{j, k\} :=$  indices of  $C_{m_1}$  and its crossing brother,  $j = k - 1$ .
    else  $\{j, k\} := \{m_1, m_2\}$ ,  $j < k$ .
  end if
  if ( $j = 1$ )
    then DIRECT-ONE( $C_1, l_1, +1$ ).
    else DIRECT-ONE( $C_j, +1, +1$ ).
  end if
  if ( $k = n$ )
    then  $\delta = l_2$ . [ $l_2$  indicates the orientation of the last edge.]
    else  $\delta = 1$ . [ $C_k$  is oriented forwards and the last edge agree.]
  end if
  if (( $j = k - 1$ )  $\wedge$  ( $C_{m_1}$  is not crossing))
    then DIRECT-ONE( $C_k, -1, \delta$ ). [-1 to suit previous orientation by  $C_j$ .]
    else DIRECT-ONE( $C_k, +1, \delta$ ). [ $C_k$  is oriented forwards and the first edge agrees.]
  end if
  if ( $j > 1$ )
    then DIRECT-K( $C_1, \dots, C_{j-1}, l_1, -1$ ).
  end if
  if ( $j < k - 1$ )
    then DIRECT-K( $C_{j+1}, \dots, C_{k-1}, -1, -1$ ).
  end if
  if ( $k < n$ ) then DIRECT-K( $C_{k+1}, \dots, C_n, -1, l_2$ ).
  end if
end DIRECT-MANY

```

Figure 20: Procedure DIRECT-MANY, second part

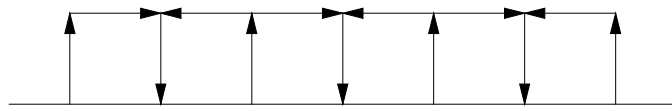

$l_1 \neq -1, l_2 \neq 1, n$ is even (a)

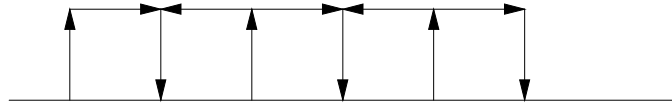

$l_1 \neq -1, l_2 \neq -1, n$ is odd (b)

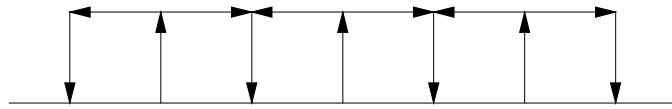

$l_1 \neq 1, l_2 \neq -1, n$ is even (c)

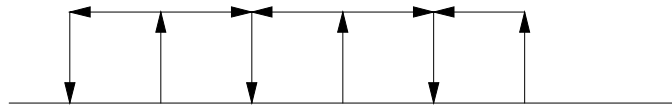

$l_1 \neq 1, l_2 \neq 1, n$ is odd (d)

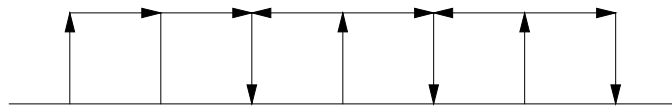

$l_1 = 1, l_2 = 1, n$ is even (e)

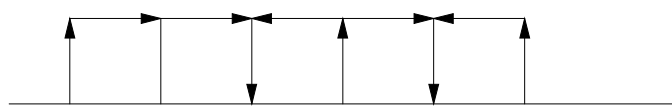

$l_1 = 1, l_2 = -1, n$ is odd (f)

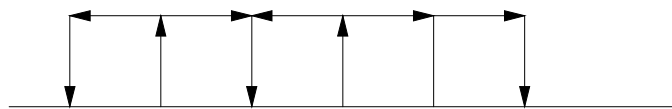

$l_1 = -1, l_2 = 1, n$ is odd (g)

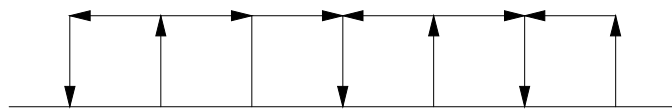

$l_1 = -1, l_2 = -1, n$ is even (h)

Figure 21: Examples for DIRECT-MANY orientations.

DIRECT-FORWARDS

input

Ordered neighbor brothers (C_1, \dots, C_n) with left points v_1, \dots, v_n , respectively.

begin

$v_{n+1} := (P_f(C_n) \cap P_s(C_n)) \setminus P_s(C_{n-1})$.

for $(i = 1, \dots, n)$

if $(i \text{ is odd})$

then *Orient $P_s(C_i)$ $v_i \rightarrow v_{i+1}$.*

else *Orient $P_s(C_i)$ $v_i \leftarrow v_{i+1}$.*

end if

end for

end *DIRECT-FORWARDS*

DIRECT-BACKWARDS

input

Ordered neighbor brothers (C_1, \dots, C_n) with left points v_1, \dots, v_n , respectively.

begin

$v_{n+1} := (P_f(C_n) \cap P_s(C_n)) \setminus P_s(C_{n-1})$.

for $(i = 1, \dots, n)$

if $(i \text{ is odd})$

then *Orient $P_s(C_i)$ $v_i \leftarrow v_{i+1}$.*

else *Orient $P_s(C_i)$ $v_i \rightarrow v_{i+1}$.*

end if

end for

end *DIRECT-BACKWARDS*

Figure 22: Procedures DIRECT-FORWARDS and DIRECT-BACKWARDS

DIRECT-INNER-CROSSING

input

Inner-crossing brothers (C_1, C_2) .

Parameters l_1 and l_2 .

begin

Let C' be the closest-containing brother of C_1 and C_2 [see Definition 3.14].

if $(C' \text{ is oriented forwards})$

then [see Figure 26(a).]

DIRECT-ONE $(C_1, l_1, +1)$.

DIRECT-ONE $(C_2, +1, l_2)$.

else [see Figure 26(b).]

DIRECT-ONE $(C_1, l_1, -1)$.

DIRECT-ONE $(C_2, -1, l_2)$.

end if

end *DIRECT-INNER-CROSSING*

Figure 23: Procedure DIRECT-INNER-CROSSING

DIRECT-TWO

input

Neighboring brothers (C_1, C_2) with left ends v_1, v_2 , respectively.

Parameters l_1 and l_2 .

begin

$u :=$ the end node of $P_s(C_1) \cap P_s(C_2)$ such that $u \notin P_f(C_1)$.

$v_3 := (P_f(C_2) \cap P_s(C_2)) \setminus P_s(C_1)$.

if *$(C_1$ and C_2 are light)*

then

if *$((l_1 \neq -1) \wedge (l_2 \neq 1))$*

then *$\text{Orient } P_s(C_1) v_1 \rightarrow v_2$. $\text{Orient } P_s(C_2) v_2 \leftarrow v_3$.*

elseif *$((l_1 = 0) \wedge (l_2 = 1)) \vee ((l_1 = -1) \wedge (l_2 \neq -1))$*

then *$\text{Orient } P_s(C_1) v_1 \leftarrow v_2$. $\text{Orient } P_s(C_2) v_2 \rightarrow v_3$.*

elseif *$((l_1 = 1) \wedge (l_2 = 1))$*

then

$\text{Orient } v_1 \rightarrow u \rightarrow v_3$.

if *$(l(C_1) < l(C_2))$*

then *$\text{Orient } u \rightarrow v_2$.*

else *$\text{Orient } u \leftarrow v_2$.*

end if

else *$((l_1 = -1) \wedge (l_2 = -1))$*

$\text{Orient } v_1 \leftarrow u \leftarrow v_3$.

if *$(l(C_1) < l(C_2))$*

then *$\text{Orient } u \leftarrow v_2$.*

else *$\text{Orient } u \rightarrow v_2$.*

end if

end if

else

$\text{DIRECT-ONE}(C_1, l_1, +1)$.

$\text{DIRECT-ONE}(C_2, -1, l_2)$.

*[Preventing a situation where both cycles are oriented backwards,
which is permitted only when both cycles are light.]*

end if

end *DIRECT-TWO*

Figure 24: Procedure DIRECT-TWO

DIRECT-ONE

input

A cycle C . Parameters l_1 and l_2 .

begin

$v_1, v_2 :=$ *the nodes in $P_s(C) \cap P_f(C)$ ordered according to orientation of $F(C)$.*

if $((l_1 \neq -1) \wedge (l_2 \neq -1))$

then *Orient C $v_1 \rightarrow v_2$.*

elseif $((C \text{ is light}) \wedge (C \text{ is not special-contained brother}) \wedge (l_1 \neq 1) \wedge (l_2 \neq 1))$

then *Orient C $v_1 \leftarrow v_2$.*

else [*C must be oriented forwards to satisfy Property 3.16, or Property 3.20*]

if $(l_1 = -1)$

then $C' :=$ *the cycle which sets the orientation $l_1 = -1$ [see Definition 3.13].*

$x :=$ *the end node of the path $P_s(C') \cap P_s(C)$ such that $x \notin F(C)$.*

 [*The path is oriented $x \rightarrow v_1$.*]

 [*The possible positions of C' are shown in Figure 27, where the bold line indicates C .*]

Orient $x \rightarrow v_2$.

if (*C' is oriented forwards*)

then $\beta = 0$.

else $\beta = l(P_c(C') \setminus C)$.

end if

if $(l(C) < l(C') + 2\beta)$

then *Orient $v_1 \rightarrow x$ [changing the current orientation].*

if $(l(C') < l(C))$

then

for every $D: (F(D) = C') \wedge (P_f(D) \subset (P_s(C') \cap P_s(C)))$
 $F(D) := C$.

end for

end if

end if

end if

if $(l_2 = -1)$

then $C'' :=$ *the cycle which sets the orientation $l_2 = -1$.*

$y :=$ *the end node of the path $P_s(C'') \cap P_s(C)$ such that $y \notin F(C)$.*

 [*The path is directed $v_2 \rightarrow y$.*]

Orient $v_1 \rightarrow y$.

if (*C'' is oriented forwards*)

then $\beta = 0$.

else $\beta = l(P_c(C'') \setminus C)$.

end if

if $(l(C) < l(C'') + 2\beta)$

then *Orient $y \rightarrow v_2$ [changing the current orientation].*

if $(l(C'') < l(C))$

then

for every $D: (F(D) = C'') \wedge (P_f(D) \subset (P_s(C'') \cap P_s(C)))$
 $F(D) := C$.

end for

end if

end if

end if

30

end if

end *DIRECT-ONE*

Figure 25: Procedure DIRECT-ONE

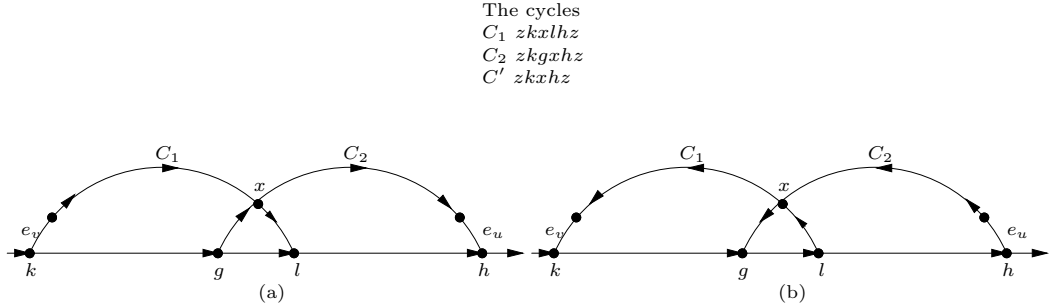

Figure 26: The orientation of DIRECT-INNER-CROSSING.

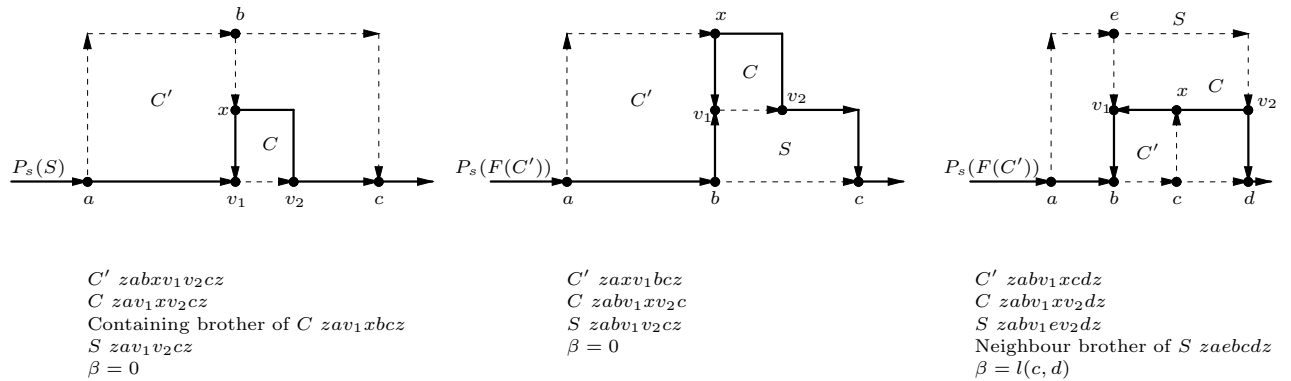

Figure 27: Examples for DIRECT-ONE.

3.3 The main result

The proof of next Proposition is given the following sections.

Proposition 3.26 *It is possible to define directed paths $M(S), B_t(S)$ and $B_h(S)$ for every cycle S , such that:*

A1 $l(M(S)) \leq 15l(P_c(S)) + 2l(P_s(S)) + l(I(S))$.

A2 • If $h(S) \notin F(S)$ then $l(B_h(S)) + l(M_h(S)) \leq 15l(P_c(S)) + 4l(P_s(S))$.

• If $t(S) \notin F(S)$ then $l(M_t(S)) + l(B_t(S)) \leq 15l(P_c(S)) + 4l(P_s(S))$.

Moreover:

• If $t(S), h(S) \notin F(S)$ then $l(B_h(S)) + l(B_t(S)) \leq 15l(P_c(S)) + 6l(P_s(S)) - l(I(S))$.

A3 *For every son C of S , if $P_f(C)$ contains at least one edge, then $P_f(C)$ and $I(S)$ have a common edge. When $P_f(C)$ contains only one node, this node is in $I(S)$.*

A4 *If C is a son of S , $P_f(C) \subset J_t(S) \cup I(S) \cup J_h(S)$.*

A5 *$M(S)$ is contained in the union of $P_s(S)$ and all cycles which are preferred to S .*

A6 *$M(S)$ is contained in $P_s(S), P_s(F(S)), M(F(S)), B_t(F(S)), B_h(F(S))$, and a set $N(S)$ of at most three other cycles.*

We will prove the persistence of these hypotheses by induction on the index $i \in \{1, \dots, g_{max}\}$ in Main, corresponding to a cycle S such that $g(S) \leq i$.

Initially $I(C_0) = C_0$. $M(C_0) = \phi$. $B_t(C_0) = \phi$. $B_h(C_0) = \phi$.

Theorem 3.27 *In the directed graph returned by MAIN, every undirected cycle $S \in \mathcal{C}$ has a directed cycle \vec{S} , such that*

$$l(\vec{S}) \leq 15l(S).$$

Proof: By Proposition 3.26 for every cycle S in the output of MAIN there are directed paths $M(S), B_t(S), B_h(S)$ and $I(S)$ such that

$$l(M(S)) \leq 15l(P_c(S)) + 2l(P_s(S)) + l(I(S)). \quad (20)$$

$I(S) \subseteq P_s(S)$ giving that $l(I(S)) \leq l(P_s(S))$ and therefore by (20):

$$l(M(S)) \leq 15l(P_c(S)) + 3l(P_s(S)).$$

The concatenation of $M(S)$ and $I(S)$ creates the directed cycle \vec{S} which connects $U(S)$ and z . Since $S = P_c(S) \cup P_s(S)$

$$l(\vec{S}) = l(M(S)) + l(I(S)) \leq 15l(P_c(S)) + 4l(P_s(S)) \leq 15l(S)$$

■

Theorem 3.28 For every node v , let $C^*(v)$ be the original cycle which serves v in G and let $C(v)$ be the undirected cycle which serves v after the application of CANCEL-CROSSING and MAIN. Then:

$$l(C(v)) \leq 27l(C^*(v)).$$

Proof: Let $\hat{C}(v)$ be the cycle which serves v after CANCEL-CROSSING is applied on the graph. According to Corollary 2.8

$$l(\hat{C}(v)) \leq 9l(C^*(v)).$$

During the application of MAIN $\hat{C}(v)$ may be farther changed. According to Remark 3.51 (below)

$$l(C(v)) \leq 3l(\hat{C}(v)).$$

Altogether

$$l(C(v)) \leq 27l(C^*(v)).$$

■

Corollary 3.29 For every node v , let $C^*(v)$ be the original cycle which serves v in G , and let $\vec{C}(v)$ be the directed cycle which connects v and z in the graph returned by MAIN. Then:

$$l(\vec{C}(v)) \leq 15 \cdot 27l(C(v)) = 405l(C(v)).$$

Theorem 3.30 Let D be the directed diameter of the graph returned by MAIN,

$$D \leq 1620D_{H_{opt}}.$$

Proof: For every node v , let $C^*(v)$ be the original cycle which serves v in G , and let $\vec{C}(v)$ be the directed cycle which connects v and z in the graph returned by MAIN. For every two nodes $v_1, v_2 \in V$ the length of the directed path from v_1 to v_2 is bounded by the sum of the length of directed path from v_1 to z in $\vec{C}(v_1)$ and the length of the path from z to v_2 in $\vec{C}(v_2)$, thus:

$$D \leq 2\max_{v \in V} \{l(\vec{C}(v))\}$$

From Corollary 3.29

$$D \leq 2 \cdot 405\max_{v \in V} \{l(C(v))\}$$

For every undirected cycle $C \in \mathcal{C}$ $l(C) \leq 2D_{H_{opt}}$, giving:

$$D \leq 1620D_{H_{opt}}.$$

■

3.4 The path $B(S)$

Lemma 3.31 In many cases we construct $B_h(S)$ and $B_t(S)$ in the following manner. We first create a directed path $B(S)$ from $M_t(S)$ to $M_h(S)$ such that $l(B(S)) \leq 2l(P_s(S)) - l(I(S))$. When $h(S) \notin F(S)$ we define $B_h(S) \subseteq M_t(S) \cup B(S)$ as follows: start in z , continue with $M_t(S)$ until it meets $B(S)$, and then use $B(S)$ to reach $h(S)$ via $J_h(S)$. Similarly when $t(S) \notin F(S)$ define $B_t(S) \subseteq M_h(S) \cup B(S)$. If $B(S)$ exists, $l(B(S)) \leq 2l(P_s(S)) - l(I(S))$, and A1 holds, then A2 holds for the paths $B_t(S), B_h(S)$ constructed above.

Proof: From A1

$$l(M_h(S)) + l(M_t(S)) = l(M(S)) \leq 15l(P_c(S)) + 2l(P_s(S)) + l(I(S)).$$

When $h(S) \notin F(S)$ since $B_h(S) \subseteq M_t(S) \cup B(S)$:

$$l(B_h(S)) + l(M_h(S)) \leq l(B(C)) + l(M_t(S)) + l(M_h(S)).$$

From the lemma's assumption we get that:

$$l(B_h(S)) + l(M_h(S)) \leq 15l(P_c(S)) + 4l(P_s(S)).$$

Similarly:

$$l(B_t(S)) + l(M_t(S)) \leq 15l(P_c(S)) + 4l(P_s(S)).$$

By assumption, when $h(S), t(S) \notin F(S)$: $B_h(S) \subseteq B(S) \cup M_t(S)$ and $B_t(S) \subseteq B(S) \cup M_h(S)$, giving:

$$l(B_h(S)) + l(B_t(S)) \leq l(M_h(S)) + l(M_t(S)) + 2l(B(S)).$$

The required bound follows now from the lemma's assumptions. ■

3.5 Outline of the proof

In Section 3.6 we prove that a cycle C with $I(C) = P_s(C)$ satisfies the induction hypotheses. This is sufficient to prove that when DIRECT-FORWARDS and DIRECT-BACKWARDS are applied, the induction hypotheses are satisfied.

In Section 3.7 we prove that when two neighbor brothers are oriented in the same direction they satisfy the induction hypotheses. This is sufficient to prove that when DIRECT-TWO and DIRECT-MANY are applied to light cycles, the induction hypotheses are satisfied.

When C is a heavy cycle or a special-contained brother DIRECT-ONE is activated to orient it. In Section 3.10 we discuss cycles oriented by DIRECT-ONE. If a cycle is neither heavy nor special-contained, previous proofs apply. Otherwise DIRECT-ONE defines the cycles C' or C'' . We continue by considering the relation between C and C', C'' . Section 3.10.1 handles the case where C and C' are brothers from the same level on containment (and uses proofs given in Section 3.8 and Section 3.9). Section 3.10.2 handles the case where C' is a brother from a previous level of containment. Finally, Section 3.10.3 handles the case where C'' is from a previous generation than C . This section is divided into two parts. Section 3.10.3 assumes that $F(C)$ is oriented forwards, and Section 3.10.3 assumes that $F(C)$ is oriented backwards.

In Section 3.11 we prove that two inner-crossing brothers satisfy the induction hypotheses. This is sufficient to prove that when DIRECT-INNER-CROSSING is applied, the induction hypotheses are satisfied.

3.6 $I(C) = P_s(C)$

We first consider the simple cases when $I(C) = P_s(C)$.

Let $S = F(C)$. Mark $\{v_1, v_2\} = P_s(C) \cap P_f(C)$. Suppose that v_1, v_2 are ordered according to direction of S .

In this proof and all similar proofs we mark $x = t(S), y = h(S)$, and the end nodes v, w of $P_s(S)$, ordered v, x, y, w .

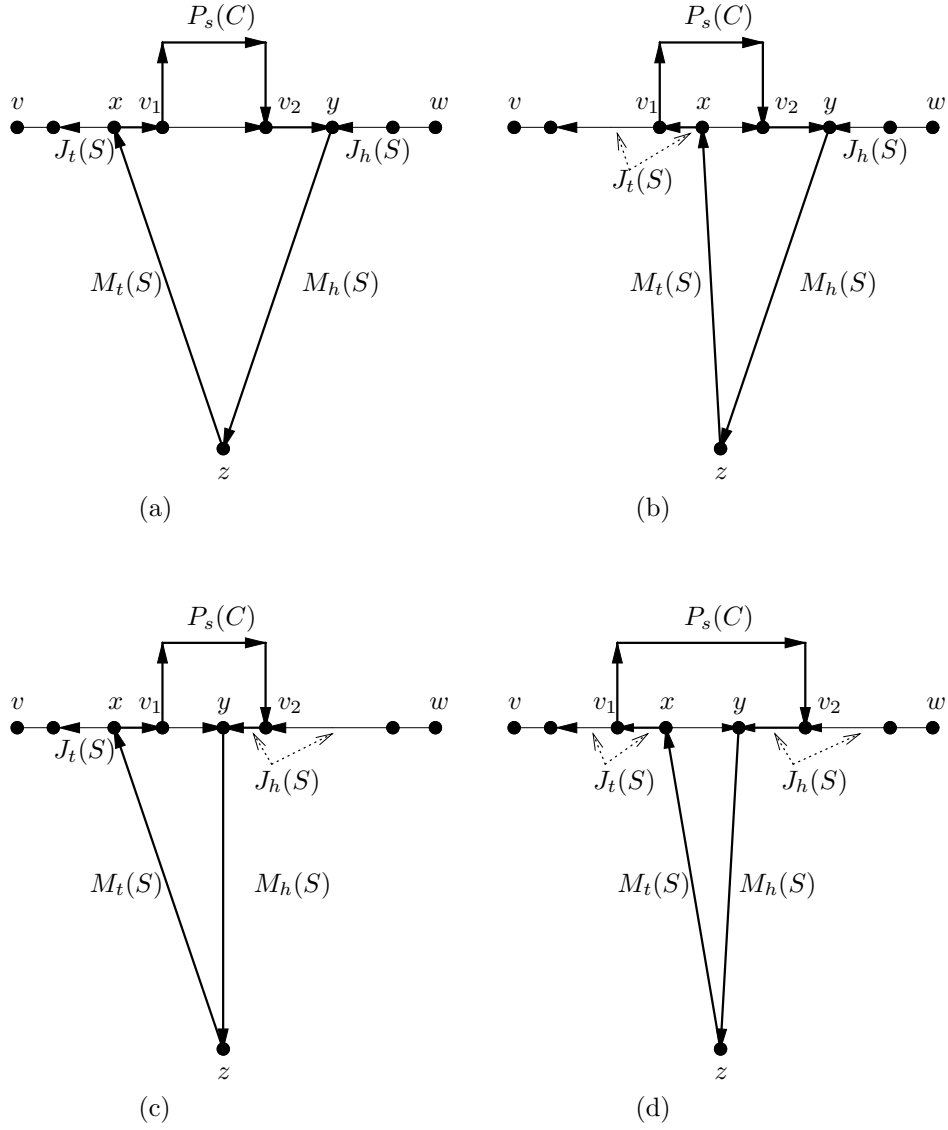

Figure 28: Figure for Lemma 3.32.

Lemma 3.32 *Suppose that S satisfies the induction hypotheses and $P_s(C)$ is oriented $v_1 \rightarrow v_2$, then C satisfies the induction hypotheses. Moreover $|N(C)| = 0$.*

Proof: Since $P_s(C)$ is oriented $v_1 \rightarrow v_2$, $I(C) = P_s(C)$. We go over the induction hypotheses:

A1 Since $S = F(C)$

$$l(v_1, v_2) \leq l(P_s(C)). \quad (21)$$

By A3 there are four cases to be considered (described in Figure 28):

(a) $[v_1, v_2] \subseteq [x, y]$ ($P_f(C) \subset I(S)$). This case is described in Figure 28 (a). From A1

$$\begin{aligned} l(M(S)) &\leq 15l(P_c(S)) + 2l(P_s(S)) + l(I(S)) \\ &= 15l(P_c(S)) + 2l(v, x) + 3l(x, v_1) + 3l(v_1, v_2) + 3l(v_2, y) + 2l(y, w). \end{aligned}$$

Since $[x \rightarrow y] = I(S)$, $[x, y]$ is oriented $x \rightarrow v_1 \rightarrow v_2 \rightarrow y$ (where $v_1 \rightarrow v_2$ refers to $P_f(C)$). Let

$$M_t(C) = M_t(S) \cup [x \rightarrow v_1], \quad M_h(C) = M_h(S) \cup [v_2 \rightarrow y],$$

then:

$$\begin{aligned} l(M(C)) &= l(M(S)) + l(x, v_1) + l(v_2, y) \\ &\leq 15l(P_c(S)) + 2l(v, x) + 4l(x, v_1) + 3l(v_1, v_2) + 4l(v_2, y) + 2l(y, w). \end{aligned}$$

By definition,

$$l(P_c(C)) = l(P_c(S)) + l(v, x) + l(x, v_1) + l(v_2, y) + l(y, w).$$

Hence,

$$l(M(C)) \leq 15l(P_c(C)) + 3l(v_1, v_2).$$

In this case also $I(C) = P_s(C)$ and using Equation (21) we obtain:

$$l(M(C)) \leq 15l(P_c(C)) + 2l(P_s(C)) + l(I(C)).$$

(b) $x \in [v_1, v_2]$ and $v_2 \in [x, y]$, so the nodes are ordered v, v_1, x, v_2, y, w . This case is described in Figure 28 (b). From A1

$$\begin{aligned} l(M(S)) &\leq 15l(P_c(S)) + 2l(P_s(S)) + l(I(S)) \\ &= 15l(P_c(S)) + 2l(v, v_1) + 2l(v_1, x) + 3l(x, v_2) + 3l(v_2, y) + 2l(y, w). \end{aligned}$$

From A4 on S , $v_1 \leftarrow x \rightarrow v_2 \rightarrow y$. Let

$$M_t(C) = M_t(S) \cup [x \rightarrow v_1], \quad M_h(C) = M_h(S) \cup [v_2 \rightarrow y],$$

then:

$$\begin{aligned} l(M(C)) &= l(M(S)) + l(x, v_1) + l(v_2, y) \\ &= 15l(P_c(S)) + 2l(v, v_1) + 3l(v_1, x) + 3l(x, v_2) + 4l(v_2, y) + 2l(y, w). \end{aligned}$$

By definition,

$$l(P_c(C)) = l(P_c(S)) + l(v, v_1) + l(v_2, y) + l(y, w).$$

Hence,

$$l(M(C)) \leq 15l(P_c(C)) + 3l(v_1, x) + 3l(x, v_2) = 15l(P_c(C)) + 3l(v_1, v_2)$$

In this case also $I(C) = P_s(C)$ and using Equation (21) we obtain:

$$l(M(C)) \leq 15l(P_c(C)) + 2l(P_s(C)) + l(I(C)).$$

- (c) $v_1 \in [x, y]$ and $y \in [v_1, v_2]$. This case is described in Figure 28 (c). The proof is similar to the proof of previous case.
- (d) $[x, y] \subset [v_1, v_2]$ ($I(S) \subset P_f(C)$), so the nodes are ordered v, v_1, x, y, v_2, w . This case is described in Figure 28 (d). From A1

$$\begin{aligned} l(M(S)) &\leq 15l(P_c(S)) + 2l(P_s(S)) + l(I(S)) \\ &= 15l(P_c(S)) + 2l(v, v_1) + 2l(v_1, x) + 3l(x, y) + 2l(y, v_2) + 2l(v_2, w). \end{aligned}$$

From A4 $v_1 \leftarrow x \rightarrow y \leftarrow v_2$. Let

$$M_t(C) = M_t(S) \cup [x \rightarrow v_1], \quad M_h(C) = M_h(S) \cup [v_2 \rightarrow y],$$

then:

$$\begin{aligned} l(M(C_1)) &= l(M(S)) + 2l(x, v_1) + l(v_2, y) \\ &\leq 15l(P_c(S)) + 2l(v, v_1) + 3l(v_1, x) + 3l(x, y) + 3l(y, v_2) + 2l(v_2, w). \end{aligned}$$

By definition

$$l(P_c(C)) = l(P_c(S)) + l(v, v_1) + l(v_2, w).$$

Hence,

$$l(M(C)) \leq 15l(P_c(C)) + 3l(v_1, x) + 3l(x, y) + 3l(y, v_2) = 15l(P_c(C)) + 3l(v_1, v_2).$$

By Equation (21):

$$l(M(C)) \leq 15l(P_c(C)) + 2l(P_s(C)) + l(I(C)).$$

A2 In this case $I(C) = P_s(C)$.

A3 Since $I(C) = P_s(C)$ and for every son \hat{C} of C $P_f(\hat{C}) \cap P_s(C) \neq \phi$, $P_f(\hat{C}) \cap I(C) \neq \phi$.

A4 If \hat{C} is a son of C , $P_f(\hat{C}) \subseteq P_s(C) = I(C)$.

A5 $M(C)$ is contained in $P_s(C)$ and $P_s(S) \cup M(S)$ which are shorter than C .

A6 $M(C) \subseteq P_s(C) \cup P_s(S) \cup M(S)$, so $N(C) = \phi$.

■

Lemma 3.33 *Suppose that S satisfies the induction hypotheses and $P_s(C)$ is oriented $v_1 \leftarrow v_2$ then C satisfies the induction hypotheses. Moreover $|N(C)| = 0$.*

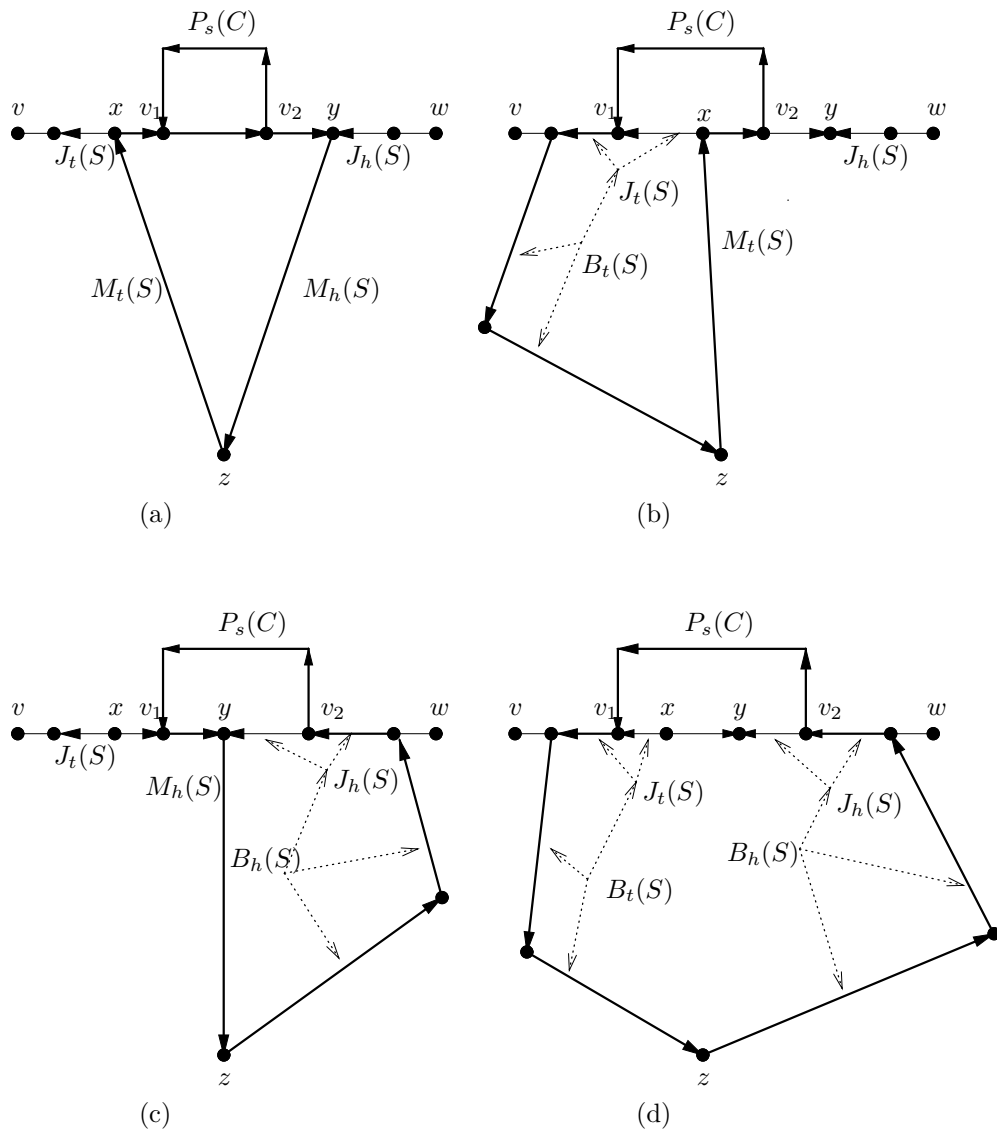

Figure 29: Figure for Lemma 3.33.

Proof: Since $P_s(C)$ is oriented in a consistent manner, $I(C) = P_s(C)$. We go over the induction hypotheses:

A1 Since C is oriented backwards, according to Property 3.16 C is light, giving:

$$l(v_1, v_2) \leq 0.5[l(v, v_1) + l(v_2, w)]. \quad (22)$$

By A3 there are four cases to be considered (described in Figure 29):

(a) $[v_1, v_2] \subset [x, y]$ ($P_f(C_2) \subset I(S)$). This case is described in Figure 29(a). From A1

$$\begin{aligned} l(M(S)) &\leq 15l(P_c(S)) + 2l(P_s(S)) + l(I(S)) \\ &= 15l(P_c(S)) + 2l(v, x) + 3l(x, v_1) + 3l(v_1, v_2) + 3l(v_2, y) + 2l(y, w). \end{aligned}$$

Since $[x \rightarrow y] = I(S)$, $[x, y]$ is oriented $x \rightarrow v_1 \rightarrow v_2 \rightarrow y$. Let

$$M_t(C) = M_t(S) \cup [x \rightarrow v_2], \quad M_h(C) = [v_1, y] \cup M_h(S).$$

From (22):

$$\begin{aligned} l(M(C)) &= l(M(S)) + l(x, v_1) + 2l(v_1, v_2) + l(v_2, y) \\ &\leq 15l(P_c(S)) + 2l(v, x) + 4l(x, v_1) + 5l(v_1, v_2) + 4l(v_2, y) + 2l(y, w) \\ &\leq 15l(P_c(S)) + 4.5l(v, x) + 6.5l(x, v_1) + 6.5l(v_2, y) + 4.5l(y, w). \end{aligned}$$

By definition

$$l(P_c(C)) = l(P_c(S)) + l(v, x) + l(x, v_1) + l(v_2, y) + l(y, w),$$

giving

$$l(M(C)) \leq 15l(P_c(C)) \leq l(P_c(C)) + 2l(P_s(C)) + l(I(C)).$$

(b) $x \in [v_1, v_2]$ and $v_2 \in [x, y]$. This case is described in Figure 29(b). Since $x \in [v_1, v_2]$ obviously $x \notin F(S)$, and therefore by A2:

$$l(M_t(S)) + l(B_t(S)) \leq 15l(P_c(S)) + 4l(P_s(S)).$$

From A4 we get that $v_1 \leftarrow x \rightarrow v_2 \rightarrow y$. Let

$$M_t(C) = M_t(S) \cup [x \rightarrow v_2], \quad M_h(C) = B_t(S) \setminus [x \rightarrow v_1].$$

Then:

$$\begin{aligned} l(M(C)) &\leq l(M_t(S)) + l(x, v_2) + l(B_t(S)) \\ &\leq 15l(P_c(S)) + 4l(P_s(S)) + l(x, v_2) \\ &\leq 15l(P_c(S)) + 4l(v, v_1) + 4l(v_1, x) + 5l(x, v_2) + 4l(v_2, y) + 4l(y, w) \\ &\leq 15l(P_c(S)) + 6.5l(v, v_1) + 6.5l(v_2, y) + 6.5l(y, w), \end{aligned}$$

where the last inequality follows from (22). By definition

$$l(P_c(C)) = l(P_c(S)) + l(v, v_1) + l(v_2, y) + l(y, w),$$

giving:

$$l(M(C)) \leq 15l(P_c(C)) \leq 15l(P_c(C)) + 2l(P_s(C)) + l(I(C)).$$

- (c) $v_1 \in [x, y]$ and $y \in [v_1, v_2]$. This case is described in Figure 29(c). The proof is similar to the proof of previous case.
- (d) $[x, y] \subset [v_1, v_2]$ ($I(S) \subset P_f(C_1)$). This case is described in Figure 29(d). From A2 (in this case $x, y \notin F(S)$)

$$l(B_h(S)) + l(B_t(S)) \leq 15l(P_c(S)) + 6l(P_s(S)).$$

From A4 we get that $v_1 \leftarrow x \rightarrow y \leftarrow v_2$. Let

$$M_t(C) = B_h(S) \setminus [v_2, y],$$

and

$$M_h(C) = B_t(S) \setminus [x, v_1].$$

Then:

$$\begin{aligned} l(M(C)) &\leq l(B_h(S)) + l(B_t(S)) \\ &\leq 15l(P_c(S)) + 6l(P_s(S)) \\ &\leq 15l(P_c(S)) + 6l(v, v_1) + 6l(v_1, x) + 6l(x, y) + 6l(y, v_2) + 6l(v_2, w) \\ &\leq 15l(P_c(S)) + 9l(v, v_1) + 2l(v_1, x) + 2l(x, y) + 2l(y, v_2) + 9l(v_2, w), \end{aligned}$$

where the last inequality follows from (22). By definition

$$l(P_c(C)) = l(P_c(S)) + l(v, v_1) + l(v_2, w),$$

giving:

$$l(M(C)) \leq 15l(P_c(C)) + 2l(v_1, v_2).$$

By Equation (21):

$$l(M(C)) \leq 15l(P_c(C)) + 2l(P_s(C)) + l(I(C)).$$

A2 In this case $I(C) = P_s(C)$.

A3 Since $I(C) = P_s(C)$ and for every son \hat{C} of C $P_f(\hat{C}) \cap P_s(C) \neq \phi$, $P_f(\hat{C}) \cap I(C) \neq \phi$.

A4 If \hat{C} is a son of C , $P_f(\hat{C}) \subseteq P_s(C) = I(C)$.

A5 $M(C)$ is contained in $P_s(C)$ and $P_s(S) \cup M(S)$ which are shorter than C .

A6 $M(C) \subseteq P_s(C) \cup P_s(S) \cup M(S)$, so $N(C) = \phi$.

■

Corollary 3.34 *The cycles directed by DIRECT-FORWARDS and DIRECT-BACKWARDS satisfy the induction hypotheses.*

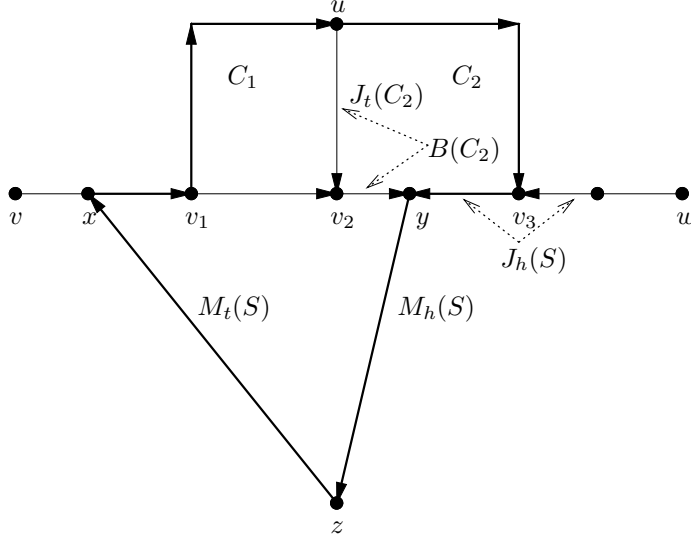

Figure 30: Figure for Lemma 3.35.

3.7 Two brothers

In this section we consider two neighbor brothers C_1 and C_2 ordered according to direction of $S = F(C_1) = F(C_2)$, where the two brothers were oriented in the same direction³ (so they were not oriented by DIRECT-FORWARDS or DIRECT-BACKWARDS). The first lemma assumes that they were both oriented forwards, and the second lemma assumes they were both oriented backwards.

Mark

- $u :=$ the end node of the path $P_s(C_1) \cap P_s(C_2)$, such that $u \notin S$.
- $v_1 := S \cap (P_s(C_1) \setminus P_s(C_2))$.
- $v_2 := S \cap (P_s(C_1) \cap P_s(C_2))$.
- $v_3 := S \cap (P_s(C_2) \setminus P_s(C_1))$.

For one of these brothers $I(C) = P_s(C)$, but for the other brother $I(C) \subset P_s(C)$.

Lemma 3.35 *Suppose that S satisfies the induction hypotheses, and C_1, C_2 were oriented (see Figure 30) $v_1 \rightarrow u \rightarrow v_2, u \rightarrow v_3$ (i.e. both were oriented forwards). Then C_2 satisfies the induction hypotheses. Moreover $|N(C_2)| = 1$.*

Proof: By Observation 3.25 the orientation $u \rightarrow v_3$ indicates that $l(C_1) < l(C_2)$ (for example in the procedure DIRECT-TWO). It follows that⁴ $U(C_2) \subset [u, v_3]$, and therefore:

$$I(C_2) = [u \rightarrow v_3], t(C_2) = u, h(C_2) = v_3.$$

³ For example, such orientation can be the result of DIRECT-TWO with $l_1 = l_2 = 1$ or $l_1 = l_2 = -1$.

⁴ $[u, v_3]$ is the path in $P_s(C_2)$, $[v_1, u]$ is the path in $P_s(C_1)$

Since $l(C_1) < l(C_2)$

$$l(v_1, u) + l(v_2, v_3) < l(v_1, v_2) + l(u, v_3). \quad (23)$$

A1 By A3 on S $x \in [v, v_2]$ and $y \in [v_2, w]$. By A4 the direction is always $x \rightarrow v_1$ and $v_3 \rightarrow y$ so we can define:

$$M_t(C_2) = M_t(S) \cup [x \rightarrow v_1] \cup [v_1 \rightarrow u], \quad M_h(C_2) = [v_3 \rightarrow y] \cup M_h(S).$$

Using A1 on S

$$\begin{aligned} l(M(C_2)) &= l(M(S)) + l(x, v_1) + l(v_1, u) + l(v_3, y) \\ &\leq 15l(P_c(S)) + 2l(P_s(S)) + l(I(S)) + l(x, v_1) + l(v_1 \rightarrow u) + l(v_3, y) \\ &\leq 15l(P_c(S)) + 4l(v, v_1) + 3l(v_1, v_2) + 3l(v_2, v_3) + 4l(v_3, w) + l(v_1 \rightarrow u). \end{aligned}$$

Note that:

- The lengths of $[v, v_1]$ and $[v_3, w]$ are taken four times to satisfy all four cases of locations for x, y . In Figure 30 the case $x \in [v, v_1], y \in [v_2, v_3]$ is described. In this case the length of $[x, v_1]$ should be counted four times: twice in $2l(P_s(S))$, once in $l(I(S))$ and once in $l(M_t(C_2))$. This is taken into account by considering $4l(v, v_1)$.
- The length of $[v_1, v_2]$ is taken only three times. When $x \notin [v_1, v_2]$ then $[v_1, v_2]$ is counted three times in $2l(P_s(S)) + l(I(S))$. When $x \in [v_1, v_2]$ then $[v_1, x]$ is counted twice in $2l(P_s(S)) + l(I(S))$ and once more in $l(M_t(C_2))$. The path $[x, v_2]$ is counted three times in $2l(P_s(S)) + l(I(S))$, giving altogether three times $l(v_1, v_2)$.
- In the same manner the length of $[v_2, v_3]$ is taken only three times both when $y \in [v_2, v_3]$ and for $y \notin [v_2, v_3]$.

From (23)

$$l(M(C_2)) \leq 15l(P_c(S)) + 4l(v, v_1) + 4l(v_1, v_2) + 2l(v_2, v_3) + 4l(v_3, w) + l(u, v_3).$$

By definition

$$l(P_c(C_2)) = l(P_c(S)) + l(v, v_1) + l(v_1, v_2) + l(v_3, w),$$

so that

$$l(M(C_2)) \leq 15l(P_c(C_2)) + 2l(v_2, v_3) + l(u, v_3).$$

Since C_2 is a son of S , $l(v_2, v_3) \leq l(P_s(C_2))$. In this case $I(C_2) = [u \rightarrow v_3]$ so

$$l(M(C_2)) \leq 15l(P_c(C_2)) + 2l(P_s(C_2)) + l(I(C_2)).$$

A2 When $y \in [v_3, w]$ we define

$$B(C_2) = [u \rightarrow v_2 \rightarrow v_3].$$

When $y \in [v_2, v_3]$ we define⁵

$$B(C_2) = [u \rightarrow v_2 \rightarrow y].$$

⁵Note that $y \in M_h(C_2)$.

In both cases $l(B(C_2)) \leq l(u, v_2) + l(v_2, v_3)$. From the definition of $I(C_2)$ and since C_2 is a son of S ,

$$\begin{aligned} l(B(C_2)) &\leq l(u, v_2) + l(v_2, v_3) \\ &= l(P_s(C_2)) - l(I(C_2)) + l(v_2, v_3) \\ &\leq l(P_s(C_2)) - l(I(C_2)) + l(P_s(C_2)) \\ &= 2l(P_s(C_2)) - l(I(C_2)). \end{aligned}$$

A3 Let \hat{C} be a son of C_2 . Since $[u, v_2] \subseteq P_s(C_1)$ and $l(C_1) < l(C_2)$, if $P_f(\hat{C}) \subseteq [u, v_2]$ then \hat{C} should have been a son of C_1 . Therefore $P_f(\hat{C}) \cap (u, v_3) \neq \emptyset$.

A4 In this case $J_t(C_2) = [u \rightarrow v_2]$. Obviously for every son \hat{C} of C_2 $P_f(\hat{C}) \subset P_s(C_2) = J_t(C_2) \cup I(C_2)$.

A5 $M(C_2) \subseteq P_s(C_2) \cup C_1 \cup M(S)$. Since $l(C_1) < l(C_2)$ the condition is satisfied.

A6 $M(C_2)$ is contained in $P_s(C_2)$, C_1 (a brother of C_2), S , $B_t(S), B_h(S)$ and $M(S)$, so $N(C_2) = \{C_1\}$.

■

Lemma 3.36 *Suppose that S satisfies the induction hypotheses, and C_1, C_2 were oriented (see Figure 31) $v_1 \leftarrow u \leftarrow v_2, u \leftarrow v_3$ (i.e. both were oriented backwards). Then C_2 satisfies the induction hypotheses. Moreover $|N(C_2)| = 1$.*

Proof: By Observation 3.25 the orientation $u \leftarrow v_3$ indicates that $l(C_1) < l(C_2)$ (for example in the procedure DIRECT-TWO). It follows that $U(C_2) \subset [u, v_3]$ and therefore

$$I(C_2) = [v_3 \rightarrow u], \quad t(C_2) = v_3, \quad h(C_2) = u.$$

From $l(C_1) < l(C_2)$ we get that (23) still holds.

A1, A2 Since C_2 was oriented backwards, according to Property 3.16 C_2 is light:

$$l(v_2, v_3) \leq 0.5[l(v, v_2) + l(v_3, w)]. \quad (24)$$

By A3 there are four cases to be considered (described in Figure 31):

(a) $[v_1, v_3] \subseteq [x, y]$. This case is described in Figure 31(a). Since $[x \rightarrow y] = I(S)$, $[x, y]$ is oriented $x \rightarrow v_1 \rightarrow v_2 \rightarrow v_3 \rightarrow y$. Let

$$M_t(C_2) = M_t(S) \cup [x \rightarrow v_1 \rightarrow v_2 \rightarrow v_3], \quad M_h(C_2) = [u \rightarrow v_1 \rightarrow v_2 \rightarrow v_3 \rightarrow y] \cup M_h(S).$$

By A1, Equations (23) and (24)

$$\begin{aligned} l(M(C_2)) &= l(M(S)) + l(x, v_1) + 2l(v_1, v_2) + 2l(v_2, v_3) + l(v_1, u) + l(v_3, y) \\ &\leq 15l(P_c(S)) + 2l(v, x) + 3l(x, v_1) + 3l(v_1, v_2) + 3l(v_2, v_3) + 3l(v_3, y) + \\ &\quad 2l(y, w) + l(x, v_1) + 2l(v_1, v_2) + 2l(v_2, v_3) + l(v_1, u) + l(v_3, y) \end{aligned}$$

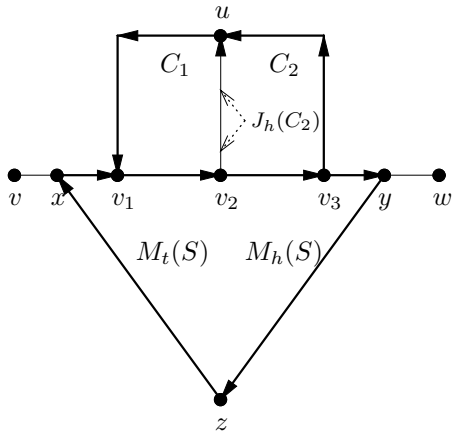

(a)

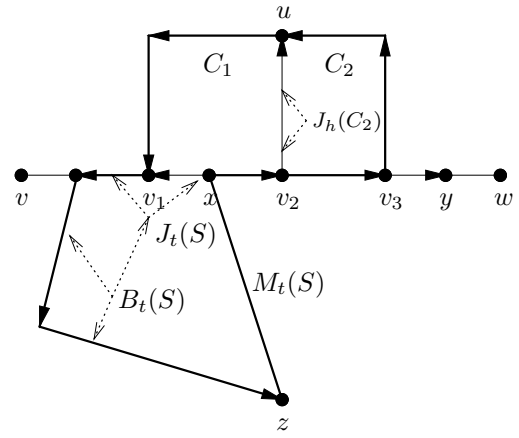

(b)

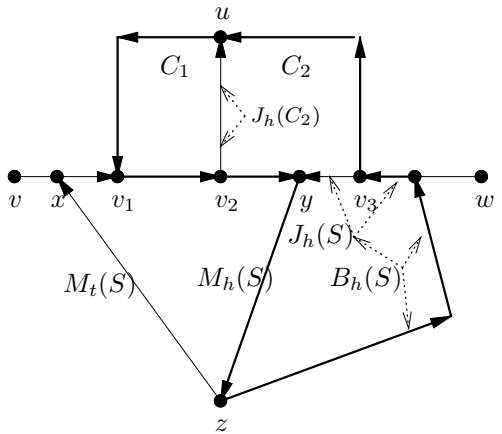

(c)

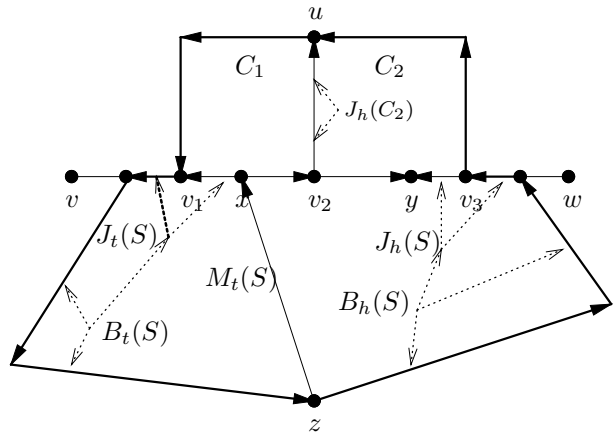

(d)

Figure 31: Figure for Lemma 3.36.

$$\begin{aligned}
&\leq 15l(P_c(S)) + 2l(v, x) + 4l(x, v_1) + 5l(v_1, v_2) + 5l(v_2, v_3) + 4l(v_3, y) + \\
&\quad 2l(y, w) + l(v_1, u) \\
&\leq 15l(P_c(S)) + 2l(v, x) + 4l(x, v_1) + 6l(v_1, v_2) + 4l(v_2, v_3) + 4l(v_3, y) + \\
&\quad 2l(y, w) + l(u, v_3) \\
&\leq 15l(P_c(S)) + 3l(v, x) + 5l(x, v_1) + 7l(v_1, v_2) + 2l(v_2, v_3) + 5l(v_3, y) + \\
&\quad 3l(y, w) + l(u, v_3).
\end{aligned}$$

By definition

$$l(P_c(C_2)) = l(P_c(S)) + l(v, x) + l(x, v_1) + l(v_1, v_2) + l(v_3, y) + l(y, w),$$

so that

$$l(M(C_2)) \leq 15l(P_c(C_2)) + 2l(v_2, v_3) + l(u, v_3).$$

Since C_2 is a son of S , $l(v_2, v_3) \leq l(P_s(C_2))$. $I(C_2) = [v_3 \rightarrow u]$ so

$$l(M(C_2)) \leq 15l(P_c(C_2)) + 2l(P_s(C_2)) + l(I(C_2)).$$

In this case we define⁶:

$$B(C_2) = [v_2 \rightarrow u].$$

From the definition of $I(C_2)$ and since C_2 is a son of S

$$l(B(C_2)) = l(v_2, u) = l(P_s(C_2)) - l(I(C_2)) \leq 2l(P_s(C_2)) - l(I(C_2)).$$

(b) $x \in [v_1, v_2]$ and $y \in [v_3, w]$. This case is described in Figure 31(b). From A4 the paths are oriented $v_1 \leftarrow x \rightarrow v_2 \rightarrow v_3 \rightarrow y$. From A2 (since $x \notin F(S)$)

$$l(M_t(S)) + l(B_t(S)) \leq 15l(P_c(S)) + 4l(P_s(S)).$$

Let

$$M_t(C_2) = M_t(S) \cup [x \rightarrow v_2 \rightarrow v_3], \quad M_h(C_2) = [u \rightarrow v_1] \cup (B_t(S) \setminus [x, v_1]),$$

then:

$$\begin{aligned}
l(M(C_2)) &\leq l(M_t(S)) + l(B_t(S)) + l(x, v_2) + l(v_2, v_3) + l(u, v_1) \\
&\leq 15l(P_c(S)) + 4l(P_s(S)) + l(x, v_2) + l(v_2, v_3) + l(u, v_1) \\
&= 15l(P_c(S)) + 4l(v, v_1) + 4l(v_1, x) + 5l(x, v_2) + 5l(v_2, v_3) + 4l(v_3, y) + \\
&\quad 4l(y, w) + l(u, v_1) \\
&\leq 15l(P_c(S)) + 4l(v, v_1) + 5l(v_1, x) + 6l(x, v_2) + 4l(v_2, v_3) + 4l(v_3, y) + \\
&\quad 4l(y, w) + l(u, v_3) \\
&\leq 15l(P_c(S)) + 5l(v, v_1) + 6l(v_1, x) + 7l(x, v_2) + 2l(v_2, v_3) + 5l(v_3, y) + \\
&\quad 5l(y, w) + l(u, v_3),
\end{aligned}$$

where the last two inequalities follow from (23) and (24). By definition

$$l(P_c(C_2)) = l(P_c(S)) + l(v, v_1) + l(v_1, x) + l(x, v_2) + l(v_3, y) + l(y, w),$$

⁶Note that $v_2 \in M_t(C_2)$.

so that

$$l(M(C_2)) \leq 15l(P_c(C_2)) + 2l(v_2, v_3) + l(u, v_3).$$

Since C_2 is a son of S , $l(v_2, v_3) \leq l(P_s(C_2))$. $I(C_2) = [u \rightarrow v_3]$ so

$$l(M(C_2)) \leq 15l(P_c(C_2)) + 2l(P_s(C_2)) + l(I(C_2)).$$

In this case again

$$B(C_2) = [v_2 \rightarrow u]$$

so as in previous case,

$$l(B(C_2)) \leq 2l(P_s(C_2)) - l(I(C_2)).$$

(c) $x \in [v, v_1]$ and $y \in [v_2, v_3]$. This case is described in Figure 31(c). From A4 the paths are oriented: $x \rightarrow v_1 \rightarrow v_2 \rightarrow y \leftarrow v_3$.

From A2 (since $y \notin F(S)$)

$$l(M_h(S)) + l(B_h(S)) \leq 15l(P_c(S)) + 4l(P_s(S)).$$

Let:

$$M_t(C_2) = (B_h(S) \setminus [v_3 \rightarrow y]), \quad M_h(C_2) = [u \rightarrow v_1 \rightarrow v_2 \rightarrow y] \cup M_h(S),$$

giving:

$$\begin{aligned} l(M(C_2)) &\leq l(M_h(S)) + l(B_h(S)) + l(u, v_1) + l(v_1, v_2) + l(v_2, y) \\ &\leq 15l(P_c(S)) + 4l(P_s(S)) + l(u, v_1) + l(v_1, v_2) + l(v_2, y) \\ &= 15l(P_c(S)) + 4l(v, x) + 4l(x, v_1) + 5l(v_1, v_2) + 5l(v_2, y) + 4l(y, v_3) + \\ &\quad 4l(v_3, w) + l(u, v_1) \\ &\leq 15l(P_c(S)) + 4l(v, x) + 4l(x, v_1) + 6l(v_1, v_2) + 4l(v_2, y) + 3l(y, v_3) + \\ &\quad 4l(v_3, w) + l(u, v_3) \\ &\leq 15l(P_c(S)) + 5l(v, x) + 5l(x, v_1) + 7l(v_1, v_2) + 2l(v_2, y) + l(y, v_3) + \\ &\quad 5l(v_3, w) + l(u, v_3), \end{aligned}$$

where the last two inequalities follow from (23) and (24). By definition

$$l(P_c(C_2)) = l(P_c(S)) + l(v, x) + l(x, v_1) + l(v_1, v_2) + l(v_3, w),$$

so that

$$l(M(C_2)) \leq 15l(P_c(C_2)) + 2l(v_2, v_3) + l(u, v_3).$$

Since $S = F(C_2)$, $l(v_2, v_3) \leq l(P_s(C_2))$. $I(C_2) = [u \rightarrow v_3]$ so

$$l(M(C_2)) \leq 15l(P_c(C_2)) + 2l(P_s(C_2)) + l(I(C_2)).$$

We prove A2 directly on C_2 (not using Lemma 3.31). From A1

$$l(M(S)) \leq 15l(P_c(S)) + 2l(P_s(S)) + l(I(S)).$$

In this case $t(C_2) = v_3 \in F(C_2)$, $h(C_2) = u \notin F(C_2)$, so only the first inequality of A2 should be proven. Let

$$B_h(C_2) = M_t(S) \cup [x \rightarrow v_1 \rightarrow v_2 \rightarrow u],$$

giving

$$\begin{aligned}
l(B_h(C_2)) + l(M_h(C_2)) &= l(M_t(S)) + l(M_h(S)) + l(x, v_1) + 2l(v_1, v_2) + l(v_2, u) + \\
&\quad l(u, v_1) + l(v_2, y) \\
&\leq 15l(P_c(S)) + 2l(P_s(S)) + l(I(S)) + l(x, v_1) + 2l(v_1, v_2) + \\
&\quad l(v_2, u) + l(u, v_1) + l(v_2, y) \\
&= 15l(P_c(S)) + 2l(v, x) + 4l(x, v_1) + 5l(v_1, v_2) + 4l(v_2, y) + \\
&\quad 2l(y, v_3) + 2l(v_3, w) + l(v_2, u) + l(u, v_1) \\
&\leq 15l(P_c(S)) + 2l(v, x) + 4l(x, v_1) + 6l(v_1, v_2) + 3l(v_2, y) + \\
&\quad l(y, v_3) + 2l(v_3, w) + l(v_2, u) + l(u, v_3) \\
&\leq 15l(P_c(S)) + 2.5l(v, x) + 4.5l(x, v_1) + 6.5l(v_1, v_2) + 2l(v_2, y) \\
&\quad 2.5l(v_3, w) + l(v_2, u) + l(u, v_3) \\
&\leq 15l(P_c(C_2)) + 2l(v_2, y) + l(P_s(C_2)),
\end{aligned}$$

where the last inequalities follow from (23), (24) and the definitions of $P_c(C_2)$ and $P_s(C_2)$. Since $S = F(C_2)$ $l(v_2, y) \leq l(v_2, v_3) \leq l(P_s(C_2))$, giving

$$l(B_h(C_2)) + l(M_h(C_2)) \leq 15l(P_c(C_2)) + 3l(P_s(C_2)).$$

(d) $x \in [v_1, v_2]$ and $y \in [v_2, v_3]$. This case is described in Figure 31(d). From A4 the paths are oriented: $v_1 \leftarrow x \rightarrow v_2 \rightarrow y \leftarrow v_3$. From A2 (since $x, y \notin F(S)$)

$$l(B_h(S)) + l(B_t(S)) \leq 15l(P_c(S)) + 6l(P_s(S)).$$

Let:

$$M_t(C_2) = B_h(S) \setminus [v_3 \rightarrow y], \quad M_h(C_2) = [u \rightarrow v_1] \cup (B_t(S) \setminus [x \rightarrow v_1]),$$

then

$$\begin{aligned}
l(M(C_2)) &\leq l(B_h(S)) + l(B_t(S)) + l(u, v_1) \\
&\leq 15l(P_c(S)) + 6l(P_s(S)) + l(u, v_1) \\
&= 15l(P_c(S)) + 6l(v, v_1) + 6l(v_1 \rightarrow x \rightarrow v_2) + 6l(v_2 \rightarrow y \rightarrow v_3) + \\
&\quad 6l(v_3, w) + l(u, v_1) \\
&\leq 15l(P_c(S)) + 6l(v, v_1) + 7l(v_1, v_2) + 5l(v_2, v_3) + 6l(v_3, w) + l(u, v_3) \\
&\leq 15l(P_c(S)) + 7.5l(v, v_1) + 8.5l(v_1, x) + 8.5l(x, v_2) + 2l(v_2, v_3) + \\
&\quad 7.5l(v_3, w) + l(u, v_3) \\
&\leq 15l(P_c(C_2)) + 2l(v_2, v_3) + l(u, v_3),
\end{aligned}$$

where the third and fourth inequalities follow from (23) and (24).

Since C_2 is a son of S $l(v_2, v_3) \leq l(P_s(C_2))$, $I(C_2) = [u \rightarrow v_3]$ so

$$l(M(C_2)) \leq 15l(P_c(C_2)) + 2l(P_s(C_2)) + l(I(C_2)).$$

We prove A2 directly on C_2 (not using Lemma 3.31). From A2

$$l(M_t(S)) + l(B_t(S)) \leq 15l(P_c(S)) + 4l(P_s(S))$$

In this case $t(C_2) = v_3 \in F(C_2)$, $h(C_2) = u \notin F(C_2)$, so only the first inequality of A2 should be proven. Let

$$B_h(C_2) = M_t(S) \cup [x \rightarrow v_2 \rightarrow u],$$

giving

$$\begin{aligned} l(B_h(C_2)) + l(M_h(C_2)) &\leq l(M_t(S)) + l(B_t(S)) + l(x, v_2) + l(v_2, u) + l(u, v_1) \\ &\leq 15l(P_c(S)) + 4l(P_s(S)) + l(x, v_2) + l(v_2, u) + l(u, v_1) \\ &= 15l(P_c(S)) + 4l(v, v_1) + 4l(v_1, x) + 5l(x, v_2) + 4l(v_2, v_3) + \\ &\quad 4l(v_3, w) + l(v_2, u) + l(u, v_1) \\ &\leq 15l(P_c(S)) + 4l(v, v_1) + 5l(v_1, x) + 6l(x, v_2) + 3l(v_2, v_3) + \\ &\quad 4l(v_3, w) + l(v_2, u) + l(u, v_3) \\ &\leq 15l(P_c(S)) + 5l(v, v_1) + 6l(v_1, x) + 7l(x, v_2) + l(v_2, v_3) + \\ &\quad 5l(v_3, w) + l(v_2, u) + l(u, v_3) \end{aligned}$$

where the last inequalities follow from (23) and (24). From the definition of $P_c(C_2)$ and $P_s(C_2)$

$$l(B_h(C_2)) + l(M_h(C_2)) \leq 15l(P_c(C_2)) + 2l(v_2, v_3) + l(P_s(C_2))$$

Since C_2 is a son of S $l(v_2, v_3) \leq l(P_s(C_2))$ giving

$$l(B_h(C_2)) + l(M_h(C_2)) \leq 15l(P_c(C_2)) + 3l(P_s(C_2)).$$

A3 Let \hat{C} be a son of C_2 . If $P_f(\hat{C}) \subseteq [u, v_2]$, since $[u, v_2] \subseteq P_s(C_1)$ and $l(C_1) < l(C_2)$ \hat{C} should have been a son of C_1 . Therefore $P_f(\hat{C}) \cap [u, v_3] \neq \emptyset$.

A4 In this case $J_h(C_2) = [v_2 \rightarrow u]$ and obviously for every son \hat{C} of C_2 $P_f(\hat{C}) \subset P_s(C_2) = J_h(C_2) \cup I(C_2)$.

A5 $M(C_2) \subseteq P_s(C_2) \cup C_1 \cup M(S)$. Since $l(C_1) < l(C_2)$ the condition is satisfied.

A6 $M(C_2)$ is contained in $P_s(C_2)$, C_1 (a brother of C_2), S and $M(S)$, so $N(C_2) = \{C_1\}$.

■

Corollary 3.37 *If C_1 and C_2 are light, the cycles oriented in DIRECT-TWO satisfy the induction hypotheses.*

Proof: In the first two cases of the procedure the cycles are directed to satisfy $I(C_i) = P_s(C_i)$ and then according to Lemmas 3.32 and 3.33 the induction hypotheses are satisfied.

Suppose that $l(C_1) < l(C_2)$. If $l_1 = l_2 = 1$ then C_1 and C_2 satisfy the induction hypotheses by Lemmas 3.32 and 3.35 respectively. If $l_1 = l_2 = -1$ then the claim holds by Lemmas 3.33 and 3.36, respectively. The case $l(C_1) > l(C_2)$ is symmetrically proven. ■

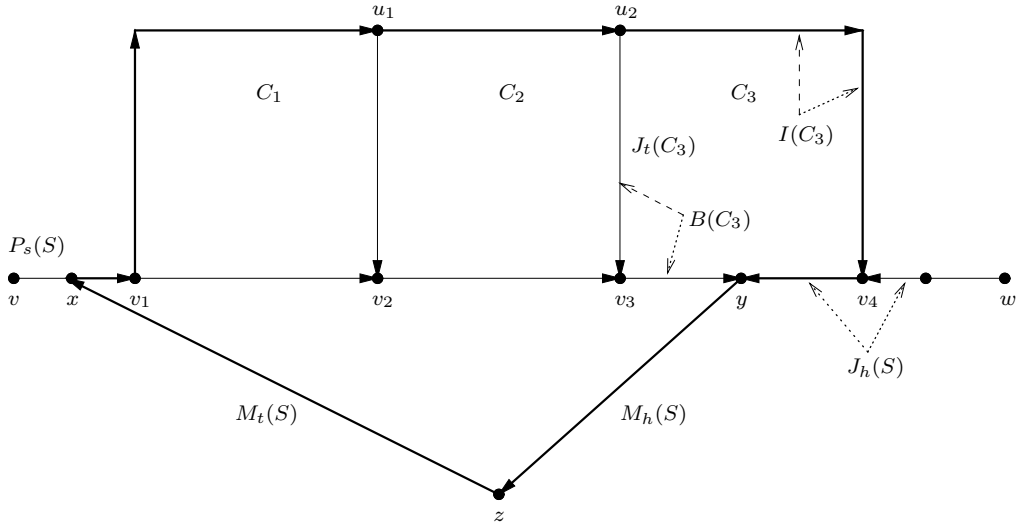

Figure 32: Figure for Lemma 3.38.

3.8 Three brothers

In this section we consider three neighbor brothers C_1, C_2, C_3 where the three brothers were all oriented forwards.⁷ In the first lemma we handle the orientation applied by the algorithm when $l(C_1) < l(C_2) < l(C_3)$. In the second lemma we handle the orientation applied by the algorithm when $l(C_1) < l(C_2)$ and $l(C_3) < l(C_2)$. Other equivalent cases can be handled by similar lemmas.

Mark

- $u_1 :=$ the end node of the path $P_s(C_1) \cap P_s(C_2)$, such that $u_1 \notin S$.
- $u_2 :=$ the end node of the path $P_s(C_2) \cap P_s(C_3)$, such that $u_2 \notin S$.
- $v_1 := S \cap (P_s(C_1) \setminus P_s(C_2))$.
- $v_2 := S \cap (P_s(C_1) \cap P_s(C_2))$.
- $v_3 := S \cap (P_s(C_2) \cap P_s(C_3))$.
- $v_4 := S \cap (P_s(C_3) \setminus P_s(C_2))$.

Lemma 3.38 *Suppose that S satisfies the induction hypotheses and C_1, C_2, C_3 were oriented $v_1 \rightarrow u_1 \rightarrow u_2 \rightarrow v_4$, $u_1 \rightarrow v_2$, $u_2 \rightarrow v_3$ (see Figure 32). Then C_3 satisfies the induction hypotheses. Moreover $|N(C_3)| = 2$.*

Proof: By Observation 3.25 the orientation $u_1 \rightarrow v_2$ indicates that $l(C_1) < l(C_2)$ and the orientation $u_2 \rightarrow v_3$ indicates that $l(C_2) < l(C_3)$. It follows that $U(C_3) \subset [u_2, v_4]$. Therefore

$$I(C_3) = [u_2 \rightarrow v_4], t(C_3) = u_2, h(C_3) = v_4.$$

⁷ For example, such orientation can be the result of DIRECT-MANY when $n = 3$, C_2 is heavy and $l_1 = l_2 = 1$.

Since $l(C_1) < l(C_2) < l(C_3)$ ⁸

$$l(v_1, u_1) + l(u_1, v_2) + l(v_3, v_4) < l(v_1, v_2) + l(v_3, u_2) + l(u_2, v_4), \quad (25)$$

$$l(u_1, v_2) + l(u_1, u_2) + l(v_3, v_4) < l(v_2, v_3) + l(u_2, v_4). \quad (26)$$

A1 By A3 on S $x \in [v, v_2]$ and $y \in [v_3, w]$. In Figure 32 the case $x \in [v, v_1]$, $y \in [v_3, v_4]$ is described. By A4 for all these cases we can define:

$$M_t(C_3) = M_t(S) \cup [x \rightarrow v_1 \rightarrow u_1 \rightarrow u_2], \quad M_h(C_3) = [v_4 \rightarrow y] \cup M_h(S).$$

Using A1 on S

$$\begin{aligned} l(M(C_3)) &= l(M(S)) + l(x, v_1) + l(v_1 \rightarrow u_1 \rightarrow u_2) + l(v_4, y) \\ &\leq 15l(P_c(S)) + 2l(P_s(S)) + l(I(S)) + l(x, v_1) + l(v_1 \rightarrow u_1 \rightarrow u_2) + l(v_4, y) \\ &\leq 15l(P_c(S)) + 4l(v, v_1) + 3l(v_1 \rightarrow v_2 \rightarrow v_3 \rightarrow v_4) + 4l(v_4, w) + \\ &\quad l(v_1 \rightarrow u_1 \rightarrow u_2). \end{aligned}$$

(The lengths of $[v, v_1]$ and $[v_4, w]$ are taken 4 times to satisfy all possible locations of x, y .)

From (25) and (26)

$$\begin{aligned} l(M(C_3)) &\leq 15l(P_c(S)) + 4l(v, v_1) + 4l(v_1, v_2) + 3l(v_2, v_3) + 2l(v_3, v_4) + \\ &\quad 4l(v_4, w) + l(P_s(C_3)) + l(u_1, u_2) \\ &\leq 15l(P_c(S)) + 4l(v, v_1) + 4l(v_1, v_2) + 4l(v_2, v_3) + l(v_3, v_4) + \\ &\quad 4l(v_4, w) + l(P_s(C_3)) + l(u_2, v_4). \end{aligned}$$

By definition

$$l(P_c(C_3)) = l(P_c(S)) + l(v, v_1) + l(v_1, v_2) + l(v_2, v_3) + l(v_4, w),$$

so that

$$l(M(C_3)) \leq 15l(P_c(C_3)) + l(v_3, v_4) + l(P_s(C_3)) + l(u_2, v_4).$$

Since C_3 is a son of S , $l(v_3, v_4) \leq l(P_s(C_3))$. $I(C_3) = [u_2 \rightarrow v_4]$ so

$$l(M(C_3)) \leq 15l(P_c(C_3)) + 2l(P_s(C_3)) + l(I(C_3)).$$

A2 When $y \in [v_4, w]$ we define

$$B(C_3) = [u_2 \rightarrow v_3 \rightarrow v_4].$$

When $y \in [v_3, v_4]$ we define

$$B(C_3) = [u_2 \rightarrow v_3 \rightarrow y].$$

In both cases $B(C_3) \subseteq [u_2 \rightarrow v_3 \rightarrow v_4]$. From the definition of $I(C_3)$ and since C_3 is a son of S ,

$$\begin{aligned} l(B(C_3)) &\leq l(u_2, v_3) + l(v_3, v_4) \\ &= l(P_s(C_3)) - l(I(C_3)) + l(v_3, v_4) \\ &\leq l(P_s(C_3)) - l(I(C_3)) + l(P_s(C_3)) \\ &= 2l(P_s(C_3)) - l(I(C_3)). \end{aligned}$$

⁸ $[v_1, u_1]$ is the path in $P_s(C_1)$ and $[u_2, v_4]$ is the path in $P_s(C_3)$

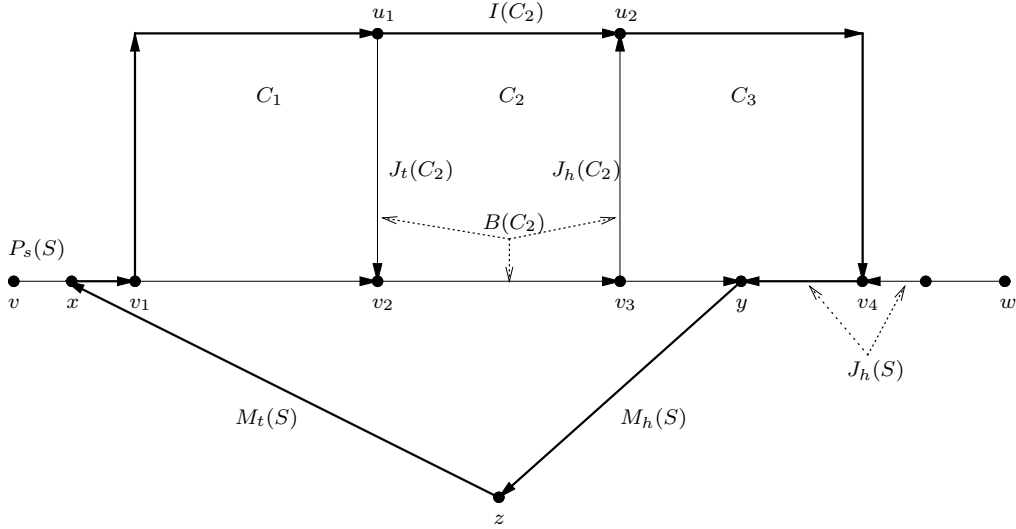

Figure 33: Figure for Lemma 3.39.

- A3** Let \hat{C} be a son of C_3 . If $P_f(\hat{C}) \subseteq [u_2, v_3]$ then since $[u_2, v_3] \subseteq P_s(C_2)$ and $l(C_2) < l(C_3)$, \hat{C} should have been a son of C_2 . Therefore $P_f(\hat{C}) \cap [u_2, v_4] \neq \emptyset$.
- A4** In this case $J_t(C_3) = [u_2 \rightarrow v_3]$. Obviously for every son \hat{C} of C_3 $P_f(\hat{C}) \subset P_s(C_3) = I(C_3) \cup J_t(C_3)$.
- A5** $M(C_3)$ is contained in $P_s(C_3) \cup C_1 \cup C_2 \cup M(S)$. Since $l(C_1) < l(C_3)$ and $l(C_2) < l(C_3)$ the condition is satisfied.
- A6** $M(C_3)$ is contained in $P_s(C_3)$, C_1, C_2 (two brothers of C_3), S and $M(S)$, so $N(C_3) = \{C_1, C_2\}$.

■

Lemma 3.39 *Suppose that S satisfies the induction hypotheses, and C_1, C_2, C_3 were oriented $v_1 \rightarrow u_1 \rightarrow u_2 \rightarrow v_4$, $u_1 \rightarrow v_2$, $v_3 \rightarrow u_2$ (see Figure 33). Then C_2 satisfies the induction hypotheses. Moreover $|N(C_2)| = 2$.*

Proof: By Observation 3.25 the orientation $u_1 \rightarrow v_2$ indicates that $l(C_1) < l(C_2)$ and the orientation $v_3 \rightarrow u_2$ indicates that $l(C_3) < l(C_2)$. It follows that $U(C_2) \subset [u_1, u_2]$ so

$$I(C_2) = [u_1 \rightarrow u_2], \quad t(C_2) = u_1, \quad h(C_2) = u_2.$$

Since $l(C_1) < l(C_2)$ and $l(C_3) < l(C_2)$:

$$l(v_1, u_1) + l(v_2, v_3) < l(u_1, u_2) + l(u_2, v_3) + l(v_1, v_2), \quad (27)$$

$$l(u_2, v_4) + l(v_2, v_3) < l(u_1, u_2) + l(v_2, u_1) + l(v_3, v_4). \quad (28)$$

A1 By A3 on S $x \in [v, v_2]$ and $y \in [v_3, w]$. In Figure 33 the case $x \in [v, v_1]$, $y \in [v_3, v_4]$ is described. By A4 for all these cases we can define:

$$M_t(C_2) = M_t(S) \cup [x \rightarrow v_1 \rightarrow u_1], \quad M_h(C_3) = [u_2 \rightarrow v_4 \rightarrow y] \cup M_h(S).$$

Using A1 on S

$$\begin{aligned} l(M(C_2)) &= l(M(S)) + l(x, v_1) + l(v_1 \rightarrow u_1) + l(u_2 \rightarrow v_4) + l(v_4, y) \\ &\leq 15l(P_c(S)) + 2l(P_s(S)) + l(I(S)) + l(x, v_1) + l(v_1 \rightarrow u_1) + l(u_2 \rightarrow v_4) + l(v_4, y) \\ &\leq 15l(P_c(S)) + 4l(v, v_1) + 3l(v_1 \rightarrow v_2 \rightarrow v_3 \rightarrow v_4) + 4l(v_4, w) + \\ &\quad l(v_1 \rightarrow u_1) + l(u_2 \rightarrow v_4). \end{aligned}$$

(The lengths of $[v, v_1]$ and $[v_4, w]$ are taken 4 times to satisfy all four cases of locations for x, y .)

From (27) and (28):

$$\begin{aligned} l(M(C_2)) &\leq 15l(P_c(S)) + 4l(v, v_1) + 4l(v_1, v_2) + 2l(v_2, v_3) + 3l(v_3, v_4) + \\ &\quad 4l(v_4, w) + l(u_1, u_2) + l(u_2, v_3) + l(u_2, v_4) \\ &\leq 15l(P_c(S)) + 4l(v, v_1) + 4l(v_1, v_2) + l(v_2, v_3) + 4l(v_3, v_4) + \\ &\quad 4l(v_4, w) + 2l(u_1, u_2) + l(u_2, v_3) + l(u_1, v_2). \end{aligned}$$

By definition

$$l(P_c(C_2)) = l(P_c(S)) + l(v, v_1) + l(v_1, v_2) + l(v_3, v_4) + l(v_4, w),$$

so that

$$l(M(C_2)) \leq 15l(P_c(C_2)) + l(v_2, v_3) + 2l(u_1, u_2) + l(u_2, v_3) + l(u_1, v_2).$$

By definition

$$l(P_s(C_2)) = l(u_1, v_2) + l(u_1, u_2) + l(u_2, v_3),$$

giving

$$l(M(C_2)) \leq 15l(P_c(C_2)) + l(v_2, v_3) + l(u_1, u_2) + l(P_s(C_2)).$$

Since C_2 is a son of S , $l(v_2, v_3) \leq l(P_s(C_2))$. $I(C_2) = [u_1 \rightarrow u_2]$ so

$$l(M(C_2)) \leq 15l(P_c(C_2)) + 2l(P_s(C_2)) + l(I(C_2)).$$

A2 For all possible locations of x and y

$$B(C_2) = [u_1 \rightarrow v_2 \rightarrow v_3 \rightarrow u_2].$$

From the definition of $I(C_2)$ and since C_2 is a son of S ,

$$\begin{aligned} l(B(C_2)) &= l(u_1, v_2) + l(v_3, u_2) + l(v_2, v_3) \\ &= l(P_s(C_2)) - l(I(C_2)) + l(v_2, v_3) \\ &\leq l(P_s(C_2)) - l(I(C_2)) + l(P_s(C_2)) \\ &= 2l(P_s(C_2)) - l(I(C_2)). \end{aligned}$$

A3 Let \hat{C} be a son of C_2 . If $P_f(\hat{C}) \subseteq [u_1, v_2]$ since $[u_2, v_3] \subseteq P_s(C_1)$ and $l(C_1) < l(C_2)$, \hat{C} should have been a son of C_1 . In a similar way if $P_f(\hat{C}) \subseteq [u_2, v_3]$ since $l(C_3) < l(C_2)$ \hat{C} would have been a son of C_3 . Therefore $P_f(\hat{C}) \cap [u_1, u_2] \neq \phi$.

A4 In this case $J_t(C_2) = [u_1 \rightarrow v_2]$ and $J_h(C_2) = [v_3 \rightarrow u_2]$. Obviously for every son \hat{C} of C_2 $P_f(\hat{C}) \subset P_s(C_2) = J_t(C_2) \cup I(C_2) \cup J_h(C_2)$.

A5 $M(C_2)$ is contained in $P_s(C_2) \cup C_1 \cup C_3 \cup M(S)$. Since $l(C_1) < l(C_2)$ and $l(C_3) < l(C_2)$ the condition is satisfied.

A6 $M(C_2)$ is contained in $P_s(C_2)$, C_1, C_3 (two brothers of C_2), S and $M(S)$, $N(C_2) = \{C_1, C_3\}$.

■

3.9 Four brothers

In this section we consider four neighbor cycles C_1, \dots, C_4 where the four brothers were all oriented forwards.⁹ In the first lemma we handle the orientation applied by the algorithm when $l(C_1) < l(C_2) < l(C_3) < l(C_4)$. In the second lemma we handle the orientation applied by the algorithm when $l(C_1) < l(C_2) < l(C_3)$ and $l(C_4) < l(C_3)$. Other equivalent cases can be handled by similar lemmas.

Mark

- $u_1 :=$ the end node of the path $P_s(C_1) \cap P_s(C_2)$, such that $u_1 \notin S$.
- $u_2 :=$ the end node of the path $P_s(C_2) \cap P_s(C_3)$, such that $u_2 \notin S$.
- $u_3 :=$ the end node of the path $P_s(C_3) \cap P_s(C_4)$, such that $u_3 \notin S$.
- $v_1 := S \cap (P_s(C_1) \setminus P_s(C_2))$.
- $v_2 := S \cap (P_s(C_1) \cap P_s(C_2))$.
- $v_3 := S \cap (P_s(C_2) \cap P_s(C_3))$.
- $v_4 := S \cap (P_s(C_3) \cap P_s(C_4))$.
- $v_5 := S \cap (P_s(C_4) \setminus P_s(C_3))$.

Lemma 3.40 *Suppose that S satisfies the induction hypotheses and C_1, C_2, C_3, C_4 were oriented $v_1 \rightarrow u_1 \rightarrow u_2 \rightarrow u_3 \rightarrow v_5$, $u_1 \rightarrow v_2$, $u_2 \rightarrow v_3$ and $u_3 \rightarrow v_4$ (see Figure 34). Then C_4 satisfies the induction hypotheses. Moreover $|N(C_4)| = 3$.*

Proof: By Observation 3.25 the orientation $u_1 \rightarrow v_2$ indicates that $l(C_1) < l(C_2)$, the orientation $u_2 \rightarrow v_3$ indicates that $l(C_2) < l(C_3)$ and the orientation $u_3 \rightarrow v_4$ indicates that $l(C_3) < l(C_4)$. It follows that $U(C_4) \subseteq [u_3, v_5]$, so

$$I(C_4) = [u_3 \rightarrow v_5], \quad t(C_4) = u_3, \quad h(C_4) = v_5.$$

⁹For example, such orientation can be the result of DIRECT-MANY when $n = 4$, C_2 and C_3 are heavy and $l_1 = l_2 = 1$.

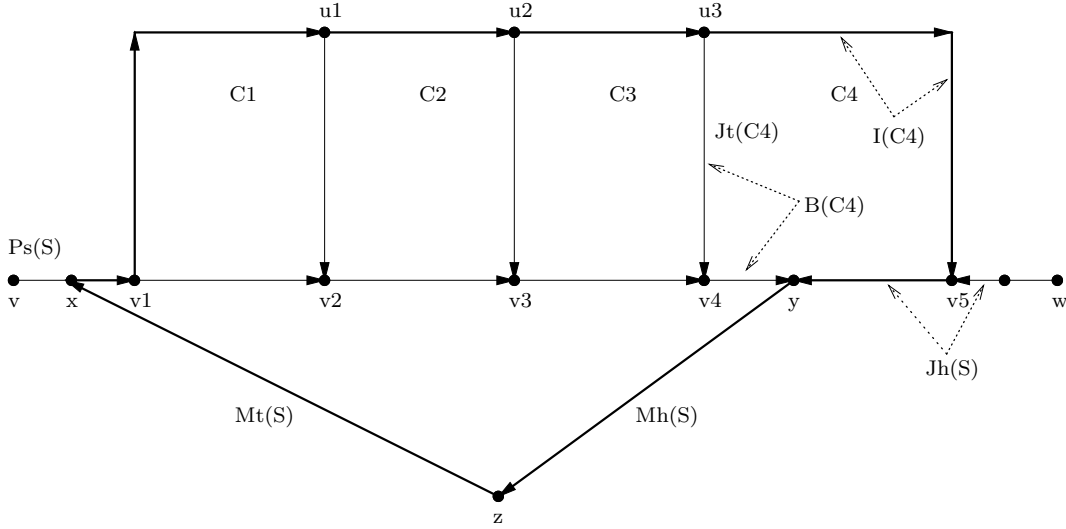

Figure 34: Figure for Lemma 3.40.

Since $l(C_1) < l(C_4)$, $l(C_2) < l(C_4)$ and $l(C_3) < l(C_4)$

$$l(v_1, u_1) + l(u_1, v_2) + l(v_4, v_5) < l(P_s(C_4)) + l(v_1, v_2), \quad (29)$$

$$l(u_1, u_2) + l(u_1, v_2) + l(u_2, v_3) + l(v_4, v_5) < l(P_s(C_4)) + l(v_2, v_3), \quad (30)$$

$$l(u_2, u_3) + l(u_2, v_3) + l(v_4, v_5) < l(u_3, v_5) + l(v_3, v_4). \quad (31)$$

A1 By A3 on S $x \in [v, v_2]$ and $y \in [v_4, w]$. By A4 for all these cases we can define:

$$M_t(C_4) = M_t(S) \cup [x \rightarrow v_1 \rightarrow u_1 \rightarrow u_2 \rightarrow u_3], \quad M_h(C_3) = [v_5 \rightarrow y] \cup M_h(S).$$

Using A1 on S

$$\begin{aligned} l(M(C_4)) &= l(M(S)) + l(x, v_1) + l(v_1 \rightarrow u_1 \rightarrow u_2 \rightarrow u_3) + l(v_5, y) \\ &\leq 15l(P_c(S)) + 2l(P_s(S)) + l(I(S)) + l(x, v_1) + l(v_1 \rightarrow u_1 \rightarrow u_2 \rightarrow u_3) + l(v_5, y) \\ &\leq 15l(P_c(S)) + 4l(v, v_1) + 3l(v_1 \rightarrow v_2 \rightarrow v_3 \rightarrow v_4 \rightarrow v_5) + 4l(v_5, w) + \\ &\quad l(v_1 \rightarrow u_1 \rightarrow u_2 \rightarrow u_3). \end{aligned}$$

(The lengths of $[v, v_1]$ and $[v_5, w]$ are taken 4 times to satisfy all four cases of locations for x, y .)

From (29),(30) and (31)

$$\begin{aligned} l(M(C_4)) &\leq 15l(P_c(S)) + 4l(v, v_1) + 4l(v_1, v_2) + 3l(v_2, v_3) + 3l(v_3, v_4) + 2l(v_4, v_5) + \\ &\quad 4l(v_5, w) + l(P_s(C_4)) + l(u_1, u_2) + l(u_2, u_3) \\ &\leq 15l(P_c(S)) + 4l(v, v_1) + 4l(v_1, v_2) + 4l(v_2, v_3) + 3l(v_3, v_4) + l(v_4, v_5) + \\ &\quad 4l(v_5, w) + 2l(P_s(C_4)) + l(u_2, u_3) \\ &\leq 15l(P_c(S)) + 4l(v, v_1) + 4l(v_1, v_2) + 4l(v_2, v_3) + 4l(v_3, v_4) + 4l(v_5, w) + \\ &\quad 2l(P_s(C_4)) + l(u_3, v_5). \end{aligned}$$

By definition

$$l(P_c(C_4)) = l(P_c(S)) + l(v, v_1) + l(v_1, v_2) + l(v_2, v_3) + l(v_3, v_4) + l(v_5, w),$$

giving:

$$l(M(C_4)) \leq 15l(P_c(C_4)) + 2l(P_s(C_4)) + l(u_3, v_5).$$

From $I(C_4) = [u_3 \rightarrow v_5]$ we get

$$l(M(C_4)) \leq 15l(P_c(C_4)) + 2l(P_s(C_4)) + l(I(C_4)).$$

A2 When $y \in [v_5, w]$ we define $B(C_4) = [u_3 \rightarrow v_4 \rightarrow v_5]$, when $y \in [v_4, v_5]$ we define $B(C_4) = [u_3 \rightarrow v_4 \rightarrow y]$. In both cases

$$l(B(C_4)) \leq l(u_3, v_4) + l(v_4, v_5).$$

From the definition of $I(C_4)$ and since C_4 is a son of S we get that

$$\begin{aligned} l(B(C_4)) &\leq l(u_3, v_4) + l(v_4, v_5) \\ &= l(P_s(C_4)) - l(I(C_4)) + l(v_4, v_5) \\ &\leq l(P_s(C_4)) - l(I(C_4)) + l(P_s(C_4)) \\ &= 2l(P_s(C_4)) - l(I(C_4)). \end{aligned}$$

A3 Let \hat{C} be a son of C_4 . If $P_f(\hat{C}) \subseteq [u_3, v_4]$ then since $[u_3, v_4] \subseteq P_s(C_3)$ and $l(C_3) < l(C_4)$, \hat{C} should have been a son of C_3 . Therefore $P_f(\hat{C}) \cap [u_3, v_5] \neq \phi$.

A4 In this case $J_t(C_4) = [u_3 \rightarrow v_4]$. Obviously for every son \hat{C} of C_4 $P_f(\hat{C}) \subset P_s(C_4) = I(C_4) \cup J_t(C_4)$.

A5 $M(C_4)$ is contained in $P_s(C_4) \cup C_1 \cup C_2 \cup C_3 \cup M(S)$. Since $l(C_i) < l(C_4)$, $i = 1, 2, 3$ the condition is satisfied.

A6 $M(C_4)$ is contained in $P_s(C_4)$, C_1, C_2, C_3 (three brothers of C_4), S and $M(S)$, so $N(C_4) = \{C_1, C_2, C_3\}$.

■

Lemma 3.41 *Suppose S satisfies the induction hypotheses, and C_1, C_2, C_3, C_4 were oriented $v_1 \rightarrow u_1 \rightarrow u_2 \rightarrow u_3 \rightarrow v_5$, $u_1 \rightarrow v_2$, $u_2 \rightarrow v_3$ and $v_4 \rightarrow u_3$ (see Figure 35). Then C_3 satisfies the induction hypotheses. Moreover $|N(C_3)| = 3$.*

Proof: By Observation 3.25 the orientation $u_1 \rightarrow v_2$ indicates that $l(C_1) < l(C_2)$, the orientation of the path $u_2 \rightarrow v_3$ indicates that $l(C_2) < l(C_3)$ and the orientation $v_4 \rightarrow u_3$ indicates that $l(C_4) < l(C_3)$. It follows that $U(C_3) \subseteq [u_2, u_3]$ (even if it is only one point) so

$$I(C_3) = [u_2 \rightarrow u_3], t(C_3) = u_2, h(C_3) = u_3.$$

Since $l(C_1) < l(C_3)$, $l(C_2) < l(C_3)$ and $l(C_4) < l(C_3)$

$$l(v_1, u_1) + l(u_1, v_2) + l(v_3, v_4) < l(P_s(C_3)) + l(v_1, v_2), \quad (32)$$

$$l(u_1, u_2) + l(u_1, v_2) + l(v_3, v_4) < l(u_2, u_3) + l(u_3, v_4) + l(v_2, v_3), \quad (33)$$

$$l(u_3, v_5) + l(v_3, v_4) < l(u_2, u_3) + l(u_2, v_3) + l(v_4, v_5). \quad (34)$$

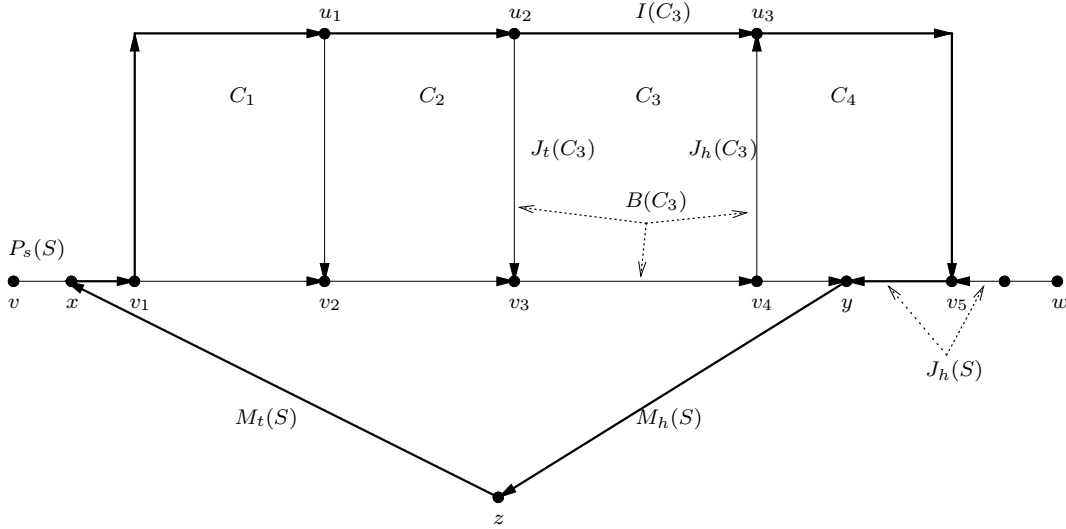

Figure 35: Figure for Lemma 3.41.

A1 By A3 on S $x \in [v, v_2]$ and $y \in [v_4, w]$. By A4 for all these cases we can define:

$$M_t(C_3) = M_t(S) \cup [x \rightarrow v_1 \rightarrow u_1 \rightarrow u_2], \quad M_h(C_3) = [u_3 \rightarrow v_5 \rightarrow y] \cup M_h(S).$$

Using A1 on S

$$\begin{aligned} l(M(C_3)) &= l(M(S)) + l(x, v_1) + l(v_1 \rightarrow u_1 \rightarrow u_2) + l(u_3 \rightarrow v_5) + l(v_5, y) \\ &\leq 15l(P_c(S)) + 2l(P_s(S)) + l(I(S)) + l(x, v_1) + l(v_1 \rightarrow u_1 \rightarrow u_2) + l(u_3 \rightarrow v_5) + l(v_5, y) \\ &\leq 15l(P_c(S)) + 4l(v, v_1) + 3l(v_1 \rightarrow v_2 \rightarrow v_3 \rightarrow v_4 \rightarrow v_5) + 4l(v_5, w) + \\ &\quad l(v_1 \rightarrow u_1 \rightarrow u_2) + l(u_3 \rightarrow v_5). \end{aligned}$$

(The lengths of $[v, v_1]$ and $[v_5, w]$ are taken 4 times to satisfy all four cases of locations for x, y .)

From (32), (33) and (34)

$$\begin{aligned} l(M(C_3)) &\leq 15l(P_c(S)) + 4l(v, v_1) + 4l(v_1, v_2) + 3l(v_2, v_3) + 2l(v_3, v_4) + 3l(v_4, v_5) + 4l(v_5, w) \\ &\quad + l(P_s(C_3)) + l(u_1, u_2) + l(u_3, v_5) \\ &\leq 15l(P_c(S)) + 4l(v, v_1) + 4l(v_1, v_2) + 4l(v_2, v_3) + l(v_3, v_4) + 3l(v_4, v_5) + 4l(v_5, w) \\ &\quad + l(P_s(C_3)) + l(u_2, u_3) + l(u_3, v_4) + l(u_3, v_5) \\ &\leq 15l(P_c(S)) + 4l(v, v_1) + 4l(v_1, v_2) + 4l(v_2, v_3) + 4l(v_4, v_5) + 4l(v_5, w) \\ &\quad + l(P_s(C_3)) + 2l(u_2, u_3) + l(u_3, v_4) + l(u_2, v_3) \\ &= 15l(P_c(S)) + 4l(v, v_1) + 4l(v_1, v_2) + 4l(v_2, v_3) + 4l(v_4, v_5) + 4l(v_5, w) \\ &\quad + 2l(P_s(C_3)) + l(u_2, u_3). \end{aligned}$$

By definition

$$l(P_c(C_3)) = l(P_c(S)) + l(v, v_1) + l(v_1, v_2) + l(v_2, v_3) + l(v_4, v_5) + l(v_5, w),$$

giving:

$$l(M(C_3)) \leq 15l(P_c(C_3)) + 2l(P_s(C_3)) + l(u_2, u_3).$$

From $I(C_3) = [u_2 \rightarrow u_3]$ we get

$$l(M(C_3)) \leq 15l(P_c(C_3)) + 2l(P_s(C_3)) + l(I(C_3)).$$

A2 For all possible locations of x and y we can define $B(C_3) = [u_2 \rightarrow v_3 \rightarrow v_4 \rightarrow u_3]$ giving

$$l(B(C_3)) \leq l(u_2, v_3) + l(v_3, v_4) + l(v_4, u_3).$$

From the definition of $I(C_3)$ and since C_3 is a son of S we get

$$\begin{aligned} l(B(C_3)) &= l(u_2, v_3) + l(v_4, u_3) + l(v_3, v_4) \\ &= l(P_s(C_3)) - l(I(C_3)) + l(v_3, v_4) \\ &\leq l(P_s(C_3)) - l(I(C_3)) + l(P_s(C_3)) \\ &= 2l(P_s(C_3)) - l(I(C_3)). \end{aligned}$$

A3 Let \hat{C} be a son of C_3 . If $P_f(\hat{C}) \subseteq [u_2, v_3]$ then since $[u_2, v_3] \subseteq P_s(C_2)$ and $l(C_2) < l(C_3)$, \hat{C} should have been a son of C_2 . Similarly, if $P_f(\hat{C}) \subseteq [u_3, v_4] \subseteq P_s(C_4)$ then since $l(C_4) < l(C_3)$ \hat{C} would have been a son of C_4 . Therefore $P_f(\hat{C}) \cap [u_2, u_3] \neq \phi$.

A4 In this case $J_t(C_3) = [u_2 \rightarrow v_3]$ and $J_h(C_3) = [v_4 \rightarrow u_3]$. Obviously for every son \hat{C} of C_3 $P_f(\hat{C}) \subset P_s(C_3) = I(C_3) \cup J_t(C_3) \cup J_h(C_3)$.

A5 $M(C_3)$ is contained in $P_s(C_3) \cup C_1 \cup C_2 \cup C_4 \cup M(S)$. Since $l(C_i) < l(C_3)$, $i = 1, 2, 4$ the condition is satisfied.

A6 $M(C_3)$ is contained in $P_s(C_3)$, C_1 , C_2 , C_4 (three brothers of C_3), S and $M(S)$, so $N(C_3) = \{C_1, C_2, C_4\}$.

■

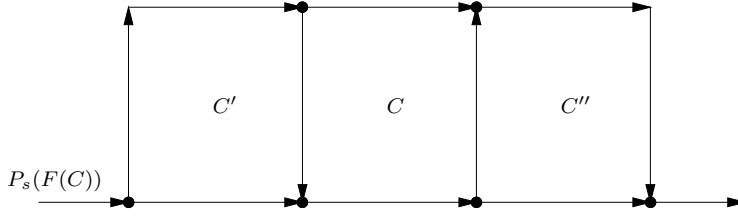

Figure 36: Figure for Lemma 3.42.

3.10 DIRECT-ONE

In this section we consider a cycle oriented by DIRECT-ONE and prove that it satisfies the induction hypotheses. The analysis is performed according to the level of containment of C' , C'' defined in DIRECT-ONE. These cycles are defined only when C should be oriented forwards (heavy or special-contained) in addition C' is defined when $l_1 = -1$ and C'' is defined when $l_2 = -1$. When C' and C'' are not defined in DIRECT-ONE, Lemma 3.32 or Lemma 3.33 applies to prove that C satisfies the induction hypotheses.

3.10.1 C' and C from the same level of containment ($lc(C') = lc(C)$)

Lemma 3.42 *Consider a cycle $C \in \mathcal{C} \setminus \{C_0\}$ and suppose that there exist C' and C'' in $N(C)$, (C' on the l_1 side and C'' on the l_2 side). (see Figure 36). C' and C'' are both defined by DIRECT-ONE. Then C is heavy or outer-crossing with one of these cycles.*

Proof: We assume that C is not outer-crossing and prove that in this case C must be heavy. Consider the time when C was in the input of procedure DIRECT.

1. If the function DIRECT-INNER-CROSSING was used, $N(C)$ cannot contain both S_1 and S_2 (see Figure 26 and 50).
2. If the function DIRECT-ONE was used and C is not heavy then either this case belongs to Lemma 3.32 or by Lemma 3.33 and then $|N(C)| = 0$, or C is a special-contained brother. In the latter case $N(C)$ may contain only cycles from one side of C .
3. If the function DIRECT-TWO was used and C is not heavy then $N(C)$ is constructed by either Lemma 3.35 or Lemma 3.36, and then $|N(C)| = 1$.
4. If the function DIRECT-MANY was used:
 - (a) When C_{m_1} is light. The functions used are DIRECT-BACKWARDS, DIRECT-FORWARDS, and DIRECT-TWO. The cycles oriented in these functions satisfy Lemmas 3.32, 3.33, 3.35 and 3.36 where $|N(C)| \leq 1$.
 - (b) When C_{m_1} is heavy, C_{m_2} is light, and C_{m_1} is not crossing.
 - $m_1 = 1$. C_1 is heavy. For the other cycles we perform DIRECT-MANY or DIRECT-TWO on light cycles, as in (a).
 - $m_1 = n$ similar to previous case.
 - $1 < m_1 < n$. In this case C_{m_1} is heavy.

- If $m_1 > 3$ then we use DIRECT-MANY or DIRECT-TWO on light cycles so $|N(C)| \leq 1$ for all these cycles.
 - If $m_1 = 2$. When $l_1 \neq 0$ C_1 is oriented backwards and $N(C_1) = \phi$. When $l_1 = 1$ then $N(C_1) \subseteq \{C_2, C_3\}$.
 - If $m_1 = n - 1$ similar proof holds.
- (c) When C_{m_2} is heavy and C_{m_1} is not crossing. The cycles C_j and C_k are heavy. We consider the other cycles:
- When $j < k - 1$. The cycles C_{j+1}, \dots, C_{k-1} are oriented by DIRECT-ONE (the case $v_1 \leftarrow v_2$), DIRECT-TWO or DIRECT-MANY (on light cycles). In all these cases $|N(C)| \leq 1$ as in (a).
 - When $j > 2$. The cycles C_1, \dots, C_{j-1} are oriented by DIRECT-TWO or DIRECT-MANY (on light cycles) with $|N(C)| \leq 1$ as in (a).
 - When $j = 2$. If $l_1 \neq 1$ then C_1 will be oriented backwards and $|N(C_1)| = 0$. If $l_1 = 1$ then $N(C_1) \subseteq \{C_2, C_3, C_4\}$.
 - When $k < n - 2$. The cycles C_{k+1}, \dots, C_n are oriented by DIRECT-TWO or DIRECT-MANY (on light cycles) with $|N(C)| \leq 1$.
 - When $k = n - 1$ similar proof like when $j = 2$.
- (d) When C_{m_1} is crossing. In this case $j = k - 1$. C_j and C_k are outer-crossing. For the cycles C_1, \dots, C_{j-1} and C_{k+1}, \dots, C_n a similar proof to case 4c holds.

■

Lemma 3.43 *Consider a non-crossing cycle C oriented by DIRECT-ONE. If the cycles that set l_1 and l_2 are in the same level of containment as C then C satisfies the induction hypotheses.*

Proof: Since C is non crossing DIRECT-ONE is called by DIRECT-MANY or DIRECT-TWO.

1. DIRECT-ONE is called by DIRECT-MANY. Note that in this case C_{m_1} is heavy. For C_1 and C_n , l_1 and l_2 are set in previous generation or level of containment. Therefore $C \neq C_1$ and $C \neq C_n$.
 - (a) C_{m_2} is light.
 - $m_1 = 1$. C_2, \dots, C_{n-1} are oriented in DIRECT-K. Since $n > 2$ DIRECT-K will not call DIRECT-ONE.
 - The same proof holds for $m_1 = n$.
 - $1 < m_1 < n$. Lemma 3.32 applies to prove that C_{m_1} satisfies the induction hypotheses.
 - $2 < m_1 < n - 1$. DIRECT-K will not call DIRECT-ONE and the orientation of C_{m_1} will not be farther changed.
 - $2 = m_1 < n - 1$. If $l(C_1) < l(C_2)$ then Lemmas 3.32 and 3.35 apply to prove that C_1 and C_2 satisfy the induction hypotheses (respectively). If $l(C_1) > l(C_2)$ equivalent lemmas apply. DIRECT-K on C_3, \dots, C_n will not call DIRECT-ONE.
 - The same proof holds for $2 < m_1 = n - 1$.
 - (b) C_{m_2} is heavy.

- $k = j + 2$. C_{j+1} is oriented by DIRECT-ONE : $v_2 \rightarrow v_1$. Lemma 3.33 applies to prove that C_{j+1} satisfies the induction hypotheses. Again it doesn't change any previously oriented cycles, and will not be farther changed in this level of containment.
- $k = j + 1$.
 - When $j = 2, k = 3, n > 4$. Lemmas 3.32, 3.35 ,3.39 and 3.38 (or equivalent lemmas) apply to prove that C_1, C_2 and C_3 satisfy the induction hypotheses.
 - The same proof holds for $j > 2, k = n - 1$.
 - $j = 2, k = 3, n = 4$. In this case Lemmas 3.32, 3.35 ,3.39, 3.38, 3.41 and 3.40 or equivalent lemmas apply to prove that C_1, C_2, C_3 and C_4 satisfy the induction hypotheses.

2. DIRECT-ONE was called by DIRECT-TWO. As in DIRECT-MANY $C \neq C_1$ and $C \neq C_2$. ■

3.10.2 C' and C are brothers with $lc(C') < lc(C)$

Consider a cycle C oriented forwards in DIRECT-ONE even though $l_1 = -1$. We observe that C is either heavy or special-contained brother, otherwise DIRECT-ONE would have oriented it backwards. Denote by D a containing brother of C . In Figure 37 C, C' and D are described before the application of DIRECT-ONE. Since $l_1 = -1$, C is the first brother in the block of contained brothers of D . We can assume that before C is oriented, C' and D satisfied the induction hypotheses. If C is heavy, then D is heavy and it is oriented forwards. If C is a special-contained brother then D is oriented forwards. Since $l_1 = -1$, $C' \in N(D)$ and C' is oriented forwards. Mark

- $v_1 := S \cap (P_s(C') \setminus P_s(D))$.
- $v_2 := S \cap (P_s(D) \cap P_s(C) \cap P_s(C'))$.
- $v_3 := S \cap (P_s(C) \setminus P_s(C'))$.
- $v_4 := S \cap (P_s(D) \setminus P_s(C'))$.
- $u_1 :=$ the end node of the path $P_s(C) \cap P_s(C')$ such that $u_1 \notin S$.
- $u_2 :=$ the end node of the path $P_s(D) \cap P_s(C')$ such that $u_2 \notin S$.

If $l(C) > l(C')$ then DIRECT-ONE will not change the direction of $[u_1, v_2]$ and D , and we only need to prove that C satisfies the induction hypotheses. If $l(C) < l(C')$ then orientation of C' , $J_t(D)$ and $B_t(D)$ are changed. In this case we also need to prove that after DIRECT-ONE is activated C' and D still satisfy the induction hypotheses. We prove all these in the following lemmas.

Lemma 3.44 *If $l(C) > l(C')$, then after DIRECT-ONE is activated C satisfies the induction hypotheses.*

Proof: There are three cases to be considered.

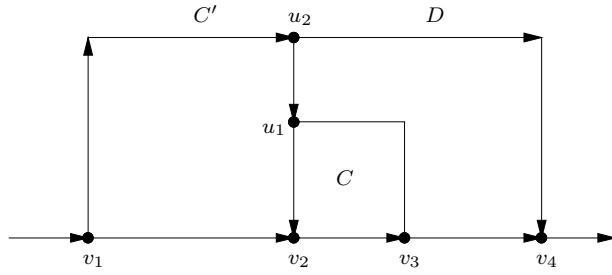

Figure 37: C' from previous containment level.

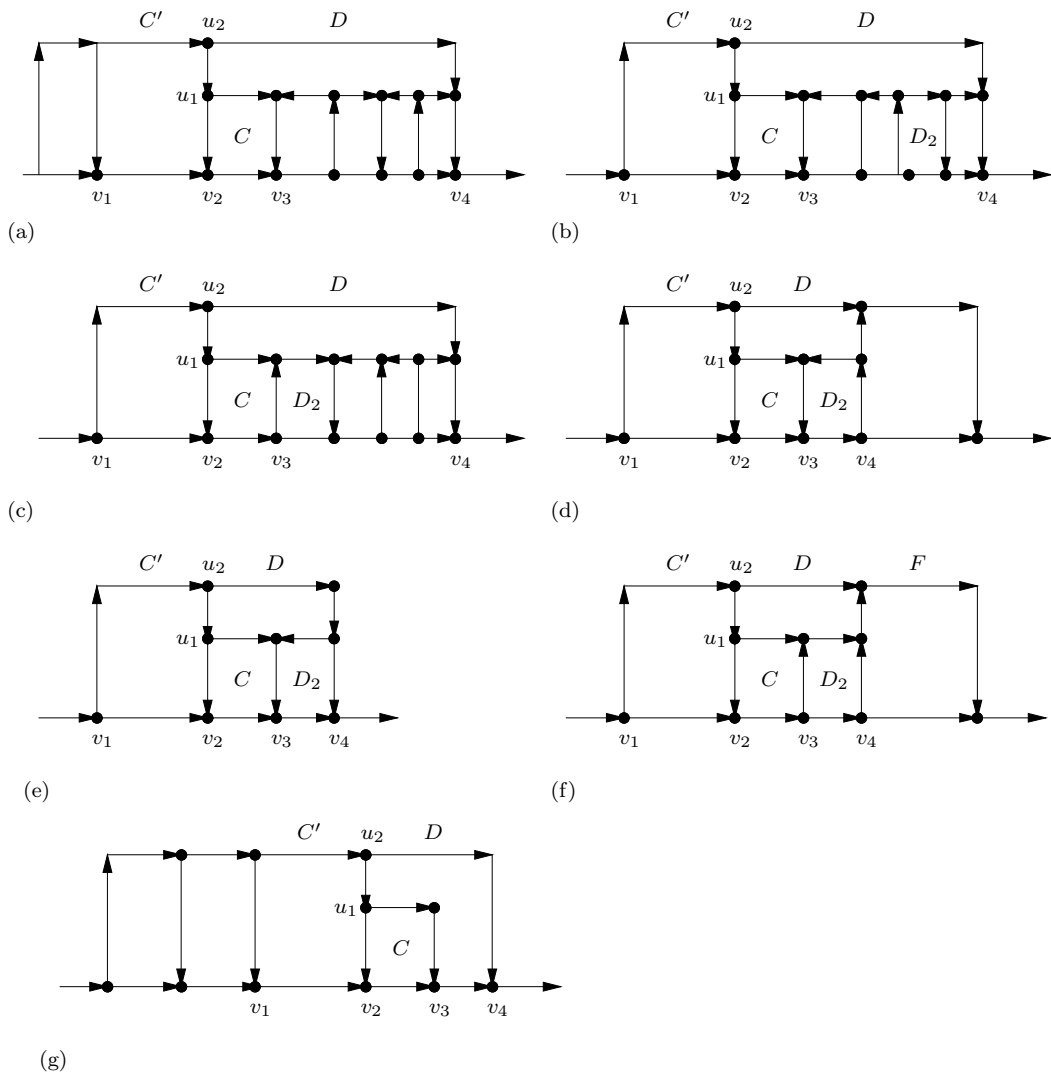

Figure 38: Figure for Lemma 3.44.

1. There are more than two contained brothers in D (DIRECT-ONE was called by DIRECT-MANY). See Figure 38 (a) (b) and (c).
 - C is the only heavy contained brother in D (see Figure 38 (a)). In this case (even after all the contained brothers of D are oriented) $N(C)$ will not contain any cycle on the l_2 side of C . By Lemma 3.42 $N(C) \subset N(D)$, $|N(C)| \leq 2$, and Lemma 3.35 or Lemma 3.38 apply to prove that C satisfies the induction hypotheses.
 - There is another heavy brother D_2 which is contained in D , such that $P_s(C) \cap P_s(D_2) = \phi$ (see Figure 38 (b)). In this case C' has to be light, and by Lemma 3.42 $N(C') = \phi$. Again $N(C)$ will not contain any cycle on the l_2 side of C so $N(C) = \{C'\}$ and Lemma 3.35 applies to prove that C satisfies the induction hypotheses.
 - There is another heavy brother D_2 which is contained in D , such that $P_s(C) \cap P_s(D_2) \neq \phi$ (see Figure 38 (c)). In this case C' has to be light, so by Lemma 3.42 $N(C') = \phi$, giving that $N(C) = \{D_2, C'\}$ and Lemma 3.39 applies to prove that C satisfies the induction hypotheses.
2. There are exactly two contained brothers in D (DIRECT-ONE was called by DIRECT-TWO) (see Figure 38 (d) (e) and (f)). Mark the other contained brother of D as D_2 .
 - D_2 is light.
 - $N(D)$ contains another cycle in the l_2 side of D (see Figure 38 (d)). In this case D_2 is oriented backwards so $N(C)$ doesn't contain any cycle in the l_2 side of C , giving that $N(C) \subset N(D)$ and $|N(C)| \leq 2$. Lemma 3.35 or Lemma 3.38 applies to prove that C satisfies the induction hypotheses.
 - $N(D)$ doesn't contain another cycle in the l_2 side of D (see Figure 38 (e)). Since D is heavy, by Lemma 3.42 $|N(D)| \leq 2$. In this case D_2 will also be oriented forwards, and $N(C) = N(D) \cup \{D_2\}$, but still $|N(C)| \leq 3$. In this case Lemma 3.39 or Lemma 3.41 applies to prove that C satisfies the induction hypotheses.
 - When F_2 is heavy (see Figure 38(f)). In this case C' has to be light, so by Lemma 3.42 $N(D)$ contains C' and possibly one more cycle F at the l_2 side of D . In this case $N(C) \subset \{D_2, C', F\}$ and Lemma 3.39 or Lemma 3.41 applies to prove that C satisfies the induction hypotheses.
3. There is exactly one contained brother in D (C is a special-contained brother of D). See Figure 38(g). Since D satisfies the induction hypotheses $N(D)$ contains at most 3 brothers at its l_1 side. $N(C)$ contains all the cycles from this side (all are shorter than C) and C will be oriented to satisfy Lemma 3.35, Lemma 3.38, or Lemma 3.40.

■

Lemma 3.45 *Suppose that $l(C) < l(C')$, then after DIRECT-ONE is activated C satisfies the induction hypotheses.*

Proof: In this case DIRECT-ONE changes a previous direction and $I(C) = P_s(C)$, so Lemma 3.32 applies to prove that C satisfy the induction hypotheses. ■

Lemma 3.46 *Suppose that $l(C) < l(C')$, then after DIRECT-ONE is activated C' satisfies the induction hypotheses.*

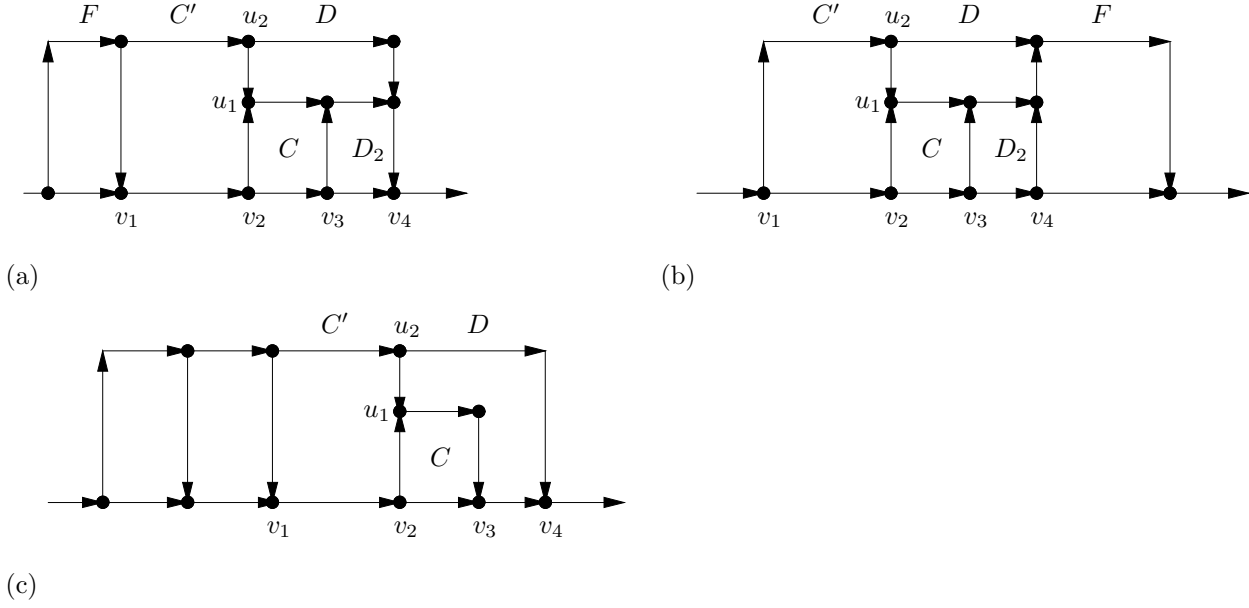

Figure 39: Figure for Lemma 3.46.

Proof: There are two cases to be considered.

1. C is heavy. According to Lemma 3.42 after DIRECT-ONE is activated $N(C')$ contains C and at most two more cycles.
 - If C' is heavy, $N(C')$ contains at most one cycle at the l_1 side of C' and one cycle at the l_2 side of C . (see Figure 39 (a)). In this case equivalent lemma to Lemma 3.35, or lemma 3.39 or Lemma 3.41 applies to prove that C' satisfies the induction hypotheses.
 - If C' is light, $N(C')$ contains C and at most two more cycles, both at the l_2 side of C . (see Figure 39 (b)). In this case equivalent lemma to Lemma 3.35, lemma 3.38 or Lemma 3.40 applies to prove that C' satisfies the induction hypotheses.
2. C is the only contained brother (in his level of containment) of D (i.e., C is a special-contained brother). By Lemma 3.42 $N(D)$ contains at most 3 cycles in its l_1 side, one of them is C' (see Figure 39 (c)). Hence, before DIRECT-ONE is activated $|N(C')| \leq 2$ (all cycles in $N(C')$ are on the l_1 side of C'). After DIRECT-ONE is activated C is added to $N(C')$ but still $|N(C')| \leq 3$ and Lemma 3.39, or Lemma 3.41 or equivalent lemma to Lemma 3.35 applies to prove that C' satisfies the induction hypotheses.

■

Lemma 3.47 Let D' be a son of D , then $P_f(D') \cap [v_2, u_1] = \phi$.

Proof: Suppose otherwise, then from planarity $P_s(D') \cap [u_1, v_3]$ includes at least one node b (see Figure 40). Let v_d be a node from $U(D')$ and v_c be a node from $U(C)$. Mark b_1, b_2 the end nodes of $P_s(D')$ such that $b_1 \in [u_2, v_4]$ subpath of $P_s(D)$, $b_2 \in [u_1, v_2]$. If $v_d \in [b_1, b]$ then the path $[b, b_2]$

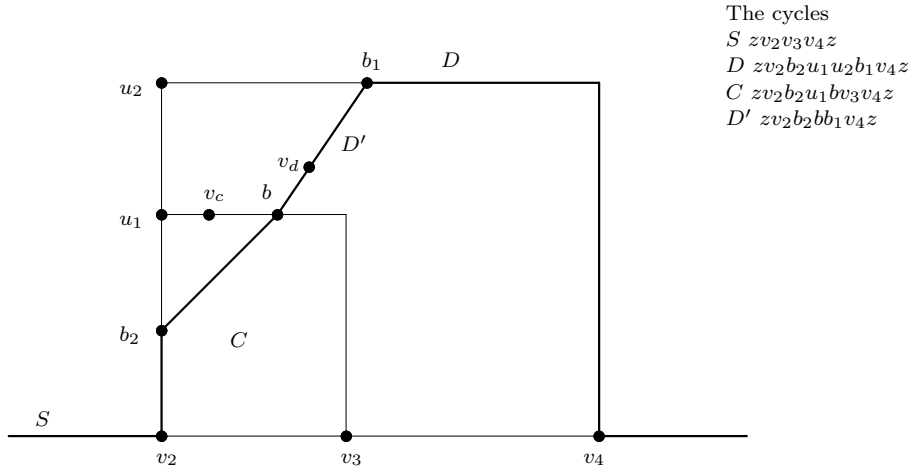

Figure 40: Figure for Lemma 3.47.

is shorter than the path $[b, u_1, b_2]$ so $v_c \notin [b, v_3]$ (otherwise it would also use the path $[b, b_2]$ which is not part of C). So either $U(D') \subseteq [b, b_1]$ and $U(C) \subseteq [b, u_1]$ or $U(D') \subseteq [b, b_2]$ and $U(C) \subseteq [b, v_3]$.

Suppose that $v_d \in [b, b_1]$ and $v_c \in [b, u_1]$ (a similar proof holds for the other case). In this case $l(b, b_2) < l(b, u_1, b_2)$ and $l(b, v_3, v_4) < l(b, b_1, v_4)$. Mark NC the cycle $C \setminus [b, u_1, b_2] \cup [b, b_2]$. Then $l(NC) < l(C)$. Obviously the node b uses this cycle. But then NC is a contained brother of D and C is the son of NC . ■

Lemma 3.48 *Suppose that $l(C) < l(C')$, then after DIRECT-ONE is activated D satisfies the induction hypotheses. See Figure 41.*

Proof: We go over the induction hypotheses:

A1 When DIRECT-ONE is activated on C the direction of the path $[u_1, v_2]$ is changed. Since $[u_1, v_2] \cap (M(D) \cup I(D))$ doesn't contain an edge, $M(D)$ and $I(D)$ are not changed. Since D satisfied A1 before DIRECT-ONE the bound on $M(D)$ still holds.

A2 We prove this by bounding the $l(B(D))$ (see Lemma 3.31). Since C' is a son of S , from A4 on S $h(S) \notin P_f(D)$. W.l.o.g we also assume that $t(S) \notin P_f(D)$ (if $t(S) \in P_f(D)$ the length of $B(D)$ is even shorter). There are two cases to be considered.

- $N(D)$ doesn't contain another cycle on the l_2 side of D , so $I(D) = [u_2 \rightarrow v_4]$. Define $B(D) = [u_2 \rightarrow u_1 \rightarrow v_3 \rightarrow v_4]$. Before DIRECT-ONE was applied D satisfied the induction hypotheses, so by A5 $l(C') < l(D)$. From $l(C) < l(C')$ also $l(C) < l(D)$ and¹⁰:

$$l(u_1, v_3) < l(u_1, v_2) + l(v_2, v_3). \quad (35)$$

Using Equation 35 and since D is a son of S :

$$l(B(D)) = l(u_2, u_1) + l(u_1, v_3) + l(v_3, v_4)$$

¹⁰ $[u_1, v_3]$ is the subpath of $P_s(C)$.

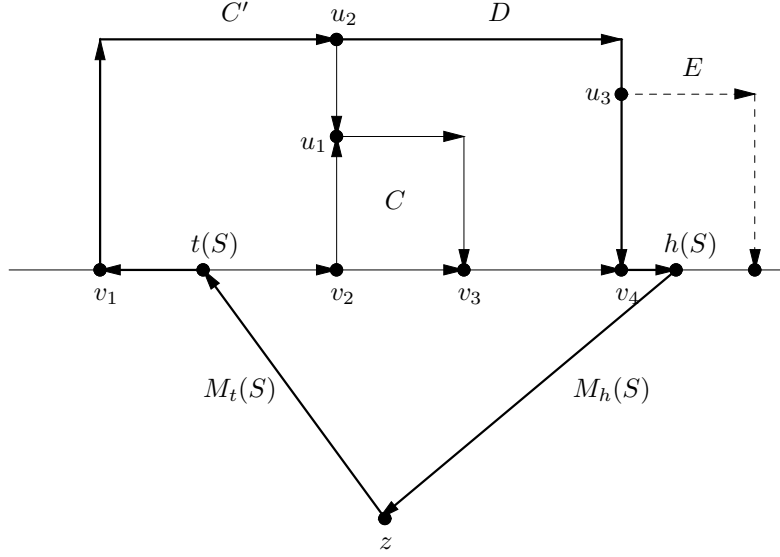

Figure 41: Figure for Lemma 3.48.

$$\begin{aligned}
&< l(u_2, u_1) + l(u_1, v_2) + l(v_2, v_3) + l(v_3, v_4) \\
&= l(P_s(D)) - l(I(D)) + l(v_2, v_3, v_4) \\
&\leq l(P_s(D)) - l(I(D)) + l(P_s(D)).
\end{aligned}$$

- $N(D)$ contains another cycle E on the l_2 side of D . Mark $[u_3, v_4] = P_s(D) \cap P_s(E)$. In this case before the application of DIRECT-ONE, $B_{old}(D)$ was $[u_2 \rightarrow u_1 \rightarrow v_2 \rightarrow v_3 \rightarrow v_4 \rightarrow u_3]$. Define $B_{new}(D) = [u_2 \rightarrow u_1 \rightarrow v_3 \rightarrow v_4 \rightarrow u_3]$. Using again Equation 35 we conclude that $B_{new}(D) < B_{old}(D)$.

A3 $I(D)$ hasn't changed so A3 still holds.

A4 $J_t(D)$ has shortened to be $[u_2 \rightarrow u_1]$, so $J_t(D) \cup I(D) \cup J_h(D) = [u_1, u_2, v_4]$. By Lemma 3.47 if D' is a son of D then $P_f(D') \subset [u_1, u_2, v_4]$.

A5 $M(D)$ hasn't changed so A5 still holds.

A6 $M(D)$ hasn't changed so A6 still holds.

■

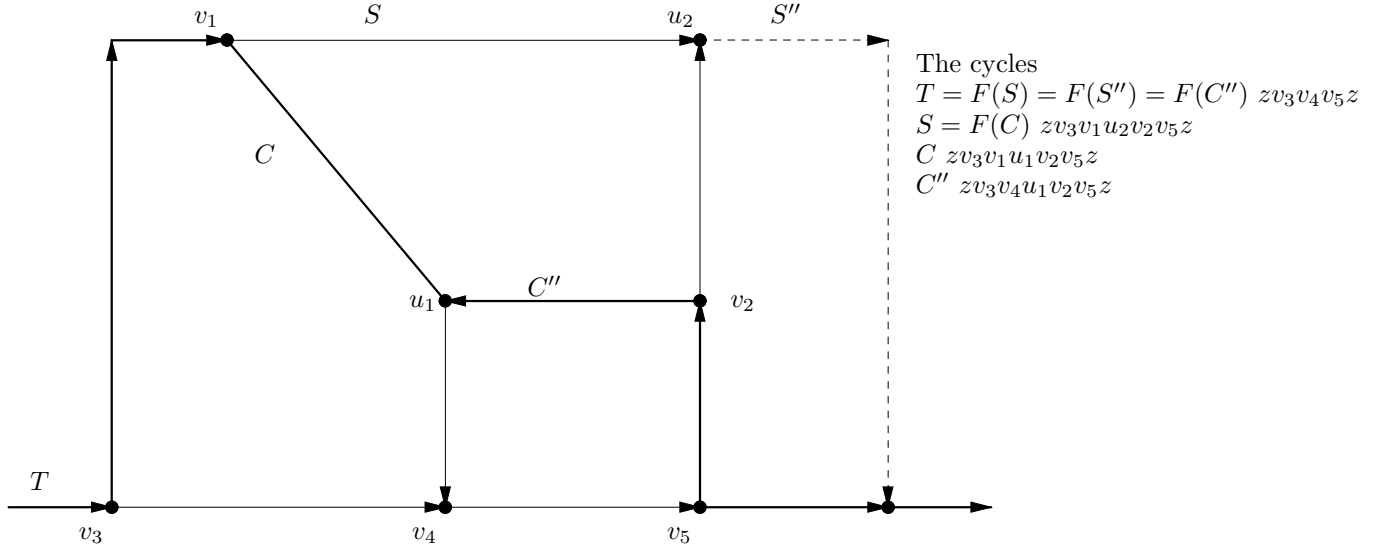

Figure 42: C'' is an uncle, S is oriented forwards.

3.10.3 C'' is an uncle (or from previous generation)

In this section we consider the case C'' is an uncle (similarly C'' can be a brother of an ancestor). In the following we assume that $P_s(C)$ is inside the part of the plane surrounded by $P_s(S) \cup P_f(S)$ (where $S = F(C)$). Similar proofs follow for the case it is outside this part of the plane.

$S = F(C)$ is oriented forwards

Here we consider a cycle C oriented forwards by DIRECT-ONE even though $l_2 = -1$. In this subsection we assume that $S = F(C)$ is oriented forwards, $T = F(S)$ and C'' a contained brother of S (see Figure 42). C which is a son of S shares the path $[v_2, u_1]$ at its l_2 side with C'' . Thus C has to be the last cycle in the block of sons of S , and C'' is oriented backwards. In Figure 42 C, C'', S and T are described before the application of DIRECT-ONE.

Mark

- $v_1 := S \cap P_s(C) \setminus P_s(C'')$.
- $v_2 := S \cap P_s(C) \cap P_s(C'')$.
- $v_3 := T \cap P_s(S) \setminus P_s(C'')$.
- $v_4 := T \cap P_s(C'') \setminus P_s(S)$.
- $v_5 := T \cap P_s(C'') \cap P_s(S)$.
- $u_1 :=$ the end node of the path $P_s(C) \cap P_s(C'')$, such that $u_1 \notin S$.

Since C'' is oriented backwards $N(S)$ contains at least one cycle at the l_2 side of $P_s(S)$ (S'' in Figure 42). We consider the case where $v_3 = t(S)$ (similar but longer proof holds otherwise). When

DIRECT-ONE is activated on C it compares $l(C)$ and $l(C'') + 2l(P_c(C'') \setminus C)$ and decides whether to change the direction of $[u_1, v_2]$. In the following two lemmas we assume $[v_1, u_1]$ was directed $v_1 \rightarrow u_1$ (C didn't have heavy brothers at its l_1 side to contradict this direction). In lemmas 3.52 and 3.54 we will consider the other case.

Lemma 3.49 *Suppose that $l(C'') + 2l(P_c(C'') \setminus C) < l(C)$, then C satisfies the induction hypotheses.*

Proof: In this case when DIRECT-ONE is activated on C it doesn't change the direction $v_2 \rightarrow u_1$.

Since $l(C'') + 2l(P_c(C'') \setminus C) < l(C)$

$$l(v_3, v_4) + l(v_4, u_1) + l(u_1, v_2) + l(v_2, v_5) + 2l(v_3, v_4) < l(v_3, v_1) + l(v_1, u_1) + l(u_1, v_2) + l(v_2, v_5)$$

giving:

$$3l(v_3, v_4) + l(v_4, u_1) < l(v_3, v_1) + l(v_1, u_1). \quad (36)$$

Since $T = F(S)$

$$l(v_3, v_4) + l(v_4, v_5) < l(v_3, v_1) + l(v_1, v_2) + l(v_2, v_5). \quad (37)$$

Since C is a son of S

$$l(v_1, v_2) < l(P_s(C)). \quad (38)$$

A1 Let $x = t(T), y = h(T)$, and the end nodes v, w of $P_s(T)$ be ordered v, x, y, w .

Since C'' was oriented backwards by Property 3.16:

$$2l(v_4, v_5) < l(v, v_3) + l(v_3, v_4) + l(v_5, w). \quad (39)$$

Since C'' was oriented backwards and S is oriented forwards, by Property 3.20 C'' is not a special-contained brother of S , and there is at least one more brother contained in S in the same level of containment as C'' . Hence, By A3 on T $x \in [v, v_4]$. Since there is at least one more brother of S on its l_2 side $y \in [v_5, w]$. $I(C) = [v_1 \rightarrow u_1]$ and by A4 we can define (see Figure 43)

$$M_t(C) = M_t(T) \cup [x \rightarrow v_3 \rightarrow v_1] \quad M_h(C) = [u_1 \rightarrow v_4 \rightarrow v_5 \rightarrow y] \cup M_h(T).$$

Using A1 on T :

$$\begin{aligned} l(M(C)) &= l(M(T)) + l(x, v_3) + l(v_3, v_1) + l(u_1, v_4) + l(v_4, v_5) + l(v_5, y) \\ &\leq 15l(P_c(T)) + 4l(v, v_3) + 3l(v_3, v_4) + 4l(v_4, v_5) + 4l(v_5, w) + l(v_3, v_1) + l(u_1, v_4). \end{aligned}$$

The length of $[v, v_3]$ is taken 4 times to satisfy both cases of locations for x . Using Equations (39), (36), (37), the definition of $P_c(C)$, (38) and the definition of $I(C)$

$$\begin{aligned} l(M(C)) &\leq 15l(P_c(T)) + 5l(v, v_3) + 4l(v_3, v_4) + 2l(v_4, v_5) + 5l(v_5, w) + l(v_3, v_1) + l(u_1, v_4) \\ &\leq 15l(P_c(T)) + 5l(v, v_3) + l(v_3, v_4) + 2l(v_4, v_5) + 5l(v_5, w) + 2l(v_3, v_1) + l(v_1, u_1) \\ &\leq 15l(P_c(T)) + 5l(v, v_3) + 5l(v_5, w) + 4l(v_3, v_1) + l(v_1, u_1) + 2l(v_1, v_2) + 2l(v_2, v_5) \\ &\leq 15l(P_c(C)) + l(v_1, u_1) + 2l(v_1, v_2) \\ &\leq 15l(P_c(C)) + l(v_1, u_1) + 2l(P_s(C)) \\ &= 15l(P_c(C)) + l(I(C)) + 2l(P_s(C)). \end{aligned}$$

$$\begin{aligned}
& 4l(v_3, v_1) + l(v_1, u_1) + 3l(v_1, v_2) \\
\leq & 15l(P_c(C)) + l(v_2, u_1) + l(v_1, u_1) + 3l(v_1, v_2) \\
\leq & 15l(P_c(C)) + l(v_2, u_1) + l(v_1, u_1) + 3l(P_s(C)) \\
\leq & 15l(P_c(C)) + 4l(P_s(C)).
\end{aligned}$$

A3 Since $2l(P_c(C'') \setminus C) + l(C'') < l(C)$ then $l(C'') < l(C)$. Let \hat{C} be a son of C . If $P_f(\hat{C}) \subset [v_2, u_1]$ then since $[v_2, u_1] \subset P_s(C'')$, \hat{C} should have been a son of C'' . Therefore $P_f(\hat{C}) \cap [v_1, u_1] \neq \phi$.

A4 $J_h(C) = [v_2 \rightarrow u_1]$ and for every \hat{C} a son of C $P_f(\hat{C}) \subset P_s(C) = I(C) \cup J_h(C)$.

A5 $M(C)$ is contained in $P_s(C)$, S , C'' and T which are all shorter than C .

A6 $M(C)$ is contained in $P_s(C)$, $P_s(S)$, $M(S)$ and C'' , so $N(C) = \{C''\}$.

■

Lemma 3.50 *Suppose that $l(C) < 2l(P_c(C'') \setminus C) + l(C'')$ then after the application of DIRECT-ONE C'' satisfies the induction hypotheses.*

Proof: In this case when DIRECT-ONE is activated on C it changes the direction of $[u_1, v_2]$ to $v_2 \rightarrow u_1$.

Since $l(C) < 2l(P_c(C'') \setminus P_c(S)) + l(C'')$:

$$l(v_3, v_1) + l(v_1, u_1) < 3l(v_3, v_4) + l(v_4, u_1). \quad (40)$$

Since C'' was oriented backwards by Property 3.16 Equation (39) still holds.

A1 Let $x = t(T)$, $y = h(T)$, and the end nodes v, w of $P_s(T)$ be ordered v, x, y, w .

Since C'' was oriented backwards by Property 3.16 Equation (39) still holds.

Since C'' was oriented backwards and S is oriented forwards, then by Property 3.20 C'' is not a special-contained brother of S , and there is at least one more brother contained in S in the same level of containment as C'' . Hence, by A3 on T $x \in [v, v_4]$. Since there is at least one more brother of S on its l_2 side and $y \in [v_5, w]$. See Figure 44.

$I(C'') = [u_1 \rightarrow v_4]$, by A4 we can define

$$M_t(C'') = M_t(T) \cup [x \rightarrow v_3 \rightarrow v_1 \rightarrow u_1] \quad M_h(C'') = [v_4 \rightarrow v_5 \rightarrow y] \cup M_h(T).$$

Using A1 on T :

$$\begin{aligned}
l(M(C'')) &= l(M(T)) + l(x, v_3) + l(v_3, v_1) + l(v_1, u_1) + l(v_4, v_5) + l(v_5, y) \\
&\leq 15l(P_c(T)) + 4l(v, v_3) + 3l(v_3, v_4) + 4l(v_4, v_5) + 3l(v_5, w) + l(v_3, v_1) + l(v_1, u_1).
\end{aligned}$$

The length of $[v, v_3]$ is taken 4 times to satisfy both cases of possible locations for x .

Using Equations (40) and (39):

$$\begin{aligned}
l(M(C'')) &\leq 15l(P_c(T)) + 4l(v, v_3) + 6l(v_3, v_4) + 4l(v_4, v_5) + 3l(v_5, w) + 3l(v_1, u_1) \\
&\leq 15l(P_c(T)) + 6l(v, v_3) + 8l(v_3, v_4) + 5l(v_5, w) + 3l(v_1, u_1).
\end{aligned}$$

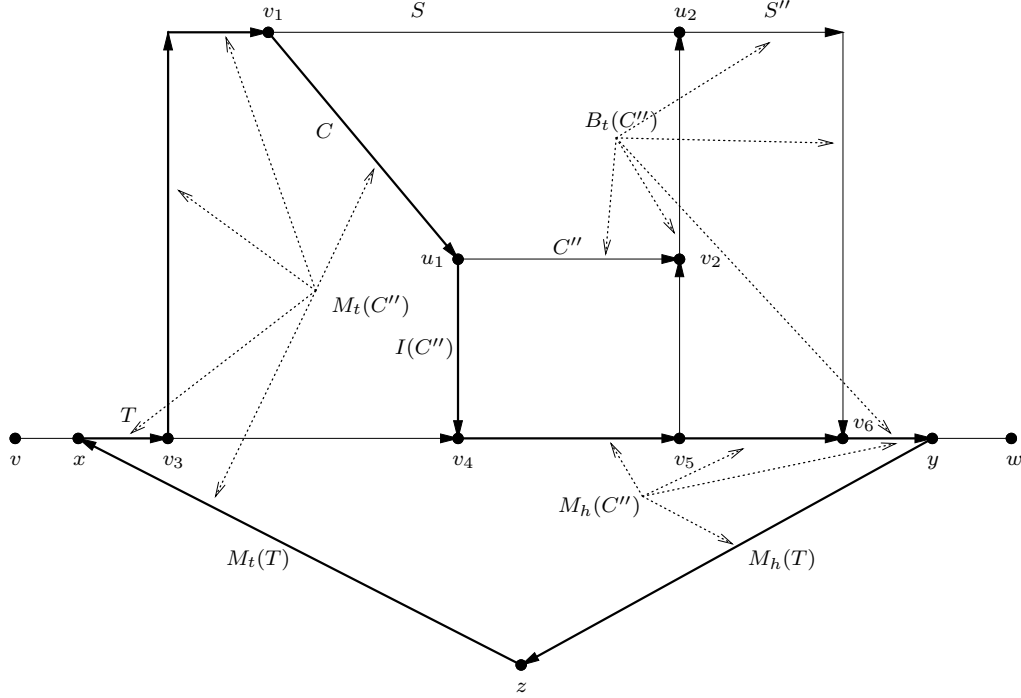

Figure 44: Figure for Lemma 3.50.

By definition

$$l(P_c(C'')) = l(P_c(T)) + l(v, v_3) + l(v_3, v_4) + l(v_5, w).$$

Using the definition of $I(C'')$ we get

$$\begin{aligned} l(M(C'')) &\leq 15l(P_c(C'')) + l(u_1, v_4) \\ &= 15l(P_c(C)) + l(I(C)) + 2l(P_s(C)). \end{aligned}$$

A2 $N(S)$ contains at least one more brother at the l_2 side of C'' . W.l.o.g we assume that that $N(S) = 1$ (again, longer but similar proofs can be given for the other cases). Mark this brother as S'' . Mark

- $u_2 :=$ the end node of the path $P_s(S) \cap P_s(S'')$ such that $u_2 \notin T$.
- $v_6 = T \cap (P_s(S'') \setminus P_s(S))$.

Since $E \in N(S)$ by A5 on S $l(S'') < l(S)$. Since C is a son of S , $l(S) < l(C)$ and by the lemma's assumption

$$l(S'') < l(S) < l(C) < l(C'') + 2l(P_c(C'') \setminus C),$$

giving:

$$l(v_4, v_5) + l(v_2, u_2) + l(u_2, v_6) < l(v_4, u_1) + l(u_1, v_2) + l(v_5, v_6) + 2l(v_3, v_4). \quad (41)$$

In this case $h(C'') = v_4 \in T$. Define

$$B_t(C'') = [u_1 \rightarrow v_2 \rightarrow u_2 \rightarrow v_6 \rightarrow y] \cup M_h(T).$$

Using A1 on T (again $l(v, v_3)$ and $l(v_6, w)$ are taken 4 times to satisfy all possible locations of x and y), (40) (41), (39), definition of $P_c(C'')$, the fact that C'' is a son of T and definition of $P_s(C'')$:

$$\begin{aligned}
l(M_t(C'')) + l(B_t(C'')) &= l(M(T)) + l(x, v_3) + l(v_3, v_1) + l(v_1, u_1) + l(u_1, v_2) + \\
&\quad l(v_2, u_2) + l(u_2, v_6) + l(v_6, y) \\
&\leq 15l(P_c(T)) + 4l(v, v_3) + 3l(v_3, v_4) + 3l(v_4, v_5) + 3l(v_5, v_6) + \\
&\quad 4l(v_6, w) + l(v_3, v_1) + l(v_1, u_1) + l(u_1, v_2) + l(v_2, u_2) + l(u_2, v_6) \\
&\leq 15l(P_c(T)) + 4l(v, v_3) + 6l(v_3, v_4) + 3l(v_4, v_5) + 3l(v_5, v_6) + \\
&\quad 4l(v_6, w) + l(u_1, v_2) + l(v_2, u_2) + l(u_2, v_6) + l(v_4, u_1) \\
&\leq 15l(P_c(T)) + 4l(v, v_3) + 8l(v_3, v_4) + 2l(v_4, v_5) + 4l(v_5, v_6) + \\
&\quad 4l(v_6, w) + 2l(u_1, v_2) + 2l(v_4, u_1) \\
&\leq 15l(P_c(C'')) + 2l(v_4, v_5) + 2l(u_1, v_2) + 2l(v_4, u_1) \\
&\leq 15l(P_c(C'')) + 2l(v_4, v_5) + 2l(P_s(C'')) \\
&\leq 15l(P_c(C'')) + 4l(P_s(C'')).
\end{aligned}$$

A3 There are two cases to be considered:

- $l(C) < l(C'')$. In this case $l(S'') < l(C'')$. Let \hat{C} be a son of C'' . If $P_f(\hat{C}) \subset ([u_1, v_2] \cup [v_2, v_5])$ then \hat{C} should have been a son of C or S'' but not of C'' .
- $l(C) > l(C'')$. Let \hat{C} be a son of C'' . If $(P_f(\hat{C}) \subset [u_1, v_2, v_5])$ DIRECT-ONE changes the undirected cycle for $U(\hat{C})$ to be a son of C (we replace the path $[v_3, v_4, u_1]$ by the path $[v_3, v_1, u_1]$).

A4 $J_t(C'') = [u_1 \rightarrow v_2]$ and for every \hat{C} a son of C'' (which remains a son after the change we described in A3) $P_f(\hat{C}) \subset [v_4, u_1] \cup [u_1, v_2] = I(C'') \cup J_t(C'')$.

A5 $M(C'')$ is contained in $P_s(C'')$, C , and T which are all shorter than C .

A6 $M(C)$ is contained in $P_s(C'')$, $P_s(T)$, $M(T)$ and C , so $N(C'') = \{C\}$.

■

Remark 3.51 We note that after DIRECT-ONE $U(C'') \subseteq [u_1, v_4]$ and for every \hat{C} son of C'' $P_f(\hat{C})$ shares an edge with $[u_1, v_4]$. For the other nodes (and sons) we changed their undirected cycle. The length of the new undirected cycle is at most three times the length of the original undirected cycle.

Proof: The change in the undirected cycle was to replace the path $[v_3, v_4, u_1]$ by the path $[v_3, v_1, u_1]$. According to Equation (40) length of the new path is at most three times the length of the old path. So this changes the length of the undirected cycle by at most three times. We also note that since C is oriented forwards and we perform these changes on sons of a cycle oriented backwards (C'') the next time we might perform such as change can only happen in the grandsons. So no overlap occurs. ■

Now assume that C has two brothers C_1, C_2 at its l_1 side, ordered C_1, C_2, C , such that $N(C) = \{C_1, C_2, C''\}$ (see Figure 45). This happens when C and C_2 are heavy, C, C_1, C_2 are oriented forwards, and $l(C_1) < l(C_2) < l(C)$. If C_1 doesn't exist then similar but simpler proofs apply.

The cycles
 T $zv_3v_4v_5v_6z$
 S $zv_3w_1w_2v_1u_2v_2v_5v_6z$
 S'' $zv_3v_4v_5v_2u_2v_6z$
 C'' $zv_3v_4u_1v_2v_5v_6z$
 C $zv_3w_1w_2v_1u_4u_1v_2v_5v_6z$
 C_1 $zv_3w_1u_3w_2v_1u_2v_2v_5v_6z$
 C_2 $zv_3w_1w_2u_3u_4v_1u_2v_2v_5v_6z$

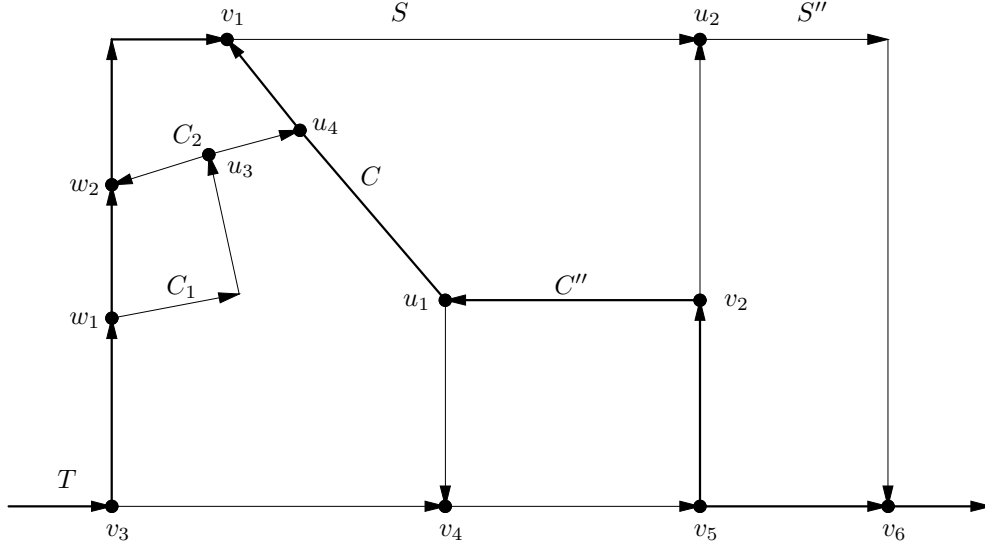

Figure 45: $N(C)$ contains two brothers at its l_1 side.

Since C'' was oriented backwards $N(S)$ contains at least one more brother at the l_2 side of C'' . W.l.o.g we assume that that $N(S) = 1$ (again longer but similar proofs follows for the other cases). Mark this brother as S'' .

Mark

- $u_2 :=$ the end node of the path $P_s(S) \cap P_s(S'')$ such that $u_2 \notin T$.
- $v_6 = T \cap (P_s(S'') \setminus P_s(S))$.
- $w_1 := S \cap (P_s(C_1) \setminus P_s(C_2))$.
- $w_2 := S \cap P_s(C_1) \cap P_s(C_2)$.
- $u_3 :=$ the end node of the path $P_s(C_1) \cap P_s(C_2)$, such that $u_3 \notin C$.
- $u_4 :=$ the end node of the path $P_s(C_2) \cap P_s(C)$, such that $u_4 \notin C$.

Since $C_1 \in N(C), C_2 \in N(C_1), l(C_1) < l(C_2) < l(C)$, and since S was oriented forwards, according to Observation 3.25 the algorithm in previous stages (before activating DIRECT-ONE on C) oriented $[w_1 \rightarrow u_3 \rightarrow u_4], [u_3 \rightarrow w_2], [u_4 \rightarrow v_1]$. Since $l(C_2) < l(C)$ DIRECT-ONE will not change the direction of $[u_4 \rightarrow v_1]$. So we only need to consider what happens to the path $[u_1, v_2]$ (whether or not its current direction $[v_2 \rightarrow u_1]$ changes).

Lemma 3.52 *Suppose that $l(C_1) < l(C_2) < l(C)$ and $l(C'') + 2l(P_c(C'') \setminus C) < l(C)$, then C satisfies the induction hypotheses.*

Proof: Since $l(C'') + 2l(P_c(C'') \setminus C) < l(C)$, when DIRECT-ONE is activated on C it will not change the direction $[v_2 \rightarrow u_1]$, Moreover Equation 36 holds. Since $l(C_1) < l(C_2) < l(C)$ by Observation 3.25 the orientation of the paths will be: $[w_1 \rightarrow u_3 \rightarrow w_2]$ and $[u_3 \rightarrow u_4 \rightarrow v_1]$.

Since $T = F(S)$ Equation (37) holds. Since $l(C_1) < l(C)$

$$l(w_1, u_3) + l(u_3, w_2) + l(v_1, v_2) < l(w_1, w_2) + l(P_s(C)). \quad (42)$$

From $l(C_2) < l(C)$

$$l(w_2, u_3) + l(u_3, u_4) + l(v_1, v_2) < l(u_4, u_1) + l(u_1, v_2) + l(w_2, v_1). \quad (43)$$

Since $S'' \in N(S)$ by A5 on S , $l(S'') < l(S)$, and since C is a son of S $l(S) < l(C)$. Therefore $l(S'') < l(C)$, giving:

$$l(v_3, v_4) + l(v_4, v_5) + l(v_2, u_2) + l(u_2, v_6) < l(v_3, w_1) + l(w_1, w_2) + l(w_2, v_1) + l(v_1, u_1) + l(u_1, v_2) + l(v_5, v_6). \quad (44)$$

A1 Let $x = t(T), y = h(T)$, and the end nodes v, w of $P_s(T)$ be ordered v, x, y, w . Since C'' is oriented backwards by Property 3.16 Equation (39) holds.

Again from A3 on T $x \in [v, v_4]$ and Since there is at least one more brother of S on its l_2 side $y \in [v_5, w]$. $I(C) = [u_4 \rightarrow u_1]$, by A4 we can define

$$M_t(C) = M_t(T) \cup [x \rightarrow v_3 \rightarrow w_1 \rightarrow u_3 \rightarrow u_3, u_4], \quad M_h(C) = [u_1 \rightarrow v_4 \rightarrow v_5 \rightarrow y] \cup M_h(T).$$

Using A1 on T :

$$\begin{aligned} l(M(C)) &= l(M(T)) + l(x, v_3) + l(v_3, w_1) + l(w_1, u_3) + l(u_3, u_4) + l(u_1, v_4) + l(v_4, v_5) + l(v_5, y) \\ &\leq 15l(P_c(T)) + 4l(v, v_3) + 3l(v_3, v_4) + 4l(v_4, v_5) + 4l(v_5, w) + l(v_3, w_1) + l(w_1, u_3) + \\ &\quad l(u_3, u_4) + l(u_1, v_4) \end{aligned}$$

The length of $[v, v_3]$ is taken 4 times to satisfy both cases of possible locations for x . Using Equations (39),(36), (37), (42),(43), the definition of $P_c(C)$, the definition of $P_s(C)$ and the definition of $I(C)$

$$\begin{aligned} l(M(C)) &\leq 15l(P_c(T)) + 5l(v, v_3) + 4l(v_3, v_4) + 2l(v_4, v_5) + 5l(v_5, w) + l(v_3, w_1) + \\ &\quad l(w_1, u_3) + l(u_3, u_4) + l(u_1, v_4) \\ &\leq 15l(P_c(T)) + 5l(v, v_3) + l(v_3, v_4) + 2l(v_4, v_5) + 5l(v_5, w) + 2l(v_3, w_1) + \\ &\quad l(w_1, u_3) + l(u_3, u_4) + l(w_1, w_2) + l(w_2, v_1) + l(v_1, u_1) \\ &\leq 15l(P_c(T)) + 5l(v, v_3) + 5l(v_5, w) + 4l(v_3, w_1) + l(w_1, u_3) + l(u_3, u_4) + \\ &\quad 3l(w_1, w_2) + 3l(w_2, v_1) + l(v_1, u_1) + 2l(v_1, v_2) + 2l(v_2, v_5) \\ &\leq 15l(P_c(T)) + 5l(v, v_3) + 5l(v_5, w) + 4l(v_3, w_1) + 4l(w_1, w_2) + 4l(w_2, v_1) + \\ &\quad l(v_1, u_1) + 2l(v_2, v_5) + l(P_s(C)) + l(u_4, u_1) + l(u_1, v_2) \\ &\leq 15l(P_c(C)) + l(v_1, u_1) + l(P_s(C)) + l(u_4, u_1) + l(u_1, v_2) \\ &\leq 15l(P_c(C)) + 2l(P_s(C)) + l(u_4, u_1) \\ &\leq 15l(P_c(C)) + 2l(P_s(C)) + l(I(C)). \end{aligned}$$

A2 In this case $t(C) = u_4 \notin S$ and $h(C) = u_1 \notin S$. So we define

$$B_h(C) = M_t(T) \cup [x \rightarrow v_3 \rightarrow v_4 \rightarrow v_5 \rightarrow v_2 \rightarrow u_1]$$

(if $x \in [v_3, v_4]$ the path is even shorter), and

$$B_t(C) = [u_4 \rightarrow v_1 \rightarrow u_2 \rightarrow v_6 \rightarrow y] \cup M_h(T).$$

This gives

$$\begin{aligned} l(B_h(C)) + l(B_t(C)) &\leq l(M_t(T)) + l(M_h(T)) + l(x, v_3) + l(v_3, v_4) + l(v_4, v_5) + l(v_5, v_2) + \\ &\quad l(v_2, u_1) + l(u_4, v_1) + l(v_1, u_2) + l(u_2, v_6) + l(v_6, y). \end{aligned}$$

Using A1 on T , the notation we use (again $l(v, v_3)$ and $l(v_6, w)$ are counted 4 times to satisfy all cases of locations of x and y), Equations (39), (36), (44), (37), the definition of $P_c(C)$, $[v_1, u_2] \subset [v_1, v_2]$, (38), the definition of $P_s(C)$ and the definition of $I(C)$

$$\begin{aligned} l(B_h(C)) + l(B_t(C)) &\leq 15(l(P_c(T)) + 2l(P_s(T)) + l(I(T)) + l(x, v_3) + l(v_3, v_4) + l(v_4, v_5) + \\ &\quad l(v_5, v_2) + l(v_2, u_1) + l(u_4, v_1) + l(v_1, u_2) + l(u_2, v_6) + l(v_6, y)) \\ &\leq 15(l(P_c(T)) + 4l(v, v_3) + 4l(v_3, v_4) + 4l(v_4, v_5) + 3l(v_5, v_6) + \\ &\quad 4l(v_6, w) + l(v_5, v_2) + l(v_2, u_1) + l(u_4, v_1) + l(v_1, u_2) + l(u_2, v_6)) \\ &\leq 15(l(P_c(T)) + 5l(v, v_3) + 5l(v_3, v_4) + 2l(v_4, v_5) + 4l(v_5, v_6) + \\ &\quad 5l(v_6, w) + l(v_5, v_2) + l(v_2, u_1) + l(u_4, v_1) + l(v_1, u_2) + l(u_2, v_6)) \\ &\leq 15(l(P_c(T)) + 5l(v, v_3) + 2l(v_3, v_4) + 2l(v_4, v_5) + 4l(v_5, v_6) + \\ &\quad 5l(v_6, w) + l(v_5, v_2) + l(v_2, u_1) + l(u_4, v_1) + l(v_1, u_2) + l(u_2, v_6) + \\ &\quad l(v_3, v_1) + l(v_1, u_1)) \\ &\leq 15(l(P_c(T)) + 5l(v, v_3) + l(v_3, v_4) + l(v_4, v_5) + 5l(v_5, v_6) + 5l(v_6, w) + \\ &\quad l(v_5, v_2) + 2l(v_2, u_1) + l(u_4, v_1) + l(v_1, u_2) + 2l(v_3, v_1) + 2l(v_1, u_1)) \\ &\leq 15(l(P_c(T)) + 5l(v, v_3) + 5l(v_5, v_6) + 5l(v_6, w) + 2l(v_5, v_2) + \\ &\quad 2l(v_2, u_1) + l(u_4, v_1) + l(v_1, u_2) + 3l(v_3, v_1) + 2l(v_1, u_1) + l(v_1, v_2)) \\ &\leq 15(l(P_c(C)) + 2l(v_2, u_1) + l(u_4, v_1) + l(v_1, u_2) + 2l(v_1, u_1) + l(v_1, v_2)) \\ &\leq 15(l(P_c(C)) + 2l(v_2, u_1) + l(u_4, v_1) + 2l(v_1, u_1) + 2l(v_1, v_2)) \\ &= 15(l(P_c(C)) + 2l(v_2, u_1) + l(u_4, v_1) + 2l(v_1, u_1) + 2l(P_s(C))) \\ &\leq 15(l(P_c(C)) + l(P_s(C) \setminus I(C)) + 4l(P_s(C))) \\ &= 15(l(P_c(C)) - l(I(C)) + 5l(P_s(C))). \end{aligned}$$

Also

$$\begin{aligned} l(B_h(C)) + l(M_h(C)) &\leq l(M_t(T)) + l(M_h(s)) + l(x, v_3) + l(v_3, v_4) + l(v_4, v_5) + l(v_5, v_2) + \\ &\quad l(v_2, u_1) + l(u_1, v_4) + l(v_4, v_5) + l(v_5, y). \end{aligned}$$

Using A1 on T , the notation we use (again $l(v, v_3)$ and $l(v_5, w)$ are counted 4 times to satisfy all cases of locations of x and y), Equations (39), (36), (37), the definition of $P_c(C)$, (38) and

the definition of $P_s(C)$:

$$\begin{aligned}
l(B_h(C)) + l(M_h(C)) &\leq 15l(P_c(T)) + 2l(P_s(T)) + l(I(T)) + l(x, v_3) + l(v_3, v_4) + \\
&\quad l(v_4, v_5) + l(v_5, v_2) + l(v_2, u_1) + l(u_1, v_4) + l(v_4, v_5) + l(v_5, y) \\
&\leq 15l(P_c(T)) + 5l(v, v_3) + 5l(v_3, v_4) + 3l(v_4, v_5) + 5l(v_5, w) + \\
&\quad l(v_5, v_2) + l(v_2, u_1) + l(u_1, v_4) \\
&\leq 15l(P_c(T)) + 5l(v, v_3) + 2l(v_3, v_4) + 3l(v_4, v_5) + 5l(v_5, w) + \\
&\quad l(v_5, v_2) + l(v_2, u_1) + l(v_3, v_1) + l(v_1, u_1) \\
&\leq 15l(P_c(T)) + 5l(v, v_3) + 5l(v_5, w) + 3l(v_5, v_2) + l(v_2, u_1) + \\
&\quad 3l(v_3, v_1) + l(v_1, u_1) + 3l(v_1, v_2) \\
&\leq 15l(P_c(C)) + l(v_2, u_1) + l(v_1, u_1) + 3l(v_1, v_2) \\
&\leq 15l(P_c(C)) + l(v_2, u_1) + l(v_1, u_1) + 3l(P_s(C)) \\
&= 15l(P_c(C)) + 4l(P_s(C)).
\end{aligned}$$

and:

$$\begin{aligned}
l(B_t(C)) + l(M_t(C)) &= l(M_t(T)) + l(M_h(T)) + l(x, v_3) + l(v_3, w_1) + l(w_1, u_3) + l(u_3, u_4) + \\
&\quad l(u_4, v_1) + l(v_1, u_2) + l(u_2, v_4) + l(v_6, y).
\end{aligned}$$

Using A1 on T , the notation we use (again $l(v, v_3)$ and $l(v_6, w)$ are counted 4 times to satisfy all cases of locations of x and y), Equations (44), (37), (42), (43), the definition of $P_c(C)$, the definition of $P_s(C)$, $[v_1, u_2] \subset [v_1, v_2]$ and Equation (38)

$$\begin{aligned}
l(B_t(C)) + l(M_t(C)) &\leq 15l(P_c(T)) + 2l(P_s(T)) + l(I(T)) + l(x, v_3) + l(v_3, w_1) + \\
&\quad l(w_1, u_3) + l(u_3, u_4) + l(u_4, v_1) + l(v_1, u_2) + l(u_2, v_6) + l(v_6, y) \\
&\leq 15l(P_c(T)) + 4l(v, v_3) + 3l(v_3, v_4) + 3l(v_4, v_5) + 3l(v_5, v_6) + \\
&\quad 4l(v_6, w) + l(v_3, w_1) + l(w_1, u_3) + l(u_3, u_4) + l(u_4, v_1) + l(v_1, u_2) + \\
&\quad l(u_2, v_6) \\
&\leq 15l(P_c(T)) + 4l(v, v_3) + 2l(v_3, v_4) + 2l(v_4, v_5) + 4l(v_5, v_6) + \\
&\quad 4l(v_6, w) + 2l(v_3, w_1) + l(w_1, u_3) + l(u_3, u_4) + l(u_4, v_1) + \\
&\quad l(v_1, u_2) + l(w_1, w_2) + l(w_2, v_1) + l(P_s(C)) \\
&\leq 15l(P_c(T)) + 4l(v, v_3) + 4l(v_5, v_6) + 4l(v_6, w) + 4l(v_3, w_1) + \\
&\quad l(w_1, u_3) + l(u_3, u_4) + l(u_4, v_1) + l(v_1, u_2) + 3l(w_1, w_2) + \\
&\quad 3l(w_2, v_1) + l(P_s(C)) + 2l(v_1, v_2) + 2l(v_2, v_5) \\
&\leq 15l(P_c(T)) + 4l(v, v_3) + 4l(v_5, v_6) + 4l(v_6, w) + 4l(v_3, w_1) + \\
&\quad l(u_3, u_4) + l(u_4, v_1) + l(v_1, u_2) + 4l(w_1, w_2) + 3l(w_2, v_1) + \\
&\quad 2l(P_s(C)) + l(v_1, v_2) + 2l(v_2, v_5) \\
&\leq 15l(P_c(T)) + 4l(v, v_3) + 4l(v_5, v_6) + 4l(v_6, w) + 4l(v_3, w_1) + \\
&\quad l(u_4, v_1) + l(v_1, u_2) + 4l(w_1, w_2) + 4l(w_2, v_1) + 2l(P_s(C)) + \\
&\quad 2l(v_2, v_5) + l(u_4, u_1) + l(u_1, v_2)
\end{aligned}$$

$$\begin{aligned}
&\leq 15l(P_c(C)) + l(u_4, v_1) + l(v_1, u_2) + 2l(P_s(C)) + l(u_4, u_1) + l(u_1, v_2) \\
&= 15l(P_c(C)) + l(v_1, u_2) + 3l(P_s(C)) \\
&\leq 15l(P_c(C)) + 4l(P_s(C)).
\end{aligned}$$

A3 From $l(C'') + 2l(P_c(C'') \setminus C) < l(C)$ we get that $l(C'') < l(C)$. Let \hat{C} be a son of C . If $P_f(\hat{C}) \subset [v_2, u_1]$ then since $[v_2, u_1] \subset P_s(C'')$ \hat{C} should have been a son of C'' . If $P_f(\hat{C}) \subset [v_1, u_4]$ then \hat{C} should have been a son of C_2 (since $[v_1, u_4] \subset P_s(C_2)$ and $l(C_2) < l(C)$). Therefore $P_f(\hat{C}) \cap [u_4, u_1] \neq \emptyset$.

A4 $J_h(C) = [v_2 \rightarrow u_1]$ and $J_t(C) = [u_4 \rightarrow v_1]$ so for every son \hat{C} of C , $P_f(\hat{C}) \subset P_s(C) = J_t(C) \cup I(C) \cup J_h(C)$.

A5 $M(C)$ is contained in $P_s(C)$, S, C_1, C_2 , C'' and T which are all shorter than C .

A6 $M(C)$ is contained in $P_s(C)$, $P_s(S)$, $M(S)$ and C_1, C_2 and C'' , so $N(C) = \{C_1, C_2, C''\}$.

■

Remark 3.53 Please note that in the following lemma the 15 bound is required.

Lemma 3.54 Suppose that $l(C_1) < l(C_2) < l(C)$, $l(C) < l(C'') + 2l(P_c(C'') \setminus C)$, and the direction is $u_1 \rightarrow v_2$ then C'' satisfies the induction hypotheses.

Proof: Since $l(C) < 2l(P_c(C'') \setminus C) + l(C'')$, Equation (40) still holds.

Since $l(C_1) < l(C) < 2l(P_c(C'') \setminus C) + l(C'')$,

$$l(v_3, w_1) + l(P_s(C_1)) + l(w_2, v_1, v_2) < 3l(v_3, v_4) + l(u_1, v_4) + l(u_1, v_2). \quad (45)$$

Since $l(C_2) < l(C) < 2l(P_c(C'') \setminus C) + l(C'')$,

$$l(v_3, w_1, w_2) + l(P_s(C_2)) + l(v_1, v_2) < 3l(v_3, v_4) + l(u_1, v_4) + l(u_1, v_2). \quad (46)$$

A1 Let $x = t(T)$, $y = h(T)$, and the end nodes v, w of $P_s(T)$ be ordered v, x, y, w .

Since C'' was oriented backwards by Property 3.16 Equation (39) still holds.

According to Property 3.20 C'' is not a special contained brother, by A3 on T $x \in [v, v_4]$, and $y \in [v_5, w]$ (since S'' exists).

By A4 we can always define

$$M_t(C'') = M_t(T) \cup [x \rightarrow v_3 \rightarrow w_1 \rightarrow u_3 \rightarrow u_4 \rightarrow u_1] \quad M_h(C'') = [v_4 \rightarrow v_5 \rightarrow y] \cup M_h(T).$$

We get that $I(C'') = [u_1 \rightarrow v_4]$. Using A1 on T :

The bound of $l(M(C))$ can be achieved as in lemma 3.50.

A2 Since $S'' \in N(S)$ by A5 on S then $l(S'') < l(S)$. Since C is a son of S , $l(S) < l(C)$, so Equation (41) still holds.

In this case $h(C'') = v_4 \in T$. Define

$$B_t(C'') = [u_1 \rightarrow v_2 \rightarrow u_2 \rightarrow v_6 \rightarrow y] \cup M_h(T).$$

Using A1 on T (again $l(v, v_3)$ and $l(v_6, w)$ are taken 4 times to satisfy all possible locations of x and y), Equations (45), (46), (40),(41), (39), definition of $P_c(C'')$ and the definition of $P_s(C'')$:

$$\begin{aligned}
l(M_t(C'')) + l(B_t(C'')) &= l(M_t(T)) + l(x, v_3) + l(v_3, w_1) + l(w_1, u_3) + l(u_3, u_4) + \\
&\quad l(u_4, u_1) + l(u_1, v_2) + l(v_2, u_2) + l(u_2, v_6) + l(v_6, y) \\
&\leq 15l(P_c(T)) + 4l(v, v_3) + 3l(v_3, v_4) + 3l(v_4, v_5) + 3l(v_5, v_6) + \\
&\quad 4l(v_6, w) + l(v_3, w_1) + l(w_1, u_3) + l(u_3, u_4) + l(u_4, u_1) + l(u_1, v_2) + \\
&\quad l(v_2, u_2) + l(u_2, v_6) \\
&\leq 15l(P_c(T)) + 4l(v, v_3) + 6l(v_3, v_4) + 3l(v_4, v_5) + 3l(v_5, v_6) + 4l(v_6, w) + \\
&\quad l(u_3, u_4) + l(u_4, u_1) + l(u_1, v_2) + l(v_2, u_2) + l(u_2, v_6) + l(u_1, v_4) \\
&\leq 15l(P_c(T)) + 4l(v, v_3) + 6l(v_3, v_4) + 3l(v_4, v_5) + 3l(v_5, v_6) + 4l(v_6, w) + \\
&\quad l(u_3, u_4) + l(u_4, u_1) + l(u_1, v_2) + l(v_2, u_2) + l(u_2, v_6) + l(u_1, v_4) \\
&\leq 15l(P_c(T)) + 4l(v, v_3) + 9l(v_3, v_4) + 3l(v_4, v_5) + 3l(v_5, v_6) + \\
&\quad 4l(v_6, w) + l(u_4, u_1) + l(u_1, v_2) + l(v_2, u_2) + l(u_2, v_6) + 2l(u_1, v_4) \\
&\leq 15l(P_c(T)) + 4l(v, v_3) + 12l(v_3, v_4) + 3l(v_4, v_5) + 3l(v_5, v_6) + \\
&\quad 4l(v_6, w) + l(u_1, v_2) + l(v_2, u_2) + l(u_2, v_6) + 3l(u_1, v_4) \\
&\leq 15l(P_c(T)) + 4l(v, v_3) + 14l(v_3, v_4) + 2l(v_4, v_5) + 4l(v_5, v_6) + \\
&\quad 4l(v_6, w) + 2l(u_1, v_2) + 4l(u_1, v_4) \\
&\leq 15l(P_c(T)) + 5l(v, v_3) + 15l(v_3, v_4) + 4l(v_5, v_6) + 5l(v_6, w) + \\
&\quad l(u_1, v_2) + 4l(u_1, v_4) + l(u_1, v_2) \\
&\leq 15l(P_c(C'')) + 2l(u_1, v_2) + 4l(u_1, v_4) \\
&\leq 15l(P_c(C'')) + 2l(P_s(C'')).
\end{aligned}$$

A3 Same proof like in Lemma 3.50.

A4 Same proof like in Lemma 3.50.

A5 $M(C'')$ is contained in $P_s(C'')$, C, C_1, C_2 and T which are all shorter than C .

A6 $M(C)$ is contained in $P_s(C'')$, $P_s(T)$, $M(T)$ and C, C_1, C_2 , so $N(C'') = \{C, C_1, C_2\}$.

■

Corollary 3.55 *After activating DIRECT-ONE on a cycle C whose father is oriented forwards and when C'' is an uncle, C and C'' will satisfy the induction hypotheses.*

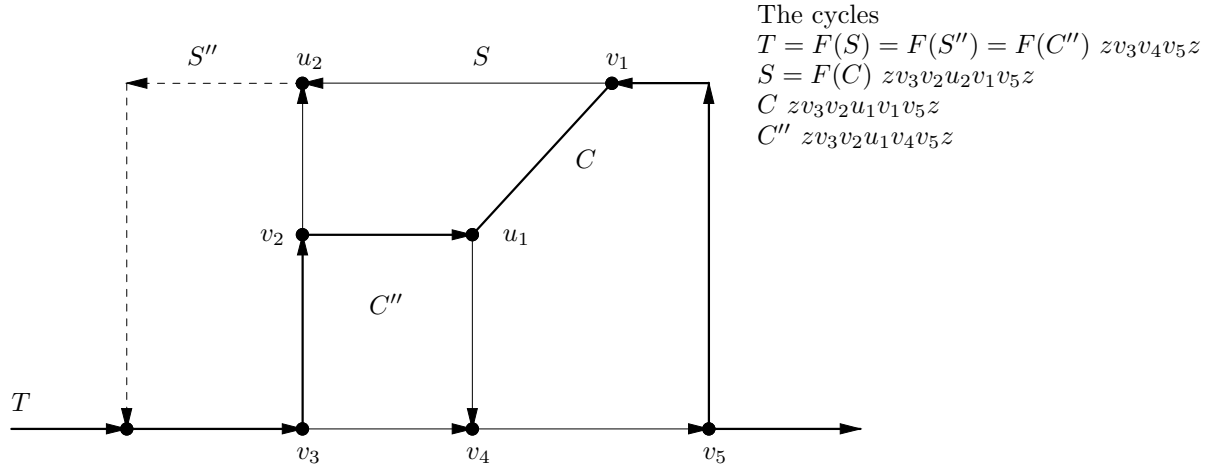

Figure 46: C'' is an uncle, S is oriented backwards.

$S = F(C)$ is oriented backwards

Here we consider a cycle C oriented forwards in DIRECT-ONE even though $l_2 = -1$. In this subsection we assume that $S = F(C)$ is oriented backwards, $T = F(S)$ and C'' a contained brother of S . C which is a son of S shares the path $[v_2, u_1]$ at its l_2 side with C'' . Thus C has to be the last cycle in the block of sons of S , and C'' is oriented forwards. In Figure 46 C, C'', S and T are described before the application of DIRECT-ONE.

Mark

- $v_1 := S \cap P_s(C) \setminus P_s(C'')$.
- $v_2 := S \cap P_s(C) \cap P_s(C'')$.
- $v_3 := T \cap P_s(C'') \cap P_s(S)$.
- $v_4 := T \cap P_s(C'') \setminus P_s(S)$.
- $v_5 := T \cap P_s(S) \setminus P_s(C'')$.
- $u_1 :=$ the end node of the path $P_s(C) \cap P_s(C'')$, such that $u_1 \notin S$.

Since C'' is oriented forwards $N(S)$ contains at least one cycle at the l_2 side of $P_s(S)$, S'' in Figure 46 (such orientation is discussed in Lemma (3.36) where $N(S) = \{S''\}$). When DIRECT-ONE is activated on C it compares $l(C)$ and $l(C'')$ (both are oriented forwards) and decides whether to change the direction of $[u_1, v_2]$. In the following two lemmas we assume $[v_1, u_1]$ was directed $v_1 \rightarrow u_1$ (C didn't have heavy brothers at its l_1 side to contradict this direction). In lemmas 3.58 and 3.58 we will consider the other case.

Lemma 3.56 *Suppose that $l(C'') < l(C)$, then C satisfies the induction hypotheses.*

Proof: In this case when DIRECT-ONE is activated on C it doesn't change the direction $v_2 \rightarrow u_1$.

Using A2 on T ($y = h(T) \notin F(T)$)

$$\begin{aligned} l(M(C)) &\leq l(B_h(T)) + l(M_h(T)) + l(v_5, v_1) + l(u_1, v_4) + l(v_4, v_5) \\ &\leq 15l(P_c(T)) + 4l(v, v_3) + 4l(v_3, v_4) + 5l(v_4, v_5) + 4l(v_5, w) + l(v_5, v_1) + l(u_1, v_4). \end{aligned}$$

(same bound as before)

Using Equations (48) (47), the definition of $P_c(C)$ and the definition of $I(C)$:

$$\begin{aligned} l(M(C)) &\leq 15l(P_c(T)) + 6l(v, v_3) + l(v_4, v_5) + 6l(v_5, w) + l(v_5, v_1) + l(u_1, v_4) \\ &\leq 15l(P_c(T)) + 6l(v, v_3) + 6l(v_5, w) + 2l(v_5, v_1) + l(u_1, v_1) \\ &\leq 15l(P_c(C)) + l(u_1, v_1) \\ &\leq 15l(P_c(C)) + l(I(C)) \end{aligned}$$

A2 In this case $t(C) = v_1 \in S$ but $h(C) = u_1 \notin S$. So we define:

$$B_h(C) = M_t(T) \cup [x \rightarrow v_3 \rightarrow v_2 \rightarrow u_1]$$

Giving (for all possible locations of y)

$$\begin{aligned} l(B_h(C)) + l(M_h(C)) &\leq l(M_t(T)) + l(M_h(T)) + l(x, v_3) + l(v_3, v_2) + l(v_2, u_1) + l(u_1, v_4) + \\ &\quad l(v_3, v_4) + l(v_4, v_5) + l(v_5, w) \end{aligned}$$

Using A1 on T , the notation we use, Equations (48) (47), the definition of $P_c(C)$ and the definition of $P_s(C)$:

$$\begin{aligned} l(B_h(C)) + l(M_h(C)) &\leq 15l(P_c(T)) + 2l(P_s(T)) + l(I(T)) + l(x, v_3) + l(v_3, v_2) + \\ &\quad l(v_2, u_1) + l(u_1, v_4) + l(v_3, v_4) + l(v_4, v_5) + l(v_5, w) \\ &\leq 15l(P_c(T)) + 4l(v, v_3) + 4l(v_3, v_4) + 4l(v_4, v_5) + 4l(v_5, w) + \\ &\quad l(v_3, v_2) + l(v_2, u_1) + l(u_1, v_4) + \\ &\leq 15l(P_c(T)) + 6l(v, v_3) + 6l(v_5, w) + l(v_3, v_2) + l(v_2, u_1) + l(u_1, v_4) \\ &\leq 15l(P_c(T)) + 6l(v, v_3) + 6l(v_5, w) + l(v_3, v_2) + l(v_2, u_1) + \\ &\quad l(u_1, v_1) + l(v_1, v_5) \\ &\leq 15l(P_c(C)) + l(v_2, u_1) + l(u_1, v_1) \\ &= 15l(P_c(C)) + l(I(C)). \end{aligned}$$

A3 In the Lemma assumption $l(C'') < l(C)$. Let \hat{C} be a son of C . If $P_f(\hat{C}) \subset [v_2, u_1]$ since $[v_2, u_1] \subset P_s(C'')$ \hat{C} should have been a son of C'' . Therefore $P_f(\hat{C}) \cap [v_1, u_1] \neq \emptyset$.

A4 $J_h(C) = [v_2 \rightarrow u_1]$ and for every \hat{C} a son of C $P_f(\hat{C}) \subset P_s(C) = I(C) \cup J_h(C)$.

A5 $M(C)$ is contained in $P_s(C)$, S , C'' and T which are all shorter than C .

A6 $M(C)$ is contained in $P_s(C)$, $P_s(S)$, $M(S)$ and C'' , so $N(C) = \{C''\}$.

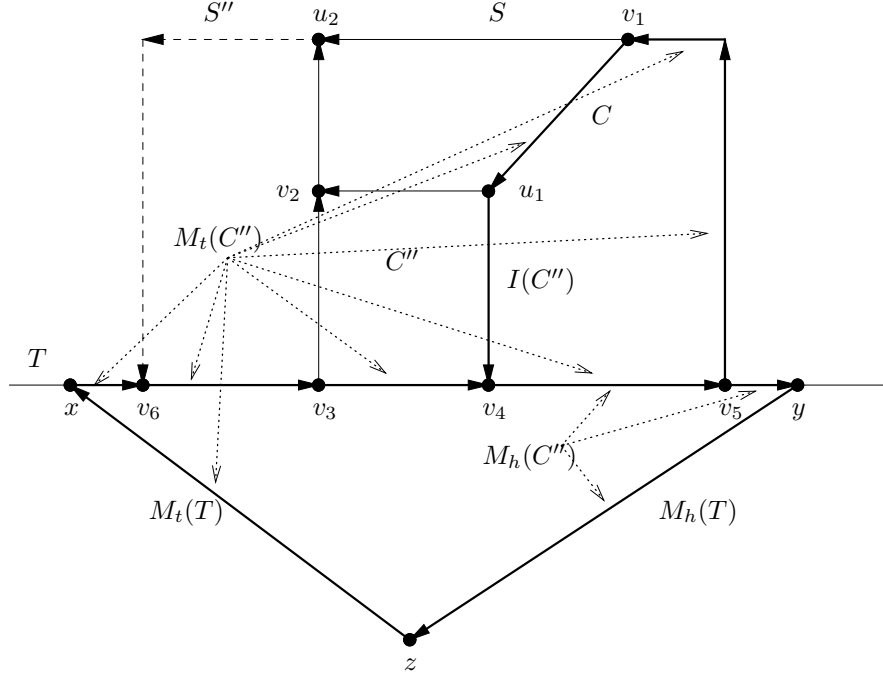

Figure 48: Figure for Lemma 3.57.

■

Lemma 3.57 *Suppose that $l(C) < l(C'')$ then after the application of DIRECT-ONE C'' satisfies the induction hypotheses.*

Proof: In this case when DIRECT-ONE is activated on C it changes the direction of $[u_1, v_2]$ to $v_2 \rightarrow u_1$.

Since $l(C) < l(C'')$:

$$l(u_1, v_1) + l(v_1, v_5) < l(u_1, v_4) + l(v_4, v_5). \quad (49)$$

A1 Let $x = t(T)$, $y = h(T)$, and the end nodes v, w of $P_s(T)$ be ordered v, x, y, w (see Figure 48). Since S was oriented backwards Equation (48) still holds.

Since there is at least one more brother of S and its l_2 side $x \in [v, v_3]$. By A4 on T $y \in [v_3, v_5]$ or $y \in [v_5, w]$.

We consider the two possible locations of y :

- $y \in [v_5, w]$ and $I(C'') = [u_1 \rightarrow v_4]$ so we can define:

$$M_t(C'') = M_t(T) \cup [x \rightarrow v_3 \rightarrow v_4 \rightarrow v_5 \rightarrow v_1 \rightarrow u_1] \quad M_h(C'') = [v_4 \rightarrow v_5 \rightarrow y] \cup M_h(T)$$

Using A1 on T :

$$\begin{aligned} l(M(C'')) &= l(M(T)) + l(x, v_3) + l(v_3, v_4) + 2l(v_4, v_5) + l(v_5, v_1) + l(v_1, u_1) + l(v_5, y) \\ &\leq 15l(P_c(T)) + 4l(v, v_3) + 4l(v_3, v_4) + 5l(v_4, v_5) + 4l(v_5, w) + l(v_5, v_1) + l(v_1, u_1). \end{aligned}$$

- $y \in [v_3, v_4] \cup [v_4, v_5]$ and $I(C'') = [u_1 \rightarrow v_4]$. So we we can define:

$$M_t(C'') = (B_h(T) \setminus [y, v_5]) \cup [v_5 \rightarrow v_1 \rightarrow u_1] \quad M_h(C'') = [v_4 \rightarrow y] \cup M_h(T)$$

Using A2 on T ($y = h(T) \notin F(T)$)

$$\begin{aligned} l(M(C'')) &\leq l(B_h(T)) + l(M_h(T)) + l(v_5, v_1) + l(v_1, u_1) + l(v_4, v_5) \\ &\leq 15l(P_c(T)) + 4l(v, v_3) + 4l(v_3, v_4) + 5l(v_4, v_5) + 4l(v_5, w) + l(v_5, v_1) + l(v_1, u_1). \end{aligned}$$

(same bound as before)

Using Equations (48), (49), the definition of $P_c(C'')$ and the definition of $I(C'')$:

$$\begin{aligned} l(M(C'')) &\leq 15l(P_c(T)) + 6l(v, v_3) + l(v_4, v_5) + 6l(v_5, w) + l(v_5, v_1) + l(v_1, u_1) \\ &\leq 15l(P_c(T)) + 6l(v, v_3) + 2l(v_4, v_5) + 6l(v_5, w) + l(u_1, v_4) \\ &\leq 15l(P_c(C'')) + l(u_1, v_4) \\ &= 15l(P_c(C'')) + l(I(C'')) \end{aligned}$$

A2 Mark:

- $u_2 :=$ the end node of the path $P_s(S) \cap P_s(S'')$ such that $u_2 \notin T$.
- $v_6 = T \cap (P_s(S'') \setminus P_s(S))$.

Since $S'' \in N(S)$ by A5 on S $l(S'') < l(S)$, since C is a son of S $l(S) < l(C)$ and by the Lemma assumption

$$l(S'') < l(S) < l(C) < l(C'')$$

giving:

$$l(v_6, u_2) + l(u_2, v_2) + l(v_3, v_4) < l(v_2, u_1) + l(u_1, v_4) + l(v_6, v_3). \quad (50)$$

In this case $h(C'') = v_4 \in T$, but $t(C'') = u_1 \notin T$.

Two possible locations of x :

- $x \in [v, v_6]$. In this case we can define:

$$B_t(C'') = [u_1 \rightarrow v_2 \rightarrow u_2 \rightarrow v_6 \rightarrow v_3 \rightarrow y] \cup M_h(T).$$

Two possible locations of y to be considered:

- $y \in [v_5, w]$.
Using A1 on T

$$\begin{aligned} l(M_t(C'')) + l(B_t(C'')) &\leq l(M_t(T)) + l(M_h(T)) + l(x, v_3) + 2l(v_3, v_4) + 2l(v_4, v_5) + \\ &\quad l(v_5, v_1) + l(v_1, u_1) + l(u_1, v_2) + l(v_2, u_2) + l(u_2, v_6) + l(v_5, y) \\ &\leq 15l(P_c(T)) + 4l(v, v_6) + 4l(v_6, v_3) + 5l(v_3, v_4) + 5l(v_4, v_5) + \\ &\quad 4l(v_5, w) + l(v_5, v_1) + l(v_1, u_1) + l(u_1, v_2) + l(v_2, u_2) + l(u_2, v_6) \end{aligned}$$

– $y \in [v_3, v_5]$.

Using A2 on T

$$\begin{aligned} l(M_t(C'')) + l(B_t(C'')) &\leq l(B_h(T)) + l(M_h(T)) + l(u_1, v_2) + l(v_2, u_2) + l(u_2, v_6) + \\ &\quad l(v_6, v_3) + l(v_3, y) + l(v_5, v_1) + l(v_1, u_1) \\ &\leq 15l(P_c(T)) + 4l(v, v_6) + 4l(v_6, v_3) + 5l(v_3, v_4) + 5l(v_4, v_5) + \\ &\quad 4l(v_5, w) + l(v_5, v_1) + l(v_1, u_1) + l(u_1, v_2) + l(v_2, u_2) + l(u_2, v_6) \end{aligned}$$

• $x \in [v_6, v_3]$. In this case we define:

$$B_t(C'') = [u_1 \rightarrow v_2 \rightarrow u_2 \rightarrow v_6] \cup B_t(T) \setminus [v_6, x].$$

Two possible locations of y :

– $y \in [v_5, w]$. Using A2 on T :

$$\begin{aligned} l(B_t(C'')) + l(M_t(C'')) &\leq l(M_t(T)) + l(B_t(T)) + l(x, v_3) + l(v_3, v_4) + l(v_4, v_5) + \\ &\quad l(v_5, v_1) + l(v_1, u_1) + l(u_1, v_2) + l(v_2, u_2) + l(u_2, v_6) \\ &\leq 15l(P_c(T)) + 4l(v, v_6) + 4l(v_6, v_3) + 5l(v_3, v_4) + 5l(v_4, v_5) + \\ &\quad 4l(v_5, w) + l(v_5, v_1) + l(v_1, u_1) + l(u_1, v_2) + l(v_2, u_2) + l(u_2, v_6) \end{aligned}$$

– $y \in [v_3, v_5]$. Using A2 on T :

$$\begin{aligned} l(B_t(C'')) + l(M_t(C'')) &= l(B_h(T)) + l(B_t(T)) - l(v_6, x) - l(y, v_5) + l(u_1, v_2) + \\ &\quad l(v_2, u_2) + l(u_2, v_6) + l(v_5, v_1) + l(v_1, u_1) \\ &\leq 15l(P_c(T)) + 6l(v, v_6) + 5l(v_6, v_3) + 5l(v_3, v_4) + 5l(v_4, v_5) + \\ &\quad 6l(v_5, w) + l(u_1, v_2) + l(v_2, u_2) + l(u_2, v_6) + l(v_5, v_1) + l(v_1, u_1) \end{aligned}$$

So in all possible locations of x and y :

$$\begin{aligned} l(B_t(C'')) + l(M_t(C'')) &\leq 15l(P_c(T)) + 6l(v, v_6) + 5l(v_6, v_3) + 5l(v_3, v_4) + 5l(v_4, v_5) + \\ &\quad 6l(v_5, w) + l(u_1, v_2) + l(v_2, u_2) + l(u_2, v_6) + l(v_5, v_1) + l(v_1, u_1) \end{aligned}$$

Using Equations (48), (50), (49), the definition of $P_c(C'')$ and the definition of $P_s(C'')$

$$\begin{aligned} l(B_t(C'')) + l(M_t(C'')) &\leq 15l(P_c(T)) + 8l(v, v_3) + 7l(v_6, v_3) + l(v_3, v_4) + l(v_4, v_5) + \\ &\quad 8l(v_5, w) + l(u_1, v_2) + l(v_2, u_2) + l(u_2, v_6) + l(v_5, v_1) + l(v_1, u_1) \\ &\leq 15l(P_c(T)) + 8l(v, v_3) + 7l(v_6, v_3) + l(v_4, v_5) + 8l(v_5, w) + \\ &\quad 2l(u_1, v_2) + l(v_5, v_1) + l(v_1, u_1) + l(u_1, v_4) \\ &\leq 15l(P_c(T)) + 8l(v, v_3) + 7l(v_6, v_3) + 2l(v_4, v_5) + 8l(v_5, w) + \\ &\quad 2l(u_1, v_2) + 2l(u_1, v_4) \\ &\leq 15l(P_c(C'')) + 2l(u_1, v_2) + 2l(u_1, v_4) \\ &\leq 15l(P_c(C'')) + 2l(P_s(C'')). \end{aligned}$$

A3 From the Lemma assumption $l(S'') < l(C) < l(C'')$. Let \hat{C} be a son of C'' if $P_f(\hat{C}) \subset ([u_1, v_2] \cup [v_2, v_3])$ then \hat{C} should have been a son of C or S'' but not C'' .

A4 Same proof like in Lemma 3.50.

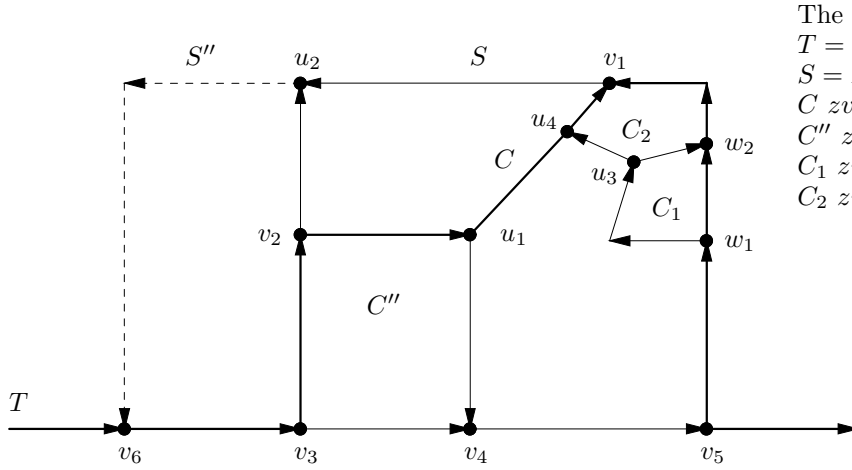

The cycles
 $T = F(S) = F(S'') = F(C'') \ zv_3v_4v_5z$
 $S = F(C) \ zv_3v_2u_2v_1v_5z$
 $C \ zv_6v_3v_2u_1v_1w_2w_1v_5z$
 $C'' \ zv_6v_3v_2u_1v_4v_5z$
 $C_1 \ zv_6v_3v_2u_2v_1w_2u_3w_1v_5z$
 $C_2 \ zv_6v_3v_2u_2v_1u_4u_3w_2w_1v_5z$

Figure 49: $F(C)$ is oriented backwards and $N(C)$ contains two brothers at its l_1 side.

A5 $M(C'')$ is contained in $P_s(C'')$, C , and T which are all shorter than C .

A6 $M(C)$ is contained in $P_s(C'')$, $P_s(T)$, $M(T)$ and C , so $N(C'') = \{C\}$.

■

Now assume that C had two brothers C_1, C_2 at its l_1 side, ordered C_1, C_2, C , such that $N(C) = \{C_1, C_2, C''\}$ (see Figure 49). This happens when C and C_2 are heavy, C, C_1, C_2 are oriented forwards and $l(C_1) < l(C_2) < l(C)$. If C_1 doesn't exist then similar but simpler proofs apply.

Since S was oriented backwards $N(S)$ contains one more brother S'' at its l_2 side. Mark:

- $u_2 :=$ the end node of the path $P_s(S) \cap P_s(S'')$ such that $u_2 \notin T$.
- $v_6 = T \cap (P_s(S'') \setminus P_s(S))$.
- $w_1 := S \cap (P_s(C_1) \setminus P_s(C_2))$.
- $w_2 := S \cap P_s(C_1) \cap P_s(C_2)$.
- $u_3 :=$ the end node of the path $P_s(C_1) \cap P_s(C_2)$, such that $u_3 \notin C$.
- $u_4 :=$ the end node of the path $P_s(C_2) \cap P_s(C)$, such that $u_4 \notin C$.

Since $C_1 \in N(C_2)$ and $C_2 \in N(C)$, $l(C_1) < l(C_2) < l(C)$. According to Observation 3.25 the algorithm in previous stage (before activating DIRECT-ONE on C) oriented $[w_1 \rightarrow u_3 \rightarrow u_4], [u_3 \rightarrow w_2], [u_4 \rightarrow v_1]$. Since $l(C_2) < l(C)$ DIRECT-ONE will not change the direction of $[u_4 \rightarrow v_1]$. So we only need to consider what happens to the path $[u_1, v_2]$ (whether or not its current direction $[v_2 \rightarrow u_1]$ changes).

Lemma 3.58 *Suppose that $l(C'') < l(C)$ and $l(C_1) < l(C_2) < l(C)$, then C satisfies the induction hypotheses.*

Proof: Since $l(C'') < l(C)$ when DIRECT-ONE is activated on C it will not change the direction $v_2 \rightarrow u_1$. Moreover Equation (47) holds. Since $l(C_1) < l(C_2) < l(C)$ by Observation 3.25 the orientation of the paths will be: $[w_1 \rightarrow u_3 \rightarrow w_2]$ and $[u_3 \rightarrow u_4 \rightarrow v_1]$.

Since $l(C_1) < l(C)$

$$l(P_s(C_1)) + l(v_1, v_2) < l(P_s(C)) + l(w_1, w_2). \quad (51)$$

Since $l(C_2) < l(C)$

$$l(u_3, w_2) + l(u_3, u_4) + l(v_1, v_2) < l(u_4, u_1) + l(u_1, v_2) + l(w_2, v_1). \quad (52)$$

From A5 on S $l(S'') < l(S) < l(C)$ giving

$$l(v_2, u_2) + l(u_2, v_6) + l(v_3, v_4) + l(v_4, v_5) < l(v_6, v_3) + l(v_5, w_1) + l(w_1, w_2) + l(w_2, v_1) + l(P_s(C)) \quad (53)$$

A1 Let $x = t(T)$, $y = h(T)$, and the end nodes v, w of $P_s(T)$ be ordered v, x, y, w . From Property 3.16 on S Equation (48) still holds.

Since $N(S)$ contains one more brother S'' at the l_2 side of S , $x \in [v, v_3]$. By A4 on T , $y \in [v_3, v_5]$ or $y \in [v_5, w]$.

We consider the two possible locations of y :

- $y \in [v_5, w]$ and $I(C) = [u_4 \rightarrow u_1]$, so we define:

$$M_t(C) = M_t(T) \cup [x \rightarrow v_3 \rightarrow v_4 \rightarrow v_5 \rightarrow w_1 \rightarrow u_3 \rightarrow u_4] \quad M_h(C) = [u_1 \rightarrow v_4 \rightarrow v_5 \rightarrow y] \cup M_h(T)$$

Using A1 on T :

$$\begin{aligned} l(M(C)) &= l(M(T)) + l(x, v_3) + l(v_3, v_4) + 2l(v_4, v_5) + l(v_1, w_1) + l(w_1, u_3) + \\ &\quad l(u_3, u_4) + l(u_1, v_4) + l(v_5, y) \\ &\leq 15l(P_c(T)) + 4l(v, v_3) + 4l(v_3, v_4) + 5l(v_4, v_5) + 4l(v_5, w) + l(v_1, w_1) + \\ &\quad l(w_1, u_3) + l(u_3, u_4) + l(u_1, v_4) \end{aligned}$$

- $y \in [v_3, v_5]$ and $I(C) = [u_4 \rightarrow u_1]$. Using A4 on T we can define:

$$M_t(C) = (B_h(T) \setminus [y, v_5]) \cup [v_5 \rightarrow w_1 \rightarrow u_3 \rightarrow u_4] \quad M_h(C) = [u_1 \rightarrow v_4 \rightarrow y] \cup M_h(T)$$

Using A2 on T ($y = h(T) \notin F(T)$)

$$\begin{aligned} l(M(C)) &\leq l(B_h(T)) + l(M_h(T)) + l(v_5, w_1) + l(w_1, u_3) + l(u_3, u_4) + l(u_1, v_4) + l(v_4, v_5) \\ &\leq 15l(P_c(T)) + 4l(v, v_3) + 4l(v_3, v_4) + 5l(v_4, v_5) + 4l(v_5, w) + l(v_5, w_1) + \\ &\quad l(w_1, u_3) + l(u_3, u_4) + l(u_1, v_4). \end{aligned}$$

(same bound as before)

Using Equations (48), (51), (52), (47), the definition of $P_c(C)$, the definition of $P_c(C)$ and the definition of $I(C)$:

$$\begin{aligned} l(M(C)) &\leq 15l(P_c(T)) + 4l(v, v_3) + 4l(v_3, v_4) + 5l(v_4, v_5) + 4l(v_5, w) + l(v_5, w_1) + \\ &\quad l(w_1, u_3) + l(u_3, u_4) + l(u_1, v_4) \end{aligned}$$

$$\begin{aligned}
&\leq 15l(P_c(T)) + 6l(v, v_3) + l(v_4, v_5) + 6l(v_5, w) + l(v_5, w_1) + l(u_3, u_4) + \\
&\quad l(u_1, v_4) + l(P_s(C)) + l(w_1, w_2) \\
&\leq 15l(P_c(T)) + 6l(v, v_3) + l(v_4, v_5) + 6l(v_5, w) + l(v_5, w_1) + l(u_1, v_4) + \\
&\quad l(P_s(C)) + l(w_1, w_2) + l(w_2, v_1) + l(u_4, u_1) + l(u_1, v_2) \\
&\leq 15l(P_c(T)) + 6l(v, v_3) + 6l(v_5, w) + 2l(v_5, w_1) + l(P_s(C)) + 2l(w_1, w_2) + \\
&\quad 2l(w_2, v_1) + 2l(u_4, u_1) + l(u_1, v_2) + l(v_1, u_1) \\
&\leq 15l(P_c(C)) + l(P_s(C)) + 2l(u_4, u_1) + l(u_1, v_2) + l(v_1, u_1) \\
&= 15l(P_c(C)) + 2l(P_s(C)) + l(u_4, u_1) \\
&= 15l(P_c(C)) + 2l(P_s(C)) + l(I(C))
\end{aligned}$$

A2 In this case $t(C) = u_4 \notin S$ and $h(C) = u_1 \notin S$.

There are three lengths to consider:

1. $l(B_h(C)) + l(M_h(C))$.

Define

$$B_h(C) = M_t(T) \cup [x \rightarrow v_3 \rightarrow v_2 \rightarrow u_1]$$

Giving (for all possible locations of y)

$$\begin{aligned}
l(B_h(C)) + l(M_h(C)) &\leq l(M_t(T)) + l(M_h(T)) + l(x, v_3) + l(v_3, v_2) + l(v_2, u_1) + \\
&\quad l(u_1, v_4) + l(v_3, v_4) + l(v_4, v_5) + l(v_5, w)
\end{aligned}$$

Using A1 on T , the notation we use, Equations (48) (47), the definition of $P_c(C)$ and the definition of $P_s(C)$:

$$\begin{aligned}
l(B_h(C)) + l(M_h(C)) &\leq 15l(P_c(T)) + 2l(P_s(T)) + l(I(T)) + l(x, v_3) + l(v_3, v_2) + \\
&\quad l(v_2, u_1) + l(u_1, v_4) + l(v_3, v_4) + l(v_4, v_5) + l(v_5, w) \\
&\leq 15l(P_c(T)) + 4l(v, v_3) + 4l(v_3, v_4) + 4l(v_4, v_5) + 4l(v_5, w) + \\
&\quad l(v_3, v_2) + l(v_2, u_1) + l(u_1, v_4) \\
&\leq 15l(P_c(T)) + 6l(v, v_3) + 6l(v_5, w) + l(v_3, v_2) + l(v_2, u_1) + l(u_1, v_4) \\
&\leq 15l(P_c(T)) + 6l(v, v_3) + 6l(v_5, w) + l(v_3, v_2) + l(v_2, u_1) + \\
&\quad l(u_1, v_1) + l(v_1, v_5) \\
&\leq 15l(P_c(C)) + l(v_2, u_1) + l(u_1, v_1) \\
&= 15l(P_c(C)) + l(I(C)).
\end{aligned}$$

2. $l(B_t(C)) + l(B_h(C))$.

Two possible locations for x :

- $x \in [v, v_6]$. In this case we can define (for all locations of y)

$$B_t(C) = [u_4 \rightarrow v_1 \rightarrow u_2 \rightarrow v_6 \rightarrow v_3 \rightarrow y] \cup M_h(T)$$

Giving:

$$\begin{aligned}
l(B_t(C)) + l(B_h(C)) &\leq l(M_t(T)) + l(M_h(T)) + l(x, v_3) + l(v_3, v_2) + l(v_2, u_1) + \\
&\quad l(u_4, v_1) + l(v_1, u_2) + l(u_2, v_6) + l(v_6, v_3) + l(v_3, y) \\
&\leq 15l(P_c(T)) + 4l(v, v_6) + 5l(v_6, v_3) + 4l(v_3, v_4) + 4l(v_4, v_5) + \\
&\quad 4l(v_5, w) + l(v_3, v_2) + l(v_2, u_1) + l(u_4, v_1) + l(v_1, u_2) + l(u_2, v_6)
\end{aligned}$$

Where the last inequality follows from A1 on T .

- $x \in [v_6, v_3]$. In this case we can define (for all locations of y)

$$B_t(C) = [u_4 \rightarrow v_1 \rightarrow u_2 \rightarrow v_6] \cup (B_t(T) \setminus [v_6, x])$$

Giving: Giving (for all possible locations of y)

$$\begin{aligned}
l(B_t(C)) + l(B_h(C)) &\leq l(B_t(T)) + l(M_t(T)) + l(x, v_3) + l(v_3, v_2) + l(v_2, u_1) + \\
&\quad l(u_4, v_1) + l(v_1, u_2) + l(u_2, v_6) \\
&\leq 15l(P_c(T)) + 4l(v, v_6) + 5l(v_6, v_3) + 4l(v_3, v_4) + 4l(v_4, v_5) + \\
&\quad 4l(v_5, w) + l(v_3, v_2) + l(v_2, u_1) + l(u_4, v_1) + l(v_1, u_2) + l(u_2, v_6)
\end{aligned}$$

Where the last inequality follows from A2 on T .

So for both locations of x :

$$\begin{aligned}
l(B_t(C)) + l(B_h(C)) &\leq 15l(P_c(T)) + 4l(v, v_6) + 5l(v_6, v_3) + 4l(v_3, v_4) + 4l(v_4, v_5) + \\
&\quad 4l(v_5, w) + l(v_3, v_2) + l(v_2, u_1) + l(u_4, v_1) + l(v_1, u_2) + l(u_2, v_6).
\end{aligned}$$

Using Equations (53), (48), the definition of $P_c(C)$, (38) and the definition of $P_s(C)$:

$$\begin{aligned}
l(B_t(C)) + l(B_h(C)) &\leq 15l(P_c(T)) + 4l(v, v_6) + 5l(v_6, v_3) + 4l(v_3, v_4) + 4l(v_4, v_5) + \\
&\quad 4l(v_5, w) + l(v_3, v_2) + l(v_2, u_1) + l(u_4, v_1) + l(v_1, u_2) + l(u_2, v_6) \\
&\leq 15l(P_c(T)) + 4l(v, v_6) + 6l(v_6, v_3) + 3l(v_3, v_4) + 3l(v_4, v_5) + \\
&\quad 4l(v_5, w) + l(v_3, v_2) + l(v_2, u_1) + l(u_4, v_1) + l(v_1, u_2) + \\
&\quad l(v_5, w_1) + l(w_1, w_2) + l(w_2, v_1) + l(P_s(C)) \\
&\leq 15l(P_c(T)) + 5.5l(v, v_6) + 7.5l(v_6, v_3) + 5.5l(v_5, w) + l(v_3, v_2) + \\
&\quad l(v_2, u_1) + l(u_4, v_1) + l(v_1, u_2) + l(v_5, w_1) + l(w_1, w_2) + \\
&\quad l(w_2, v_1) + l(P_s(C)) \\
&\leq 15l(P_c(C)) + l(v_2, u_1) + l(u_4, v_1) + l(v_1, u_2) + l(P_s(C)) \\
&\leq 15l(P_c(C)) + l(v_2, u_1) + l(u_4, v_1) + 2l(P_s(C)) \\
&\leq 15l(P_c(C)) + 3l(P_s(C))
\end{aligned}$$

3. $l(B_t(C)) + l(M_t(C))$.

There are four possible locations for x and y

- $x \in [v, v_6]$ and $y \in [v_5, w]$. In this case

$$l(B_t(C)) + l(M_t(C)) = l(M_t(T)) + l(M_h(T)) + l(x, v_3) + 2l(v_3, v_4) + 2l(v_4, v_5) +$$

$$\begin{aligned}
& l(v_5, w_1) + l(w_1, u_3) + l(u_3, u_4) + l(u_4, v_1) + l(v_1, u_2) + \\
& l(u_2, v_6) + l(v_6, v_3) + l(v_5, w) \\
\leq & 15l(P_c(T)) + 4l(v, v_6) + 5l(v_6, v_3) + 5l(v_3, v_4) + 5l(v_4, v_5) + \\
& 4l(v_5, w) + l(v_5, w_1) + l(w_1, u_3) + l(u_3, u_4) + l(u_4, v_1) + \\
& l(v_1, u_2) + l(u_2, v_6).
\end{aligned}$$

Where the last inequality follows from A1 on T .

- $x \in [v, v_6]$ and $y \in [v_3, v_5]$. In this case

$$\begin{aligned}
l(B_t(C)) + l(M_t(C)) & \leq l(B_h(T)) + l(M_h(T)) + l(v_5, w_1) + l(w_1, u_3) + l(u_3, u_4) + \\
& l(u_4, v_1) + l(v_1, u_2) + l(u_2, v_6) + l(v_6, v_3) + l(v_3, v_4) + l(v_4, v_5) \\
& \leq 15l(P_c(T)) + 4l(v, v_6) + 5l(v_6, v_3) + 5l(v_3, v_4) + 5l(v_4, v_5) + \\
& 4l(v_5, w) + l(v_5, w_1) + l(w_1, u_3) + l(u_3, u_4) + l(u_4, v_1) + \\
& l(v_1, u_2) + l(u_2, v_6).
\end{aligned}$$

Where the last inequality follows from A2 on T .

- $x \in [v_6, v_3]$ and $y \in [v_5, w]$. In this case

$$\begin{aligned}
l(B_t(C)) + l(M_t(C)) & \leq l(M_t(T)) + l(B_t(T)) + l(x, v_3) + l(v_3, v_4) + l(v_4, v_5) + \\
& l(v_5, w_1) + l(w_1, u_3) + l(u_3, u_4) + l(u_4, v_1) + \\
& l(v_1, u_2) + l(u_2, v_6) \\
& \leq 15l(P_c(T)) + 5l(v, v_6) + 4l(v_6, v_3) + 5l(v_3, v_4) + 5l(v_4, v_5) + \\
& 4l(v_5, y) + l(v_5, w_1) + l(w_1, u_3) + l(u_3, u_4) + l(u_4, v_1) + \\
& l(v_1, u_2) + l(u_2, v_6).
\end{aligned}$$

Where the last inequality follows from A2 on T .

- $x \in [v_6, v_3]$ $y \in [v_3, v_5]$. In this case

$$\begin{aligned}
l(B_t(C)) + l(M_t(C)) & = l(B_h(T)) + l(B_t(T)) - l(y, v_5) - l(v_6, x) + l(v_5, w_1) + \\
& l(w_1, u_3) + l(u_3, u_4) + l(u_4, v_1) + l(v_1, u_2) + l(u_2, v_6) \\
& \leq 15l(P_c(T)) + 6l(v, v_6) + 5l(v_6, v_3) + 5l(v_3, v_4) + 5l(v_4, v_5) + \\
& 6l(v_5, w) + l(v_5, w_1) + l(w_1, u_3) + l(u_3, u_4) + l(u_4, v_1) + \\
& l(v_1, u_2) + l(u_2, v_6).
\end{aligned}$$

Where the last inequality follows from A2 on T .

So for all locations of x and y

$$\begin{aligned}
l(B_t(C)) + l(M_t(C)) & \leq 15l(P_c(T)) + 6l(v, v_6) + 5l(v_6, v_3) + 5l(v_3, v_4) + 5l(v_4, v_5) + \\
& 6l(v_5, w) + l(v_5, w_1) + l(w_1, u_3) + l(u_3, u_4) + l(u_4, v_1) + \\
& l(v_1, u_2) + l(u_2, v_6).
\end{aligned}$$

Using Equations (51), (52), (53), (48), the definition of $P_c(C)$ and the definition of $P_s(C)$

$$l(B_t(C)) + l(M_t(C)) \leq 15l(P_c(T)) + 6l(v, v_6) + 5l(v_6, v_3) + 5l(v_3, v_4) + 5l(v_4, v_5) +$$

$$\begin{aligned}
& 6l(v_5, w) + l(v_5, w_1) + l(w_1, u_3) + l(u_3, u_4) + l(u_4, v_1) + \\
& l(v_1, u_2) + l(u_2, v_6) \\
\leq & 15l(P_c(T)) + 6l(v, v_6) + 5l(v_6, v_3) + 5l(v_3, v_4) + 5l(v_4, v_5) + \\
& 6l(v_5, w) + l(v_5, w_1) + l(u_3, u_4) + l(u_4, v_1) + l(u_2, v_6) + \\
& l(P_s(C)) + l(w_1, w_2) \\
\leq & 15l(P_c(T)) + 6l(v, v_6) + 5l(v_6, v_3) + 5l(v_3, v_4) + 5l(v_4, v_5) + \\
& 6l(v_5, w) + l(v_5, w_1) + l(u_4, v_1) + l(u_2, v_6) + l(P_s(C)) + \\
& l(w_1, w_2) + l(w_2, v_1) + l(u_4, u_1) + l(u_1, v_2) \\
\leq & 15l(P_c(T)) + 6l(v, v_6) + 6l(v_6, v_3) + 4(v_3, v_4) + 4l(v_4, v_5) + \\
& 6l(v_5, w) + 2l(v_5, w_1) + l(u_4, v_1) + 2l(P_s(C)) + 2l(w_1, w_2) + \\
& 2l(w_2, v_1) + l(u_4, u_1) + l(u_1, v_2) \\
\leq & 15l(P_c(T)) + 8l(v, v_6) + 8l(v_6, v_3) + 8l(v_5, w) + 2l(v_5, w_1) + \\
& l(u_4, v_1) + 2l(P_s(C)) + 2l(w_1, w_2) + 2l(w_2, v_1) + l(u_4, u_1) + \\
& l(u_1, v_2) \\
\leq & 15l(P_c(C)) + l(u_4, v_1) + 2l(P_s(C)) + l(u_4, u_1) + l(u_1, v_2) \\
\leq & 15l(P_c(C)) + 3l(P_s(C)).
\end{aligned}$$

- A3** In the Lemma assumption $l(C'') < l(C)$ and $l(C_2) < l(C)$. Let \hat{C} be a son of C . If $P_f(\hat{C}) \subset [v_2, u_1]$ since $[v_2, u_1] \subset P_s(C'')$, \hat{C} should have been a son of C'' . Similarly if $P_f(\hat{C}) \subset [v_1, u_4]$ then \hat{C} should have been a son of C_2 . Therefore $P_f(C') \cap [u_4, u_1] \neq \phi$.
- A4** $J_h(C) = [v_2 \rightarrow u_1]$, $J_t(C) = [u_4 \rightarrow v_1]$ and for every \hat{C} a son of C $P_f(\hat{C}) \subset P_s(C) = I(C) \cup J_h(C) \cup J_t(C)$.
- A5** $M(C)$ is contained in $P_s(C), P_s(C_1), P_s(C_2), S, C''$ and T which are all shorter than C .
- A6** $M(C)$ is contained in $P_s(C), P_s(C_1), P_s(C_2), P_s(S), M(S)$ and C'' , so $N(C) = \{C'', C_1, C_2\}$.

■

Lemma 3.59 *Suppose that $l(C) < l(C'')$ then after the application of DIRECT-ONE C'' satisfies the induction hypotheses.*

Proof: In this case when DIRECT-ONE is activated on C it changes the direction of $[u_1, v_2]$ to $v_2 \rightarrow u_1$. Since $l(C) < l(C'')$ we get that Equation (49) still holds.

Since $l(C_1) < l(C) < l(C'')$:

$$l(P_s(C_1)) + l(w_2, v_1) + l(v_1, v_2) + l(v_5, w_1) < l(v_2, u_1) + l(u_1, v_4) + l(v_4, v_5) \quad (54)$$

Since $l(C_2) < l(C) < l(C'')$:

$$l(P_s(C_2)) + l(v_1, v_2) + l(v_5, w_1) + l(w_1, w_2) < l(v_2, u_1) + l(u_1, v_4) + l(v_4, v_5) \quad (55)$$

A1 Let $x = t(T), y = h(T)$, and the end nodes v, w of $P_s(T)$ be ordered v, x, y, w . Since S was oriented backwards Equation (48) still holds. Since $N(S)$ contains one more brother S'' at the l_2 side of S $x \in [v, v_3]$, and $y \in [v_3, v_5]$ or $y \in [v_5, w]$.

There are two cases to be considered:

- $y \in [v_5, w]$. Since $I(C'') = [u_1 \rightarrow v_4]$ we can define:

$$M_t(C'') = M_t(T) \cup [x \rightarrow v_3 \rightarrow v_4 \rightarrow v_5 \rightarrow w_1 \rightarrow u_3 \rightarrow u_4 \rightarrow u_1] \quad M_h(C'') = [v_4 \rightarrow v_5 \rightarrow y] \cup M_h(T)$$

Using A1 on T :

$$\begin{aligned} l(M(C'')) &= l(M(T)) + l(x, v_3) + l(v_3, v_4) + 2l(v_4, v_5) + l(v_5, w_1) + l(w_1, u_3) + \\ &\quad l(u_3, u_4) + l(u_4, u_1) + l(v_5, y) \\ &\leq 15l(P_c(T)) + 4l(v, v_3) + 4l(v_3, v_4) + 5l(v_4, v_5) + 4l(v_5, w) + \\ &\quad l(v_5, w_1) + l(w_1, u_3) + l(u_3, u_4) + l(u_4, u_1). \end{aligned}$$

- $y \in [v_3, v_5]$.

Using A4 on T we can define

$$M_t(C'') = (B_h(T) \setminus [y, v_5]) \cup [v_5 \rightarrow w_1 \rightarrow u_3 \rightarrow u_4 \rightarrow u_1] \quad M_h(C'') = [v_4 \rightarrow y] \cup M_h(T)$$

Using A2 on T ($y = h(T) \notin F(T)$)

$$\begin{aligned} l(M(C'')) &\leq l(B_h(T)) + l(M_h(T)) + l(v_5, w_1) + l(w_1, u_3) + l(u_3, u_4) + l(u_4, u_1) + l(v_4, v_5) \\ &\leq 15l(P_c(T)) + 4l(v, v_3) + 4l(v_3, v_4) + 5l(v_4, v_5) + 4l(v_5, w) + l(v_5, w_1) + \\ &\quad l(w_1, u_3) + l(u_3, u_4) + l(u_4, u_1). \end{aligned}$$

(same bound as before)

Using Equations (48),(54),(55), (49), the definition of $P_c(C'')$, the definition of $P_s(C'')$ and the definition of $I(C'')$:

$$\begin{aligned} l(M(C'')) &\leq 15l(P_c(T)) + 6l(v, v_3) + l(v_4, v_5) + 6l(v_5, w) + l(v_5, w_1) + l(w_1, u_3) + \\ &\quad l(u_3, u_4) + l(u_4, u_1) \\ &\leq 15l(P_c(T)) + 6l(v, v_3) + 2l(v_4, v_5) + 6l(v_5, w) + l(u_3, u_4) + l(u_4, u_1) + \\ &\quad l(v_2, u_1) + l(u_1, v_4) \\ &\leq 15l(P_c(T)) + 6l(v, v_3) + 2l(v_4, v_5) + 6l(v_5, w) + l(u_4, u_1) + 2l(v_2, u_1) + \\ &\quad 2l(u_1, v_4) \\ &\leq 15l(P_c(T)) + 6l(v, v_3) + 3l(v_4, v_5) + 6l(v_5, w) + 2l(v_2, u_1) + 3l(u_1, v_4) \\ &\leq 15l(P_c(C'')) + 2l(v_2, u_1) + 3l(u_1, v_4) \\ &\leq 15l(P_c(C'')) + 2l(P_s(C'')) + l(u_1, v_4) \\ &= 15l(P_c(C'')) + 2l(P_s(C'')) + l(I(C'')). \end{aligned}$$

A2 $N(S)$ contains a brother at the l_2 side of S . We marked this brother as S'' .

Since $S'' \in N(S)$ by A5 on S $l(S'') < l(S)$, since C is a son of S $l(S) < l(C)$ and by the Lemma assumption Equation (50) still holds.

In this case $h(C'') = v_4 \in T$, but $t(C'') = u_1 \notin T$.

Two possible locations of x to be considered:

- $x \in [v, v_6]$

$$B_t(C'') = [u_1 \rightarrow v_2 \rightarrow u_2 \rightarrow v_6 \rightarrow v_3 \rightarrow y] \cup M_h(T).$$

Two possible locations of y :

- $y \in [v_5, w]$

Using A1 on T

$$\begin{aligned} l(M_t(C'')) + l(B_t(C'')) &\leq l(M_t(T)) + l(M_h(T)) + l(x, v_3) + 2l(v_3, v_4) + 2l(v_4, v_5) + \\ &\quad l(v_5, w_1) + l(w_1, u_3) + l(u_3, u_4) + l(u_4, u_1) + l(u_1, v_2) + \\ &\quad l(v_2, u_2) + l(u_2, v_6) + l(v_5, y) \\ &\leq 15l(P_c(T)) + 4l(v, v_6) + 4l(v_6, v_3) + 5l(v_3, v_4) + 5l(v_4, v_5) + \\ &\quad 4l(v_5, w) + l(v_5, w_1) + l(w_1, u_3) + l(u_3, u_4) + l(u_4, u_1) + \\ &\quad l(u_1, v_2) + l(v_2, u_2) + l(u_2, v_6). \end{aligned}$$

- $y \in [v_3, v_5]$:

Using A2 on T

$$\begin{aligned} l(M_t(C'')) + l(B_t(C'')) &\leq l(B_h(T)) + l(M_h(T)) + l(u_1, v_2) + l(v_2, u_2) + l(u_2, v_6) + \\ &\quad l(v_6, v_3) + l(v_3, y) + l(v_5, w_1) + l(w_1, u_3) + l(u_3, u_4) + \\ &\quad l(u_4, u_1) \\ &\leq 15l(P_c(T)) + 4l(v, v_6) + 5l(v_6, v_3) + 5l(v_3, v_4) + 5l(v_4, v_5) + \\ &\quad 4l(v_5, w) + l(u_1, v_2) + l(v_2, u_2) + l(u_2, v_6) + l(v_5, w_1) + \\ &\quad l(w_1, u_3) + l(u_3, u_4) + l(u_4, u_1). \end{aligned}$$

- $x \in [v_6, v_3]$. In this case we define:

$$B_t(C'') = [u_1 \rightarrow v_2 \rightarrow u_2 \rightarrow v_6] \cup B_t(T) \setminus [v_6, x].$$

Two possible locations of y :

- $y \in [v_5, w]$. Using A2 on T :

$$\begin{aligned} l(B_t(C'')) + l(M_t(C'')) &\leq l(M_t(T)) + l(B_t(T)) + l(x, v_3) + l(v_3, v_4) + l(v_4, v_5) + \\ &\quad l(v_5, w_1) + l(w_1, u_3) + l(u_3, u_4) + l(u_4, u_1) + l(u_1, v_2) + \\ &\quad l(v_2, u_2) + l(u_2, v_6) \\ &\leq 15l(P_c(T)) + 4l(v, v_6) + 4l(v_6, v_3) + 5l(v_3, v_4) + 5l(v_4, v_5) + \\ &\quad 4l(v_5, w) + l(v_5, w_1) + l(w_1, u_3) + l(u_3, u_4) + l(u_4, u_1) + \\ &\quad l(u_1, v_2) + l(v_2, u_2) + l(u_2, v_6). \end{aligned}$$

– $y \in [v_3, v_5]$. Using A2 on T

$$\begin{aligned}
l(B_t(C'')) + l(M_t(C'')) &= l(B_h(T)) + l(B_t(T)) - l(v_6, x) - l(y, v_5) + l(u_1, v_2) + \\
&\quad l(v_2, u_2) + l(u_2, v_6) + l(v_5, w_1) + l(w_1, u_3) + l(u_3, u_4) + \\
&\quad l(u_4, u_1) \\
&\leq 15l(P_c(T)) + 6l(v, v_6) + 5l(v_6, v_3) + 5l(v_3, v_4) + 5l(v_4, v_5) + \\
&\quad 6l(v_5, w) + l(u_1, v_2) + l(v_2, u_2) + l(u_2, v_6) + l(v_5, w_1) + \\
&\quad l(w_1, u_3) + l(u_3, u_4) + l(u_4, u_1).
\end{aligned}$$

So for all possible locations of x and y :

$$\begin{aligned}
l(B_t(C'')) + l(M_t(C'')) &\leq 15l(P_c(T)) + 6l(v, v_6) + 5l(v_6, v_3) + 5l(v_3, v_4) + 5l(v_4, v_5) + \\
&\quad 6l(v_5, w) + l(u_1, v_2) + l(v_2, u_2) + l(u_2, v_6) + l(v_5, w_1) + l(w_1, u_3) + \\
&\quad l(u_3, u_4) + l(u_4, u_1).
\end{aligned}$$

Using Equations (48),(54),(55) (50), (49), the definition of $P_c(C'')$ and the definition of $P_s(C'')$

$$\begin{aligned}
l(B_t(C'')) + l(M_t(C'')) &\leq 15l(P_c(T)) + 8l(v, v_6) + 7l(v_6, v_3) + l(v_3, v_4) + l(v_4, v_5) + \\
&\quad 8l(v_5, w) + l(u_1, v_2) + l(v_2, u_2) + l(u_2, v_6) + l(v_5, w_1) + l(w_1, u_3) + \\
&\quad l(u_3, u_4) + l(u_4, u_1) \\
&\leq 15l(P_c(T)) + 8l(v, v_6) + 7l(v_6, v_3) + l(v_3, v_4) + 2l(v_4, v_5) + \\
&\quad 8l(v_5, w) + 2l(u_1, v_2) + l(v_2, u_2) + l(u_2, v_6) + l(u_3, u_4) + \\
&\quad l(u_4, u_1) + l(u_1, v_4) \\
&\leq 15l(P_c(T)) + 8l(v, v_6) + 7l(v_6, v_3) + l(v_3, v_4) + 3l(v_4, v_5) + \\
&\quad 8l(v_5, w) + 3l(u_1, v_2) + l(v_2, u_2) + l(u_2, v_6) + \\
&\quad l(u_4, u_1) + 2l(u_1, v_4) \\
&\leq 15l(P_c(T)) + 8l(v, v_6) + 8l(v_6, v_3) + 3l(v_4, v_5) + 8l(v_5, w) + \\
&\quad 4l(u_1, v_2) + l(u_4, u_1) + 3l(u_1, v_4) \\
&\leq 15l(P_c(T)) + 8l(v, v_6) + 8l(v_6, v_3) + 4l(v_4, v_5) + 8l(v_5, w) + \\
&\quad 4l(u_1, v_2) + 4l(u_1, v_4) \\
&\leq 15l(P_c(C'')) + 4l(u_1, v_2) + 4l(u_1, v_4) \\
&\leq 15l(P_c(C'')) + 4l(P_s(C''))
\end{aligned}$$

A3 From the Lemma assumption we get that $l(S'') < l(C) < l(C'')$. Let \hat{C} be a son of C'' . if $P_f(\hat{C}) \subset ([u_1, v_2] \cup [v_2, v_3])$ then \hat{C} should have been a son of C or S'' but not of C'' .

A4 Same proof like in Lemma 3.50.

A5 $M(C'')$ is contained in $P_s(C'')$, C, C_1, C_2 and T which are all shorter than C .

A6 $M(C)$ is contained in $P_s(C'')$, $P_s(T)$, $M(T)$ and C, C_1, C_2 , so $N(C'') = \{C, C_1, C_2\}$.

■

Corollary 3.60 *After activating DIRECT-ONE on a cycle C whose father is oriented backwards and when C'' is an uncle, C and C'' will satisfy the induction hypotheses.*

The cycles
 C_1 $zv_1uv_2v_4z$
 C_2 $zv_1v_3uv_4z$
 C_3 zv_1uv_4z

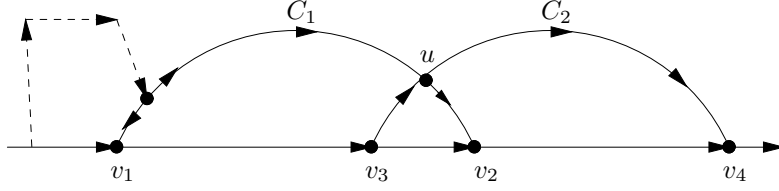

Figure 50: Figure for Lemma 3.11.

3.11 Inner-Crossing brothers

Suppose that C_1 and C_2 are inner-crossing brothers. According to Observation (3.14) they have a containing brother C_3 such that C_1, C_2 are the only maximal uncontained brothers of C_3 and $l(C_3) < \min\{l(C_1), l(C_2)\}$. Since C_3 contains C_1 and C_2 it will be oriented before them. Since they are the only maximal uncontained brothers of C_3 they will be oriented together in the next level of containment. C_1 and C_2 will be oriented in the same direction as C_3 . In the next proof we assume that C_3 was oriented forwards (and thus so would C_1 and C_2). Similar proof applies when C_3 is oriented backwards.

Lemma 3.61 *Suppose that C_3 is oriented forwards. When DIRECT-ONE is applied on C_1 , it doesn't change previous orientation and C_1 will be oriented to satisfy the induction hypotheses.*

Proof: Before DIRECT-ONE was applied on C_1 , C_3 satisfied the induction hypotheses. According to the lemma assumption it is oriented forwards. Mark (see Figure 50):

- $S := F(C_1, C_2)$.
- $v_1, v_2 :=$ the end nodes of $P_s(C_1) \cap P_s(S)$ (ordered according to direction of $I(S)$).
- $v_3, v_4 :=$ the end nodes of $P_s(C_2) \cap P_s(S)$ (ordered according to direction of $I(S)$).
- $u := (P_s(C_1) \cap P_s(C_2)) \setminus (P_s(S))$.

Since C_1 and C_2 are inner-crossing $P_s(C_3) = [v_1, u, v_4]$. Hence $u \in U(C_3)$ and $U(C_1) \subset [u, v_2]$ ($U(C_2) \subset [v_3, u]$). When DIRECT-ONE is activated on C_1 it compares C_1 and C_3 , since $l(C_3) < l(C_1)$ it doesn't change previous orientation. DIRECT-ONE orients $[u \rightarrow v_2]$. C_3 and any cycle C such that $C_3 \in N(C)$ will not be changed. Since C_3 satisfied the induction hypotheses before DIRECT-ONE was applied on C_1 , $|N(C_3)| \leq 3$. For every cycle $C^* \in N(C_3)$, $l(C^*) < l(C_3)$. After DIRECT-ONE $N(C_1) = N(C)$ so $|N(C)| \leq 3$ and for every cycle $C^* \in N(C)$, $l(C^*) < l(C_3) < l(C_1)$. Hence C_1 will be oriented to satisfy the conditions of lemmas (3.32), (3.35), (3.38) or (3.40) and will satisfy the induction hypotheses. ■

References

- [1] Nili Guttman-Beck and Refael Hassin, “Series-parallel orientations preserving the cycle-radius,” revision submitted to *Information Processing Letters* (2011).