

# The crossing number of locally twisted cubes \*

Haoli Wang, Xirong Xu, Yuansheng Yang<sup>†</sup>, Bao Liu

Department of Computer Science,  
Dalian University of Technology, Dalian, 116024, P. R. China

Wenping Zheng

Key Laboratory of Computational Intelligence and Chinese Information  
Processing of Ministry of Education,  
Shanxi University, Taiyuan, 030006, P. R. China

Guoqing Wang

Center for Combinatorics, LPMC-TJKLC  
Nankai University, Tianjin, 300071, P. R. China

## Abstract

The *crossing number* of a graph  $G$  is the minimum number of pairwise intersections of edges in a drawing of  $G$ . Motivated by the recent work [Faria, L., Figueiredo, C.M.H. de, Sykora, O., Vrt'o, I.: An improved upper bound on the crossing number of the hypercube. *J. Graph Theory* **59**, 145–161 (2008)] which solves the upper bound conjecture on the crossing number of  $n$ -dimensional hypercube proposed by Erdős and Guy, we give upper and lower bounds of the crossing number of locally twisted cube, which is one of variants of hypercube.

**Keywords:** *Drawing; Crossing number; Locally twisted cube; Interconnection network*

## 1 Introduction

The *crossing number*  $cr(G)$  of a graph  $G$  is the minimum number of pairwise intersections of edges in a drawing of  $G$  in the plane. The notion of crossing number is a central one for Topological Graph Theory and has been studied extensively by mathematicians including Erdős, Guy, Turán and Tutte, et al. (see [9, 11, 18, 19, 23, 30–32]). In the past thirty years, it turned out that crossing number has many important applications in discrete and computational geometry (see [3, 16, 17, 24, 25, 27, 29]). For example,

---

\*The research is supported by NSFC (60973014, 60803034, 11001035) and SRFDP (200801081017, 200801411073).

<sup>†</sup>corresponding author's email : yangys@dlut.edu.cn

Székely [27] employed the ‘crossing lemma’ [1, 14] to give a simple proof of the following well-known theorem in discrete and computational geometry.

**Theorem A.** (Szemerédi-Trotter [28]) *Given  $n$  points and  $\ell$  lines in the plane, there is a constant  $c$  for which the number of incidences among the points and lines is at most  $c[(n\ell)^{2/3} + n + \ell]$ .*

On the other hand, the immediate applications in VLSI theory and wiring layout problems (see [2, 13, 14, 22]) also inspired the study of crossing number of some popular parallel network topologies such as hypercube and its variations. Among all the popular parallel network topologies, hypercube is the first to be studied (see [4–7, 15, 26]). An  $n$ -dimensional hypercube  $Q_n$  is a graph in which the nodes can be one-to-one labeled with 0-1 binary sequences of length  $n$ , so that the labels of any two adjacent nodes differ in exactly one bit.

Computing the crossing number was proved to be NP-complete by Garey and Johnson [10]. Thus, it is not surprising that the exact crossing numbers are known for graphs of few families and that the arguments often strongly depend on their structures (see for example [8, 20, 21, 34]). Even for hypercube, for a long time the only known result on the exact value of crossing number of  $Q_n$  has been  $cr(Q_3) = 0$ ,  $cr(Q_4) = 8$  [4],  $cr(Q_5) \leq 56$  [15]. Hence, it is more practical to find upper and lower bounds of crossing numbers of some kind of graphs. Concerned with upper bound of crossing number of hypercube, Erdős and Guy [9] in 1973 conjectured the following:

$$cr(Q_n) \leq \frac{5}{32}4^n - \lfloor \frac{n^2 + 1}{2} \rfloor 2^{n-2}.$$

In 2008, Faria, Figueiredo, Sykora and Vrt’o [7] constructed a drawing of  $Q_n$  in the plane which has the conjectured number of crossings mentioned above. Early in 1993 Sykora and Vrt’o [26] also proved a lower bound of  $cr(Q_n)$ :

$$cr(Q_n) > \frac{1}{20}4^n - (n^2 + 1)2^{n-1}.$$

Since the hypercube does not have the smallest possible diameter for its resources, to achieve smaller diameter with the same number of nodes and links as an  $n$ -dimensional cube, a variety of hypercube variants were proposed. Locally twisted cube is one of these variants. The  $n$ -dimensional locally twisted cube  $LTQ_n$ , proposed by Yang et al. [33] in 2005, keeps as many nice properties of hypercube as possible and is conceptually closer to traditional hypercube, while it has diameters of about half of that of a hypercube of the same size. Therefore, it would be more attractive to study the crossing number of the  $n$ -dimensional locally twisted cubes.

The  $n$ -dimensional locally twisted cube  $LTQ_n (n \geq 2)$  is defined recursively as follows.

- (a)  $LTQ_2$  is a graph isomorphic to  $Q_2$ .
- (b) For  $n \geq 3$ ,  $LTQ_n$  is built from two disjoint copies of  $LTQ_{n-1}$  according to the following steps. Let  $0LTQ_{n-1}$  denote the graph obtained by prefixing the label of each

vertex of one copy of  $LTQ_{n-1}$  with 0, let  $1LTQ_{n-1}$  denote the graph obtained by prefixing the label of each vertex of the other copy  $LTQ_{n-1}$  with 1, and connect each vertex  $x = 0x_2x_3 \dots x_n$  of  $0LTQ_{n-1}$  with the vertex  $1(x_2+x_n)x_3 \dots x_n$  of  $1LTQ_{n-1}$  by an edge, where  $+$  represents the modulo 2 addition.

The graphs shown in Figure 1.1 are  $LTQ_3$  and  $LTQ_4$ , respectively.

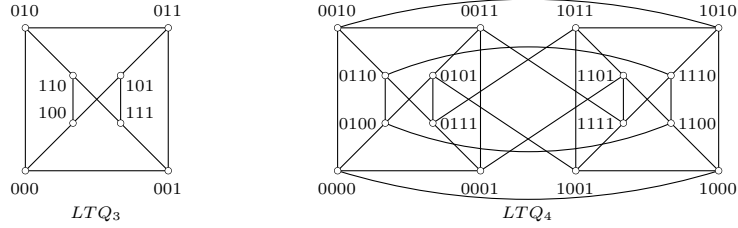

Figure 1.1: Locally twisted cubes  $LTQ_3$  and  $LTQ_4$

In this paper, we mainly obtain the following bounds of the crossing number of  $LTQ_n$ :

$$\frac{4^n}{20} - (n^2 + 1)2^{n-1} < cr(LTQ_n) \leq \frac{265}{6}4^{n-4} - \left(n^2 + \frac{15 + (-1)^{n-1}}{6}\right)2^{n-3}.$$

## 2 Upper bound for $cr(LTQ_n)$

A drawing of  $G$  is said to be a *good* drawing, provided that no edge crosses itself, no adjacent edges cross each other, no two edges cross more than once, and no three edges cross in a point. It is well known that the crossing number of a graph is attained only in *good* drawings of the graph. So, we always assume that all drawings throughout this paper are good drawings. For a good drawing  $D$  of a graph  $G$ , let  $\nu_D(G)$  be the number of crossings in  $D$ . In what follows,  $\nu_D(G)$  is abbreviated to  $\nu_D$  when it is unambiguous.

Let  $x = x_1x_2 \dots x_n$  and  $y = y_1y_2 \dots y_n$  be two vertices of  $LTQ_n$ . Denote

$$\mathcal{D}(x_1x_2 \dots x_n) = 2^{n-1}x_1 + 2^{n-2}x_2 + \dots + 2^0x_n$$

to be the corresponding decimal number of  $x_1x_2 \dots x_n$ . Let

$$\theta_i(x) = x_i \quad \text{for } i \in \{1, 2, \dots, n\}.$$

Let  $\lambda(x, y)$  be the smallest positive integer  $i \in \{1, 2, \dots, n\}$  such that  $\theta_i(x) \neq \theta_i(y)$ . We define

$$Dim(x, y) = \begin{cases} \lambda(x, y), & \text{if } x \text{ and } y \text{ are adjacent;} \\ \infty, & \text{otherwise.} \end{cases}$$

In particular, for an edge  $e = xy$ , let  $Dim(e) = Dim(x, y)$  and say the edge  $e$  lies in the  $Dim(e)$ -dimension. We call  $x$  an *odd vertex* if  $|\{1 \leq i \leq n : x_i = 1\}| \equiv 1 \pmod{2}$ , and an *even vertex* if otherwise.

For the clearness of composition, in the rest of this section, any vertex  $x \in V(LTQ_n)$  in figures will be represented by the corresponding decimal number  $\mathcal{D}(x)$ . We first give a drawing of  $LTQ_4$  with 10 crossings and a drawing of  $LTQ_5$  with 68 crossings as shown in Figure 2.1. Hence, we have the following

**Proposition 1.**  $cr(LTQ_4) \leq 10$  and  $cr(LTQ_5) \leq 68$ .

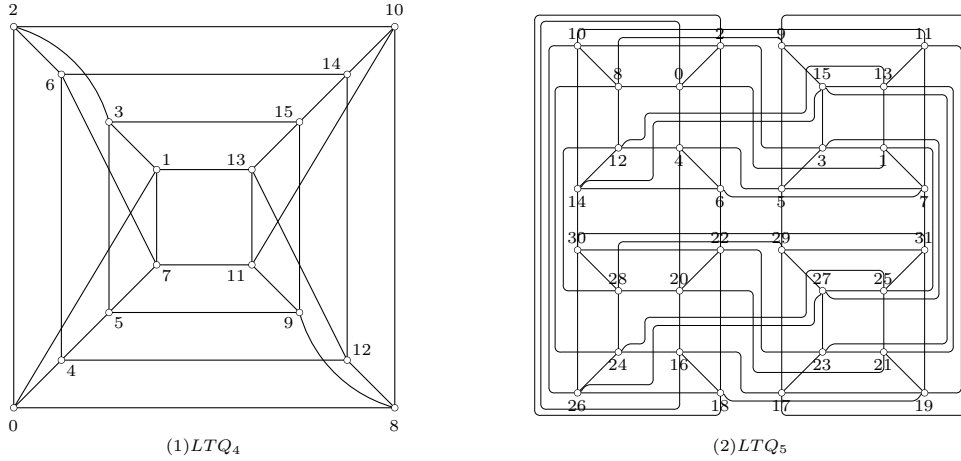

Figure 2.1: Drawings of  $LTQ_4$  with 10 crossings and  $LTQ_5$  with 68 crossings

Before proving the upper bound of  $cr(LTQ_n)$  for  $n \geq 6$ , we need to introduce some technical notations. We define two structures  $M^i$  and  $M_c^i$ , called “meshes” which will be used in counting the number of crossings. Consider the canonical geometry of the real plane  $\mathbb{R}^2$ . By  $[0, 1]$  we denote the closed interval joining the points  $(0, 0)$  and  $(1, 0)$  of the horizontal real axis. Let  $r$  and  $s$  be a non-horizontal pair of parallel straight lines in the real plane  $\mathbb{R}^2$ , such that the point  $(0, 0)$  belongs to  $r$  and the point  $(1, 0)$  belongs to  $s$ . For a positive integer  $n$ , let  $\mathcal{L}_n = \{(r_i, s_i) : i \in \{1, 2, \dots, n\}\}$  be a set of non-horizontal pairs of parallel straight lines in the real plane  $\mathbb{R}^2$ , such that the point  $(0, 0)$  belongs to  $r_i$  and the point  $(1, 0)$  belongs to  $s_i$ .

A mesh with index  $n$ , denoted  $M^n$ , is the set of points of the plane consisting of the points of the  $n$ -element set  $\mathcal{L}_n$  plus the points in the interval  $[0, 1]$ . In Figure 2.2, we show as an example a drawing of each  $M^1$ ,  $M^2$ ,  $M^3$  and  $M^5$ .

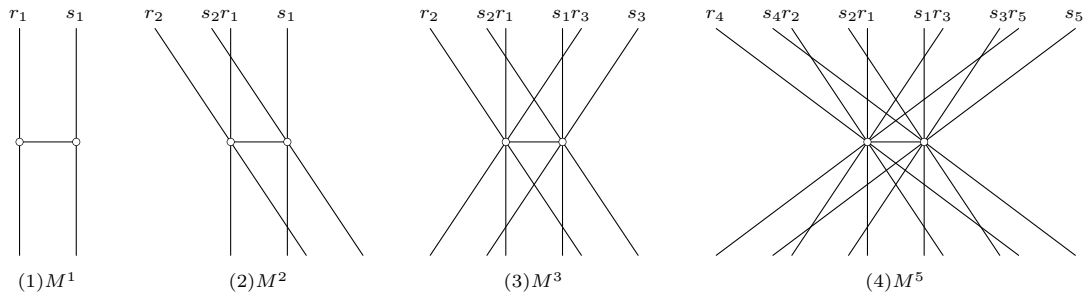

Figure 2.2: Drawings of  $M^1$ ,  $M^2$ ,  $M^3$  and  $M^5$

A *chopped mesh* with index  $n$ , denoted  $M_c^n$ , is the set of points of  $M^n$  without a pair of parallel semi-straight lines of the left-most lower semi-plane. In Figure 2.3, we show a drawing of each  $M_c^1$ ,  $M_c^2$ ,  $M_c^3$  and  $M_c^5$ .

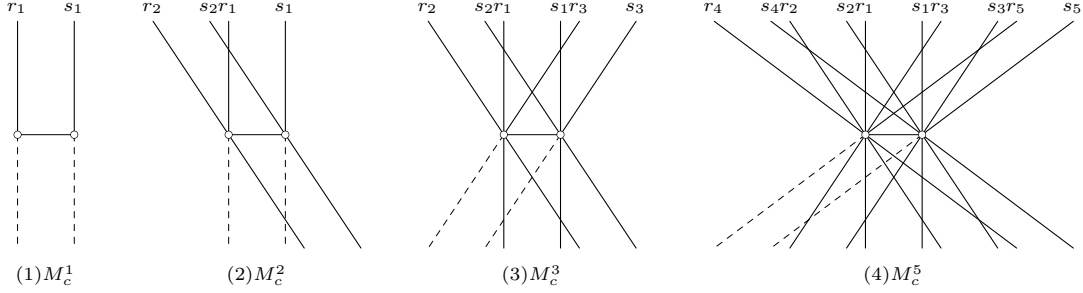

Figure 2.3: Drawings of  $M_c^1$ ,  $M_c^2$ ,  $M_c^3$  and  $M_c^5$

**Lemma 2.1.** [7] *For any positive integer  $n$ , there is a drawing of  $M^n$  with  $n(n-1)$  crossings.*

**Lemma 2.2.** [7] *For any positive integer  $n$ , there is a drawing of  $M_c^n$  with  $(n-1)^2$  crossings.*

To prove the general upper bound of  $cr(LTQ_n)$ , we need to construct a drawing  $D_n$  of  $LTQ_n$  with the desired number of crossings. The philosophy is putting the obtained drawing  $D_{n-1}$  of  $LTQ_{n-1}$  on the given coordinate systems (see Figure 2.5) and then replacing each vertex of  $LTQ_{n-1}$  by two vertices of  $LTQ_n$  and replacing each edge of  $LTQ_{n-1}$  by a bunch of two edges of  $LTQ_n$ . Hence, we need the following definitions.

**Definition 2.1.** *Let  $x$  be a vertex of  $LTQ_n$ , and let  $e \in E(LTQ_n)$  be an edge incident with  $x$ . Assume that  $x$  is drawn precisely on some axis  $A$ . We call  $e$  an *a-arc* or *b-arc* with respect to  $x$ , provided that the edge  $e$  is drawn to be upward from  $A$  (based upon the positive direction of the axis  $A$ ) or to be downward from  $A$ , respectively. In particular, let*

$$\alpha(x) = |\{e \in E(LTQ_n) : e \text{ is an a-arc with respect to } x\}|$$

and

$$\beta(x) = |\{e \in E(LTQ_n) : e \text{ is a b-arc with respect to } x\}|.$$

For example, as shown in Figure 2.5, the three edges joining vertex 23 and vertices 17, 27, 21 are a-arcs with respect to vertex 23, and the three edges joining vertex 23 and vertices 22, 39, 15 are b-arcs with respect to vertex 23.

**Definition 2.2.** *Let  $x$  and  $y$  be two vertices of  $LTQ_n$  with  $\text{Dim}(x, y) = n-1$ . Assume that  $x$  and  $y$  are drawn next to each other on some axis. Then we define the forward direction of  $x$  to be coincident with the direction from  $y$  to  $x$  if  $\theta_n(x) = 1$  and  $x$  is an odd vertex and that the forward direction of  $x$  to be coincident with the direction from  $x$  to  $y$  if otherwise (see Figure 2.4).*



Figure 2.4: The forward direction of vertex  $x$

**Definition 2.3.** Let  $x$  and  $y$  be two adjacent vertices of  $LTQ_n$ . For  $i \in \{1, 2\}$ , we define  $\varepsilon_i = \varepsilon_i(x, y)$  and  $\zeta_i = \zeta_i(x, y)$  satisfying that  $\{(\varepsilon_1, \zeta_1), (\varepsilon_2, \zeta_2)\} = \{(0, 1), (1, 0)\}$  if  $\text{Dim}(x, y) = n - 1$  and  $\theta_n(x) = 1$ , and that  $\{(\varepsilon_1, \zeta_1), (\varepsilon_2, \zeta_2)\} = \{(0, 0), (1, 1)\}$  otherwise.

In what follows,  $\varepsilon_i(x, y), \zeta_i(x, y)$  are abbreviated to  $\varepsilon_i, \zeta_i$  respectively when it is unambiguous. Let  $x = x_1x_2 \cdots x_n$  be a vertex of  $LTQ_n$ . We define

$$x^\delta = x_1x_2 \cdots x_{n-1}\delta x_n$$

to be a vertex of  $LTQ_{n+1}$ , where  $\delta \in \{0, 1\}$ .

**Observation 2.1.** Let  $x$  and  $y$  be two adjacent vertices of  $LTQ_n$ . Then  $x^{\varepsilon_i}$  and  $y^{\zeta_i}$  are adjacent vertices of  $LTQ_{n+1}$ , in particular,

$$\text{Dim}(x^{\varepsilon_i}, y^{\zeta_i}) = \begin{cases} \text{Dim}(x, y), & \text{if } \text{Dim}(x, y) \leq n - 1; \\ n + 1, & \text{if } \text{Dim}(x, y) = n; \end{cases}$$

**Observation 2.2.** Let  $x, y, u, v$  be four vertices of  $LTQ_n$  with  $\text{Dim}(x, u) = \text{Dim}(y, v) = n - 1$ . If  $x$  and  $y$  are adjacent, then  $u$  and  $v$  are adjacent, in particular,  $\text{Dim}(u, v) = \text{Dim}(x, y)$ .

Now we are in a position to prove the general upper bound of  $cr(LTQ_n)$ .

**Theorem 2.1.** For  $n \geq 6$ ,

$$cr(LTQ_n) \leq \frac{265}{6}4^{n-4} - \left(n^2 + \frac{15 + (-1)^{n-1}}{6}\right)2^{n-3}.$$

*Proof.* To prove the theorem, we shall construct a drawing  $D_n$  of  $LTQ_n$  for any  $n \geq 6$ , which satisfies the following five properties.

**Property 1:**  $\nu_{D_n} = \frac{265}{6}4^{n-4} - \left(n^2 + \frac{15 + (-1)^{n-1}}{6}\right)2^{n-3}$ .

**Property 2:** Every vertex  $x$  of  $LTQ_n$  is drawn precisely on some axis, and moreover,  $|\alpha(x) - \beta(x)| \leq 1$ .

**Property 3:** Let  $x, u$  be two vertices of  $LTQ_n$  with  $\text{Dim}(x, u) = n - 1$ . Then  $x$  and  $u$  are drawn next to each other on the same axis. Moreover,  $\alpha(x) = \alpha(u)$  and  $\beta(x) = \beta(u)$ .

**Property 4:** Let  $x, y, u, v$  be four vertices of  $LTQ_n$  with  $\text{Dim}(x, u) = \text{Dim}(y, v) = n - 1$ . Assume that  $x$  and  $y$  are adjacent. Then  $xy$  is an  $a$ -arc ( $b$ -arc) with respect to  $x$  if and only if  $uv$  is an  $a$ -arc ( $b$ -arc) with respect to  $u$ .

**Property 5:** Let  $x, y, u, v$  be four vertices of  $LTQ_n$  with  $Dim(x, u) = Dim(y, v) = n - 1$ . If  $Dim(x, y) < n$  then  $\nu_{D_n}(xy, uv) = 0$ .

Assume first  $n = 6$ . The drawing  $D_6$  is given in Figure 2.5. It is not hard to check that Properties 2, 3, 4 and 5 hold for  $D_6$ . We verify that the number of crossings is  $400 = \frac{265}{6} \cdot 4^{6-4} - (6^2 + \frac{15+(-1)^{6-1}}{6}) \cdot 2^{6-3}$ , and so Property 1 holds for  $D_6$ .

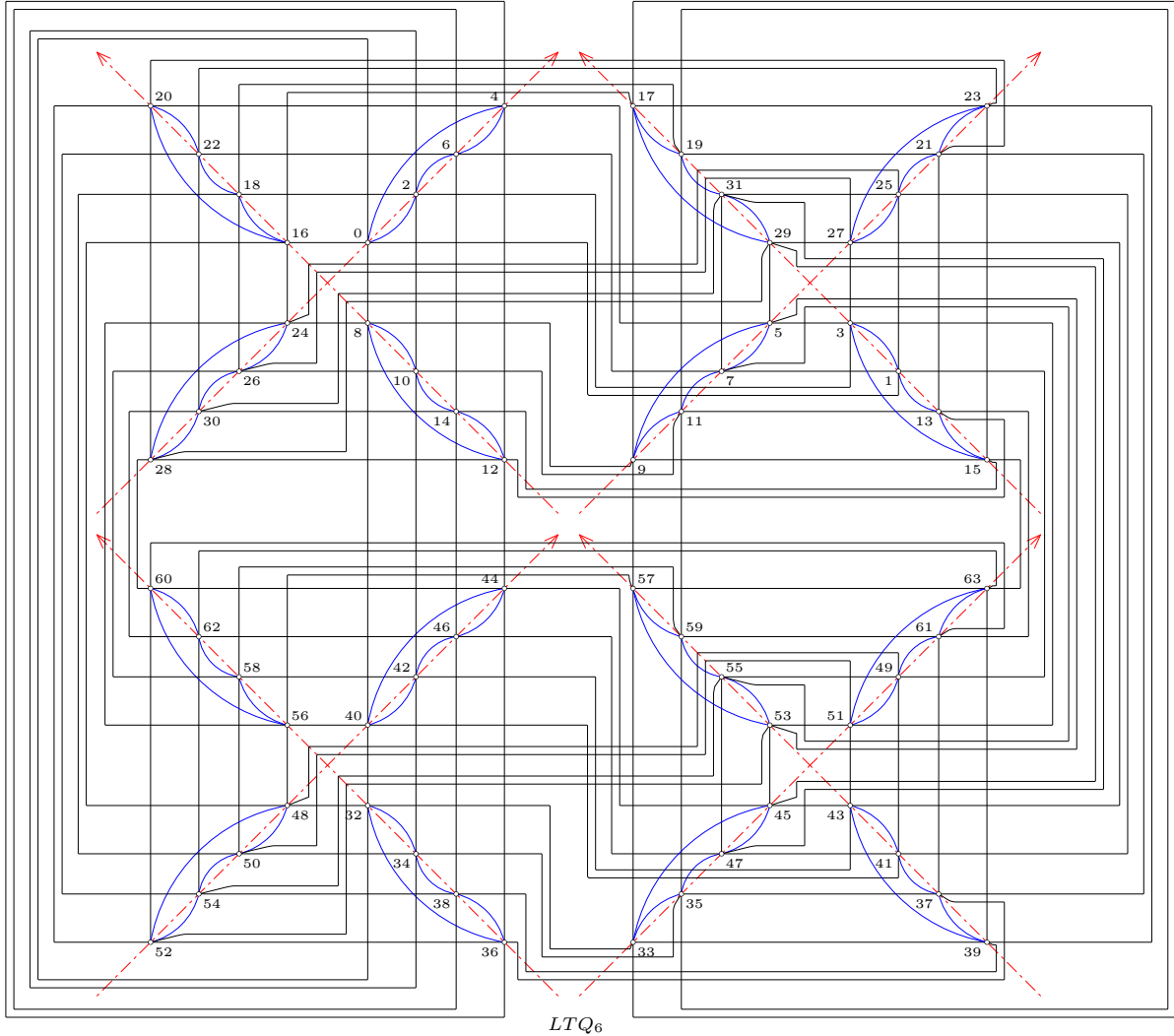

Figure 2.5: The drawing of  $D_6$

Now assume that  $n \geq 6$  and that there exists a drawing  $D_n$  of  $LTQ_n$  satisfying Properties 1, 2, 3, 4 and 5. It suffices to construct a drawing  $D_{n+1}$  of  $LTQ_{n+1}$  for which the above properties hold. The process of constructing  $D_{n+1}$  is as follows. Replace each vertex  $x$  of  $LTQ_n$  in the “small” neighborhood of  $x$  in the drawing  $D_n$  by two vertices  $x^0, x^1 \in V(LTQ_{n+1})$ , both of which are drawn precisely on the same axis as  $x$  such that the direction from  $x^0$  to  $x^1$  is coincident with the forward direction of  $x$ . Then join  $x^0$  and  $x^1$  by an  $a$ -arc or  $b$ -arc with respect to  $x^0$  ( $x^1$ ) according to  $\alpha(x) \leq \beta(x)$  or not. By Observation 2.1, we need to replace each edge incident with  $x$  in  $LTQ_n$ , denoted

$e = xy \in E(LTQ_n)$ , by a bunch of two edges  $x^{\varepsilon_1}y^{\zeta_1}, x^{\varepsilon_2}y^{\zeta_2} \in E(LTQ_{n+1})$  which are “parallel” or crossed each other at “infinity” (compared to the “small” neighborhoods of  $x$  and  $y$ ), and drawn along the original edge  $e$ .

To illustrate the process above, we give in Figure 2.6 the extracted local drawing on vertices 9, 11, 7, 5 in  $D_6$  and the corresponding extended drawings in  $D_7$  and  $D_8$ . Notice that in Figure 2.6(1) the vertices 11 and 7 are odd vertices, and that  $Dim(9, 11) = Dim(5, 7) = 5 = n - 1$ . Hence, the forward direction of the vertex 11(7) is from 9(5) to 11(7).

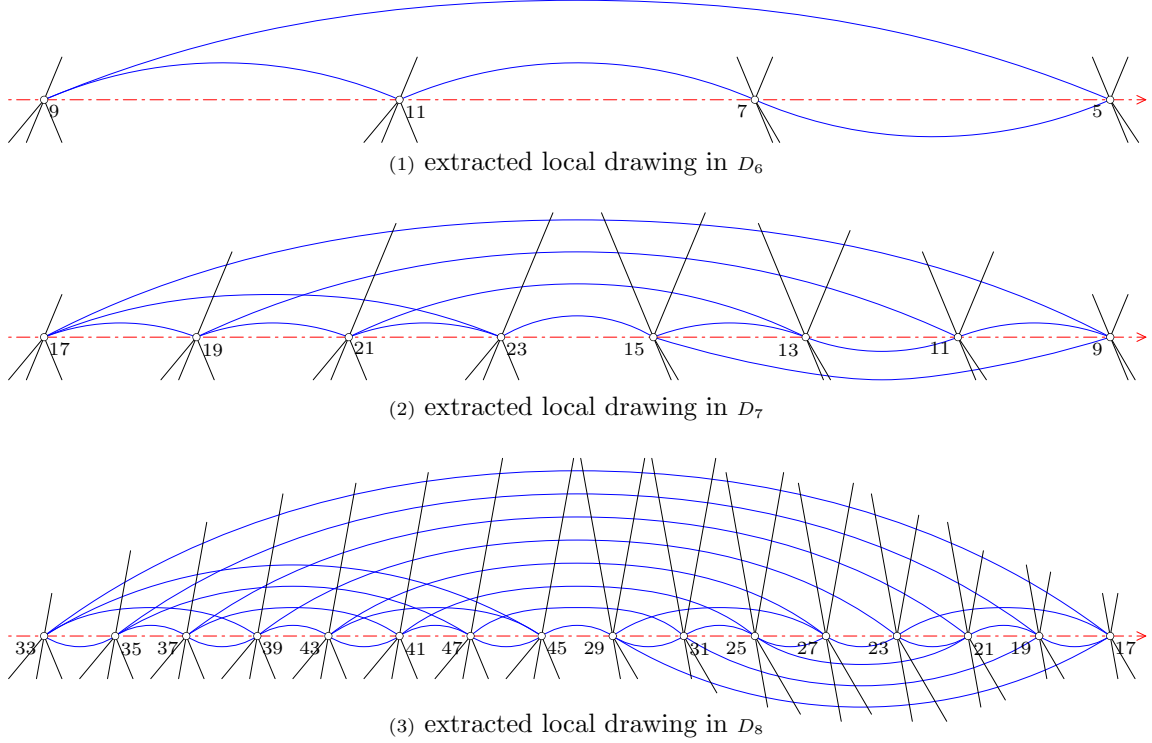

Figure 2.6: The extracted local drawings

By the process described as above, we conclude that Properties 2, 3 and 4 hold for  $D_{n+1}$ . Because that  $D_n$  has Properties 3, 4 and 5, we can verify that  $\nu_{D_{n+1}}(x^{\varepsilon_1}y^{\zeta_1}, x^{\varepsilon_2}y^{\zeta_2}) = 0$  for any edge  $xy \in LTQ_n$  with  $Dim(xy) < n - 1$  (see Figure 2.7, where  $u, v \in V(LTQ_n)$  such that  $Dim(u, x) = Dim(v, y) = n - 1$ ) and that  $\nu_{D_{n+1}}(x^{\varepsilon_1}y^{\zeta_1}, x^{\varepsilon_2}y^{\zeta_2}) = 0$  for any edge  $xy \in LTQ_n$  with  $Dim(xy) = n - 1$  (see Figure 2.8). Combining with Observation 2.1, we conclude that Property 5 holds for  $D_{n+1}$ .

It remains to show that Property 1 holds for  $D_{n+1}$ .

**Claim A.** For any vertex  $x$  of  $LTQ_n$ , the number of crossings produced in the “small” neighborhood of the new edge  $x^0x^1$  in  $D_{n+1}$  are equal to  $\frac{(n-1)^2}{4}$  for odd  $n$  and  $\frac{n(n-2)}{4}$  for even  $n$ .

*Proof of Claim A.* Since  $D_{n+1}$  has Properties 2, 3 and 4, we conclude that the neighborhood of the new edge  $x^0x^1$  corresponds to a drawing of  $M_c^{\frac{n+1}{2}}$  for odd  $n$ , and a drawing



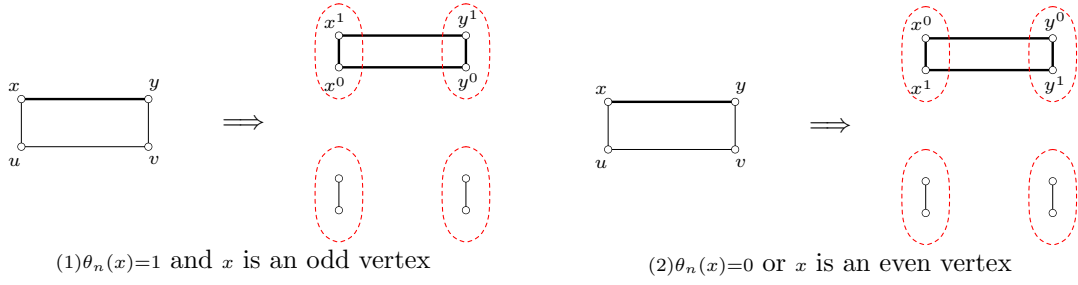

Figure 2.7: The case for  $\text{Dim}(xy) < n - 1$

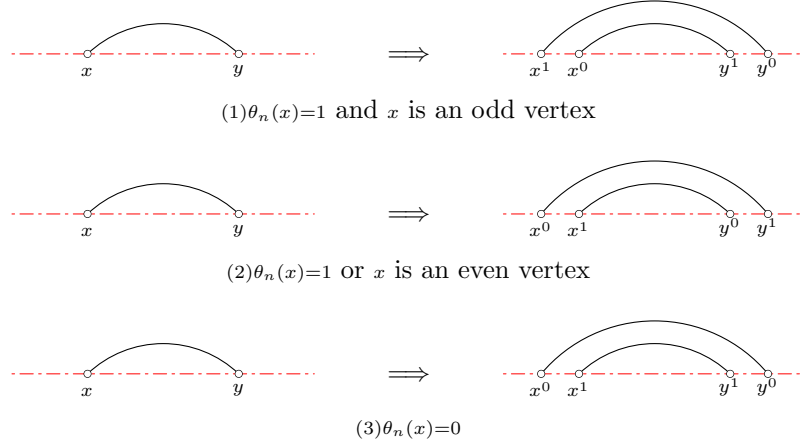

Figure 2.8: The case for  $\text{Dim}(xy) = n - 1$

of  $M^{\frac{n}{2}}$  for even  $n$ . Then the claim follows from Lemma 2.1 and Lemma 2.2.  $\square$

**Claim B.**  $|\{xy \in E(LTQ_n) : \text{Dim}(xy) = n \text{ and } \nu_{D_{n+1}}(x^{\varepsilon_1}y^{\zeta_1}, x^{\varepsilon_2}y^{\zeta_2}) = 1\}| = 2^{n-2}$ .

*Proof of Claim B.* By Observation 2.2, there exists a partition  $E_1, \dots, E_{2^{n-2}}$  of  $\{e \in LTQ_n : \text{Dim}(e) = n\}$  with  $|E_i| = 2$ , say

$$E_i = \{x_i y_i, u_i v_i\},$$

such that

$$\text{Dim}(x_i, u_i) = \text{Dim}(y_i, v_i) = n - 1,$$

where  $i \in \{1, 2, \dots, 2^{n-2}\}$ . To prove Claim B, it suffices to show that

$$\nu_{D_{n+1}}(x_i^{\varepsilon_1} y_i^{\zeta_1}, x_i^{\varepsilon_2} y_i^{\zeta_2}) + \nu_{D_{n+1}}(u_i^{\varepsilon_1} v_i^{\zeta_1}, u_i^{\varepsilon_2} v_i^{\zeta_2}) = 1 \quad (1)$$

for all  $i \in \{1, 2, \dots, 2^{n-2}\}$ . Assume without loss of generality that  $\theta_n(y_i) = \theta_n(v_i) = 1$  and  $v_i$  is an odd vertex, i.e.,  $\theta_n(x_i) = \theta_n(u_i) = 0$  and  $y_i$  is an even vertex. Since  $D_n$  has properties 3 and 4, we can verify (1) immediately by two cases  $\nu_{D_n}(x_i y_i, u_i v_i) = 0$  and  $\nu_{D_n}(x_i y_i, u_i v_i) = 1$ , which are shown in Figure 2.9. This proves Claim B.  $\square$

By the process of constructing  $D_{n+1}$ , we conclude that

$$\nu_{D_{n+1}} = 4 \cdot \nu_{D_n} + \Gamma_n + |\{xy \in E(LTQ_n) : \nu_{D_{n+1}}(x^{\varepsilon_1}y^{\zeta_1}, x^{\varepsilon_2}y^{\zeta_2}) = 1\}| \quad (2)$$

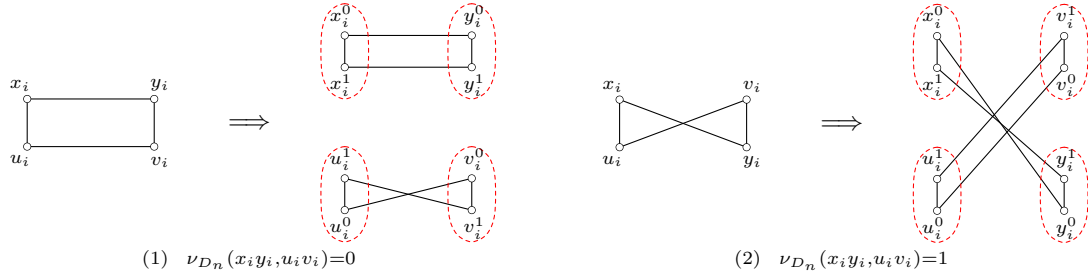

Figure 2.9: Two cases of  $\nu_{D_n}(x_i y_i, u_i v_i) = 0$  and  $\nu_{D_n}(x_i y_i, u_i v_i) = 1$

where  $\Gamma_n$  denotes the total number of crossings produced in the “small” neighborhoods of all new edges  $x^0 x^1$ . By Claim A, we have that

$$\Gamma_n = \begin{cases} 2^n \cdot \frac{(n-1)^2}{4}, & \text{if } n \equiv 1 \pmod{2}; \\ 2^n \cdot \frac{n(n-2)}{4}, & \text{if } n \equiv 0 \pmod{2}. \end{cases} \quad (3)$$

Recall that  $D_{n+1}$  has Property 5. It follows from Observation 2.1 that  $|\{xy \in E(LTQ_n) : \text{Dim}(xy) \leq n-1 \text{ and } \nu_{D_{n+1}}(x^{\varepsilon_1} y^{\zeta_1}, x^{\varepsilon_2} y^{\zeta_2}) = 1\}| = 0$ . By Claim B, we have that

$$|\{xy \in E(LTQ_n) : \nu_{D_{n+1}}(x^{\varepsilon_1} y^{\zeta_1}, x^{\varepsilon_2} y^{\zeta_2}) = 1\}| = 2^{n-2}. \quad (4)$$

By (2), (3) and (4), we conclude that

$$\nu_{D_{n+1}} = \begin{cases} 4 \cdot \nu_{D_n} + 2^n \cdot \frac{(n-1)^2}{4} + 2^{n-2} = 4\nu_{D_n} + (n^2 - 2n + 2)2^{n-2}, & \text{if } n \equiv 1 \pmod{2}; \\ 4 \cdot \nu_{D_n} + 2^n \cdot \frac{n(n-2)}{4} + 2^{n-2} = 4\nu_{D_n} + (n^2 - 2n + 1)2^{n-2}, & \text{if } n \equiv 0 \pmod{2}. \end{cases}$$

Since  $D_n$  has Property 1, it is easy to verify that Property 1 holds for  $D_{n+1}$ . This completes the proof of Theorem 2.1.  $\square$

For the convenience of the reader, we offer in Figure 2.10 and 2.11 drawings for  $LTQ_7$  and  $LTQ_8$  obtained according to the process of constructing  $D_n$ .

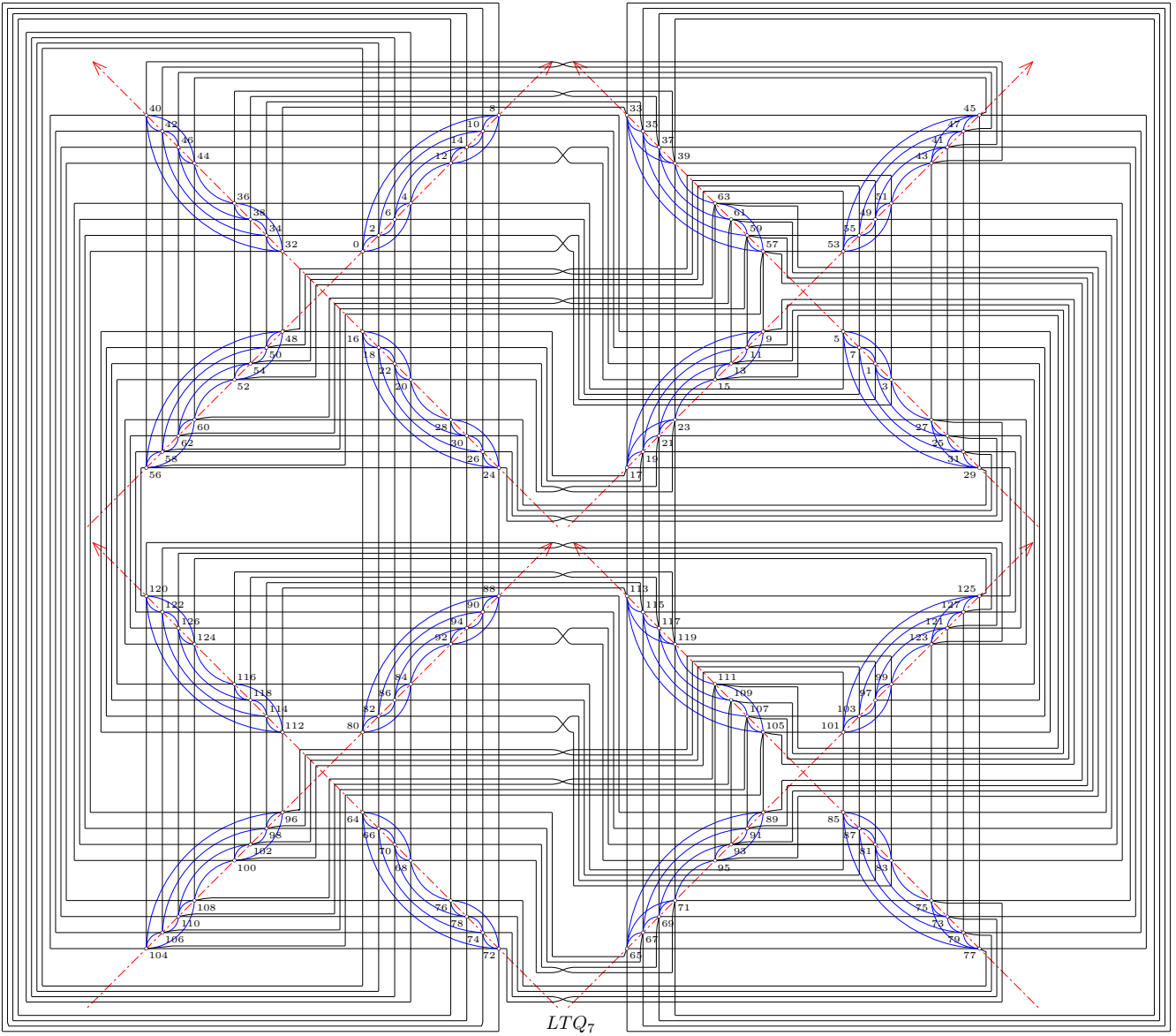

Figure 2.10: The drawing  $D_7$

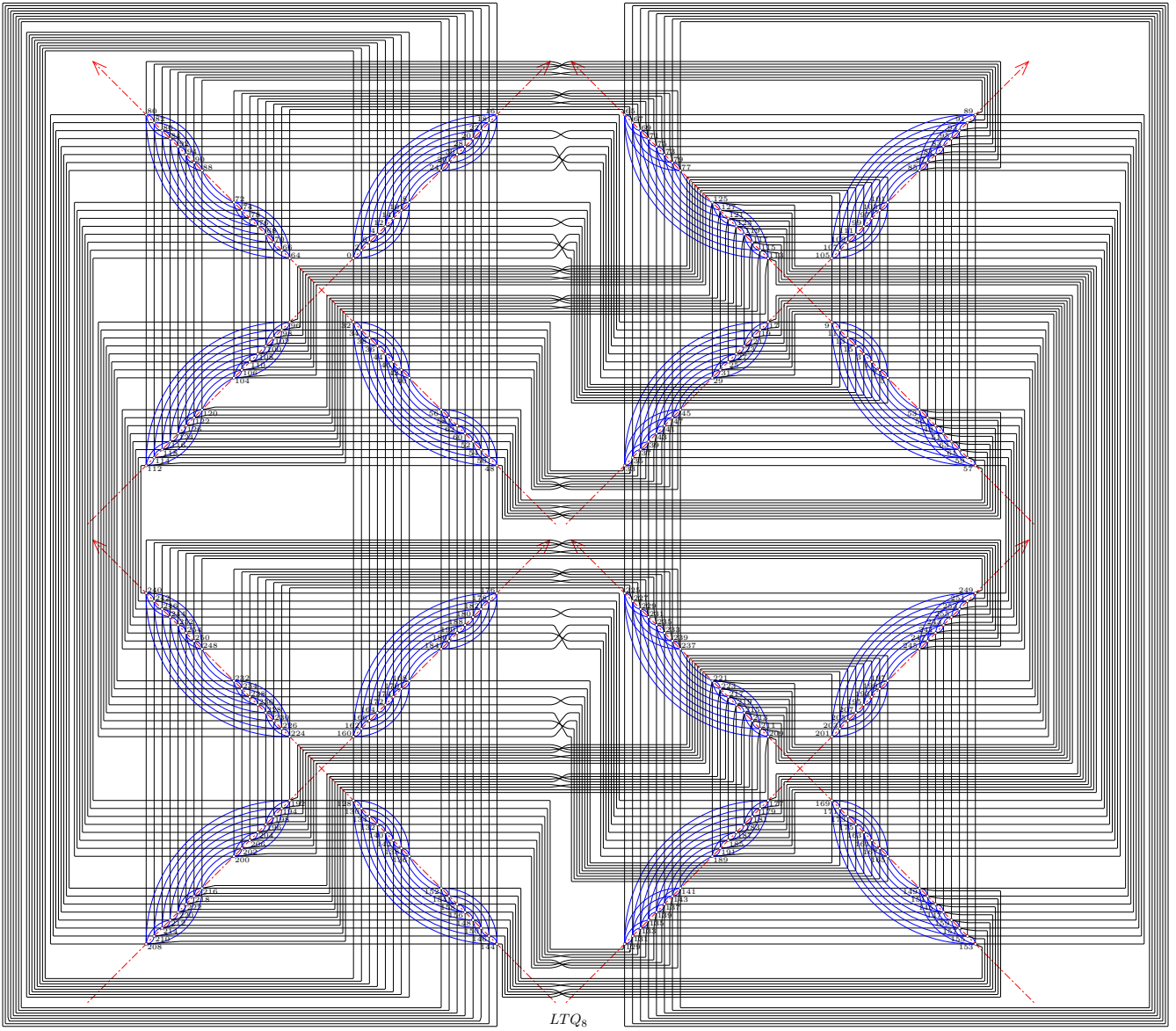

Figure 2.11: The drawing  $D_8$

### 3 Lower bound for $cr(LTQ_n)$

We begin this section with the following observation.

**Observation 3.1.** *Let  $u$  be a vertex of  $LTQ_n$ . For any  $i \in \{1, 2, \dots, n\}$ , there exists exactly one vertex  $u_i \in V(LTQ_n)$  such that  $u$  and  $u_i$  are adjacent with  $\lambda(u, u_i) = i$ .*

Let  $v$  be a vertex of  $LTQ_n$ . Let  $\tau_v : V(LTQ_n) \setminus \{v\} \rightarrow V(LTQ_n)$  be a map defined as follows: for any vertex  $u \in V(LTQ_n) \setminus \{v\}$ , let  $\tau_v(u)$  be the vertex of  $LTQ_n$  such that  $u$  and  $\tau_v(u)$  are adjacent with  $\lambda(u, \tau_v(u)) = \lambda(u, v)$ .

It is easy to see that either  $\tau_v(u) = v$  or  $\lambda(u, v) + 1 \leq \lambda(\tau_v(u), v) \leq n$ . Hence, we can define the following.

**Definition 3.1.** *For any two vertices  $u, v \in V(LTQ_n)$ , let  $\mathcal{P}_{u,v} = (u_0, u_1, \dots, u_\ell)$  be the unique path of  $LTQ_n$  such that  $u_0 = u$ ,  $u_\ell = v$  and  $\tau_v(u_i) = u_{i+1}$  for any  $i \in \{0, 1, \dots, \ell - 1\}$ .*

Note that

$$\lambda(u_0, v) < \lambda(u_1, v) < \dots < \lambda(u_{\ell-1}, v). \quad (5)$$

For any two vertices  $v, w \in V(LTQ_n)$  and integers  $1 \leq t_1 \leq t_2 \leq n$ , let

$$D_v(t_1, t_2) = \{u \in V(LTQ_n) \setminus \{v\} : t_1 \leq \lambda(u, v) \leq t_2\},$$

and let

$$\mathcal{F}(v, w; t_1, t_2) = D_v(t_1, t_2) \cap \{u \in V(LTQ_n) \setminus \{v\} : w \text{ is in } \mathcal{P}_{u,v}\}.$$

**Lemma 3.1.** *Let  $v, w$  be two vertices of  $LTQ_n$ , where  $d = \lambda(w, v)$ . Let  $k$  be an integer such that  $1 \leq k \leq d$ . Then*

$$|\mathcal{F}(v, w; k, d)| = 2^{d-k}.$$

*Proof.* By induction on  $d - k$ . If  $k = d$ , it follows from (5) that  $\mathcal{F}(v, w; d, d) = \{w\}$ , done. Hence, we assume

$$k < d.$$

By (5), we have  $\mathcal{F}(v, w; k, k) = \{u \in D_v(k, k) : \tau_v(u) \in \mathcal{F}(v, w; k + 1, d)\}$ . Combining with Observation 3.1, we conclude that  $|\mathcal{F}(v, w; k, k)| = |\mathcal{F}(v, w; k + 1, d)|$ . It follows from the induction hypothesis that  $|\mathcal{F}(v, w; k, d)| = |\mathcal{F}(v, w; k, k)| + |\mathcal{F}(v, w; k + 1, d)| = 2 \times 2^{d-(k+1)} = 2^{d-k}$ . The lemma follows.  $\square$

We shall introduce the lower bound method proposed by Leighton [13]. Let  $G_1 = (V_1, E_1)$  and  $G_2 = (V_2, E_2)$  be graphs. An embedding of  $G_1$  in  $G_2$  is a couple of mapping  $(\varphi, \kappa)$  satisfying

$$\varphi : V_1 \rightarrow V_2$$

is an injection

$$\kappa : E_1 \rightarrow \{\text{set of all paths in } G_2\},$$

such that if  $uv \in E_1$  then  $\kappa(uv)$  is a path between  $\varphi(u)$  and  $\varphi(v)$ . For any  $e \in E_2$  define

$$cg_e(\varphi, \kappa) = |\{f \in E_1 : e \in \kappa(f)\}|$$

and

$$cg(\varphi, \kappa) = \max_{e \in E_2} \{cg_e(\varphi, \kappa)\}.$$

The value  $cg(\varphi, \kappa)$  is called congestion.

Let  $2K_m$  be the complete multigraph of  $m$  vertices, in which every two vertices are joined by two parallel edges.

**Lemma 3.2.** [13] *Let  $(\varphi, \kappa)$  be an embedding of  $G_1$  in  $G_2$  with congestion  $cg(\varphi, \kappa)$ . Let  $\Delta(G_2)$  denote the maximal degree of  $G_2$ . Then*

$$cr(G_2) \geq \frac{cr(G_1)}{cg^2(\varphi, \kappa)} - \frac{|V_2|}{2} \Delta^2(G_2).$$

According to Erdős [9] and Kainen [12], the following lemmas are held.

**Lemma 3.3.** [9]  $cr(K_{2^n}) \geq \frac{2^n(2^n-1)(2^n-2)(2^n-3)}{80}$ .

**Lemma 3.4.** [12]  $cr(2K_{2^n}) = 4cr(K_{2^n})$ .

Now we are in a position to show the lower bound of  $cr(LTQ_n)$ .

**Theorem 3.1.**  $cr(LTQ_n) > \frac{4^n}{20} - (n^2 + 1)2^{n-1}$ .

*Proof.* By Lemma 3.2, Lemma 3.3 and Lemma 3.4, we need only to construct an embedding  $(\varphi, \kappa)$  of  $2K_{2^n}$  into  $LTQ_n$  with congestion  $cg(\varphi, \kappa)$  at most  $2^n$ . Let  $\varphi$  be an arbitrary bijection of  $V(2K_{2^n})$  onto  $V(LTQ_n)$ . We define the mapping  $\kappa$  as follows. For any two vertices  $u$  and  $v$  of  $LTQ_n$ , take  $\mathcal{P}_{u,v}$  and  $\mathcal{P}_{v,u}$  to be the images (paths) of the two parallel edges between  $\varphi^{-1}(u)$  and  $\varphi^{-1}(v)$  under  $\kappa$ .

Let  $e = xy$  be an arbitrary edge of  $LTQ_n$ , where  $d = \text{Dim}(e)$ . It suffices to show

$$cg_e(\varphi, \kappa) \leq 2^n.$$

Consider first the number of paths  $\mathcal{P}_{u,v}$  traversing  $x$  previous  $y$ , denoted  $p(x, y)$ . Let  $V_{x,y} = \{v \in V(LTQ_n) \setminus \{x\} : \tau_v(x) = y\}$ . Note that

$$p(x, y) = \sum_{v \in V_{x,y}} |\{u \in V(LTQ_n) \setminus \{v\} : x \text{ is in } \mathcal{P}_{u,v}\}|. \quad (6)$$

We see that  $v \in V_{x,y}$  if and only if,

$$\lambda(v, x) = d, \quad (7)$$

or equivalently,

$$\theta_i(v) = \theta_i(x) \text{ for all } i \in \{1, 2, \dots, d-1\} \text{ and } \theta_d(v) = \overline{\theta_d(x)}.$$

This implies that

$$|V_{x,y}| = 2^{n-d}. \quad (8)$$

Combined with (5), (7) and Lemma 3.1, we have that for any  $v \in V_{x,y}$ ,

$$|\{u \in V(LTQ_n) \setminus \{v\} : x \text{ is in } \mathcal{P}_{u,v}\}| = |\mathcal{F}(v, x; 1, d)| = 2^{d-1}. \quad (9)$$

By (6), (8) and (9), we have

$$p(x, y) = 2^{n-1}.$$

Similarly, the number  $p(y, x)$  of paths  $\mathcal{P}_{u,v}$  traversing  $y$  previous  $x$  is  $2^{n-1}$ . Therefore,

$$cg_e(\varphi, \kappa) = p(x, y) + p(y, x) = 2^n.$$

This completes the proof of Theorem 3.1. □

## References

- [1] Ajtai, M., Chvátal, V., Newborn, M., Szemerédi, E.: Crossing-free subgraphs. *Ann. Discrete Math.* **60**, 9–12 (1982)
- [2] Bhatt, S.N., Leighton, F.T.: A framework for solving VLSI graph layout problems. *J. Comput. System Sci.* **28**, 300–343 (1984)
- [3] Bienstock, D.: Some probably hard crossing number problems. *Discrete Comput. Geom.* **6**, 443–459 (1991)
- [4] Dean, A.M., Richter, R.B.: The crossing number of  $C_4 \times C_4$ . *J. Graph Theory* **19**, 125–129 (1995)
- [5] Eggleton, R.B., Guy, R.K.: The crossing number of the n-cube. *Notices Amer. Math. Soc.* **17**, 757 (1970)
- [6] Faria, L., Figueiredo, C.M.H. de: On Eggleton and Guy’s conjectured upper bound for the crossing number of the n-cube. *Math. Slovaca* **50**, 271–287 (2000)
- [7] Faria, L., Figueiredo, C.M.H. de, Sykora, O., Vrt’o, I.: An improved upper bound on the crossing number of the hypercube. *J. Graph Theory* **59**, 145–161 (2008)
- [8] Fiorini, S.: On the crossing number of generalized Petersen graphs. *Ann. Discrete Math.* **30**, 225–242 (1986)
- [9] Erdős, P., Guy, R.K.: Crossing number problems. *Amer. Math. Monthly* **80**, 52–58 (1973)

- [10] Garey, M.R., Johnson, D.S.: Crossing number is NP-complete. *SIAM J. Alg. Disc. Math.* **4**, 312–316 (1983)
- [11] Guy, R.K.: A combinatorial problem. *Nabla(Bull. Malayan Math. Soc.)* **7**, 68–72 (1960)
- [12] Kainen, P.C.: A lower bound for crossing numbers of graphs with applications to  $K_n$ ,  $K_{p,q}$ , and  $Q(d)$ . *J. Combin. Theory Ser. B* **12**, 287–298 (1972)
- [13] Leighton, F.T.: New lower bound techniques for VLSI. *Math. Systems Theory* **17**, 47–70 (1984)
- [14] Leighton, F.T.: *Complexity Issues in VLSI*. Found. Comput. Ser., MIT Press, Cambridge, MA (1983)
- [15] Madej, T.: Bounds for the crossing number of the n-cube. *J. Graph Theory* **15**, 81–97 (1991)
- [16] Matoušek, J.: *Lectures on Discrete Geometry*. New York (2002)
- [17] Pach, J., Sharir, M.: On the number of incidences between points and curves. *Combin. Probab. Comput.* **7**, 121–127 (1998)
- [18] Pach, J., Spencer, J., Tóth, G.: New bounds on crossing numbers. *Discrete Comput. Geom.* **24**, 623–644 (2000)
- [19] Pach, J., Tóth, G.: Thirteen problems on crossing numbers. *Geombinatorics* **9**, 194–207 (2000)
- [20] Pan, S., Richter, R. B.: The crossing number of  $K_{11}$  is 100. *J. Graph Theory* **56**, 128–134 (2007)
- [21] Richter, R.B., Thomassen, C.: Intersections of curve systems and the crossing number of  $C_5 \times C_5$ . *Discrete Comput. Geom.* **13**, 149–159 (1995)
- [22] Salazar, G.: On the crossing numbers of loop networks and generalized Petersen graphs. *Discrete Math.* **302**, 243–253 (2005)
- [23] Shahrokhi, F., Sýkora, O., Székely, L.A., Vrt'o, I.: Crossing numbers: bounds and applications. In: *Intuitive Geometry*. Bólyai Soc. Math. Stud., vol. 6, Akadémiai Kiadó, pp. 179–206 (1997)
- [24] Solymosi, J., Tardos, G., Tóth, Cs.D.: The  $k$  most frequent distances in the plane. *Discrete Comput. Geom.* **28**, 639–648 (2002)
- [25] Solymosi, J., Tóth, Cs.D.: Distinct distances in the plane. *Discrete Comput. Geom.* **25**, 629–634 (2001)
- [26] Sykora, O., Vrt' o, I.: On crossing numbers of hypercubes and cube connected cycles. *BIT* **33**, 232–237 (1993)



- [27] Székely, L.A.: Crossing number is hard Erdős Problem in Discrete geometry. *Combin. Probab. Comput.* **6**, 353–358 (1997)
- [28] Szemerédi, E., Trotter, W.T.: Extremal problems in discrete geometry. *Combinatorica.* **3**, 381–392 (1983)
- [29] Tao, T., Vu, V.: Additive combinatorics. Cambridge University Press (2006)
- [30] Turán, P.: A note of welcome. *J. Graph Theory* **1**, 7–9 (1977)
- [31] Tutte, W.T.: Toward a theory of crossing numbers. *J. Combinatorial Theory* **8**, 45–53 (1970)
- [32] White, A.T., Beineke, L.W.: Topological graph theory. In: *Selected Topics in Graph Theory.* (Beineke, L.W. and Wilson, R.J., eds.), Academic Press, London, pp. 15–49 (1983)
- [33] Yang, X.F., Evans, D.J., Megson, G.M.: The locally twisted cubes. *Int. J. Comput. Math.* **82**, 401–413 (2005)
- [34] Zarankiewicz, K.: On a problem of P. Turán concerning graphs. *Fund. Math.* **41**, 137–145 (1954)