

THE SINE-GORDON EQUATION IN THE SEMICLASSICAL LIMIT: DYNAMICS OF FLUXON CONDENSATES

ROBERT J. BUCKINGHAM AND PETER D. MILLER

ABSTRACT. We study the Cauchy problem for the sine-Gordon equation in the semiclassical limit with pure-impulse initial data of sufficient strength to generate both high-frequency rotational motion near the peak of the impulse profile and also high-frequency librational motion in the tails. We show that for small times independent of the semiclassical scaling parameter, both types of motion are accurately described by explicit formulae involving elliptic functions. These formulae demonstrate consistency with predictions of Whitham's formal modulation theory in both the hyperbolic (modulationally stable) and elliptic (modulationally unstable) cases.

CONTENTS

1. Introduction	2
1.1. Pure impulse initial data for the sine-Gordon equation. Connection to the Zakharov-Shabat scattering problem	6
1.2. Exact solutions. Impulse threshold for generation of rotational waves	9
1.3. Statement of results	11
1.4. Outline of the rest of the paper	15
1.5. Notation and terminology	16
2. Formulation of the Inverse Problem for Fluxon Condensates	16
3. Elementary Transformations of $\mathbf{J}(w)$	21
3.1. Choice of Δ	22
3.2. Interpolation of residues. Removal of poles	22
3.3. Analysis of the jump conditions for $\mathbf{M}(w)$	26
3.4. Control of exponentials. The so-called g -function	31
4. Construction of $g(w)$	33
4.1. Two types of "genus-1" ansatz for $g(w)$	33
4.2. Finding g when $t = 0$	40
4.3. Continuation of g to nonzero t	44
4.4. Solution of the Whitham modulation equations	53
5. Use of $g(w)$	58
5.1. Opening a lens	58
5.2. Construction of a global parametrix	62
5.3. The effect of conjugation. Estimation of the error	69
Appendix A. Proofs of Propositions Concerning Initial Data	73
A.1. Proof of Proposition 1.1	73
A.2. Proof of Proposition 1.2	74
Appendix B. Details of the Outer Parametrix in Cases L and R	75
B.1. The outer parametrix in case L. Proof of Proposition 5.2 in this case	75
B.2. The outer parametrix in case R. Proof of Proposition 5.2 in this case	83
B.3. Recovery of the potentials. Proof of Proposition 5.3	88
References	98

Date: October 28, 2018.

The authors were partially supported by the National Science Foundation under grant DMS-0807653. Additionally, R. J. Buckingham acknowledges the support of the Charles Phelps Taft Research Foundation.

1. INTRODUCTION

The sine-Gordon equation in laboratory coordinates

$$\epsilon^2 u_{tt} - \epsilon^2 u_{xx} + \sin(u) = 0, \quad x \in \mathbb{R}, \quad t > 0, \quad (1.1)$$

is a model for magnetic flux propagation in long superconducting Josephson junctions [22], but perhaps may be most easily thought of as the equation describing mechanical vibrations of a “ribbon” pendulum (the continuum limit of a system of linearly arranged co-axial pendula with nearest-neighbor torsion coupling). These and other applications are discussed in detail in the review article [3]. The correct Cauchy problem for this equation involves determining the solution consistent with the given initial data

$$u(x, 0) = F(x) \quad \text{and} \quad \epsilon u_t(x, 0) = G(x). \quad (1.2)$$

Here $F(x)$ and $G(x)$ are independent of the fixed parameter ϵ . This Cauchy problem is globally well-posed [4]: if $p \geq 1$ and F , F' , and G are functions in $L^p(\mathbb{R})$ then there is a unique solution with u , u_x , and u_t all lying in $L^\infty_{\text{loc}}(\mathbb{R}_+; L^p(\mathbb{R}))$. Moreover if the initial data have one more L^p derivative, so that F'' and G' are functions in $L^p(\mathbb{R})$, then this further regularity is preserved as well so that u_{xx} and u_{tx} lie in $L^\infty_{\text{loc}}(\mathbb{R}_+; L^p(\mathbb{R}))$. These well-posedness results also hold in a slightly modified form when the initial displacement has nonzero asymptotic values: $F(x) \rightarrow 2\pi n_\pm$, $n_\pm \in \mathbb{Z}$, as $x \rightarrow \pm\infty$. In this case the topological charge $n_+ - n_-$ is preserved for all time in the solution u .

If suitable initial conditions F and G are fixed, one may therefore in principle construct the unique global solution $u(x, t)$ of (1.1) subject to (1.2) for each positive ϵ . Our interest is in the asymptotic behavior of this family of global solutions in the *semiclassical limit* $\epsilon \rightarrow 0$. The well-known elementary excitations of the sine-Gordon equation include solitons of kink (or antikink) and breather type; these have a width proportional to ϵ while the length scales in the initial conditions (1.2) are independent of ϵ . This suggests that when $\epsilon \ll 1$ the initial conditions of the system can be viewed as preparing a “condensate” whose ultimate breakup will liberate approximately $1/\epsilon$ fundamental particles.

The decay process will take some time to become complete, and during the intermediate stages one may expect that some solitons may partially emerge from the condensate moving with nearly identical velocities, thus forming a modulated wavetrain. The simplest models for these wavetrains are the periodic (modulo 2π) traveling wave exact solutions of (1.1) of the form

$$u(x, t) = U \left(\frac{\Phi(x, t)}{\epsilon} \right), \quad U(\zeta + 2\pi) = U(\zeta) \pmod{2\pi}, \quad \Phi(x, t) = kx - \omega t, \quad (1.3)$$

where k is the *wavenumber* and ω the *frequency* of the wavetrain. With this substitution, the sine-Gordon equation reduces to an ordinary differential equation that can be integrated once to

$$\frac{1}{2}(\omega^2 - k^2) \left(\frac{dU}{d\zeta} \right)^2 - \cos(U) = \mathcal{E} \quad (1.4)$$

where \mathcal{E} is an integration constant having the interpretation of *energy*. There are four types of solutions subject to the periodicity condition:

- *Superluminal librational wavetrains* correspond to $\omega^2 > k^2$ and $|\mathcal{E}| < 1$. From a phase portrait it is evident that $U(\zeta + 2\pi) = U(\zeta)$ if the nonlinear dispersion relation

$$\omega^2 - k^2 = 2\pi^2 \left[\int_{-\cos^{-1}(-\mathcal{E})}^{+\cos^{-1}(-\mathcal{E})} \frac{d\phi}{\sqrt{\cos(\phi) + \mathcal{E}}} \right]^{-2} \quad (1.5)$$

is satisfied, and then U oscillates about a mean value of $U = 0 \pmod{2\pi}$ with an amplitude strictly less than π .

- *Subluminal librational wavetrains* correspond to $\omega^2 < k^2$ and $|\mathcal{E}| < 1$. From a phase portrait it is evident that $U(\zeta + 2\pi) = U(\zeta)$ if the nonlinear dispersion relation

$$\omega^2 - k^2 = -2\pi^2 \left[\int_{-\cos^{-1}(\mathcal{E})}^{+\cos^{-1}(\mathcal{E})} \frac{d\phi}{\sqrt{\cos(\phi) - \mathcal{E}}} \right]^{-2} \quad (1.6)$$

is satisfied, and then U oscillates about a mean value of $U = \pi \pmod{2\pi}$ with an amplitude strictly less than π .

- *Superluminal rotational wavetrains* correspond to $\omega^2 > k^2$ and $\mathcal{E} > 1$. Here the phase portrait indicates that $U(\zeta + 2\pi) = U(\zeta) \pm 2\pi$ if the nonlinear dispersion relation

$$\omega^2 - k^2 = 8\pi^2 \left[\int_{-\pi}^{\pi} \frac{d\phi}{\sqrt{\cos(\phi) + \mathcal{E}}} \right]^{-2} \quad (1.7)$$

is satisfied, with $U'(\zeta)$ strictly nonzero being largest in magnitude when $\zeta = 0 \pmod{2\pi}$.

- *Subluminal rotational wavetrains* correspond to $\omega^2 < k^2$ and $\mathcal{E} < -1$. Here the phase portrait indicates that $U(\zeta + 2\pi) = U(\zeta) \pm 2\pi$ if the nonlinear dispersion relation

$$\omega^2 - k^2 = -8\pi^2 \left[\int_{-\pi}^{\pi} \frac{d\phi}{\sqrt{\cos(\phi) - \mathcal{E}}} \right]^{-2} \quad (1.8)$$

is satisfied, with $U'(\zeta)$ strictly nonzero being largest in magnitude when $\zeta = \pi \pmod{2\pi}$.

In the classical mechanics literature [13] the term *libration* is used to characterize the kind of motion in which both position and momentum are periodic functions while the term *rotation* is used to characterize motions in which momentum is periodic but position is not because the momentum has a nonzero average value. Furthermore, the dichotomy of subluminal waves versus superluminal waves is important because the sine-Gordon equation is strictly hyperbolic with characteristic velocities $v_p = \pm 1$; thus subluminal waves have phase velocities bounded in magnitude by the characteristic velocity, while superluminal waves move faster than the (unit) characteristic speed. In the superluminal (respectively, subluminal) case, the energy value of $\mathcal{E} = 1$ (respectively, $\mathcal{E} = -1$) corresponds to the separatrix in the phase portrait of the simple pendulum, at which point the period (respectively, wavelength) of the waves tends to infinity. In this limit, each of the four types of wavetrain degenerates into a train of well-separated kink-type solitons; for rotational waves the kinks all have the same topological charge, while for librational waves the pulses alternate from kink to antikink for zero net charge.

In a body of work beginning with his seminal 1965 paper [24], Whitham developed a nonlinear theory of modulated wavetrains. The main idea in the current context is that one seeks solutions of the sine-Gordon equation (1.1) of the approximate form

$$u(x, t) = U \left(\frac{\Phi(x, t)}{\epsilon} \right) + \mathcal{O}(\epsilon) \quad (1.9)$$

over space and time intervals of $\mathcal{O}(1)$ length, where two essential changes are made in the leading term:

- (1) The parameters k , ω , and \mathcal{E} are no longer taken as constant, but are allowed to depend on (x, t) as long as the appropriate nonlinear dispersion relation is satisfied pointwise, and
- (2) The phase $\Phi(x, t)$ is replaced with a general (nonlinear) function of (x, t) and the local wavenumber and frequency are derived therefrom by the relations

$$k(x, t) := \frac{\partial \Phi}{\partial x} \quad \text{and} \quad \omega(x, t) := -\frac{\partial \Phi}{\partial t}. \quad (1.10)$$

By consistency, the definition (1.10) imposes that k and ω are necessarily linked by

$$\frac{\partial k}{\partial t} + \frac{\partial \omega}{\partial x} = 0, \quad (1.11)$$

an equation that expresses *conservation of waves*. It then follows that for the error term in (1.9) to remain $\mathcal{O}(\epsilon)$ formally, one additional partial differential equation on k , ω , and \mathcal{E} , only two of which are independent due to the nonlinear dispersion relation, is required to hold. This equation may be derived by many different methods. Perhaps the most direct in this context is to appeal to an averaged variational principle [25]. The sine-Gordon equation (1.1) is the Euler-Lagrange equation for the variational principle:

$$\frac{\delta}{\delta u} \iint L[u] dx dt = 0 \implies \epsilon^2 u_{tt} - \epsilon^2 u_{xx} + \sin(u) = 0 \quad (1.12)$$

where the Lagrangian density is

$$L[u] := \frac{1}{2} \epsilon^2 u_t^2 - \left[\frac{1}{2} \epsilon^2 u_x^2 - \cos(u) \right] \quad (1.13)$$

having the interpretation of the difference between kinetic and potential energy densities. The procedure is to substitute the exact wavetrain into L , using the differential equation (1.4) satisfied by U to simplify the resulting expression:

$$L \left[U \left(\frac{kx - \omega t}{\epsilon} \right) \right] = \frac{1}{2}(\omega^2 - k^2)U'(\zeta)^2 + \cos(U(\zeta)) = 2(\mathcal{E} + \cos(U(\zeta))) - \mathcal{E}, \quad (1.14)$$

where for the exact solution $\epsilon\zeta = kx - \omega t$. This expression is periodic in ζ with period 2π , so one may define its period average as

$$\langle L \rangle := \frac{1}{\pi} \int_{-\pi}^{+\pi} (\mathcal{E} + \cos(U(\zeta))) d\zeta - \mathcal{E}. \quad (1.15)$$

An exact expression for $U(\zeta)$ is not necessary; using the differential equation (1.4), a shifted version of U may be used as the integration variable although the details are slightly different in the four cases; defining integrals

$$I_{\text{L}}(\mathcal{E}) := \frac{\sqrt{2}}{\pi} \int_{-\cos^{-1}(\mathcal{E})}^{+\cos^{-1}(\mathcal{E})} \sqrt{\cos(\phi) - \mathcal{E}} d\phi > 0, \quad -1 < \mathcal{E} < 1, \quad (1.16)$$

and

$$I_{\text{R}}(\mathcal{E}) := \frac{1}{\sqrt{2}\pi} \int_{-\pi}^{\pi} \sqrt{\cos(\phi) - \mathcal{E}} d\phi > 0, \quad \mathcal{E} < -1, \quad (1.17)$$

and noting for future reference that

$$I_{\text{L}}''(\mathcal{E}) > 0 \text{ for } -1 < \mathcal{E} < 1 \text{ while } I_{\text{R}}''(\mathcal{E}) < 0 \text{ for } \mathcal{E} < -1, \quad (1.18)$$

the result is that

$$\langle L \rangle = J(\mathcal{E})\mu\sqrt{|\omega^2 - k^2|} - \mathcal{E} \quad (1.19)$$

where $\mu = \text{sgn}(\omega^2 - k^2)$ distinguishes the superluminal and subluminal cases, and where

$$J(\mathcal{E}) := I_{\text{L}}(-\mu\mathcal{E}) \quad \text{or} \quad J(\mathcal{E}) := I_{\text{R}}(-\mu\mathcal{E}) \quad (1.20)$$

depending on whether we are considering librational or rotational wavetrains, respectively. One then substitutes $k = \theta_x$ and $\omega = -\theta_t$ and formulates the *averaged variational principle*:

$$\frac{\delta}{\delta\mathcal{E}} \iint \langle L \rangle dx dt = 0 \quad \text{and} \quad \frac{\delta}{\delta\theta} \iint \langle L \rangle dx dt = 0. \quad (1.21)$$

The first of these two equations reproduces in each case the corresponding nonlinear dispersion relation (1.5)–(1.8) in the form

$$\frac{\partial \langle L \rangle}{\partial \mathcal{E}} = J'(\mathcal{E})\mu\sqrt{|\omega^2 - k^2|} - 1 = 0. \quad (1.22)$$

The second is a first-order partial differential equation:

$$\frac{\partial}{\partial t} \left[-\frac{\partial \langle L \rangle}{\partial \omega} \right] + \frac{\partial}{\partial x} \left[\frac{\partial \langle L \rangle}{\partial k} \right] = 0. \quad (1.23)$$

This equation together with (1.11) and the nonlinear dispersion relation (1.22) to eliminate one of the three variables yields a closed system of equations to determine these fields as functions of (x, t) . From the exposition in [22] one learns to appreciate the utility of taking \mathcal{E} and the *phase velocity*

$$v_{\text{p}} := \frac{\omega}{k} \quad (1.24)$$

as the two unknowns, and thus the calculations go as follows. Clearly, one has

$$-\frac{\partial \langle L \rangle}{\partial \omega} = -\frac{\omega J(\mathcal{E})}{\sqrt{|\omega^2 - k^2|}} \quad \text{and} \quad \frac{\partial \langle L \rangle}{\partial k} = -\frac{k J(\mathcal{E})}{\sqrt{|\omega^2 - k^2|}}. \quad (1.25)$$

Using $\omega = v_{\text{p}}k$ together with the nonlinear dispersion relation in the form (1.22) shows that k and ω may be eliminated in favor of v_{p} and \mathcal{E} :

$$k = \frac{\sigma\mu}{J'(\mathcal{E})\sqrt{|v_{\text{p}}^2 - 1|}} \quad \text{and} \quad \omega = v_{\text{p}}k = \frac{\sigma\mu v_{\text{p}}}{J'(\mathcal{E})\sqrt{|v_{\text{p}}^2 - 1|}}, \quad (1.26)$$

where $\sigma = \pm 1$ is an arbitrary sign whose role is to select different branches of the dispersion relation. Therefore, the variational modulation equation (1.23) becomes

$$\frac{\partial}{\partial t} \left[\frac{v_p J(\mathcal{E})}{\sqrt{|v_p^2 - 1|}} \right] + \frac{\partial}{\partial x} \left[\frac{J(\mathcal{E})}{\sqrt{|v_p^2 - 1|}} \right] = 0 \quad (1.27)$$

and the conservation of waves equation (1.11) becomes

$$\frac{\partial}{\partial t} \left[\frac{1}{J'(\mathcal{E})\sqrt{|v_p^2 - 1|}} \right] + \frac{\partial}{\partial x} \left[\frac{v_p}{J'(\mathcal{E})\sqrt{|v_p^2 - 1|}} \right] = 0 \quad (1.28)$$

(the sign $\sigma = \pm 1$ drops out in each case). An application of the chain rule puts the system in the form

$$\frac{\partial}{\partial t} \begin{bmatrix} v_p \\ \mathcal{E} \end{bmatrix} + \frac{1}{\mathcal{V}(v_p, \mathcal{E})} \begin{bmatrix} v_p [J(\mathcal{E})J''(\mathcal{E}) + J'(\mathcal{E})^2] & (1 - v_p^2)^2 J'(\mathcal{E})J''(\mathcal{E}) \\ -J(\mathcal{E})J'(\mathcal{E}) & v_p [J(\mathcal{E})J''(\mathcal{E}) + J'(\mathcal{E})^2] \end{bmatrix} \frac{\partial}{\partial x} \begin{bmatrix} v_p \\ \mathcal{E} \end{bmatrix} = \mathbf{0} \quad (1.29)$$

where

$$\mathcal{V}(v_p, \mathcal{E}) := J(\mathcal{E})J''(\mathcal{E}) + v_p^2 J'(\mathcal{E})^2. \quad (1.30)$$

Thus the dependence on the sign $\mu = \pm 1$ also disappears except from within the definition (1.20) of $J(\mathcal{E})$. Actually, this system as written has an apparent singularity if v_p blows up as can happen in the superluminal cases when the wavenumber k vanishes. In these cases it is better to introduce the *reciprocal phase velocity*

$$n_p := \frac{1}{v_p} \quad (1.31)$$

and then in the overlap region where neither v_p nor n_p vanishes, (1.29) takes the form

$$\frac{\partial}{\partial t} \begin{bmatrix} n_p \\ \mathcal{E} \end{bmatrix} + \frac{1}{\mathcal{N}(n_p, \mathcal{E})} \begin{bmatrix} n_p [J(\mathcal{E})J''(\mathcal{E}) + J'(\mathcal{E})^2] & -(1 - n_p^2)^2 J'(\mathcal{E})J''(\mathcal{E}) \\ J(\mathcal{E})J'(\mathcal{E}) & n_p [J(\mathcal{E})J''(\mathcal{E}) + J'(\mathcal{E})^2] \end{bmatrix} \frac{\partial}{\partial x} \begin{bmatrix} n_p \\ \mathcal{E} \end{bmatrix} = \mathbf{0} \quad (1.32)$$

where

$$\mathcal{N}(n_p, \mathcal{E}) := n_p^2 J(\mathcal{E})J''(\mathcal{E}) + J'(\mathcal{E})^2. \quad (1.33)$$

This latter form of the Whitham modulation equations has no apparent singularity when $n_p \rightarrow 0$ corresponding to $v_p \rightarrow \infty$.

The characteristic velocities $c = c_j$, $j = 0, 1$, are the eigenvalues of the coefficient matrix of x -derivatives and therefore are the roots of the quadratic equation

$$(v_p [J(\mathcal{E})J''(\mathcal{E}) + J'(\mathcal{E})^2] - \mathcal{V}(v_p, \mathcal{E})c)^2 + (1 - v_p^2)^2 J(\mathcal{E})J'(\mathcal{E})^2 J''(\mathcal{E}) = 0 \quad (1.34)$$

or, equivalently as the coefficient matrices in (1.29) and (1.32) are similar,

$$(n_p [J(\mathcal{E})J''(\mathcal{E}) + J'(\mathcal{E})^2] - \mathcal{N}(n_p, \mathcal{E})c)^2 + (1 - n_p^2)^2 J(\mathcal{E})J'(\mathcal{E})^2 J''(\mathcal{E}) = 0. \quad (1.35)$$

Since $\mathcal{V}(v_p, \mathcal{E})$ and $\mathcal{N}(n_p, \mathcal{E})$ are real the Whitham modulation system in either form (1.29) or (1.32) is hyperbolic (corresponding to real and distinct characteristic velocities) if and only if $J(\mathcal{E})J''(\mathcal{E}) < 0$. Using (1.20) and (1.18) then shows that the Whitham systems governing modulations of rotational waves (both types, superluminal and subluminal) are hyperbolic, while those governing librational waves (again, both types) are elliptic. The Whitham modulation theory has been generalized to handle modulated *multiphase* waves [12, 10, 11] having any number of 2π -periodic phase variables; however the full implications of the resulting modulation equations generalizing (1.32) have apparently only been understood for waves with a maximum of two phases.

The Whitham modulation theory makes predictions of so-called ‘‘modulational stability’’ of wavetrains on the basis of whether the quasilinear system of modulation equations is hyperbolic (modulationally stable) or elliptic (modulationally unstable). One should think of modulational stability as linear (neutral) stability of perturbations to the wavetrain that have similar characteristic wavelengths and periods to the unperturbed exact wavetrain solution. Thus, hyperbolicity of the modulation equations suggests the absence of a ‘‘slow’’ sideband instability, but does not necessarily rule out instabilities to perturbations with wavenumbers far from the unperturbed wavenumber k or even sideband instabilities with exponential growth rates that are

far from the unperturbed frequency ω . Among the candidate wavetrain types for stability of the linearized equation

$$\epsilon^2 v_{tt} - \epsilon^2 v_{xx} + \cos\left(U\left(\frac{kx - \omega t}{\epsilon}\right)\right) v = 0 \quad (1.36)$$

(in the sense of a $L^2(\mathbb{R})$ estimate on v and ϵv_t that depends on initial data but is independent of t) there are thus only the subluminal and superluminal rotational wavetrains. It is not difficult to believe that the superluminal rotational wavetrains are linearly unstable, since in the limiting case of $k = 0$ and $\mathcal{E} \downarrow 1$ one obtains an orbit homoclinic to the exact constant solution $u(x, t) \equiv (2m + 1)\pi$, $m \in \mathbb{Z}$ which is obviously unstable to small spatially constant perturbations. Indeed, such perturbations cause all of the vertical pendula to “drop” simultaneously; the growth rate of the perturbation is clearly large compared to the zero frequency of the unperturbed solution explaining why the instability is not captured by Whitham theory. The definitive statement in the literature [21] is that the subluminal rotational wavetrains are indeed linearly stable (and the only stable type among the four types of traveling waves), although we have not been able to verify the line of argument in all details (it is not clear to us from the proof that the stable solutions obtained in the case of subluminal rotational wavetrains form a basis of $L^2(\mathbb{R})$, or that the exponentially growing solutions obtained in the other three cases are relevant as they appear to be unbounded in x).

In this paper, we will analyze the Cauchy problem for (1.1) with initial data F and G independent of ϵ , in the semiclassical limit $\epsilon \rightarrow 0$. We will show that for a general class of “pure impulse” initial data, most of the real x -axis is occupied for small time (independent of ϵ) by modulated superluminal wavetrains of either rotational or librational types. This result shows the relevance of the Whitham modulation theory even in some cases when it results in elliptic modulation equations. (In a forthcoming paper [5] we will show that the remaining part of the x -axis is occupied by more complicated oscillations that nonetheless have a certain universal form for t small.)

1.1. Pure impulse initial data for the sine-Gordon equation. Connection to the Zakharov-Shabat scattering problem. Equation (1.1) is the compatibility condition for the Lax pair

$$4i\epsilon \mathbf{v}_x = \begin{bmatrix} 4E(w) - \frac{i}{\sqrt{-w}}(1 - \cos(u)) & \frac{i}{\sqrt{-w}} \sin(u) - i\epsilon(u_x + u_t) \\ \frac{i}{\sqrt{-w}} \sin(u) + i\epsilon(u_x + u_t) & -4E(w) + \frac{i}{\sqrt{-w}}(1 - \cos(u)) \end{bmatrix} \mathbf{v}, \quad (1.37)$$

$$4i\epsilon \mathbf{v}_t = \begin{bmatrix} 4D(w) + \frac{i}{\sqrt{-w}}(1 - \cos(u)) & -\frac{i}{\sqrt{-w}} \sin(u) - i\epsilon(u_x + u_t) \\ -\frac{i}{\sqrt{-w}} \sin(u) + i\epsilon(u_x + u_t) & -4D(w) - \frac{i}{\sqrt{-w}}(1 - \cos(u)) \end{bmatrix} \mathbf{v}, \quad (1.38)$$

where

$$E(w) := \frac{i}{4} \left[\sqrt{-w} + \frac{1}{\sqrt{-w}} \right] \quad \text{and} \quad D(w) := \frac{i}{4} \left[\sqrt{-w} - \frac{1}{\sqrt{-w}} \right], \quad (1.39)$$

and $w \in \mathbb{C} \setminus \mathbb{R}_+$ is the spectral parameter. *Here and throughout this paper, the radical refers to the principal branch of the square root.* Analysis of the Cauchy problem for (1.1) posed with initial data (1.2) may be carried out in some detail by means of the inverse scattering transform based on the differential equation (1.37), the so-called Faddeev-Takhtajan eigenvalue problem. A self-contained account of this analysis can be found in our paper [4], where the spectral parameter $z = i\sqrt{-w}$ is used; the utility of w is related to an even symmetry of the spectrum in the z -plane.

By *pure impulse* initial data we simply mean data for which the initial displacement $F(x)$ vanishes identically. An elementary observation is that if $F(x) \equiv 0$, then for $t = 0$ the Faddeev-Takhtajan eigenvalue problem reduces to the Zakharov-Shabat eigenvalue problem:

$$\epsilon \mathbf{v}_x = \begin{bmatrix} -i\lambda & \psi(x) \\ -\psi(x)^* & i\lambda \end{bmatrix} \mathbf{v}, \quad \psi(x) := -\frac{1}{4}G(x), \quad \lambda := E(w). \quad (1.40)$$

This is the eigenvalue problem in the Lax pair for the sine-Gordon equation in characteristic coordinates and the cubic focusing nonlinear Schrödinger equations. Although when viewed as an eigenvalue problem of the form $\mathcal{L}\mathbf{v} = \lambda\mathbf{v}$ the operator \mathcal{L} is nonselfadjoint, several useful facts are known about the spectrum of \mathcal{L} in the case relevant here that $\psi(x)$ is real. It is easy to see that for real ψ the discrete spectrum comes in

quartets symmetric with respect to the involutions $\lambda \mapsto \lambda^*$ and $\lambda \mapsto -\lambda$. Moreover, Klaus and Shaw [15] have proved that if $\psi \in L^1(\mathbb{R}) \cap C^1(\mathbb{R})$ is real, of one sign, and has a single critical point (so that the graph of $|\psi(x)|$ is “bell-shaped”), then the discrete spectrum is purely imaginary and nondegenerate.

In the context of pure impulse initial data for which G is a nonpositive (without loss of generality) function of Klaus-Shaw type, the necessarily purely imaginary eigenvalues λ may be approximated by a formal WKB method applicable when $\epsilon \ll 1$. The result of this analysis is that with the Klaus-Shaw function $G(x)$ one associates the WKB phase integral

$$\Psi(\lambda) := \frac{1}{4} \int_{x_-(\lambda)}^{x_+(\lambda)} \sqrt{G(s)^2 + 16\lambda^2} ds, \quad 0 < y := -i\lambda < \max_{x \in \mathbb{R}} \left(-\frac{1}{4}G(x) \right), \quad (1.41)$$

where $x_-(\lambda) < x_+(\lambda)$ are the two roots of $G(s)^2 + 16\lambda^2$ when λ is as indicated. Then one defines approximate eigenvalues λ_k^0 by the Bohr-Sommerfeld quantization rule

$$\Psi(\lambda_k^0) = \pi \epsilon \left(k + \frac{1}{2} \right), \quad k = 0, 1, 2, \dots, N(\epsilon) - 1, \quad (1.42)$$

where the asymptotic number of eigenvalues on the positive imaginary axis is

$$N(\epsilon) = \left\lfloor \frac{1}{2} + \frac{1}{4\pi\epsilon} \|G\|_1 \right\rfloor, \quad (1.43)$$

where $\|\cdot\|_1$ denotes the standard $L^1(\mathbb{R})$ norm. To each simple eigenvalue λ of the Zakharov-Shabat eigenvalue problem (1.40) there corresponds a *proportionality constant* γ relating the solution having normalized decaying asymptotics as $x \rightarrow -\infty$ with the solution having normalized decaying asymptotics as $x \rightarrow +\infty$. If G is a real even function of x , then one can show by symmetry that $\gamma = \pm 1$, and WKB theory for Klaus-Shaw potentials suggests that the proportionality constants alternate in sign along the imaginary axis. Thus for even G , to the approximate eigenvalue λ_k^0 we associate the approximate proportionality constant γ_k^0 given by

$$\gamma_k^0 := (-1)^{k+1}, \quad k = 0, 1, 2, \dots, N(\epsilon) - 1, \quad \text{for even } G. \quad (1.44)$$

The final ingredient of the scattering data for G in the Zakharov-Shabat problem (1.40) is the reflection coefficient defined for real λ . According to the WKB approximation, the reflection coefficient is small pointwise for $\lambda \neq 0$ when $\epsilon \ll 1$.

In this paper, we study even, pure impulse initial data of Klaus-Shaw type for the sine-Gordon equation (1.1). Thus we assume

Assumption 1.1. *The initial conditions (1.2) for (1.1) satisfy $F(x) \equiv 0$.*

Assumption 1.2. *In the initial condition (1.2) for ϵu_t , the function $G(x)$ is a nonpositive function of Klaus-Shaw type, that is, $G \in L^1(\mathbb{R}) \cap C^1(\mathbb{R})$ and G has a unique local (and global) minimum.*

Assumption 1.3. *The function G is even in x : $G(-x) = G(x)$, placing the unique minimum of G at $x = 0$.*

Note that under Assumptions 1.2 and 1.3, G restricted to \mathbb{R}_+ has a unique inverse function $G^{-1} : (G(0), 0) \rightarrow \mathbb{R}_+$, and in terms of it we may rewrite the WKB phase integral in the form

$$\Psi(\lambda) = \frac{1}{2} \int_0^{G^{-1}(-v)} \sqrt{G(s)^2 - v^2} ds, \quad \lambda = \frac{iv}{4}, \quad 0 < v < -G(0). \quad (1.45)$$

Thus, $\Psi(iv/4)$ defined on $(0, -G(0))$ is an Abel-type integral transform of the nondecreasing function $G(x) < 0$ defined on \mathbb{R}_+ .

Proposition 1.1. *On its range, the inverse of the transform (1.45) is given by the formula*

$$G^{-1}(w) = -\frac{4}{\pi} \int_{-w}^{-G(0)} \frac{\varphi(v) dv}{\sqrt{v^2 - w^2}}, \quad G(0) < w < 0, \quad (1.46)$$

where

$$\varphi(v) := \frac{d}{dv} \Psi(\lambda), \quad \lambda = \frac{iv}{4}. \quad (1.47)$$

The proof of this proposition is a rather straightforward application of Fubini's Theorem and is given in Appendix A.

We will require that the WKB phase integral have certain analyticity properties to be outlined in Proposition 1.2 below. We now make an assumption on G that will be sufficient to establish Proposition 1.2 and that can easily be checked for a given G :

Assumption 1.4. *The function G is strictly increasing and real-analytic at each $x > 0$, and the positive and real-analytic function*

$$\mathcal{G}(m) := \frac{\sqrt{m}\sqrt{G(0)^2 - m}}{2G'(G^{-1}(-\sqrt{m}))}, \quad 0 < m < G(0)^2 \quad (1.48)$$

can be analytically continued to neighborhoods of $m = 0$ and $m = G(0)^2$, with $\mathcal{G}(0) > 0$ and $\mathcal{G}(G(0)^2) > 0$.

We point out that the class of functions $\mathcal{G}(m)$ satisfying Assumption 1.4 obviously parametrizes a corresponding class of admissible functions $G(x)$ by simply viewing (1.48) as an equation to be solved for $x = G^{-1}$ given \mathcal{G} . The solution is:

$$x = \int_{G^2}^{G(0)^2} \frac{\mathcal{G}(m) dm}{m\sqrt{G(0)^2 - m}}. \quad (1.49)$$

For example, the function $\mathcal{G}(m) \equiv C > 0$ clearly satisfies the analyticity and positivity conditions on \mathcal{G} listed in Assumption 1.4, and in this case the integral in (1.49) can be evaluated in terms of elementary functions and the resulting function $x = G^{-1}(G)$ can be inverted to yield

$$G = G(0) \operatorname{sech} \left(\frac{G(0)}{2C} x \right), \quad (1.50)$$

perhaps the simplest example of an admissible initial condition.

Proposition 1.2. *Suppose that Assumptions 1.2–1.4 hold. Then the function $\Psi(\lambda)$ defined by (1.45) for $\lambda = iv/4$ and $0 < v < -G(0)$ is positive and strictly decreasing (to zero) in v . Furthermore, Ψ is real-analytic for $0 < v < -G(0)$ and has an analytic continuation to neighborhoods of $v = 0$ and $v = -G(0)$, for which*

$$\Psi(\lambda) = 0 \quad \text{and} \quad \frac{d}{dv} \Psi(\lambda) < 0, \quad \text{for } \lambda = -iG(0)/4, \quad (1.51)$$

and, for some $\delta > 0$,

$$\Psi(\lambda) = \frac{1}{4} \|G\|_1 + i\alpha\lambda + \sum_{n=1}^{\infty} \beta_n \lambda^{2n}, \quad |\lambda| < \delta \quad (1.52)$$

where $\alpha > 0$ and $\beta_n \in \mathbb{R}$ for all n .

We provide the proof of this statement in Appendix A. In particular, Proposition 1.2 guarantees the existence of a simply-connected open set $\Xi \subset \mathbb{C}$ containing the closed imaginary interval $0 \leq -4i\lambda \leq -G(0)$ in which $\Psi(\lambda)$ may be considered as a holomorphic function of λ whose restriction to that interval is a real-valued function given by (1.41). By Schwartz reflection we therefore will have

$$\Psi(-\lambda^*) = \Psi(\lambda)^*, \quad \lambda \in \Xi, \quad -\lambda^* \in \Xi, \quad (1.53)$$

which also shows that without loss of generality we may simply take Ξ to be symmetric with respect to reflection through the imaginary axis. By the strict monotonicity and reality of $\Psi(\lambda)$ for $0 \leq -4i\lambda \leq -G(0)$ it follows from the Cauchy-Riemann equations that there exists some positive number $\delta_1 < \delta$ such that for λ in the open rectangle $D_+ := \{\lambda \in \Xi, 0 < \Re\{\lambda\} < \delta_1, 0 < \Im\{\lambda\} < -G(0)/4\}$ the inequality $\Im\{\Psi(\lambda)\} > 0$ holds, with the strict inequality failing only as λ approaches the imaginary axis. According to (1.53), if $\lambda \in D_- := -D_+^*$, then $\Im\{\Psi(\lambda)\} < 0$.

Our analysis will require an assumption about $\epsilon > 0$:

Assumption 1.5. *The small number ϵ lies in the infinite sequence*

$$\epsilon = \epsilon_N := \frac{\|G\|_1}{4\pi N}, \quad N = 1, 2, 3, \dots \quad (1.54)$$

For such ϵ we have from (1.43) that $N(\epsilon) = N$.

Clearly, according to (1.52), Assumption 1.5 implies that

$$\frac{\Psi(0)}{\epsilon_N} = \pi N, \quad N = 1, 2, 3, \dots \quad (1.55)$$

Also, according to WKB theory, another implication of Assumption 1.5 is that the reflection coefficient is *uniformly* small for $\lambda \in \mathbb{R}$, *i.e.* the choice (1.54) makes the reflection coefficient negligible in a neighborhood of $\lambda = 0$.

In fact, our strategy will be to replace the scattering data corresponding to initial data of the above type with its WKB approximation, admittedly an *ad hoc* step, and then to carry out rigorous analysis of the inverse-scattering problem in the limit $\epsilon \rightarrow 0$. The sequence of exact solutions of (1.1) generated by the spectral approximation procedure and indexed by $N = 1, 2, 3, \dots$ is an example of a semiclassical soliton ensemble in the sense of [18]. In the context of the sine-Gordon equation and its application to superconducting Josephson junctions we will call this sequence $\{u_N(x, t)\}$ of exact solutions the *fluxon condensate* associated with the impulse profile $G(x)$. The accuracy of this procedure for studying the Cauchy problem is suggested by the fact that the fluxon condensate recovers the initial data at $t = 0$ to within an error of $\mathcal{O}(\epsilon)$ (see Corollary 1.1 below). Also, there exist special cases for which the fluxon condensate represents the *exact* solution of the Cauchy problem when ϵ lies in the sequence $\epsilon = \epsilon_N$ (see (1.54)), giving further justification to the procedure.

1.2. Exact solutions. Impulse threshold for generation of rotational waves. If furthermore we suppose that the sine-Gordon system (1.1) on \mathbb{R} is set into motion at $t = 0$ by pure impulse initial data of the special form

$$F(x) \equiv 0 \quad \text{and} \quad G(x) = -4A \operatorname{sech}(x) \quad (1.56)$$

for some $A > 0$, the Zakharov-Shabat problem reduces further to a special case that was studied by Satsuma and Yajima [20]. From their work it follows that if $\epsilon = \epsilon_N := A/N$ for $N = 1, 2, 3, \dots$, the reflection coefficient for (1.40) vanishes identically as a function of λ , and the eigenvalues in the upper half-plane are the purely imaginary numbers $\lambda = iA - i(k + \frac{1}{2})\epsilon_N$, for $k = 0, 1, \dots, N - 1$. The auxiliary scattering data consist of the proportionality constants linking eigenfunctions with prescribed decay as $x \rightarrow -\infty$ with those having prescribed decay as $x \rightarrow +\infty$: these are simply alternating signs $(-1)^{k+1}$. It is easily confirmed that these scattering data correspond exactly to the WKB approximation described above when G is defined as above; in particular, the phase integral (1.41) evaluates to

$$\Psi(\lambda) = i\pi\lambda + \pi A, \quad \text{if } G(x) = -4A \operatorname{sech}(x). \quad (1.57)$$

In such a reflectionless situation, it becomes possible to solve the inverse-scattering problem by finite-dimensional linear algebra, and thus we obtain an exact solution $u(x, t)$ of (1.1) with $\epsilon = \epsilon_N$ and ϵ -independent initial data (1.56) for each positive integer N . We will give more details about this procedure later (see the final paragraph of §2), but for now we discuss the results of an empirical study of these exact solutions.

Figure 1.1 shows plots of the exact solution of the Cauchy problem for (1.1) with initial conditions given by (1.56) with $A = 1/4$. These plots show that the initial impulse sets the pendula into nearly synchronous librational motion of frequency proportional to N (inversely proportional to ϵ). However, an instability seems to appear in the modulational pattern, leading to a kind of focusing of wave energy near $x = 0$. In a region of the (x, t) -plane that seems to become more well-defined as N increases, the focused waves take on a different character; in particular, the synchrony of nearby pendula is lost as spatial structures with wavelengths inversely proportional to N spontaneously appear. Nonetheless, the oscillations present after the focusing event are still fairly regular and result in an approximately quasiperiodic spatiotemporal pattern. This type of dynamics is qualitatively similar to what is known to occur in the semiclassical limit of the focusing nonlinear Schrödinger equation [19, 14, 23, 17], another problem that has elliptic modulation equations as is expected here before the focusing due to the apparent librational motion.

In Figure 1.2 we give plots analogous to those in Figure 1.1 but now we increase the amplitude of the impulse by choosing $A = 3/4$. The dynamics are evidently quite different: one clearly can identify three types of behavior near $t = 0$:

- Nearly synchronous librational motion of the pendula is apparent for large $|x|$, where the initial impulse is weak.

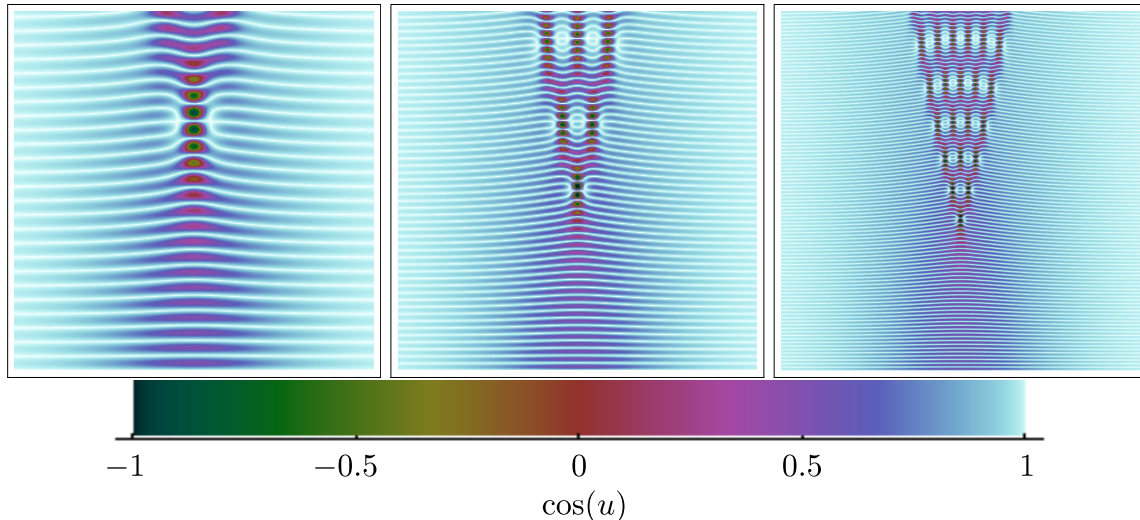

FIGURE 1.1. Plots of $\cos(u)$ with $A = 1/4$ over the (x,t) -plane. The horizontal axis is $-2.5 < x < 2.5$ and the vertical axis is $0 < t < 5$. Left: $N = 4$. Center: $N = 8$. Right: $N = 16$.

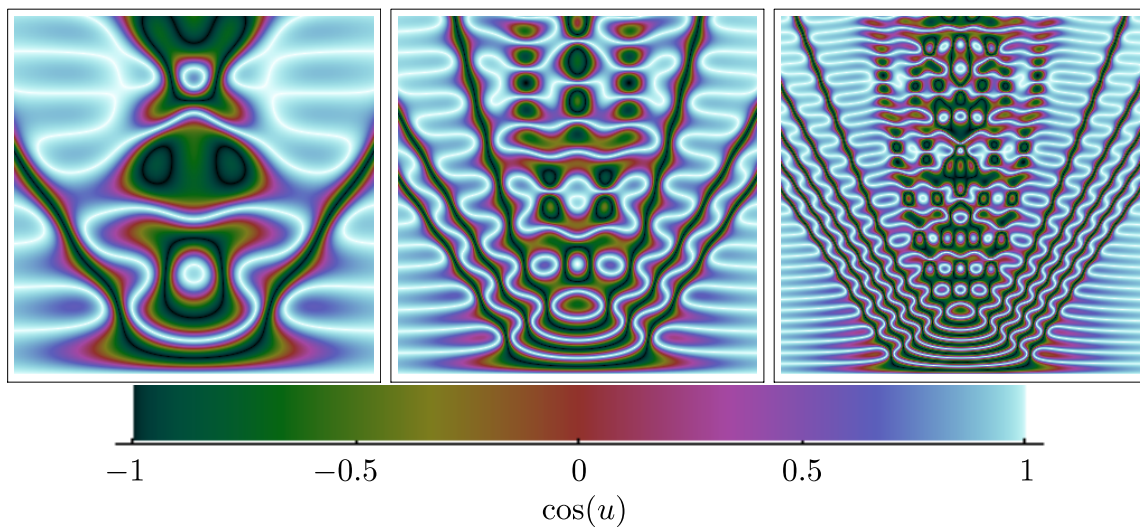

FIGURE 1.2. Same as in Figure 1.1 but now $A = 3/4$.

- Nearly synchronous rotational motion of the pendula is apparent for small $|x|$, where the initial impulse is strongest.
- Strongly asynchronous motion of undetermined type is apparent near two transitional values of x . These transitional points appear to shed kinks and antikinks.

These plots therefore suggest that some sort of transition in the dynamics occurs when the maximum amplitude of the impulse, A , exceeds some threshold value between $A = 1/4$ and $A = 3/4$. In our paper [4] we observed that in similar families of exact solutions an analogous transition occurs if the initial data (F, G) when viewed as a curve (parametrized by x) in the phase portrait of the simple pendulum equation $\epsilon^2 u_{tt} + \sin(u) = 0$ crosses the separatrix (and the transition appears to occur near the specific x -values where

crossings occur). Thus one expects that the existence of $x \in \mathbb{R}$ where

$$(1 - \cos(F(x))) + \frac{1}{2}G(x)^2 = 2 \quad (1.58)$$

may lead to a different kind of dynamics in a small time interval near $t = 0$ of length independent of ϵ . This equation has real solutions when $F(x)$ and $G(x)$ are given by (1.56) if $A > 1/2$. From the plots in Figure 1.2 it is clear that when $A > 1/2$ there is a symmetrical interval around $x = 0$ in which the impulse is sufficiently large to cause rotation of the angle u outside of the fundamental range $-\pi < u < \pi$, which leads to an emission of kinks carrying positive and negative topological charge in opposite directions from the ends of this (shrinking in time) interval, which bound a triangular region in the (x, t) -plane. This region therefore appears to contain a modulated superluminal rotational wavetrain, while for $|x|$ sufficiently large one observes what appear to be modulated superluminal librational waves.

The goal of this paper is to show that this type of structure is universal for pure-impulse fluxon condensates with sufficient impulse present at $t = 0$. Thus we further impose

Assumption 1.6. *The function $G(x)$ satisfies $G(0) < -2$.*

By Assumptions 1.2, 1.3, and 1.6, there exists a positive number $x_{\text{crit}} > 0$ defined by

$$x_{\text{crit}} := G^{-1}(-2), \quad (1.59)$$

and based upon the above heuristic discussion we may expect the dynamics of pure-impulse fluxon condensates to be of a different character for $|x| < x_{\text{crit}}$ than for $|x| > x_{\text{crit}}$.

1.3. Statement of results. Our results concern the asymptotic behavior, in the limit $N \uparrow \infty$ equivalent to $\epsilon_N \downarrow 0$, of the functions $u_N(x, t)$ making up the fluxon condensate associated with the pure-impulse initial condition of impulse profile $G(\cdot)$. As mentioned above, for fixed N , $u_N(x, t)$ is not exactly the solution of the Cauchy initial-value problem with the corresponding initial data (although it is an exact solution of (1.1)), and the proper definition will be given below in Definition 2.1. The statements below concern two regions of the (x, t) -plane depending on $G(\cdot)$ but not on $\epsilon = \epsilon_N$. The region S_L is specified in terms of a continuous time-horizon function $T_L(x) > 0$ defined for $|x| > x_{\text{crit}}$ with $\lim_{|x| \downarrow x_{\text{crit}}} T_L(x) = 0$; then $(x, t) \in S_L$ if and only if $|x| > x_{\text{crit}}$ and $|t| < T_L(x)$. The region S_R is specified in terms of a continuous time-horizon function $T_R(x) > 0$ defined for $|x| < x_{\text{crit}}$ with $\lim_{|x| \uparrow x_{\text{crit}}} T_R(x) = 0$, as well as two curves $t = t_{\pm}(x)$ with $t_{\pm}(0) = 0$, $t'_+(x) > 0$, and $t'_-(x) < 0$. Then $(x, t) \in S_R$ if and only if $|x| < x_{\text{crit}}$, $|t| < T_R(x)$, and $t \neq t_{\pm}(x)$. See Figure 1.3.

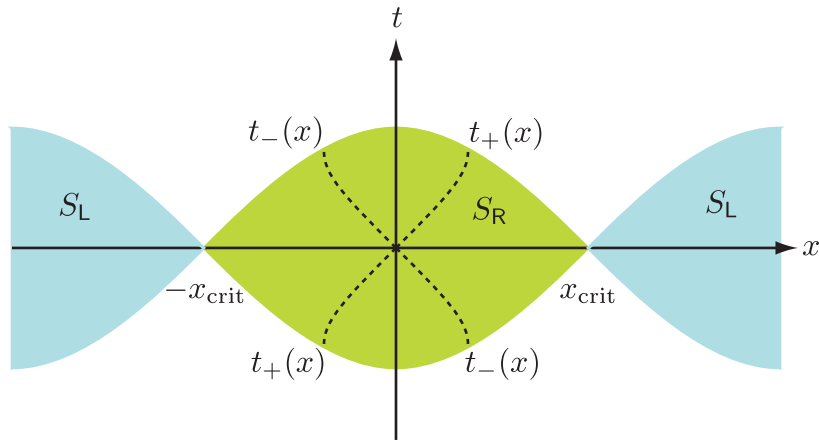

FIGURE 1.3. *The regions S_L and S_R .*

Let $K(\cdot)$ denote the complete elliptic integral of the first kind:

$$K(m) := \int_0^1 \frac{ds}{\sqrt{(1-s^2)(1-ms^2)}}, \quad 0 < m < 1. \quad (1.60)$$

We will prove the following two results under Assumptions 1.1–1.6, and also under the more technical Assumption 2.1 to be presented shortly. The asymptotic formulae for the fluxon condensate are in fact quite explicit in terms of the Jacobi elliptic functions $\text{sn}(z; m)$, $\text{cn}(z; m)$, and $\text{dn}(z; m)$, for which we cite the text by Akhiezer [1] as a reference.

Theorem 1.1 (Small-Time Librational Asymptotics). *There exist well-defined differentiable functions $n_p : S_L \rightarrow (-1, 1)$ and $\mathcal{E} : S_L \rightarrow (-1, 1)$ satisfying the initial conditions $n_p(x, 0) = 0$ and $\mathcal{E}(x, 0) = \frac{1}{2}G(x)^2 - 1$ and the elliptic Whitham system (1.32) where $J(\mathcal{E}) := I_L(-\mathcal{E})$ and $I_L(\cdot)$ is given by (1.16), as well as the inequality*

$$x \frac{\partial n_p}{\partial t}(x, 0) < 0, \quad |x| > x_{\text{crit}}. \quad (1.61)$$

Defining an elliptic parameter $m = m(x, t)$ by

$$m(x, t) = m_L(x, t) := \frac{1 + \mathcal{E}(x, t)}{2} \in (0, 1), \quad (x, t) \in S_L, \quad (1.62)$$

and a real phase $\Phi(x, t)$ by

$$\Phi(x, t) := - \int_0^t \omega(x, t') dt', \quad (1.63)$$

where

$$\omega(x, t) := - \frac{\pi}{2K(m(x, t))} \frac{1}{\sqrt{1 - n_p(x, t)^2}}, \quad (1.64)$$

the following asymptotic formulae hold pointwise for $(x, t) \in S_L$:

$$\begin{aligned} \cos\left(\frac{1}{2}u_N(x, t)\right) &= \text{dn}\left(\frac{2\Phi(x, t)K(m(x, t))}{\pi\epsilon_N}; m(x, t)\right) + \mathcal{O}(\epsilon_N) \\ \sin\left(\frac{1}{2}u_N(x, t)\right) &= -\sqrt{m(x, t)} \text{sn}\left(\frac{2\Phi(x, t)K(m(x, t))}{\pi\epsilon_N}; m(x, t)\right) + \mathcal{O}(\epsilon_N) \\ \epsilon_N \frac{\partial u_N}{\partial t}(x, t) &= -\frac{4K(m(x, t))}{\pi} \frac{\partial \Phi}{\partial t} \sqrt{m(x, t)} \text{cn}\left(\frac{2\Phi(x, t)K(m(x, t))}{\pi\epsilon_N}; m(x, t)\right) + \mathcal{O}(\epsilon_N). \end{aligned} \quad (1.65)$$

Moreover, the error terms are uniform for (x, t) in compact subsets of S_L . The phase $\Phi(x, t)$ also satisfies $\partial \Phi / \partial x = k(x, t) := \omega(x, t)n_p(x, t)$.

The accuracy of the asymptotic formulae (1.65) is illustrated in Figure 1.4.

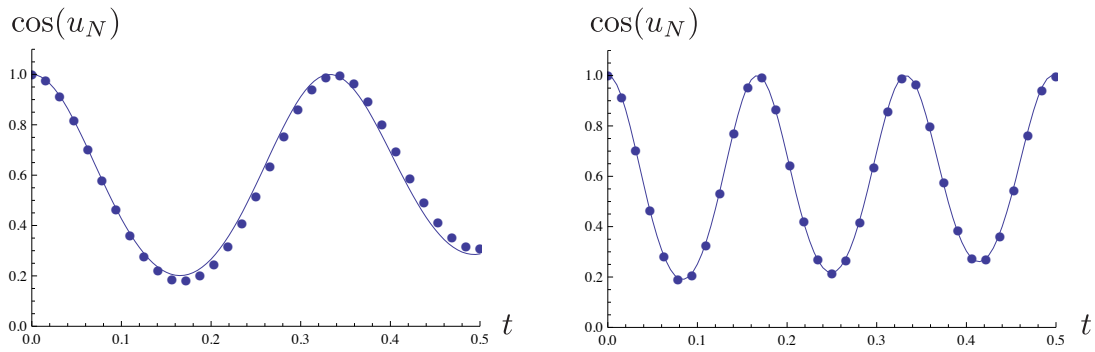

FIGURE 1.4. *The cosine of the exact solution $u_N(x, t)$ for the special initial data described in §1.2 for $A = 3/4$ plotted with points, and the corresponding asymptotic formula plotted with curves, for fixed $x = 1.5$ and $0 < t < 0.5$ so that $(x, t) \in S_L$ yielding librational motion as described by Theorem 1.1. Left: $N = 8$, or equivalently $\epsilon_N = 0.09375$. Right: $N = 16$, or equivalently $\epsilon_N = 0.046875$.*

Theorem 1.2 (Small-Time Rotational Asymptotics). *There exist well-defined differentiable functions $n_p : S_R \rightarrow (-1, 1)$ and $\mathcal{E} : S_R \rightarrow (1, +\infty)$ satisfying the initial conditions $n_p(x, 0) = 0$ and $\mathcal{E}(x, 0) = \frac{1}{2}G(x)^2 - 1$ and the hyperbolic Whitham system (1.32) where $J(\mathcal{E}) = I_R(-\mathcal{E})$ and $I_R(\cdot)$ is given by (1.17), as well as the inequality*

$$x \frac{\partial n_p}{\partial t}(x, 0) > 0, \quad 0 < |x| < x_{\text{crit}}. \quad (1.66)$$

Moreover, the functions $n_p(x, t)$ and $\mathcal{E}(x, t)$ extend continuously along with their first partial derivatives to the curves $t = t_{\pm}(x)$, and they obey the (x, t) -independent inequalities

$$0 \leq \frac{1 - n_p(x, t)}{1 + n_p(x, t)} \left(\mathcal{E}(x, t) + \sqrt{\mathcal{E}(x, t)^2 - 1} \right) < \frac{1}{4} \left(G(0) - \sqrt{G(0)^2 - 4} \right)^2 \quad (1.67)$$

and

$$\frac{1 - n_p(x, t)}{1 + n_p(x, t)} \left(\mathcal{E}(x, t) - \sqrt{\mathcal{E}(x, t)^2 - 1} \right) > \frac{1}{4} \left(G(0) + \sqrt{G(0)^2 - 4} \right)^2 > 0. \quad (1.68)$$

Defining an elliptic parameter $m = m(x, t)$ by

$$m(x, t) = m_R(x, t) := \frac{2}{1 + \mathcal{E}(x, t)} \in (0, 1), \quad (x, t) \in S_R, \quad (1.69)$$

and a real phase $\Phi(x, t)$ by

$$\Phi(x, t) := - \int_0^t \omega(x, t') dt', \quad (1.70)$$

where

$$\omega(x, t) := - \frac{\pi}{2K(m(x, t))} \frac{\sqrt{\mathcal{E}(x, t) + \sqrt{\mathcal{E}(x, t)^2 - 1}} + \sqrt{\mathcal{E}(x, t) - \sqrt{\mathcal{E}(x, t)^2 - 1}}}{2} \frac{1}{\sqrt{1 - n_p(x, t)^2}}, \quad (1.71)$$

the following asymptotic formulae hold pointwise for $(x, t) \in S_R$:

$$\begin{aligned} \cos\left(\frac{1}{2}u_N(x, t)\right) &= \text{cn}\left(\frac{2\Phi(x, t)K(m(x, t))}{\pi\epsilon_N}; m(x, t)\right) + \mathcal{O}(\epsilon_N) \\ \sin\left(\frac{1}{2}u_N(x, t)\right) &= -\text{sn}\left(\frac{2\Phi(x, t)K(m(x, t))}{\pi\epsilon_N}; m(x, t)\right) + \mathcal{O}(\epsilon_N) \\ \epsilon_N \frac{\partial u_N}{\partial t}(x, t) &= -\frac{4K(m(x, t))}{\pi} \frac{\partial \Phi}{\partial t} \text{dn}\left(\frac{2\Phi(x, t)K(m(x, t))}{\pi\epsilon_N}; m(x, t)\right) + \mathcal{O}(\epsilon_N). \end{aligned} \quad (1.72)$$

Moreover, the error terms are uniform for (x, t) in compact subsets of S_R . The phase $\Phi(x, t)$ also satisfies $\partial\Phi/\partial x = k(x, t) := \omega(x, t)n_p(x, t)$.

The accuracy of the asymptotic formulae (1.72) is illustrated in Figure 1.5.

We now make several observations about these results:

- The asymptotic formulae (1.65) correspond to a high-frequency superluminal librational wavetrain that is relatively slowly modulated through the (x, t) -dependence of the quantities n_p and \mathcal{E} . Indeed, Taylor expansion of these formulae about a fixed point $(x_0, t_0) \in S_L$ shows that if one sets $x = x_0 + \epsilon_N \tilde{x}$ and $t = t_0 + \epsilon_N \tilde{t}$ and takes the limit $\epsilon_N \downarrow 0$ holding \tilde{x} and \tilde{t} fixed, we recover an exact superluminal librational wavetrain solution of the sine-Gordon equation as a function of x and t characterized by the fixed energy $\mathcal{E}(x_0, t_0)$ and the linear phase $\Phi(x_0, t_0) + k(x_0, t_0)(x - x_0) - \omega(x_0, t_0)(t - t_0)$. It is clear in this case that the function $u_N(x, t)$ is confined to the range $(-\pi, \pi)$ and that both u_N and its time derivative are periodic functions of the linear phase as is consistent with librational motion. Similarly, the asymptotic formulae (1.72) correspond to a high-frequency and slowly modulated superluminal rotational wavetrain, and in particular u_N is monotonic while its derivative is periodic, as is consistent with rotational motion.
- We have excluded the curves $t = t_{\pm}(x)$ from S_R as a matter of complete academic honesty, as our proof would require a technical modification to extend pointwise asymptotics to these curves, and to have uniformity for $t \approx t_{\pm}(x)$ is yet a further matter requiring a double-scaling limit. However, it is easy to see that the explicit terms in the asymptotic formulae (1.72) undergo no phase transition in

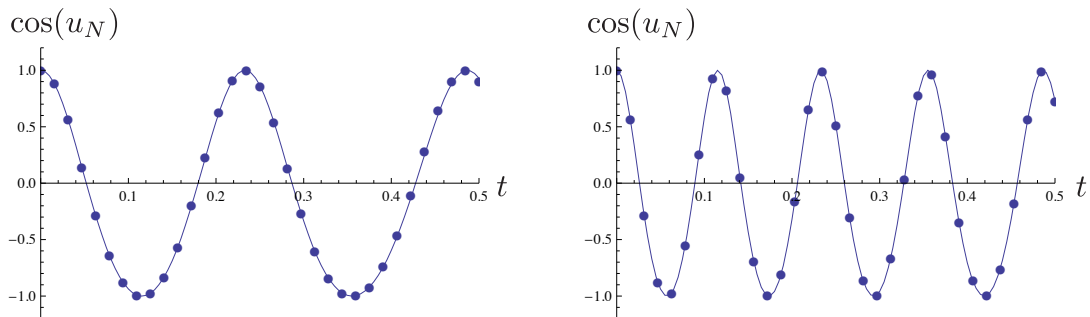

FIGURE 1.5. The cosine of the exact solution $u_N(x, t)$ for the special initial data described in §1.2 for $A = 3/4$ plotted with points, and the corresponding asymptotic formula plotted with curves, for fixed $x = -0.15625$ and $0 < t < 0.5$ so that $(x, t) \in S_R$ yielding rotational motion as described by Theorem 1.2. Left: $N = 8$, or equivalently $\epsilon_N = 0.09375$. Right: $N = 16$, or equivalently $\epsilon_N = 0.046875$. Note that for the given value of x , $t_-(x) \approx 0.153$, but that there is no evidence of any change in behavior near this value of t in either the exact solution or the asymptotic solution.

the vicinity of the curves $t = t_{\pm}(x)$, and while we cannot honestly exclude the possibility that there is some phenomenon here to be captured by more detailed analysis, there is no indication of such in the plots shown in §1.2.

- As part of our proof, we show that in each case the asymptotic formula for $\epsilon_N \partial u_N / \partial t$ is consistent with those for $\cos(\frac{1}{2}u_N)$ and $\sin(\frac{1}{2}u_N)$ in the sense that differentiation of the latter with respect to t assuming that the error terms remain subdominant after differentiation yields the former up to terms of order $\mathcal{O}(\epsilon_N)$.
- The inequalities (1.61) and (1.66) together with the initial condition $n_p(x, 0) = 0$ give information about the direction of motion of the waves. For example, if $x > x_{\text{crit}}$ and $t > 0$, the fluxon condensate behaves like a train of superluminal librational waves propagating rapidly to the left (since the phase velocity v_p is large and negative), and if $0 < x < x_{\text{crit}}$ and $t > 0$ the condensate behaves like a train of superluminal rotational waves propagating rapidly to the right.
- The fields $n_p(x, t)$ and $\mathcal{E}(x, t)$ have in each case exactly the interpretation of reciprocal phase velocity and energy as explained earlier in the context of formal modulation theory. Although we conclude that these quantities satisfy the Whitham system (1.32), we wish to emphasize that at no point in our proof do we apply techniques from the theory of partial differential equations (*e.g.*, the Cauchy-Kovalevskaya method) to solve the Whitham system with the specified initial data. Instead, the fields $n_p(x, t)$ and $\mathcal{E}(x, t)$ are constructed by means of the solution of a system of nonlinear algebraic equations via the Implicit Function Theorem. We first obtain functions $\mathbf{p} = \mathbf{p}(x, t)$ and $\mathbf{q} = \mathbf{q}(x, t)$ by solving the equations $M = I = 0$ (see Proposition 4.7), or for $(x, t) \in S_R$ the equations $\hat{M} = \hat{I} = 0$ (see Proposition 4.9), and then recover $n_p(x, t)$ and $\mathcal{E}(x, t)$ therefrom via (4.35) and (4.92) respectively. The fact that these functions satisfy the quasilinear partial differential equations (1.32) is, from the point of view of our methodology, more or less a coincidence.
- Interestingly, the asymptotics of the fluxon condensate are accurately described by superluminal wavetrains, even though the fundamental particles of the condensate are all subluminal solitons of kink and breather type.
- The semiclassical asymptotics of the sine-Gordon equation are, at least in the case of a sufficiently strong initial impulse consistent with Assumption 1.6, much more complicated even for small times t (independent of ϵ_N) than in the case of more well-known integrable partial differential equations like Korteweg-de Vries (see [6]) and focusing nonlinear Schrödinger (see [14, 23]). For these latter problems, there is an initial stage of the evolution where the asymptotics are described for all $x \in \mathbb{R}$ in terms of elementary functions. Here, we require two different types of formulae both involving

higher transcendental functions, and even these do not suffice to describe the dynamics near the transitional points $x = \pm x_{\text{crit}}$.

- If, in contrast to Assumption 1.6 we instead take $-2 < G(0) \leq 0$, then it will be clear from our proof that the region S_{L} extends to include a full neighborhood of $(x, t) = (0, 0)$, and hence becomes connected, including the entire $t = 0$ axis. Then Theorem 1.1 will suffice to describe the semiclassical asymptotics for small time uniformly for $x \in \mathbb{R}$. This is consistent with the dynamics pictured in Figure 1.1.
- Our results show that the two superluminal types of modulated single-phase wave behavior observed in Figure 1.2 for small time and x bounded away from $\pm x_{\text{crit}}$ are universal for the class of initial data we consider. It is reasonable to conjecture that the qualitatively different behavior observed in the space-time plane on the other side of nonlinear caustic curves might also be universal, and that it might correspond to various types of modulated *multiphase* waves. We note that, with appropriate modifications and additional work, the methods described in this paper are capable of handling these other cases. Specifically, for (x, t) in these regions the model Riemann-Hilbert problems `refrhp:wOdotlibrational` and 5.2 will need to be generalized to ones that are solved using the function theory of higher-genus hyperelliptic Riemann surfaces. The associated Whitham equations that generalize (1.32) will also have a correspondingly increased number of dependent variables (see [12, 10, 11]).

The relevance of the fluxon condensate $\{u_N(x, t)\}$ to the Cauchy problem for (1.1) with $\epsilon = \epsilon_N$ and with pure-impulse initial data characterized by the even Klaus-Shaw function G is then the following result:

Corollary 1.1. *When $t = 0$, the fluxon condensate $\{u_N(x, t)\}$ associated with the pure-impulse initial condition of impulse profile $G(\cdot)$ satisfies*

$$u_N(x, 0) = \mathcal{O}(\epsilon_N) \pmod{4\pi} \quad \text{and} \quad \epsilon_N \frac{\partial u_N}{\partial t}(x, 0) = G(x) + \mathcal{O}(\epsilon_N) \quad (1.73)$$

where the error estimates are valid pointwise for $x \neq 0$ and $|x| \neq x_{\text{crit}}$, and uniformly on compact subsets of the set of pointwise validity.

In this sense, the fluxon condensate approximates the solution of the Cauchy problem for (1.1) with initial data (1.2) when $\epsilon = \epsilon_N$ and N is large.

1.4. Outline of the rest of the paper. The remaining sections of the paper are devoted to the proofs of Theorems 1.1 (small-time librational asymptotics) and 1.2 (small-time rotational asymptotics). These are proven using the well-developed inverse-scattering method (see the brief discussion in §1.1 and the more detailed exposition in our paper [4]). The fluxon condensates $\{u_N(x, t)\}$ we study are defined by their scattering data, effectively skipping the forward-scattering transform. Thus all of our analysis concerns the inverse-scattering transform.

Our approach is to use the Riemann-Hilbert problem formulation of the inverse-scattering transform. Since the scattering data are reflectionless (that is, comprised of only eigenvalues and the corresponding proportionality constants), the associated Riemann-Hilbert problem for the 2×2 matrix-valued function $\mathbf{J}(w)$ has only poles and a completely trivial jump on the positive real axis (which could be removed at the cost of artificially doubling the number of poles through the transformation $w = z^2$). This setup and parts of the subsequent analysis are similar to an analogous work on semiclassical soliton ensembles for the focusing nonlinear Schrödinger equation [14].

Our first step is to make a local change of variables $\mathbf{J}(w) \rightarrow \mathbf{M}(w)$ in the Riemann-Hilbert problem in §3.2 that removes the poles at the price of introducing further jump contours (which are more amenable to analysis). Depending on the value of x and t , different transformations are used in different parts of the spectral w -plane. These different transformations are illustrated in Figures 3.1–3.6. Note that only one of these cases ($\Delta = \emptyset$ shown in Figure 3.1) is required to analyze solutions with even initial data for small times and x bounded away from the origin.

In §3.4 we make another transformation $\mathbf{M}(w) \rightarrow \mathbf{N}(w)$ involving a g -function, a standard tool (first introduced in [6]) for controlling the behavior of jump matrices in the Riemann-Hilbert problem. The details of the construction of the g -function are contained in §4. Finding the g -function involves identifying parts of the jump contours as a *band* β and parts as a *gap* γ . There are two possible topological configurations

for the band β (see Figures 4.1 and 4.2). In case L (leading to librational wavetrains), the band endpoints are a complex-conjugate pair ($w = \mathfrak{p} \pm i\sqrt{-\mathfrak{q}}$). In case R (leading to rotational wavetrains), the band endpoints are real ($w = \mathfrak{p} \pm \sqrt{\mathfrak{q}}$). The band endpoints are chosen to enforce certain conditions making the jump matrices easy to analyze in the limit $\epsilon_N \rightarrow 0$. The key part of the analysis is proving there exists a g -function *independent of ϵ_N* such that these conditions are satisfied for some fixed small time. This analysis is particularly delicate in a neighborhood of $(x, t) = (0, 0)$, as described in §4.3.2. In §4.4 we show that the band endpoints associated to an admissible g -function satisfy the Whitham modulation equations (1.32) in Riemann invariant (diagonal) form.

In §5.1 we open lenses in the Riemann-Hilbert problem by making the transformation $\mathbf{N}(w) \rightarrow \mathbf{O}(w)$ as illustrated in Figures 5.1–5.4. This has the effect of making the jump matrices exponentially close to the identity in ϵ_N except on the band β , the positive real axis, and in small neighborhoods of the band endpoints. In §5.2 we construct the *global parametrix* $\dot{\mathbf{O}}(w)$, which is an explicit approximation of $\mathbf{O}(w)$ that is valid in the whole complex w -plane. In §5.3 we prove rigorously that $\dot{\mathbf{O}}(w)$ is an $\mathcal{O}(\epsilon_N)$ -approximation of $\mathbf{O}(w)$. Thus we can use $\dot{\mathbf{O}}(w)$ to compute the solution $u_N(x, t)$ to the sine-Gordon equation modulo errors of size $\mathcal{O}(\epsilon_N)$. Finally, Appendix B contains the details of calculating the solutions $u_N(x, t)$ from the outer parametrix $\dot{\mathbf{O}}(w)$. A significant portion of the effort in Appendix B is devoted to translating more or less standard formulae involving Riemann theta functions of genus one into expressions involving Jacobi elliptic functions with suitable moduli. This is necessary to establish the simple form of the asymptotic formulae appearing in the statements of Theorems 1.1 and 1.2.

1.5. Notation and terminology. With the exception of the identity matrix \mathbb{I} and the three Pauli matrices,

$$\sigma_1 := \begin{bmatrix} 0 & 1 \\ 1 & 0 \end{bmatrix}, \quad \sigma_2 := \begin{bmatrix} 0 & -i \\ i & 0 \end{bmatrix}, \quad \sigma_3 := \begin{bmatrix} 1 & 0 \\ 0 & -1 \end{bmatrix}, \quad (1.74)$$

we will denote matrices by bold capital letters (*e.g.* \mathbf{M}) and vectors by bold lowercase letters (*e.g.* \mathbf{v}). We will use \bar{A} for the closure of a set $A \subset \mathbb{R}^2$, and denote complex conjugation with an asterisk.

In what follows, by a planar *arc* we will mean the image of a continuous and piecewise-smooth one-to-one map $(0, 1) \ni t \mapsto w(t) \in \mathbb{C} \cong \mathbb{R}^2$ with parameter t and nonvanishing derivative. By a planar *contour* we will mean the \mathbb{R}^2 -closure of a finite union of arcs. Thus a contour is always a closed set in the topology of \mathbb{R}^2 and may contain self-intersection points where various arcs meet. An *oriented contour* is a contour K written in a particular way as the \mathbb{R}^2 -closure of a finite union, denoted \vec{K} , of pairwise-disjoint arcs each of which is assigned an orientation in the obvious way according to its parametrization by t . An oriented contour may include at most a finite number of points at which the orientation is not properly defined. These may be self-intersection points, endpoints, or points dividing an arc into oppositely-oriented sub-arcs.

If K is an oriented contour and $f : \mathbb{C} \setminus K \rightarrow \mathbb{C}$ is an analytic function, we denote by $f_+(\xi)$ (respectively $f_-(\xi)$) the boundary value taken by $f(w)$ as $w \rightarrow \xi \in \vec{K}$ from the left (right) according to local orientation, if it exists. We use analogous notation for vector-valued functions (*e.g.* $\mathbf{v}_\pm(\xi)$) and matrix-valued functions (*e.g.* $\mathbf{M}_\pm(\xi)$). Given a contour K we define a metric d_K on $\mathbb{C} \setminus K$ as follows:

$$d_K(w_1, w_2) := \inf_{\substack{P \subset \mathbb{C} \setminus K \\ P: w_1 \rightarrow w_2}} \text{length}(P) \quad (1.75)$$

where the infimum is taken over paths $P \subset \mathbb{C} \setminus K$ connecting the points w and z . If $0 < \alpha \leq 1$, an analytic function $f : \mathbb{C} \setminus K \rightarrow \mathbb{C}$ is said to be *uniformly Hölder- α continuous* if

$$\sup_{w_1, w_2 \in \mathbb{C} \setminus K} \frac{|f(w_1) - f(w_2)|}{d_K(w_1, w_2)^\alpha} < \infty. \quad (1.76)$$

This definition generalizes in the obvious way to vector-valued or matrix-valued functions, and also may be analogously defined relative to open domains $U \setminus K$, $U \subset \mathbb{C}$, U open.

2. FORMULATION OF THE INVERSE PROBLEM FOR FLUXON CONDENSATES

Let a function $G : \mathbb{R} \rightarrow \mathbb{R}$ satisfying the conditions set out in the introduction be given, and let a decreasing sequence $\{\epsilon_N\}_{N=1}^\infty$ be defined by (1.54). For each integer $N > 0$, define numbers $\lambda_k^0 = \lambda_{N,k}^0$ on the positive imaginary axis by the Bohr-Sommerfeld quantization rule (1.42) with the WKB phase integral

(1.41) and the conditions $\epsilon = \epsilon_N$ and $N(\epsilon) = N$. Regardless of the value of $N = 1, 2, 3, \dots$, the numbers $\{\lambda_{N,k}^0\}_{k=0}^{N-1}$ will each have exactly two distinct preimages in the w -plane with $|\arg(-w)| < \pi$ under the map $\lambda = E(w)$ if the following additional condition is satisfied.

Assumption 2.1. *The fraction $\Psi(i/2)/\|G\|_1$ is irrational.*

This simply guarantees that none of the numbers $\{\lambda_{N,k}^0\}_{k=0}^{N-1}$ coincide with $\lambda = i/2$, the unique critical value of $E(w)$ for $|\arg(-w)| < \pi$, which ensures the poles that will appear in the definition of Riemann-Hilbert Problem 2.1 below are all simple. Rationality of $\Psi(i/2)/\|G\|_1$ can also be admitted with the same effect at the cost of passing to a subsequence of values of N .

Let a function $Q(w)$ be defined for $|\arg(-w)| < \pi$ as follows:

$$Q(w) = Q(w; x, t) := E(w)x + D(w)t, \quad (2.1)$$

and define

$$\Pi_N(w) := \prod_{k=0}^{N-1} \frac{E(w) + \lambda_{N,k}^0}{E(w) - \lambda_{N,k}^0}, \quad |\arg(-w)| < \pi. \quad (2.2)$$

According to Assumption 2.1, the denominator of $\Pi_N(w)$ has $2N$ simple zeros in the domain of definition, while the numerator of $\Pi_N(w)$ is analytic and nonvanishing. Let P_N denote the set of poles of $\Pi_N(w)$, $2N$ points consisting of $2N_B$ points in complex conjugate pairs on the unit circle S^1 and $2N_K$ points on the negative real axis in involution with respect to the map $w \rightarrow 1/w$. We may write $\Pi_N(w)$ equivalently in the form

$$\Pi_N(w) = \prod_{y \in P_N} \frac{\sqrt{-w} + \sqrt{-y}}{\sqrt{-w} - \sqrt{-y}}. \quad (2.3)$$

The basic Riemann-Hilbert problem of inverse scattering to construct the fluxon condensate corresponding to G is then the following. We are following the description of the inverse-scattering problem given in Appendix A of [4] but we are exploiting the symmetry $z \mapsto -z$ to formulate the problem in terms of the complex variable $w = z^2$, which introduces a jump on \mathbb{R}_+ .

Riemann-Hilbert Problem 2.1 (Basic Problem of Inverse Scattering). *Find a 2×2 matrix function $\mathbf{H}(w) = \mathbf{H}_N(w; x, t)$ of the complex variable w with the following properties:*

Analyticity: $\mathbf{H}(w)$ is analytic for $w \in \mathbb{C} \setminus (P_N \cup \mathbb{R}_+)$.

Jump Condition: There is a neighborhood $U = U_N$ of \mathbb{R}_+ such that $\mathbf{H}(w)$ is uniformly Hölder- α continuous for all $\alpha \in (0, 1]$ on $U \setminus \mathbb{R}_+$. Letting \mathbb{R}_+ be oriented from left to right, the boundary values taken by $\mathbf{H}(w)$ on \mathbb{R}_+ are related by the jump condition

$$\mathbf{H}_+(\xi) = \sigma_2 \mathbf{H}_-(\xi) \sigma_2, \quad \xi \in \vec{\mathbb{R}}_+. \quad (2.4)$$

Singularities: Each of the points of P_N is a simple pole of $\mathbf{H}(w)$. If $y \in P_N$ with $E(y) = \lambda_{N,k}^0$ for $k = 0, \dots, N-1$, then

$$\operatorname{Res}_{w=y} \mathbf{H}(w) = \lim_{w \rightarrow y} \mathbf{H}(w) \begin{bmatrix} 0 & 0 \\ (-1)^{k+1} \operatorname{Res}_{w=y} e^{2iQ(w;x,t)/\epsilon_N} \Pi_N(w) & 0 \end{bmatrix}. \quad (2.5)$$

These amount to one matrix-valued condition on the residue of $\mathbf{H}(w)$ at each of its poles.

Normalization: The following normalization condition holds:

$$\lim_{w \rightarrow \infty} \mathbf{H}(w) = \mathbb{I}, \quad (2.6)$$

where the limit is uniform with respect to angle for $|\arg(-w)| < \pi$.

It is an easy application of Liouville's Theorem that any solution of this problem must satisfy $\det(\mathbf{H}(w)) \equiv 1$, from which it follows that if $\mathbf{H}_1(w)$ and $\mathbf{H}_2(w)$ are any two solutions, the matrix ratio $\mathbf{R}(w) := \mathbf{H}_1(w)\mathbf{H}_2(w)^{-1}$ is analytic for $|\arg(-w)| < \pi$ (has removable singularities at the points of P_N and acquires no additional singularities from inversion of $\mathbf{H}_2(w)$), is Hölder- α continuous in $U \setminus \mathbb{R}_+$, and tends to

the identity matrix as $w \rightarrow \infty$. The boundary values taken by $\mathbf{R}(w)$ on $\vec{\mathbb{R}}_+$ satisfy $\mathbf{R}_+(\xi) = \sigma_2 \mathbf{R}_-(\xi) \sigma_2$. If we set

$$\mathbf{S}(z) := \begin{cases} \mathbf{R}(z^2), & \Im\{z\} > 0, \\ \sigma_2 \mathbf{R}(z^2) \sigma_2, & \Im\{z\} < 0, \end{cases} \quad (2.7)$$

then it is clear that $\mathbf{S}(z)$ extends to an entire function of $z \in \mathbb{C}$ with identity asymptotics as $z \rightarrow \infty$. Hence Liouville's Theorem shows that $\mathbf{S}(z) \equiv \mathbb{I}$ and so by restriction to $\Im\{z\} > 0$, $\mathbf{H}_1(w) \equiv \mathbf{H}_2(w)$ for $|\arg(-w)| < \pi$. Therefore, solutions to Riemann-Hilbert Problem 2.1 are necessarily unique if they exist.

Given any solution $\mathbf{H}(w)$ of Riemann-Hilbert Problem 2.1, another is easily generated by setting $\mathbf{H}^\sharp(w) := \mathbf{H}(w^*)^*$. By uniqueness it follows that $\mathbf{H}^\sharp(w) \equiv \mathbf{H}(w)$, or equivalently, that the unique solution of Riemann-Hilbert Problem 2.1 necessarily satisfies

$$\mathbf{H}(w^*) = \mathbf{H}(w)^*. \quad (2.8)$$

If for some $(x, t) \in \mathbb{R}^2$, $\mathbf{H}(w)$ is the unique solution to Riemann-Hilbert Problem 2.1 for all integer $N \geq N_0$ for sufficiently large N_0 , then a construction similar to (2.7) involving the variable z such that $w = z^2$ shows that if it exists the solution $\mathbf{H}(w)$ has convergent series expansions of the form

$$\mathbf{H}(w) = \sum_{k=0}^{\infty} \mathbf{H}_N^{0,k}(x, t) (\sqrt{-w})^k, \quad |w| < r \quad (2.9)$$

and

$$\mathbf{H}(w) = \mathbb{I} + \sum_{k=1}^{\infty} \mathbf{H}_N^{\infty,k}(x, t) (\sqrt{-w})^{-k}, \quad |w| > R \quad (2.10)$$

for suitable numbers r and R independent of N . We will use the notation

$$\mathbf{A}_N(x, t) := \mathbf{H}_N^{0,0}(x, t), \quad \mathbf{B}_N^0(x, t) := \mathbf{H}_N^{0,0}(x, t)^{-1} \mathbf{H}_N^{0,1}(x, t), \quad \mathbf{B}_N^\infty(x, t) := \mathbf{H}_N^{\infty,1}(x, t), \quad (2.11)$$

defining three matrices depending parametrically on $(x, t) \in \mathbb{R}^2$ and the integer $N \geq N_0$. These matrices necessarily satisfy the conditions

$$\det(\mathbf{A}_N(x, t)) = 1, \quad \mathbf{A}_N(x, t) = \sigma_2 \mathbf{A}_N(x, t) \sigma_2, \quad \text{and} \quad \mathbf{A}_N(x, t) = \mathbf{A}_N(x, t)^*, \quad (2.12)$$

$$\text{tr}(\mathbf{B}_N^\infty(x, t)) = 0, \quad \mathbf{B}_N^\infty(x, t) = -\sigma_2 \mathbf{B}_N^\infty(x, t) \sigma_2, \quad \text{and} \quad \mathbf{B}_N^\infty(x, t) = \mathbf{B}_N^\infty(x, t)^*, \quad (2.13)$$

and

$$\text{tr}(\mathbf{B}_N^0(x, t)) = 0, \quad \mathbf{B}_N^0(x, t) = -\sigma_2 \mathbf{B}_N^0(x, t) \sigma_2, \quad \text{and} \quad \mathbf{B}_N^0(x, t) = \mathbf{B}_N^0(x, t)^*. \quad (2.14)$$

Definition 2.1 (Fluxon condensates). *Given $(x, t) \in \mathbb{R}^2$, suppose that Riemann-Hilbert Problem 2.1 has a solution for all integer $N \geq N_0$. Then, the fluxon condensate $\{u_N(x, t)\}_{N=N_0}^\infty$ associated with the impulse profile G is given (modulo addition of arbitrary integer multiples of 4π) in terms of $\mathbf{A}_N(x, t)$ as follows:*

$$\cos\left(\frac{1}{2}u_N(x, t)\right) = A_{N,11}(x, t) \quad \text{and} \quad \sin\left(\frac{1}{2}u_N(x, t)\right) = A_{N,21}(x, t). \quad (2.15)$$

Note that the identities (2.12) ensure the reality of these expressions as well as the Pythagorean identity $\sin(\frac{1}{2}u_N(x, t))^2 + \cos(\frac{1}{2}u_N(x, t))^2 = 1$.

Proposition 2.1. *Suppose that $\Omega \subset \mathbb{R}^2$ is open and an integer $N_0 > 0$ is given such that Riemann-Hilbert Problem 2.1 has a solution whenever $(x, t) \in \Omega$ and $N \geq N_0$, and that the fluxon condensate $\{u_N(x, t)\}_{N=N_0}^\infty$ is defined as above for $(x, t) \in \Omega$. Then for each integer $N \geq N_0$, $u = u_N(x, t)$ is an exact real-valued solution of the sine-Gordon equation (1.1) with $\epsilon = \epsilon_N$. Moreover,*

$$\epsilon_N \frac{\partial u_N}{\partial t}(x, t) = B_{N,12}^0(x, t) + B_{N,12}^\infty(x, t). \quad (2.16)$$

Proof. Consider the matrix $\mathbf{F}(w)$ defined in terms of the solution $\mathbf{H}(w)$ of Riemann-Hilbert Problem 2.1 by

$$\mathbf{F}(w) := \mathbf{H}(w) e^{-iQ(w;x,t)\sigma_3/\epsilon_N}. \quad (2.17)$$

Aside from an introduced essential singularity at $w = 0$, the matrix $\mathbf{F}(w)$ is analytic exactly where $\mathbf{H}(w)$ is, and has similar properties where analyticity is violated. Namely, $\mathbf{F}(w)$ is Hölder- α continuous in $U \setminus \mathbb{R}_+$ except at $w = 0$ where the exponential factor has an essential singularity, and as a consequence of the identity $Q_+(\xi) = -Q_-(\xi)$ for $\xi \in \vec{\mathbb{R}}_+$ one has that the boundary values of $\mathbf{F}(w)$ satisfy the jump condition

$\mathbf{F}_+(\xi) = \sigma_2 \mathbf{F}_-(\xi) \sigma_2$ for $\xi \in \vec{\mathbb{R}}_+$. Also, $\mathbf{F}(w)$ has simple poles at the points of P_N , and if $y \in P_N$ with $E(y) = \lambda_{N,k}^0$ then

$$\operatorname{Res}_{w=y} \mathbf{F}(w) = \lim_{w \rightarrow y} \mathbf{F}(w) \begin{bmatrix} 0 & 0 \\ (-1)^{k+1} \operatorname{Res}_{w=y} \Pi_N(w) & 0 \end{bmatrix}. \quad (2.18)$$

Note that neither the jump nor residue conditions involve $(x, t) \in \mathbb{R}^2$, from which it follows that the matrices

$$\mathbf{U}(w) := 4i\epsilon_N \mathbf{F}_x(w) \mathbf{F}(w)^{-1} = 4i\epsilon_N \mathbf{H}_x(w) \mathbf{H}(w)^{-1} + 4E(w) \mathbf{H}(w) \sigma_3 \mathbf{H}(w)^{-1} \quad (2.19)$$

and

$$\mathbf{V}(w) := 4i\epsilon_N \mathbf{F}_t(w) \mathbf{F}(w)^{-1} = 4i\epsilon_N \mathbf{H}_t(w) \mathbf{H}(w)^{-1} + 4D(w) \mathbf{H}(w) \sigma_3 \mathbf{H}(w)^{-1} \quad (2.20)$$

are functions of $z = i\sqrt{-w}$ that are analytic for $z \in \mathbb{C} \setminus \{0\}$. These functions have the following asymptotic behavior as $w \rightarrow 0$ and $w \rightarrow \infty$:

$$\begin{aligned} \mathbf{U}(w) &= \begin{cases} \frac{1}{\sqrt{-w}} i \mathbf{A}_N(x, t) \sigma_3 \mathbf{A}_N(x, t)^{-1} + \mathcal{O}(1), & w \rightarrow 0, \\ \sqrt{-w} i \sigma_3 + i [\mathbf{B}_N^\infty(x, t), \sigma_3] + \mathfrak{o}(1), & w \rightarrow \infty, \end{cases} \\ \mathbf{V}(w) &= \begin{cases} -\frac{1}{\sqrt{-w}} i \mathbf{A}_N(x, t) \sigma_3 \mathbf{A}_N(x, t)^{-1} + \mathcal{O}(1), & w \rightarrow 0, \\ \sqrt{-w} i \sigma_3 + i [\mathbf{B}_N^\infty(x, t), \sigma_3] + \mathfrak{o}(1), & w \rightarrow \infty. \end{cases} \end{aligned} \quad (2.21)$$

It then follows from Liouville's Theorem applied in the z -plane that in fact $\mathbf{U}(w)$ and $\mathbf{V}(w)$ are Laurent polynomials in z of degree $(1, 1)$:

$$\begin{aligned} \mathbf{U}(w) &= \sqrt{-w} i \sigma_3 + i [\mathbf{B}_N^\infty(x, t), \sigma_3] + \frac{1}{\sqrt{-w}} i \mathbf{A}_N(x, t) \sigma_3 \mathbf{A}_N(x, t)^{-1} \\ \mathbf{V}(w) &= \sqrt{-w} i \sigma_3 + i [\mathbf{B}_N^\infty(x, t), \sigma_3] - \frac{1}{\sqrt{-w}} i \mathbf{A}_N(x, t) \sigma_3 \mathbf{A}_N(x, t)^{-1}. \end{aligned} \quad (2.22)$$

According to (2.12), we may write $\mathbf{A}_N(x, t)$ in the form

$$\mathbf{A}_N(x, t) = \begin{bmatrix} \cos(\phi) & -\sin(\phi) \\ \sin(\phi) & \cos(\phi) \end{bmatrix} \quad (2.23)$$

where $\phi = \phi_N(x, t)$ is a real angle. Likewise, according to (2.13) we may write $\mathbf{B}_N^\infty(x, t)$ in the form

$$\mathbf{B}_N^\infty(x, t) = \begin{bmatrix} -d & c \\ c & d \end{bmatrix} \quad (2.24)$$

where $c = c_N(x, t)$ and $d = d_N(x, t)$ are real-valued fields. In terms of these we therefore have

$$\begin{aligned} \mathbf{U}(w) &= \sqrt{-w} i \sigma_3 + 2c \sigma_2 + \frac{1}{\sqrt{-w}} (i \cos(2\phi) \sigma_3 + i \sin(2\phi) \sigma_1) \\ \mathbf{V}(w) &= \sqrt{-w} i \sigma_3 + 2c \sigma_2 - \frac{1}{\sqrt{-w}} (i \cos(2\phi) \sigma_3 + i \sin(2\phi) \sigma_1). \end{aligned} \quad (2.25)$$

Since when considered as a function of x and t , the matrix $\mathbf{F}(w)$ is a simultaneous fundamental solution matrix of the first-order overdetermined system

$$4i\epsilon_N \mathbf{F}_x = \mathbf{U} \mathbf{F} \quad \text{and} \quad 4i\epsilon_N \mathbf{F}_t = \mathbf{V} \mathbf{F}, \quad (2.26)$$

it follows that this system is compatible, implying that the *zero-curvature condition*

$$4i\epsilon_N \mathbf{U}_t - 4i\epsilon_N \mathbf{V}_x + [\mathbf{U}, \mathbf{V}] = \mathbf{0} \quad (2.27)$$

holds. Since $\{\sigma_1/\sqrt{-w}, \sigma_3/\sqrt{-w}, \sigma_2\}$ is a linearly independent set, the zero-curvature equation implies the following three equations:

$$\begin{aligned} (\epsilon_N \phi_t + \epsilon_N \phi_x - c) \cos(2\phi) &= 0 \\ (\epsilon_N \phi_t + \epsilon_N \phi_x - c) \sin(2\phi) &= 0 \\ \epsilon_N c_t - \epsilon_N c_x + \frac{1}{2} \sin(2\phi) &= 0. \end{aligned} \quad (2.28)$$

The first two are together equivalent to the single equation $\epsilon_N \phi_t + \epsilon_N \phi_x - c = 0$, which may be used to eliminate c from the third equation, yielding

$$\epsilon_N^2 \phi_{tt} - \epsilon_N^2 \phi_{xx} + \frac{1}{2} \sin(2\phi) = 0, \quad (2.29)$$

which is the sine-Gordon equation (1.1) for $u_N = 2\phi$ with $\epsilon = \epsilon_N$.

Obviously we have

$$\begin{aligned} \sin\left(\frac{1}{2}u_N\right) &= \sin(\phi) = A_{N,21}(x, t) \\ \cos\left(\frac{1}{2}u_N\right) &= \cos(\phi) = A_{N,11}(x, t) \end{aligned} \quad (2.30)$$

in accordance with (2.23) and (2.15). Finally, the identity (2.16) arises from the constant term in the Laurent expansion (in powers of $\sqrt{-w}$) of the differential equation $4i\epsilon_N \mathbf{H}_t(w) + 4D(w)\mathbf{H}(w)\sigma_3 = \mathbf{V}(w)\mathbf{H}(w)$ equivalent to $4i\epsilon_N \mathbf{F}_t(w) = \mathbf{V}(w)\mathbf{F}(w)$. \square

Note that since P_N consists of points y with $|\arg(-y)| < \pi$, it is a consequence of the definitions (1.39) and (2.1) involving the principal branch of the square root that for each fixed N and t we have

$$\lim_{x \rightarrow +\infty} \operatorname{Res}_{w=y \in P_N} e^{2iQ(w;x,t)/\epsilon_N} \Pi_N(w) = 0. \quad (2.31)$$

From this it can be shown that for each $w \in \mathbb{C} \setminus (P_N \cup \mathbb{R}_+)$ and for each $t \in \mathbb{R}$, $\mathbf{H}_N(w; x, t) \rightarrow \mathbb{I}$ as $x \rightarrow +\infty$. By contrast, the asymptotic behavior of \mathbf{H} as $x \rightarrow -\infty$ is not at all clear, and this is more than merely a technical difficulty. The ‘‘preference’’ that \mathbf{H} has for large positive x stems from a choice in defining the spectral theory for which Riemann-Hilbert Problem 2.1 is the inverse-spectral problem in terms of scattering ‘‘from the right’’. Given this asymmetry, it should be no surprise if asymptotic analysis of \mathbf{H} in the semiclassical limit of large N must take a different route for $-x$ than it does for x . This asymmetry can be addressed in two different ways:

- If the initial conditions $F(x) := u(x, 0)$ and $G(x) := \epsilon_N u_t(x, 0)$ for the sine-Gordon Cauchy problem are both either even or odd functions then this symmetry is preserved in time and knowledge of the solution for, say, positive x is sufficient. The special initial conditions under consideration in this paper have even symmetry. Moreover, it can be shown directly from the conditions of Riemann-Hilbert Problem 2.1 that the functions $\{u_N(x, t)\}_{N=N_0}^\infty$ approximating the solution to the Cauchy problem are all even functions of x .
- The inverse problem may be reformulated in terms of scattering ‘‘from the left’’.

In fact it will turn out that for certain values of $(x, t) \in \mathbb{R}^2$ of interest, neither of the above two approaches will be of much help. However, a modification of the second approach that can be thought of as formulating the inverse problem in terms of scattering theory ‘‘partly from the left and partly from the right’’ will indeed succeed. The idea is to select a subset $\Delta \subset P_N$ of the pole divisor of $\mathbf{H}(w)$ and set $\nabla := P_N \setminus \Delta$. Then define from the solution $\mathbf{H}_N(w; x, t)$ of Riemann-Hilbert Problem 2.1 a new matrix function given by

$$\mathbf{J}_N(w; x, t) := \mathbf{H}_N(w; x, t) \left(\prod_{y \in \Delta} \frac{\sqrt{-w} + \sqrt{-y}}{\sqrt{-w} - \sqrt{-y}} \right)^{-\sigma_3}. \quad (2.32)$$

It is easy to see that if $\mathbf{H}_N(w; x, t)$ satisfies Riemann-Hilbert Problem 2.1 then $\mathbf{J}_N(w; x, t)$ satisfies the following equivalent problem.

Riemann-Hilbert Problem 2.2 (Modified Problem of Inverse Scattering). *Find a 2×2 matrix function $\mathbf{J}(w) = \mathbf{J}_N(w; x, t)$ of the complex variable w with the following properties:*

Analyticity: $\mathbf{J}(w)$ is analytic for $w \in \mathbb{C} \setminus (P_N \cup \mathbb{R}_+)$.

Jump Condition: There is a neighborhood $U = U_N$ of \mathbb{R}_+ such that $\mathbf{J}(w)$ is uniformly Hölder- α continuous for all $\alpha \in (0, 1]$ on $U \setminus \mathbb{R}_+$. Letting \mathbb{R}_+ be oriented from left to right, the boundary values taken by $\mathbf{J}(w)$ on \mathbb{R}_+ are related by the jump condition

$$\mathbf{J}_+(\xi) = \sigma_2 \mathbf{J}_-(\xi) \sigma_2, \quad \xi \in \overline{\mathbb{R}}_+. \quad (2.33)$$

Singularities: Each of the points of P_N is a simple pole of $\mathbf{J}(w)$. If $y \in \nabla \subset P_N$ with $E(y) = \lambda_{N,k}^0$ for $k = 0, \dots, N-1$, then

$$\operatorname{Res}_{w=y} \mathbf{J}(w) = \lim_{w \rightarrow y} \mathbf{J}(w) \begin{bmatrix} 0 & 0 \\ (-1)^{k+1} \operatorname{Res}_{w=y} e^{2iQ(w;x,t)/\epsilon_N} \Pi_N(w) & 0 \end{bmatrix}, \quad (2.34)$$

and if $y \in \Delta \subset P_N$ with $E(y) = \lambda_{N,k}^0$ for $k = 0, \dots, N-1$, then

$$\operatorname{Res}_{w=y} \mathbf{J}(w) = \lim_{w \rightarrow y} \mathbf{J}(w) \begin{bmatrix} 0 & (-1)^{k+1} \operatorname{Res}_{w=y} e^{-2iQ(w;x,t)/\epsilon_N} \Pi_N(w)^{-1} \\ 0 & 0 \end{bmatrix}, \quad (2.35)$$

where $\Pi_N(w)$ is re-defined as

$$\Pi_N(w) := \prod_{p \in \nabla} \frac{\sqrt{-w} + \sqrt{-p}}{\sqrt{-w} - \sqrt{-p}} \cdot \prod_{q \in \Delta} \frac{\sqrt{-w} - \sqrt{-q}}{\sqrt{-w} + \sqrt{-q}}, \quad (2.36)$$

(note that this definition reduces to the earlier one, see (2.2) and (2.3), in the special case when $\Delta = \emptyset$ and hence $\nabla = P_N$). These amount to one matrix-valued condition on the residue of $\mathbf{J}(w)$ at each of its poles.

Normalization: The following normalization condition holds:

$$\lim_{w \rightarrow \infty} \mathbf{J}(w) = \mathbb{I}, \quad (2.37)$$

where the limit is uniform with respect to angle for $|\arg(-w)| < \pi$.

It is clear that in passing from \mathbf{H} to \mathbf{J} the nature of the residue conditions is changed near those points $y \in \Delta \subset P_N$ and is left unchanged near those points $y \in \nabla = P_N \setminus \Delta$. The special case of $\Delta = P_N$ and $\nabla = \emptyset$ corresponds to reformulating the inverse problem in terms of scattering theory “from the left”. Indeed, we see that in this case the exponential $e^{2iQ(w;x,t)/\epsilon_N}$ has been completely replaced by its reciprocal, which makes the limit $x \rightarrow -\infty$ particularly transparent; from the conditions of this problem it is easy to prove that if $\Delta = P_N$ then $\mathbf{J}_N(w; x, t) \rightarrow \mathbb{I}$ as $x \rightarrow -\infty$ whenever $t \in \mathbb{R}$ and $w \in \mathbb{C} \setminus (P_N \cup \mathbb{R}_+)$. More generally, this calculation suggests that if $x \in \mathbb{R}$ is a value for which semiclassical asymptotic analysis of $\mathbf{H}(w)$ is difficult, the problem may be resolved by analyzing the equivalent matrix $\mathbf{J}(w)$ instead for a particular choice of Δ .

From now on we will take Riemann-Hilbert Problem 2.2 as the basic object of study in the limit $N \rightarrow \infty$, where the set Δ is to be chosen differently for different $(x, t) \in \mathbb{R}^2$ to facilitate the asymptotic analysis.

Having formulated Riemann-Hilbert Problem 2.2, we can now explain how the plots in §1.2 were made. For any choice of $\Delta \subset P_N$ it is easy to see that $\mathbf{J}(w)$ is a rational function of $z = i\sqrt{-w}$ and it may therefore be written as a finite partial fraction expansion with simple denominators and constant term \mathbb{I} to satisfy the normalization condition. The matrix coefficients in the expansion are then determined from the residue conditions (2.34) and (2.35), which imply a square system of linear equations to be solved for the coefficients. In this way, the construction of $\sin(\frac{1}{2}u_N(x, t))$ and $\cos(\frac{1}{2}u_N(x, t))$ may be reduced to a finite-dimensional (of dimension proportional to N) linear algebra problem parametrized explicitly by $(x, t) \in \mathbb{R}^2$. The linear algebra problem is ill-conditioned when N is large (this difficulty can be partly ameliorated by judicious choice of Δ given x and t), but nonetheless implementing this approach numerically allows one to explore the phenomenology of the semiclassical limit while avoiding many traditional pitfalls (for example, stiffness and propagation of errors) of direct numerical simulation of the Cauchy problem for the sine-Gordon equation (1.1) when ϵ is small. For more details about implementation of this direct approach to inverse scattering see our recent paper [4].

3. ELEMENTARY TRANSFORMATIONS OF $\mathbf{J}(w)$

We now embark upon a sequence of explicit invertible transformations with the aim of converting Riemann-Hilbert Problem 2.2 into an equivalent one that is better suited to asymptotic analysis in the limit $N \rightarrow \infty$. Throughout the rest of the paper we will use the following notation for the composition of the WKB phase integral Ψ with the function E :

$$\theta_0(w) := \Psi(E(w)). \quad (3.1)$$

3.1. Choice of Δ . The set P_N can be decomposed into a disjoint union $P_N = P_N^{\mathbb{B}} \cup P_N^{\mathbb{K}}$ with $P_N^{\mathbb{B}} \cap P_N^{\mathbb{K}} = \emptyset$. Here $P_N^{\mathbb{B}}$ consists of $N_{\mathbb{B}}$ nonreal complex-conjugate pairs of complex numbers on the unit circle S^1 in the w -plane, while $P_N^{\mathbb{K}}$ consists of $N_{\mathbb{K}}$ pairs of reciprocal negative real numbers (*i.e.* of the form $(w, 1/w)$ with $w < 0$), none equal to -1 . Since each conjugate pair of poles contributes to the fluxon condensate one breather soliton while each negative pole contributes one kink soliton, the fluxon condensate may be viewed as a nonlinear superposition of $2N_{\mathbb{K}}$ kinks and $N_{\mathbb{B}}$ breathers. As a consequence of Assumption 1.6, both $N_{\mathbb{K}}$ and $N_{\mathbb{B}}$ are proportional to N and as $N \rightarrow \infty$, $P_N^{\mathbb{B}}$ fills out the whole unit circle while $P_N^{\mathbb{K}}$ fills out a negative interval of the form $[\mathbf{a}, \mathbf{b}]$ where:

$$\mathbf{a} := -\frac{1}{4} \left(\sqrt{G(0)^2 - 4} - G(0) \right)^2, \quad \mathbf{b} := -\frac{1}{4} \left(\sqrt{G(0)^2 - 4} + G(0) \right)^2 = \frac{1}{\mathbf{a}}. \quad (3.2)$$

Note that both \mathbf{a} and \mathbf{b} are independent of N and that $\mathbf{a} < -1 < \mathbf{b} < 0$. If Assumption 1.6 were not satisfied, that is, if $G(0) > -2$, then $P_N^{\mathbb{K}}$ would be empty and $P_N^{\mathbb{B}}$ would fill out a proper sub-arc of the unit circle as $N \rightarrow \infty$.

We will consider six different configurations for the subset $\Delta \subset P_N$. To each fixed number $\tau_\infty \in (\mathbf{a}, -1) \cup (-1, \mathbf{b})$ we associate a sequence $\{\tau_N\}_{N=N_0}^\infty$ of real numbers with limit τ_∞ by

$$\theta_0(\tau_N) = \pi \epsilon_N \left\lfloor \frac{\theta_0(\tau_\infty)}{\pi \epsilon_N} \right\rfloor, \quad N \geq N_0. \quad (3.3)$$

(This equation can be solved for τ_N near τ_∞ for $N \geq N_0$ with N_0 sufficiently large by the Implicit Function Theorem since the only critical point of $\theta_0(w)$ in (\mathbf{a}, \mathbf{b}) , namely $w = -1$, has been excluded.) According to the Bohr-Sommerfeld quantization rule (1.42), when N is large, τ_N is approximately halfway between two neighboring points in $P_N^{\mathbb{K}}$. The six choices of Δ we consider are the following:

- $\Delta = \emptyset$. In this case $\mathbf{J}(w) = \mathbf{H}(w)$ and Riemann-Hilbert Problems 2.1 and 2.2 coincide.
- $\Delta = P_N^{\mathbb{K}^<}$. In this case we choose $\mathbf{a} < \tau_\infty < -1$ and set $\Delta = P_N^{\mathbb{K}^<} := P_N^{\mathbb{K}} \cap [\mathbf{a}, \tau_N]$. Thus Δ is localized near $w = \mathbf{a}$.
- $\Delta = P_N^{\mathbb{K}^>}$. In this case we choose $-1 < \tau_\infty < \mathbf{b}$ and set $\Delta = P_N^{\mathbb{K}^>} := P_N^{\mathbb{K}} \cap [\tau_N, \mathbf{b}]$. Thus Δ is localized near $w = \mathbf{b}$.
- $\nabla = \emptyset$. This is complementary to the case when $\Delta = \emptyset$.
- $\nabla = P_N^{\mathbb{K}^<}$. In this case we choose $\mathbf{a} < \tau_\infty < -1$ and set $\nabla = P_N^{\mathbb{K}^<} := P_N^{\mathbb{K}} \cap [\mathbf{a}, \tau_N]$. Thus ∇ is localized near $w = \mathbf{a}$.
- $\nabla = P_N^{\mathbb{K}^>}$. In this case we choose $-1 < \tau_\infty < \mathbf{b}$ and set $\nabla = P_N^{\mathbb{K}^>} := P_N^{\mathbb{K}} \cap [\tau_N, \mathbf{b}]$. Thus ∇ is localized near $w = \mathbf{b}$.

We will refer to τ_N (and sometimes also its limit τ_∞ as $N \rightarrow \infty$) as a *transition point*. One consequence of the definition (3.3) in relation to the Bohr-Sommerfeld quantization rule (1.42) and the fact that P_N contains an even number of points is the identity

$$\frac{\theta_0(\tau_N)}{\pi \epsilon_N} = \#\Delta \pmod{2} \quad (3.4)$$

where $\#\Delta$ denotes the number of points in Δ .

For most (x, t) , specifically outside of a small neighborhood of $(x, t) = (0, 0)$, the only cases we will use are $\Delta = \emptyset$ and $\nabla = \emptyset$. In fact, $\Delta = \emptyset$ is the only case needed to analyze the behavior for small times and positive x bounded away from the origin. It is then possible to use evenness of the Cauchy data (Assumption 1.3) to obtain results for negative x . However, we include the case $\nabla = \emptyset$ for completeness (and to admit future generalizations of our methodology to non-even Cauchy data). The analysis of the neighborhood of the origin that relies on the four additional cases in which neither Δ nor ∇ is empty is somewhat more complicated and is presented in a self-contained fashion in §4.3.2. A reader not interested in these details can safely ignore all of the cases except for $\Delta = \emptyset$ and $\nabla = \emptyset$ along with references to any transition points, and may also skip most of §4.3.2.

3.2. Interpolation of residues. Removal of poles. As a consequence of the Bohr-Sommerfeld quantization rule (1.42), whenever $y \in P_N$ with $E(y) = \lambda_{N,k}^0$ then

$$\mp i e^{\pm i \theta_0(y)/\epsilon_N} = (-1)^k, \quad k = 0, \dots, N-1. \quad (3.5)$$

Thus the exponential function on the left-hand side analytically interpolates the signs $(-1)^k$ at the corresponding poles of \mathbf{J} . This gives two different ways to combine the sign $(-1)^{k+1}$ appearing in the nilpotent residue matrices in the conditions (2.34) and (2.35) with the residue factor, a fact we can use to formulate an invertible transformation of \mathbf{J} into another matrix \mathbf{M} that will not have any point singularities whatsoever.

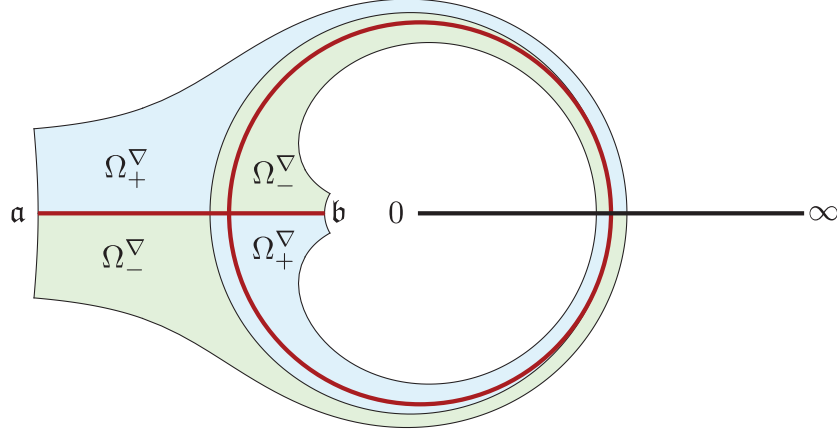

FIGURE 3.1. The case of $\Delta = \emptyset$. Here $\Omega_{\pm}^{\Delta} = \emptyset$. The set $P_{\infty} := [\mathbf{a}, \mathbf{b}] \cup S^1$ in which P_N accumulates for large N is shown in dark red for reference, and the branch cut \mathbb{R}_+ is shown with a black line.

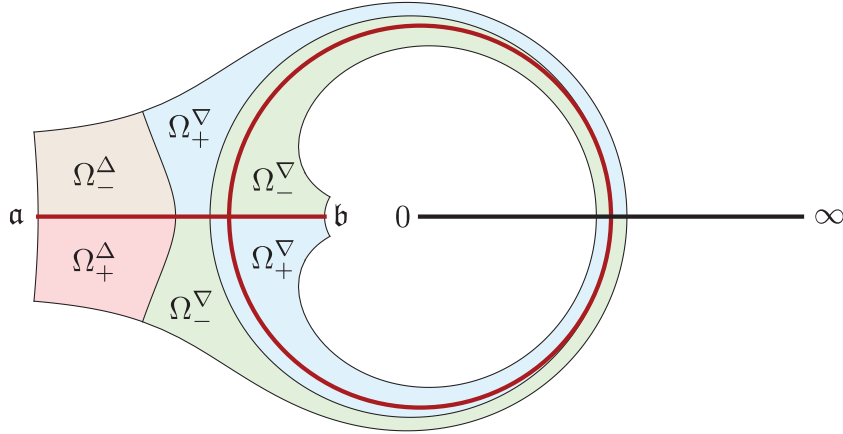

FIGURE 3.2. The case of $\Delta = P_N^{\leq K}$. The regions Ω_{\pm}^{Δ} about the real axis in the interval (\mathbf{a}, τ_N) where $\mathbf{a} < \tau_{\infty} < \min(w^+, -1)$.

We now introduce four disjoint open regions of the w -plane with $|\arg(-w)| < \pi$, denoted Ω_{\pm}^{∇} and Ω_{\pm}^{Δ} , such that $\overline{E(\Omega)} = \overline{D_+} \cup \overline{D_-}$, where $\Omega := \Omega_+^{\nabla} \cup \Omega_-^{\nabla} \cup \Omega_+^{\Delta} \cup \Omega_-^{\Delta}$, and where the open rectangles D_{\pm} are as defined following the statement of Proposition 1.2. The details of the definitions of these regions are different depending on which of the six cases of choice of Δ we are considering (see Figures 3.1–3.6), but the following features are common to all cases:

- $\overline{\Omega}$ is independent of N , x , and t , and always contains the pole locus P_N for all N . Moreover, $\overline{\Omega^{\nabla}}$ contains $\nabla \subset P_N$ while $\overline{\Omega^{\Delta}}$ contains $\Delta \subset P_N$, where $\Omega^{\nabla} := \Omega_+^{\nabla} \cup \Omega_-^{\nabla}$ and $\Omega^{\Delta} := \Omega_+^{\Delta} \cup \Omega_-^{\Delta}$. This will allow us to remove the poles from \mathbf{J} by making appropriate substitutions based on (3.5) in Ω_{\pm}^{∇} and Ω_{\pm}^{Δ} .

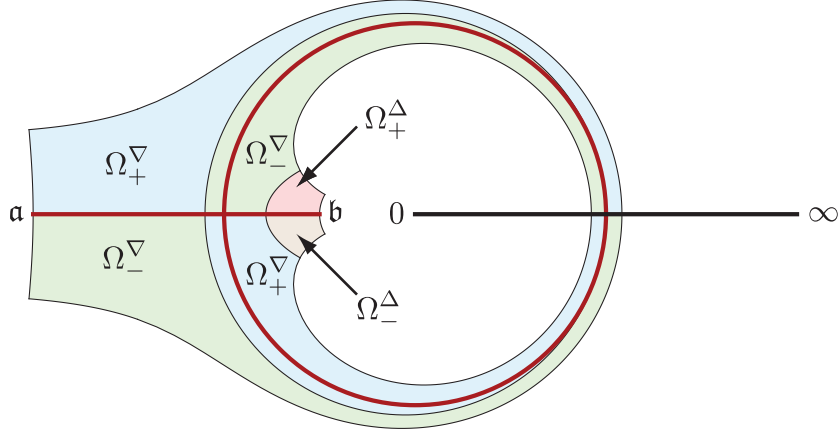

FIGURE 3.3. The case of $\Delta = P_N^{K^>}$. The regions Ω_+^Δ and Ω_-^Δ about the real axis in the interval (τ_N, \mathfrak{b}) where $\max(w^+, -1) < \tau_\infty < \mathfrak{b}$.

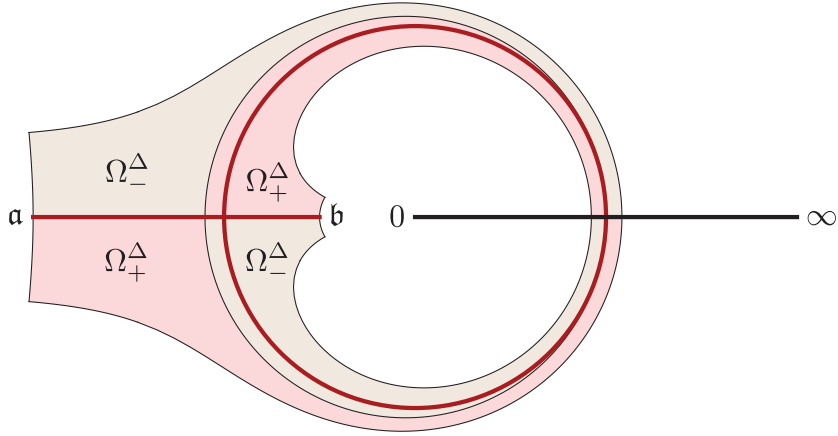

FIGURE 3.4. The case of $\nabla = \emptyset$. Here $\Omega_\pm^\nabla = \emptyset$.

- Schwartz symmetry is present: $\Omega_-^\nabla = \Omega_+^{\nabla*}$ and $\Omega_-^\Delta = \Omega_+^{\Delta*}$.
- Either the common boundary of Ω_+^∇ with Ω_-^∇ or that of Ω_+^Δ with Ω_-^Δ (but not both) contains a Schwartz-symmetric closed curve that meets the real axis at $w = 1$ and exactly one other point, $w = w^+ \in (a, \mathfrak{b})$. This closed curve is allowed to cross the unit circle at points other than $w = 1$, perhaps nontangentially.
- Only the common boundary of Ω_+^∇ and Ω_-^Δ , or the common boundary of Ω_+^Δ and Ω_-^∇ , will depend on N (necessarily through the transition point τ_N where these curves meet the real axis); the other curves must be independent of N .

For convenience, we assume that the common boundary of Ω_+^∇ and Ω_-^Δ , and also the common boundary of Ω_+^Δ and Ω_-^∇ , are arcs of level curves of $\Im\{E(w)\}$ as illustrated in Figures 3.1–3.6.

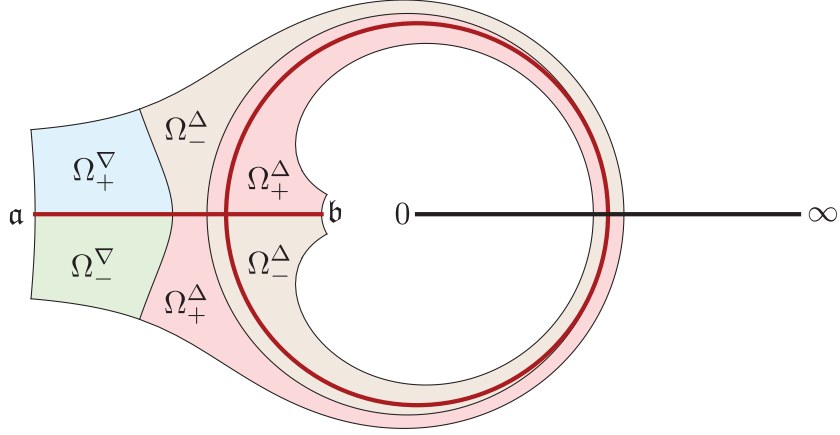

FIGURE 3.5. The case of $\nabla = P_N^{\prec K}$. The regions Ω_+^∇ and Ω_-^∇ about the real axis in the interval $(\mathbf{a}, \tau_\infty)$ where $\mathbf{a} < \tau_\infty < \min(w^+, 1)$.

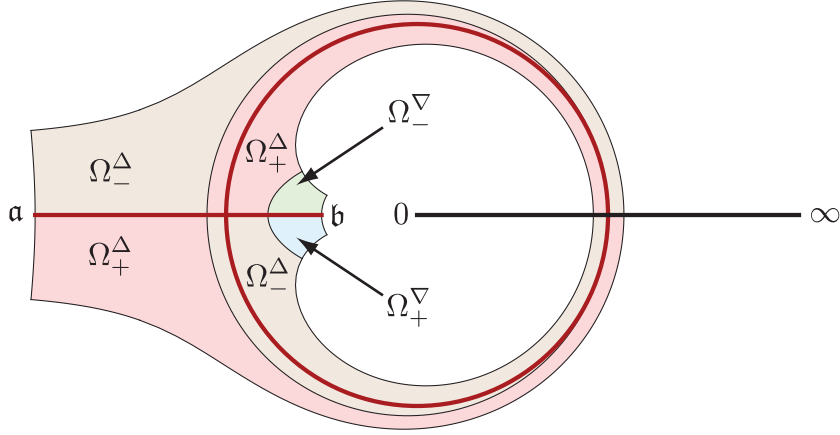

FIGURE 3.6. The case of $\nabla = P_N^{K \succ}$. The regions Ω_+^∇ and Ω_-^∇ about the real axis in the interval (τ_N, \mathbf{b}) where $\max(w^+, 1) < \tau_\infty < \mathbf{b}$.

In each of the six cases we will now transform the matrix $\mathbf{J}(w)$ into an equivalent matrix $\mathbf{M}(w) = \mathbf{M}_N(w; x, t)$ by the following explicit formula:

$$\mathbf{M}(w) := \begin{cases} \mathbf{J}(w) \begin{bmatrix} 1 & 0 \\ \mp i \Pi_N(w) e^{[2iQ(w; x, t) \pm i\theta_0(w)]/\epsilon_N} & 1 \end{bmatrix}, & w \in \Omega_\pm^\nabla, \\ \mathbf{J}(w) \begin{bmatrix} 1 & \pm i \Pi_N(w)^{-1} e^{-[2iQ(w; x, t) \pm i\theta_0(w)]/\epsilon_N} \\ 0 & 1 \end{bmatrix}, & w \in \Omega_\pm^\Delta, \\ \mathbf{J}(w), & w \in \mathbb{C} \setminus (\bar{\Omega} \cup \mathbb{R}_+). \end{cases} \quad (3.6)$$

Note that by this transformation, \mathbf{M} inherits from \mathbf{J} the Schwartz symmetry $\mathbf{M}(w^*) = \mathbf{M}(w)^*$.

It is a consequence of the interpolation formula (3.5) and the residue conditions (2.34) and (2.35) that $\mathbf{M}(w)$ has only removable singularities in and up to the boundary of each of the regions of its definition, and thus it may be considered as a sectionally analytic function of w taking continuous boundary values

on but having jump discontinuities across an oriented contour Σ that is the positively-oriented boundary of $\Omega_+^\nabla \cup \Omega_+^\Delta$ together with the negatively-oriented boundary of $\Omega_-^\nabla \cup \Omega_-^\Delta$ and two intervals of the positive real axis, which we take to be both oriented to the right.

We introduce notation for various subcontours of Σ as follows:

- The part of Σ consisting of the common boundaries of Ω_\pm^∇ (respectively Ω_\pm^Δ) omitting only the segments on the positive real axis we denote by Σ^∇ (respectively Σ^Δ).
- The common boundary of Ω_+^∇ and Ω_-^Δ will be denoted $\Sigma^{\nabla\Delta}$. The common boundary of Ω_+^Δ and Ω_-^∇ will be denoted $\Sigma^{\Delta\nabla}$.
- The common boundary of Ω_\pm^∇ (respectively Ω_\pm^Δ) and $\bar{\Omega}$ will be denoted Σ_\pm^∇ (respectively Σ_\pm^Δ). These are just the non-real arcs of $\Sigma \setminus (\Sigma^\nabla \cup \Sigma^\Delta \cup \Sigma^{\nabla\Delta} \cup \Sigma^{\Delta\nabla})$.
- The part of the common boundary of the sets Ω_\pm^∇ (respectively Ω_\pm^Δ) on the positive real line will be denoted $\Sigma_{>0}^\nabla$ (respectively $\Sigma_{>0}^\Delta$).
- The contour $\mathbb{R}_+ \setminus (\Sigma_{>0}^\nabla \cup \Sigma_{>0}^\Delta)$ will be denoted simply $\Sigma_{>0}$.

The contour Σ and its components are illustrated in Figure 3.7 for the case of $\Delta = P_N^{\leftarrow K}$. We also make

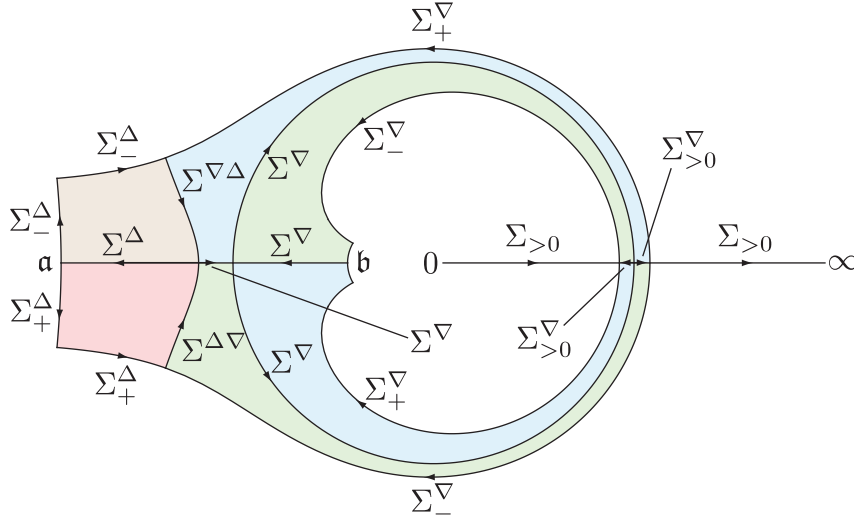

FIGURE 3.7. The components of the contour Σ in the case $\Delta = P_N^{\leftarrow K}$. Compare with Figure 3.2. Since in this case it is Ω_\pm^∇ and not Ω_\pm^Δ that meet the positive real axis near $w = 1$, the contour component $\Sigma_{>0}^\Delta$ does not exist. It is generally the case that, aside from the two disconnected components of $\Sigma_{>0}$ which are always taken to be oriented to the right, all contour arcs are oriented with regions labelled “+” on the left and regions labelled “-” on the right.

the accumulation set of P_N , $P_\infty := [\mathbf{a}, \mathbf{b}] \cup S^1$, into an oriented contour by using homotopy to $\Sigma^\nabla \cup \Sigma^\Delta$ fixing the points $w = \mathbf{a}$, $w = \tau_N$, and $w = \mathbf{b}$ to assign orientation. Note that P_∞ , taken without regard to orientation, is the inverse image under $\lambda = E(w)$ of the interval $0 \leq -4i\lambda \leq -G(0)$. The contour $\Sigma^\nabla \cup \Sigma^\Delta$ followed by $-P_\infty$ forms the boundary of a bounded region that we denote by $Z \subset \mathbb{C}$. We write $Z = Z_+ \cup Z_-$, where according to the orientation of $\Sigma^\nabla \cup \Sigma^\Delta \cup (-P_\infty)$, ∂Z_+ is positively oriented while ∂Z_- is negatively oriented.

3.3. Analysis of the jump conditions for $\mathbf{M}(w)$. The jump conditions satisfied by the continuous boundary values of $\mathbf{M}(w)$ across the contour Σ will involve the product $\Pi_N(w)$, and to formulate the jump conditions in a concise way it will be convenient to consider the asymptotic behavior of $\Pi_N(w)$ as $N \rightarrow \infty$. But

first, we introduce some elementary logarithm-type functions. For $y \notin \mathbb{R}_+$, let

$$l(w; y) := \log \left(\frac{\sqrt{-w} + \sqrt{-y}}{\sqrt{-w} - \sqrt{-y}} \right) \quad (3.7)$$

denote the principal branch, obtained by composing the principal branches of the logarithm and the square roots. For fixed y , this is a function of w that is single-valued and analytic except along a piecewise-linear branch cut consisting of a finite line segment from $w = y$ to $w = 0$ along which we have the logarithmic jump condition $l_+(w; y) - l_-(w; y) = 2\pi i$ and the semi-infinite ray \mathbb{R}_+ along which we have $l_+(w; y) + l_-(w; y) = 0$. As $w \rightarrow \infty$ in the domain of analyticity, $l(w; y) \rightarrow 0$. For $y < 0$, we define a new function by setting

$$m^K(w; y) := l(w; y) + \begin{cases} -i\pi, & |w| < 1 \text{ and } \Im\{w\} > 0, \\ i\pi, & |w| < 1 \text{ and } \Im\{w\} < 0, \\ 0, & |w| > 1. \end{cases} \quad (3.8)$$

If $y \leq -1$, then $m^K(w; y)$ has a unique analytic continuation to the interval $w \in (-1, 0)$ and has branch cuts consisting of the intervals $[y, -1]$ and \mathbb{R}_+ as well as the upper and lower arcs of the unit circle. If $-1 \leq y < 0$, then $m^K(w; y)$ has a unique analytic continuation to the interval $w \in (y, 0)$ and has branch cuts consisting of the intervals $[-1, y]$ and \mathbb{R}_+ as well as the upper and lower arcs of the unit circle. We also define a function $m^{K, \Sigma}(w; y)$ for $y < 0$ by a completely analogous formula in which the conditions $|w| < 1$ and $|w| > 1$ are respectively replaced by the conditions that w lie inside and outside of the region bounded by the nonreal arcs of $\Sigma^\nabla \cup \Sigma^\Delta$. Finally, if $y = -e^{i\omega}$ with $-\pi < \omega < \pi$, then we set

$$m^B(w; y) := l(w; y) + \begin{cases} -i\pi, & |w| < 1 \text{ and } -\pi < \arg(-w) < \omega, \\ i\pi, & |w| < 1 \text{ and } \omega < \arg(-w) < \pi, \\ 0, & |w| > 1. \end{cases} \quad (3.9)$$

This function has a unique analytic continuation to the line segment connecting $w = y$ with $w = 0$, and its branch cuts consist of the unit circle and the interval \mathbb{R}_+ .

Now, set

$$L_N^0(w) := \sum_{\substack{y \in \nabla \\ \Im\{y\}=0}} m^K(w; y)\epsilon_N - \sum_{\substack{y \in \Delta \\ \Im\{y\}=0}} m^K(w; y)\epsilon_N + \sum_{\substack{y \in \nabla \\ \Im\{y\} \neq 0}} m^B(w; y)\epsilon_N - \sum_{\substack{y \in \Delta \\ \Im\{y\} \neq 0}} m^B(w; y)\epsilon_N. \quad (3.10)$$

(For the various choices of Δ under consideration, only one of the latter two sums will be present in any one case.) This function is analytic for $w \in \mathbb{C} \setminus (P_\infty \cup \mathbb{R}_+)$ because each summand is. It also satisfies the identity $L_N^0(w^*) = L_N^0(w)^*$; indeed this holds term-by-term in the first two sums, and in each of the last two sums (whichever one is present) we may group the indices y in complex-conjugate pairs and the desired Schwartz symmetry holds for each pair. The boundary values taken by $L_N^0(w)$ on \mathbb{R}_+ satisfy $L_{N+}^0(w) + L_{N-}^0(w) = 0$ as this identity holds term-by-term in each of the sums. Finally, we have the identity

$$\Pi_N(w) = e^{L_N^0(w)/\epsilon_N}, \quad w \in \mathbb{C} \setminus (P_\infty \cup \mathbb{R}_+). \quad (3.11)$$

This identity would be completely obvious were it not for the $\pm i\pi$ contributions in the definitions of $m^K(w; y)$ and $m^B(w; y)$; that it holds in the presence of these contributions follows from the fact that $P_N = \nabla \cup \Delta$ consists of an even number of points.

Along any arc of P_∞^∇ , the part of P_∞ that is the accumulation set of ∇ , we may enumerate the points of ∇ in order $\{\dots, y_{n-1}, y_n, y_{n+1}, \dots\}$ consistent with the local orientation of P_∞ . Note that this order is the same as that of increasing k in the Bohr-Sommerfeld quantization rule (1.42). Thus, from (1.42) we have

$$\theta_0(y_{n+1}) - \theta_0(y_{n-1}) = 2\pi\epsilon_N. \quad (3.12)$$

Expanding the left-hand side around y_n gives the spacing between consecutive points of ∇ as

$$\Delta y(y_n) := \frac{y_{n+1} - y_{n-1}}{2} = \frac{\pi\epsilon_N}{\theta'_0(y_n)} + \mathcal{O}(\epsilon_N^3). \quad (3.13)$$

Therefore, for each $w \in \mathbb{C} \setminus (P_\infty \cup \mathbb{R}_+)$,

$$\begin{aligned}
& \sum_{\substack{y \in \nabla \\ \Im\{y\}=0}} m^K(w; y) \epsilon_N + \sum_{\substack{y \in \nabla \\ \Im\{y\} \neq 0}} m^B(w; y) \epsilon_N \\
&= \frac{1}{\pi} \sum_{\substack{y \in \nabla \\ \Im\{y\}=0}} \theta'_0(y) m^K(w; y) \Delta y(y) + \frac{1}{\pi} \sum_{\substack{y \in \nabla \\ \Im\{y\} \neq 0}} \theta'_0(y) m^B(w; y) \Delta y(y) \\
&= \frac{1}{\pi} \int_{P_\infty^\nabla \cap \mathbb{R}} \theta'_0(y) m^K(w; y) dy + \frac{1}{\pi} \int_{P_\infty^\nabla \cap (\mathbb{C} \setminus \mathbb{R})} \theta'_0(y) m^B(w; y) dy + \mathcal{O}(\epsilon_N^2),
\end{aligned} \tag{3.14}$$

where the second-order accuracy comes from the fact that the sum is a midpoint rule approximation to the integral away from $y = -1$ (the extreme sample points are asymptotically half as far from the endpoints of P_∞^∇ as they are from their neighbors due to the $1/2$ in the Bohr-Sommerfeld quantization rule (1.42) and the choice (3.3) of the transition point $w = \tau_N$) and the fact that $E'(-1) = 0$. In a similar way, but taking into account that $P_\infty^\Delta = P_\infty \setminus P_\infty^\nabla$ is oriented *oppositely* to the direction of increasing k in (1.42),

$$\begin{aligned}
& - \sum_{\substack{y \in \Delta \\ \Im\{y\}=0}} m^K(w; y) \epsilon_N - \sum_{\substack{y \in \Delta \\ \Im\{y\} \neq 0}} m^B(w; y) \epsilon_N \\
&= \frac{1}{\pi} \int_{P_\infty^\Delta \cap \mathbb{R}} \theta'_0(y) m^K(w; y) dy + \frac{1}{\pi} \int_{P_\infty^\Delta \cap (\mathbb{C} \setminus \mathbb{R})} \theta'_0(y) m^B(w; y) dy + \mathcal{O}(\epsilon_N^2).
\end{aligned} \tag{3.15}$$

The error terms are in fact uniform in w for w bounded away from P_∞ , and in particular, for such w ,

$$L_N^0(w) = L^0(w) + \mathcal{O}(\epsilon_N^2) \quad \text{and} \quad \Pi_N(w) e^{-L^0(w)/\epsilon_N} = 1 + \mathcal{O}(\epsilon_N), \quad N \rightarrow \infty, \tag{3.16}$$

where

$$L^0(w) := \frac{1}{\pi} \int_{P_\infty \cap \mathbb{R}} \theta'_0(y) m^K(w; y) dy + \frac{1}{\pi} \int_{P_\infty \cap (\mathbb{C} \setminus \mathbb{R})} \theta'_0(y) m^B(w; y) dy. \tag{3.17}$$

This ‘‘continuum limit’’ of $L_N^0(w)$ is analytic for $w \in \mathbb{C} \setminus (P_\infty \cup \mathbb{R}_+)$ and shares the same symmetry properties as its discretization: $L^0(w^*) = L^0(w)^*$, and $L_+^0(w) + L_-^0(w) = 0$ for $w \in \mathbb{R}_+$.

Another useful form of $L^0(w)$ is easily obtained by integrating by parts. In the integral over $P_\infty \cap \mathbb{R}$, one expects endpoint contributions from the two points $y = \mathfrak{a}$ and $y = \mathfrak{b}$, as well as from the points $y = -1$ and $y = \tau_N$ (the latter only if neither Δ nor ∇ is empty so that a transition point exists) where the orientation of P_∞ changes. In the integral over $P_\infty \cap (\mathbb{C} \setminus \mathbb{R})$ one expects endpoint contributions from the two points at $y = 1$ on opposite sides of the branch cut \mathbb{R}_+ and from the two points at $y = -1$. However, since $m^K(w; -1) = m^B(w; -1)$ the contributions from $y = -1$ will cancel between the two integrals. Also, in the integral over $P_\infty \cap (\mathbb{C} \setminus \mathbb{R})$ the sum of the contributions from the two endpoints at $y = 1$ vanishes because $E(y) = 0$ for both points and $m^B(w; 1+) + m^B(w; 1-) = 0$. Furthermore, in the integral over $P_\infty \cap \mathbb{R}$ the contributions from the endpoints $y = \mathfrak{a}$ and $y = \mathfrak{b}$ both vanish individually because both correspond to $E(y) = -iG(0)/4$, the point at which $\theta_0(y)$ vanishes. On the other hand, the contribution from $y = \tau_N$ generally survives, but it takes a particularly simple form: $\pm 2\theta_0(\tau_N) m^K(w; \tau_N)/\pi$, where the ‘‘+’’ sign (respectively ‘‘-’’ sign) corresponds to the case when P_∞ is oriented toward (respectively away from) the transition point $y = \tau_N$. But according to the condition (3.3) characterizing the transition point τ_N , this contribution can be written as $2\epsilon_N n m^K(w; \tau_N)$ where $n \in \mathbb{Z}$, and according to (3.4), $n = \#\Delta \pmod{2}$. Explicitly differentiating $m^K(w; y)$ and $m^B(w; y)$ with respect to y to integrate by parts then yields

$$L^0(w) = \frac{\sqrt{-w}}{\pi} \int_{P_\infty} \frac{\theta_0(y)}{\sqrt{-y}} \frac{dy}{y-w} + 2\epsilon_N n m^K(w; \tau_N). \tag{3.18}$$

This form of $L^0(w)$ allows us to exploit analyticity of $\theta_0(\cdot)$ on P_∞ to apply Cauchy’s Theorem, showing that

$$L^0(w) = L(w) + \begin{cases} \mp 2i\theta_0(w) \pmod{2\pi i\epsilon_N}, & w \in Z_\pm \\ 0, & w \in \mathbb{C} \setminus \overline{Z}, \end{cases} \tag{3.19}$$

where

$$L(w) := \frac{\sqrt{-w}}{\pi} \int_{\Sigma^\nabla \cup \Sigma^\Delta} \frac{\theta_0(y)}{\sqrt{-y}} \frac{dy}{y-w} + 2\epsilon_N n m^{K, \Sigma}(w; \tau_N). \quad (3.20)$$

In this definition of $L(w)$, the function $\theta_0(y)$ in the integrand denotes the analytic continuation of the function of the same name from P_∞ . The domain of analyticity of $L(w)$ is therefore $\mathbb{C} \setminus (\Sigma^\nabla \cup \Sigma^\Delta \cup \mathbb{R}_+)$. Like $L^0(w)$, $L(w)$ has Schwartz symmetry ($L(w^*) = L(w)^*$) and satisfies $L_+(w) + L_-(w) = 0$ for $w \in \mathbb{R}_+$. Furthermore,

$$L_+(\xi) - L_-(\xi) = 2i\theta_0(\xi) + \begin{cases} 2\pi i \epsilon_N \# \Delta \pmod{4\pi i \epsilon_N}, & \xi \in (\Sigma^\nabla \cup \Sigma^\Delta) \cap (\mathbb{C} \setminus \mathbb{R}) \\ 0 \pmod{4\pi i \epsilon_N}, & \xi \in (\Sigma^\nabla \cup \Sigma^\Delta) \cap \mathbb{R}, \end{cases} \quad (3.21)$$

and moreover the exact relation $L_+(\xi) - L_-(\xi) = 2i\theta_0(\xi)$ holds for those $\xi \in (\Sigma^\nabla \cup \Sigma^\Delta) \cap \mathbb{R}$ that do not lie on the branch cut of $m^{K, \Sigma}(w; \tau_N)$. We define for future reference

$$Y(w) := \Pi_N(w) e^{-L(w)/\epsilon_N}, \quad (3.22)$$

a quantity that by (3.16) and (3.20) is uniformly 1 + $\mathcal{O}(\epsilon_N)$ for w bounded away from Z and P_∞ .

Let $\bar{L}(\xi)$ denote the average of boundary values taken by $L(w)$ on $\Sigma^\nabla \cup \Sigma^\Delta$:

$$\bar{L}(\xi) := \frac{1}{2} (L_+(\xi) + L_-(\xi)), \quad \xi \in \Sigma^\nabla \cup \Sigma^\Delta. \quad (3.23)$$

We now introduce two quantities closely related to this average:

$$\varphi^\nabla(\xi) := \bar{L}(\xi) + \begin{cases} i\pi n \epsilon_N, & \xi \in \Sigma^\nabla, \Im\{\xi\} > 0, \\ 0, & \xi \in \Sigma^\nabla, \Im\{\xi\} = 0, \\ -i\pi n \epsilon_N, & \xi \in \Sigma^\nabla, \Im\{\xi\} < 0, \end{cases} \quad (3.24)$$

and

$$\varphi^\Delta(\xi) := \bar{L}(\xi) + \begin{cases} i\pi n \epsilon_N, & \xi \in \Sigma^\Delta, \Im\{\xi\} > 0, \\ 0, & \xi \in \Sigma^\Delta, \Im\{\xi\} = 0, \\ -i\pi n \epsilon_N, & \xi \in \Sigma^\Delta, \Im\{\xi\} < 0. \end{cases} \quad (3.25)$$

It follows from Proposition 1.2 that φ^∇ and φ^Δ are analytic functions on each arc of Σ^∇ and Σ^Δ respectively. The self-intersection point $\xi = w^+$ lies either in Σ^∇ or Σ^Δ , and the additive constants in the definitions (3.24) and (3.25) ensure that for the relevant function analyticity extends to a full complex neighborhood of $\xi = w^+$. Now set

$$T^\nabla(\xi) := 2\Pi_N(\xi) \cos(\epsilon_N^{-1} \theta_0(\xi)) e^{-\varphi^\nabla(\xi)/\epsilon_N}, \quad \xi \in \bar{\Sigma}^\nabla \quad (3.26)$$

and

$$T^\Delta(\xi) := 2\Pi_N(\xi)^{-1} \cos(\epsilon_N^{-1} \theta_0(\xi)) e^{\varphi^\Delta(\xi)/\epsilon_N}, \quad \xi \in \bar{\Sigma}^\Delta. \quad (3.27)$$

According to the Bohr-Sommerfeld quantization rule (1.42), these functions are analytic where defined (all singularities are removable), and we shall denote the analytic continuations from the contours of definition by the same symbols. Moreover, it can be proved that both $T^\nabla(w) \approx 1$ and $T^\Delta(w) \approx 1$, a fact whose proof is only slightly more subtle than the analysis of $Y(w)$ presented above (the proof given in [2] relates the product $\Pi_N(w)$ to the Gamma function and applies the reflection identity $\Gamma(z)\Gamma(1-z)\sin(\pi z) = \pi$ and Stirling's formula). We formalize our results concerning the functions Y , T^∇ , and T^Δ with this proposition:

Proposition 3.1 (Baik *et. al.*, [2]). *The function $Y(w)$ is analytic for $w \in \mathbb{C} \setminus (\Sigma^\nabla \cup \Sigma^\Delta \cup P_\infty \cup \mathbb{R}_+)$. Uniformly on compact sets in the domain of analyticity disjoint from the region Z in between P_∞ and $\Sigma^\nabla \cup \Sigma^\Delta$,*

$$Y(w) = 1 + \mathcal{O}(\epsilon_N). \quad (3.28)$$

This estimate fails if w approaches either \mathbf{a} or \mathbf{b} from within the above region of definition, but nonetheless both $Y(w)$ and $Y(w)^{-1}$ remain bounded if these points are approached nontangentially to the real axis. On the other hand, uniformly on compact subsets of Z_\pm ,

$$Y(w) = e^{\mp 2i\theta_0(w)/\epsilon_N} (1 + \mathcal{O}(\epsilon_N)). \quad (3.29)$$

The function $T^\nabla(w)$ is analytic for $w \in \overline{\Omega_+^\nabla} \cup \overline{\Omega_-^\nabla} \setminus (\mathbb{R}_+ \cup \{\mathbf{a}, \mathbf{b}, \tau_N\})$, and uniformly on each compact set in the interior of this region,

$$T^\nabla(w) = 1 + \mathcal{O}(\epsilon_N). \quad (3.30)$$

This estimate fails if w approaches either \mathbf{a} or \mathbf{b} from within the above region of definition, but nonetheless $T^\nabla(w)$ remains uniformly bounded near these points as $\epsilon_N \downarrow 0$.

The function $T^\Delta(w)$ is analytic for $w \in \overline{\Omega_+^\Delta} \cup \overline{\Omega_-^\Delta} \setminus (\mathbb{R}_+ \cup \{\mathbf{a}, \mathbf{b}, \tau_N\})$, and uniformly on each compact set in the interior of this region,

$$T^\Delta(w) = 1 + \mathcal{O}(\epsilon_N). \quad (3.31)$$

As above, this estimate fails if w approaches either \mathbf{a} or \mathbf{b} from within the region where $T^\Delta(w)$ is defined but still $T^\Delta(w)$ remains bounded.

Finally, we have the algebraic relations

$$T^\nabla(w) = Y(w) \left(1 + e^{\pm 2i\theta_0(w)/\epsilon_N} \right), \quad w \in \overline{\Omega_\pm^\nabla} \setminus \mathbb{R}, \quad (3.32)$$

and

$$T^\Delta(w) = Y(w)^{-1} \left(1 + e^{\pm 2i\theta_0(w)/\epsilon_N} \right), \quad w \in \overline{\Omega_\mp^\Delta} \setminus \mathbb{R}. \quad (3.33)$$

The proof of (3.28) and (3.29) has essentially been given above, and the algebraic relations (3.32) and (3.33) follow directly from the definitions of $Y(w)$, $T^\nabla(w)$, and $T^\Delta(w)$ with the use of the jump condition (3.21). The asymptotic relations (3.30) and (3.31) are easily proved from the other results *as long as w is kept bounded away from P_∞* . For example, suppose $w \in \Omega_+^\Delta$, in which case $T^\Delta(w) = Y(w)^{-1}(1 + e^{2i\theta_0(w)/\epsilon_N})$ according to (3.33), and w lies on the right of Σ^Δ so $w \notin Z_+$. If also $w \in E^{-1}(D_+)$, then w lies on the right of P_∞ so $w \notin Z_-$, in which case (3.28) applies and we obtain (3.31) from the inequality $\Im\{\theta_0(w)\} > 0$. On the other hand if also $w \in E^{-1}(D_-)$, then w lies on the left of P_∞ so $w \in Z_-$, in which case (3.29) applies and we obtain (3.31) from the inequality $\Im\{\theta_0(w)\} < 0$. Note, however, that the case when w is near P_∞ must be considered separately; see [2] for details.

With the notation of $Y(w)$, $T^\nabla(w)$, and $T^\Delta(w)$ established, we may write down the jump condition satisfied by $\mathbf{M}(w)$ across the various arcs of Σ in a simple form. Indeed, we have

$$\mathbf{M}_+(\xi) = \mathbf{M}_-(\xi) \begin{bmatrix} 1 & 0 \\ -iT^\nabla(\xi)e^{[2iQ(\xi)+\varphi^\nabla(\xi)]/\epsilon_N} & 1 \end{bmatrix}, \quad \xi \in \vec{\Sigma}^\nabla, \quad (3.34)$$

$$\mathbf{M}_+(\xi) = \mathbf{M}_-(\xi) \begin{bmatrix} 1 & iT^\Delta(\xi)e^{-[2iQ(\xi)+\varphi^\Delta(\xi)]/\epsilon_N} \\ 0 & 1 \end{bmatrix}, \quad \xi \in \vec{\Sigma}^\Delta, \quad (3.35)$$

$$\mathbf{M}_+(\xi) = \mathbf{M}_-(\xi) \begin{bmatrix} 1 + e^{2i\theta_0(\xi)/\epsilon_N} & iY(\xi)^{-1}e^{-[2iQ(\xi)+L(\xi)-i\theta_0(\xi)]/\epsilon_N} \\ -iY(\xi)e^{[2iQ(\xi)+L(\xi)+i\theta_0(\xi)]/\epsilon_N} & 1 \end{bmatrix}, \quad \xi \in \vec{\Sigma}^{\nabla\Delta}, \quad (3.36)$$

$$\mathbf{M}_+(\xi) = \mathbf{M}_-(\xi) \begin{bmatrix} 1 & iY(\xi)^{-1}e^{-[2iQ(\xi)+L(\xi)+i\theta_0(\xi)]/\epsilon_N} \\ -iY(\xi)e^{[2iQ(\xi)+L(\xi)-i\theta_0(\xi)]/\epsilon_N} & 1 + e^{-2i\theta_0(\xi)/\epsilon_N} \end{bmatrix}, \quad \xi \in \vec{\Sigma}^{\Delta\nabla}, \quad (3.37)$$

$$\mathbf{M}_+(\xi) = \mathbf{M}_-(\xi) \begin{bmatrix} 1 & 0 \\ -iY(\xi)e^{[2iQ(\xi)+L(\xi)\pm i\theta_0(\xi)]/\epsilon_N} & 1 \end{bmatrix}, \quad \xi \in \vec{\Sigma}_\pm^\nabla, \quad (3.38)$$

$$\mathbf{M}_+(\xi) = \mathbf{M}_-(\xi) \begin{bmatrix} 1 & -iY(\xi)^{-1}e^{-[2iQ(\xi)+L(\xi)\mp i\theta_0(\xi)]/\epsilon_N} \\ 0 & 1 \end{bmatrix}, \quad \xi \in \vec{\Sigma}_\pm^\Delta, \quad (3.39)$$

$$\mathbf{M}_+(\xi) = \sigma_2 \mathbf{M}_-(\xi) \sigma_2 \begin{bmatrix} 1 + e^{i[\theta_0+(\xi)-\theta_0-(\xi)]/\epsilon_N} & iY_-(\xi)e^{[2iQ_-(\xi)+L_-(\xi)-i\theta_0-(\xi)]/\epsilon_N} \\ -iY_+(\xi)e^{[2iQ_+(\xi)+L_+(\xi)+i\theta_0+(\xi)]/\epsilon_N} & 1 \end{bmatrix}, \quad \xi \in \vec{\Sigma}_{>0}^\nabla, \quad (3.40)$$

$$\mathbf{M}_+(\xi) = \sigma_2 \mathbf{M}_-(\xi) \sigma_2 \begin{bmatrix} 1 & iY_+(\xi)^{-1}e^{-[2iQ_+(\xi)+L_+(\xi)+i\theta_0+(\xi)]/\epsilon_N} \\ -iY_-(\xi)^{-1}e^{-[2iQ_-(\xi)+L_-(\xi)-i\theta_0-(\xi)]/\epsilon_N} & 1 + e^{-i[\theta_0+(\xi)-\theta_0-(\xi)]/\epsilon_N} \end{bmatrix}, \quad \xi \in \vec{\Sigma}_{>0}^\Delta, \quad (3.41)$$

and finally,

$$\mathbf{M}_+(\xi) = \sigma_2 \mathbf{M}_-(\xi) \sigma_2, \quad \xi \in \vec{\Sigma}_{>0}^\Delta. \quad (3.42)$$

In deriving the jump conditions (3.40) and (3.41) we used the fact that for $\xi \in \vec{\mathbb{R}}_+$, $Q_+(\xi) + Q_-(\xi) \equiv 0$ and $\Pi_{N_+}(\xi)\Pi_{N_-}(\xi) \equiv 1$. Written this way, the jump relations display the key importance of the exponents

$2iQ(\xi) + L(\xi) \pm i\theta_0(\xi)$, $2iQ(\xi) + \varphi^\nabla(\xi)$, and $2iQ(\xi) + \varphi^\Delta(\xi)$. It remains to introduce a mechanism to control the corresponding exponentials, and this is the purpose of the next transformation.

3.4. Control of exponentials. The so-called g -function. Let $g(w)$ be a scalar function analytic for $w \in \mathbb{C} \setminus (\Sigma^\nabla \cup \Sigma^\Delta \cup \mathbb{R}_+)$. In terms of this to-be-determined function, a new unknown can be obtained from $\mathbf{M}(w)$ as follows:

$$\mathbf{N}(w) := \mathbf{M}(w)e^{-g(w)\sigma_3/\epsilon_N}. \quad (3.43)$$

It follows that

$$\mathbf{N}_+(\xi) = \mathbf{N}_-(\xi) \begin{bmatrix} e^{-i\theta(\xi)/\epsilon_N} & 0 \\ -iT^\nabla(\xi)e^{\phi(\xi)/\epsilon_N} & e^{i\theta(\xi)/\epsilon_N} \end{bmatrix}, \quad \xi \in \bar{\Sigma}^\nabla, \quad \Im\{\xi\} = 0, \quad (3.44)$$

$$\mathbf{N}_+(\xi) = \mathbf{N}_-(\xi) \begin{bmatrix} e^{-i\theta(\xi)/\epsilon_N} & 0 \\ -iT^\nabla(\xi)e^{[\phi(\xi)+i\pi\epsilon_N\#\Delta]/\epsilon_N} & e^{i\theta(\xi)/\epsilon_N} \end{bmatrix}, \quad \xi \in \bar{\Sigma}^\nabla, \quad \Im\{\xi\} \neq 0, \quad (3.45)$$

and

$$\mathbf{N}_+(\xi) = \mathbf{N}_-(\xi) \begin{bmatrix} e^{-i\theta(\xi)/\epsilon_N} & iT^\Delta(\xi)e^{-\phi(\xi)/\epsilon_N} \\ 0 & e^{i\theta(\xi)/\epsilon_N} \end{bmatrix}, \quad \xi \in \bar{\Sigma}^\Delta, \quad \Im\{\xi\} = 0, \quad (3.46)$$

$$\mathbf{N}_+(\xi) = \mathbf{N}_-(\xi) \begin{bmatrix} e^{-i\theta(\xi)/\epsilon_N} & iT^\Delta(\xi)e^{-[\phi(\xi)+i\pi\epsilon_N\#\Delta]/\epsilon_N} \\ 0 & e^{i\theta(\xi)/\epsilon_N} \end{bmatrix}, \quad \xi \in \bar{\Sigma}^\Delta, \quad \Im\{\xi\} \neq 0, \quad (3.47)$$

where

$$\theta(\xi) := -i(g_+(\xi) - g_-(\xi)) \quad \text{and} \quad \phi(\xi) := 2iQ(\xi) + \bar{L}(\xi) - g_+(\xi) - g_-(\xi), \quad \xi \in \bar{\Sigma}^\nabla \cup \bar{\Sigma}^\Delta. \quad (3.48)$$

These definitions assume that the indicated boundary values of g exist unambiguously (independent of direction of approach). The key to the Deift-Zhou steepest-descent method in this context is to choose $g(w)$ and the non-real arcs of the contour Σ^∇ or Σ^Δ so that the functions $\theta(\xi)$ and $\phi(\xi)$ have properties that can be exploited to make the matrix $\mathbf{N}(w)$ easy to approximate in the limit $\epsilon_N \rightarrow 0$.

Consider the analytic matrix functions defined as follows:

$$\mathbf{L}^\nabla(w) := \begin{cases} T^\nabla(w)^{-\sigma_3/2} \begin{bmatrix} 1 & -ie^{-[2iQ(w)+L(w)-i\theta_0(w)-2g(w)]/\epsilon_N} \\ 0 & 1 \end{bmatrix}, & w \in \Omega_+^\nabla, \\ T^\nabla(w)^{-\sigma_3/2} \begin{bmatrix} 1 & ie^{-[2iQ(w)+L(w)+i\theta_0(w)-2g(w)]/\epsilon_N} \\ 0 & 1 \end{bmatrix}, & w \in \Omega_-^\nabla, \end{cases} \quad (3.49)$$

$$\mathbf{L}^\Delta(w) := \begin{cases} T^\Delta(w)^{\sigma_3/2} \begin{bmatrix} 1 & 0 \\ ie^{[2iQ(w)+L(w)-i\theta_0(w)-2g(w)]/\epsilon_N} & 1 \end{bmatrix}, & w \in \Omega_+^\Delta, \\ T^\Delta(w)^{\sigma_3/2} \begin{bmatrix} 1 & 0 \\ -ie^{[2iQ(w)+L(w)+i\theta_0(w)-2g(w)]/\epsilon_N} & 1 \end{bmatrix}, & w \in \Omega_-^\Delta, \end{cases} \quad (3.50)$$

where the square roots $T^\nabla(w)^{1/2}$ and $T^\Delta(w)^{1/2}$ are defined to be the principal branches, so that in view of (3.30) and (3.31) from Proposition 3.1 we have $T^\nabla(w)^{1/2} \approx 1$ and $T^\Delta(w)^{1/2} \approx 1$ throughout the domain of definition of $\mathbf{L}^\nabla(w)$ and $\mathbf{L}^\Delta(w)$ respectively.

Proposition 3.2. *The jump conditions for $\mathbf{N}(w)$ on the contours $\Sigma^{\nabla\Delta}$ and $\Sigma^{\Delta\nabla}$ may be written in the form*

$$\mathbf{N}_+(\xi)\mathbf{L}_+^\nabla(\xi) = \mathbf{N}_-(\xi)\mathbf{L}_-^\Delta(\xi), \quad \xi \in \bar{\Sigma}^{\nabla\Delta} \quad (3.51)$$

and

$$\mathbf{N}_+(\xi)\mathbf{L}_+^\Delta(\xi) = \mathbf{N}_-(\xi)\mathbf{L}_-^\nabla(\xi), \quad \xi \in \bar{\Sigma}^{\Delta\nabla}. \quad (3.52)$$

Proof. Note that on $\bar{\Sigma}^{\nabla\Delta}$ and $\bar{\Sigma}^{\Delta\nabla}$ we have $Q_+(\xi) = Q_-(\xi)$, $L_+(\xi) = L_-(\xi)$, $g_+(\xi) = g_-(\xi)$, $Y_+(\xi) = Y_-(\xi)$, and $\theta_{0+}(\xi) = \theta_{0-}(\xi)$. The formulae (3.51) and (3.52) then follow from taking principal branch square roots factor-by-factor in the algebraic identities (3.32) and (3.33), a meaningful step since $\Sigma^{\nabla\Delta}$ and $\Sigma^{\Delta\nabla}$ are disjoint from Z . \square

Proposition 3.3. *Suppose that*

$$g_+(\xi) + g_-(\xi) = 0, \quad \xi \in \vec{\mathbb{R}}_+. \quad (3.53)$$

Then, the jump conditions for $\mathbf{N}(w)$ on the contours $\Sigma_{>0}^\nabla$ and $\Sigma_{>0}^\Delta$ may be written in the form

$$\mathbf{N}_+(\xi)\mathbf{L}_+^\nabla(\xi) = \sigma_2\mathbf{N}_-(\xi)\mathbf{L}_-^\nabla(\xi)\sigma_2 \begin{bmatrix} 1 + A^\nabla(\xi) & B^\nabla(\xi)e^{-[2iQ_+(\xi)+L_+(\xi)-2g_+(\xi)]/\epsilon_N} \\ B^\nabla(\xi)e^{[2iQ_+(\xi)+L_+(\xi)-2g_+(\xi)]/\epsilon_N} & 1 + A^\nabla(\xi) \end{bmatrix}, \quad \xi \in \vec{\Sigma}_{>0}^\nabla, \quad (3.54)$$

where

$$A^\nabla(\xi) = \mathcal{O}(\epsilon_N) \quad \text{and} \quad B^\nabla(\xi) = \mathcal{O}\left(\epsilon_N \frac{\lambda^2}{\epsilon_N^2} e^{-\alpha\lambda/\epsilon_N}\right), \quad \lambda = E_+(\xi) > 0, \quad (3.55)$$

and

$$\mathbf{N}_+(\xi)\mathbf{L}_+^\Delta(\xi) = \sigma_2\mathbf{N}_-(\xi)\mathbf{L}_-^\Delta(\xi)\sigma_2 \begin{bmatrix} 1 + A^\Delta(\xi) & B^\Delta(\xi)e^{-[2iQ_+(\xi)+L_+(\xi)-2g_+(\xi)]/\epsilon_N} \\ B^\Delta(\xi)e^{[2iQ_+(\xi)+L_+(\xi)-2g_+(\xi)]/\epsilon_N} & 1 + A^\Delta(\xi) \end{bmatrix}, \quad \xi \in \vec{\Sigma}_{>0}^\Delta, \quad (3.56)$$

where

$$A^\Delta(\xi) = \mathcal{O}(\epsilon_N) \quad \text{and} \quad B^\Delta(\xi) = \mathcal{O}\left(\epsilon_N \frac{\lambda^2}{\epsilon_N^2} e^{-\alpha\lambda/\epsilon_N}\right), \quad \lambda = E_-(\xi) > 0. \quad (3.57)$$

In both (3.55) and (3.57) the parameter $\alpha > 0$ is defined in Proposition 1.2. Also,

$$\mathbf{N}_+(\xi) = \sigma_2\mathbf{N}_-(\xi)\sigma_2, \quad \xi \in \vec{\Sigma}_{>0}. \quad (3.58)$$

Proof. The relation (3.58) follows directly from (3.42) and (3.43) taking into account the given condition (3.53) on the boundary values of g . To prove (3.55) and (3.57), note firstly that from (1.39), (2.1), and (3.20) one has both

$$Q_+(\xi) + Q_-(\xi) = 0 \quad \text{and} \quad e^{\frac{1}{2}[L_+(\xi)+L_-(\xi)]/\epsilon_N} = 1, \quad \xi \in \vec{\mathbb{R}}_+. \quad (3.59)$$

From the latter it follows also that $Y_+(\xi)Y_-(\xi) = 1$ for $\xi \in \vec{\mathbb{R}}_+$. Since \mathbb{R}_+ is disjoint from Z , we may define $Y(w)^{1/2}$ as the principal branch of the square root for w just above and below \mathbb{R}_+ and it follows from (3.28) from Proposition 3.1 that $Y_+(\xi)^{1/2}Y_-(\xi)^{1/2} = 1$ for $\xi \in \vec{\mathbb{R}}_+$ also. Now from taking principal branch square roots factor-by-factor in (3.32) and (3.33) one can express the factors $T^\nabla(w)^{1/2}$ and $T^\Delta(w)^{1/2}$ appearing in (3.49) and (3.50) in terms of $Y(w)^{1/2}$ and the principal branches $(1 + e^{\pm\theta_0(w)/\epsilon_N})^{1/2}$, which are also well-defined for $w \in \mathbb{R}_+$.

One may now combine these facts and definitions with the jump conditions (3.40) and (3.41) to see that (3.54) holds where for $\xi \in \vec{\Sigma}_{>0}^\nabla$,

$$\begin{aligned} A^\nabla(\xi) &:= \frac{1 + e^{i[\theta_{0+}(\xi)-\theta_{0-}(\xi)]/\epsilon_N}}{(1 + e^{2i\theta_{0+}(\xi)/\epsilon_N})^{1/2}(1 + e^{-2i\theta_{0-}(\xi)/\epsilon_N})^{1/2}} - 1 \\ B^\nabla(\xi) &:= -i \frac{e^{i\theta_{0+}(\xi)/\epsilon_N} - e^{-i\theta_{0-}(\xi)/\epsilon_N}}{(1 + e^{2i\theta_{0+}(\xi)/\epsilon_N})^{1/2}(1 + e^{-2i\theta_{0-}(\xi)/\epsilon_N})^{1/2}}, \end{aligned} \quad (3.60)$$

and that (3.56) holds where for $\xi \in \vec{\Sigma}_{>0}^\Delta$,

$$\begin{aligned} A^\Delta(\xi) &:= \frac{1 + e^{-i[\theta_{0+}(\xi)-\theta_{0-}(\xi)]/\epsilon_N}}{(1 + e^{-2i\theta_{0+}(\xi)/\epsilon_N})^{1/2}(1 + e^{2i\theta_{0-}(\xi)/\epsilon_N})^{1/2}} - 1 \\ B^\Delta(\xi) &:= -i \frac{e^{i\theta_{0-}(\xi)/\epsilon_N} - e^{-i\theta_{0+}(\xi)/\epsilon_N}}{(1 + e^{-2i\theta_{0+}(\xi)/\epsilon_N})^{1/2}(1 + e^{2i\theta_{0-}(\xi)/\epsilon_N})^{1/2}}. \end{aligned} \quad (3.61)$$

The desired estimates on $A^\nabla(\xi)$, $B^\nabla(\xi)$, $A^\Delta(\xi)$, and $B^\Delta(\xi)$ now follow from Proposition 1.2, in particular from the Taylor series of $\Psi(\lambda)$ about $\lambda = 0$. Indeed, given $\xi \in \mathbb{R}_+$, $E_+(\xi) + E_-(\xi) = 0$, and moreover $E_+(\xi)$ is real and positive for $\xi \in \vec{\Sigma}_{>0}^\nabla$ and real and negative for $\xi \in \vec{\Sigma}_{>0}^\Delta$ (the change of sign comes from the reversal

of orientation). Therefore, recalling (3.1), using (1.52) from Proposition 1.2 together with Assumption 1.5, and writing

$$\nu(\lambda^2) := \sum_{n=1}^{\infty} \beta_n \lambda^{2n}, \quad (3.62)$$

we find

$$A^\nabla(\xi) = \left| 1 + \frac{e^{-2\alpha\lambda/\epsilon_N}}{1 + e^{-2\alpha\lambda/\epsilon_N}} \left[e^{2i\nu(\lambda^2)/\epsilon} - 1 \right] \right|^{-1} - 1 = \mathcal{O} \left(\frac{\lambda^2}{\epsilon_N} e^{-2\alpha\lambda/\epsilon_N} \right) = \mathcal{O}(\epsilon_N), \quad \lambda = E_+(\xi) > 0 \quad (3.63)$$

and

$$B^\nabla(\xi) = 2(-1)^N \frac{e^{-\alpha\lambda/\epsilon_N} \sin(\epsilon_N^{-1} \nu(\lambda^2))}{|1 + e^{-2\alpha\lambda/\epsilon_N} e^{2i\nu(\lambda^2)/\epsilon_N}|} = \mathcal{O} \left(\frac{\lambda^2}{\epsilon_N} e^{-\alpha\lambda/\epsilon_N} \right), \quad \lambda = E_+(\xi) > 0, \quad (3.64)$$

therefore proving (3.55). In exactly the same way one obtains the estimates (3.57), thereby completing the proof. \square

Note that in the special case in which $\Psi(\lambda)$ is given by the formula (1.57), the error terms in (3.55) and (3.57) vanish identically, a fact that was exploited to simplify the analysis of the semiclassical limit of the focusing nonlinear Schrödinger equation with corresponding special initial data in [17].

4. CONSTRUCTION OF $g(w)$

We proceed under the assumption that the Riemann-Hilbert problem for \mathbf{N} will reduce, under appropriate changes of variables, to a problem solved using a genus-1 Riemann surface (*i.e.*, an elliptic curve), at least for small t and x bounded away from $\pm x_{\text{crit}}$. This assumption is consistent with the qualitative behavior observed in Figure 1.2, in which the solution appears to have one oscillatory phase for these values of x and t . In other parts of the space-time plane, the solution appears to have more than one oscillatory phase, suggesting that the corresponding Riemann-Hilbert problem will be solved using a Riemann surface of genus greater than one, which will require modifying the following calculations.

4.1. Two types of “genus-1” ansatz for $g(w)$. Let \mathbf{p} and \mathbf{q} be real parameters and consider the quadratic polynomial $R(w; \mathbf{p}, \mathbf{q})^2$ given by

$$R(w; \mathbf{p}, \mathbf{q})^2 := (w - \mathbf{p})^2 - \mathbf{q}. \quad (4.1)$$

When working in a region of the space-time plane where more than one nonlinear phase is expected, it is necessary to choose $R(w)^2$ to be a higher-degree polynomial (with a corresponding increase in the number of parameters $\mathbf{p}_j, \mathbf{q}_j$ specifying the roots of $R(w)^2$).

We must distinguish two cases, which we label as “L” and “R” as these will correspond ultimately to local asymptotics for the fluxon condensate $u_N(x, t)$ in terms of periodic librational and rotational wavetrains, respectively.

L This case is defined by the inequality $\mathbf{q} < 0$. The quadratic $R(w; \mathbf{p}, \mathbf{q})^2$ has distinct roots forming a complex-conjugate pair $w = \mathbf{p} \pm i\sqrt{-\mathbf{q}}$. The roots are assumed to lie on the nonreal arcs of the contour $\Sigma^\nabla \cup \Sigma^\Delta$ (or, rather, given \mathbf{p} and \mathbf{q} with $\mathbf{q} < 0$ the regions Ω_\pm^∇ and Ω_\pm^Δ are assumed to be positioned so that this holds). We define a subcontour $\beta \subset \Sigma^\nabla \cup \Sigma^\Delta$ consisting of the closure of the arc of Σ connecting the two roots of $R(w; \mathbf{p}, \mathbf{q})^2$ via $w = 1$. Thus β is a simple contour (with no self-intersection points). Whenever we are in case L, we will assume that there is no transition point, *i.e.*, either $\Delta = \emptyset$ or $\nabla = \emptyset$.

R This case is defined by the inequalities $\mathbf{q} > 0$ and

$$\mathbf{a} \leq \mathbf{p} - \sqrt{\mathbf{q}} < \mathbf{p} + \sqrt{\mathbf{q}} \leq \mathbf{b}. \quad (4.2)$$

The distinct real roots $w = \mathbf{p} \pm \sqrt{\mathbf{q}}$ therefore lie in the real interval $[\mathbf{a}, \mathbf{b}]$ of $\Sigma^\nabla \cup \Sigma^\Delta$. We then assume further that the point $w = w^+$ where the nonreal arcs of $\Sigma^\nabla \cup \Sigma^\Delta$ meet the interval $[\mathbf{a}, \mathbf{b}]$ lies between the two roots. We define a subcontour $\beta \subset \Sigma^\nabla \cup \Sigma^\Delta$ as the union of the closure of the nonreal arcs of $\Sigma^\nabla \cup \Sigma^\Delta$ with the real interval $[\mathbf{p} - \sqrt{\mathbf{q}}, \mathbf{p} + \sqrt{\mathbf{q}}]$. Thus β is a non-simple (self-intersecting) contour having a single self-intersection point (a simple crossing) at $w = w^+$. Whenever we are in case R, we will assume that if there is a transition point $w = \tau_N$, it lies in β .

In both cases, we define $\gamma := \overline{(\Sigma^\nabla \cup \Sigma^\Delta)} \setminus \beta$, and we assume the contours β and γ inherit the orientation of Σ . See Figures 4.1 and 4.2 for illustrations of β and γ in cases L and R respectively.

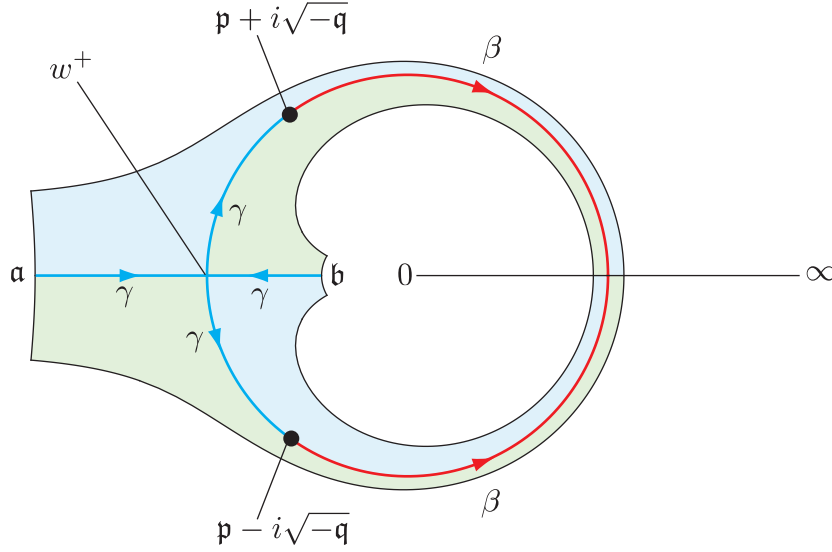

FIGURE 4.1. The subcontours β (red) and γ (blue) for a configuration of type L. The orientations here correspond to the case $\Delta = \emptyset$ (see Figure 3.1).

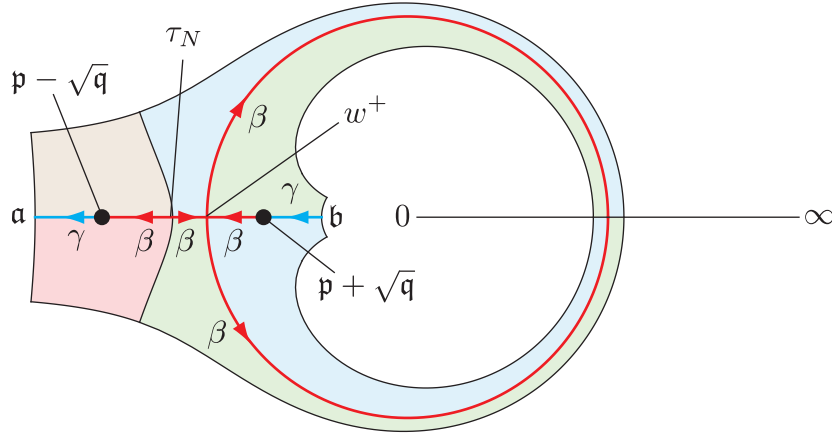

FIGURE 4.2. The subcontours β (red) and γ (blue) for a configuration of type R. The orientations here correspond to the case $\Delta = P_N^{\leq K}$ (see Figure 3.2). This illustrates the fact that if a transition point τ_N is present it is assumed to lie in the subcontour β .

We define an analytic branch $R(w) = R(w; \mathbf{p}, \mathbf{q})$ of the square root of the quadratic $R(w; \mathbf{p}, \mathbf{q})^2$ by taking the branch cut to coincide with β and choosing the sign so that $R(w) = w + \mathcal{O}(1)$ as $w \rightarrow \infty$. Note that in case R as well as the borderline case $v = 0$, $R(w)$ is a sectionally analytic function of w because the branch cut locus β has a self-intersection point at $w = w^+$.

It will be useful below to have available some compact notation for certain sums of contour integrals. We therefore define

$$\int_C F(\xi) d\xi := \int_{\partial\Omega_+^\nabla \setminus \Sigma^\nabla} F(\xi) d\xi + \int_{\partial\Omega_-^\nabla \setminus \Sigma^\nabla} F(\xi) d\xi + \int_{\partial\Omega_+^\Delta \setminus \Sigma^\Delta} F(\xi) d\xi + \int_{\partial\Omega_-^\Delta \setminus \Sigma^\Delta} F(\xi) d\xi \quad (4.3)$$

and we will use this formula in some situations where $F(\xi)$ is to be understood along the four contours on the right-hand side in the sense of taking a boundary value from within the region whose boundary is involved in the integration. For example, if the regions Ω_{\pm}^{∇} meet the positive real axis in the contour $\Sigma_{>0}^{\nabla}$ and if F is a function having a jump discontinuity across this contour, then the two terms on the right-hand side of (4.3) involving integration over $\partial\Omega_{\pm}^{\nabla} \setminus \Sigma^{\nabla}$ require use of two different boundary values $F_{\pm}(\xi)$ taken by F on $\bar{\Sigma}_{>0}^{\nabla}$. If $F(\xi)$ depends on a parameter w through a Cauchy factor $(\xi - w)^{-1}$ then $\int_C F(\xi) d\xi$ will be analytic in w in a bounded domain we denote as $\Omega^{\circ} := (\Omega \cup \Sigma^{\nabla} \cup \Sigma^{\Delta}) \setminus \{\mathbf{a}, \tau_N, \mathbf{b}, 1\}$.

In order to construct suitable functions $g(w)$ with which to transform the matrix $\mathbf{M}(w)$ into $\mathbf{N}(w)$, we will need to impose certain relations between the real parameters \mathbf{p} and \mathbf{q} and the independent variables x and t . We will define two functions $M(\mathbf{p}, \mathbf{q}, x, t)$ and $I(\mathbf{p}, \mathbf{q}, x, t)$. Then the ‘‘moment condition’’ $M(\mathbf{p}, \mathbf{q}, x, t) = 0$ and the ‘‘integral condition’’ $I(\mathbf{p}, \mathbf{q}, x, t) = 0$ will be used to study the dependence of the roots of $R(w; \mathbf{p}, \mathbf{q})^2$ on x and t . For fixed x and t , the solvability of the equations $M = 0$ and $I = 0$ for \mathbf{p} and \mathbf{q} will be a necessary condition for asymptotic reduction to a model Riemann-Hilbert problem solvable in terms of elliptic functions. However, this will not be a sufficient condition. It may happen that for some (x, t) this system is solvable but certain necessary inequalities (see Proposition 4.9) fail along arcs of the subcontour γ . In this case, it becomes necessary to introduce new arcs of the subcontour β near the points where the inequalities have failed in γ . Thus, β becomes disconnected, and there are more endpoints (*i.e.*, roots of $R(w)^2$). To determine these additional parameters it then becomes necessary to also include further equations $M_j = 0$ and $I_j = 0$. Ultimately this will effect an asymptotic reduction to a model Riemann-Hilbert problem solvable in terms of higher-genus hyperelliptic functions.

For the moment, we think of $(\mathbf{p}, \mathbf{q}, x, t)^{\top} \in \mathbb{R}^4$ as a parameter vector, and begin by defining a function $M = M(\mathbf{p}, \mathbf{q}, x, t)$ as

$$M := \frac{x - t}{\sqrt{\mathbf{p}^2 - \mathbf{q}}} + x + t - \frac{2}{\pi} \int_C \frac{\theta'_0(\xi) \sqrt{-\xi} d\xi}{R(\xi; \mathbf{p}, \mathbf{q})}. \quad (4.4)$$

Now let $H(w) = H(w; \mathbf{p}, \mathbf{q}, x, t)$ be the function defined by

$$H(w) := -\frac{1}{4\sqrt{-w}} \left[\frac{x - t}{w\sqrt{\mathbf{p}^2 - \mathbf{q}}} + \frac{2}{\pi} \int_C \frac{\theta'_0(\xi) \sqrt{-\xi} d\xi}{R(\xi; \mathbf{p}, \mathbf{q})(\xi - w)} \right], \quad w \in \Omega^{\circ}. \quad (4.5)$$

This function is analytic where it is defined (the singularity at $w = 0$ and corresponding branch cut along \mathbb{R}_+ are excluded from Ω°), but it does have jump discontinuities across the contours $\Sigma_{>0}^{\nabla}$ or $\Sigma_{>0}^{\Delta}$ (depending on which of the six cases of Δ we are considering), as well as across $\Sigma^{\nabla\Delta}$ and $\Sigma^{\Delta\nabla}$ if there exists a transition point. Note that $H(w)$ satisfies $H(w^*)^* = H(w)$, so that in particular the zeros of $H(w)$ in its domain of definition either lie on the negative real axis or come in complex-conjugate pairs. We may now define a second function $I = I(\mathbf{p}, \mathbf{q}, x, t)$ as

$$\begin{aligned} I &:= \Re \left\{ \int_{\beta \cap \mathbb{C}_+} R_+(\xi) H(\xi) d\xi \right\} \\ &= \frac{1}{2} \int_{\beta \cap \mathbb{C}_+} R_+(\xi) H(\xi) d\xi + \frac{1}{2} \int_{\beta \cap \mathbb{C}_-} R_-(\xi) H(\xi) d\xi. \end{aligned} \quad (4.6)$$

Finally, let $f(w) = f(w; \mathbf{p}, \mathbf{q}, x, t)$ be given by the formula

$$f(w) := i \frac{dQ}{dw}(w; x, t) + \frac{x - t}{8\sqrt{\mathbf{p}^2 - \mathbf{q}}} \frac{R(w; \mathbf{p}, \mathbf{q})}{w\sqrt{-w}} - \frac{R(w; \mathbf{p}, \mathbf{q})}{2\pi\sqrt{-w}} \int_{\gamma} \frac{\theta'_0(\xi) \sqrt{-\xi} d\xi}{R(\xi; \mathbf{p}, \mathbf{q})(\xi - w)} + \frac{1}{2} \frac{dL}{dw}(w). \quad (4.7)$$

Proposition 4.1. *Let parameters \mathbf{p} , \mathbf{q} , x , and t be given so that the quadratic $R(w; \mathbf{p}, \mathbf{q})^2$ is in case L, case R, or the borderline case of $\mathbf{q} = 0$, and assume that the regions Ω_{\pm}^{∇} and Ω_{\pm}^{Δ} are chosen so that the contour $\Sigma^{\nabla} \cup \Sigma^{\Delta}$ is consistent with the roots of the quadratic with well-defined subcontours β and γ . Suppose also that the moment condition $M = 0$ and the integral condition $I = 0$ both hold. Then an analytic function $g(w)$ is defined for $w \in \mathbb{C} \setminus (\beta \cup \mathbb{R}_+)$ as follows.*

[L] *In this case we set*

$$g(w) := \int_0^w f(w') dw' \quad (4.8)$$

where the path of integration is arbitrary in $\mathbb{C} \setminus (\beta \cup \mathbb{R}_+)$.

R In this case we set

$$g(w) := \begin{cases} \int_0^w f(w') dw', & w \in \Upsilon_0, \\ \int_\infty^w f(w') dw', & w \in \Upsilon_\infty, \end{cases} \quad (4.9)$$

where Υ_0 and Υ_∞ are respectively the bounded and unbounded connected components of $\mathbb{C} \setminus (\beta \cup \mathbb{R}_+)$, and in each case the path of integration is arbitrary in the given domain.

(In the borderline case of $\mathbf{q} = 0$ we also use the definition (4.9).) The function $g(w)$ so-defined satisfies in all cases the Schwartz-symmetry condition

$$g(w^*) = g(w)^* \quad (4.10)$$

and is a uniformly Hölder- $\frac{1}{2}$ continuous map $\mathbb{C} \setminus (\beta \cup \mathbb{R}_+) \rightarrow \mathbb{C}$. The function $\theta : \vec{\Sigma}^\nabla \cup \vec{\Sigma}^\Delta \rightarrow \mathbb{C}$ defined by (3.48) satisfies

$$\Im\{\theta(\xi)\} \equiv 0, \quad \xi \in (\vec{\Sigma}^\nabla \cup \vec{\Sigma}^\Delta) \cap \mathbb{R}, \quad (4.11)$$

$$\theta(\xi) \equiv 0, \quad \xi \in \vec{\gamma}, \quad (4.12)$$

and

$$\frac{d\theta}{d\xi}(\xi) = iR_+(\xi; \mathbf{p}, \mathbf{q})H(\xi), \quad \xi \in \vec{\beta}. \quad (4.13)$$

Also, we have

$$g_+(\xi) + g_-(\xi) = 0, \quad \xi \in \vec{\mathbb{R}}_+. \quad (4.14)$$

The function $\phi : \vec{\Sigma}^\nabla \cup \vec{\Sigma}^\Delta \rightarrow \mathbb{C}$ defined by (3.48) satisfies

$$\Im\{\phi(\xi)\} \equiv 0, \quad \xi \in (\vec{\Sigma}^\nabla \cup \vec{\Sigma}^\Delta) \cap \mathbb{R}, \quad (4.15)$$

$$\phi(\xi) \equiv \pm i\Phi, \quad \xi \in \vec{\beta} \cap \mathbb{C}_\pm, \quad (4.16)$$

for some real number Φ ,

$$\phi(\xi) \equiv 0, \quad \xi \in \vec{\beta} \cap \mathbb{R}, \quad (4.17)$$

and

$$\frac{d\phi}{d\xi}(\xi) = R(\xi; \mathbf{p}, \mathbf{q})H(\xi), \quad \xi \in \vec{\gamma}. \quad (4.18)$$

Finally, g satisfies the decay condition

$$\lim_{w \rightarrow \infty} g(w) = 0. \quad (4.19)$$

Proof. Even without the conditions $M = 0$ and $I = 0$, it is obvious from the definition (4.7) that the function $f(w)$ is analytic at least for $w \in \mathbb{C} \setminus (\Sigma^\nabla \cup \Sigma^\Delta \cup \mathbb{R}_+)$. From the Plemelj formula and the definition (3.20) of $L(w)$, one finds that

$$f_+(\xi) - f_-(\xi) = 0, \quad \xi \in \vec{\gamma}, \quad (4.20)$$

which, upon taking into account the continuity of the boundary values taken by f along $\vec{\gamma}$, shows that f is analytic in the larger domain $\mathbb{C} \setminus (\beta \cup \mathbb{R}_+)$.

Now $f(w)$ is automatically integrable at $w = 0$. Indeed, (3.20) shows that $L(w)$ has a well-defined limiting value as $w \rightarrow 0$ with $|\arg(-w)| < \pi$ (and is in fact uniformly Hölder- $\frac{1}{2}$ for such w), the term involving the integral over γ is clearly $\mathcal{O}((-w)^{-1/2})$, and the sum of the remaining two terms is as well (after canceling a term proportional to $(-w)^{-3/2}$ between them). This fact gives sense to the formulae defining $g(w)$ in case L and also in the domain Υ_0 in case R. But the moment condition $M = 0$ also makes f integrable at $w = \infty$:

$$f(w) = \frac{1}{8\sqrt{-w}} \left[\frac{x-t}{\sqrt{\mathbf{p}^2 - \mathbf{q}}} + x + t + \frac{4}{\pi} \int_\gamma \frac{\theta'_0(\xi)\sqrt{-\xi} d\xi}{R(\xi; \mathbf{p}, \mathbf{q})} \right] + \mathcal{O}\left((-w)^{-3/2}\right), \quad w \rightarrow \infty. \quad (4.21)$$

By a simple contour deformation argument (using the fact that $R(\xi; \mathbf{p}, \mathbf{q})$ changes sign across $\vec{\beta}$), we may write the integral over γ as minus one-half of the corresponding integral over C (recall (4.3)) and thus identify

the term in brackets as the ‘‘moment’’ $M(\mathbf{p}, \mathbf{q}, x, t)$. Therefore in case R, $g(w)$ is well-defined and analytic for $w \in \Upsilon_\infty$, and in case L we observe that g has a well-defined limiting value as $w \rightarrow \infty$.

The Schwartz symmetry (4.10) of g now follows immediately from the definition of g and the corresponding symmetry $f(z^*) = f(z)^*$ obvious from (4.7), and the Hölder- $\frac{1}{2}$ continuity of g can be read off from the formula for $f = g'$. Also, since by definition g has no jump across the contour $\vec{\gamma}$ we see from the definition (3.48) of θ that (4.12) holds.

Next, observe that

$$\begin{aligned} f_+(\xi) - f_-(\xi) &= R_+(\xi; \mathbf{p}, \mathbf{q}) \left[\frac{x-t}{4\sqrt{\mathbf{p}^2 - \mathbf{q}} \xi \sqrt{-\xi}} - \frac{1}{\pi\sqrt{-\xi}} \int_\gamma \frac{\theta'_0(\xi') \sqrt{-\xi'} d\xi'}{R(\xi'; \mathbf{p}, \mathbf{q})(\xi' - \xi)} \right] + i\theta'_0(\xi) \\ &= -R_+(\xi)H(\xi), \quad \xi \in \vec{\beta}, \end{aligned} \quad (4.22)$$

where the second line follows from a residue calculation and a contour deformation like that used in identifying the leading term in (4.21) with a multiple of $M(\mathbf{p}, \mathbf{q}, x, t)$. Similarly,

$$2i \frac{dQ}{d\xi}(\xi; x, t) + \frac{d\bar{L}}{d\xi}(\xi) - f_+(\xi) - f_-(\xi) = R(\xi)H(\xi), \quad \xi \in \vec{\gamma}. \quad (4.23)$$

Together with the definitions (3.48) of θ and ϕ , these two relations establish (4.13) and (4.18).

Simpler calculations show that

$$f_+(\xi) + f_-(\xi) = 0, \quad \xi \in \vec{\mathbb{R}}_+, \quad (4.24)$$

integration of which yields (4.14), and

$$f_+(\xi) + f_-(\xi) = 2i \frac{dQ}{d\xi}(\xi; x, t) + \frac{d\bar{L}}{d\xi}(\xi), \quad \xi \in \vec{\beta}. \quad (4.25)$$

The latter shows that ϕ defined by (3.48) is constant in each arc of $\vec{\beta}$. Since it follows from the Schwartz symmetry (4.10) of g and the jump condition (4.14) that g takes purely imaginary boundary values along \mathbb{R}_+ , an examination of the functions θ and ϕ along β near its intersection point $w = 1$ with \mathbb{R}_+ shows that the limiting values of these functions taken along $\vec{\beta}$ (either of the two arcs) as $\xi \in \vec{\beta}$ tends to $\xi = 1$ are, respectively, real and imaginary. Since $\phi(\xi^*) = \phi(\xi)^*$, the identities (4.16) follow immediately. Now, Schwartz symmetry of g (4.10) also shows that both $\theta(\xi)$ and $\phi(\xi)$ are real-valued for $\xi \in (\bar{\Sigma}^\nabla \cup \bar{\Sigma}^\Delta) \cap \mathbb{R}$, proving (4.11) and (4.15). If we are in case R, so that $\vec{\beta}$ contains two real arcs, we can now show that $\phi \equiv 0$ on these two arcs, proving (4.17). Indeed, for $\xi \in \vec{\beta} \cap \mathbb{R}$, we may use constancy of ϕ along the arc to obtain

$$\begin{aligned} \Re\{\phi(\xi)\} &= \lim_{\substack{\xi' \rightarrow w^+ \\ \xi' \in \vec{\beta} \cap \mathbb{R}}} \Re\{\phi(\xi')\} \\ &= \Re\{2iQ + \bar{L}\}(w^+) - \lim_{\substack{\xi' \rightarrow w^+ \\ \xi' \in \vec{\beta} \cap \mathbb{R}}} \Re\{g_+(\xi') + g_-(\xi')\}, \quad \xi \in \vec{\beta} \cap \mathbb{R}. \end{aligned} \quad (4.26)$$

Note that while $2iQ(\xi) + \bar{L}(\xi)$ is not continuous on β in a neighborhood of the self-intersection point $\xi = w^+$ due to jump discontinuities in \bar{L} (see (3.24) and (3.25) and the discussion just below these definitions), its real part is, which makes $\Re\{2iQ + \bar{L}\}$ well-defined at $\xi = w^+$ regardless of the arc along which this point is approached, and explains the notation $\Re\{2iQ + \bar{L}\}(w^+)$. But $g_+(\xi') + g_-(\xi') = 2g_+(\xi') - i\theta(\xi')$ and $\theta(\xi')$ is real for $\xi' \in \vec{\beta} \cap \mathbb{R}$, so

$$\Re\{\phi(\xi)\} = \Re\{2iQ + \bar{L}\}(w^+) - 2 \lim_{\substack{\xi' \rightarrow w^+ \\ \xi' \in \vec{\beta} \cap \mathbb{R}}} \Re\{g_+(\xi')\}, \quad \xi \in \vec{\beta} \cap \mathbb{R}. \quad (4.27)$$

Now if U is a small neighborhood of the self-intersection point $w = w^+$ of β , then $g : U \setminus \beta \rightarrow \mathbb{C}$ is uniformly Hölder- $\frac{1}{2}$ continuous, so the latter limit may be taken along a different arc of β with the same result:

$$\Re\{\phi(\xi)\} = \Re\{2iQ + \bar{L}\}(w^+) - 2 \lim_{\substack{\xi' \rightarrow w^+ \\ \xi' \in \vec{\beta} \cap \mathbb{C}_\pm}} \Re\{g_+(\xi')\}, \quad \xi \in \vec{\beta} \cap \mathbb{R}, \quad (4.28)$$

where the upper or lower half-plane is used depending on whether the original arc of $\vec{\beta} \cap \mathbb{R}$ was oriented to the right or left respectively. Now we can write this in terms of the limiting values of ϕ and θ along $\vec{\beta} \cap \mathbb{C}_\pm$:

$$\begin{aligned} \Re\{\phi(\xi)\} &= \lim_{\substack{\xi' \rightarrow w^+ \\ \xi' \in \vec{\beta} \cap \mathbb{C}_\pm}} \Re\{\phi(\xi') + i\theta(\xi')\} \\ &= \lim_{\substack{\xi' \rightarrow w^+ \\ \xi' \in \vec{\beta} \cap \mathbb{C}_\pm}} \Re\{i\theta(\xi')\}, \quad \xi \in \vec{\beta} \cap \mathbb{R}, \end{aligned} \quad (4.29)$$

where the second line follows because ϕ is a purely imaginary constant $\pm i\Phi$ along $\vec{\beta} \cap \mathbb{C}_\pm$. Finally, since $\theta(\xi)$ has a real limiting value as $\xi \rightarrow 1$ with $\xi \in \vec{\beta} \cap \mathbb{C}_\pm$, we obtain that $\Re\{\phi(\xi)\} \equiv 0$ for $\xi \in \vec{\beta} \cap \mathbb{R}$ as a consequence of the integral condition $I = 0$. But from (4.15), $\phi(\xi)$ is real for $\xi \in \mathbb{R}$, so (4.17) follows.

The decay condition (4.19) is obvious from the definition in case R, and in case L it follows from the integral condition $I = 0$. Indeed, writing $g(\infty)$ in case L as the the integral

$$g(\infty) = \int_0^{-\infty} f(\xi) d\xi, \quad (4.30)$$

we may split the integral into two equal parts, and in each part we deform the contour into the right half-plane in opposite directions, bringing the two contours against $\beta \cup \mathbb{R}_+$. Using (4.24) cancels the contributions to $g(\infty)$ coming from integrals along the upper and lower edges of \mathbb{R}_+ , leaving only

$$g(\infty) = \pm \frac{1}{2} \int_\beta (f_+(\xi) - f_-(\xi)) d\xi \quad (4.31)$$

where the sign is different depending on whether $\beta \subset \Sigma^\nabla$ or $\beta \subset \Sigma^\Delta$. But in either case, we now can use (4.22) and the symmetry $f(\xi^*) = f(\xi)^*$ to see that the condition $I = 0$ guarantees that $g(\infty) = 0$ in case L. \square

If \mathbf{p} and \mathbf{q} can be eliminated by means of the equations $M(\mathbf{p}, \mathbf{q}, x, t) = 0$ and $I(\mathbf{p}, \mathbf{q}, x, t) = 0$, then we may view g as being a function of w depending parametrically only on x and t . Now, according to Proposition 4.1 there will be a real constant Φ associated with g . In the situation that \mathbf{p} and \mathbf{q} have been eliminated, we will have $\Phi = \Phi(x, t)$, and it will be useful to characterize the dependence of $\Phi(x, t)$ on the remaining parameters x and t .

Proposition 4.2. *Suppose that $\mathbf{p} = \mathbf{p}(x, t)$ and $\mathbf{q} = \mathbf{q}(x, t)$ constitute a differentiable solution of the equations $M(\mathbf{p}, \mathbf{q}, x, t) = 0$ and $I(\mathbf{p}, \mathbf{q}, x, t) = 0$, so that $g(w; x, t) = g(w; \mathbf{p}(x, t), \mathbf{q}(x, t), x, t)$, and let the constant $\Phi = \Phi(x, t)$ be obtained therefrom as described in Proposition 4.1. Then $\Phi(x, t)$ is jointly differentiable in x and t with real-valued first-order partial derivatives, depending on x and t only via \mathbf{p} and \mathbf{q} , given by*

$$\frac{\partial \Phi}{\partial x} = \frac{\pi}{4\mathcal{D}} \left[1 - \frac{1}{\sqrt{\mathbf{p}^2 - \mathbf{q}}} \right] \quad \text{and} \quad \frac{\partial \Phi}{\partial t} = \frac{\pi}{4\mathcal{D}} \left[1 + \frac{1}{\sqrt{\mathbf{p}^2 - \mathbf{q}}} \right], \quad (4.32)$$

where in case L,

$$\mathcal{D} = \frac{K(m_L)}{(\mathbf{p}^2 - \mathbf{q})^{1/4}}, \quad m_L := \frac{1}{2} \left(1 - \frac{\mathbf{p}}{\sqrt{\mathbf{p}^2 - \mathbf{q}}} \right) \in (0, 1), \quad (4.33)$$

and in case R,

$$\mathcal{D} = \frac{2K(m_R)}{\sqrt{-\mathbf{p} + \sqrt{\mathbf{q}}} + \sqrt{-\mathbf{p} - \sqrt{\mathbf{q}}}}, \quad m_R := \frac{4\sqrt{\mathbf{p}^2 - \mathbf{q}}}{(\sqrt{-\mathbf{p} + \sqrt{\mathbf{q}}} + \sqrt{-\mathbf{p} - \sqrt{\mathbf{q}}})^2} \in (0, 1), \quad (4.34)$$

where $K(\cdot)$ denotes the complete elliptic integral of the first kind defined by (1.60). In particular, defining a quantity $n_{\mathbf{p}}$ by

$$n_{\mathbf{p}} := -\frac{\partial \Phi}{\partial x} = \frac{1 - \sqrt{\mathbf{p}^2 - \mathbf{q}}}{1 + \sqrt{\mathbf{p}^2 - \mathbf{q}}}, \quad (4.35)$$

and noting that $\mathbf{p}^2 - \mathbf{q} > 0$ in both cases L and R, we see that $n_{\mathbf{p}}$ is an algebraic function of \mathbf{p} and \mathbf{q} satisfying $|n_{\mathbf{p}}| < 1$. Also, $0 < \mathbf{p}^2 - \mathbf{q} < 1$ implies $n_{\mathbf{p}} > 0$ while $\mathbf{p}^2 - \mathbf{q} > 1$ implies $n_{\mathbf{p}} < 0$.

Proof. Consider the functions $X(w)$ and $T(w)$ defined in terms of $g(w) = g(w; x, t)$ as follows:

$$X(w) := \frac{\pi}{\sqrt{-w}R(w)} \frac{\partial g(w)}{\partial x}, \quad T(w) := \frac{\pi}{\sqrt{-w}R(w)} \frac{\partial g(w)}{\partial t}. \quad (4.36)$$

These functions are both analytic for $w \in \mathbb{C} \setminus \beta$. Indeed, from (4.14) in Proposition 4.1 we see that in spite of the explicit presence of the square root $\sqrt{-w}$ in the definitions, $X(w)$ and $T(w)$ may be considered to be analytic in a neighborhood of the positive real axis, and then analyticity for $w \in \mathbb{C} \setminus \beta$ follows from elementary properties of the remaining factors. It is also a consequence of (4.19) and the relation $g'(w) = f(w)$ with $f(w)$ given by (4.7) that $g(w) = \mathcal{O}((-w)^{-1/2})$ for large w , and this implies that $X(w) = \mathcal{O}(w^{-2})$ and $T(w) = \mathcal{O}(w^{-2})$ as $w \rightarrow \infty$.

Differentiation (with respect to x and t) of the identities $\phi(\xi) \equiv \pm i\Phi$ for $\xi \in \vec{\beta} \cap \mathbb{C}_{\pm}$ and $\phi(\xi) \equiv 0$ for $\xi \in \vec{\beta} \cap \mathbb{R}$ using the definition (3.48) of ϕ in terms of $g(w)$ yields the following jump conditions for $X(w)$ and $T(w)$ along β :

$$\begin{aligned} X_+(\xi) - X_-(\xi) &= \frac{\pi}{\sqrt{-\xi}R_+(\xi)} \begin{cases} 2iE(\xi) \mp i \frac{\partial \Phi}{\partial x}, & \xi \in \vec{\beta} \cap \mathbb{C}_{\pm}, \\ 2iE(\xi), & \xi \in \vec{\beta} \cap \mathbb{R}, \end{cases} \\ T_+(\xi) - T_-(\xi) &= \frac{\pi}{\sqrt{-\xi}R_+(\xi)} \begin{cases} 2iD(\xi) \mp i \frac{\partial \Phi}{\partial t}, & \xi \in \vec{\beta} \cap \mathbb{C}_{\pm}, \\ 2iD(\xi), & \xi \in \vec{\beta} \cap \mathbb{R}. \end{cases} \end{aligned} \quad (4.37)$$

(Note that $\vec{\beta} \cap \mathbb{R} = \emptyset$ in case L.)

Since we know directly from their definitions that the functions $X(w)$ and $T(w)$ must be $\mathcal{O}(w^{-2})$ for large w , they are necessarily given by Cauchy integrals via the Plemelj formula in terms of the jump data (4.37):

$$\begin{aligned} X(w) &= \int_{\beta} \frac{E(\xi) d\xi}{\sqrt{-\xi}R_+(\xi)(\xi - w)} - \frac{\partial \Phi}{\partial x} \left[\frac{1}{2} \int_{\beta \cap \mathbb{C}_+} \frac{d\xi}{\sqrt{-\xi}R_+(\xi)(\xi - w)} - \frac{1}{2} \int_{\beta \cap \mathbb{C}_-} \frac{d\xi}{\sqrt{-\xi}R_+(\xi)(\xi - w)} \right], \\ T(w) &= \int_{\beta} \frac{D(\xi) d\xi}{\sqrt{-\xi}R_+(\xi)(\xi - w)} - \frac{\partial \Phi}{\partial t} \left[\frac{1}{2} \int_{\beta \cap \mathbb{C}_+} \frac{d\xi}{\sqrt{-\xi}R_+(\xi)(\xi - w)} - \frac{1}{2} \int_{\beta \cap \mathbb{C}_-} \frac{d\xi}{\sqrt{-\xi}R_+(\xi)(\xi - w)} \right]. \end{aligned} \quad (4.38)$$

But while these formulae indeed exhibit decay for large w , without further conditions we will have only $X(w) = \mathcal{O}(w^{-1})$ and $T(w) = \mathcal{O}(w^{-1})$ as $w \rightarrow \infty$. Imposing on these formulae the more rapid required rate of decay of $\mathcal{O}(w^{-2})$ as $w \rightarrow \infty$ reveals conditions determining the partial derivatives of Φ with respect to x and t :

$$\frac{\partial \Phi}{\partial x} = \frac{1}{\mathcal{D}} \int_{\beta} \frac{E(\xi)}{\sqrt{-\xi}R_+(\xi)} d\xi \quad \text{and} \quad \frac{\partial \Phi}{\partial t} = \frac{1}{\mathcal{D}} \int_{\beta} \frac{D(\xi)}{\sqrt{-\xi}R_+(\xi)} d\xi, \quad (4.39)$$

where

$$\mathcal{D} := \frac{1}{2} \int_{\beta \cap \mathbb{C}_+} \frac{d\xi}{\sqrt{-\xi}R_+(\xi)} - \frac{1}{2} \int_{\beta \cap \mathbb{C}_-} \frac{d\xi}{\sqrt{-\xi}R_+(\xi)}. \quad (4.40)$$

Now the fractions $E(w)/\sqrt{-w}$ and $D(w)/\sqrt{-w}$ are simple rational functions of w :

$$\frac{E(w)}{\sqrt{-w}} = \frac{i}{4} \left(1 - \frac{1}{w} \right) \quad \text{and} \quad \frac{D(w)}{\sqrt{-w}} = \frac{i}{4} \left(1 + \frac{1}{w} \right), \quad (4.41)$$

and by elementary contour deformations,

$$\int_{\beta} \frac{1 \pm \xi^{-1}}{R_+(\xi)} d\xi = \frac{1}{2} \oint_0 \frac{1 \pm w^{-1}}{R(w)} dw - \frac{1}{2} \oint_{\infty} \frac{1 \pm w^{-1}}{R(w)} dw, \quad (4.42)$$

where the first integral is over a small positively-oriented circle surrounding only $w = 0$ and the second integral is over a large positively-oriented circle outside of which R is analytic. (This result holds regardless of whether the branch point configuration is of type L or of type R.) Evaluating these integrals by residues at $w = 0$ and $w = \infty$ respectively yields

$$\int_{\beta} \frac{1 \pm \xi^{-1}}{R_+(\xi)} d\xi = \pm \frac{i\pi}{R(0)} - i\pi. \quad (4.43)$$

Therefore, using $R(0) = -\sqrt{\mathbf{p}^2 - \mathbf{q}}$ establishes the formulae (4.32).

It remains to characterize the denominator \mathcal{D} in cases L and R. In case L, elementary contour deformations show that

$$\mathcal{D} = \frac{1}{2} \int_0^{-\infty} \frac{dw}{\sqrt{-w}R(w)} = \frac{1}{2} \int_{-\infty}^0 \frac{dw}{\sqrt{-w((w-\mathbf{p})^2 - \mathbf{q})}}. \quad (4.44)$$

By the substitution $w \mapsto s$ given by

$$w = \sqrt{\mathbf{p}^2 - \mathbf{q}} \frac{z-1}{z+1} \quad \text{followed by} \quad z = \pm \sqrt{1-s^2} \quad (4.45)$$

and comparing with the definition (1.60) of the complete elliptic integral of the first kind, we establish (4.33). On the other hand, in case R, by simple contour deformations,

$$\mathcal{D} = \int_0^{\mathbf{p}+\sqrt{\mathbf{q}}} \frac{dw}{\sqrt{-w}R(w)} = \int_{u+\sqrt{v}}^0 \frac{dw}{\sqrt{-w((w-\mathbf{p})^2 - \mathbf{q})}}. \quad (4.46)$$

By the substitution $w \mapsto s$ given by

$$w = - \left[\frac{\sqrt{-\mathbf{p} + \sqrt{\mathbf{q}}} + \sqrt{-\mathbf{p} - \sqrt{\mathbf{q}}}}{2s} - \sqrt{\frac{(\sqrt{-\mathbf{p} + \sqrt{\mathbf{q}}} + \sqrt{-\mathbf{p} - \sqrt{\mathbf{q}}})^2}{4s^2} - \sqrt{\mathbf{p}^2 - \mathbf{q}}} \right]^2, \quad (4.47)$$

a bijection mapping the real path from $w = w_1 = \mathbf{p} + \sqrt{\mathbf{q}} < 0$ to $w = 0$ onto the real path from $s = 1$ to $s = 0$, we then obtain (4.34) by comparing with (1.60). \square

4.2. Finding g when $t = 0$.

Proposition 4.3. *Suppose $t = 0$, and that $\Delta = \emptyset$ for $x \geq 0$ while $\nabla = \emptyset$ for $x \leq 0$ (for $x = 0$ we may choose either $\Delta = \emptyset$ or $\nabla = \emptyset$). Then the equations $M(\mathbf{p}, \mathbf{q}, x, t) = 0$ and $I(\mathbf{p}, \mathbf{q}, x, t) = 0$ are satisfied identically if*

$$\mathbf{p} = \mathbf{p}(x) = 1 - \frac{1}{2}G(x)^2, \quad x \in \mathbb{R} \quad (4.48)$$

and $\mathbf{q} = \mathbf{q}(x) = \mathbf{p}(x)^2 - 1$.

Note that the proof will show that the equation $M(\mathbf{p}, \mathbf{p}^2 - 1, x, 0) = 0$ has *no real solution* \mathbf{p} if $x < 0$ and $\Delta = \emptyset$. This explains the need of introducing in general the set $\Delta \subset P_N$ and shows that scattering theory “from the right” is insufficient to capture the semiclassical asymptotics for all (x, t) .

Proof. Consistently with the condition $\mathbf{q} = \mathbf{p}^2 - 1$ we choose the branch cuts β of $R(w; \mathbf{p}, \mathbf{p}^2 - 1)$ to lie on the unit circle (and some intervals of the negative real axis in case R). Then it follows that

$$R(w; \mathbf{p}, \mathbf{p}^2 - 1) = \sqrt{-w} \hat{R}(E(w); \mathbf{p}), \quad (4.49)$$

where for $\mathbf{p} < 1$, $\hat{R}(\lambda; \mathbf{p})^2 = -16\lambda^2 - 2(1 - \mathbf{p})$ with $\hat{R}(\lambda, \mathbf{p})$ being analytic away from the branch cut in the λ -plane lying along the imaginary axis between the two imaginary roots of $\hat{R}(\lambda; \mathbf{p})^2$, and with branch chosen so that $\hat{R}(\lambda, \mathbf{p}) = 4i\lambda + \mathcal{O}(\lambda^{-1})$ as $\lambda \rightarrow \infty$. Therefore, with $\mathbf{q} = \mathbf{p}^2 - 1$ and $t = 0$ the moment condition $M = 0$ can be written in the form

$$x = \frac{1}{\pi} \int_C \frac{\theta'_0(\xi) d\xi}{\hat{R}(E(\xi); \mathbf{p})}. \quad (4.50)$$

Recalling (3.1), this suggests taking $\lambda = E(\xi)$ as the variable of integration, yielding

$$x = \frac{2}{\pi} \int_{E(C)} \frac{\Psi'(\lambda) d\lambda}{\hat{R}(\lambda; \mathbf{p})}, \quad (4.51)$$

where the factor of 2 appears because the contours of integration making up the scheme denoted C contain pairs of distinct points $(\xi, 1/\xi)$ that have the same image in the λ -plane. Here $E(C)$ denotes the images of these contours in the λ -plane counted with the same multiplicities as in the definition of C ; this simply means that in (4.51)

- if $\Delta = \emptyset$ we are integrating over two contours from $\lambda = -iG(0)/4$ on the positive imaginary axis to $\lambda = 0$, with the two contours lying on opposite sides of the branch cut of $\hat{R}(\lambda; \mathbf{p})$, while

- if $\nabla = \emptyset$ we are integrating over the same two contours as in the case that $\Delta = \emptyset$ but with the orientation reversed.

By deforming these contours to the imaginary axis taking into account the change of sign of $\hat{R}(\lambda; \mathbf{p})$ across its branch cut, and using the substitution $\lambda = iv/4$ we therefore obtain

$$x = -\frac{4\sigma}{\pi} \int_{\sqrt{2(1-\mathbf{p})}}^{-G(0)} \frac{\varphi(v) dv}{\sqrt{v^2 - 2(1-\mathbf{p})}}, \quad \varphi(v) := \frac{d}{dv} \Psi(iv/4), \quad (4.52)$$

where $\sigma = 1$ for $\Delta = \emptyset$ and $\sigma = -1$ for $\nabla = \emptyset$. It then follows from Proposition 1.1 that

$$x = \sigma G^{-1}(-\sqrt{2(1-\mathbf{p})}) \quad (4.53)$$

which can be solved for $\mathbf{p} = \mathbf{p}(x)$ if either $x = 0$ or x has the same sign as σ , yielding in all of these cases the formula (4.48).

If the condition $M(\mathbf{p}, \mathbf{q}, x, 0) = 0$ is used to eliminate the parameter x from $H(w; \mathbf{p}, \mathbf{q}, x, 0)$, then subject also to the condition $\mathbf{q} = \mathbf{p}^2 - 1$ we obtain

$$R(w; \mathbf{p}, \mathbf{p}^2 - 1)H(w; \mathbf{p}, \mathbf{p}^2 - 1, x, 0) = -\frac{1}{2\pi} \hat{R}(E(w); \mathbf{p}) \int_C \left(\frac{1}{\xi - w} + \frac{1}{2w} \right) \frac{\theta'_0(\xi) d\xi}{\hat{R}(E(\xi); \mathbf{p})}, \quad (4.54)$$

where $\mathbf{p} = \mathbf{p}(x)$ is given by (4.48). But since C is mapped onto itself, with orientation preserved, by the involution $\xi \mapsto 1/\xi$, we have

$$\int_C \frac{1}{\xi - w} \frac{\theta'_0(\xi) d\xi}{\hat{R}(E(\xi); \mathbf{p})} = \int_C \frac{1}{\xi^{-1} - w} \frac{\theta'_0(\xi) d\xi}{\hat{R}(E(\xi); \mathbf{p})}, \quad (4.55)$$

so averaging these two formulae we obtain for $\mathbf{p} = \mathbf{p}(x)$ given by (4.48) that

$$R(w; \mathbf{p}, \mathbf{p}^2 - 1)H(w; \mathbf{p}, \mathbf{p}^2 - 1, x, 0) = \frac{1}{2\pi} \hat{R}(E(w); \mathbf{p}) E(w) \frac{dE}{dw} \int_C \frac{1}{E(w)^2 - E(\xi)^2} \frac{\theta'_0(\xi) d\xi}{\hat{R}(E(\xi); \mathbf{p})}. \quad (4.56)$$

With the substitution $\lambda = E(\xi)$ this becomes

$$R(w; \mathbf{p}, \mathbf{p}^2 - 1)H(w; \mathbf{p}, \mathbf{p}^2 - 1, x, 0) = \frac{1}{\pi} \hat{R}(E(w); \mathbf{p}) E(w) \frac{dE}{dw} \int_{E(C)} \frac{1}{E(w)^2 - \lambda^2} \frac{\Psi'(\lambda) d\lambda}{\hat{R}(\lambda; \mathbf{p})}. \quad (4.57)$$

Note that the integral factor is real if $E(w)$ is imaginary. Now, in the definition (4.6) of $I(\mathbf{p}, \mathbf{q}, x, t)$, the integration variable ξ lies on the unit circle in the upper half-plane, and therefore $E(\xi)$ is imaginary, as is $E'(\xi) d\xi$ and the boundary value taken by $\hat{R}(E(\xi); \mathbf{p})$ on the branch cut. It then follows immediately that the integral condition $I = 0$ holds. \square

Note that the relation $\mathbf{q} = \mathbf{p}^2 - 1$ is suggested by the fact that when $t = 0$ the inverse-scattering problem reduces to that for the Zakharov-Shabat system (1.40) under the mapping $\lambda = E(w)$. The condition $\mathbf{q} = \mathbf{p}^2 - 1$ maps the radical $R(w; \mathbf{p}, \mathbf{q})$ into the radical $\hat{R}(\lambda; \mathbf{p})$ whose branching points are known (for Klaus-Shaw potentials, see [18]) to lie on the imaginary axis in the λ -plane.

Proposition 4.4. *Suppose that $t = 0$, and that $\Delta = \emptyset$ for $x \geq 0$ while $\nabla = \emptyset$ for $x \leq 0$ (for $x = 0$ we may choose either $\Delta = \emptyset$ or $\nabla = \emptyset$). Assume also that $\mathbf{q} = \mathbf{q}(x) = \mathbf{p}(x)^2 - 1$ where $\mathbf{p} = \mathbf{p}(x)$ is given by (4.48), and that the contour $\beta \cup \gamma$ coincides with the union of the unit circle $|w| = 1$ and the real interval $[\mathbf{a}, \mathbf{b}]$. Then for each $x \in \mathbb{R}$, an analytic function $g : \mathbb{C} \setminus (\beta \cup \mathbb{R}_+) \rightarrow \mathbb{C}$ is well-defined by Proposition 4.1, with associated functions $\theta : \vec{\beta} \cup \vec{\gamma} \rightarrow \mathbb{C}$ and $\phi : \vec{\beta} \cup \vec{\gamma} \rightarrow \mathbb{C}$ defined by (3.48), and the following hold:*

- $\Phi = 0$.
- $\phi(\xi) < 0$ for $\xi \in \vec{\gamma}$ if $\Delta = \emptyset$ and $\phi(\xi) > 0$ for $\xi \in \vec{\gamma}$ if $\nabla = \emptyset$. Moreover, $\phi(\xi)$ is bounded away from zero for $\xi \in \vec{\gamma}$ except in a neighborhood of either of the two roots of $R(\xi; \mathbf{p}, \mathbf{q})^2$ (which are endpoints of $\vec{\gamma}$).
- $\theta(\xi)$ and $\theta_0(\xi) - \theta(\xi)$ are both real and nondecreasing (nonincreasing) with orientation if $\Delta = \emptyset$ (if $\nabla = \emptyset$). Moreover, for $\xi \in \vec{\beta}$, $\theta'(\xi)$ is bounded away from zero except in neighborhoods of the two roots of $R(\xi; \mathbf{p}, \mathbf{q})^2$ (endpoints of $\vec{\beta}$) and, in case \mathbf{R} , the point $\xi = -1$.
- $H(\xi) = H(\xi; \mathbf{p}(x), \mathbf{q}(x), x, 0)$ is bounded away from zero for $\xi \in \beta \cup \gamma$ except in a neighborhood of $\xi = -1$ where $H(\xi)$ has a simple zero.

Recalling the definition (1.59) of x_{crit} , we note that (4.48) shows that for $t = 0$, g is in case R for $|x| < x_{\text{crit}}$ and in case L for $|x| > x_{\text{crit}}$, while $|x| = x_{\text{crit}}$ is the borderline case.

Proof. According to Proposition 4.1, $g(w) \rightarrow 0$ as $w \rightarrow \infty$ and the boundary values taken by g on $\beta \cup \mathbb{R}_+$ are related as follows:

$$g_+(\xi) + g_-(\xi) = \begin{cases} 0, & \xi \in \mathbb{R}_+, \\ 2iQ(\xi) + \bar{L}(\xi), & \xi \in \beta \cap \mathbb{R}, \\ 2iQ(\xi) + \bar{L}(\xi) \mp i\Phi, & \xi \in \beta \cap \mathbb{C}_\pm. \end{cases} \quad (4.58)$$

Writing $g(w) = \sqrt{-w}R(w)s(w)$, we see that s is a function analytic for $w \in \mathbb{C} \setminus \beta$ satisfying $s(w) = o(w^{-3/2})$ as $w \rightarrow \infty$ (and therefore since β is bounded, $s(w) = \mathcal{O}(w^{-2})$ as $w \rightarrow \infty$). Moreover, the differences of boundary values of s on β are now determined from (4.58):

$$s_+(\xi) - s_-(\xi) = \frac{1}{\sqrt{-\xi}R_+(\xi)} \begin{cases} 2iQ(\xi) + \bar{L}(\xi), & \xi \in \beta \cap \mathbb{R}, \\ 2iQ(\xi) + \bar{L}(\xi) \mp i\Phi, & \xi \in \beta \cap \mathbb{C}_\pm. \end{cases} \quad (4.59)$$

It follows that s is necessarily given by a Cauchy integral:

$$s(w) = \frac{1}{2\pi i} \int_{\beta} \frac{2iQ(\xi) + \bar{L}(\xi)}{\sqrt{-\xi}R_+(\xi)} \frac{d\xi}{\xi - w} - \frac{\Phi}{2\pi} \left[\int_{\beta \cap \mathbb{C}_+} \frac{1}{\sqrt{-\xi}R_+(\xi)} \frac{d\xi}{\xi - w} - \int_{\beta \cap \mathbb{C}_-} \frac{1}{\sqrt{-\xi}R_+(\xi)} \frac{d\xi}{\xi - w} \right]. \quad (4.60)$$

Now this formula provides apparent decay at the rate $s(w) = \mathcal{O}(w^{-1})$ as $w \rightarrow \infty$, so the true faster rate of decay $s(w) = \mathcal{O}(w^{-2})$ implies that

$$\Phi = \frac{1}{2i\mathcal{D}} \int_{\beta} \frac{2iQ(\xi) + \bar{L}(\xi)}{\sqrt{-\xi}R_+(\xi)} d\xi, \quad (4.61)$$

where \mathcal{D} is given by (4.33) in case L and by (4.34) in case R, and is obviously nonzero in both cases. But if $t = 0$ and if $\mathbf{p} = \mathbf{p}(x)$ and $\mathbf{q} = \mathbf{q}(x)$ while the contour β is as specified in the hypotheses, then it is easy to check that β is mapped onto itself preserving orientation by the involution $\xi \rightarrow \xi^{-1}$, while the integrand changes sign under this involution. This proves that $\Phi = 0$ for all x at $t = 0$.

Now Proposition 4.1 also asserts that

$$R(\xi)H(\xi) = \phi'(\xi) = 2iQ'(\xi) + \bar{L}'(\xi) - 2g'(\xi), \quad \xi \in \bar{\gamma}, \quad (4.62)$$

where $R(\xi) = R(\xi; \mathbf{p}(x), \mathbf{q}(x))$. Holding $\xi \in \bar{\gamma}$ fixed, we differentiate with respect to x :

$$\frac{\partial}{\partial x} R(\xi)H(\xi) = 2iE'(\xi) - 2\frac{\partial^2 g}{\partial \xi \partial x}, \quad \xi \in \bar{\gamma}. \quad (4.63)$$

Recalling the function $X(w)$ defined in the proof of Proposition 4.2 by (4.36) and given in explicit form by (4.38), we have

$$\frac{\partial}{\partial x} R(\xi)H(\xi) = 2iE'(\xi) - \frac{2}{\pi} \frac{\partial}{\partial \xi} \left[\sqrt{-\xi}R(\xi)X(\xi) \right], \quad \xi \in \bar{\gamma}. \quad (4.64)$$

But, $\partial\Phi/\partial x = 0$, so we may evaluate $X(\xi)$ in closed form using (4.38) and simple contour deformations:

$$X(\xi) = \int_{\beta} \frac{E(\zeta) d\zeta}{\sqrt{-\zeta}R_+(\zeta)(\zeta - \xi)} = \frac{\pi}{4\xi R(\xi)} [1 - \xi + R(\xi)], \quad (4.65)$$

where we have used the fact that $\mathbf{p}^2 - \mathbf{q} = 1$ implies $R(0) = -1$. Therefore, recalling the definition (1.39) of $E(w)$ we find simply that

$$\frac{\partial}{\partial x} R(\xi)H(\xi) = \frac{1}{2} \frac{\partial}{\partial \xi} \left[\frac{R(\xi)}{\sqrt{-\xi}} \right], \quad \xi \in \bar{\gamma}. \quad (4.66)$$

Using (4.49) and the identity

$$\frac{\partial \hat{R}}{\partial \lambda}(\lambda; \mathbf{p}(x)) = -\frac{16\lambda}{\mathbf{p}'(x)} \frac{\partial \hat{R}}{\partial x}(\lambda; \mathbf{p}(x)) \quad (4.67)$$

then yields

$$\frac{\partial}{\partial x} R(\xi)H(\xi) = -\frac{8E(\xi)E'(\xi)}{\mathbf{p}'(x)} \frac{\partial \hat{R}}{\partial x}(E(\xi); \mathbf{p}(x)), \quad \xi \in \bar{\gamma}. \quad (4.68)$$

Now with $\sigma = 1$ for $\Delta = \emptyset$ and $\sigma = -1$ for $\nabla = \emptyset$ we integrate from $x_0(\xi) := \sigma G^{-1}(4iE(\xi))$ to x :

$$R(\xi)H(\xi) = -8E(\xi)E'(\xi) \int_{\sigma G^{-1}(4iE(\xi))}^x \frac{\partial \hat{R}}{\partial y}(E(\xi); \mathbf{p}(y)) \frac{dy}{\mathbf{p}'(y)}, \quad \xi \in \vec{\gamma}, \quad (4.69)$$

where we observe that the contribution from the lower limit of integration vanishes because by definition (see (4.5)) $H(\xi; \mathbf{p}(x_0), \mathbf{q}(x_0), x_0, 0)$ is finite and $R(\xi; \mathbf{p}(x_0), \mathbf{q}(x_0)) = 0$. If w_k is either of the two roots of $R(w; \mathbf{p}(x), \mathbf{q}(x))^2$, then we have $\phi(w_k) = \pm i\Phi = 0$, so

$$\phi(\xi) = \int_{w_k}^{\xi} R(\zeta)H(\zeta) d\zeta = -8 \int_{E(w_k)}^{E(\xi)} \lambda \int_{\sigma G^{-1}(4i\lambda)}^x \frac{\partial \hat{R}}{\partial y}(\lambda; \mathbf{p}(y)) \frac{dy}{\mathbf{p}'(y)} d\lambda, \quad \xi \in \vec{\gamma} \quad (4.70)$$

where we have made the substitution $\lambda = E(\zeta)$. So, if $\Delta = \emptyset$ (so $x \geq 0$) then $x \geq \sigma G^{-1}(4i\lambda)$ so $dy > 0$ and $\mathbf{p}'(y) \geq 0$ while $\partial \hat{R}(\lambda; \mathbf{p}(y))/\partial y \leq 0$ and $\lambda d\lambda < 0$, yielding $\phi(\xi) < 0$ for $\xi \in \vec{\gamma}$. On the other hand, if $\nabla = \emptyset$ (so $x \leq 0$) then $x \leq \sigma G^{-1}(4i\lambda)$ so $dy < 0$ and $\mathbf{p}'(y) \leq 0$ while $\partial \hat{R}(\lambda; \mathbf{p}(y))/\partial y \geq 0$ and $\lambda d\lambda < 0$, yielding $\phi(\xi) > 0$ for $\xi \in \vec{\gamma}$. In both cases we easily obtain from (4.69) the inequality

$$|H(\xi)| = \frac{8|E(\xi)||E'(\xi)|}{|\xi|^{1/2}|\hat{R}(E(\xi); \mathbf{p}(x))|} \left| \int_{\sigma G^{-1}(4iE(\xi))}^x \frac{\partial \hat{R}}{\partial y}(E(\xi); \mathbf{p}(y)) \frac{dy}{\mathbf{p}'(y)} \right| \geq \frac{8|E(\xi)||E'(\xi)|}{|\xi|^{1/2} \sup_{y \in \mathbb{R}} |G(y)G'(y)|}, \quad \xi \in \vec{\gamma}. \quad (4.71)$$

Proposition 4.1 asserts further that

$$iR_+(\xi)H(\xi) = \theta'(\xi) = -i[g'_+(\xi) - g'_-(\xi)], \quad \xi \in \vec{\beta}. \quad (4.72)$$

Differentiating with respect to x for $\xi \in \vec{\beta}$ fixed gives

$$\frac{\partial}{\partial x} iR_+(\xi)H(\xi) = -i \left[\frac{\partial^2 g_+}{\partial \xi \partial x} - \frac{\partial^2 g_-}{\partial \xi \partial x} \right] = -\frac{i}{\pi} \frac{\partial}{\partial \xi} \left[\sqrt{-\xi} R_+(\xi)(X_+(\xi) + X_-(\xi)) \right], \quad \xi \in \vec{\beta}. \quad (4.73)$$

Substituting from the explicit formula (4.65) gives

$$\frac{\partial}{\partial x} iR_+(\xi)H(\xi) = \frac{i}{2} \frac{\partial}{\partial \xi} \left[\frac{R_+(\xi)}{\sqrt{-\xi}} \right], \quad \xi \in \vec{\beta}, \quad (4.74)$$

which can be equivalently written in the form

$$\frac{\partial}{\partial x} iR_+(\xi)H(\xi) = -i \frac{8E(\xi)E'(\xi)}{\mathbf{p}'(x)} \frac{\partial \hat{R}_+}{\partial x}(E(\xi); \mathbf{p}(x)), \quad \xi \in \vec{\beta}, \quad (4.75)$$

where $\hat{R}_+(E(\xi); \mathbf{p}(x))$ refers to the boundary value from the left as the (vertical) branch cut is traversed by $E(\xi)$ when ξ moves along an oriented arc of $\vec{\beta}$. Integrating from $x' = \sigma G^{-1}(4iE(\xi))$ to $x' = x$ then gives

$$\frac{d\theta}{d\xi}(\xi) = iR_+(\xi)H(\xi) = -8iE(\xi)E'(\xi) \int_{\sigma G^{-1}(4iE(\xi))}^x \frac{\partial \hat{R}_+}{\partial y}(E(\xi); \mathbf{p}(y)) \frac{dy}{\mathbf{p}'(y)}, \quad \xi \in \vec{\beta}. \quad (4.76)$$

Of course $d\theta/d\xi = 0$ for $\xi \in \vec{\gamma}$. This shows that $d\theta/dv$ is a monotone function of x , where $v = -4iE(\xi)$ is a real parameter for $\beta \cup \gamma$. The extreme value is attained at $x = 0$, at which point γ vanishes and according to (1.45), for each $\xi \in \vec{\beta}$ the right-hand side of (4.76) becomes $\theta'_0(\xi)$. This proves the desired monotonicity of $\theta_0(\xi) - \theta(\xi)$.

Now $\theta(w_k) = 0$ when w_k denotes either of the two roots of $R(w; \mathbf{p}(x), \mathbf{q}(x))$, so

$$\theta(\xi) = i \int_{w_k}^{\xi} R_+(\zeta)H(\zeta) d\zeta = -8i \int_{E(w_k)}^{E(\xi)} \lambda \int_{\sigma G^{-1}(4i\lambda)}^x \frac{\partial \hat{R}_+}{\partial y}(\lambda; \mathbf{p}(y)) \frac{dy}{\mathbf{p}'(y)} d\lambda, \quad \xi \in \vec{\beta}. \quad (4.77)$$

From this formula it follows that $\theta(\xi) > 0$ for $\xi \in \vec{\beta}$ regardless of whether $\Delta = \emptyset$ or $\nabla = \emptyset$. Also, from (4.76) we have the inequality

$$|H(\xi)| = \frac{8|E(\xi)||E'(\xi)|}{|\xi|^{1/2}|\hat{R}(E(\xi); \mathbf{p}(x))|} \left| \int_{\sigma G^{-1}(4iE(\xi))}^x \frac{\partial \hat{R}_+}{\partial y}(E(\xi); \mathbf{p}(y)) \frac{dy}{\mathbf{p}'(y)} \right| \geq \frac{8|E(\xi)||E'(\xi)|}{|\xi|^{1/2} \sup_{y \in \mathbb{R}} |G(y)G'(y)|}, \quad \xi \in \vec{\beta}. \quad (4.78)$$

Combining (4.71) and (4.78) shows that H is bounded away from zero along $\beta \cup \gamma$, uniformly with respect to x , except possibly in neighborhoods of points $\xi \in \beta \cup \gamma$ at which either $E(\xi) = 0$ (corresponding to $\xi = 1$)

or $E'(\xi) = 0$ (corresponding to $\xi = -1$). While $H(w)$ indeed has a simple zero at $w = -1$ as is clear from (4.57), there is no zero at $w = 1$ as we will now show. Suppose that $x \in \mathbb{R}$ is fixed, and $\xi \in \vec{\beta}$. Then by collapsing the contour $E(C)$ to the imaginary axis and extracting a residue at $\lambda = E(\xi)$, (4.57) shows that

$$H(\xi; \mathbf{p}, \mathbf{p}^2 - 1, x, 0) = \frac{E'(\xi)\Psi'(E(\xi))}{i\sqrt{-\xi}\widehat{R}_+(E(\xi); \mathbf{p})} - \frac{2E(\xi)}{\pi\sqrt{-\xi}} \frac{dE}{d\xi}(\xi) \int_{E(\gamma)} \frac{1}{E(\xi)^2 - \lambda^2} \frac{\Psi'(\lambda) d\lambda}{\widehat{R}(\lambda; \mathbf{p})}, \quad \xi \in \vec{\beta}. \quad (4.79)$$

Taking the limit along β of $\xi \rightarrow 1$ (either from the upper or lower half-plane) shows that H has nonzero limiting values contributed by the first (residue) term in the above formula.

This completes the proof of the assertion regarding the function H . The assertions regarding the functions ϕ and θ then follow from this, the formulae $\phi'(\xi) = R(\xi)H(\xi)$ for $\xi \in \vec{\gamma}$ and $\theta'(\xi) = iR_+(\xi)H(\xi)$ for $\xi \in \vec{\beta}$, and the inequalities $\theta(\xi) > 0$ for $\xi \in \vec{\beta}$, $\phi(\xi) < 0$ for $\xi \in \vec{\gamma}$ if $\Delta = \emptyset$, and $\phi(\xi) > 0$ or $\xi \in \vec{\gamma}$ if $\nabla = \emptyset$. \square

4.3. Continuation of g to nonzero t . We begin by establishing some differential identities. Here we are viewing M and I as functions of the roots of $R(w; \mathbf{p}, \mathbf{q})$ rather than as functions of \mathbf{p} and \mathbf{q} themselves.

Proposition 4.5. *Let w_k , $k = 0, 1$, denote either of the two roots of the quadratic $R(w; \mathbf{p}, \mathbf{q})^2$. Then*

$$\frac{\partial M}{\partial w_k} = 2\sqrt{-w_k}H(w_k) \quad (4.80)$$

and

$$\frac{\partial I}{\partial w_k} = -\frac{1}{4}\sqrt{-w_k}H(w_k) \left[\int_{\beta \cap \mathbb{C}_+} \frac{R_+(\xi) d\xi}{\sqrt{-\xi}(\xi - w_k)} + \int_{\beta \cap \mathbb{C}_-} \frac{R_-(\xi) d\xi}{\sqrt{-\xi}(\xi - w_k)} \right], \quad (4.81)$$

where in each case the partial derivative with respect to w_k is calculated holding the other root fixed, that is, by the chain rule in which u and v are expressed in terms of the two roots.

Proof. Writing $R(w)^2 = (w - w_0)(w - w_1)$ it follows easily that

$$\frac{\partial R}{\partial w_k} = -\frac{1}{2} \frac{R(w)}{w - w_k} \quad (4.82)$$

where both w and the other root are held fixed. The identity (4.80) follows by substituting $\sqrt{\mathbf{p}^2 - \mathbf{q}} = \sqrt{-w_0}\sqrt{-w_1}$ into (4.4), differentiating under the integral sign using (4.82) (the contours of C are independent of w_k), and comparing with the definition (4.5) of H . In a similar way, one shows that

$$\frac{\partial}{\partial w_k} R(\xi)H(\xi) = -\frac{1}{2} \frac{\sqrt{-w_k}}{\sqrt{-\xi}} \frac{R(\xi)}{\xi - w_k} H(w_k), \quad (4.83)$$

and using this in (4.6) proves (4.81). \square

Proposition 4.6. *Let w_0 and w_1 denote the two roots of $R(w)^2$. The Jacobian*

$$\mathcal{J}(w_0, w_1) := \det \begin{bmatrix} \frac{\partial M}{\partial w_0} & \frac{\partial M}{\partial w_1} \\ \frac{\partial I}{\partial w_0} & \frac{\partial I}{\partial w_1} \end{bmatrix} \quad (4.84)$$

of the map $(w_0, w_1) \mapsto (M, I)$ is

$$\mathcal{J}(w_0, w_1) := -\mathcal{D}\sqrt{-w_0}\sqrt{-w_1}H(w_0)H(w_1)(w_1 - w_0) \quad (4.85)$$

where H is defined by (4.5) and \mathcal{D} is defined by (4.33) in case L and by (4.34) in case R.

Proof. This is an immediate consequence of Proposition 4.5, the definition of $R(w)$, and the formula (4.40) for \mathcal{D} , which applies in both cases L and R. \square

4.3.1. Continuation from $x \notin \{0, \pm x_{\text{crit}}\}$.

Proposition 4.7. *There exist disjoint open neighborhoods \mathcal{O}_L^\pm and \mathcal{O}_R^\pm in the (x, t) -plane with*

$$\mathcal{O}_L^- \cap \mathbb{R} = (-\infty, -x_{\text{crit}}) \quad \text{and} \quad \mathcal{O}_L^+ \cap \mathbb{R} = (x_{\text{crit}}, +\infty) \quad (4.86)$$

and

$$\mathcal{O}_R^- \cap \mathbb{R} = (-x_{\text{crit}}, 0) \quad \text{and} \quad \mathcal{O}_R^+ \cap \mathbb{R} = (0, x_{\text{crit}}), \quad (4.87)$$

such that, with $\mathcal{O} := \mathcal{O}_L^- \cup \mathcal{O}_R^- \cup \mathcal{O}_R^+ \cup \mathcal{O}_L^+$, the following hold true.

- There are differentiable maps $\mathbf{p} : \mathcal{O} \rightarrow \mathbb{R}$ and $\mathbf{q} : \mathcal{O} \rightarrow \mathbb{R}$ uniquely determined by the properties that

$$\mathbf{p}(x, 0) = 1 - \frac{1}{2}G(x)^2 \quad \text{and} \quad \mathbf{q}(x, 0) = \mathbf{p}(x, 0)^2 - 1, \quad (x, 0) \in \mathcal{O}, \quad (4.88)$$

and

$$M(\mathbf{p}(x, t), \mathbf{q}(x, t), x, t) = I(\mathbf{p}(x, t), \mathbf{q}(x, t), x, t) = 0, \quad (x, t) \in \mathcal{O}, \quad (4.89)$$

where it is assumed that in the definition of M and I , $\Delta = \emptyset$ for $(x, t) \in \mathcal{O}_R^+ \cup \mathcal{O}_L^+$ while $\nabla = \emptyset$ for $(x, t) \in \mathcal{O}_R^- \cup \mathcal{O}_L^-$.

- The quantity $n_{\mathbf{p}}(x, t)$ defined for $(x, t) \in \mathcal{O}$ in terms of $\mathbf{p}(x, t)$ and $\mathbf{q}(x, t)$ by (4.35) satisfies $n_{\mathbf{p}}(x, 0) = 0$ and

$$\frac{\partial n_{\mathbf{p}}}{\partial t}(x, 0) < 0, \quad (x, 0) \in \mathcal{O}_R^- \cup \mathcal{O}_L^+ \quad (4.90)$$

and

$$\frac{\partial n_{\mathbf{p}}}{\partial t}(x, 0) > 0, \quad (x, 0) \in \mathcal{O}_L^- \cup \mathcal{O}_R^+. \quad (4.91)$$

- A connected contour $\beta \cup \gamma$, consisting of the union of (i) a Schwartz-symmetric closed curve passing through $w = 1$ and enclosing the origin with (ii) the interval $[\mathbf{a}, \mathbf{b}]$, can be chosen so that for each $(x, t) \in \mathcal{O}$ an analytic function $g : \mathbb{C} \setminus (\beta \cup \mathbb{R}_+) \rightarrow \mathbb{C}$ is well-defined by Proposition 4.1, with associated functions $\theta : \vec{\beta} \cup \vec{\gamma} \rightarrow \mathbb{C}$ and $\phi : \vec{\beta} \cup \vec{\gamma} \rightarrow \mathbb{C}$ defined by (3.48), and so that the following hold:
 - The function ϕ satisfies $\Re\{\phi(\xi)\} < 0$ for $\xi \in \vec{\gamma}$ if $(x, t) \in \mathcal{O}_R^+ \cup \mathcal{O}_L^+$ and $\Re\{\phi(\xi)\} > 0$ for $\xi \in \vec{\gamma}$ if $(x, t) \in \mathcal{O}_R^- \cup \mathcal{O}_L^-$. Moreover, $\Re\{\phi(\xi)\}$ is bounded away from zero for $\xi \in \vec{\gamma}$ except in a neighborhood of either of the two roots of $R(\xi; \mathbf{p}(x, t), \mathbf{q}(x, t))^2$ (which are endpoints of $\vec{\gamma}$).
 - The function $\theta(\xi)$ is real and nondecreasing (nonincreasing) with orientation for $\xi \in \vec{\beta}$ if $(x, t) \in \mathcal{O}_R^+ \cup \mathcal{O}_L^+$ (if $(x, t) \in \mathcal{O}_R^- \cup \mathcal{O}_L^-$). Moreover, $\theta'(\xi)$ is bounded away from zero except in neighborhoods of the two roots of $R(\xi; \mathbf{p}(x, t), \mathbf{q}(x, t))^2$ (endpoints of $\vec{\beta}$) and, in case R, a single point $\xi = w^+ < 0$ that converges to $\xi = -1$ as $t \rightarrow 0$.
 - The function $H(\xi) = H(\xi; \mathbf{p}(x, t), \mathbf{q}(x, t), x, t)$ is bounded away from zero for $\xi \in \beta \cup \gamma$ except in a neighborhood of $\xi = w^+$ where $H(\xi)$ has a simple zero.

The notation is meant to suggest the fact that the configuration of the roots of $R(w; \mathbf{p}(x, t), \mathbf{q}(x, t))^2$ is of type R for $(x, t) \in \mathcal{O}_R^+ \cup \mathcal{O}_R^-$ and is of type L for $(x, t) \in \mathcal{O}_L^+ \cup \mathcal{O}_L^-$. We have therefore defined the function $n_{\mathbf{p}}(x, t)$ appearing in the statements of Theorems 1.1 and 1.2 in terms of $\mathbf{p}(x, t)$ and $\mathbf{q}(x, t)$ for $(x, t) \in \mathcal{O}$ by (4.35). We are now also in a position to define the accompanying function $\mathcal{E}(x, t)$ for $(x, t) \in \mathcal{O}$:

$$\mathcal{E}(x, t) := -\frac{\mathbf{p}(x, t)}{\sqrt{\mathbf{p}(x, t)^2 - \mathbf{q}(x, t)}}, \quad (x, t) \in \mathcal{O}. \quad (4.92)$$

We can now also identify the region S_L involved in the statement of Theorem 1.1 as the union $\mathcal{O}_L^+ \cup \mathcal{O}_L^-$.

Proof. The existence of the maps \mathbf{p} and \mathbf{q} is a consequence of the Implicit Function Theorem. Indeed, since for $x \neq 0$ the roots w_0 and w_1 of $R(w; \mathbf{p}(x, 0), \mathbf{q}(x, 0))^2$ lie within the domain of analyticity of $H(w)$, Proposition 4.5 shows that M and I are differentiable with respect to these roots. Furthermore, since under the additional hypothesis $|x| \neq x_{\text{crit}}$ the roots of $R(w; \mathbf{p}(x, 0), \mathbf{q}(x, 0))^2$ are distinct and neither is equal to -1 , it follows from Propositions 4.4 and 4.6 that the Jacobian (4.84) is nonzero when $(x, 0) \in \mathcal{O}$. Therefore we may solve uniquely for w_0 and w_1 in terms of (x, t) from the equations $M = I = 0$, and since $\mathbf{p} = (w_0 + w_1)/2$ and $\mathbf{q} = (w_0 - w_1)^2/4$ we also have \mathbf{p} and \mathbf{q} .

According to (4.35) in Proposition 4.2, the fact that $\mathbf{p}(x, 0)^2 - \mathbf{q}(x, 0) = 1$ implies that $n_{\mathbf{p}} = 0$ when $t = 0$. Also,

$$\frac{\partial n_{\mathbf{p}}}{\partial t} = -\frac{1}{\sqrt{\Pi}(1 + \sqrt{\Pi})^2} \frac{\partial \Pi}{\partial t}, \quad \Pi := \mathbf{p}^2 - \mathbf{q} = w_0 w_1 \quad (4.93)$$

so that $\partial n_{\mathbf{p}}/\partial t$ and $\partial \Pi/\partial t$ have opposite signs. By differentiation of the equations $M = I = 0$ with respect to t one obtains the system of equations

$$\frac{\partial M}{\partial w_0} \frac{\partial w_0}{\partial t} + \frac{\partial M}{\partial w_1} \frac{\partial w_1}{\partial t} + \frac{\partial M}{\partial t} = 0 \quad \text{and} \quad \frac{\partial I}{\partial w_0} \frac{\partial w_0}{\partial t} + \frac{\partial I}{\partial w_1} \frac{\partial w_1}{\partial t} + \frac{\partial I}{\partial t} = 0, \quad (4.94)$$

from which follows the identity

$$\frac{\partial \Pi}{\partial t} = \frac{1}{\mathcal{J}(w_0, w_1)} \left[\left(w_1 \frac{\partial M}{\partial w_1} - w_0 \frac{\partial M}{\partial w_0} \right) \frac{\partial I}{\partial t} + \left(w_0 \frac{\partial I}{\partial w_0} - w_1 \frac{\partial I}{\partial w_1} \right) \frac{\partial M}{\partial t} \right]. \quad (4.95)$$

Now by noting the explicit t dependence in M and (via the definition of H) in I we have

$$\frac{\partial M}{\partial t} = \frac{\sqrt{\Pi} - 1}{\sqrt{\Pi}} \quad \text{and} \quad \frac{\partial I}{\partial t} = \frac{1}{4\sqrt{\Pi}} \Re \left\{ \int_{\beta \cap \mathbb{C}_+} \frac{R_+(\xi; \mathbf{p}, \mathbf{q})}{\xi \sqrt{-\xi}} d\xi \right\}. \quad (4.96)$$

Therefore, as $t = 0$ implies that $\Pi = 1$, we also have $\partial M/\partial t = 0$ when $t = 0$, simplifying the identity (4.95). Using also Proposition 4.5 and the fact that when $t = 0$, $R_+(\xi; \mathbf{p}, \mathbf{q}) = \sqrt{-\xi} \hat{R}_+(E(\xi); \mathbf{p}(x, 0))$ gives

$$\frac{\partial \Pi}{\partial t} \Big|_{t=0} = \frac{1}{2 \mathcal{J}(w_0, w_1)} [w_1 \sqrt{-w_1} H(w_1) - w_0 \sqrt{-w_0} H(w_0)] \Re \left\{ \int_{\beta \cap \mathbb{C}_+} \hat{R}_+(E(\xi); \mathbf{p}(x, 0)) \frac{d\xi}{\xi} \right\}. \quad (4.97)$$

Using (4.69) with $\sigma = \text{sgn}(x)$ and taking the limit as ξ approaches either root w_k of $R(w; \mathbf{p}, \mathbf{q})^2$ from γ , we have the formula

$$\sqrt{-w_k} H(w_k) = -4 \frac{D(w_k)}{w_k} U(x), \quad t = 0, \quad (4.98)$$

where we have also used the identity $D(w) = 2wE'(w)$, and where $U(x)$ is defined as

$$U(x) := E(w_k) \lim_{\substack{\xi \rightarrow w_k \\ \xi \in \gamma}} \left[\frac{1}{\hat{R}(E(\xi); \mathbf{p}(x, 0))} \int_{\text{sgn}(x)G^{-1}(4iE(\xi))}^x \frac{dy}{\hat{R}(E(\xi); \mathbf{p}(y, 0))} \right], \quad t = 0. \quad (4.99)$$

The quantity $U(x)$ has the same value regardless of whether $w_k = w_0$ or $w_k = w_1$ because $E(w_0) = E(w_1)$ at $t = 0$, which explains why we omit any notational dependence of U on k . Finally, using (4.98) together with formula (4.85) from Proposition 4.6 we write (4.97) in the form

$$\frac{\partial \Pi}{\partial t} \Big|_{t=0} = \frac{1}{8\mathcal{D}D(w_0)D(w_1)U(x)} \frac{D(w_1) - D(w_0)}{w_1 - w_0} \Re \left\{ \int_{\beta \cap \mathbb{C}_+} \hat{R}_+(E(\xi); \mathbf{p}(x, 0)) \frac{d\xi}{\xi} \right\}. \quad (4.100)$$

Here we have used the relationship $\Pi = w_0 w_1 = 1$ which is valid at $t = 0$.

We now determine the phases of the various factors in this formula.

- Since $E(w_0) = E(w_1)$ is a positive imaginary number, and since $G^{-1}(4iE(\xi)) \rightarrow |x|$ as $\xi \rightarrow w_k$ with $\xi \in \gamma$, while $\xi \in \gamma$ implies that $G^{-1}(4iE(\xi)) < |x|$, and in the range of integration $\hat{R}(E(\xi); \mathbf{p}(y, 0)) < 0$ for $\xi \in \gamma$, it follows that $U(x)$ is imaginary and has the same sign as x .
- According to (4.33) and (4.34) from Proposition 4.2, \mathcal{D} is a positive quantity.
- By explicit calculation,

$$\frac{D(w_1) - D(w_0)}{w_1 - w_0} = -\frac{i}{4} \frac{1}{\sqrt{-w_0} + \sqrt{-w_1}} \left(1 + \frac{1}{\sqrt{\Pi}} \right) = -\frac{i}{2} \frac{1}{\sqrt{-w_0} + \sqrt{-w_1}}, \quad t = 0, \quad (4.101)$$

a quantity that is negative imaginary.

- A similar direct calculation shows that

$$D(w_0)D(w_1) = -\frac{1}{16\sqrt{\Pi}}(1 + w_0)(1 + w_1) = -\frac{1}{16}(1 + w_0)(1 + w_1), \quad t = 0, \quad (4.102)$$

and this quantity is positive real for $(x, 0) \in \mathcal{O}_{\mathbb{R}}^{\pm}$ but is negative real for $(x, 0) \in \mathcal{O}_{\mathbb{L}}^{\pm}$.

- Since $\beta \cap \mathbb{C}_+$ is, for $t = 0$, an arc of the unit circle that we may take (without loss of generality) to be oriented in the counterclockwise direction, we see that $d\xi/\xi = i d\theta$, a positive imaginary increment, while the boundary value $\hat{R}_+(E(\xi); u(x, 0))$ is negative imaginary, and hence

$$\int_{\beta \cap \mathbb{C}_+} \hat{R}_+(E(\xi); \mathbf{p}(x, 0)) \frac{d\xi}{\xi} \in \mathbb{R}_+. \quad (4.103)$$

Combining these phases then yields the sign structure of $\partial\Pi/\partial t$ at $t = 0$ that produces the desired sign structure for $\partial n_p/\partial t$ at $t = 0$.

We now describe how to construct the contours β and γ to guarantee all of the corresponding conditions in the statement of the proposition. Of course all of these conditions are generalizations for $t \neq 0$ of corresponding conditions that hold true when $t = 0$ according to Proposition 4.4 when $\beta \cup \gamma$ is taken to coincide with the union of the unit circle with the interval $[\mathbf{a}, \mathbf{b}]$ so our argument will be a perturbative one, in which the unit circle is replaced by a suitable nearby curve. Firstly, since when $t = 0$, the function H is bounded away from zero on $\beta \cup \gamma$ except at $w = -1$ where H has a simple root, the same holds (also at $t = 0$) throughout Ω° if the latter is chosen without loss of generality to be close enough to $\beta \cup \gamma$. Now since $H(w; \mathbf{p}(x, t), \mathbf{q}(x, t), x, t)$ is an analytic function of w depending continuously on (x, t) near $(x, 0)$ and that satisfies $H(w^*) = H(w)$ it will also be bounded away from zero in Ω° for t small except near some real point $w = w^+$ close to $w = -1$ where it has a simple zero. It is easy to check that $H(w; \mathbf{p}(x, t), \mathbf{q}(x, t), x, t)$ has (two different) analytic continuations to a neighborhood of $w = 1$ from Ω° from the upper and lower half planes, so the limiting values $H(1_\pm; \mathbf{p}(x, t), \mathbf{q}(x, t), x, t)$ are both finite and nonzero. The contour $\beta \cap \mathbb{C}_+$ is then obtained by solving the well-posed autonomous initial-value problem

$$\frac{d\xi^*}{d\tau} = -iR_+(\xi; \mathbf{p}(x, t), \mathbf{q}(x, t))H(\xi; \mathbf{p}(x, t), \mathbf{q}(x, t), x, t), \quad \tau > 0, \quad \xi(0) = 1 \quad (4.104)$$

where we interpret $H(1)$ as $H(1_+)$. Clearly, τ parameterizes a trajectory along which $\Im\{\theta\}$ is constant and $\Re\{\theta\}$ is nonincreasing with parametrization τ , since

$$\frac{d\theta(\xi(\tau))}{d\tau} = \frac{d\theta}{d\xi} \cdot \frac{d\xi}{d\tau} = [iR_+(\xi)H(\xi)] [-iR_+(\xi)H(\xi)]^* = -|iR_+(\xi)H(\xi)|^2 \leq 0. \quad (4.105)$$

The vector field of (4.104) varies continuously with time t , and the only critical points in Ω° are $\xi = w^+$ and the two distinct roots of R^2 . Since an integral curve of this vector field for $t = 0$ connected $\xi = 1$ with the root of R^2 in \mathbb{C}_+ (in case L) or with $\xi = -1$ (in case R) and since the Melnikov-type integral condition $I = 0$ continues to hold true for $t \neq 0$, the solution of the initial-value problem (4.104) is a curve terminating at the perturbed root of R (in case L, in finite τ) or at the point $\xi = w^+ <$ (in case R, in infinite τ). This arc together with its Schwartz reflection in \mathbb{C}_- and, in case R, the real interval connecting the roots of R^2 , is β for $t \neq 0$. Upon assigning $\vec{\beta}$ its orientation according to whether case $\Delta = \emptyset$ or $\nabla = \emptyset$ holds, we easily see that since no critical points of the vector field of (4.104) lie in $\vec{\beta}$, the desired strict inequality for $d\theta/d\xi$ holds along $\vec{\beta}$. To construct the contour γ cruder methods suffice. In case L, γ is the union of the real interval $[\mathbf{a}, \mathbf{b}]$ with a Schwartz-symmetrical arc connecting the two complex-conjugate roots of R^2 ; we define $\gamma \cap \mathbb{C}_+$ for $t \neq 0$ as the image of the same for $t = 0$ under the linear mapping

$$\xi \mapsto \frac{w_0(x, t) - w^+}{w_0(x, 0) + 1} \xi + \frac{w_0(x, t) + w^+ w_0(x, 0)}{w_0(x, 0) + 1} \quad (4.106)$$

($w_0(x, t)$ is the root of R^2 in \mathbb{C}_+) taking $\xi = w_0(x, 0)$ to $w_0(x, t)$ and $\xi = -1$ to w^+ . In case R there is nothing to do since γ has to be the union of real intervals $[\mathbf{a}, w_0(x, t)] \cup [w_1(x, t), \mathbf{b}]$ where $w_0(x, t) < w_1(x, t)$ are the two roots of R^2 . In both cases, an easy continuity argument together with the fact that $\Re\{\phi\} = 0$ at the simple roots of R^2 and a local analysis of $d\phi/d\xi = R(\xi)H(\xi)$ near these roots shows that the desired inequality for $\Re\{\phi(\xi)\}$ holds on $\vec{\gamma}$. \square

It should be noted that elements of this proof actually provide computationally feasible numerical methods for continuation of g as x and t vary.

4.3.2. *Continuation from $x = 0$.* When $x = t = 0$, the roots of $R(w; \mathbf{p}, \mathbf{q})^2$ coincide with \mathbf{a} and \mathbf{b} and this implies that M and I are not differentiable with respect to the roots at this point. To circumvent this difficulty, it now becomes necessary to exploit more than the two simplest configurations of Δ and ∇ first introduced in §3.1; we must now consider the possibility that neither Δ nor ∇ is empty.

We begin with several observations concerning the functions $M(\mathbf{p}, \mathbf{q}, x, t)$ and $I(\mathbf{p}, \mathbf{q}, x, t)$. Fix some small $\delta > 0$ and consider configurations of type R in which the roots $w_{\prec} = \mathbf{p} - \sqrt{\mathbf{q}}$ and $w_{\succ} = \mathbf{p} + \sqrt{\mathbf{q}}$ of $R(w; \mathbf{p}, \mathbf{q})^2$ (in this section this will be more suggestive notation than w_0 and w_1) satisfy $\mathbf{a} < w_{\prec} < \mathbf{a} + \delta < -1 < \mathbf{b} - \delta < w_{\succ} < \mathbf{b}$, which bounds $\mathbf{q} > 0$ away from zero. If we further fix two real values τ_{∞}^{\prec} and τ_{∞}^{\succ} with $\mathbf{a} + \delta < \tau_{\infty}^{\prec} < -1 < \tau_{\infty}^{\succ} < \mathbf{b} - \delta$, then we may compare M and I for the various cases listed in §3.1, in which we use the transition point $\tau_{\infty} = \tau_{\infty}^{\prec}$ when we have $\Delta = P_N^{\prec K}$ or $\nabla = P_N^{\prec K}$, and we use the transition point $\tau_{\infty} = \tau_{\infty}^{\succ}$ when we have $\Delta = P_N^{K \succ}$ or $\nabla = P_N^{K \succ}$.

The first observation is that in this situation the functions (M, I) are the same in the case $\Delta = P_N^{\prec K}$ as in the case $\nabla = P_N^{K \succ}$, and are the same in the case $\nabla = P_N^{\prec K}$ as in the case $\Delta = P_N^{K \succ}$. To see this, it is useful to note that by a simple contour deformation in which the components of $\partial\Omega_{\pm}^{\nabla} \setminus \Sigma^{\nabla}$ and $\partial\Omega_{\pm}^{\Delta} \setminus \Sigma^{\Delta}$ are collapsed toward $\beta \cup \gamma$ we may write M , originally defined by (4.4), in the form

$$M = \frac{x-t}{\sqrt{\mathbf{p}^2 - \mathbf{q}}} + x + t + \frac{4}{\pi} \int_{\gamma} \frac{\theta'_0(\xi) \sqrt{-\xi} d\xi}{R(\xi; \mathbf{p}, \mathbf{q})} \quad (4.107)$$

and we see that the only way that this formula depends on the choice of Δ is via the orientation of the contour arcs in γ , and so the desired equivalence for M follows because the transition points lie in the complementary contour β . Exactly the same contour deformations, when applied to the definition of $H(w)$, will result in the additional contribution of a residue at $\xi = w$; if $w \in \beta$ we have:

$$H(w) = -\frac{1}{4\sqrt{-w}} \left[\frac{x-t}{w\sqrt{\mathbf{p}^2 - \mathbf{q}}} - \frac{4}{\pi} \int_{\gamma} \frac{\theta'_0(\xi) \sqrt{-\xi} d\xi}{R(\xi; \mathbf{p}, \mathbf{q})(\xi - w)} \right] + \frac{\theta'_0(w)}{iR_+(w; \mathbf{p}, \mathbf{q})}. \quad (4.108)$$

Our analysis of the formula (4.107) applies to all but the last term. This last term does indeed distinguish between $\Delta = P_N^{\prec K}$ and $\nabla = P_N^{K \succ}$ and between $\Delta = P_N^{K \succ}$ and $\nabla = P_N^{\prec K}$ due to a change of orientation of $\beta \cap \mathbb{C}_+$, which changes the sign of the boundary value $R_+(w; \mathbf{p}, \mathbf{q})$. However, this discrepancy contributes nothing to the integral I , since recalling the definition (4.6) we have

$$\Re \left\{ \int_{\beta \cap \mathbb{C}_+} R_+(\xi; \mathbf{p}, \mathbf{q}) \left[\frac{2\theta'_0(\xi)}{iR_+(\xi; \mathbf{p}, \mathbf{q})} \right] d\xi \right\} = \pm 2\Im \{ \theta_0(w^+) - \Psi(0) \} = 0, \quad (4.109)$$

and for the remaining terms we note that integrating over the (oriented) contour $\beta \cap \mathbb{C}_+$ against the (oriented) boundary value $R_+(\xi; \mathbf{p}, \mathbf{q})$ is an orientation-invariant operation.

The second observation is that since \mathbf{q} is bounded away from zero, we may consider M and I , in any of the six choices of Δ listed in §3.1, as well-defined functions of the roots $w_{\prec} < w_{\succ}$. These are both analytic functions of w_{\prec} and w_{\succ} in the intervals $\mathbf{a} < w_{\prec} < \mathbf{a} + \delta$ and $\mathbf{b} - \delta < w_{\succ} < \mathbf{b}$. Next, recall the part of Proposition 1.2 guaranteeing that $\theta_0(w)$ has an analytic continuation from $w > \mathbf{a}$ and $w < \mathbf{b}$ to small neighborhoods of $w = \mathbf{a}$ and of $w = \mathbf{b}$ respectively. Using this fact, we may construct the analytic continuation $\mathcal{M}_{\prec} \{(M, I)\}$ of (M, I) with respect to w_{\prec} (holding w_{\succ} , x , and t fixed) about a small positively-oriented loop about $w = \mathbf{a}$ beginning and ending on the real axis with $\mathbf{a} < w_{\prec} < \mathbf{a} + \delta$. We may also construct a similar analytic continuation denoted $\mathcal{M}_{\succ} \{(M, I)\}$ with respect to w_{\succ} (holding w_{\prec} , x , and t fixed) about a small positively-oriented loop about $w = \mathbf{b}$ beginning and ending on the real axis with $\mathbf{b} - \delta < w_{\succ} < \mathbf{b}$.

The third and most important observation is that these two monodromy operations \mathcal{M}_{\prec} and \mathcal{M}_{\succ} simply result in involutive permutations among the various cases of choice of Δ enumerated in §3.1. These relations are shown in Figure 4.3. These facts are elementary consequences of the formulae (4.107) and (4.108). Indeed, the analytic continuation operations both leave the non-integral terms invariant, and \mathcal{M}_{\prec} (respectively \mathcal{M}_{\succ}) may be realized in these formulae by analytic continuation of the integrand from the real axis and the generalization of the real segment of γ near $w = \mathbf{a}$ (respectively $w = \mathbf{b}$) to a straight-line contour connecting $w = \mathbf{a}$ with $w = w_{\prec}$ (respectively connecting $w = \mathbf{b}$ with $w = w_{\succ}$). This latter operation results in a change of sign of the square root in the integrand, which is equivalent to the reversal of orientation of the corresponding segment of γ , and hence in the desired permutation of formulae.

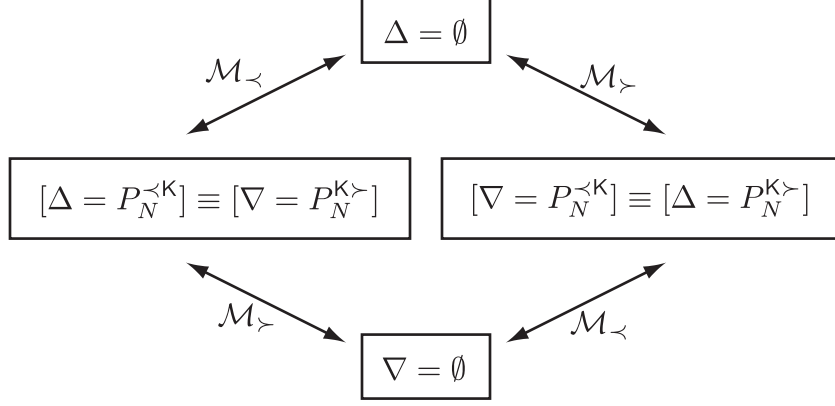

FIGURE 4.3. The effect of the two monodromy generators on the four distinct types of function pairs (M, I) .

Let Γ_{\prec} be the two-sheeted Riemann surface obtained from taking two copies of the disc $|w - \mathbf{a}| < \delta$ slit along $w < \mathbf{a}$ and identified in the usual way. Similarly, let Γ_{\succ} be the two-sheeted Riemann surface obtained from taking two copies of the disc $|w - \mathbf{b}| < \delta$ slit along $w > \mathbf{b}$ and identified in the usual way. The multivalued square roots $k_{\prec} := (w - \mathbf{a})^{1/2}$ and $k_{\succ} := (\mathbf{b} - w)^{1/2}$ are global analytic coordinates for Γ_{\prec} and Γ_{\succ} respectively. We now define a function $\Gamma_{\prec} \times \Gamma_{\succ} \times \mathbb{R}_{x,t}^2 \rightarrow \mathbb{C}^2$ by setting

$$(\hat{M}, \hat{I})(k_{\prec}, k_{\succ}, x, t) := \begin{cases} (M, I)(\mathbf{p}, \mathbf{q}, x, t)|_{\Delta=\emptyset}, & \Re\{k_{\prec}\} \geq 0, & \Re\{k_{\succ}\} \geq 0 \\ (M, I)(\mathbf{p}, \mathbf{q}, x, t)|_{\Delta=P_N^{\prec K}}, & \Re\{k_{\prec}\} \leq 0, & \Re\{k_{\succ}\} \geq 0 \\ (M, I)(\mathbf{p}, \mathbf{q}, x, t)|_{\nabla=P_N^{\prec K}}, & \Re\{k_{\prec}\} \geq 0, & \Re\{k_{\succ}\} \leq 0 \\ (M, I)(\mathbf{p}, \mathbf{q}, x, t)|_{\nabla=\emptyset}, & \Re\{k_{\prec}\} \leq 0, & \Re\{k_{\succ}\} \leq 0, \end{cases} \quad (4.110)$$

where on the right-hand side, $\mathbf{p} = (w_{\prec} + w_{\succ})/2$, $\mathbf{q} = (w_{\prec} - w_{\succ})^2/4$, and $w_{\prec} := \mathbf{a} + k_{\prec}^2$ while $w_{\succ} := \mathbf{b} - k_{\succ}^2$. In the second and third lines we could have equivalently used $\nabla = P_N^{K \succ}$ and $\Delta = P_N^{\prec K}$ respectively. The monodromy arguments above show that (\hat{M}, \hat{I}) is a pair of single-valued analytic functions on $\Gamma_{\prec} \times \Gamma_{\succ}$ for each $(x, t) \in \mathbb{R}^2$, except possibly on the coordinate axes $k_{\prec} = 0$ or $k_{\succ} = 0$. But it is easy to see that the pair (\hat{M}, \hat{I}) extends continuously to the axes, and hence any singularities are removable, so (\hat{M}, \hat{I}) is a pair of analytic functions defined on the whole product $\Gamma_{\prec} \times \Gamma_{\succ}$.

In fact, given the above discussion, it is not hard to write down explicit formulae for the functions \hat{M} and \hat{I} . Indeed, starting from the formula (4.107) for M and taking into account the change of orientation of the two arcs of γ corresponding to changes in sign of k_{\prec} and k_{\succ} , we arrive at the formula

$$\begin{aligned} \hat{M}(k_{\prec}, k_{\succ}, x, t) &= \frac{x - t}{\sqrt{1 - \mathbf{a}k_{\prec}^2 + \mathbf{b}k_{\succ}^2 - k_{\prec}^2 k_{\succ}^2}} + x + t \\ &\quad - \frac{4k_{\prec}}{\pi} \int_0^1 \frac{\theta'_0(\mathbf{a} + k_{\prec}^2 s) \sqrt{-\mathbf{a} - k_{\prec}^2 s} ds}{\sqrt{1 - s} \sqrt{\mathbf{b} - \mathbf{a} - k_{\prec}^2 - k_{\prec}^2 s}} + \frac{4k_{\succ}}{\pi} \int_0^1 \frac{\theta'_0(\mathbf{b} - k_{\succ}^2 s) \sqrt{-\mathbf{b} + k_{\succ}^2 s} ds}{\sqrt{1 - s} \sqrt{\mathbf{b} - \mathbf{a} - k_{\prec}^2 - k_{\prec}^2 s}}. \end{aligned} \quad (4.111)$$

Since the last term of the rewritten formula (4.108) for $H(w)$ contributes nothing to I , we may omit it and apply the same process as used to arrive at the above formula for \hat{M} to obtain

$$\hat{I}(k_{\prec}, k_{\succ}, x, t) = \Re \left\{ \int_{\beta \cap \mathbb{C}_+} R_+(w; \mathbf{p}, \mathbf{q}) \hat{H}(w) dw \right\} \quad (4.112)$$

where $\mathbf{p} = \frac{1}{2}(\mathbf{a} + \mathbf{b} + k_{\prec}^2 - k_{\succ}^2)$ and $\mathbf{q} = \frac{1}{4}(\mathbf{b} - \mathbf{a} - k_{\prec}^2 - k_{\succ}^2)^2$ and where

$$\begin{aligned} \hat{H}(w) := & -\frac{1}{4\sqrt{-w}} \left[\frac{x-t}{w\sqrt{1-\mathbf{a}k_{\prec}^2+\mathbf{b}k_{\succ}^2-k_{\prec}^2k_{\succ}^2}} \right. \\ & + \frac{4k_{\prec}}{\pi} \int_0^1 \frac{\theta'_0(\mathbf{a}+k_{\prec}^2s)\sqrt{-\mathbf{a}-k_{\prec}^2s}ds}{(\mathbf{a}+k_{\prec}^2s-w)\sqrt{1-s}\sqrt{\mathbf{b}-\mathbf{a}-k_{\prec}^2-k_{\succ}^2s}} \\ & \left. - \frac{4k_{\succ}}{\pi} \int_0^1 \frac{\theta'_0(\mathbf{b}-k_{\succ}^2s)\sqrt{-\mathbf{b}+k_{\succ}^2s}ds}{(\mathbf{b}-k_{\succ}^2s-w)\sqrt{1-s}\sqrt{\mathbf{b}-\mathbf{a}-k_{\prec}^2-k_{\succ}^2s}} \right]. \end{aligned} \quad (4.113)$$

In particular, it is easy to see that the two functions \hat{M} and \hat{I} are differentiable with respect to k_{\prec} and k_{\succ} at the origin $k_{\prec} = k_{\succ} = 0$ where, essentially, all six cases of (M, I) coincide with the same value, corresponding to the configuration $w_{\prec} = \mathbf{a}$ and $w_{\succ} = \mathbf{b}$ that occurs when $x = t = 0$. Therefore, we may compute the Jacobian of (\hat{M}, \hat{I}) with respect to the global analytic coordinates (k_{\prec}, k_{\succ}) of the manifold $\Gamma_{\prec} \times \Gamma_{\succ}$ (holding x and t fixed). By analogy with (4.84) we define

$$\hat{\mathcal{J}}(k_{\prec}, k_{\succ}) := \det \begin{bmatrix} \frac{\partial \hat{M}}{\partial k_{\prec}} & \frac{\partial \hat{M}}{\partial k_{\succ}} \\ \frac{\partial \hat{I}}{\partial k_{\prec}} & \frac{\partial \hat{I}}{\partial k_{\succ}} \end{bmatrix}. \quad (4.114)$$

Proposition 4.8. *At the origin $k_{\prec} = k_{\succ} = 0$, the Jacobian is*

$$\hat{\mathcal{J}}(0, 0) = -\frac{4\mathcal{D}_0}{\pi^2} (G(0)^2 - 4) \left[\frac{d}{dv} \Psi(iv/4) \Big|_{v=-G(0)} \right]^2, \quad (4.115)$$

where \mathcal{D}_0 denotes the positive quantity \mathcal{D} defined by (4.34) in the case that the roots $\mathbf{p} \pm \sqrt{\mathbf{q}}$ of $R(w)^2$ are taken to be \mathbf{a} and \mathbf{b} . Hence, $\hat{\mathcal{J}}(0, 0) < 0$ via Proposition 1.2 and Assumption 1.6, and $\hat{\mathcal{J}}(0, 0)$ is also independent of x and t .

Proof. We compute the Jacobian $\hat{\mathcal{J}}(0, 0)$ by calculating the partial derivatives of $\hat{\mathcal{J}}(k_{\prec}, k_{\succ})$ for $k_{\prec} > 0$ and $k_{\succ} > 0$ and then letting $k_{\prec} \downarrow 0$ and $k_{\succ} \downarrow 0$. In this situation we can use the formula $(\hat{M}, \hat{I}) = (M, I)|_{\Delta=\emptyset}$ with the right-hand side evaluated at $w_{\prec} = \mathbf{a} + k_{\prec}^2$ and $w_{\succ} = \mathbf{b} - k_{\succ}^2$. But then, by Proposition 4.6 we have

$$\begin{aligned} \hat{\mathcal{J}}(k_{\prec}, k_{\succ}) &= \det \begin{bmatrix} \frac{\partial M}{\partial w_{\prec}} & \frac{\partial M}{\partial w_{\succ}} \\ \frac{\partial I}{\partial w_{\prec}} & \frac{\partial I}{\partial w_{\succ}} \end{bmatrix} \Big|_{\Delta=\emptyset} \cdot \det \begin{bmatrix} \frac{\partial w_{\prec}}{\partial k_{\prec}} & \frac{\partial w_{\prec}}{\partial k_{\succ}} \\ \frac{\partial w_{\succ}}{\partial k_{\prec}} & \frac{\partial w_{\succ}}{\partial k_{\succ}} \end{bmatrix} \\ &= -4k_{\prec}k_{\succ} \mathcal{J}(w_{\prec}, w_{\succ})|_{\Delta=\emptyset} \\ &= 4\mathcal{D} \sqrt{-\mathbf{a}-k_{\prec}^2} \sqrt{-\mathbf{b}+k_{\succ}^2} (\mathbf{b}-\mathbf{a}-k_{\prec}^2-k_{\succ}^2) \\ &\quad \cdot k_{\prec} H_{\Delta=\emptyset}(\mathbf{a}+k_{\prec}^2) \cdot k_{\succ} H_{\Delta=\emptyset}(\mathbf{b}-k_{\succ}^2), \end{aligned} \quad (4.116)$$

where the notation $H_{\Delta=\emptyset}(w)$ specifies that the formula (4.5) is to be interpreted in the case $\Delta = \emptyset$. Taking the limit $k_{\prec} \downarrow 0$ and $k_{\succ} \downarrow 0$ and recalling that $\mathbf{a}\mathbf{b} = 1$ gives

$$\hat{\mathcal{J}}(0, 0) = 4\mathcal{D}_0(\mathbf{b}-\mathbf{a}) \cdot \lim_{k_{\prec}, k_{\succ} \downarrow 0} k_{\prec} H_{\Delta=\emptyset}(\mathbf{a}+k_{\prec}^2) \cdot \lim_{k_{\prec}, k_{\succ} \downarrow 0} k_{\succ} H_{\Delta=\emptyset}(\mathbf{b}-k_{\succ}^2). \quad (4.117)$$

By applying elementary contour deformations to (4.5) we see that for any sufficiently small $d > 0$,

$$\lim_{k_{\prec}, k_{\succ} \downarrow 0} k_{\prec} H_{\Delta=\emptyset}(\mathbf{a}+k_{\prec}^2) = -\frac{1}{\pi} \lim_{k_{\prec}, k_{\succ} \downarrow 0} \frac{k_{\prec}}{\sqrt{-\mathbf{a}-k_{\prec}^2}} \int_{\mathbf{a}-d}^{\mathbf{a}} \frac{\theta'_0(\xi)\sqrt{-\xi}d\xi}{R(\xi)(\xi-\mathbf{a}-k_{\prec}^2)} \quad (4.118)$$

and

$$\lim_{k_{\prec}, k_{\succ} \downarrow 0} k_{\succ} H_{\Delta=\emptyset}(\mathbf{b}-k_{\succ}^2) = -\frac{1}{\pi} \lim_{k_{\prec}, k_{\succ} \downarrow 0} \frac{k_{\succ}}{\sqrt{-\mathbf{b}+k_{\succ}^2}} \int_{\mathbf{b}+d}^{\mathbf{b}} \frac{\theta'_0(\xi)\sqrt{-\xi}d\xi}{R(\xi)(\xi-\mathbf{b}+k_{\succ}^2)}. \quad (4.119)$$

Now,

$$\mathbf{a} - d < \xi < \mathbf{a} \text{ implies } R(\xi)(\xi - \mathbf{a} - k_{\prec}^2) = (\mathbf{a} + k_{\prec}^2 - \xi)^{3/2} \sqrt{\mathbf{b} - k_{\prec}^2 - \xi} \quad (4.120)$$

and

$$\mathbf{b} < \xi < \mathbf{b} + d \text{ implies } R(\xi)(\xi - \mathbf{b} + k_{\succ}^2) = -(\xi - \mathbf{b} + k_{\succ}^2)^{3/2} \sqrt{\xi - \mathbf{a} - k_{\succ}^2} \quad (4.121)$$

where in both cases we mean the positive 3/2 power on the right-hand side. Therefore, by the substitution $\xi = \mathbf{a} + k_{\prec}^2 \zeta$ and a dominated convergence argument,

$$\lim_{k_{\prec}, k_{\succ} \downarrow 0} \frac{k_{\prec}}{\sqrt{-\mathbf{a} - k_{\prec}^2}} \int_{\mathbf{a}-d}^{\mathbf{a}} \frac{\theta'_0(\xi) \sqrt{-\xi} d\xi}{R(\xi)(\xi - \mathbf{a} - k_{\prec}^2)} = -\frac{2\theta'_0(\mathbf{a})}{\sqrt{\mathbf{b} - \mathbf{a}}}. \quad (4.122)$$

Similarly, but now using the substitution $\xi = \mathbf{b} - k_{\succ}^2 \zeta$,

$$\lim_{k_{\prec}, k_{\succ} \downarrow 0} \frac{k_{\succ}}{\sqrt{-\mathbf{b} + k_{\succ}^2}} \int_{\mathbf{b}+d}^{\mathbf{b}} \frac{\theta'_0(\xi) \sqrt{-\xi} d\xi}{R(\xi)(\xi - \mathbf{b} + k_{\succ}^2)} = -\frac{2\theta'_0(\mathbf{b})}{\sqrt{\mathbf{b} - \mathbf{a}}}. \quad (4.123)$$

Therefore, (4.117) becomes

$$\hat{\mathcal{J}}(0, 0) = \frac{16\mathcal{D}_0}{\pi^2} \theta'_0(\mathbf{a}) \theta'_0(\mathbf{b}). \quad (4.124)$$

Since $E(\mathbf{a}) = E(\mathbf{b}) = -iG(0)/4$,

$$\hat{\mathcal{J}}(0, 0) = \frac{16\mathcal{D}_0}{\pi^2} \Psi'(-iG(0)/4)^2 E'(\mathbf{a}) E'(\mathbf{b}). \quad (4.125)$$

Next, since $E'(\mathbf{a})E'(\mathbf{b}) = -(\mathbf{a} + \mathbf{b} + 2)/64$ and $\lambda = iv/4$,

$$\hat{\mathcal{J}}(0, 0) = \frac{4\mathcal{D}_0}{\pi^2} \left[\frac{d}{dv} \Psi(iv/4) \Big|_{v=-G(0)} \right]^2 (\mathbf{a} + \mathbf{b} + 2). \quad (4.126)$$

Finally, recalling the definitions (3.2) of a and b , we obtain (4.115). \square

Proposition 4.9. *There exists an open neighborhood $\mathcal{O}_{\mathbb{R}}^0$ of the origin $(0, 0)$ in the (x, t) -plane such that the following hold true.*

- *There are differentiable maps $k_{\prec} : \mathcal{O}_{\mathbb{R}}^0 \rightarrow \mathbb{R}$ and $k_{\succ} : \mathcal{O}_{\mathbb{R}}^0 \rightarrow \mathbb{R}$ uniquely characterized by the properties that $k_{\prec}(0, 0) = k_{\succ}(0, 0) = 0$ and*

$$\hat{M}(k_{\prec}(x, t), k_{\succ}(x, t), x, t) = \hat{I}(k_{\prec}(x, t), k_{\succ}(x, t), x, t) = 0, \quad (x, t) \in \mathcal{O}_{\mathbb{R}}^0. \quad (4.127)$$

Via the identification $w_{\prec} = \mathbf{a} + k_{\prec}^2$ and $w_{\succ} = \mathbf{b} - k_{\succ}^2$ and the relations $\mathbf{p} = (w_{\prec} + w_{\succ})/2$ and $\mathbf{q} = (w_{\prec} - w_{\succ})^2/4$, we obtain a solution of the equations $M(\mathbf{p}(x, t), \mathbf{q}(x, t), x, t) = 0$ and $I(\mathbf{p}(x, t), \mathbf{q}(x, t), x, t) = 0$ corresponding to a configuration with

- $\Delta = \emptyset$ when $k_{\prec} \geq 0$ and $k_{\succ} \geq 0$,
- $\Delta = P_N^{\prec K}$ or $\nabla = P_N^{K \succ}$ when $k_{\prec} \leq 0$ and $k_{\succ} \geq 0$,
- $\nabla = P_N^{\prec K}$ or $\Delta = P_N^{K \succ}$ when $k_{\prec} \geq 0$ and $k_{\succ} \leq 0$,
- $\nabla = \emptyset$ when $k_{\prec} \leq 0$ and $k_{\succ} \leq 0$.

Also, the functions $k_{\prec}(x, t)$ and $k_{\succ}(x, t)$ satisfy

$$\frac{\partial k_{\prec}}{\partial t}(0, 0) < 0 \quad \text{and} \quad \frac{\partial k_{\succ}}{\partial t}(0, 0) > 0 \quad (4.128)$$

and

$$\frac{\partial k_{\prec}}{\partial x}(0, 0) > 0 \quad \text{and} \quad \frac{\partial k_{\succ}}{\partial x}(0, 0) > 0. \quad (4.129)$$

- *Let Δ and ∇ be chosen according to the signs of $k_{\prec}(x, t)$ and $k_{\succ}(x, t)$ as above. Then, there is a Schwartz-symmetric closed curve transversely intersecting the real axis (only) at $w = 1$ and $w = w^+$ (see below) such that with β chosen as the union of this curve with the interval $[w_{\prec}(x, t), w_{\succ}(x, t)]$ and γ chosen as the union of closed intervals $[\mathbf{a}, w_{\prec}(x, t)]$ and $[w_{\succ}(x, t), \mathbf{b}]$ (recall that the local orientation of these contours depends on choice of Δ), there is for each $(x, t) \in \mathcal{O}_{\mathbb{R}}^0$ an analytic function $g : \mathbb{C} \setminus (\beta \cup \mathbb{R}_+) \rightarrow \mathbb{C}$ well-defined by Proposition 4.1, with associated functions $\theta : \vec{\beta} \cup \vec{\gamma} \rightarrow \mathbb{C}$ and $\phi : \vec{\beta} \cup \vec{\gamma} \rightarrow \mathbb{C}$ defined by (3.48), so that the following hold:*

- The function ϕ satisfies $\phi(\xi) < 0$ for $\xi \in \vec{\gamma} \cap \Sigma^\nabla$ and $\phi(\xi) > 0$ for $\xi \in \vec{\gamma} \cap \Sigma^\Delta$. Moreover, $\phi(\xi)$ is bounded away from zero for $\xi \in \vec{\gamma}$ except in neighborhoods of w_\prec and w_\succ (which are endpoints of $\vec{\gamma}$).
- The function $\theta(\xi)$ is real and nondecreasing (nonincreasing) with orientation for $\xi \in \vec{\beta} \cap \Sigma^\nabla$ (for $\xi \in \vec{\beta} \cap \Sigma^\Delta$). Moreover, $\theta'(\xi)$ is bounded away from zero except in neighborhoods of $\xi = w_\prec$ and $\xi = w_\succ$ (endpoints of β) and the simple root $\xi = w^+$ of H converging to $\xi = -1$ as $(x, t) \rightarrow (0, 0)$.
- The function $H(\xi) = H(\xi; \mathbf{p}(x, t), \mathbf{q}(x, t), x, t)$ is bounded away from zero for $\xi \in \beta \cup \gamma$ except in a neighborhood of $\xi = w^+$, a point converging to $\xi = -1$ as $(x, t) \rightarrow (0, 0)$, where $H(\xi)$ has a simple zero.

Proof. By the Implicit Function Theorem, it follows from Proposition 4.8 that the equations $\hat{M} = 0$ and $\hat{I} = 0$ may be solved uniquely near $(x, t) = (0, 0)$ and $(k_\prec, k_\succ) = (0, 0)$ for differentiable functions $k_\prec(x, t)$ and $k_\succ(x, t)$, which are both easily seen to be real-valued for real $(x, t) \in \mathcal{O}_\mathbb{R}^0$. Sign changes in these two functions correspond to sheet exchanges on the Riemann surfaces Γ_\prec and Γ_\succ , so from the definition (4.110) we confirm that we are in fact solving $M = I = 0$ in various cases of choice of Δ . The inequalities (4.128) follow from implicit differentiation of the equations $\hat{M} = 0$ and $\hat{I} = 0$ with respect to t at $(x, t) = (0, 0)$ and $(k_\prec, k_\succ) = (0, 0)$, and arguments similar to those used in the proof of Proposition 4.8 to compute the limiting values of various partial derivatives. The inequalities (4.129) can be obtained similarly, but also may be understood in the context of Proposition 4.7 since increasing (decreasing) x with $t = 0$ leads to an overlap of $\mathcal{O}_\mathbb{R}^0$ with $\mathcal{O}_\mathbb{R}^+$ (with $\mathcal{O}_\mathbb{R}^-$) and in the latter we have $\Delta = \emptyset$ ($\nabla = \emptyset$) corresponding in the present context to k_\prec and k_\succ both positive (both negative).

The perturbation theory of the simple root $\xi = w^+$ of H near $\xi = -1$ and the proof of existence of the contour $\beta \cap \mathbb{C}_+$ connecting $\xi = 1$ with $\xi = w^+$ along which $\theta(\xi)$ is real and monotone both work exactly the same as in the proof of Proposition 4.7, although we should point out that given $(x, t) \in \mathcal{O}_\mathbb{R}^0$, the contour $\beta \cap \mathbb{C}_+$ will generally be a different curve, and w^+ a different negative real value, for different allowed choices of Δ (this situation is relevant if and only if $k_\prec(x, t)k_\succ(x, t) \leq 0$). The desired monotonicity of $\theta(\xi)$ along the intervals (w_\prec, w^+) and (w^+, w_\succ) also follows by simple perturbation arguments from $t = 0$.

Of course when $k_\prec(x, t)k_\succ(x, t) = 0$ one or both intervals of γ have collapsed to points, so it remains to show that ϕ , necessarily real for $\xi \in \vec{\gamma} \subset \mathbb{R}_-$, actually satisfies the desired inequalities in γ when the degenerate configuration $\gamma = \{\mathbf{a}, \mathbf{b}\}$ present at $(x, t) = (0, 0)$ is unfolded. This will follow from an analysis of $H(w)$ valid when w is near either \mathbf{a} or \mathbf{b} and (x, t) is near $(0, 0)$. For some small $d > 0$ fixed,

$$H(w) = -\frac{\sigma_\prec}{\pi\sqrt{-w}} \int_{\mathbf{a}-d}^{\mathbf{a}} \frac{\theta'_0(\xi)\sqrt{-\xi} d\xi}{R(\xi; \mathbf{p}, \mathbf{q})(\xi - w)} + \mathcal{O}(1), \quad w \downarrow \mathbf{a}, \quad (4.130)$$

where $\sigma_\prec = 1$ if $\Delta = \emptyset$, $\Delta = P_N^{\mathbf{K}\succ}$, or $\nabla = P_N^{\prec\mathbf{K}}$ and $\sigma_\prec = -1$ if $\nabla = \emptyset$, $\nabla = P_N^{\mathbf{K}\succ}$, or $\Delta = P_N^{\prec\mathbf{K}}$, and where the error term $\mathcal{O}(1)$ is uniform for $(x, t) \in \mathcal{O}_\mathbb{R}^0$. By choosing d small enough, we have from Proposition 1.2 and $E(\mathbf{a}) = -iG(0)/4$ that

$$\theta'_0(\xi) \geq \frac{1}{2}\theta'_0(\mathbf{a}) > 0, \quad \mathbf{a} - d \leq \xi \leq \mathbf{a}, \quad (4.131)$$

Also, since ξ lies to the left of both w_\prec and w_\succ where $R < 0$,

$$-\frac{\sqrt{-\xi}}{R(\xi; \mathbf{p}, \mathbf{q})} \geq -\frac{\sqrt{-\mathbf{a}}}{R(\xi; \mathbf{p}, \mathbf{q})} \geq \frac{\sqrt{-\mathbf{a}}}{\sqrt{w_\prec - \mathbf{a} + d}\sqrt{w_\succ - \mathbf{a} + d}} \geq \frac{\sqrt{-\mathbf{a}}}{\mathbf{b} - \mathbf{a} + d} > 0 \quad (4.132)$$

holds in the same interval $\mathbf{a} - d \leq \xi \leq \mathbf{a}$. So from (4.130) we have

$$-\sigma_\prec H(w) \geq \frac{\theta'_0(\mathbf{a})\sqrt{-\mathbf{a}}|\log(w - \mathbf{a})|}{2\pi(\mathbf{b} - \mathbf{a} + d)\sqrt{-w}} + \mathcal{O}(1) > 0, \quad w \downarrow \mathbf{a}. \quad (4.133)$$

Similarly,

$$H(w) = -\frac{\sigma_\succ}{\pi\sqrt{-w}} \int_{\mathbf{b}}^{\mathbf{b}+d} \frac{\theta'_0(\xi)\sqrt{-\xi} d\xi}{R(\xi; \mathbf{p}, \mathbf{q})(\xi - w)} + \mathcal{O}(1), \quad w \uparrow \mathbf{b}, \quad (4.134)$$

where $\sigma_\succ = 1$ if $\nabla = \emptyset$, $\nabla = P_N^{\prec\mathbf{K}}$, or $\Delta = P_N^{\mathbf{K}\succ}$ and $\sigma_\succ = -1$ if $\Delta = \emptyset$, $\Delta = P_N^{\prec\mathbf{K}}$, or $\nabla = P_N^{\mathbf{K}\succ}$, and where the error term $\mathcal{O}(1)$ is uniform for $(x, t) \in \mathcal{O}_\mathbb{R}^0$. Over the interval of integration we have from Proposition 1.2

and the fact that $E(\mathbf{b}) = -iG(0)/4$ that

$$-\theta'_0(\xi) \geq -\frac{1}{2}\theta'_0(\mathbf{b}) > 0, \quad \mathbf{b} \leq \xi \leq \mathbf{b} + d, \quad (4.135)$$

and since now ξ lies to the right of both w_{\leftarrow} and w_{\rightarrow} in a region where again $R < 0$,

$$-\frac{\sqrt{-\xi}}{R(\xi; \mathbf{p}, \mathbf{q})} \geq -\frac{\sqrt{-\mathbf{b}-d}}{R(\xi; \mathbf{p}, \mathbf{q})} \geq \frac{\sqrt{-\mathbf{b}-d}}{\sqrt{d+\mathbf{b}-w_{\leftarrow}}\sqrt{d+\mathbf{b}-w_{\rightarrow}}} \geq \frac{\sqrt{-\mathbf{b}-d}}{\mathbf{b}-\mathbf{a}+d} > 0 \quad (4.136)$$

also holds for $\mathbf{b} \leq \xi \leq \mathbf{b} + d$, so

$$-\sigma_{\rightarrow}H(w) \geq -\frac{\theta'_0(\mathbf{b})\sqrt{-\mathbf{b}-d}|\log(\mathbf{b}-w)|}{2\pi(\mathbf{b}-\mathbf{a}+d)\sqrt{-w}} + \mathcal{O}(1), \quad w \uparrow \mathbf{b}. \quad (4.137)$$

The inequality (4.133) shows that $\sigma_{\leftarrow}H(w)$ is large and negative for w to the right of $w = \mathbf{a}$, while (4.137) shows that $\sigma_{\rightarrow}H(w)$ is large and negative for w to the left of $w = \mathbf{b}$, with both statements holding uniformly for $(x, t) \in \mathcal{O}_{\mathbf{R}}^0$. Therefore, since $R(\xi; \mathbf{p}, \mathbf{q}) < 0$ both for $\mathbf{a} \leq \xi < w_{\leftarrow}$ and for $w_{\rightarrow} < \xi \leq \mathbf{b}$, we learn that $\phi'(\xi) = H(\xi)R(\xi; \mathbf{p}, \mathbf{q})$ has the same sign as σ_{\leftarrow} for $\mathbf{a} \leq \xi < w_{\leftarrow}$ and has the same sign as σ_{\rightarrow} for $w_{\rightarrow} < \xi \leq \mathbf{b}$. Since $\phi(\xi) = 0$ both when $\xi = w_{\leftarrow}$ and when $\xi = w_{\rightarrow}$, we obtain the desired inequalities on ϕ for $\xi \in \bar{\gamma}$. \square

Note that via the construction of g for each $(x, t) \in \mathcal{O}_{\mathbf{R}}^0$ and Proposition 4.1, Proposition 4.9 effectively guarantees the existence of a real constant $\Phi = \Phi(x, t)$ that might at first sight appear to depend upon various artificial details of the choice of Δ . However, according to Proposition 4.2, the partial derivatives $\partial\Phi/\partial x$ and $\partial\Phi/\partial t$ are necessarily given in terms of the functions $u : \mathcal{O}_{\mathbf{R}}^0 \rightarrow \mathbb{R}$ and $v : \mathcal{O}_{\mathbf{R}}^0 \rightarrow \mathbb{R}$, and this makes $\Phi(x, t)$ well-defined for $(x, t) \in \mathcal{O}_{\mathbf{R}}^0$ up to a constant. The constant is then determined by the fact that $\Phi(0, 0) = 0$ as guaranteed by Proposition 4.4 by taking limits from nonzero x at $t = 0$. Therefore, $\Phi : \mathcal{O}_{\mathbf{R}}^0 \rightarrow \mathbb{R}$ is indeed a well-defined differentiable function that also agrees with corresponding functions defined in terms of g in $\mathcal{O}_{\mathbf{R}}^{\pm}$ where these domains overlap.

The functions $u : \mathcal{O}_{\mathbf{R}}^0 \rightarrow \mathbb{R}$ and $v : \mathcal{O}_{\mathbf{R}}^0 \rightarrow \mathbb{R}$ agree with those previously defined in the overlap region $\mathcal{O}_{\mathbf{R}}^0 \cap (\mathcal{O}_{\mathbf{R}}^+ \cup \mathcal{O}_{\mathbf{R}}^-)$, and this allows us to extend the definitions (4.35) of $n_{\mathbf{p}}(x, t)$ and (4.92) of $\mathcal{E}(x, t)$ in a consistent way to the full union $\mathcal{O}_{\mathbf{R}}^0 \cup \mathcal{O}_{\mathbf{R}}^+ \cup \mathcal{O}_{\mathbf{R}}^-$. The region $S_{\mathbf{R}}$ involved in the formulation of Theorem 1.2 is exactly this union with two curves $t = t_{\pm}(x)$ omitted. The curve $t = t_+(x)$ is obtained by solving the equation $k_{\leftarrow}(x, t) = 0$ for t , which is possible near the origin according to the inequalities (4.128)–(4.129), and the signs of $t - t_+(x)$ and $k_{\leftarrow}(x, t)$ are opposite. Similarly the curve $t = t_-(x)$ is obtained from the equation $k_{\rightarrow}(x, t) = 0$, and the signs of $t - t_-(x)$ and $k_{\rightarrow}(x, t)$ coincide. Therefore along the curve $t = t_+(x)$, we have $w_{\leftarrow} = \mathbf{p} - \sqrt{\mathbf{q}} = \mathbf{a}$, while along the curve $t = t_-(x)$, we have $w_{\rightarrow} = \mathbf{p} + \sqrt{\mathbf{q}} = \mathbf{b}$. The inequalities (1.67)–(1.68) are a consequence of the inequalities $w_{\leftarrow} = \mathbf{a} + k_{\leftarrow}^2 > \mathbf{a}$ and $w_{\rightarrow} = \mathbf{b} - k_{\rightarrow}^2 < \mathbf{b}$ that hold for $(x, t) \in S_{\mathbf{R}}$ because $k_{\leftarrow}(x, t)$ and $k_{\rightarrow}(x, t)$ are real.

4.4. Solution of the Whitham modulation equations. We are now in a position to describe how the functions $\mathbf{p} = \mathbf{p}(x, t)$ and $\mathbf{q} = \mathbf{q}(x, t)$ relate to the formally-derived Whitham modulation equations described in the introduction.

Proposition 4.10. *Let $\mathbf{p} = \mathbf{p}(x, t)$ and $\mathbf{q} = \mathbf{q}(x, t)$ be the unique solutions of the equations $M = I = 0$ matching the given initial data as described in Proposition 4.7 (or Proposition 4.9 for (x, t) near $(0, 0)$). Let $n_{\mathbf{p}} = n_{\mathbf{p}}(x, t)$ and $\mathcal{E} = \mathcal{E}(x, t)$ be calculated explicitly from \mathbf{p} and \mathbf{q} via (4.35) and (4.92) respectively. Then these fields satisfy the Whitham modulation equations (1.32) for superluminal rotational waves (when \mathbf{p} and \mathbf{q} correspond to case \mathbf{R} , that is, for $(x, t) \in S_{\mathbf{R}}$) and for superluminal librational waves (when \mathbf{p} and \mathbf{q} correspond to case \mathbf{L} , that is, for $(x, t) \in S_{\mathbf{L}}$).*

The rest of this section is devoted to the proof of this proposition. In fact, the roots w_0 and w_1 of the quadratic $R(w; \mathbf{p}, \mathbf{q})^2$, when expressed in terms of $n_{\mathbf{p}}$ and \mathcal{E} , will turn out to be *Riemann invariants* for the system (1.32).

4.4.1. Diagonalization of the Whitham system. We begin by writing the Whitham system (1.32) in terms of standard complete elliptic integrals by evaluating $J(\mathcal{E})$ given by (1.20) in the two cases of modulated superluminal wavetrains of librational and rotational types. The condition of superluminality ($\omega^2 > k^2$) implies that for librational wavetrains we have $J(\mathcal{E}) = I_{\mathbf{L}}(-\mathcal{E})$ and for rotational wavetrains we have $J(\mathcal{E}) = I_{\mathbf{R}}(-\mathcal{E})$.

For superluminal rotational waves, we recall the definition (1.17) and obtain:

$$J(\mathcal{E}) = I_{\text{R}}(-\mathcal{E}) = \frac{1}{\pi\sqrt{2}} \int_{-\pi}^{\pi} \sqrt{\cos(\phi) + \mathcal{E}} d\phi = \frac{\sqrt{2}}{\pi} \int_0^{\pi} \sqrt{\cos(\phi) + \mathcal{E}} d\phi, \quad (4.138)$$

for $\mathcal{E} > 1$. By the substitution $\cos(\phi) = 1 - 2z^2$, this becomes simply

$$J(\mathcal{E}) = \frac{4}{\pi} \sqrt{\frac{1+\mathcal{E}}{2}} E\left(\frac{2}{1+\mathcal{E}}\right) \quad \text{for superluminal rotational waves,} \quad (4.139)$$

where $E(m)$ is the standard complete elliptic integral of the second kind:

$$E(m) := \int_0^1 \frac{\sqrt{1-mz^2}}{\sqrt{1-z^2}} dz, \quad 0 < m < 1. \quad (4.140)$$

For superluminal librational waves, we recall instead the definition (1.16) and obtain:

$$J(\mathcal{E}) = I_{\text{L}}(-\mathcal{E}) = \frac{\sqrt{2}}{\pi} \int_{-\cos^{-1}(-\mathcal{E})}^{\cos^{-1}(-\mathcal{E})} \sqrt{\cos(\phi) + \mathcal{E}} d\phi = \frac{2\sqrt{2}}{\pi} \int_0^{\cos^{-1}(-\mathcal{E})} \sqrt{\cos(\phi) + \mathcal{E}} d\phi, \quad (4.141)$$

for $-1 < \mathcal{E} < 1$. By the substitution $\cos(\phi) = 1 - (1 + \mathcal{E})z^2$, this becomes simply

$$J(\mathcal{E}) = \frac{8}{\pi} E\left(\frac{1+\mathcal{E}}{2}\right) - \frac{4}{\pi}(1-\mathcal{E})K\left(\frac{1+\mathcal{E}}{2}\right) \quad \text{for superluminal librational waves,} \quad (4.142)$$

where $K(m)$ is the standard complete elliptic integral of the first kind defined for $0 < m < 1$ by (1.60).

Now recall the differential identities [1]

$$K'(m) = \frac{E(m) - (1-m)K(m)}{2m(1-m)}, \quad E'(m) = \frac{E(m) - K(m)}{2m}. \quad (4.143)$$

Since in each case $J(\mathcal{E})$ is a linear combination of $K(m)$ and $E(m)$ and m is a function of \mathcal{E} , it is clear that $K(m)$ and $E(m)$ can be eliminated between $J(\mathcal{E})$, $J'(\mathcal{E})$, and $J''(\mathcal{E})$ to yield a linear second-order differential equation satisfied by $J(\mathcal{E})$. We shall now show that this equation is the same in both cases. In the case of superluminal rotational waves, the above formula for $E'(m)$ yields

$$J'(\mathcal{E}) = \frac{1}{\pi} \sqrt{\frac{2}{1+\mathcal{E}}} K\left(\frac{2}{1+\mathcal{E}}\right) \quad \text{for superluminal rotational waves,} \quad (4.144)$$

and then differentiating again, eliminating K and E , and comparing with (4.139) we obtain

$$J''(\mathcal{E}) = \frac{1}{4(1-\mathcal{E}^2)} J(\mathcal{E}). \quad (4.145)$$

Similarly, in the case of superluminal librational waves, we have

$$J'(\mathcal{E}) = \frac{2}{\pi} K\left(\frac{1+\mathcal{E}}{2}\right) \quad \text{for superluminal librational waves,} \quad (4.146)$$

so after one further differentiation we eliminate K and E and compare with (4.142) to arrive again at exactly the same second-order linear differential equation (4.145).

Given two complex-conjugate or real and negative variables w_0 and w_1 , we express \mathcal{E} and n_{p} in terms of these by the relations

$$\mathcal{E} = -\frac{w_0 + w_1}{2\sqrt{w_0 w_1}}, \quad n_{\text{p}} = \frac{1 - \sqrt{w_0 w_1}}{1 + \sqrt{w_0 w_1}}. \quad (4.147)$$

It is obvious that if w_0 and w_1 are real and negative, then $\mathcal{E} > 1$, and this corresponds to the case of modulated superluminal rotational waves. It is also clear that if w_0 and w_1 are complex conjugates, then $-1 < \mathcal{E} < 1$, and this corresponds to the case of modulated superluminal librational waves. The Jacobian of the map $(w_0, w_1) \mapsto (n_{\text{p}}, \mathcal{E})$ is

$$\mathbf{S} := \begin{bmatrix} \partial n_{\text{p}} / \partial w_0 & \partial n_{\text{p}} / \partial w_1 \\ \partial \mathcal{E} / \partial w_0 & \partial \mathcal{E} / \partial w_1 \end{bmatrix} = \begin{bmatrix} -\frac{w_1}{(1 + \sqrt{w_0 w_1})^2 \sqrt{w_0 w_1}} & -\frac{w_0}{(1 + \sqrt{w_0 w_1})^2 \sqrt{w_0 w_1}} \\ \frac{4w_0 \sqrt{w_0 w_1}}{w_1 - w_0} & \frac{4w_1 \sqrt{w_0 w_1}}{w_0 - w_1} \end{bmatrix}. \quad (4.148)$$

Therefore, if we write the Whitham system in the form

$$\frac{\partial}{\partial t} \begin{bmatrix} n_p \\ \mathcal{E} \end{bmatrix} + \mathbf{A}(n_p, \mathcal{E}) \frac{\partial}{\partial x} \begin{bmatrix} n_p \\ \mathcal{E} \end{bmatrix} = \mathbf{0}, \quad (4.149)$$

where $\mathbf{A}(n_p, \mathcal{E})$ is the coefficient matrix appearing in equation (1.32) (and of course we can equally well express this explicitly in terms of w_0 and w_1 using (4.147)) then we may equivalently write this as a system of equations for w_0 and w_1 as

$$\frac{\partial}{\partial t} \begin{bmatrix} w_0 \\ w_1 \end{bmatrix} + \mathbf{S}^{-1} \mathbf{A} \mathbf{S} \frac{\partial}{\partial x} \begin{bmatrix} w_0 \\ w_1 \end{bmatrix} = \mathbf{0}. \quad (4.150)$$

It is now a direct calculation to show that, *as a consequence of the differential equation* (4.145), $\mathbf{S}^{-1} \mathbf{A} \mathbf{S}$ is a diagonal matrix, that is, the columns of the Jacobian \mathbf{J} are independent eigenvectors of \mathbf{A} . Moreover, once $J''(\mathcal{E})$ is eliminated using (4.145), the denominator $\mathcal{N}(n_p, \mathcal{E})$ defined by (1.33) factors as a difference of squares, and the numerator of each of the diagonal elements of $\mathbf{S}^{-1} \mathbf{A} \mathbf{S}$ is divisible by exactly one of the two factors in $\mathcal{N}(n_p, \mathcal{E})$. It follows that the Whitham system can be written in the diagonal form

$$\frac{\partial w_j}{\partial t} + c_j(w_0, w_1) \frac{\partial w_j}{\partial x} = 0, \quad j = 0, 1 \quad (4.151)$$

where the characteristic velocities (eigenvalues of \mathbf{A}) are given by

$$c_j := \frac{\sqrt{w_0 w_1} (1 + \sqrt{w_0 w_1}) J(\mathcal{E}) + (w_j - w_{1-j}) (1 - \sqrt{w_0 w_1}) J'(\mathcal{E})}{\sqrt{w_0 w_1} (1 - \sqrt{w_0 w_1}) J(\mathcal{E}) + (w_j - w_{1-j}) (1 + \sqrt{w_0 w_1}) J'(\mathcal{E})}. \quad (4.152)$$

In other words, the variables w_0 and w_1 are Riemann invariants for the Whitham system (1.32).

4.4.2. Diagonal quasilinear system satisfied by the roots of $R(w)^2$. We will now show that if $w_0(x, t)$ and $w_1(x, t)$ are obtained by solving the moment and integral conditions $M = I = 0$, then they also satisfy a system of partial differential equations in Riemann-invariant form. Implicitly differentiating M and I with respect to x and t gives

$$M_{w_0} w_{0,(x,t)} + M_{w_1} w_{1,(x,t)} + M_{(x,t)} = 0 \quad \text{and} \quad I_{w_0} w_{0,(x,t)} + I_{w_1} w_{1,(x,t)} + I_{(x,t)} = 0. \quad (4.153)$$

Solving for the partial derivatives of w_j with respect to x and t assuming that the Jacobian determinant of (M, I) with respect to (w_0, w_1) is nonzero, we can easily confirm the identities

$$\frac{\partial w_j}{\partial t} + \hat{c}_j \frac{\partial w_j}{\partial x} = 0, \quad j = 0, 1 \quad (4.154)$$

where

$$\hat{c}_j := -\frac{I_{w_{1-j}} M_t - M_{w_{1-j}} I_t}{I_{w_{1-j}} M_x - M_{w_{1-j}} I_x}, \quad j = 0, 1. \quad (4.155)$$

We will now show that while the various partial derivatives appearing in (4.155) contain explicit dependence on x and t , as well as dependence on initial data through the function $\theta_0(w)$, the combinations \hat{c}_j are in fact functions of w_0 and w_1 alone. Indeed, recalling (4.96), we have

$$M_t = \frac{\sqrt{w_0 w_1} - 1}{\sqrt{w_0 w_1}} \quad \text{and} \quad I_t = \frac{1}{8\sqrt{w_0 w_1}} \left[\int_{\beta \cap \mathbb{C}_+} \frac{R_+(\xi) d\xi}{\xi \sqrt{-\xi}} + \int_{\beta \cap \mathbb{C}_-} \frac{R_-(\xi) d\xi}{\xi \sqrt{-\xi}} \right], \quad (4.156)$$

and by similar explicit calculations using the definitions of M and I (the latter in terms of the function H) we obtain

$$M_x = \frac{\sqrt{w_0 w_1} + 1}{\sqrt{w_0 w_1}} \quad \text{and} \quad I_x = -\frac{1}{8\sqrt{w_0 w_1}} \left[\int_{\beta \cap \mathbb{C}_+} \frac{R_+(\xi) d\xi}{\xi \sqrt{-\xi}} + \int_{\beta \cap \mathbb{C}_-} \frac{R_-(\xi) d\xi}{\xi \sqrt{-\xi}} \right]. \quad (4.157)$$

These partial derivatives are obviously functions of w_0 and w_1 (independent of x and t , and also not depending on the initial data). The partial derivatives of M and I with respect to w_{1-j} are obtained from equations (4.80) and (4.81) respectively in the statement of Proposition 4.5, and while these depend also on x , t , and θ_0 via a common factor of $H(w_{1-j})$, this factor will cancel out of the expression for \hat{c}_j . The result is that

$$\hat{c}_j = \frac{A - (1 - \sqrt{w_0 w_1}) B_j}{A - (1 + \sqrt{w_0 w_1}) B_j}, \quad (4.158)$$

where

$$A := \int_{\beta \cap \mathbb{C}_+} \frac{R_+(\xi) d\xi}{\xi \sqrt{-\xi}} + \int_{\beta \cap \mathbb{C}_-} \frac{R_-(\xi) d\xi}{\xi \sqrt{-\xi}}, \quad (4.159)$$

and

$$\begin{aligned} B_j &:= \int_{\beta \cap \mathbb{C}_+} \frac{R_+(\xi) d\xi}{\sqrt{-\xi}(\xi - w_{1-j})} + \int_{\beta \cap \mathbb{C}_-} \frac{R_-(\xi) d\xi}{\sqrt{-\xi}(\xi - w_{1-j})} \\ &= \int_{\beta \cap \mathbb{C}_+} \frac{\xi - w_j}{R_+(\xi) \sqrt{-\xi}} d\xi + \int_{\beta \cap \mathbb{C}_-} \frac{\xi - w_j}{R_-(\xi) \sqrt{-\xi}} d\xi. \end{aligned} \quad (4.160)$$

It is now obvious that $\hat{c}_j = \hat{c}_j(w_0, w_1)$ is an explicit function of w_0 and w_1 only with no dependence on initial data.

We may put \hat{c}_j into a form that admits a comparison with the characteristic velocities c_j of the Whitham system (1.32) by noting that regardless of whether the radical R is in case R or in case L and regardless of whether in the former case there may exist transition points, we may integrate by parts to write A in the form

$$A = \int_{\beta \cap \mathbb{C}_+} \frac{2\xi - w_0 - w_1}{R_+(\xi) \sqrt{-\xi}} d\xi + \int_{\beta \cap \mathbb{C}_-} \frac{2\xi - w_0 - w_1}{R_-(\xi) \sqrt{-\xi}} d\xi. \quad (4.161)$$

Therefore, some elementary algebraic manipulations show that \hat{c}_j may be written in the form

$$\hat{c}_j = \frac{\sqrt{w_0 w_1} (1 + \sqrt{w_0 w_1}) U + (w_j - w_{1-j}) (1 - \sqrt{w_0 w_1}) V}{\sqrt{w_0 w_1} (1 - \sqrt{w_0 w_1}) U + (w_j - w_{1-j}) (1 + \sqrt{w_0 w_1}) V} \quad (4.162)$$

where

$$U := \frac{A}{\sqrt{w_0 w_1}} = \frac{1}{\sqrt{w_0 w_1}} \left[\int_{\beta \cap \mathbb{C}_+} \frac{2\xi - w_0 - w_1}{\sqrt{-\xi} R_+(\xi)} d\xi + \int_{\beta \cap \mathbb{C}_-} \frac{2\xi - w_0 - w_1}{\sqrt{-\xi} R_-(\xi)} d\xi \right] \quad (4.163)$$

and

$$V := \int_{\beta \cap \mathbb{C}_+} \frac{d\xi}{\sqrt{-\xi} R_+(\xi)} + \int_{\beta \cap \mathbb{C}_-} \frac{d\xi}{\sqrt{-\xi} R_-(\xi)}. \quad (4.164)$$

To complete the proof of Proposition 4.10, it therefore remains to show that the functions $\hat{c}_j(w_0, w_1)$ coincide with the Whitham characteristic velocities $c_j(w_0, w_1)$, a calculation that is different in cases R and L.

4.4.3. Equivalence of c_j and \hat{c}_j in case R. Comparing (4.162) with (4.152) we observe that to prove that $c_j = \hat{c}_j$ holds in case R it is sufficient to show that there is some nonvanishing quantity $C(w_0, w_1)$ that is symmetrical in its two variables such that the following identities hold:

$$CU = J(\mathcal{E}) = \frac{4}{\pi} \sqrt{\frac{1 + \mathcal{E}}{2}} E\left(\frac{2}{1 + \mathcal{E}}\right) \quad (4.165)$$

and

$$CV = J'(\mathcal{E}) = \frac{1}{\pi} \sqrt{\frac{2}{1 + \mathcal{E}}} K\left(\frac{2}{1 + \mathcal{E}}\right) \quad (4.166)$$

where $\mathcal{E} = \mathcal{E}(w_0, w_1)$ is defined by (4.147).

First, we evaluate V in case R. By elementary contour deformations, we have

$$V = 2 \int_0^{w_1} \frac{d\xi}{\sqrt{-\xi} R(\xi)} = 2 \int_{w_1}^0 \frac{dw}{\sqrt{-w(w - w_0)(w - w_1)}}, \quad (4.167)$$

where $w_0 < w_1 < 0$. By the substitution (4.47) we then obtain (after some nontrivial algebra)

$$V = \frac{2}{(w_0 w_1)^{1/4}} \sqrt{\frac{2}{1 + \mathcal{E}}} K\left(\frac{2}{1 + \mathcal{E}}\right). \quad (4.168)$$

Therefore, the identity (4.166) holds if

$$C(w_0, w_1) = \frac{(w_0 w_1)^{1/4}}{2\pi}. \quad (4.169)$$

With C so determined, we carry out the same contour deformations and make exactly the same substitution (4.47) to obtain

$$\begin{aligned}
CU &= \frac{1}{\pi(w_0w_1)^{1/4}} \int_0^{w_1} \frac{2\xi - w_0 - w_1}{\sqrt{-\xi}R(\xi)} d\xi \\
&= \frac{1}{\pi(w_0w_1)^{1/4}} \int_{w_1}^0 \frac{2w - w_0 - w_1}{\sqrt{-w(w-w_0)(w-w_1)}} dw \\
&= \frac{4}{\pi} \sqrt{\frac{1+\mathcal{E}}{2}} \int_0^1 \frac{\sqrt{1-ms^2} - (1-s^2)}{\sqrt{1-s^2}\sqrt{1-ms^2}} \frac{ds}{s^2}, \quad m := \frac{2}{1+\mathcal{E}} \in (0,1).
\end{aligned} \tag{4.170}$$

In the final integral, the numerator of the integrand cannot be broken up without introducing a nonintegrable singularity at $s = 0$. Now let $R_1(s)^2 = 1 - s^2$ and $R_2(s)^2 = 1 - ms^2$, take the branch cut of $R_1(s)$ to be the real interval $[-1, 1]$ with $R_1 \sim is$ as $s \rightarrow \infty$, and take the branch cut of $R_2(s)$ to be the union $(-\infty, -1/\sqrt{m}] \cup [1/\sqrt{m}, +\infty)$ with $R_2(0) = 1$. Then by elementary contour deformations,

$$\int_0^1 \frac{\sqrt{1-ms^2} - (1-s^2)}{\sqrt{1-s^2}\sqrt{1-ms^2}} \frac{ds}{s^2} = \frac{1}{2} \int_{-1}^1 \frac{\sqrt{1-ms^2} - (1-s^2)}{\sqrt{1-s^2}\sqrt{1-ms^2}} \frac{ds}{s^2} = \frac{1}{4} \oint_L \frac{1-s^2 - R_2(s)}{R_1(s)R_2(s)} \frac{ds}{s^2} \tag{4.171}$$

where L is a positively-oriented loop surrounding the branch cut of $R_1(s)$ but lying in the domain of analyticity of $R_2(s)$. In this formulation the integral can indeed be broken into two separate integrals as $s = 0$ is no longer on the path of integration. Therefore,

$$\int_0^1 \frac{\sqrt{1-ms^2} - (1-s^2)}{\sqrt{1-s^2}\sqrt{1-ms^2}} \frac{ds}{s^2} = \frac{1}{4} \oint_L \frac{R_1(s)}{R_2(s)} \frac{ds}{s^2} - \frac{1}{4} \oint_L \frac{ds}{sR_1(s)}. \tag{4.172}$$

Since $sR_1(s)$ is analytic and nonvanishing outside of L , and since $sR_1(s) \sim is^2$ as $s \rightarrow \infty$, the second integral vanishes identically. By another contour deformation and the substitution $x = 1/(s\sqrt{m})$, we therefore obtain

$$\int_0^1 \frac{\sqrt{1-ms^2} - (1-s^2)}{\sqrt{1-s^2}\sqrt{1-ms^2}} \frac{ds}{s^2} = \int_{1/\sqrt{m}}^{+\infty} \frac{\sqrt{s^2-1}}{\sqrt{ms^2-1}} \frac{ds}{s^2} = \int_0^1 \frac{\sqrt{1-mx^2}}{\sqrt{1-x^2}} dx = E(m). \tag{4.173}$$

Using this result in (4.170) confirms the identity (4.165) and completes the proof that $c_j = \hat{c}_j$ in case R.

4.4.4. *Equivalence of c_j and \hat{c}_j in case L.* To prove that $c_j = \hat{c}_j$ in case L, it is sufficient to show that for some symmetrical nonvanishing function $C(w_0, w_1)$ we have the identities

$$CU = J(\mathcal{E}) = \frac{8}{\pi} E\left(\frac{1+\mathcal{E}}{2}\right) - \frac{4}{\pi} (1-\mathcal{E}) K\left(\frac{1+\mathcal{E}}{2}\right) \tag{4.174}$$

and

$$CV = J'(\mathcal{E}) = \frac{2}{\pi} K\left(\frac{1+\mathcal{E}}{2}\right). \tag{4.175}$$

To prove these identities we consider, for $p = 0, 1$, the integral

$$I_p := \int_{\beta \cap \mathbb{C}_+} \frac{(2\xi - w_0 - w_1)^p d\xi}{\sqrt{-\xi}R_+(\xi)} + \int_{\beta \cap \mathbb{C}_-} \frac{(2\xi - w_0 - w_1)^p d\xi}{\sqrt{-\xi}R_-(\xi)} = \frac{1}{2i} \oint_L \frac{(2\xi - w_0 - w_1)^p d\xi}{\sqrt{\xi}R(\xi)} \tag{4.176}$$

where the second equality follows from a simple contour deformation, and L is a positively-oriented loop surrounding the branch cut of R , which we recall for case L is an arc connecting $w_0 := re^{i\theta}$ and $w_1 = re^{-i\theta}$ with $r > 0$ and $0 < \theta < \pi$, passing through the real axis only at $\xi = 1$. We make the substitution

$$\xi = r \frac{1+z}{1-z} \tag{4.177}$$

which maps the points $\xi = re^{\pm i\theta}$ to $z = \pm i \tan(\theta/2)$ and maps $\xi = 0$ to $z = -1$ and $\xi = \infty$ to $z = 1$. Taking care with the sign of $R(\xi(z))$ we find that I_p becomes

$$I_p = \frac{1}{i\sqrt{r} \cos(\theta/2)} \int_{-i \tan(\theta/2)}^{+i \tan(\theta/2)} \left(\frac{2r}{1-z}\right)^p \frac{[(1 - \cos(\theta)) + (1 + \cos(\theta))z]^p dz}{\sqrt{1-z^2}\sqrt{z^2 + \tan^2(\theta/2)}}. \tag{4.178}$$

In the case $p = 0$, set $z = ix \tan(\theta/2)$ to obtain

$$I_0 = \frac{1}{\sqrt{r} \cos(\theta/2)} \int_{-1}^{+1} \frac{dx}{\sqrt{1-x^2} \sqrt{1 + \tan(\theta/2)^2 x^2}} = \frac{2}{\sqrt{r} \cos(\theta/2)} \int_0^1 \frac{dx}{\sqrt{1-x^2} \sqrt{1 + \tan(\theta/2)^2 x^2}}. \quad (4.179)$$

Then, set $t = \sqrt{1-x^2}$ to obtain

$$I_0 = \frac{2}{\sqrt{r}} K(\sin(\theta/2)^2) = \frac{2}{(w_0 w_1)^{1/4}} K\left(\frac{1+\mathcal{E}}{2}\right). \quad (4.180)$$

To evaluate I_1 , first multiply the numerator and denominator of the integrand by $1+z$ to find

$$\begin{aligned} I_1 &= \frac{2\sqrt{r}}{i \cos(\theta/2)} \int_{-i \tan(\theta/2)}^{+i \tan(\theta/2)} \frac{(1 - \cos(\theta)) + 2z + (1 - \cos(\theta))z^2}{(1-z^2)\sqrt{1-z^2}\sqrt{z^2 + \tan(\theta/2)^2}} dz \\ &= \frac{2\sqrt{r}}{i \cos(\theta/2)} \int_{-i \tan(\theta/2)}^{+i \tan(\theta/2)} \frac{(1 - \cos(\theta)) + (1 - \cos(\theta))z^2}{(1-z^2)\sqrt{1-z^2}\sqrt{z^2 + \tan(\theta/2)^2}} dz \end{aligned} \quad (4.181)$$

where we have used even/odd parity to simplify the result. Since $(1 - \cos(\theta)) + (1 + \cos(\theta))z^2 = 2 - (1 + \cos(\theta))(1 - z^2)$, we get

$$\begin{aligned} I_1 &= \frac{4\sqrt{r}}{i \cos(\theta/2)} \int_{-i \tan(\theta/2)}^{+i \tan(\theta/2)} \frac{dz}{(1-z^2)^{3/2} \sqrt{z^2 + \tan(\theta/2)^2}} - 2r(1 + \cos(\theta))I_0 \\ &= \frac{8\sqrt{r}}{i \cos(\theta/2)} \int_0^{+i \tan(\theta/2)} \frac{dz}{(1-z^2)^{3/2} \sqrt{z^2 + \tan(\theta/2)^2}} - 4(w_0 w_1)^{1/4} (1 - \mathcal{E}) K\left(\frac{1+\mathcal{E}}{2}\right). \end{aligned} \quad (4.182)$$

Again using the substitution $z = ix \tan(\theta/2)$ followed by $t = \sqrt{1-x^2}$ we arrive at

$$I_1 = 8\sqrt{r} \cos(\theta/2)^2 \int_0^1 \frac{dt}{\sqrt{1-t^2}(1-mt^2)^{3/2}} - 4(w_0 w_1)^{1/4} (1 - \mathcal{E}) K\left(\frac{1+\mathcal{E}}{2}\right), \quad m := \frac{1+\mathcal{E}}{2}. \quad (4.183)$$

Finally, making the monotone decreasing substitution $t \mapsto s$ given by $(1-mt^2)(1-ms^2) = 1-m$, we obtain

$$I_1 = 8(w_0 w_1)^{1/4} E\left(\frac{1+\mathcal{E}}{2}\right) - 4(w_0 w_1)^{1/4} (1 - \mathcal{E}) K\left(\frac{1+\mathcal{E}}{2}\right). \quad (4.184)$$

Since $U = I_1/\sqrt{w_0 w_1}$ and $V = I_0$, the formulae (4.180) and (4.184) confirm the identities (4.174) and (4.175) upon making the choice of $C(w_0, w_1) = (w_0 w_1)^{1/4}/\pi$. This completes the proof that $c_j = \hat{c}_j$ in case L.

5. USE OF $g(w)$

5.1. Opening a lens. Recall the matrix unknown $\mathbf{N}(w)$ defined by (3.43), and the matrix functions $\mathbf{L}^\nabla(w)$ and $\mathbf{L}^\Delta(w)$ defined by (3.49) and (3.50) respectively. The most crucial step in the Deift-Zhou steepest descent method is the opening of a “lens” about the contour β , which in the current context takes the form of an explicit substitution leading to a new unknown $\mathbf{O}(w)$ as follows. Let the lens Λ be an open subset of Ω° containing $\vec{\beta}$ as indicated in various configurations (depending on case L or case R and in the latter case whether or where a transition point exists) in Figures 5.1–5.4. The precise shape of the lens is not important, but rather that it lies close to $\vec{\beta}$ without coinciding except at the endpoints, that it fully abuts the real segments $\vec{\Sigma}_{>0}^\nabla$ or $\vec{\Sigma}_{>0}^\Delta$, and that if a transition point τ_N is present in case R then Λ fully abuts the contours $\vec{\Sigma}^{\nabla\Delta}$ and $\vec{\Sigma}^{\Delta\nabla}$.

Now set

$$\mathbf{O}(w) := \begin{cases} \mathbf{N}(w)\mathbf{L}^\nabla(w), & w \in \Omega^\nabla \cap \Lambda \\ \mathbf{N}(w)\mathbf{L}^\Delta(w), & w \in \Omega^\Delta \cap \Lambda \\ \mathbf{N}(w), & w \in \mathbb{C} \setminus (\bar{\Lambda} \cup \partial\Omega \cup \mathbb{R}_+). \end{cases} \quad (5.1)$$

The reason for including the contours $\vec{\Sigma}^{\nabla\Delta}$ and $\vec{\Sigma}^{\Delta\nabla}$ in the interior of Λ should a transition point exist is now clear: according to Proposition 3.2, $\mathbf{O}(w)$ can be analytically continued to the contours $\vec{\Sigma}^{\nabla\Delta}$ and $\vec{\Sigma}^{\Delta\nabla}$, so $\mathbf{O}(w)$ no longer has any jump discontinuity across any contour emanating into the complex plane from a transition point. The contour of discontinuity for $\mathbf{O}(w)$ is therefore $\Sigma_{\mathbf{O}} := (\Sigma \setminus (\Sigma^{\nabla\Delta} \cup \Sigma^{\Delta\nabla})) \cup \partial\Lambda$, as is illustrated with solid curves in Figures 5.1–5.4.

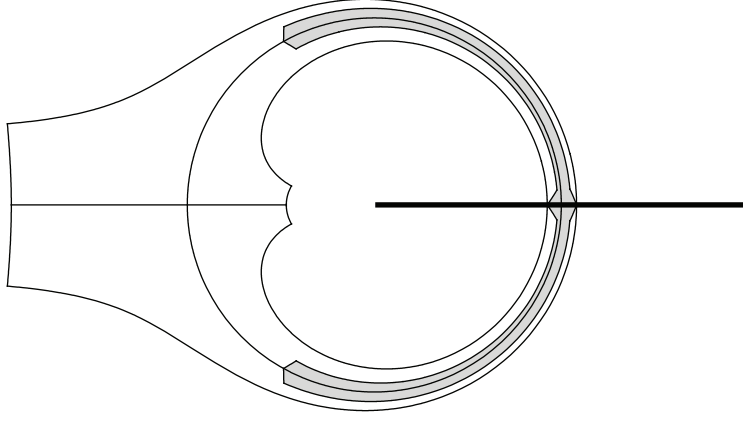

FIGURE 5.1. The contour $\Sigma_{\mathbf{O}}$ of discontinuity of the sectionally analytic function $\mathbf{O}(w)$ in case \mathbf{L} assuming either $\Delta = \emptyset$ or $\nabla = \emptyset$. The lens Λ is shaded.

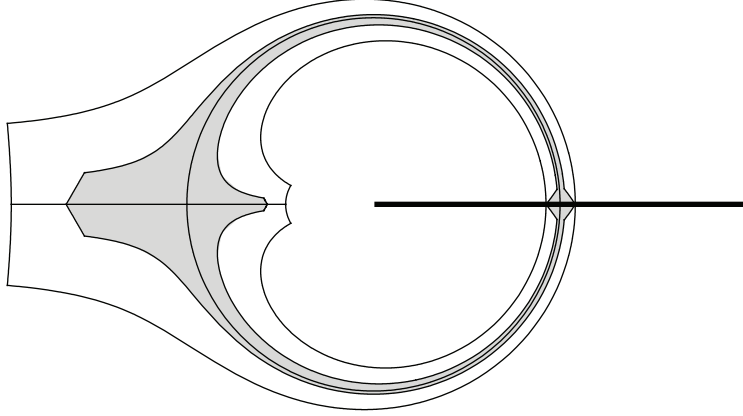

FIGURE 5.2. The contour $\Sigma_{\mathbf{O}}$ of discontinuity of the sectionally analytic function $\mathbf{O}(w)$ in case \mathbf{R} with either $\Delta = \emptyset$ or $\nabla = \emptyset$. The lens Λ is shaded.

Recall that on the arcs $\vec{\beta} \cap \mathbb{C}_{\pm}$ we have $\phi(\xi) \equiv \pm i\Phi$ whereas on $\vec{\beta} \cap \mathbb{R}$ we have $\phi(\xi) \equiv 0$. Set

$$\Phi_{\Delta} = \Phi_{\Delta}(x, t) := \Phi(x, t) + \pi \epsilon_N \# \Delta, \quad (5.2)$$

where recall $\# \Delta$ is defined in (3.4). Then by direct calculation using the definition (3.49), the jump condition (3.44) for $\mathbf{N}(w)$, the definitions (3.48) of θ and ϕ in terms of boundary values of g , and the jump condition (3.21) for L , we see that $\mathbf{O}(w)$ satisfies the jump conditions

$$\mathbf{O}_{+}(\xi) = \mathbf{O}_{-}(\xi) \begin{bmatrix} 0 & -ie^{\mp i\Phi_{\Delta}/\epsilon_N} \\ -ie^{\pm i\Phi_{\Delta}/\epsilon_N} & 0 \end{bmatrix}, \quad \xi \in \vec{\beta} \cap \Sigma^{\nabla} \cap \mathbb{C}_{\pm} \quad (5.3)$$

and

$$\mathbf{O}_{+}(\xi) = \mathbf{O}_{-}(\xi) \begin{bmatrix} 0 & -i \\ -i & 0 \end{bmatrix}, \quad \xi \in \vec{\beta} \cap \Sigma^{\nabla} \cap \mathbb{R}. \quad (5.4)$$

Similarly, from (3.50) and (3.46) we obtain

$$\mathbf{O}_{+}(\xi) = \mathbf{O}_{-}(\xi) \begin{bmatrix} 0 & ie^{\mp i\Phi_{\Delta}/\epsilon_N} \\ ie^{\pm i\Phi_{\Delta}/\epsilon_N} & 0 \end{bmatrix}, \quad \xi \in \vec{\beta} \cap \Sigma^{\Delta} \cap \mathbb{C}_{\pm} \quad (5.5)$$

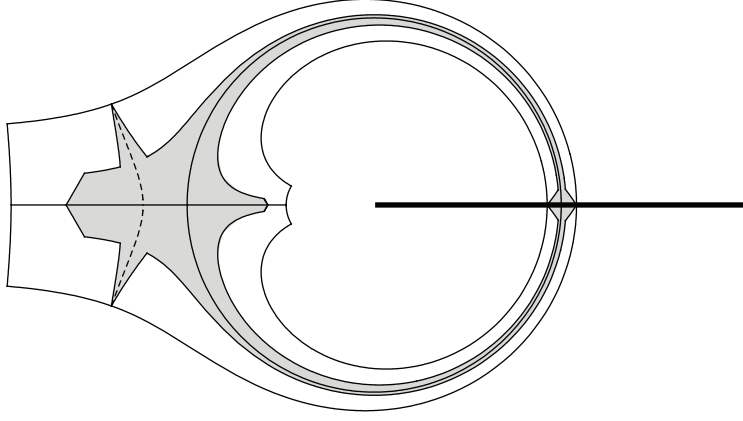

FIGURE 5.3. The contour $\Sigma_{\mathbf{O}}$ of discontinuity of the sectionally analytic function $\mathbf{O}(w)$ in case \mathbf{R} with either $\Delta = P_N^{\mathbf{R}\succ}$ or $\nabla = P_N^{\mathbf{R}\prec}$. The lens Λ is shaded, and the dashed curves emanating from the transition point $\tau_N \in \beta$ do not belong to $\Sigma_{\mathbf{O}}$ according to Proposition 3.2.

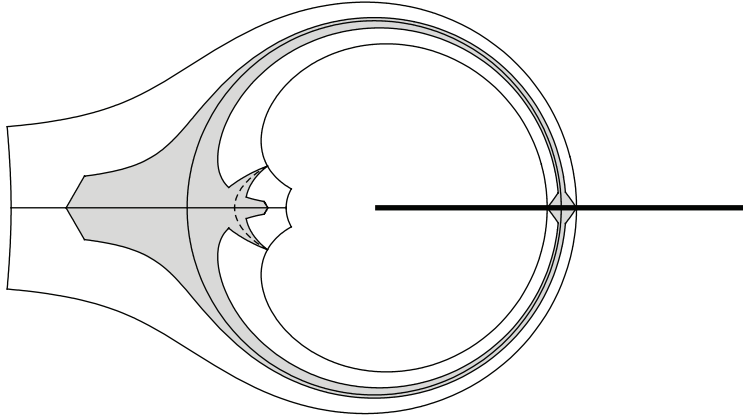

FIGURE 5.4. The contour $\Sigma_{\mathbf{O}}$ of discontinuity of the sectionally analytic function $\mathbf{O}(w)$ in case \mathbf{R} with either $\Delta = P_N^{\mathbf{R}\succ}$ or $\nabla = P_N^{\mathbf{R}\prec}$. The lens Λ is shaded, and the dashed curves emanating from the transition point $\tau_N \in \beta$ do not belong to $\Sigma_{\mathbf{O}}$ according to Proposition 3.2.

and

$$\mathbf{O}_+(\xi) = \mathbf{O}_-(\xi) \begin{bmatrix} 0 & i \\ i & 0 \end{bmatrix}, \quad \xi \in \vec{\beta} \cap \Sigma^\Delta \cap \mathbb{R}. \quad (5.6)$$

Therefore, the jump matrix for $\mathbf{O}(w)$ along $\vec{\beta}$ is piecewise constant with respect to ξ (but has nontrivial dependence on the parameters x and t via $\Phi = \Phi(x, t) \in \mathbb{R}$). Moreover, we observe that the jump matrices in (5.3) and (5.4) are respectively inverse to those in (5.5) and (5.6), while the contours $\vec{\beta} \cap \Sigma^\nabla$ and $\vec{\beta} \cap \Sigma^\Delta$ are sub-arcs of $\vec{\beta}$ that are oppositely oriented. This shows that (5.3)–(5.4) are describing *the same* jump conditions as are (5.5)–(5.6).

Next, we consider the jump conditions relating the boundary values taken by $\mathbf{O}(w)$ from the upper and lower half-planes along the positive real axis, recalling Proposition 3.3. Clearly, from (3.58) and the fact that the boundary values of $\mathbf{N}(w)$ and of $\mathbf{O}(w)$ agree for $\xi \in \vec{\Sigma}_{>0}$, we have

$$\mathbf{O}_+(\xi) = \sigma_2 \mathbf{O}_-(\xi) \sigma_2, \quad \xi \in \vec{\Sigma}_{>0}. \quad (5.7)$$

To analyze the jump conditions for $\mathbf{O}(w)$ on the contours $\Sigma_{>0}^\nabla$ or $\Sigma_{>0}^\Delta$ (only one or the other of which is present in any of the six choices of Δ under consideration), we need to calculate the exponent $2iQ_+(\xi) + L_+(\xi) - 2g_+(\xi)$ appearing in (3.54) and (3.56). Of course this exponent has an analytic continuation into Ω_\pm^∇ or Ω_\pm^Δ as $2iQ(w) + L(w) - 2g(w)$, and taking the boundary value on $\vec{\beta}$ near $\xi = 1$ from the relevant domain we learn that $2iQ_+(\xi) + L_+(\xi) - 2g_+(\xi)$ is the analytic continuation through the adjacent domain Ω_\pm^∇ or Ω_\pm^Δ of the function $\phi(\xi) + i\theta_0(\xi) - i\theta(\xi) + i\pi\epsilon_N \# \Delta \pmod{2\pi i\epsilon_N}$ defined on $\vec{\beta}$. Since $\phi(\xi) \equiv \pm i\Phi \in i\mathbb{R}$ along $\vec{\beta}$, we then have

$$B^\nabla(\xi)e^{\pm[2iQ_+(\xi)+L_+(\xi)-2g_+(\xi)]/\epsilon_N} = \mathcal{O}\left(\epsilon_N \frac{\lambda^2}{\epsilon_N^2} e^{-\alpha\lambda/\epsilon_N} e^{|\Re\{i\theta(\xi)-i\theta_0(\xi)\}|/\epsilon_N}\right), \quad \lambda = E_+(\xi) > 0, \quad \xi \in \vec{\Sigma}_{>0}^\nabla, \quad (5.8)$$

and

$$B^\Delta(\xi)e^{\pm[2iQ_+(\xi)+L_+(\xi)-2g_+(\xi)]/\epsilon_N} = \mathcal{O}\left(\epsilon_N \frac{\lambda^2}{\epsilon_N^2} e^{-\alpha\lambda/\epsilon_N} e^{|\Re\{i\theta(\xi)-i\theta_0(\xi)\}|/\epsilon_N}\right), \quad \lambda = E_-(\xi) > 0, \quad \xi \in \vec{\Sigma}_{>0}^\Delta, \quad (5.9)$$

where in both cases the aforementioned analytic continuation of $\theta(\xi) - \theta_0(\xi)$ from $\vec{\beta}$ is implied. Due to Proposition 1.2, this difference has an analytic continuation from $\vec{\beta}$ to a neighborhood of $\xi = 1$ (note that this will be a different analytic function depending upon which of the two arcs of β meeting at $\xi = 1$ is involved), and furthermore, from the integral condition $I = 0$, we will have $\Re\{i\theta(1) - i\theta_0(1)\} = 0$. Using the formula (4.13), we can easily obtain that

$$i\theta'(\xi) - i\theta_0'(\xi) = \frac{R_+(\xi; \mathbf{p}, \mathbf{q})}{4\sqrt{-\xi}} \left(\frac{x-t}{\xi\sqrt{\mathbf{p}^2 - \mathbf{q}}} - \frac{4}{\pi} \int_\gamma \frac{\theta_0'(\zeta)\sqrt{-\zeta} d\zeta}{R(\zeta; \mathbf{p}, \mathbf{q})(\zeta - \xi)} \right), \quad \xi \in \vec{\beta}, \quad (5.10)$$

so letting $\xi \rightarrow 1$ along β yields a purely imaginary quantity in the limit. It follows that $\Re\{i\theta(\xi) - i\theta_0(\xi)\} = \mathcal{O}(\lambda^2)$ as $\lambda = E_\pm(\xi) \rightarrow 0$ for ξ real. Therefore, by choosing the width parameter δ_1 of the rectangles D_\pm defined after the statement of Proposition 1.2 to be sufficiently small we will have $|\Re\{i\theta(\xi) - i\theta_0(\xi)\}| \leq \alpha\lambda/2$, and then from Proposition 3.3 we will have that

$$\mathbf{O}_+(\xi) = \sigma_2 \mathbf{O}_-(\xi) \sigma_2 (\mathbb{I} + \mathcal{O}(\epsilon_N)), \quad \xi \in \vec{\Sigma}_{>0}^\nabla \cup \vec{\Sigma}_{>0}^\Delta. \quad (5.11)$$

Now suppose that $\xi \in \vec{\gamma}$. Then from (5.1) we have $\mathbf{O}_\pm(\xi) = \mathbf{N}_\pm(\xi)$, so to evaluate the jump conditions satisfied by $\mathbf{O}(w)$ we may recall the jump conditions for $\mathbf{N}(w)$ in the form (3.44)–(3.47). According to Proposition 3.1, the factors $T^\nabla(\xi)$ and $T^\Delta(\xi)$ are uniformly bounded on $\gamma \cap \Sigma^\nabla$ and $\gamma \cap \Sigma^\Delta$ respectively. Furthermore, by Proposition 4.1, we have $\theta(\xi) \equiv 0$ for $\xi \in \gamma$. Finally, Proposition 4.7 or Proposition 4.9 guarantees that $\Re\{\phi(\xi)\}$ is strictly negative for $\xi \in \gamma \cap \Sigma^\nabla$ and strictly positive for $\xi \in \gamma \cap \Sigma^\Delta$ as long as ξ is bounded away from the band endpoints. We conclude that $\mathbf{O}_+(\xi) = \mathbf{O}_-(\xi)(\mathbb{I} + \text{exponentially small in } \epsilon_N)$ holds uniformly for $\xi \in \vec{\gamma}$ bounded away from both band endpoints.

Consider next the jump of $\mathbf{O}(w)$ across the boundary of the lens Λ . We assume that the arcs of $\partial\Lambda$ inherit orientation from the arcs of the band $\vec{\beta}$ that they enclose. The matrix $\mathbf{N}(w)$ is continuous across $\partial\Lambda$, so from (5.1),

$$\mathbf{O}_+(\xi) = \begin{cases} \mathbf{O}_-(\xi) \mathbf{L}^\nabla(\xi)^{\mp 1}, & \xi \in \partial\Lambda \cap \Omega_\pm^\nabla \\ \mathbf{O}_-(\xi) \mathbf{L}^\Delta(\xi)^{\mp 1}, & \xi \in \partial\Lambda \cap \Omega_\pm^\Delta. \end{cases} \quad (5.12)$$

Referring to the definitions (3.49)–(3.50), we see that these may be written in the form

$$\mathbf{O}_+(\xi) = \mathbf{O}_-(\xi) \left(\mathbb{I} + \mathcal{O}(T^\nabla(\xi)^{1/2} - 1) + \mathcal{O}(T^\nabla(\xi)^{-1/2} - 1) + \mathcal{O}(e^{-[2iQ(\xi)+L(\xi)\mp i\theta_0(\xi)-2g(\xi)]/\epsilon_N}) \right), \quad (5.13)$$

$$\xi \in \partial\Lambda \cap \Omega_\pm^\nabla,$$

and

$$\mathbf{O}_+(\xi) = \mathbf{O}_-(\xi) \left(\mathbb{I} + \mathcal{O}(T^\Delta(\xi)^{1/2} - 1) + \mathcal{O}(T^\Delta(\xi)^{-1/2} - 1) + \mathcal{O}(e^{[2iQ(\xi)+L(\xi)\mp i\theta_0(\xi)-2g(\xi)]/\epsilon_N}) \right), \quad (5.14)$$

$$\xi \in \partial\Lambda \cap \Omega_\pm^\Delta,$$

assuming that in each case the three error terms on the right-hand side are bounded. If as $\epsilon_N \downarrow 0$ the point ξ remains bounded away from the singular points \mathbf{a} and \mathbf{b} of $T^\nabla(\cdot)$ and $T^\Delta(\cdot)$, then according to

Proposition 3.1 the first two error terms in each case are $\mathcal{O}(\epsilon_N)$. The exponent $2iQ(\xi) + L(\xi) \mp i\theta_0(\xi) - 2g(\xi)$ is, modulo $i\pi\epsilon_N$, the analytic continuation from β to Ω_{\pm}^{∇} of $\phi(\xi) \mp i\theta(\xi)$. Since according to Proposition 4.1 $\phi(\xi)$ is an imaginary constant in β , and since according to Proposition 4.7 or 4.9 $\theta(\xi)$ is analytic, real, and increasing along parts of $\vec{\beta}$ in Σ^{∇} with derivative bounded away from zero away from the band endpoints, it follows from the Cauchy-Riemann equations that $\Re\{2iQ(\xi) + L(\xi) \mp i\theta_0(\xi) - 2g(\xi)\}$ is strictly positive for $\xi \in \partial\Lambda \cap \Omega_{\pm}^{\nabla}$ bounded away from the band endpoints. Therefore the final error term in (5.13) is exponentially small as $\epsilon_N \downarrow 0$ uniformly for ξ bounded away from band endpoints. Completely analogous reasoning yields the same conclusion for the final error term in (5.14). We conclude that $\mathbf{O}_+(\xi) = \mathbf{O}_-(\xi)(\mathbb{I} + \mathcal{O}(\epsilon_N))$ holds for $\xi \in \partial\Lambda$ as long as ξ is bounded away from the two band endpoints (which, given the shape of the lens Λ , also implies that ξ is bounded away from \mathfrak{a} and \mathfrak{b}).

Finally let us consider the jump conditions satisfied by $\mathbf{O}(w)$ across the contours Σ_{\pm}^{∇} and Σ_{\pm}^{Δ} , that is the contours that make up the boundary of the whole region $\bar{\Omega}$. For ξ on any of these curves we have $\mathbf{O}_{\pm}(\xi) = \mathbf{N}_{\pm}(\xi)$. Therefore, to calculate the jump matrices on these curves we need to combine the definition (3.43) of $\mathbf{N}(w)$ in terms of $\mathbf{M}(w)$ with the jump conditions (3.38)–(3.39). Since $g(w)$ is analytic on Σ_{\pm}^{∇} and Σ_{\pm}^{Δ} , we obtain the jump conditions

$$\mathbf{O}_+(\xi) = \mathbf{O}_-(\xi) \begin{bmatrix} 1 & 0 \\ -iY(\xi)e^{[2iQ(\xi)+L(\xi)\pm i\theta_0(\xi)-2g(\xi)]/\epsilon_N} & 1 \end{bmatrix}, \quad \xi \in \vec{\Sigma}_{\pm}^{\nabla}, \quad (5.15)$$

$$\mathbf{O}_+(\xi) = \mathbf{O}_-(\xi) \begin{bmatrix} 1 & -iY(\xi)^{-1}e^{-[2iQ(\xi)+L(\xi)\mp i\theta_0(\xi)-2g(\xi)]/\epsilon_N} \\ 0 & 1 \end{bmatrix}, \quad \xi \in \vec{\Sigma}_{\pm}^{\Delta}. \quad (5.16)$$

The exponent $2iQ(\xi) + L(\xi) \pm i\theta_0(\xi) - 2g(\xi)$ occurring in (5.15) is, modulo $i\pi\epsilon_N$, the analytic continuation into the domain Ω_{\pm}^{∇} from the contour Σ^{∇} of the function $\phi(\xi) \mp i\theta(\xi) \pm 2i\theta_0(\xi)$. If $t = 0$, then $\phi(\xi)$ and $\theta_0(\xi)$ are real, and $\phi(\xi) \leq 0$, for $\xi \in \Sigma^{\nabla}$. According to Proposition 4.4, $\theta_0(\xi) - \theta(\xi)$ is real and nondecreasing for $\xi \in \vec{\Sigma}^{\nabla}$. Also, by Proposition 1.2, $\theta_0(\xi)$ is strictly increasing with derivative bounded below by a positive constant for $\xi \in \vec{\Sigma}^{\nabla}$, and hence the same is true of $2\theta_0(\xi) - \theta(\xi)$. It follows by a Cauchy-Riemann argument that if the width $2\delta_1$ of the rectangle $D_+ \cup D_-$ that is the closure of the image of Ω under $E(\cdot)$ is sufficiently small, then when $t = 0$, $\Re\{2iQ(\xi) + L(\xi) \pm i\theta_0(\xi) - 2g(\xi)\}$ will be strictly negative on all parts of Σ_{\pm}^{∇} with the possible exception of points near \mathfrak{a} and \mathfrak{b} where the contours Σ_{\pm}^{∇} meet Σ^{∇} . But if the band endpoints are bounded away from \mathfrak{a} and \mathfrak{b} , that is (according to Proposition 4.3) if x is bounded away from zero, then $\phi(\mathfrak{a})$ and $\phi(\mathfrak{b})$ will be strictly negative by Proposition 4.4, so the strict inequality on the exponent in (5.15) persists right down to the real axis when $t = 0$. Since for x away from $x = 0$ the inequality is strict uniformly on Σ_{\pm}^{∇} , it also persists uniformly on Σ_{\pm}^{∇} for sufficiently small $t \neq 0$. (Assuming $|t|$ sufficiently small also ensures that the nonreal arcs of Σ^{∇} or Σ^{Δ} are contained within Ω .) Completely analogous arguments also show that the exponential factor occurring in (5.16) is exponentially small uniformly on Σ_{\pm}^{Δ} if x is bounded away from zero and t is small enough. If x approaches zero, then the exponential decay only fails near $\xi = \mathfrak{a}$ and $\xi = \mathfrak{b}$. Now, the factors $Y(\xi)$ and $Y(\xi)^{-1}$ are uniformly bounded on Σ_{\pm}^{∇} and Σ_{\pm}^{Δ} respectively, according to Proposition 3.1. We conclude that for t sufficiently small, $\mathbf{O}_+(\xi) = \mathbf{O}_-(\xi)(\mathbb{I} + \text{exponentially small})$ holds uniformly for $\xi \in \Sigma_{\pm}^{\nabla}$ and $\xi \in \Sigma_{\pm}^{\Delta}$ except near \mathfrak{a} and \mathfrak{b} when x is also small.

We formalize these observations concerning the jump conditions satisfied by $\mathbf{O}(w)$ in the following proposition.

Proposition 5.1. *Suppose that the point (x, t) lies in one of the domains \mathcal{O}_L^{\pm} , \mathcal{O}_R^{\pm} (see Proposition 4.7), or \mathcal{O}_R^0 (see Proposition 4.9), and $|t|$ is sufficiently small. Let U_0 and U_1 be discs of small radius independent of x , t , and ϵ_N centered at the band endpoints $w_0(x, t)$ and $w_1(x, t)$ (see Figures 5.8–5.11). Then for $\xi \in \vec{\beta}$, $\mathbf{O}(w)$ satisfies exactly the piecewise constant jump conditions (5.3)–(5.6). For $\xi \in \mathbb{R}_+$, $\mathbf{O}(w)$ satisfies exactly the simple jump condition (5.7) except in a small interval near $\xi = 1$ where the $\mathcal{O}(\epsilon_N)$ approximate version (5.11) of this condition holds. Finally uniformly for $\xi \in \Sigma_{\mathbf{O}} \setminus (\beta \cup \mathbb{R}_+ \cup U_0 \cup U_1)$, we have simply $\mathbf{O}_+(\xi) = \mathbf{O}_-(\xi)(\mathbb{I} + \mathcal{O}(\epsilon_N))$.*

5.2. Construction of a global parametrix. A global parametrix for $\mathbf{O}(w)$ is a sectionally-analytic matrix function $\hat{\mathbf{O}}(w)$ designed to satisfy the jump conditions of $\mathbf{O}(w)$ for $\xi \in \Sigma_{\mathbf{O}} \cap (\beta \cup \mathbb{R}_+ \cup U_0 \cup U_1)$, with the only modification being that we use the jump condition (5.7) on all of \mathbb{R}_+ rather than omitting a small interval near $\xi = 1$ where $\mathbf{O}(w)$ satisfies the approximate relation (5.11). The global parametrix $\hat{\mathbf{O}}(w)$ will

be analytic (have no jump discontinuity) for $\xi \in \Sigma_{\mathbf{O}} \setminus (\beta \cup \mathbb{R}_+ \cup U_0 \cup U_1)$, that is, on the arcs of the jump contour $\Sigma_{\mathbf{O}}$ where Proposition 5.1 guarantees that $\mathbf{O}_+(\xi) = \mathbf{O}_-(\xi)(\mathbb{I} + \mathcal{O}(\epsilon_N))$. It is standard to construct $\dot{\mathbf{O}}(w)$ by patching together (i) an *outer parametrix* denoted $\dot{\mathbf{O}}^{\text{out}}(w)$ expected to be a valid approximation of $\mathbf{O}(w)$ away from the two roots of $R(w; \mathbf{p}, \mathbf{q})^2$ and (ii) two *inner parametrices* denoted $\dot{\mathbf{O}}_0^{\text{in}}(w)$ and $\dot{\mathbf{O}}_1^{\text{in}}(w)$ expected to be valid approximations of $\mathbf{O}(w)$ for $w \in U_0$ and $w \in U_1$ respectively:

$$\dot{\mathbf{O}}(w) := \begin{cases} \dot{\mathbf{O}}_k^{\text{in}}(w), & w \in U_k, \quad k = 0, 1, \\ \dot{\mathbf{O}}^{\text{out}}(w), & \text{otherwise.} \end{cases} \quad (5.17)$$

It is also an important part of the construction of $\dot{\mathbf{O}}(w)$ that the outer and inner parametrices are well-matched on the boundaries ∂U_k of the discs.

Our construction of $\dot{\mathbf{O}}(w)$ in this section rests essentially upon the following two facts that hold true for $(x, t) \in S_{\text{L}} \cup S_{\text{R}}$:

- The roots of $R(w; \mathbf{p}, \mathbf{q})^2$ are distinct. Error terms will become uncontrolled if the roots are allowed to coalesce, which occurs only on the common boundary of S_{L} and S_{R} consisting of the two points $x = \pm x_{\text{crit}}$. In a forthcoming paper [5] we will give a complete analysis of the interesting dynamics that occur for $x \approx \pm x_{\text{crit}}$ and $|t|$ small.
- No root of $R(w; \mathbf{p}, \mathbf{q})^2$ coincides with \mathbf{a} or \mathbf{b} . Again, error estimates will fail if one of the roots approaches either \mathbf{a} or \mathbf{b} , as occurs along the two curves $t = t_{\pm}(x)$ excluded from S_{R} along which the choice of Δ must be changed as explained in Proposition 4.9. Unlike the coalescence of two roots of $R(w; \mathbf{p}, \mathbf{q})^2$, which as mentioned above leads to interesting new dynamics, the exclusion of the curves $t = t_{\pm}(x)$ appears to us to be serving a merely technical purpose, allowing us to avoid more complicated inner parametrices. As mentioned in §1.3 there appears to be no exceptional behavior near the omitted curves in the (x, t) -plane.

The outer parametrix must be considered separately in the two cases (L and R) because the contour geometry is qualitatively different. Taking into account just the jump conditions for $\mathbf{O}(w)$ on the band β and the positive real axis \mathbb{R}_+ , the outer parametrix $\dot{\mathbf{O}}^{\text{out}}(w)$ is to be determined as a solution of one or the other of the following two Riemann-Hilbert problems. The outer parametrix will depend parametrically on the fast phase $\nu := \Phi_{\Delta}/\epsilon_N$ as well as on the geometry of the contour β , although both of these dependencies are suppressed in our notation.

Riemann-Hilbert Problem 5.1 (Outer parametrix, case L). *Let ν be a real number, and let $w_0 \in \mathbb{C}_+$. Let $\vec{\beta}_+$ denote an oriented arc in \mathbb{C}_+ from $w = 1$ to $w = w_0$ and let $\vec{\beta}_-$ denote the complex-conjugated arc from $w = 1$ to $w = w_1 = w_0^*$. Find a matrix $\dot{\mathbf{O}}^{\text{out}}(w)$ with the following properties.*

Analyticity: $\dot{\mathbf{O}}^{\text{out}}(w)$ is an analytic function of w for $w \in \mathbb{C} \setminus (\beta_+ \cup \beta_- \cup \mathbb{R}_+)$ and Hölder- γ continuous for any $\gamma \leq 1$ with the exception of arbitrarily small neighborhoods of the points $w = w_0$ and $w = w_1 = w_0^*$. In the neighborhood U_k of w_k , the elements of $\dot{\mathbf{O}}^{\text{out}}(w)$ are bounded by a multiple of $|w - w_k|^{-1/4}$.

Jump condition: The boundary values taken by $\dot{\mathbf{O}}^{\text{out}}(w)$ along $\vec{\beta}_{\pm}$ and $\vec{\mathbb{R}}_+$ (the latter oriented from the origin to $+\infty$) satisfy the following jump conditions:

$$\dot{\mathbf{O}}_+^{\text{out}}(\xi) = \dot{\mathbf{O}}_-^{\text{out}}(\xi) i \sigma_1 e^{\pm i \nu \sigma_3}, \quad \xi \in \vec{\beta}_{\pm}, \quad (5.18)$$

and

$$\dot{\mathbf{O}}_+^{\text{out}}(\xi) = \sigma_2 \dot{\mathbf{O}}_-^{\text{out}}(\xi) \sigma_2, \quad \xi \in \vec{\mathbb{R}}_+. \quad (5.19)$$

Normalization: The following normalization condition holds:

$$\lim_{w \rightarrow \infty} \dot{\mathbf{O}}^{\text{out}}(w) = \mathbb{I}. \quad (5.20)$$

The jump conditions satisfied by $\dot{\mathbf{O}}^{\text{out}}(w)$ in case L are summarized in Figure 5.5.

Riemann-Hilbert Problem 5.2 (Outer parametrix, case R). *Let ν be a real number, and let $w_0 < w^+ < w_1 < 0$ be given. Let $\vec{\beta}_+$ denote an oriented arc in \mathbb{C}_+ from $w = 1$ to $w = w^+$, let $\vec{\beta}_-$ denote the complex-conjugated arc in \mathbb{C}_- from $w = 1$ to $w = w^+$, and let $\vec{\beta}_{\leftarrow}$ and $\vec{\beta}_{\rightarrow}$ denote real arcs oriented from $w = w^+$ to $w = w_0$ and $w = w_1$ respectively. Find a matrix $\dot{\mathbf{O}}^{\text{out}}(w)$ with the following properties.*

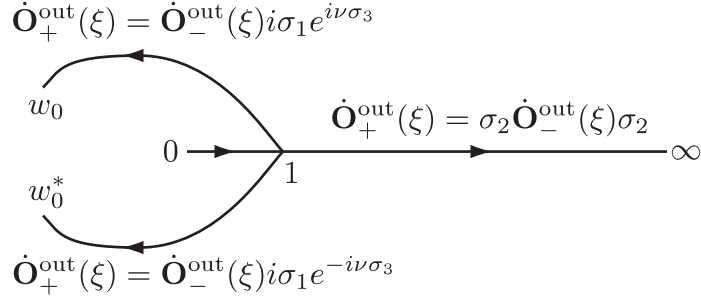

FIGURE 5.5. The jump conditions satisfied by the matrix $\dot{\mathbf{O}}^{\text{out}}(w)$ that we will show is normalized in the stronger sense that $\dot{\mathbf{O}}^{\text{out}}(w) = \mathbb{I} + \mathcal{O}(|w|^{-1/2})$ as $w \rightarrow \infty$. The only other singularities admitted are $\mathcal{O}(|w - w_k|^{-1/4})$ near the points w_0 and w_0^* .

Analyticity: $\dot{\mathbf{O}}^{\text{out}}(w)$ is an analytic function of w for $w \in \mathbb{C} \setminus (\beta_+ \cup \beta_- \cup \beta_{<} \cup \beta_{>} \cup \mathbb{R}_+)$, Hölder- γ continuous for any $\gamma \leq 1$ with the exception of arbitrarily small neighborhoods of the points $w = w_0$ and $w = w_1$. In the neighborhood U_k of w_k , the elements of $\dot{\mathbf{O}}^{\text{out}}(w)$ are bounded by a multiple of $|w - w_k|^{-1/4}$.

Jump condition: The boundary values taken by $\dot{\mathbf{O}}^{\text{out}}(w)$ along $\vec{\beta}_{\pm}$, $\vec{\beta}_{<}$, $\vec{\beta}_{>}$, and $\vec{\mathbb{R}}_+$ (the latter oriented from the origin to $+\infty$) satisfy the following jump conditions:

$$\dot{\mathbf{O}}_+^{\text{out}}(\xi) = \dot{\mathbf{O}}_-^{\text{out}}(\xi) i \sigma_1 e^{\pm i\nu\sigma_3}, \quad \xi \in \vec{\beta}_{\pm}, \quad (5.21)$$

$$\dot{\mathbf{O}}_+^{\text{out}}(\xi) = \dot{\mathbf{O}}_-^{\text{out}}(\xi) i \sigma_1, \quad \xi \in \vec{\beta}_{<} \cup \vec{\beta}_{>}, \quad (5.22)$$

and

$$\dot{\mathbf{O}}_+^{\text{out}}(\xi) = \sigma_2 \dot{\mathbf{O}}_-^{\text{out}}(\xi) \sigma_2, \quad \xi \in \vec{\mathbb{R}}_+. \quad (5.23)$$

Normalization: The following normalization condition holds:

$$\lim_{w \rightarrow \infty} \dot{\mathbf{O}}^{\text{out}}(w) = \mathbb{I}. \quad (5.24)$$

The jump conditions satisfied by $\dot{\mathbf{O}}^{\text{out}}(w)$ in case R are summarized in Figure 5.6.

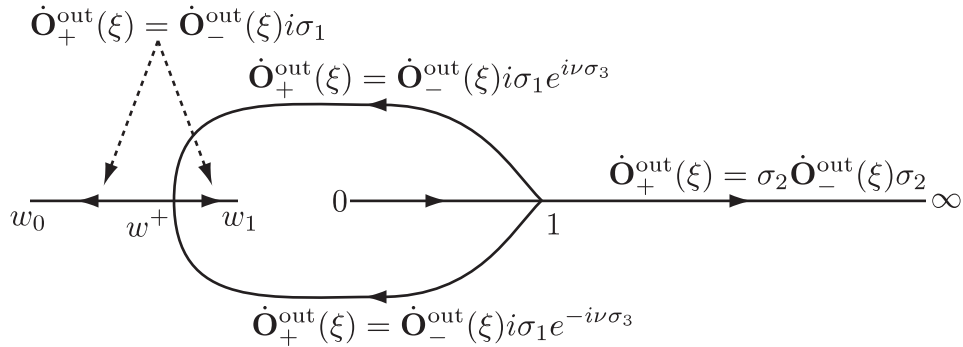

FIGURE 5.6. The jump conditions satisfied by the matrix $\dot{\mathbf{O}}^{\text{out}}(w)$ that we will show is normalized in the stronger sense that $\dot{\mathbf{O}}^{\text{out}}(w) = \mathbb{I} + \mathcal{O}(|w|^{-1/2})$ as $w \rightarrow \infty$. The only other singularities admitted are $\mathcal{O}(|w - w_k|^{-1/4})$ near the points w_0 and w_0^* .

A standard Liouville argument shows that these two Riemann-Hilbert problems have at most one solution. Existence of a unique solution may be accomplished by explicit construction involving Riemann Θ -functions of genus one. For us to be able to continue the current line of argument it is sufficient to state the following

proposition, whose proof can be found in Appendix B. Recall that in using the outer parametrix we will be setting $\nu = \Phi_\Delta/\epsilon_N$.

Proposition 5.2. *Riemann-Hilbert Problems 5.1 and 5.2 each have a unique solution with the following properties:*

- $\dot{\mathbf{O}}^{\text{out}}(w)$ depends continuously on ν and remains uniformly bounded (despite having no limit) as $\nu \rightarrow \infty$ for $w \in \mathbb{C} \setminus (U_0 \cup U_1)$.
- $|w - w_k|^{1/4} \dot{\mathbf{O}}^{\text{out}}(w)$ is uniformly bounded as $\nu \rightarrow \infty$ for $w \in U_k$, $k = 0, 1$.
- For all w where $\dot{\mathbf{O}}^{\text{out}}(w)$ is defined, $\det(\dot{\mathbf{O}}^{\text{out}}(w)) = 1$.

Whether it solves Riemann-Hilbert Problem 5.1 (case L) or Riemann-Hilbert Problem 5.2 (case R), the matrix $\dot{\mathbf{O}}^{\text{out}}(w)$ has the following asymptotic forms:

$$\dot{\mathbf{O}}^{\text{out}}(w) = \dot{\mathbf{O}}^{0,0} + \dot{\mathbf{O}}^{0,1} \sqrt{-w} + \mathcal{O}(w), \quad w \rightarrow 0 \quad (5.25)$$

and

$$\dot{\mathbf{O}}^{\text{out}}(w) = \mathbb{I} + \frac{\dot{\mathbf{O}}^{\infty,1}}{\sqrt{-w}} + \mathcal{O}(w^{-1}), \quad w \rightarrow \infty, \quad (5.26)$$

and the matrix coefficients $\dot{\mathbf{O}}^{0,0}$, $\dot{\mathbf{O}}^{0,1}$, and $\dot{\mathbf{O}}^{\infty,1}$ are all uniformly bounded as $\nu \rightarrow \infty$.

In terms of the matrix elements of the coefficients $\dot{\mathbf{O}}^{0,0}$, $\dot{\mathbf{O}}^{0,1}$, and $\dot{\mathbf{O}}^{\infty,1}$ we now define the following quantities:

$$\dot{C} := (-1)^{\#\Delta} \dot{O}_{11}^{0,0}, \quad (5.27)$$

$$\dot{S} := (-1)^{\#\Delta} \dot{O}_{21}^{0,0}, \quad (5.28)$$

and

$$\begin{aligned} \dot{G} &:= \dot{O}_{12}^{\infty,1} + \left[(\dot{\mathbf{O}}^{0,0})^{-1} \dot{\mathbf{O}}^{0,1} \right]_{12} \\ &= \dot{O}_{12}^{\infty,1} + \dot{O}_{22}^{0,0} \dot{O}_{12}^{0,1} - \dot{O}_{12}^{0,0} \dot{O}_{22}^{0,1}, \end{aligned} \quad (5.29)$$

where the second line follows from the first because according to Proposition 5.2, $\det(\dot{\mathbf{O}}^{0,0}) = \det(\dot{\mathbf{O}}^{\text{out}}(0)) = 1$.

In Appendix B the following simple formulae for \dot{C} , \dot{S} , and \dot{G} are established.

Proposition 5.3. *Let $\nu = \Phi_\Delta/\epsilon_N = \Phi(x, t)/\epsilon_N + \pi\#\Delta$, and let the contour β depend on $(x, t) \in \mathbb{R}^2$ as described in Proposition 4.7 or Proposition 4.9. If $\dot{\mathbf{O}}^{\text{out}}(w)$ is the solution of Riemann-Hilbert Problem 5.1 (case L), the derived quantities defined by (5.27)–(5.29) are given by*

$$\begin{aligned} \dot{C} &= \dot{C}_N(x, t) = \text{dn} \left(\frac{2\Phi K(m)}{\pi\epsilon_N}; m \right), \\ \dot{S} &= \dot{S}_N(x, t) = -\sqrt{m} \text{sn} \left(\frac{2\Phi K(m)}{\pi\epsilon_N}; m \right), \\ \dot{G} &= \dot{G}_N(x, t) = -\frac{4K(m)}{\pi} \frac{\partial\Phi}{\partial t} \sqrt{m} \text{cn} \left(\frac{2\Phi K(m)}{\pi\epsilon_N}; m \right), \end{aligned} \quad (5.30)$$

where the elliptic parameter is

$$m = m_{\mathbb{L}} := \sin(\zeta)^2, \quad 0 < \zeta := \frac{1}{2} \arg(w_0) < \frac{\pi}{2}, \quad (5.31)$$

which coincides with the function of \mathcal{E} given by (1.62). On the other hand, if $\dot{\mathbf{O}}^{\text{out}}(w)$ is the solution of Riemann-Hilbert Problem 5.2, the derived quantities defined by (5.27)–(5.29) are given by

$$\begin{aligned} \dot{C} &= \dot{C}_N(x, t) = \text{cn} \left(\frac{2\Phi K(m)}{\pi\epsilon_N}; m \right), \\ \dot{S} &= \dot{S}_N(x, t) = -\text{sn} \left(\frac{2\Phi K(m)}{\pi\epsilon_N}; m \right), \\ \dot{G} &= \dot{G}_N(x, t) = -\frac{4K(m)}{\pi} \frac{\partial\Phi}{\partial t} \text{dn} \left(\frac{2\Phi K(m)}{\pi\epsilon_N}; m \right), \end{aligned} \quad (5.32)$$

where now

$$m = m_R := \frac{4\sqrt{w_0 w_1}}{(\sqrt{-w_0} + \sqrt{-w_1})^2}, \quad (5.33)$$

which coincides with the function of \mathcal{E} given by (1.69). Here $K(\cdot)$ is the complete elliptic integral of the first kind as defined by (1.60), and both elliptic parameters correspond to the so-called normal case of $0 < m < 1$.

In both cases, the quantities \dot{C}_N , \dot{S}_N , and \dot{G}_N are all periodic in the fast phase variable Φ/ϵ_N with period 2π , and the differential relations

$$\epsilon_N \frac{\partial \dot{S}_N}{\partial t}(x, t) = \frac{1}{2} \dot{C}_N(x, t) \dot{G}_N(x, t) + \mathcal{O}(\epsilon_N) \quad \text{and} \quad \epsilon_N \frac{\partial \dot{C}_N}{\partial t}(x, t) = -\frac{1}{2} \dot{S}_N(x, t) \dot{G}_N(x, t) + \mathcal{O}(\epsilon_N) \quad (5.34)$$

(where m is a function of x and t through the roots $w_0 = w_0(x, t)$ and $w_1 = w_1(x, t)$ of $R(w; \mathbf{p}, \mathbf{q})^2$) hold uniformly for bounded (x, t) .

Now we describe the inner parametrix $\dot{\mathbf{O}}_k^{\text{in}}(w)$, which are constructed in a fairly standard way from Airy functions. The use of such ‘‘Airy’’ parametrix has been a linchpin of many papers using the Deift-Zhou methodology going back to the original reference [8]. A reference that describes a similar construction as in the present case where the functions $T^\nabla(w)$ and $T^\Delta(w)$ appear in the jump conditions is [2]. The basic Airy parametrix is the solution of the following Riemann-Hilbert Problem.

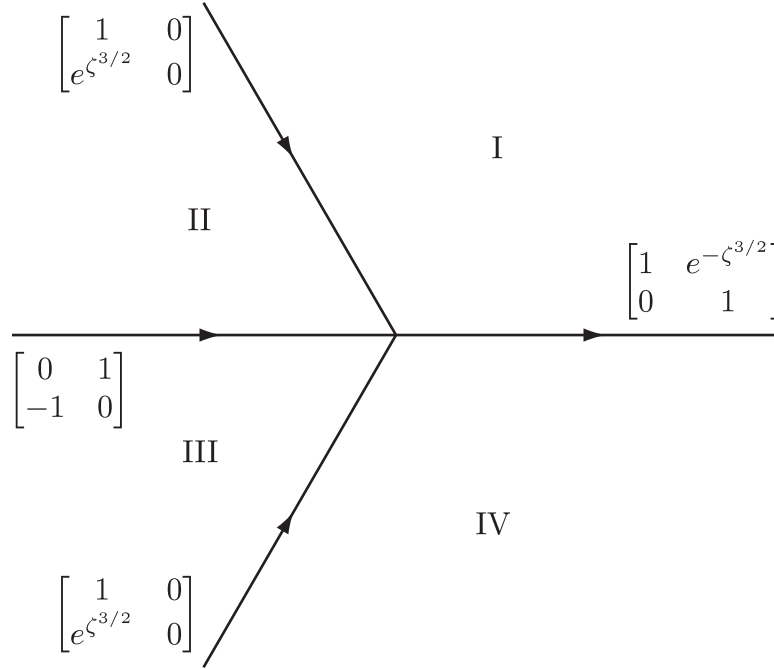

FIGURE 5.7. The jump matrix $\mathbf{V}_{\text{Airy}}(\zeta)$ defined on the contour Σ_{Airy} .

Riemann-Hilbert Problem 5.3 (Airy parametrix). Consider the contour Σ_{Airy} illustrated in Figure 5.7 consisting of four rays with angles $\arg(\zeta) = 0$, $\arg(\zeta) = \pm 2\pi/3$, and $\arg(-\zeta) = 0$. Find a 2×2 matrix function $\mathbf{Z}(\zeta)$ with the following properties:

Analyticity: $\mathbf{Z}(\zeta)$ is an analytic function of $\zeta \in \mathbb{C} \setminus \Sigma_{\text{Airy}}$ and Hölder- γ continuous for any $\gamma \leq 1$ in each sector of analyticity.

Jump condition: The boundary values taken by $\mathbf{Z}(\zeta)$ on the rays of Σ_{Airy} are related by the jump condition $\mathbf{Z}_+(\xi) = \mathbf{Z}_-(\xi) \mathbf{V}_{\text{Airy}}(\xi)$ for $\xi \in \bar{\Sigma}_{\text{Airy}}$, where the jump matrix $\mathbf{V}_{\text{Airy}}(\xi)$ is as defined in Figure 5.7.

Normalization: $\mathbf{Z}(\zeta)$ satisfies the normalization condition

$$\lim_{\zeta \rightarrow \infty} \mathbf{Z}(\zeta) \mathbf{U} \zeta^{-\sigma_3/4} = \mathbb{I} \quad (5.35)$$

uniformly with respect to direction, where \mathbf{U} is the unitary matrix

$$\mathbf{U} := \frac{1}{\sqrt{2}} \begin{bmatrix} e^{-i\pi/4} & e^{i\pi/4} \\ e^{i\pi/4} & e^{-i\pi/4} \end{bmatrix}. \quad (5.36)$$

It is well-documented [8, 2] that this problem has a unique solution given by the following formulae. Let $\tau := (\frac{3}{4})^{2/3} \zeta$. Then

$$\mathbf{Z}(\zeta) := \sqrt{2\pi} \left(\frac{4}{3}\right)^{\sigma_3/6} \begin{bmatrix} e^{-3\pi i/4} \text{Ai}'(\tau) & e^{11\pi i/12} \text{Ai}'(\tau e^{-2\pi i/3}) \\ e^{-\pi i/4} \text{Ai}(\tau) & e^{\pi i/12} \text{Ai}(\tau e^{-2\pi i/3}) \end{bmatrix} e^{2\tau^{3/2} \sigma_3/3}, \quad 0 < \arg(\zeta) < \frac{2\pi}{3}, \quad (5.37)$$

$$\mathbf{Z}(\zeta) := \sqrt{2\pi} \left(\frac{4}{3}\right)^{\sigma_3/6} \begin{bmatrix} e^{-5\pi i/12} \text{Ai}'(\tau e^{2\pi i/3}) & e^{11\pi i/12} \text{Ai}'(\tau e^{-2\pi i/3}) \\ e^{-7\pi i/12} \text{Ai}(\tau e^{2\pi i/3}) & e^{\pi i/12} \text{Ai}(\tau e^{-2\pi i/3}) \end{bmatrix} e^{2\tau^{3/2} \sigma_3/3}, \quad \frac{2\pi}{3} < \arg(\zeta) < \pi, \quad (5.38)$$

$$\mathbf{Z}(\zeta) := \sqrt{2\pi} \left(\frac{4}{3}\right)^{\sigma_3/6} \begin{bmatrix} e^{11\pi i/12} \text{Ai}'(\tau e^{-2\pi i/3}) & e^{7\pi i/12} \text{Ai}'(\tau e^{2\pi i/3}) \\ e^{\pi i/12} \text{Ai}(\tau e^{-2\pi i/3}) & e^{5\pi i/12} \text{Ai}(\tau e^{2\pi i/3}) \end{bmatrix} e^{2\tau^{3/2} \sigma_3/3}, \quad -\pi < \arg(\zeta) < -\frac{2\pi}{3}, \quad (5.39)$$

$$\mathbf{Z}(\zeta) := \sqrt{2\pi} \left(\frac{4}{3}\right)^{\sigma_3/6} \begin{bmatrix} e^{-3\pi i/4} \text{Ai}'(\tau) & e^{7\pi i/12} \text{Ai}'(\tau e^{2\pi i/3}) \\ e^{-\pi i/4} \text{Ai}(\tau) & e^{5\pi i/12} \text{Ai}(\tau e^{2\pi i/3}) \end{bmatrix} e^{2\tau^{3/2} \sigma_3/3}, \quad -\frac{2\pi}{3} < \arg(\zeta) < 0. \quad (5.40)$$

Moreover, it is easy to show from standard asymptotic formulae for the Airy function $\text{Ai}(\cdot)$ that the normalization condition (5.35) holds in the stronger sense that

$$\mathbf{Z}(\zeta) \mathbf{U} \zeta^{-\sigma_3/4} = \mathbb{I} + \begin{bmatrix} \mathcal{O}(\zeta^{-3/2}) & \mathcal{O}(\zeta^{-1}) \\ \mathcal{O}(\zeta^{-2}) & \mathcal{O}(\zeta^{-3/2}) \end{bmatrix}, \quad \zeta \rightarrow \infty. \quad (5.41)$$

To construct $\dot{\mathbf{O}}_k^{\text{in}}(w)$ from $\mathbf{Z}(\zeta)$, we must consider two cases, depending upon whether the point $w = w_k$ lies in Σ^∇ or Σ^Δ . We assume that the corresponding disc U_k is small enough that all of $U_k \cap (\Sigma^\nabla \cup \Sigma^\Delta)$ lies also in Σ^∇ or Σ^Δ respectively.

If $w_k \in \Sigma^\nabla$, then in the adjacent contour γ the function $\phi(\xi)$ satisfies $\Re\{\phi(\xi)\} < 0$ and $\phi'(\xi) = R(\xi)H(\xi)$ where the quadratic $R(\xi)^2$ has a simple zero at w_k and $H(\xi)$ is analytic and bounded away from zero near w_k . It follows that the function defined by taking the principal branch in the formula

$$W_\nabla(w) := (\phi(w_k) - \phi(w))^{2/3}, \quad w \in \gamma \quad (5.42)$$

(recall that $\phi(w_k) = 0$ if $w_k \in \mathbb{R}$, while $\phi(w_k) = \pm i\Phi$ if $w_k \in \mathbb{C}_\pm$) can be analytically continued from $\gamma \cap U_k$ to the full neighborhood U_k , and (by taking U_k sufficiently small, but independent of ϵ_N) $W_\nabla(w) \neq 0$ for $w \in U_k$. Thus, $W = W_\nabla(w)$ defines a conformal map taking U_k to a neighborhood of the origin in the W -plane. At this point, we choose the parts of the four contour arcs meeting at w_k within U_k so that their images under W_∇ are straight segments with angles $\arg(W) = 0$ (for $W_\nabla(\gamma)$), $\arg(-W) = 0$ (for $W_\nabla(\beta)$), and $\arg(W) = \pm 2\pi/3$ (for $W_\nabla(\partial\Lambda \cap \Omega_\mp^\nabla)$). To tie the independent variable ζ of $\mathbf{Z}(\zeta)$ to w , we set

$$\zeta := \frac{W_\nabla(w)}{\epsilon_N^{2/3}}, \quad w_k \in \Sigma^\nabla. \quad (5.43)$$

Thus, the disc U_k is mapped under $w \mapsto \zeta$ to a neighborhood of the origin in the ζ -plane whose outer boundary is expanding at the uniform rate of $\epsilon_N^{-2/3}$ as $\epsilon_N \downarrow 0$. Set $c_\nabla := e^{i\pi/4 \pm i\Phi_\Delta/(2\epsilon_N)}$ if $w_k \in \mathbb{C}_\pm$ and $c_\nabla := e^{i\pi/4}$ if $w_k \in \mathbb{R}$, and let a nonzero piecewise analytic function $d^\nabla(w)$ be defined in U_k as follows:

$$d^\nabla(w) := \begin{cases} 1, & |\arg(-W_\nabla(w))| < \pi/3 \\ T^\nabla(w)^{1/2}, & |\arg(W_\nabla(w))| < 2\pi/3. \end{cases} \quad (5.44)$$

It is then straightforward to verify that if $\mathbf{H}^\nabla(w)$ is any matrix that is holomorphic for $w \in U_k$, with ζ defined in terms of w by (5.43),

$$\dot{\mathbf{O}}_k^{\text{in}}(w) := \mathbf{H}^\nabla(w) \mathbf{Z}(\zeta) (-i\sigma_1) c_\nabla^{\sigma_3} d^\nabla(w)^{\sigma_3}, \quad w \in U_k, \quad w_k \in \Sigma^\nabla, \quad (5.45)$$

is analytic exactly where $\mathbf{O}(w)$ is and satisfies exactly the same jump conditions as $\mathbf{O}(w)$ does within the neighborhood U_k . It remains to determine the holomorphic prefactor $\mathbf{H}^\nabla(w)$, and this is done to achieve accurate matching onto the outer parametrix $\dot{\mathbf{O}}^{\text{out}}(w)$ on the disc boundary ∂U_k . To do this, we now observe that the unimodular matrices $\dot{\mathbf{O}}^{\text{out}}(w)c_{\nabla}^{-\sigma_3}(i\sigma_1)$ and $W_{\nabla}(w)^{\sigma_3/4}\mathbf{U}^\dagger$ satisfy the same analyticity and jump conditions for $w \in U$ and grow at the same rate as $w \rightarrow w_k$; therefore, their matrix ratio $\mathbf{B}^\nabla(w)$ is unimodular and analytic in U_k , and moreover, it is a consequence of Proposition 5.2 that this ratio is uniformly bounded as $\epsilon_N \downarrow 0$. We then set

$$\mathbf{H}^\nabla(w) := \mathbf{B}^\nabla(w)\epsilon_N^{\sigma_3/6}, \quad \text{where} \quad \mathbf{B}^\nabla(w) := \left[\dot{\mathbf{O}}^{\text{out}}(w)c_{\nabla}^{-\sigma_3}(i\sigma_1) \right] \cdot \left[W_{\nabla}(w)^{\sigma_3/4}\mathbf{U}^\dagger \right]^{-1}. \quad (5.46)$$

Then, it is a direct matter to check that

$$\dot{\mathbf{O}}_k^{\text{in}}(w)\dot{\mathbf{O}}^{\text{out}}(w)^{-1} = \mathbf{C}^\nabla(w)\zeta^{-\sigma_3/4}(\mathbf{Z}(\zeta)\mathbf{U}\zeta^{-\sigma_3/4})\zeta^{\sigma_3/4}\mathbf{C}^\nabla(w)^{-1}\mathbf{D}^\nabla(w), \quad w \in U_k, \quad w_k \in \Sigma^\nabla, \quad (5.47)$$

where

$$\mathbf{C}^\nabla(w) := \dot{\mathbf{O}}^{\text{out}}(w)c_{\nabla}^{-\sigma_3}(i\sigma_1)\mathbf{U} \quad \text{and} \quad \mathbf{D}^\nabla(w) := \dot{\mathbf{O}}^{\text{out}}(w)d^\nabla(w)^{\sigma_3}\dot{\mathbf{O}}^{\text{out}}(w)^{-1}. \quad (5.48)$$

Now if $w = \xi \in \partial U_k$, then Proposition 5.2 guarantees that $\dot{\mathbf{O}}^{\text{out}}(\xi)$ and its inverse are bounded on ∂U_k uniformly as $\epsilon_N \downarrow 0$, while Proposition 3.1 guarantees that $d^\Delta(w)^{\sigma_3} = \mathbb{I} + \mathcal{O}(\epsilon_N)$ holds uniformly for $w \in U_k$, so it follows that $\mathbf{C}^\nabla(\xi) = \mathcal{O}(1)$, $\mathbf{C}^\nabla(\xi)^{-1} = \mathcal{O}(1)$, and $\mathbf{D}^\nabla(\xi) = \mathbb{I} + \mathcal{O}(\epsilon_N)$ are uniform estimates for $\xi \in \partial U_k$. Furthermore, since $w = \xi \in \partial U_k$ is equivalent to $\zeta^{-1} = \mathcal{O}(\epsilon_N^{2/3})$, we may use the large- ζ asymptotic formula (5.41) to obtain $\zeta^{-\sigma_3/4}(\mathbf{Z}(\zeta)\mathbf{U}\zeta^{-\sigma_3/4})\zeta^{\sigma_3/4} = \mathbb{I} + \mathcal{O}(\zeta^{-3/2}) = \mathbb{I} + \mathcal{O}(\epsilon_N)$ for $w = \xi \in \partial U_k$. The result of these calculations is the uniform estimate

$$\dot{\mathbf{O}}_k^{\text{in}}(\xi)\dot{\mathbf{O}}^{\text{out}}(\xi)^{-1} = \mathbb{I} + \mathcal{O}(\epsilon_N), \quad \xi \in \partial U_k, \quad k = 0, 1. \quad (5.49)$$

This relation shows that our choice of the holomorphic prefactor $\mathbf{H}^\nabla(w)$ yields an accurate match between the inner and outer parametrices on the disc boundary ∂U_k .

If instead $w_k \in \Sigma^\Delta$, then in the adjacent contour γ the function $\phi(\xi)$ satisfies $\Re\{\phi(\xi)\} > 0$ so the correct conformal mapping is defined by taking the principal branch in

$$W_\Delta(w) := (\phi(w) - \phi(w_k))^{2/3}, \quad w \in \gamma \quad (5.50)$$

and analytically continuing from $\gamma \cap U_k$ to U_k (using the fact that $\phi(w) - \phi(w_k)$ behaves as $(w - w_k)^{3/2}$ near $w = w_k$). Choosing the contours within U_k so that their images under $W = W_\Delta(w)$ lie along rays with angles $\arg(W) = 0$ (for $W_\Delta(\gamma)$), $\arg(-W) = 0$ (for $W_\Delta(\beta)$), and $\arg(W) = \pm 2\pi/3$ (for $W_\Delta(\partial\Lambda \cap \Omega_\pm^\Delta)$), we choose the independent variable ζ in the Airy parametrix $\mathbf{Z}(\zeta)$ to be given by

$$\zeta := \frac{W_\Delta(w)}{\epsilon_N^{2/3}}, \quad w_k \in \Sigma^\Delta. \quad (5.51)$$

Setting $c_\Delta := e^{-\pi i/4 \pm i\Phi_\Delta/(2\epsilon_N)}$ if $w_k \in \mathbb{C}_\pm$ and $C_\Delta := e^{-\pi i/4}$ if $w_k \in \mathbb{R}$, and defining $d^\Delta(w)$ for $w \in U_k$ by

$$d^\Delta(w) := \begin{cases} 1, & |\arg(-W_\Delta(w))| < \pi/3 \\ T^\Delta(w)^{-1/2}, & |\arg(W_\Delta(w))| < 2\pi/3, \end{cases} \quad (5.52)$$

we define the inner parametrix as

$$\dot{\mathbf{O}}_k^{\text{in}}(w) := \mathbf{H}^\Delta(w)\mathbf{Z}(\zeta)c_\Delta^{\sigma_3}d^\Delta(w)^{\sigma_3}, \quad w \in U_k, \quad w_k \in \Sigma^\Delta, \quad (5.53)$$

where ζ is a function of w and ϵ_N by (5.51), and the holomorphic prefactor $\mathbf{H}^\Delta(w)$ is given by

$$\mathbf{H}^\Delta(w) := \mathbf{B}^\Delta(w)\epsilon_N^{\sigma_3/6}, \quad \text{where} \quad \mathbf{B}^\Delta(w) := \left[\dot{\mathbf{O}}^{\text{out}}(w)c_\Delta^{-\sigma_3} \right] \cdot \left[W_\Delta(w)^{\sigma_3/4}\mathbf{U}^\dagger \right]^{-1}. \quad (5.54)$$

It is again straightforward to confirm that for $w \in U_k$, $\dot{\mathbf{O}}_k^{\text{in}}(w)$ is analytic where $\mathbf{O}(w)$ is, and satisfies exactly the same jump conditions as does $\mathbf{O}(w)$. Also,

$$\dot{\mathbf{O}}_k^{\text{in}}(w)\dot{\mathbf{O}}^{\text{out}}(w)^{-1} = \mathbf{C}^\Delta(w)\zeta^{-\sigma_3/4}(\mathbf{Z}(\zeta)\mathbf{U}\zeta^{-\sigma_3/4})\zeta^{\sigma_3/4}\mathbf{C}^\Delta(w)^{-1}\mathbf{D}^\Delta(w), \quad w \in U_k, \quad w_k \in \Sigma^\Delta, \quad (5.55)$$

where

$$\mathbf{C}^\Delta(w) := \dot{\mathbf{O}}^{\text{out}}(w)c_\Delta^{-\sigma_3}\mathbf{U} \quad \text{and} \quad \mathbf{D}^\Delta(w) := \dot{\mathbf{O}}^{\text{out}}(w)d^\Delta(w)^{\sigma_3}\dot{\mathbf{O}}^{\text{out}}(w)^{-1}. \quad (5.56)$$

Completely analogous reasoning as in the case that $w_k \in \Sigma^\nabla$ then shows that the estimate (5.49) holds also when $w_k \in \Sigma^\Delta$.

We formalize these results in the following proposition.

Proposition 5.4. *Suppose that the root w_k of the quadratic $R(w; \mathbf{p}, \mathbf{q})^2$ is bounded away from the other root and also from \mathbf{a} and \mathbf{b} , and let the inner parametrix $\dot{\mathbf{O}}_k^{\text{in}}(w)$ be defined for w in a suitably small (but independent of ϵ_N) neighborhood U_k of w_k by either (5.45)–(5.46) (if $w_k \in \Sigma^\nabla$) or (5.53)–(5.54) (if $w_k \in \Sigma^\Delta$). Then $\det(\dot{\mathbf{O}}_k^{\text{in}}(w)) = 1$ where defined, $\mathbf{O}(w)\dot{\mathbf{O}}_k^{\text{in}}(w)^{-1}$ is analytic for $w \in U_k$, and the mismatch with the outer parametrix on ∂U_k is characterized by the estimate (5.49).*

We emphasize that it is a consequence of the differential identities (4.13) and (4.18) along with the fact that H is bounded away from zero near each of the distinct roots of $R(w; \mathbf{p}, \mathbf{q})^2$ that the matrix $\mathbf{Z}(\zeta)$ can be used to construct the correct inner parametrix for $\mathbf{O}(w)$ in U_k . Indeed, were the function $\phi(w) - \phi(w_k)$ to vanish to higher order due to coalescence of roots of $R(w; \mathbf{p}, \mathbf{q})^2$ or the presence of a zero of the analytic function H , a more exotic inner parametrix would be required because $W_\nabla(w)$ or $W_\Delta(w)$ would fail to be a proper conformal map. A more fruitful approach in such a situation is to investigate the double-scaling limit where ϕ degenerates due to allowing (x, t) to converge to some critical point at an appropriate rate as $\epsilon_N \downarrow 0$. We will carry out such analysis in a forthcoming paper [5] for the case when the two roots of $R(w; \mathbf{p}, \mathbf{q})^2$ coalesce on the real axis when $t = 0$ and $x = \pm x_{\text{crit}}$. Modified inner parametrices will also be required if one or the other roots of $R(w; \mathbf{p}, \mathbf{q})^2$ “bounces off” of \mathbf{a} or \mathbf{b} as explained in Proposition 4.9, but this is a far less interesting special case.

5.3. The effect of conjugation. Estimation of the error. Consider the matrix $\mathbf{E}(w)$ (the error in approximating $\mathbf{O}(w)$ with the global parametrix $\dot{\mathbf{O}}(w)$) defined by

$$\mathbf{E}(w) := \mathbf{O}(w)\dot{\mathbf{O}}(w)^{-1} \tag{5.57}$$

for all $w \in \mathbb{C}$ where both matrices on the right-hand side are well-defined. Since according to Propositions 5.2 and 5.4 the outer parametrix $\dot{\mathbf{O}}(w)$ defined by (5.17) is a unimodular sectionally analytic matrix function, it follows that the same is true of $\mathbf{E}(w)$. Also, since (i) the outer parametrix $\dot{\mathbf{O}}^{\text{out}}(w)$ satisfies exactly the same jump condition as does $\mathbf{O}(w)$ on the arcs of the contour $\vec{\beta}$ and (ii) the inner parametrices $\dot{\mathbf{O}}_k^{\text{in}}(w)$ satisfy exactly the same jump conditions as does $\mathbf{O}(w)$ on all contours within the open discs U_k , the error $\mathbf{E}(w)$ can be analytically continued to all of these contour arcs. Thus, the jump contour for $\mathbf{E}(w)$, denoted $\Sigma_{\mathbf{E}}$, is as illustrated in Figures 5.8–5.11.

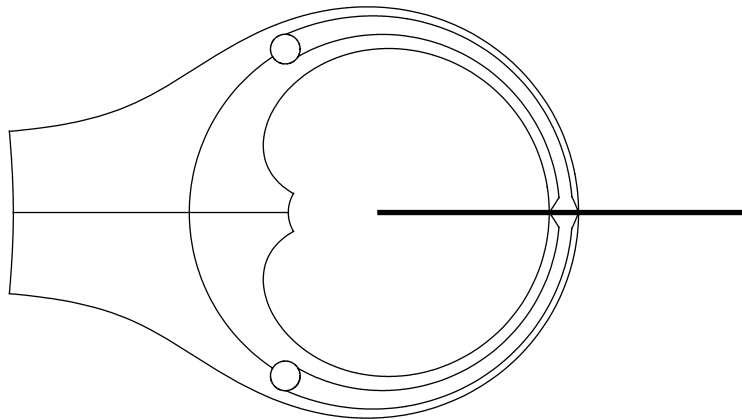

FIGURE 5.8. The contour $\Sigma_{\mathbf{E}}$ of discontinuity of the sectionally analytic function $\mathbf{E}(w)$ in case L. The circles are the boundaries of the discs U_1 and U_2 .

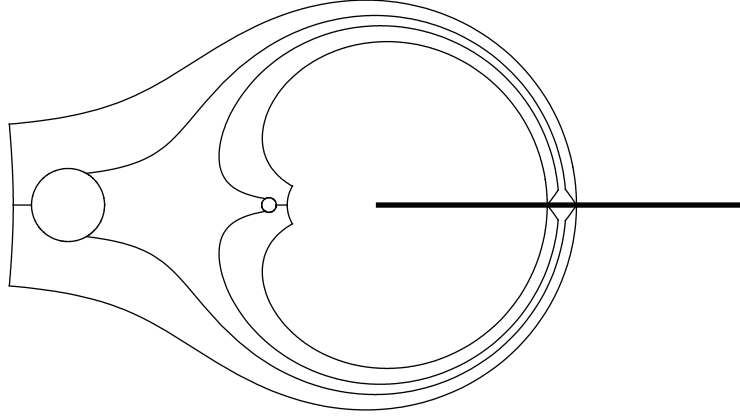

FIGURE 5.9. The contour $\Sigma_{\mathbf{E}}$ of discontinuity of the sectionally analytic function $\mathbf{E}(w)$ in case \mathbf{R} with either $\Delta = \emptyset$ or $\nabla = \emptyset$. The circles are the boundaries of the discs U_1 and U_2 .

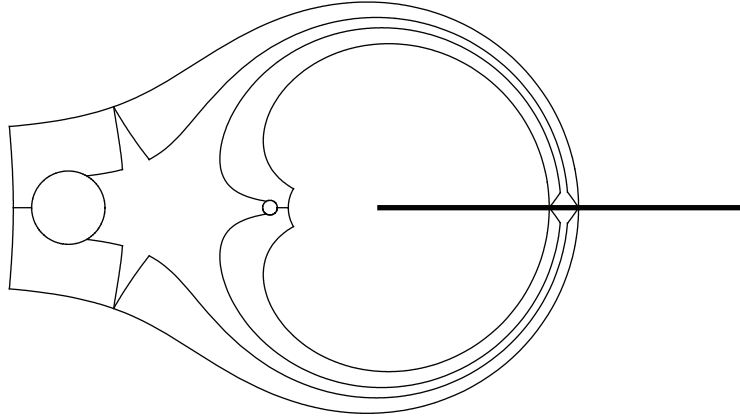

FIGURE 5.10. The contour $\Sigma_{\mathbf{E}}$ of discontinuity of the sectionally analytic function $\mathbf{E}(w)$ in case \mathbf{R} with either $\Delta = P_N^{\leftarrow \mathbf{R}}$ or $\nabla = P_N^{\leftarrow \mathbf{R}}$. The circles are the boundaries of the discs U_1 and U_2 .

Now while the global parametrix $\hat{\mathbf{O}}(w)$ is known, the matrix $\mathbf{O}(w)$ is only characterized by being related via explicit transformations to $\mathbf{H}(w)$, which in turn is specified only as the (unknown) solution of Riemann-Hilbert Problem 2.1. However, the conditions of Riemann-Hilbert Problem 2.1 imply an equivalent Riemann-Hilbert problem whose solution must give $\mathbf{E}(w)$. As both $\mathbf{O}(w)$ and $\hat{\mathbf{O}}(w)$ tend to the identity matrix as $w \rightarrow \infty$ (in the case of $\mathbf{O}(w)$ this follows from the sequence of explicit transformations relating it back to $\mathbf{H}(w)$ and the normalization condition (2.6) for the latter, and in the case of $\hat{\mathbf{O}}(w)$ this follows from the fact that $\hat{\mathbf{O}}(w) = \hat{\mathbf{O}}^{\text{out}}(w)$ for large $|w|$ and from the normalization condition on the outer parametrix as specified from the conditions of Riemann-Hilbert Problem 5.1 or 5.2), we must require that $\mathbf{E}(w) \rightarrow \mathbb{I}$ as $w \rightarrow \infty$. To formulate the Riemann-Hilbert problem for the error it remains to analyze the jump conditions satisfied by $\mathbf{E}(w)$ along the contour $\Sigma_{\mathbf{E}}$ pictured in Figures 5.8–5.11.

First consider the jump of $\mathbf{E}(w)$ across the positive real axis $\xi \in \mathbb{R}_+ \subset \Sigma_{\mathbf{E}}$. On either side of \mathbb{R}_+ we have $\hat{\mathbf{O}}_{\pm}(\xi) = \hat{\mathbf{O}}_{\pm}^{\text{out}}(\xi)$, and according to the jump conditions of Riemann-Hilbert Problem 5.1 or 5.2 we therefore have the exact relation $\hat{\mathbf{O}}_+(\xi) = \sigma_2 \hat{\mathbf{O}}_-(\xi) \sigma_2$ for $\xi \in \mathbb{R}_+$. According to Proposition 5.1 the corresponding boundary values of $\mathbf{O}(w)$ are related by $\mathbf{O}_+(\xi) = \sigma_2 \mathbf{O}_-(\xi) \sigma_2 (\mathbb{I} + \mathcal{O}(\epsilon_N))$, where the error term is identically zero except in the interval J where the lens Λ abuts the positive real axis from above and below. Using the fact (see Proposition 5.2) that $\hat{\mathbf{O}}_-(\xi) = \hat{\mathbf{O}}_-^{\text{out}}(\xi)$ is, along with its inverse, uniformly bounded for $\xi > 0$, we

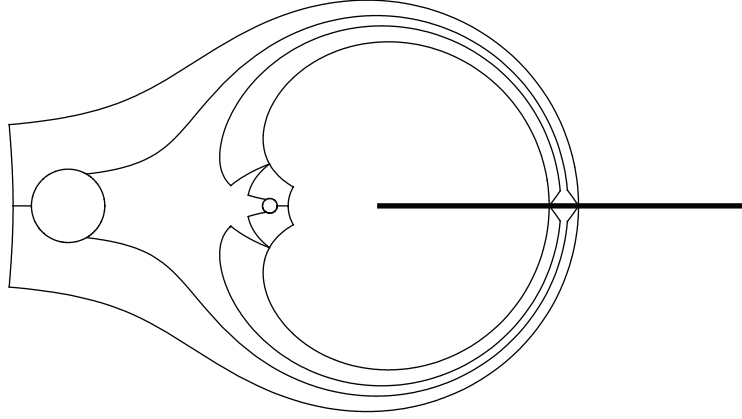

FIGURE 5.11. The contour $\Sigma_{\mathbf{E}}$ of discontinuity of the sectionally analytic function $\mathbf{E}(w)$ in case \mathbf{R} with either $\Delta = P_N^{\mathbf{R}, >}$ or $\nabla = P_N^{\mathbf{R}, >}$. The circles are the boundaries of the discs U_1 and U_2 .

then see that $\mathbf{E}_+(\xi) = \sigma_2 \mathbf{E}_-(\xi) \sigma_2 (\mathbb{I} + \mathbf{X}(\xi))$ holds for $\xi > 0$, where $\mathbf{X}(\xi) = \mathcal{O}(\epsilon_N)$ for $\xi \in J$ and otherwise $\mathbf{X}(\xi) \equiv 0$.

Across the disc boundaries $\partial U_k \subset \Sigma_{\mathbf{E}}$ we have no discontinuity of $\mathbf{O}(w)$, but $\mathbf{E}(w)$ is discontinuous because the global parametrix $\dot{\mathbf{O}}(w)$ is discontinuous due to the mismatch between the outer and inner parametrix. If we take the disc boundaries to be oriented in the clockwise direction, then we have $\mathbf{E}_+(\xi) = \mathbf{E}_-(\xi) [\dot{\mathbf{O}}_k^{\text{in}}(\xi) \dot{\mathbf{O}}_k^{\text{out}}(\xi)^{-1}]$ for $\xi \in \partial U_k$, and according to Proposition 5.4, this jump condition can be written in the form $\mathbf{E}_+(\xi) = \mathbf{E}_-(\xi) (\mathbb{I} + \mathcal{O}(\epsilon_N))$.

Finally, consider $\xi \in \Sigma_{\mathbf{E}} \setminus (\mathbb{R}_+ \cup \partial U_0 \cup \partial U_1)$. According to Proposition 5.1, we have $\mathbf{O}_+(\xi) = \mathbf{O}_-(\xi) (\mathbb{I} + \mathcal{O}(\epsilon_N))$ holding uniformly for all such ξ . But the global parametrix has no jump, and we have $\dot{\mathbf{O}}(\xi) = \dot{\mathbf{O}}^{\text{out}}(\xi)$ on these contour arcs, and again recalling Proposition 5.2 as $\epsilon_N \downarrow 0$ the global parametrix is uniformly bounded here along with its inverse. Therefore $\mathbf{E}_+(\xi) = \mathbf{E}_-(\xi) \dot{\mathbf{O}}^{\text{out}}(\xi) (\mathbb{I} + \mathcal{O}(\epsilon_N)) \dot{\mathbf{O}}^{\text{out}}(\xi)^{-1} = \mathbf{E}_-(\xi) (\mathbb{I} + \mathcal{O}(\epsilon_N))$ holds uniformly for $\xi \in \Sigma_{\mathbf{E}} \setminus (\mathbb{R}_+ \cup \partial U_0 \cup \partial U_1)$.

It follows from these considerations that $\mathbf{E}(w)$ may be characterized as the solution of the following Riemann-Hilbert problem.

Riemann-Hilbert Problem 5.4 (Error). *Seek a 2×2 matrix $\mathbf{E}(w)$ with the following properties:*

Analyticity: $\mathbf{E}(w)$ is analytic for $w \in \mathbb{C} \setminus \Sigma_{\mathbf{E}}$ where $\Sigma_{\mathbf{E}}$ is the contour (independent of ϵ_N) pictured in various cases in Figures 5.8–5.11, and in each component of the domain of analyticity is uniformly Hölder continuous with any exponent $\gamma \leq 1$.

Jump conditions: The boundary values taken by $\mathbf{E}(w)$ on $\Sigma_{\mathbf{E}}$ are related as follows. For $\xi \in \mathbb{R}_+$,

$$\mathbf{E}_+(\xi) = \sigma_2 \mathbf{E}_-(\xi) \sigma_2 (\mathbb{I} + \mathbf{X}(\xi)) \quad (5.58)$$

where $\mathbf{X}(\xi) = \mathcal{O}(\epsilon_N)$ for $\xi \in J$ and $\mathbf{X}(\xi) = 0$ for $\xi \in \mathbb{R}_+ \setminus J$. For all remaining $\xi \in \Sigma_{\mathbf{E}}$ we have the uniform estimate

$$\mathbf{E}_+(\xi) = \mathbf{E}_-(\xi) (\mathbb{I} + \mathcal{O}(\epsilon_N)) \quad (5.59)$$

as $\epsilon_N \downarrow 0$.

Normalization: The matrix $\mathbf{E}(w)$ satisfies the condition

$$\lim_{\substack{w \rightarrow \infty \\ |\arg(-w)| < \pi}} \mathbf{E}(w) = \mathbb{I}. \quad (5.60)$$

This Riemann-Hilbert problem closely resembles a problem of “small-norm” type, except for the form of the jump condition along the positive real axis (the branch cut of $\sqrt{-w}$). But if we consider unfolding the

branch cut by setting $w = z^2$ and then defining a matrix function $\mathbf{F}(z)$ in terms of $\mathbf{E}(w)$ by

$$\mathbf{F}(z) := \begin{cases} \mathbf{E}(z^2), & \Im\{z\} > 0 \\ \sigma_2 \mathbf{E}(z^2) \sigma_2, & \Im\{z\} < 0, \end{cases} \quad (5.61)$$

then the jump contour $\Sigma_{\mathbf{F}}$ for $\mathbf{F}(z)$ in the z -plane includes two disjoint images of $\Sigma_{\mathbf{E}} \setminus \mathbb{R}_+$, one in the upper half-plane and one in the lower half-plane; moreover from (5.59) the jump of $\mathbf{F}(z)$ across the arcs of either of these two images is of the form $\mathbf{F}_+(z) = \mathbf{F}_-(z)(\mathbb{I} + \mathcal{O}(\epsilon_N))$. If $z \in \mathbb{R}$, then it follows from (5.58) that $\mathbf{F}_+(z) = \mathbf{F}_-(z)(\mathbb{I} + \mathcal{O}(\epsilon_N))$ where the error term vanishes identically if $z^2 \notin J$. Thus, $\mathbf{F}(z)$ is the solution of a ‘‘small-norm’’ Riemann-Hilbert problem of standard form. It is a metatheorem in this subject that such problems have unique solutions that are uniformly close to the identity matrix on compact sets that avoid the jump contour and in a full neighborhood of the point at infinity. Indeed, solving the singular integral equations corresponding to such a problem involves inverting an operator (on, say, $L^2(\Sigma_{\mathbf{F}})$) that is a perturbation of the identity of size $\mathcal{O}(\epsilon_N)$ in operator norm. Such a problem can of course be solved by iteration, and the resulting Neumann series also functions as an asymptotic series as $\epsilon_N \downarrow 0$. This yields a representation of $\mathbf{F}(z)$ in terms of a Cauchy integral:

$$\mathbf{F}(z) = \mathbb{I} + \frac{1}{2\pi i} \int_{\Sigma_{\mathbf{F}}} \frac{\mathbf{Y}(\xi) d\xi}{\xi - z}, \quad (5.62)$$

where $\mathbf{Y} \in L^2(\Sigma_{\mathbf{F}})$ with $\|\mathbf{Y}(\cdot)\|_2 = \mathcal{O}(\epsilon_N)$. Note that since $\Sigma_{\mathbf{F}}$ is compact, by Cauchy-Schwarz we also have $\mathbf{Y} \in L^1(\Sigma_{\mathbf{F}})$ with $\|\mathbf{Y}(\cdot)\|_1 = \mathcal{O}(\epsilon_N)$. It follows that if K is a compact subset of \mathbb{C} disjoint from $\Sigma_{\mathbf{F}}$, then

$$\sup_{z \in K} \|\mathbf{F}(z) - \mathbb{I}\| = \mathcal{O}(\epsilon_N) \quad (5.63)$$

because the Cauchy kernel $(\xi - z)^{-1}$ is uniformly bounded for $\xi \in \Sigma_{\mathbf{F}}$ and $z \in K$. Also, if z lies outside of a sufficiently large disc containing $\Sigma_{\mathbf{F}}$, then the geometric series $(\xi - z)^{-1} = -(z^{-1} + \xi z^{-2} + \xi^2 z^{-3} + \dots)$ is uniformly convergent for $\xi \in \Sigma_{\mathbf{F}}$, and so we obtain the convergent series expansion for $\mathbf{F}(z)$ as $z \rightarrow \infty$

$$\mathbf{F}(z) = \mathbb{I} - \sum_{n=1}^{\infty} \frac{1}{2\pi i z^n} \int_{\Sigma_{\mathbf{F}}} \mathbf{Y}(\xi) \xi^{n-1} d\xi, \quad (5.64)$$

and the coefficient of each negative power of z is $\mathcal{O}(\epsilon_N)$. Corresponding results hold for $\mathbf{E}(w)$ by restricting z to the upper half-plane and using (5.61).

We have thus shown that the significance of the global parametrix $\dot{\mathbf{O}}(w)$ defined by (5.17) is the following approximation result.

Proposition 5.5. *Suppose (x, t) is a point in one of the domains $\mathcal{O}_{\mathbb{L}}^{\pm}$, $\mathcal{O}_{\mathbb{R}}^{\pm}$ (see Proposition 4.7), or $\mathcal{O}_{\mathbb{R}}^0$ (see Proposition 4.9), and that $|t|$ is sufficiently small. If also the roots of the quadratic $R(w; \mathbf{p}, \mathbf{q})^2$ do not coincide, nor does either root equal \mathbf{a} or \mathbf{b} , then Riemann-Hilbert Problem 2.1 has a unique solution $\mathbf{H}(w)$, and the matrix $\mathbf{O}(w)$ obtained therefrom by means of the systematic substitutions $\mathbf{H} \mapsto \mathbf{J}$ (see (2.32)), $\mathbf{J} \mapsto \mathbf{M}$ (see (3.6)), $\mathbf{M} \mapsto \mathbf{N}$ (see (3.43)), and $\mathbf{N} \mapsto \mathbf{O}$ (see (5.1)) has expansions for large and small w of the form*

$$\mathbf{O}(w) = \mathbf{O}_N^{0,0}(x, t) + \mathbf{O}_N^{0,1}(x, t) \sqrt{-w} + \mathcal{O}(w), \quad w \rightarrow 0 \quad (5.65)$$

and

$$\mathbf{O}(w) = \mathbb{I} + \frac{\mathbf{O}_N^{\infty,1}(x, t)}{\sqrt{-w}} + \mathcal{O}(w^{-1}), \quad w \rightarrow \infty, \quad (5.66)$$

and the coefficients satisfy the estimates (see Proposition 5.2)

$$\begin{aligned} \mathbf{O}_N^{0,0}(x, t) &= \dot{\mathbf{O}}^{0,0} + \mathcal{O}(\epsilon_N) \\ \mathbf{O}_N^{0,1}(x, t) &= \dot{\mathbf{O}}^{0,1} + \mathcal{O}(\epsilon_N) \\ \mathbf{O}_N^{\infty,1}(x, t) &= \dot{\mathbf{O}}^{\infty,1} + \mathcal{O}(\epsilon_N), \end{aligned} \quad (5.67)$$

where the dependence on N and (x, t) on the right-hand side enters through $\nu = \Phi(x, t)/\epsilon_N + \pi\#\Delta$ and the motion of the contour β . The $\mathcal{O}(\epsilon_N)$ error terms are also uniform with respect to (x, t) as long as the roots of the quadratic $R(w; \mathbf{p}, \mathbf{q})^2$ are bounded away from each other and from \mathbf{a} and \mathbf{b} .

If w lies in a small neighborhood of the origin, or alternatively if $|w|$ is sufficiently large, then according to (5.1) $\mathbf{O}(w)$ coincides with $\mathbf{N}(w)$, and according to (3.6) $\mathbf{M}(w)$ coincides with $\mathbf{J}(w)$, the latter matrix function being the solution of Riemann-Hilbert Problem 2.2. Recalling the relations (2.32) and (3.43), we see that for such w ,

$$\mathbf{H}(w) = \mathbf{O}(w)e^{g(w)\sigma_3/\epsilon_N} \left(\prod_{y \in \Delta} \frac{\sqrt{-w} + \sqrt{-y}}{\sqrt{-w} - \sqrt{-y}} \right)^{\sigma_3}. \quad (5.68)$$

Since $g(0) = g(\infty) = 0$, the diagonal factor relating $\mathbf{H}(w)$ and $\mathbf{O}(w)$ has the expansions

$$e^{g(w)\sigma_3/\epsilon_N} \left(\prod_{y \in \Delta} \frac{\sqrt{-w} + \sqrt{-y}}{\sqrt{-w} - \sqrt{-y}} \right)^{\sigma_3} = \begin{cases} (-1)^{\#\Delta} + \mathbf{C}_N^{0,1}(x, t)\sqrt{-w} + \mathcal{O}(w), & w \rightarrow 0 \\ 1 + \mathbf{C}_N^{\infty,1}(x, t)/\sqrt{-w} + \mathcal{O}(w^{-1}), & w \rightarrow \infty \end{cases} \quad (5.69)$$

for some diagonal matrices $\mathbf{C}_N^{0,1}(x, t)$ and $\mathbf{C}_N^{\infty,1}(x, t)$. The matrices $\mathbf{A}_N(x, t)$, $\mathbf{B}_N^0(x, t)$, and $\mathbf{B}_N^\infty(x, t)$ obtained from $\mathbf{H}(w)$ via (2.9)–(2.11) are then written in terms of the expansion coefficients of $\mathbf{O}(w)$ from (5.65)–(5.66) as

$$\begin{aligned} \mathbf{A}_N(x, t) &= (-1)^{\#\Delta} \mathbf{O}_N^{0,0}(x, t) \\ \mathbf{B}_N^0(x, t) &= (-1)^{\#\Delta} \mathbf{C}_N^{0,1}(x, t) + \mathbf{O}_N^{0,0}(x, t)^{-1} \mathbf{O}_N^{0,1}(x, t) \\ \mathbf{B}_N^\infty(x, t) &= \mathbf{O}_N^{\infty,1}(x, t) + \mathbf{C}_N^{\infty,1}(x, t). \end{aligned} \quad (5.70)$$

Then using Proposition 5.5 these are expressed asymptotically in terms of the corresponding expansion coefficients of the outer parametrix $\dot{\mathbf{O}}^{\text{out}}(w)$ as follows:

$$\begin{aligned} \mathbf{A}_N(x, t) &= (-1)^{\#\Delta} \dot{\mathbf{O}}^{0,0} + \mathcal{O}(\epsilon_N) \\ \mathbf{B}_N^0(x, t) &= (-1)^{\#\Delta} \mathbf{C}_N^{0,1}(x, t) + (\dot{\mathbf{O}}^{0,0})^{-1} \dot{\mathbf{O}}^{0,1} + \mathcal{O}(\epsilon_N) \\ \mathbf{B}_N^\infty(x, t) &= \dot{\mathbf{O}}^{\infty,1} + \mathbf{C}_N^{\infty,1}(x, t) + \mathcal{O}(\epsilon_N) \end{aligned} \quad (5.71)$$

(recall that according to Proposition 5.2 the coefficients $\dot{\mathbf{O}}^{0,0}$, $\dot{\mathbf{O}}^{0,1}$, and $\dot{\mathbf{O}}^{\infty,1}$ are bounded as $\epsilon_N \downarrow 0$, along with $(\dot{\mathbf{O}}^{0,0})^{-1}$). Now we recall the definitions of the quantities $\cos(\frac{1}{2}u_N(x, t))$ and $\sin(\frac{1}{2}u_N(x, t))$ (see (2.15)), and of $\epsilon_N u_{N,t}(x, t)$ (see (2.16)) characterizing the fluxon condensate $\{u_N(x, t)\}_{N=N_0}^\infty$ according to Definition 2.1, and compare with the definitions (5.27)–(5.29) to obtain the asymptotic formulae

$$\cos\left(\frac{1}{2}u_N(x, t)\right) = \dot{C}_N(x, t) + \mathcal{O}(\epsilon_N) \quad \text{and} \quad \sin\left(\frac{1}{2}u_N(x, t)\right) = \dot{S}_N(x, t) + \mathcal{O}(\epsilon_N) \quad (5.72)$$

and

$$\epsilon_N \frac{\partial u_N}{\partial t}(x, t) = \dot{G}_N(x, t) + \mathcal{O}(\epsilon_N), \quad (5.73)$$

where the asymptotics are valid for the same ranges of (x, t) and with the same nature of convergence as in the statement of Proposition 5.5. The asymptotic formulae (5.72) are differentiable with respect to t (yielding (5.73)) according to (5.34) from Proposition 5.3.

APPENDIX A. PROOFS OF PROPOSITIONS CONCERNING INITIAL DATA

A.1. Proof of Proposition 1.1. Given a real-valued differentiable function $f(v)$ defined on $0 < v < V$, define

$$I[f](w) := -\frac{4}{\pi} \int_{-w}^V \frac{f'(v) dv}{\sqrt{v^2 - w^2}}, \quad -V < w < 0 \quad (A.1)$$

as the right-hand side of (1.46) with $f'(v) = \varphi(v)$. If f is in the range of (1.45) for some G satisfying Assumptions 1.2 and 1.3, then we know that $V = -G(0)$ and

$$f'(v) = -\frac{v}{2} \int_0^{G^{-1}(-v)} \frac{ds}{\sqrt{G(s)^2 - v^2}}, \quad 0 < v < V = -G(0). \quad (A.2)$$

Therefore in this case we have

$$I[f](w) = \frac{1}{\pi} \int_{-w}^{-G(0)} \int_0^{G^{-1}(-v)} \frac{2v}{\sqrt{v^2 - w^2} \sqrt{G(s)^2 - v^2}} ds dv, \quad G(0) < w < 0. \quad (\text{A.3})$$

Exchanging the order of integration and setting $\tau = v^2$ yields

$$I[f](w) = \frac{1}{\pi} \int_0^{G^{-1}(w)} \int_{w^2}^{G(s)^2} \frac{d\tau}{\sqrt{\tau - w^2} \sqrt{G(s)^2 - \tau}} ds. \quad (\text{A.4})$$

The inner integral evaluates to π (independent of s and w) so

$$I[f](w) = \int_0^{G^{-1}(w)} ds = G^{-1}(w) \quad (\text{A.5})$$

yielding the identity (1.46) as desired.

A.2. Proof of Proposition 1.2. First note that analyticity and strict monotonicity of $G(x)$ automatically ensures the analyticity and positivity of \mathcal{G} in the open interval of its definition. Now assume that $0 < v < -G(0)$. Introducing $m = G(s)^2$ as a change of variables in (1.45) yields

$$\Psi(\lambda) = \frac{1}{2} \int_{v^2}^{G(0)^2} \sqrt{\frac{m - v^2}{G(0)^2 - m}} \mathcal{G}(m) \frac{dm}{m}, \quad \lambda = \frac{iv}{4}, \quad (\text{A.6})$$

where \mathcal{G} is defined in terms of G by (1.48) and satisfies the conditions of Assumption 1.4. Let $S(m; v)$ be the analytic function of m for $m \in \mathbb{C} \setminus [v^2, G(0)^2]$ that satisfies

$$S(m; v)^2 = \frac{m - v^2}{G(0)^2 - m} \quad \text{and} \quad \lim_{\delta \downarrow 0} S(m + i\delta; v) > 0 \quad \text{for } v^2 < m < G(0)^2. \quad (\text{A.7})$$

Then, with L_1 being the contour loop shown in Figure A.1,

$$\Psi(\lambda) = \frac{1}{4} \oint_{L_1} S(m; v) \mathcal{G}(m) \frac{dm}{m}. \quad (\text{A.8})$$

Since S is also analytic as a function of v when m lies on L_1 and v lies in the open region bounded by

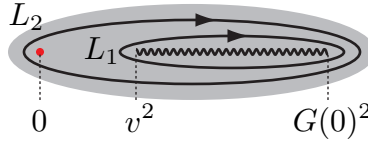

FIGURE A.1. The loop contour L_1 surrounds the branch cut $[v^2, G(0)^2]$ of $S(m; v)$ while the loop contour L_2 also encloses the origin. Both contours lie within the presumed domain of analyticity of $\mathcal{G}(m)$ (shaded).

L_1 , and since S is continuous in m for such v and m , this formula immediately shows that $\Psi(\lambda)$ is analytic for each $v \in (0, -G(0))$. To analyze the behavior near the endpoints, we proceed as follows. By a simple contour deformation,

$$\begin{aligned} \Psi(\lambda) &= \frac{i\pi}{2} S(0; v) \mathcal{G}(0) + \frac{1}{4} \oint_{L_2} S(m; v) \mathcal{G}(m) \frac{dm}{m} \\ &= \frac{\pi v \mathcal{G}(0)}{2G(0)} + \frac{1}{4} \oint_{L_2} S(m; v) \mathcal{G}(m) \frac{dm}{m}, \end{aligned} \quad (\text{A.9})$$

where we used the fact that $S(0, v) = -iv/G(0)$. Now $S(m; v)$ has the following convergent expansions:

$$S(m; v) = S(m; 0) \left[1 - \frac{v^2}{m} \right]^{1/2} = S(m, 0) \left[1 - \sum_{k=1}^{\infty} \frac{(2k-1)!!}{(2k)!!} \frac{v^{2k}}{m^k} \right], \quad |m| > |v|^2, \quad (\text{A.10})$$

$$\begin{aligned}
S(m; v) &= S(m; -G(0)) \left[1 - \frac{-2G(0)(v + G(0)) + (v + G(0))^2}{m - G(0)^2} \right]^{1/2} \\
&= S(m; -G(0)) \left[1 - \sum_{k=1}^{\infty} \frac{(2k-1)!!}{(2k)!!} \left(\frac{-2G(0)(v + G(0)) + (v + G(0))^2}{m - G(0)^2} \right)^k \right] \\
&= S(m; -G(0)) \left[1 + \frac{G(0)(v + G(0))}{m - G(0)^2} + \dots \right], \quad |m - G(0)^2| > |-2G(0)(v + G(0)) + (v + G(0))^2|.
\end{aligned} \tag{A.11}$$

Note also that $S(m; -G(0)) \equiv i$. Both of these expansions are uniformly convergent on the contour L_2 if v is confined to a sufficiently small neighborhood of $v = 0$ or $v = -G(0)$ respectively, and hence the integral in (A.9) may be calculated term-by-term. In the case of the expansion for v small, the result is a convergent series in even nonnegative powers of v with purely imaginary coefficients. In the case of the expansion for v near $-G(0)$, the result is a convergent series in (generally) all nonnegative integer powers of $v + G(0)$, again with purely imaginary coefficients. Since power series always converge in disks, we now see that we have constructed the analytic continuation of $\Psi(\lambda)$ valid for v in full complex neighborhoods of $v = 0$ and $v = -G(0)$ respectively. The form of the Taylor series (1.52) is now clear, but it remains to confirm the positivity of α and the value of $\Psi(0)$. But from (A.9),

$$\alpha = -\frac{2\pi\mathcal{G}(0)}{G(0)} > 0 \tag{A.12}$$

since $G(0) < 0$ and $\mathcal{G}(0) > 0$ by hypothesis, and the constant term $\Psi(0) = \|G\|_1/4$ is easier to evaluate directly by passing to the limit $\lambda \rightarrow 0$ in the formula (1.45) than by working with the series. Finally, to confirm the relations (1.51), one may pass to the limit $\lambda \rightarrow -iG(0)/4$ in (1.45) to obtain $\Psi(-iG(0)/4) = 0$, and then also from (A.9) and (A.11)

$$\frac{d}{dv} \Psi(\lambda) \Big|_{v=-G(0)} = \frac{\pi\mathcal{G}(0)}{2G(0)} + \frac{iG(0)}{4} \oint_{L_2} \frac{\mathcal{G}(m)}{m - G(0)^2} \frac{dm}{m} = \frac{\pi\mathcal{G}(G(0)^2)}{2G(0)} < 0 \tag{A.13}$$

since $\mathcal{G}(G(0)^2) > 0$ by hypothesis, where the integral over L_2 is evaluated explicitly by residues.

APPENDIX B. DETAILS OF THE OUTER PARAMETRIX IN CASES L AND R

Since many of the important details of the asymptotic behavior of the sine-Gordon equation are derived from the appropriate outer parametrix, we here provide all details of the solution of Riemann-Hilbert Problems 5.1 and 5.2 in terms of Riemann Θ -functions of genus one. We also explain how the extracted potentials (approximate solutions of sine-Gordon) can be reduced to a very simple form in terms of Jacobi elliptic functions. This appendix contains all details of the proofs of Propositions 5.2 and 5.3.

B.1. The outer parametrix in case L. Proof of Proposition 5.2 in this case.

B.1.1. *Solution of Riemann-Hilbert Problem 5.1 in terms of Baker-Akhiezer functions.* The first step in solving Riemann-Hilbert Problem 5.1 for $\dot{\mathbf{O}}^{\text{out}}(w)$ is to introduce a new, equivalent, unknown $\mathbf{P}(w)$, given in terms of $\dot{\mathbf{O}}^{\text{out}}(w)$ by

$$\mathbf{P}(w) := \begin{cases} \dot{\mathbf{O}}^{\text{out}}(w), & \Im\{w\} > 0 \\ \sigma_2 \dot{\mathbf{O}}^{\text{out}}(w) \sigma_2, & \Im\{w\} < 0. \end{cases} \tag{B.1}$$

The equivalent Riemann-Hilbert problem satisfied by $\mathbf{P}(w)$ is described by the scheme shown in Figure B.1. As was the case with $\dot{\mathbf{O}}^{\text{out}}(w)$, the boundary values taken on the two disjoint components of the jump contour are continuous and bounded with the exception of the endpoints w_0 and w_0^* where inverse fourth roots are tolerated.

Next, we remove the real parameter ν from the jump conditions by defining the scalar function $h(w)$ as follows:

$$h(w) := -\frac{S(w)}{2\pi i} \int_{w_0^*}^{w_0} \frac{ds}{S_+(s)(s-w)}, \tag{B.2}$$

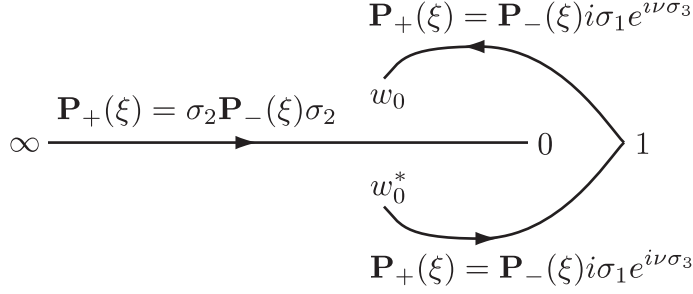

FIGURE B.1. *The jump conditions satisfied by the matrix $\mathbf{P}(w)$ normalized as $\mathbf{P}(w) = \mathbb{I} + \mathcal{O}(|w|^{-1/2})$ as $w \rightarrow \infty$.*

where the integration is along the jump contour shown in Figure B.1 and where $S(w)^2 := w(w-w_0)(w-w_0^*)$, $S(w)$ is analytic in the complement of the jump contours, and $S(w) = w^{3/2}(1 + \mathcal{O}(w^{-1}))$ as $w \rightarrow \infty$ (principal branch of $w^{3/2}$). Note that

$$h(w) = pw^{1/2} + \mathcal{O}(|w|^{-1/2}), \quad w \rightarrow \infty, \quad (\text{B.3})$$

where

$$p := \frac{1}{2\pi i} \int_{w_0^*}^{w_0} \frac{ds}{S_+(s)}. \quad (\text{B.4})$$

The function defined by (B.2) satisfies $h_+(\xi) + h_-(\xi) = 0$ for ξ on the negative real axis, and $h_+(\xi) + h_-(\xi) = -1$ for ξ on the contour connecting w_0^* and w_0 . It takes continuous and bounded boundary values on the entire jump contour. The new unknown we define in place of $\mathbf{P}(w)$ is then

$$\mathbf{Q}(w) := \mathbf{P}(w)e^{i\nu h(w)\sigma_3}. \quad (\text{B.5})$$

Direct calculations then show that the conditions determining $\mathbf{Q}(w)$ are as indicated in Figure B.2. Inverse

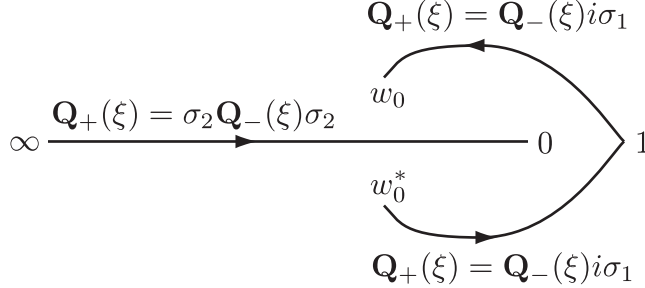

FIGURE B.2. *The jump conditions satisfied by the matrix $\mathbf{Q}(w)$ normalized as $\mathbf{Q}(w)e^{-i\nu w^{1/2}\sigma_3} = \mathbb{I} + \mathcal{O}(|w|^{-1/2})$ as $w \rightarrow \infty$.*

fourth root singularities are again admitted at w_0 and w_0^* .

The next transformation is undertaken to diagonalize the prefactor of σ_2 in the jump condition on the negative real axis. So, since

$$\sigma_2 = \mathbf{V}\sigma_3\mathbf{V}^{-1}, \quad \mathbf{V} := \frac{1}{\sqrt{2}} \begin{bmatrix} e^{-i\pi/4} & -e^{-i\pi/4} \\ e^{i\pi/4} & e^{i\pi/4} \end{bmatrix}, \quad \det(\mathbf{V}) = 1, \quad \mathbf{V}^{-1} = \mathbf{V}^\dagger, \quad (\text{B.6})$$

the matrix defined by

$$\mathbf{R}(w) := \mathbf{V}^\dagger \mathbf{Q}(w) \quad (\text{B.7})$$

satisfies the conditions indicated in Figure B.3. Inverse fourth root singularities are once again admitted at w_0 and w_0^* .

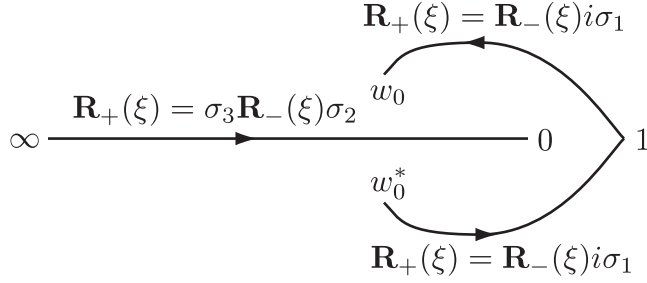

FIGURE B.3. The jump conditions satisfied by the matrix $\mathbf{R}(w)$ normalized as $\mathbf{R}(w)e^{-ip\nu w^{1/2}\sigma_3} = \mathbf{V}^\dagger + \mathcal{O}(|w|^{-1/2})$ as $w \rightarrow \infty$.

The next transformations aim to convert the post-multiplicative jump matrices both into the permutation matrix σ_1 . To accomplish this on the arc connecting w_0^* to w_0 , we introduce the function $q(w)$ satisfying

$$q(w)^4 = \frac{w - w_0}{w - w_0^*}, \quad (\text{B.8})$$

that is uniquely specified as being analytic except on the contour arc connecting w_0^* to w_0 and satisfying $q(w) = 1 + \mathcal{O}(w^{-1})$ as $w \rightarrow \infty$. This function satisfies $q_+(w) = iq_-(w)$ for w on the contour arc of discontinuity. Setting

$$\mathbf{S}(w) := q(w)^{-1}\mathbf{R}(w), \quad (\text{B.9})$$

we find that the new unknown $\mathbf{S}(w)$ corresponds to the conditions in Figure B.4. Note that multiplication

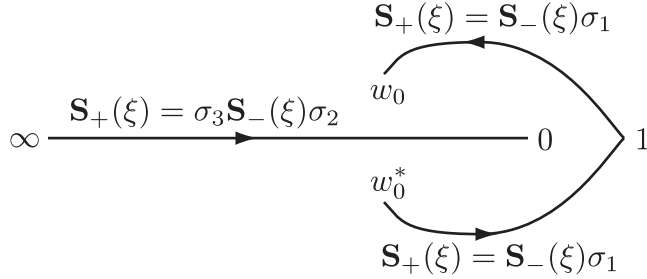

FIGURE B.4. The jump conditions satisfied by the matrix $\mathbf{S}(w)$ normalized as $\mathbf{S}(w)e^{-ip\nu w^{1/2}\sigma_3} = \mathbf{V}^\dagger + \mathcal{O}(|w|^{-1/2})$ as $w \rightarrow \infty$. Unlike $\hat{\mathbf{O}}^{\text{out}}(w)$, $\mathbf{P}(w)$, $\mathbf{Q}(w)$, and $\mathbf{R}(w)$, the matrix $\mathbf{S}(w)$ is required to be bounded in a neighborhood of $w = w_0^*$ while we allow a stronger singularity at $w = w_0$: $\mathbf{S}(w) = \mathcal{O}(|w - w_0|^{-1/2})$.

by $q(w)$ changes the nature of the admissible singularities at w_0 and w_0^* : $\mathbf{S}(w)$ is now required to be bounded at w_0^* , and an inverse square root singularity is admitted at w_0 .

To convert the jump condition on the negative real axis to the same form, we first separate the two rows of $\mathbf{S}(w)$ by writing

$$\mathbf{S}(w) = \begin{bmatrix} \mathbf{s}_1(w)^\top \\ \mathbf{s}_2(w)^\top \end{bmatrix} \quad (\text{B.10})$$

and we also write $\mathbf{V} = [\mathbf{v}_1, \mathbf{v}_2]$ to give notation for the normalized eigenvectors of σ_2 (see (B.6)). As σ_3 is diagonal, the jump conditions for the individual rows decouple and in each case these conditions only involve matrix multiplication on the right. Thus we have $\mathbf{s}_{j+}(\xi)^\top = \mathbf{s}_{j-}(\xi)^\top \sigma_1$ for $j = 1, 2$ and ξ on the contour

arc connecting w_0^* and w_0 , while we have $\mathbf{s}_{1+}(\xi)^\top = \mathbf{s}_{1-}(\xi)^\top \sigma_2$ and $\mathbf{s}_{2+}(\xi)^\top = \mathbf{s}_{2-}(\xi)^\top (-\sigma_2)$ for ξ on the negative real axis. Now set

$$\mathbf{t}_1(w)^\top := \sqrt{2}\mathbf{s}_1(w)^\top e^{-i\pi k(w)\sigma_3/2} \quad \text{and} \quad \mathbf{t}_2(w)^\top := i\sqrt{2}\mathbf{s}_2(w)^\top e^{i\pi k(w)\sigma_3/2}, \quad \text{where} \quad k(w) := \frac{1}{2} + h(w). \quad (\text{B.11})$$

The function k is analytic on the complement of the contours and satisfies $k_+(\xi) + k_-(\xi) = 0$ on the arc connecting w_0^* with w_0 while $k_+(\xi) + k_-(\xi) = 1$ for negative real ξ . Using (B.3) one sees that $k(w)$ has the asymptotic behavior

$$k(w) = pw^{1/2} + \frac{1}{2} + \mathcal{O}(|w|^{-1/2}), \quad w \rightarrow \infty. \quad (\text{B.12})$$

From this information it is easy to see that on all jump contours we have

$$\mathbf{t}_{j+}(\xi)^\top = \mathbf{t}_{j-}(\xi)^\top \sigma_1, \quad j = 1, 2, \quad (\text{B.13})$$

and we also have the normalization conditions

$$\mathbf{t}_j(w)^\top e^{-ip\varphi_j w^{1/2}\sigma_3} = [1, 1] + \mathcal{O}(|w|^{-1/2}), \quad w \rightarrow \infty \quad (\text{B.14})$$

where

$$\varphi_1 := \nu - \frac{\pi}{2} \quad \text{and} \quad \varphi_2 := \nu + \frac{\pi}{2}. \quad (\text{B.15})$$

Both $\mathbf{t}_1(w)^\top$ and $\mathbf{t}_2(w)^\top$ may become unbounded in the finite w -plane only as $w \rightarrow w_0$, where all four scalar components must be $\mathcal{O}(|w - w_0|^{-1/2})$.

Finally, we implement the involutive jump conditions (B.13) by viewing the elements of the row vectors $\mathbf{t}_j(w)^\top$ as single-valued scalar functions on an appropriate Riemann surface. Let X be the Riemann surface of the equation $y^2 = S(w)^2 = w(w - w_0)(w - w_0^*)$ compactified at $y = w = \infty$. We view the finite part of X as two copies of the w -plane (sheets) cut along the branch cuts of the function $S(w)$ and glued together in the usual way. We define on $X \setminus \{\infty, w_0\}$ two scalar functions $t_1(P)$ and $t_2(P)$ as follows:

$$t_j(P) := \begin{cases} [\mathbf{t}_j(w(P))^\top]_1, & P \in \text{sheet 1} \\ [\mathbf{t}_j(w(P))^\top]_2, & P \in \text{sheet 2}, \end{cases} \quad (\text{B.16})$$

where for row vectors $[u_1, u_2]_j := u_j$, and $w(P)$ denotes the ‘‘sheet projection’’ function. These definitions are consistent along the cuts where the sheets are identified precisely because the jump matrices for $\mathbf{t}_j(w)^\top$ have all been reduced to the simple permutation (sheet exchange) matrix σ_1 . The *Baker-Akhiezer functions* $t_j : X \setminus \{w_0, \infty\} \rightarrow \mathbb{C}$ are analytic in their domain of definition, which omits just two points of X . Since

$$y_0(P) := \begin{cases} (w(P) - w_0)^{1/2}, & P \in \text{sheet 1} \\ -(w(P) - w_0)^{1/2}, & P \in \text{sheet 2} \end{cases} \quad (\text{B.17})$$

is a holomorphic local coordinate for X near the branch point $P = w_0$, we see that $t_j(P)$ admits a simple pole at this point. Near the point $P = \infty$, $t_j(P)$ has exponential behavior:

$$t_j(P) e^{-ip\varphi_j y_\infty(P)^{-1}} = 1 + \mathcal{O}(y_\infty(P)), \quad P \rightarrow \infty \quad (\text{B.18})$$

where

$$y_\infty(P) := \begin{cases} w(P)^{-1/2}, & P \in \text{sheet 1} \\ -w(P)^{-1/2}, & P \in \text{sheet 2} \end{cases} \quad (\text{B.19})$$

is a holomorphic local coordinate for X near the branch point $P = \infty$.

B.1.2. Construction of the Baker-Akhiezer functions. To express $t_j(P)$ in terms of special functions requires a few ingredients. Firstly, one chooses a basis of homology cycles on X consisting of two noncontractible oriented closed paths, a and b , such that b intersects a exactly once, from the right of a . For later convenience, we suppose that neither of these paths passes through the point $P = \infty$. The homology cycles we choose are illustrated in Figure B.5. As X is a genus one Riemann surface (elliptic curve), there is a one-dimensional space of holomorphic differentials; as a basis we choose the unique holomorphic differential on X of the form

$$\omega(P) = c \frac{dw(P)}{\tilde{S}(P)} \quad (\text{B.20})$$

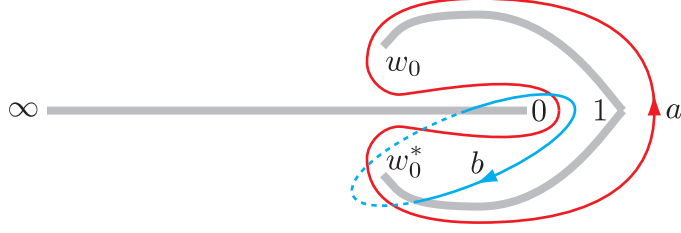

FIGURE B.5. *The homology basis on the sheets of X . Thick curves indicate branch cuts where the two sheets are identified, solid curves are on sheet 1 and dashed curves are on sheet 2.*

where $\tilde{S}(P)$ denotes the lift to X of the function $S(w)$:

$$\tilde{S}(P) := \begin{cases} S(w(P)), & P \in \text{sheet 1} \\ -S(w(P)), & P \in \text{sheet 2}, \end{cases} \quad (\text{B.21})$$

and where the constant c is chosen so that

$$\oint_a \omega(P) = 2\pi i. \quad (\text{B.22})$$

Denote by \mathcal{H} the other loop integral of $\omega(P)$:

$$\mathcal{H} := \oint_b \omega(P) = 2\pi i \frac{\oint_b \frac{dw(P)}{\tilde{S}(P)}}{\oint_a \frac{dw(P)}{\tilde{S}(P)}}. \quad (\text{B.23})$$

It is easy to see that although \mathcal{H} is complex, $\Re\{\mathcal{H}\} < 0$. The *Riemann Θ -function* corresponding to \mathcal{H} is the entire function of $z \in \mathbb{C}$ given by the Fourier series

$$\Theta(z; \mathcal{H}) := \sum_{n=-\infty}^{\infty} e^{\frac{1}{2}\mathcal{H}n^2} e^{nz}. \quad (\text{B.24})$$

A simple relabeling of the sum by $n \mapsto -n$ shows that

$$\Theta(-z; \mathcal{H}) = \Theta(z; \mathcal{H}). \quad (\text{B.25})$$

The Riemann Θ -function satisfies the *automorphic identities*:

$$\Theta(z + 2\pi i; \mathcal{H}) = \Theta(z; \mathcal{H}) \quad (\text{B.26})$$

and

$$\Theta(z + \mathcal{H}; \mathcal{H}) = e^{-\frac{1}{2}\mathcal{H}} e^{-z} \Theta(z; \mathcal{H}). \quad (\text{B.27})$$

The function $\Theta(z; \mathcal{H})$ vanishes to first order at all points z of the form $z = \mathcal{K} + 2\pi im + \mathcal{H}n$ and nowhere else, where m and n are integers and where

$$\mathcal{K} = \mathcal{K}(\mathcal{H}) := i\pi + \frac{1}{2}\mathcal{H} \quad (\text{B.28})$$

is the *Riemann constant*. We choose as a base point on X the branch point $P_0 = w_0$, and then define the *Abel map* by

$$A(P) := \int_{P_0}^P \omega(P') \pmod{2\pi im + \mathcal{H}n}, \quad m, n \in \mathbb{Z}. \quad (\text{B.29})$$

The value of $A(P)$ is not completely determined only because the path is only determined modulo the cycles a and b . Finally, let $\Omega(P)$ denote the abelian differential of the second kind with double pole at $P = \infty$:

$$\Omega(P) := \frac{w(P) + C}{2\tilde{S}(P)} dw(P) \quad (\text{B.30})$$

where the constant C is chosen so that

$$\oint_a \Omega(P) = 0. \quad (\text{B.31})$$

Note that by asymptotic expansion of (B.30), we have

$$\int_{P_0}^P \Omega(P') = \frac{1}{y_\infty(P)} + \mathcal{O}(1), \quad P \rightarrow \infty. \quad (\text{B.32})$$

Let κ denote the other loop integral of $\Omega(P)$:

$$\kappa := \oint_b \Omega(P). \quad (\text{B.33})$$

Lemma B.1 (see [9]). $\kappa = 2c$.

Proof. Let \tilde{X} denote the canonical dissection of X obtained by cutting X along the cycles a and b . \tilde{X} is a simply-connected complex manifold with boundary illustrated in Figure B.6. Consider the meromorphic

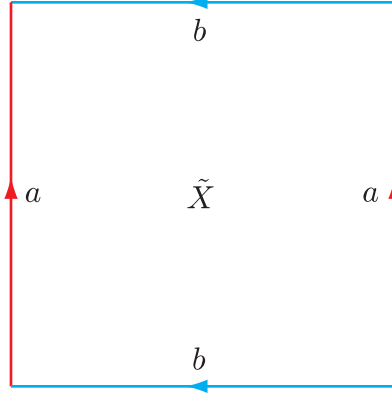

FIGURE B.6. The canonical dissection \tilde{X} of the compact Riemann surface X . Note that if we omit the upper and right-hand boundaries, then the points of X and those of \tilde{X} are in one-to-one correspondence.

differential defined on \tilde{X} given by the following expression:

$$\Gamma(P) := A(P)\Omega(P). \quad (\text{B.34})$$

Here, the Abel mapping is well defined since \tilde{X} is simply connected. Let $\partial\tilde{X}$ denote the positively-oriented boundary of \tilde{X} , and consider the integral

$$I := \oint_{\partial\tilde{X}} \Gamma(P). \quad (\text{B.35})$$

We will evaluate I two different ways. On the one hand, we may evaluate I by residues. The only singularity of $\Gamma(P)$ is a double pole at the point $P = \infty \in \tilde{X}$, and while $\Omega(P)$ has no residue there, $\Gamma(P)$ indeed has one:

$$\begin{aligned} \Gamma(P) &= \left[A(\infty) - \int_P^\infty \omega(P') \right] \left[\left(\frac{1}{2} y_\infty(P) + \mathcal{O}(y_\infty(P)^3) \right) \left(-2 \frac{dy_\infty(P)}{y_\infty(P)^3} \right) \right] \\ &= \left[A(\infty) - 2cy_\infty(P) + \mathcal{O}(y_\infty(P)^2) \right] \left[\left(\frac{1}{2} y_\infty(P) + \mathcal{O}(y_\infty(P)^3) \right) \left(-2 \frac{dy_\infty(P)}{y_\infty(P)^3} \right) \right] \\ &= \left[-\frac{A(\infty)}{y_\infty(P)^2} + \frac{2c}{y_\infty(P)} + \mathcal{O}(1) \right] dy_\infty(P), \quad P \rightarrow \infty, \end{aligned} \quad (\text{B.36})$$

so by the Residue Theorem,

$$I = \oint_{\partial\tilde{X}} \Gamma(P) = 4\pi ic. \quad (\text{B.37})$$

On the other hand, we may evaluate I directly:

$$I = \oint_{\partial\tilde{X}} \Gamma(P) = \int_a [A_{\text{right}}(P) - A_{\text{left}}(P)] \Omega(P) + \int_b [A_{\text{top}}(P) - A_{\text{bottom}}(P)] \Omega(P), \quad (\text{B.38})$$

where the subscripts on A indicate where the corresponding points P live on the diagram of \tilde{X} shown in Figure B.6. But clearly,

$$A_{\text{right}}(P) - A_{\text{left}}(P) = - \oint_b \omega(P') = -\mathcal{H} \quad \text{and} \quad A_{\text{top}}(P) - A_{\text{bottom}}(P) = \oint_a \omega(P') = 2\pi i. \quad (\text{B.39})$$

Therefore,

$$I = -\mathcal{H} \oint_a \Omega(P) + 2\pi i \oint_b \Omega(P), \quad (\text{B.40})$$

and due to the choice of the constant C , we simply find

$$I = 2\pi i \kappa. \quad (\text{B.41})$$

Comparing (B.37) with (B.41), we see that $\kappa = 2c$, as desired. \square

It then follows from (B.4), (B.20), and the normalization condition (B.22) that

$$p\kappa = \frac{1}{\pi i} \int_{w_0^*}^{w_0} \frac{c ds}{S_+(s)} = -\frac{1}{2\pi i} \oint_a \omega = -1. \quad (\text{B.42})$$

We now give Krichever's formula [16] for the Baker-Akhiezer functions $t_j(P)$:

$$\begin{aligned} t_j(P) &:= N_j \frac{\Theta(A(P) + \mathcal{K} + ip\kappa\varphi_j; \mathcal{H})}{\Theta(A(P) + \mathcal{K}; \mathcal{H})} \exp\left(ip\varphi_j \int_{w_0}^P \Omega(P')\right) \\ &= N_j \frac{\Theta(A(P) + \mathcal{K} - i\varphi_j; \mathcal{H})}{\Theta(A(P) + \mathcal{K}; \mathcal{H})} \exp\left(ip\varphi_j \int_{w_0}^P \Omega(P')\right), \end{aligned} \quad (\text{B.43})$$

where N_j is a normalizing constant. Here, the path in the exponent is intended to be the same as that in the Abel map $A(P)$. This expression is well-defined in spite of the indeterminacy of the path of integration due to this identification of paths and the two automorphic identities (B.26) and (B.27) satisfied by Θ . Indeed:

- Adding an a -cycle to the path does not change the exponent due to (B.31), and the Θ -functions are also unchanged due to (B.22) and (B.26).
- Adding a b -cycle to the path adds $-i\varphi_j$ to the exponent according to (B.33) and (B.42), but this is compensated by the ratio of Θ -functions according to (B.23) and (B.27).

Moreover, since by our choice of base point $A(P)$ vanishes to first order in the holomorphic local parameter $y_0(P)$ when $P = w_0$, it is clear that $t_j(P)$ may have a simple pole at this point. Also, from the asymptotic behavior (B.32) of $\Omega(P)$ it is clear that if the constant N_j is chosen correctly $t_j(P)$ will have the desired asymptotic behavior (B.18) as $P \rightarrow \infty$.

To compute N_j , let us select a path from $P = w_0$ to $P = \infty$ that lies entirely on sheet 1 of X and along which $\Im\{w(P)\} \geq 0$. This unambiguously determines $A(\infty)$ as well as the constant term in the asymptotic expansion of the exponent. It is easy to verify for such a path that

$$A(\infty) = -\frac{1}{2} \oint_b \omega(P) = -\frac{1}{2} \mathcal{H}. \quad (\text{B.44})$$

Also, as P tends to $P = \infty$ along such a path (which we take to lie along the negative real axis for large w),

$$\begin{aligned} \int_{w_0}^P \Omega(P') &= \frac{1}{2} \oint_a \Omega(P') - \frac{1}{2} \oint_b \Omega(P') + \int_0^{w(P)} \frac{w+C}{2S_+(w)} dw \\ &= -\frac{1}{2} \kappa + \int_0^{w(P)} \frac{w+C}{2S_+(w)} dw, \end{aligned} \quad (\text{B.45})$$

and

$$\begin{aligned} \int_0^{w(P)} \frac{w+C}{2S_+(w)} dw &= \int_0^{w(P)} \left[\frac{w+C}{2S_+(w)} - \frac{1}{2i}(-w)^{-1/2} \right] dw + i(-w(P))^{1/2} \\ &= \int_0^{w(P)} \left[\frac{w+C}{2S_+(w)} - \frac{1}{2i}(-w)^{-1/2} \right] dw + \frac{1}{y_\infty(P)}. \end{aligned} \quad (\text{B.46})$$

The remaining integrand is integrable at infinity, so by doubling the contour of integration along the branch cut on the negative real axis and then closing the contour in the right half-plane we may write

$$\begin{aligned} \int_0^{w(P)} \left[\frac{w+C}{2S_+(w)} - \frac{1}{2i}(-w)^{-1/2} \right] dw &= \int_0^{-\infty} \left[\frac{w+C}{2S_+(w)} - \frac{1}{2i}(-w)^{-1/2} \right] dw + \mathcal{O}(y_\infty(P)) \\ &= -\frac{1}{2} \oint_a \left[\frac{w(P)+C}{2\tilde{S}(P)} - \frac{1}{2\sqrt{w(P)}} \right] dw(P) + \mathcal{O}(y_\infty(P)) \\ &= -\frac{1}{2} \oint_a \Omega(P) + \frac{1}{4} \oint_a \frac{dw(P)}{\sqrt{w(P)}} + \mathcal{O}(y_\infty(P)) \\ &= \mathcal{O}(y_\infty(P)). \end{aligned} \quad (\text{B.47})$$

Therefore,

$$\int_{w_0}^P \Omega(P') = \frac{1}{y_\infty(P)} - \frac{1}{2}\kappa + \mathcal{O}(y_\infty(P)), \quad (\text{B.48})$$

and so we find

$$\lim_{P \rightarrow \infty} t_j(P) e^{-i\varphi_j p y_\infty(P)^{-1}} = N_j \frac{\Theta(i\pi - i\varphi_j; \mathcal{H})}{\Theta(i\pi; \mathcal{H})} e^{i\varphi_j/2}, \quad (\text{B.49})$$

It follows that the normalization constant is simply

$$N_j := \frac{\Theta(i\pi; \mathcal{H})}{\Theta(i\pi - i\varphi_j; \mathcal{H})} e^{-i\varphi_j/2}. \quad (\text{B.50})$$

This completes the construction of $t_j(P)$, and hence of $\dot{\mathbf{O}}^{\text{out}}(w)$. To obtain an especially useful formula for $\dot{\mathbf{O}}^{\text{out}}(w)$, we need another intermediate result. The function

$$l(w) := p \int_{w_0}^w \frac{w'+C}{2S(w')} dw' \quad (\text{B.51})$$

is well-defined for w in the cut plane (the first sheet of X as illustrated in Figure B.5) due to the condition (B.31), which makes the integral independent of path.

Lemma B.2. $l(w) = k(w) := h(w) + \frac{1}{2}$.

Proof. Clearly, l and k are analytic in the same domain, and are both uniformly bounded on bounded subsets of this domain. Since S changes sign across the cut connecting w_0 and w_0^* it is obvious that along this cut, $l_+(w) + l_-(w) = k_+(w) + k_-(w) = 0$. Now because the integrand of l is the restriction of the differential $\Omega(P)$ to the first sheet, it is easy to see that $l(0) = -\frac{1}{2}p\kappa$, so by (B.42), in fact $l(0) = \frac{1}{2}$. Again using the fact that S changes sign across the negative real axis, we see that along this cut $l_+(w) + l_-(w) = 2l(0) = k_+(w) + k_-(w) = 1$. Also, both $l(w)$ and $k(w)$ have the same leading asymptotic behavior as $w \rightarrow \infty$, namely, $pw^{1/2} + \mathcal{O}(w^{-1/2})$. Setting $m(w) := (l(w) - k(w))/S(w)$ we see that $m(w)$ is a function that is analytic where S is, with at worst inverse square-root singularities at $w = 0, w_0, w_0^*$. Moreover, along the open arcs of discontinuity of S , we have $m_+(w) \equiv m_-(w)$, so m extends continuously to these arcs. It follows that $m(w)$ is necessarily an entire function of w . Then, since $m(w) = \mathcal{O}(w^{-2})$ as $w \rightarrow \infty$, $m(w) \equiv 0$ by Liouville's Theorem, and the result follows. \square

We now present a formula for $\dot{\mathbf{O}}^{\text{out}}(w)$. For w in the cut plane, let $P_k(w)$ denote the preimage of w under $w(P)$ on sheet k of X . Then, by composing the transformations leading from $\dot{\mathbf{O}}^{\text{out}}(w)$ to the Baker-Akhiezer

functions $t_j(P)$, we find that for $\Im\{w\} > 0$,

$$\dot{\mathbf{O}}^{\text{out}}(w) = \begin{bmatrix} \frac{q}{2} (t_1(P_1)e^{-i\varphi_1 h} + t_2(P_1)e^{-i\varphi_2 h}) & \frac{q}{2i} (t_1(P_2)e^{i\varphi_1 h} - t_2(P_2)e^{i\varphi_2 h}) \\ \frac{q}{2i} (t_2(P_1)e^{-i\varphi_2 h} - t_1(P_1)e^{-i\varphi_1 h}) & \frac{q}{2} (t_1(P_2)e^{i\varphi_1 h} + t_2(P_2)e^{i\varphi_2 h}) \end{bmatrix} \quad (\text{B.52})$$

while for $\Im\{w\} < 0$,

$$\dot{\mathbf{O}}^{\text{out}}(w) = \begin{bmatrix} \frac{q}{2} (t_1(P_2)e^{i\varphi_1 h} + t_2(P_2)e^{i\varphi_2 h}) & \frac{q}{2i} (t_1(P_1)e^{-i\varphi_1 h} - t_2(P_1)e^{-i\varphi_2 h}) \\ \frac{q}{2i} (t_2(P_2)e^{i\varphi_2 h} - t_1(P_2)e^{i\varphi_1 h}) & \frac{q}{2} (t_1(P_1)e^{-i\varphi_1 h} + t_2(P_1)e^{-i\varphi_2 h}) \end{bmatrix}. \quad (\text{B.53})$$

The dependence on w enters these formulae via $q = q(w)$, $P_j = P_j(w)$, and $h = h(w)$.

To simplify $t_j(P_1(w))e^{-i\varphi_j h(w)}$, we evaluate the formula (B.43) by selecting in both the Abel map and the integral in the exponent a path from w_0 to $P_1(w)$ lying entirely in the finite w -plane on sheet 1 of X . Therefore, using Lemma B.2 and (B.50),

$$\begin{aligned} t_j(P_1(w))e^{-i\varphi_j h(w)} &= N_j \frac{\Theta(A(P_1(w)) + \mathcal{K} - i\varphi_j; \mathcal{H})}{\Theta(A(P_1(w)) + \mathcal{K}; \mathcal{H})} e^{i\varphi_j l(w) - i\varphi_j h(w)} \\ &= \frac{\Theta(i\pi; \mathcal{H})\Theta(A(P_1(w)) + \mathcal{K} - i\varphi_j; \mathcal{H})}{\Theta(i\pi - i\varphi_j; \mathcal{H})\Theta(A(P_1(w)) + \mathcal{K}; \mathcal{H})}. \end{aligned} \quad (\text{B.54})$$

To evaluate $t_j(P_2(w))e^{i\varphi_j h(w)}$, we proceed similarly, choosing a path from w_0 to $P_2(w)$ lying in the finite w -plane on sheet 2 of X to obtain

$$\begin{aligned} t_j(P_2(w))e^{i\varphi_j h(w)} &= N_j \frac{\Theta(A(P_2(w)) + \mathcal{K} - i\varphi_j; \mathcal{H})}{\Theta(A(P_2(w)) + \mathcal{K}; \mathcal{H})} e^{-i\varphi_j l(w) + i\varphi_j h(w)} \\ &= \frac{\Theta(i\pi; \mathcal{H})\Theta(A(P_2(w)) + \mathcal{K} - i\varphi_j; \mathcal{H})}{\Theta(i\pi - i\varphi_j; \mathcal{H})\Theta(A(P_2(w)) + \mathcal{K}; \mathcal{H})} e^{i\varphi_j}. \end{aligned} \quad (\text{B.55})$$

This latter formula can be further simplified with the observation that $A(P_2(w)) = -A(P_1(w))$ because the base point P_0 has been chosen as the branch point w_0 , so with the use of the relations (B.25)–(B.27) and the definition (B.28) of \mathcal{K} we obtain ultimately

$$t_j(P_2(w))e^{i\varphi_j h(w)} = \frac{\Theta(i\pi; \mathcal{H})\Theta(A(P_1(w)) + \mathcal{K} + i\varphi_j; \mathcal{H})}{\Theta(i\pi + i\varphi_j; \mathcal{H})\Theta(A(P_1(w)) + \mathcal{K}; \mathcal{H})}. \quad (\text{B.56})$$

In the formulae (B.54) and (B.56), $A(P_1(w))$ represents any value of the integral

$$A(P_1(w)) := \int_{w_0}^w \frac{c d\xi}{S(\xi)}. \quad (\text{B.57})$$

This essentially completes the proof of Proposition 5.2 in case L. Indeed, the uniform bounds on $\dot{\mathbf{O}}^{\text{out}}(w)$ follow from the formulae (B.52), (B.53), (B.54), and (B.56) upon noting that the only dependence on ν occurs via the angles φ_j defined by (B.15), and that Θ satisfies the periodicity relation (B.26). That $\det(\dot{\mathbf{O}}^{\text{out}}(w)) = 1$ is a consequence of the fact that the jump matrices have determinant equal to 1, via a standard Liouville argument.

B.2. The outer parametrix in case R. Proof of Proposition 5.2 in this case.

B.2.1. *Solution of Riemann-Hilbert Problem 5.2 in terms of Baker-Akhiezer functions.* The contour of discontinuity of $\dot{\mathbf{O}}^{\text{out}}(w)$ as illustrated in Figure 5.6 divides the complementary region into a bounded component Υ_0 and an unbounded component Υ_∞ . The first step in solving Riemann-Hilbert Problem 5.2 is to make an explicit substitution to simplify the contour. We therefore define a new unknown $\mathbf{P}(w)$ in terms of $\dot{\mathbf{O}}^{\text{out}}(w)$ by

$$\mathbf{P}(w) := \begin{cases} \dot{\mathbf{O}}^{\text{out}}(w), & \Im\{w\} > 0 \text{ and } w \in \Upsilon_\infty \\ \dot{\mathbf{O}}^{\text{out}}(w)i\sigma_1 e^{i\nu\sigma_3}, & \Im\{w\} > 0 \text{ and } w \in \Upsilon_0 \\ \sigma_2 \dot{\mathbf{O}}^{\text{out}}(w)\sigma_2, & \Im\{w\} < 0 \text{ and } w \in \Upsilon_\infty \\ \sigma_2 \dot{\mathbf{O}}^{\text{out}}(w)\sigma_3 e^{i\nu\sigma_3}, & \Im\{w\} < 0 \text{ and } w \in \Upsilon_0. \end{cases} \quad (\text{B.58})$$

This substitution has the effect of collapsing the contour to the real axis and removing the jump discontinuity along \mathbb{R}_+ . The matrix $\mathbf{P}(w)$ may be analytically continued to the domain $\mathbb{C} \setminus (-\infty, 0]$, and its boundary values on the negative real axis are necessarily continuous except at the points w_0 and w_1 at which negative one-fourth power singularities are admitted. The jump conditions satisfied by $\mathbf{P}(w)$ are illustrated in Figure B.7.

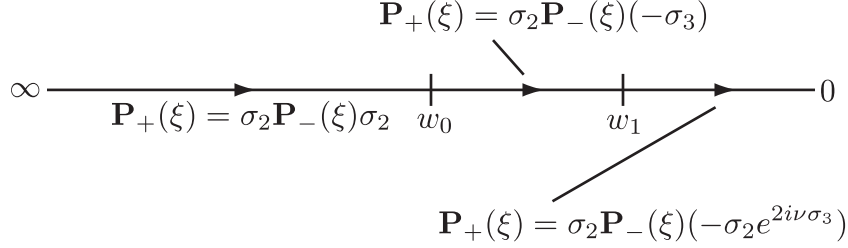

FIGURE B.7. The jump conditions satisfied by the matrix $\mathbf{P}(w)$ normalized as $\mathbf{P}(w) = \mathbb{I} + \mathcal{O}(|w|^{-1/2})$ as $w \rightarrow \infty$.

Next, we remove the real parameter ν from the jump conditions by defining the scalar function $h(w)$ by

$$h(w) := -\frac{S(w)}{\pi i} \int_{w_1}^0 \frac{ds}{S_+(s)(s-w)}, \quad (\text{B.59})$$

where $S(w)^2 := w(w-w_0)(w-w_1)$, $S(w)$ is analytic in the complement of the real intervals $-\infty < w \leq w_0$ and $w_1 \leq w \leq 0$, and $S(w) = w^{3/2}(1 + \mathcal{O}(w^{-1}))$ as $w \rightarrow \infty$ (principal branch of $w^{3/2}$). The asymptotic behavior of $h(w)$ as $w \rightarrow \infty$ is given by

$$h(w) = pw^{1/2} + \mathcal{O}(|w|^{-1/2}), \quad w \rightarrow \infty, \quad (\text{B.60})$$

where

$$p := \frac{1}{\pi i} \int_{w_1}^0 \frac{ds}{S_+(s)}. \quad (\text{B.61})$$

The function defined by (B.59) is analytic exactly where $S(w)$ is, and it satisfies $h_+(\xi) + h_-(\xi) = 0$ for $-\infty < \xi < w_0$ and $h_+(\xi) + h_-(\xi) = -2$ for $w_1 < \xi < 0$, taking continuous and bounded boundary values. In place of $\mathbf{P}(w)$ we now take the new unknown defined by

$$\mathbf{Q}(w) := \mathbf{P}(w)e^{i\nu h(w)\sigma_3}. \quad (\text{B.62})$$

By direct calculation we obtain the jump conditions determining $\mathbf{Q}(w)$ as shown in Figure B.8. The boundary

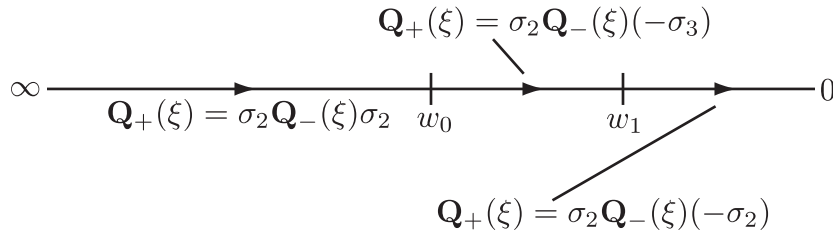

FIGURE B.8. The jump conditions satisfied by the matrix $\mathbf{Q}(w)$ normalized as $\mathbf{Q}(w)e^{-i\nu h(w)\sigma_3} = \mathbb{I} + \mathcal{O}(|w|^{-1/2})$ as $w \rightarrow \infty$.

values taken by $\mathbf{Q}(w)$ are continuous except at the points w_0 and w_1 at which inverse fourth-root singularities are admitted.

We next diagonalize the prefactor of σ_2 with the use of the eigenvector matrix \mathbf{V} given in (B.6). Setting

$$\mathbf{R}(w) = \mathbf{V}^\dagger \mathbf{Q}(w), \quad (\text{B.63})$$

one finds that the jump conditions on the negative real axis are reduced to those shown in Figure B.9, and

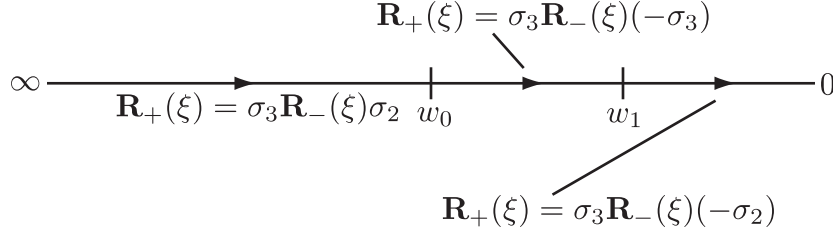

FIGURE B.9. The jump conditions satisfied by the matrix $\mathbf{R}(w)$ normalized as $\mathbf{R}(w)e^{-ip\nu w^{1/2}\sigma_3} = \mathbf{V}^\dagger + \mathcal{O}(|w|^{-1/2})$ as $w \rightarrow \infty$.

the only discontinuities of the boundary values are once again inverse fourth roots admitted at w_0 and w_1 .

Now, let $q(w)$ be the function satisfying

$$q(w)^4 = \frac{w - w_0}{w - w_1} \quad (\text{B.64})$$

and the normalization condition $\lim_{w \rightarrow \infty} q(w) = 1$, and taken to be analytic for $w \in \mathbb{C} \setminus [w_0, w_1]$. Its boundary values taken on the branch cut $[w_0, w_1]$ are related by $q_+(\xi) = -iq_-(\xi)$. Note also that

$$q(0) = \left(\frac{w_0}{w_1}\right)^{1/4} > 0. \quad (\text{B.65})$$

Now define a new unknown $\mathbf{S}(w)$ by

$$\mathbf{S}(w) := q(w)^{-1} \mathbf{R}(w). \quad (\text{B.66})$$

Taking into account the type of singularities that $\mathbf{R}(w)$ may have near $w = w_0$ and $w = w_1$, we see that $\mathbf{S}(w) = \mathcal{O}(|w - w_0|^{-1/2})$ for w near w_0 , while $\mathbf{S}(w)$ is bounded near $w = w_1$. The jump conditions satisfied by $\mathbf{S}(w)$ on the negative real axis are illustrated in Figure B.10.

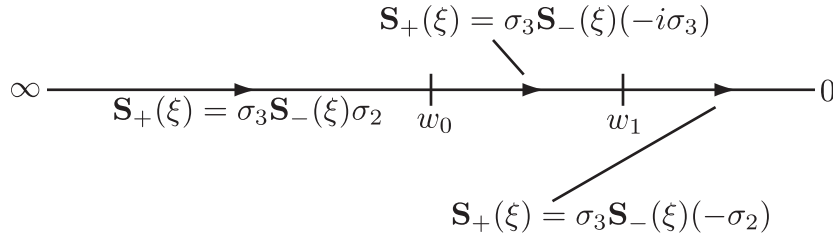

FIGURE B.10. The jump conditions satisfied by the matrix $\mathbf{S}(w)$ normalized as $\mathbf{S}(w)e^{-ip\nu w^{1/2}\sigma_3} = \mathbf{V}^\dagger + \mathcal{O}(|w|^{-1/2})$ as $w \rightarrow \infty$. Unlike $\mathbf{O}^{\text{out}}(w)$, $\mathbf{P}(w)$, $\mathbf{Q}(w)$, and $\mathbf{R}(w)$, the matrix $\mathbf{S}(w)$ is required to be bounded in a neighborhood of $w = w_1$ while we admit a stronger singularity at $w = w_0$: $\mathbf{S}(w) = \mathcal{O}(|w - w_0|^{-1/2})$.

We now separate the rows of the matrix $\mathbf{S}(w)$ by writing

$$\mathbf{S}(w) = \begin{bmatrix} \mathbf{s}_1(w)^\top \\ \mathbf{s}_2(w)^\top \end{bmatrix}, \quad (\text{B.67})$$

and introduce two new row vectors $\mathbf{t}_1(w)^\top$ and $\mathbf{t}_2(w)^\top$ by setting

$$\mathbf{t}_1(w)^\top = \sqrt{2} \mathbf{s}_1(w)^\top e^{-i\pi k(w)\sigma_3/2} \quad \text{and} \quad \mathbf{t}_2(w)^\top = i\sqrt{2} \mathbf{s}_2(w)^\top e^{i\pi k(w)\sigma_3/2} \quad (\text{B.68})$$

where $k(w)$ is the function analytic for $w \in \mathbb{C} \setminus \mathbb{R}_-$ given by

$$k(w) := \frac{1}{2} + h(w) - \frac{S(w)}{2\pi i} \int_{w_0}^{w_1} \frac{ds}{S(s)(s-w)}. \quad (\text{B.69})$$

Note that $k(w)$ is bounded on compact sets in the w -plane and has the asymptotic behavior

$$k(w) = \left[p + \frac{1}{2\pi i} \int_{w_0}^{w_1} \frac{ds}{S(s)} \right] w^{1/2} + \frac{1}{2} + \mathcal{O}(|w|^{-1/2}), \quad w \rightarrow \infty. \quad (\text{B.70})$$

Also, the jump conditions satisfied by k on the negative real axis are as follows: $k_+(\xi) + k_-(\xi) = 1$ for $\xi < w_0$, $k_+(\xi) - k_-(\xi) = -1$ for $w_0 < \xi < w_1$, and $k_+(\xi) + k_-(\xi) = -1$ for $w_1 < \xi < 0$.

From this information it follows that $\mathbf{t}_j(w)^\top$ are analytic for $w \in \mathbb{C} \setminus ((-\infty, w_0] \cup [w_1, 0])$, and they satisfy the involutive jump conditions

$$\mathbf{t}_{j+}(\xi)^\top = \mathbf{t}_{j-}(\xi)^\top \sigma_1, \quad j = 1, 2, \quad (\text{B.71})$$

for ξ in either of the two intervals of discontinuity, and we also have the normalization conditions

$$\mathbf{t}_j(w)^\top e^{-ip\varphi_j w^{1/2} \sigma_3} = [1, 1] + \mathcal{O}(|w|^{-1/2}), \quad w \rightarrow \infty \quad (\text{B.72})$$

where φ_1 and φ_2 are given by

$$\varphi_1 := \nu - \frac{\pi}{2} - \frac{1}{4ip} \int_{w_0}^{w_1} \frac{ds}{S(s)} \quad \text{and} \quad \varphi_2 := \nu + \frac{\pi}{2} + \frac{1}{4ip} \int_{w_0}^{w_1} \frac{ds}{S(s)}. \quad (\text{B.73})$$

Both $\mathbf{t}_1(w)^\top$ and $\mathbf{t}_2(w)^\top$ may become unbounded in the finite w -plane only as $w \rightarrow w_0$, where all four scalar components must be $\mathcal{O}(|w - w_0|^{-1/2})$.

We are now in a position to identify the components of the row vectors $\mathbf{t}_j(w)^\top$ as sheet projections of scalar Baker-Akhiezer functions $t_j(P)$ onto the two sheets of the Riemann surface X of the equation $y^2 = S(w)^2 = w(w - w_0)(w - w_1)$ compactified at $y = w = \infty$. Viewing X as two copies (sheets) of the w -plane cut along the intervals $(-\infty, w_0]$ and $[w_1, 0]$ and appropriately glued together, the Baker-Akhiezer functions are then defined just as in case L:

$$t_j(P) := \begin{cases} [\mathbf{t}_j(w(P))^\top]_1, & P \in \text{sheet 1} \\ [\mathbf{t}_j(w(P))^\top]_2, & P \in \text{sheet 2}. \end{cases} \quad (\text{B.74})$$

These functions are analytic on X except at exactly two points: the branch point $w = w_0$ at which $t_j(P)$ admits a simple pole (in the holomorphic local coordinate $y_0(P)$ given by (B.17)), and the branch point $w = \infty$ at which $t_j(P)$ has exponential behavior in terms of the holomorphic local coordinate $y_\infty(P)$ defined by (B.19):

$$t_j(P) e^{-ip\varphi_j y_\infty(P)^{-1}} = 1 + \mathcal{O}(y_\infty(P)), \quad P \rightarrow \infty. \quad (\text{B.75})$$

B.2.2. Construction of the Baker-Akhiezer functions. To write down Krichever's formula for $t_j(P)$, we define a homology basis on X as shown in Figure B.11. With this basis selected, we define a holomorphic differential

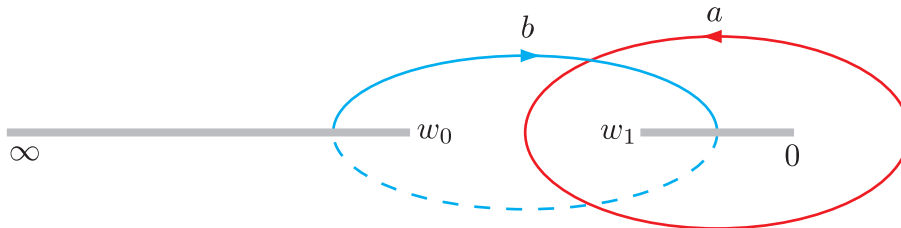

FIGURE B.11. A homology basis for the Riemann surface X . Solid curves lie on sheet 1 and dashed curves lie on sheet 2.

$\omega(P)$, corresponding constants \mathcal{H} and \mathcal{K} , Riemann Θ -function $\Theta(z; \mathcal{H})$, the Abel mapping $A(P)$ with base point $P_0 = w_0$, meromorphic differential $\Omega(P)$, and corresponding constant κ by exactly the same sequence

of formulae as in case L, namely (B.20)–(B.33). Lemma B.1 also holds in the current context, with the implication that

$$p\kappa = \frac{2}{\pi i} \int_{w_1}^0 \frac{c ds}{S_+(s)} = -\frac{1}{\pi i} \oint_a \omega(P) = -2. \quad (\text{B.76})$$

Also, we see that φ_j can be expressed in terms of \mathcal{H} as follows:

$$\varphi_1 = \nu - \frac{\pi}{2} - \frac{i\mathcal{H}}{8} \quad \text{and} \quad \varphi_2 = \nu + \frac{\pi}{2} + \frac{i\mathcal{H}}{8}. \quad (\text{B.77})$$

The Krichever formula for the Baker-Akhiezer functions $t_j(P)$ is then

$$\begin{aligned} t_j(P) &:= N_j \frac{\Theta(A(P) + \mathcal{K} + ip\kappa\varphi_j; \mathcal{H})}{\Theta(A(P) + \mathcal{K}; \mathcal{H})} \exp\left(ip\varphi_j \int_{w_0}^P \Omega(P')\right) \\ &= N_j \frac{\Theta(A(P) + \mathcal{K} - 2i\varphi_j; \mathcal{H})}{\Theta(A(P) + \mathcal{K}; \mathcal{H})} \exp\left(ip\varphi_j \int_{w_0}^P \Omega(P')\right), \end{aligned} \quad (\text{B.78})$$

where N_j is a constant chosen to enforce the normalization condition (B.75).

To compute the normalization constants, choose a path from $P = w_0$ to $P = \infty$ on sheet 1 with $\Im\{w\} \geq 0$, and obtain

$$A(\infty) = -\frac{1}{2} \oint_a \omega(P) = -\pi i. \quad (\text{B.79})$$

Also, as P tends to $P = \infty$ along such a path (we may take P on sheet 1 with $w(P) > 0$),

$$\begin{aligned} \int_{w_0}^P \Omega(P') &= \frac{1}{2} \oint_b \Omega(P') - \frac{1}{2} \oint_a \Omega(P') + \int_0^{w(P)} \frac{w+C}{2S(w)} dw \\ &= \frac{1}{2}\kappa + \int_0^{w(P)} \frac{w+C}{2S(w)} dw, \end{aligned} \quad (\text{B.80})$$

and

$$\begin{aligned} \int_0^{w(P)} \frac{w+C}{2S(w)} dw &= \int_0^{w(P)} \left[\frac{w+C}{2S(w)} - \frac{1}{2}w^{-1/2} \right] dw + w(P)^{1/2} \\ &= \int_0^{w(P)} \left[\frac{w+C}{2S(w)} - \frac{1}{2}w^{-1/2} \right] dw + \frac{1}{y_\infty(P)}. \end{aligned} \quad (\text{B.81})$$

The remaining integrand is integrable at infinity, and doubling the contour of integration and rotating the contours through the upper and lower half-planes respectively to lie along the negative real axis gives

$$\begin{aligned} \int_0^{w(P)} \left[\frac{w+C}{2S(w)} - \frac{1}{2}w^{-1/2} \right] dw &= \int_0^\infty \left[\frac{w+C}{2S(w)} - \frac{1}{2}w^{-1/2} \right] dw + \mathcal{O}(y_\infty(P)) \\ &= -\frac{1}{2} \oint_b \Omega(P') + \mathcal{O}(y_\infty(P)) \\ &= -\frac{1}{2}\kappa + \mathcal{O}(y_\infty(P)), \end{aligned} \quad (\text{B.82})$$

and therefore

$$\int_{w_0}^P \Omega(P') = \frac{1}{y_\infty(P)} + \mathcal{O}(y_\infty(P)). \quad (\text{B.83})$$

It follows that

$$\lim_{P \rightarrow \infty} t_j(P) e^{-ip\varphi_j y_\infty(P)^{-1}} = N_j \frac{\Theta(\frac{1}{2}\mathcal{H} - 2i\varphi_j; \mathcal{H})}{\Theta(\frac{1}{2}\mathcal{H}; \mathcal{H})}, \quad (\text{B.84})$$

so the normalization constants are given by

$$N_j := \frac{\Theta(\frac{1}{2}\mathcal{H}; \mathcal{H})}{\Theta(\frac{1}{2}\mathcal{H} - 2i\varphi_j; \mathcal{H})}, \quad (\text{B.85})$$

completing the construction of the Baker-Akhiezer functions $t_j(P)$, and hence of $\dot{\mathbf{O}}^{\text{out}}(w)$. To obtain a useful expression for $\dot{\mathbf{O}}^{\text{out}}(w)$ we recall the function $l(w)$ defined by the formula (B.51) for $w \in \mathbb{C} \setminus ((-\infty, w_0] \cup [w_1, 0])$; the analogue of Lemma B.2 in the current context is then the following.

Lemma B.3. $l(w) = h(w)$.

Proof. The proof is virtually the same as that of Lemma B.2; one uses the identity (B.76) to show that $l(w)$ and $h(w)$ satisfy the same additive jump conditions on the intervals $(-\infty, w_0)$ and $(w_1, 0)$, and then uses this information to establish that the ratio $(l(w) - h(w))/S(w)$ is an entire function of w that vanishes as $w \rightarrow \infty$. \square

To write formulae for $\dot{\mathbf{O}}^{\text{out}}(w)$, it is convenient to introduce the scalar function

$$n(w) := \frac{\mathcal{H}}{8}h(w) - \frac{S(w)}{4} \int_{w_0}^{w_1} \frac{ds}{S(s)(s-w)}. \quad (\text{B.86})$$

Then, with $P_j(w)$ denoting the point on sheet j of X corresponding to w , for $\Im\{w\} > 0$ and $w \in \Upsilon_\infty$:

$$\dot{\mathbf{O}}^{\text{out}}(w) = \begin{bmatrix} \frac{q}{2} (t_1(P_1)e^{-i\varphi_1 h+n} + t_2(P_1)e^{-i\varphi_2 h-n}) & \frac{q}{2i} (t_1(P_2)e^{i\varphi_1 h-n} - t_2(P_2)e^{i\varphi_2 h+n}) \\ \frac{q}{2i} (t_2(P_1)e^{-i\varphi_2 h-n} - t_1(P_1)e^{-i\varphi_1 h+n}) & \frac{q}{2} (t_1(P_2)e^{i\varphi_1 h-n} + t_2(P_2)e^{i\varphi_2 h+n}) \end{bmatrix}, \quad (\text{B.87})$$

for $\Im\{w\} > 0$ and $w \in \Upsilon_0$:

$$\dot{\mathbf{O}}^{\text{out}}(w) = \begin{bmatrix} \frac{q}{2} (t_1(P_2)e^{i\varphi_1 h-n} - t_2(P_2)e^{i\varphi_2 h+n}) e^{i\nu} & -\frac{q}{2i} (t_1(P_1)e^{-i\varphi_1 h+n} + t_2(P_1)e^{-i\varphi_2 h-n}) e^{-i\nu} \\ -\frac{q}{2i} (t_1(P_2)e^{i\varphi_1 h-n} + t_2(P_2)e^{i\varphi_2 h+n}) e^{i\nu} & \frac{q}{2} (t_2(P_1)e^{-i\varphi_2 h-n} - t_1(P_1)e^{-i\varphi_1 h+n}) e^{-i\nu} \end{bmatrix}, \quad (\text{B.88})$$

for $\Im\{w\} < 0$ and $w \in \Upsilon_0$:

$$\dot{\mathbf{O}}^{\text{out}}(w) = \begin{bmatrix} \frac{q}{2} (t_2(P_1)e^{-i\varphi_2 h-n} - t_1(P_1)e^{-i\varphi_1 h+n}) e^{-i\nu} & \frac{q}{2i} (t_1(P_2)e^{i\varphi_1 h-n} + t_2(P_2)e^{i\varphi_2 h+n}) e^{i\nu} \\ \frac{q}{2i} (t_1(P_1)e^{-i\varphi_1 h+n} + t_2(P_1)e^{-i\varphi_2 h-n}) e^{-i\nu} & \frac{q}{2} (t_1(P_2)e^{i\varphi_1 h-n} - t_2(P_2)e^{i\varphi_2 h+n}) e^{i\nu} \end{bmatrix}, \quad (\text{B.89})$$

and for $\Im\{w\} < 0$ and $w \in \Upsilon_\infty$:

$$\dot{\mathbf{O}}^{\text{out}}(w) = \begin{bmatrix} \frac{q}{2} (t_1(P_2)e^{i\varphi_1 h-n} + t_2(P_2)e^{i\varphi_2 h+n}) & -\frac{q}{2i} (t_2(P_1)e^{-i\varphi_2 h-n} - t_1(P_1)e^{-i\varphi_1 h+n}) \\ -\frac{q}{2i} (t_1(P_2)e^{i\varphi_1 h-n} - t_2(P_2)e^{i\varphi_2 h+n}) & \frac{q}{2} (t_1(P_1)e^{-i\varphi_1 h+n} + t_2(P_1)e^{-i\varphi_2 h-n}) \end{bmatrix}. \quad (\text{B.90})$$

It is then easy to check from these formulae that the exponentials $e^{\pm i\varphi_j h(w)}$ are exactly cancelled out by corresponding exponentials in the Baker-Akhiezer functions; indeed assuming the path of integration to be confined to the half-plane containing w for $\Im\{w\} \neq 0$,

$$t_j(P_1(w))e^{-i\varphi_j h(w)} = \frac{\Theta(\frac{1}{2}\mathcal{H}; \mathcal{H})\Theta(A(P_1(w)) + \mathcal{K} - 2i\varphi_j; \mathcal{H})}{\Theta(\frac{1}{2}\mathcal{H} - 2i\varphi_j; \mathcal{H})\Theta(A(P_1(w)) + \mathcal{K}; \mathcal{H})} \quad (\text{B.91})$$

and

$$t_j(P_2(w))e^{i\varphi_j h(w)} = \frac{\Theta(\frac{1}{2}\mathcal{H}; \mathcal{H})\Theta(A(P_2(w)) + \mathcal{K} - 2i\varphi_j; \mathcal{H})}{\Theta(\frac{1}{2}\mathcal{H} - 2i\varphi_j; \mathcal{H})\Theta(A(P_2(w)) + \mathcal{K}; \mathcal{H})}, \quad (\text{B.92})$$

due to Lemma B.3. Therefore, all remaining dependence on ν is either within the arguments of the Θ -functions or in the exponential factors $e^{\pm i\nu}$, leading in both cases to bounded oscillations as $\nu \rightarrow \infty$. This essentially completes the proof of Proposition 5.2 in case R.

B.3. Recovery of the potentials. Proof of Proposition 5.3. Here we obtain explicit formulae for \dot{C} , \dot{S} , and \dot{G} as defined from $\dot{\mathbf{O}}^{\text{out}}(w)$ by (5.27)–(5.29).

B.3.1. *Formulae for \dot{C} , \dot{S} , and \dot{G} in case L.* To obtain such formulae in case L, it is enough to evaluate the asymptotic behavior of $\dot{\mathbf{O}}^{\text{out}}(w)$ for $\Im\{w\} > 0$ using (B.52). The value of $A(P_1(w))$ for $w \approx 0$ and $w \approx \infty$ may be determined by choosing the path in (B.57) to lie in the upper half-plane, avoiding (except of course at the endpoints $w = w_0$ and $w = 0$ or $w = \infty$) the branch cuts of S . Then it is easy to see that

$$A(P_1(0)) = \frac{1}{2} \oint_a \omega(P) - \frac{1}{2} \oint_b \omega(P) = \pi i - \frac{1}{2} \mathcal{H}, \quad (\text{B.93})$$

and from (B.44) we have $A(P_1(\infty)) = -\mathcal{H}/2$. Also, using the fact that $w^{1/2} = i\sqrt{-w}$ (principal branches) for $\Im\{w\} > 0$, we have

$$\begin{aligned} A(P_1(w)) - A(P_1(0)) &= \int_0^w \frac{c d\xi}{S(\xi)} \\ &= \int_0^w \frac{c d\xi}{-|w_0| \xi^{1/2} (1 + \mathcal{O}(\xi))} \\ &= -\frac{2c}{|w_0|} w^{1/2} + \mathcal{O}(w^{3/2}) \\ &= -\frac{2ic}{|w_0|} \sqrt{-w} + \mathcal{O}(w^{3/2}), \quad w \rightarrow 0, \quad \Im\{w\} > 0 \end{aligned} \quad (\text{B.94})$$

and

$$\begin{aligned} A(P_1(w)) - A(P_1(\infty)) &= \int_\infty^w \frac{c d\xi}{S(\xi)} \\ &= \int_\infty^w \frac{c d\xi}{\xi^{3/2} (1 + \mathcal{O}(\xi^{-1}))} \\ &= -2cw^{-1/2} + \mathcal{O}(w^{-3/2}) \\ &= \frac{2ic}{\sqrt{-w}} + \mathcal{O}(w^{-3/2}), \quad w \rightarrow \infty, \quad \Im\{w\} > 0. \end{aligned} \quad (\text{B.95})$$

The final ingredients needed are the asymptotic formulae for $q(w)$:

$$q(w) = e^{i\zeta} + \mathcal{O}(w), \quad 0 < \zeta := \frac{1}{2} \arg(w_0) < \frac{\pi}{2}, \quad w \rightarrow 0 \quad (\text{B.96})$$

and

$$q(w) = 1 + \mathcal{O}(w^{-1}), \quad w \rightarrow \infty. \quad (\text{B.97})$$

Using the Taylor expansion of the entire function $\Theta(z; \mathcal{H})$ with respect to z and the identities (B.25) and (B.26), it then follows from substituting (B.54) and (B.56) into (B.52) and using $\varphi_2 - \varphi_1 = \pi$ that

$$\dot{O}_{11}^{0,0} = \dot{O}_{22}^{0,0} = \frac{e^{i\zeta}}{2} \frac{\Theta(i\pi; \mathcal{H})}{\Theta(0; \mathcal{H})} \left[\frac{\Theta(i\varphi_1; \mathcal{H})}{\Theta(i\varphi_2; \mathcal{H})} + \frac{\Theta(i\varphi_2; \mathcal{H})}{\Theta(i\varphi_1; \mathcal{H})} \right] \quad (\text{B.98})$$

and

$$\dot{O}_{12}^{0,0} = -\dot{O}_{21}^{0,0} = \frac{e^{i\zeta}}{2i} \frac{\Theta(i\pi; \mathcal{H})}{\Theta(0; \mathcal{H})} \left[\frac{\Theta(i\varphi_1; \mathcal{H})}{\Theta(i\varphi_2; \mathcal{H})} - \frac{\Theta(i\varphi_2; \mathcal{H})}{\Theta(i\varphi_1; \mathcal{H})} \right]. \quad (\text{B.99})$$

Note that the matrix $\dot{\mathbf{O}}^{0,0} = \dot{\mathbf{O}}^{\text{out}}(0)$ is invariant under conjugation by σ_2 , as must be the case since by the conditions of Riemann-Hilbert Problem 5.1, $\dot{\mathbf{O}}^{\text{out}}(w)$ is to be Hölder continuous up to \mathbb{R}_+ . These formulae are sufficient to calculate \dot{C} and \dot{S} : substitution into (5.27) gives

$$\dot{C} = (-1)^{\#\Delta} \frac{e^{i\zeta}}{2} \frac{\Theta(i\pi; \mathcal{H})}{\Theta(0; \mathcal{H})} \left[\frac{\Theta(i\varphi_2; \mathcal{H})}{\Theta(i\varphi_1; \mathcal{H})} + \frac{\Theta(i\varphi_1; \mathcal{H})}{\Theta(i\varphi_2; \mathcal{H})} \right] \quad (\text{B.100})$$

and substitution into (5.28) gives

$$\dot{S} = (-1)^{\#\Delta} \frac{e^{i\zeta}}{2i} \frac{\Theta(i\pi; \mathcal{H})}{\Theta(0; \mathcal{H})} \left[\frac{\Theta(i\varphi_2; \mathcal{H})}{\Theta(i\varphi_1; \mathcal{H})} - \frac{\Theta(i\varphi_1; \mathcal{H})}{\Theta(i\varphi_2; \mathcal{H})} \right]. \quad (\text{B.101})$$

The higher-order coefficients that we need to calculate $\dot{G}_N(x, t)$ are:

$$\dot{O}_{22}^{0,1} = -\frac{ice^{i\zeta}}{|w_0|} \frac{\Theta(i\pi; \mathcal{H})}{\Theta(0; \mathcal{H})} \left[\frac{\Theta'(i\varphi_1; \mathcal{H})}{\Theta(i\varphi_2; \mathcal{H})} + \frac{\Theta'(i\varphi_2; \mathcal{H})}{\Theta(i\varphi_1; \mathcal{H})} \right], \quad (\text{B.102})$$

$$\dot{O}_{12}^{0,1} = -\frac{ce^{i\zeta}}{|w_0|} \frac{\Theta(i\pi; \mathcal{H})}{\Theta(0; \mathcal{H})} \left[\frac{\Theta'(i\varphi_1; \mathcal{H})}{\Theta(i\varphi_2; \mathcal{H})} - \frac{\Theta'(i\varphi_2; \mathcal{H})}{\Theta(i\varphi_1; \mathcal{H})} \right], \quad (\text{B.103})$$

and

$$\dot{O}_{12}^{\infty,1} = c \left[\frac{\Theta'(i\varphi_2; \mathcal{H})}{\Theta(i\varphi_2; \mathcal{H})} - \frac{\Theta'(i\varphi_1; \mathcal{H})}{\Theta(i\varphi_1; \mathcal{H})} \right]. \quad (\text{B.104})$$

Here by $\Theta'(z; \mathcal{H})$ we mean the partial derivative with respect to z holding \mathcal{H} fixed. Substituting into (5.29) we have

$$\dot{G} = c \left[1 + \frac{e^{2i\zeta}}{|w_0|} \frac{\Theta(i\pi; \mathcal{H})^2}{\Theta(0; \mathcal{H})^2} \right] \left[\frac{\Theta'(i\varphi_2; \mathcal{H})}{\Theta(i\varphi_2; \mathcal{H})} - \frac{\Theta'(i\varphi_1; \mathcal{H})}{\Theta(i\varphi_1; \mathcal{H})} \right]. \quad (\text{B.105})$$

Evaluation of \mathcal{H} . Transformations of Θ with respect to \mathcal{H} . We now seek to simplify the formulae for \dot{C} , \dot{S} , and \dot{G} . Of course one would like to introduce Jacobi elliptic functions at this stage, but it turns out that since \mathcal{H} is complex the resulting formulae involve elliptic parameters m that are not in the so-called *normal case* of $0 < m < 1$. To arrive at the simplest formulae in terms of Jacobi elliptic functions with a parameter $m \in (0, 1)$ we will therefore first make some transformations of \mathcal{H} . Elementary contour definitions in the two integrals involved in the definition (B.23) show that \mathcal{H} can be written in the form

$$\mathcal{H} = \frac{1}{2}(\mathcal{H}_0 + 2\pi i), \quad (\text{B.106})$$

where \mathcal{H}_0 is given by the ratio of integrals

$$\mathcal{H}_0 := -2\pi \frac{\int_0^{+\infty} \frac{dw}{\sqrt{w(w-w_0)(w-w_0^*)}}}{\int_{-\infty}^0 \frac{dw}{\sqrt{-w(w-w_0)(w-w_0^*)}}}, \quad (\text{B.107})$$

where the square roots are both positive. Using the substitution

$$w = -|w_0| \frac{z-1}{z+1} \quad \text{followed by} \quad z = \pm \sqrt{1-s^2} \quad (\text{B.108})$$

and recalling the complete elliptic integral of the first kind defined by (1.60) we obtain

$$\int_0^{+\infty} \frac{dw}{\sqrt{w(w-w_0)(w-w_0^*)}} = \frac{2K(\cos(\zeta)^2)}{\sqrt{|w_0|}}. \quad (\text{B.109})$$

Similarly by means of the substitution (4.45) we find

$$\int_{-\infty}^0 \frac{dw}{\sqrt{-w(w-w_0)(w-w_0^*)}} = \frac{2K(\sin(\zeta)^2)}{\sqrt{|w_0|}}. \quad (\text{B.110})$$

Therefore,

$$\mathcal{H}_0 = -2\pi \frac{K(m')}{K(m)} \quad (\text{B.111})$$

where the elliptic parameter $m \in (0, 1)$ and its complementary parameter $m' := 1 - m \in (0, 1)$ are given by

$$m := \sin(\zeta)^2, \quad m' := \cos(\zeta)^2. \quad (\text{B.112})$$

Note that \mathcal{H}_0 is a negative real number. According to the theory of elliptic functions (see [1]) it is Riemann Θ -functions with parameter \mathcal{H}_0 that are associated with Jacobi elliptic functions of elliptic parameter $m \in (0, 1)$.

Adding $2\pi i$ to \mathcal{H}_0 and then dividing by two amounts to the composition of two classical transformations of Θ -functions [1]. Indeed, the so-called *first principal first-degree transformation* implies that

$$\Theta(z; \mathcal{H} + 2\pi i) = \Theta(z + i\pi; \mathcal{H}), \quad z \in \mathbb{C}, \quad \Re\{\mathcal{H}\} < 0, \quad (\text{B.113})$$

an identity that allows us to add $2\pi i$ to \mathcal{H}_0 . Also, the so-called *Gauss transformation* (a second-degree transformation) implies that

$$\Theta(i\pi; \frac{1}{2}\mathcal{H})\Theta(z; \frac{1}{2}\mathcal{H}) = \Theta(z + i\pi; \mathcal{H})^2 + e^{-z}e^{\mathcal{H}/4}\Theta(z + i\pi - \frac{1}{2}\mathcal{H}; \mathcal{H})^2, \quad z \in \mathbb{C}, \quad \Re\{\mathcal{H}\} < 0, \quad (\text{B.114})$$

and

$$\Theta(0; \frac{1}{2}\mathcal{H})\Theta(z + i\pi; \frac{1}{2}\mathcal{H}) = \Theta(z + i\pi; \mathcal{H})^2 - e^{-z}e^{\mathcal{H}/4}\Theta(z + i\pi - \frac{1}{2}\mathcal{H}; \mathcal{H})^2, \quad z \in \mathbb{C}, \quad \Re\{\mathcal{H}\} < 0, \quad (\text{B.115})$$

identities that allow us to divide $\mathcal{H}_0 + 2\pi i$ by two. Combining these together and using the identity (B.26) yields

$$\frac{\Theta(i\pi; \mathcal{H})\Theta(z; \mathcal{H})}{\Theta(z + i\pi; \mathcal{H})\Theta(0; \mathcal{H})} = \frac{\Theta(z; \mathcal{H}_0)^2 + ie^{-z}e^{\mathcal{H}_0/4}\Theta(z + i\pi - \frac{1}{2}\mathcal{H}_0; \mathcal{H}_0)^2}{\Theta(z; \mathcal{H}_0)^2 - ie^{-z}e^{\mathcal{H}_0/4}\Theta(z + i\pi - \frac{1}{2}\mathcal{H}_0; \mathcal{H}_0)^2}, \quad \mathcal{H} = \frac{1}{2}(\mathcal{H}_0 + 2\pi i). \quad (\text{B.116})$$

The elliptic parameter m can be expressed directly in terms of special values of Θ -functions with parameter \mathcal{H}_0 as follows [1]:

$$\frac{\Theta(i\pi; \mathcal{H}_0)^4}{\Theta(0; \mathcal{H}_0)^4} = 1 - m \quad \text{and} \quad e^{\mathcal{H}_0/2} \frac{\Theta(-\frac{1}{2}\mathcal{H}_0; \mathcal{H}_0)^4}{\Theta(0; \mathcal{H}_0)^4} = m. \quad (\text{B.117})$$

Since $\mathcal{H}_0 < 0$ we see from (B.24) that all four Θ -function values appearing in this identity are real, so we may take the positive square root of both sides.

We may now introduce the Jacobi elliptic functions [1] with parameter m related to \mathcal{H}_0 by (B.111) or equivalently by (B.117):

$$\text{sn}\left(\frac{K(m)z}{\pi i}; m\right) := ie^{-z/2} \frac{\Theta(0; \mathcal{H}_0)\Theta(z + i\pi - \frac{1}{2}\mathcal{H}_0; \mathcal{H}_0)}{\Theta(-\frac{1}{2}\mathcal{H}_0; \mathcal{H}_0)\Theta(z + i\pi; \mathcal{H}_0)}, \quad z \in \mathbb{C}, \quad (\text{B.118})$$

$$\text{cn}\left(\frac{K(m)z}{\pi i}; m\right) := e^{-z/2} \frac{\Theta(i\pi; \mathcal{H}_0)\Theta(z - \frac{1}{2}\mathcal{H}_0; \mathcal{H}_0)}{\Theta(-\frac{1}{2}\mathcal{H}_0; \mathcal{H}_0)\Theta(z + i\pi; \mathcal{H}_0)}, \quad z \in \mathbb{C}, \quad (\text{B.119})$$

and

$$\text{dn}\left(\frac{K(m)z}{\pi i}; m\right) := \frac{\Theta(i\pi; \mathcal{H}_0)\Theta(z; \mathcal{H}_0)}{\Theta(0; \mathcal{H}_0)\Theta(z + i\pi; \mathcal{H}_0)}, \quad z \in \mathbb{C}. \quad (\text{B.120})$$

Setting

$$Z_j := \frac{K(m)}{\pi} \varphi_j, \quad (\text{B.121})$$

and substituting into (B.100) and (B.101) firstly from (B.116)–(B.117) and then from (B.118)–(B.120) we obtain:

$$\dot{C} = (-1)^{\#\Delta} \frac{e^{i\zeta}}{2} \left[\frac{\text{dn}(Z_1; m)^2 - i\sqrt{mm'}\text{sn}(Z_1; m)^2}{\text{dn}(Z_1; m)^2 + i\sqrt{mm'}\text{sn}(Z_1; m)^2} + \frac{\text{dn}(Z_2; m)^2 - i\sqrt{mm'}\text{sn}(Z_2; m)^2}{\text{dn}(Z_2; m)^2 + i\sqrt{mm'}\text{sn}(Z_2; m)^2} \right] \quad (\text{B.122})$$

$$\dot{S} = (-1)^{\#\Delta} \frac{e^{i\zeta}}{2i} \left[\frac{\text{dn}(Z_2; m)^2 - i\sqrt{mm'}\text{sn}(Z_2; m)^2}{\text{dn}(Z_2; m)^2 + i\sqrt{mm'}\text{sn}(Z_2; m)^2} - \frac{\text{dn}(Z_1; m)^2 - i\sqrt{mm'}\text{sn}(Z_1; m)^2}{\text{dn}(Z_1; m)^2 + i\sqrt{mm'}\text{sn}(Z_1; m)^2} \right]. \quad (\text{B.123})$$

To express \dot{G} in terms of Jacobi elliptic functions, first we note that using $z = i\pi$ in (B.116), taking into account the periodicity relation (B.26), and then using the positive square roots of the identities (B.117) together with (B.112) gives

$$e^{2i\zeta} \frac{\Theta(i\pi; \mathcal{H})^2}{\Theta(0; \mathcal{H})^2} = 1. \quad (\text{B.124})$$

Now, by simple contour deformations and the use of the normalization condition (B.22) defining c , it follows that $2c\mathcal{D} = \pi$, where \mathcal{D} is the denominator defined by (4.33). Therefore, if we allow the branch points w_0 and w_0^* to depend on (x, t) via the moment and integral conditions $M = I = 0$, it follows from (4.32) of Proposition 4.2 that we may write \dot{G} in the form

$$\dot{G} = 2 \frac{\partial \Phi}{\partial t} \left[\frac{\Theta'(i\varphi_2; \mathcal{H})}{\Theta(i\varphi_2; \mathcal{H})} - \frac{\Theta'(i\varphi_1; \mathcal{H})}{\Theta(i\varphi_1; \mathcal{H})} \right]. \quad (\text{B.125})$$

Since $\varphi_2 = \varphi_1 + \pi$, this can be written as a logarithmic derivative:

$$\dot{G} = -2i \frac{\partial \Phi}{\partial t} \frac{d}{d\varphi_1} \log \left(\frac{\Theta(i\varphi_1 + i\pi; \mathcal{H})}{\Theta(i\varphi_1; \mathcal{H})} \right). \quad (\text{B.126})$$

Applying (B.116) and the positive square roots of (B.117), we may then substitute from (B.118)–(B.120) to obtain

$$\dot{G} = -2i \frac{\partial \Phi}{\partial t} \frac{d}{d\varphi_1} \log \left(\frac{\text{dn}(Z_1; m)^2 + i\sqrt{mm'} \text{sn}(Z_1; m)^2}{\text{dn}(Z_1; m)^2 - i\sqrt{mm'} \text{sn}(Z_1; m)^2} \right). \quad (\text{B.127})$$

Use of elliptic function identities for a fixed elliptic parameter. Now, we simplify \dot{C} , \dot{S} , and \dot{G} further by recalling some identities relating elliptic functions at a fixed value of the elliptic parameter m . Firstly, using the Pythagorean identities [1]

$$\text{sn}(\cdot; m)^2 + \text{cn}(\cdot; m)^2 = \text{dn}(\cdot; m)^2 + m \text{sn}(\cdot; m)^2 = 1 \quad (\text{B.128})$$

to eliminate $\text{dn}(Z_j; m)^2$ and recalling that $e^{i\zeta} = \sqrt{m'} + i\sqrt{m}$, we have

$$\dot{C} = (-1)^{\#\Delta} \frac{e^{i\zeta}}{2} \left[\frac{1 - i\sqrt{m}e^{-i\zeta} \text{sn}(Z_1; m)^2}{1 + i\sqrt{m}e^{i\zeta} \text{sn}(Z_1; m)^2} + \frac{1 - i\sqrt{m}e^{-i\zeta} \text{sn}(Z_2; m)^2}{1 + i\sqrt{m}e^{i\zeta} \text{sn}(Z_2; m)^2} \right], \quad (\text{B.129})$$

$$\dot{S} = (-1)^{\#\Delta} \frac{e^{i\zeta}}{2i} \left[\frac{1 - i\sqrt{m}e^{-i\zeta} \text{sn}(Z_2; m)^2}{1 + i\sqrt{m}e^{i\zeta} \text{sn}(Z_2; m)^2} - \frac{1 - i\sqrt{m}e^{-i\zeta} \text{sn}(Z_1; m)^2}{1 + i\sqrt{m}e^{i\zeta} \text{sn}(Z_1; m)^2} \right], \quad (\text{B.130})$$

and

$$\dot{G} = -2i \frac{\partial \Phi}{\partial t} \frac{d}{d\varphi_1} \log \left(\frac{1 + i\sqrt{m}e^{i\zeta} \text{sn}(Z_1; m)^2}{1 - i\sqrt{m}e^{-i\zeta} \text{sn}(Z_1; m)^2} \right). \quad (\text{B.131})$$

Next, using the double-angle identity

$$\text{sn}(Z; m)^2 = \frac{m \text{cn}(2Z; m) - \text{dn}(2Z; m) + m'}{m \text{cn}(2Z; m) - m \text{dn}(2Z; m)}, \quad (\text{B.132})$$

these can be written in the form

$$\dot{C} = (-1)^{\#\Delta} \frac{e^{i\zeta}}{2} \left[\frac{\sqrt{m}e^{-i\zeta} \text{cn}(2Z_1; m) + i \text{dn}(2Z_1; m) - i\sqrt{m'}e^{-i\zeta}}{\sqrt{m}e^{i\zeta} \text{cn}(2Z_1; m) - i \text{dn}(2Z_1; m) + i\sqrt{m'}e^{i\zeta}} + \frac{\sqrt{m}e^{-i\zeta} \text{cn}(2Z_2; m) + i \text{dn}(2Z_2; m) - i\sqrt{m'}e^{-i\zeta}}{\sqrt{m}e^{i\zeta} \text{cn}(2Z_2; m) - i \text{dn}(2Z_2; m) + i\sqrt{m'}e^{i\zeta}} \right], \quad (\text{B.133})$$

$$\dot{S} = (-1)^{\#\Delta} \frac{e^{i\zeta}}{2i} \left[\frac{\sqrt{m}e^{-i\zeta} \text{cn}(2Z_2; m) + i \text{dn}(2Z_2; m) - i\sqrt{m'}e^{-i\zeta}}{\sqrt{m}e^{i\zeta} \text{cn}(2Z_2; m) - i \text{dn}(2Z_2; m) + i\sqrt{m'}e^{i\zeta}} - \frac{\sqrt{m}e^{-i\zeta} \text{cn}(2Z_1; m) + i \text{dn}(2Z_1; m) - i\sqrt{m'}e^{-i\zeta}}{\sqrt{m}e^{i\zeta} \text{cn}(2Z_1; m) - i \text{dn}(2Z_1; m) + i\sqrt{m'}e^{i\zeta}} \right], \quad (\text{B.134})$$

and

$$\dot{G} = -2i \frac{\partial \Phi}{\partial t} \frac{d}{d\varphi_1} \log \left(\frac{\sqrt{m}e^{i\zeta} \text{cn}(2Z_1; m) - i \text{dn}(2Z_1; m) + i\sqrt{m'}e^{i\zeta}}{\sqrt{m}e^{-i\zeta} \text{cn}(2Z_1; m) + i \text{dn}(2Z_1; m) - i\sqrt{m'}e^{-i\zeta}} \right). \quad (\text{B.135})$$

Then, since

$$2Z_1 = W - K(m) \quad \text{and} \quad 2Z_2 = W + K(m) \quad \text{where} \quad W := \frac{2\nu K(m)}{\pi}, \quad (\text{B.136})$$

the use of the identities

$$\text{cn}(W \pm K(m); m) = \mp \sqrt{m'} \frac{\text{sn}(W; m)}{\text{dn}(W; m)} \quad \text{and} \quad \text{dn}(W \pm K(m); m) = \frac{\sqrt{m'}}{\text{dn}(W; m)} \quad (\text{B.137})$$

yields

$$\begin{aligned} \dot{C} = & (-1)^{\#\Delta} \frac{e^{i\zeta}}{2} \left[\frac{\sqrt{m}e^{-i\zeta}\operatorname{sn}(W; m) + i - ie^{-i\zeta}\operatorname{dn}(W; m)}{\sqrt{m}e^{i\zeta}\operatorname{sn}(W; m) - i + ie^{i\zeta}\operatorname{dn}(W; m)} \right. \\ & \left. + \frac{-\sqrt{m}e^{-i\zeta}\operatorname{sn}(W; m) + i - ie^{-i\zeta}\operatorname{dn}(W; m)}{-\sqrt{m}e^{i\zeta}\operatorname{sn}(W; m) - i + ie^{i\zeta}\operatorname{dn}(W; m)} \right], \end{aligned} \quad (\text{B.138})$$

$$\begin{aligned} \dot{S} = & (-1)^{\#\Delta} \frac{e^{i\zeta}}{2i} \left[\frac{-\sqrt{m}e^{-i\zeta}\operatorname{sn}(W; m) + i - ie^{-i\zeta}\operatorname{dn}(W; m)}{-\sqrt{m}e^{i\zeta}\operatorname{sn}(W; m) - i + ie^{i\zeta}\operatorname{dn}(W; m)} \right. \\ & \left. - \frac{\sqrt{m}e^{-i\zeta}\operatorname{sn}(W; m) + i - ie^{-i\zeta}\operatorname{dn}(W; m)}{\sqrt{m}e^{i\zeta}\operatorname{sn}(W; m) - i + ie^{i\zeta}\operatorname{dn}(W; m)} \right], \end{aligned} \quad (\text{B.139})$$

and

$$\dot{G} = \frac{4K(m)}{i\pi} \frac{\partial\Phi}{\partial t} \frac{d}{dW} \log \left(\frac{\sqrt{m}\operatorname{sn}(W; m) - ie^{-i\zeta} + i\operatorname{dn}(W; m)}{\sqrt{m}\operatorname{sn}(W; m) + ie^{i\zeta} - i\operatorname{dn}(W; m)} \right). \quad (\text{B.140})$$

Again applying (B.128) and $e^{i\zeta} = \sqrt{m'} + i\sqrt{m}$, and the differential identities [1]

$$\begin{aligned} \frac{d}{dW} \operatorname{sn}(W; m) &= \operatorname{cn}(W; m)\operatorname{dn}(W; m) \\ \frac{d}{dW} \operatorname{cn}(W; m) &= -\operatorname{sn}(W; m)\operatorname{dn}(W; m) \\ \frac{d}{dW} \operatorname{dn}(W; m) &= -m\operatorname{cn}(W; m)\operatorname{sn}(W; m), \end{aligned} \quad (\text{B.141})$$

these become simply

$$\begin{aligned} \dot{C} &= (-1)^{\#\Delta} \operatorname{dn}(W; m) \\ \dot{S} &= -(-1)^{\#\Delta} \sqrt{m}\operatorname{sn}(W; m) \\ \dot{G} &= -\frac{4K(m)}{\pi} \frac{\partial\Phi}{\partial t} \sqrt{m}\operatorname{cn}(W; m). \end{aligned} \quad (\text{B.142})$$

We have already introduced (x, t) -dependence via the conditions $M = I = 0$. If we also recall that $\nu = \Phi/\epsilon_N + \pi\#\Delta$, then W takes the form

$$W = \frac{2\Phi K(m)}{\pi\epsilon_N} + 2\#\Delta K(m). \quad (\text{B.143})$$

But, since $\#\Delta$ is even in case L, and since $\operatorname{sn}(\cdot; m)$, $\operatorname{cn}(\cdot; m)$, and $\operatorname{dn}(\cdot; m)$ are all periodic with period $4K(m)$, the formulae (B.142) reduce to the expressions (5.30), as desired.

This nearly completes the proof of Proposition 5.3 in case L. It only remains to confirm the differential relations (5.34). Note, however, that by partial differentiation with respect to m of the relation

$$\int_0^{\operatorname{sn}(u; m)} \frac{dt}{\sqrt{1-t^2}\sqrt{1-mt^2}} = u, \quad (\text{B.144})$$

the use of the Pythagorean identities (B.128) shows that

$$\frac{\partial}{\partial m} \operatorname{sn}(u; m) = -\operatorname{cn}(u; m)\operatorname{dn}(u; m) \int_0^{\operatorname{sn}(u; m)} \frac{\partial}{\partial m} \left[\frac{1}{\sqrt{1-t^2}\sqrt{1-mt^2}} \right] dt. \quad (\text{B.145})$$

Now the integral increases by $4K'(m)$ when u increases by $4K(m)$, the fundamental real period of $\operatorname{sn}(\cdot; m)$. Therefore,

$$\frac{\partial}{\partial m} \operatorname{sn}(u; m) = -\operatorname{cn}(u; m)\operatorname{dn}(u; m) \left[\frac{K'(m)}{K(m)} u + f(u; m) \right], \quad (\text{B.146})$$

where $f(u + 4K(m); m) = f(u; m)$, making f periodic and hence bounded with respect to u . By partial differentiation of $\dot{S}_N(x, t)$ as given by the formula (5.30) we obtain

$$\begin{aligned} \epsilon_N \frac{\partial \dot{S}_N}{\partial t}(x, t) = & -\frac{\epsilon_N}{2\sqrt{m}} \frac{\partial m}{\partial t} \operatorname{sn}(u; m) - \epsilon_N \sqrt{m} \frac{\partial m}{\partial t} \frac{\partial}{\partial m} \operatorname{sn}(u; m) \\ & - \sqrt{m} \frac{\partial}{\partial u} \operatorname{sn}(u; m) \left[\frac{2K(m)}{\pi} \frac{\partial \Phi}{\partial t} + \frac{2\Phi K'(m)}{\pi} \frac{\partial m}{\partial t} \right], \quad u = \frac{2\Phi K(m)}{\pi \epsilon_N}. \end{aligned} \quad (\text{B.147})$$

Using (B.141) and (B.146) to evaluate the partial derivatives of $\operatorname{sn}(u; m)$ (note that the derivatives in (B.141) are in fact partial derivatives with m held fixed) this becomes

$$\begin{aligned} \epsilon_N \frac{\partial \dot{S}_N}{\partial t}(x, t) = & -\frac{2K(m)}{\pi} \frac{\partial \Phi}{\partial t} \sqrt{m} \operatorname{cn}(u; m) \operatorname{dn}(u; m) \\ & + \epsilon_N \frac{\partial m}{\partial t} \left[\sqrt{m} \operatorname{cn}(u; m) \operatorname{dn}(u; m) f(u; m) - \frac{1}{2\sqrt{m}} \operatorname{sn}(u; m) \right], \end{aligned} \quad (\text{B.148})$$

and the first of the relations (5.34) then follows upon comparing with the formulae (5.30). The second relation is established in a completely analogous manner. This finally completes the proof of Proposition 5.3 in case L.

B.3.2. Formulae for \dot{C} , \dot{S} , and \dot{G} in case R. Once again to obtain the asymptotic behavior of $\dot{\mathbf{O}}^{\text{out}}(w)$ as $w \rightarrow 0$ and $w \rightarrow \infty$, it is sufficient to assume that $\Im\{w\} > 0$, and therefore to use the formula (B.87) to analyze the limit $w \rightarrow 0$ and the formula (B.88) to analyze the limit $w \rightarrow \infty$. By choosing a path in the open upper half-plane, we easily obtain the following asymptotic formulae for the Abel mapping:

$$A(P_1(w)) = \frac{1}{2}H - i\pi + \frac{2ic}{\sqrt{w_0 w_1}} \sqrt{-w} + \mathcal{O}(w^{3/2}), \quad w \rightarrow 0, \quad \Im\{w\} > 0, \quad (\text{B.149})$$

and

$$A(P_1(w)) = -i\pi + \frac{2ic}{\sqrt{-w}} + \mathcal{O}(w^{-3/2}), \quad w \rightarrow \infty, \quad \Im\{w\} > 0, \quad (\text{B.150})$$

and of course $A(P_2(w)) = -A(P_1(w))$. Also, we have the following asymptotic formulae for $q(w)$:

$$q(w) = \left(\frac{w_0}{w_1} \right)^{1/4} + \mathcal{O}(w), \quad w \rightarrow 0 \quad (\text{B.151})$$

and

$$q(w) = 1 + \mathcal{O}(w^{-1}), \quad w \rightarrow \infty. \quad (\text{B.152})$$

We will also require asymptotic expansions of $n(w)$ defined by (B.86) valid for large and small w . Beginning with the exact formula

$$n(w) = -\frac{S(w)}{4} \left[\frac{\mathcal{H}}{2\pi i} \int_{w_1}^0 \frac{ds}{S_+(s)(s-w)} + \int_{w_0}^{w_1} \frac{ds}{S(s)(s-w)} \right] \quad (\text{B.153})$$

we may use the expansion $S(w) = w^{-3/2}(1 + \mathcal{O}(w^{-1}))$ as $w \rightarrow \infty$ and expand $(s-w)^{-1}$ in a geometric series for large w to obtain

$$\begin{aligned} n(w) = & \frac{w^{1/2}}{4} (1 + \mathcal{O}(w^{-1})) \left[\frac{\mathcal{H}}{2\pi i} \int_{w_1}^0 \frac{ds}{S_+(s)} + \int_{w_0}^{w_1} \frac{ds}{S(s)} \right. \\ & \left. + \left(\frac{\mathcal{H}}{2\pi i} \int_{w_1}^0 \frac{s ds}{S_+(s)} + \int_{w_0}^{w_1} \frac{s ds}{S(s)} \right) w^{-1} + \mathcal{O}(w^{-2}) \right], \quad w \rightarrow \infty. \end{aligned} \quad (\text{B.154})$$

But, by definition of \mathcal{H} , we may write this in the form

$$n(w) = \frac{1}{2w^{1/2}} \left[\frac{\mathcal{H}}{2\pi i} \int_{w_1}^0 \frac{s+C}{2S_+(s)} ds + \int_{w_0}^{w_1} \frac{s+C}{2S(s)} ds + \mathcal{O}(w^{-1}) \right], \quad w \rightarrow \infty. \quad (\text{B.155})$$

Identifying the integrals as cycles of the meromorphic differential $\Omega(P)$ then yields

$$\begin{aligned} n(w) &= \frac{1}{2w^{1/2}} \left[\frac{1}{2}\kappa + \mathcal{O}(w^{-1}) \right] \\ &= \frac{c}{2i\sqrt{-w}} + \mathcal{O}(w^{-3/2}), \quad w \rightarrow \infty, \quad \Im\{w\} > 0, \end{aligned} \quad (\text{B.156})$$

where in the second line we have used Lemma B.1. On the other hand, we may write $n(w)$ in the form

$$n(w) = -\frac{S(w)}{4} \left[-\frac{\mathcal{H}}{4\pi i} \oint_a \frac{ds}{S(s)(s-w)} + \int_{w_0}^{w_1} \frac{ds}{S(s)(s-w)} \right] \quad (\text{B.157})$$

where it is understood that w lies outside of the loop contour a pictured in Figure B.11. If we let w cross the contour a to approach the origin, then we obtain a residue contribution:

$$n(w) = -\frac{\mathcal{H}}{8} - \frac{S(w)}{4} \left[-\frac{\mathcal{H}}{4\pi i} \oint_a \frac{ds}{S(s)(s-w)} + \int_{w_0}^{w_1} \frac{ds}{S(s)(s-w)} \right] \quad (\text{B.158})$$

where it is now understood that w lies *inside* of a . In particular, the expression in brackets has a well-defined value at $w = 0$ (it is in fact analytic in a neighborhood of $w = 0$). Since $S(w) = \sqrt{w_0 w_1} w^{1/2} (1 + \mathcal{O}(w))$ as $w \rightarrow 0$, we therefore see that

$$n(w) = -\frac{\mathcal{H}}{8} - \frac{\sqrt{w_0 w_1}}{8} \left[-\frac{\mathcal{H}}{2\pi i} \oint_a \frac{ds}{S(s)s} + 2 \int_{w_0}^{w_1} \frac{ds}{S(s)s} \right] w^{1/2} + \mathcal{O}(w^{3/2}), \quad w \rightarrow 0. \quad (\text{B.159})$$

The differential identity

$$d(w) := \frac{(w-w_0)(w-w_1)}{S(w)} \implies d'(w) = \frac{w}{2S(w)} - \frac{w_0 w_1}{2wS(w)} \quad (\text{B.160})$$

allows integration by parts, leading to the equivalent expansion

$$n(w) = -\frac{\mathcal{H}}{8} - \frac{1}{8\sqrt{w_0 w_1}} \left[-\frac{\mathcal{H}}{2\pi i} \oint_a \frac{s ds}{S(s)} + 2 \int_{w_0}^{w_1} \frac{s ds}{S(s)} \right] w^{1/2} + \mathcal{O}(w^{3/2}), \quad w \rightarrow 0. \quad (\text{B.161})$$

Using the definitions of \mathcal{H} and the meromorphic differential $\Omega(P)$, this may be written in the form

$$\begin{aligned} n(w) &= -\frac{\mathcal{H}}{8} - \frac{1}{4\sqrt{w_0 w_1}} \left[-\frac{\mathcal{H}}{2\pi i} \oint_a \Omega(P) + \oint_b \Omega(P) \right] w^{1/2} + \mathcal{O}(w^{3/2}) \\ &= -\frac{\mathcal{H}}{8} - \frac{\kappa}{4\sqrt{w_0 w_1}} w^{1/2} + \mathcal{O}(w^{3/2}) \\ &= -\frac{\mathcal{H}}{8} + \frac{c}{2i\sqrt{w_0 w_1}} \sqrt{-w} + \mathcal{O}(w^{3/2}), \quad w \rightarrow 0, \quad \Im\{w\} > 0, \end{aligned} \quad (\text{B.162})$$

where Lemma B.1 has again been used.

Applying these expansions for w small with $\Im\{w\} > 0$ to the formula (B.88) with the help of (B.91)–(B.92) then yields

$$\dot{O}_{11}^{0,0} = \dot{O}_{22}^{0,0} = \frac{1}{2} \left(\frac{w_0}{w_1} \right)^{1/4} \frac{\Theta(\frac{1}{2}\mathcal{H}; \mathcal{H})}{\Theta(0; \mathcal{H})} e^{\mathcal{H}/8} \left[\frac{\Theta(2i\varphi_1; \mathcal{H})}{\Theta(2i\varphi_2; \mathcal{H})} e^{i\nu} + \frac{\Theta(2i\varphi_2; \mathcal{H})}{\Theta(2i\varphi_1; \mathcal{H})} e^{-i\nu} \right] \quad (\text{B.163})$$

and

$$\dot{O}_{12}^{0,0} = -\dot{O}_{21}^{0,0} = \frac{1}{2i} \left(\frac{w_0}{w_1} \right)^{1/4} \frac{\Theta(\frac{1}{2}\mathcal{H}; \mathcal{H})}{\Theta(0; \mathcal{H})} e^{\mathcal{H}/8} \left[\frac{\Theta(2i\varphi_1; \mathcal{H})}{\Theta(2i\varphi_2; \mathcal{H})} e^{i\nu} - \frac{\Theta(2i\varphi_2; \mathcal{H})}{\Theta(2i\varphi_1; \mathcal{H})} e^{-i\nu} \right]. \quad (\text{B.164})$$

As in case L, we observe that the matrix $\dot{O}^{0,0} = \dot{O}^{\text{out}}(0)$ is invariant under conjugation by σ_2 . Substitution from these formulae into (5.27) and (5.28) gives, respectively,

$$\dot{C} = \frac{(-1)^{\#\Delta}}{2} \left(\frac{w_0}{w_1} \right)^{1/4} \frac{\Theta(\frac{1}{2}\mathcal{H}; \mathcal{H})}{\Theta(0; \mathcal{H})} e^{\mathcal{H}/8} \left[\frac{\Theta(2i\varphi_1; \mathcal{H})}{\Theta(2i\varphi_2; \mathcal{H})} e^{i\nu} + \frac{\Theta(2i\varphi_2; \mathcal{H})}{\Theta(2i\varphi_1; \mathcal{H})} e^{-i\nu} \right] \quad (\text{B.165})$$

and

$$\dot{S} = -\frac{(-1)^{\#\Delta}}{2i} \left(\frac{w_0}{w_1} \right)^{1/4} \frac{\Theta(\frac{1}{2}\mathcal{H}; \mathcal{H})}{\Theta(0; \mathcal{H})} e^{\mathcal{H}/8} \left[\frac{\Theta(2i\varphi_1; \mathcal{H})}{\Theta(2i\varphi_2; \mathcal{H})} e^{i\nu} - \frac{\Theta(2i\varphi_2; \mathcal{H})}{\Theta(2i\varphi_1; \mathcal{H})} e^{-i\nu} \right]. \quad (\text{B.166})$$

The higher-order coefficients we need to calculate \dot{G} are obtained by continuing the expansion for w near the origin to higher order, and also by expanding (B.87) as $w \rightarrow \infty$ with $\Im\{w\} > 0$ with the help of (B.91)–(B.92):

$$\begin{aligned} \dot{O}_{22}^{0,1} = & -\frac{ic}{\sqrt{w_0 w_1}} \left(\frac{w_0}{w_1}\right)^{1/4} \frac{\Theta(\frac{1}{2}\mathcal{H}; \mathcal{H})}{\Theta(0; \mathcal{H})} e^{\mathcal{H}/8} \left[\frac{\Theta'(2i\varphi_1; \mathcal{H})}{\Theta(2i\varphi_2; \mathcal{H})} e^{i\nu} + \frac{\Theta'(2i\varphi_2; \mathcal{H})}{\Theta(2i\varphi_1; \mathcal{H})} e^{-i\nu} \right. \\ & \left. + \frac{1}{4} \frac{\Theta(2i\varphi_1; \mathcal{H})}{\Theta(2i\varphi_2; \mathcal{H})} e^{i\nu} - \frac{1}{4} \frac{\Theta(2i\varphi_2; \mathcal{H})}{\Theta(2i\varphi_1; \mathcal{H})} e^{-i\nu} \right], \end{aligned} \quad (\text{B.167})$$

$$\begin{aligned} \dot{O}_{12}^{0,1} = & -\frac{c}{\sqrt{w_0 w_1}} \left(\frac{w_0}{w_1}\right)^{1/4} \frac{\Theta(\frac{1}{2}\mathcal{H}; \mathcal{H})}{\Theta(0; \mathcal{H})} e^{\mathcal{H}/8} \left[\frac{\Theta'(2i\varphi_1; \mathcal{H})}{\Theta(2i\varphi_2; \mathcal{H})} e^{i\nu} - \frac{\Theta'(2i\varphi_2; \mathcal{H})}{\Theta(2i\varphi_1; \mathcal{H})} e^{-i\nu} \right. \\ & \left. + \frac{1}{4} \frac{\Theta(2i\varphi_1; \mathcal{H})}{\Theta(2i\varphi_2; \mathcal{H})} e^{i\nu} + \frac{1}{4} \frac{\Theta(2i\varphi_2; \mathcal{H})}{\Theta(2i\varphi_1; \mathcal{H})} e^{-i\nu} \right], \end{aligned} \quad (\text{B.168})$$

and

$$\dot{O}_{12}^{\infty,1} = c \left[\frac{\Theta'(2i\varphi_2; \mathcal{H})}{\Theta(2i\varphi_2; \mathcal{H})} - \frac{\Theta'(2i\varphi_1; \mathcal{H})}{\Theta(2i\varphi_1; \mathcal{H})} - \frac{1}{2} \right]. \quad (\text{B.169})$$

Substituting into (5.29) we have

$$\dot{G} = c \left[1 - \frac{1}{w_1} \frac{\Theta(\frac{1}{2}\mathcal{H}; \mathcal{H})^2 e^{\mathcal{H}/4}}{\Theta(0; \mathcal{H})^2} \right] \left[\frac{\Theta'(2i\varphi_2; \mathcal{H})}{\Theta(2i\varphi_2; \mathcal{H})} - \frac{\Theta'(2i\varphi_1; \mathcal{H})}{\Theta(2i\varphi_1; \mathcal{H})} - \frac{1}{2} \right]. \quad (\text{B.170})$$

Evaluation of \mathcal{H} . Transformations of Θ with respect to \mathcal{H} . By simple contour deformations (referring to Figure B.11) and the definitions of $\tilde{S}(P)$ and of $S(w)$, we see that

$$\mathcal{H} = -2\pi \frac{\int_{w_0}^{w_1} \frac{dw}{\sqrt{w(w-w_0)(w-w_1)}}}{\int_{w_1}^0 \frac{dw}{\sqrt{-w(w-w_0)(w-w_1)}}} \quad (\text{B.171})$$

where in each case the positive square root is meant. Although this is a negative real quantity and hence is associated with an elliptic parameter that is in the normal case, it will be in fact convenient to rewrite \mathcal{H} in the form $\mathcal{H} = 2\mathcal{H}_0$ and associate \mathcal{H}_0 with an elliptic parameter m . To this end, we recall the substitution (4.47) and obtain

$$\int_{w_1}^0 \frac{dw}{\sqrt{-w(w-w_0)(w-w_1)}} = \frac{2K(m)}{\sqrt{-w_0} + \sqrt{-w_1}} \quad (\text{B.172})$$

where

$$m := \frac{4\sqrt{w_0 w_1}}{(\sqrt{-w_0} + \sqrt{-w_1})^2} \in (0, 1). \quad (\text{B.173})$$

For the denominator of \mathcal{H} , we use the globally bijective fractional-linear substitution

$$w = -\sqrt{w_0 w_1} \frac{(\sqrt{-w_0} + \sqrt{-w_1}) - (\sqrt{-w_0} - \sqrt{-w_1})s}{(\sqrt{-w_0} + \sqrt{-w_1}) + (\sqrt{-w_0} - \sqrt{-w_1})s} \quad (\text{B.174})$$

to obtain

$$\int_{w_0}^{w_1} \frac{dw}{\sqrt{w(w-w_0)(w-w_1)}} = \frac{4K(m')}{\sqrt{-w_0} + \sqrt{-w_1}} \quad (\text{B.175})$$

where $m' := 1 - m$. Therefore, it follows that

$$\mathcal{H} = 2\mathcal{H}_0, \quad \mathcal{H}_0 := -2\pi \frac{K(m')}{K(m)} \quad (\text{B.176})$$

where the elliptic modulus m is given by (B.173).

Multiplying \mathcal{H}_0 by two corresponds to a Gauss transformation (in reverse). If we try directly to apply (B.114)–(B.115) to express Θ -functions with parameter \mathcal{H} in terms of those with parameter \mathcal{H}_0 we will need to choose branches of square roots. This difficulty can, however, be circumvented by using the formula [26]

$$\Theta(2z; 2\mathcal{H}) = \frac{\Theta(z; \mathcal{H})^2 + \Theta(z + i\pi; \mathcal{H})^2}{2\Theta(0; 2\mathcal{H})}, \quad z \in \mathbb{C}, \quad \Re\{\mathcal{H}\} < 0. \quad (\text{B.177})$$

We may now rewrite (B.165) and (B.166) in terms of Θ -functions with parameter \mathcal{H}_0 with the help of (B.177), and then substitute into these formulae the definitions of the Jacobi elliptic functions (B.118)–(B.120). Using also the positive square roots of the identities (B.117), the standard Θ -function properties (B.25)–(B.27) along with the fact that $\Theta(i\pi + \frac{1}{2}\mathcal{H}_0; \mathcal{H}_0) = 0$, and also the identity

$$\left(\frac{w_0}{w_1}\right)^{1/4} = \frac{1 + \sqrt{m'}}{\sqrt{m}} \quad (\text{B.178})$$

following from (B.173), we see that

$$\dot{C} = \frac{(-1)^{\#\Delta}}{2i} \left[\frac{\text{dn}(Z_1; m)^2 + \sqrt{m'}}{\sqrt{mm'}\text{sn}(Z_1; m)^2 - \sqrt{m}\text{cn}(Z_1; m)^2} + \frac{\text{dn}(Z_2; m)^2 + \sqrt{m'}}{\sqrt{mm'}\text{sn}(Z_2; m)^2 - \sqrt{m}\text{cn}(Z_2; m)^2} \right] \quad (\text{B.179})$$

and

$$\dot{S} = \frac{(-1)^{\#\Delta}}{2} \left[\frac{\text{dn}(Z_1; m)^2 + \sqrt{m'}}{\sqrt{mm'}\text{sn}(Z_1; m)^2 - \sqrt{m}\text{cn}(Z_1; m)^2} - \frac{\text{dn}(Z_2; m)^2 + \sqrt{m'}}{\sqrt{mm'}\text{sn}(Z_2; m)^2 - \sqrt{m}\text{cn}(Z_2; m)^2} \right], \quad (\text{B.180})$$

where Z_j are defined in terms of φ_j by (B.121) (although in the current case φ_j and m have different meanings than they did in case L).

To express \dot{G} given by (B.170) in terms of elliptic functions, we first note that since $\mathcal{H} = 2\mathcal{H}_0$, (B.177) together with the positive square roots of the identities (B.117), the definition (B.173), and the fact that $\Theta(\frac{1}{2}\mathcal{H}_0 + i\pi; \mathcal{H}_0) = 0$ imply that

$$\frac{1}{w_1} \frac{\Theta(\frac{1}{2}\mathcal{H}; \mathcal{H})^2 e^{\mathcal{H}/4}}{\Theta(0; \mathcal{H})^2} = -\frac{1}{\sqrt{w_0 w_1}}. \quad (\text{B.181})$$

Elementary contour deformations show that $c\mathcal{D} = \pi$, where \mathcal{D} is defined for case R by (4.34). If we now let w_0 and w_1 depend on (x, t) such that the moment and integral conditions $M = I = 0$ are satisfied, then Proposition (4.2) applies, and from (4.32) one finds that

$$c \left[1 - \frac{1}{w_1} \frac{\Theta(\frac{1}{2}\mathcal{H}; \mathcal{H})^2 e^{\mathcal{H}/4}}{\Theta(0; \mathcal{H})^2} \right] = 4 \frac{\partial \Phi_{\Delta}}{\partial t} = 4 \frac{\partial \Phi}{\partial t}. \quad (\text{B.182})$$

Also, since $\varphi_2 = \varphi_1 + \pi + i\mathcal{H}/4$, we may write \dot{G} in the form

$$\dot{G} = -2i \frac{\partial \Phi}{\partial t} \frac{d}{d\varphi_1} \log \left[e^{-i\varphi_1} \frac{\Theta(2i\varphi_1 - \frac{1}{2}\mathcal{H}; \mathcal{H})}{\Theta(2i\varphi_1; \mathcal{H})} \right]. \quad (\text{B.183})$$

Substituting from (B.118)–(B.120) after first using (B.177) and the positive square roots of (B.117) we arrive at the formula

$$\dot{G} = -2i \frac{\partial \Phi}{\partial t} \frac{d}{d\varphi_1} \log \left(\frac{\text{cn}(Z_1; m)^2 - \sqrt{m'}\text{sn}(Z_1; m)^2}{\text{dn}(Z_1; m)^2 + \sqrt{m'}} \right). \quad (\text{B.184})$$

Use of elliptic function identities for a fixed elliptic parameter. Using the Pythagorean identities (B.128) allows us to write \dot{C} and \dot{S} in terms of $\text{sn}(Z_1; m)^2$ and $\text{sn}(Z_2; m)^2$ only, and \dot{G} as a logarithmic derivative of a quantity involving $\text{sn}(Z_1; m)^2$ only. Next, we apply the double-angle identity (B.132) and note that

$$2Z_1 = W - K(m) + iK(m') \quad \text{and} \quad 2Z_2 = W + K(m) - iK(m') \quad \text{where} \quad W := \frac{2\nu K(m)}{\pi}, \quad (\text{B.185})$$

allowing the use of the identities

$$\text{cn}(W \pm K(m) \mp iK(m'); m) = \frac{i\sqrt{m'}}{\sqrt{m}\text{cn}(W; m)} \quad \text{and} \quad \text{dn}(W \pm K(m) \mp iK(m'); m) = \mp i\sqrt{m'} \frac{\text{sn}(W; m)}{\text{cn}(W; m)}. \quad (\text{B.186})$$

Finally, we again apply (B.128), and in the case of \dot{G} the differential identities (B.141), to express \dot{C} , \dot{S} , and \dot{G} simply as:

$$\begin{aligned}\dot{C} &= (-1)^{\#\Delta} \text{cn}(W; m) \\ \dot{S} &= -(-1)^{\#\Delta} \text{sn}(W; m) \\ \dot{G} &= -\frac{4K(m)}{\pi} \frac{\partial \Phi}{\partial t} \text{dn}(W; m).\end{aligned}\tag{B.187}$$

Finally, inserting the value of ν as $\nu = \Phi/\epsilon_N + \pi\#\Delta$, the phase W becomes

$$W = \frac{2\Phi K(m)}{\pi\epsilon_N} + 2\#\Delta K(m),\tag{B.188}$$

and since $\text{sn}(u + 2K(m); m) = -\text{sn}(u; m)$, $\text{cn}(u + 2K(m); m) = -\text{cn}(u; m)$, while $\text{dn}(u + 2K(m); m) = \text{dn}(u; m)$, we see that even though $\#\Delta$ is not necessarily even in case R, the formulae (B.187) indeed have the desired form (5.32).

To prove that (5.34) holds also in case R, we differentiate $\dot{S}_N(x, t)$ given by (5.32), keeping in mind that $m = m(x, t)$:

$$\epsilon_N \frac{\partial \dot{S}_N}{\partial t}(x, t) = -\epsilon_N \frac{\partial m}{\partial t} \frac{\partial}{\partial m} \text{sn}(u; m) - \frac{\partial}{\partial u} \text{sn}(u; m) \left[\frac{2\Phi K'(m)}{\pi} \frac{\partial m}{\partial t} + \frac{2K(m)}{\pi} \frac{\partial \Phi}{\partial t} \right], \quad u = \frac{2\Phi K(m)}{\pi\epsilon_N}.\tag{B.189}$$

Computing the partial derivatives of $\text{sn}(u; m)$ using (B.141) and (B.146) this becomes

$$\epsilon_N \frac{\partial \dot{S}_N}{\partial t}(x, t) = -\frac{2K(m)}{\pi} \frac{\partial \Phi}{\partial t} \text{cn}(u; m) \text{dn}(u; m) + \epsilon_N \frac{\partial m}{\partial t} \text{cn}(u; m) \text{dn}(u; m) f(u; m)\tag{B.190}$$

from which the first of the formulae (5.34) follows by comparison with (5.32) (the second is proved analogously). This completes the proof of Proposition 5.3 in case R.

REFERENCES

- [1] N. I. Akhiezer, *Elements of the Theory of Elliptic Functions*, Translations of Mathematical Monographs **79**, American Mathematical Society, Providence, 1990.
- [2] J. Baik, T. Kriecherbauer, K. T.-R. McLaughlin, and P. D. Miller, *Discrete Orthogonal Polynomials: Asymptotics and Applications*, Annals of Mathematics Studies **164**, Princeton University Press, Princeton, 2007.
- [3] A. Barone, F. Esposito, C. J. Magee, and A. C. Scott, "Theory and applications of the sine-Gordon equation," *Riv. Nuovo Cim.*, **1**, 227–267, 1971.
- [4] R. Buckingham and P. D. Miller, "Exact solutions of semiclassical non-characteristic Cauchy problems for the sine-Gordon equation," *Physica D*, **237**, 2296–2341, 2008.
- [5] R. Buckingham and P. D. Miller, "The sine-Gordon equation in the semiclassical limit: critical behavior near a separatrix", preprint, 2011.
- [6] P. Deift, S. Venakides, and X. Zhou, "New results in small dispersion KdV by an extension of the steepest descent method for Riemann-Hilbert problems," *Internat. Math. Res. Notices*, **1997**, 285–299, 1997.
- [7] P. Deift and X. Zhou, "A steepest-descent method for oscillatory Riemann-Hilbert problems: asymptotics for the mKdV equation," *Ann. of Math.*, **137**, 295–368, 1993.
- [8] P. Deift and X. Zhou, "Asymptotics for the Painlevé II equation," *Comm. Pure Appl. Math.*, **48**, 277–337, 1995.
- [9] B. A. Dubrovin, "Theta functions and non-linear equations," *Russian Math. Surveys*, **36**, 11–92, 1981.
- [10] N. Ercolani, M. G. Forest, and D. W. McLaughlin, "Modulational stability of two-phase sine-Gordon wavetrains," *Stud. Appl. Math.*, **71**, 91–101, 1984.
- [11] N. Ercolani, M. G. Forest, D. W. McLaughlin, and R. Montgomery, "Hamiltonian structure for the modulation equations of a sine-Gordon wavetrain," *Duke Math. J.*, **55**, 949–983, 1987.
- [12] M. G. Forest and D. W. McLaughlin, "Modulations of sinh-Gordon and sine-Gordon wavetrains," *Stud. Appl. Math.*, **68**, 11–59, 1983.
- [13] H. Goldstein, *Classical Mechanics*, Second edition, Addison-Wesley, Reading, Mass., 1980.
- [14] S. Kamvissis, K. T.-R. McLaughlin, and P. D. Miller, *Semiclassical Soliton Ensembles for the Focusing Nonlinear Schrödinger Equation*, Annals of Mathematics Studies, Volume 154, Princeton University Press, Princeton, NJ, 2003.
- [15] M. Klaus and J. K. Shaw, "Purely imaginary eigenvalues of Zakharov-Shabat systems," *Phys. Rev. E*, **65**, 36607–36611, 2002.
- [16] I. M. Krichever, "Methods of algebraic geometry in the theory of nonlinear equations," *Russian Math. Surveys*, **32**, 185–213, 1977.
- [17] G. D. Lyng and P. D. Miller, "The N -soliton of the focusing nonlinear Schrödinger equation for N large," *Comm. Pure Appl. Math.*, **60**, 951–1026, 2007.

- [18] P. D. Miller, "Asymptotics of semiclassical soliton ensembles: rigorous justification of the WKB approximation," *Internat. Math. Res. Not.*, **2002**, 383–454, 2002.
- [19] P. D. Miller and S. Kamvissis, "On the semiclassical limit of the focusing nonlinear Schrödinger equation," *Phys. Lett. A*, **247**, 75–86, 1998.
- [20] J. Satsuma and N. Yajima, "Initial value problems of one-dimensional self-modulation of nonlinear waves in dispersive media," *Supp. Prog. Theo. Phys.*, **55**, 284–306, 1974.
- [21] A. C. Scott, "Waveform stability on a nonlinear Klein-Gordon equation," *Proc. IEEE (Lett.)*, **57**, 1338–1339, 1969.
- [22] A. C. Scott, F. Chu, S. Reible, "Magnetic flux propagation on a Josephson transmission line," *J. Appl. Phys.*, **47**, 3272–3286, 1976.
- [23] A. Tovbis, S. Venakides, and X. Zhou, "On semiclassical (zero dispersion limit) solutions of the focusing nonlinear Schrödinger equation," *Comm. Pure Appl. Math.*, **57**, 877–985, 2004.
- [24] G. B. Whitham, "Non-linear dispersive waves," *Proc. Roy. Soc. Lond. Ser. A, Math. and Phys. Sci.*, **283**, 238–261, 1965.
- [25] G. B. Whitham, *Linear and Nonlinear Waves*, Wiley-Interscience, New York, NY, 1974.
- [26] <http://functions.wolfram.com/EllipticFunctions/EllipticTheta1/18/02/02/01/>.

(R. J. Buckingham) DEPARTMENT OF MATHEMATICAL SCIENCES, UNIVERSITY OF CINCINNATI, PO BOX 210025, CINCINNATI, OH 45221.

E-mail address: buckinrt@uc.edu

URL: <http://homepages.uc.edu/~buckinrt/>

(P. D. Miller) DEPARTMENT OF MATHEMATICS, UNIVERSITY OF MICHIGAN, EAST HALL, 530 CHURCH ST., ANN ARBOR, MI 48109.

E-mail address: millerpd@umich.edu

URL: <http://www.math.lsa.umich.edu/~millerpd/>