

ON GENUS-1 SIMPLIFIED BROKEN LEFSCHETZ FIBRATIONS

KENTA HAYANO

ABSTRACT. Auroux, Donaldson and Katzarkov introduced broken Lefschetz fibrations as a generalization of Lefschetz fibrations in order to describe near-symplectic 4-manifolds. We first study monodromy representations of higher sides of genus-1 simplified broken Lefschetz fibrations. We then completely classify diffeomorphism types of such fibrations with connected fibers and with less than six Lefschetz singularities. In these studies, we obtain several families of genus-1 simplified broken Lefschetz fibrations, which we conjecture contain all such fibrations, and determine the diffeomorphism types of the total spaces of these fibrations. Our results are generalizations of Kas' classification theorem of genus-1 Lefschetz fibrations, which states that the total space of a non-trivial genus-1 Lefschetz fibration over S^2 is diffeomorphic to an elliptic surface $E(n)$, for some $n \geq 1$.

1. INTRODUCTION

Broken Lefschetz fibrations were introduced by Auroux, Donaldson and Katzarkov [1] as a generalization of Lefschetz fibrations. Donaldson [5] proved that symplectic 4-manifolds admit Lefschetz fibrations after blow-ups and Gompf [6] proved the converse, i.e., the total space of every non-trivial Lefschetz fibration admits a symplectic structure. In [1], Auroux, Donaldson and Katzarkov extended these results to 4-manifolds with near-symplectic structure, which is a closed 2-form symplectic outside a union of circles where it vanishes transversely. In fact, they proved that a 4-manifold M is near-symplectic if and only if M admits a broken Lefschetz pencil structure with certain conditions. So it is quite natural to try to generalize various results about Lefschetz fibrations to those for broken Lefschetz fibrations.

Classification of diffeomorphism types of total spaces M of non-trivial genus-1 Lefschetz fibrations over S^2 have already been done by Kas [9]. He proved that M is diffeomorphic to an elliptic surface $E(n)$, for some $n \geq 1$. Especially, the diffeomorphism type of M is determined only by the Euler characteristic of M . Our main results generalize Kas' theorem to genus-1 simplified broken Lefschetz fibrations.

Williams [14] proved that every closed connected oriented smooth 4-manifold admits a simplified broken Lefschetz fibration structure by using singularity theory. So it is natural to examine the minimal genus of all simplified broken Lefschetz fibrations $M \rightarrow S^2$ on a fixed 4-manifold M . As far as the author knows, there are few results about the above question so far. This problem is another motivation of our study and our main theorems give a partial

answer to the question. Moreover, we will show that the minimal genus of all simplified broken Lefschetz fibrations on $\sharp k\mathbb{C}\mathbb{P}^2$ is greater than 1 for all $k > 0$ (c.f. Corollary 4.10).

Our main results is as follows.

Main Theorem A. *The following 4-manifolds admit genus-1 simplified broken Lefschetz fibration structures with non-empty round singular locus.*

- $\sharp k\mathbb{C}\mathbb{P}^2 \sharp \overline{\ell\mathbb{C}\mathbb{P}^2}$, where $\ell > 0$.
- $\sharp kS^2 \times S^2$.
- $L \sharp \overline{r\mathbb{C}\mathbb{P}^2}$, where L is either of the manifolds L_n and L'_n defined by Pao [13].

Main Theorem B. *Let M be a total space of a genus-1 simplified broken Lefschetz fibration with non-empty round singular locus and with r Lefschetz singularities. If $r \geq 5$, then M is diffeomorphic to one of the following 4-manifolds.*

- $\sharp k\mathbb{C}\mathbb{P}^2 \sharp (r-k)\overline{\mathbb{C}\mathbb{P}^2}$, where $0 \leq k \leq r-1$.
- $\sharp kS^2 \times S^2$, where $k = \frac{r}{2}$ for even r .
- $S^1 \times S^3 \sharp S \sharp \overline{r\mathbb{C}\mathbb{P}^2}$, where S is either of the manifolds $S^2 \times S^2$ and $S^2 \tilde{\times} S^2$.
- $L \sharp \overline{r\mathbb{C}\mathbb{P}^2}$, where L is either of the manifolds L_n and L'_n .

Remark 1.1. In private talks with R.İ.Baykur, he told the author about an alternative proof of a part of Main Theorem A. His proof depends on singularity theory, while ours on Kirby calculus. The latter includes essential tools used in the proof of Main Theorem B.

While the author was writing this paper, Baykur and Kamada [4] posted a paper about genus-1 simplified broken Lefschetz fibrations on arXiv. They obtained some results about genus-1 simplified broken Lefschetz fibrations independent of the author. They proved that, possibly after blow-ups, a genus-1 simplified broken Lefschetz fibration is isomorphic to $(n+1)\mathbb{C}\mathbb{P}^2 \sharp (5n+k+5)\overline{\mathbb{C}\mathbb{P}^2}$ with monodromy factorization $(t_a, t_b)^{3n+3} t_a^k$ for non-negative integers n and k (c.f. Theorem 10 of [4]).

In Section 3, we examine monodromy representations of higher sides of genus-1 simplified broken Lefschetz fibrations by using a graphical method, called the chart description, which is used in [8] to determine monodromy representations of genus-1 Lefschetz fibrations. Although our method is similar to that of [8], the definition of our chart is slightly different from that in [8]. We first give the definition of chart and review some basic techniques used in [8]. We then prove that the monodromy of the higher side of a genus-1 simplified broken Lefschetz fibration can be represented by a certain normal form after successive application of chart moves.

In Section 4, we construct some families of genus-1 simplified broken Lefschetz fibrations by giving monodromy representations of higher sides of such fibrations. We then determine diffeomorphism types of total spaces of these fibrations by using Kirby calculus. Main Theorem A will be proved in the last of this section. We will also prove that 4-manifolds with positive definite intersection form cannot admit genus-1 simplified broken Lefschetz fibration structures by using Kirby calculus. Some examples obtained in this section are also used to prove Main Theorem B in the last section.

We devote the last section to proving Main Theorem B. We prove that all genus-1 simplified broken Lefschetz fibrations with connected fibers and with less than six Lefschetz singularities are contained in the families obtained in Section 4 by moving certain word sequences representing monodromy representations. We end this section with explaining why the number of Lefschetz singularities is limited in Main Theorem B.

Acknowledgments. The author wishes to express his gratitude to Hisaaki Endo for his encouragement and many useful suggestions. He would also like to thank Refik İnanç Baykur, Seiichi Kamada and Osamu Saeki for commenting on the draft of this paper and for helpful discussions.

2. PRELIMINARIES

2.1. broken Lefschetz fibrations. Let M and B be compact connected oriented smooth manifolds of dimension 4 and 2, respectively.

Definition 2.1. A smooth map $f : M \rightarrow B$ is called a *broken Lefschetz fibration* if it satisfies the following conditions:

- (1) $\partial M = f^{-1}(\partial B)$;
- (2) there exist a finite set $\mathcal{C} = \{p_1, \dots, p_n\}$ and a one dimensional submanifold Z in $\text{int}M$ such that df_p is surjective for all $p \in M \setminus (\mathcal{C} \cup Z)$;
- (3) for each p_i , there exist a complex local coordinate (z_1, z_2) around p_i and a complex local coordinate ξ around $f(p_i)$ such that $z_1(p_i) = z_2(p_i) = 0$ and f is locally written as $\xi = f(z_1, z_2) = z_1 z_2$;
- (4) for each $p \in Z$, there exist a real local coordinate (t, x_1, x_2, x_3) around p and a real local coordinate (y_1, y_2) around $f(p)$ such that $Z = \{(t, 0, 0, 0) | t \in \mathbb{R}\}$ and f is locally written as $(y_1, y_2) = f(t, x_1, x_2, x_3) = (t, x_1^2 + x_2^2 - x_3^2)$;
- (5) the restriction map of f to $Z \cup \mathcal{C}$ is injective;
- (6) for any $q \in B \setminus f(Z)$, $f^{-1}(q)$ has no (-1) -spheres.

We call a smooth map f an *achiral broken Lefschetz fibration* if f satisfies the conditions (1), (2), (4), (5), (6) and the following condition:

- (3)' for each p_i , there exist a complex local coordinate (z_1, z_2) around p_i and a complex local coordinate ξ around $f(p_i)$ such that $z_1(p_i) = z_2(p_i) = 0$ and f is locally written as $\xi = f(z_1, z_2) = z_1 z_2$ or $z_1 \overline{z_2}$.

If $Z = \emptyset$, we call f simply a (*achiral*) *Lefschetz fibration*. A regular fiber of such a fibration is a closed oriented connected surface. We call its genus the *genus* of f . For simplicity, we will refer (achiral) broken Lefschetz fibrations and (achiral) Lefschetz fibrations by (A)BLF and (A)LF, respectively.

We call a singularity locally written as $f(z_1, z_2) = z_1 z_2$ (resp. $f(z_1, z_2) = z_1 \overline{z_2}$) a *Lefschetz singularity* (resp. *achiral Lefschetz singularity*). Also, we call Z and $f(Z)$ in the definition above the *round singular locus* and the *round singular image*, respectively. A inverse image of $\nu f(Z)$ is called a *round cobordism* of f , where $\nu f(Z)$ is a regular neighborhood of $f(Z)$.

Let $f : M \rightarrow S^2$ be a BLF. Suppose that f has a connected round singular locus. Then the round singular image of f is an embedded circle and the circle divides S^2 into two 2-disks D_1 and D_2 . Moreover, one of the following occurs:

- a regular fiber of the fibration $f^{-1}(D_i) \rightarrow D_i$ is connected, while a regular fiber of the fibration $f^{-1}(D_j) \rightarrow D_j$ is disconnected;
- any regular fibers are connected and a genus of a regular fiber of the fibration $f^{-1}(D_i) \rightarrow D_i$ is just one higher than a genus of a regular fiber of the fibration $f^{-1}(D_j) \rightarrow D_j$,

where $\{i, j\} = \{1, 2\}$. We call an inverse image of D_i the *higher side* of f and an inverse image of D_j the *lower side* of f .

Definition 2.2. A BLF $f : M \rightarrow S^2$ is *simplified* if f satisfies the following conditions:

- (1) f has a connected round singular locus;
- (2) every Lefschetz singularity of f is contained in the higher side of f ;
- (3) all fibers of f are connected.

The genus of the higher side of f as an LF is called the *genus* of f .

We sometimes refer to simplified BLF as SBLF for short.

2.2. Monodromy representations. We review the definition of monodromy representations. For more details, see [7]. Let $f : M \rightarrow B$ be a genus- g LF, $\mathcal{C} \subset M$ the set of critical points of f and $\psi_0 : f^{-1}(y_0) \rightarrow \Sigma_g$ an orientation preserving diffeomorphism for a point $y_0 \in B \setminus f(\mathcal{C})$. For a loop $\gamma : (I, \partial I) \rightarrow (B \setminus f(\mathcal{C}), y_0)$, the pull-back $\gamma^*f = \{(t, x) \in I \times M \mid \gamma(t) = f(x)\}$ of f by γ is a trivial Σ_g -bundle over I . Let $\Psi : \gamma^*f \rightarrow I \times \Sigma_g$ be a trivialization of this bundle which is equal to ψ_0 on $\{0\} \times f^{-1}(y_0)$ and $\Psi(t, x) = (t, \psi_t(x))$. Then $[\psi_1 \circ \psi_0^{-1}] \in \mathcal{M}_g$ is independent of the choice of a trivialization Ψ , where \mathcal{M}_g is the mapping class group of Σ_g . We define $\rho_f : \pi_1(B \setminus f(\mathcal{C}), y_0) \rightarrow \mathcal{M}_g$ as follows:

$$\rho_f([\gamma]) = [\psi_1 \circ \psi_0^{-1}].$$

This map is well-defined and called a *monodromy representation* of f . If we define the group multiplication of \mathcal{M}_g as $[f] \cdot [g] = [g \circ f]$ for $[f], [g] \in \mathcal{M}_g$, then ρ_f is a homomorphism. In this paper, the group multiplication of \mathcal{M}_g is always defined as above. We remark that if we change the choice of a diffeomorphism ψ_0 , we obtain a new monodromy representation by composing an inner automorphism by a fixed element $\psi \in \mathcal{M}_g$. Two monodromy representations $\rho_f : \pi_1(B \setminus f(\mathcal{C}), y_0) \rightarrow \mathcal{M}_g$ and $\rho_{f'} : \pi_1(B' \setminus f'(\mathcal{C}'), y'_0) \rightarrow \mathcal{M}_g$ are *equivalent* if there exist an element $g \in \mathcal{M}_g$ and an orientation preserving diffeomorphism $h : (B, f(\mathcal{C}), y_0) \rightarrow (B', f'(\mathcal{C}'), y'_0)$ such that

$$\text{conj}(g) \circ \rho_f = \rho_{f'} \circ h_*,$$

where $\text{conj}(g)$ is the inner automorphism of \mathcal{M}_g by the element g and $h_* : \pi_1(B \setminus f(\mathcal{C}), y_0) \rightarrow \pi_1(B' \setminus f'(\mathcal{C}'), y'_0)$ is the isomorphism induced by h .

A monodromy representation of an LF over D^2 is written by a sequence of elements of the mapping class group as follows. We put $f(\mathcal{C}) = \{y_1, \dots, y_n\}$. Let A_1, \dots, A_n be embedded paths in D^2 , beginning at y_0 and otherwise disjoint, connecting y_0 to the respective critical values y_1, \dots, y_n . We choose indices so that the paths A_1, \dots, A_n are cyclically ordered by traveling counterclockwise around y_0 . We obtain an ordered basis a_1, \dots, a_n of $\pi_1(D^2 \setminus f(\mathcal{C}), y_0)$ by connecting a counterclockwise circle around each y_i to the base point y_0 by using A_i . Then the element $a_1 \cdot \dots \cdot a_n$ represents $[\partial D^2]$ in $\pi_1(D^2 \setminus f(\mathcal{C}), y_0)$. We put $W_f = (\rho_f(a_1), \dots, \rho_f(a_n))$. It is the sequence of elements of the mapping class group of Σ_g . We call this a *Hurwitz system of f* or a *monodromy factorization*. We put $w(W_f) = \rho_f(a_1) \cdot \dots \cdot \rho_f(a_n) \in \mathcal{M}_g$.

We obtain a sequence of elements of \mathcal{M}_g from an LF f over D^2 by choosing an identification ψ_0 and paths A_1, \dots, A_n as above. However, this sequence depends on these choices. We now review the effects of changing an identification and paths, see also [7], [11]. First, if we change an identification ψ_0 , then all the elements of the sequence are conjugated by a fixed element ψ of \mathcal{M}_g , i.e. $(\rho_f(a_1), \dots, \rho_f(a_n)) \rightarrow (\psi^{-1}\rho_f(a_1)\psi, \dots, \psi^{-1}\rho_f(a_n)\psi)$. We call this transformation a *simultaneous conjugation* by ψ . Second, if we change paths in D^2 as Figure 2.1, then the pair of the elements $(\varphi_i, \varphi_{i+1}) = (\rho_f(a_i), \rho_f(a_{i+1}))$ in W_f is replaced by the pair $(\varphi_{i+1}, \varphi_{i+1}^{-1} \cdot \varphi_i \cdot \varphi_{i+1})$. These transformations and their inverse are called *elementary transformations*. Lastly, if we change paths to other paths in D^2 satisfying the conditions mentioned above, then the sequence is changed by successive application of elementary transformations since any two paths satisfying the conditions are connected by successive application of isotopies in $D^2 \setminus f(\mathcal{C})$ and the moves shown in Figure 2.1.(c.f.[7])

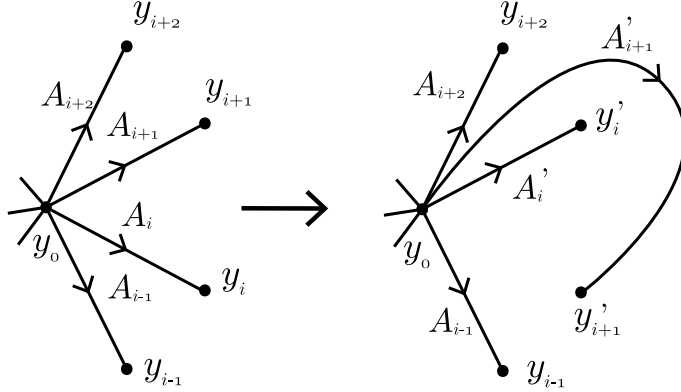

FIGURE 2.1.

From the above arguments, we obtain:

Lemma 2.3. *Let $f_i : M_i \rightarrow D^2$ ($i = 1, 2$) be a genus- g LF and W_{f_i} a Hurwitz system ($i = 1, 2$). If W_{f_1} is changed into W_{f_2} by successive application of simultaneous conjugations and elementary transformations, then f_1 and f_2 are isomorphic. (i.e. there exist orientation preserving diffeomorphisms $\Phi : M_1 \rightarrow M_2$ and $\varphi : D^2 \rightarrow D^2$ such that $\varphi \circ f_1 = f_2 \circ \Phi$)*

Let $[f]$ be an element of \mathcal{M}_1 . $[f]$ induces an isomorphism $f_* : H_1(T^2; \mathbb{Z}) \rightarrow H_1(T^2; \mathbb{Z})$. We fix generators μ and λ of $H_1(T^2; \mathbb{Z})$. Then f is represented by a matrix $A \in SL(2, \mathbb{Z})$ as follows:

$$(f_*(\mu), f_*(\lambda)) = (\mu, \lambda)^t A.$$

The correspondence $[f] \mapsto A$ induces an isomorphism between the groups \mathcal{M}_1 and $SL(2, \mathbb{Z})$. We assume that $\mu \cdot \lambda = 1$, where $\mu \cdot \lambda$ represents the intersection number of μ and λ . In this paper, we always identify the group \mathcal{M}_1 with the group $SL(2, \mathbb{Z})$ via the above isomorphism.

Let $\gamma_{p,q}$ be a simple closed curve on T^2 representing the element $p\mu + q\lambda$ in $H_1(T^2; \mathbb{Z})$ for relatively prime integers p, q and $T_{p,q} \in \mathcal{M}_1$ the right-handed Dehn twist along $\gamma_{p,q}$. Then, by the Picard-Lefschetz formula,

$$T_{1,0} = \begin{pmatrix} 1 & 0 \\ 1 & 1 \end{pmatrix}, \quad T_{0,1} = \begin{pmatrix} 1 & -1 \\ 0 & 1 \end{pmatrix}.$$

If we put $X_1 = \begin{pmatrix} 1 & 0 \\ 1 & 1 \end{pmatrix}$, $X_2 = \begin{pmatrix} 1 & -1 \\ 0 & 1 \end{pmatrix}$, then $SL(2, \mathbb{Z})$ has the following finite presentation [10]:

$$SL(2, \mathbb{Z}) = \langle X_1, X_2 | (X_1 X_2)^6, X_1 X_2 X_1 X_2^{-1} X_1^{-1} X_2^{-1} \rangle.$$

Let $f : M \rightarrow S^2$ be a genus-1 SBLF, then the higher side of f is a genus-1 LF over D^2 . So we can take a Hurwitz system of this fibration. We call this a *Hurwitz system* of f .

2.3. Kirby diagrams of broken Lefschetz fibrations. The technique of handle decomposition of BLFs was studied in [3]. We review this technique in this subsection. The reader should turn to [3] for the details of this technique and the examples of Kirby diagrams of BLFs. We begin with the definition of (4-dimensional) round handles, which arises in the discussion of this subsection.

Definition 2.4. Let M be a smooth 4-manifold and we put

$$R_i^\pm = I \times D^i \times D^{3-i} / ((1, x_1, x_2, x_3) \sim (0, \pm x_1, x_2, \pm x_3)).$$

where $i = 1, 2$. Let $\psi : I \times \partial D^i \times D^{3-i} / \sim \rightarrow \partial M$ be an embedding. We call $M \cup_\psi R_i^\pm$ a 4-manifold obtained by attaching a *round i -handle* and R_i^+ (resp. R_i^-) (*4-dimensional*) *untwisted* (resp. *twisted*) *round i -handle*.

Remark 2.5. In [3], round handles of arbitrary dimension are defined, but in this paper, only 4-dimensional ones appear. Throughout this paper, we assume that round handles are always of 4-dimension. Both untwisted and twisted round handles are diffeomorphic to $S^1 \times D^3$, but attaching regions of two round handles are different. The attaching region of an untwisted round i -handle is the trivial $S^{i-1} \times D^{3-i}$ -bundle over S^1 , while the attaching region of a twisted round i -handle is a non-trivial $S^{i-1} \times D^{3-i}$ -bundle over S^1 .

The following lemma shows that a round handle attachment is described by attaching two handles with consecutive indices:

Lemma 2.6 ([3]). *For $i \in \{1, 2\}$, round i -handle attachment is given by i -handle attachment followed by $(i + 1)$ -handle attachment whose attaching sphere goes over the belt sphere of the i -handle geometrically twice, algebraically zero times if the round handle is untwisted and twice if the round handle is twisted.*

The next lemma shows relation between round handle attachment and handle decomposition of broken Lefschetz fibrations:

Lemma 2.7 ([3]). *Let W be a round cobordism of a BLF with connected round singular locus $Z \subset W$ and $\partial_- W \subset \partial W$ the union of connected components of the boundary of W facing to the lower side. Then W is obtained by attaching an untwisted or twisted round 1-handle to $\partial_- W \times I$. Moreover, the restriction of the BLF to $\psi(I \times \partial D^1 \times \{0\} / \sim) \subset \partial_- W \times \{1\}$ is a double cover of the image of this map, where ψ is the attaching map of the round handle.*

Remark 2.8. We also obtain a round cobordism W by a round 2-handle attachment via dual handle decomposition. More precisely, let $\partial_+ W \subset \partial W$ be the union of connected components of the boundary of W facing to the higher side, then W is obtained by attaching an untwisted or twisted round 2-handle to $\partial_+ W \times I$. Moreover, as above lemma, when the BLF restricts to $\psi(I \times \partial D^2 \times \{0\} / \sim) \subset \partial_+ W \times I$, this map is S^1 -bundle over the image of the map, which is trivial if the round handle is untwisted and non-trivial if the round handle is twisted, where ψ is the attaching map of the round handle.

This lemma says that a round cobordism is described by a round handle attachment. Conversely, let $f : M \rightarrow B$ be a BLF and \tilde{M} the manifold obtained by attaching a round handle whose attaching map satisfies the condition mentioned above, then we can extend the map f to a BLF $\tilde{f} : \tilde{M} \rightarrow B$ which has only one round singular locus in the round handle at the center of the core of the fiberwise attached 1-handle (resp. 2-handle) if the index of the round handle is 1 (resp. 2).

We are ready to discuss Kirby diagrams of BLF. We begin with discussion of diagrams of round 1-handles. By Lemma 2.6, we can describe a diagram of a round 1-handle as shown in Figure 2.2. Moreover, by Lemma 2.7, the bold curves in Figure 2.2 is a double cover if a round 1-handle describes a round cobordism of BLF.

A round cobordism can be also described by a round 2-handle attachment, which is given by 2-handle attachment followed by 3-handle attachment. By the condition mentioned in Remark 2.8, round 2-handle attachment to a BLF is realized as a fiberwise 2-handle attachment if the round handle describes a round cobordism of an extended BLF. Let H_2 (resp. H_3) be a 2-handle (resp. 3-handle) of such a round 2-handle, then the attaching circle of H_2 is in a regular fiber of the surface bundle in the boundary of the BLF and its framing is along the regular fiber. Moreover, the attaching circle of H_2 is preserved under the monodromy of the surface bundle up to isotopy. As usual, we do not draw the 3-handle H_3 , which is forced to be attached in a way that it completes fiberwise 2-handle attachment. Thus we only draw the attaching circle of the 2-handle when we draw the round 2-handle and the difference between the untwisted and twisted cases is somewhat implicit. However, we can

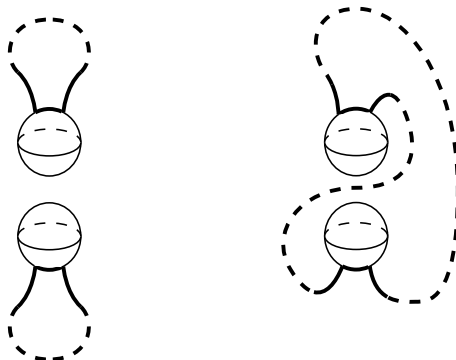

FIGURE 2.2. the left diagram is the untwisted round handle, while the right diagram is the twisted one.

distinguish these two cases by the action of the monodromy representation of the boundary surface bundle; the round 2-handle is untwisted if this action preserves the orientation of the attaching circle and twisted if this action reverses the orientation of the attaching circle.

3. CHART DESCRIPTIONS

In [8], chart descriptions were introduced to describe a monodromy representation of a genus-1 ALF. We modify the definition of a chart description to describe a monodromy representation of a higher side of a genus-1 SBLF and show that such a monodromy representation satisfies a kind of condition in this section. We begin with the modified definition of a chart.

Definition 3.1. Let Γ be a finite graph in D^2 (possibly being empty or having *hoops* that are closed edges without vertices). Then Γ is called a *chart* if Γ satisfies the following conditions:

- (1) the degree of each vertex is equal to 1, 6 or 12;
- (2) each vertex in ∂D^2 has degree-1;
- (3) each edge in Γ is labeled 1 or 2 and oriented;
- (4) for a degree-1 vertex which is in $\text{int}D^2$, the incident edge is oriented inward (see Figure 3.1);
- (5) for a degree-6 vertex, the six incident edges are labeled alternately with 1 and 2, and three consecutive edges are oriented inward and the other three edges are oriented outward (see Figure 3.1, where $\{i, j\} = \{1, 2\}$);
- (6) for a degree-12 vertex, the twelve incident edges are labeled alternately with 1 and 2, and all edges are oriented inward or all edges are oriented outward (see Figure 3.1, where $\{i, j\} = \{1, 2\}$);
- (7) an interior of each edge is in $\text{int}D^2$;
- (8) let $\{v_1, \dots, v_n\}$ be the set of vertices in ∂D^2 . We assume that the indices are chosen so that v_1, \dots, v_n appear in this order when we travel counterclockwise on ∂D^2 . We define a pair (i_k, ε_k) by the following rules:

- (i) i_k is a label of the edge e whose end is v_k ;
- (ii) ε_k is $+1$ if e is oriented away from v and -1 if e is oriented toward v .

Then, for some k , the sequence $((i_k, \varepsilon_k), \dots, (i_n, \varepsilon_n), (i_1, \varepsilon_1), \dots, (i_{k-1}, \varepsilon_{k-1}))$ consists of following subsequences:

- (a) $((1, \varepsilon))$;
- (b) $((i, \varepsilon), (j, \varepsilon), (i, \varepsilon), (j, \varepsilon), (i, \varepsilon), (j, \varepsilon))$ ($\{i, j\} = \{1, 2\}$),

where ε is equal to 1 or 2.

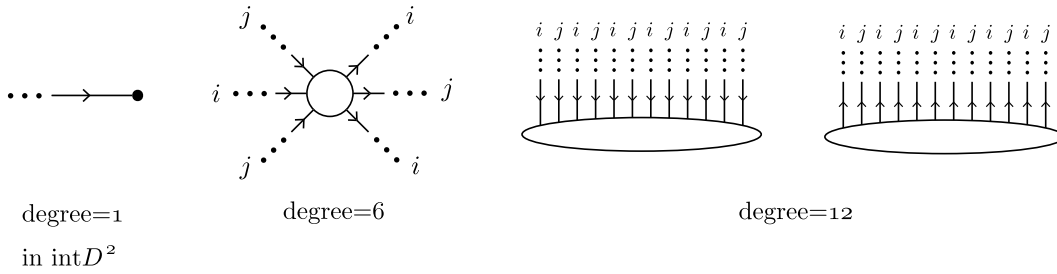

FIGURE 3.1. vertices of a chart.

An example of a chart is illustrated in Figure 3.2. For this chart, the sequence mentioned in the condition (8) of the definition of charts is as follows:

$$((1, -1), (1, -1), (1, -1), (1, -1), (2, +1), (1, +1), (2, +1), (1, +1), (2, +1), (1, +1)),$$

which satisfies the condition mentioned in the definition.

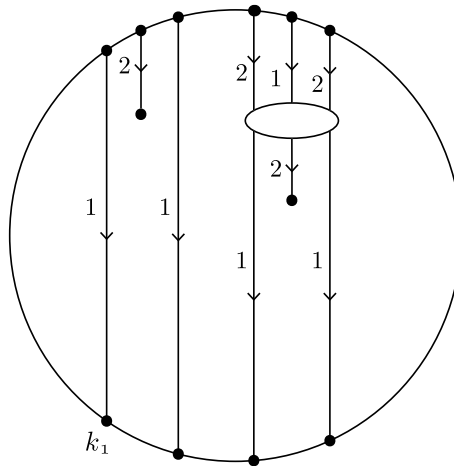

FIGURE 3.2. An example of a chart

For a chart Γ , we denote by $V(\Gamma)$ the set of all the vertices of Γ , and by S_Γ the subset of $V(\Gamma)$ consisting of the degree-1 vertices in $\text{int}D^2$. Let v be a vertex of Γ . An edge e incident

to v is called an *incoming edge* of v if e is oriented toward v and an *outgoing edge* of v if e is oriented away from v .

An degree-1 or 12 vertex of a chart is *positive* (resp. *negative*) if all the edges incident to the vertex is outgoing edge (resp. incoming edge) of the vertex. We remark that each degree-1 vertex in $\text{int}D^2$ is negative by the definition of charts.

Among the six edges incident to a degree-6 vertex v of a chart, three consecutive edges are incoming edges of v and the other three edges are outgoing edges of v . We call the middle edge of the three incoming edges or the three outgoing edges a *middle edge* and another edge a *non-middle edge*.

An edge in a chart is called a (d_1, d_2) -edge if its end points are a degree- d_1 vertex and a degree- d_2 vertex, where $d_1, d_2 \in \{1, 6, 12\}$ and $d_1 \leq d_2$. An edge in a chart is called a (∂, d) -edge if one of its end points is in ∂D^2 and the other is degree- d vertex, where $d \in \{1, 6, 12\}$, and we call an edge whose two end points are in ∂D^2 a (∂, ∂) -edge. A $(\partial, *)$ -edge is called a *boundary edge*, where $* \in \{1, 6, 12, \partial\}$.

For a chart Γ , let $((i_1, \varepsilon_1), \dots, (i_n, \varepsilon_n))$ be a sequence determined by the rule mentioned in the condition (8) of the definition of charts. We assume that indices are chosen so that this sequence consists of the two subsequences; $((1, \varepsilon))$ and $((i, \varepsilon), (j, \varepsilon), (i, \varepsilon), (j, \varepsilon), (i, \varepsilon), (j, \varepsilon))$ ($\{i, j\} = \{1, 2\}$), where $\varepsilon = 1$ or 2 . We call such a sequence a *boundary sequence* of Γ and two subsequences above the *unit subsequences*. For a fixed decomposition of the sequence into the unit subsequences, the union of six vertices which corresponds to a subsequence $((i, \varepsilon), (j, \varepsilon), (i, \varepsilon), (j, \varepsilon), (i, \varepsilon), (j, \varepsilon))$ and the six edges incident to the vertices is called a *boundary comb* of Γ with respect to the fixed decomposition.

Let Γ be a chart in D^2 . A path $\eta : [0, 1] \rightarrow D^2$ is said to be *in general position* with respect to Γ if $\eta([0, 1]) \cap \Gamma$ is empty or consists of finite points in $\Gamma \setminus V(\Gamma)$ and η intersects edges of Γ transversely. Let η be such a path. We put $\eta([0, 1]) \cap \Gamma = \{p_1, \dots, p_n\}$. We assume that p_1, \dots, p_n appear in this order when we go along η from $\eta(0)$ to $\eta(1)$. For each p_i , we define a letter $w_i = X_k^\varepsilon$ by following rules:

- (i) k is the label of the edge of Γ containing the point p_i ;
- (ii) ε is equal to $+1$ if the intersection number $\eta \cdot$ (the edge containing p_i) is $+1$ and -1 if the intersection number $\eta \cdot$ (the edge containing p_i) is -1 .

We put $w_\Gamma(\eta) = w_1, \dots, w_n$ and call this word the *intersection word* of η with respect to Γ . We assume that this word represents an element of $SL(2, \mathbb{Z})$ by regarding the letters X_1, X_2 as the matrices defined in subsection 2.2.

Definition 3.2. Let Γ be a chart in D^2 . We fix a point $y_0 \in D^2 \setminus V(\Gamma)$. We define a homomorphism

$$\rho_\Gamma : \pi_1(D^2 \setminus S_\Gamma, y_0) \rightarrow SL(2, \mathbb{Z})$$

as follows: For an element $x \in \pi_1(D^2 \setminus S_\Gamma, y_0)$, we choose a representative path

$$\eta : [0, 1] \rightarrow D^2 \setminus S_\Gamma$$

of x so that η is in general position with respect to Γ . Then we put $\rho_\Gamma(x) = w_\Gamma(\eta)$. We call the homomorphism ρ_Γ the *monodromy representation associated with Γ* .

We can prove the following lemma by an argument similar to that given in the proof of Lemma 12 of [8].

Lemma 3.3. *The homomorphism $\rho_\Gamma : \pi_1(D^2 \setminus S_\Gamma, y_0) \rightarrow SL(2, \mathbb{Z})$ is well-defined.*

Since the monodromy of the boundary of the higher side of a genus-1 SBLF fixes a simple closed curve in a regular fiber, the monodromy is represented by an element $\pm X_1^m$, where m is an integer. So we can also prove the following lemma by the same argument as that in the proof of Theorem 15 of [8].

Lemma 3.4. *Let $f : M \rightarrow S^2$ be a genus-1 SBLF. Then there exists a chart Γ in D^2 such that the monodromy representation of the higher side of f is equal to the monodromy representation associated with Γ up to inner automorphisms of $SL(2, \mathbb{Z})$.*

By Lemma 3.4, the monodromy representation of the higher side of a genus-1 SBLF is represented by a chart. However, such a chart is not unique. We next introduce moves of charts which do not change the associated monodromy representations.

Lemma 3.5. *Let Γ_1 and Γ_2 be charts and $E \subset D^2$ a 2-disk. We assume that the following conditions:*

- (a) $E \cap S_{\Gamma_i} = \emptyset$ ($i = 1, 2$);
- (b) Γ_1 and Γ_2 are identical outside of E ;
- (c) $D^2 \setminus E$ is path connected.

Then the monodromy representation associated with Γ_1 is equal to the one associated with Γ_2 .

We can prove Lemma 3.5 similarly to the proof of Lemma 16 in [8].

Definition 3.6. When two charts Γ_1 and Γ_2 are in the situation of Lemma 3.5, we say that Γ_1 is obtained from Γ_2 by a *CI-move* in E . Especially, a CI-move described in Figure 3.3 is called a *channel change*.

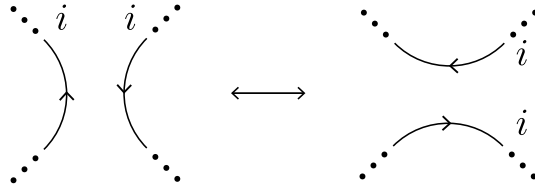

FIGURE 3.3. a channel change

Lemma 3.7. *Let Γ_1 and Γ_2 be charts and $E \subset D^2$ a 2-disk. We assume that the following conditions:*

- (a) Γ_1 and Γ_2 are differ by one of Figure 3.4 in E ;
- (b) Γ_1 and Γ_2 are identical outside of E ;
- (c) $D^2 \setminus E$ is path connected.

Then the monodromy representation associated with Γ_1 is equal to the one associated with Γ_2 up to an equivalence.

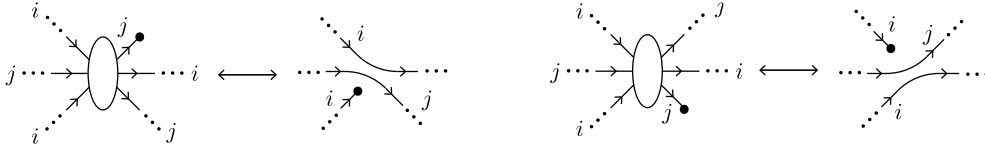

FIGURE 3.4. CII-moves

The proof of Lemma 3.7 is quite similar to that of Lemma 18 of [8]. So we omit it.

Definition 3.8. When two charts Γ_1 and Γ_2 are in the situation of Lemma 3.7, we say that Γ_1 is obtained from Γ_2 by a *CII-move* in E .

Remark 3.9. CII-moves defined in [8] have four types of substitution (see Figure 6 of [8]), while CII-moves we defined have only two types of substitution illustrated in Figure 3.4. This is because charts defined in [8] may have positive degree-1 vertices in $\text{int}D^2$ but our charts never have by the definition.

By a *C-move*, we mean a CI-move, CII-move or an isotopic deformation in D^2 . Two charts are *C-move equivalent* if they are related by a finite sequence of C-moves. The monodromy representations associated with such charts is equivalent by Lemma 3.5 and Lemma 3.7.

Theorem 3.10. Let $f : M \rightarrow S^2$ be a genus-1 SBLF and W_f a Hurwitz system of f . Then by successive application of simultaneous conjugations and elementary transformations, we can change W_f into a sequence W which satisfies the following conditions:

- (a) $w(W) = \pm X_1^m$;
- (b) $W = (X_1, \dots, X_1, X_1^{-n_1} X_2 X_1^{n_1}, \dots, X_1^{-n_s} X_2 X_1^{n_s})$,

where m, n_1, \dots, n_s are integers.

Lemma 3.11. Let Γ be a chart. Then by successive application of C-moves, we can change Γ into a chart which has no degree-12 vertices.

Proof. We first remark that a chart move illustrated in Figure 3.5 is a CI-move, where two vertices v_1 and v_2 satisfy one of the following conditions:

- (a) v_1 and v_2 are not contained in a same boundary comb;
- (b) v_1 and v_2 are end points of a boundary comb.

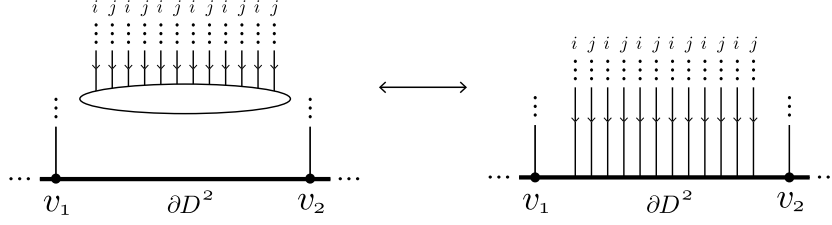

FIGURE 3.5. CI-moves used to prove Lemma 3.11, where the bold lines represent ∂D^2 .

We choose a decomposition of the boundary sequence of Γ into the unit subsequences. Let v_1 and v_2 be consecutive vertices in ∂D^2 which satisfy one of the conditions (a) and (b) as above. We denote by S the connected component of $\partial D^2 \setminus (\partial D^2 \cap \Gamma)$ between v_1 and v_2 . We can move all the degree-12 vertices in Γ into a region of $\partial D^2 \setminus \Gamma$ containing S by using CI-moves illustrated in Figure 12 of [8]. Then, by the CI-move illustrated in Figure 3.5, we can eliminate all the degree-12 vertices in Γ . This completes the proof of Lemma 3.11. \square

Lemma 3.12. *Let Γ be a chart. Then, by successive application of C-moves, we can change Γ into a chart Γ' such that each $(1, 6)$ -edge e in Γ' satisfies the following conditions:*

- (i) e is a middle edge;
- (ii) the label of e is 2;
- (iii) let K be the connected component of $D^2 \setminus \Gamma'$ whose closure contains e . Then $K \cap \partial D^2$ is not empty.

The idea of the proof of Lemma 3.12 is similar to the proof of Lemma 22 in [8]. But two proofs are slightly different because of the difference of the definition of charts. So we give the full proof below.

Proof. Let $n(\Gamma)$ be the sum of the number of degree-6 vertices and the number of $(1, 6)$ -edges in Γ . The proof proceeds by induction on $n(\Gamma)$.

If $n(\Gamma) = 0$, the conclusion of Lemma 3.12 holds since Γ has no $(1, 6)$ -edges. We assume that $n(\Gamma) > 0$ and Γ does not satisfy at least one of the condition (i), (ii) or (iii) of Lemma 3.12.

Case.1: Suppose that Γ has a non-middle $(1, 6)$ -edge. Let v be a degree-6 vertex which is an end point of a $(1, 6)$ -edge. We can apply a CII-move around v and eliminate this vertex. Then one of the following occurs:

- both the number of degree-6 vertices and the number of $(1, 6)$ -edges decrease;
- the number of $(1, 6)$ -edges is unchanged, but the number of degree-6 vertices decreases;

In each case, $n(\Gamma)$ decreases and the conclusion holds by the induction hypothesis.

Case.2: Suppose that Γ has a middle $(1, 6)$ -edge whose label is 1. Let e be the edge and v_0 and v_1 the end points of e whose degrees are 1 and 6, respectively. We denote by K the

connected component of $D^2 \setminus \Gamma$ whose closure contains v_0 , v_1 and e . We take a sequence f_1, \dots, f_m of edges of Γ with signs as in the proof of Lemma 22 of [8]. For each f_i , we take a letter $w(f_i) = X_k^\varepsilon$, where k is equal to the label of the edge f_i and ε is equal to the sign of f_i . We remark that both f_1 and f_m are equal to e and the sign of f_1 is negative, while the sign of f_m is positive, since the vertex v_0 is negative.

Case.2.1: There exists a consecutive pair f_i and f_{i+1} such that two edges are incident to a common vertex and

$$(w(f_i), w(f_{i+1})) = (X_1^{-1}, X_2^{-1}).$$

Case.2.2: There exists a consecutive pair f_i and f_{i+1} such that two edges are incident to a common vertex and

$$(w(f_i), w(f_{i+1})) = (X_2, X_1).$$

Case.2.3: $K \cap \partial D^2 = \emptyset$.

If one of the above three cases occurs, then the conclusion holds by the same argument as that in Lemma 22 of [8].

Case.2.4: Suppose that $K \cap \partial D^2 \neq \emptyset$. Then one of the edges f_1, \dots, f_m is a boundary edge. By Cases 2.1 and 2.2, we can assume that $(w(f_i), w(f_{i+1}))$ is not equal to the subsequences (X_1^{-1}, X_2^{-1}) and (X_2, X_1) if f_i and f_{i+1} are incident to a common vertex. Let f_k be a boundary edge with the smallest index. By the assumption above, $w(f_k)$ is equal to either X_1^{-1} or X_2 . If $w(f_k) = X_1^{-1}$, we can decrease the number of $(1, 6)$ -edges by applying C-moves illustrated in Figure 3.6. So the conclusion holds by the induction hypothesis.

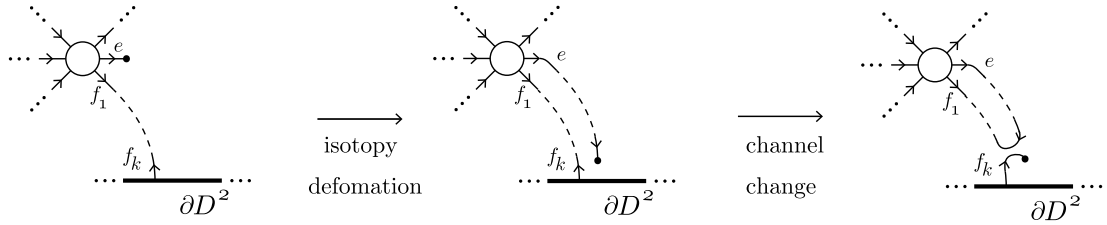

FIGURE 3.6. The bold line in the figure describes ∂D^2 .

Suppose that $w(f_k) = X_2$. One of f_{k+1}, \dots, f_m is a boundary edge but not a $(\partial, 1)$ -edge. Let f_l be such an edge with the smallest index.

Case.2.4.1: Suppose that $w(f_l) = X_1$. Then we can decrease the number of $(1, 6)$ -edges by applying C-moves illustrated in Figure 3.7 and the conclusion holds by the induction hypothesis.

Case.2.4.2: Suppose that $w(f_l) = X_2$. When we fix a decomposition of the boundary sequence of Γ into unit subsequences, f_k is contained in a boundary comb which is different to a boundary comb that f_l contains. So we can apply C-moves as shown in Figure 3.8 and conclusion holds by induction.

Case.2.4.3: Suppose that $w(f_l) = X_2^{-1}$. If both f_k and f_l were contained in a same boundary comb, there would be at least one $(\partial, 1)$ -edge between f_k and f_l . But all the

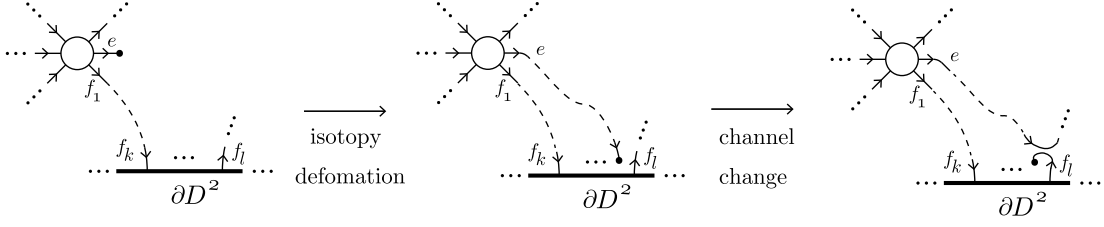

FIGURE 3.7.

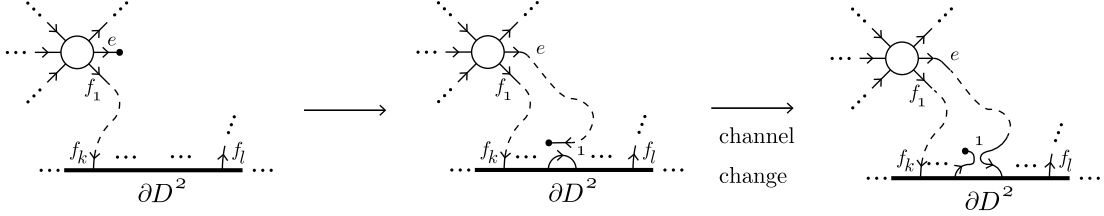

FIGURE 3.8. We first apply CI-move between the two boundary comb which contain f_k and f_l , respectively, and we obtain a new 1-labeled (∂, ∂) -edge. Then we move v_0 near this edge by isotopy deformation and apply a channel change.

degree-1 edges are negative. This contradiction says that a boundary comb that contains f_k is different to a boundary comb that contains f_l . So we can apply C-moves similar to the C-moves we use in Case.2.4.2. And the conclusion holds by induction hypothesis.

Case.2.4.4: Suppose that $w(f_l) = X_1^{-1}$. If each f_{l+1}, \dots, f_m were not a boundary edge, then,

$$(w(f_l), \dots, w(f_m)) = (X_1^{-1}, X_2, X_1^{-1}, X_2, \dots)$$

This contradicts $w(f_m) = X_1$. So at least one of f_{l+1}, \dots, f_n is a boundary edge. Let $f_{k'}$ be such an edge with smallest index. Then $w(f_{k'})$ is equal to either X_1^{-1} or X_2 . If $w(f_{k'}) = X_1^{-1}$, the conclusion holds by the above argument. If $w(f_{k'}) = X_2$, one of four cases above occurs for $f_{k'}$. When one of the former three cases occurs, the conclusion holds by the same argument. When Case.2.4.4 occurs for $f_{k'}$, we can take $f_{k''}$ again as we take $f_{k'}$. We can repeat the above argument and thus the conclusion holds since m is finite.

Case.3: Suppose that Γ has a middle $(1, 6)$ -edge whose label is 2. We define K as we defined in Case.2. If $K \cap \partial D^2 = \emptyset$, we can prove the conclusion by the same argument as that in Cases 2.1, 2.2 and 2.3. So we conclude that $K \cap \partial D^2 \neq \emptyset$.

Combining the conclusions of Cases.1, 2 and 3, we complete the proof of Lemma 3.12. \square

Proof of Theorem 3.10: By Lemma 3.4, we can take a chart Γ that ρ_Γ is equal to the monodromy representation of the higher side of f up to inner automorphisms of $SL(2, \mathbb{Z})$. We first eliminate degree-12 vertices in Γ by applying Lemma 3.11. Then, by applying

Lemma 3.12, we change the chart Γ into a chart that all the $(1, 6)$ -edges in the charts satisfy the conditions (i), (ii) and (iii) in Lemma 3.12. In the process to prove Lemma 3.12, no new degree-12 vertices appear. So the chart obtained by the above process has no degree-12 vertices. Let $\{v_1, \dots, v_m\}$ be the set of degree-1 vertices of Γ in ∂D^2 . We choose the indices of v_i so that v_1, \dots, v_m appear in this order when we travel counterclockwise on ∂D^2 and that v_1 and v_m satisfy one of the following conditions:

- v_1 and v_m are not contained in a same boundary comb;
- v_1 and v_m are end points of a boundary comb.

We denote by e_i a boundary edge incident to v_i . We put $S_\Gamma = \{p_1, \dots, p_n\}$. Let K_i be a connected component of $D^2 \setminus \Gamma$ whose closure contains p_i . By the assumption about Γ , each p_i is an end point of either $(1, 6)$ -edge or $(\partial, 1)$ -edge. For each p_i which is an end point of $(1, 6)$ -edge, we choose a connected component E_i of $K_i \cap \partial D^2$. We denote the two points of ∂E_i by v_{k_i} and v_{k_i+1} , where $k_i \in \{1, \dots, m\}$ and $v_{m+1} = v_1$. Let V be a sufficiently small collar neighborhood of ∂D^2 in D^2 and p_0 a point in $V \cap K$, where K is a connected component of $D^2 \setminus \Gamma$ whose closure contains a connected component of $\partial D^2 \setminus \{v_1, \dots, v_m\}$ between v_m and v_1 . We take embedded paths A_i ($i=1, \dots, n$) in D^2 starting from p_0 as follows:

- (a) if $i \neq j$, then $A_i \cap A_j = \{p_0\}$;
- (b) if p_i is incident to a $(\partial, 1)$ -edge e_j , then A_i starts from p_0 , travels in V across the edges e_1, \dots, e_{j-1} , goes into K_i and ends at p_i ;
- (c) if p_i is incident to a $(1, 6)$ -edge, then A_i starts from p_0 , travels in V across the edges e_1, \dots, e_{k_i-1} , goes into K_i and ends at p_i .

For example, the paths A_1, \dots, A_n are as shown in Figure 3.9 for the charts described in Figure 3.2.

Let a_i be an element of $\pi_1(D^2 \setminus S_\Gamma, p_0)$ which is represented by a curve obtained by connecting counterclockwise circle around p_i to the base point p_0 by using A_i . It is sufficient to prove that each $\rho_\Gamma(a_i)$ is equal to either X_1 or $X_1^{-n} X_2 X_1^n$, where n is an integer.

Case.1: Suppose that p_i is an end point of $(1, 6)$ -edge and e_{k_i} is not contained in a boundary comb. Then the intersection word of A_i is equal to X_1^n . So $\rho_\Gamma(a_i)$ is equal to X_1 if the label of the $(1, 6)$ -edge is 1 and $X_1^n X_2 X_1^{-1}$ if the label of the $(1, 6)$ -edge is 2.

Case.2: Suppose that p_i is an end point of $(\partial, 1)$ -edge and the edge is not contained in a boundary comb. Then the intersection word of A_i is equal to X_1^n and the conclusion holds.

Case.3: Suppose that p_i is an end point of $(1, 6)$ -edge and e_{k_i} is contained in a boundary comb. Let e_l and e_{l+6} be two edges at the end of the boundary comb which contains e_{k_i} . Then one of 24 cases illustrated in Figure 3.10 occurs. The intersection word of a path which starts from p_0 , travels in V across the edges e_1, \dots, e_{l-1} , ends near the boundary comb is equal to X_1^n , where n is an integer. Since the label of the $(1, 6)$ -edge incident to p_i is 2,

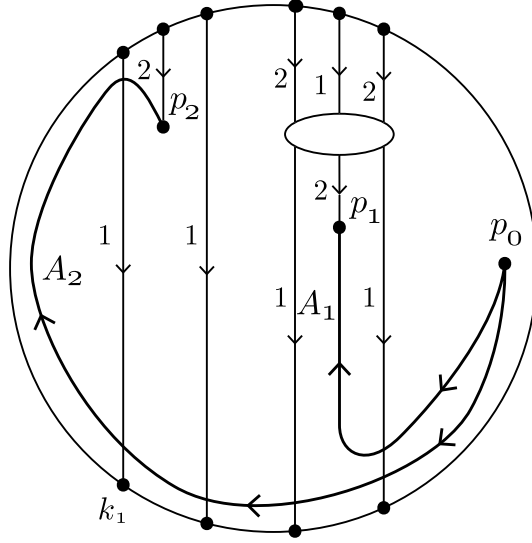

FIGURE 3.9. Examples of paths A_1, \dots, A_n determined by the condition (a) and the constructions (b) and (c).

$\rho_\Gamma(a_i)$ is calculated as follows:

$$\rho_\Gamma(a_i) = \begin{cases} X_1^{n+1} X_2 X_1^{-n-1} & \text{(If the case (1) or (2) occurs.)}, \\ X_1^{n+1} X_2 X_1 X_2 X_1^{-1} X_2^{-1} X_1^{-n-1} & \text{(If the case (3) or (4) occurs.)}, \\ X_1^{n+1} X_2 X_1 X_2 X_1 X_2 X_1^{-1} X_2^{-1} X_1^{-1} X_2^{-1} X_1^{-n-1} & \text{(If the case (5) or (6) occurs.)}, \\ X_1^n X_2 X_1^{-n} & \text{(If the case (7) occurs.)}, \\ X_1^n X_2 X_1 X_2 X_1^{-1} X_2^{-1} X_1^{-n} & \text{(If the case (8) or (9) occurs.)}, \\ X_1^n X_2 X_1 X_2 X_1 X_2 X_1^{-1} X_2^{-1} X_1^{-1} X_2^{-1} X_1^{-n} & \text{(If the case (10) or (11) occurs.)}, \\ X_1^n X_2 X_1 X_2 X_1 X_2 X_1 X_2 X_1^{-1} X_2^{-1} X_1^{-1} X_2^{-1} X_1^{-1} X_2^{-1} X_1^{-n} & \text{(If the case (12) occurs.)}, \\ X_1^{n-1} X_2 X_1^{-n+1} & \text{(If the case (13) or (14) occurs.)}, \\ X_1^{n-1} X_2^{-1} X_1^{-1} X_2 X_1 X_2 X_1^{-n+1} & \text{(If the case (15) or (16) occurs.)}, \\ X_1^{n-1} X_2^{-1} X_1^{-1} X_2^{-1} X_1^{-1} X_2 X_1 X_2 X_1 X_2 X_1^{-n+1} & \text{(If the case (17) or (18) occurs.)}, \\ X_1^n X_2 X_1^{-n} & \text{(If the case (19) occurs.)}, \\ X_1^n X_2^{-1} X_1^{-1} X_2 X_1 X_2 X_1^{-n} & \text{(If the case (20) or (21) occurs.)}, \\ X_1^n X_2^{-1} X_1^{-1} X_2^{-1} X_1^{-1} X_2 X_1 X_2 X_1 X_2 X_1^{-n} & \text{(If the case (22) or (23) occurs.)}, \\ X_1^n X_2^{-1} X_1^{-1} X_2^{-1} X_1^{-1} X_2^{-1} X_1^{-1} X_2 X_1 X_2 X_1 X_2 X_1 X_2 X_1^{-n} & \text{(If the case (24) occurs.)}. \end{cases}$$

Since $X_1X_2X_1X_2^{-1}X_1^{-1}X_2^{-1} = (X_1X_2)^6 = 1$, we obtain:

$$\rho_\Gamma(a_i) = \begin{cases} X_1^{n+1}X_2X_1^{-n-1} & \text{(If the case (1), (2), (22) or (23) occurs.)}, \\ X_1 & \text{If the case (3), (4), (8), (9), (15), (16), (20) or (21) occurs.}, \\ X_1^{n-1}X_2X_1^{-n+1} & \text{(If the case (5), (6), (10), (11), (13) or (14) occurs.)}, \\ X_1^nX_2X_1^n & \text{(If the case (7), (12), (17), (18), (19) or (24) occurs.)}. \end{cases}$$

For each case, the conclusion holds.

Case.4: Suppose that p_i is an end point of $(\partial, 1)$ -edge e_j and e_j is contained in a boundary comb. Let e_l and e_{l+6} be two edges at the end of the boundary comb which contains e_j . Since the degree-1 vertex p_i is negative, one of 12 cases illustrated in Figure 3.11 occurs. We assume that the intersection word of a path which starts from p_0 , travels in V across the edges e_1, \dots, e_{l-1} , ends near the boundary comb is equal to X_1^n , where n is an integer. Then $\rho_\Gamma(a_i)$ is calculated as follows:

$$\rho_\Gamma(a_i) = \begin{cases} X_1 & \text{(If the case (1) occurs.)}, \\ X_1^{n+1}X_2X_1^{-n-1} & \text{(If the case (2) occurs.)}, \\ X_1^{n+1}X_2X_1X_2^{-1}X_1^{-n-1} & \text{(If the case (3) occurs.)}, \\ X_1^{n+1}X_2X_1X_2X_1^{-1}X_2^{-1}X_1^{-n-1} & \text{(If the case (4) occurs.)}, \\ X_1^{n+1}X_2X_1X_2X_1X_2^{-1}X_1^{-1}X_2^{-1}X_1^{-n-1} & \text{(If the case (5) occurs.)}, \\ X_1^{n+1}X_2X_1X_2X_1X_2X_1^{-1}X_2^{-1}X_1^{-1}X_2^{-1}X_1^{-n-1} & \text{(If the case (6) occurs.)}, \\ X_1^nX_2X_1^{-n} & \text{(If the case (7) occurs.)}, \\ X_1^nX_2X_1X_2^{-1}X_1^{-n} & \text{(If the case (8) occurs.)}, \\ X_1^nX_2X_1X_2X_1^{-1}X_2^{-1}X_1^{-n} & \text{(If the case (9) occurs.)}, \\ X_1^nX_2X_1X_2X_1X_2^{-1}X_1^{-1}X_2^{-1}X_1^{-n} & \text{(If the case (10) occurs.)}, \\ X_1^nX_2X_1X_2X_1X_2X_1^{-1}X_2^{-1}X_1^{-1}X_2^{-1}X_1^{-n} & \text{(If the case (11) occurs.)}, \\ X_1^nX_2X_1X_2X_1X_2X_1X_2^{-1}X_1^{-1}X_2^{-1}X_1^{-1}X_2^{-1}X_1^{-n} & \text{(If the case (12) occurs.)}. \end{cases}$$

By the relations of $SL(2, \mathbb{Z})$, we obtain:

$$\rho_\Gamma(a_i) = \begin{cases} X_1 & \text{(If the case (1), (4), (9) or (12) occurs.)}, \\ X_1^{n+1}X_2X_1^{-n-1} & \text{(If the case (2) or (5) occurs.)}, \\ X_1^nX_2X_1^{-n} & \text{(If the case (3), (6), (7) or (10) occurs.)}, \\ X_1^{n-1}X_2X_1^{-n+1} & \text{(If the case (8) or (11) occurs.)}. \end{cases}$$

For each cases, the conclusion holds.

Combining the conclusions we obtain in Cases.1, 2, 3 and 4, we complete the proof of Theorem 3.10. \square

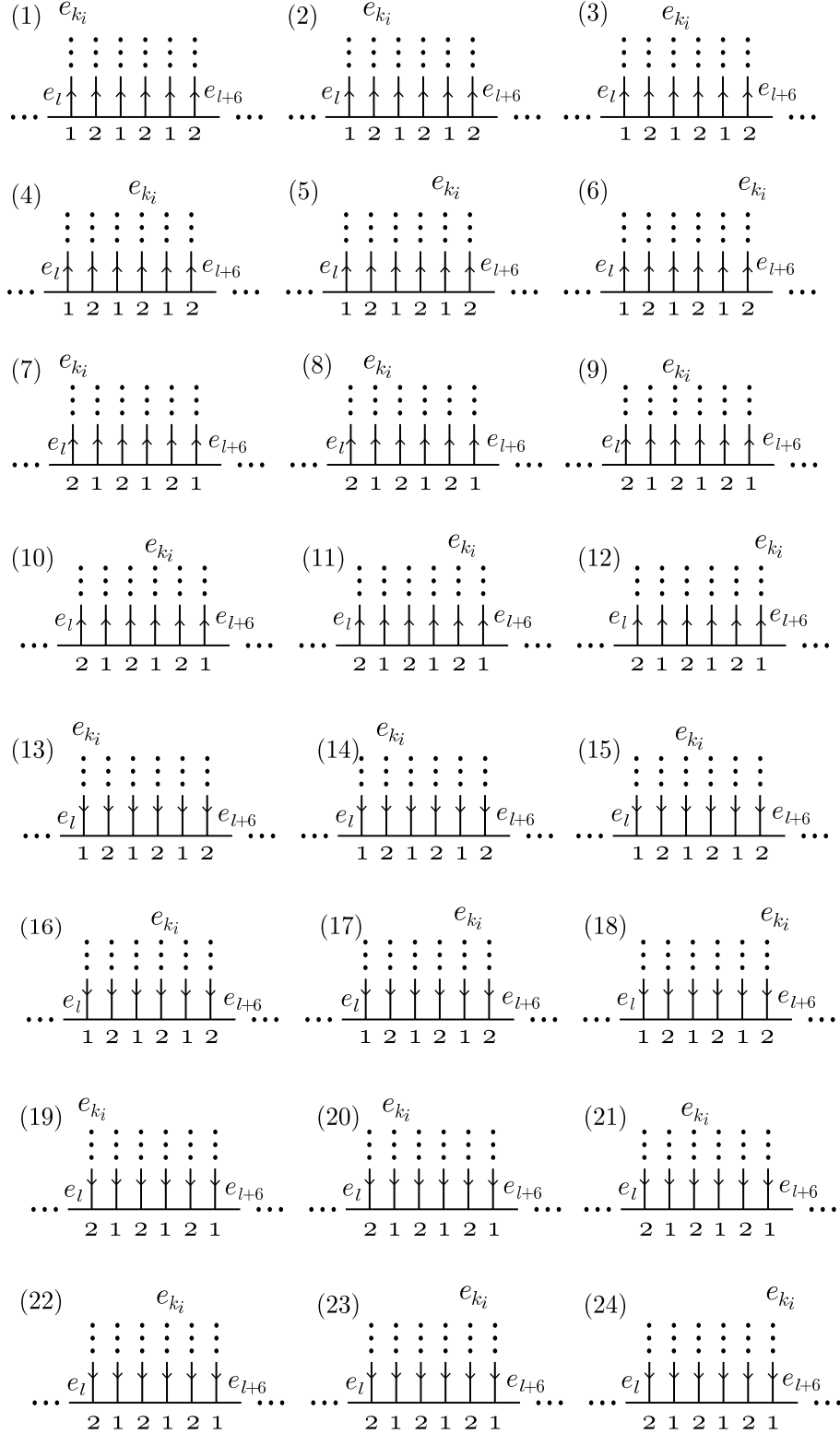
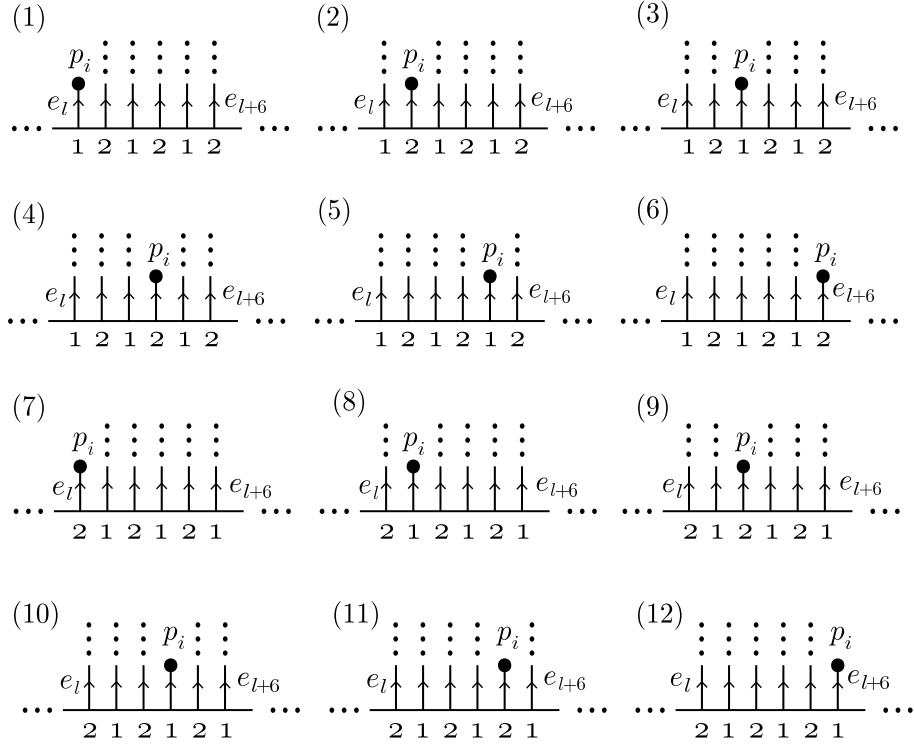

FIGURE 3.10. 24 cases about e_{k_i} and the boundary comb containing e_{k_i} .

FIGURE 3.11. 12 cases about e_j and the boundary comb containing e_j .

4. EXAMPLES

In this section, we give examples of genus-1 SBLFs. We have already known that the monodromy representations of the higher sides of such fibrations satisfy a certain condition by Theorem 3.10. We first give some examples of sequences of elements of $SL(2, \mathbb{Z})$ and examine what 4-manifolds these sequences represent. We denote by $T(n_1, \dots, n_s)$ the following sequence:

$$(X_1^{-n_1} X_2 X_1^{n_1}, \dots, X_1^{-n_s} X_2 X_1^{n_s}).$$

Proposition 4.1. *We define sequences S_r and T_s as follows:*

$$S_r = (X_1, \dots, X_1) \quad (r \text{ } X_1 \text{ 's stand in a line}).$$

$$T_s = \begin{cases} (X_1^{-1} X_2 X_1, X_1 X_2 X_1^{-1}) & (s = 2), \\ (X_1^{-3} X_2 X_1^3, X_2, X_1^3 X_2 X_1^{-3}) & (s = 3), \\ (X_1^{-2s+3} X_2 X_1^{2s-3}, X_1^{-2s+6} X_2 X_1^{2s-6}, X_1^{-2s+10} X_2 X_1^{2s-10}, X_1^{-2s+14} X_2 X_1^{2s-14}, \dots, \\ X_1^{2s-10} X_2 X_1^{-2s+10}, X_1^{2s-6} X_2 X_1^{-2s+6}, X_1^{2s-3} X_2 X_1^{-2s+3}) & (s \geq 4). \end{cases}$$

that is, $T_s = T(n_1, \dots, n_s)$, where $n_1 = 2s - 3$, $n_s = -2s + 3$, $n_i = 2s - 6 + 4(i - 1)$ ($i = 2, \dots, s - 1$). Then, $w(S_r) = X_1^r$ and $w(T_s) = (-1)^{s+1} X_1^{-5s+6}$. So these sequences are Hurwitz systems of some genus-1 SBLF.

Proof: It is obvious that $w(S_r)$ is equal to X_1^r . We prove $w(T_s) = (-1)^{s+1} X_1^{-5s+6}$ by induction on s . Since $(X_1 X_2)^3 = -E$ and $X_1 X_2 X_1 = X_2 X_1 X_2$, we obtain:

$$\begin{aligned} X_2 X_1^2 X_2 X_1^2 &= X_2 X_1 (X_2 X_1 X_2) X_1 \\ &= -E. \end{aligned}$$

So $w(T_2)$ and $w(T_3)$ is computed as follows:

$$\begin{aligned} w(T_2) &= (X_1^{-1} X_2 X_1) (X_1 X_2 X_1^{-1}) \\ &= X_1^{-1} (X_2 X_1^2 X_2) X_1^{-1} \\ &= X_1^{-1} (-X_1^{-2}) X_1^{-1} \\ &= -X_1^{-4}. \\ w(T_3) &= (X_1^{-3} X_2 X_1^3) X_2 (X_1^3 X_2 X_1^{-3}) \\ &= X_1^{-3} X_2 X_1 (X_1^2 X_2 X_1^2) X_1 X_2 X_1^{-3} \\ &= X_1^{-3} X_2 X_1 (-X_2^{-1}) X_1 X_2 X_1^{-3} \\ &= -X_1^{-3} (X_2 X_1 X_2^{-1}) X_1 X_2 X_1^{-3} \\ &= -X_1^{-3} (X_1^{-1} X_2 X_1) X_1 X_2 X_1^{-3} \\ &= -X_1^{-4} (X_2 X_1^2 X_2) X_1^{-3} \\ &= X_1^{-9}. \end{aligned}$$

By the definition of T_s , $w(T_s)$ is represented by $w(T_{s-2})$ as follows:

$$\begin{aligned} w(T_s) &= (X_1^{-2s+3} X_2 X_1^{2s-3}) (X_1^{-2s+6} X_2 X_1^{2s-6}) (X_1^{-2s+7} X_2^{-1} X_1^{2s-7}) w(T_{s-2}) \\ &\quad (X_1^{2s-7} X_2^{-1} X_1^{-2s+7}) (X_1^{2s-6} X_2 X_1^{-2s+6}) (X_1^{2s-3} X_2 X_1^{-2s+3}) \\ &= X_1^{-2s+3} X_2 X_1^2 (X_1 X_2 X_1) X_2^{-1} X_1^{2s-7} w(T_{s-2}) X_1^{2s-7} X_2^{-1} (X_1 X_2 X_1) X_1^2 X_2 X_1^{-2s+3} \\ &= X_1^{-2s+3} (X_2 X_1^2 X_2) X_1^{2s-6} w(T_{s-2}) X_1^{2s-6} (X_2 X_1^2 X_2) X_1^{-2s+3} \\ &= X_1^{-2s+3} (-X_1^{-2}) X_1^{2s-6} w(T_{s-2}) X_1^{2s-6} (-X_1^{-2}) X_1^{-2s+3} \\ &= X_1^{-5} w(T_{s-2}) X_1^{-5}. \end{aligned}$$

Thus the conclusion holds by the induction hypothesis. This completes the proof of Proposition 4.1. \square

Theorem 4.2. *Let $f : M \rightarrow S^2$ be a genus-1 SBLF. Suppose that $W_f = S_r$. Then M is diffeomorphic to one of the following 4-manifolds:*

- (1) $\sharp r \overline{\mathbb{C}\mathbb{P}^2}$;

- (2) $L \sharp r \overline{\mathbb{C}\mathbb{P}^2}$;
(3) $S^1 \times S^3 \sharp S \sharp r \overline{\mathbb{C}\mathbb{P}^2}$,

where S is either of the manifolds $S^2 \times S^2$ and $S^2 \tilde{\times} S^2$ and L is either of the manifolds L_n and L'_n .

Before proving Theorem 4.2, we review the definition and some properties of L_n and L'_n . For more details, see [13]. Let N_0 and N_1 be 4-manifolds diffeomorphic to $D^2 \times T^2$. The boundaries of N_0 and N_1 are $\partial D^2 \times T^2$. Let (t, x, y) be a coordinate of \mathbb{R}^3 . We identify $\partial D^2 \times T^2$ with $\mathbb{R}^3/\mathbb{Z}^3$. The group $GL(3, \mathbb{Z})$ naturally acts on \mathbb{R}^3 and this action keeps the lattice \mathbb{Z}^3 . So $GL(3, \mathbb{Z})$ acts on $\partial D^2 \times T^2$. For an element A of $GL(3, \mathbb{Z})$, we denote by f_A an self-diffeomorphism of $\partial D^2 \times T^2$ defined as follows:

$$f_A([t, x, y]) = [(t, x, y)^t A].$$

We define elements A_n and A'_n of $GL(3, \mathbb{Z})$ as follows:

$$A_n = \begin{pmatrix} 0 & 1 & 1 \\ 0 & n & n-1 \\ 1 & n & 0 \end{pmatrix}, \quad A'_n = \begin{pmatrix} 0 & 1 & 1 \\ 0 & n & n-1 \\ 1 & n-1 & 0 \end{pmatrix}$$

Let $B^3 \subset D^2 \times S_y^1$ be an embedded 3-ball, where S_x^1 and S_y^1 represent circles with coordinates x and y , respectively. Then,

$$B^3 \times S_x^1 \subset (D^2 \times S_y^1) \times S_x^1 = D^2 \times T^2 = N_0.$$

We take a diffeomorphism $\iota : S^2 \rightarrow \partial B^3$. We obtain a diffeomorphism as follows:

$$h = \iota \times id : S^2 \times S^1 \rightarrow \partial B^3 \times S^1.$$

We define L_n and L'_n as follows:

$$\begin{aligned} L_n &= D^2 \times S^2 \cup_h (N_0 \setminus (\text{int} B^3 \times S^1)) \cup_{f_{A_n}} N_1, \\ L'_n &= D^2 \times S^2 \cup_h (N_0 \setminus (\text{int} B^3 \times S^1)) \cup_{f_{A'_n}} N_1. \end{aligned}$$

The original definitions of L_n and L'_n are different from the above definitions. However, both two definitions are same (c.f. Lemma V.7 in [13]).

We next take handle decompositions of L_n and L'_n . Since $N_1 = D^2 \times T^2$, a Kirby diagram of N_1 is as shown in Figure 4.1. The coordinate (t, x, y) is also described as in Figure 4.1.

$B^3 \times S^1$ has a handle decomposition consisting of a 0-handle and a 1-handle. So we can decompose $N_0 \setminus (\text{int} B^3 \times S^1)$ as follows:

$$N_0 \setminus (\text{int} B^3 \times S^1) = \partial N_0 \times I \cup (\text{2-handle}) \cup (\text{3-handle}).$$

Let $C_1 \subset \partial N_0$ be an attaching circle of the 2-handle. By the construction of the decomposition, we obtain:

$$C_1 = \{[t, 0, 0] \in \partial N_0 \mid t \in [0, 1]\}.$$

Since $f_{A_n}([t, 0, 0]) = f_{A'_n}([t, 0, 0]) = [0, 0, t]$, an attaching circle of the 2-handle is in a regular fiber and along y -axis in the diagram of N_1 . Since $f_{A_n}([t, 0, \varepsilon]) = f_{A'_n}([t, 0, \varepsilon]) = [\varepsilon, (n-1)\varepsilon, t]$

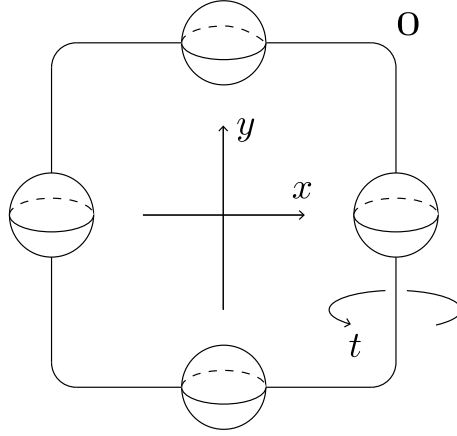

FIGURE 4.1. A Kirby diagram of N_1 . t represents the coordinate of ∂D^2 and x and y represent the coordinate of T^2 .

for sufficiently small $\varepsilon > 0$, the framing of the 2-handle is along a regular fiber. Hence the diagram of $(N_0 \setminus (\text{int}B^3 \times S^1)) \cup_{f_{A_n}} N_1$ and $(N_0 \setminus (\text{int}B^3 \times S^1)) \cup_{f_{A'_n}} N_1$ is as shown in Figure 4.2.

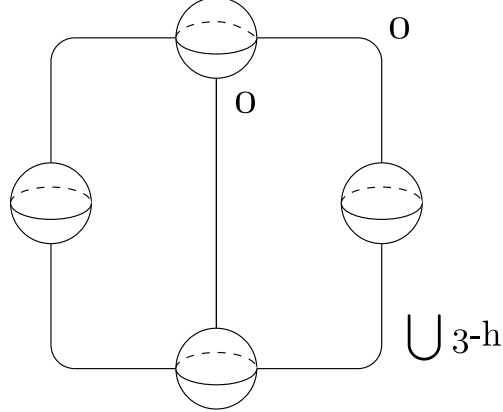

FIGURE 4.2. An diagram of $(N_0 \setminus (\text{int}B^3 \times S^1)) \cup_{f_{A_n}} N_1$ and $(N_0 \setminus (\text{int}B^3 \times S^1)) \cup_{f_{A'_n}} N_1$.

We can decompose $D^2 \times S^2$ as follows:

$$D^2 \times S^2 = \partial D^2 \times S^2 \times I \cup (2\text{-handle}) \cup (4\text{-handle}).$$

Let $C_2 \subset \partial N_0$ be the image under h of the attaching circle of the 2-handle of $D^2 \times S^2$. After moving C_2 by isotopy in N_0 , we obtain:

$$C_2 = \{[0, t, \delta] \in \partial N_0 | t \in [0, 1]\},$$

where $\delta > 0$ is sufficiently small.

The framing of the 2-handle is $\{[0, t, \delta'] \in \partial N_0 | t \in [0, 1]\}$, where $\delta' > \delta$ is sufficiently small. Since $f_{A_n}([0, t, \delta]) = [t + \delta, nt + (n - 1)\delta, nt]$, we can describe the attaching circle of the 2-handle of $D^2 \times S^2$ contained in L_n and the knot representing the framing of the 2-handle in the diagram described in Figure 4.2. Eventually, we can describe a diagram of L_n as shown in Figure 4.3.

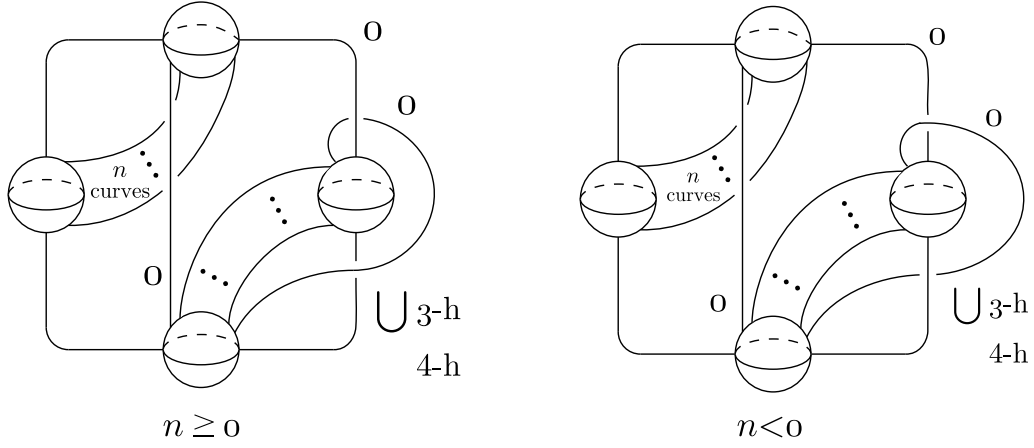

FIGURE 4.3. Left: A Kirby diagram of L_n for $n \geq 0$. Right: A Kirby diagram of L_n for $n < 0$.

Similarly, a diagram of L'_n is described as shown in Figure 4.4.

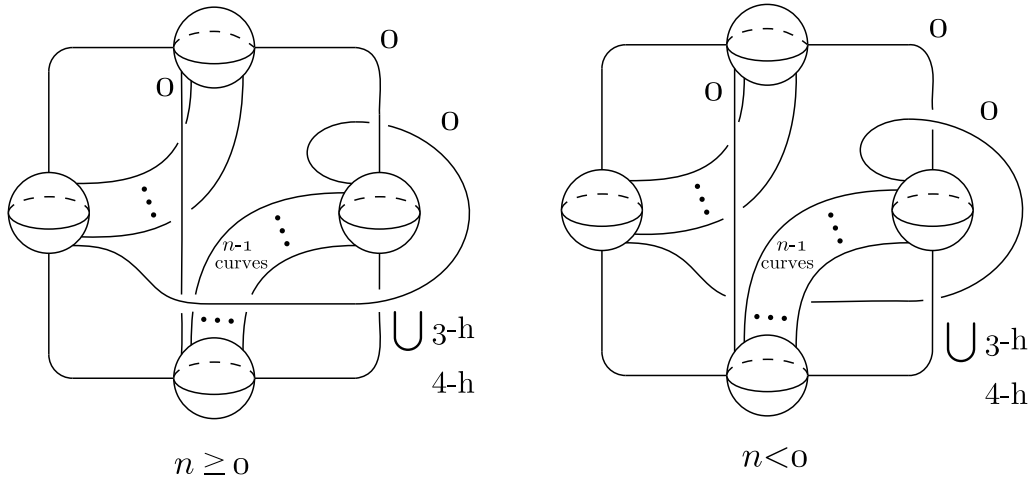

FIGURE 4.4. Left: A Kirby diagram of L'_n for $n \geq 0$. Right: A Kirby diagram of L'_n for $n < 0$.

By the diagrams of L_n and L'_n described in Figure 4.3 and Figure 4.4, both L_n and L'_n admit genus-1 SBLFs without Lefschetz singularities. We can easily prove by Kirby calculus that L_{-n} (resp. L'_{-n}) is diffeomorphic to L_n (resp. L'_n).

Proof of Theorem 4.2: The higher side of f is obtained by attaching r 2-handles to a trivial T^2 bundle over D^2 . Each attaching circle of the 2-handle is in a regular fiber and isotopic to a simple closed curve $\gamma_{1,0}$. Since $w(W_f) = X_1^r$, a 2-handle of a round 2-handle is attached along $\gamma_{1,0}$ in a regular fiber of the boundary of the higher side. We obtain M by attaching a 2-handle and a 4-handle to the 4-manifold obtained by successive handle attachment to $D^2 \times T^2$. If the attaching circle of the 2-handle of $D^2 \times S^2$ goes through the 1-handle that the 2-handle of the round handle goes through, We can slide the 2-handle of $D^2 \times S^2$ to the 2-handle of the round handle so that the 2-handle of $D^2 \times S^2$ does not go through the 1-handle. Thus a Kirby diagram of M is one of the diagrams in Figure 4.5, where n and l are integers. It is obvious that both two 4-manifolds illustrated in Figure 4.5 are diffeomorphic to each other. We denote by $M_{n,l}$ the 4-manifold illustrated in Figure 4.5. We remark that l framed knot in Figure 4.5 represents a 2-handle of $D^2 \times S^2$ and the attachment of the lower side depends only on the parity of l . So $M_{n,l}$ and $M_{n,l'}$ are diffeomorphic to each other if $l \equiv l' \pmod{2}$.

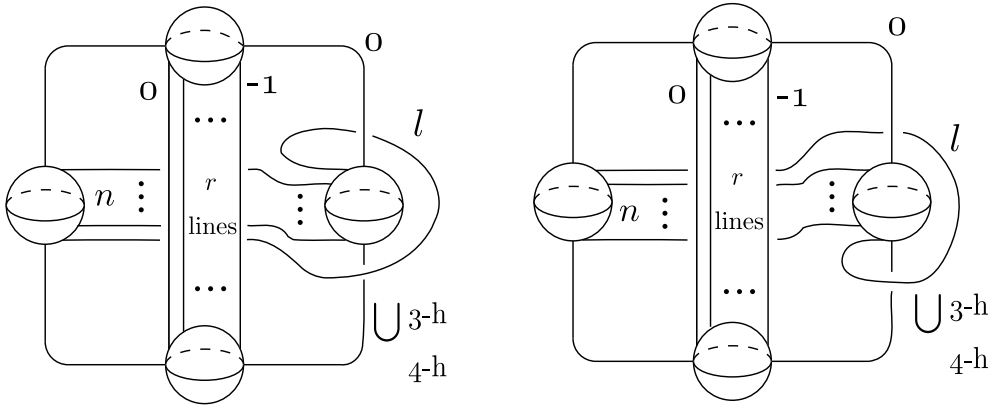
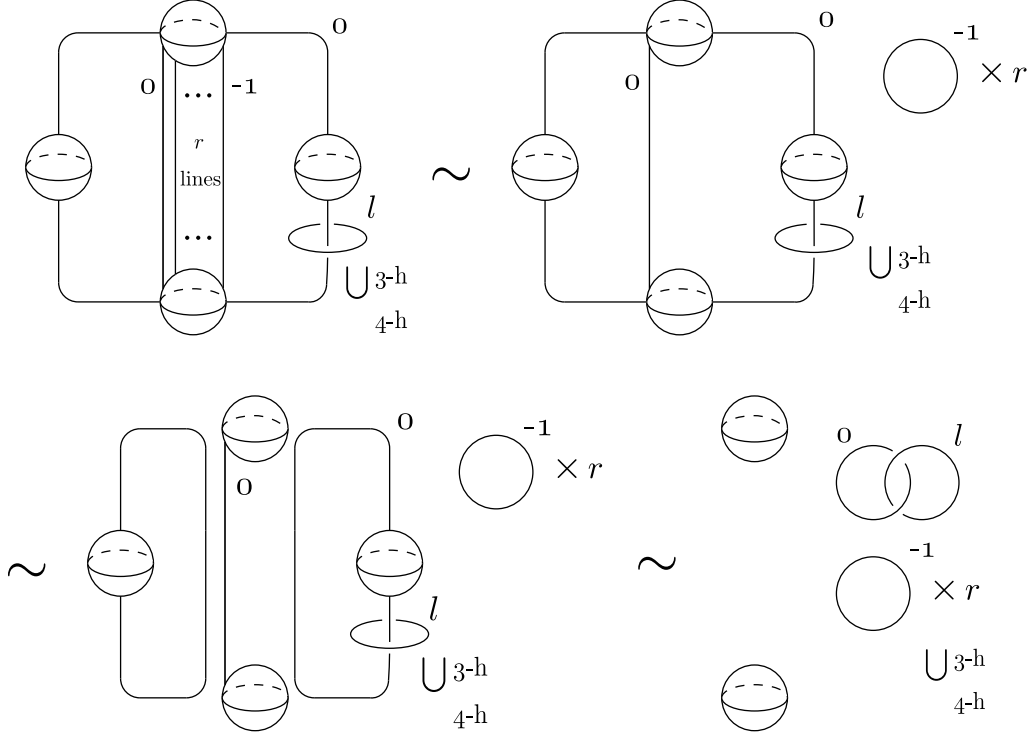

FIGURE 4.5. A Kirby diagram of a genus-1 SBLF whose Hurwitz system is S_r . Framings of r 2-handles parallel to the 2-handle of the round 2-handle are all -1 .

We will determine what 4-manifold $M_{n,l}$ is by Kirby calculus.

We first examine the case $n = 0$. A Kirby diagram of $M_{0,l}$ is as shown in Figure 4.6. We first slide r 2-handles representing Lefschetz singularities to the 2-handle of the round 2-handle. Then we slide the 2-handle of $D^2 \times T^2$ to the 2-handle of the round 2-handle and move this 2-handle so that the attaching circle of the 2-handle does not go through 1-handles. We obtain the last diagram of Figure 4.6 by eliminating the obvious canceling pair.

FIGURE 4.6. A Kirby diagram of $M_{0,l}$.

Thus we obtain:

$$M_{0,l} = S^1 \times S^3 \# S \# \overline{r\mathbb{C}P^2},$$

where S is equal to $S^2 \times S^2$ if l is even and $S^2 \tilde{\times} S^2$ if l is odd.

We next examine the case $n = 1$. We first slide r 1-framed 2-handles and the 2-handle of $D^2 \times T^2$ as we slide in the case $n = 0$. Then we can eliminate the obvious canceling pair. We next move the 2-handle of $D^2 \times T^2$ so that the attaching circle of the 2-handle does not go through the 1-handle. Then we can eliminate two pairs of handles. Thus we can prove:

$$M_{1,n} = \#r\overline{\mathbb{C}P^2}.$$

Lastly, we examine the case $n \geq 2$. A Kirby diagram of $M_{n,l}$ is illustrated in Figure 4.7 and we change the diagram as shown in Figure 4.7 by performing similar calculus to the calculus illustrated in Figure 4.6.

We can change the diagrams of L_n and L'_n illustrated in Figure 4.3 and 4.4 as shown in Figure 4.8. The upper four diagrams in Figure 4.8 describe L_n , where $n \geq 0$. We first slide 2-handle of $D^2 \times S^2$ to the 2-handle of N_0 . Then we move the 2-handle of $D^2 \times S^2$ by isotopy and slide the 2-handle of $D^2 \times T^2$ to the 2-handle of N_0 . We can obtain the last diagram of

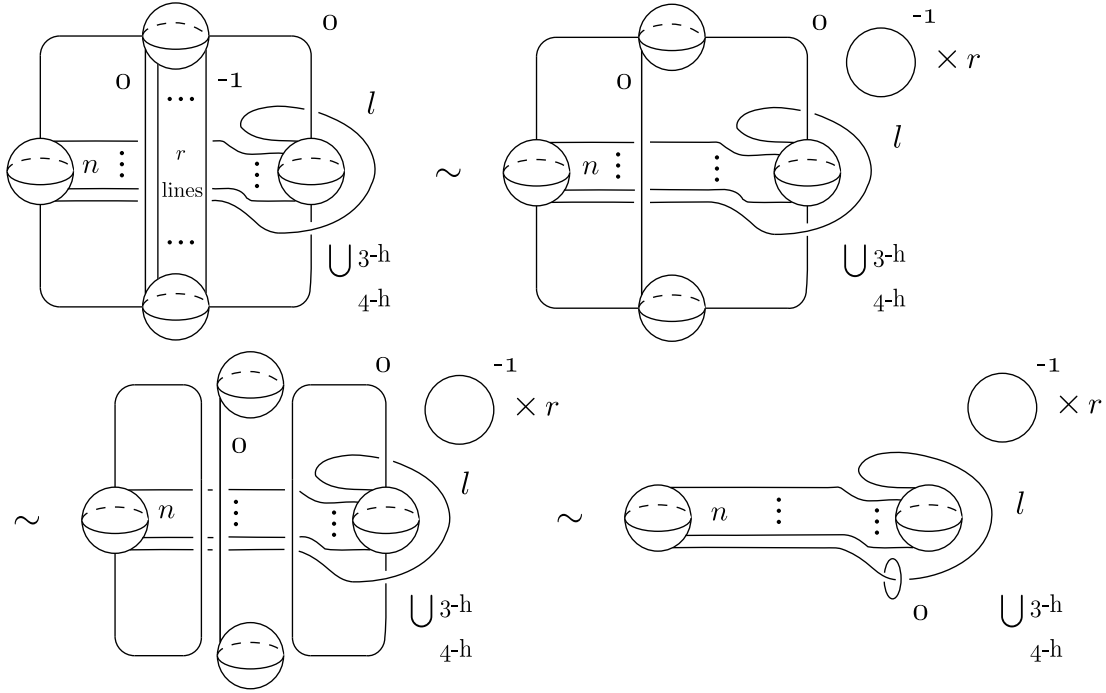
 FIGURE 4.7. A Kirby diagram of $M_{n,l}$, where $n \geq 2$.

the four by eliminating a canceling pair. The lower four diagrams in Figure 4.8 describe L'_n , where $n \geq 0$. By the same method as above, we obtain the last diagram of the four.

Thus we obtain:

$$M_{n,l} = L \sharp r \overline{\mathbb{C}\mathbb{P}^2},$$

where L is either L_n or L'_n . This completes the proof of Theorem 4.2. \square

Theorem 4.3. *Let $f : M \rightarrow S^2$ be a genus-1 SBLF. Suppose that $W_f = T_s$. Then M is diffeomorphic to $S \sharp (s-2)\mathbb{C}\mathbb{P}^2$, where S is either of the manifolds $S^2 \times S^2$ and $S^2 \tilde{\times} S^2$.*

Before proving Theorem 4.3, we change T_s by applying elementary transformations and simultaneous conjugations so that we can easily determine what 4-manifold T_s represents.

Lemma 4.4. *Suppose that $s \geq 3$. Then, by successive application of elementary transformations and simultaneous conjugations, we can change T_s into a following sequence:*

$$(T_{2,1}, T_{2,3}, \dots, T_{2,2s-5}, T_{1,s-1}, T_{1,-1}).$$

Proof: By applying simultaneous conjugation, we can transform T_s as follows:

$$T_s \rightarrow \begin{cases} (X_1^{-5} X_2 X_1^5, X_1^{-2} X_2 X_1^2, X_1 X_2 X_1^{-1}) & (s = 3) \\ (X_1^{-4s+7} X_2 X_1^{4s-7}, X_1^{-4s+10} X_2 X_1^{4s-10}, X_1^{-4s+14} X_2 X_1^{4s-14}, X_1^{-4s+18} X_2 X_1^{4s-18}, \dots \\ \dots, X_1^{-6} X_2 X_1^6, X_1^{-2} X_2 X_1^2, X_1 X_2 X_1^{-1}) & (s \geq 4) \end{cases}$$

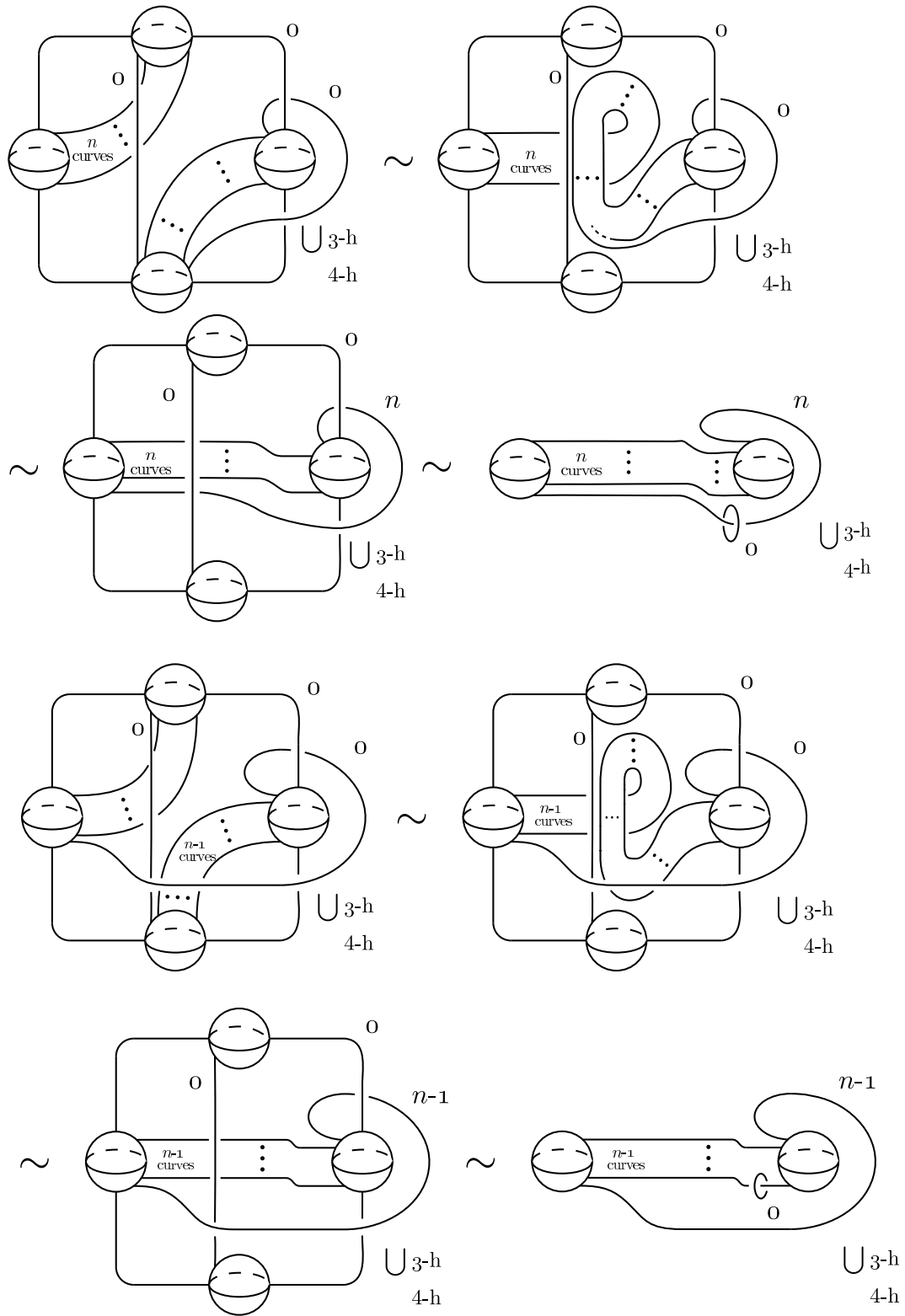

FIGURE 4.8. The upper four diagrams describe L_n , while the lower four diagrams describe L'_n .

$$= \begin{cases} (T_{5,1}, T_{2,1}, T_{-1,1}) & (s = 3), \\ (T_{4s-7,1}, T_{4s-10,1}, T_{4s-14,1}, T_{4s-18,1}, \dots, T_{6,1}, T_{2,1}, T_{-1,1}) & (s \geq 4). \end{cases}$$

We first prove that the following formula holds up to orientation of simple closed curves:

$$(4.1) \quad T_{2,2l-1} \circ T_{2,2l-3} \circ \dots \circ T_{2,1}(\gamma_{4k-10,1}) = \gamma_{4k-10-4l, 4lk-4l^2-10l+1},$$

where $k \geq 4$ and $l \leq k-3$.

We prove the formula(4.1) by induction on l . By the Picard-Lefschetz formula, we obtain:

$$\begin{aligned} T_{2,1}(\gamma_{4k-10,1}) &= \gamma_{4k-10,1} - ((4k-10) - 2 \cdot 1)\gamma_{2,1} \\ &= \gamma_{4k-10,1} - (4k-12)\gamma_{2,1} \\ &= \gamma_{-4k+14, -4k+13} \end{aligned}$$

Thus the formula(4.1) holds for $l = 1$.

For general l , by the induction hypothesis, we obtain:

$$\begin{aligned} &T_{2,2l-1} \circ T_{2,2l-3} \circ \dots \circ T_{2,1}(\gamma_{4k-10,1}) \\ &= T_{2,2l-1}(\gamma_{4k-6-4l, 4lk-4k-4l^2-2l+7}) \\ &= \gamma_{4k-6-4l, 4lk-4k-4l^2-2l+7} - ((2l-1)(4k-6-4l) - 2(4lk-4k-4l^2-2l+7))\gamma_{2,2l-1} \\ &= \gamma_{4k-6-4l, 4lk-4k-4l^2-2l+7} - (4k-4l-8)\gamma_{2,2l-1} \\ &= \gamma_{-4k+10+4l, -4lk+4l^2+10l-1}. \end{aligned}$$

So the formula(4.1) holds for general l and we obtain:

$$\text{conj}(T_{2,2k-7} \circ T_{2,2k-9} \circ \dots \circ T_{2,1})(T_{4k-10,1}) = T_{2,2k-5}.$$

Thus, for $s \geq 4$, we can transform T_s as follows:

$$\begin{aligned} T_s &\rightarrow (T_{4s-7,1}, T_{4s-10,1}, T_{4s-14,1}, T_{4s-18,1}, \dots, T_{6,1}, T_{2,1}, T_{-1,1}) \\ &\rightarrow (T_{4s-7,1}, T_{4s-10,1}, T_{4s-14,1}, T_{4s-18,1}, \dots, T_{10,1}, T_{2,1}, T_{2,3}, T_{-1,1}) \\ &\rightarrow (T_{4s-7,1}, T_{4s-10,1}, T_{4s-14,1}, T_{4s-18,1}, \dots, T_{14,1}, T_{2,1}, T_{2,3}, T_{2,5}, T_{-1,1}) \\ &\rightarrow \dots \\ &\rightarrow (T_{4s-7,1}, T_{2,1}, T_{2,3}, \dots, T_{2,2s-5}, T_{-1,1}). \end{aligned}$$

We next prove that the following formula holds up to orientation:

$$(4.2) \quad T_{2,2l-1} \circ T_{2,2l-3} \circ \dots \circ T_{2,1}(\gamma_{4k-7,1}) = \gamma_{4k-7-4l, 4lk-4l^2-7l+1},$$

where $k \geq 3$ and $1 \leq l \leq k-2$. We prove the formula(4.2) by induction on l .

By the Picard-Lefschetz formula, we obtain:

$$\begin{aligned} T_{2,1}(\gamma_{4k-7,1}) &= \gamma_{4k-7,1} - ((4k-7) - 2)\gamma_{2,1} \\ &= \gamma_{4k-7,1} - (4k-9)\gamma_{2,1} \\ &= \gamma_{-4k+11, -4k+10}. \end{aligned}$$

So the formula(4.2) holds for $l = 1$.

For general l , by the induction hypothesis, we obtain:

$$\begin{aligned}
& T_{2,2l-1} \circ T_{2,2l-3} \circ \cdots \circ T_{2,1}(\gamma_{4k-7,1}) \\
&= T_{2,2l-1}(\gamma_{4k-3-4l,4lk-4k-4l^2+l+4}) \\
&= \gamma_{4k-3-4l,4lk-4k-4l^2+l+4} - ((2l-1)(4k-3-4l) - 2(4lk-4k-4l^2+l+4))\gamma_{2,2l-1} \\
&= \gamma_{4k-3-4l,4lk-4k-4l^2+l+4} - (-4l+4k-5)\gamma_{2,2l-1} \\
&= \gamma_{-4k+4l+7,-4lk+4l^2+7l-1}.
\end{aligned}$$

Thus the formula(4.2) holds for general l and we obtain:

$$\text{conj}(T_{2,2k-5} \circ T_{2,2k-7} \circ \cdots \circ T_{2,1})(T_{4k-7,1}) = T_{1,k-1}.$$

So we can transform T_s into the following sequence:

$$(T_{2,1}, T_{2,3}, \dots, T_{2,2s-5}, T_{1,s-1}, T_{1,-1}).$$

This completes the proof of Lemma 4.4. \square

Proof of Theorem 4.3: Let M_s be the total space of genus-1 SBLF with $W_f = T_s$. We first examine the case $s = 2$. We can describe a diagram of M_2 as shown in Figure 4.9. We slide the 2-handles representing Lefschetz singularities and the 2-handle of $D^2 \times T^2$ to the 2-handle of the round handle. Then we eliminate the obvious canceling pair and slide the (-2) -framed knot and the l -framed knot to the 0-framed knot. We can change the l -framed knot and the 0-framed meridian of this into a Hopf link by using the 0-framed meridian. We can obtain the last diagram of Figure 4.9 by canceling two pairs of handles. Thus we obtain:

$$M_2 = S,$$

where S is $S^2 \times S^2$ if m is even and $S^2 \tilde{\times} S^2$ if m is odd.

For general s , we can describe a diagram of M_s as shown in Figure 4.10. We can move this diagram to the upper diagram of Figure 4.11 by sliding all the 2-handles describing Lefschetz singularities and the 2-handle of $D^2 \times T^2$ to the 2-handle of the round handle. To obtain the lower diagram of Figure 4.11, we slide the 2-handles going through the 1-handle to 0-framed 2-handle and eliminate the obvious canceling pair.

We will prove the conclusion by induction on s . We first examine the case $s = 3$. The left diagram in Figure 4.12 represents the manifold M_3 and we can move it to the center diagram of Figure 4.12 by isotopy. It is easy to transform the center diagram of Figure 4.12 to the right one and we obtain:

$$M_3 = \#2\mathbb{C}\mathbb{P}^2 \# \overline{\mathbb{C}\mathbb{P}^2}.$$

To complete the proof, we will move inner two 2-handles of the lower diagram in Figure 4.11 as shown in Figure 4.13. We first move the $(s-2)$ -framed 2-handle by isotopy. And we slide the $(4s-11)$ -framed 2-handle to the $(s-2)$ -framed 2-handle twice. We then obtain the last diagram of Figure 4.13. Thus we obtain:

$$M_s = M_{s-1} \# \mathbb{C}\mathbb{P}^2$$

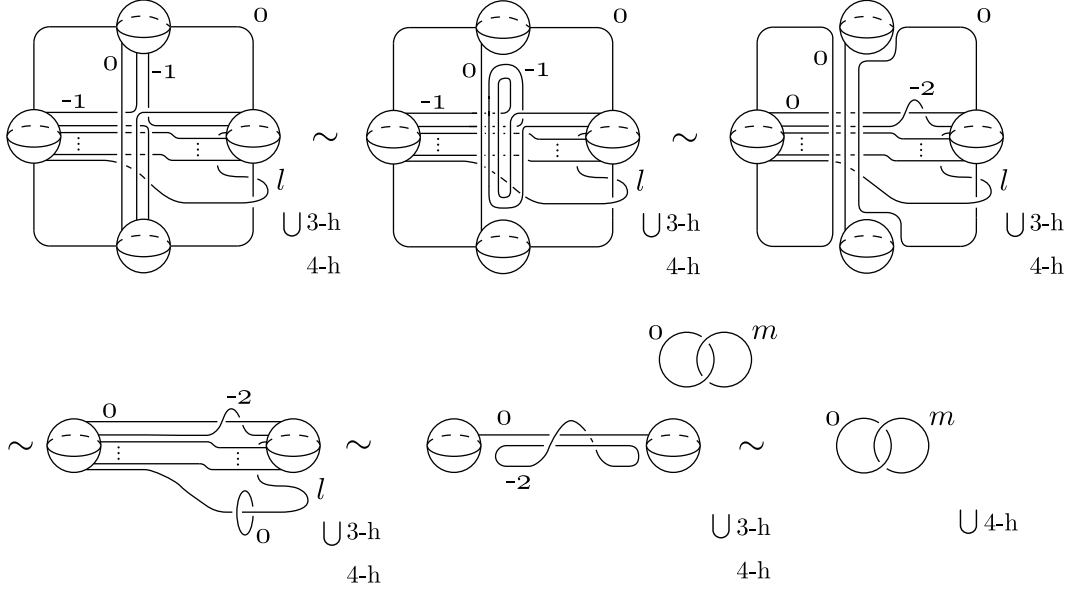
 FIGURE 4.9. A diagram of a SBLF whose Hurwitz system is T_2 .

$$= \sharp(s-1)\mathbb{C}\mathbb{P}^2 \sharp \overline{\mathbb{C}\mathbb{P}^2},$$

where the second equality holds by induction hypothesis. This completes the proof of Theorem 4.3. \square

For sequences of elements of $SL(2, \mathbb{Z})$ W and W' , we denote by WW' a sequence obtained by standing elements of W' after standing elements of W in a row.

Theorem 4.5. *Let $f : M \rightarrow S^2$ and $g : M' \rightarrow S^2$ be genus-1 SBLFs.*

- (1) *If $W_f = S_r W_g$, then M is diffeomorphic to $M' \sharp_r \overline{\mathbb{C}\mathbb{P}^2}$.*
- (2) *If $W_f = W_g T_s$, then M is diffeomorphic to $M' \sharp S \sharp (s-2)\mathbb{C}\mathbb{P}^2$, where S is either of the manifolds $S^2 \times S^2$ and $S^2 \tilde{\times} S^2$.*

We need the following lemma to prove Theorem 4.5.

Lemma 4.6. *Let $f : M \rightarrow D^2$ be a genus-1 LF. Suppose that f has at least one Lefschetz singularities and the monodromy of ∂M is equal to $\pm E \in SL(2, \mathbb{Z})$. Then every orientation and fiber preserving self-diffeomorphism φ of ∂M can be extended to an orientation and fiber preserving self-diffeomorphism Φ of M up to isotopy. i.e. $\Phi|_{\partial M}$ is isotopic to φ .*

We remark that the conclusion of Lemma 4.6 holds by the following theorem if the monodromy of ∂M is trivial.

Theorem 4.7 ([12]). *Let $f : M \rightarrow D^2$ be a genus-1 LF and $T \subset M$ a regular fiber of f . Suppose that $W_f = (X_1, X_2)$. Then for every orientation and fiber preserving self-diffeomorphism φ of $\partial \nu T$, there exists an orientation and fiber preserving self-diffeomorphism Φ of $M \setminus \text{int} \nu T$ such that Φ is equal to φ on $\partial \nu T$ and that Φ is the identity map on ∂M .*

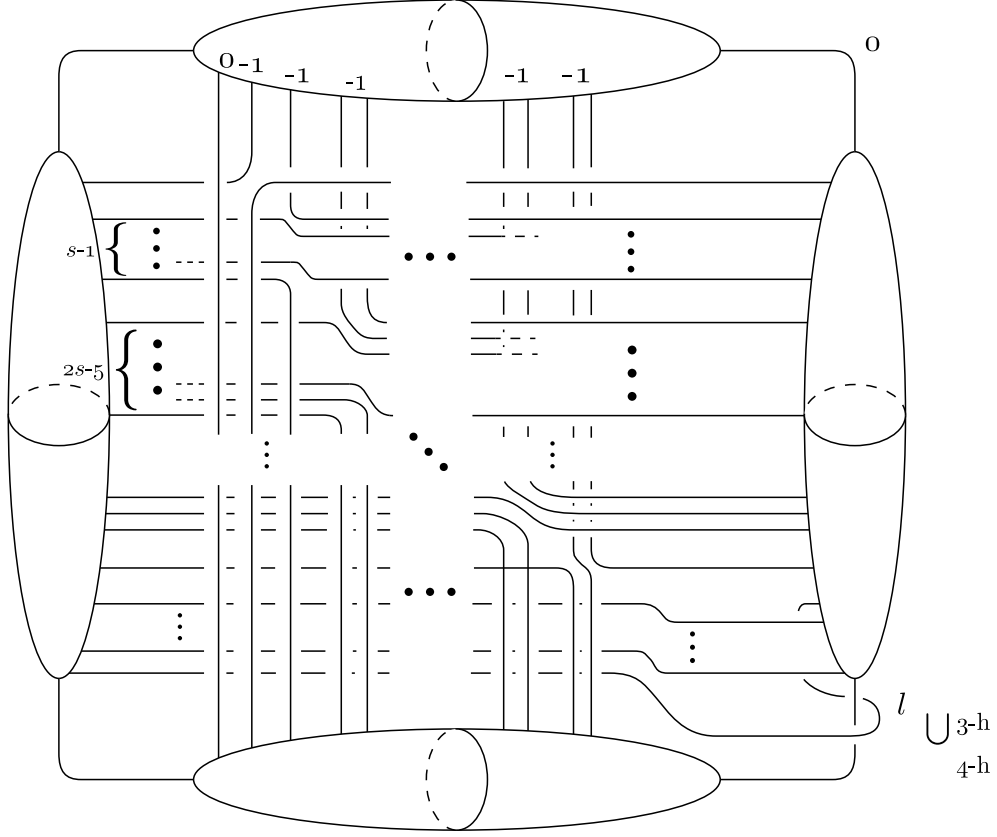
FIGURE 4.10. A diagram of M_s .

Proof of Lemma 4.6: We assume that an induced map on ∂D^2 by φ is identity map. It is sufficient to prove the conclusion under the above hypothesis. Both $M \cup_{id} \overline{M}$ and $M \cup_{\varphi} \overline{M}$ naturally have genus-1 ALF structures over $D^2 \cup_{id} \overline{D^2}$. We denote these ALFs by f_1 and f_2 , respectively. Then it is sufficient to prove that there exists an orientation and fiber preserving diffeomorphism $\tilde{\Phi} : M \cup_{\varphi} \overline{M} \rightarrow M \cup_{id} \overline{M}$ such that the image under Φ of M (resp. \overline{M}) is in M (resp. \overline{M}) and that $\tilde{\Phi}$ is identity map on \overline{M} .

∂M is isomorphic to $I \times T^2 / ((1, x) \sim (0, \pm Ex))$ as a torus bundle. We fix an identification $\xi_0 : \partial M \rightarrow I \times T^2 / \sim$ of the two bundles and we identify ∂D^2 with $[0, 1] / \{0, 1\}$ by using ξ_0 .

Step.1: Suppose that an isotopy class of $\varphi : \{\frac{1}{2}\} \times T^2 \rightarrow \{\frac{1}{2}\} \times T^2$ is equal to $E \in SL(2, \mathbb{Z})$. Then we can move φ by isotopy to the map such that the restriction of the map to $[\frac{1}{2} - \varepsilon, \frac{1}{2} + \varepsilon] \times T^2$ is the identity map. Let $E \subset D^2$ be an embedded 2-disk satisfying the following conditions:

- $E \cap \partial D^2 = [\frac{1}{2} - \varepsilon, \frac{1}{2} + \varepsilon]$;
- E contains no critical values of f .

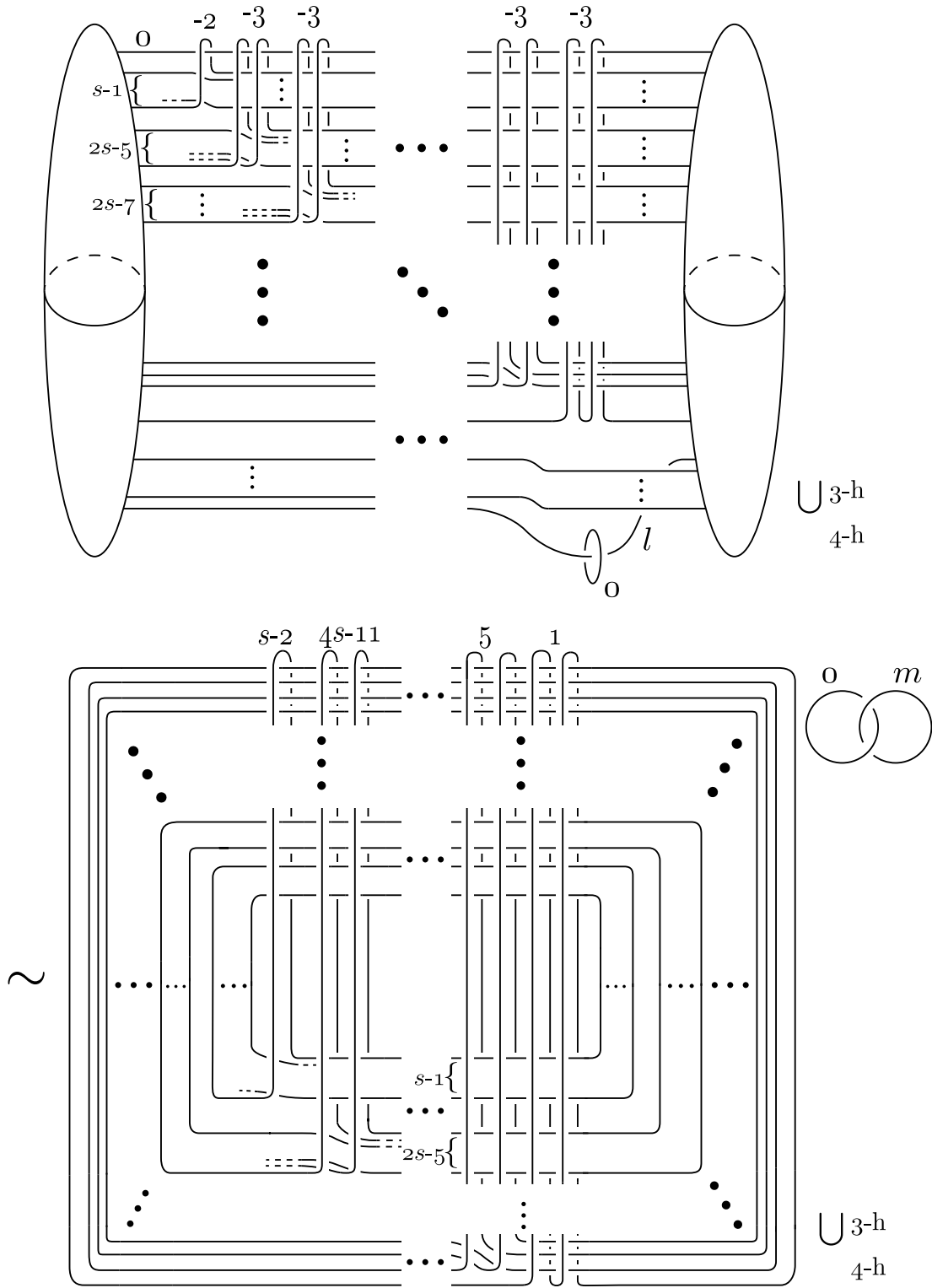

FIGURE 4.11.

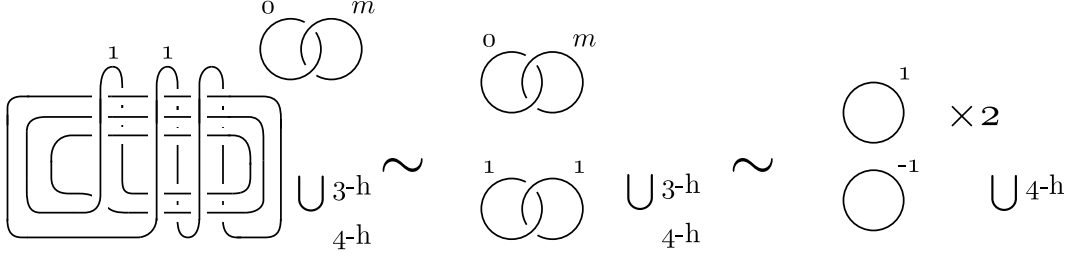

FIGURE 4.12.

We denote by $\{p_1, \dots, p_n\} \subset D^2$ a set of critical values of f . We put $p_0 = \frac{1}{2}$ and $\alpha_1, \dots, \alpha_n$ be embedded paths in D^2 , beginning at p_0 and otherwise disjoint, intersecting with ∂D^2 at only p_0 , connecting p_0 to the critical values p_1, \dots, p_n , respectively. Let W_α be a regular neighborhood of $\alpha_1 \cup \dots \cup \alpha_n$ such that $W_\alpha \cap \partial D^2 \subset E$. We denote by $\overline{W}_\alpha, \overline{E}$ and \overline{p}_i the image under $id : D^2 \rightarrow \overline{D}^2$ of W_α, E and p_i , respectively. Then we can define an orientation and fiber preserving diffeomorphism from $f_1^{-1}(E \cup W_\alpha \cup \overline{W}_\alpha \cup \overline{E})$ to $f_2^{-1}(E \cup W_\alpha \cup \overline{W}_\alpha \cup \overline{E})$ by using the identity maps of M and \overline{M} . We denote this map by ι and $E \cup W_\alpha \cup \overline{W}_\alpha \cup \overline{E}$ by D_0 .

Let $D \subset \text{int} D^2$ be an embedded 2-disk such that D contains two critical values of f and that a Hurwitz system of $f|_{f^{-1}(D)}$ is (X_1, X_2) . Let $D_1 \subset \text{int} D$ be an embedded disk such that D_1 contains no critical values of f and $D_1 \cap (E \cup W_\alpha) = \emptyset$. Then $D^2 \cup_{id} \overline{D}^2 \setminus \text{int}(D_0 \cup D_1)$ is an annulus and we can take a vector field X_A satisfying the following conditions:

- X_A is non-zero on every point of the annulus;
- each integral curve of X_A intersects ∂D_0 and ∂D_1 transversely;
- for any integral curve c of X_A , there exists $t \in \mathbb{R}$ such that $c(s)$ is in \overline{D}^2 if $s \leq t$ and in D^2 if $s \geq t$.

Let \mathcal{H}_i ($i = 1, 2$) be horizontal distributions of the restriction of f_i to $M \cup \overline{M} \setminus f_i^{-1}(\{p_1, \dots, p_n\})$ such that \mathcal{H}_1 and \mathcal{H}_2 are identical on \overline{M} . We can take vector fields X_1 and X_2 on $M \cup_{id} \overline{M}$ and $M \cup_\varphi \overline{M}$, respectively, by lifting X_A by using \mathcal{H}_1 and \mathcal{H}_2 . Then we can define a map $\Theta : f_1^{-1}(D^2 \cup \overline{D}^2 \setminus \text{int}(D_0 \cup D_1)) \rightarrow f_2^{-1}(D^2 \cup \overline{D}^2 \setminus \text{int}(D_0 \cup D_1))$ as follows:

$$\Theta(c_{1,x}(t)) = c_{2,x}(t),$$

where $c_{1,x}$ (resp. $c_{2,x}$) is an integral curve of X_1 (resp. X_2) starting at $x \in f_1^{-1}(\partial D_0) = f_2^{-1}(\partial D_0)$. Then Θ is an orientation and fiber preserving diffeomorphism and the restriction of Θ to $\overline{M} \cap f_1^{-1}(D^2 \cup \overline{D}^2 \setminus \text{int}(D_0 \cup D_1))$ is the identity map.

We can obtain by Theorem 4.7 an orientation and fiber preserving diffeomorphism $\tilde{\varphi} : f_1^{-1}(D \setminus \text{int} D_1) \rightarrow f_2^{-1}(D \setminus \text{int} D_1)$ satisfying the following conditions:

- $\tilde{\varphi}|_{f_1^{-1}(\partial D_1)} = \Theta|_{f_1^{-1}(\partial D_1)}^{-1}$;
- $\tilde{\varphi}|_{f_1^{-1}(\partial D)}$ is the identity map.

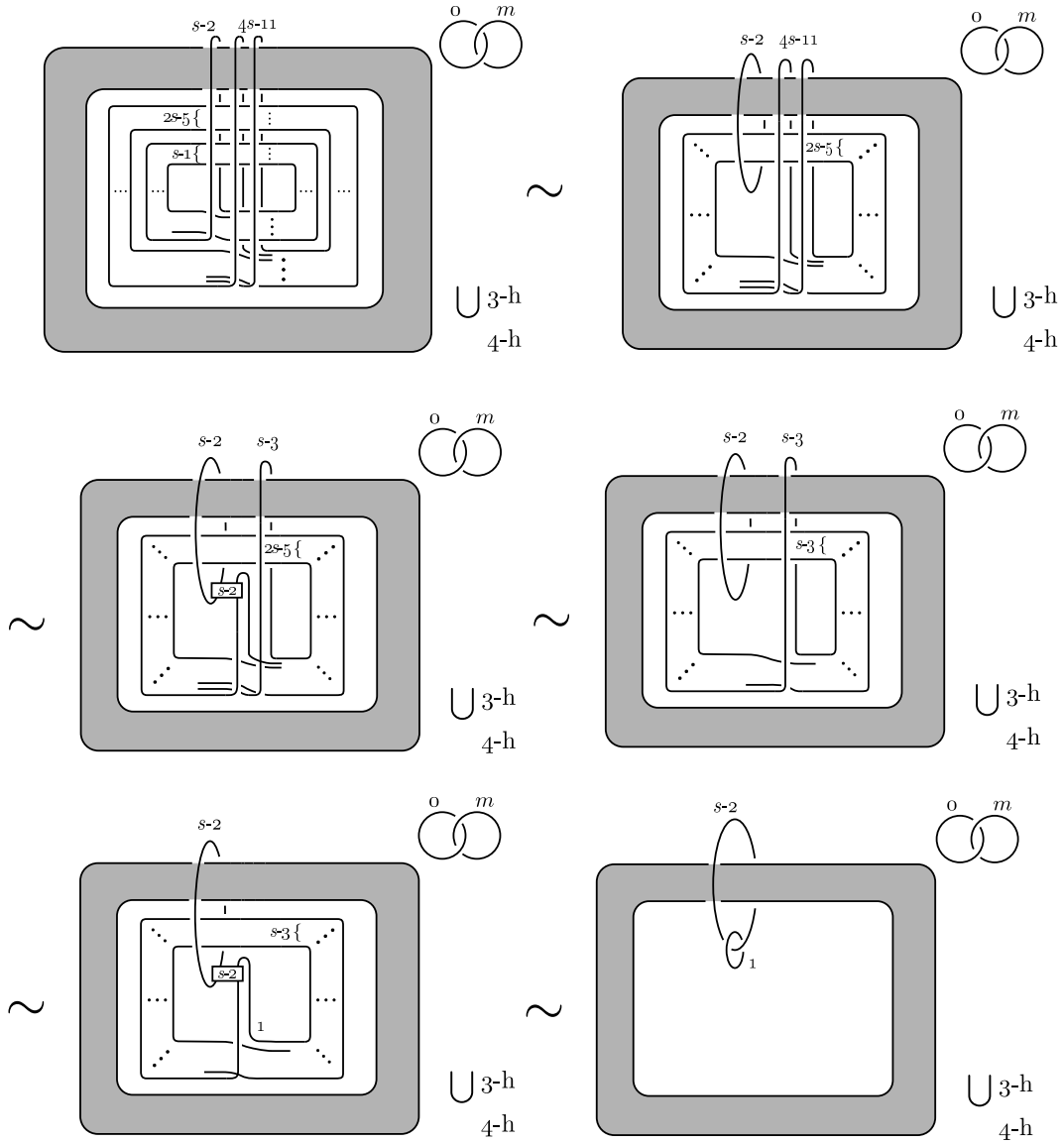

FIGURE 4.13. Only inner two 2-handles of the diagram and a Hopf link are described and the other handles are in the shaded part.

Then we obtain the following commutative diagram:

$$\begin{array}{ccc}
f_1^{-1}(D_0) & \xrightarrow{\iota} & f_2^{-1}(D_0) \\
\text{id}|_{f_1^{-1}(\partial D_0)} \downarrow & & \downarrow \text{id}|_{f_2^{-1}(\partial D_0)} \\
f_1^{-1}(D^2 \cup \overline{D^2} \setminus \text{int}(D_0 \cup D)) & \xrightarrow{\Theta} & f_2^{-1}(D^2 \cup \overline{D^2} \setminus \text{int}(D_0 \cup D)) \\
\text{id}|_{f_1^{-1}(\partial D)} \downarrow & & \downarrow \text{id}|_{f_2^{-1}(\partial D)} \\
f_1^{-1}(D \setminus \text{int}D_1) & \xrightarrow{\Theta \circ \tilde{\varphi}} & f_2^{-1}(D \setminus \text{int}D_1) \\
\text{id}|_{f_1^{-1}(\partial D_1)} \downarrow & & \downarrow \text{id}|_{f_2^{-1}(\partial D_1)} \\
f_1^{-1}(D_1) & \xrightarrow{id} & f_2^{-1}(D_1),
\end{array}$$

where vertical maps are defined only on boundaries. We can obtain by the above diagram an orientation and fiber preserving diffeomorphism $\tilde{\Phi} : M \cup_{id} \overline{M} \rightarrow M \cup_{\varphi} \overline{M}$ which is the identity map on \overline{M} . This proves the conclusion.

Step.2: We next prove the conclusion for general φ . By Step.1, it is sufficient to prove that, for any element $A \in SL(2, \mathbb{Z})$, there exists an orientation and fiber preserving diffeomorphism $\Psi_A : M \rightarrow M$ such that the image under Ψ_A of $\{\frac{1}{2}\} \times T^2$ is in $\{\frac{1}{2}\} \times T^2$ and that the mapping class of the restriction of Ψ_A to $\{\frac{1}{2}\} \times T^2$ is equal to A . To prove this claim, we use the following theorem.

Theorem 4.8 ([11]). *Let (B_1, \dots, B_n) be a sequence of elements of $SL(2, \mathbb{Z})$. Suppose that each B_i is conjugate to X_1 and that $B_1 \cdots B_n = \pm E$. Then, by successive application of elementary transformations, we can change (B_1, \dots, B_n) into the following sequence:*

$$(X_1, X_2, X_1, X_2, \dots, X_1, X_2).$$

We put $\tilde{p}_0 \in \text{int}D^2 \setminus \{p_1, \dots, p_n\}$ and let γ be an embedded path in D^2 , connecting \tilde{p}_0 to p_0 , intersecting ∂D^2 at only p_0 transversely. We can take an isotopy class of an orientation preserving diffeomorphism between $f^{-1}(\tilde{p}_0)$ and T^2 by using γ . We fix a representative element $\theta_0 : f^{-1}(\tilde{p}_0) \rightarrow T^2$ of this class. By Theorem 4.8, we can take embedded paths $\alpha_1, \dots, \alpha_n$ in $\text{int}D^2$ satisfying the following conditions:

- (a) α_i starts at \tilde{p}_0 and connects \tilde{p}_0 to p_i ;
- (b) $\alpha_i \cap \alpha_j = \{\tilde{p}_0\}$ if $i \neq j$;
- (c) $\alpha_i \cap \gamma = \{\tilde{p}_0\}$;
- (d) $\gamma, \alpha_1, \dots, \alpha_n$ appear in this order when we travel counterclockwise around \tilde{p}_0 ;
- (e) a Hurwitz system of f determined by $\theta_0, \alpha_1, \dots, \alpha_n$ is

$$(X_1, X_2, \dots, X_1, X_2).$$

Similarly, we can take embedded paths β_1, \dots, β_n in $\text{int}D^2$ so that they satisfy the following conditions:

- (a)' β_i starts at \tilde{p}_0 and connects \tilde{p}_0 to p_{k_i} , where $\{p_{k_1}, \dots, p_{k_n}\} = \{p_1, \dots, p_n\}$;
- (b)' $\beta_i \cap \beta_j = \{\tilde{p}_0\}$ if $i \neq j$;
- (c)' $\beta_i \cap \gamma = \{\tilde{p}_0\}$;

- (d)' $\gamma, \beta_1, \dots, \beta_n$ appear in this order when we travel counterclockwise around \tilde{p}_0 ;
(e)' a Hurwitz system of f determined by $\theta_0, \beta_1, \dots, \beta_n$ is

$$(A^{-1}X_1A, A^{-1}X_2A, \dots, A^{-1}X_1A, A^{-1}X_2A).$$

We denote by E_0 a disk neighborhood of \tilde{p}_0 in $\text{int}D^2 \setminus \{p_1, \dots, p_n\}$. Let $\tilde{\theta}_0 : f^{-1}(E_0) \rightarrow E_0 \times T^2$ be an extension of an identification θ_0 . We define a diffeomorphism $\Psi_1 : f^{-1}(E_0) \rightarrow f^{-1}(E_0)$ as follows:

$$\Psi_1(p, x) = (p, Ax),$$

where $(p, x) \in D^2 \times T^2$. Let W_α and W_β be regular neighborhoods of $\alpha_1 \cup \dots \cup \alpha_n$ and $\beta_1 \cup \dots \cup \beta_n$, respectively. We denote by V_1, \dots, V_n sufficiently small neighborhoods in $\text{int}D^2$ of p_1, \dots, p_n , respectively. We can easily extend Ψ_1 to:

$$\Psi_2 : f^{-1}(E_0 \cup W_\alpha \setminus (V_0 \cup \dots \cup V_n)) \rightarrow f^{-1}(E_0 \cup W_\beta \setminus (V_0 \cup \dots \cup V_n)).$$

Moreover, we can take Ψ_2 so that the image under Ψ_2 of the inverse image of α_i is in the inverse image of β_i . Then the image under Ψ_2 of a vanishing cycle in a regular neighborhood of f near $f^{-1}(p_i)$ is isotopic to a vanishing cycle in a regular neighborhood of f near $f^{-1}(p_{k_i})$. Thus Ψ_2 can be extended to:

$$\Psi_3 : f^{-1}(E_0 \cup W_\alpha) \rightarrow f^{-1}(E_0 \cup W_\beta).$$

We can easily extend this map to a self-diffeomorphism of M and this extended self-diffeomorphism satisfies the desired condition. This completes the proof of Lemma 4.6. \square

Proof of Theorem 4.5: By Lemma 4.6, without loss of generality, we can assume that the attaching circle of the 2-handle of the round handle in M is isotopic to $\gamma_{1,0}$ in a regular fiber.

We first prove the statement (1). We can describe a diagram of M as shown in Figure 4.14. We can divide the diagram into (-1) -framed unknots and a diagram of M' by sliding 2-handles corresponding to elements in S_r to the 2-handle of the round handle. This proves the statement (1).

We next prove the statement (2) by induction on the number of elements in W_g . The statement is true if $W_g = \emptyset$ by Theorem 4.3. If W_g contains a element X_1 , the statement holds by the statement (1) and the induction hypothesis. Suppose that $W_g \neq \emptyset$ and W_g does not contain X_1 . We can assume that W_g is equal to the following normal form:

$$(X_1^{n_1} X_2 X_1^{-n_1}, \dots, X_1^{n_u} X_2 X_1^{-n_u}).$$

Then a diagram of M can be described as shown in Figure 4.15. By applying moves as we performed to prove Theorem 4.3, we obtain the first diagram in Figure 4.16. After handle slidings, we obtain the last diagram in Figure 4.16. There exists a 2-handle whose attaching circle intersects the belt sphere of the 1-handle geometrically once in a shaded part. We denote the 2-handle by H . By sliding the 0-framed 2-handle intersecting the belt sphere of the 1-handle geometrically once to H and using the 0-framed meridian, we can divide the diagram into a diagram of S , $s - 2$ (-1) -framed unknots and a diagram of M' . This proves the statement (2).

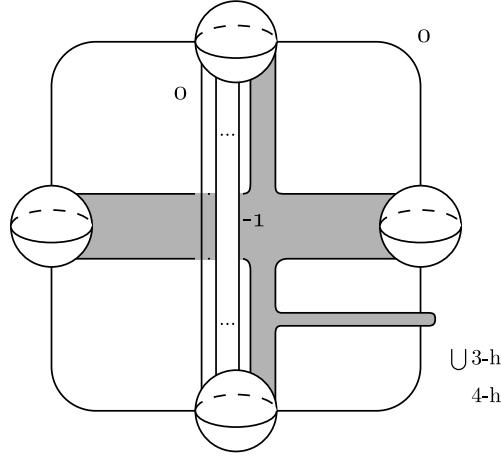

FIGURE 4.14. A diagram of a total space of a SBLF with associated sequence $S_r W_g$. Only handles of $D^2 \times T^2$, round handle and 2-handles corresponding to elements in S_r are described and the other handles are in a shaded part.

Combining the conclusions obtained above, we complete the proof of Theorem 4.5. \square

We can prove the following theorem by an argument similar to that in the proof of Theorem 4.5.

Theorem 4.9. *Let $f : M \rightarrow S^2$ be a genus-1 SBLF. Suppose that $W_f = S_r T(n_1, \dots, n_s)$ and $s > 0$. Then there exists a 4-manifold M' such that $M = M' \sharp S$, where S is either of the manifolds $S^2 \times S^2$ and $S^2 \tilde{\times} S^2$.*

Proof: By assumption about W_f , we can draw a diagram of M as shown in Figure 4.17. We first slide the 2-handle of $D^2 \times T^2$ to the 2-handle of the round 2-handle twice. Then the 2-handle of $D^2 \times T^2$ becomes a 0-framed meridian of l -framed 2-handle in the diagram. Since we assume that $s > 0$, there exists a 2-handle H in a shaded part such that an attaching circle of H goes through the 1-handle that the l -framed 2-handle goes through. By sliding l -framed 2-handle to H and using the 0-framed meridian, we can change the l -framed 2-handle and the 0-framed meridian into the Hopf link. Thus we complete the proof of Theorem 4.17. \square

Corollary 4.10. *4-manifolds with positive definite intersection form cannot admit any genus-1 SBLF structures. Especially, $k\mathbb{C}P^2$ cannot admit any such fibrations for any positive integers k .*

We end this section with the proof of Main Theorem A.

Proof of Main Theorem A: By Theorem 4.2, 4.3 and 4.5, it is sufficient to prove that only $\sharp k S^2 \times S^2$ admits a genus-1 SBLF structure. A diagram in Figure 4.18 represents the total

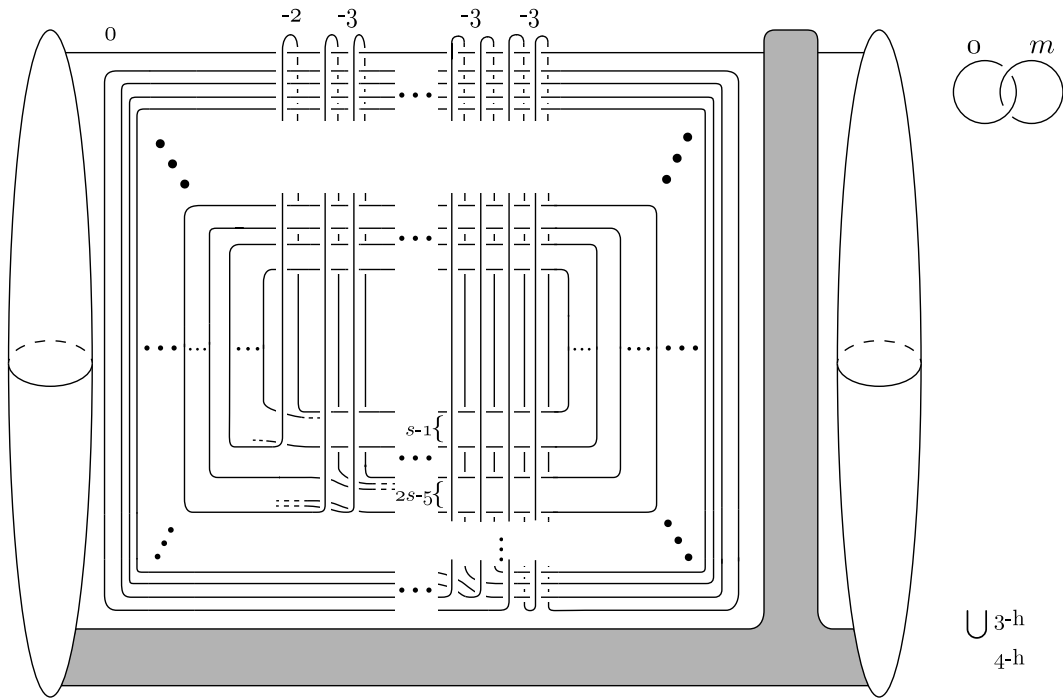

FIGURE 4.15. A diagram of a total space of a SBLF whose Hurwitz system is $W_g T_s$. Only handles of $D^2 \times T^2$, round handle and 2-handles corresponding to elements in T_s are described and the 2-handle of the round handle is eliminated.

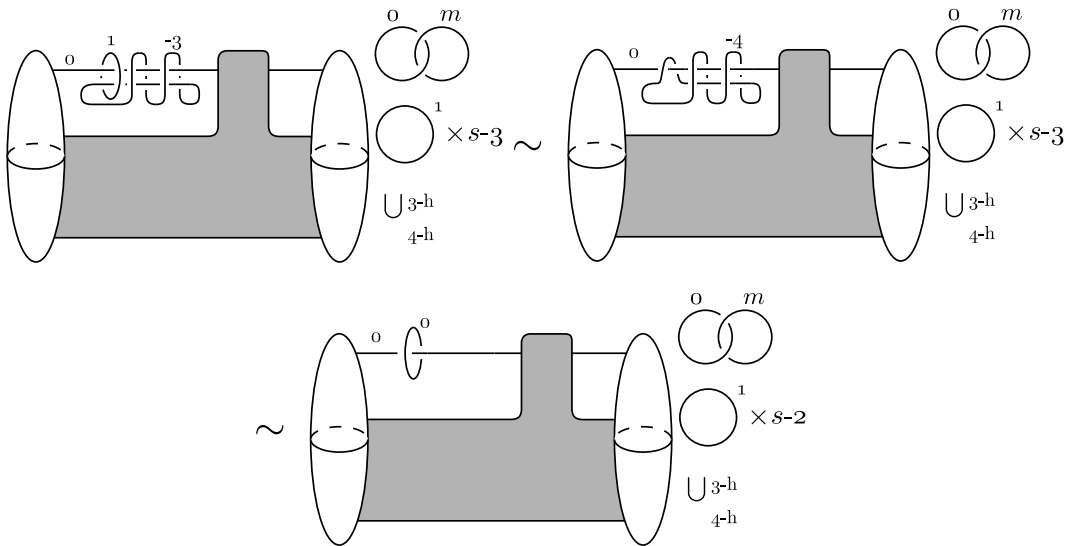

FIGURE 4.16.

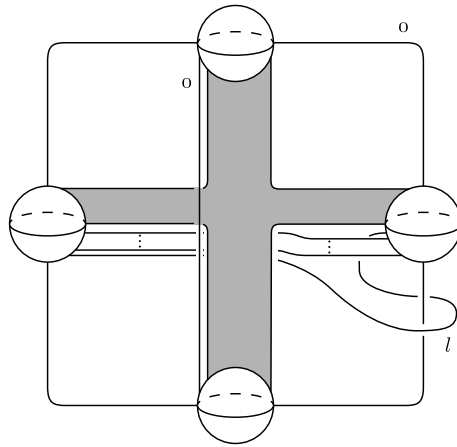

FIGURE 4.17.

space of a genus-1 SBLF whose monodromy representation is represented by the sequence kT_2 . We denote this manifold by M_k .

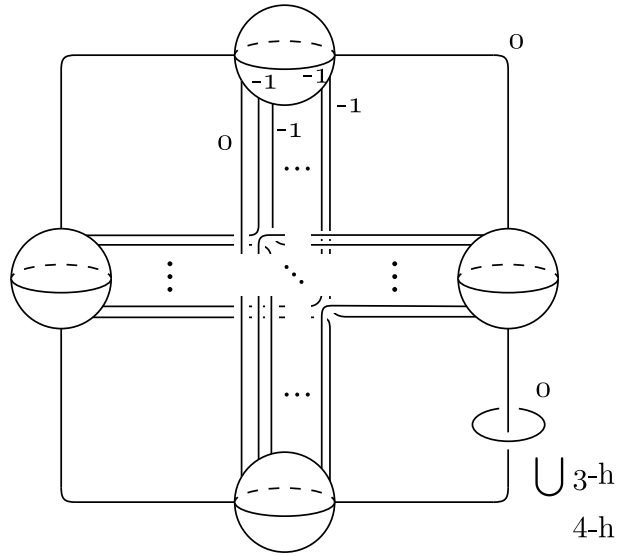

FIGURE 4.18.

We can prove that M_k is diffeomorphic to $S^2 \times S^2$ by applying same moves as we apply in the proof of the statement (2) of Theorem 4.5. This completes the proof of Main Theorem A. □

5. PROOF OF MAIN THEOREM B

We will use some properties of $PSL(2, \mathbb{Z}) = SL(2, \mathbb{Z})/\{\pm E\}$ for proving Main Theorem B. So we first review these properties before proving the theorem.

We define matrices A and B in $SL(2, \mathbb{Z})$ as follows:

$$A = \begin{pmatrix} 0 & -1 \\ 1 & 1 \end{pmatrix}, B = \begin{pmatrix} 1 & 2 \\ -1 & -1 \end{pmatrix}.$$

Then $\{A, B\}$ is a generator of $SL(2, \mathbb{Z})$. In fact, both X_1 and X_2 are represented by A and B as follows:

$$X_1 = ABA, X_2 = BA^2.$$

Let a, b, x_1 and x_2 be elements of $PSL(2, \mathbb{Z})$ represented by A, B, X_1 and X_2 , respectively. Then $PSL(2, \mathbb{Z})$ has the following finite presentation [10]:

$$PSL(2, \mathbb{Z}) = \langle a, b \mid a^3, b^2 \rangle.$$

Especially, $PSL(2, \mathbb{Z})$ is isomorphic to a free product $\mathbb{Z}/3 * \mathbb{Z}/2$.

The sequence (w_1, \dots, w_n) of elements of $PSL(2, \mathbb{Z})$ is called *reduced* if the set $\{w_i, w_{i+1}\}$ is equal to either of the sets $\{a, b\}$ and $\{a^2, b\}$ for each $i \in \{1, \dots, n-1\}$. The proof of Main Theorem B is based on the following theorem.

Theorem 5.1 ([10]). *For every element g of $PSL(2, \mathbb{Z})$, there exists a reduced sequence (w_1, \dots, w_n) of $PSL(2, \mathbb{Z})$ such that $g = w_1 \cdots w_n$. Moreover, such a sequence is unique.*

For an element $g \in PSL(2, \mathbb{Z})$, we take the reduced sequence (w_1, \dots, w_n) such that $g = w_1 \cdots w_n$. We define an element $t(g)$ as follows:

$$t(g) = w_n \cdots w_1.$$

Then a map $t : PSL(2, \mathbb{Z}) \rightarrow PSL(2, \mathbb{Z})$ is well-defined by Theorem 5.1 and it is an anti-homomorphism. Since $x_1 = aba$ and $x_2 = ba^2$, we obtain $t(x_1) = x_1$ and $t(x_2) = x_1^{-1}x_2x_1$.

Now we are ready to prove Main Theorem B.

Proof of Main Theorem B: Let $f : M \rightarrow S^2$ be a genus-1 SBLF with non-empty wound singular locus and with r Lefschetz singularities. Let W_f be a Hurwitz system of f which satisfies $w(W_f) = \pm X_1^m$, where $m \in \mathbb{Z}$. We can assume by Theorem 3.10 that $W_f = S_k T(n_1, \dots, n_{r-k})$.

For the case $r = 0$, the conclusion holds directly by Theorem 4.2.

For the case $r = 1$, W_f is either of the sequence S_1 and $T(n_1)$. If W_f were $T(n_1)$, $w(W_f)$ would not be equal to $\pm X_1^m$. So W_f is equal to S_1 and the conclusion holds by Theorem 4.2.

For the case $r = 2$, W_f is equal to $S_2, S_1T(n_1)$ or $T(n_1, n_2)$. W_f is not equal to $S_1T(n_1)$ since $w(W_f) = \pm X_1^m$. If W_f is equal to S_2 , then M is diffeomorphic to $\#2\overline{CP^2}, S^1 \times$

$S^3 \# S^2 \overline{\mathbb{C}\mathbb{P}^2}$ or $L \# 2 \overline{\mathbb{C}\mathbb{P}^2}$. If W_f is equal to $T(n_1, n_2)$ and $n_1 - n_2 = 1$, we can change W_f by elementary transformations as follows:

$$\begin{aligned}
W_f &= (X_1^{-n_1} X_2 X_1^{n_1}, X_1^{-n_2} X_2 X_1^{n_2}) \\
&\mapsto ((X_1^{-n_1} X_2 X_1^{n_1})(X_1^{-n_2} X_2 X_1^{n_2})(X_1^{-n_1} X_2^{-1} X_1^{n_1}), X_1^{-n_1} X_2 X_1^{n_1}) \\
&= (X_1^{-n_1} (X_2 X_1 X_2 X_1^{-1} X_2^{-1}) X_1^{n_1}, X_1^{-n_1} X_2 X_1^{n_1}) \\
&= (X_1^{-n_1} X_1 X_1^{n_1}, X_1^{-n_1} X_2 X_1^{n_1}) \\
&= (X_1, X_1^{-n_1} X_2 X_1^{n_1}) \\
&= S_1 T(n_1).
\end{aligned}$$

This contradiction says that $n_1 - n_2 \neq 1$. Since $w(W_f) = \pm X_1^m$, the following equation holds:

$$\begin{aligned}
&x_1^{-n_1} x_2 x_1^{n_1} x_1^{-n_2} x_2 x_1^{n_2} = x_1^m \\
(5.1) \quad &\Rightarrow x_2 x_1^{n_1 - n_2} x_2 = x_1^m,
\end{aligned}$$

where $n = m + n_1 - n_2$. The right side of the equation (5.1) is represented by a and b as follows:

$$\begin{aligned}
x_2 x_1^{n_1 - n_2} x_2 &= \begin{cases} ba^2 \cdot a^2 (ba)^{-n_1 + n_2 - 1} ba^2 ba^2 & (n_1 - n_2 \leq 0) \\ ba^2 \cdot a (ba^2)^{n_1 - n_2 - 1} baba^2 & (n_1 - n_2 \geq 2) \end{cases} \\
&= \begin{cases} (ba)^{-n_1 + n_2} ba^2 ba^2 & (n_1 - n_2 \leq 0), \\ a^2 (ba^2)^{n_1 - n_2 - 2} baba^2 & (n_1 - n_2 \geq 2). \end{cases}
\end{aligned}$$

x_1^n is represented by a and b as follows:

$$(5.2) \quad x_1^n = \begin{cases} a (ba^2)^{n-1} ba & (n \geq 1), \\ a^2 (ba)^{-n-1} ba^2 & (n \leq -1). \end{cases}$$

By Theorem 5.1, we obtain $n_1 - n_2 = 2$. Then we can change W_f into T_2 by applying simultaneous conjugation. Thus M is diffeomorphic to either of the manifolds $S^2 \times S^2$ and $S^2 \tilde{\times} S^2$.

For the case $r = 3$, W_f is equal to S_3 , $S_2 T(n_1)$, $S_1 T(n_1, n_2)$ or $T(n_1, n_2, n_3)$. The case $W_f = S_2 T(n_1)$ never occurs since $w(W_f) = \pm X_1^m$. If $W_f = S_3$ or $S_1 T(n_1, n_2)$, 4-manifolds that M can be is well-known by Theorem 4.2, 4.3, 4.5 and the argument for the case $r = 2$ and these are contained in a family of 4-manifolds in the statement of Main Theorem B. So all we need to examine is the case $W_f = T(n_1, n_2, n_3)$. We can assume that $n_i - n_{i+1} \neq 1$ ($i = 1, 2$) by the same argument as in the case $r = 2$. If $n_i - n_{i+1} = 2$ for $i = 1$ or 2 , then $X_1^{-n_i} X_2 X_1^{n_i} X_1^{-n_{i+1}} X_2 X_1^{n_{i+1}} = -X_1^{-4}$ and we can change W_f into $T(\tilde{n})T_2$ by elementary transformations and simultaneous conjugations, where \tilde{n} is an integer. This contradicts $w(W_f) = \pm X_1^m$. So $n_i - n_{i+1} \neq 2$ for $i = 1, 2$. Since $W_f = \pm X_1^m$, the following equation

holds:

$$(5.3) \quad \begin{aligned} x_1^{-n_1} x_2 x_1^{n_1} x_1^{-n_2} x_2 x_1^{-n_3} x_1 x_2 x_1^{n_3} &= x_1^m \\ \Rightarrow x_2 x_1^{n_1-n_2} x_2 x_1^{n_2-n_3} x_2 &= x_1^n, \end{aligned}$$

where $n = m + n_1 - n_3$. If $n_1 - n_2 \leq 0$, Then the right side of the above equation is represented by a and b as follows:

$$\begin{aligned} x_2 x_1^{n_1-n_2} x_2 x_1^{n_2-n_3} x_2 &= \begin{cases} ba^2 \cdot a^2 (ba)^{-n_1+n_2-1} ba^2 \cdot ba^2 \cdot a (ba^2)^{n_2-n_3-1} \cdot ba^2 & (n_2 - n_3 \geq 3) \\ ba^2 \cdot a^2 (ba)^{-n_1+n_2-1} ba^2 \cdot ba^2 \cdot a^2 (ba)^{-n_2+n_3-1} \cdot ba^2 & (n_2 - n_3 \leq 0) \end{cases} \\ &= \begin{cases} (ba)^{-n_1+n_2} ba \cdot (ba^2)^{n_2-n_3-3} ba^2 & (n_2 - n_3 \geq 3), \\ (ba)^{-n_1+n_2} ba^2 (ba)^{-n_2+n_3} ba^2 & (n_2 - n_3 \leq 0). \end{cases} \end{aligned}$$

This would not be equal to x_1^n by (5.2) and Theorem 5.1. Thus we obtain $n_1 - n_2 \geq 3$. By operating a map t to both sides of the equation (5.3), we obtain:

$$\begin{aligned} (x_1^{-1} x_2 x_1) x_1^{n_2-n_3} (x_1^{-1} x_2 x_1) x_1^{n_1-n_2} (x_1^{-1} x_2 x_1) &= x_1^n \\ \Rightarrow x_2 x_1^{n_2-n_3} x_2 x_1^{n_1-n_2} x_2 &= x_1^n. \end{aligned}$$

So we obtain $n_2 - n_3 \geq 3$ by the same argument as above. Thus the right side of the equation (5.3) is represented by a and b as follows:

$$\begin{aligned} &x_2 x_1^{n_1-n_2} x_2 x_1^{n_2-n_3} x_2 \\ &= ba^2 \cdot a (ba^2)^{n_1-n_2-1} ba \cdot ba^2 \cdot a (ba^2)^{n_2-n_3-1} ba \cdot ba^2 \\ &= a^2 (ba^2)^{n_1-n_2-2} ba \cdot a^2 (ba^2)^{n_2-n_3-2} baba^2 \\ &= a^2 (ba^2)^{n_1-n_2-3} ba (ba^2)^{n_2-n_3-3} baba^2. \end{aligned}$$

By Theorem 5.1, we obtain $n_1 - n_2 = n_2 - n_3 = 3$. Then we can change W_f into T_3 by applying simultaneous conjugation and M is diffeomorphic to $\sharp 2\mathbb{C}\mathbb{P}^2 \sharp \overline{\mathbb{C}\mathbb{P}^2}$.

For the case $r = 4$, W_f is equal to S_4 , $S_3T(n_1)$, $S_2T(n_1, n_2)$, $S_1T(n_1, n_2, n_3)$ or $T(n_1, n_2, n_3, n_4)$. But all we need to examine is the case $W_f = T(n_1, n_2, n_3, n_4)$ as the case $r = 3$. We can assume that $n_i - n_{i+1} \neq 1, 2$ for $i = 1, 2, 3$ by the same argument as in the case $r = 3$. If $n_i - n_{i+1} = n_{i+1} - n_{i+2} = 3$ for $i = 1$ or 2 , then we can change W_f into $T(\tilde{n})T_3$ by elementary transformations and simultaneous conjugations, where \tilde{n} is an integer. This contradicts $w(W_f) = \pm X_1^m$. So we obtain $(n_i - n_{i+1}, n_{i+1} - n_{i+2}) \neq (3, 3)$ for $i = 1, 2$. Since $W_f = \pm X_1^m$, we obtain the following equation:

$$(5.4) \quad \begin{aligned} x_1^{-n_1} x_2 x_1^{n_1} x_1^{-n_2} x_2 x_1^{n_2} x_1^{-n_3} x_2 x_1^{n_3} x_1^{-n_4} x_2 x_1^{n_4} &= x_1^m \\ \Rightarrow x_2 x_1^{n_1-n_2} x_2 x_1^{n_2-n_3} x_2 x_1^{n_3-n_4} x_2 &= x_1^n, \end{aligned}$$

where $n = m + n_1 - n_4$. If $n_1 - n_2 \leq 0$, the right side of the equation (5.4) is represented by a and b as follows:

$$x_2 x_1^{n_1-n_2} x_2 x_1^{n_2-n_3} x_2 x_1^{n_3-n_4} x_2$$

$$\begin{aligned}
& \left\{ \begin{array}{l}
ba^2 \cdot a^2(ba)^{-n_1+n_2-1}ba^2 \cdot ba^2 \cdot a(ba^2)^{n_2-n_3-1}ba \cdot ba^2 \\
\quad \cdot a(ba^2)^{n_3-n_4-1}ba \cdot ba^2 \quad (n_2 - n_3 \geq 3, n_3 - n_4 \geq 3) \\
ba^2 \cdot a^2(ba)^{-n_1+n_2-1}ba^2 \cdot ba^2 \cdot a^2(ba)^{-n_2+n_3-1}ba^2 \cdot ba^2 \\
\quad \cdot a(ba^2)^{n_3-n_4-1}ba \cdot ba^2 \quad (n_2 - n_3 \leq 0, n_3 - n_4 \geq 3) \\
ba^2 \cdot a^2(ba)^{-n_1+n_2-1}ba^2 \cdot ba^2 \cdot a(ba^2)^{n_2-n_3-1}ba \cdot ba^2 \\
\quad \cdot a^2(ba)^{-n_3+n_4-1}ba^2 \cdot ba^2 \quad (n_2 - n_3 \geq 3, n_3 - n_4 \leq 0) \\
ba^2 \cdot a^2(ba)^{-n_1+n_2-1}ba^2 \cdot ba^2 \cdot a^2(ba)^{-n_2+n_3-1}ba^2 \cdot ba^2 \\
\quad \cdot a^2(ba)^{-n_3+n_4-1}ba^2 \cdot ba^2 \quad (n_2 - n_3 \leq 0, n_3 - n_4 \leq 0)
\end{array} \right. \\
& = \left\{ \begin{array}{l}
(ba)^{-n_1+n_2}ba(ba^2)^{n_2-n_3-3}ba(ba^2)^{n_3-n_4-3}baba^2 \quad (n_2 - n_3 \geq 3, n_3 - n_4 \geq 3), \\
(ba)^{-n_1+n_2}ba^2(ba)^{-n_2+n_3}ba(ba^2)^{n_3-n_4-2}baba^2 \quad (n_2 - n_3 \leq 0, n_3 - n_4 \geq 3), \\
(ba)^{-n_1+n_2}ba(ba^2)^{n_2-n_3-2}(ba)^{-n_3+n_4+1}ba^2ba^2 \quad (n_2 - n_3 \geq 3, n_3 - n_4 \leq 0), \\
(ba)^{-n_1+n_2}ba^2(ba)^{-n_2+n_3}ba^2(ba)^{-n_3+n_4}ba^2ba^2 \quad (n_2 - n_3 \leq 0, n_3 - n_4 \leq 0).
\end{array} \right.
\end{aligned}$$

This would not be equal to x_1^n by (5.2) and Theorem 5.1. Thus we obtain $n_1 - n_3 \geq 3$. By operating a map t to both sides of the equation (5.4), we obtain:

$$x_2x_1^{n_3-n_4}x_2x_1^{n_2-n_3}x_2x_1^{n_1-n_2}x_2 = x_1^n.$$

So we obtain $n_3 - n_4 \geq 3$ by the same argument above. If $n_2 - n_3 \leq 0$, the right side of the equation (5.4) is represented by a and b as follows:

$$\begin{aligned}
& x_2x_1^{n_1-n_2}x_2x_1^{n_2-n_3}x_2x_1^{n_3-n_4}x_2 \\
& = ba^2 \cdot a(ba^2)^{n_1-n_2-1}ba \cdot ba^2 \cdot a^2(ba)^{-n_2+n_3-1}ba^2 \cdot ba^2 \cdot a(ba^2)^{n_3-n_4-1}ba \cdot ba^2 \\
& = a^2(ba^2)^{n_1-n_2-1}(ba)^{-n_2+n_3+1}ba(ba^2)^{n_3-n_4-2}ba \cdot ba^2.
\end{aligned}$$

This would not be equal to x_1^n and we obtain $n_2 - n_3 \geq 3$. Thus the right side of the equation (5.4) is represented by a and b as follows:

$$\begin{aligned}
& x_2x_1^{n_1-n_2}x_2x_1^{n_2-n_3}x_2x_1^{n_3-n_4}x_2 \\
& = ba^2 \cdot a(ba^2)^{n_1-n_2-1}ba \cdot ba^2 \cdot a(ba^2)^{n_2-n_3-1}ba \cdot ba^2 \cdot a(ba^2)^{n_3-n_4-1}ba \cdot ba^2 \\
& = a^2(ba^2)^{n_1-n_2-3}ba(ba^2)^{n_2-n_3-3}a^2(ba^2)^{n_3-n_4-3}baba^2 \\
& = \begin{cases} a^2(ba^2)^{n_1-n_2-4}ba(ba^2)^{n_3-n_4-4}baba^2 & (n_2 - n_3 = 3), \\ a^2(ba^2)^{n_1-n_2-3}ba(ba^2)^{n_2-n_3-4}ba(ba^2)^{n_3-n_4-3}baba^2 & (n_2 - n_3 \geq 4). \end{cases}
\end{aligned}$$

By Theorem 5.1, we obtain:

$$(n_1 - n_2, n_2 - n_3, n_3 - n_4) = (3, 4, 3) \text{ or } (4, 3, 4).$$

Then we can easily change W_f into T_4 by elementary transformations and simultaneous conjugations. Thus M is diffeomorphic to $\sharp 3\mathbb{CP}^2 \sharp \overline{\mathbb{CP}^2}$.

For the case $r = 5$, W_f is equal to S_5 , $S_4T(n_1)$, $S_3T(n_1, n_2)$, $S_2T(n_1, n_2, n_3)$, $S_1T(n_1, n_2, n_3, n_4)$ or $T(n_1, n_2, n_3, n_4, n_5)$. But all we need to examine is the case $W_f = T(n_1, n_2, n_3, n_4, n_5)$

as the case $r = 4$. We can assume that $n_i - n_{i+1} \neq 1, 2$ for $i = 1, 2, 3, 4$ and $(n_j - n_{j+1}, n_{j+1} - n_{j+2}) \neq (3, 3)$ for $j = 1, 2, 3$ by the same argument as in the case $r = 4$. If $(n_i - n_{i+1}, n_{i+1} - n_{i+2}, n_{i+2} - n_{i+3}) = (3, 4, 3)$ or $(4, 3, 4)$ for $i = 1$ or 2 , then we can change W_f into $T(\tilde{n})T_4$ by elementary transformations and simultaneous conjugations, where \tilde{n} is an integer. This contradicts $w(W_f) = \pm X_1^m$. So we obtain $(n_i - n_{i+1}, n_{i+1} - n_{i+2}, n_{i+2} - n_{i+3}) = (3, 4, 3), (4, 3, 4)$ for $i = 1, 2$. Since $w(W_f) = \pm X_1^m$, we obtain the following equation:

$$(5.5) \quad \begin{aligned} & x_1^{-n_1} x_2 x_1^{n_1} x_1^{-n_2} x_2 x_1^{n_2} x_1^{-n_3} x_2 x_1^{n_3} x_1^{-n_4} x_2 x_1^{n_4} x_1^{-n_5} x_2 x_1^{n_5} = x_1^m \\ \Rightarrow & x_2 x_1^{n_1 - n_2} x_2 x_1^{n_2 - n_3} x_2 x_1^{n_3 - n_4} x_2 x_1^{n_4 - n_5} x_2 = x_1^m, \end{aligned}$$

where $n = m + n_1 - n_5$. If $n_1 - n_2 \leq 0$ and $n_2 - n_3 \leq 0$, the right side of the equation (5.5) is represented by a and b as follows:

$$\begin{aligned} & x_2 x_1^{n_1 - n_2} x_2 x_1^{n_2 - n_3} x_2 x_1^{n_3 - n_4} x_2 x_1^{n_4 - n_5} x_2 \\ = & \begin{cases} \begin{aligned} & ba^2 \cdot a^2 (ba)^{-n_1 + n_2 - 1} ba^2 \cdot ba^2 \cdot a^2 (ba)^{-n_2 + n_3 - 1} ba^2 \cdot ba^2 \\ & \cdot a (ba^2)^{n_3 - n_4 - 1} ba \cdot ba^2 \cdot a (ba^2)^{n_4 - n_5 - 1} ba \cdot ba^2 \end{aligned} & (n_3 - n_4 \geq 3, n_4 - n_5 \geq 3) \\ \begin{aligned} & ba^2 \cdot a^2 (ba)^{-n_1 + n_2 - 1} ba^2 \cdot ba^2 \cdot a^2 (ba)^{-n_2 + n_3 - 1} ba^2 \cdot ba^2 \\ & \cdot a^2 (ba)^{-n_3 + n_4 - 1} ba^2 \cdot ba^2 \cdot a (ba^2)^{n_4 - n_5 - 1} ba \cdot ba^2 \end{aligned} & (n_3 - n_4 \leq 0, n_4 - n_5 \geq 3) \\ \begin{aligned} & ba^2 \cdot a^2 (ba)^{-n_1 + n_2 - 1} ba^2 \cdot ba^2 \cdot a^2 (ba)^{-n_2 + n_3 - 1} ba^2 \cdot ba^2 \\ & \cdot a (ba^2)^{n_3 - n_4 - 1} ba \cdot ba^2 \cdot a^2 (ba)^{-n_4 + n_5 - 1} ba^2 \cdot ba^2 \end{aligned} & (n_3 - n_4 \geq 3, n_4 - n_5 \leq 0) \\ \begin{aligned} & ba^2 \cdot a^2 (ba)^{-n_1 + n_2 - 1} ba^2 \cdot ba^2 \cdot a^2 (ba)^{-n_2 + n_3 - 1} ba^2 \cdot ba^2 \\ & \cdot a^2 (ba)^{-n_3 + n_4 - 1} ba^2 \cdot ba^2 \cdot a^2 (ba)^{-n_4 + n_5 - 1} ba^2 \cdot ba^2 \end{aligned} & (n_3 - n_4 \leq 0, n_4 - n_5 \leq 0) \end{cases} \\ = & \begin{cases} (ba)^{-n_1 + n_2} ba^2 (ba)^{-n_2 + n_3} ba (ba^2)^{n_3 - n_4 - 3} ba (ba^2)^{n_4 - n_5 - 3} baba^2 & (n_3 - n_4 \geq 3, n_4 - n_5 \geq 3), \\ (ba)^{-n_1 + n_2} ba^2 (ba)^{-n_2 + n_3} ba^2 (ba)^{-n_3 + n_4} ba (ba^2)^{n_4 - n_5 - 2} baba^2 & (n_3 - n_4 \leq 0, n_4 - n_5 \geq 3), \\ (ba)^{-n_1 + n_2} ba^2 (ba)^{-n_2 + n_3} ba (ba^2)^{n_3 - n_4 - 2} ba (ba)^{-n_4 + n_5} ba^2 ba^2 & (n_3 - n_4 \geq 3, n_4 - n_5 \leq 0), \\ (ba)^{-n_1 + n_2} ba^2 (ba)^{-n_2 + n_3} ba^2 (ba)^{-n_3 + n_4} ba^2 (ba)^{-n_4 + n_5} ba^2 ba^2 & (n_3 - n_4 \leq 0, n_4 - n_5 \leq 0). \end{cases} \end{aligned}$$

This would not be equal to x_1^n by Theorem 5.1. So either of the cases $n_1 - n_2 \geq 3$ and $n_2 - n_3 \geq 3$ holds. If $n_1 - n_2 \leq 0$, then $n_2 - n_3 \geq 3$ and the right side of the equation (5.5) is represented by a and b as follows:

$$x_2 x_1^{n_1 - n_2} x_2 x_1^{n_2 - n_3} x_2 x_1^{n_3 - n_4} x_2 x_1^{n_4 - n_5} x_2$$

$$\begin{aligned}
& \left\{ \begin{array}{l}
ba^2 \cdot a^2 (ba)^{-n_1+n_2-1} ba^2 \cdot ba^2 \cdot a (ba^2)^{n_2-n_3-1} ba \cdot ba^2 \\
\cdot a (ba^2)^{n_3-n_4-1} ba \cdot ba^2 \cdot a (ba^2)^{n_4-n_5-1} ba \cdot ba^2 \quad (n_3 - n_4 \geq 3, n_4 - n_5 \geq 3) \\
ba^2 \cdot a^2 (ba)^{-n_1+n_2-1} ba^2 \cdot ba^2 \cdot a (ba^2)^{n_2-n_3-1} ba \cdot ba^2 \\
\cdot a^2 (ba)^{-n_3+n_4-1} ba^2 \cdot ba^2 \cdot a (ba^2)^{n_4-n_5-1} ba \cdot ba^2 \quad (n_3 - n_4 \leq 0, n_4 - n_5 \geq 3) \\
ba^2 \cdot a^2 (ba)^{-n_1+n_2-1} ba^2 \cdot ba^2 \cdot a (ba^2)^{n_2-n_3-1} ba \cdot ba^2 \\
\cdot a (ba^2)^{n_3-n_4-1} ba \cdot ba^2 \cdot a^2 (ba)^{-n_4+n_5-1} ba^2 \cdot ba^2 \quad (n_3 - n_4 \geq 3, n_4 - n_5 \leq 0) \\
ba^2 \cdot a^2 (ba)^{-n_1+n_2-1} ba^2 \cdot ba^2 \cdot a (ba^2)^{n_2-n_3-1} ba \cdot ba^2 \\
\cdot a^2 (ba)^{-n_3+n_4-1} ba^2 \cdot ba^2 \cdot a^2 (ba)^{-n_4+n_5-1} ba^2 \cdot ba^2 \quad (n_3 - n_4 \leq 0, n_4 - n_5 \leq 0)
\end{array} \right. \\
& = \left\{ \begin{array}{l}
(ba)^{-n_1+n_2} ba (ba^2)^{n_2-n_3-3} ba (ba^2)^{n_3-n_4-3} a^2 (ba^2)^{n_4-n_5-3} baba^2 \quad (n_3 - n_4 \geq 3, n_4 - n_5 \geq 3) \\
(ba)^{-n_1+n_2} ba (ba^2)^{n_2-n_3-2} (ba)^{-n_3+n_4+1} ba (ba^2)^{n_4-n_5-2} baba^2 \quad (n_3 - n_4 \leq 0, n_4 - n_5 \geq 3) \\
(ba)^{-n_1+n_2} ba (ba^2)^{n_2-n_3-3} ba (ba^2)^{n_3-n_4-3} ba (ba)^{-n_4+n_5} ba^2 ba^2 \quad (n_3 - n_4 \geq 3, n_4 - n_5 \leq 0) \\
(ba)^{-n_1+n_2} ba (ba^2)^{n_2-n_3-2} (ba)^{-n_3+n_4+1} ba^2 (ba)^{-n_4+n_5} ba^2 ba^2 \quad (n_3 - n_4 \leq 0, n_4 - n_5 \leq 0)
\end{array} \right. \\
& = \left\{ \begin{array}{l}
(ba)^{-n_1+n_2} ba (ba^2)^{n_2-n_3-3} ba (ba^2)^{n_3-n_4-4} ba (ba^2)^{n_4-n_5-3} baba^2 \quad (n_3 - n_4 \geq 4, n_4 - n_5 \geq 3), \\
(ba)^{-n_1+n_2} ba (ba^2)^{n_2-n_3-4} ba (ba^2)^{n_4-n_5-4} baba^2 \quad (n_3 - n_4 = 3, n_4 - n_5 \geq 3), \\
(ba)^{-n_1+n_2} ba (ba^2)^{n_2-n_3-2} (ba)^{-n_3+n_4+1} ba (ba^2)^{n_4-n_5-2} baba^2 \quad (n_3 - n_4 \leq 0, n_4 - n_5 \geq 3), \\
(ba)^{-n_1+n_2} ba (ba^2)^{n_2-n_3-3} ba (ba^2)^{n_3-n_4-3} ba (ba)^{-n_4+n_5} ba^2 ba^2 \quad (n_3 - n_4 \geq 3, n_4 - n_5 \leq 0), \\
(ba)^{-n_1+n_2} ba (ba^2)^{n_2-n_3-2} (ba)^{-n_3+n_4+1} ba^2 (ba)^{-n_4+n_5} ba^2 ba^2 \quad (n_3 - n_4 \leq 0, n_4 - n_5 \leq 0).
\end{array} \right.
\end{aligned}$$

This would not be equal to x_1^n by Theorem 5.1. So we obtain $n_1 - n_2 \geq 3$. By operating a map t to both sides of the equation (5.5), we obtain:

$$(5.6) \quad x_2 x_1^{n_4-n_5} x_2 x_1^{n_3-n_4} x_2 x_1^{n_2-n_3} x_2 x_1^{n_1-n_2} x_2 = x_1^n$$

So we obtain $n_4 - n_5 \geq 3$. If $n_2 - n_3 \leq 0$, the right side of the equation (5.5) is represented by a and b as follows:

$$\begin{aligned}
& x_2 x_1^{n_1-n_2} x_2 x_1^{n_2-n_3} x_2 x_1^{n_3-n_4} x_2 x_1^{n_4-n_5} x_2 \\
& = \left\{ \begin{array}{l}
ba^2 \cdot a (ba^2)^{n_1-n_2-1} ba \cdot ba^2 \cdot a^2 (ba)^{-n_2+n_3-1} ba^2 \cdot ba^2 \\
\cdot a (ba^2)^{n_3-n_4-1} ba \cdot ba^2 \cdot a (ba^2)^{n_4-n_5-1} ba \cdot ba^2 \quad (n_3 - n_4 \geq 3) \\
ba^2 \cdot a (ba^2)^{n_1-n_2-1} ba \cdot ba^2 \cdot a^2 (ba)^{-n_2+n_3-1} ba^2 \cdot ba^2 \\
\cdot a^2 (ba)^{-n_3+n_4-1} ba^2 \cdot ba^2 \cdot a (ba^2)^{n_4-n_5-1} ba \cdot ba^2 \quad (n_3 - n_4 \leq 0)
\end{array} \right. \\
& = \left\{ \begin{array}{l}
a^2 ba^2 (ba^2)^{n_1-n_2-3} (ba)^{-n_2+n_3+1} ba (ba^2)^{n_3-n_4-3} ba (ba^2)^{n_4-n_5-3} baba^2 \quad (n_3 - n_4 \geq 3), \\
a^2 ba^2 (ba^2)^{n_1-n_2-3} (ba)^{-n_2+n_3+1} ba^2 (ba)^{-n_3+n_4} ba (ba^2)^{n_4-n_5-2} baba^2 \quad (n_3 - n_4 \leq 0).
\end{array} \right.
\end{aligned}$$

This would not be equal to x_1^n by Theorem 5.1 and we obtain $n_2 - n_3 \geq 3$. We also obtain $n_3 - n_4 \geq 3$ by the equation (5.6). Thus the right side of the equation (5.5) is represented

by a and b as follows:

$$\begin{aligned}
& x_2 x_1^{n_1-n_2} x_2 x_1^{n_2-n_3} x_2 x_1^{n_3-n_4} x_2 x_1^{n_4-n_5} x_2 \\
&= ba^2 \cdot a(ba^2)^{n_1-n_2-1} ba \cdot ba^2 \cdot a(ba^2)^{n_2-n_3-1} ba \cdot ba^2 \cdot a(ba^2)^{n_3-n_4-1} ba \cdot ba^2 \cdot a(ba^2)^{n_4-n_5-1} ba \cdot ba^2 \\
&= a^2(ba^2)^{n_1-n_2-2} a^2(ba^2)^{n_2-n_3-3} a^2(ba^2)^{n_3-n_4-3} a^2(ba^2)^{n_4-n_5-3} baba^2 \\
&= a^2(ba^2)^{n_1-n_2-3} ba(ba^2)^{n_2-n_3-3} a^2(ba^2)^{n_3-n_4-3} a^2(ba^2)^{n_4-n_5-3} baba^2 \\
&= \begin{cases} a^2(ba^2)^{n_1-n_2-3} ba(ba^2)^{n_2-n_3-4} ba(ba^2)^{n_3-n_4-3} a^2(ba^2)^{n_4-n_5-3} baba^2 & (n_2 - n_3 \geq 4) \\ a^2(ba^2)^{n_1-n_2-4} ba(ba^2)^{n_3-n_4-5} ba(ba^2)^{n_4-n_5-3} baba^2 & (n_2 - n_3 = 3) \end{cases} \\
&= \begin{cases} a^2(ba^2)^{n_1-n_2-3} ba(ba^2)^{n_2-n_3-4} ba(ba^2)^{n_3-n_4-4} ba(ba^2)^{n_4-n_5-3} baba^2 & (n_2 - n_3 \geq 4, n_3 - n_4 \geq 4), \\ a^2(ba^2)^{n_1-n_2-3} ba(ba^2)^{n_2-n_3-5} ba(ba^2)^{n_4-n_5-4} baba^2 & (n_2 - n_3 \geq 4, n_3 - n_4 = 3), \\ a^2(ba^2)^{n_1-n_2-4} ba(ba^2)^{n_3-n_4-5} ba(ba^2)^{n_4-n_5-3} baba^2 & (n_2 - n_3 = 3). \end{cases}
\end{aligned}$$

By Theorem 5.1, we obtain:

$$(n_1 - n_2, n_2 - n_3, n_3 - n_4, n_4 - n_5) = (3, 4, 4, 3), (3, 5, 3, 4) \text{ or } (4, 3, 5, 3).$$

Then we can easily change W_f into T_5 by elementary transformations and simultaneous conjugations. Thus M is diffeomorphic to $\sharp 4\mathbb{C}\mathbb{P}^2 \overline{\sharp \mathbb{C}\mathbb{P}^2}$.

Combining the above arguments, we complete the proof of Main Theorem B. \square

Remark 5.2. In the case $r = 6$, the following sequence appears as a candidate of a Hurwitz system of a SBLF:

$$\tilde{T}_6 = (X_1^{-10} X_2 X_1^{10}, X_1^{-6} X_2 X_1^6, X_1^{-1} X_2 X_1, X_1^2 X_2 X_1^{-2}, X_1^6 X_2 X_1^{-6}, X_1^{11} X_2 X_1^{-11}).$$

Indeed, it is easy to see that $w(\tilde{T}_6) = -X_1^{-24}$. We can change \tilde{T}_6 into the following sequence by successive application of elementary transformations and simultaneous conjugations:

$$(T_{3,1}, T_{3,2}, T_{2,3}, T_{2,5}, T_{1,4}, T_{-1,1}).$$

We can draw a Kirby diagram of the total space of a SBLF whose Hurwitz systems \tilde{T}_6 . We can prove by Kirby calculus that this 4-manifold is diffeomorphic to $\sharp 5\mathbb{C}\mathbb{P}^2 \overline{\sharp \mathbb{C}\mathbb{P}^2}$, which is the total space of a SBLF whose Hurwitz system is T_6 . However, the author does not know whether \tilde{T}_6 can be changed into T_6 by elementary transformations and simultaneous conjugations.

Conjecture 5.3. The *only* following 4-manifolds admit genus-1 SBLF structures:

- $\sharp k\mathbb{C}\mathbb{P}^2 \overline{\sharp l\mathbb{C}\mathbb{P}^2}$, where $l > 0$.
- $\sharp kS^2 \times S^2$.
- $S^1 \times S^3 \overline{\sharp S \sharp r\mathbb{C}\mathbb{P}^2}$, where S is either $S^2 \times S^2$ or $S^2 \tilde{\times} S^2$.
- $L \sharp r\mathbb{C}\mathbb{P}^2$, where L is either L_n or L'_n .

More strongly, the families of genus-1 SBLF obtained in Section 4 contain all genus-1 SBLFs.

REFERENCES

- [1] D. Auroux, S. K. Donaldson and L. Katzarkov, Singular Lefschetz pencils, *Geom. Topol.* **9**(2005), 1043–1114
- [2] R. İ. Baykur, Existence of broken Lefschetz fibrations, *Int. Math. Res. Notices* **2008**(2008)
- [3] R. İ. Baykur, Topology of broken Lefschetz fibrations and near-symplectic 4-manifolds, *Pacific J. Math.* **240**(2009), 201–230
- [4] R. İ. Baykur, S. Kamada, Classification of broken Lefschetz fibrations with small fiber genera, preprint, [arXiv:math.GT/1010.5814](https://arxiv.org/abs/math/1010.5814)
- [5] S. K. Donaldson, Lefschetz pencils on symplectic manifolds, *J. Differential Geom.* **53**(1999), no.2, 205–236
- [6] R. E. Gompf, Toward a topological characterization of symplectic manifolds, *J. Symplectic Geom.* **2**(2004), no.2, 177–206
- [7] R. E. Gompf, A.I.Stipsicz, *4-Manifolds and Kirby Calculus*, Graduate Studies in Mathematics **20**, American Mathematical Society, 1999.
- [8] S. Kamada, Y. Matsumoto, T. Matumoto, K. Waki, Chart description and a new proof of the classification theorem of genus one Lefschetz fibrations, *J.Math. Soc. Japan* **57**(2005), no.2 537–555
- [9] A. Kas, On the deformation types of regular elliptic surfaces, *Complex Analysis and Algebraic Geometry*, 107–111
- [10] W. Magnus, A.Karrass, D.Solitar, *Combinatorial group theory*. Presentations of groups in terms of generators and relations. Second revised edition. Dover Publications, Inc., New York, 1976
- [11] Y. matsumoto, Torus fibrations over the 2-sphere with the simplest singular fibers, *J. Math. Soc. Japan* **37**(1985), no.4, 605–636
- [12] B. Moishezon, *Complex surfaces and connected sums of complex projective planes*, Lecture Notes in Math. **603**, Springer-Verlag, 1977.
- [13] P. S. Pao, The topological structure of 4-manifold with effective torus actions. I, *Amer. Math. Soc.* **227**(1977), 279–317
- [14] J. Williams, The h -principle for broken Lefschetz fibrations, *Geom. Topol.* **14**(2010), no.2, 1015–1063

DEPARTMENT OF MATHEMATICS, GRADUATE SCHOOL OF SCIENCE, OSAKA UNIVERSITY, TOYONAKA, OSAKA 560-0043, JAPAN

E-mail address: `k-hayano@cr.math.sci.osaka-u.ac.jp`