

NONINTERSECTING RANDOM WALKS IN THE NEIGHBORHOOD OF A SYMMETRIC TACNODE

BY MARK ADLER¹, PATRIK L. FERRARI² AND PIERRE VAN MOERBEKE³

*Brandeis University, Bonn University, and Université de Louvain
and Brandeis University*

Consider a continuous time random walk in \mathbb{Z} with independent and exponentially distributed jumps ± 1 . The model in this paper consists in an infinite number of such random walks starting from the complement of $\{-m, -m+1, \dots, m-1, m\}$ at time $-t$, returning to the same starting positions at time t , and *conditioned not to intersect*. This yields a determinantal process, whose gap probabilities are given by the Fredholm determinant of a kernel. Thus this model consists of two groups of random walks, which are contained within two ellipses which, with the choice $m \simeq 2t$ to leading order, just touch: so we have a *tacnode*. We determine the new limit extended kernel under the scaling $m = \lfloor 2t + \sigma t^{1/3} \rfloor$, where parameter σ controls the strength of interaction between the two groups of random walkers.

1. Introduction. In the past decade, systems of vicious random walks and nonintersecting Brownian motions have been investigated, and quantities such as the correlation functions [39], the one-point distribution functions and limit processes under appropriate scaling limits have been studied. Nonintersecting Brownian motions arise in the study of random matrices [33, 34, 38], and space (and/or) time discrete versions in random tiling and growth models [22, 23, 27–29, 40, 42, 43]. Most of these works use the mathematical framework shared by Brownian motions starting from a

Received May 2011; revised October 2011.

¹Supported by NSF Grant DMS-07-04271.

²Supported by the German National Foundation via the SFB611-A12 project.

³Supported by NSF Grant DMS-07-04271, a European Science Foundation grant (MIS-GAM), a Marie Curie grant (ENIGMA), FNRS and “Inter-University Attraction Pole (Belgium)” (NOSY) grants.

AMS 2000 subject classifications. Primary 60G60, 60G55, 35Q53; secondary 60G10, 35Q58.

Key words and phrases. PNG-models, nonintersecting random walks, kernels, Tacnode process.

<p>This is an electronic reprint of the original article published by the Institute of Mathematical Statistics in <i>The Annals of Probability</i>, 2013, Vol. 41, No. 4, 2599–2647. This reprint differs from the original in pagination and typographic detail.</p>

point, and either ending at the same point after a given time or the boundary condition is free (with possible extra boundary conditions like staying positive [37, 51]).

Consider N nonintersecting Brownian bridges $x_i(\tau)$ on \mathbb{R} , leaving from 0 at time $\tau = -2N$ and forced to 0 at time $\tau = 2N$. For large N , the mean density of Brownian paths has support, for each $-2N < \tau < 2N$, on the interval $(-\sqrt{4N^2 - \tau^2}, \sqrt{4N^2 - \tau^2})$. This means that on the macroscopic scale, where space and time units are set equal to N , one sees a circle. Near its boundary, the density of Brownian paths is of order $N^{-1/3}$, thus to see something nontrivial one needs to look in a space window of size $N^{1/3}$ and, by Brownian scalings, a time window of size $N^{2/3}$. We call this the “*Airy microscope*,” since it holds

$$(1.1) \quad \lim_{N \rightarrow \infty} \mathbb{P}(\text{all } N^{-1/3}(x_i(2sN^{2/3}) - 2N) \in E^c - s^2) = \mathbb{P}(\mathcal{A}_2(s) \cap E = \emptyset),$$

where \mathcal{A}_2 is the so-called *Airy₂ process*. It has a *universal* character and was discovered in the context of the so-called multilayer PNG model [42]. The scaling (1.1) is equivalent to the customary $N^{-1/6}$ -GUE-edge rescaling along the circle for nonintersecting Brownian motions leaving from the origin at time $t = 0$ and returning to the origin at time $t = 1$; this is done by an appropriate change of the variance of the Brownian motions.

In the context of growth models, generalizations have been introduced with external sources [11, 26]. Its analog in terms of Brownian motions is to require that a finite number of Brownian motions end up at some point αN . Then under the scaling in (1.1), the limit process is a transition process from *Airy₂* to Brownian motion. For extensions to more general sources, see [9, 17], while for the case that the top r Brownian motion ends up at $2N$, see [3] and [4].

A further known situation occurs when a fraction pN of the N nonintersecting Brownian motions (leaving from the origin at time $t = -2N$) end at time $t = 2N$ at position aN and another fraction $(1 - p)N$ at bN , with $a < b$. When $N \rightarrow \infty$, the mean density of Brownian particles has its support on one interval in the beginning and on two intervals near the end. Thus a bifurcation appears for some intermediate time τ_0 , where one interval splits into two intervals, creating a “heart-like” shape with a cusp at the origin. Near this cusp appears a new *universal* process, upon looking through the “*Pearcey microscope*,” where the space window is $N^{1/4}$, and the time window is $N^{1/2}$. The new process is called the *Pearcey process* [50] and is independent of the values of a, b and p ; see [6]. Once the bifurcation has taken place, the Brownian motions will eventually fluctuate like the *Airy₂* process near the edge, with a transition from the *Pearcey* to the *Airy₂* process [2]. The *Pearcey* process has also been obtained as the limit of discrete models; see [13, 14, 41].

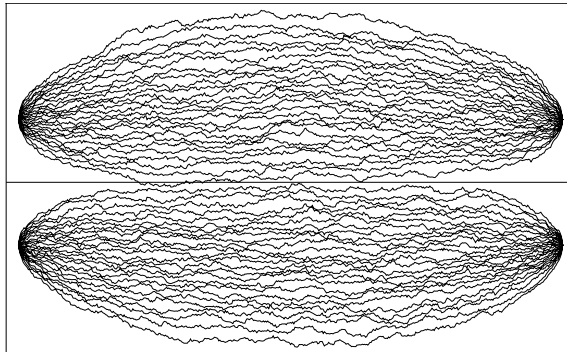

FIG. 1. Illustration of the tacnode with $N = 50$ Brownian bridges.

The motivation of our work is to understand what happens when half of the nonintersecting Brownian motions start and end at a point, while the second half start and end at another point. When the two starting points are sufficiently far apart from each other, the mean density of particles will be confined to two separate circles, with Airy_2 processes appearing near the boundary, as described above. When the two starting points move away from each other at an appropriate rate proportional to N , the two circles will just touch, creating a tacnode. A new *critical* process appears by looking at the two sets of nonintersecting Brownian motions, which experience a brief meeting in the neighborhood of the tacnode, but looked at with the *Airy scaling*; we call it the *tacnode process*. Pictorially it can be thought of as two Airy_2 processes touching; see Figure 1.

In this paper we obtain an explicit formula for the kernel governing this tacnode process for nonintersecting continuous-time random walks, rather than nonintersecting Brownian motions. The same result is expected to hold for the Brownian motion case, since under the scaling the discrete nature of the random walks is lost, and the random walks become Brownian paths. Our main result is the limiting kernel at the tacnode under appropriate scaling limit, stated in Theorem 2.2. Before taking the limit, the kernel is given by Theorem 2.1. The model is to let two groups of nonintersecting random walks with jumps ± 1 , rate 1 and $2m + 1$ integers apart evolve during a total time or order m , with space–time rescaled *à la Airy*, namely $x \sim \xi m^{1/3}$ and $\tau \sim sm^{2/3}$ as suggested by formula (1.1). The parameter m , defined here, plays the role of the number of particles N , previously defined.

There is an important difference with respect to the Airy_2 and Pearcey cases: here we have a one-parameter family of processes, which is obtained by modulating the endpoints' distance between the two sets of Brownian motions over distance of order $N^{1/3}$. For the Pearcey processes (and the Airy_2 process), geometric changes of this type only have the effect of modifying the position (and orientation) of the cusp, but the underlying Pearcey

process remains unchanged. In the literature there is another known situation with a process in a tacnode-like geometry [13], which, however, differs from the present one.

For Brownian motions the problem can be approached using multiple orthogonal polynomials [19]; then Delvaux, Kuijlaars and Zhang [20] carry out asymptotics for these polynomials yielding a Riemann–Hilbert description of the tacnode process kernel (which meanwhile appeared on the arXiv). In the forthcoming paper [31], Johansson uses a different approach leading to an explicit kernel for the Brownian motion problem, but seemingly and surprisingly different from the one obtained in the present paper. In another forthcoming paper Adler, Johansson and van Moerbeke [5] consider a tacnode process in the context of domino tilings of two overlapping Aztec diamonds and found yet another kernel; in the same paper they show that the kernels obtained are all equivalent! A direct relation with the Riemann–Hilbert type formulation of the kernel [20] remains an open problem. In a recent preprint about nonintersecting Brownian motions, Ferrari and Veto [24] discuss a kernel for a nonsymmetric tacnode, which contains a parameter sensing the relative number of Brownian motions, or equivalently, the ratio of the curvature of the curves meeting at the tacnode.

Outline. In Section 2 we define the model and state the two main results. In Section 3, Theorem 3.1, we derive the finite time result for $\tau = 0$, which is reshaped in Section 4 as a preparation to carrying out the large time limit. Before actually doing this, we indicate in Section 5 how to introduce the time, leading to the finite multi-time kernel in Theorem 5.4, an extension of the kernel appearing in Proposition 4.1. In Section 6, we take the limit of the multi-time kernel, leading to the proof of the first formula of Theorem 2.2. In Section 7, we sketch the proof of the double integral representation of the kernel, the second formula of Theorem 2.2, using the steepest descent analysis.

2. Model and results. Consider a continuous time random walk in \mathbb{Z} with jumps ± 1 , occurring independently with rate 1; that is, the waiting times of the up- and down-jumps are independent and exponentially distributed with mean 1. The transition probability $p_t(x, y)$ of going from x to y during a time interval of length t is given by

$$(2.1) \quad p_t(x, y) = e^{-2t} I_{|x-y|}(2t),$$

where I_n is the modified Bessel function of degree n ; see [1].

Consider now an infinite number of continuous time random walks starting from $\{\dots, -m-2, -m-1\} \cup \{m+1, m+2, \dots\}$ at time $\tau = -t$, returning to the starting positions at time $\tau = t$, and *conditioned not to intersect*; see Figure 2. Denote $\tilde{x}_k(\tau)$ the position of the walk that starts and ends at po-

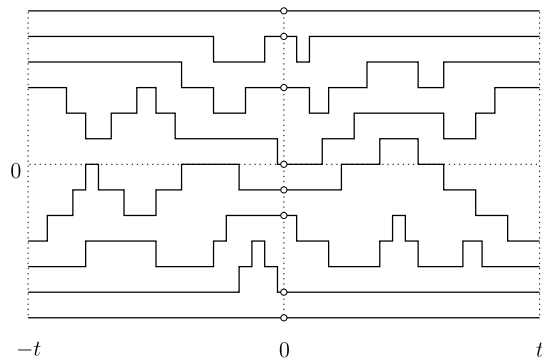

FIG. 2. The lines are the nonintersecting walks $\tilde{\mathbf{x}}$. The white circles are the support of the point process $\tilde{\eta}$.

sition k . Then, the point process $\tilde{\eta}$ on \mathbb{Z} (described by the little white circles in Figure 2) defined by

$$(2.2) \quad \tilde{\eta}(x) = \sum_{k \in \mathbb{Z} \setminus \{-m, \dots, m\}} \delta_{x, \tilde{x}_k(0)}$$

with δ the Kronecker-delta, is determinantal; that is, there exists a kernel $\tilde{\mathbb{K}}_m$ such that the k -point correlation function $\rho^{(k)}$ is given by $\rho^{(k)}(y_1, \dots, y_k) = \det(\tilde{\mathbb{K}}_m(y_i, y_j))_{1 \leq i, j \leq k}$. One of the interesting quantities is the *gap probability of a set E* , which is given by $\mathbb{P}(\tilde{\eta}(\mathbb{1}_E) = 0)$, that is, the probability that none of the random walks are in E at time $\tau = 0$. For a determinantal point process the gap probability is given by the Fredholm determinant of the associated kernel $\tilde{\mathbb{K}}_m$ projected onto E . For more informations on determinantal point processes, see [25, 30, 36, 45, 46].

The determinantal structure still holds if we consider the point process on a set of time-slices instead of a single time $\tau = 0$. This means that given times $\tau_1 < \tau_2 < \dots < \tau_p$ in the interval $(-t, t)$, the point process on $\{\tau_1, \dots, \tau_p\} \times \mathbb{Z}$ defined by

$$(2.3) \quad \tilde{\eta}(\tau, x) = \sum_{r=1}^p \sum_{k \in \mathbb{Z} \setminus \{-m, \dots, m\}} \delta_{(\tau, x), (\tau_r, \tilde{x}_k(\tau_r))}$$

is determinantal. That is, the space-time correlation functions are given by the determinant of an extended kernel, which we denote by $\tilde{\mathbb{K}}_m^{\text{ext}}(t_1, x_1; t_2, x_2)$, where $t_i \in \{\tau_1, \dots, \tau_p\}$ and $x_i \in \mathbb{Z}$.

It is more convenient to first study the *dual* or complementary process $\mathbf{x}(\tau)$. The *dual proceeds along the gaps of $\tilde{\mathbf{x}}(\tau)$* . In this instance, the dual $\mathbf{x}(\tau)$ of $\tilde{\mathbf{x}}(\tau)$ is described by $n = 2m + 1$ ($m \in \mathbb{N}$) *nonintersecting* continuous-time random walks, starting from $-m, -m + 1, \dots, m - 1, m$ at time $\tau = -t$,

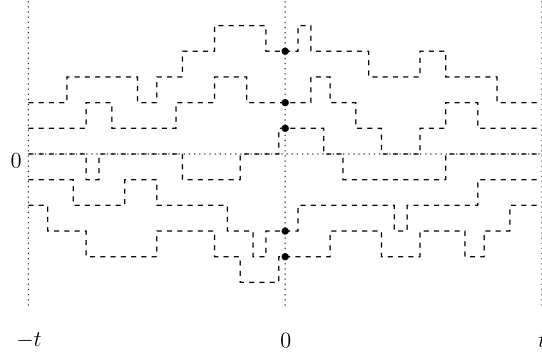

FIG. 3. The dotted lines are the nonintersecting walks \mathbf{x} , the dual process of $\tilde{\mathbf{x}}$ of Figure 2. The black circles are the support of the point process η .

returning to the starting positions at time $\tau = t$; see Figure 3, and Figure 4 for the superposition of the trajectories of $\mathbf{x}(\tau)$ and $\tilde{\mathbf{x}}(\tau)$.

In particular, the dual process $\mathbf{x}(\tau)$ at $\tau = 0$ is given by the little black circles in Figure 3. The probability measure at time $\tau = 0$ is obtained by the Karlin–McGregor formula [32], and thus it is a determinantal process for a kernel \mathbb{K}_m . Finally, the complementation principle by Borodin, Olshanski and Okounkov (see Appendix of [16]) tells us that, if the kernel \mathbb{K}_m governs the process $\mathbf{x}(\tau)$, then the kernel $\mathbb{K}_m = \mathbb{1} - \mathbb{K}_m$ describes the dual process $\tilde{\mathbf{x}}(\tau)$.

THEOREM 2.1. *The determinantal point process $\tilde{\eta}(\tau, x)$ on $\{\tau_1, \dots, \tau_p\} \times \mathbb{R}$, $\tau_i \in (-t, t)$, defined by the two groups of nonintersecting walkers, starting and ending $2m+1$ apart, at times $-t$ and t , respectively, has gap probabilities on any compact set $E \subset \{\tau_1, \dots, \tau_p\} \times \mathbb{R}$ given by*

$$(2.4) \quad \mathbb{P}(\tilde{\eta}(1_E) = 0) = \det(\mathbb{1} - \tilde{\mathbb{K}}_m^{\text{ext}})_{L^2(E)},$$

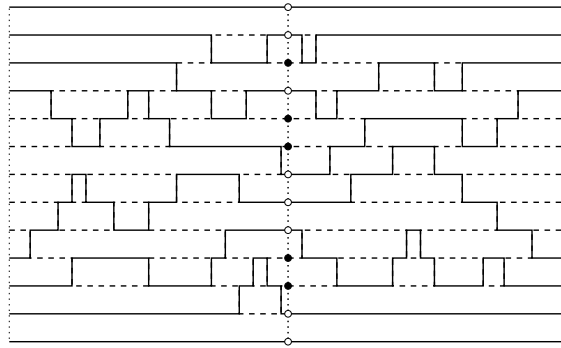

FIG. 4. Superposition of Figures 2 and 3.

where the kernel $\tilde{\mathbb{K}}_m^{\text{ext}}$ is given by

$$\begin{aligned}
& \frac{e^{2t_2}}{e^{2t_1}} \tilde{\mathbb{K}}_m^{\text{ext}}(t_1, x_1; t_2, x_2) \\
&= -\mathbb{1}_{[t_2 < t_1]} I_{|x_1 - x_2|}(2(t_2 - t_1)) \\
&\quad - \frac{V_m}{(2\pi i)^2} \oint_{\Gamma_0} dz \oint_{\Gamma_{0,z}} dw \frac{e^{t(z-z^{-1})}}{e^{t(w-w^{-1})}} \frac{e^{-t_1(z+z^{-1})}}{e^{-t_2(w+w^{-1})}} \frac{w^{x_2-m-1}}{z^{x_1-m}} \\
&\quad \times \frac{H_{2m+1}(w)H_{2m+1}(z^{-1})}{z-w} \\
&\quad - \frac{V_m}{(2\pi i)^2} \oint_{\Gamma_0} dw \oint_{\Gamma_{0,w}} dz \frac{e^{t(w-w^{-1})}}{e^{t(z-z^{-1})}} \frac{e^{-t_1(z+z^{-1})}}{e^{-t_2(w+w^{-1})}} \frac{w^{x_2+m}}{z^{x_1+m+1}} \\
&\quad \times \frac{H_{2m+1}(z)H_{2m+1}(w^{-1})}{w-z} \\
&\quad - \mathbb{1}_{[x_1 \neq x_2]} \frac{V_m}{2\pi i} \oint_{\Gamma_0} dz \frac{e^{(t_2-t_1)(z+z^{-1})}}{z^{x_1-x_2+1}} H_{2m+1}(z^{-1})H_{2m+1}(z)
\end{aligned} \tag{2.5}$$

with $V_m := 1/(H_{2m+1}(0)H_{2m+2}(0))$. The function H_n is itself the Fredholm determinant on $\ell^2(\{n, n+1, \dots\})$

$$H_n(z^{-1}) := \det(\mathbb{1} - K(z^{-1}))_{\ell^2(\{n, n+1, \dots\})} \tag{2.6}$$

of the kernel

$$K(z^{-1})_{k,\ell} := \frac{(-1)^{k+\ell}}{(2\pi i)^2} \oint_{\Gamma_0} du \oint_{\Gamma_{0,u}} dv \frac{u^\ell}{v^{k+1}} \frac{1}{v-u} \frac{u-z}{v-z} \frac{e^{2t(u-u^{-1})}}{e^{2t(v-v^{-1})}}, \tag{2.7}$$

where Γ_0 is any anticlockwise simple loop enclosing 0 and similarly $\Gamma_{0,u}$ encircles the poles at 0 and u (but not z).⁴

The extended kernel, governing the process $\tilde{\eta}(\tau, x)$, is given in terms of the kernel $\tilde{\mathbb{K}}_m(x_1, x_2) = \tilde{\mathbb{K}}_m^{\text{ext}}(0, x_1; 0, x_2)$, governing the distribution $\tilde{\eta}(0, x)$, by

$$\begin{aligned}
\tilde{\mathbb{K}}_m^{\text{ext}}(t_1, x_1; t_2, x_2) &= -\mathbb{1}_{[t_2 < t_1]} (e^{(t_2-t_1)\mathcal{H}})(x_1, x_2) \\
&\quad + (e^{-t_1\mathcal{H}} \tilde{\mathbb{K}}_m e^{t_2\mathcal{H}})(x_1, x_2),
\end{aligned} \tag{2.8}$$

where \mathcal{H} is the discrete Laplacian

$$(\mathcal{H}f)(x) = f(x+1) + f(x-1) - 2f(x). \tag{2.9}$$

⁴For any set of points S , the notation $\oint_{\Gamma_S} dz f(z)$ means that the integration path goes anticlockwise around the points in S but does not include any other poles of f .

Remark that the transition probability of (2.1), defined for $t \geq 0$, can be written as $p_t(x, y) = e^{t\mathcal{H}}\mathbb{1}(x, y) =: e^{t\mathcal{H}}(x, y)$. Here, $\mathbb{1}$ denotes the identity operator on \mathbb{Z} , that is, $\mathbb{1}(x, y) = 1$ if $x = y$ and $\mathbb{1}(x, y) = 0$ if $x \neq y$.

The formula for the kernel $\tilde{\mathbb{K}}_m(x_1, x_2) = \tilde{\mathbb{K}}_m^{\text{ext}}(0, x_1; 0, x_2)$ at $t_1 = t_2 = 0$ of Theorem 2.1, will be established in Section 3, whereas the one for $\tilde{\mathbb{K}}_m^{\text{ext}}$ will be shown in Section 5. In Sections 4 and 5, it will be shown that both kernels $\tilde{\mathbb{K}}_m(x, y)$ and $\tilde{\mathbb{K}}_m^{\text{ext}}(t_1, x_2; t_2, x_2)$ have a representation, whose constituents can be expressed in terms of Bessel functions; see the expression (4.14) and the time-dependent kernel (5.26), derived from (4.14), via recipe (2.8). Also, note that the kernel $K(z^{-1})$ is a rank-one perturbation of the kernel $K(0)$, whose Fredholm determinant

$$(2.10) \quad H_n(0) = \det(\mathbb{1} - K(0))_{\ell^2(\{n, n+1, \dots\})}$$

is the distribution of the longest increasing subsequence of a random permutation in the Poissonized version, or, equivalently, it yields the distribution of the height function in the polynuclear growth (PNG) model [10, 42]. In the scaling limit, considered in Section 6, $H_n(0)$ will converge to the Tracy–Widom distribution F_2 .

To study the limiting behavior, when $m, t \rightarrow \infty$, consider first the system of nonintersecting random walks starting at time $-t$ and ending at positions $\{\dots, -m-2, -m-1\}$ at time t . This is, up to a shift by $m+1$, the multilayer PNG model studied by Prähofer and Spohn in [42]. Their work shows that the top random walk at time $\tau = 0$ has fluctuations around $x = -m + 2t$ of order $t^{1/3}$. By symmetry, if one considers only the nonintersecting random walks starting and ending at position $\{m+1, m+2, \dots\}$, the bottom random walk at time $\tau = 0$ fluctuates around $x = m - 2t$ also in the spatial scale $t^{1/3}$.

The top and bottom random walks interact if the proportion of deleted configurations, due to interaction, is nonzero. This happens when $m = 2t$ to leading order in t . The first scaling where interaction is relevant is given by $m = 2t + \sigma t^{1/3}$. The parameter σ modulates the strength of interaction of the two sets of nonintersecting random walks. In the extreme cases $\sigma \rightarrow \infty$, we clearly (by a simple probabilistic argument) go back to the situation of two independent PNG models; thus the top of the lower walks and the bottom of the upper walks are governed by the Airy_2 process [42]. On the other hand, when $\sigma \rightarrow -\infty$, one expects to see a point process governed by the sine kernel or the Pearcey process. Moreover, locally the paths will look like random walks, so the exponents in the scaling for time and space are in a ratio 2 : 1. Thus, we set the scaling⁵

$$(2.11) \quad m = 2t + \sigma t^{1/3}, \quad x_i = \xi_i t^{1/3}, \quad t_i = s_i t^{2/3}, \quad i = 1, 2.$$

⁵We do not write explicitly the integer parts, since in the $t \rightarrow \infty$ limit it is irrelevant.

Also note that for each time $-t < \tau < t$, the density of particles has its support on two semi-infinite intervals, whose boundary, as a function of τ , describes two curves, which at $\tau = 0$ form a *tacnode*. The purpose of Theorem 2.2 is to describe the fluctuations of the random walks in the $t \rightarrow \infty$ limit in the neighborhood of $(x, \tau) = (0, 0)$, but in the new space–time scale, given by (2.11).

In order to state the second main result, define the standard Airy kernel,

$$(2.12) \quad K_{\text{Ai}}(\xi_1, \xi_2) := \int_0^\infty d\lambda \text{Ai}(\xi_1 + \lambda) \text{Ai}(\xi_2 + \lambda)$$

and the function $\mathcal{Q}(\kappa)$, already appearing in [48],

$$(2.13) \quad \mathcal{Q}(\kappa) := [(\mathbb{1} - \chi_{\tilde{\sigma}} K_{\text{Ai}} \chi_{\tilde{\sigma}})^{-1} \chi_{\tilde{\sigma}} \text{Ai}](\kappa) \quad \text{with } \tilde{\sigma} := 2^{2/3} \sigma$$

and where $\chi_a(x) = \mathbb{1}_{[x > a]}$. We further set

$$(2.14) \quad \text{Ai}^{(s)}(\xi) := e^{\xi s + (2/3)s^3} \text{Ai}(\xi + s^2),$$

which equals the standard Airy function $\text{Ai}(\xi)$, when $s = 0$, and define the functions

$$(2.15) \quad \begin{aligned} \mathcal{A}(s, \xi) &:= \text{Ai}^{(s)}(\sigma - \xi) \\ &+ \int_{\tilde{\sigma}}^\infty d\kappa \int_0^\infty d\alpha \mathcal{Q}(\kappa) \text{Ai}(\kappa + \alpha) \text{Ai}^{(s)}(2^{1/3}\alpha + \sigma - \xi), \\ \mathcal{B}(s, \xi) &:= \int_{\tilde{\sigma}}^\infty d\kappa \mathcal{Q}(\kappa) \text{Ai}^{(s)}(2^{1/3}\kappa - \sigma + \xi) \end{aligned}$$

and

$$(2.16) \quad \begin{aligned} \mathcal{C}(s, \xi) &:= 2^{-1/3} \int_{\tilde{\sigma}}^\infty d\kappa \mathcal{Q}(\kappa) \left[\text{Ai}^{(2^{-2/3}s)}(\kappa + 2^{-1/3}\xi) \right. \\ &+ \int_{\tilde{\sigma}}^\infty d\lambda \mathcal{Q}(\lambda) \int_0^\infty d\alpha \text{Ai}(\alpha + \lambda) \\ &\left. \times \text{Ai}^{(2^{-2/3}s)}(\alpha + \kappa + 2^{-1/3}\xi) \right] \\ &+ (\xi \leftrightarrow -\xi), \end{aligned}$$

where with $(\xi \leftrightarrow -\xi)$ we mean the same expression with ξ replaced by $-\xi$. Finally, we define the following two Laplace transforms, $\hat{\mathcal{P}}(u)$ and $\hat{\mathcal{Q}}(u)$:

$$(2.17) \quad \begin{aligned} \hat{\mathcal{Q}}(u) &:= \int_{\tilde{\sigma}}^\infty d\kappa \mathcal{Q}(\kappa) e^{\kappa u 2^{1/3}}, \\ \hat{\mathcal{P}}(u) &:= - \int_0^\infty d\kappa e^{-\kappa u 2^{1/3}} \int_{\tilde{\sigma}}^\infty d\mu \mathcal{Q}(\mu) \text{Ai}(\mu + \kappa). \end{aligned}$$

THEOREM 2.2. *Near the tacnode appears a new determinantal process on $\{s_1, \dots, s_p\} \times \mathbb{R}$, the tacnode process \mathcal{T} , whose gap probabilities on any compact set $E \subset \{s_1, \dots, s_p\} \times \mathbb{R}$ are given by*

$$(2.18) \quad \mathbb{P}(\mathcal{T}(\mathbb{1}_E) = 0) = \det(\mathbb{1} - \mathcal{K}^{\text{ext}})_{L^2(E)}.$$

The kernel \mathcal{K}^{ext} is the limit of $\tilde{\mathbb{K}}_m^{\text{ext}}$ under the scaling (2.11),

$$(2.19) \quad \mathcal{K}^{\text{ext}}(s_1, \xi_1; s_2, \xi_2) := \lim_{t \rightarrow \infty} \frac{(-1)^{x_2} e^{4t_2}}{(-1)^{x_1} e^{4t_1}} t^{1/3} \tilde{\mathbb{K}}_m^{\text{ext}}(t_1, x_1; t_2, x_2),$$

where the convergence is uniform for ξ_1, ξ_2 and s_1, s_2 in bounded sets. The kernel \mathcal{K}^{ext} has the following representations:

$$(2.20) \quad \begin{aligned} & \mathcal{K}^{\text{ext}}(s_1, \xi_1; s_2, \xi_2) \\ &= -\frac{\mathbb{1}_{[s_2 < s_1]}}{\sqrt{4\pi(s_1 - s_2)}} \exp\left(-\frac{(\xi_1 - \xi_2)^2}{4(s_1 - s_2)}\right) + \mathcal{C}(s_1 - s_2, \xi_1 - \xi_2) \\ &+ \int_0^\infty d\gamma (\mathcal{A}(s_1, \xi_1 - \gamma) \mathcal{A}(-s_2, \xi_2 - \gamma) + \mathcal{A}(s_1, -\xi_1 - \gamma) \mathcal{A}(-s_2, -\xi_2 - \gamma) \\ &\quad - \mathcal{A}(s_1, \xi_1 - \gamma) \mathcal{B}(-s_2, \xi_2 - \gamma) - \mathcal{A}(s_1, -\xi_1 - \gamma) \mathcal{B}(-s_2, -\xi_2 - \gamma) \\ &\quad - \mathcal{B}(s_1, \xi_1 - \gamma) \mathcal{A}(-s_2, \xi_2 - \gamma) - \mathcal{B}(s_1, -\xi_1 - \gamma) \mathcal{A}(-s_2, -\xi_2 - \gamma)) \\ &- \int_{-\infty}^0 d\gamma (\mathcal{B}(s_1, \xi_1 - \gamma) \mathcal{B}(-s_2, \xi_2 - \gamma) + \mathcal{B}(s_1, -\xi_1 - \gamma) \mathcal{B}(-s_2, -\xi_2 - \gamma)) \end{aligned}$$

as well as (with arbitrary $\delta > 0$)

$$(2.21) \quad \begin{aligned} & \mathcal{K}^{\text{ext}}(s_1, \xi_1; s_2, \xi_2) \\ &= -\frac{\mathbb{1}_{[s_2 < s_1]}}{\sqrt{4\pi(s_1 - s_2)}} \exp\left(-\frac{(\xi_1 - \xi_2)^2}{4(s_1 - s_2)}\right) + \mathcal{C}(s_1 - s_2, \xi_1 - \xi_2) \\ &+ \frac{1}{(2\pi i)^2} \int_{\delta + i\mathbb{R}} du \int_{-\delta + i\mathbb{R}} dv \frac{e^{u^3/3 - \sigma u} e^{s_1 u^2}}{e^{v^3/3 - \sigma v} e^{s_2 v^2}} \left(\frac{e^{\xi_1 u}}{e^{\xi_2 v}} + \frac{e^{-\xi_1 u}}{e^{-\xi_2 v}} \right) \\ &\quad \times \frac{(1 - \hat{\mathcal{P}}(u))(1 - \hat{\mathcal{P}}(-v))}{u - v} \\ &- \frac{1}{(2\pi i)^2} \int_{2\delta + i\mathbb{R}} du \int_{\delta + i\mathbb{R}} dv \frac{e^{u^3/3 - \sigma u} e^{s_1 u^2}}{e^{-v^3/3 - \sigma v} e^{s_2 v^2}} \left(\frac{e^{\xi_1 u}}{e^{\xi_2 v}} + \frac{e^{-\xi_1 u}}{e^{-\xi_2 v}} \right) \\ &\quad \times \frac{(1 - \hat{\mathcal{P}}(u)) \hat{\mathcal{Q}}(-v)}{u - v} \\ &- \frac{1}{(2\pi i)^2} \int_{-\delta + i\mathbb{R}} du \int_{-2\delta + i\mathbb{R}} dv \frac{e^{-u^3/3 - \sigma u} e^{s_1 u^2}}{e^{v^3/3 - \sigma v} e^{s_2 v^2}} \left(\frac{e^{\xi_1 u}}{e^{\xi_2 v}} + \frac{e^{-\xi_1 u}}{e^{-\xi_2 v}} \right) \end{aligned}$$

$$\begin{aligned}
& \times \frac{(1 - \hat{\mathcal{P}}(-v))\hat{\mathcal{Q}}(u)}{u - v} \\
& + \frac{1}{(2\pi i)^2} \int_{-\delta + i\mathbb{R}} du \int_{\delta + i\mathbb{R}} dv \frac{e^{-u^3/3 - \sigma u} e^{s_1 u^2}}{e^{-v^3/3 - \sigma v} e^{s_2 v^2}} \left(\frac{e^{\xi_1 u}}{e^{\xi_2 v}} + \frac{e^{-\xi_1 u}}{e^{-\xi_2 v}} \right) \\
& \times \frac{\hat{\mathcal{Q}}(u)\hat{\mathcal{Q}}(-v)}{u - v}.
\end{aligned}$$

Note the kernel (2.21) is invariant under the involution $(s_1, \xi_1; s_2, \xi_2) \mapsto (-s_2, -\xi_2; -s_1, -\xi_1)$, thus reflecting the symmetry of the symmetric tacnode.

The form (2.20) of the limiting extended kernel in Theorem 2.2 will be shown in Section 6, whereas a sketch of the proof of its double integral representation (2.21) will be given in Section 7.

In the preprint [20], the analogous problem for Brownian Motion will be analyzed with the Riemann–Hilbert approach applied to multiple orthogonal polynomials. It would be interesting to see how to relate the two formulas (which we expect to be equivalent).

3. Finite system at $\tau = 0$. In this section we will prove Theorem 2.1, in particular the formula for kernel $\mathbb{K}_m(x, y) = \mathbb{K}_m^{\text{ext}}(0, x; 0, y)$, as in (2.5), for $t_1 = t_2 = 0$. Consider a continuous time random walk in \mathbb{Z} with jumps ± 1 , which occur independently with rate 1; that is, the waiting times of the up- and down-jumps are independent and exponentially distributed with mean 1. Thus, the number of up-jumps (and similarly down-jumps) during the time interval $[0, t]$ is Poisson distributed,

$$(3.1) \quad \mathbb{P}(k \text{ up-jumps during } [0, t]) = e^{-t} \frac{t^k}{k!}.$$

As will be shown, the transition probability $p_t(x, y)$ of going from x to y during a time interval of length t is given by

$$(3.2) \quad p_t(x, y) = e^{-2t} I_{|x-y|}(2t),$$

where I_n is the modified Bessel function of degree n ; see [1]. To prove (3.2), first notice that by symmetry, it is enough to consider $y - x \geq 0$. To go from x to y , the process must perform k steps down and $k + y - x$ steps up. Since the moment, at which the down or up steps occur, is independent of whether it is a down or an up step, one may assume the process doing first k steps down and then $k + y - x$ steps up. By the strong Markov property of the random walk and the independence of the jumps,

$$p_t(x, y) = \sum_{k \geq 0} \mathbb{P}(\{k + y - x \text{ up-steps and } k \text{ down-steps}\} \text{ during time } t)$$

$$\begin{aligned}
(3.3) \quad &= e^{-2t} \sum_{k \geq 0}^{\infty} \frac{t^k}{k!} \frac{t^{y-x+k}}{(y-x+k)!} \\
&= e^{-2t} I_{|x-y|}(2t).
\end{aligned}$$

The modified Bessel function has the following expressions (for $n \in \mathbb{Z}$)

$$(3.4) \quad I_n(2t) = \frac{1}{2\pi i} \oint_{S^1} \frac{dz}{z} e^{t(z+z^{-1})} z^{\pm n} = \sum_{k=0}^{\infty} \frac{t^k}{k!} \frac{t^{k+|n|}}{(k+|n|)!}$$

with $S^1 = \{z \in \mathbb{C} \mid |z| = 1\}$.

Consider now $n = 2m + 1$ ($m \in \mathbb{N}$) continuous time random walks starting from $-m, -m + 1, \dots, m - 1, m$ at time $\tau = -t$, returning at the starting positions at time $\tau = t$, and *conditioned not to intersect*. Denote by $x_k(\tau)$ the position at time τ of the random walk which started from $m + 1 - k$ (i.e., the k th highest one), see Figure 3 for an illustration with $m = 2$.

The probability at time $\tau = 0$ is easily obtained by the Karlin–McGregor formula [32], namely

$$\begin{aligned}
(3.5) \quad &\mathbb{P} \left(\bigcap_{k=1}^{2m+1} \{x_k(0) = y_k\} \mid \bigcap_{k=1}^{2m+1} \{x_k(t) = x_k(-t) = m + 1 - k\} \right) \\
&= \text{const} \times \det[p_t(m + 1 - i, y_j)]_{1 \leq i, j \leq 2m+1} \\
&\quad \times \det[p_t(y_i, m + 1 - j)]_{1 \leq i, j \leq 2m+1} \\
&= \text{const} \times (\det[I_{y_i + j - 1 - m}(2t)]_{1 \leq i, j \leq 2m+1})^2.
\end{aligned}$$

It is well known by [12] that the process above

$$(3.6) \quad \mathbf{x}(\tau) := \{x_k(\tau), 1 \leq k \leq 2m + 1\}, \quad \tau \in [-t, t],$$

with a measure of this form, gives rise to a determinantal point process (random point measure)

$$(3.7) \quad \eta = \sum_{k=1}^{2m+1} \delta_{x_k(0)}$$

with a certain kernel $\mathbb{K}_m(x, y)$, to be computed in Theorem 3.1.

Instead of the process $\mathbf{x}(\tau)$, we shall analyze its complementary (dual) process, which we denote by

$$(3.8) \quad \tilde{\mathbf{x}}(\tau) = \{\tilde{x}_k(\tau), k \in \mathbb{Z} \setminus [1, 2m + 1]\}, \quad \tau \in [-t, t].$$

If \mathbf{x} denotes the trajectories of the $2m + 1$ particles, then let $\tilde{\mathbf{x}}$ denote the trajectories of the holes, obtained by the particle-hole transformation; see Figures 2 and 4.

The reason for starting with the process \mathbf{x} is that the Karlin–McGregor formula applies to a finite number of paths, while $\tilde{\mathbf{x}}$ has an infinite number

of paths. By the complementation principle in the Appendix of [16], the dual point process at $\tau = 0$,

$$(3.9) \quad \tilde{\eta} = \sum_k \delta_{\tilde{x}_k(0)},$$

is also determinantal with correlation kernel

$$(3.10) \quad \tilde{\mathbb{K}}_m(x, y) = \delta_{x, y} - \mathbb{K}_m(x, y).$$

First of all, we compute the kernel $\mathbb{K}_m(x, y)$ in a form which will be suitable for asymptotic analysis.

THEOREM 3.1. *The point processes η and $\tilde{\eta}$, defined in (3.7) and (3.9), are determinantal with correlation kernel \mathbb{K}_m and $\tilde{\mathbb{K}}_m$ given below. Thus, for any finite subset $E \subset \mathbb{Z}$, the gap probability of E is given by*

$$(3.11) \quad \begin{aligned} \mathbb{P}(\eta(\mathbf{1}_E) = 0) &= \det(\mathbf{1} - \mathbb{K}_m)_{\ell^2(E)}, \\ \mathbb{P}(\tilde{\eta}(\mathbf{1}_E) = 0) &= \det(\mathbf{1} - \tilde{\mathbb{K}}_m)_{\ell^2(E)} \end{aligned}$$

with kernels $\mathbb{K}_m(x, y)$ and $\tilde{\mathbb{K}}_m(x, y)$, invariant⁶ under the involution $(x, y) \leftrightarrow (-y, -x)$, namely

$$(3.12) \quad \begin{aligned} \mathbb{K}_m(x, y) &= \frac{V_m}{(2\pi i)^2} \oint_{\Gamma_0} dz \oint_{\Gamma_{0,z}} dw \frac{e^{t(z-z^{-1})}}{e^{t(w-w^{-1})}} \frac{w^{y-m-1}}{z^{x-m}} \\ &\quad \times \frac{H_{2m+1}(w)H_{2m+1}(z^{-1})}{z-w} \\ &\quad + \frac{V_m}{(2\pi i)^2} \oint_{\Gamma_0} dw \oint_{\Gamma_{0,w}} dz \frac{e^{t(w-w^{-1})}}{e^{t(z-z^{-1})}} \frac{w^{y+m}}{z^{x+m+1}} \\ &\quad \times \frac{H_{2m+1}(z)H_{2m+1}(w^{-1})}{w-z} \\ &\quad + \frac{V_m}{2\pi i} \oint_{\Gamma_0} dz \frac{1}{z^{x-y+1}} H_{2m+1}(z^{-1})H_{2m+1}(z) \end{aligned}$$

and

$$\begin{aligned} \tilde{\mathbb{K}}_m(x, y) &= -\frac{V_m}{(2\pi i)^2} \oint_{\Gamma_0} dz \oint_{\Gamma_{0,z}} dw \frac{e^{t(z-z^{-1})}}{e^{t(w-w^{-1})}} \frac{w^{y-m-1}}{z^{x-m}} \\ &\quad \times \frac{H_{2m+1}(w)H_{2m+1}(z^{-1})}{z-w} \end{aligned}$$

⁶As it should from the geometry of the problem! The involution interchanges the two double integrals in (3.12), as is seen from renaming $w \leftrightarrow z$ in the second double integral; also the third term, the single integral, only depends on $|x - y|$, as is seen from $z \rightarrow z^{-1}$.

$$(3.13) \quad -\frac{V_m}{(2\pi i)^2} \oint_{\Gamma_0} dw \oint_{\Gamma_{0,w}} dz \frac{e^{t(w-w^{-1})}}{e^{t(z-z^{-1})}} \frac{w^{y+m}}{z^{x+m+1}} \\ \times \frac{H_{2m+1}(z)H_{2m+1}(w^{-1})}{w-z} \\ - \mathbb{1}_{[x \neq y]} \frac{V_m}{2\pi i} \oint_{\Gamma_0} dz \frac{1}{z^{x-y+1}} H_{2m+1}(z^{-1})H_{2m+1}(z),$$

where $V_m = 1/(H_{2m+1}(0)H_{2m+2}(0))$. The function H_n itself is a Fredholm determinant on $\ell^2(\{n, n+1, \dots\})$

$$(3.14) \quad H_n(z^{-1}) := \det(\mathbb{1} - K(z^{-1}))_{\ell^2(\{n, n+1, \dots\})}$$

of the kernel

$$(3.15) \quad K(z^{-1})_{k,\ell} := \frac{(-1)^{k+\ell}}{(2\pi i)^2} \oint_{\Gamma_0} du \oint_{\Gamma_{0,u}} dv \frac{u^\ell}{v^{k+1}} \frac{1}{v-u} \frac{u-z}{v-z} \frac{e^{2t(u-u^{-1})}}{e^{2t(v-v^{-1})}},$$

where Γ_0 is any anticlockwise simple loop enclosing 0 and similarly $\Gamma_{0,u}$ encircles 0 and u only (hence not z).

PROOF. *Step 1: Computing the kernel $\mathbb{K}_m(x, y)$ for the inliers $\mathbf{x}(\tau)$ at $\tau = 0$, from the Karlin–McGregor formula (3.5):* It is well known by [12] that a measure of the form (3.5) implies that the point process (random point measure) η , as in (3.7), is determinantal with correlation kernel

$$(3.16) \quad \mathbb{K}_m(x, y) = \sum_{k,\ell=1}^{2m+1} \varphi_k(y)[A^{-1}]_{k,\ell} \varphi_\ell(x), \quad x, y \in \mathbb{Z},$$

where

$$(3.17) \quad \varphi_k(x) = I_{x+k-1-m}(2t),$$

and A is the $(2m+1) \times (2m+1)$ matrix with entries

$$(3.18) \quad [A]_{k,\ell} \equiv \langle \varphi_k, \varphi_\ell \rangle = \sum_{x \in \mathbb{Z}} \varphi_k(x) \varphi_\ell(x).$$

Using (3.4) and (3.17), the entries of the $(2m+1) \times (2m+1)$ matrix A , as in (3.18), are given by

$$(3.19) \quad A_{k,\ell} = \sum_{x \in \mathbb{Z}} \varphi_k(x) \varphi_\ell(x) = \sum_{x \geq 0} \varphi_k(x) \varphi_\ell(x) + \sum_{x < 0} \varphi_k(x) \varphi_\ell(x) \\ = \sum_{x \geq 0} \frac{1}{(2\pi i)^2} \oint_{\Gamma_0} dz \oint_{\Gamma_0} dw \frac{e^{t(z+z^{-1})} e^{t(w+w^{-1})}}{z^k w^\ell} \frac{1}{(zw)^{x-m}} \\ + \sum_{x < 0} \frac{1}{(2\pi i)^2} \oint_{\Gamma_0} dz \oint_{\Gamma_0} dw \frac{e^{t(z+z^{-1})} e^{t(w+w^{-1})}}{z^k w^\ell} \frac{1}{(zw)^{x-m}}.$$

In the first integrals, we deform the paths to $|z| = 1$ and $|w| = R > 1$. Then we take the sum inside the integrals and use $\sum_{x \geq 0} (zw)^{-x} = wz/(wz - 1)$. Similarly, in the second integrals, we deform the paths as $|z| = 1$ and $|w| = 1/R < 1$ and use $\sum_{x < 0} (zw)^{-x} = -wz/(wz - 1)$. This leads to

$$\begin{aligned}
(3.20) \quad A_{k,\ell} &= \frac{1}{(2\pi i)^2} \oint_{|z|=1} dz \oint_{|w|=R} dw \frac{e^{t(z+z^{-1})} e^{t(w+w^{-1})}}{z^{k-m} w^{\ell-m}} \frac{wz}{wz-1} \\
&\quad - \frac{1}{(2\pi i)^2} \oint_{|z|=1} dz \oint_{|w|=1/R} dw \frac{e^{t(z+z^{-1})} e^{t(w+w^{-1})}}{z^{k-m} w^{\ell-m}} \frac{wz}{wz-1} \\
&= \frac{1}{2\pi i} \oint_{|z|=1} dz \frac{e^{2t(z+z^{-1})}}{z^{k-\ell+1}} = I_{k-\ell}(4t),
\end{aligned}$$

since for any value of z , the two integrals differ only by the residue⁷ at $w = 1/z$. However, doing the asymptotics of the kernel $\mathbb{K}_m(x, y)$ with this choice of basis and thus with this A^{-1} seems to be hopeless.

Step 2: Changing the basis $\varphi_k \mapsto \psi_k$, such that $A \mapsto \mathbb{1}$ in the kernel $\mathbb{K}_m(x, y)$, that is, so that $\mathbb{K}_m(x, y) = \sum_{k=1}^{2m+1} \psi_k(x) \psi_k(y)$. Replace the basis $(\varphi_k(x))_{k=1, \dots, 2m+1}$ with an orthonormal basis $(\psi_k(x))_{k=1, \dots, 2m+1}$ with respect to the $\ell^2(\mathbb{Z})$ scalar product $\langle \cdot, \cdot \rangle$ used in (3.18) [generating the same vector space, i.e., $\det(\varphi_k(x_j))_{1 \leq k, j \leq n} = \text{const} \times \det(\psi_k(x_j))_{1 \leq k, j \leq n}$ so that the measure (3.5) has the same form, but with $A = \mathbb{1}$]. More precisely, we shall search for polynomials P_k of degree k such that, upon defining $d\rho_t(z) := \frac{dz}{2\pi iz} e^{t(z+z^{-1})}$,

$$\begin{aligned}
(3.21) \quad \psi_k(x) &= \oint_{S^1} \frac{d\rho_t(z)}{z^{x-m}} P_{k-1}(z^{-1}) \\
&= \oint_{S^1} d\rho_t(w) w^{x-m} P_{k-1}(w), \quad 1 \leq k \leq 2m+1,
\end{aligned}$$

satisfies, using the same argument as in (3.20),

$$\begin{aligned}
(3.22) \quad \delta_{k,\ell} &= \langle \psi_k, \psi_\ell \rangle \\
&= \sum_{x \in \mathbb{Z}} \oint_{\Gamma_0} d\rho_t(z) \oint_{\Gamma_0} d\rho_t(w) (zw)^{x-m} P_{k-1}(z) P_{\ell-1}(w) \\
&= \oint_{S^1} d\rho_{2t}(z) P_{k-1}(z) P_{\ell-1}(z^{-1}) \\
&=: \langle\langle P_{k-1}, P_{\ell-1} \rangle\rangle,
\end{aligned}$$

thus defining a new inner-product $\langle\langle \cdot, \cdot \rangle\rangle$ on the circle $S^1 = \{z \in \mathbb{C} \mid |z| = 1\}$. So it suffices to find an orthonormal basis of polynomials on the circle for

⁷This residue argument will reappear later in (3.40).

the weight $d\rho_{2t}(z)$. A classical expression for the polynomial $P_k(z)$ is (see, e.g., [47])

$$(3.23) \quad P_k(z) = \frac{1}{\sqrt{\det m_k \cdot \det m_{k+1}}} \det \begin{pmatrix} [\mu_{i,j}]_{\substack{0 \leq i \leq k \\ 0 \leq j \leq k-1}} & \begin{matrix} 1 \\ z \\ \vdots \\ z^k \end{matrix} \end{pmatrix},$$

where $m_k = [\mu_{i,j}]_{0 \leq i,j \leq k-1}$ and

$$(3.24) \quad \mu_{i,j} := \langle\langle z^i, z^j \rangle\rangle = \oint_{S^1} d\rho_{2t}(z) z^{i-j} = I_{i-j}(4t).$$

Hence the $P_k(z)$ are polynomials of z with real coefficients. Orthonormal polynomials on the circle satisfy a Christoffel–Darboux-type formula, due to Szegő; see [44]. Namely, with the notation $P_n^*(z) = z^n \overline{P(\bar{z}^{-1})}$ and further using the reality of the coefficients, one obtains for $z, w \in S^1$,

$$(3.25) \quad \begin{aligned} \sum_{\ell=0}^{n-1} P_\ell(z^{-1}) P_\ell(w) &= \sum_{\ell=0}^{n-1} \overline{P_\ell(z)} P_\ell(w) \\ &= \frac{\overline{P_n^*(z)} P_n^*(w) - \overline{P_n(z)} P_n(w)}{1 - \bar{z}w} \\ &= \frac{\overline{z^n P_n(\bar{z}^{-1})} w^n \overline{P_n(\bar{w}^{-1})} - \overline{P_n(z)} P_n(w)}{1 - w/z} \\ &= \frac{z^{-n} P_n(z) w^n P_n(w^{-1}) - P_n(z^{-1}) P_n(w)}{1 - w/z}. \end{aligned}$$

Step 3: Expressing the polynomials $P_n(z)$ in terms of the Fredholm determinant $H_n(z^{-1})$, as in (3.14). In order to do this, one first introduces the bilinear form

$$(3.26) \quad \langle f, g \rangle_{\mathbf{t}, \mathbf{s}} := \frac{1}{2\pi i} \oint_{S^1} \frac{du}{u} f(u) g(u^{-1}) e^{\sum_{j=1}^{\infty} (t_j u^j - s_j u^{-j})},$$

upon setting $\mathbf{t} := (t_1, t_2, \dots) \in \mathbb{C}^\infty$ and $\mathbf{s} := (s_1, s_2, \dots) \in \mathbb{C}^\infty$. It was shown in [7, 8] (see also the lecture notes [52]) that the functions⁸

$$(3.27) \quad \begin{aligned} p_n^{(1)}(\mathbf{t}, \mathbf{s}; z) &:= z^n \frac{\tau_n(\mathbf{t} - [z^{-1}], \mathbf{s})}{\sqrt{\tau_n(\mathbf{t}, \mathbf{s}) \tau_{n+1}(\mathbf{t}, \mathbf{s})}}, \\ p_n^{(2)}(\mathbf{t}, \mathbf{s}; z) &:= z^n \frac{\tau_n(\mathbf{t}, \mathbf{s} + [z^{-1}])}{\sqrt{\tau_n(\mathbf{t}, \mathbf{s}) \tau_{n+1}(\mathbf{t}, \mathbf{s})}} \end{aligned}$$

⁸For $\alpha \in \mathbb{C}$, one defines $[\alpha] = (\alpha, \frac{\alpha^2}{2}, \frac{\alpha^3}{3}, \dots) \in \mathbb{C}^\infty$.

are bi-orthonormal polynomials with regard to the bilinear form (3.26). In the formulas above, the $\tau_n(\mathbf{t}, \mathbf{s})$ are 2-Toda τ -functions and are defined as Toeplitz determinants, which are also expressible as a Fredholm determinant of the kernel (3.29) below, using the Borodin–Okounkov identity [15]. We obtain

$$(3.28) \quad \begin{aligned} \tau_n(\mathbf{t}, \mathbf{s}) &:= \det \left[\frac{1}{2\pi i} \oint_{S^1} \frac{du}{u} u^{k-\ell} e^{\sum_{j=1}^{\infty} (t_j u^j - s_j u^{-j})} \right]_{1 \leq k, \ell \leq n} \\ &= Z(\mathbf{t}, \mathbf{s}) \det(\mathbb{1} - \mathbf{K}(\mathbf{t}, \mathbf{s}))_{\ell^2(\{n, n+1, \dots\})}, \quad Z(\mathbf{t}, \mathbf{s}) := e^{-\sum_{j=1}^{\infty} j t_j s_j}, \end{aligned}$$

where the kernel $\mathbf{K}(\mathbf{t}, \mathbf{s})$ is given by

$$(3.29) \quad \mathbf{K}(\mathbf{t}, \mathbf{s})_{k, \ell} := \frac{1}{(2\pi i)^2} \oint_{\Gamma_0} du \oint_{\Gamma_{0, u}} dv \frac{u^\ell}{v^{k+1}} \frac{1}{v-u} \frac{e^{\sum_{j=1}^{\infty} (t_j v^{-j} + s_j v^j)}}{e^{\sum_{j=1}^{\infty} (t_j u^{-j} + s_j u^j)}}.$$

The coefficients t_j, s_j have to be such that the expression $\sum_{j=1}^{\infty} (t_j u^j - s_j u^{-j})$ appearing in the exponent of (3.28) is analytic in the annulus $\rho < |z| < \rho^{-1}$ for $0 < \rho < 1$. Then, the Borodin–Okounkov identity (3.28) gives a kernel $\mathbf{K}(\mathbf{t}, \mathbf{s})$, with contours given by $|u| = |v|^{-1} = \rho'$, with $0 < \rho < \rho' < 1$. Assume, using Cauchy's theorem, that the contours may be deformed to any circle of radius $0 < \rho < 1$. Then, using $\sum_{j=1}^{\infty} (v/z)^j / j = -\ln(1 - v/z)$ (for $|v/z| < 1$), we obtain

$$(3.30) \quad \begin{aligned} &\mathbf{K}(\mathbf{t}, \mathbf{s} + [z^{-1}])_{k, \ell} \\ &= \frac{1}{(2\pi i)^2} \oint_{\Gamma_0} du \oint_{\Gamma_{0, u}} dv \frac{u^\ell}{v^{k+1}} \frac{1}{v-u} \frac{1-u/z}{1-v/z} \frac{e^{\sum_{j=1}^{\infty} (t_j v^{-j} + s_j v^j)}}{e^{\sum_{j=1}^{\infty} (t_j u^{-j} + s_j u^j)}} \end{aligned}$$

and

$$(3.31) \quad Z(\mathbf{t}, \mathbf{s} + [z^{-1}]) = e^{-\sum_{j=1}^{\infty} j t_j (s_j + z^{-j}/j)} = Z(\mathbf{t}, \mathbf{s}) e^{-\sum_{j=1}^{\infty} t_j z^{-j}}.$$

We now specialize all this to the locus

$$(3.32) \quad \mathcal{L} = \{\mathbf{t} = (2t, 0, 0, \dots), \mathbf{s} = (-2t, 0, 0, \dots)\}.$$

On this locus, one checks that $Z(\mathbf{t}, \mathbf{s})|_{\mathcal{L}} = e^{4t^2}$, that $\mathbf{K}(\mathbf{t}, \mathbf{s})$ and its translation, restricted to the locus \mathcal{L} , are closely related to the kernel $K(z^{-1})$ defined in (3.15)⁹

$$(3.33) \quad \begin{aligned} \mathbf{K}(\mathbf{t}, \mathbf{s})|_{\mathcal{L}} &\stackrel{\text{conj}}{=} K(0), \\ \mathbf{K}(\mathbf{t}, \mathbf{s} + [z^{-1}])|_{\mathcal{L}} &\stackrel{\text{conj}}{=} K(z^{-1}), \end{aligned}$$

⁹With $A \stackrel{\text{conj}}{=} B$ we mean that the two kernels A and B are conjugate kernels. In the present case, the conjugation factor is $(-1)^{k-\ell}$. We remind the reader that two conjugate kernels define the same determinantal point process.

and that the restriction of $\tau_n(\mathbf{t}, \mathbf{s})$ to \mathcal{L} leads to the Fredholm determinant $H_n(z^{-1})$ as defined in (3.14),

$$(3.34) \quad \begin{aligned} \tau_n(\mathbf{t}, \mathbf{s})|_{\mathcal{L}} &= H_n(0)Z(\mathbf{t}, \mathbf{s})|_{\mathcal{L}} = e^{4t^2} H_n(0), \\ \tau_n(\mathbf{t}, \mathbf{s} + [z^{-1}])|_{\mathcal{L}} &= H_n(z^{-1})e^{-2t/z} Z(\mathbf{t}, \mathbf{s})|_{\mathcal{L}} \\ &= H_n(z^{-1})e^{4t^2 - 2t/z}. \end{aligned}$$

Moreover, the bilinear form $\langle f, g \rangle_{\mathbf{t}, \mathbf{s}}$ defined in (3.26) reduces to the inner-product $\langle\langle f, g \rangle\rangle$ defined in (3.22),

$$(3.35) \quad \langle f, g \rangle_{\mathbf{t}, \mathbf{s}}|_{\mathcal{L}} = \frac{1}{2\pi i} \oint_{S^1} \frac{du}{u} e^{2t(u+u^{-1})} f(u)g(u^{-1}) = \langle\langle f, g \rangle\rangle.$$

It follows that the bi-orthogonal functions for $\langle f(z), g(z) \rangle_{\mathbf{t}, \mathbf{s}}$, restricted to the locus \mathcal{L} , coincide with the orthonormal polynomials defined by (3.22), which by (3.27), (3.34) and (3.33) yields

$$(3.36) \quad P_n(z) = p_n^{(1)}(\mathbf{t}, \mathbf{s}; z)|_{\mathcal{L}} = p_n^{(2)}(\mathbf{t}, \mathbf{s}; z)|_{\mathcal{L}} = \frac{z^n e^{-2t/z} H_n(z^{-1})}{\sqrt{H_n(0)H_{n+1}(0)}},$$

where

$$(3.37) \quad H_n(z^{-1}) = \det(\mathbb{1} - K(z^{-1}))_{\ell^2(\{n, n+1, \dots\})}$$

with the kernel $K(z^{-1})$ as in (3.15); this follows from (3.33). The fact that the $p_n^{(1)}$ and $p_n^{(2)}$ are equal on the locus \mathcal{L} is a consequence of the symmetry of the inner-product $\langle\langle, \rangle\rangle$, as in (3.22). However, one easily verifies it with the above formulas. The equivalence of the Fredholm determinant parts is evident only after the change of variable $v \rightarrow 1/\tilde{u}$ and $u \rightarrow 1/\tilde{v}$. Then, the kernel obtained for $p_n^{(1)}$ is the transpose of the one for $p_n^{(2)}$.

Step 4: Expressing the kernel $\mathbb{K}_m(x, y)$ as (3.12). Using this new basis ψ_k , as in (3.21), and using the Christoffel–Darboux formula (3.25), the kernel $\mathbb{K}_m(x, y)$ becomes, by Step 2 (recall that $n = 2m + 1$),

$$(3.38) \quad \begin{aligned} \mathbb{K}_m(x, y) &= \sum_{k=1}^n \psi_k(x)\psi_k(y) \\ &= \int_{S^1}^* d\rho_t(z) \int_{S^1} d\rho_t(w) \frac{w^{y-m}}{z^{x-m}} \sum_{k=0}^{n-1} P_k(z^{-1})P_k(w) \\ &= \int_{\Gamma_0} d\rho_t(z) \int_{\Gamma_{0,z}} d\rho_t(w) \frac{w^{y-m}}{z^{x-m-1}} \frac{1}{z-w} \left(\left(\frac{w}{z} \right)^n P_n(z)P_n(w^{-1}) \right. \\ &\quad \left. - P_n(z^{-1})P_n(w) \right). \end{aligned}$$

Note that the w -integrand in the double integral $\overset{*}{=}$ has no pole at $w = z$, enabling one to deform the w -contour so as to include $z \in S^1$; this has the advantage that the double integral of the difference can be written as the difference of two double integrals, each of them being finite.

Inserting (3.36) into (3.38) and setting $V_m = 1/(H_{2m+1}(0)H_{2m+2}(0))$ we get

$$(3.39) \quad \begin{aligned} & \mathbb{K}_m(x, y) \\ &= \frac{V_m}{(2\pi i)^2} \oint_{\Gamma_0} dz \oint_{\Gamma_{0,z}} dw \frac{e^{t(z-z^{-1})}}{e^{t(w-w^{-1})}} \frac{w^{y-m-1}}{z^{x-m}} \frac{H_{2m+1}(w)H_{2m+1}(z^{-1})}{z-w} \\ & \quad - \frac{V_m}{(2\pi i)^2} \oint_{\Gamma_0} dz \oint_{\Gamma_{0,z}} dw \frac{e^{t(w-w^{-1})}}{e^{t(z-z^{-1})}} \frac{w^{y+m}}{z^{x+m+1}} \frac{H_{2m+1}(z)H_{2m+1}(w^{-1})}{z-w}. \end{aligned}$$

The expression in (3.12) is finally obtained by noticing that

$$(3.40) \quad \begin{aligned} & \frac{1}{(2\pi i)^2} \oint_{\Gamma_0} dz \oint_{\Gamma_{0,z}} dw \frac{F(z, w)}{w-z} \\ &= \frac{1}{(2\pi i)^2} \oint_{\Gamma_0} dw \oint_{\Gamma_{0,w}} dz \frac{F(z, w)}{w-z} + \oint_{\Gamma_0} \frac{dz}{2\pi i} F(z, z), \end{aligned}$$

proving formula (3.12).

Step 5: Expressing the dual kernel $\tilde{\mathbb{K}}_m(x, y)$ as (3.13). First of all, by (3.36), we have

$$(3.41) \quad H_n(z^{-1}) = P_n(z) e^{2t/z} z^{-n} \sqrt{H_n(0)H_{n+1}(0)}.$$

Thus (with $n = 2m + 1$), the last term of (3.12) is given by

$$(3.42) \quad \begin{aligned} & \frac{V_m}{2\pi i} \oint_{\Gamma_0} \frac{dz}{z^{x-y+1}} H_{2m+1}(z^{-1}) H_{2m+1}(z) \\ &= \frac{1}{2\pi i} \oint_{S^1} \frac{dz}{z^{x-y+1}} e^{2t(z+z^{-1})} P_n(z) P_n(z^{-1}). \end{aligned}$$

In particular, at $x = y$ we have

$$(3.43) \quad (3.42)|_{x=y} = \langle\langle P_n, P_n \rangle\rangle = 1$$

and thus

$$(3.44) \quad \begin{aligned} & \frac{V_m}{2\pi i} \oint_{\Gamma_0} \frac{dz}{z^{x-y+1}} H_{2m+1}(z^{-1}) H_{2m+1}(z) \\ &= \delta_{x,y} + (1 - \delta_{x,y}) \frac{V_m}{2\pi i} \oint_{\Gamma_0} dz \frac{1}{z^{x-y+1}} H_{2m+1}(z^{-1}) H_{2m+1}(z). \end{aligned}$$

So, $\tilde{\mathbb{K}}_m(x, y) = \delta_{x,y} - \mathbb{K}_m(x, y) = \tilde{\mathbb{K}}_m^{\text{ext}}(0, x_1; 0, x_2)$ of (2.5), thus establishing Theorem 3.1. This also ends the proof of Theorem 2.1 for $t_1 = t_2 = 0$. \square

4. Reshaping, motivation and Bessel representation. In this section we first reshape the kernel (2.5) of Theorem 2.1 for $t_1 = t_2 = 0$, to make it adequate for asymptotic analysis. Second, we rewrite all the terms using Bessel functions and the Bessel kernel. This will allow us to use known asymptotics for Bessel functions and kernel, without the need for new asymptotic analysis.

4.1. *Reshaping.* Note that the kernel $K(z^{-1})$, defined in (3.15), with $|u| < |v| < |z|$, namely

$$(4.1) \quad K(z^{-1})_{k,\ell} := \frac{(-1)^{k+\ell}}{(2\pi i)^2} \oint_{\Gamma_0} du \oint_{\Gamma_{0,u}} dv \frac{u^\ell}{v^{k+1}} \frac{1}{v-u} \frac{u-z}{v-z} \frac{e^{2t(u-u^{-1})}}{e^{2t(v-v^{-1})}}$$

is a rank-one perturbation

$$(4.2) \quad K(z^{-1})_{k,\ell} = K(0)_{k,\ell} + h_k(z^{-1})g_\ell$$

of the symmetric¹⁰ kernel

$$(4.3) \quad K(0)_{k,\ell} = \frac{(-1)^{k+\ell}}{(2\pi i)^2} \oint_{\Gamma_0} du \oint_{\Gamma_{0,u}} dv \frac{u^\ell}{v^{k+1}} \frac{1}{v-u} \frac{e^{2t(u-u^{-1})}}{e^{2t(v-v^{-1})}},$$

upon using the identity

$$(4.4) \quad \frac{1}{v-u} \frac{u-z}{v-z} = \frac{1}{v-u} - \frac{1}{v-z},$$

where (remember $|v| < |z|$ in the first integration below)

$$(4.5) \quad \begin{aligned} h_k(z^{-1}) &= \frac{-1}{2\pi i} \oint_{\Gamma_0} \frac{dv}{(-v)^{k+1}} \frac{e^{-2t(v-v^{-1})}}{v-z} \\ &= \frac{-1}{2\pi i} \oint_{\Gamma_{0,z}} \frac{dv}{(-v)^{k+1}} \frac{e^{-2t(v-v^{-1})}}{v-z} + \frac{e^{-2t(z-z^{-1})}}{(-z)^{k+1}} \\ &=: \bar{h}_k(z^{-1}) + \frac{e^{-2t(z-z^{-1})}}{(-z)^{k+1}} \end{aligned}$$

and

$$(4.6) \quad g_\ell = \frac{-1}{2\pi i} \oint_{\Gamma_0} du (-u)^\ell e^{2t(u-u^{-1})}.$$

In (4.5), one has replaced the integration about a small circle around 0 by an integration about a contour containing z as well; this is done in order to be able to expand, later on, $1/(v-z)$ in a power series in z/v . Therefore we

¹⁰As is seen by replacing $u \mapsto 1/u, v \mapsto 1/v$.

can rewrite the Fredholm determinant $H_n(z^{-1})$ of $K(z^{-1})$ as

$$(4.7) \quad H_n(z^{-1}) = H_n(0)(1 - R_n(z^{-1})),$$

where¹¹

$$(4.8) \quad \begin{aligned} R_n(z^{-1}) &:= \langle Q, \chi_n h(z^{-1}) \rangle, \\ Q_k &:= ((\mathbb{1} - \chi_n K(0) \chi_n)^{-1} \chi_n g)_k \end{aligned}$$

and $\chi_n(k) = \mathbb{1}_{[k \geq n]}$; here the symmetry of $K(0)$ is being used. Accordingly $R_n(z^{-1}) = \langle Q, \chi_n h(z^{-1}) \rangle$, as in (4.8), decomposes as (recall that $n = 2m + 1$)

$$(4.9) \quad R_n(z^{-1}) = S_n(z^{-1}) + \frac{e^{-2t(z-z^{-1})}}{(-z)^n} T_n(z^{-1})$$

with

$$(4.10) \quad S_n(z^{-1}) = \langle Q, \chi_n \bar{h}(z^{-1}) \rangle, \quad T_n(z^{-1}) = \sum_{k \geq 1} \frac{Q_{n+k-1}}{(-z)^k}.$$

We set for $x \in \mathbb{Z}$,

$$(4.11) \quad \begin{aligned} A(x) &:= \frac{-1}{2\pi i} \oint_{\Gamma_0} dz \frac{e^{t(z-z^{-1})}}{(-z)^{x-m}} (1 - S_n(z^{-1})), \\ B(x) &:= \frac{-1}{2\pi i} \oint_{\Gamma_0} dz \frac{e^{-t(z-z^{-1})}}{(-z)^{x+m+1}} T_n(z^{-1}), \\ C_1(x) &:= \frac{-1}{2\pi i} \oint_{\Gamma_0} dz \frac{T_n(z^{-1}) T_n(z)}{(-z)^{x+1}}, \\ C_2(x) &:= \mathbb{1}_{[x \neq 0]} \frac{-1}{2\pi i} \oint_{\Gamma_0} dz \frac{R_n(z^{-1}) + R_n(z) - R_n(z^{-1}) R_n(z)}{(-z)^{x+1}}, \\ C(x) &:= 2C_1(x) + C_2(x). \end{aligned}$$

Remark that $C_1(x) = C_1(-x)$ and $C_2(x) = C_2(-x)$. Also introduce functions $E_i(z, w)$, which also depend on $n = 2m + 1$,

$$(4.12) \quad \begin{aligned} E_1(z, w) &:= \frac{e^{t(z-z^{-1})}}{e^{t(w-w^{-1})}} \left(\frac{z}{w} \right)^m (1 - S_n(z^{-1}))(1 - S_n(w)), \\ E_2(z, w) &:= -\frac{e^{t(z-z^{-1})}}{e^{-t(w-w^{-1})}} (-z)^m (-w)^{m+1} (1 - S_n(z^{-1})) T_n(w), \\ E_3(z, w) &:= -\frac{e^{-t(z-z^{-1})}}{e^{t(w-w^{-1})}} (-z)^{-m-1} (-w)^{-m} T_n(z^{-1}) (1 - S_n(w)), \end{aligned}$$

¹¹For $a = (a_k)_{k \in \mathbb{Z}}$ and $b = (b_k)_{k \in \mathbb{Z}}$, the inner-product $\langle a, b \rangle := \sum_{k \in \mathbb{Z}} a_k b_k$.

$$E_4(z, w) := -\frac{e^{t(z-z^{-1})}}{e^{t(w-w^{-1})}} \left(\frac{z}{w}\right)^m T_n(z)T_n(w^{-1}).$$

With these notations, the following statement holds.

PROPOSITION 4.1. *The kernel $\tilde{\mathbb{K}}_m(x, y)$ in (3.13) has the following expression:*

$$(4.13) \quad \begin{aligned} & (-1)^{x-y} \frac{H_{n+1}(0)}{H_n(0)} \tilde{\mathbb{K}}_m(x, y) \\ & = C(x-y) \\ & \quad + \frac{1}{(2\pi i)^2} \oint_{\Gamma_0} dz \oint_{\Gamma_{0,z}} dw \frac{\sum_{i=1}^4 E_i(z, w)}{z-w} \left(\frac{(-w)^{y-1}}{(-z)^x} + \frac{(-z)^y}{(-w)^{x+1}} \right) \end{aligned}$$

as well as the Airy kernel-like expression:

$$(4.14) \quad \begin{aligned} & (-1)^{x-y} \frac{H_{n+1}(0)}{H_n(0)} \tilde{\mathbb{K}}_m(x, y) \\ & = C(x-y) \\ & \quad + \sum_{c \geq 0} (A(x-c)A(y-c) + A(-x-c)A(-y-c) \\ & \quad - A(x-c)B(y-c) - A(-x-c)B(-y-c) \\ & \quad - B(x-c)A(y-c) - B(-x-c)A(-y-c)) \\ & \quad - \sum_{c < 0} (B(x-c)B(y-c) + B(-x-c)B(-y-c)). \end{aligned}$$

PROOF. Let us first prove (4.13). Consider the kernel $\tilde{\mathbb{K}}_m(x, y)$ as in (3.13); one uses $H_n(z^{-1}) = H_n(0)(1 - R_n(z^{-1}))$, as in (4.7), and one renames the integration variables $(w, z) \rightarrow (z, w)$ in the second double integral, enabling us to combine the two double integrals. Then, taking into account the prefactor,

$$(4.15) \quad \begin{aligned} & (-1)^{x-y} \frac{H_{n+1}(0)}{H_n(0)} \tilde{\mathbb{K}}_m(x, y) \\ & = \frac{\mathbb{1}_{[x \neq y]}}{2\pi i} \oint_{\Gamma_0} \frac{dz}{(-z)^{x-y+1}} (1 - R_n(z^{-1}))(1 - R_n(z)) \\ & \quad + \frac{1}{(2\pi i)^2} \oint_{\Gamma_0} dz \oint_{\Gamma_{0,z}} dw \frac{e^{t(z-z^{-1})}}{e^{t(w-w^{-1})}} \left(\frac{z}{w}\right)^m \left(\frac{(-w)^{y-1}}{(-z)^x} + \frac{(-z)^y}{(-w)^{x+1}} \right) \\ & \quad \quad \quad \times \frac{(1 - R_n(z^{-1}))(1 - R_n(w))}{z-w}. \end{aligned}$$

That the single integral above equals C_2 , defined in (4.11), follows from the fact that the -1 term can be deleted, since $\frac{1}{2\pi i} \oint_{\Gamma_0} dz z^{y-x-1} = \delta_{x,y}$ and $\delta_{x,y} \mathbb{1}_{x \neq y} = 0$. Multiply out $(1 - R_n(z^{-1}))(1 - R_n(w))$, use the expression (4.10) of R_n and the functions E_i 's defined in (4.12) with the result

$$(4.15) = \frac{1}{(2\pi i)^2} \oint_{\Gamma_0} dz \oint_{\Gamma_{0,z}} dw \frac{1}{z-w} \left(\frac{(-w)^{y-1}}{(-z)^x} + \frac{(-z)^y}{(-w)^{x+1}} \right) \\ (4.16) \quad \times \left(E_1(z, w) + E_2(z, w) + E_3(z, w) - \frac{w}{z} E_4(w, z) \right) \\ + C_2(x-y).$$

The double integral, involving the last expression in brackets, is not in a usable form, in view of the saddle point method and the topology of the contours (see the discussion after the proof). Namely, the *integrations have to be interchanged*, at the expense of a residue term, as is given by the general formula (3.40). So, using this formula, and further renaming $z \leftrightarrow w$, the double integral with E_4 becomes

$$(4.17) \quad \frac{1}{(2\pi i)^2} \oint_{\Gamma_0} dz \oint_{\Gamma_{0,z}} dw \frac{1}{z-w} \left(\frac{(-w)^{y-1}}{(-z)^x} + \frac{(-z)^y}{(-w)^{x+1}} \right) E_4(z, w) \\ + 2C_1(x-y),$$

where $C_1(x)$ is defined in (4.11). So, taking equation (4.16) and (4.17) into account, we find that formula (4.13) for the kernel $\tilde{\mathbb{K}}_m(x, y)$ holds.

Next we prove (4.14). The first observation is that the kernel (4.13) depends on x and y through the expression in brackets only; the latter itself is invariant for the interchange $(x, y) \mapsto (-y, -x)$. So it suffices to consider the double integral associated with the first term $(-w)^{y-1}(-z)^{-x}$ only; the other one is automatic. Since the integration paths can be taken to satisfy $|z| < |w|$, in the double integral of (4.13), one may use the series

$$(4.18) \quad \frac{1}{z-w} = \frac{1}{(-w)} \sum_{c \geq 0} \left(\frac{-z}{-w} \right)^c \quad \text{valid for } |w| > |z|,$$

and one notices that for each of the E_i , the double integral decouples into the product of two integrals over Γ_0 :

$$(4.19) \quad \frac{1}{(2\pi i)^2} \oint_{\Gamma_0} dz \oint_{\Gamma_{0,z}} dw \frac{E_1(z, w)}{z-w} \frac{(-w)^{y-1}}{(-z)^x} \\ = \sum_{c \geq 0} \oint_{\Gamma_0} \frac{-dz}{2\pi i} \frac{e^{t(z-z^{-1})}}{(-z)^{x-m-c}} (1 - S_n(z^{-1}))$$

$$\begin{aligned} & \times \oint_{\Gamma_0} \frac{-dw}{2\pi i} \frac{(-w)^{y-m-c-2}}{e^{t(w-w^{-1})}} (1 - S_n(w)) \\ & = \sum_{c \geq 0} A(x-c)A(y-c). \end{aligned}$$

To see that the second integral equals $A(y-c)$, one performs the change of variable $w \mapsto 1/w$. Since the only poles are at $w = 0$ and $w^{-1} = 0$, this is allowed; so, we do not pick up further poles. The same decoupling occurs for the other E_i 's, which yields

$$(4.20) \quad \begin{aligned} & \frac{1}{(2\pi i)^2} \oint_{\Gamma_0} dz \oint_{\Gamma_{0,z}} dw \frac{E_2(z,w)}{z-w} \frac{(-w)^{y-1}}{(-z)^x} = - \sum_{c \geq 0} A(x-c)B(y-c), \\ & \frac{1}{(2\pi i)^2} \oint_{\Gamma_0} dz \oint_{\Gamma_{0,z}} dw \frac{E_3(z,w)}{z-w} \frac{(-w)^{y-1}}{(-z)^x} = - \sum_{c \geq 0} B(x-c)A(y-c) \end{aligned}$$



and

$$(4.21) \quad \begin{aligned} & \frac{1}{(2\pi i)^2} \oint_{\Gamma_0} dz \oint_{\Gamma_{0,z}} dw \frac{E_4(z,w)}{z-w} \frac{(-w)^{y-1}}{(-z)^x} \\ & = - \sum_{c \geq 0} B(-x+c+1)B(-y+c+1) \\ & = - \sum_{c < 0} B(-x-c)B(-y-c). \end{aligned}$$

Then adding the same expressions with the interchange $(x, y) \mapsto (-y, -x)$ yields formula (4.14), completing the proof of Proposition 4.1. \square

In anticipation of Section 7 on the integral representation of the limiting kernel, which will be obtained by saddle point analysis, some comments must be made here; they will also explain the interchange of integrals, which occurred in (4.17). Given the future rescaling $m \simeq 2t$ with $x = \xi_1 t^{1/3}$, $y = \xi_2 t^{1/3}$ for $t \rightarrow \infty$, the steepest descent method applied to $A(x)$ and $B(x)$ at $z = -1$, in particular to the part of the integrand $e^{\pm t(z-z^{-1})}(-z)^{\pm m} = e^{\pm tF(z)}$, respectively, uses the Taylor expansions

$$(4.22) \quad \begin{aligned} & F(z) := z - z^{-1} + 2 \log(-z) = \frac{1}{3}(z+1)^3 + \mathcal{O}(z+1)^4, \\ & \log(-z) = -(z+1) - \frac{1}{2}(z+1)^2 + \mathcal{O}(z+1)^3. \end{aligned}$$

The steepest descent path for $A(x)$ will therefore look like  with an angle of approximately $\pm\pi/3$, whereas for $B(x)$ it will look like  with an angle of approximately $\pm 2\pi/3$ with the positive real axis. The contours of *the*

¹²The angles can be within the range $\pi/3 \pm \pi/6$ and $2\pi/3 \pm \pi/6$.

four double integrals of equation (4.13), associated with each one of the E_i 's, from the point of view of steepest descent analysis about $z, w = -1$, are topologically two circles, a z -circle inside a w -circle, which are deformed so that locally near $z = w = -1$ they look like the set of pictures in Figure 5 (see Section 7), with the two circles intersecting the real axis at the common point $z, w = -1$ and to the right of -1 .

4.2. *Bessel reformulation.* The purpose of this section is to express the functions $A(x), B(x), C_1(x)$ and $C_2(x)$, as in (4.11) in terms of Bessel functions, the expressions Q_k and the Bessel kernel $K(0)$, as in (4.8) and (4.3). Throughout we will be using the integral representation of the Bessel function of order $n \in \mathbb{Z}$, together with its symmetries,

$$(4.23) \quad J_n(2t) = \frac{1}{2\pi i} \oint_{\Gamma_0} dz \frac{e^{t(z-z^{-1})}}{z^{n+1}} = (-1)^n J_{-n}(2t) = (-1)^n J_n(-2t).$$

$J_n(2t)$ is different from the modified Bessel function $I_n(2t)$, defined in (3.4). To do so, we shall need the following Bessel function expressions for the basic building blocks.

LEMMA 4.2. *The kernel $K(0)$ defined in (4.3), the expressions h_k and g_ℓ given in (4.5) and (4.6) and the functions $T_n(z^{-1})$ and $S_n(z^{-1})$, given in (4.10), can be expressed in terms of Bessel functions as follows:*

$$(4.24) \quad \begin{aligned} K(0)_{k,\ell} &= \sum_{a \geq 0} J_{k+a+1}(4t) J_{\ell+a+1}(4t) \\ &=: B_{2t}(k+1, \ell+1), \quad g_\ell = J_{\ell+1}(4t), \\ h_k(z^{-1}) &= - \sum_{a \geq 0} (-z)^a J_{k+a+1}(4t) + \frac{e^{-2t(z-z^{-1})}}{(-z)^{k+1}} \\ &= \bar{h}_k(z^{-1}) + \frac{e^{-2t(z-z^{-1})}}{(-z)^{k+1}}, \\ T_n(z^{-1}) &= \sum_{k \geq n} \frac{Q_k}{(-z)^{k-n+1}}, \\ S_n(z^{-1}) &= - \sum_{\substack{a \geq 0 \\ k \geq n}} (-z)^a Q_k J_{k+a+1}(4t), \end{aligned}$$

where $B_t(i, j)$ is the Bessel kernel in [42]. Also,

$$(4.25) \quad Q_k = \sum_{\ell \geq n} P_{k,\ell} J_{\ell+1}(4t) \quad \text{with } P_{k,\ell} = ((\mathbb{1} - \chi_n K(0) \chi_n)^{-1})_{k,\ell}.$$

PROOF. For $K(0)_{k,\ell}$ one uses in (4.3) the series $1/(v-u) = v^{-1} \sum_{a \geq 0} (u/v)^a$ for $|u| < |v|$ and then (4.23). The same geometric series is used for $h_k(z^{-1})$ in (4.5) but with u replaced by z , from which formula (4.24) for $h_k(z^{-1})$ and the formula for S_n by (4.10) follow. Finally, one has $g_\ell = (-1)^{\ell-1} J_{-1-\ell}(2t) = J_{\ell+1}(2t)$. \square

The more intricate term is C_2 from (4.11).

LEMMA 4.3. *The expression $C_2(x)$, as in (4.11), equals*

$$(4.26) \quad C_2(x) = \mathbb{1}_{[x \neq 0]} C_2^*(x),$$

where

$$(4.27) \quad \begin{aligned} C_2^*(x) &= (-1)^x \frac{1}{2\pi i} \oint_{\Gamma_0} dz \frac{1}{z^{x+1}} (R_n(z^{-1}) + R_n(z) - R_n(z^{-1})R_n(z)) \\ &= \sum_{k \geq n} Q_k \left(\mathbb{1}_{[x \neq 0]} J_{k-|x|+1}(4t) - Q_{k+|x|} + \sum_{\ell \geq n} Q_\ell K(0)_{k,\ell-|x|} \right). \end{aligned}$$

PROOF. One first notices that the integrand in (4.27) is invariant under the mapping $z \mapsto z^{-1}$. Then, using formula (4.24) for $R_n(z^{-1}) = \sum_{k \geq n} Q_k h_k(z^{-1})$, one breaks up the calculation as follows:

(a) *Terms from $R_n(z^{-1}) + R_n(z)$.* We have

$$(4.28) \quad R_n(z^{-1}) + R_n(z) = \sum_{k \geq n} Q_k (h_k(z^{-1}) + h_k(z))$$

and thus, by integration, one checks first for $x > 0$, then for $x < 0$ and for $x = 0$, that, using the symmetry properties of the Bessel functions [see (4.23)],

$$(4.29) \quad \begin{aligned} &\frac{1}{2\pi i} \oint_{\Gamma_0} dz \frac{h_k(z^{-1}) + h_k(z)}{z^{x+1}} \\ &= (-1)^x (\mathbb{1}_{x>0} J_{k+1-x}(4t) + \mathbb{1}_{x<0} J_{k+1+x}(4t)) \\ &= (-1)^x \mathbb{1}_{[x \neq 0]} J_{k+1-|x|}(4t). \end{aligned}$$

Substituting into the left-hand side of (4.27) gives the first term on the right-hand side of (4.27).

(b) *Terms from $R_n(z^{-1})R_n(z)$.* We have

$$(4.30) \quad R_n(z^{-1})R_n(z) = \sum_{k,\ell \geq n} Q_k Q_\ell h_k(z^{-1})h_\ell(z).$$

From (4.23) and (4.24) we get

$$\begin{aligned}
& \frac{1}{2\pi i} \oint_{\Gamma_0} dz \frac{h_k(z^{-1})h_\ell(z)}{z^{x+1}} \\
&= \sum_{a,b \geq 0} (-1)^{a-b} \delta_{a-b,x} J_{k+a+1}(4t) J_{b+\ell+1}(4t) \\
&\quad - \sum_{b \geq 0} (-1)^{b+k+1} J_{\ell+b+1}(4t) J_{k+b+1+x}(-4t) \\
(4.31) \quad & - \sum_{a \geq 0} (-1)^{a+\ell+1} J_{k+a+1}(4t) J_{x-\ell-a-1}(4t) + (-1)^x \delta_{\ell-k,x} \\
&= (-1)^x \left(\delta_{\ell-k,x} - \sum_{a \geq 0} J_{k+a+1}(4t) J_{\ell+a+1-|x|}(4t) \right) \\
&= (-1)^x (\delta_{\ell-k,x} - K(0)_{k,\ell-|x|}),
\end{aligned}$$

using in the last equality the expression (4.24) for the kernel $K(0)$. In the second equality we used the symmetries (4.23) of the Bessel functions. Substituted into (4.30), this gives the last two terms in (4.27). \square

PROPOSITION 4.4. *The expressions $A(x), B(x), C(x)$, defined in (4.11) for $x \in \mathbb{Z}$, can be expressed in terms of Bessel functions J_k , Q_k and the kernel $K(0)$, as follows:*

$$\begin{aligned}
(4.32) \quad A(x) &= J_{m+1-x}(2t) + \sum_{k \geq n} \sum_{a \geq 0} Q_k J_{k+1+a}(4t) J_{m+1+a-x}(2t), \\
B(x) &= \sum_{k \geq n} Q_k J_{k-m+x}(2t)
\end{aligned}$$

and

$$\begin{aligned}
(4.33) \quad C(x) &= \sum_{k \geq n} Q_k (J_{k-x+1}(4t) + J_{k+x+1}(4t)) \\
&\quad + \sum_{k,\ell \geq n} Q_k Q_\ell (K(0)_{k+x,\ell} + K(0)_{k-x,\ell}).
\end{aligned}$$

PROOF. The formulas for A and B follow directly from (4.11) and the expressions for T_n and S_n in (4.24), together with the symmetries (4.23) of the Bessel functions. Then

$$C_1(x) = \frac{-1}{2\pi i} \oint_{\Gamma_0} dz \frac{T_n(z^{-1})T_n(z)}{(-z)^{x+1}}$$

$$\begin{aligned}
(4.34) \quad &= \sum_{k, \ell \geq n} Q_k Q_\ell \frac{(-1)^x}{2\pi i} \oint_{\Gamma_0} dz \frac{(-z)^{k-\ell}}{z^{x+1}} \\
&= \sum_{k, \ell \geq n} Q_k Q_\ell \delta_{k-\ell, x} = \sum_{k \geq n} Q_k Q_{k+|x|}.
\end{aligned}$$

From Lemma 4.3, it follows that

$$(4.35) \quad C_2(x) = \mathbb{1}_{[x \neq 0]} \sum_{k \geq n} Q_k \left(J_{k-|x|+1}(4t) - Q_{k+|x|} + \sum_{\ell \geq n} Q_\ell K(0)_{k, \ell-|x|} \right).$$

Next we show that $\mathbb{1}_{[x \neq 0]}$ can actually be omitted. To do so, it suffices to show that the sum on the right-hand side of (4.35) vanishes when $x = 0$.

Indeed, setting $P = (\mathbb{1} - \chi_n K(0) \chi_n)^{-1}$, as in (4.25), remember that $g_\ell = J_{\ell+1}(4t)$ and that $Q_k = (P \chi_n g)_k$. Then, denoting $\langle \cdot, \cdot \rangle$ the canonical scalar product on $\ell^2(\mathbb{Z})$ we get, for $x = 0$, that the right-hand side of (4.35) equals

$$\begin{aligned}
(4.36) \quad &\langle P \chi_n g, \chi_n g \rangle - \langle P \chi_n g, \chi_n P \chi_n g \rangle + \langle P \chi_n g, \chi_n K(0) \chi_n P \chi_n g \rangle \\
&= \langle P \chi_n g, \chi_n g \rangle - \langle P \chi_n g, \chi_n (\mathbb{1} - \chi_n K(0) \chi_n) P \chi_n g \rangle \\
&= \langle P \chi_n g, \chi_n g \rangle - \langle P \chi_n g, \chi_n g \rangle = 0.
\end{aligned}$$

Plugging these results into $C(x) = 2C_1(x) + C_2(x)$ we obtain

$$(4.37) \quad C(x) = \sum_{k \geq n} Q_k \left(J_{k-|x|+1}(4t) + Q_{k+|x|} + \sum_{\ell \geq n} Q_\ell K(0)_{k, \ell-|x|} \right).$$

It follows from the relation $P = \mathbb{1} + \chi_n K(0) \chi_n P$ [see the definition of Q and P in (4.25)] that acting on $\chi_n g$ and taking the k th entry,

$$(4.38) \quad Q_k = \mathbb{1}_{[k \geq n]} \left(J_{k+1}(4t) + \sum_{\ell \geq n} K(0)_{k, \ell} Q_\ell \right).$$

Using this relation for $Q_{k+|x|}$ in (4.37) we obtain

$$\begin{aligned}
(4.39) \quad C(x) &= \sum_{k \geq n} Q_k (J_{k-|x|+1}(4t) + J_{k+|x|+1}(4t)) \\
&\quad + \sum_{k, \ell \geq n} Q_k Q_\ell (K(0)_{k, \ell-|x|} + K(0)_{k+|x|, \ell}).
\end{aligned}$$

Finally, since $K(0)$ is symmetric, we replace $K(0)_{k, \ell-|x|} = K(0)_{\ell-|x|, k}$ and change the labeling $k \leftrightarrow \ell$. This yields (4.33), except for replacing $|x|$ by x , which can then be done. \square

5. Extended kernel for finite time. Formula (4.14) (in Proposition 4.1) with $A(x), B(x), C(x)$ given by Proposition 4.4 gives the kernel $\tilde{\mathbb{K}}_m$ governing the fluctuations of the walkers near the point of meeting of the two groups of nonintersecting random walkers at time $\tau = 0$. In this section we prove Theorem 2.1 and we extend Proposition 4.1 to the multitime setting (Theorem 5.4).

Consider the $n = 2m + 1$ walks whose positions were denoted by $x_k(\tau)$ in Section 3. Consider p different time slices $\tau_1 < \tau_2 < \dots < \tau_p$ in the interval $(-t, t)$. Then, the probability measure at these times of the positions of the random walks is given by

$$\begin{aligned}
(5.1) \quad & \mathbb{P} \left(\bigcap_{j=1}^p \bigcap_{k=1}^n \{x_k(\tau_j) = y_k^j\} \middle| \bigcap_{k=1}^n \{x_k(t) = x_k(-t) = m + 1 - k\} \right) \\
& = \text{const} \times \det[p_{t+\tau_1}(m + 1 - i, y_j^1)]_{1 \leq i, j \leq n} \\
& \quad \times \left(\prod_{\ell=1}^{p-1} \det[p_{\tau_{\ell+1}-\tau_\ell}(y_i^\ell, y_j^{\ell+1})]_{1 \leq i, j \leq n} \right) \\
& \quad \times \det[p_{t-\tau_p}(y_i^p, m + 1 - j)]_{1 \leq i, j \leq n}.
\end{aligned}$$

It is well known that a measure of this form has determinantal correlations in space–time [18, 21, 28, 38, 49], as stated in the following proposition.

THEOREM 5.1. *Any probability measure on $\{x_i^{(\ell)}, 1 \leq i \leq n, 1 \leq \ell \leq p\}$ of the form¹³*

$$\begin{aligned}
(5.2) \quad & \frac{1}{Z} \det(\phi(\tau_0, a_i; \tau_1, x_j^{(1)}))_{1 \leq i, j \leq n} \prod_{\ell=1}^{p-1} \det(\phi(\tau_\ell, x_i^{(\ell)}; \tau_{\ell+1}, x_j^{(\ell+1)}))_{1 \leq i, j \leq n} \\
& \quad \times \det(\phi(\tau_p, x_i^{(p)}; \tau_{p+1}, b_j))_{1 \leq i, j \leq n}
\end{aligned}$$

has, assuming $Z \neq 0$, the following determinantal k -point correlation functions for $t_1, \dots, t_k \in \{\tau_1, \dots, \tau_p\}$:

$$(5.3) \quad \rho^{(k)}(t_1, x_1, \dots, t_k, x_k) = \det(K(t_i, x_i; t_j, x_j))_{1 \leq i, j \leq k}.$$

The space–time kernel K (often called extended kernel) is given by

$$\begin{aligned}
(5.4) \quad & K(t_1, x_1; t_2, x_2) = -\phi(t_1, x_1; t_2, x_2) \mathbb{1}(t_2 > t_1) \\
& \quad + \sum_{i, j=1}^n \phi(t_1, x_1; \tau_{p+1}, b_i) [B^{-1}]_{i, j} \phi(\tau_0, a_j; t_2, x_2)
\end{aligned}$$

¹³The functions $\phi(\tau_\ell, x; \tau_{\ell+1}, y)$ themselves may in fact vary with ℓ above.

with ($*$ means integration with regard to the consecutive dots)

$$(5.5) \quad \phi(\tau_r, x; \tau_s, y) = \begin{cases} \phi(\tau_r, x; \tau_{r+1}, \cdot) * \cdots * \phi(\tau_{s-1}, \cdot; \tau_s, y), & \text{if } \tau_r < \tau_s, \\ 0, & \text{if } \tau_r \geq \tau_s, \end{cases}$$

and with the $n \times n$ matrix B having entries $B_{i,j} = \phi(\tau_0, a_i; \tau_{p+1}, b_j)$.

Our measure (5.1) has the form required by Theorem 5.1. The normalization constant Z is nothing else but the partition function and it is nonzero since the set of n paths satisfying the nonintersection constraint is nonempty. We already determined the one-time kernel for $\tau = 0$. To get the extended kernel one has to let the one-time kernel “evolve” by means of the operator of the random walk. This formulation was already present in the work of Prähofer and Spohn on the Airy_2 process [42].

LEMMA 5.2. *The extended kernel $\tilde{\mathbb{K}}_m^{\text{ext}}(t_1, x_1; t_2, x_2)$ of the time-dependent point process $\tilde{\eta}(\tau, x)$ is given in terms of the kernel $\tilde{\mathbb{K}}_m(x_1, x_2) = \tilde{\mathbb{K}}_m^{\text{ext}}(0, x_1; 0, x_2)$ of the same point process $\tilde{\eta}(x)$ at $\tau = 0$ by the formula*

$$(5.6) \quad \begin{aligned} \tilde{\mathbb{K}}_m^{\text{ext}}(t_1, x_1; t_2, x_2) &= -\mathbb{1}_{[t_2 < t_1]}(e^{(t_2 - t_1)\mathcal{H}})(x_1, x_2) \\ &\quad + (e^{-t_1\mathcal{H}}\tilde{\mathbb{K}}_m e^{t_2\mathcal{H}})(x_1, x_2), \end{aligned}$$

where the infinitesimal generator \mathcal{H} of the single random walk, the discrete Laplacian, acts on functions f as

$$(5.7) \quad \mathcal{H}f(x) = f(x+1) + f(x-1) - 2f(x), \quad x \in \mathbb{Z}.$$

Comparing the first term of (5.4) and (5.6), one sees a different ordering in the times. This is consequence of the dual transformation.

PROOF OF LEMMA 5.2. The operator \mathcal{H} in (5.7) is the generator of the continuous time process defined by the transition probability $p_t(x, y)$, in (2.1). Indeed, one checks that this transition probability is given by [the reader is reminded of the notation following formula (2.9)]

$$(5.8) \quad \begin{aligned} p_t(x, y) &= e^{-2t} I_{|x-y|}(2t) = \frac{1}{2\pi i} \oint_{\Gamma_0} dz \frac{e^{t(z+z^{-1}-2)}}{z^{x-y+1}} \\ &= e^{t\mathcal{H}}\mathbb{1}(x, y) = (e^{t\mathcal{H}})(x, y), \end{aligned}$$

because

$$(5.9) \quad \begin{aligned} \frac{\partial}{\partial t} p_t(x, y) &= \frac{1}{2\pi i} \oint_{\Gamma_0} \frac{dz}{z^{x-y+1}} (z + z^{-1} - 2) e^{t(z+z^{-1}-2)} \\ &= p_t(x-1, y) + p_t(x+1, y) - 2p_t(x, y) \\ &= (\mathcal{H}p_t)(x, y) \end{aligned}$$

with initial conditions $p_0(x, y) = \mathbb{1}(x, y)$. Here, $\mathbb{1}$ denotes the identity operator on \mathbb{Z} , that is, $\mathbb{1}(x, y) = 1$ if $x = y$ and $\mathbb{1}(x, y) = 0$ if $x \neq y$. The one-point kernel in Section 3, formula (3.38), was written as a sum involving $\psi_k(x)$ and $\psi_k(y)$. Under the time flow, they will become different functions; therefore, we set $\Psi_k(0, x) = \Phi_k(0, x) = \psi_k(x)$, and thus, with this new notation, the kernel reads

$$(5.10) \quad \mathbb{K}_m(x_1, x_2) = \sum_{k=1}^n \psi_k(x_1)\psi_k(x_2) = \sum_{k=1}^n \Psi_k(0, x_1)\Phi_k(0, x_2).$$

The two set of functions $\{\Phi_k(0, x), k = 1, \dots, n\}$ and $\{\Psi_k(0, x), k = 1, \dots, n\}$ satisfy

$$(5.11) \quad \begin{aligned} \text{span}\{\Phi_k(0, x), k = 1, \dots, n\} &= \text{span}\{p_t(m+1-k, x), k = 1, \dots, n\}, \\ \text{span}\{\Psi_k(0, x), k = 1, \dots, n\} &= \text{span}\{p_t(x, m+1-k), k = 1, \dots, n\} \\ &\text{with } \langle \Phi_k(0, x), \Psi_p(0, x) \rangle = \delta_{k,p}, \end{aligned}$$

so that the matrix B defined in (5.4) becomes the identity matrix.

Let us consider the functions of Theorem 5.1. First of all, the function $\phi(t_1, x_1; t_2, x_2)$ appearing in (5.4) becomes

$$(5.12) \quad \begin{aligned} \phi(t_1, x_1; t_2, x_2)\mathbb{1}_{[t_2 > t_1]} &= \mathbb{1}_{[t_2 > t_1]}p_{t_2-t_1}(x_1, x_2) \\ &= \mathbb{1}_{[t_2 > t_1]}(e^{(t_2-t_1)\mathcal{H}})(x_1, x_2), \end{aligned}$$

where $t_1, t_2 \in \{\tau_1, \dots, \tau_p\}$. Next, with $\tau_0 = -t$, $\tau_{p+1} = t$ we have

$$(5.13) \quad \phi(t_1, x; t, b_k) = p_{t-t_1}(x, b_k) = (e^{-t_1\mathcal{H}})(x, \cdot) * \phi(0, \cdot; t, b_k)$$

and

$$(5.14) \quad \phi(-t, a_k; t_2, x) = p_{t_2+t}(a_k, x) = \phi(-t, a_k; 0, \cdot) * (e^{t_2\mathcal{H}})(\cdot, x).$$

With the choice of basis used for the kernel at $\tau = 0$, we have that $\phi(0, \cdot; t, b_k)$ is replaced by $\Psi_k(0, \cdot)$ and $\phi(-t, a_k; 0, \cdot)$ by $\Phi_k(0, \cdot)$ (so that $B = \mathbb{1}$). Thus in Theorem 5.1 we have replaced

$$(5.15) \quad \begin{aligned} \phi(t_1, x; t, b_k) &\rightarrow (e^{-t_1\mathcal{H}})(x, \cdot) * \Psi_k(0, \cdot) \\ &= (e^{-t_1\mathcal{H}}\Psi_k(0, \cdot))(x) =: \Psi_k(t_1, x) \end{aligned}$$

and

$$(5.16) \quad \begin{aligned} \phi(-t, a_k; t_2, x) &\rightarrow \Phi_k(0, \cdot) * (e^{t_2\mathcal{H}})(\cdot, x) = (\Phi_k(0, \cdot)e^{t_2\mathcal{H}})(x) \\ &= (e^{t_2\mathcal{H}\top}\Phi_k(0, \cdot))(x) =: \Phi_k(t_2, x). \end{aligned}$$

Therefore the extended kernel has the following expression in terms of the kernel \mathbb{K}_m in (3.38):

$$\begin{aligned} \mathbb{K}_m^{\text{ext}}(t_1, x_1; t_2, x_2) &= -\mathbb{1}_{[t_1 < t_2]} p_{t_2-t_1}(x_1, x_2) + \sum_{k=1}^n \Psi_k(t_1, x_1) \Phi_k(t_2, x_2) \\ (5.17) \qquad \qquad \qquad &= -\mathbb{1}_{[t_1 < t_2]} (e^{(t_2-t_1)\mathcal{H}})(x_1, x_2) + (e^{-t_1\mathcal{H}} \mathbb{K}_m e^{t_2\mathcal{H}})(x_1, x_2). \end{aligned}$$

Notice that, using the semi-group property of $e^{t\mathcal{H}}$, we have the consistency relations (for $i = 1, \dots, p$)

$$\begin{aligned} \Psi_k(\tau_i, x) &= (e^{(\tau_p-\tau_i)\mathcal{H}} \Psi_k(\tau_p, \cdot))(x), \\ (5.18) \qquad \qquad \qquad \Phi_k(\tau_i, x) &= (\Phi_k(\tau_1, \cdot) e^{(\tau_i-\tau_1)\mathcal{H}})(x). \end{aligned}$$

The kernel $\tilde{\mathbb{K}}_m^{\text{ext}}$ for the dual random walk is then given by taking the complement. Using (5.17) and remembering that $\tilde{\mathbb{K}}_m = \mathbb{1} - \mathbb{K}_m$ from formula (3.10), we get

$$\begin{aligned} \tilde{\mathbb{K}}_m^{\text{ext}}(t_1, x_1; t_2, x_2) &= \mathbb{1}_{[t_1=t_2]} \mathbb{1}(x_1, x_2) - \mathbb{K}_m^{\text{ext}}(t_1, x_1; t_2, x_2) \\ &= \mathbb{1}_{[t_1=t_2]} \mathbb{1}(x_1, x_2) + \mathbb{1}_{[t_1 < t_2]} (e^{(t_2-t_1)\mathcal{H}})(x_1, x_2) \\ (5.19) \qquad \qquad \qquad &\quad - (e^{-t_1\mathcal{H}} \mathbb{K}_m e^{t_2\mathcal{H}})(x_1, x_2) \\ &= \mathbb{1}_{[t_1=t_2]} (e^{(t_2-t_1)\mathcal{H}})(x_1, x_2) + \mathbb{1}_{[t_1 < t_2]} (e^{(t_2-t_1)\mathcal{H}})(x_1, x_2) \\ &\quad - (e^{(t_2-t_1)\mathcal{H}})(x_1, x_2) + (e^{-t_1\mathcal{H}} (\mathbb{1} - \mathbb{K}_m) e^{t_2\mathcal{H}})(x_1, x_2) \\ &= -\mathbb{1}_{[t_2 < t_1]} (e^{(t_2-t_1)\mathcal{H}})(x_1, x_2) + (e^{-t_1\mathcal{H}} \tilde{\mathbb{K}}_m e^{t_2\mathcal{H}})(x_1, x_2), \end{aligned}$$

yielding (5.6), completing the proof of Lemma 5.2. \square

With the help of Lemma 5.2, we can easily prove Theorem 2.1, starting from Theorem 3.1.

PROOF OF THEOREM 2.1. One of the key ingredients is that $f(x) := u^x$ is an eigenfunction of \mathcal{H} with eigenvalue $u + u^{-1} - 2$. Indeed,

$$\begin{aligned} (\mathcal{H}f)(x) &= u^{x+1} + u^{x-1} - 2u^x = (u + u^{-1} - 2)u^x \\ (5.20) \qquad \qquad \qquad &= (u + u^{-1} - 2)f(x). \end{aligned}$$

Moreover, \mathcal{H} is symmetric. Therefore,

$$\begin{aligned} (e^{t\mathcal{H}}f)(x) &= e^{t(u+u^{-1}-2)}f(x), \\ (5.21) \qquad \qquad \qquad (f e^{t\mathcal{H}})(x) &= (e^{t\mathcal{H}^\top}f)(x) = e^{t(u+u^{-1}-2)}f(x). \end{aligned}$$

Then, (2.5) follows straightforwardly from (3.13) by applying $e^{-t_1\mathcal{H}}$ to the left, $e^{t_2\mathcal{H}}$ to the right of \mathbb{K}_m [together with (5.8) for the first term of (5.6)].
 \square

For the further analysis, we extend the reformulation of the kernel for $\tau = 0$, as in Proposition 4.1, to the extended case. For that purpose, we first define the basic functions replacing A , B , and C of the one-time case (see Proposition 4.4). To do so, define a new function $J_x^{(\tau)}(2t)$ dependent on a parameter τ

$$(5.22) \quad \begin{aligned} J_x^{(\tau)}(2t) &:= \oint_{\Gamma_0} \frac{dz}{2\pi iz} \frac{e^{t(z-z^{-1})}}{z^x} e^{\tau(z+z^{-1}-2)} \\ &= e^{-2\tau} \left(\frac{t+\tau}{t-\tau} \right)^{x/2} J_x(2\sqrt{t^2-\tau^2}). \end{aligned}$$

Also define a τ -dependent extension of the kernel $K(0)_{k,\ell}$, as in (4.24), namely

$$(5.23) \quad K^{(\tau)}(0)_{k,\ell} := \sum_{a \geq 0} J_{a+k+1}^{(\tau)}(4t) J_{a+\ell+1}(4t).$$

Then define new functions $A(\tau, x), B(\tau, x), C(\tau, x)$ with $\tau \in \mathbb{R}$ and $x \in \mathbb{Z}$, which extend the functions $A(x), B(x), C(x)$, first defined in (4.11) and re-expressed in (4.32), by

$$(5.24) \quad \begin{aligned} A(\tau, x) &:= J_{m+1-x}^{(\tau)}(2t) + \sum_{k \geq n} \sum_{a \geq 0} Q_k J_{k+1+a}(4t) J_{m+1+a-x}^{(\tau)}(2t), \\ B(\tau, x) &:= \sum_{k \geq n} Q_k J_{k-m+x}^{(\tau)}(2t), \\ C(\tau, x) &:= \sum_{k \geq n} Q_k (J_{k+1+x}^{(\tau)}(4t) + J_{k+1-x}^{(\tau)}(4t)) \\ &\quad + \sum_{k, \ell \geq n} Q_k Q_\ell (K^{(\tau)}(0)_{k+x, \ell} + K^{(\tau)}(0)_{k-x, \ell}). \end{aligned}$$

Remember $H_n(0) = \det(\mathbb{1} - K(0))_{\ell^2(n, n+1, \dots)}$.

LEMMA 5.3. *Given the notation (4.12) for the E_i 's, the extended kernel $\tilde{\mathbb{K}}_m^{\text{ext}}$ is given by*

$$\frac{(-1)^{x_2} e^{4t_2}}{(-1)^{x_1} e^{4t_1}} \frac{H_{n+1}(0)}{H_n(0)} \tilde{\mathbb{K}}_m^{\text{ext}}(t_1, x_1; t_2, x_2)$$

$$\begin{aligned}
(5.25) \quad &= -\mathbb{1}_{[t_2 < t_1]} p_{t_1 - t_2}(x_1, x_2) \frac{H_{n+1}(0)}{H_n(0)} + C(t_1 - t_2, x_1 - x_2) \\
&+ \frac{1}{(2\pi i)^2} \oint_{\Gamma_0} dz \oint_{\Gamma_{0,z}} dw \frac{1}{z-w} \sum_{i=1}^4 E_i(z, w) \\
&\times \left(\frac{(-w)^{x_2-1}}{(-z)^{x_1}} \frac{e^{-t_1(z+z^{-1}+2)}}{e^{-t_2(w+w^{-1}+2)}} + \frac{(-z)^{x_2}}{(-w)^{x_1+1}} \frac{e^{-t_1(w+w^{-1}+2)}}{e^{-t_2(z+z^{-1}+2)}} \right).
\end{aligned}$$

THEOREM 5.4. *The extended kernel $\tilde{\mathbb{K}}_m^{\text{ext}}$ is also expressed as*

$$\begin{aligned}
(5.26) \quad &\frac{(-1)^{x_2} e^{4t_2}}{(-1)^{x_1} e^{4t_1}} \frac{H_{n+1}(0)}{H_n(0)} \tilde{\mathbb{K}}_m^{\text{ext}}(t_1, x_1; t_2, x_2) \\
&= -\mathbb{1}_{[t_2 < t_1]} p_{t_1 - t_2}(x_1, x_2) \frac{H_{n+1}(0)}{H_n(0)} + C(t_1 - t_2, x_1 - x_2) \\
&+ \sum_{c \geq 0} (A(t_1, x_1 - c)A(-t_2, x_2 - c) + A(t_1, -x_1 - c)A(-t_2, -x_2 - c) \\
&\quad - A(t_1, x_1 - c)B(-t_2, x_2 - c) - A(t_1, -x_1 - c)B(-t_2, -x_2 - c) \\
&\quad - B(t_1, x_1 - c)A(-t_2, x_2 - c) - B(t_1, -x_1 - c)A(-t_2, -x_2 - c)) \\
&- \sum_{c < 0} (B(t_1, x_1 - c)B(-t_2, x_2 - c) + B(t_1, -x_1 - c)B(-t_2, -x_2 - c)).
\end{aligned}$$

PROOFS OF LEMMA 5.3 AND THEOREM 5.4. First of all, let us focus on the term $(e^{(t_2-t_1)\mathcal{H}})(x_1, x_2)$ in (5.6). Remember that $t_2 - t_1 < 0$, so we can rewrite

$$\begin{aligned}
(5.27) \quad &\frac{(-1)^{x_2} e^{4t_2}}{(-1)^{x_1} e^{4t_1}} (e^{(t_2-t_1)\mathcal{H}})(x_1, x_2) = \frac{(-1)^{x_2} e^{2t_2}}{(-1)^{x_1} e^{2t_1}} I_{|x_1-x_2|}(2(t_2-t_1)) \\
&= \frac{e^{2t_2}}{e^{2t_1}} I_{|x_1-x_2|}(2(t_1-t_2)) \\
&= p_{t_1-t_2}(x_1, x_2),
\end{aligned}$$

where we used the property $I_n(-2t) = (-1)^n I_n(2t)$ of the modified Bessel function; see (3.4).

Next we derive the double integrals in (5.25). The corresponding expression of the kernel $\tilde{\mathbb{K}}_m$ in (4.13) is a linear combination [not forgetting the conjugation factor of the left-hand side of (4.13)] of

$$(5.28) \quad -\frac{w^{x_2-1}}{z^{x_1}} - \frac{z^{x_2}}{w^{x_1+1}}.$$

Applying $e^{-t_1\mathcal{H}}$ to the left and $e^{t_2\mathcal{H}}$ to the right, (5.28) transforms into

$$(5.29) \quad -\frac{w^{x_2-1}}{z^{x_1}} \frac{e^{-t_1(z+z^{-1}-2)}}{e^{-t_2(w+w^{-1}-2)}} - \frac{z^{x_2}}{w^{x_1+1}} \frac{e^{-t_1(w+w^{-1}-2)}}{e^{-t_2(z+z^{-1}-2)}}.$$

The multiplication by the prefactor $\frac{(-1)^{x_2} e^{4t_2}}{(-1)^{x_1} e^{4t_1}}$ leads then to the expression in (5.25).

Next derive the terms with the sums in (5.26) and the expression for C . We act with the semigroup on the summation part of the kernel (4.14), which is expressed in terms of $A(x), B(x), C(x)$, namely

$$(5.30) \quad \frac{H_{n+1}(0)}{H_n(0)} \tilde{\mathbb{K}}_m(x_1, x_2) = \sum_{c \geq 0} [(-1)^{x_1} A(x_1 - c)][(-1)^{x_2} A(x_2 - c)] + \cdots \\ + (-1)^{x_1 - x_2} C(x_1 - x_2)$$

with $A(x), B(x), C(x)$ given in Proposition 4.4. So, except for the term $C(x_1 - x_2)$, the expression above is a sum of decoupled terms. Therefore acting on the $(-1)^x A(\pm x - c)$'s and $(-1)^x B(\pm x - c)$'s with $e^{-t_1\mathcal{H}}$ to the left amounts (by linearity) to acting on the $(-1)^x J_{N \pm x}(2t)$ (for some N depending on the terms) and finally to acting on $1/(-z)^{\pm x}$ inside the integration. More precisely, by (5.21) with $f(x) := 1/(-z)^{\pm x}$, we have

$$(5.31) \quad (e^{-t_1\mathcal{H}} f)(x) = e^{t_1(z+z^{-1}+2)} f(x) \quad \text{and} \\ (f e^{t_2\mathcal{H}})(x) = e^{-t_2(z+z^{-1}+2)} f(x),$$

from which, by linearity,

$$(5.32) \quad \sum_{y \in \mathbb{Z}} (e^{-t_1\mathcal{H}})(x, y) (-1)^y J_{N \pm y}(2t) = \oint_{\Gamma_0} \frac{dz}{2\pi iz} \frac{e^{t(z-z^{-1})}}{z^N} (e^{-t_1\mathcal{H}} f)(x) \\ = \oint_{\Gamma_0} \frac{dz}{2\pi iz} \frac{e^{t(z-z^{-1})}}{z^N (-z)^{\pm x}} e^{t_1(z+z^{-1}+2)} \\ = (-1)^x e^{4t_1} J_{N \pm x}^{(t_1)}(2t)$$

and

$$(5.33) \quad \sum_{y \in \mathbb{Z}} (-1)^y J_{N \pm y}(2t) (e^{t_2\mathcal{H}})(y, x) = (-1)^x e^{-4t_2} J_{N \pm x}^{(-t_2)}(2t).$$

This extends to the functions $(-1)^x A(\pm x - c)$, $(-1)^x B(\pm x - c)$ because they are linear in the $(-1)^x J_{N \pm x}(2t)$ [see (4.32)]. Explicitly, applying $e^{-t_1\mathcal{H}}$ (to the left) to $(-1)^x A(\pm x - c)$ amounts to replacing $A(\pm x - c)$ with $e^{4t_1} A(t_1, \pm x - c)$. Similarly, applying $e^{t_2\mathcal{H}}$ (to the right) to $(-1)^x A(\pm x - c)$ amounts to replacing $A(\pm x - c)$ with $e^{-4t_2} A(-t_2, \pm x - c)$. The same holds for B

instead of A . Thus we have obtained the terms in kernel (5.26) including A 's and B 's.

Exactly the same procedure applies for the term $(-1)^{x_1-x_2}C(x_1-x_2)$, because it is again a linear combination of $(-1)^{x_1-x_2}J_{N\pm x_1\mp x_2}(4t)$. Therefore acting with $e^{-t_1\mathcal{H}}$ and $e^{t_2\mathcal{H}}$ as before on $(-1)^{x_1-x_2}C(x_1-x_2)$ leads to the replacement of $C(x_1-x_2)$ by $e^{4(t_1-t_2)}C(t_1-t_2, x_1-x_2)$. This completes the proof of formulas (5.25) and (5.26) for the extended kernel, thus establishing Lemma 5.3 and Theorem 5.4. \square

6. Asymptotics. In this section we prove the first half of Theorem 2.2, namely formula (2.20). From the discussion in Section 2 after Theorem 2.1, concerning the interaction between the top and bottom sets of random walks, we rescale space, time and the gap $n = 2m + 1$ between the two groups of walkers, as follows:

$$(6.1) \quad m = 2t + \sigma t^{1/3}, \quad x_i = \xi_i t^{1/3}, \quad t_i = s_i t^{2/3}, \quad i = 1, 2,$$

where $\sigma \in \mathbb{R}$ is a fixed parameter modulating the “strength of interaction” between the upper and lower sets of walks. To prove formula (2.20) of Theorem 2.2, we first analyze the asymptotics of the building blocks and determine some bounds which will be used later to show that we can exchange (by dominated convergence) the large time limit with the integrals (sums).

Recall from (5.22), (2.13) and (5.23) the functions $J_x^{(\tau)}(2t)$ and \mathcal{Q} , and the kernel $K^{(\tau)}(0)_{k,\ell}$,

$$J_x^{(\tau)}(2t) = e^{-2\tau} \left(\frac{t+\tau}{t-\tau} \right)^{x/2} J_x(2\sqrt{t^2-\tau^2}),$$

$$(6.2) \quad K^{(\tau)}(0)_{k,\ell} = \sum_{a \geq 0} J_{a+k+1}^{(\tau)}(4t) J_{a+\ell+1}(4t),$$

$$\mathcal{Q}(\kappa) = [(\mathbb{1} - \chi_{\tilde{\sigma}} K_{\text{Ai}} \chi_{\tilde{\sigma}})^{-1} \chi_{\tilde{\sigma}} \text{Ai}](\kappa) \quad \text{with } \tilde{\sigma} := 2^{2/3}\sigma,$$

and where $\chi_a(x) = \mathbb{1}_{[x>a]}$. Remember from (2.14) the definition of

$$(6.3) \quad \text{Ai}^{(s)}(\xi) := e^{\xi s + (2/3)s^3} \text{Ai}(\xi + s^2)$$

and define the Airy-like kernel

$$(6.4) \quad K_{\text{Ai}}^{(s)}(\kappa, \lambda) := \int_0^\infty d\gamma \text{Ai}^{(s2^{-2/3})}(\kappa + \gamma) \text{Ai}(\lambda + \gamma).$$

Also define the following step functions of $\kappa, \lambda \in \mathbb{R}$, for which—by anticipation—we indicate the limits for $t \rightarrow \infty$:

$$\mathcal{J}_t^{(s)}(\kappa) := t^{1/3} J_{[2t+\kappa t^{1/3}+1]}^{(st^{2/3})}(2t) \rightarrow \text{Ai}^{(s)}(\kappa),$$

$$\begin{aligned}
\mathcal{K}_t^{(s)}(\kappa, \lambda) &:= (2t)^{1/3} K^{(st^{2/3})}(0)_{[4t+\kappa(2t)^{1/3}], [4t+\lambda(2t)^{1/3}]} \rightarrow K_{\text{Ai}}^{(s)}(\kappa, \lambda), \\
(6.5) \quad \mathcal{Q}_t(\kappa) &:= (2t)^{1/3} Q_{[4t+\kappa(2t)^{1/3}]} \\
&= [(\mathbb{1} - \chi_{(n-4t)/(2t)^{1/3}} \mathcal{K}_t^{(0)} \chi_{(n-4t)/(2t)^{1/3}})^{-1} \chi_{(n-4t)/(2t)^{1/3}} \mathcal{J}_{2t}^{(0)}](\kappa) \\
&\rightarrow \mathcal{Q}(\kappa).
\end{aligned}$$

LEMMA 6.1. *We have the following bounds and limits for $\mathcal{J}_t^{(s)}$ and $\mathcal{K}_t^{(s)}$ defined in (6.5). There exists a $t_0 > 0$ such that uniformly for $t \geq t_0$ it holds that*

$$(6.6) \quad |\mathcal{J}_t^{(s)}(\kappa)| \leq c_1 \min\{1, e^{-\theta\kappa}\}, \quad |\mathcal{K}_t^{(s)}(\kappa, \lambda)| \leq c_2 e^{-\theta(\kappa+\lambda)}$$

for any fixed $\theta > 0$ and some constants $c_1, c_2 > 0$ (independent of t). Moreover

$$(6.7) \quad \lim_{t \rightarrow \infty} \mathcal{J}_t^{(s)}(\kappa) = \text{Ai}^{(s)}(\kappa), \quad \lim_{t \rightarrow \infty} \mathcal{K}_t^{(s)}(\kappa, \lambda) = K_{\text{Ai}}^{(s)}(\kappa, \lambda)$$

uniformly for κ, λ , and s in a bounded set.

PROOF. We have

$$\begin{aligned}
\mathcal{J}_t^{(s)}(\xi) &= t^{1/3} J_{[2t+\xi t^{1/3}]}^{(st^{2/3})}(2t) \\
(6.8) \quad &= e^{-2st^{2/3}} \left(\frac{1 + st^{-1/3}}{1 - st^{-1/3}} \right)^{(1/2)[2t+\xi t^{1/3}]} \\
&\quad \times t^{1/3} J_{[2t+\xi t^{1/3}]}(2t \sqrt{1 - s^2 t^{-2/3}}).
\end{aligned}$$

The prefactor can be estimated for $t \rightarrow \infty$, as follows:

$$(6.9) \quad e^{-2st^{2/3}} \left(\frac{1 + st^{-1/3}}{1 - st^{-1/3}} \right)^{t+(1/2)\xi t^{1/3}} = e^{\xi s + (2/3)s^3} (1 + \mathcal{O}(t^{-1/3})),$$

where the $\mathcal{O}(t^{-1/3})$ is uniform for s in a bounded set and independent of ξ . Therefore, for t large enough, |(6.9)| $\leq \exp(2|\xi s| + |s^3|)$. Concerning the remaining part of (6.8), using (A.4), one readily obtains

$$(6.10) \quad \lim_{t \rightarrow \infty} t^{1/3} J_{[2t+\xi t^{1/3}]}(2t \sqrt{1 - s^2 t^{-2/3}}) = \text{Ai}(\xi + s^2).$$

Regarding the bound, for s in a bounded set, if t is large enough it follows from bound (A.6) that

$$(6.11) \quad |t^{1/3} J_{[2t+\xi t^{1/3}]}(2t \sqrt{1 - s^2 t^{-2/3}})|$$

is first of all uniformly bounded and for large ξ it decays as $e^{-\beta\xi}$ for any choice of $\beta > 0$. The statements in the first parts of (6.6) and (6.7) then

follow if we choose β satisfying $\beta \geq \theta + 2|s|$ for any s in the given bounded set.

To compute the limit of $\mathcal{K}_t^{(s)}$, one uses definition (6.5) and formula (6.2) for $K^{(st^{2/3})}(0)$, but with J replaced by \mathcal{J} in the last equality below,

$$\begin{aligned}
(6.12) \quad \mathcal{K}_t^{(s)}(\kappa, \lambda) &= (2t)^{1/3} K^{(st^{2/3})}(0)_{[4t+\kappa(2t)^{1/3}], [4t+\lambda(2t)^{1/3}]} \\
&= (2t)^{1/3} \sum_{\gamma \in (2t)^{-1/3}\mathbb{N}} J_{[4t+(\gamma+\kappa)(2t)^{1/3}]}^{(s2^{-2/3}(2t)^{2/3})}(4t) J_{[4t+(\gamma+\lambda)(2t)^{1/3}]}(4t) \\
&= \frac{1}{(2t)^{1/3}} \sum_{\gamma \in (2t)^{-1/3}\mathbb{N}} \mathcal{J}_{2t}^{(s2^{-2/3})}(\kappa + \gamma) \mathcal{J}_{2t}^{(0)}(\lambda + \gamma).
\end{aligned}$$

From this, using bound (6.6) on \mathcal{J} , we obtain

$$(6.13) \quad |\mathcal{K}_t^{(s)}(\kappa, \lambda)| \leq c_1^2 e^{-\theta(\kappa+\lambda)} \frac{1}{(2t)^{1/3}} \sum_{\gamma \in (2t)^{-1/3}\mathbb{N}} e^{-2\theta\gamma} \leq c_2 e^{-\theta(\kappa+\lambda)}$$

for $t \geq t_0 = 1$ and some $c_2 > 0$, uniformly for s in a bounded set.

We can think of the sum in (6.12) as an integral of piece-wise constant functions. The first bound in (6.6) allows us to use dominated convergence to exchange the limit and the integral. Then, $\lim_{t \rightarrow \infty} \mathcal{J}_t^{(s)}(\kappa) = \text{Ai}^{(s)}(\kappa)$ yields

$$(6.14) \quad \lim_{t \rightarrow \infty} \mathcal{K}_t^{(s)}(\kappa, \lambda) = \int_0^\infty d\gamma \text{Ai}^{(2^{-2/3}s)}(\kappa + \gamma) \text{Ai}(\lambda + \gamma) = K_{\text{Ai}}^{(s)}(\kappa, \lambda). \quad \square$$

LEMMA 6.2. *Set $\tilde{\sigma}_t := \frac{n-4t}{(2t)^{1/3}}$ and define the operator $\mathcal{M}_t = \chi_{\tilde{\sigma}_t} \mathcal{K}_t^{(0)} \chi_{\tilde{\sigma}_t}$, appearing in the definition (6.5) of \mathcal{Q}_t . Then, uniformly for $t \geq t_0$, we have for the operator-norm¹⁴ $\|\cdot\|$,*

$$(6.15) \quad \|\mathcal{M}_t\| < 1,$$

which implies that

$$(6.16) \quad \|(\mathbb{1} - \mathcal{M}_t)^{-1}\| \leq (1 - \|\mathcal{M}_t\|)^{-1} \leq C < \infty$$

for some finite constant C independent of t .

PROOF. By Lemma 6.1 and the fact that $\tilde{\sigma}_t \rightarrow \tilde{\sigma}$ as $t \rightarrow \infty$, it follows that

$$(6.17) \quad \lim_{t \rightarrow \infty} \mathcal{M}_t = \chi_{\tilde{\sigma}} K_{\text{Ai}} \chi_{\tilde{\sigma}} =: \mathcal{M}$$

¹⁴Where $\|A\| = \sup_{|f| \leq 1} |Af|$.

pointwise. Moreover,

$$\begin{aligned}
(6.18) \quad & \lim_{t \rightarrow \infty} \|\mathcal{M}_t - \mathcal{M}\|^2 \leq \lim_{t \rightarrow \infty} \|\mathcal{M}_t - \mathcal{M}\|_{\text{HS}}^2 \\
& = \lim_{t \rightarrow \infty} \int d\kappa d\lambda |\mathcal{M}_t(\kappa, \lambda) - \mathcal{M}(\kappa, \lambda)|^2 \\
& = \int d\kappa d\lambda \lim_{t \rightarrow \infty} |\mathcal{M}_t(\kappa, \lambda) - \mathcal{M}(\kappa, \lambda)|^2 = 0,
\end{aligned}$$

where we use by Lemma 6.1 dominated convergence to exchange the limit and the integral together with (6.17). It is known that $\lambda_{\max} = \|\mathcal{M}\| < 1$ for any fixed $\tilde{\sigma}$ (see, e.g., [48]). This, together with (6.18), implies that

$$(6.19) \quad \|\mathcal{M}_t\| \leq \|\mathcal{M}\| + \|\mathcal{M}_t - \mathcal{M}\| < 1$$

for t large enough. \square

LEMMA 6.3. *Consider \mathcal{Q}_t as defined in (6.5). There exists a $t_0 > 0$ such that, uniformly for $t \geq t_0$, it holds*

$$(6.20) \quad |\mathcal{Q}_t(\kappa)| \leq c_3 e^{-\theta\kappa}$$

for any $\theta > 0$ and some constant $c_3 > 0$ (independent of t). Moreover,

$$(6.21) \quad \lim_{t \rightarrow \infty} \mathcal{Q}_t(\kappa) = \mathcal{Q}(\kappa)$$

uniformly for κ in a bounded set.

PROOF. For the sake of this proof, set $\mathcal{J}_t := \mathcal{J}_t^{(0)}$ and $\mathcal{K}_t := \mathcal{K}_t^{(0)}$. First of all we prove that $\mathcal{Q}_t(\kappa)$ is uniformly bounded for $t \geq t_0$. Recall that $\mathcal{Q}_t(\kappa) = [(\mathbb{1} - \mathcal{M}_t)^{-1} \chi_{\tilde{\sigma}_t} \mathcal{J}_{2t}](\kappa)$. Since $(\mathbb{1} - \mathcal{M}_t)^{-1}$ exists, we can use the identity

$$(6.22) \quad (\mathbb{1} - \mathcal{M}_t)^{-1} = \mathbb{1} + \chi_{\tilde{\sigma}_t} \mathcal{K}_t \chi_{\tilde{\sigma}_t} (\mathbb{1} - \mathcal{M}_t)^{-1},$$

which upon integrating from $\tilde{\sigma}$ to ∞ against the function \mathcal{J}_{2t} gives

$$(6.23) \quad \mathcal{Q}_t(\kappa) = \chi_{\tilde{\sigma}_t} \mathcal{J}_{2t}(\kappa) + \int_{\tilde{\sigma}_t}^{\infty} d\lambda \mathcal{K}_t(\kappa, \lambda) [(\mathbb{1} - \mathcal{M}_t)^{-1} \chi_{\tilde{\sigma}_t} \mathcal{J}_{2t}](\lambda).$$

Thus,

$$(6.24) \quad |\mathcal{Q}_t(\kappa)| \leq |\chi_{\tilde{\sigma}_t} \mathcal{J}_{2t}(\kappa)| + \int_{\tilde{\sigma}_t}^{\infty} d\lambda |\mathcal{K}_t(\kappa, \lambda)| |[(\mathbb{1} - \mathcal{M}_t)^{-1} \chi_{\tilde{\sigma}_t} \mathcal{J}_{2t}](\lambda)|.$$

But

$$(6.25) \quad |[(\mathbb{1} - \mathcal{M}_t)^{-1} \chi_{\tilde{\sigma}_t} \mathcal{J}_{2t}](\lambda)| \leq \|(\mathbb{1} - \mathcal{M}_t)^{-1}\| \|\mathcal{J}_{2t}\|_{\infty}$$

is uniformly bounded for $t \geq t_0$ (by Lemmas 6.1 and 6.2). Then, using the bound for \mathcal{K}_t and $\mathcal{J}_t^{(s)}(\kappa)$ in (6.6) we obtain the bound (6.20).

To prove (6.21), we show that

$$(6.26) \quad |\mathcal{Q}_t - \mathcal{Q}|_\infty = \sup_{\kappa} |\mathcal{Q}_t(\kappa) - \mathcal{Q}(\kappa)| \rightarrow 0$$

as $t \rightarrow \infty$. We have

$$(6.27) \quad \begin{aligned} |\mathcal{Q}_t - \mathcal{Q}|_\infty &= |(\mathbb{1} - \mathcal{M}_t)^{-1} \chi_{\tilde{\sigma}_t} \mathcal{J}_{2t} - (\mathbb{1} - \mathcal{M})^{-1} \chi_{\tilde{\sigma}} \text{Ai}|_\infty \\ &\leq |[(\mathbb{1} - \mathcal{M}_t)^{-1} - (\mathbb{1} - \mathcal{M})^{-1}] \chi_{\tilde{\sigma}} \mathcal{J}_{2t}|_\infty \\ &\quad + |(\mathbb{1} - \mathcal{M})^{-1} [\chi_{\tilde{\sigma}} \mathcal{J}_{2t} - \chi_{\tilde{\sigma}} \text{Ai}]|_\infty + \mathcal{O}(t^{-1/3}), \end{aligned}$$

where the correction term $\mathcal{O}(t^{-1/3})$ comes from the fact that the difference between $\tilde{\sigma}_t$ and $\tilde{\sigma}$ is not larger than $(2t)^{-1/3}$. Then,

$$(6.28) \quad \begin{aligned} (6.27) &\leq \|(\mathbb{1} - \mathcal{M}_t)^{-1} - (\mathbb{1} - \mathcal{M})^{-1}\| |\chi_{\tilde{\sigma}} \mathcal{J}_{2t}|_\infty \\ &\quad + \|(\mathbb{1} - \mathcal{M})^{-1}\| |\chi_{\tilde{\sigma}} \mathcal{J}_{2t} - \chi_{\tilde{\sigma}} \text{Ai}|_\infty + \mathcal{O}(t^{-1/3}). \end{aligned}$$

The first term goes to zero as $t \rightarrow \infty$. Indeed, $|\chi_{\tilde{\sigma}} \mathcal{J}_{2t}|_\infty \leq C < \infty$ by Lemma 6.1, and, using the identity

$$(6.29) \quad (\mathbb{1} - \mathcal{M}_t)^{-1} - (\mathbb{1} - \mathcal{M})^{-1} = (\mathbb{1} - \mathcal{M}_t)^{-1} [\mathcal{M}_t - \mathcal{M}] (\mathbb{1} - \mathcal{M})^{-1}$$

together with the fact that $\|\mathcal{M}_t\| < 1$, $\|\mathcal{M}\| < 1$, and $\|\mathcal{M} - \mathcal{M}_t\| \rightarrow 0$ in the $t \rightarrow \infty$ limit [see Lemma 6.2 and (6.18)]; so one has $\|(\mathbb{1} - \mathcal{M}_t)^{-1} - (\mathbb{1} - \mathcal{M})^{-1}\| \rightarrow 0$. The second term goes to zero as well, since $\|(\mathbb{1} - \mathcal{M})^{-1}\|$ is bounded and, by Lemma 6.1, $|\chi_{\tilde{\sigma}} \mathcal{J}_{2t} - \chi_{\tilde{\sigma}} \text{Ai}|_\infty \rightarrow 0$. \square

PROOF OF THEOREM 2.2, FORMULA (2.20). We now define new functions $\mathcal{A}_t(s, \xi)$, $\mathcal{B}_t(s, \xi)$, $\mathcal{C}_t(s, \xi)$, which are rescaled versions of $A(\tau, x)$, $B(\tau, x)$, $C(\tau, x)$ [see formula (5.24)] under the scaling (6.1):

$$(6.30) \quad \begin{aligned} \mathcal{A}_t(s, \xi) &:= t^{1/3} A(st^{2/3}, \xi t^{1/3}), \\ \mathcal{B}_t(s, \xi) &:= t^{1/3} B(st^{2/3}, \xi t^{1/3}), \\ \mathcal{C}_t(s, \xi) &:= t^{1/3} C(st^{2/3}, \xi t^{1/3}). \end{aligned}$$

As $t \rightarrow \infty$, these functions will converge to $\mathcal{A}(s, \xi)$, $\mathcal{B}(s, \xi)$, $\mathcal{C}(s, \xi)$ of (2.15) and (2.16).

One then recognizes in these expressions functions (6.5), thus yielding

$$(6.31) \quad \begin{aligned} \mathcal{A}_t(s, \xi) &= \mathcal{J}_t^{(s)}(\sigma - \xi) \\ &\quad + \frac{1}{(2t)^{1/3}} \sum_{\kappa \in I_{n,t}} \frac{1}{(2t)^{1/3}} \sum_{\alpha \in (2t)^{-1/3} \mathbb{N}} \mathcal{Q}_t(\kappa) \mathcal{J}_{2t}^{(0)}(\kappa + \alpha) \\ &\quad \times \mathcal{J}_t^{(s)}(2^{1/3} \alpha + \sigma - \xi), \end{aligned}$$

$$\begin{aligned}
\mathcal{B}_t(s, \xi) &= \frac{1}{(2t)^{1/3}} \sum_{\kappa \in I_{n,t}} \mathcal{Q}_t(\kappa) \mathcal{J}_t^{(s)}(\xi - \sigma + 2^{1/3}\kappa - t^{-1/3}), \\
\mathcal{C}_t(s, \xi) &= \frac{2^{-1/3}}{(2t)^{1/3}} \sum_{\kappa \in I_{n,t}} \mathcal{Q}_t(\kappa) (\mathcal{J}_{2t}^{(2^{-2/3}s)}(\kappa - 2^{-1/3}\xi) \\
&\quad + \mathcal{J}_{2t}^{(2^{-2/3}s)}(\kappa + 2^{-1/3}\xi)) \\
&\quad + \frac{2^{-1/3}}{(2t)^{2/3}} \sum_{\kappa, \lambda \in I_{n,t}} \mathcal{Q}_t(\kappa) \mathcal{Q}_t(\lambda) (\mathcal{K}_t^{(s)}(\kappa - 2^{-1/3}\xi, \lambda) \\
&\quad + \mathcal{K}_t^{(s)}(\kappa + 2^{-1/3}\xi, \lambda)).
\end{aligned}$$

For instance, the function $J_{k+1+a}(4t)$ in $A(\tau, x)$ becomes, upon setting $a = \alpha(2t)^{1/3}$ and $\kappa := (2t)^{-1/3}(k - 4t)$,

$$(6.32) \quad J_{k+1+a}(4t) = J_{[4t+(\kappa+\alpha)(2t)^{1/3}+1]}(4t) = (2t)^{-1/3} \mathcal{J}_{2t}^{(0)}(\kappa + \alpha).$$

Notice that the sum over $k \geq n$ in the expressions (5.24) becomes a sum over $\kappa \in I_{n,t}$ with

$$(6.33) \quad I_{n,t} := (2t)^{-1/3}(\{n, n+1, \dots\} - 4t),$$

so that the condition $k \geq n = 2m+1 = 4t + 2\sigma t^{1/3} + 1$ translates into $\kappa = (2t)^{-1/3}(k - 4t) > 2^{2/3}\sigma = \tilde{\sigma}$. Setting the summation variable $c = \gamma t^{1/3}$, rewrite the kernel (5.26) in Theorem 5.4, with the scaling (6.1)

$$\begin{aligned}
&\frac{(-1)^{x_2} e^{4t_2}}{(-1)^{x_1} e^{4t_1}} \frac{H_{n+1}(0)}{H_n(0)} \tilde{\mathbb{K}}_m^{\text{ext}}(t_1, x_1; t_2, x_2) \\
&= -\mathbb{1}_{[s_1 > s_2]} \frac{H_{n+1}(0)}{H_n(0)} t^{1/3} p_{(s_1-s_2)t^{2/3}}(\xi_1 t^{1/3}, \xi_2 t^{1/3}) + \mathcal{C}_t(s_1 - s_2, \xi_1 - \xi_2) \\
&\quad + \frac{1}{t^{1/3}} \sum_{\gamma \in t^{-1/3}\mathbb{N}} (\mathcal{A}_t(s_1, \xi_1 - \gamma) \mathcal{A}_t(-s_2, \xi_2 - \gamma) \\
&\quad \quad + \mathcal{A}_t(s_1, -\xi_1 - \gamma) \mathcal{A}_t(-s_2, -\xi_2 - \gamma) \\
&\quad \quad - \mathcal{A}_t(s_1, \xi_1 - \gamma) \mathcal{B}_t(-s_2, \xi_2 - \gamma) \\
(6.34) \quad &\quad - \mathcal{A}_t(s_1, -\xi_1 - \gamma) \mathcal{B}_t(-s_2, -\xi_2 - \gamma) \\
&\quad \quad - \mathcal{B}_t(s_1, \xi_1 - \gamma) \mathcal{A}_t(-s_2, \xi_2 - \gamma) \\
&\quad \quad - \mathcal{B}_t(s_1, -\xi_1 - \gamma) \mathcal{A}_t(-s_2, -\xi_2 - \gamma)) \\
&\quad - \frac{1}{t^{1/3}} \sum_{\gamma \in t^{-1/3}\mathbb{Z}_-} (\mathcal{B}_t(s_1, \xi_1 - \gamma) \mathcal{B}_t(-s_2, \xi_2 - \gamma) \\
&\quad \quad + \mathcal{B}_t(s_1, -\xi_1 - \gamma) \mathcal{B}_t(-s_2, -\xi_2 - \gamma)).
\end{aligned}$$

In view of (2.10) we have $\lim_{t \rightarrow \infty} H_{n+1}(0)/H_n(0) = 1$ and in the $t \rightarrow \infty$ limit, $(n - 4t)/(2t)^{1/3} \rightarrow \tilde{\sigma}$. Notice that the sums with the preceding volume element, $1/t^{1/3}$ or $1/(2t)^{1/3}$ depending on the case, can be just thought of as integrals with the integrand being piece-wise constant. What follows holds uniformly in t for $t \geq t_0$ where t_0 is a fixed constant. The exponential bounds of Lemmas 6.1 and 6.3 imply that for any $\theta > 0$ there exists some $c > 0$ (the constant c depends on σ , which is, however, fixed)

$$(6.35) \quad |\mathcal{A}_t(s, -\xi)| \leq ce^{-\theta\xi} \quad \text{and} \quad \lim_{t \rightarrow \infty} \mathcal{A}_t(s, \xi) = \mathcal{A}(s, \xi).$$

Moreover $\mathcal{A}_t(s, \xi)$ tends to $\mathcal{A}(s, \xi)$ uniformly on bounded sets, by uniform convergence on bounded sets and dominated convergence of the integrand. Using the exponential bound of Lemma 6.3 and the fact that \mathcal{J}_t is just bounded, we obtain similarly

$$(6.36) \quad |\mathcal{B}_t(s, \xi)| \leq c \min\{1, e^{-\theta\xi}\} \quad \text{and} \quad \lim_{t \rightarrow \infty} \mathcal{B}_t(s, \xi) = \mathcal{B}(s, \xi).$$

Finally, the exponential bounds of Lemmas 6.1 and 6.3 imply that

$$(6.37) \quad |\mathcal{C}_t(s, \xi)| \leq c \quad \text{and} \quad \lim_{t \rightarrow \infty} \mathcal{C}_t(s, \xi) = \mathcal{C}(s, \xi),$$

where the last limit holds uniformly for ξ and s in bounded sets.

Using the bounds in (6.35), (6.36) and (6.37), one concludes that the integrands (summands) in (6.34) are uniformly bounded by functions which are integrable (summable). This is uniform for ξ, η and s in a bounded set. Then, by dominated convergence, we can take the limit inside, thus yielding (2.20). Finally, the Gaussian term in (2.20) comes from the known asymptotic (for $s > 0$),

$$(6.38) \quad \lim_{t \rightarrow \infty} t^{1/3} e^{-2st^{2/3}} I_{\xi t^{1/3}}(2st^{2/3}) = \frac{1}{\sqrt{4\pi s}} \exp(-\xi^2/(4s)),$$

which can be derived from a saddle point argument. \square

7. Integral representation of the Tacnode kernel. To derive the double integral representation (2.21) of Theorem 2.2 there are two ways. One can use the Airy functions integral representations (A.7) together with

$$(7.1) \quad \int_0^\infty d\lambda e^{-\lambda(u-v)} = \frac{1}{u-v} \quad \text{whenever } \Re(u-v) > 0.$$

This is quite straightforward, but it requires several computations which are not reported here.

The second is to do a steepest descent analysis starting from formula (5.25) in Lemma 2.1. Here we merely indicate a sketch of the saddle point argument (not a proof). The limits of the other terms have been discussed in the previous section. The main task here is to take the limit of this double

integral, when $t \rightarrow \infty$, with the scaling

$$(7.2) \quad \begin{aligned} n &= 2m + 1, & m &= 2t + \sigma t^{1/3}, \\ z &= -1 + \zeta t^{-1/3} & \text{and } w &= -1 + \omega t^{-1/3}, \\ x_i &= \xi_i t^{1/3} & \text{and } t_i &= s_i t^{2/3}, \quad i = 1, 2. \end{aligned}$$

Also recall the definitions (2.17) of the Laplace transforms $\hat{Q}(\zeta)$ and $\hat{P}(\zeta)$, as well as the function \mathcal{C} in (2.16). The reader is reminded of the steepest descent discussion in Section 4.1. For taking the limit of the extended kernel, we need the following lemma.

LEMMA 7.1. *Given the scaling (7.2) above, the following limits hold:*

$$(7.3) \quad \lim_{t \rightarrow \infty} e^{t(z-z^{-1})} (-z)^m = e^{\zeta^3/3 - \sigma\zeta}$$

and

$$(7.4) \quad \begin{aligned} \lim_{t \rightarrow \infty} T_n(z^{-1}) &= e^{-2\sigma\zeta} \hat{Q}(\zeta), & \lim_{t \rightarrow \infty} T_n(w) &= e^{2\sigma\omega} \hat{Q}(-\omega), \\ \lim_{t \rightarrow \infty} S_n(z^{-1}) &= \hat{P}(\zeta), & \lim_{t \rightarrow \infty} S_n(w) &= \hat{P}(-\omega), \end{aligned}$$

where \hat{P} and \hat{Q} are the Laplace transforms defined in (2.17). One also checks

$$(7.5) \quad \lim_{t \rightarrow \infty} \frac{(-w)^{x_2-1}}{(-z)^{x_1}} = \frac{e^{\xi_1\zeta}}{e^{\xi_2\omega}} \quad \text{and} \quad \lim_{t \rightarrow \infty} e^{-t_i(z+z^{-1}+2)} = e^{s_i\zeta^2}.$$

PROOF. Letting $t \rightarrow \infty$, setting $n = 2m + 1$, $m = 2t + \sigma t^{1/3}$, the critical point will be at $z, w = -1$, and thus the leading contribution will come from the neighborhood of the critical points, which suggests the scalings in z and w above. The Taylor expansion of the F -function (4.22) gives

$$(7.6) \quad \begin{aligned} e^{t(z-z^{-1})} (-z)^m &= e^{t(z-z^{-1})+m \log(-z)} = e^{tF(z)+\sigma t^{1/3} \log(-z)} \\ &= e^{tF(-1+\zeta t^{-1/3})+\sigma t^{1/3} \log(1-\zeta t^{-1/3})} \\ &= e^{\zeta^3/3 - \sigma\zeta} (1 + \mathcal{O}(t^{-1/3})). \end{aligned}$$

Setting in addition the scaling for t_i and x_i , one finds by Taylor expanding about $z = -1$ and $w = -1$ the limits (7.5). Introducing the running variable $k = 4t + \kappa(2t)^{1/3}$, one gets

$$\begin{aligned} \lim_{t \rightarrow \infty} T_n(z^{-1}) &= \lim_{t \rightarrow \infty} \sum_{k \geq n} \frac{Q_k}{(-z)^{k-n+1}} \\ &= \lim_{t \rightarrow \infty} \sum_{k \geq n} Q_k e^{-(k-n+1) \log(-z)} \end{aligned}$$

$$\begin{aligned}
(7.7) \quad &= \lim_{t \rightarrow \infty} (2t)^{-1/3} \sum_{\kappa \geq \bar{\sigma} + (2t)^{-1/3}} (2t)^{1/3} Q_{4t + \kappa(2t)^{1/3}} \\
&\quad \times e^{-(\kappa - \bar{\sigma})(2t)^{1/3}(-\zeta t^{-1/3})} \\
&= \int_{\kappa \geq \bar{\sigma}} d\kappa Q(\kappa) e^{(\kappa - \bar{\sigma})\zeta 2^{1/3}} = e^{-2\sigma\zeta} \hat{Q}(\zeta)
\end{aligned}$$

and similarly

$$(7.8) \quad \lim_{t \rightarrow \infty} T_n(w) = e^{2\sigma\omega} \int_{\kappa \geq \bar{\sigma}} d\kappa Q(\kappa) e^{-\kappa\omega 2^{1/3}} = e^{2\sigma\omega} \hat{Q}(-\omega).$$

The limit of the expression S_n , as in (4.10), involves \bar{h}_k , as in (4.24). Using the formula (4.24) for $\bar{h}_k(z^{-1})$ in terms of Bessel functions and Lemma 6.1, one checks, introducing the running variable $a = \mu(2t)^{1/3}$,

$$\begin{aligned}
(7.9) \quad &\lim_{t \rightarrow \infty} \bar{h}_k(z^{-1}) = - \lim_{t \rightarrow \infty} \sum_{a \geq 0} (-z)^a J_{k+a+1}(4t) \\
&= - \lim_{t \rightarrow \infty} (2t)^{-1/3} \sum_{\kappa \geq \bar{\sigma} + (2t)^{-1/3}} e^{\mu(2t)^{1/3} \log(1 - \zeta t^{-1/3})} \mathcal{J}_{2t}^{(0)}(\kappa + \mu) \\
&= - \int_0^\infty d\mu e^{-\mu\zeta 2^{1/3}} \text{Ai}(\kappa + \mu).
\end{aligned}$$

Therefore, one finds

$$\begin{aligned}
(7.10) \quad &\lim_{t \rightarrow \infty} S_n(z^{-1}) = \lim_{t \rightarrow \infty} \langle Q, \chi_n \bar{h}(z^{-1}) \rangle = \lim_{t \rightarrow \infty} \sum_{k \geq n} Q_k \bar{h}_k(z^{-1}) \\
&= \lim_{t \rightarrow \infty} (2t)^{-1/3} \sum_{\kappa \geq \bar{\sigma} + (2t)^{-1/3}} (2t)^{1/3} Q_t(\kappa) \bar{h}_k(z^{-1}) \\
&= - \int_{\kappa \geq \bar{\sigma}} d\kappa Q(\kappa) \int_0^\infty d\mu e^{-\mu\zeta 2^{1/3}} \text{Ai}(\kappa + \mu) = \hat{\mathcal{P}}(\zeta).
\end{aligned}$$

This completes the proof of Lemma 7.1. \square

Sketch of Proof of Theorem 2.2, formula (2.21). Since the sum in brackets in (5.25) is invariant under the involution $x_1 \leftrightarrow -x_2$ and $t_1 \leftrightarrow -t_2$, it suffices to consider the double integral, with the first term only. The second half comes for free by acting with the involution! Given scaling (7.2), Lemma 7.1 yields

$$(7.11) \quad \lim_{t \rightarrow \infty} t^{1/3} \frac{dz dw}{z - w} \frac{(-w)^{x_2 - 1} e^{-t_1(z + z^{-1} + 2)}}{(-z)^{x_1} e^{-t_2(w + w^{-1} + 2)}} = \frac{d\zeta d\omega}{\zeta - \omega} \left(\frac{e^{\xi_1 \zeta}}{e^{\xi_2 \omega}} \right) \frac{e^{s_1 \zeta^2}}{e^{s_2 \omega^2}}$$

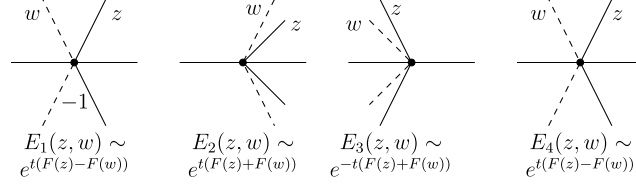
FIG. 5. Contours $z \in \Gamma_0$ and $w \in \Gamma_{0,z}$ in the neighborhood of $z = w = -1$.

and, from (4.12),

$$\begin{aligned}
 \lim_{t \rightarrow \infty} \sum_{i=1}^4 E_i(z, w) &= \frac{e^{\zeta^3/3 - \sigma\zeta}}{e^{\omega^3/3 - \sigma\omega}} (1 - \hat{\mathcal{P}}(\zeta))(1 - \hat{\mathcal{P}}(-\omega)) \\
 &\quad - \frac{e^{\zeta^3/3 - \sigma\zeta}}{e^{-\omega^3/3 + \sigma\omega}} e^{2\sigma\omega} (1 - \hat{\mathcal{P}}(\zeta)) \hat{\mathcal{Q}}(-\omega) \\
 &\quad - \frac{e^{-\zeta^3/3 + \sigma\zeta}}{e^{\omega^3/3 - \sigma\omega}} e^{-2\sigma\zeta} (1 - \hat{\mathcal{P}}(-\omega)) \hat{\mathcal{Q}}(\zeta) \\
 &\quad - \frac{e^{\zeta^3/3 - \sigma\zeta}}{e^{\omega^3/3 - \sigma\omega}} \frac{e^{2\sigma\zeta}}{e^{2\sigma\omega}} \hat{\mathcal{Q}}(-\zeta) \hat{\mathcal{Q}}(\omega).
 \end{aligned}
 \tag{7.12}$$

Combining (7.11) and (7.12) yields the following limit below, first with the contours as indicated in Figure 5, which then can be transformed into the vertical lines above in Figure 6, compatible with Figure 5. Indeed, to pick steepest descent paths about $z = w = -1$ respecting the integration contours in $\oint_{\Gamma_0} dz \oint_{\Gamma_{0,z}} dw$ of (7.13), one must choose the local paths, as illustrated in Figure 5; these paths must be completed by closed contours encircling the origin deformed to provide steepest descent contours. In the ζ, ω scale, there are 4 rays emanating from the origin $\omega = \zeta = 0$; one is then free to deform these rays so as to obtain two parallel imaginary lines near the origin, as depicted in Figure 6. Therefore the following limit holds for the first double integral

$$\lim_{t \rightarrow \infty} \frac{t^{1/3}}{(2\pi i)^2} \oint_{\Gamma_0} dz \oint_{\Gamma_{0,z}} \frac{dw}{z-w} \frac{(-w)^{x_2-1} e^{-t_1(z+z^{-1}+2)}}{(-z)^{x_1} e^{-t_2(w+w^{-1}+2)}} \sum_{i=1}^4 E_i(z, w)$$

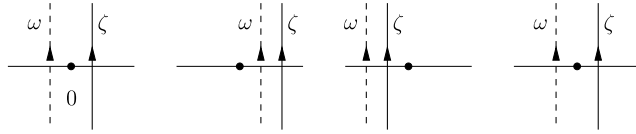
FIG. 6. Vertical lines $\pm\delta + i\mathbb{R}$ and $\pm 2\delta + i\mathbb{R}$ of integration for ζ and ω .

$$\begin{aligned}
&= \frac{1}{(2\pi i)^2} \int_{\delta+i\mathbb{R}} d\zeta \int_{-\delta+i\mathbb{R}} d\omega \frac{e^{\zeta^3/3-\sigma\zeta} e^{s_1\zeta^2}}{e^{\omega^3/3-\sigma\omega} e^{s_2\omega^2}} \left(\frac{e^{\xi_1\zeta}}{e^{\xi_2\omega}} \right) \\
&\quad \times \frac{(1-\hat{\mathcal{P}}(\zeta))(1-\hat{\mathcal{P}}(-\omega))}{\zeta-\omega} \tag{i} \\
&- \frac{1}{(2\pi i)^2} \int_{2\delta+i\mathbb{R}} d\zeta \int_{\delta+i\mathbb{R}} d\omega \frac{e^{\zeta^3/3-\sigma\zeta} e^{s_1\zeta^2}}{e^{-\omega^3/3-\sigma\omega} e^{s_2\omega^2}} \left(\frac{e^{\xi_1\zeta}}{e^{\xi_2\omega}} \right) \\
&\quad \times \frac{(1-\hat{\mathcal{P}}(\zeta))\hat{\mathcal{Q}}(-\omega)}{\zeta-\omega} \tag{ii} \\
&- \frac{1}{(2\pi i)^2} \int_{-\delta+i\mathbb{R}} d\zeta \int_{-2\delta+i\mathbb{R}} d\omega \frac{e^{-\zeta^3/3-\sigma\zeta} e^{s_1\zeta^2}}{e^{\omega^3/3-\sigma\omega} e^{s_2\omega^2}} \left(\frac{e^{\xi_1\zeta}}{e^{\xi_2\omega}} \right) \\
&\quad \times \frac{(1-\hat{\mathcal{P}}(-\omega))\hat{\mathcal{Q}}(\zeta)}{\zeta-\omega} \tag{iii} \\
&- \frac{1}{(2\pi i)^2} \int_{\delta+i\mathbb{R}} d\zeta \int_{-\delta+i\mathbb{R}} d\omega \frac{e^{\zeta^3/3+\sigma\zeta} e^{s_1\zeta^2}}{e^{\omega^3/3+\sigma\omega} e^{s_2\omega^2}} \left(\frac{e^{\xi_1\zeta}}{e^{\xi_2\omega}} \right) \\
&\quad \times \frac{\hat{\mathcal{Q}}(-\zeta)\hat{\mathcal{Q}}(\omega)}{\zeta-\omega}. \tag{iv}
\end{aligned}$$

In view of the scaling (7.2), the involution $x_1 \leftrightarrow -x_2$ and $t_1 \leftrightarrow -t_2$ induces the involution $\xi_1 \leftrightarrow -\xi_2$ and $s_1 \leftrightarrow -s_2$, so that the limit of the other double integral is given by the same formula (7.13) above, but with

$$(7.14) \quad \xi_1 \leftrightarrow -\xi_2 \quad \text{and} \quad s_1 \leftrightarrow -s_2.$$

We are also allowed to interchange the integration variables $\zeta \leftrightarrow -\omega$, provided the contours of integration are modified accordingly; this last interchange implies

$$(7.15) \quad \int_{\delta+i\mathbb{R}} d\zeta \int_{-\delta+i\mathbb{R}} d\omega \quad \text{remains}$$

$$(7.16) \quad \int_{2\delta+i\mathbb{R}} d\zeta \int_{\delta+i\mathbb{R}} d\omega \quad \text{and} \quad \int_{-\delta+i\mathbb{R}} d\zeta \int_{-2\delta+i\mathbb{R}} d\omega \quad \text{interchange.}$$

So, the three combined maps,

$$(7.17) \quad \zeta \leftrightarrow -\omega, \quad s_1 \leftrightarrow -s_2, \quad \xi_1 \leftrightarrow -\xi_2$$

have the following effect on the four double integrals (i), ..., (iv) in (7.13):

double integral (i) with $\frac{e^{\xi_1\zeta}}{e^{\xi_2\omega}} \rightarrow$ same double integral (i), except for $\frac{e^{-\xi_1\zeta}}{e^{-\xi_2\omega}}$;

double integral (ii) with $\frac{e^{\xi_1 \zeta}}{e^{\xi_2 \omega}} \rightarrow$ same double integral (iii), except for $\frac{e^{-\xi_1 \zeta}}{e^{-\xi_2 \omega}}$;

double integral (iii) with $\frac{e^{\xi_1 \zeta}}{e^{\xi_2 \omega}} \rightarrow$ same double integral (ii), except for $\frac{e^{-\xi_1 \zeta}}{e^{-\xi_2 \omega}}$;

double integral (iv) with $\frac{e^{\xi_1 \zeta}}{e^{\xi_2 \omega}} \rightarrow$ same double integral (iv), except for $\frac{e^{-\xi_1 \zeta}}{e^{-\xi_2 \omega}}$.

Therefore the limit

$$(7.18) \quad \lim_{t \rightarrow \infty} \frac{t^{1/3}}{(2\pi i)^2} \oint_{\Gamma_0} dz \oint_{\Gamma_{0,z}} \frac{dw}{z-w} \sum_{i=1}^4 E_i(z, w) \\ \times \left(\frac{(-w)^{x_2-1}}{(-z)^{x_1}} \frac{e^{-t_1(z+z^{-1}+2)}}{e^{-t_2(w+w^{-1}+2)}} + \frac{(-z)^{x_2}}{(-w)^{x_1+1}} \frac{e^{-t_1(w+w^{-1}+2)}}{e^{-t_2(z+z^{-1}+2)}} \right)$$

is given by the right-hand side of (7.13) with the replacement

$$(7.19) \quad \frac{e^{\xi_1 \zeta}}{e^{\xi_2 \omega}} \rightarrow \frac{e^{\xi_1 \zeta}}{e^{\xi_2 \omega}} + \frac{e^{-\xi_1 \zeta}}{e^{-\xi_2 \omega}}.$$

Finally, in order to change the sign of the last integral, one switches the sign $\omega \rightarrow -\omega$ and $\zeta \rightarrow -\zeta$, which changes

$$(7.20) \quad - \int_{\delta+i\mathbb{R}} d\zeta \int_{-\delta+i\mathbb{R}} d\omega \frac{1}{\zeta-\omega} \quad \text{into} \quad + \int_{-\delta+i\mathbb{R}} d\zeta \int_{\delta+i\mathbb{R}} d\omega \frac{1}{\zeta-\omega}.$$

Renaming variables $\zeta \rightarrow u, \omega \rightarrow v$ gives formula (2.21).

APPENDIX: SOME PROPERTIES OF BESSEL AND AIRY FUNCTIONS

Let us recall that the Bessel function representation of order $n \in \mathbb{Z}$

$$(A.1) \quad J_n(2t) = \frac{1}{2\pi i} \oint_{\Gamma_0} dz \frac{e^{t(z-z^{-1})}}{z^{n+1}}$$

has the symmetries

$$(A.2) \quad J_n(2t) = (-1)^n J_{-n}(2t) = (-1)^n J_n(-2t).$$

Moreover,

$$(A.3) \quad \frac{1}{2\pi i} \oint_{\Gamma_0} \frac{dz}{z} \frac{e^{b(z-z^{-1})} e^{a(z+z^{-1})}}{z^n} = \left(\frac{b+a}{b-a} \right)^{n/2} J_n(2\sqrt{b^2-a^2}).$$

It is well known [1] that

$$(A.4) \quad \lim_{t \rightarrow \infty} t^{1/3} J_{[2t+\xi t^{1/3}]}(2t) = \text{Ai}(\xi).$$

An uniform bound obtained in [35] is

$$(A.5) \quad |(2t)^{1/3} J_n(2t)| \leq c, \quad c = 0.785\dots, \quad n \in \mathbb{Z}.$$

This bound, together with uniform expansion which can be found in [1] is used in Lemma A.1 of [22] to get the following result. Fix any $\theta > 0$. Then, there exists a constant $t_0 > 0$ and a constant $C > 0$ such that, uniformly in $t \geq t_0$,

$$(A.6) \quad |t^{1/3} J_{[2t+\xi t^{1/3}]}(2t)| \leq C \min\{1, e^{-\theta\xi}\}.$$

Actually, the statement of Lemma A.1 of [22] is for $\theta = 1/2$ but inspecting the proof it is straightforward to see that it holds for any fixed $\theta > 0$. The Airy function has, among others, the following two integral representations. For any $\delta > 0$, it holds

$$(A.7) \quad \text{Ai}(x) = \frac{1}{2\pi i} \int_{\delta+i\mathbb{R}} du e^{u^3/3-ux}, \quad \text{Ai}(x) = \frac{1}{2\pi i} \int_{-\delta+i\mathbb{R}} dv e^{-v^3/3+vx}.$$

Moreover, for any $\delta > 0$, it holds

$$(A.8) \quad \begin{aligned} \text{Ai}^{(s)}(x) &= e^{sx+2s^3/3} \text{Ai}(x+s^2) = \frac{1}{2\pi i} \int_{\delta+i\mathbb{R}} du e^{u^3/3+u^2s-ux}, \\ \text{Ai}^{(s)}(x) &= e^{sx+2s^3/3} \text{Ai}(x+s^2) = \frac{1}{2\pi i} \int_{-\delta+i\mathbb{R}} dv e^{-v^3/3+v^2s+vx}. \end{aligned}$$

REFERENCES

- [1] ABRAMOWITZ, M. and STEGUN, I. A., eds. (1984). *Pocketbook of Mathematical Functions*. Verlag Harri Deutsch, Thun, Switzerland. [MR0768931](#)
- [2] ADLER, M., CAFASSO, M. and VAN MOERBEKE, P. (2011). From the Pearcey to the Airy process. *Electron. J. Probab.* **16** 1048–1064. [MR2820069](#)
- [3] ADLER, M., DELÉPINE, J. and VAN MOERBEKE, P. (2009). Dyson’s nonintersecting Brownian motions with a few outliers. *Comm. Pure Appl. Math.* **62** 334–395. [MR2487852](#)
- [4] ADLER, M., FERRARI, P. L. and VAN MOERBEKE, P. (2010). Airy processes with wanderers and new universality classes. *Ann. Probab.* **38** 714–769. [MR2642890](#)
- [5] ADLER, M., JOHANSSON, K. and VAN MOERBEKE, P. (2012). Double Aztec diamonds and the tacnode process. Available at arXiv:[1112.5532](#).
- [6] ADLER, M., ORANTIN, N. and VAN MOERBEKE, P. (2010). Universality for the Pearcey process. *Phys. D* **239** 924–941. [MR2639611](#)
- [7] ADLER, M. and VAN MOERBEKE, P. (1997). String-orthogonal polynomials, string equations, and 2-Toda symmetries. *Comm. Pure Appl. Math.* **50** 241–290. [MR1431810](#)
- [8] ADLER, M. and VAN MOERBEKE, P. (2001). Integrals over classical groups, random permutations, Toda and Toeplitz lattices. *Comm. Pure Appl. Math.* **54** 153–205. [MR1794352](#)

- [9] BAIK, J., BEN AROUS, G. and PÉCHÉ, S. (2005). Phase transition of the largest eigenvalue for nonnull complex sample covariance matrices. *Ann. Probab.* **33** 1643–1697. [MR2165575](#)
- [10] BAIK, J., DEIFT, P. and JOHANSSON, K. (1999). On the distribution of the length of the longest increasing subsequence of random permutations. *J. Amer. Math. Soc.* **12** 1119–1178. [MR1682248](#)
- [11] BAIK, J. and RAINS, E. M. (2000). Limiting distributions for a polynuclear growth model with external sources. *J. Stat. Phys.* **100** 523–541. [MR1788477](#)
- [12] BORODIN, A. (1999). Biorthogonal ensembles. *Nuclear Phys. B* **536** 704–732. [MR1663328](#)
- [13] BORODIN, A. and DUITS, M. (2011). Limits of determinantal processes near a tacnode. *Ann. Inst. Henri Poincaré Probab. Stat.* **47** 243–258. [MR2779404](#)
- [14] BORODIN, A. and KUAN, J. (2010). Random surface growth with a wall and Plancherel measures for $O(\infty)$. *Comm. Pure Appl. Math.* **63** 831–894. [MR2662425](#)
- [15] BORODIN, A. and OKOUNKOV, A. (2000). A Fredholm determinant formula for Toeplitz determinants. *Integral Equations Operator Theory* **37** 386–396. [MR1780118](#)
- [16] BORODIN, A., OKOUNKOV, A. and OLSHANSKI, G. (2000). Asymptotics of Plancherel measures for symmetric groups. *J. Amer. Math. Soc.* **13** 481–515 (electronic). [MR1758751](#)
- [17] BORODIN, A. and PÉCHÉ, S. (2008). Airy kernel with two sets of parameters in directed percolation and random matrix theory. *J. Stat. Phys.* **132** 275–290. [MR2415103](#)
- [18] BORODIN, A. and RAINS, E. M. (2005). Eynard–Mehta theorem, Schur process, and their Pfaffian analogs. *J. Stat. Phys.* **121** 291–317. [MR2185331](#)
- [19] DELVAUX, S. and KUIJLAARS, A. B. J. (2009). A phase transition for nonintersecting Brownian motions, and the Painlevé II equation. *Int. Math. Res. Not. IMRN* **19** 3639–3725. [MR2539187](#)
- [20] DELVAUX, S., KUIJLAARS, A. B. J. and ZHANG, L. (2011). Critical behavior of nonintersecting Brownian motions at a tacnode. *Comm. Pure Appl. Math.* **64** 1305–1383. [MR2849479](#)
- [21] EYNARD, B. and MEHTA, M. L. (1998). Matrices coupled in a chain. I. Eigenvalue correlations. *J. Phys. A* **31** 4449–4456. [MR1628667](#)
- [22] FERRARI, P. L. (2004). Polynuclear growth on a flat substrate and edge scaling of GOE eigenvalues. *Comm. Math. Phys.* **252** 77–109. [MR2103905](#)
- [23] FERRARI, P. L. and SPOHN, H. (2003). Step fluctuations for a faceted crystal. *J. Stat. Phys.* **113** 1–46. [MR2012974](#)
- [24] FERRARI, P. L. and VETŐ, B. (2012). Non-colliding Brownian bridges and the asymmetric tacnode process. Available at arXiv:[1112.5002](#).
- [25] HOUGH, J. B., KRISHNAPUR, M., PERES, Y. and VIRÁG, B. (2006). Determinantal processes and independence. *Probab. Surv.* **3** 206–229. [MR2216966](#)
- [26] IMAMURA, T. and SASAMOTO, T. (2004). Fluctuations of the one-dimensional polynuclear growth model with external sources. *Nuclear Phys. B* **699** 503–544. [MR2098552](#)
- [27] JOHANSSON, K. (2002). Non-intersecting paths, random tilings and random matrices. *Probab. Theory Related Fields* **123** 225–280. [MR1900323](#)
- [28] JOHANSSON, K. (2003). Discrete polynuclear growth and determinantal processes. *Comm. Math. Phys.* **242** 277–329. [MR2018275](#)

- [29] JOHANSSON, K. (2005). Non-intersecting, simple, symmetric random walks and the extended Hahn kernel. *Ann. Inst. Fourier (Grenoble)* **55** 2129–2145. [MR2187949](#)
- [30] JOHANSSON, K. (2006). Random matrices and determinantal processes. In *Mathematical Statistical Physics. Session LXXXIII: Lecture Notes at Les Houches Summer School 2005* (A. BOVIER, F. DUNLOP, A. VAN ENTER, F. DEN HOLLANDER AND J. DALIBARD, eds.) 1–55. Elsevier, Amsterdam. [MR2581882](#)
- [31] JOHANSSON, K. (2011). Non-colliding Brownian motions and the extended tacnode process. Available at arXiv:[1105.4027](#).
- [32] KARLIN, S. and MCGREGOR, J. (1959). Coincidence probabilities. *Pacific J. Math.* **9** 1141–1164. [MR0114248](#)
- [33] KATORI, M. and TANEMURA, H. (2004). Symmetry of matrix-valued stochastic processes and noncolliding diffusion particle systems. *J. Math. Phys.* **45** 3058–3085. [MR2077500](#)
- [34] KATORI, M. and TANEMURA, H. (2007). Noncolliding Brownian motion and determinantal processes. *J. Stat. Phys.* **129** 1233–1277. [MR2363394](#)
- [35] LANDAU, L. J. (2000). Bessel functions: Monotonicity and bounds. *J. Lond. Math. Soc. (2)* **61** 197–215. [MR1745392](#)
- [36] LYONS, R. (2003). Determinantal probability measures. *Publ. Math. Inst. Hautes Études Sci.* **98** 167–212. [MR2031202](#)
- [37] NAGAO, T. (2003). Dynamical correlations for vicious random walk with a wall. *Nuclear Phys. B* **658** 373–396. [MR1976323](#)
- [38] NAGAO, T. and FORRESTER, P. J. (1998). Multilevel dynamical correlation functions for Dyson’s Brownian motion model of random matrices. *Phys. Lett. A* **247** 42–46.
- [39] NAGAO, T., KATORI, M. and TANEMURA, H. (2003). Dynamical correlations among vicious random walkers. *Phys. Lett. A* **307** 29–35. [MR1969523](#)
- [40] OKOUNKOV, A. and RESHETIKHIN, N. (2003). Correlation function of Schur process with application to local geometry of a random 3-dimensional Young diagram. *J. Amer. Math. Soc.* **16** 581–603 (electronic). [MR1969205](#)
- [41] OKOUNKOV, A. and RESHETIKHIN, N. (2007). Random skew plane partitions and the Pearcey process. *Comm. Math. Phys.* **269** 571–609. [MR2276355](#)
- [42] PRÄHOFFER, M. and SPOHN, H. (2002). Scale invariance of the PNG droplet and the Airy process. *J. Stat. Phys.* **108** 1071–1106. [MR1933446](#)
- [43] SASAMOTO, T. and IMAMURA, T. (2004). Fluctuations of the one-dimensional polynuclear growth model in half-space. *J. Stat. Phys.* **115** 749–803. [MR2054161](#)
- [44] SIMON, B. (2005). *Orthogonal Polynomials on the Unit Circle. Part 1: Classical Theory*. American Mathematical Society Colloquium Publications **54**. Amer. Math. Soc., Providence, RI. [MR2105088](#)
- [45] SOSHNIKOV, A. B. (2006). Determinantal random fields. In *Encyclopedia of Mathematical Physics* (J.-P. FRANCOISE, G. NABER AND T. S. TSUN, eds.) 47–53. Elsevier, Oxford.
- [46] SPOHN, H. (2006). Exact solutions for KPZ-type growth processes, random matrices, and equilibrium shapes of crystals. *Phys. A* **369** 71–99. [MR2246567](#)
- [47] SZEGŐ, G. (1967). *Orthogonal Polynomials*, 3rd ed. American Mathematical Society Colloquium Publications **23**. Amer. Math. Soc., Providence, RI. [MR0310533](#)
- [48] TRACY, C. A. and WIDOM, H. (1994). Level-spacing distributions and the Airy kernel. *Comm. Math. Phys.* **159** 151–174. [MR1257246](#)
- [49] TRACY, C. A. and WIDOM, H. (1998). Correlation functions, cluster functions, and spacing distributions for random matrices. *J. Stat. Phys.* **92** 809–835. [MR1657844](#)

- [50] TRACY, C. A. and WIDOM, H. (2006). The Pearcey process. *Comm. Math. Phys.* **263** 381–400. [MR2207649](#)
- [51] TRACY, C. A. and WIDOM, H. (2007). Nonintersecting Brownian excursions. *Ann. Appl. Probab.* **17** 953–979. [MR2326237](#)
- [52] VAN MOERBEKE, P. (2011). Random and integrable models in mathematics and physics. In *Random Matrices, Random Processes and Integrable Systems. CRM Series in Mathematics and Physics* (J. HARNAD, ed.) 3–130. Springer, New York. [MR2858436](#)

M. ADLER
P. VAN MOERBEKE
DEPARTMENT OF MATHEMATICS
BRANDEIS UNIVERSITY
WALTHAM, MASSACHUSETTS 02453
USA
E-MAIL: adler@brandeis.edu
vanmoerbeke@brandeis.edu

P. L. FERRARI
INSTITUTE FOR APPLIED MATHEMATICS
BONN UNIVERSITY
ENDENICHER ALLEE 60
53115 BONN
GERMANY
E-MAIL: ferrari@uni-bonn.de

P. VAN MOERBEKE
DEPARTMENT OF MATHEMATICS
UNIVERSITÉ DE LOUVAIN
1348 LOUVAIN-LA-NEUVE
BELGIUM
E-MAIL: pierre.vanmoerbeke@uclouvain.be