

# A Theory of Network Equivalence

## Part I: Point-to-Point Channels

Ralf Koetter, *Fellow, IEEE*, Michelle Effros, *Fellow, IEEE*, and Muriel Médard, *Fellow, IEEE*

### Abstract

A family of equivalence tools for bounding network capacities is introduced. Part I treats networks built from point-to-point channels. Part II generalizes the technique to networks containing wireless channels such as broadcast, multiple access, and interference channels. The main result of part I is roughly as follows. Given a network of noisy, independent, memoryless point-to-point channels, a collection of demands can be met on the given network if and only if it can be met on another network where each noisy channel is replaced by a noiseless bit pipe with throughput equal to the noisy channel capacity. This result was known previously for the case of a single-source multicast demand. The result given here treats general demands – including, for example, multiple unicast demands – and applies even when the achievable rate region for the corresponding demands is unknown in both the noisy network and its noiseless counterpart.

**Keywords:** Capacity, network coding, equivalence, component models

### I. INTRODUCTION

The study of network communications has two natural facets reflecting different approaches to thinking about networks. On the one hand, networks are considered in the graph theoretic setup consisting of nodes connected by links. The links are typically not noisy channels but noise-free bit pipes that can be used error free up to a certain capacity. Typical concepts include information flows and routing issues. On

R. Koetter was with the Technical University of Munich. M. Effros is with the Department of Electrical Engineering, California Institute of Technology, Pasadena, CA 91125 USA e-mail: effros@caltech.edu. M. Médard is with the Department of Electrical Engineering and Computer Science, Massachusetts Institute of Technology, Cambridge, MA 02139 USA e-mail: medard@mit.edu.

the other hand, multiterminal information theory addresses information transmission through networks by studying noisy channels, or rather the stochastic relationship between input and output signals at devices in a network. Here the questions typically concern fundamental limits of communication. The capacity regions of broadcast, multiple access, and interference channels are all examples of questions that are addressed in the context of multiterminal information theory. These questions appear to have no obvious equivalent in networks consisting of error free bit pipes. Nevertheless, these two views of networking are two natural facets of the same problem, namely communication through networks. This paper explores the relationship between these two worlds.

Establishing viable bridges between these two areas shows to be surprisingly fertile. For example, questions about feedback in multiterminal systems are quite nicely expressed in networks of error free bit-pipes. Separation issues — in particular separation between network coding and channel coding — have natural answers, revealing many network capacity problems as combinatorial rather than statistical, even when communication occurs across networks of noisy channels. Most importantly, bounding general network capacities reduces to solving a central network coding problem described as follows: Given a network of *error free* rate-constrained bit pipes, is a given set of demands (e.g., a collection of unicast and multicast connections) simultaneously satisfiable or not. In certain situations, most notably a single multicast demand, this question is solved, and the answer is easily characterized [1]. Unfortunately, the general case is wide open and suspected to be hard. (Currently, NP hardness is only established for linear network coding [2].) While it appears that fully characterizing the combinatorial network coding problem is out of reach [3], moderate size networks can be solved quite efficiently, and there are algorithms available that, with running time that is exponential in the number of nodes, treat precisely this problem for general demands [4], [5], [6]. The possibility of characterizing, in principle, the rate region of a combinatorial network coding problem will be a corner stone for our investigations.

The combinatorial nature of the network coding problem creates a situation not unlike issues in complexity theory. In that case, since precise expressions as to how difficult a problem is in absolute terms are difficult to derive, research is instead devoted to showing that one problem is essentially as difficult as another one (even though precise characterizations are not available for either). Inspired by this analogy, we here take a similar approach, characterizing the relationship between arbitrary network capacity problems and the central combinatorial network coding capacity problem. This characterization is, in fact, all we need if we want to address separation issues in networks. It also opens the door to other questions, such as degree-of-freedom or high signal to noise ratio analyses, which reveal interesting insights.

It is interesting to note the variety of new tools generated in recent years for studying network capacities (e.g., [1], [7], [8], [4], [9], [10], [11], [5], [12], [3]). The reduction of a network information theoretic question to its combinatorial essence is also at the heart of some of these publications (see, e.g. [12]). Our approach is very different in terms of technique and also results, focusing not on the solution of network capacities when good outer bounds are available but on proving relationships between capacity regions even (or especially) when these capacity regions remain inaccessible using available analytical techniques. Nonetheless, we believe it to be no coincidence that the reduction of a problem to its combinatorial essence plays a central role in a variety of techniques for studying network capacities.

## II. INTUITION AND SUMMARY OF RESULTS

The goal of finding capacities for general networks under general demands is currently out of reach. Establishing connections between the networking and information theoretic views of network communications simplifies the task by allowing us to identify both the stochastic and the combinatorial facets of the communication problem and to apply the appropriate tools to each. For example, consider a network of independent, memoryless, noisy point-to-point channels. To derive the multicast capacity of this network, Borade [7] and Song, Yeung, and Cai [13] first find the noisy network's cut-set outer bound and then demonstrate the achievability of that bound by applying a multicast network code over point-to-point channels made reliable using independent channel coding on each point-to-point channel. The resulting separation theorem establishes one tight connection between the two natural views of communication networks. This paper considers whether similar connections can be established for general demands. Relating the capacity of stochastic networks to the network coding capacity allows us to apply analytical and computational tools from the network coding literature (e.g., [4], [5], [6]) to bound the capacity of networks of stochastic channels.

While it is tempting to believe that the separation result derived for a single-source multicast demand in [7], [13] should also apply under general demands, it is clear that the proof technique does not. That is, first establishing a tight outer bound and then showing that that outer bound can be achieved by separate network and channel coding is not a feasible strategy for treating all possible demand types over all possible network topologies. The proof is further complicated by the observation that joint channel and network codes have a variety of clear advantages over separated codes even when separated strategies suffice to achieve the network capacity. Example 1 illustrates one such advantage, showing that operating channels above their respective capacities can improve communication reliability across the network as

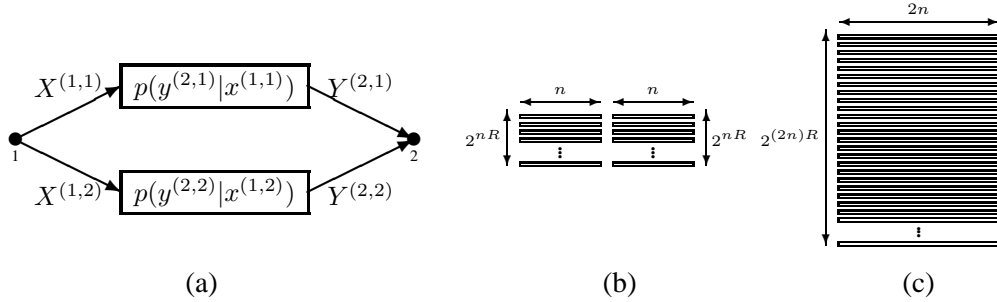

Fig. 1. (a) The network discussed in the comparison of separate network and channel coding to joint network and channel coding in Example 1. (b) A pair of  $(2^{nR}, n)$  channel codes; each is used to reliably transmit  $nR$  bits over  $n$  uses of a single channel in the separated strategy. (c) A single  $(2^{(2n)R}, 2n)$  channel code; this is used to reliably transmit information across  $n$  uses of the pair of channels in the joint coding strategy. The joint coding strategy achieves twice the error exponent by operating each channel at roughly twice its capacity.

a whole. It remains to be determined whether operating channels above their capacities can also increase the achievable rate region for cases beyond the single-source multicast demand studied in [7], [13].

**Example 1** Consider the problem of establishing a unicast connection over the two-node network shown in Figure 1(a). Node 1 transmits a pair of channel inputs  $x^{(1)} = (x^{(1,1)}, x^{(1,2)})$ . Node 2 receives a pair of channel outputs  $y^{(2)} = (y^{(2,1)}, y^{(2,2)})$ . The inputs and outputs are stochastically related through a pair of independent but identical channels, thus

$$p(y^{(2,1)}, y^{(2,2)} | x^{(1,1)}, x^{(1,2)}) = p(y^{(2,1)} | x^{(1,1)}) p(y^{(2,2)} | x^{(1,2)})$$

for all  $(x^{(1,1)}, x^{(1,2)}, y^{(2,1)}, y^{(2,2)}) \in \mathcal{X}^{(1,1)} \times \mathcal{X}^{(1,2)} \times \mathcal{Y}^{(2,1)} \times \mathcal{Y}^{(2,2)}$  while  $p(y^{(2,1)} | x^{(1,1)}) = p(y^{(2,2)} | x^{(1,2)})$  for all  $(x^{(1,1)}, y^{(2,1)}) = (x^{(1,2)}, y^{(2,2)})$ . For each rate  $R < C = \max_{p(x)} I(X; Y)$  and each blocklength  $n$ , we compare two strategies for reliably communicating from node 1 to node 2. The first (see Figure 1(b)) is an optimal separate network and channel code that reliably communicates across each channel using an optimal  $(2^{nR}, n)$  channel code. The second strategy (see Figure 1(c)) applies a single optimal  $(2^{2nR}, 2n)$  channel code across the pair of channels, sending the first  $n$  symbols of each codeword across the first channel and the remaining  $n$  symbols across the second channel. The decoder observes the outputs of both channels and reliably decodes using its blocklength- $2n$  channel decoder. Using this approach, each channel has  $2^{2nR}$  possible inputs. Thus when  $R$  is close to  $C$ , this joint channel and network code operates each channel at roughly twice its capacity – making reliable transmission across each channel alone impossible. Since the joint code operates a  $2n$  dimensional code over  $n$  time steps, it achieves a better error exponent than the separated code. ■

Our main result is roughly as follows. An arbitrary collection of demands can be met on a network of noisy, independent, memoryless point-to-point channels, if and only if the same demands can be met on another network where each noisy channel is replaced by a noiseless bit pipe of the corresponding capacity. This result agrees with [7], [13] in the case of multicast demands.

Our proof introduces a new technique for bounding the capacity region of one network in terms of the capacity region of another network. Critically, this approach can be employed even when the capacity regions of both networks are unknown. We prove equivalence by first showing that the rate region for the noiseless bit-pipe network is a subset of that for the network of noisy channels and then showing that the rate region for the network of noiseless bit pipes is a superset of that for the network of noisy channels. In each case, we show the desired relationship by demonstrating that codes that can be operated reliably on one network can be operated with similar error probability on the other network. Codes for the bit-pipe network can be operated across the network of noisy channels using an independent channel code across each channel. Operating codes for the network of noisy channels across the bit-pipe network is more difficult since networks of noisy channels allow a far richer algorithmic behavior than networks of noiseless bit pipes. While it is known that a noiseless bit-pipe of a given throughput can emulate any discrete memoryless channel of lesser capacity [14], applying this result seems to be difficult. Difficulties arise with continuous random variables, timing questions, and proving continuity of rate regions in the channel statistics. Worst of all, since we do not know which strategy achieves the network capacity, we must be able to emulate all of them. We therefore prove our main claim directly, without exploiting [14]. We use a source coding argument to show that we can emulate each noisy channel across the corresponding noiseless bit pipe to sufficient accuracy that any code designed for the network of noisy channels can be operated across the noiseless bit-pipe network with a similar error probability. It is important to note that the given approach does not require knowing the rate region of either network nor what the optimal codes look like, and it never answers the question of whether a particular rate point is in the rate region or not. The proofs only demonstrate that any rate point in the interior of the rate region for one network must also be in the interior of the rate region for the other network.

The given relationship between networks of noisy point-to-point channels and networks of noiseless bit-pipes has a number of surprisingly powerful consequences. For example, it demonstrates that at its core characterizing network capacity is a combinatoric problem rather than a probabilistic one: Shannon's channel coding theorem tells us everything that we need to know about the noise in independent, point-to-point channels. Understanding the relationship between the two facets of network communications

likewise lends insight into a variety of network information theoretic questions. For example, the classical result that feedback does not increase the capacity of a point-to-point channel now can be proven in two ways. The first is the classical information theoretic argument that shows that the channel has no information that is useful to the transmitter that the transmitter does not already know. The second observes that the min-cut between the transmitter and the receiver in the equivalent network is the same with or without feedback; therefore feedback does not increase capacity. While both proofs lead to the same well-known result, the latter is easier to generalize. For example, the following result is an immediate consequence of the given network equivalence and the well-known characterization of the multicast capacity in network coding [1]. Given any network of noisy, memoryless, point-to-point channels and any multicast demand, feedback increases the multicast capacity if and only if it increases the min-cut on the equivalent deterministic network. Likewise, since capacities are known for a variety of network coding problems [8], we can immediately determine whether feedback increases the achievable rate regions for a variety of other demand types (e.g., multiple-source multicast demands, single-source non-overlapping demands, and single-source non-overlapping plus multicast demands).

### III. THE SETUP

Our notation is similar to that of Cover and Thomas [15, Section 15.10]. A multiterminal network is defined by a vertex set  $\mathcal{V} = \{1, \dots, m\}$  with associated random variables  $X^{(v)} \in \mathcal{X}^{(v)}$  which are transmitted from node  $v$  and  $Y^{(v)} \in \mathcal{Y}^{(v)}$  which are received at node  $v$ . The alphabets  $\mathcal{X}^{(v)}$  and  $\mathcal{Y}^{(v)}$  may be discrete or continuous. They may also be vectors or scalars. For example, if node  $v$  transmits information over  $k$  binary symmetric channels, then  $\mathcal{X}^{(v)} = \{0, 1\}^k$ . The network is assumed to be memoryless and characterized by a conditional probability distribution

$$p(\mathbf{y}|\mathbf{x}) = p(y^{(1)}, \dots, y^{(m)} | x^{(1)}, \dots, x^{(m)}).$$

Note that for continuous random variables this assumption implies that we restrict our attention to cases where this conditional distribution (in this case a conditional probability density function) exists. A code of blocklength  $n$  operates the network over  $n$  time steps with the goal of communicating, for each distinct pair of nodes  $u$  and  $v$ , message

$$W^{(u \rightarrow v)} \in \mathcal{W}^{(u \rightarrow v)} \stackrel{\text{def}}{=} \{1, \dots, 2^{nR^{(u \rightarrow v)}}\}$$

from source node  $u$  to sink node  $v$ . The messages  $W^{(u \rightarrow v)}$  are independent and uniformly distributed by assumption (the proof also goes through unchanged if the same message is available at more than one

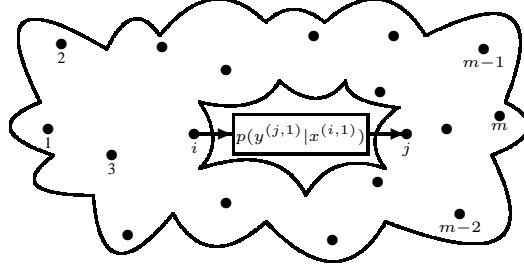

Fig. 2. An  $m$ -node network containing a channel  $p(y^{(j,1)}|x^{(i,1)})$  from node  $i$  to node  $j$ . Here  $x^{(i)} = (x^{(i,1)}, x^{(i,2)})$ ,  $y^{(j)} = (y^{(j,1)}, y^{(j,2)})$ , and the distribution  $p(y^{(1)}, \dots, y^{(j-1)}, y^{(j,2)}, y^{(j+1)}, \dots, y^{(m)} | x^{(1)}, \dots, x^{(i-1)}, x^{(i,2)}, x^{(i+1)}, \dots, x^{(m)})$  on the remaining channel outputs given the remaining channel inputs is arbitrary.

node in the network). The vector of messages  $W^{(u \rightarrow v)}$  is denoted by  $W$ . The constant  $R^{(u \rightarrow v)}$  is called the rate of the transmission, and the vector of rates  $R^{(u \rightarrow v)}$  is denoted by  $\mathcal{R}$ . Since no message is required from a node  $u$  to itself,  $R^{(u \rightarrow u)} = 0$ , and  $\mathcal{R}$  is treated as a  $m(m-1)$ -dimensional vector. By [16], for any network coding problem with generic demands, we can construct a multiple unicast problem such that the given demands can be met in the original network if and only if the unicast demands can be met in the constructed network. This argument generalizes immediately to the network model presented here. Therefore, there is no loss of generality (and considerable simplification of notation) in describing messages for all node pairs  $((u, v) \in \{1, \dots, m\}^2$  such that  $u \neq v$ ) rather than messages for all possible multicasts  $((u, B)$  with  $u \in \{1, \dots, m\}$  and  $B \subseteq \{1, \dots, m\} \setminus u$ ).

We denote the random variable transmitted by node  $v$  at time  $t$  as  $X_t^{(v)}$  and the full vector of time- $t$  transmissions by all nodes as  $\mathbf{X}_t$ . We likewise denote the random variable received by node  $v$  at time  $t$  by  $Y_t^{(v)}$  and the full vector of time- $t$  channel outputs by  $\mathbf{Y}_t$ . A network is written as a triple

$$\left( \prod_{v=1}^m \mathcal{X}^{(v)}, p(\mathbf{y}|\mathbf{x}), \prod_{v=1}^m \mathcal{Y}^{(v)} \right) \quad (1)$$

with the additional constraint that random variable  $X_t^{(v)}$  is a function of random variables

$$\{Y_1^{(v)}, \dots, Y_{t-1}^{(v)}, W^{(v \rightarrow 1)}, \dots, W^{(v \rightarrow m)}\}$$

alone.

While this characterization is very general, it does not exploit any information about the network's structure. Later discussion treats networks made entirely from point-to-point channels, but we begin by considering a network that is completely arbitrary except for its inclusion of a point-to-point channel from

node  $i$  to node  $j$ , as shown in Figure 2, that is independent of the remainder of the network distribution. Precisely, the conditional distribution on all channel outputs given all channel inputs factors as

$$p(\mathbf{y}|\mathbf{x}) = p(y^{(j,1)}|x^{(i,1)})p(y^{(1)}, \dots, y^{(j-1)}, y^{(j,2)}, y^{(j+1)}, \dots, y^{(m)}|x^{(1)}, \dots, x^{(i-1)}, x^{(i,2)}, x^{(i+1)}, \dots, x^{(m)}),$$

where  $\mathcal{X}^{(i)} = \mathcal{X}^{(i,1)} \times \mathcal{X}^{(i,2)}$ ,  $\mathcal{Y}^{(j)} = \mathcal{Y}^{(j,1)} \times \mathcal{Y}^{(j,2)}$ ,  $(\mathcal{X}^{(i,1)}, p(y^{(j,1)}|x^{(i,1)}), \mathcal{Y}^{(j,1)})$  is the point-to-point channel, and

$$\left( \mathcal{X}^{(i,2)} \times \prod_{v \neq i} \mathcal{X}^{(v)}, p(y^{(1)}, \dots, y^{(j-1)}, y^{(j,2)}, y^{(j+1)}, \dots, y^{(m)}|x^{(1)}, \dots, x^{(i-1)}, x^{(i,2)}, x^{(i+1)}, \dots, x^{(m)}), \right. \\ \left. \mathcal{Y}^{(j,2)} \times \prod_{v \neq j} \mathcal{Y}^{(v)} \right)$$

is the remainder of the network. As mentioned previously, for continuous-alphabet channels we restrict our attention to networks for which the above conditional probability density functions exist. We also restrict our attention to channels for which the input distribution that achieves the capacity of channel  $(\mathcal{X}^{(i,1)}, p(y^{(j,1)}|x^{(i,1)}), \mathcal{Y}^{(j,1)})$  in isolation has a probability density function. This includes most of the continuous channels studied in the literature.

The notation  $\mathbf{X} = (X^{(i,1)}, X^{-(i,1)})$  and  $\mathbf{Y} = (Y^{(j,1)}, Y^{-(j,1)})$  is sometimes useful to succinctly distinguish the input and output of the point-to-point channel from the remainder of the network channel inputs and outputs. Using this notation, an  $m$ -node network containing an independent point-to-point channel from node  $i$  to node  $j$  is written as

$$\mathcal{N} = \left( \mathcal{X}^{-(i,1)} \times \mathcal{X}^{(i,1)}, p(y^{(j,1)}|x^{(i,1)})p(y^{-(j,1)}|x^{-(i,1)}), \mathcal{Y}^{-(j,1)} \times \mathcal{Y}^{(j,1)} \right). \quad (2)$$

Figure 1(a) shows one example where the remainder of the network is itself a point-to-point channel. In this paper we want to investigate some information theoretic aspects of replacing factor  $p(y^{(j,1)}|x^{(i,1)})$ .

**Remark 1** The given definitions are sufficiently general to model a wide variety of memoryless channel types. For example, the distribution  $p(y^{-(j,1)}|x^{-(i,1)})$  may model wireless components like broadcast, multiple access, and interference channels. If  $\mathcal{X}^{(i,1)}$  and  $\mathcal{Y}^{(j,1)}$  are vector alphabets, then the channel from node  $i$  to node  $j$  is a point-to-point MIMO channel. In some situations it is important to be able to embed the transmissions of various nodes in a schedule which may or may not depend on the messages to be sent and the symbols that were received in the network. It is straightforward to model such a situation in the above setup by including in the input and output alphabets symbols for the case when nothing was sent on a particular node input. In this way we can assume that at each time  $t$  random variables  $X_t^{(v)}$  and  $Y_t^{(v)}$  are given.



**Definition 1** Let a network

$$\mathcal{N} \stackrel{\text{def}}{=} \left( \prod_{v=1}^m \mathcal{X}^{(v)}, p(\mathbf{y}|\mathbf{x}), \prod_{v=1}^m \mathcal{Y}^{(v)} \right)$$

be given. A blocklength- $n$  solution  $\mathcal{S}(\mathcal{N})$  to this network is defined as a set of encoding and decoding functions:

$$X_t^{(v)} : (\mathcal{Y}^{(v)})^{t-1} \times \prod_{v'=1}^m \mathcal{W}^{(v \rightarrow v')} \rightarrow \mathcal{X}^{(v)}$$

$$\hat{W}^{(u \rightarrow v)} : (\mathcal{Y}^{(v)})^n \times \prod_{v'=1}^m \mathcal{W}^{(v \rightarrow v')} \rightarrow \mathcal{W}^{(u \rightarrow v)}$$

mapping  $(Y_1^{(v)}, \dots, Y_{t-1}^{(v)}, W^{(v \rightarrow 1)}, \dots, W^{(v \rightarrow m)})$  to  $X_t^{(v)}$  for each  $v \in V$  and  $t \in \{1, \dots, n\}$  and mapping  $(Y_1^{(v)}, \dots, Y_n^{(v)}, W^{(v \rightarrow 1)}, \dots, W^{(v \rightarrow m)})$  to  $\hat{W}^{(u \rightarrow v)}$  for each  $u, v \in V$ . The solution  $\mathcal{S}(\mathcal{N})$  is called a  $(\lambda, \mathcal{R})$ -solution, denoted  $(\lambda, \mathcal{R})\text{-}\mathcal{S}(\mathcal{N})$ , if  $\Pr(W^{(u \rightarrow v)} \neq \hat{W}^{(u \rightarrow v)}) < \lambda$  for all source and sink pairs  $u, v$  using the specified encoding and decoding functions.

**Definition 2** The rate region  $\mathcal{R}(\mathcal{N}) \subset \mathbb{R}_+^{m(m-1)}$  of a network  $\mathcal{N}$  is the closure of all rate vectors  $\mathcal{R}$  such that for any  $\lambda > 0$  and all  $n$  sufficiently large, there exists a  $(\lambda, \mathcal{R})\text{-}\mathcal{S}(\mathcal{N})$  solution of blocklength  $n$ . We use  $\text{int}(\mathcal{R}(\mathcal{N}))$  to denote the interior of rate region  $\mathcal{R}(\mathcal{N})$ .

The goal of this paper is not to give the capacity regions of networks with respect to various demands, which is an intractable problem. Rather, we wish to develop equivalence relationships between capacity regions of networks. Given the existence of a solution  $(\lambda, \mathcal{R})\text{-}\mathcal{S}(\mathcal{N})$  of some blocklength  $n$  for a network  $\mathcal{N}$  we will try to imply statements for the existence of a solution  $(\lambda', \mathcal{R}')\text{-}\mathcal{S}(\mathcal{N}')$  of some blocklength  $n'$  for a network  $\mathcal{N}'$ .

To make this precise, consider a memoryless network  $\mathcal{N}$  containing an independent channel from node  $i$  to node  $j$ . Then

$$p(\mathbf{y}|\mathbf{x}) = p(y^{(j,1)}|x^{(i,1)})p(y^{-(j,1)}|x^{-(i,1)}).$$

Let another network  $\mathcal{N}'$  be given with random variables  $(\tilde{X}^{(i,1)}, \tilde{Y}^{(j,1)})$  replacing  $(X^{(i,1)}, Y^{(j,1)})$  in  $\mathcal{N}$ . We have replaced the point-to-point channel characterized by  $p(y^{(j,1)}|x^{(i,1)})$  with another point-to-point channel characterized by  $\tilde{p}(\tilde{y}^{(j,1)}|\tilde{x}^{(i,1)})$ . When  $I(X^{(i,1)}; Y^{(j,1)}) < I(\tilde{X}^{(i,1)}; \tilde{Y}^{(j,1)})$ , we want to prove that the existence of a  $(\lambda, \mathcal{R})\text{-}\mathcal{S}(\mathcal{N})$  solution implies the existence of a  $(\lambda', \mathcal{R}')\text{-}\mathcal{S}(\mathcal{N}')$  solution, where  $\lambda'$  can be made arbitrarily small if  $\lambda$  can. Since node  $j$  need not decode  $Y^{(j,1)}$ , channel capacity is not necessarily a relevant characterization of the channel's behavior. For example a Gaussian channel from

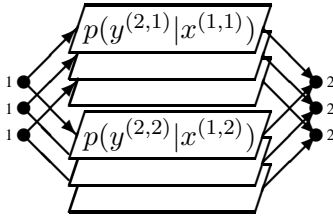

Fig. 3. The 3-fold stacked network  $\underline{\mathcal{N}}$  for the network  $\mathcal{N}$  in Figure 1(a).

$i$  to  $j$  might contribute a real-valued estimation of the input random variable; a binary erasure channel that replaces it cannot immediately deliver the same functionality.

Our proof does not invent a coding scheme. Instead, we demonstrate a technique for operating any coding scheme for  $\mathcal{N}$  on the network  $\mathcal{N}'$ . Since there exists a coding scheme for  $\mathcal{N}$  that achieves any point in the interior of  $\mathcal{R}(\mathcal{N})$ , showing that we can operate all codes for  $\mathcal{N}$  on  $\mathcal{N}'$  proves that  $\mathcal{R}(\mathcal{N}) \subseteq \mathcal{R}(\mathcal{N}')$ . We do not know the form of an optimal code for  $\mathcal{N}$ . Therefore, our method must work for all possible codes on  $\mathcal{N}$ . For example, it must succeed even when the code for  $\mathcal{N}$  is time-varying. As a result, we cannot apply typicality arguments across time. We introduce instead a notion of *stacking* in order to exploit averaging arguments across multiple uses of the network rather than trying to apply such arguments across time.

#### IV. STACKED NETWORKS AND STACKED SOLUTIONS

An  $N$ -fold stacked network  $\underline{\mathcal{N}}_N$  is the network  $\mathcal{N}$  repeated  $N$  times. That is,  $\underline{\mathcal{N}}_N$  has  $N$  copies of each vertex  $v \in \{1, \dots, m\}$  and  $N$  copies of the channel  $p(\mathbf{y}|\mathbf{x})$ . Figure 3 shows the 3-fold stacked network for the network in Figure 1. We abuse notation by simplifying  $\underline{\mathcal{N}}_N$  to  $\underline{\mathcal{N}}$  throughout, specifying the number layers in the stack ( $N$ ) by context. Eventually,  $N$  will be allowed to grow without bound in order to exploit asymptotic typicality arguments. The  $N$ -fold stacked network is used to deliver  $N$  independent messages  $W^{(u \rightarrow v)}$  from each transmitter node  $u$  to each receiver node  $v$ . All copies of a node can, at each time  $t$ , collaborate in determining their channel inputs  $X_t^{(v)}$ . Likewise, all copies of a node  $v$  can collaborate in reconstructing messages  $W^{(u \rightarrow v)}$ . This potential for collaboration across the layers of the stack seems to make the  $N$ -fold stacked network  $\underline{\mathcal{N}}$  considerably more powerful than the network  $\mathcal{N}$  from which it was derived. However, the increase in the number of degrees of freedom in a stacked network solution is accompanied by an increased burden in the reconstruction constraint. A code for the stacked network is successful only if it decodes without error in every layer. This becomes

difficult as  $N$  grows without bound.

Since the  $N$ -fold stacked network contains  $N$  copies of  $\mathcal{N}$ , it does not meet the definition of a network (for example, its vertex set is a multiset and not a set<sup>1</sup>). Thus new definitions are required. We carry over notation and variable definitions from the network  $\mathcal{N}$  to the stacked network  $\underline{\mathcal{N}}$  by underlining the variable names. So for any distinct  $u, v \in \{1, \dots, m\}$ ,  $\underline{W}^{(u \rightarrow v)} \in \underline{\mathcal{W}}^{(u \rightarrow v)} \stackrel{\text{def}}{=} (\mathcal{W}^{(u \rightarrow v)})^N$  is the  $N$ -dimensional vector of messages that the  $N$  copies of node  $u$  send to the corresponding copies of node  $v$ , and  $\underline{X}_t^{(v)} \in \underline{\mathcal{X}}^{(v)} \stackrel{\text{def}}{=} (\mathcal{X}^{(v)})^N$  and  $\underline{Y}_t^{(v)} \in \underline{\mathcal{Y}}^{(v)} \stackrel{\text{def}}{=} (\mathcal{Y}^{(v)})^N$  are the  $N$ -dimensional vectors of channel inputs and channel outputs, respectively, for node  $v$  at time  $t$ . The variables in the  $\ell$ -th layer of the stack are denoted by an argument  $\ell$ , for example  $\underline{W}^{(u \rightarrow v)}(\ell)$  is the message from node  $u$  to node  $v$  in the  $\ell$ -th layer of the stack and  $\underline{X}_t^{(v)}(\ell)$  is the layer- $\ell$  channel input from node  $v$  at time  $t$ . Since  $\underline{W}^{(u \rightarrow v)}$  is an  $N$ -dimensional vector of messages, when  $W^{(u \rightarrow v)} \in \mathcal{W}^{(u \rightarrow v)} \stackrel{\text{def}}{=} \{1, \dots, 2^{nR^{(u \rightarrow v)}}\}$  in  $\mathcal{N}$ ,  $\underline{W}^{(u \rightarrow v)} \in \underline{\mathcal{W}}^{(u \rightarrow v)} \stackrel{\text{def}}{=} \{1, \dots, 2^{nR^{(u \rightarrow v)}}\}^N$  in  $\underline{\mathcal{N}}$ . We therefore define the rate  $R^{(u \rightarrow v)}$  for a stacked network to be  $(\log |\underline{\mathcal{W}}^{(u \rightarrow v)}|)/(nN)$ ; this normalization makes rate regions in a network and its corresponding stacked network comparable.

**Definition 3** Let a network

$$\mathcal{N} \stackrel{\text{def}}{=} \left( \prod_{v=1}^m \mathcal{X}^{(v)}, p(\mathbf{y}|\mathbf{x}), \prod_{v=1}^m \mathcal{Y}^{(v)} \right)$$

be given. Let  $\underline{\mathcal{N}}$  be the  $N$ -fold stacked network for  $\mathcal{N}$ . A blocklength- $n$  solution  $\mathcal{S}(\underline{\mathcal{N}})$  to this network is defined as a set of encoding and decoding functions

$$\begin{aligned} \underline{X}_t^{(v)} &: (\underline{\mathcal{Y}}^{(v)})^{t-1} \times \prod_{v'=1}^m \underline{\mathcal{W}}^{(v \rightarrow v')} \rightarrow \underline{\mathcal{X}}^{(v)} \\ \hat{\underline{W}}^{(u \rightarrow v)} &: (\underline{\mathcal{Y}}^{(v)})^n \times \prod_{v'=1}^m \underline{\mathcal{W}}^{(v \rightarrow v')} \rightarrow \underline{\mathcal{W}}^{(u \rightarrow v)} \end{aligned}$$

mapping  $(\underline{Y}_1^{(v)}, \dots, \underline{Y}_{t-1}^{(v)}, \underline{W}^{(v \rightarrow 1)}, \dots, \underline{W}^{(v \rightarrow m)})$  to  $\underline{X}_t^{(v)}$  for each  $t \in \{1, \dots, n\}$  and  $v \in \{1, \dots, m\}$  and mapping  $(\underline{Y}_1^{(v)}, \dots, \underline{Y}_n^{(v)}, \underline{W}^{(v \rightarrow 1)}, \dots, \underline{W}^{(v \rightarrow m)})$  to  $\hat{\underline{W}}^{(u \rightarrow v)}$  for each  $u, v \in \{1, \dots, m\}$ . The solution  $\mathcal{S}(\underline{\mathcal{N}})$  is called a  $(\lambda, \mathcal{R})$ -solution for  $\underline{\mathcal{N}}$ , denoted  $(\lambda, \mathcal{R})\text{-}\mathcal{S}(\underline{\mathcal{N}})$ , if the encoding and decoding functions imply

$$\Pr(\underline{W}^{(u \rightarrow v)} \neq \hat{\underline{W}}^{(u \rightarrow v)}) < \lambda$$

for all source and sink pairs  $u, v$ .

<sup>1</sup>The vertex set is a multiset since it contains  $N$  copies of each element  $\{1, \dots, m\}$ .

**Definition 4** The rate region  $\mathcal{R}(\underline{\mathcal{N}}) \subset \mathbb{R}_+^{m(m-1)}$  of a stacked network  $\underline{\mathcal{N}}$  is the closure of all rate vectors  $\mathcal{R}$  such that a  $(\lambda, \mathcal{R})$ - $\mathcal{S}(\underline{\mathcal{N}})$  solution exists for any  $\lambda > 0$  and all  $N$  sufficiently large.

Theorem 1, below, shows that the rate regions for a network  $\mathcal{N}$  and its corresponding stacked network  $\underline{\mathcal{N}}$  are identical. That result further demonstrates that the error probability for the stacked network can be made to decay exponentially in the number of layers  $N$ . The proof builds a blocklength- $n$  solution for network  $\underline{\mathcal{N}}$  by first using a channel code to map each message  $\underline{W}^{(u \rightarrow v)} \in \underline{\mathcal{W}}^{(u \rightarrow v)} \stackrel{\text{def}}{=} \{1, \dots, 2^{nR^{(u \rightarrow v)}}\}^N$  to a message in alphabet  $\tilde{\mathcal{W}}^{(u \rightarrow v)} \stackrel{\text{def}}{=} \{1, \dots, 2^{n\tilde{R}^{(u \rightarrow v)}}\}^N$  for some  $\tilde{R}^{(u \rightarrow v)} > R^{(u \rightarrow v)}$  and then applying the same blocklength- $n$  solution for network  $\mathcal{N}$  independently in each layer of the stack. We call such a solution a stacked solution.

**Definition 5** Let a network  $\mathcal{N} \stackrel{\text{def}}{=} (\prod_{v=1}^m \mathcal{X}^{(v)}, p(\mathbf{y}|\mathbf{x}), \prod_{v=1}^m \mathcal{Y}^{(v)})$  be given. Let  $\underline{\mathcal{N}}$  be the  $N$ -fold stacked network for  $\mathcal{N}$ . A blocklength- $n$  stacked solution  $\underline{\mathcal{S}}(\underline{\mathcal{N}})$  to network  $\underline{\mathcal{N}}$  is defined as a set of mappings

$$\begin{aligned} \underline{\tilde{W}}^{(u \rightarrow v)} &: \underline{\mathcal{W}}^{(u \rightarrow v)} \rightarrow \tilde{\mathcal{W}}^{(u \rightarrow v)} \\ \underline{X}_t^{(v)} &: (\mathcal{Y}^{(v)})^{t-1} \times \prod_{v'=1}^m \tilde{\mathcal{W}}^{(v \rightarrow v')} \rightarrow \mathcal{X}^{(v)} \\ \underline{\hat{W}}^{(u \rightarrow v)} &: (\mathcal{Y}^{(v)})^n \times \prod_{v'=1}^m \tilde{\mathcal{W}}^{(v \rightarrow v')} \rightarrow \tilde{\mathcal{W}}^{(u \rightarrow v)} \\ \underline{\hat{W}}^{(u \rightarrow v)} &: \underline{\tilde{W}}^{(u \rightarrow v)} \rightarrow \underline{\mathcal{W}}^{(u \rightarrow v)} \end{aligned}$$

such that

$$\begin{aligned} \underline{\tilde{W}}^{(u \rightarrow v)} &= \underline{\tilde{W}}^{(u \rightarrow v)}(\underline{W}^{(u \rightarrow v)}) \\ \underline{X}_t^{(v)}(\ell) &= X_t^{(v)}\left(\underline{Y}_1^{(v)}(\ell), \dots, \underline{Y}_{t-1}^{(v)}(\ell), \underline{\tilde{W}}^{(v \rightarrow 1)}(\ell), \dots, \underline{\tilde{W}}^{(v \rightarrow m)}(\ell)\right) \\ \underline{\hat{W}}^{(u \rightarrow v)}(\ell) &= \hat{W}^{(u \rightarrow v)}\left(\underline{Y}_1^{(v)}(\ell), \dots, \underline{Y}_n^{(v)}(\ell), \underline{\tilde{W}}^{(v \rightarrow 1)}(\ell), \dots, \underline{\tilde{W}}^{(v \rightarrow m)}(\ell)\right) \\ \underline{\hat{W}}^{(u \rightarrow v)} &= \underline{\hat{W}}^{(u \rightarrow v)}(\underline{\hat{W}}^{(u \rightarrow v)}) \end{aligned}$$

for each  $u, v \in \{1, \dots, m\}$ ,  $t \in \{1, \dots, n\}$ , and  $\ell \in \{1, \dots, N\}$ . The solution  $\underline{\mathcal{S}}(\underline{\mathcal{N}})$  is called a stacked  $(\lambda, \mathcal{R})$ -solution, denoted  $(\lambda, \mathcal{R})$ - $\underline{\mathcal{S}}(\underline{\mathcal{N}})$ , if the specified mappings imply

$$\Pr(\underline{W}^{(u \rightarrow v)} \neq \underline{\hat{W}}^{(u \rightarrow v)}) < \lambda$$

for all source and sink pairs  $u, v$ .

**Theorem 1** The rate regions  $\mathcal{R}(\mathcal{N})$  and  $\mathcal{R}(\underline{\mathcal{N}})$  are identical, and for each  $\mathcal{R} \in \text{int}(\mathcal{R}(\underline{\mathcal{N}}))$ , there exists a sequence of  $(2^{-N^\delta}, \mathcal{R})$ - $\underline{\mathcal{S}}(\underline{\mathcal{N}})$  stacked solutions for  $\underline{\mathcal{N}}$  for some  $\delta > 0$ .

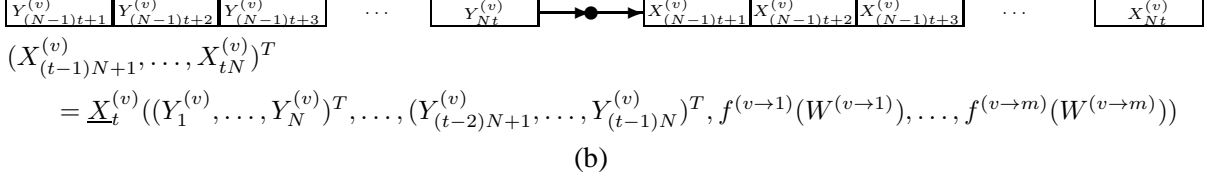
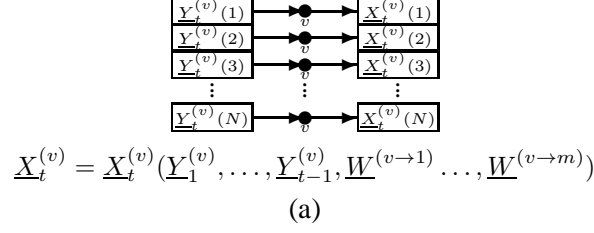

Fig. 4. A blocklength- $n$  solution  $\mathcal{S}(\underline{\mathcal{N}})$  for network  $\underline{\mathcal{N}}$  can be operated with the same error probability over  $nN$  time steps in  $\mathcal{N}$ . (a) Inputs and outputs at time  $t$  of the  $N$  copies of node  $v$  in  $\underline{\mathcal{N}}$ . (b) Inputs and outputs of node  $v$  at times  $(N-1)t+1, \dots, Nt$  in  $\mathcal{N}$ . Vectors  $(X_{(t-1)N+1}^{(v)}, \dots, X_{tN}^{(v)})^T$  and  $(Y_{(t-1)N+1}^{(v)}, \dots, Y_{tN}^{(v)})^T$  in  $\mathcal{N}$  play the same role as vectors  $\underline{X}_t^{(v)}$  and  $\underline{Y}_t^{(v)}$  in  $\underline{\mathcal{N}}$ .

*Proof.* We first show that  $\mathcal{R}(\underline{\mathcal{N}}) \subseteq \mathcal{R}(\mathcal{N})$ . Perhaps surprisingly, this turns out to be the easier part of the proof. Let  $\mathcal{R} \in \text{int}(\mathcal{R}(\underline{\mathcal{N}}))$ . Then for any  $\lambda \in (0, 1]$ , there exists a  $(\lambda, \mathcal{R})$ - $\mathcal{S}(\underline{\mathcal{N}})$  solution to the stacked network  $\underline{\mathcal{N}}$ . Let  $n$  be the blocklength of  $\mathcal{S}(\underline{\mathcal{N}})$ . The argument that follows uses  $\mathcal{S}(\underline{\mathcal{N}})$  to build a blocklength  $nN$   $(\lambda, \mathcal{R})$ - $\mathcal{S}(\mathcal{N})$  solution for network  $\mathcal{N}$ . Roughly, the operations performed at time  $t$  by the  $N$  copies of node  $v$  in  $\mathcal{S}(\underline{\mathcal{N}})$  are performed by the single copy of node  $v$  at times  $(t-1)N+1, \dots, tN$  in  $\mathcal{S}(\mathcal{N})$ , as shown in Figure 4. This gives the desired result since the error probability and rate of  $\mathcal{S}(\mathcal{N})$  on  $\mathcal{N}$  equal the error probability and rate of  $\mathcal{S}(\underline{\mathcal{N}})$  on  $\underline{\mathcal{N}}$ .

To make the argument formal, for each  $(u, v)$ , let

$$f^{(u \rightarrow v)} : \{1, \dots, 2^{NnR^{(u \rightarrow v)}}\} \rightarrow \{1, \dots, 2^{nR^{(u \rightarrow v)}}\}^N$$

be the natural one-to-one mapping from a single sequence of  $NnR^{(u \rightarrow v)}$  bits to  $N$  consecutive subsequences each of  $nR^{(u \rightarrow v)}$  bits. Let  $g^{(u \rightarrow v)}$  be the inverse of  $f^{(u \rightarrow v)}$ . We use  $f^{(u \rightarrow v)}$  to map messages from the message alphabet of the rate- $R^{(u \rightarrow v)}$  blocklength- $Nn$  code  $\mathcal{S}(\mathcal{N})$  to the message alphabet for the  $N$ -layer, rate- $R^{(u \rightarrow v)}$ , blocklength- $n$  code  $\mathcal{S}(\underline{\mathcal{N}})$ . The mapping is one-to-one since in each scenario the total number

of bits transmitted from node  $u$  to node  $v$  is  $NnR^{(u \rightarrow v)}$ . For each  $t \in \{1 \dots, n\}$ , let

$$\begin{aligned} X^{(v)}(t) &= (X_{(t-1)N+1}^{(v)}, \dots, X_{tN}^{(v)})^T \\ Y^{(v)}(t) &= (Y_{(t-1)N+1}^{(v)}, \dots, Y_{tN}^{(v)})^T \end{aligned}$$

denote vectors containing the channel inputs and outputs at node  $v$  for  $N$  consecutive time steps beginning at time  $(t-1)N+1$ . This is a simple blocking of symbols into vectors, with superscript  $T$  denoting vector transpose. We define the solution  $\mathcal{S}(\mathcal{N})$  as

$$\begin{aligned} X^{(v)}(t) &= \underline{X}_t^{(v)}(Y^{(v)}(1), \dots, Y^{(v)}(t-1), f^{(v \rightarrow 1)}(W^{(v \rightarrow 1)}), \dots, f^{(v \rightarrow m)}(W^{(v \rightarrow m)})) \\ \hat{W}^{(u \rightarrow v)} &= g^{(u \rightarrow v)}(\underline{\hat{W}}^{(u \rightarrow v)}(Y^{(v)}(1), \dots, Y^{(v)}(n), f^{(v \rightarrow 1)}(W^{(v \rightarrow 1)}), \dots, f^{(v \rightarrow m)}(W^{(v \rightarrow m)}))). \end{aligned}$$

Since  $\mathcal{S}(\mathcal{N})$  satisfies the causality constraints and operates precisely the mappings from  $\mathcal{S}(\underline{\mathcal{N}})$  on  $\mathcal{N}$ , the solution  $\mathcal{S}(\mathcal{N})$  achieves the same rate and error probability on  $\mathcal{N}$  as the solution  $\mathcal{S}(\underline{\mathcal{N}})$  achieves on  $\underline{\mathcal{N}}$ .

For the converse, the job is more difficult. A solution  $(\lambda, \mathcal{R})$ - $\mathcal{S}(\mathcal{N})$  needs to achieve an error probability of at most  $\lambda$  for every  $(u, v)$  pair in a network. A solution  $(\lambda, \mathcal{R})$ - $\mathcal{S}(\underline{\mathcal{N}})$  also needs to achieve an error probability of at most  $\lambda$  for each  $(u, v)$ , but here the error event is a union over errors in each of the  $N$  layers with  $N$  growing arbitrarily large.

Let  $\mathcal{R} \in \text{int}(\mathcal{R}(\mathcal{N}))$ , and fix some  $\tilde{\mathcal{R}} \in \text{int}(\mathcal{R}(\mathcal{N}))$  for which  $\tilde{\mathcal{R}}^{(u \rightarrow v)} > \mathcal{R}^{(u \rightarrow v)}$  for all  $u, v$ . We use a solution of rate  $\tilde{\mathcal{R}}$  on  $\mathcal{N}$  to build a stacked solution of rate  $\mathcal{R}$  on  $\underline{\mathcal{N}}$ . Set  $\rho = \min_{u,v} (\tilde{\mathcal{R}}^{(u \rightarrow v)} - \mathcal{R}^{(u \rightarrow v)})$ . For any  $p \in [0, 1]$ , let  $h(p) \stackrel{\text{def}}{=} -p \log p - (1-p) \log(1-p)$  be the binary entropy function. For reasons that will become clear later, we wish to find constants  $\lambda$  and  $n$  satisfying

$$\max_{u,v} \tilde{\mathcal{R}}^{(u \rightarrow v)} \lambda + h(\lambda)/n < \rho.$$

such that there exists a  $(\lambda, \tilde{\mathcal{R}})$ - $\mathcal{S}(\mathcal{N})$  solution of blocklength  $n$ . This is possible because  $\tilde{\mathcal{R}} \in \text{int}(\mathcal{R}(\mathcal{N}))$  implies that for any  $\lambda \in (0, 1]$  and all  $n$  sufficiently large there exists a blocklength- $n$   $(\lambda, \tilde{\mathcal{R}})$ - $\mathcal{S}(\mathcal{N})$  solution. We therefore meet the desired constraint by choosing  $\lambda$  to be small (say  $\lambda = \rho / (2 \max_{i,j} \tilde{\mathcal{R}}^{(u \rightarrow v)})$ ) and then choosing  $n$  sufficiently large. The chosen  $n$  will be the blocklength of our code for all values of  $N$ .

Fix a  $(\lambda, \tilde{\mathcal{R}})$ - $\mathcal{S}(\mathcal{N})$  solution of blocklength  $n$ . For the  $(\lambda, \tilde{\mathcal{R}})$ - $\mathcal{S}(\mathcal{N})$  solution, denote the message set by  $\tilde{\mathcal{W}}^{(u \rightarrow v)} \stackrel{\text{def}}{=} \{1, \dots, 2^{n\tilde{\mathcal{R}}^{(u \rightarrow v)}}\}$ , and let  $\tilde{W}^{(u \rightarrow v)}$  and  $\hat{W}^{(u \rightarrow v)}$  be the message and its reconstruction, respectively, using the fixed  $(\lambda, \tilde{\mathcal{R}})$ - $\mathcal{S}(\mathcal{N})$  solution. We use  $\mathcal{S}(\mathcal{N})$  as the solution applied independently in each layer of our stacked solution.

While solution  $\mathcal{S}(\mathcal{N})$  yields error probability no greater than  $\lambda$  in each layer of the stack, the error probability over all  $N$  layers may still be high. The stacked solution's channel codes are included to remedy this problem. For each  $(u, v)$ , the layers of the stack behave like  $N$  independent instances of channel  $(\tilde{\mathcal{W}}^{(u \rightarrow v)}, p(\hat{w}^{(u \rightarrow v)} | \check{w}^{(u \rightarrow v)}), \tilde{\mathcal{W}}^{(u \rightarrow v)})$ , where  $p(\hat{w}^{(u \rightarrow v)} | \check{w}^{(u \rightarrow v)}) = \Pr(\hat{W} = \check{w} | \check{W}^{(u \rightarrow v)} = \check{w}^{(u \rightarrow v)})$  under solution  $\mathcal{S}(\mathcal{N})$ . By assumption,  $\check{W}^{(u \rightarrow v)}$  is uniformly distributed on  $\tilde{\mathcal{W}}^{(u \rightarrow v)}$ , so this channel has mutual information

$$\begin{aligned} I(\check{W}^{(u \rightarrow v)}; \hat{W}^{(u \rightarrow v)}) &= n\tilde{R}^{(u \rightarrow v)} - H(\check{W}^{(u \rightarrow v)}; \hat{W}^{(u \rightarrow v)}) \\ &> n\tilde{R}^{(u \rightarrow v)} - (\lambda n\tilde{R}^{(u \rightarrow v)} + h(\lambda)) \end{aligned}$$

by Fano's inequality. Note that the desired rate per channel use  $nR^{(u \rightarrow v)}$  is strictly less than the channel's mutual information, precisely

$$I(\check{W}^{(u \rightarrow v)}; \hat{W}^{(u \rightarrow v)}) - nR^{(u \rightarrow v)} > n\rho - (\lambda n\tilde{R}^{(u \rightarrow v)} + h(\lambda)) > 0,$$

owing to our earlier choice of  $\lambda$  and  $n$ . We therefore design a  $(2^{N(nR^{(u \rightarrow v)})}, N)$  channel code for each  $(u, v)$  by choosing  $2^{N(nR^{(u \rightarrow v)})}$  blocklength- $N$  codewords uniformly from  $\tilde{\mathcal{W}}^{(u \rightarrow v)}$ , where  $\tilde{\mathcal{W}}^{(u \rightarrow v)} \stackrel{\text{def}}{=} (\tilde{\mathcal{W}}^{(u \rightarrow v)})^N$ . The channel encoder and channel decoder specify the mappings  $\tilde{W}^{(u \rightarrow v)}$  and  $\hat{W}^{(u \rightarrow v)}$ , respectively, for our stacked solution. Applying the strong coding theorem for discrete memoryless channels [17, Theorem 5.6.2], the expected error probability of this randomly drawn code is  $2^{-N\delta}$ . The value  $\delta$  is an increasing function of the gap  $\min_{u,v} [I(\check{W}^{(u \rightarrow v)}; \hat{W}^{(u \rightarrow v)}) - nR^{(u \rightarrow v)}]$ . Since the expected error probability (with respect to the random channel code designs for all messages  $\check{W}^{(u \rightarrow v)}$ ) decays as  $2^{-N\delta}$ , there exists a single instance of all channel codes that does at least as well. Thus the stacked solution  $\underline{\mathcal{S}}(\underline{\mathcal{N}})$  that first channel codes each message  $\check{W}^{(u \rightarrow v)}$  to  $\hat{W}^{(u \rightarrow v)}$  and then applies the blocklength- $n$  solution  $\mathcal{S}(\mathcal{N})$  independently in each layer of the stack achieves error probability no greater than  $2^{-N\delta}$  for  $N$  sufficiently large. ■

Since the proof of Theorem 1 shows that stacked solutions can obtain all rates in the interior of  $\mathcal{R}(\underline{\mathcal{N}})$ , we restrict our attention to stacked codes going forward; there is no loss of generality in this restriction.

The arguments that build on Theorem 1 later in the paper employ not the single instance of the code chosen at the end of the proof but the random code design that precedes it. This random code design is combined with a collection of other random code designs. Choosing the instances of all random codes jointly guarantees good end-to-end performance. To understand the implications of the given random

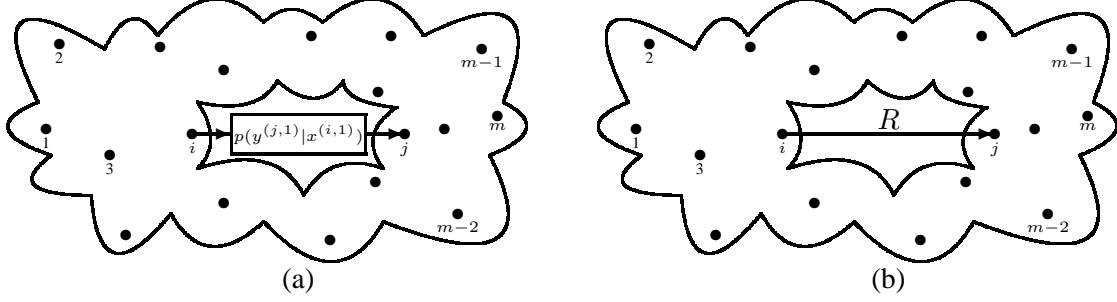

Fig. 5. (a) A network  $\mathcal{N}$  and (b) the corresponding network  $\mathcal{N}_R$  that replaces channel  $(\mathcal{X}^{(i,1)}, p(y^{(j,1)}|x^{(i,1)}), \mathcal{Y}^{(j,1)})$  by a capacity- $R$  noiseless bit pipe  $(\{0, 1\}^R, \delta(\tilde{y}^{(j,1)} - \tilde{x}^{(i,1)}), \{0, 1\}^R)$ .

code design, let

$$\begin{aligned} \underline{\mathbf{X}}_t(\ell) &\stackrel{\text{def}}{=} (\underline{X}_t^{(1)}(\ell), \dots, \underline{X}_t^{(m)}(\ell)) \\ \underline{\mathbf{Y}}_t(\ell) &\stackrel{\text{def}}{=} (\underline{Y}_t^{(1)}(\ell), \dots, \underline{Y}_t^{(m)}(\ell)) \end{aligned}$$

be the vectors of all channel inputs and all channel outputs in layer  $\ell$  of the stacked network at time  $t$ . For each  $(u, v)$ , the messages  $\underline{W}^{(u \rightarrow v)}(1), \dots, \underline{W}^{(u \rightarrow v)}(N)$  input to the stacked solution are independent and identically distributed (i.i.d.). Since each channel code's codewords are drawn from the uniform distribution on  $\underline{\mathcal{W}}^{(u \rightarrow v)}$ , the coded messages  $\tilde{\underline{W}}^{(u \rightarrow v)}(1), \dots, \tilde{\underline{W}}^{(u \rightarrow v)}(N)$  for a random code are also i.i.d. and uniform. Finally, since the solutions in the layers of  $\underline{\mathcal{N}}$  are independent and identical,

$$(\underline{\mathbf{X}}_t(1), \underline{\mathbf{Y}}_t(1)), \dots, (\underline{\mathbf{X}}_t(N), \underline{\mathbf{Y}}_t(N))$$

are also i.i.d. for each  $t$ . This structure allows us to apply typicality arguments across the layers of the network for a fixed time  $t$ .

## V. NETWORK EQUIVALENCE

The equivalence result derived in this section relates the rate region of a network

$$\mathcal{N} = \left( \mathcal{X}^{-(i,1)} \times \mathcal{X}^{(i,1)}, p(y^{(j,1)}|x^{(i,1)})p(y^{-(j,1)}|x^{-(i,1)}), \mathcal{Y}^{-(j,1)} \times \mathcal{Y}^{(j,1)} \right)$$

to that of a network  $\mathcal{N}_R$  that replaces channel  $(\mathcal{X}^{(i,1)}, p(y^{(j,1)}|x^{(i,1)}), \mathcal{Y}^{(j,1)})$  by a capacity- $R$  noiseless bit pipe, here denoted by  $(\{0, 1\}^R, \delta(\tilde{y}^{(j,1)} - \tilde{x}^{(i,1)}), \{0, 1\}^R)$ . Thus

$$\mathcal{N}_R \stackrel{\text{def}}{=} \left( \mathcal{X}^{-(i,1)} \times \{0, 1\}^R, \delta(\tilde{y}^{(j,1)} - \tilde{x}^{(i,1)})p(y^{-(j,1)}|x^{-(i,1)}), \mathcal{Y}^{-(j,1)} \times \{0, 1\}^R \right)$$



Employing a common abuse of notation, we allow non-integer values of  $R$  to designate capacitated bit pipes that require more than a single channel use to deliver some integer number of bits. Applying the stacking approach of Theorem 1, the arguments that follow transmit information over the  $N$  copies of each channel in an  $N$ -fold stacked network; thus we have channel  $(\{0, 1\}^{NR}, \delta(\underline{x}^{(i,1)} - \underline{y}^{(j,1)}), \{0, 1\}^{NR})$  in the  $N$ -fold stacked network  $\underline{\mathcal{N}}_R$ . As usual,  $N$  is allowed to grow without bound, so the transmission of  $\lfloor NR \rfloor$  bits over  $N$  channel uses achieves rate arbitrarily close to  $R$ .

Before turning to the equivalence result, we prove the continuity of capacity region  $\mathcal{R}(\underline{\mathcal{N}}_R)$  in  $R$  for all  $R > 0$ . Precisely, for any  $R > 0$  and  $\delta < R$ , we define

$$\epsilon(\delta) \stackrel{\text{def}}{=} \max_{\mathcal{R} \in \mathcal{R}(\underline{\mathcal{N}}_{R+\delta})} \min_{\tilde{\mathcal{R}} \in \mathcal{R}(\underline{\mathcal{N}}_{R-\delta})} \|\mathcal{R} - \tilde{\mathcal{R}}\|_\infty$$

to be the worst-case  $\ell_\infty$ -norm between a point in  $\mathcal{R}(\underline{\mathcal{N}}_{R+\delta})$  and its closest point in  $\mathcal{R}(\underline{\mathcal{N}}_{R-\delta})$ . We then show that for any  $\epsilon > 0$ , there exists a  $\delta > 0$  for which  $\epsilon(\delta) \leq \epsilon$ . Continuity of the rate region at  $R = 0$  remains an open problem for most networks [18], [19]. The subtle underlying question here is whether a number of bits that grows sublinearly in the coding dimension can change the network capacity.

**Lemma 2** *Rate region  $\mathcal{R}(\underline{\mathcal{N}}_R)$  is continuous in  $R$  for all  $R > 0$ .*

*Proof.* By Theorem 1 it suffices to prove that  $\mathcal{R}(\underline{\mathcal{N}}_R)$  is continuous in  $R$ . Note that  $\mathcal{R}(\underline{\mathcal{N}}_R)$  is non-decreasing in  $R$ ; that is  $\tilde{R} < R$  implies  $\mathcal{R}(\underline{\mathcal{N}}_{\tilde{R}}) \subseteq \mathcal{R}(\underline{\mathcal{N}}_R)$  since any  $(\lambda, \mathcal{R})$ - $\mathcal{S}(\underline{\mathcal{N}}_{\tilde{R}})$  solution for  $N$ -fold stacked network  $\underline{\mathcal{N}}_{\tilde{R}}$  can be run with the same error probability on  $N$ -fold stacked network  $\underline{\mathcal{N}}_R$ . Thus for any  $R > 0$  and any  $\delta \in (0, R)$ ,  $\mathcal{R}(\underline{\mathcal{N}}_{R-\delta}) \subseteq \mathcal{R}(\underline{\mathcal{N}}_R) \subseteq \mathcal{R}(\underline{\mathcal{N}}_{R+\delta})$ . Fix any  $\delta > 0$  and  $\mathcal{R} \in \text{int}(\mathcal{R}(\underline{\mathcal{N}}_{R+\delta}))$ . For any  $\lambda > 0$  and all  $N$  sufficiently large there exists a  $(\lambda, \mathcal{R})$ - $\mathcal{S}(\underline{\mathcal{N}}_{R+\delta})$  solution for the  $N$ -fold stacked network  $\underline{\mathcal{N}}_{R+\delta}$ . Recall that  $\underline{\mathcal{N}}_{R+\delta}$  and  $\underline{\mathcal{N}}_{R-\delta}$  differ only in the capacity of the bit pipe from node  $i$  to node  $j$ . Thus any solution  $\mathcal{S}(\underline{\mathcal{N}}_{R+\delta})$  that achieves error probability  $\lambda$  on  $N$ -fold stacked network  $\underline{\mathcal{N}}_{R+\delta}$  can be run with the same error probability on  $\tilde{N}$ -fold stacked network  $\underline{\mathcal{N}}_{R-\delta}$  provided

$$\tilde{N}(R - \delta) \geq N(R + \delta).$$

This is accomplished by operating solution  $\mathcal{S}(\underline{\mathcal{N}}_{R+\delta})$  unchanged across the first  $N$  copies of the channel  $(\mathcal{X}^{-(i,1)}, p(y^{-(j,1)} | x^{-(i,1)}), \mathcal{Y}^{-(j,1)})$  in  $\underline{\mathcal{N}}_{R-\delta}$  and sending the  $N(R + \delta)$  bits intended for transmission across  $N$  bit pipes of rate  $R + \delta$  in  $\underline{\mathcal{N}}_{R+\delta}$  across the  $\tilde{N}$  bit pipes of rate  $R - \delta$  in  $\underline{\mathcal{N}}_{R-\delta}$ . Set  $\tilde{N} = \lceil N(R + \delta)/(R - \delta) \rceil$ . Then the rate of the resulting code is

$$\tilde{\mathcal{R}} = \frac{\mathcal{R}N}{\tilde{N}} \geq \mathcal{R} \frac{N(R - \delta)}{N(R + \delta) + R - \delta}.$$

Since  $\mathcal{R}$  and  $R$  are fixed, the difference

$$\mathcal{R} - \tilde{\mathcal{R}} \leq \mathcal{R} \frac{2N\delta + R - \delta}{N(R + \delta) + R - \delta}.$$

can be made arbitrarily small by letting  $N$  grow and  $\delta$  approach 0. Since  $\mathcal{R}$  is arbitrary, we have the desired result. ■

The following lemma derives a lower bound on  $\mathcal{R}(\mathcal{N})$ .

**Lemma 3** Consider a pair of networks

$$\begin{aligned} \mathcal{N} &= \left( \mathcal{X}^{-(i,1)} \times \mathcal{X}^{(i,1)}, p(y^{(j,1)}|x^{(i,1)})p(y^{-(j,1)}|x^{-(i,1)}), \mathcal{Y}^{-(j,1)} \times \mathcal{Y}^{(j,1)} \right) \\ \mathcal{N}_C &= \left( \mathcal{X}^{-(i,1)} \times \{0, 1\}^C, \delta(\tilde{y}^{(j,1)} - \tilde{x}^{(i,1)})p(y^{-(j,1)}|x^{-(i,1)}), \mathcal{Y}^{-(j,1)} \times \{0, 1\}^C \right), \end{aligned}$$

where  $C = \max_{p(x^{(i,1)})} I(X^{(i,1)}; Y^{(j,1)})$  is the capacity of channel  $(\mathcal{X}^{(i,1)}, p(y^{(j,1)}|x^{(i,1)}), \mathcal{Y}^{(j,1)})$ . Then

$$\mathcal{R}(\mathcal{N}_C) \subseteq \mathcal{R}(\mathcal{N}).$$

*Proof.* The following proof shows that  $\mathcal{R}(\mathcal{N}_R) \subseteq \mathcal{R}(\mathcal{N})$  for all  $R < C$ . This shows that  $\cup_{R < C} \mathcal{R}(\mathcal{N}_R) \subseteq \mathcal{R}(\mathcal{N})$ , which gives the desired result by Lemma 2 and the closure in the definition of  $\mathcal{R}(\mathcal{N})$ . Applying Theorem 1, for each  $R < C$  we show that  $\mathcal{R}(\mathcal{N}_R) \subseteq \mathcal{R}(\mathcal{N})$  by showing that  $\mathcal{R}(\underline{\mathcal{N}}_R) \subseteq \mathcal{R}(\underline{\mathcal{N}})$ .

Fix any  $R < C$ ,  $\mathcal{R} \in \text{int}(\mathcal{R}(\underline{\mathcal{N}}_R))$ , and  $\lambda > 0$ . We first use the argument from the proof of Theorem 1 to build a sequence of rate- $\mathcal{R}$  solutions  $\underline{\mathcal{S}}(\underline{\mathcal{N}}_R)$  with error probability no greater than  $2^{-N\delta}$  for all  $N$  sufficiently large. Recall that only the channel code on the messages  $\underline{W}^{(u \rightarrow v)}$  changes with  $N$ . Thus for all  $N \geq 1$ , solution  $\underline{\mathcal{S}}(\underline{\mathcal{N}}_R)$  applies the same solution  $\mathcal{S}(\mathcal{N}_R)$  in each layer of the stack. Let  $n$  be the blocklength of code  $\mathcal{S}(\mathcal{N}_R)$  (and therefore the blocklength of  $\underline{\mathcal{S}}(\underline{\mathcal{N}}_R)$  for all  $N$ ).

Since  $R < C$ ,  $\lambda > 0$ , and  $n$  are fixed, there exists a sequence of channel codes  $\{(\alpha_N, \beta_N)\}_{N=1}^{\infty}$  for channel  $(\mathcal{X}^{(i,1)}, p(y^{(j,1)}|x^{(i,1)}), \mathcal{Y}^{(j,1)})$  with encoders  $\alpha_N$ , decoders  $\beta_N$ , and maximal error probability  $\max_{\underline{w}} \Pr(\beta_N(\underline{Y}^{(j,1)}) \neq \underline{w} | \underline{X}^{(i,1)} = \alpha_N(P_e^{(N)})) < \lambda/(2n)$  for all  $N$  sufficiently large.<sup>2</sup>

The next step is to build a solution  $\mathcal{S}(\underline{\mathcal{N}})$  for  $N$ -fold stacked network  $\underline{\mathcal{N}}$ . Solution  $\mathcal{S}(\underline{\mathcal{N}})$  operates  $\underline{\mathcal{S}}(\underline{\mathcal{N}}_R)$  across  $\underline{\mathcal{N}}$  by using channel code  $(\alpha_N, \beta_N)$  at each time  $t$  to transmit across the  $N$  copies of channel

<sup>2</sup>We here divide by  $n$  since the channel code will be applied  $n$  times, once for each instant in time for this blocklength- $n$  code. Application of the union bound then gives an error probability over these  $n$  time steps.

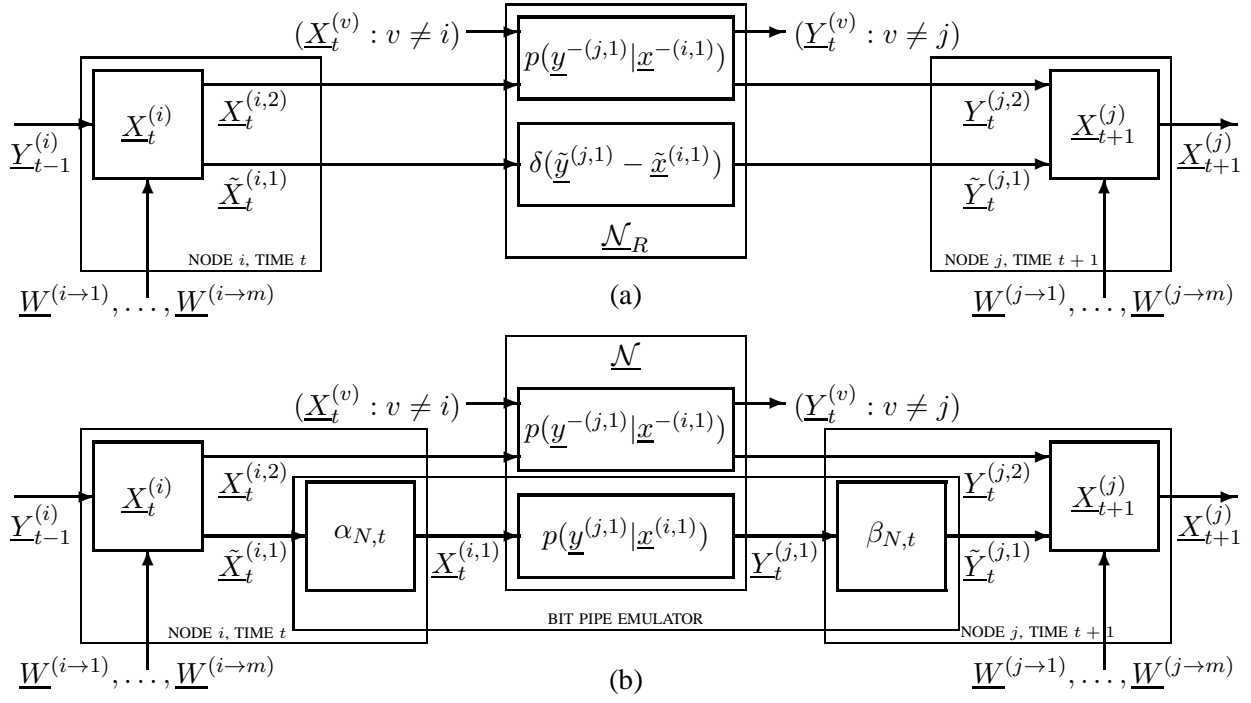

Fig. 6. Operation of node  $i$  at time  $t$  and node  $j$  at time  $t+1$  in solutions (a)  $\underline{S}(\mathcal{N}_R)$  and (b)  $\underline{S}(\mathcal{N})$ . We show the nodes at different times since the output  $\tilde{\underline{X}}_t^{(i,1)}$  from node  $i$  at time  $t$  cannot influence the encoder at node  $j$  until time  $t+1$  (due to the causality constraint).

$(\mathcal{X}^{(i,1)}, p(\underline{y}^{(j,1)} | \underline{x}^{(i,1)}), \mathcal{Y}^{(j,1)})$  in  $\mathcal{N}$ , as shown in Figure 6. Precisely, at time  $t$ , node  $v$  performs any necessary channel decoding on the channel output to give

$$\tilde{\underline{Y}}_t^{(v)} = \begin{cases} (\beta_N(\underline{Y}_t^{(j,1)}), \underline{Y}_t^{(j,2)}) & v = j \\ \underline{Y}_t^{(v)} & v \neq j, \end{cases}$$

then applies the node encoders from  $\underline{S}(\mathcal{N}_R)$  as

$$\tilde{\underline{X}}_t^{(v)} = \underline{X}_t^{(v)}(\tilde{\underline{Y}}_1^{(v)}, \dots, \tilde{\underline{Y}}_{t-1}^{(v)}, \underline{W}^{(v \rightarrow 1)}, \dots, \underline{W}^{(v \rightarrow m)}),$$

and finally applies any necessary channel encoding as

$$\underline{X}_t^{(v)} = \begin{cases} (\alpha_N(\tilde{\underline{X}}_t^{(i,1)}), \tilde{\underline{X}}_t^{(i,2)}) & \text{if } v = i \\ \tilde{\underline{X}}_t^{(v)} & \text{if } v \neq i. \end{cases}$$

before transmission across the channel. At time  $n$ , node  $v$  applies the decoder from  $\underline{S}(\mathcal{N}_R)$  to give

$$\hat{\underline{W}}^{(u \rightarrow v)} = \hat{\underline{W}}^{(u \rightarrow v)}(\tilde{\underline{Y}}_1^{(v)}, \dots, \tilde{\underline{Y}}_n^{(v)}, \underline{W}^{(v \rightarrow 1)}, \dots, \underline{W}^{(v \rightarrow m)}).$$

To bound the error probability, note that two things can go wrong. Either the channel code fails at one or more time steps or the channel code succeeds at all  $n$  time steps but the code fails anyway. If the channel code  $(\alpha_N, \beta_N)$  succeeds at all times  $t \in \{1, \dots, n\}$ , then the conditional probability of an error given  $\underline{W} = \underline{w}$  is precisely what it would have been for the original code. Let  $E_t$  denote the event that the channel code fails at time  $t$ . Then we bound the error probability as

$$\begin{aligned} \Pr(\hat{W} \neq W) &\stackrel{(a)}{\leq} \sum_{t=1}^n \Pr(E_t) + \sum_{\underline{w}} \Pr(\hat{W} \neq \underline{w} | \{\underline{W} = \underline{w}\} \cap \cap_{t=1}^n E_t^c) \Pr(\{\underline{W} = \underline{w}\} \cap \cap_{t=1}^n E_t^c) \\ &\stackrel{(b)}{\leq} \left( \sum_{t=1}^n \frac{\lambda}{2n} \right) + 2^{-N\delta}, \end{aligned}$$

which is less than  $\lambda$  for all  $N$  sufficiently large. Inequality (a) follows from the union bound. Inequality (b) follows from the error probability bound for the channel code and from the observation that  $\Pr(\{\underline{W} = \underline{w}\} \cap \cap_{t=1}^n E_t^c) \leq \Pr(\underline{W} = \underline{w})$  for all  $\underline{w}$ . ■

Lemma 3 applies channel coding to emulate a noiseless bit pipe  $(\{0, 1\}^R, \delta(\tilde{y}^{(j,1)} | \tilde{x}^{(i,1)}), \{0, 1\}^R)$  across a noisy channel  $(\mathcal{X}^{(i,1)}, p(y^{(j,1)} | x^{(i,1)}), \mathcal{Y}^{(j,1)})$  so that a code for  $\mathcal{N}_R$  can be run across  $\mathcal{N}$  with the aid of the channel code. Theorem 4 employs a code that emulates noisy channel  $(\mathcal{X}^{(i,1)}, p(y^{(j,1)} | x^{(i,1)}), \mathcal{Y}^{(j,1)})$  across noiseless bit pipe  $(\{0, 1\}^R, \delta(\tilde{y}^{(j,1)} | \tilde{x}^{(i,1)}), \{0, 1\}^R)$  so that a code for  $\mathcal{N}$  can be run across  $\mathcal{N}_R$  with similar error probability.

**Theorem 4** Consider a pair of networks

$$\begin{aligned} \mathcal{N} &= \left( \mathcal{X}^{-(i,1)} \times \mathcal{X}^{(i,1)}, p(y^{(j,1)} | x^{(i,1)}) p(y^{-(j,1)} | x^{-(i,1)}), \mathcal{Y}^{-(j,1)} \times \mathcal{Y}^{(j,1)} \right) \\ \mathcal{N}_R &= \left( \mathcal{X}^{-(i,1)} \times \{0, 1\}^R, \delta(\tilde{y}^{(j,1)} - \tilde{x}^{(i,1)}) p(y^{-(j,1)} | x^{-(i,1)}), \mathcal{Y}^{-(j,1)} \times \{0, 1\}^R \right), \end{aligned}$$

where  $(\mathcal{X}^{(i,1)}, p(y^{(j,1)} | x^{(i,1)}), \mathcal{Y}^{(j,1)})$  is a channel of capacity  $C \stackrel{\text{def}}{=} \max_{p(x^{(i,1)})} I(X^{(i,1)}; Y^{(j,1)})$ .

If  $R > C$ , then

$$\mathcal{R}(\mathcal{N}) \subseteq \mathcal{R}(\mathcal{N}_R).$$

*Proof.* By Theorem 1 it suffices to show that  $\mathcal{R}(\underline{\mathcal{N}}) \subseteq \mathcal{R}(\underline{\mathcal{N}}_R)$ . Fix an arbitrary point  $\mathcal{R} \in \text{int}(\mathcal{R}(\underline{\mathcal{N}}))$  and any  $\lambda > 0$ . The argument that follows shows that for all  $N$  sufficiently large there exists a  $(\lambda, \mathcal{R})$  solution  $\mathcal{S}(\underline{\mathcal{N}}_R)$  for  $N$ -fold stacked network  $\underline{\mathcal{N}}_R$ . We first define a random code design algorithm and bound the expected error probability with respect to the random design. This random design includes random selection of  $m(m-1)$  channel codes and random design of channel emulators for each time step. In order

to ensure good end-to-end performance, we do not choose a single instance of any of the randomly designed codes until all of the codes are in place. At that point, we choose all codes simultaneously.

Step 1 - Choose code  $\mathcal{S}(\mathcal{N})$  and define distributions  $p_t(x^{(i,1)}, y^{(j,1)})$ :

Recall from the proof of Theorem 1 that there exists a rate- $\mathcal{R}$  solution  $\mathcal{S}(\mathcal{N})$  of some finite blocklength  $n$  from which good stacked solutions  $\underline{\mathcal{S}}(\underline{\mathcal{N}})$  for  $N$ -fold stacked network  $\underline{\mathcal{N}}$  can be built for all  $N$  sufficiently large. The stacked solution applies an independent random channel code to each message  $\underline{W}^{(u \rightarrow v)}$  and then applies  $\mathcal{S}(\mathcal{N})$  independently in each layer of  $\underline{\mathcal{N}}$ . Taking an expectation over the random channel code designs yields expected error probability no larger than  $2^{-N\delta}$  for all  $N$  sufficiently large. We therefore begin by fixing a solution  $\mathcal{S}(\mathcal{N})$  as in Theorem 1 and building the corresponding stacked solution  $\underline{\mathcal{S}}(\underline{\mathcal{N}})$ . For each  $t \in \{1, \dots, n\}$ , let  $p_t(x^{(i,1)})$  be the distribution established on the input to channel  $(\mathcal{X}^{(i,1)}, p(y^{(j,1)}|x^{(i,1)}), \mathcal{Y}^{(j,1)})$  at time  $t$  by solution  $\mathcal{S}(\mathcal{N})$ . Distribution  $p_t(x^{(i,1)})$  may vary with  $t$  due, for example, to feedback in the network. Then  $p_t(\underline{x}^{(i,1)}, \underline{y}^{(j,1)}) \stackrel{\text{def}}{=} \prod_{\ell=1}^N p_t(\underline{x}^{(i,1)}(\ell))p(\underline{y}^{(j,1)}(\ell)|\underline{x}^{(i,1)}(\ell))$  is the time- $t$  distribution across  $(\underline{\mathcal{X}}^{(i,1)}, p(\underline{y}^{(j,1)}|\underline{x}^{(i,1)}), \underline{\mathcal{Y}}^{(j,1)})$  under solution  $\underline{\mathcal{S}}(\underline{\mathcal{N}})$ .

Step 2 - Typical set definitions and properties:

Let  $\epsilon = (\epsilon(1), \dots, \epsilon(n))$  be a vector of positive constants,<sup>3</sup> and for each  $t$  define

$$A_{\epsilon,t}^{(N)} \stackrel{\text{def}}{=} \left\{ (\underline{x}^{(i,1)}, \underline{y}^{(j,1)}) \in \underline{\mathcal{X}}^{(i,1)} \times \underline{\mathcal{Y}}^{(j,1)} : \right. \\ \left| -\frac{1}{N} \log p_t(\underline{x}^{(i,1)}) - H(X_t^{(i,1)}) \right| \leq \epsilon(t) \\ \left| -\frac{1}{N} \log p_t(\underline{y}^{(j,1)}) - H(Y_t^{(j,1)}) \right| \leq a(\epsilon, t) \\ \left. \left| -\frac{1}{N} \log p_t(\underline{x}^{(i,1)}, \underline{y}^{(j,1)}) - H(X_t^{(i,1)}, Y_t^{(j,1)}) \right| \leq a(\epsilon, t) \right\},$$

where  $H(X_t^{(i,1)})$ ,  $H(Y_t^{(j,1)})$ , and  $H(X_t^{(i,1)}, Y_t^{(j,1)})$  are the entropies on  $X_t^{(i,1)}$ ,  $Y_t^{(j,1)}$ , and  $(X_t^{(i,1)}, Y_t^{(j,1)})$  under  $p_t(x^{(i,1)}, y^{(j,1)})$ ,<sup>4</sup> and

$$a(\epsilon, t) \stackrel{\text{def}}{=} (1 + \epsilon(t)) \cdot \inf \left\{ \epsilon' > 0 : \Pr \left( \left| -\frac{1}{N} \log p_t(\underline{Y}_t^{(j,1)}) - H(Y_t^{(j,1)}) \right| > \epsilon' \vee \right. \right. \\ \left. \left. \left| -\frac{1}{N} \log p_t(\underline{X}_t^{(i,1)}, \underline{Y}_t) - H(X_t^{(i,1)}, Y_t^{(j,1)}) \right| > \epsilon' \right) \leq 2^{-N6\epsilon(t)} \text{ for all } N \text{ sufficiently large} \right\}. \quad (3)$$

<sup>3</sup>Our parameter choice in the typical set definition varies with  $t$  both to accommodate variation in  $p_t(x^{(i,1)}, y^{(j,1)})$  and to handle the cumulative impact of channel emulation at multiple time steps.

<sup>4</sup>We use notation  $H(\cdot)$  for both discrete and differential entropy. We assume that  $H(X_t^{(i,1)}, Y_t^{(j,1)}) < \infty$ .

(This infimum is shown to be well defined in the proof of Lemma 6 in Appendix I.) Define set

$$\hat{A}_{\epsilon,t}^{(N)} \stackrel{\text{def}}{=} \left\{ (\underline{x}^{(i,1)}, \underline{y}^{(j,1)}) \in A_{\epsilon,t}^{(N)} : p \left( (A_{\epsilon,t}^{(N)})^c \mid \underline{x}^{(i,1)} \right) \leq 2^{-3N\epsilon(t)} \right\},$$

where  $p_t((A_{\epsilon,t}^{(N)})^c \mid \underline{x}^{(i,1)}) \stackrel{\text{def}}{=} \sum_{\underline{y}^{(j,1)}: (\underline{x}^{(i,1)}, \underline{y}^{(j,1)}) \notin \hat{A}_{\epsilon,t}^{(N)}} p(\underline{y}^{(j,1)} \mid \underline{x}^{(i,1)})$ . We henceforth call  $\hat{A}_{\epsilon,t}^{(N)}$  the typical set. This typical set definition restricts attention to those typical channel inputs  $\underline{x}^{(i,1)}$  that are most likely to yield jointly typical channel outputs. This restriction is later useful for showing that the number of jointly typical channel outputs for each typical channel input is roughly the same. Such a result could be obtained more directly for finite-alphabet channels if we used strong typicality, but we here treat the general case.

Lemma 6 in Appendix 6 shows that

$$p_t((\hat{A}_{\epsilon,t}^{(N)})^c) < 2^{-Nc(\epsilon,t)} \quad (4)$$

for some constant  $c(\epsilon, t)$  that goes to zero as  $\epsilon(t)$  goes to zero and grows large as  $\epsilon(t)$  grows large.

### Step 3 - Design of channel emulators:

We next design codes  $(\alpha_{N,t}, \beta_{N,t})$ ,  $t \in \{1, \dots, n\}$ . The goal of the code design is to build a collection of devices for emulating  $N$  independent uses of channel  $(\mathcal{X}^{(i,1)}, p(y^{(j,1)} \mid x^{(i,1)}), \mathcal{Y}^{(j,1)})$  over  $N$  independent uses of bit pipe  $(\{0, 1\}^R, \delta(\tilde{y}^{(j,1)} - \tilde{x}^{(i,1)}), \{0, 1\}^R)$ . The code for time  $t$  emulates the channel under input distribution  $p_t(\underline{x}^{(i,1)})$ . Code  $(\alpha_{N,t}, \beta_{N,t})$  has encoder  $\alpha_{N,t} : \mathcal{X}^{(i,1)} \rightarrow \{0, 1\}^{NR}$  and decoder  $\beta_{N,t} : \{0, 1\}^{NR} \rightarrow \mathcal{Y}^{(j,1)}$ . Thus  $(\alpha_{N,t}, \beta_{N,t})$  is effectively a lossy source code with rate  $R$  and blocklength  $N$ . This source code differs from traditional source codes in that a good reproduction is not a value  $\hat{X}_t^{(i,1)}$  that reproduces  $\underline{X}_t^{(i,1)}$  to low distortion but a value  $\underline{Y}_t^{(j,1)}$  that is similar statistically to the vector of outputs observed when  $\underline{X}_t^{(i,1)}$  is transmitted across  $(\underline{x}^{(i,1)}, p(y^{(j,1)} \mid \underline{x}^{(i,1)}), \underline{y}^{(j,1)})$ . Since the channel usually maps typical inputs to jointly typical outputs, we design our source code to do the same.

First, randomly design decoder  $\beta_{N,t} : \{1, \dots, 2^{NR}\} \rightarrow \mathcal{Y}^{(j,1)}$  by drawing codewords

$$\beta_{N,t}(1), \dots, \beta_{N,t}(2^{NR}) \sim \text{i.i.d. } p_t(\underline{y}^{(j,1)}). \quad (5)$$

Then, design encoder  $\alpha_{N,t} : \mathcal{X}^{(i,1)} \rightarrow \{1, \dots, 2^{NR}\}$  as

$$\alpha_{N,t}(\underline{x}^{(i,1)}) = \begin{cases} k & \text{if } (\underline{x}^{(i,1)}, \beta_{N,t}(k)) \in \hat{A}_{\epsilon,t}^{(N)} \\ 1 & \text{if } \nexists k \text{ s.t. } (\underline{x}^{(i,1)}, \beta_{N,t}(k)) \in \hat{A}_{\epsilon,t}^{(N)}. \end{cases} \quad (6)$$

When there is more than one index  $k$  for which  $(\underline{x}^{(i,1)}, \beta_{N,t}(k)) \in \hat{A}_{\epsilon,t}^{(N)}$ , the encoder design chooses uniformly at random among them.

### Step 4 - Definition of solution $\mathcal{S}(\underline{\mathcal{N}}_R)$ :

The next step is to employ codes  $\{(\alpha_{N,t}, \beta_{N,t})\}_{t=1}^n$  to operate  $\underline{\mathcal{S}}(\underline{\mathcal{N}})$  across network  $\underline{\mathcal{N}}_R$ . We begin with an

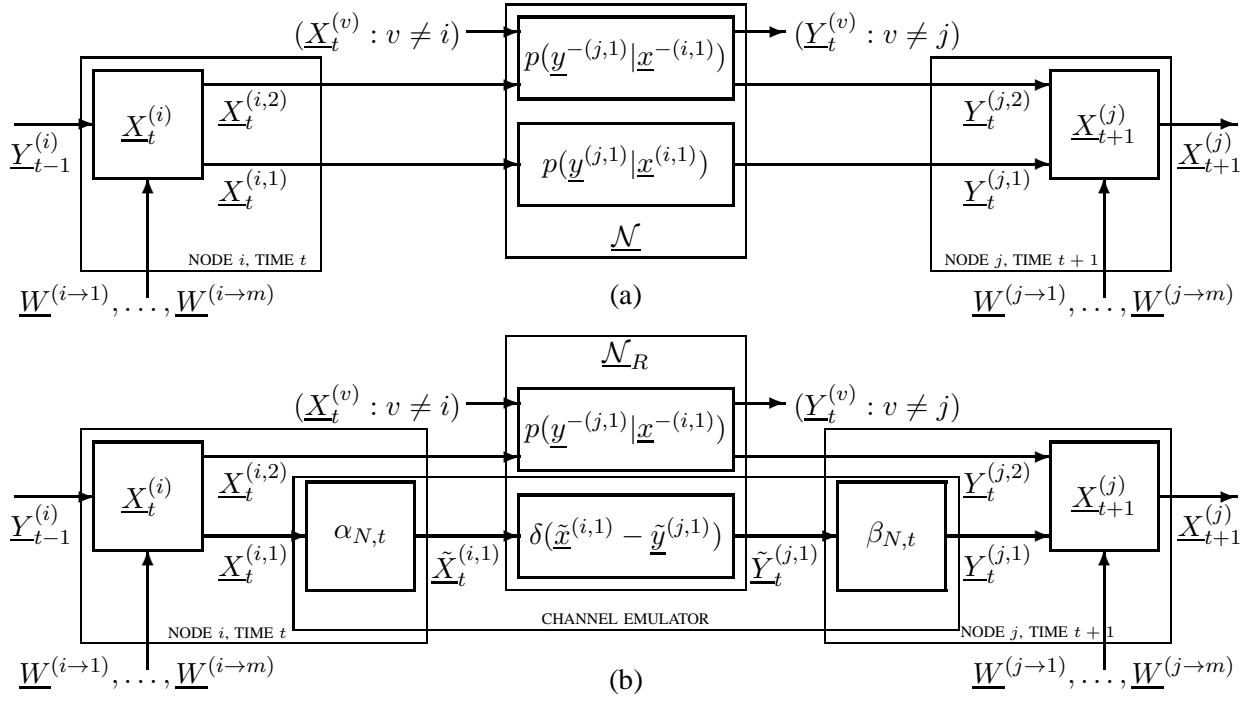

Fig. 7. Operation of node  $i$  at time  $t$  and node  $j$  at time  $t+1$  in solutions (a)  $\underline{S}(\underline{N})$  and (b)  $\underline{S}(\underline{N}_R)$ . We show the nodes at different times since the output  $\underline{X}_t^{(i,1)}$  from node  $i$  at time  $t$  cannot influence the encoder at node  $j$  until time  $t+1$  (due to the causality constraint).

informal description of the resulting code, here denoted by  $\underline{S}(\underline{N}_R)$ . For each node  $v \notin \{i, j\}$ , the operation of node  $v$  in  $\underline{S}(\underline{N}_R)$  is identical to the operation of node  $v$  in  $\underline{S}(\underline{N})$ . Node  $i$  applies its node encoder from  $\underline{S}(\underline{N})$  as usual and then source codes the resulting channel input transmission; the node decoder at node  $i$  is unchanged. Node  $j$  source decodes the bit-pipe output before applying its usual encoder and decoder from  $\underline{S}(\underline{N})$ . Figure 7 illustrates these operations, defined formally below.

For each  $v \in V$  and  $t \in \{1, \dots, n\}$ , let  $\tilde{\underline{Y}}_t^{(v)}$  be the time- $t$  channel output at node  $v$  in  $\underline{S}(\underline{N}_R)$ . Each node  $v$  applies its node encoder as

$$\underline{X}_t^{(v)} = \underline{X}_t^{(v)}(\underline{Y}_1^{(v)}, \dots, \underline{Y}_{t-1}^{(v)}, \underline{W}^{(v \rightarrow 1)}, \dots, \underline{W}^{(v \rightarrow m)}),$$

which it encodes (if necessary) as

$$\tilde{\underline{X}}_t^{(v)} = \begin{cases} (\alpha_{N,t}(\underline{X}_t^{(i,1)}), \underline{X}_t^{(i,2)}) & \text{if } v = i \\ \underline{X}_t^{(v)} & \text{if } v \neq i. \end{cases}$$

TABLE I  
SUMMARY OF NOTATION FOR SOLUTION  $\underline{\mathcal{S}}(\underline{\mathcal{N}}_R)$

Variable	Meaning
$\mathcal{S}(\mathcal{N})$	solution used in each layer of $\underline{\mathcal{S}}(\underline{\mathcal{N}})$
$n$	blocklength of solutions $\mathcal{S}(\mathcal{N})$ and $\underline{\mathcal{S}}(\underline{\mathcal{N}})$
$\underline{W} = (\underline{W}^{(u \rightarrow v)} : (u, v) \in \{1, \dots, m\})$	messages
$\underline{\mathbf{X}}_t = (\underline{X}^{(v)} : v \in \{1, \dots, m\})$	network inputs at time $t$
$\underline{\mathbf{Y}}_t = (\underline{Y}^{(v)} : v \in \{1, \dots, m\})$	network outputs at time $t$
$\hat{\underline{W}} = (\hat{\underline{W}}^{(u \rightarrow v)} : (u, v) \in \{1, \dots, m\})$	reconstruction of messages

before transmission. Here  $\underline{Y}_t^{(v)}$  designates the channel output after any necessary decoding, giving

$$\underline{Y}_t^{(v)} = \begin{cases} (\beta_{N,t}(\tilde{\underline{Y}}_t^{(j,1)}), \tilde{\underline{Y}}_t^{(j,2)}) & \text{if } v = j \\ \tilde{\underline{Y}}_t^{(v)} & \text{if } v \neq j. \end{cases}$$

Finally, node  $v$  applies the decoders from  $\underline{\mathcal{S}}(\underline{\mathcal{N}})$  as

$$\hat{\underline{W}}^{(u \rightarrow v)} = \hat{\underline{W}}^{(u \rightarrow v)}(\underline{Y}_1^{(v)}, \dots, \underline{Y}_n^{(v)}, \underline{W}^{(v \rightarrow 1)}, \dots, \underline{W}^{(v \rightarrow m)}).$$

Solution  $\mathcal{S}(\underline{\mathcal{N}}_R)$  is not a stacked solution since each  $(\alpha_{N,t}, \beta_{N,t})$  operates across the layers of the stack.

#### Step 5 - Characterizing the behavior of $\mathcal{S}(\underline{\mathcal{N}}_R)$ :

In order to analyze the error probability of code  $\mathcal{S}(\underline{\mathcal{N}}_R)$  we first characterize its statistical behavior. Table I summarizes the random variables used in the definition of the solution  $\underline{\mathcal{S}}(\underline{\mathcal{N}})$  from which  $\mathcal{S}(\underline{\mathcal{N}}_R)$  is built.

Applying solution  $\underline{\mathcal{S}}(\underline{\mathcal{N}})$  on  $N$ -fold stacked network  $\underline{\mathcal{N}}$  yields joint distribution

$$p(\underline{w}, \underline{\mathbf{x}}^n, \underline{\mathbf{y}}^n, \hat{\underline{w}}) = p(\underline{w}) \left[ \prod_{t=1}^n p(\underline{\mathbf{x}}_t | \underline{\mathbf{y}}^{t-1}, \underline{w}) \right] \left[ \prod_{t=1}^n p(\underline{\mathbf{y}}_t | \underline{\mathbf{x}}_t) \right] p(\hat{\underline{w}} | \underline{w}, \underline{\mathbf{y}}^n).$$

Here  $p(\underline{w})$  is the distribution on messages;  $p(\underline{\mathbf{x}}_t | \underline{\mathbf{y}}^{t-1}, \underline{w})$  results from the operation of all node encoders at time  $t$ , each of which maps its received channel outputs and outgoing messages to channel inputs;  $p(\underline{\mathbf{y}}_t | \underline{\mathbf{x}}_t)$  is the memoryless channel distribution; and  $p(\hat{\underline{w}} | \underline{w}, \underline{\mathbf{y}}^n)$  results from the operation of all node decoders, each of which maps its received channel outputs and outgoing messages to reproductions of its incoming messages. Here  $p(\underline{\mathbf{x}}_t | \underline{\mathbf{y}}^{t-1}, \underline{w})$  and  $p(\hat{\underline{w}} | \underline{w}, \underline{\mathbf{y}}^n)$  capture both the distribution over channel codes and the deterministic operation of the node encoders from  $\mathcal{S}(\underline{\mathcal{N}})$ .

The corresponding distribution for solution  $\mathcal{S}(\underline{\mathcal{N}}_R)$  on  $\underline{\mathcal{N}}_R$  is similar. In particular, since the distribution on messages is given and we employ all of the same codes, distributions  $p(\underline{w})$ ,  $p(\underline{\mathbf{x}}_t | \underline{\mathbf{y}}^{t-1}, \underline{w})$ , and



$p(\hat{\underline{w}}|\underline{w}, \underline{y}^n)$  remain unchanged. The only difference between  $\underline{\mathcal{S}}(\underline{\mathcal{N}})$  and  $\mathcal{S}(\underline{\mathcal{N}}_R)$  is the replacement of channel  $(\underline{\mathcal{X}}^{(i,1)}, p(\underline{y}^{(j,1)}|\underline{x}^{(i,1)}), \underline{\mathcal{Y}}^{(j,1)})$  by the random channel emulator. Thus at time  $t$ , solution  $\mathcal{S}(\underline{\mathcal{N}}_R)$  replaces the channel distribution

$$p(\underline{y}^{(j,1)}|\underline{x}^{(i,1)}) = \prod_{\ell=1}^N p(\underline{y}^{(j,1)}(\ell)|\underline{x}^{(i,1)}(\ell))$$

by the emulation distribution

$$\hat{p}_t(\underline{y}^{(j,1)}|\underline{x}^{(i,1)}) \stackrel{\text{def}}{=} \Pr(\beta_{N,t}(\alpha_{N,t}(\underline{x}^{(i,1)})) = \underline{y}^{(j,1)}).$$

(Note that the channel emulator eventually applied is a deterministic source code. The given distribution reflects only the random code design.) Thus  $\mathcal{S}(\underline{\mathcal{N}}_R)$  achieves distribution

$$\hat{p}(\underline{w}, \underline{\mathbf{x}}^n, \underline{\mathbf{y}}^n, \hat{\underline{w}}) = p(\underline{w}) \left[ \prod_{t=1}^n p(\underline{\mathbf{x}}_t|\underline{\mathbf{y}}^{t-1}, \underline{w}) \right] \left[ \prod_{t=1}^n \hat{p}_t(\underline{y}_t^{(j,1)}|\underline{x}_t^{(i,1)}) p(\underline{y}^{-(j,1)}|\underline{x}^{-(i,1)}) \right] p(\hat{\underline{w}}|\underline{w}, \underline{\mathbf{y}}^n). \quad (7)$$

In general,  $\hat{p}_t(\underline{y}^{(j,1)}|\underline{x}^{(i,1)})$  will not be precisely equal to the channel distribution  $p(\underline{y}^{(j,1)}|\underline{x}^{(i,1)})$  that it was designed to emulate. Lemma 9 in Appendix II shows

$$\hat{p}_t(\underline{y}^{(j,1)}|\underline{x}^{(i,1)}) \leq p(\underline{y}^{(j,1)}|\underline{x}^{(i,1)}) 2^{N(4a(\epsilon,t)+2\epsilon(t)+1/N)} \quad (8)$$

for all  $(\underline{x}_t^{(i,1)}, \underline{y}_t^{(j,1)}) \in \hat{A}_{\epsilon,t}^{(N)}$ . Let

$$\hat{p}_t((\hat{A}_{\epsilon,t}^{(N)})^c|\underline{x}_t^{(i,1)}) \stackrel{\text{def}}{=} \Pr((\underline{X}_t^{(i,1)}, \underline{Y}_t^{(j,1)}) \notin \hat{A}_{\epsilon,t}^{(N)} | \underline{X}_t^{(i,1)} = \underline{x}_t^{(i,1)})$$

denote the conditional probability that  $(\underline{X}_t^{(i,1)}, \underline{Y}_t^{(j,1)}) \notin \hat{A}_{\epsilon,t}^{(N)}$  given  $\underline{X}_t^{(i,1)} = \underline{x}_t^{(i,1)}$  under operation of code  $\mathcal{S}(\underline{\mathcal{N}}_R)$ . Using a proof similar to that for the rate-distortion theorem, Lemma 10 in Appendix III shows

$$\hat{p}_t((\hat{A}_{\epsilon,t}^{(N)})^c|\underline{x}_t^{(i,1)}) \leq p_t((\hat{A}_{\epsilon,t}^{(N)})^c|\underline{x}_t^{(i,1)}) + e^{-2^{N(R-I(\underline{X}_t^{(i,1)}, \underline{Y}_t^{(j,1)})) - 2a(\epsilon,t) - \epsilon(t)}}. \quad (9)$$

#### Step 6 - Bounding the expected error probability:

The following error analysis relies on both probabilities resulting from the operation of  $\underline{\mathcal{S}}(\underline{\mathcal{N}})$  on  $\underline{\mathcal{N}}$  and probabilities resulting from the operation of random code  $\mathcal{S}(\underline{\mathcal{N}}_R)$  on  $\underline{\mathcal{N}}_R$ . To avoid confusion between the two, we use  $\Pr$  in the former case and  $\widehat{\Pr}$  in the latter case.

Define

$$B_t^{(N)} \stackrel{\text{def}}{=} \left\{ (\underline{x}^{(i,1)}, \underline{y}^{(j,1)}) : \Pr \left( \hat{\underline{W}} \neq \underline{W} \mid (\underline{X}_t^{(i,1)}, \underline{Y}_t^{(j,1)}) = (\underline{x}^{(i,1)}, \underline{y}^{(j,1)}) \right) \geq 2^{-N\delta/2} \right\} \quad (10)$$

to be the set of input-output pairs on channel  $(\underline{\mathcal{X}}^{(i,1)}, p(\underline{y}^{(j,1)}|\underline{x}^{(i,1)}), \underline{\mathcal{Y}}^{(j,1)})$  at time  $t$  that are most likely to lead to errors in the operation of  $\underline{\mathcal{S}}(\underline{\mathcal{N}})$  on  $\underline{\mathcal{N}}$ ; we think of  $B_t^{(N)}$  as the ‘‘bad’’ set. For each  $t \in \{1, \dots, n\}$  we treat  $(\underline{X}_t^{(i,1)}, \underline{Y}_t^{(j,1)}) \notin \hat{A}_{\epsilon,t}^{(N)} \setminus B_t^{(N)}$  as an error event. We therefore define  $G_t \subseteq (\underline{\mathcal{X}}^{(i,1)} \times \underline{\mathcal{Y}}^{(j,1)})^n$  as

$$G_t \stackrel{\text{def}}{=} \cup_{t'=1}^t \{(\underline{X}_{t'}^{(i,1)}, \underline{Y}_{t'}^{(j,1)}) \in \hat{A}_{\epsilon,t'}^{(N)} \setminus B_{t'}^{(N)}\} \text{ for each } t \in \{1, \dots, n\}$$

and  $G_0 \stackrel{\text{def}}{=} (\underline{\mathcal{X}}^{(i,1)} \times \underline{\mathcal{Y}}^{(j,1)})^n$  to be the event that none of these error events has occurred in the first  $t$  time steps; we think of each  $G_t$  as a “good” set since it describes the event that channel input-output pairs up to time  $t$  were typical and not “bad.” Since  $(G_n)^c = \cup_{t=1}^n ((G_{t-1} \cap (\hat{A}_{\epsilon,t}^{(N)})^c) \cup (G_{t-1} \cap \hat{A}_{\epsilon,t}^{(N)} \cap B_t^{(N)}))$ , the union bound gives

$$\widehat{\Pr}(\underline{W} \neq \hat{\underline{W}}) \leq \sum_{t=1}^n \left[ \widehat{\Pr}(G_{t-1} \cap (\hat{A}_{\epsilon,t}^{(N)})^c) + \widehat{\Pr}(G_{t-1} \cap \hat{A}_{\epsilon,t}^{(N)} \cap B_t^{(N)}) \right] + \widehat{\Pr}(G_n \cap \{\underline{W} \neq \hat{\underline{W}}\}).$$

This is an expected error probability since  $\widehat{\Pr}(\cdot)$  captures the random code design in addition to the random message choice and random action of the channel  $(\underline{\mathcal{X}}^{-(i,1)}, p(\underline{y}^{-(j,1)}|\underline{x}^{-(i,1)}), \underline{\mathcal{Y}}^{-(j,1)})$ . To bound the first two terms in this sum, note that by (7) and (8),

$$\begin{aligned} & \widehat{\Pr}(G_{t-1} \cap \{\underline{X}_t^{(i,1)} = \underline{x}^{(i,1)}\}) \\ & \leq \sum_{(\underline{w}, \underline{\mathbf{x}}^{t-1}, \underline{\mathbf{y}}^{t-1}, \underline{\mathbf{x}}_t^{-(i,1)}): (\underline{\mathbf{x}}_{t'}^{(i,1)}, \underline{\mathbf{y}}_{t'}^{(j,1)}) \in \hat{A}_{\epsilon,t}^{(N)} \quad \forall t' < t} p(\underline{w}) \left[ \prod_{t'=1}^t p(\underline{\mathbf{x}}_{t'} | \underline{\mathbf{y}}_{t'}^{t'-1}, \underline{w}) \right] \\ & \quad \cdot \left[ \prod_{t'=1}^{t-1} \hat{p}_t(\underline{\mathbf{y}}_{t'}^{(j,1)} | \underline{\mathbf{x}}_{t'}^{(i,1)}) p(\underline{\mathbf{y}}_{t'}^{-(j,1)} | \underline{\mathbf{x}}_{t'}^{-(i,1)}) \right] \\ & \leq \sum_{(\underline{w}, \underline{\mathbf{x}}^{t-1}, \underline{\mathbf{y}}^{t-1}, \underline{\mathbf{x}}_t^{-(i,1)}): (\underline{\mathbf{x}}_{t'}^{(i,1)}, \underline{\mathbf{y}}_{t'}^{(j,1)}) \in \hat{A}_{\epsilon,t}^{(N)} \quad \forall t' < t} 2^{N \sum_{t'=1}^{t-1} (4a(\epsilon, t') + 2\epsilon(t') + 1/N)} p(\underline{w}, \underline{\mathbf{x}}^t, \underline{\mathbf{y}}^{t-1}) \\ & \leq 2^{N \sum_{t'=1}^{t-1} (4a(\epsilon, t') + 2\epsilon(t') + 1/N)} p_t(\underline{x}^{(i,1)}) \end{aligned} \tag{11}$$

for each  $\underline{x}^{(i,1)} \in \underline{\mathcal{X}}^{(i,1)}$ . This bound captures how the input distribution to node  $i$  at time  $t$  is affected by the replacement of the channel by its emulator in all previous time steps. Applying (9), (11), and (4) gives

$$\begin{aligned} & \widehat{\Pr}(G_{t-1} \cap (\hat{A}_{\epsilon,t}^{(N)})^c) \\ & = \sum_{\underline{x}^{(i,1)} \in \underline{\mathcal{X}}^{(i,1)}} \widehat{\Pr}(G_{t-1} \cap \{\underline{X}_t^{(i,1)} = \underline{x}^{(i,1)}\}) \hat{p}_t((\hat{A}_{\epsilon,t}^{(N)})^c | \underline{x}^{(i,1)}) \\ & \leq \left[ \sum_{\underline{x}^{(i,1)} \in \underline{\mathcal{X}}^{(i,1)}} \widehat{\Pr}(G_{t-1} \cap \{\underline{X}_t^{(i,1)} = \underline{x}^{(i,1)}\}) p_t((\hat{A}_{\epsilon,t}^{(N)})^c | \underline{x}^{(i,1)}) \right] + e^{-2^{N(R-I(X_t^{(i,1)}; Y_t^{(j,1)})) - 2a(\epsilon, t) - \epsilon(t)}} \\ & \leq \sum_{\underline{x}^{(i,1)} \in \underline{\mathcal{X}}^{(i,1)}} 2^{N \sum_{t'=1}^{t-1} (4a(\epsilon, t') + 2\epsilon(t') + 1/N)} p_t(\underline{x}^{(i,1)}) p_t((\hat{A}_{\epsilon,t}^{(N)})^c | \underline{x}^{(i,1)}) + e^{-2^{N(R-I(X_t^{(i,1)}; Y_t^{(j,1)})) - 2a(\epsilon, t) - \epsilon(t)}} \\ & \leq 2^{-N(c(\epsilon, t) - \sum_{t'=1}^{t-1} (4a(\epsilon, t') + 2\epsilon(t') + 1/N))} + e^{-2^{N(R-I(X_t^{(i,1)}; Y_t^{(j,1)})) - 2a(\epsilon, t) - \epsilon(t)}}. \end{aligned} \tag{12}$$

To bound  $\widehat{\Pr}(G_{t-1} \cap \hat{A}_{\epsilon,t}^{(N)} \cap B_t^{(N)})$ , recall that for all  $N$  is sufficiently large  $\underline{\mathcal{S}}(\underline{\mathcal{N}})$  is a  $(2^{-N\delta}, \mathcal{R})$  solution for  $\underline{\mathcal{N}}$  and that there are fewer than  $m^2$  messages to transmit. Thus for solution  $\underline{\mathcal{S}}(\underline{\mathcal{N}})$  on  $\underline{\mathcal{N}}$ ,  $\Pr(\hat{\underline{W}} \neq$

$\underline{W}) < m^2 2^{-N\delta}$  by the union bound, giving

$$\begin{aligned}
m^2 2^{-N\delta} &> \Pr(\underline{\hat{W}} \neq \underline{W}) \\
&\geq \sum_{(\underline{x}^{(i,1)}, \underline{y}^{(j,1)}) \in B_t^{(N)}} p_t(\underline{x}^{(i,1)}, \underline{y}^{(j,1)}) \Pr(\underline{\hat{W}} \neq \underline{W} | (\underline{x}^{(i,1)}, \underline{y}^{(j,1)})) \\
&\geq 2^{-N\delta/2} p_t(B_t^{(N)}),
\end{aligned}$$

which implies  $p_t(B_t^{(N)}) < m^2 2^{-N\delta/2}$  on  $\underline{\mathcal{N}}$ . Thus for solution  $\mathcal{S}(\underline{\mathcal{N}}_R)$  on  $\underline{\mathcal{N}}_R$ ,

$$\begin{aligned}
&\widehat{\Pr}(G_{t-1} \cap \hat{A}_{\epsilon,t}^{(N)} \cap B_t^{(N)}) \\
&= \sum_{\underline{x}^{(i,1)} \in \underline{\mathcal{X}}^{(i,1)}} \widehat{\Pr}(G_{t-1} \cap \{\underline{X}_t^{(i,1)} = \underline{x}^{(i,1)}\}) \hat{p}_t(\hat{A}_{\epsilon,t}^{(N)} \cap B_t^{(N)} | \underline{X}_t^{(i,1)} = \underline{x}^{(i,1)}) \\
&\stackrel{(a)}{\leq} 2^N \sum_{t'=1}^{t-1} (4a(\epsilon, t') + 2\epsilon(t') + 1/N) \sum_{\underline{x}^{(i,1)} \in \underline{\mathcal{X}}^{(i,1)}} p_t(\underline{x}^{(i,1)}) \hat{p}_t(\hat{A}_{\epsilon,t}^{(N)} \cap B_t^{(N)} | \underline{X}_t^{(i,1)} = \underline{x}^{(i,1)}) \\
&\stackrel{(b)}{\leq} 2^N \sum_{t'=1}^t (4a(\epsilon, t') + 2\epsilon(t') + 1/N) \sum_{\underline{x}^{(i,1)} \in \underline{\mathcal{X}}^{(i,1)}} p_t(\underline{x}^{(i,1)}) p_t(\hat{A}_{\epsilon,t}^{(N)} \cap B_t^{(N)} | \underline{X}_t^{(i,1)} = \underline{x}^{(i,1)}) \\
&< m^2 2^{-N(\delta/2 - \sum_{t'=1}^t (4a(\epsilon, t') + 2\epsilon(t') + 1/N))}, \tag{13}
\end{aligned}$$

where (a) follows from (11), and (b) follows from (8). Finally,

$$\begin{aligned}
&\widehat{\Pr}(G_n \cap \{\underline{W} \neq \underline{\hat{W}}\}) \\
&\stackrel{(a)}{\leq} \sum_{(\underline{w}, \underline{\hat{w}}, \underline{\mathbf{x}}^n, \underline{\mathbf{y}}^n) : \underline{w} \neq \underline{\hat{w}}, (\underline{x}_t^{(i,1)}, \underline{y}_t^{(j,1)}) \in \hat{A}_{\epsilon,t}^{(N)} \setminus B_t^{(N)}} p(\underline{w}) \left[ \prod_{t=1}^n p(\underline{\mathbf{x}}_t | \underline{\mathbf{y}}^{t-1}, \underline{w}) \right] \\
&\quad \cdot 2^N \sum_{t=1}^n (4a(\epsilon, t) + 2\epsilon(t) + 1/N) \left[ \prod_{t=1}^n p(\underline{\mathbf{y}}_t | \underline{\mathbf{x}}_t) \right] p(\underline{\hat{w}} | \underline{w}, \underline{\mathbf{y}}^n) \\
&\stackrel{(b)}{\leq} 2^N \sum_{t=1}^n (4a(\epsilon, t) + 2\epsilon(t) + 1/N) \sum_{(\underline{w}, \underline{\hat{w}}, \underline{x}_1^{(i,1)}, \underline{y}_1^{(j,1)}) : \underline{w} \neq \underline{\hat{w}}, (\underline{x}_1^{(i,1)}, \underline{y}_1^{(j,1)}) \in \hat{A}_{\epsilon,1}^{(N)} \setminus B_1^{(N)}} p(\underline{w}, \underline{x}_1^{(i,1)}, \underline{y}_1^{(j,1)}, \underline{\hat{w}}) \\
&= 2^N \sum_{t=1}^n (4a(\epsilon, t) + 2\epsilon(t) + 1/N) \sum_{(\underline{x}_1^{(i,1)}, \underline{y}_1^{(j,1)}) \in \hat{A}_{\epsilon,1}^{(N)} \setminus B_1^{(N)}} p_1(\underline{x}_1^{(i,1)}, \underline{y}_1^{(j,1)}) \Pr(\underline{\hat{W}} \neq \underline{W} | (\underline{x}_1^{(i,1)}, \underline{y}_1^{(j,1)})) \\
&\stackrel{(c)}{\leq} 2^N \sum_{t=1}^n (4a(\epsilon, t) + 2\epsilon(t) + 1/N) 2^{-N\delta/2} \tag{14}
\end{aligned}$$

Equation (a) follows from (7) and (8). In (b), we sum  $\underline{\mathcal{X}}^{(i,1)} \times \underline{\mathcal{Y}}^{(j,1)}$  rather than  $\hat{A}_{\epsilon,t}^{(N)} \setminus B_t^{(N)}$  for all  $t > 1$ .

Equation (c) follows from the definition of  $B_t^{(N)}$  in (10) and the bound  $p_1(\hat{A}_{\epsilon,1}^{(N)} \setminus B_1^{(N)}) \leq 1$ .

### Step 7 - Parameter choice:

We finally show that we can choose typical set parameters  $\epsilon = (\epsilon(1), \dots, \epsilon(n))$  such that  $\widehat{\Pr}(\underline{W} \neq \underline{\hat{W}}) < \lambda$

for all  $N$  sufficiently large. Since  $n$  is fixed and finite, (12), (13), and (14) imply that the expected error probability of  $\mathcal{S}(\underline{\mathcal{N}}_R)$  goes to zero provided

$$\begin{aligned} \sum_{t'=1}^{t-1} (4a(\epsilon, t') + 2\epsilon(t') + 1/N) &< c(\epsilon, t) \\ 2a(\epsilon, t) + \epsilon(t) &< R - I(X_t^{(i,1)}; Y_t^{(j,1)}) \\ \sum_{t=1}^n (4a(\epsilon, t) + 2\epsilon(t) + 1/N) &< \delta/2. \end{aligned}$$

Recall that constants  $a(\epsilon, t)$  (defined in (3)) and  $c(\epsilon, t)$  (defined in Lemma 6 in Appendix I) depend only on distribution  $p_t(\underline{x}^{(i,1)}, \underline{y}^{(j,1)})$  and the value  $\epsilon(t)$ . Each goes to 0 as  $\epsilon(t)$  approaches 0. The following sequential choice of  $\epsilon(n), \dots, \epsilon(1)$  yields the desired result. Set  $\epsilon(n)$  such that  $4a(\epsilon, n) + 2\epsilon(n) \leq \delta/(4n)$ .

Then for each subsequent  $t$ , set  $\epsilon(t)$  such that

$$2a(\epsilon, t) + \epsilon(t) \leq \min \left\{ \frac{\delta}{4n}, \frac{R - I_t(X_t^{(i,1)}; Y_t^{(j,1)})}{2}, \frac{c(\epsilon, t+1)}{t+1}, \dots, \frac{c(\epsilon, n)}{n} \right\}.$$

This gives the desired result since  $R > I(\underline{X}_t^{(i,1)}; \underline{Y}_t^{(j,1)})$  (by the theorem assumption and definition of capacity) and  $\delta > 0$ .

Since the expected error probability with respect to the given distribution over codes approaches zero as  $N$  grows without bound, there must exist a single instance of the code  $\mathcal{S}(\underline{\mathcal{N}}_R)$  that does at least as well. ■

**Remark 2** It is interesting to specify the choice of parameters in Theorems 1 and 4 required to guarantee the existence of a  $(\tilde{\lambda}, \mathcal{R})$ - $\mathcal{S}(\mathcal{N}_R)$  solution for an arbitrary  $\tilde{\lambda} > 0$  and  $\mathcal{R} \in \text{int}(\mathcal{R}(\mathcal{N}))$ . Since we have  $\mathcal{R} \in \text{int}(\mathcal{R}(\mathcal{N}))$  there exists a  $\tilde{\mathcal{R}} \in \text{int}(\mathcal{R}(\mathcal{N}))$  with  $\tilde{\mathcal{R}} > \mathcal{R}$ . We choose  $\rho$  in Theorem 1 accordingly as  $\min_{u,v} \{\tilde{R}^{(u \rightarrow v)} - R^{(u \rightarrow v)}\}$ . Once  $\rho$  is chosen, we choose  $\lambda$  and  $n$  so that the condition  $\rho > \max_{u,v} \{\tilde{R}^{(u \rightarrow v)}\} \lambda + h(\lambda)/n$  is satisfied for a  $(\lambda, \mathcal{R})$ - $\mathcal{S}(\mathcal{N})$  solution of blocklength  $n$ . Note that  $R^{(u \rightarrow v)}$  is less than the capacity of the channel  $p(\hat{W}^{(u \rightarrow v)} | W^{(u \rightarrow v)})$  imposed by this solution, so  $\delta > 0$ . Fixing  $\mathcal{S}(\mathcal{N})$  fixes distributions  $p_t(x^{(i,1)})$ . We next choose  $\epsilon$  as specified above and design source code  $(\alpha_{N,t}, \beta_{N,t})$  for  $N$  sufficiently large. The resulting code can be run on  $\mathcal{N}_R$  (rather than  $\underline{\mathcal{N}}_R$ ) as described in the proof of Theorem 1.

Corollary 5 finally proves network equivalence for point-to-point channels.

**Corollary 5** Consider a pair of networks

$$\begin{aligned} \mathcal{N} &= \left( \mathcal{X}^{-(i,1)} \times \mathcal{X}^{(i,1)}, p(y^{(j,1)} | x^{(i,1)}) p(y^{-(j,1)} | x^{-(i,1)}), \mathcal{Y}^{-(j,1)} \times \mathcal{Y}^{(j,1)} \right) \\ \mathcal{N}_C &= \left( \mathcal{X}^{-(i,1)} \times \{0, 1\}^C, \delta(\tilde{y}^{(j,1)} - \tilde{x}^{(i,1)}) p(y^{-(j,1)} | x^{-(i,1)}), \mathcal{Y}^{-(j,1)} \times \{0, 1\}^C \right), \end{aligned}$$

where  $(\mathcal{X}^{(i,1)}, p(y^{(j,1)}|x^{(i,1)}), \mathcal{Y}^{(j,1)})$  is a channel of capacity  $C = \max_{p(x^{(i,1)})} I(X^{(i,1)}; Y^{(j,1)}) > 0$ . Then

$$\mathcal{R}(\mathcal{N}) = \mathcal{R}(\mathcal{N}_C).$$

*Proof.* The result is immediate from Lemmas 2 and 3 and Theorem 4. ■

## VI. CONCLUSIONS

The preceding results show that the capacity of a memoryless network containing an independent point-to-point channel equals the capacity of another network where that noiseless channel is replaced by a noiseless bit pipe of the same capacity; thus any collection of demands (e.g., a collection of unicast demands) can be met on the first network if and only if it can be met on the second. Sequentially applying this result to each channel in a network of point-to-point channels proves that the capacity of a network of independent, memoryless, point-to-point channels equals the capacity of a network of noiseless bit-pipes of the corresponding capacities. This also implies that the capacity of a network of independent, memoryless, point-to-point channels equals the capacity of any other network of independent, memoryless, point-to-point channels of the same capacities. Thus, from the perspective of capacity, a Gaussian channel is no different from a binary erasure channel of the same capacity, despite the Gaussian channel's far broader range of possible behaviors. The given equivalence result proves the optimality of coding strategies that separate joint source and network coding from channel coding; there is no loss in capacity associated with performing independent channel coding on every point-to-point channel. The result also opens the way to the analysis of noisy networks using analytical and computational tools built for characterizing network coding capacities.

In addition to proving the equivalence between networks of noisy channels and networks of point-to-point bit pipes, the other main contribution of this work is the introduction of a new strategy for tackling networks of noisy components. Lemma 3 and Theorem 4 show that the capacity of one network is a subset of the capacity of another network by showing that any code that can be run with asymptotically negligible error probability on the first network can be run on the second network with similar error probability. In part II of this paper, we apply the same approach in bounding the capacities of more general networks. This approach represents one step towards the goal of building computational tools for bounding capacities of networks using deterministic models of the network's component channels.

APPENDIX I

LEMMA 6

Lemma 6 proves that  $p_t((\hat{A}_{\epsilon,t}^{(N)})^c)$  decays exponentially to zero. Using the notation of Section IV,  $\underline{X}^{(i,1)} = (\underline{X}^{(i,1)}(1), \dots, \underline{X}^{(i,1)}(N))$  and  $\underline{Y}^{(j,1)} = (\underline{Y}^{(j,1)}(1), \dots, \underline{Y}^{(j,1)}(N))$  denote  $N$ -dimensional vectors corresponding to the  $N$ -fold stacked network.

**Lemma 6** *Let  $(\underline{X}^{(i,1)}, \underline{Y}^{(j,1)})$  be drawn i.i.d.  $p_t(x^{(i,1)}, y^{(j,1)})$ . Then there exists a constant  $c(\epsilon, t) > 0$  for which*

$$p_t((\hat{A}_{\epsilon,t}^{(N)})^c) < 2^{-Nc(\epsilon,t)}$$

for all  $N$  sufficiently large. Constant  $c(\epsilon, t)$  approaches 0 as  $\epsilon(t) > 0$  approaches 0.

*Proof.* The result follows from Chernoff's bound which we apply to averages of i.i.d. random variables. Chernoff's bound states that for any i.i.d. random variables  $A(1), A(2), \dots, A(N)$ ,

$$\Pr \left( \frac{1}{N} \sum_{\ell=1}^N A(\ell) > a \right) \leq e^{N \min_{s>0} [M(s) - sa]},$$

where  $M(s) \stackrel{\text{def}}{=} \ln E[e^{sA}]$  and  $\min_{s>0} [M(s) - sa] \leq 0$  for all  $a \geq E[A]$  with equality if and only if  $a = E[A]$  (see, for example, [20, pp.482-484]). Note that  $|\min_{s>0} [M(s) - sa]|$  grows without bound as  $a$  increases while  $|\min_{s>0} [M(s) - sa]|$  approaches 0 as  $a$  approaches  $E[A]$ .

We begin by applying the Chernoff bound to the following sequence of random variables

$$-\log p_t(\underline{X}^{(i,1)}(1)), \dots, -\log p_t(\underline{X}^{(i,1)}(N)).$$

We then negate the sequence and apply the Chernoff bound again. Combining these results with the union bound gives

$$p_t \left( \left| -\frac{1}{N} \log p_t(\underline{X}^{(i,1)}) - H(X_t^{(i,1)}) \right| > \epsilon(t) \right) \leq 2^{-Nb_0+1}$$

for some  $b_0 > 0$  as discussed above. Likewise, for any  $\epsilon' > 0$ ,

$$p_t \left( \left| -\frac{1}{N} \log p_t(\underline{Y}^{(j,1)}) - H(Y_t^{(j,1)}) \right| > \epsilon' \right) \leq 2^{-Nb_1+1}$$

$$p_t \left( \left| -\frac{1}{N} \log p_t(\underline{X}^{(i,1)}, \underline{Y}^{(j,1)}) - H(X_t^{(i,1)}, Y_t^{(j,1)}) \right| > \epsilon' \right) \leq 2^{-Nb_2+1}$$

for some  $b_1, b_2 > 0$ . Since  $b_1$  and  $b_2$  can be made arbitrarily large by choosing  $\epsilon'$  large enough, the infimum in the definition of  $a(\epsilon, t)$  is well-defined.

Now note that

$$\begin{aligned}
p_t((A_{\epsilon,t}^{(N)})^c) &\leq p_t \left( \left| -\frac{1}{N} \log p_t(\underline{X}^{(i,1)}) - H(X_t^{(i,1)}) \right| > \epsilon(t) \right) \\
&\quad + p_t \left( \left| -\frac{1}{N} \log p_t(\underline{Y}^{(j,1)}) - H(Y_t^{(j,1)}) \right| > a(\epsilon, t) \right) \\
&\quad \vee \left| -\frac{1}{N} \log p_t(\underline{X}^{(i,1)}, \underline{Y}^{(j,1)}) - H(X_t^{(i,1)}, Y_t^{(j,1)}) \right| > a(\epsilon, t) \Big) \\
&\leq 2^{-Nb_0+1} + 2^{-N6\epsilon(t)}
\end{aligned}$$

where the first inequality applies the union bound and the second inequality follows from our first Chernoff bound and the definition of  $a(\epsilon, t)$ . Let

$$\begin{aligned}
C_t^{(N)} &\stackrel{\text{def}}{=} \left\{ \underline{x}^{(i,1)} \in \underline{\mathcal{X}}^{(i,1)} : \left| -\frac{1}{N} \log p_t(\underline{x}^{(i,1)}) - H(X_t^{(i,1)}) \right| \leq \epsilon(t), \right. \\
&\quad \left. p_t \left( (A_{\epsilon,t}^{(N)})^c \mid \underline{X}_t^{(i,1)} = \underline{x}^{(i,1)} \right) > 2^{-3N\epsilon(t)} \right\}.
\end{aligned}$$

Then

$$\begin{aligned}
p_t((\hat{A}_{\epsilon,t}^{(N)})^c) &= p_t \left( (A_{\epsilon,t}^{(N)})^c \right) + p_t \left( \{(\underline{x}^{(i,1)}, \underline{y}^{(j,1)}) \in A_{\epsilon,t}^{(N)} : \underline{x}^{(i,1)} \in C_t^{(N)}\} \right) \\
&= p_t \left( (A_{\epsilon,t}^{(N)})^c \right) + \sum_{\underline{x}^{(i,1)} \in C_t^{(N)}} p_t(\underline{x}^{(i,1)}) p \left( A_{\epsilon,t}^{(N)} \mid \underline{X}_t^{(i,1)} = \underline{x}^{(i,1)} \right) \\
&\leq p_t \left( (A_{\epsilon,t}^{(N)})^c \right) + p_t \left( C_t^{(N)} \right) \\
&\leq 2^{-Nb_0+1} + 2^{-N6\epsilon(t)} + p_t \left( C_t^{(N)} \right).
\end{aligned}$$

To bound  $p_t(C_t^{(N)})$ , note that from the definitions of  $a(\epsilon, t)$  and  $C_t^{(N)}$ ,

$$\begin{aligned}
2^{-N6\epsilon(t)} &\geq \sum_{\underline{x}^{(i,1)} \in C_t^{(N)}} p_t(\underline{x}^{(i,1)}) p \left( \left| -\frac{1}{N} \log p_t(\underline{Y}^{(j,1)}) - H(Y_t^{(j,1)}) \right| > a(\epsilon, t) \right. \\
&\quad \left. \vee \left| -\frac{1}{N} \log p_t(\underline{X}^{(i,1)}, \underline{Y}^{(j,1)}) - H(X_t^{(i,1)}, Y_t^{(j,1)}) \right| > a(\epsilon, t) \mid \underline{X}_t^{(i,1)} = \underline{x}^{(i,1)} \right) \\
&> p_t(C_t^{(N)}) 2^{-3N\epsilon(t)}.
\end{aligned}$$

Thus  $p_t(C_t^{(N)}) < 2^{-N3\epsilon(t)}$ , which gives the desired result. ■

## APPENDIX II

### LEMMA 9

Lemma 9 bounds the distribution  $\hat{p}_t(\underline{y}^{(j,1)} \mid \underline{x}^{(i,1)})$  obtained by random source code  $(\alpha_{N,t}, \beta_{N,t})$ . Our restriction on the typical set is useful for that proof. The randomness in  $\hat{p}_t(\underline{y}^{(j,1)} \mid \underline{x}^{(i,1)})$  results from the random source code choice. Lemmas 7 and 8 are intermediate steps used in the proof of Lemma 9.

Let function  $K_t(\underline{x}^{(i,1)}, \underline{y}^{(j,1)})$  be defined as

$$K_t(\underline{x}^{(i,1)}, \underline{y}^{(j,1)}) \stackrel{\text{def}}{=} \begin{cases} 1 & \text{if } (\underline{x}^{(i,1)}, \underline{y}^{(j,1)}) \in \hat{A}_{\epsilon,t}^{(N)} \\ 0 & \text{otherwise} \end{cases} \quad (15)$$

(cf. [15, steps 10.93-10.102]). Lemma 7, below, characterizes  $\hat{p}_t(\underline{y}^{(j,1)}|\underline{x}^{(i,1)})$  as a function of the probability

$$q_t(\underline{x}^{(i,1)}) \stackrel{\text{def}}{=} \sum_{\underline{y}^{(j,1)} \in \underline{\mathcal{Y}}^{(j,1)}} K_t(\underline{x}^{(i,1)}, \underline{y}^{(j,1)}) p_t(\underline{y}^{(j,1)})$$

that a single codeword drawn at random is jointly typical with  $\underline{x}^{(i,1)}$ . Precisely, the lemma shows that  $p_t(\underline{y}^{(j,1)})/q_t(\underline{x}^{(i,1)})$  is the probability that  $\underline{x}^{(i,1)}$  is mapped to  $\underline{y}^{(j,1)}$  given that there is at least one codeword in the codebook that is typical with  $\underline{x}^{(i,1)}$ . Lemma 8 then bounds  $q_t(\underline{x}^{(i,1)})$  for all  $\underline{x}^{(i,1)}$  satisfying the conditions of  $\hat{A}_{\epsilon,t}^{(N)}$ .

**Lemma 7** *Let  $(\alpha_{N,t}, \beta_{N,t})$  be the random source code defined in (5) and (6). Then for any  $(\underline{x}^{(i,1)}, \underline{y}^{(j,1)}) \in \hat{A}_{\epsilon,t}^{(N)}$ ,*

$$\hat{p}_t(\underline{y}^{(j,1)}|\underline{x}^{(i,1)}) = p_t(\underline{y}^{(j,1)}) \frac{1 - (1 - q_t(\underline{x}^{(i,1)}))^{2^{NR}}}{q_t(\underline{x}^{(i,1)})}.$$

*Proof.* Recall that  $q_t(\underline{x}^{(i,1)})$  is the probability that a single randomly drawn codeword  $\underline{Y}^{(j,1)}$  satisfies  $(\underline{x}^{(i,1)}, \underline{Y}^{(j,1)}) \in \hat{A}_{\epsilon,t}^{(N)}$ . Using the given random code design, for any  $(\underline{x}^{(i,1)}, \underline{y}^{(j,1)}) \in \hat{A}_{\epsilon,t}^{(N)}$ ,

$$\begin{aligned} & \hat{p}_t(\underline{y}^{(j,1)}|\underline{x}^{(i,1)}) \\ &= \sum_{j=1}^{2^{NR}} \sum_{k=1}^j \binom{2^{NR}}{j} \binom{j}{k} (1 - q_t(\underline{x}^{(i,1)}))^{2^{NR}-j} (q_t(\underline{x}^{(i,1)}) - p_t(\underline{y}^{(j,1)}))^{j-k} (p_t(\underline{y}^{(j,1)}))^k \frac{k}{j} \\ &= p_t(\underline{y}^{(j,1)}) \sum_{j=1}^{2^{NR}} \binom{2^{NR}}{j} \frac{1}{j} (1 - q_t(\underline{x}^{(i,1)}))^{2^{NR}-j} \sum_{k=1}^j \binom{j}{k} [a^{j-k} k b^{k-1}]. \end{aligned}$$

Here  $j$  is the number of codewords that are jointly typical with  $\underline{x}^{(i,1)}$ ,  $k$  is the number of those codewords that equal  $\underline{y}^{(j,1)}$ , and term  $k/j$  follows from the uniform distribution over jointly typical codewords in the encoder design. In the second equality,  $a = q_t(\underline{x}^{(i,1)}) - p_t(\underline{y}^{(j,1)})$  and  $b = p_t(\underline{y}^{(j,1)})$ . Thus

$$\begin{aligned} \hat{p}_t(\underline{y}^{(j,1)}|\underline{x}^{(i,1)}) &= p_t(\underline{y}^{(j,1)}) \sum_{j=1}^{2^{NR}} \binom{2^{NR}}{j} \frac{1}{j} (1 - q_t(\underline{x}^{(i,1)}))^{2^{NR}-j} \frac{\partial}{\partial b} [(a+b)^j - a^j] \\ &= p_t(\underline{y}^{(j,1)}) \sum_{j=1}^{2^{NR}} \binom{2^{NR}}{j} \frac{1}{j} (1 - q_t(\underline{x}^{(i,1)}))^{2^{NR}-j} j (q_t(\underline{x}^{(i,1)}))^{j-1} \\ &= p_t(\underline{y}^{(j,1)}) \frac{1 - (1 - q_t(\underline{x}^{(i,1)}))^{2^{NR}}}{q_t(\underline{x}^{(i,1)})}. \end{aligned}$$



■

**Lemma 8** Given  $\underline{x}^{(i,1)} \in \mathcal{X}^{(i,1)}$ , if  $\left| -\frac{1}{N} \log p_t(\underline{x}^{(i,1)}) - H(X_t^{(i,1)}) \right| \leq \epsilon(t)$  and  $p_t((A_{\epsilon,t}^{(N)})^c | \underline{x}^{(i,1)}) < 2^{-3N\epsilon(t)}$ , then

$$q_t(\underline{x}^{(i,1)}) \geq 2^{-N(I(X_t^{(i,1)}; Y_t^{(j,1)}) + \epsilon(t) + 2a(\epsilon,t) + \frac{1}{N})}$$

for all  $N$  sufficiently large.

*Proof.* For any  $\underline{x}^{(i,1)}$  satisfying the given constraints, we first derive a bound on the number of  $\underline{y}^{(j,1)}$  values for which  $(\underline{x}^{(i,1)}, \underline{y}^{(j,1)}) \in \hat{A}_{\epsilon,t}^{(N)}$ . This is obtained by drawing a random variable  $\underline{Y}^{(j,1)}$  according to conditional distribution  $\prod_{\ell=1}^N p_t(\underline{y}^{(j,1)}(\ell) | \underline{x}^{(i,1)}(\ell))$  and showing that  $(\underline{x}^{(i,1)}, \underline{Y}^{(j,1)}) \in \hat{A}_{\epsilon,t}^{(N)}$  with probability approaching 1. Since all  $\underline{y}^{(j,1)}$  that are jointly typical with  $\underline{x}^{(i,1)}$  are approximately equally probable, this probability bound leads to a bound on the number of  $\underline{y}^{(j,1)}$  vectors that are jointly typical with  $\underline{x}^{(i,1)}$  and then to a bound on the desired probability.

By the lemma assumptions,

$$p_t((\underline{X}^{(i,1)}, \underline{Y}^{(j,1)}) \notin A_{\epsilon,t}^{(N)} | \underline{X}^{(i,1)} = \underline{x}^{(i,1)}) < 2^{-3N\epsilon(t)},$$

which approaches 0 as  $N$  grows without bound. Let  $F_t(\underline{x}^{(i,1)}) \stackrel{\text{def}}{=} \{\underline{y}^{(j,1)} : (\underline{x}^{(i,1)}, \underline{y}^{(j,1)}) \in A_{\epsilon,t}^{(N)}\}$ . Then for  $N$  sufficiently large,

$$\begin{aligned} \frac{1}{2} \leq 1 - 2^{-3N\epsilon(t)} &\leq \sum_{\underline{y}^{(j,1)} \in F_t(\underline{x}^{(i,1)})} p(\underline{y}^{(j,1)} | \underline{x}^{(i,1)}) \\ &= \sum_{\underline{y}^{(j,1)} \in F_t(\underline{x}^{(i,1)})} \frac{p_t(\underline{x}^{(i,1)}, \underline{y}^{(j,1)})}{p_t(\underline{x}^{(i,1)})} \\ &\leq |F_t(\underline{x}^{(i,1)})| 2^{-N(H(Y_t^{(j,1)} | X_t^{(i,1)}) - a(\epsilon,t) - \epsilon(t))}, \end{aligned}$$

where the last inequality follows from the usual probability bounds for typical strings. Thus

$$|F_t(\underline{x}^{(i,1)})| \geq 2^{N(H(Y_t^{(j,1)} | X_t^{(i,1)}) - a(\epsilon,t) - \epsilon(t) - 1/N)},$$

which we apply to bound  $q_t(\underline{x}^{(i,1)})$  as

$$\begin{aligned} q_t(\underline{x}^{(i,1)}) &= \sum_{\underline{y}^{(j,1)} \in F_t(\underline{x}^{(i,1)})} p_t(\underline{y}^{(j,1)}) \\ &\geq |F_t(\underline{x}^{(i,1)})| 2^{-N(H(Y_t^{(j,1)}) + a(\epsilon,t))} \\ &\geq 2^{-N(I(X_t^{(i,1)}; Y_t^{(j,1)}) + 2a(\epsilon,t) + \epsilon(t) + 1/N)}. \end{aligned}$$

■

**Lemma 9** For all  $(\underline{x}^{(i,1)}, \underline{y}^{(j,1)}) \in \hat{A}_{\epsilon,t}^{(N)}$ ,

$$\hat{p}_t(\underline{y}^{(j,1)}|\underline{x}^{(i,1)}) \leq p(\underline{y}^{(j,1)}|\underline{x}^{(i,1)})2^{N(4a(\epsilon,t)+2\epsilon(t)+1/N)}.$$

*Proof.* By Lemmas 7 and 8 and the usual bounds on the probabilities of typical elements,

$$\begin{aligned} \hat{p}_t(\underline{y}^{(j,1)}|\underline{x}^{(i,1)}) &= p_t(\underline{y}^{(j,1)}) \frac{1 - (1 - q_t(\underline{x}^{(i,1)}))^{2^{NR}}}{q_t(\underline{x}^{(i,1)})} \leq \frac{p_t(\underline{y}^{(j,1)})}{q_t(\underline{x}^{(i,1)})} \\ &\leq p(\underline{y}^{(j,1)}|\underline{x}^{(i,1)}) \frac{p_t(\underline{x}^{(i,1)})p_t(\underline{y}^{(j,1)})}{p_t(\underline{x}^{(i,1)}, \underline{y}^{(j,1)})} \frac{1}{2^{-N(I(X_t^{(i,1)}; Y_t^{(j,1)})+2a(\epsilon,t)+\epsilon(t)+1/N)}} \\ &\leq p(\underline{y}^{(j,1)}|\underline{x}^{(i,1)}) \frac{2^{-N(I(X_t^{(i,1)}; Y_t^{(j,1)})-2a(\epsilon,t)-\epsilon(t))}}{2^{-N(I(X_t^{(i,1)}; Y_t^{(j,1)})+2a(\epsilon,t)+\epsilon(t)+1/N)}} \\ &= p(\underline{y}^{(j,1)}|\underline{x}^{(i,1)})2^{N(4a(\epsilon,t)+2\epsilon(t)+1/N)}. \end{aligned}$$

■

### APPENDIX III

#### LEMMA 10

Lemma 10 bounds the conditional probability that  $(\underline{X}_t^{(i,1)}, \underline{Y}_t^{(j,1)})$  is not jointly typical under the operation of  $\mathcal{S}(\hat{\mathcal{N}})$ .

**Lemma 10** For all  $\underline{x}^{(i,1)} \in \mathcal{X}^{(i,1)}$ ,

$$\hat{p}_t((\hat{A}_{\epsilon,t}^{(N)})^c|\underline{x}^{(i,1)}) \leq p_t((\hat{A}_{\epsilon,t}^{(N)})^c|\underline{x}^{(i,1)}) + e^{-2^{N(R-I(X_t^{(i,1)}; Y_t^{(j,1)}))-2a(\epsilon,t)-\epsilon(t)}}.$$

*Proof.* If  $|(1/N) \log p_t(\underline{x}^{(i,1)}) - H(X_t^{(i,1)})| > \epsilon(t)$  or  $p_t((\hat{A}_{\epsilon,t}^{(N)})^c|\underline{x}^{(i,1)}) > 2^{-3N\epsilon(t)}$ , then

$$\hat{p}_t((\hat{A}_{\epsilon,t}^{(N)})^c|\underline{x}^{(i,1)}) = p_t((\hat{A}_{\epsilon,t}^{(N)})^c|\underline{x}^{(i,1)}) = 1$$

by definition of  $\hat{A}_{\epsilon,t}^{(N)}$ . Otherwise,  $(\underline{x}_t^{(i,1)}, \underline{y}_t^{(j,1)}) \notin \hat{A}_{\epsilon,t}^{(N)}$  when none of the  $2^{NR}$  codewords of  $\beta_{N,t}$  is jointly typical with  $\underline{x}_t^{(i,1)}$ . In this case, using definition (15) and following the proof of the rate-distortion theorem,

$$\begin{aligned} \hat{p}_t((\hat{A}_{\epsilon,t}^{(N)})^c|\underline{x}^{(i,1)}) &= \left(1 - \sum_{\underline{y}^{(j,1)}} p_t(\underline{y}^{(j,1)}) K_t(\underline{x}^{(i,1)}, \underline{y}^{(j,1)})\right)^{2^{NR}} \\ &\stackrel{(a)}{\leq} 1 - \sum_{\underline{y}^{(j,1)}} p(\underline{y}^{(j,1)}|\underline{x}^{(i,1)}) K_t(\underline{x}^{(i,1)}, \underline{y}^{(j,1)}) + e^{-2^{N(R-I(X_t^{(i,1)}; Y_t^{(j,1)}))-2a(\epsilon,t)-\epsilon(t)}} \\ &= p_t((\hat{A}_{\epsilon,t}^{(N)})^c|\underline{X}^{(i,1)} = \underline{x}^{(i,1)}) + e^{-2^{N(R-I(X_t^{(i,1)}; Y_t^{(j,1)}))-2a(\epsilon,t)-\epsilon(t)}}. \end{aligned}$$

where (a) follows from  $(1 - ab)^k \leq 1 - a + e^{-bk}$  [15, Lemma 10.5.3] and the usual bounds on probabilities of typical strings

$$\begin{aligned} p_t(\underline{y}^{(j,1)}) &= p(\underline{y}^{(j,1)}|\underline{x}^{(i,1)}) \frac{p_t(\underline{y}^{(j,1)})p_t(\underline{x}^{(i,1)})}{p_t(\underline{x}^{(i,1)}, \underline{y}^{(j,1)})} \\ &\geq p(\underline{y}^{(j,1)}|\underline{x}^{(i,1)}) 2^{-N(I(X_t^{(i,1)}; Y_t^{(j,1)}) + 2a(\epsilon, t) + \epsilon(t))}. \end{aligned}$$

for all  $\underline{x}^{(i,1)} \in \underline{\mathcal{X}}^{(i,1)}$ . ■

## REFERENCES

- [1] R. Ahlswede, N. Cai, S.-Y. R. Li, and R. W. Yeung, "Network information flow," *IEEE Transactions on Information Theory*, vol. IT-46, pp. 1204–1216, July 2000.
- [2] M. Langberg, M. Sprintson, and J. Bruck, "Network coding: a computational perspective," *IEEE Transactions on Information Theory*, vol. 55, no. 1, pp. 145–157, 2008.
- [3] T. Chan and A. Grant, "Dualities between entropy function and network codes," *IEEE Transactions on Information Theory*, vol. 54, pp. 4470–4487, Oct. 2008.
- [4] L. Song, R. W. Yeung, and N. Cai, "Zero-error network coding for acyclic networks," *IEEE Transactions on Information Theory*, vol. 49, pp. 3129–3139, July 2003.
- [5] N. Harvey, R. Kleinberg, and A. R. Lehman, "On the capacity of information networks," *IEEE Transactions on Information Theory*, vol. 52, pp. 2345–2364, June 2006.
- [6] A. Subramanian and A. Thangaraj, "A simple algebraic formulation for the scalar linear network coding problem," *ArXiv e-prints*, July 2008.
- [7] S. Borade, "Network information flow: limits and achievability," in *Proceedings of the IEEE International Symposium on Information Theory*, p. 139, July 2002.
- [8] R. Koetter and M. Médard, "An algebraic approach to network coding," *IEEE/ACM Transactions on Networking*, vol. 11, pp. 782–795, Oct. 2003.
- [9] N. Harvey and R. Kleinberg, "Tighter cut-set bounds for  $k$ -pairs communication problems," in *Proceedings of the Allerton Conference on Communication, Control, and Computing*, (Monticello, IL), Sept. 2005.
- [10] G. Kramer and S. Savari, "Capacity bounds for relay networks," in *Information Theory and Applications Workshop*, (San Diego, California), IEEE, Jan. 2006.
- [11] G. Kramer and S. Savari, "Edge-cut bounds on network coding rates," *Journal of Network and Systems Mngmnt*, vol. 14, pp. 49–67, Mar. 2006.
- [12] A. Avestimehr, S. Diggavi, and D. Tse, "Approximate capacity of Gaussian relay networks," in *Proceedings of the IEEE International Symposium on Information Theory*, pp. 474–478, July 2008.
- [13] L. Song, R. W. Yeung, and N. Cai, "A separation theorem for single-source network coding," *IEEE Transactions on Information Theory*, vol. 52, pp. 1861–1871, May 2006.
- [14] C. Bennett, P. Shor, J. Smolin, and A. Thapliyal, "Entanglement-assisted capacity of a quantum channel and the reverse Shannon theorem," *IEEE Transactions on Information Theory*, vol. 48, pp. 2637–2655, Oct. 2002.
- [15] T. M. Cover and J. A. Thomas, *Elements of Information Theory*. Wiley, second ed., 2006.

- [16] R. Dougherty and K. Zeger, "Nonreversibility and equivalent constructions of multiple-unicast networks," *IEEE Transactions on Information Theory*, vol. 52, no. 11, pp. 5067–5077, 2006.
- [17] R. G. Gallager, *Information Theory and Reliable Communication*. New York: John Wiley & Sons, Inc., 1968.
- [18] W.-H. Gu and M. Effros, "A strong converse for a collection of network source coding problems," in *Proceedings of the IEEE International Symposium on Information Theory*, (Seoul, Korea), pp. 2316–2320, June 2009.
- [19] W.-H. Gu, *On achievable rate regions for source coding networks*. Ph.D. dissertation, California Institute of Technology, Pasadena, CA, 2009.
- [20] U. Madhow, *Fundamentals of Digital Communication*. Cambridge, U.K.: Cambridge University Press, 1998.

# A Theory of Network Equivalence

## Part II: Multiterminal Channels

Ralf Koetter, *Fellow, IEEE*, Michelle Effros, *Fellow, IEEE*, and Muriel Médard, *Fellow, IEEE*

### Abstract

The equivalence tools used in Part I to study networks of independent, noisy, memoryless, point-to-point channels are here extended to networks containing more general channel types. Definitions of upper and lower bounding channel models are introduced. By these definitions, a collection of communication demands can be met on a network of independent channels if it can be met on a network where each channel is replaced by its lower bounding model and only if it can be met on a network where each channel is replaced by its upper bounding model. This work derives general conditions under which a network of noiseless bit pipes is an upper or lower bounding model for a multiterminal channel. Example upper and lower bounding models for broadcast, multiple access, and interference channels are given. It is then shown that bounding the difference between the upper and lower bounding models for a given channel yields bounds on the accuracy of network capacity bounds derived using those models. By bounding the capacity of a network of independent noisy channels by the network coding capacity of a network of noiseless bit pipes, this approach represents one step towards the goal of building computational tools for bounding network capacities.

**Keywords:** Capacity, network coding, equivalence, component models

### I. INTRODUCTION

This work is motivated by the desire to build computational tools for characterizing the capacities of networks. Traditionally, the information theoretic investigation of network capacities has proceeded largely

R. Koetter was with the Technical University of Munich. M. Effros is with the Department of Electrical Engineering, California Institute of Technology, Pasadena, CA 91125 USA e-mail: effros@caltech.edu. M. Médard is with the Department of Electrical Engineering and Computer Science, Massachusetts Institute of Technology, Cambridge, MA 02139 USA e-mail: medard@mit.edu.

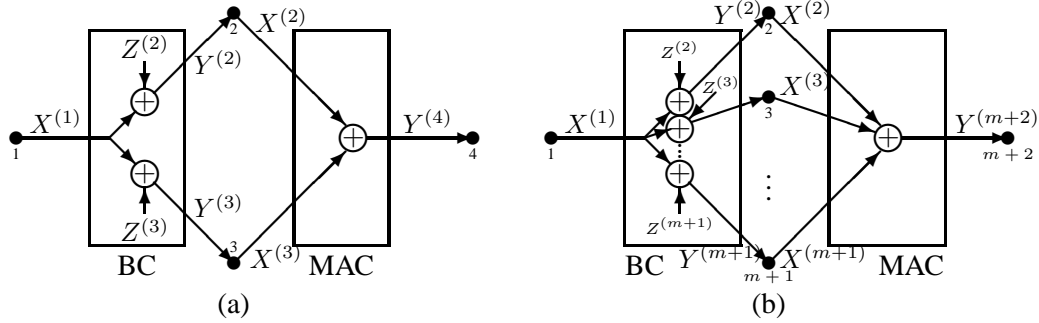

Fig. 1. Separate network and channel coding fails to achieve the unicast capacity of (a) a four-node network with dependent noise at the receivers of the broadcast channel and (b) an  $(m + 2)$ -node network with independent noise at the receivers of the broadcast channel.

by studying example networks. Shannon's original proof of the capacity of a network described by a single point-to-point channel [1] was followed by Ahlswede's [2] and Liao's [3] capacity derivations for a single multiple access channel, Cover's early work on a single broadcast channel [4], and so on. While the solution to one network capacity problem may lend some insight into future problems, deriving the capacity of each new network is often difficult. As a result, even the capacities for three-node networks remain incompletely solved.

The problem is further complicated by the fact that the capacities of individual channels can vastly underestimate the rates that those channels can carry in larger networks. For example, consider the network in Figure 1(a), where a broadcast channel  $p(y^{(2)}, y^{(3)}|x^{(1)})$  is followed by a multiple access channel  $p(y^{(4)}|x^{(2)}, x^{(3)})$ . The two channels are independent, giving

$$p(y^{(2)}, y^{(3)}, y^{(4)}|x^{(1)}, x^{(2)}, x^{(3)}) = p(y^{(2)}, y^{(3)}|x^{(1)})p(y^{(4)}|x^{(2)}, x^{(3)}).$$

Example 1 shows that the maximal rate for a single unicast demand from source node 1 to sink node 4 can far exceed the maximal sum-rate in the broadcast channel's capacity region. Example 2 provides another related example. Both examples show that reliable transmission across a network does not require reliable transmission across each channel in the network and that restricting each component to transmit reliably – that is employing a separated network and channel coding strategy that makes each channel individually reliable – sometimes decreases the network capacity.

**Example 1** Figure 1(a) shows a four-node network comprising a Gaussian broadcast channel followed by a real additive multiple access channel. The broadcast channel has power constraint  $E[(X^{(1)})^2] \leq P$  and channel outputs  $Y^{(2)} = X^{(1)} + Z^{(2)}$  and  $Y^{(3)} = X^{(1)} + Z^{(3)}$ , where  $Z^{(2)}$  and  $Z^{(3)}$  are statistically

dependent mean-0, variance- $N$  random variables with  $Z^{(2)} = -Z^{(3)}$ , and  $P$  and  $N$  are real-valued positive constants. The multiple access channel has power constraints  $E[(X^{(2)})^2], E[(X^{(3)})^2] \leq P + N$  at each transmitter and output  $Y^{(4)} = X^{(2)} + X^{(3)}$ . We consider a single unicast demand, where node 1 wishes to reliably transmit information to node 4. If we channel code to make each channel reliable and then apply network coding, the achievable rate cannot exceed the broadcast channel's maximal sum rate

$$\max_{\alpha} \left[ \frac{1}{2} \log \left( 1 + \frac{\alpha P}{N} \right) + \frac{1}{2} \log \left( 1 + \frac{(1-\alpha)P}{\alpha P + N} \right) \right] = \frac{1}{2} \log \left( 1 + \frac{P}{N} \right).$$

Yet the network's unicast capacity is infinite since nodes 2 and 3 can simply retransmit their channel outputs uncoded to give output  $Y^{(4)} = (X^{(1)} + Z^{(2)}) + (X^{(1)} + Z^{(3)}) = 2X^{(1)}$  at node 4. ■

It is tempting to believe that the gap between the optimal performance and the performance achieved by separate network and channel coding in Example 1 arises due to the unusual statistical dependence in the noise. Unfortunately, similar phenomena can also arise when the noise at the receivers of a broadcast channel is independent, as shown in Example 2

**Example 2** Figure 1(b) shows a  $(m+2)$ -node network made from a Gaussian broadcast channel and a real additive multiple access channel. The broadcast channel has power constraint  $E[(X^{(1)})^2] \leq P$  and channel outputs  $Y^{(i)} = X^{(1)} + Z^{(i)}$ ,  $i \in \{2, \dots, m+1\}$ , where  $Z^{(i)}$  are independent mean-0, variance- $N$  Gaussian random variables, and  $P$  and  $N$  are real-valued positive constants. The multiple access channel has power constraint  $E[(X^{(i)})^2] \leq P + N$  at each transmitter  $i \in \{2, \dots, m+1\}$  and output  $Y^{(m+2)} = \sum_{i=2}^{m+1} X^{(i)}$ . We consider a single unicast demand, where node 1 wishes to reliably transmit information to node  $(m+2)$ . The maximal achievable unicast rate using separate network and channel codes is bounded by the broadcast channel's maximal sum rate

$$\max_{\alpha_2, \dots, \alpha_{m+1}} \sum_{i=2}^{m+1} \frac{1}{2} \log \left( 1 + \frac{\alpha_i P}{\sum_{j=2}^{i-1} \alpha_j P + N} \right) = \frac{1}{2} \log \left( 1 + \frac{P}{N} \right).$$

The unicast capacity of the network is greater than or equal to

$$\frac{1}{2} \log \left( 1 + \frac{mP}{N} \right)$$

since nodes 2 through  $m+1$  can simply retransmit their channel outputs uncoded to give output

$$Y^{(m+2)} = \sum_{i=2}^{m+1} (X^{(1)} + Z^{(i)}) = mX^{(1)} + \sum_{i=2}^{m+1} Z^{(i)},$$

which is a Gaussian channel with power  $E[(mX^{(1)})^2] = m^2P$  and noise variance  $E[(\sum_{i=2}^{m+1} Z^{(i)})^2] = mN$ . Thus the gap between the optimal performance and the lower bound achieved through the use of a separated strategy is sometimes large even in networks with independent noise. ■

Given the difficulty of solving network capacities even for small networks and the failure of individual channel capacities to predict the capacity of networks made from those channels, the gap between the size of the networks whose capacities we can analyze and the size of the networks over which we communicate in practice seems to be growing ever larger. To address this challenge, we here propose a strategy for bounding the behaviors of individual channels in a manner that captures their full range of behaviors in larger network systems. That is, we derive upper and lower bounding models on individual channels such that the capacity region of any network that contains the given channel is bounded below by the capacity region of a network that replaces that component by its lower bounding model and bounded above by the capacity region of a network that replaces that component by its upper bounding model. Thus, an arbitrary collection of demands (e.g., a collection of unicasts) can be met on a given network if it can be met on the network that replaces channels by their lower bounding models and only if it can be met on the network that replaces channels by their upper bounding models.

We focus on upper and lower bounding models comprised of noiseless bit pipes. Using such models, we can bound the capacity of a network of noisy channels by the network coding capacity of the network that replaces each channel by its noiseless model. While network coding capacities are not solved in the general case, a variety of computational tools can be used to bound them. (See, for example, [5], [6], [7].)

Part I [8] in this two-part series derived upper and lower bounding models for point-to-point channels. In that case, the upper and lower bounds were identical. We here derive upper and lower bounds for more general channel types using the same basic strategy: We demonstrate that the capacity region of one network is a subset of that of another network by showing that solutions for the first network can be run on the second network. Sections II and III include the problem setup and channel model definitions. Section IV derives sufficient conditions for upper and lower bounding models. We derive upper and lower bounding models for broadcast, multiple access, and interference channels as examples. When a channel's upper and lower bounding models differ, we bound the accuracy of the resulting capacity bounds by comparing the upper and lower bounding models. Such accuracy bounds may be useful both directly and for determining which larger network components should be modeled in the future.



## II. THE SETUP

We use the notation established in [9]. Network  $\mathcal{N}$  has  $m$  nodes,  $\mathcal{V} = \{1, \dots, m\}$ . Each node transmits an input random variable  $X^{(v)} \in \mathcal{X}^{(v)}$  and receives an output random variable  $Y^{(v)} \in \mathcal{Y}^{(v)}$ . We use  $\mathbf{X} = (X^{(v)} : v \in \mathcal{V})$  and  $\mathbf{Y} = (Y^{(v)} : v \in \mathcal{V})$  to denote the vectors of network inputs and outputs. The alphabets may be discrete or continuous. The network is assumed to be memoryless and to be characterized by a conditional probability distribution

$$p(\mathbf{y}|\mathbf{x}) = p(y^{(1)}, \dots, y^{(m)} | x^{(1)}, \dots, x^{(m)}).$$

Applying a result from [10], we characterize rate regions for arbitrary demands by characterizing the multiple unicast rate region. This choice simplifies the notation and yields no loss of generality (see [9]).

Thus a blocklength- $n$  code communicates message

$$W^{(u \rightarrow v)} \in \mathcal{W}^{(u \rightarrow v)} \stackrel{\text{def}}{=} \{1, \dots, 2^{nR^{(u \rightarrow v)}}\}$$

from node  $u$  to node  $v$  for each  $u, v \in \{1, \dots, m\}$ . Messages  $W = (W^{(u \rightarrow v)} : (u, v) \in \{1, \dots, m\}^2)$  are independent and uniformly distributed (though the proof goes through if the same message is available at multiple nodes). By assumption,  $\mathcal{R} = (R^{(u \rightarrow v)} : (u, v) \in \{1, \dots, m\}^2)$  satisfies  $R^{(v \rightarrow v)} = 0$  for all  $v$ .

At time  $t$ , node  $v$  transmits  $X_t^{(v)}$  and receives  $Y_t^{(v)}$ . We therefore describe the network by a triple

$$\left( \prod_{v=1}^m \mathcal{X}^{(v)}, p(\mathbf{y}|\mathbf{x}), \prod_{v=1}^m \mathcal{Y}^{(v)} \right) \tag{1}$$

with the causality constraint that  $X_t^{(v)}$  is a function only of

$$\{Y_1^{(v)}, \dots, Y_{t-1}^{(v)}, W^{(v \rightarrow 1)}, \dots, W^{(v \rightarrow m)}\}.$$

For the purposes of this paper, network  $\mathcal{N}$  is arbitrary except for its inclusion of an independent channel  $\mathcal{C}$ , as shown in Figure 2. To make this precise, let  $V_1, V_2 \subset \{1, \dots, m\}$ ,  $V_1 \cap V_2 = \emptyset$ , denote the nodes transmitting to and receiving from channel  $\mathcal{C}$ , respectively. For example, a broadcast channel  $\mathcal{C}$  has a single transmitter  $V_1 = \{i\}$  and multiple receivers  $V_2 = \{j_1, \dots, j_k\}$ , a multiple access channel has multiple transmitters  $V_1 = \{i_1, \dots, i_k\}$  and a single receiver  $V_2 = \{j\}$ , and so on. Since each node  $v \in V_1$  may transmit over both  $\mathcal{C}$  and the remainder of the network and each node  $v \in V_2$  may receive information both from  $\mathcal{C}$  and from the remainder of the network, we define  $\mathcal{X}^{(v)} \stackrel{\text{def}}{=} \mathcal{X}^{(v,1)} \times \mathcal{X}^{(v,2)}$  for  $v \in V_1$  and  $\mathcal{Y}^{(v)} \stackrel{\text{def}}{=} \mathcal{Y}^{(v,1)} \times \mathcal{Y}^{(v,2)}$  for  $v \in V_2$ . We then use  $X^{V_1} \in \mathcal{X}^{V_1}$  and  $Y^{V_2} \in \mathcal{Y}^{V_2}$  to denote the

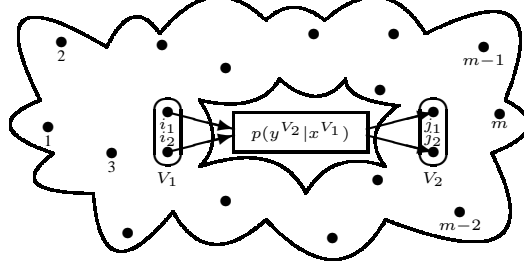

Fig. 2. An  $m$ -node network containing a channel  $p(y^{V_2}|x^{V_1}) = p(y^{(j_1,1)}, y^{(j_2,1)}|x^{(i_1,1)}, x^{(i_2,2)})$  from nodes  $V_1 = \{i_1, i_2\}$  to node  $V_2 = \{j_1, j_2\}$ . The distribution  $p(y^{-V_2}|x^{-V_1})$  on the remaining channel outputs given the remaining channel inputs is arbitrary.

input and output to channel  $\mathcal{C}$  and  $X^{-V_1} \in \mathcal{X}^{-V_1}$  and  $Y^{-V_2} \in \mathcal{Y}^{-V_2}$  to denote the input and output to remainder of the network. The respective alphabets are given by

$$\begin{aligned} \mathcal{X}^{V_1} &= \prod_{v \in V_1} \mathcal{X}^{(v,1)} & \mathcal{X}^{-V_1} &= \left( \prod_{v \notin V_1} \mathcal{X}^{(v)} \right) \times \left( \prod_{v \in V_1} \mathcal{X}^{(v,2)} \right) \\ \mathcal{Y}^{V_2} &= \prod_{v \in V_2} \mathcal{Y}^{(v,1)} & \mathcal{Y}^{-V_2} &= \left( \prod_{v \notin V_2} \mathcal{Y}^{(v)} \right) \times \left( \prod_{v \in V_2} \mathcal{Y}^{(v,2)} \right). \end{aligned}$$

The independence of channel  $\mathcal{C}$  from the rest of the network implies a factorization of the conditional distribution  $p(\mathbf{y}|\mathbf{x})$ , giving network characterization

$$\mathcal{N} = (\mathcal{X}^{-V_1} \times \mathcal{X}^{V_1}, p(y^{-V_2}|x^{-V_1})p(y^{V_2}|x^{V_1}), \mathcal{Y}^{-V_2} \times \mathcal{Y}^{V_2}),$$

again with the constraint that random variable  $X_t^{(v)}$  is a function of random variables  $\{Y_1^{(v)}, \dots, Y_{t-1}^{(v)}, W^{(v \rightarrow 1)}, \dots, W^{(v \rightarrow m)}\}$  alone.

The following definitions are identical to those in [9], which describes them in greater detail.

**Definition 1** Let a network

$$\mathcal{N} \stackrel{\text{def}}{=} \left( \prod_{v=1}^m \mathcal{X}^{(v)}, p(\mathbf{y}|\mathbf{x}), \prod_{v=1}^m \mathcal{Y}^{(v)} \right)$$

be given. A blocklength- $n$  solution  $\mathcal{S}(\mathcal{N})$  for this network is a set of encoding and decoding functions:

$$\begin{aligned} X_t^{(v)} &: (\mathcal{Y}^{(v)})^{t-1} \times \prod_{v'=1}^m \mathcal{W}^{(v \rightarrow v')} \rightarrow \mathcal{X}^{(v)} \\ \hat{W}^{(u \rightarrow v)} &: (\mathcal{Y}^{(v)})^n \times \prod_{v'=1}^m \mathcal{W}^{(v \rightarrow v')} \rightarrow \mathcal{W}^{(u \rightarrow v)} \end{aligned}$$

mapping  $(Y_1^{(v)}, \dots, Y_{t-1}^{(v)}, W^{(v \rightarrow 1)}, \dots, W^{(v \rightarrow m)})$  to  $X_t^{(v)}$  for each  $v \in V$  and  $t \in \{1, \dots, n\}$  and mapping  $(Y_1^{(v)}, \dots, Y_n^{(v)}, W^{(v \rightarrow 1)}, \dots, W^{(v \rightarrow m)})$  to  $\hat{W}^{(u \rightarrow v)}$  for each  $u, v \in V$ . The solution  $\mathcal{S}(\mathcal{N})$  is called a  $(\lambda, \mathcal{R})$ -solution, denoted  $(\lambda, \mathcal{R})$ - $\mathcal{S}(\mathcal{N})$ , if  $\Pr(W^{(u \rightarrow v)} \neq \hat{W}^{(u \rightarrow v)}) < \lambda$  for all source and sink pairs  $u, v$  using the specified encoding and decoding functions.

**Definition 2** The rate region  $\mathcal{R}(\mathcal{N}) \subset \mathbb{R}_+^{m(m-1)}$  of a network  $\mathcal{N}$  is the closure of all rate vectors  $\mathcal{R}$  such that for any  $\lambda > 0$  and all  $n$  sufficiently large, there exists a  $(\lambda, \mathcal{R})$ - $\mathcal{S}(\mathcal{N})$  solution of blocklength  $n$ . We use  $\text{int}(\mathcal{R}(\mathcal{N}))$  to denote the interior of rate region  $\mathcal{R}(\mathcal{N})$ .

Given a network  $\mathcal{N}$ , the  $N$ -fold stacked network  $\underline{\mathcal{N}}$  contains  $N$  copies of  $\mathcal{N}$  and delivers  $N$  independent messages  $W^{(u \rightarrow v)}$  for each  $(u, v)$ . We carry over notation and variable definitions from the network  $\mathcal{N}$  to the stacked network  $\underline{\mathcal{N}}$  by underlining the variable names. So  $\underline{W}^{(u \rightarrow v)} \in \underline{\mathcal{W}}^{(u \rightarrow v)} \stackrel{\text{def}}{=} (\mathcal{W}^{(u \rightarrow v)})^N$  is the  $N$ -dimensional vector of messages that the  $N$  copies of node  $u$  send to the corresponding copies of node  $v$ , and  $\underline{X}_t^{(v)} \in \underline{\mathcal{X}}^{(v)} \stackrel{\text{def}}{=} (\mathcal{X}^{(v)})^N$  and  $\underline{Y}_t^{(v)} \in \underline{\mathcal{Y}}^{(v)} \stackrel{\text{def}}{=} (\mathcal{Y}^{(v)})^N$  are the  $N$ -dimensional vectors of network inputs and network outputs, respectively, for node  $v$  at time  $t$ . The variables in the  $\ell$ -th layer of the stack are denoted by an argument  $\ell$ , for example  $\underline{W}^{(u \rightarrow v)}(\ell)$  is the message from node  $u$  to node  $v$  in the  $\ell$ -th layer of the stack and  $\underline{X}_t^{(v)}(\ell)$  is the layer- $\ell$  channel input from node  $v$  at time  $t$ . The rate  $R^{(u \rightarrow v)}$  for a stacked network equals  $(\log |\underline{\mathcal{W}}^{(u \rightarrow v)}|)/(nN)$ ; this normalization makes rate regions in a network and its corresponding stacked network comparable.

**Definition 3** Let a network

$$\mathcal{N} \stackrel{\text{def}}{=} \left( \prod_{v=1}^m \mathcal{X}^{(v)}, p(\mathbf{y}|\mathbf{x}), \prod_{v=1}^m \mathcal{Y}^{(v)} \right)$$

be given. Let  $\underline{\mathcal{N}}$  be the  $N$ -fold stacked network for  $\mathcal{N}$ . A blocklength- $n$  solution  $\mathcal{S}(\underline{\mathcal{N}})$  to this network is defined as a set of encoding and decoding functions

$$\begin{aligned} \underline{X}_t^{(v)} &: (\underline{\mathcal{Y}}^{(v)})^{t-1} \times \prod_{v'=1}^m \underline{\mathcal{W}}^{(v \rightarrow v')} \rightarrow \underline{\mathcal{X}}^{(v)} \\ \underline{\hat{W}}^{(u \rightarrow v)} &: (\underline{\mathcal{Y}}^{(v)})^n \times \prod_{v'=1}^m \underline{\mathcal{W}}^{(v \rightarrow v')} \rightarrow \underline{\mathcal{W}}^{(u \rightarrow v)} \end{aligned}$$

mapping  $(\underline{Y}_1^{(v)}, \dots, \underline{Y}_{t-1}^{(v)}, \underline{W}^{(v \rightarrow 1)}, \dots, \underline{W}^{(v \rightarrow m)})$  to  $\underline{X}_t^{(v)}$  for each  $t \in \{1, \dots, n\}$  and  $v \in \{1, \dots, m\}$  and mapping  $(\underline{Y}_1^{(v)}, \dots, \underline{Y}_n^{(v)}, \underline{W}^{(v \rightarrow 1)}, \dots, \underline{W}^{(v \rightarrow m)})$  to  $\underline{\hat{W}}^{(u \rightarrow v)}$  for each  $u, v \in \{1, \dots, m\}$ . The solution  $\mathcal{S}(\underline{\mathcal{N}})$  is called a  $(\lambda, \mathcal{R})$ -solution for  $\underline{\mathcal{N}}$ , denoted  $(\lambda, \mathcal{R})$ - $\mathcal{S}(\underline{\mathcal{N}})$ , if the encoding and decoding functions imply  $\Pr(\underline{W}^{(u \rightarrow v)} \neq \underline{\hat{W}}^{(u \rightarrow v)}) < \lambda$  for all source and sink pairs  $u, v$ .

**Definition 4** The rate region  $\mathcal{R}(\underline{\mathcal{N}}) \subset \mathbb{R}_+^{m(m-1)}$  of a stacked network  $\underline{\mathcal{N}}$  is the closure of all rate vectors  $\mathcal{R}$  such that a  $(\lambda, \mathcal{R})$ - $\mathcal{S}(\underline{\mathcal{N}})$  solution exists for any  $\lambda > 0$  and all  $N$  sufficiently large.

Theorem 1 from [9], reproduced below, shows that if the messages  $\underline{W}^{(u \rightarrow v)}$  are channel coded before transmission, then any rate  $\mathcal{R}$  that can be achieved across a stacked network can be achieved by a code that applies the same solution independently in each layer. Such solutions are called stacked solutions. A formal definition of stacked solutions follows. Since stacked solutions are optimal by Theorem 1, there is no loss of generality in restricting our attention to stacked solutions going forward.

**Definition 5** Let a network  $\mathcal{N} \stackrel{\text{def}}{=} (\prod_{v=1}^m \mathcal{X}^{(v)}, p(\mathbf{y}|\mathbf{x}), \prod_{v=1}^m \mathcal{Y}^{(v)})$  be given. Let  $\underline{\mathcal{N}}$  be the  $N$ -fold stacked network for  $\mathcal{N}$ . A blocklength- $n$  stacked solution  $\underline{\mathcal{S}}(\underline{\mathcal{N}})$  to network  $\underline{\mathcal{N}}$  is defined as a set of mappings

$$\begin{aligned} \underline{\tilde{W}}^{(u \rightarrow v)} &: \underline{\mathcal{W}}^{(u \rightarrow v)} \rightarrow \underline{\tilde{\mathcal{W}}}^{(u \rightarrow v)} \\ \underline{X}_t^{(v)} &: (\mathcal{Y}^{(v)})^{t-1} \times \prod_{v'=1}^m \tilde{\mathcal{W}}^{(v \rightarrow v')} \rightarrow \mathcal{X}^{(v)} \\ \hat{\underline{W}}^{(u \rightarrow v)} &: (\mathcal{Y}^{(v)})^n \times \prod_{v'=1}^m \tilde{\mathcal{W}}^{(v \rightarrow v')} \rightarrow \tilde{\mathcal{W}}^{(u \rightarrow v)} \\ \underline{\hat{W}}^{(u \rightarrow v)} &: \underline{\tilde{\mathcal{W}}}^{(u \rightarrow v)} \rightarrow \underline{\mathcal{W}}^{(u \rightarrow v)} \end{aligned}$$

such that

$$\begin{aligned} \underline{\tilde{W}}^{(u \rightarrow v)} &= \underline{\tilde{W}}^{(u \rightarrow v)}(\underline{W}^{(u \rightarrow v)}) \\ \underline{X}_t^{(v)}(\ell) &= X_t^{(v)}\left(\underline{Y}_1^{(v)}(\ell), \dots, \underline{Y}_{t-1}^{(v)}(\ell), \underline{\tilde{W}}^{(v \rightarrow 1)}(\ell), \dots, \underline{\tilde{W}}^{(v \rightarrow m)}(\ell)\right) \\ \hat{\underline{W}}^{(u \rightarrow v)}(\ell) &= \hat{W}^{(u \rightarrow v)}\left(\underline{Y}_1^{(v)}(\ell), \dots, \underline{Y}_n^{(v)}(\ell), \underline{\tilde{W}}^{(v \rightarrow 1)}(\ell), \dots, \underline{\tilde{W}}^{(v \rightarrow m)}(\ell)\right) \\ \underline{\hat{W}}^{(u \rightarrow v)} &= \underline{\hat{W}}^{(u \rightarrow v)}(\hat{\underline{W}}^{(u \rightarrow v)}) \end{aligned}$$

for each  $u, v \in \{1, \dots, m\}$ ,  $t \in \{1, \dots, n\}$ , and  $\ell \in \{1, \dots, N\}$ . Here  $(\underline{\tilde{W}}^{(u \rightarrow v)}, \underline{\hat{W}}^{(u \rightarrow v)})$  is the blocklength- $N$  channel code for the message from  $u$  to  $v$ ,  $X_t^{(v)}$  is the node- $v$  single-layer encoder at time  $t$ , and  $\hat{W}^{(u \rightarrow v)}$  is the node- $v$  single-layer decoder at time  $t$ . The solution  $\underline{\mathcal{S}}(\underline{\mathcal{N}})$  is called a stacked  $(\lambda, \mathcal{R})$ -solution, denoted  $(\lambda, \mathcal{R})$ - $\underline{\mathcal{S}}(\underline{\mathcal{N}})$ , if the specified mappings imply  $\Pr(\underline{W}^{(u \rightarrow v)} \neq \underline{\hat{W}}^{(u \rightarrow v)}) < \lambda$  for all pairs  $(u, v) \in \mathcal{V}^2$ .

**Definition 6** The rate region  $\mathcal{R}(\underline{\mathcal{N}}) \subset \mathbb{R}_+^{m(m-1)}$  of a stacked network  $\underline{\mathcal{N}}$  is the closure of all rate vectors  $\mathcal{R}$  such that a  $(\lambda, \mathcal{R})$ - $\mathcal{S}(\underline{\mathcal{N}})$  solution exists for any  $\lambda > 0$  and all  $N$  sufficiently large.

**Theorem 1** [9, Theorem 1] The rate regions  $\mathcal{R}(\mathcal{N})$  and  $\mathcal{R}(\underline{\mathcal{N}})$  are identical, and for each  $\mathcal{R} \in \text{int}(\mathcal{R}(\underline{\mathcal{N}}))$ , there exists a sequence of blocklength- $n$   $(2^{-N^\delta}, \mathcal{R})$ - $\underline{\mathcal{S}}(\underline{\mathcal{N}})$  stacked solutions for  $\underline{\mathcal{N}}$  for some  $n \geq 1$  and

$\delta > 0$ . ■

### III. BIT-PIPE MODELS

The equivalence tools derived below relate the rate region of a network  $\mathcal{N}$  to those of a network  $\mathcal{N}(\mathcal{R}_C)$  in which channel  $\mathcal{C}$  is replaced by a bit-pipe model  $\mathcal{C}(\mathcal{R}_C)$  corresponding to some rate vector  $\mathcal{R}_C$ . We here define  $\mathcal{R}_C$  and  $\mathcal{C}(\mathcal{R}_C)$  for a generic channel  $\mathcal{C}$  with input nodes  $V_1$  and output nodes  $V_2$ . Figure 3 illustrates these definitions for two example channels. Let

$$\begin{aligned}\mathcal{M} &\stackrel{\text{def}}{=} \{(A, B) : A \subseteq V_1, B \subseteq V_2, A, B \neq \emptyset\} \\ \mathcal{R}_C &\stackrel{\text{def}}{=} (R^{(A \rightarrow B)} : (A, B) \in \mathcal{M}).\end{aligned}$$

For each  $(A, B) \in \mathcal{M}$ , bit-pipe model  $\mathcal{C}(\mathcal{R}_C)$ , defined formally below, delivers rate  $R^{(A \rightarrow B)}$  from transmitter set  $A$  to receiver set  $B$ . When  $|A| = 1$ ,  $A$  transmits directly to each node in  $B$ . When  $|A| > 1$ , each node  $i \in A$  delivers  $\log |\mathcal{X}^{(i,1)}|$  bits (i.e., a symbol from alphabet  $\mathcal{X}^{(i,1)}$ ) to an internal node  $v^A$ , which delivers  $R^{(A \rightarrow B)}$  bits to each node in  $B$ .

**Definition 7** *The bit-pipe model  $\mathcal{C}(\mathcal{R}_C)$  is defined as*

$$\mathcal{C}(\mathcal{R}_C) \stackrel{\text{def}}{=} \left( \tilde{\mathcal{X}}^{V_o} \times \tilde{\mathcal{X}}^{V_1}, p(\tilde{y}^{V_o}, \tilde{y}^{V_2} | \tilde{x}^{V_o}, \tilde{x}^{V_1}), \tilde{\mathcal{Y}}^{V_o} \times \tilde{\mathcal{Y}}^{V_2} \right), \quad (2)$$

where  $\tilde{x}^{V_1}$  and  $\tilde{y}^{V_2}$  are the network inputs and outputs for the nodes in  $V_1$  and  $V_2$ ,  $\tilde{x}^{V_o}$  and  $\tilde{y}^{V_o}$  are the network inputs and outputs for the internal nodes  $V_o = \{v^A : A \subseteq V_1, |A| > 1\}$ . For each  $A \subseteq V_1$  with  $|A| > 1$  and  $i \in A$ , node  $v^A$  receives copy  $\tilde{y}^{(v^A, i)}$  of  $x^{(i,1)}$ . For each  $(A, B) \in \mathcal{M}$  and  $j \in B$ , node  $j$  receives copy  $\tilde{y}^{(A \rightarrow B), j}$  of  $\tilde{x}^{(A \rightarrow B)}$ . Therefore

$$\begin{aligned}\tilde{\mathcal{X}}^{V_1} &\stackrel{\text{def}}{=} \prod_{i \in V_1} \tilde{\mathcal{X}}^{(i,1)} & \tilde{\mathcal{Y}}^{V_2} &\stackrel{\text{def}}{=} \prod_{j \in V_2} \tilde{\mathcal{Y}}^{(j,1)} \\ \tilde{\mathcal{X}}^{(i,1)} &\stackrel{\text{def}}{=} \mathcal{X}^{(i,1)} \times \prod_{(\{i\}, B) \in \mathcal{M}} \tilde{\mathcal{X}}^{\{i\} \rightarrow B} & \tilde{\mathcal{Y}}^{(j,1)} &\stackrel{\text{def}}{=} \prod_{(A, B) \in \mathcal{M}: j \in B} \tilde{\mathcal{X}}^{(A \rightarrow B)} \\ \tilde{\mathcal{X}}^{(A \rightarrow B)} &\stackrel{\text{def}}{=} \{0, 1\}^{R^{(A \rightarrow B)}} & \tilde{\mathcal{Y}}^{V_o} &\stackrel{\text{def}}{=} \prod_{A \subseteq V_1: |A| > 1} \tilde{\mathcal{Y}}^{(v^A)} \\ \tilde{\mathcal{X}}^{V_o} &\stackrel{\text{def}}{=} \prod_{A \subseteq V_1: |A| > 1} \tilde{\mathcal{X}}^{(v^A)} & \tilde{\mathcal{Y}}^{(v^A)} &\stackrel{\text{def}}{=} \prod_{i \in A} \mathcal{X}^{(i,1)} \\ \tilde{\mathcal{X}}^{(v^A)} &\stackrel{\text{def}}{=} \prod_{B \subseteq V_2} \tilde{\mathcal{X}}^{(A \rightarrow B)}\end{aligned}$$

$$p(\tilde{y}^{V_o}, \tilde{y}^{V_2} | \tilde{x}^{V_o}, \tilde{x}^{V_1}) \stackrel{\text{def}}{=} \left( \prod_{(A, B) \in \mathcal{M}: |A| > 1} \prod_{i \in A} \delta(\tilde{y}^{(v^A, i)} - x^{(i,1)}) \right) \left( \prod_{(A, B) \in \mathcal{M}} \prod_{j \in B} \delta(\tilde{y}^{(A \rightarrow B), j} - \tilde{x}^{(A \rightarrow B)}) \right).$$

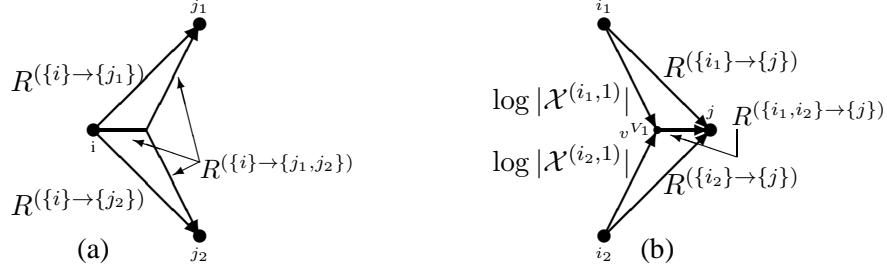

Fig. 3. Bit-pipe models  $\mathcal{C}(\mathcal{R}_C)$  for (a) the broadcast channel with  $V_1 = \{i\}$  and  $V_2 = \{j_1, j_2\}$ , and (b) the multiple access channel with  $V_1 = \{i_1, i_2\}$  and  $V_2 = \{j\}$ . For the broadcast channel,  $\mathcal{R}_C = (R^{\{\{i\} \rightarrow \{j_1, j_2\}\}}, R^{\{\{i\} \rightarrow \{j_1\}\}}, R^{\{\{i\} \rightarrow \{j_2\}\}})$  describes a common information rate to be delivered to both receivers and a private information rate for each receiver. For the multiple access channel,  $\mathcal{R}_C = (R^{\{\{i_1\} \rightarrow \{j\}\}}, R^{\{\{i_2\} \rightarrow \{j\}\}}, R^{\{\{i_1, i_2\} \rightarrow \{j\}\}})$  describes an individual information rate from each transmitter and a shared information rate from the pair of transmitters.

Since any network  $\mathcal{N}(\mathcal{R}_C)$  interacts with  $\mathcal{C}(\mathcal{R}_C)$  only through nodes  $V_1$  and  $V_2$  and does not have direct access to the nodes in  $V_o$ , the remainder of this paper abuses notation by replacing (2) by

$$\mathcal{C}(\mathcal{R}_C) = \left( \tilde{\mathcal{X}}^{V_1}, p(\tilde{y}^{V_2} | \tilde{x}^{V_1}), \tilde{\mathcal{Y}}^{V_2} \right). \quad (3)$$

In another common abuse of notation, we allow non-integer values of  $R^{(A \rightarrow B)}$  to designate capacitated bit-pipes that require more than a single channel use to deliver some integer number of bits. Applying the stacking approach from the previous section, the arguments that follow transmit information over  $N$  copies of each bit pipe in the stacked network, giving alphabet  $\tilde{\mathcal{X}}^{(A \rightarrow B)} \stackrel{\text{def}}{=} \{0, 1\}^{NR^{(A \rightarrow B)}}$ .

**Definition 8** Bit-pipe model  $\mathcal{C}(\mathcal{R}_C) = (\tilde{\mathcal{X}}^{V_1}, p(\tilde{y}^{V_2} | \tilde{x}^{V_1}), \tilde{\mathcal{Y}}^{V_2})$  is a lower-bounding model for channel  $\mathcal{C} = (\mathcal{X}^{V_1}, p(y^{V_2} | x^{V_1}), \mathcal{Y}^{V_2})$ , written  $\mathcal{C}(\mathcal{R}_C) \subseteq \mathcal{C}$ , if and only if  $\mathcal{R}(\mathcal{N}(\mathcal{R}_C)) \subseteq \mathcal{R}(\mathcal{N})$  for all

$$\begin{aligned} \mathcal{N} &= (\mathcal{X}^{V_1} \times \mathcal{X}^{-V_1}, p(y^{V_2} | x^{V_1})p(y^{-V_2} | x^{-V_1}), \mathcal{Y}^{V_2} \times \mathcal{Y}^{-V_2}) \\ \mathcal{N}(\mathcal{R}_C) &= (\tilde{\mathcal{X}}^{V_1} \times \mathcal{X}^{-V_1}, p(\tilde{y}^{V_2} | \tilde{x}^{V_1})p(y^{-V_2} | x^{-V_1}), \tilde{\mathcal{Y}}^{V_2} \times \mathcal{Y}^{-V_2}). \end{aligned}$$

**Definition 9** Bit-pipe model  $\mathcal{C}(\mathcal{R}_C) = (\tilde{\mathcal{X}}^{V_1}, p(\tilde{y}^{V_2} | \tilde{x}^{V_1}), \tilde{\mathcal{Y}}^{V_2})$  is an upper-bounding model for channel  $\mathcal{C} = (\mathcal{X}^{V_1}, p(y^{V_2} | x^{V_1}), \mathcal{Y}^{V_2})$ , written  $\mathcal{C} \subseteq \mathcal{C}(\mathcal{R}_C)$ , if and only if  $\mathcal{R}(\mathcal{N}) \subseteq \mathcal{R}(\mathcal{N}(\mathcal{R}_C))$  for all

$$\begin{aligned} \mathcal{N} &= (\mathcal{X}^{V_1} \times \mathcal{X}^{-V_1}, p(y^{V_2} | x^{V_1})p(y^{-V_2} | x^{-V_1}), \mathcal{Y}^{V_2} \times \mathcal{Y}^{-V_2}) \\ \mathcal{N}(\mathcal{R}_C) &= (\tilde{\mathcal{X}}^{V_1} \times \mathcal{X}^{-V_1}, p(\tilde{y}^{V_2} | \tilde{x}^{V_1})p(y^{-V_2} | x^{-V_1}), \tilde{\mathcal{Y}}^{V_2} \times \mathcal{Y}^{-V_2}). \end{aligned}$$

The following lemma shows the continuity of network capacity in the rate of any bit pipes it contains.

**Lemma 2** [9, Lemma 2] Consider any network

$$\mathcal{N}_R = (\mathcal{X}^{-V_1} \times \mathcal{X}^{V_1}, p(y^{-V_2}|x^{-V_1})p(y^{V_2}|x^{V_1}), \mathcal{Y}^{-V_2} \times \mathcal{Y}^{V_2})$$

with  $V_1 = \{i\}$  and  $V_2 = \{j\}$  connected by a rate- $R$  bit pipe

$$(\mathcal{X}^{V_1}, p(y^{V_2}|x^{V_1}), \mathcal{Y}^{V_2}) = (\{0, 1\}^R, \delta(y^{(j,1)} - x^{(i,1)}), \{0, 1\}^R).$$

Rate region  $\mathcal{R}(\mathcal{N}_R)$  is continuous in  $R$  for all  $R > 0$ . ■

#### IV. THE EQUIVALENCE TOOLS

Given any network  $\mathcal{N}$  containing channel  $\mathcal{C}$ , let  $\mathcal{N}(\mathcal{R}_\mathcal{C})$  be the network achieved by replacing  $\mathcal{C}$  by  $\mathcal{C}(\mathcal{R}_\mathcal{C})$  in  $\mathcal{N}$ . We here derive conditions under which  $\mathcal{R}(\mathcal{N}(\mathcal{R}_\mathcal{C})) \subseteq \mathcal{R}(\mathcal{N})$  (i.e.,  $\mathcal{C}(\mathcal{R}_\mathcal{C})$  is a lower bounding model for  $\mathcal{C}$ ) or  $\mathcal{R}(\mathcal{N}) \subseteq \mathcal{R}(\mathcal{N}(\mathcal{R}_\mathcal{C}))$  (i.e.,  $\mathcal{C}(\mathcal{R}_\mathcal{C})$  is an upper bounding model for  $\mathcal{C}$ ).

Lemma 3, below, uses channel coding arguments to derive lower bounding models. The proof runs a code  $\underline{\mathcal{S}}(\underline{\mathcal{N}}(\mathcal{R}_\mathcal{C}))$  across network  $\underline{\mathcal{N}}$  with the aid of a rate- $\mathcal{R}_\mathcal{C}$  channel code for  $\mathcal{C}$ . The resulting error probability approximates the error probability of  $\underline{\mathcal{S}}(\underline{\mathcal{N}}(\mathcal{R}_\mathcal{C}))$  on  $\underline{\mathcal{N}}(\mathcal{R}_\mathcal{C})$  provided that the probability of channel coding error is small. We therefore begin by defining channel codes for a generic channel  $\mathcal{C}$ .

Given a channel  $\mathcal{C}$  with input nodes  $V_1$  and output nodes  $V_2$ , a channel code for  $\mathcal{C}$  is a mechanism for reliably delivering some collection of rates  $(R^{\{\{i\} \rightarrow B\}} : i \in V_1, B \subseteq V_2)$  from each transmitter  $i \in V_1$  to each subset of receivers  $B \subseteq V_2$ . For example, a channel code for broadcast channel  $\mathcal{C}$  with transmitter  $V_1 = \{i\}$  and receivers  $V_2 = \{j_1, j_2\}$  delivers common information at rate  $R^{\{\{i\} \rightarrow \{j_1, j_2\}\}}$  and private information at rates  $R^{\{\{i\} \rightarrow \{j_2\}\}}$  and  $R^{\{\{i\} \rightarrow \{j_1\}\}}$  for some  $R^{\{\{i\} \rightarrow \{j_1, j_2\}\}}, R^{\{\{i\} \rightarrow \{j_2\}\}}, R^{\{\{i\} \rightarrow \{j_1\}\}} \geq 0$ . Since there is no mechanism for delivering messages from a set of transmitters, we define channel codes only for rates  $\mathcal{R}_\mathcal{C}$  that satisfy  $R^{(A \rightarrow B)} = 0$  for all  $(A, B) \in \mathcal{M}$  with  $|A| > 1$ .<sup>1</sup>

**Definition 10** Given a channel  $\mathcal{C} = (\mathcal{X}^{V_1}, p(y^{V_2}|x^{V_1}), \mathcal{Y}^{V_2})$ , let  $\mathcal{R}_\mathcal{C}$  be a rate vector with  $R^{(A \rightarrow B)} = 0$  for all  $(A, B) \in \mathcal{M}$  with  $|A| > 1$ . For any  $N \geq 1$ , a  $(2^{N\mathcal{R}_\mathcal{C}}, N)$  channel code  $(\alpha_N, \beta_N)$  for channel  $\mathcal{C}$  defines a collection of encoding functions  $\alpha_N = (\alpha_N^{(i)} : i \in V_1)$  and decoding functions  $\beta_N = (\beta_N^{\{\{i\} \rightarrow B\}, j} : (\{i\}, B) \in \mathcal{M}, j \in B)$  with

$$\begin{aligned} \alpha_N^{(i)} &: \prod_{B \subseteq V_2} \tilde{\mathcal{X}}^{\{\{i\} \rightarrow B\}} \rightarrow \underline{\mathcal{X}}^{(i,1)} \\ \beta_N^{\{\{i\} \rightarrow B\}, j} &: \underline{\mathcal{Y}}^{(j,1)} \rightarrow \tilde{\mathcal{X}}^{\{\{i\} \rightarrow B\}}. \end{aligned}$$

<sup>1</sup>Nonzero values of  $R^{(A \rightarrow B)}$  are useful for upper bounding models derived later in the paper.

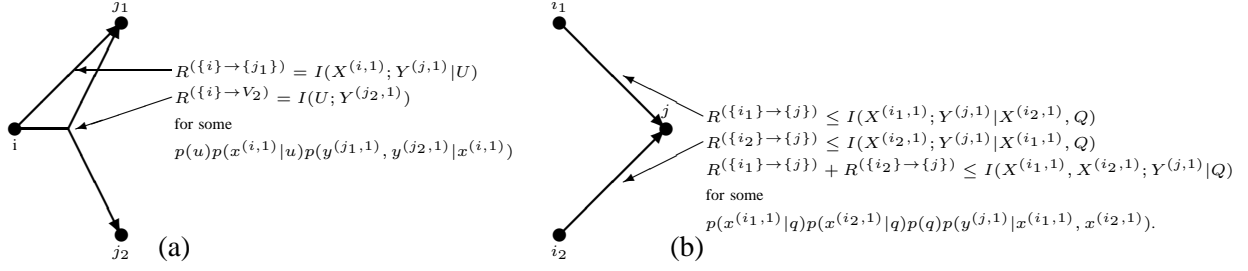

Fig. 4. Lower bounding models for the (a) degraded broadcast and (b) multiple access channels.

Let  $\underline{\mathcal{W}} \stackrel{\text{def}}{=} \prod_{(\{i\}, B) \in \mathcal{M}} \underline{\mathcal{X}}^{\{\{i\} \rightarrow B\}}$ . The code's average error probability is

$$P_e^{(N)} \stackrel{\text{def}}{=} \frac{1}{|\underline{\mathcal{W}}|} \sum_{\underline{w} \in \underline{\mathcal{W}}} \Pr \left( \bigcup_{(\{i\}, B) \in \mathcal{M}} \bigcup_{j \in B} \beta_N^{\{\{i\} \rightarrow B\}, j}(\underline{Y}^{(j,1)}) \neq \underline{w}^{\{\{i\} \rightarrow B\}} \right)$$

$$\underline{\mathcal{X}}^{(i,1)} = \alpha_N^{(i)}(\underline{w}^{\{\{i\} \rightarrow B\}} : B \subseteq V_2) \forall i \in V_1.$$

**Definition 11** The capacity region  $\mathcal{R}(\mathcal{C})$  of channel  $\mathcal{C}$  is the closure of all rate vectors  $\mathcal{R}_C$  such that for any  $\lambda > 0$  and all  $N$  sufficiently large, there exists a  $(2^{N\mathcal{R}_C}, N)$  channel code for channel  $\mathcal{C}$  with average error probability  $P_e^{(N)} < \lambda$ .

Lemma 3, below, shows that  $\mathcal{R}_C \in \mathcal{R}(\mathcal{C})$  implies  $\mathcal{C}(\mathcal{R}_C)$  is a lower bounding model for  $\mathcal{C}$ . Applying Lemma 3 with existing achievability bounds for any network gives immediate lower bounding models for that network. Figure 4 shows two examples. Zero capacity bit pipes can carry no bits, so they are not drawn.

**Lemma 3** If  $\mathcal{R}_C \in \mathcal{R}(\mathcal{C})$ , then  $\mathcal{C}(\mathcal{R}_C) \subseteq \mathcal{C}$ .

*Proof.* The following argument treats points  $\mathcal{R}_C \in \text{int}(\mathcal{R}(\mathcal{C}))$ . The result then follows since  $\mathcal{R}(\mathcal{N}(\mathcal{R}_C)) \subseteq \mathcal{R}(\mathcal{N})$  for all  $\mathcal{R}_C \in \text{int}(\mathcal{R}(\mathcal{C}))$  and  $\mathcal{R}(\mathcal{N}(\mathcal{R}_C))$  is continuous in  $\mathcal{R}_C$  by Lemma 2 together imply that  $\mathcal{R}(\mathcal{N}(\mathcal{R}_C)) \subseteq \mathcal{R}(\mathcal{N})$  for all  $\mathcal{R}_C \in \mathcal{R}(\mathcal{C})$  by the closure in the definition of the network capacity region.

Consider a pair of networks,

$$\mathcal{N} = (\mathcal{X}^{V_1} \times \mathcal{X}^{-V_1}, p(y^{V_2}|x^{V_1})p(y^{-V_2}|x^{-V_1}), \mathcal{Y}^{V_2} \times \mathcal{Y}^{-V_2})$$

$$\mathcal{N}(\mathcal{R}_C) = (\tilde{\mathcal{X}}^{V_1} \times \mathcal{X}^{-V_1}, p(\tilde{y}^{V_2}|\tilde{x}^{V_1})p(y^{-V_2}|x^{-V_1}), \tilde{\mathcal{Y}}^{V_2} \times \mathcal{Y}^{-V_2}).$$

Let  $\underline{\mathcal{N}}$  and  $\underline{\mathcal{N}}(\mathcal{R}_C)$  be the  $N$ -fold stacked networks for  $\mathcal{N}$  and  $\mathcal{N}(\mathcal{R}_C)$ . By Theorem 1, it suffices to prove



that  $\mathcal{R}(\underline{\mathcal{N}}(\mathcal{R}_C)) \subseteq \mathcal{R}(\underline{\mathcal{N}})$  for  $N$  sufficiently large. Fix any  $\mathcal{R} \in \text{int}(\mathcal{R}(\underline{\mathcal{N}}(\mathcal{R}_C)))$  and any  $\lambda > 0$ . We begin by building a rate- $\mathcal{R}$  stacked solution  $\underline{\mathcal{S}}(\underline{\mathcal{N}}(\mathcal{R}_C))$ . By Theorem 1, there exists a sequence of stacked solutions  $\underline{\mathcal{S}}(\underline{\mathcal{N}}(\mathcal{R}_C))$  of some fixed blocklength  $n$  (independent of  $N$ ) but increasing stack size such that  $\Pr(\hat{W} \neq W) \leq 2^{-N^\delta}$  for all  $N$  sufficiently large. Fix such a sequence of codes.

Since  $\mathcal{R}_C \in \text{int}(\mathcal{R}(C))$ ,  $\lambda > 0$ , and  $n$  are fixed, there exists a sequence of channel codes  $\{(\alpha_N, \beta_N)\}_{N=1}^\infty$  for channel  $C$  with encoders  $\alpha_N = (\alpha_N^{(i)} : (i) \in V_1)$ , decoders  $\beta_N = (\beta_N^{\{\{i\} \rightarrow B\}, j} : (\{i\}, B) \in \mathcal{M}, j \in B)$ , and average error  $P_e^{(N)} < \lambda/(2n)$  for all  $N$  sufficiently large.<sup>2</sup> For reasons that are explained below, we may wish to use different channel codes at each time  $t$ . We therefore use notation  $(\alpha_{N,t}, \beta_{N,t})$  for the time- $t$  channel code,  $t \in \{1, \dots, n\}$ .

We now build a solution  $\mathcal{S}(\underline{\mathcal{N}})$  for  $N$ -fold stacked network  $\underline{\mathcal{N}}$ . Solution  $\mathcal{S}(\underline{\mathcal{N}})$  operates  $\underline{\mathcal{S}}(\underline{\mathcal{N}}(\mathcal{R}_C))$  across  $\underline{\mathcal{N}}$  by channel encoding  $\underline{X}_t^{V_1}$  before transmission across  $C$  and channel decoding  $\underline{Y}_t^{V_2}$  before use in the node encoders and decoders of  $\underline{\mathcal{S}}(\underline{\mathcal{N}}(\mathcal{R}_C))$ . Precisely, at time  $t$  node  $v$  applies the node encoders from  $\underline{\mathcal{S}}(\underline{\mathcal{N}}(\mathcal{R}_C))$  as

$$\tilde{X}_t^{(v)} = \underline{X}^{(v)}(\tilde{Y}_1^{(v)}, \dots, \tilde{Y}_{t-1}^{(v)}, \underline{W}^{(v \rightarrow 1)}, \dots, \underline{W}^{(v \rightarrow m)}),$$

where  $\tilde{Y}_t^{(v)}$  is the network output  $\underline{Y}_t^{(v)}$  channel decoded (if necessary) as

$$\tilde{Y}_t^{(v)} = \begin{cases} \left( \left( \beta_{N,t}^{\{\{i\} \rightarrow B\}, v}(\underline{Y}_t^{(v,1)}) : (\{i\}, B) \in \mathcal{M}, v \in B \right), \underline{Y}_t^{(v,2)} \right) & \text{if } v \in V_2 \\ \underline{Y}_t^{(v)} & \text{otherwise.} \end{cases}$$

Node  $v$  then applies channel encoder  $\alpha_{N,t}$  (if necessary) as

$$\underline{X}_t^{(v)} = \begin{cases} \left( \alpha_{N,t}^{(v)}(\tilde{X}_t^{(v,1)}), \tilde{X}_t^{(v,2)} \right) & \text{if } v \in V_1 \\ \tilde{X}_t^{(v)} & \text{otherwise,} \end{cases}$$

and then transmits across the network. At time  $n$ , node  $v$  applies the decoder from  $\underline{\mathcal{S}}(\underline{\mathcal{N}}(\mathcal{R}_C))$  to give

$$\underline{W}^{(u \rightarrow v)} = \hat{W}^{(u \rightarrow v)}(\tilde{Y}_1^{(v)}, \dots, \tilde{Y}_n^{(v)}, \underline{W}^{(v \rightarrow 1)}, \dots, \underline{W}^{(v \rightarrow m)}).$$

To bound the error probability, note that two things can go wrong. Either the channel code can fail at one or more times steps or all channel codes can succeed but the code can fail anyway. If the channel codes  $\{(\alpha_{N,t}, \beta_{N,t})\}_{t=1}^n$  all succeed, then the conditional probability of an error given  $\underline{W} = \underline{w}$  is precisely what it

<sup>2</sup>We here divide by  $n$  since the channel code will be applied across the layers of the stack  $n$  times, once for each  $t \in \{1, \dots, n\}$  for this blocklength  $n$  code. Application of the union bound then gives an error probability over these  $n$  time steps.

would have been for the original code. Let  $E_t$  denote the event that the channel code  $(\alpha_{N,t}, \beta_{N,t})$  employed at time  $t$  fails. Then we bound the error probability as

$$\begin{aligned} \Pr(\hat{W} \neq W) &\stackrel{(a)}{\leq} \sum_{t=1}^n \Pr(E_t) + \sum_{\underline{w}} \Pr(\hat{W} \neq W | W = \underline{w} \cap \cap_{t=1}^n E_t^c) p(\underline{w} \cap \cap_{t=1}^n E_t^c) \\ &\stackrel{(b)}{\leq} \left( \sum_{t=1}^n \frac{\lambda}{2n} \right) + 2^{-N\delta}, \end{aligned}$$

which is less than  $\lambda$  for all  $N$  sufficiently large. Inequality (a) follows from the union bound. Inequality (b) follows from the channel code's error probability bound and the observation that  $p(\underline{w} \cap \cap_{t=1}^n E_t^c) \leq p(\underline{w})$  for all  $\underline{w}$ . Bounding the channel code's expected error probability in (a) is slightly subtle since the capacity definition guarantees only that the code's average error probability goes to zero. An argument suggested by [11], reproduced as Lemma 11 in Appendix I, shows that, under careful choice of the channel code's index assignments, each channel code  $(\alpha_{N,t}, \beta_{N,t})$  can achieve an expected error probability no greater than the code's average error probability  $\lambda/(2n)$ . Since the channel input distribution may vary with time, the channel code (or just the channel code's index assignments) may likewise need to vary with time. ■

**Remark 1** The family of lower bounding models described in Lemma 3 is tight in the sense that there exist networks  $\mathcal{N}$  for which the closure of  $\cup_{\mathcal{R}_C \in \mathcal{R}(\mathcal{C})} \mathcal{R}(\mathcal{N}(\mathcal{R}_C))$  is precisely equal to  $\mathcal{R}(\mathcal{N})$ . This observation is immediate since network  $\mathcal{N}$  can be the channel  $\mathcal{C}$  in isolation. Thus Lemma 3 does not necessarily give a tight capacity bound for all networks that employ channel  $\mathcal{C}$ , but we cannot hope to increase the rates in this model and still obtain a lower bound for any network that contains  $\mathcal{C}$ .

Just as Lemma 3 derives lower bounding models by showing that channel coding can be used to emulate a collection of noiseless bit pipes across a noisy channel, Theorem 4, below, derives upper bounding models by showing that lossy source coding can be used to emulate a noisy channel  $\mathcal{C}$  across a bit-pipe model  $\mathcal{C}(\mathcal{R}_C)$ . Specifically, we prove that  $\mathcal{R}(\mathcal{N}) \subseteq \mathcal{R}(\mathcal{N}(\mathcal{R}_C))$  by showing that we can run a solution  $\underline{\mathcal{S}}(\mathcal{N})$  across network  $\mathcal{N}(\mathcal{R}_C)$  with similar error probability if the source code can emulate the channel to sufficient accuracy. We therefore begin by defining source codes to run across a generic bit-pipe model  $\mathcal{C}(\mathcal{R}_C)$ . The source codes introduced here differ from traditional source codes in that a good reproduction of  $\underline{X}_t^{V_1}$  is not a value  $\hat{X}_t^{V_1}$  that reproduces it to low distortion but a value  $\underline{Y}_t^{V_2}$  that is similar statistically to the output that would be observed if  $\underline{X}^{V_1}$  were transmitted across  $N$  independent copies of  $\mathcal{C}$ . We therefore call the codes channel emulators and measure performance as emulation accuracy.

**Definition 12** A random  $(2^{N\mathcal{R}_C}, N)$  emulator  $\hat{\mathcal{C}} = (\alpha_N, \beta_N)$  for channel  $\mathcal{C} = (\mathcal{X}^{V_1}, p(y^{V_2}|x^{V_1}), \mathcal{Y}^{V_2})$  under channel input distribution  $p(x^{V_1})$  defines a distribution over the family of possible encoders  $\alpha_N =$

$(\alpha_N^{(A \rightarrow B)} : (A, B) \in \mathcal{M})$  and decoders  $\beta_N = (\beta_N^{(j)} : j \in V_2)$ , where

$$\alpha_N^{(A \rightarrow B)} : \prod_{i \in A} \underline{\mathcal{X}}^{(i,1)} \rightarrow \tilde{\underline{\mathcal{X}}}^{(A \rightarrow B)}$$

$$\beta_N^{(j)} : \prod_{(A,B) \in \mathcal{M} : j \in B} \tilde{\underline{\mathcal{X}}}^{(A \rightarrow B)} \rightarrow \underline{\mathcal{Y}}^{(i,1)}.$$

While any instance of code  $(\alpha_N, \beta_N)$  is deterministic, the distribution over codes establishes an emulation distribution

$$\hat{p}(\underline{y}^{V_2} | \underline{x}^{V_1}) \stackrel{\text{def}}{=} \Pr(\beta_N(\alpha_N(\underline{x}^{V_1})) = \underline{y}^{V_2}).$$

For any  $\nu > 0$ , we define error probability  $P_e^{(N)}(\nu)$  as

$$P_e^{(N)}(\nu) = \sum_{\underline{x}^{V_1}, \underline{y}^{V_2}} p(\underline{x}^{V_1}) \hat{p}(\underline{y}^{V_2} | \underline{x}^{V_1}) \mathbf{1} \left( \frac{1}{N} \log \left( \frac{\hat{p}(\underline{y}^{V_2} | \underline{x}^{V_1})}{p(\underline{y}^{V_2} | \underline{x}^{V_1})} \right) > \nu \right),$$

where, as usual,  $p(\underline{x}^{V_1}) = \prod_{\ell=1}^N p(\underline{x}^{V_1}(\ell))$  and  $p(\underline{y}^{V_2} | \underline{x}^{V_1}) = \prod_{\ell=1}^N p(\underline{y}^{V_2}(\ell) | \underline{x}^{V_1}(\ell))$ .

**Definition 13** The emulation region  $\mathcal{E}(\mathcal{C})$  of channel  $\mathcal{C}$  is the closure of all rate vectors  $\mathcal{R}_{\mathcal{C}}$  such that for any input distribution  $p(x^{V_1})$ , any constant  $\nu > 0$ , and all  $N$  sufficiently large there exists a sequence of  $(2^{N\mathcal{R}_{\mathcal{C}}}, N)$  emulation codes  $(\alpha_N, \beta_N)$  with  $P_e^{(N)}(\nu) < 2^{-\eta(\nu)N}$  for some positive function  $\eta(\nu)$  dependent on  $p$  such that  $\eta(\nu)$  approaches 0 as  $\nu$  approaches 0.

Theorem 4, below, demonstrates that the standard of accuracy used to define the emulation region is sufficient to guarantee that  $\mathcal{C}(\mathcal{R}_{\mathcal{C}})$  is an upper bounding model for  $\mathcal{C}$ . Whether this condition is also necessary remains an open problem.

**Theorem 4** If  $\mathcal{R}_{\mathcal{C}} \in \text{int}(\mathcal{E}(\mathcal{C}))$ , then  $\mathcal{C} \subseteq \mathcal{C}(\mathcal{R}_{\mathcal{C}})$ .

*Proof.* Fix rate vector  $\mathcal{R}_{\mathcal{C}} \in \text{int}(\mathcal{E}(\mathcal{N}))$ , and consider a pair of networks

$$\mathcal{N} = (\mathcal{X}^{V_1} \times \mathcal{X}^{-V_1}, p(y^{V_2} | x^{V_1}) p(y^{-V_2} | x^{-V_1}), \mathcal{Y}^{V_2} \times \mathcal{Y}^{-V_2})$$

$$\mathcal{N}(\mathcal{R}_{\mathcal{C}}) = (\tilde{\mathcal{X}}^{V_1} \times \mathcal{X}^{-V_1}, p(\tilde{y}^{V_2} | \tilde{x}^{V_1}) p(y^{-V_2} | x^{-V_1}), \tilde{\mathcal{Y}}^{V_2} \times \mathcal{Y}^{-V_2}).$$

Next fix  $\mathcal{R} \in \text{int}(\mathcal{R}(\mathcal{N}))$ . The argument that follows shows that  $\mathcal{R} \in \mathcal{R}(\underline{\mathcal{N}}(\mathcal{R}_{\mathcal{C}}))$ . This suffices to prove the desired result by Theorem 1 and the closure in the definition of  $\mathcal{R}(\mathcal{N}(\mathcal{R}_{\mathcal{C}}))$ .

Step 1 - Choose code  $\mathcal{S}(\mathcal{N})$  and define distribution  $p_t(x^{V_1}, y^{V_2})$ :

By Theorem 1, there exists a solution  $\mathcal{S}(\mathcal{N})$  of some finite blocklength  $n$  from which we can build a  $(2^{-N^\delta}, \mathcal{R})$ - $\underline{\mathcal{S}}(\underline{\mathcal{N}})$  stacked solution for  $N$ -fold stacked network  $\underline{\mathcal{N}}$  for all  $N$  sufficiently large. Each stacked

solution applies a random channel code to each message  $\underline{W}^{(u \rightarrow v)}$  and then independently applies  $\mathcal{S}(\mathcal{N})$  in each layer of  $\underline{\mathcal{N}}$ . For each  $t \in \{1, \dots, n\}$ , let  $p_t(x^{V_1})$  be the input distribution to channel  $\mathcal{C}$  at time  $t$  under solution  $\mathcal{S}(\mathcal{N})$ . Then  $p_t(\underline{x}^{V_1}, \underline{y}^{V_2}) \stackrel{\text{def}}{=} \prod_{\ell=1}^N p_t(\underline{x}^{V_1}(\ell)) p(\underline{y}^{V_2}(\ell) | \underline{x}^{V_1}(\ell))$  is the time- $t$  distribution across the  $N$  copies of channel  $\mathcal{C}$  in network  $\underline{\mathcal{N}}$  using solution  $\underline{\mathcal{S}}(\underline{\mathcal{N}})$ .

Step 2 - Choose channel emulators and bound the probability of emulation failure:

For each  $t \in \{1, \dots, n\}$ , choose  $\nu(t) > 0$  to satisfy

$$\begin{aligned} \sum_{t'=1}^{t-1} \nu(t') &< \eta_t(\nu(t))/2 \quad \forall t \in \{1, \dots, n\} \\ \sum_{t=1}^n \nu(t) &< \delta/2, \end{aligned}$$

where  $\eta_t(\cdot)$  designates the function  $\eta$  corresponding to channel input distribution  $p_t(x^{V_1})$ ; these parameter choices make the error probability vanish in Step 5, below. We meet these constraints through the following sequence of parameter choices. First, set  $\nu(n) = \delta/(4n)$ . Then, in order of decreasing  $t$  for each  $t < n$ , set  $\nu(t) = \min\{\delta/(4n), \min_{t' > t} \eta_{t'}(\nu(t'))/(4t')\}$ .

Since  $\mathcal{R}_{\mathcal{C}} \in \text{int}(\mathcal{E}(\mathcal{C}))$ , for each  $t \in \{1, \dots, n\}$  there exists a sequence of  $(2^{N\mathcal{R}_{\mathcal{C}}}, N)$  random emulation codes  $\hat{\mathcal{C}}_{N,t} = (\alpha_{N,t}, \beta_{N,t})$  that emulate channel  $\mathcal{C}$  under input distribution  $p_t(x^{V_1})$  with probability  $P_{e,t}^{(N)}(\nu(t)) < 2^{-N\eta_t(\nu(t))}$  for all  $N$  sufficiently large. Let  $\hat{p}_{N,t}(\underline{y}^{V_2} | \underline{x}^{V_1})$  be the emulation distribution for  $\hat{\mathcal{C}}_{N,t}$ , and define

$$\begin{aligned} A_t^{(N)} &\stackrel{\text{def}}{=} \left\{ (\underline{x}^{V_1}, \underline{y}^{V_2}) : \frac{1}{N} \log \left( \frac{\hat{p}_{N,t}(\underline{y}^{V_2} | \underline{x}^{V_1})}{p(\underline{y}^{V_2} | \underline{x}^{V_1})} \right) \leq \nu(t) \right\} \\ C_t^{(N)} &\stackrel{\text{def}}{=} \left\{ \underline{x}^{V_1} : \hat{p}_{N,t}((A_t^{(N)})^c | \underline{x}^{V_1}) > 2^{-N\eta_t(\nu(t))/2} \right\}, \end{aligned}$$

where for any set  $\mathcal{S} \subseteq \mathcal{X}^{V_1} \times \mathcal{Y}^{V_2}$ ,

$$\hat{p}_t(\mathcal{S} | \underline{x}^{V_1}) \stackrel{\text{def}}{=} \sum_{\underline{y}^{V_2}: (\underline{x}^{V_1}, \underline{y}^{V_2}) \in \mathcal{S}} \hat{p}_t(\underline{y}^{V_2} | \underline{x}^{V_1}).$$

To bound  $p_t(C_t^{(N)}) = \sum_{\underline{x}^{V_1} \in C_t^{(N)}} p_t(\underline{x}^{V_1})$ , note that

$$\begin{aligned} 2^{-N\eta_t(\nu(t))} &\geq \sum_{\underline{x}^{V_1} \in C_t^{(N)}} p_t(\underline{x}^{V_1}) \hat{p}((A_t^{(N)})^c | \underline{x}^{V_1}) + \sum_{\underline{x}^{V_1} \notin C_t^{(N)}} p_t(\underline{x}^{V_1}) \hat{p}((A_t^{(N)})^c | \underline{x}^{V_1}) \\ &> 2^{-N\eta_t(\nu(t))/2} \sum_{\underline{x}^{V_1} \in C_t^{(N)}} p_t(\underline{x}^{V_1}) + 0 \cdot \sum_{\underline{x}^{V_1} \notin C_t^{(N)}} p_t(\underline{x}^{V_1}), \end{aligned}$$

giving  $p_t(C_t^{(N)}) < 2^{-N\eta_t(\nu(t))/2}$ .

Step 3 - Define solution  $\mathcal{S}(\underline{\mathcal{N}}(\mathcal{R}_C))$ :

Let  $\mathcal{S}(\underline{\mathcal{N}}(\mathcal{R}_C))$  be the code that results from operating solution  $\underline{\mathcal{S}}(\underline{\mathcal{N}})$  across network  $\underline{\mathcal{N}}(\mathcal{R}_C)$  with the aid of emulation codes  $\{(\alpha_{N,t}, \beta_{N,t})\}_{t=1}^n$ . Formally, for each  $v \in V$ , let  $\tilde{\underline{Y}}_t^{(v)}$  denote the network output received by node  $v$  at time  $t$ . At time  $t$ , node  $v$  applies the node encoder from  $\underline{\mathcal{S}}(\underline{\mathcal{N}})$  to obtain

$$\underline{X}_t^{(v)} = \underline{X}_t^{(v)}(\underline{Y}_1^{(v)}, \dots, \underline{Y}_{t-1}^{(v)}, \underline{W}^{(v \rightarrow 1)}, \dots, \underline{W}^{(v \rightarrow m)});$$

here  $\underline{Y}_t^{(v)}$  is the channel output  $\tilde{\underline{Y}}_t^{(v)}$  decoded (if necessary) as

$$\underline{Y}_t^{(v)} = \begin{cases} (\beta_{N,t}^{(v)}(\tilde{\underline{Y}}_t^{(v,1)}), \tilde{\underline{Y}}_t^{(v,2)}) & \text{if } v \in V_2 \\ \tilde{\underline{Y}}_t^{(v)} & \text{otherwise.} \end{cases}$$

Node  $v$  then encodes  $\underline{X}_t^{(v)}$  (if necessary) to give

$$\tilde{\underline{X}}_t^{(v)} = \begin{cases} ((\alpha_{N,t}^{\{v\} \rightarrow B}(\underline{X}_t^{(v,1)}) : B \subseteq V_2), \underline{X}_t^{(v,2)}) & \text{if } v \in V_1 \\ (\alpha_{N,t}^{(A \rightarrow B)}(\underline{X}_t^{(v',1)}) : v' \in A) : B \subseteq V_2) & \text{if } v = v^A \text{ for some } A \subseteq V_1 \\ \underline{X}_t^{(v)} & \text{otherwise,} \end{cases}$$

which it transmits across the bit-pipe model. After time  $n$ , node  $v$  applies the decoders from  $\underline{\mathcal{S}}(\underline{\mathcal{N}})$  as

$$\underline{\hat{W}}^{(u \rightarrow v)} = \underline{\hat{W}}^{(u \rightarrow v)}(\underline{Y}_1^{(v)}, \dots, \underline{Y}_n^{(v)}, \underline{W}^{(v \rightarrow 1)}, \dots, \underline{W}^{(v \rightarrow m)}).$$

Solution  $\mathcal{S}(\underline{\mathcal{N}}(\mathcal{R}_C))$  is not a stacked solution since each  $(\alpha_{N,t}, \beta_{N,t})$  operates across the layers of the stack.

Step 4 - Characterize the statistical behavior of  $\mathcal{S}(\underline{\mathcal{N}}(\mathcal{R}_C))$ :

Under the operation of  $\underline{\mathcal{S}}(\underline{\mathcal{N}})$  on  $\underline{\mathcal{N}}$ , the joint distribution on messages  $\underline{w}$ , network input vectors  $\underline{\mathbf{x}}^n = (\underline{\mathbf{x}}_1, \dots, \underline{\mathbf{x}}_n)$ , network output vectors  $\underline{\mathbf{y}}^n = (\underline{\mathbf{y}}_1, \dots, \underline{\mathbf{y}}_n)$ , and message reconstructions  $\underline{\hat{w}}$  is

$$p(\underline{w}, \underline{\mathbf{x}}^n, \underline{\mathbf{y}}^n, \underline{\hat{w}}) = p(\underline{w}) \left[ \prod_{t=1}^n p(\underline{\mathbf{x}}_t | \underline{\mathbf{y}}^{t-1}, \underline{w}) \right] \left[ \prod_{t=1}^n p(\underline{y}_t^{V_2} | \underline{x}_t^{V_1}) p(\underline{y}_t^{-V_2} | \underline{x}_t^{-V_1}) \right] p(\underline{\hat{w}} | \underline{\mathbf{y}}^n, \underline{w}),$$

where  $\underline{\mathbf{x}}_t$  and  $\underline{\mathbf{y}}_t$  again represent the full vectors of network inputs and outputs at time  $t$ ;  $p(\underline{w})$  is the distribution on messages; each  $p(\underline{\mathbf{x}}_t | \underline{\mathbf{y}}^{t-1}, \underline{w})$  is a product distribution describing the independent operations performed by the node encoders at time  $t$ ;  $p(\underline{y}_t^{V_2} | \underline{x}_t^{V_1}) p(\underline{y}_t^{-V_2} | \underline{x}_t^{-V_1})$  describes the memoryless network distribution; and  $p(\underline{\hat{w}} | \underline{\mathbf{y}}^n, \underline{w})$  is the product distribution describing the independent operation of each node decoder. Only the channel distribution changes when we run  $\mathcal{S}(\underline{\mathcal{N}}(\mathcal{R}_C))$  on  $\underline{\mathcal{N}}(\mathcal{R}_C)$ , giving

$$\hat{p}(\underline{w}, \underline{\mathbf{x}}^n, \underline{\mathbf{y}}^n, \underline{\hat{w}}) = p(\underline{w}) \left[ \prod_{t=1}^n p(\underline{\mathbf{x}}_t | \underline{\mathbf{y}}^{t-1}, \underline{w}) \right] \left[ \prod_{t=1}^n \hat{p}_t(\underline{y}_t^{V_2} | \underline{x}_t^{V_1}) p(\underline{y}_t^{-V_2} | \underline{x}_t^{-V_1}) \right] p(\underline{\hat{w}} | \underline{\mathbf{y}}^n, \underline{w}).$$

Step 5 - Bound the expected error probability:

The following error analysis relies on both probabilities resulting from running  $\underline{\mathcal{S}}(\underline{\mathcal{N}})$  on  $\underline{\mathcal{N}}$  and probabilities resulting from running  $\mathcal{S}(\underline{\mathcal{N}}(\mathcal{R}_C))$  on  $\underline{\mathcal{N}}(\mathcal{R}_C)$ . We use  $\Pr(\cdot)$  for the former and  $\widehat{\Pr}(\cdot)$  for the latter.

Let

$$B_t^{(N)} \stackrel{\text{def}}{=} \left\{ (\underline{x}^{V_1}, \underline{y}^{V_2}) : \Pr \left( \hat{W} \neq \underline{W} \mid (\underline{X}_t^{V_1}, \underline{Y}_t^{V_2}) = (\underline{x}^{V_1}, \underline{y}^{V_2}) \right) \geq 2^{-N\delta/2} \right\}. \quad (4)$$

denote the set of input-output pairs on channel  $\mathcal{C}$  at time  $t$  that are most likely to lead to errors in the operation of  $\underline{\mathcal{S}}(\underline{\mathcal{N}})$  on  $\underline{\mathcal{N}}$ . The following error probability bound treats  $(\underline{X}_t^{V_1}, \underline{Y}_t^{V_2}) \notin A_t^{(N)}$  and  $(\underline{X}_t^{V_1}, \underline{Y}_t^{V_2}) \in B_t^{(N)}$  for any  $t \in \{1, \dots, n\}$  as error events. We therefore define

$$G_t \stackrel{\text{def}}{=} \{(\underline{x}_t, \underline{y}_t) : (\underline{x}_t^{V_1}, \underline{y}_t^{V_2}) \in A_t^{(N)} \setminus B_t^{(N)}\}$$

and bound the expected error probability of code  $\mathcal{S}(\underline{\mathcal{N}}(\mathcal{R}_C))$  as

$$\begin{aligned} \widehat{\Pr}(\hat{W} \neq \underline{W}) &\leq \sum_{t=1}^n \widehat{\Pr}(\cap_{t' < t} G_{t'} \cap (A_t^{(N)})^c) + \sum_{t=1}^n \widehat{\Pr}(\cap_{t' < t} G_{t'} \cap A_t^{(N)} \cap B_t^{(N)}) \\ &\quad + \widehat{\Pr}(\cap_{t' \leq n} G_{t'} \cap \{\hat{W} \neq \underline{W}\}). \end{aligned}$$

To bound the first two terms in the sum, note that for each  $\underline{x}^{V_1} \in \underline{\mathcal{X}}^{V_1}$ ,

$$\begin{aligned} &\widehat{\Pr}(\cap_{t' < t} G_{t'} \cap \{\underline{X}_t^{V_1} = \underline{x}^{V_1}\}) \\ &= \sum_{(\underline{w}, \underline{x}^{t-1}, \underline{y}^{t-1}, \underline{x}_t^{-V_1}) : (\underline{x}_t^{V_1}, \underline{y}_t^{V_2}) \in G_{t'} \forall t' < t} p(\underline{w}) \left[ \prod_{t'=1}^t p(\underline{x}_{t'} | \underline{y}^{t'-1}, \underline{w}) \right] \left[ \prod_{t'=1}^{t-1} \hat{p}_{t'}(y_{t'}^{V_2} | \underline{x}_{t'}^{V_1}) p(y_{t'}^{-V_2} | \underline{x}_{t'}^{-V_1}) \right] \\ &\leq \sum_{(\underline{w}, \underline{x}^{t-1}, \underline{y}^{t-1}, \underline{x}_t^{-V_1}) : (\underline{x}_t^{V_1}, \underline{y}_t^{V_2}) \in G_{t'} \forall t' < t} p(\underline{w}) \left[ \prod_{t'=1}^t p(\underline{x}_{t'} | \underline{y}^{t'-1}, \underline{w}) \right] \left[ \prod_{t'=1}^{t-1} 2^{N\nu(t')} p_{t'}(y_{t'}^{V_2} | \underline{x}_{t'}^{V_1}) p(y_{t'}^{-V_2} | \underline{x}_{t'}^{-V_1}) \right] \\ &= 2^{N \sum_{t'=1}^{t-1} \nu(t')} \sum_{(\underline{w}, \underline{x}^{t-1}, \underline{y}^{t-1}, \underline{x}_t^{-V_1}) : (\underline{x}_t^{V_1}, \underline{y}_t^{V_2}) \in G_{t'} \forall t' < t} p(\underline{w}, \underline{x}^t, \underline{y}^{t-1}) \\ &\leq 2^{N \sum_{t'=1}^{t-1} \nu(t')} p_t(\underline{x}^{V_1}) \end{aligned}$$

since  $\underline{x}_{t'}^{V_1} \in G_{t'}$  implies  $\underline{x}_{t'}^{V_1} \in A_{t'}^{(N)}$  which implies  $p(y_{t'}^{V_2} | \underline{x}_{t'}^{V_1}) < 2^{N\nu(t')} p(y_{t'}^{V_2} | \underline{x}_{t'}^{V_1})$ . Thus

$$\begin{aligned} &\widehat{\Pr}(\cap_{t' < t} G_{t'} \cap (A_t^{(N)})^c) \\ &\leq 2^{N \sum_{t'=1}^{t-1} \nu(t')} \sum_{\underline{x}^{V_1} \in C_t^{(N)}} 1 \cdot p_t(\underline{x}^{V_1}) + 2^{N \sum_{t'=1}^{t-1} \nu(t')} \sum_{\underline{x}^{V_1} \notin C_t^{(N)}} \hat{p}_t((A_t^{(N)})^c | \underline{x}^{V_1}) p_t(\underline{x}^{V_1}) \\ &< 2^{-N(\eta_t(\nu(t))/2 - \sum_{t'=1}^{t-1} \nu(t'))} + 2^{-N(\eta_t(\nu(t))/2 - \sum_{t'=1}^{t-1} \nu(t'))} \end{aligned}$$

by the definition of  $C_t^{(N)}$  and the bound on  $p_t(C_t^{(N)})$  from Step 2. This sum goes to zero as  $N$  grows without bound by our earlier parameter choice.

To bound  $\hat{p}_t(\cap_{t' < t} G_{t'} \cap A_t^{(N)} \cap B_t^{(N)})$ , recall that  $\underline{\mathcal{S}}(\underline{\mathcal{N}})$  is a  $(2^{-N\delta}, \mathcal{R})$  solution and there are fewer than  $m^2$  messages to transmit. Thus  $\Pr(\hat{W} \neq W) < m^2 2^{-N\delta}$  for solution  $\underline{\mathcal{S}}(\underline{\mathcal{N}})$  by the union bound, giving

$$\begin{aligned} m^2 2^{-N\delta} &> \Pr(\hat{W} \neq W) \\ &\geq \sum_{(\underline{x}^{V_1}, \underline{y}^{V_2}) \in B_t^{(N)}} p_t(\underline{x}^{V_1}, \underline{y}^{V_2}) \Pr(\hat{W} \neq W | \underline{x}^{V_1}, \underline{y}^{V_2}) \\ &\geq 2^{-N\delta/2} p_t(B_t^{(N)}), \end{aligned}$$

giving  $p_t(B_t^{(N)}) < m^2 2^{-N\delta/2}$ . Thus

$$\begin{aligned} \widehat{\Pr}(\cap_{t' < t} G_{t'} \cap A_t^{(N)} \cap B_t^{(N)}) &\leq 2^{N \sum_{t'=1}^{t-1} \nu(t')} \sum_{(\underline{x}^{V_1}, \underline{y}^{V_2}) \in A_t^{(N)} \cap B_t^{(N)}} p_t(\underline{x}^{V_1}) \hat{p}_t(\underline{y}^{V_2} | \underline{x}^{V_1}) \\ &\leq 2^{N \sum_{t'=1}^t \nu(t')} \sum_{(\underline{x}^{V_1}, \underline{y}^{V_2}) \in A_t^{(N)} \cap B_t^{(N)}} p_t(\underline{x}^{V_1}) p_t(\underline{y}^{V_2} | \underline{x}^{V_1}) \\ &\leq 2^{N \sum_{t'=1}^t \nu(t')} p_t(B_t^{(N)}) \\ &< m^2 2^{-N(\delta/2 - \sum_{t'=1}^t \nu(t'))}, \end{aligned}$$

which also goes to zero by our choice of  $\nu(1), \dots, \nu(n)$ .

Finally,

$$\begin{aligned} &\widehat{\Pr}\left(\cap_{t=1}^n G_t \cap \{\hat{W} \neq W\}\right) \\ &\stackrel{(a)}{<} \sum_{(\underline{w}, \underline{x}^n, \underline{y}^n, \hat{w}) : \hat{w} \neq w, (\underline{x}_t^{V_1}, \underline{y}_t^{V_2}) \in G_t \forall t} p(\underline{w}) \left[ \prod_{t=1}^n p(\underline{x}_t | \underline{y}^{t-1}, \underline{w}) \right] \left[ \prod_{t=1}^n 2^{N \sum_{t'=1}^n \nu(t')} p_t(\underline{y}_t | \underline{x}_t) \right] p(\hat{w} | \underline{w}, \underline{x}^n, \underline{y}^n) \\ &\stackrel{(b)}{\leq} 2^{N \sum_{t=1}^n \nu(t)} \sum_{(\underline{w}, \underline{x}^n, \underline{y}^n, \hat{w}) : \hat{w} \neq w, (\underline{x}_1^{V_1}, \underline{y}_1^{V_2}) \in A_1^{(N)} \setminus B_1^{(N)}} p(\underline{w}, \underline{x}^n, \underline{y}^n, \hat{w}) \\ &= 2^{N \sum_{t=1}^n \nu(t)} \sum_{(\underline{x}^{V_1}, \underline{y}^{V_2}) \in A_1^{(N)} \setminus B_1^{(N)}} p_1(\underline{x}^{V_1}, \underline{y}^{V_2}) \Pr(\hat{W} \neq W | (\underline{x}^{V_1}, \underline{y}^{V_2})) \\ &\stackrel{(c)}{<} 2^{-N(\delta/2 - \sum_{t=1}^n \nu(t))} p_1(A_1^{(N)} \setminus B_1^{(N)}) \\ &\leq 2^{-N(\delta/2 - \sum_{t=1}^n \nu(t))}. \end{aligned}$$

Equation (a) follows from our probability characterization in Step 4 since  $(\underline{x}_t^{V_1}, \underline{y}_t^{V_2}) \in A_t^{(N)}$  for all  $t$  by definition of  $G_t$ . In (b), we bound the sum over  $A_t^{(N)} \setminus B_t^{(N)}$  by the sum over all  $\underline{\mathcal{X}}^{V_1} \times \underline{\mathcal{Y}}^{V_2}$  for all  $t > 1$ . Equation (c) follows from the definition of  $B_t^{(N)}$  in (4). This term also goes to zero as  $N$  grows large by our choice of  $\nu(1), \dots, \nu(n)$ . Since the expected error probability for our randomly drawn code can be made arbitrarily small there exists a single instance that does at least as well. Thus  $\mathcal{R} \in \mathcal{R}(\underline{\mathcal{N}}(\mathcal{R}_c))$ . ■

**Remark 2** Lemma 2 can be used to show that Theorem 4 also holds for all points  $\mathcal{R}_C$  on the outer boundary of  $\mathcal{E}(\mathcal{N})$  with strictly positive coefficients. It is not clear whether it holds for all boundary points since  $\mathcal{N}_R$  is not known to be continuous at  $R = 0$  for general networks [12], [13].

## V. UPPER BOUNDING MODELS

While existing achievability results for individual channels lead immediately to lower bounding networks (see Lemma 3), capacity upper bounds do not generally give legitimate upper bounding networks. Roughly speaking, there are two causes of this phenomenon. First, capacity upper bounds for multi-input channels ( $|V_1| > 1$ ) assume independent transmissions from their input nodes; when the channel is used within a larger network, the inputs may be statistically dependent. Second, capacity upper bounds assume reliable transmission across each component channel; operating individual channels above their capacities sometimes increases the network capacity, as shown in Examples 1 and 2. By Theorem 4, we can build upper bounding models by finding points in the emulation region described in Definition 12.

We here derive example upper bounding models for the broadcast, multiple access, and interference channels. All of the results use the bit-pipe models defined in Section III, removing bit pipes of capacity 0. Recall that for each  $A \subseteq V_1$ , internal node  $v^A$  receives a noiseless description of channel inputs ( $X^{(v,1)} : v \in A$ ). These noiseless descriptions are transmitted along internal edges of capacity  $\log |\mathcal{X}^{(v)}|$ , as described in the model definitions;  $\log |\mathcal{X}^{(v)}|$  is infinite when  $\mathcal{X}^{(v)}$  is continuous. In Section VI, we bound the accuracy of capacity bounds derived using these models for a variety of example channel types, including channels with continuous alphabets.

This section derives general form solutions. Examples for specific channels appear in Section VI. Each result describes a family of upper bounding models both because multiple rate vectors satisfy the given bounds and because switching the roles of the nodes in asymmetrical solutions may yield new bounds. Taking the intersection of the rate regions corresponding to different bounds may yield a tighter bound.

Given a broadcast channel with transmitter  $V_1 = \{i\}$  and receivers  $V_2 = \{j_1, j_2\}$ , Theorem 5 derives an upper bounding model of the form shown in Figure 5(a).

**Theorem 5** *Let*

$$\begin{aligned} \mathcal{C} &= (\mathcal{X}^{(i,1)}, p(y^{(j_1,1)}, y^{(j_2,1)} | x^{(i,1)}), \mathcal{Y}^{(j_1,1)} \times \mathcal{Y}^{(j_2,2)}) \\ \mathcal{C}(\mathcal{R}_C) &= (\tilde{\mathcal{X}}^{(i,1)}, p(\tilde{y}^{(j_1,1)}, \tilde{y}^{(j_2,1)} | \tilde{x}^{(i,s)}), \tilde{\mathcal{Y}}^{(j_1,1)} \times \tilde{\mathcal{Y}}^{(j_2,1)}) \end{aligned}$$



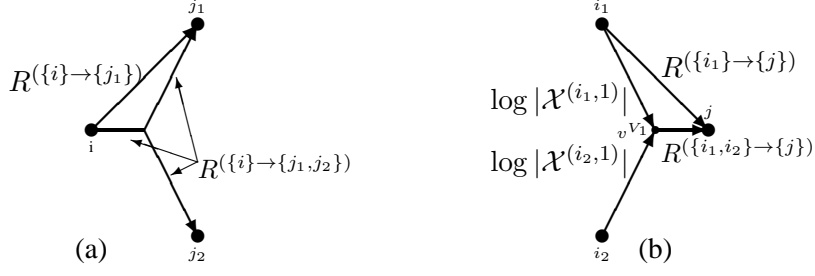

Fig. 5. Upper bounding models for the (a) broadcast channel (Theorem 5), and (b) multiple access channel (Theorem 6).

be a broadcast channel and its corresponding bit-pipe model for some  $\mathcal{R}_C$  satisfying

$$\begin{aligned} R(\{i\} \rightarrow \{j_1, j_2\}) &> I(X^{(i,1)}; Y^{(j_2,1)}) \\ R(\{i\} \rightarrow \{j_1, j_2\}) + R(\{i\} \rightarrow \{j_1\}) &> I(X^{(i,1)}; Y^{(j_1,1)}, Y^{(j_2,1)}) \end{aligned}$$

for all distributions  $p(x^{(i,1)}, y^{(j_1,1)}, y^{(j_2,1)}) = p(x^{(i,1)})p(y^{(j_1,1)}, y^{(j_2,1)}|x^{(i,1)})$ . Then  $\mathcal{C} \subseteq \mathcal{C}(\mathcal{R}_C)$ .

*Proof.* See Appendix III. ■

Theorem 6 derives an upper bounding model of the form shown in Figure 5(b) for a multiple access channel with transmitters  $V_1 = \{i_1, i_2\}$  and receiver  $V_2 = \{j\}$ .

**Theorem 6** Let

$$\begin{aligned} \mathcal{C} &= (\mathcal{X}^{(i_1,1)} \times \mathcal{X}^{(i_2,1)}, p(y^{(j,1)}|x^{(i_1,1)}, x^{(i_2,1)}), \mathcal{Y}^{(j,1)}) \\ \mathcal{C}(\mathcal{R}_C) &= (\tilde{\mathcal{X}}^{(i_1,1)} \times \tilde{\mathcal{X}}^{(i_2,1)}, p(\tilde{y}^{(j,1)}|\tilde{x}^{(i_1,1)}, \tilde{x}^{(i_2,1)}), \tilde{\mathcal{Y}}^{(j,1)}) \end{aligned}$$

be a multiple access channel and its corresponding bit-pipe model for some  $\mathcal{R}_C$ . If for each distribution  $p(x^{(i_1,1)}, x^{(i_2,1)})$  there exists a distribution  $p(u|x^{(i_1,1)})$  on an alphabet  $\mathcal{U}$  with  $|\mathcal{U}| \leq |\mathcal{X}^{(i_1,1)}|$  such that

$$\begin{aligned} R(\{i_1\} \rightarrow \{j\}) &> I(X^{(i_1,1)}; U) \\ R(\{i_1, i_2\} \rightarrow \{j\}) &> I(X^{(i_1,1)}, X^{(i_2,1)}; Y^{(j,1)}|U), \end{aligned}$$

then  $\mathcal{C} \subseteq \mathcal{C}(\mathcal{R}_C)$ .

*Proof.* See Appendix IV. ■

Let  $\mathcal{C} = (\mathcal{X}^{(i_1,1)} \times \mathcal{X}^{(i_2,1)}, p(y^{(j_1,1)}, y^{(j_2,1)}|x^{(i_1,1)}, x^{(i_2,1)}), \mathcal{Y}^{(j_1,1)} \times \mathcal{Y}^{(j_2,2)})$  be an interference channel with transmitters  $V_1 = \{i_1, i_2\}$  and receivers  $V_2 = \{j_1, j_2\}$ . Theorems 7 and 8 derive upper bounding

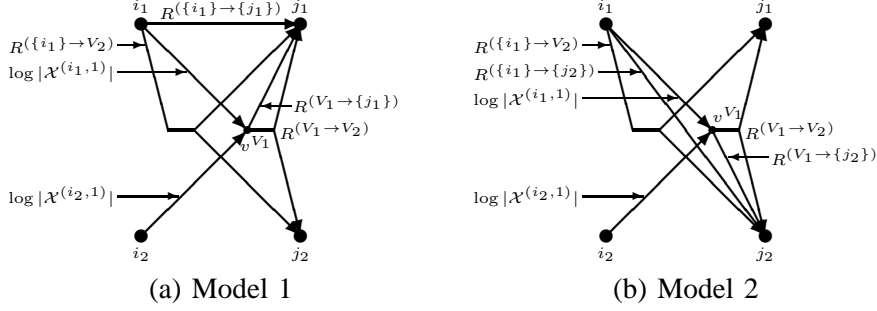

Fig. 6. Upper bounding models for the interference channel.

models for  $\mathcal{C}$  of the forms shown in Figures 6(a) and (b), respectively. In the first case, node  $i_1$  transmits two descriptions, one to just  $j_1$  and the other to both receivers. Node  $v^{V_1}$  noiselessly receives both channel inputs and transmits one description to  $j_1$  and the other to both receivers.

**Theorem 7** *Let*

$$\begin{aligned} \mathcal{C} &= (\mathcal{X}^{(i_1,1)} \times \mathcal{X}^{(i_2,1)}, p(y^{(j_1,1)}, y^{(j_2,1)} | x^{(i_1,1)}, x^{(i_2,1)}), \mathcal{Y}^{(j_1,1)} \times \mathcal{Y}^{(j_2,2)}) \\ \mathcal{C}(\mathcal{R}_C) &= (\tilde{\mathcal{X}}^{(i_1,1)} \times \tilde{\mathcal{X}}^{(i_2,1)}, p(\tilde{y}^{(j_1,1)}, \tilde{y}^{(j_2,1)} | \tilde{x}^{(i_1,1)}, \tilde{x}^{(i_2,1)}), \tilde{\mathcal{Y}}^{(j_1,1)} \times \tilde{\mathcal{Y}}^{(j_2,1)}) \end{aligned}$$

*be an interference channel and its rate- $\mathcal{R}_C$  bit-pipe model. If for each distribution  $p(x^{(i_1,1)}, x^{(i_2,1)})$  there exist conditional distributions  $p(u_2 | x^{(i_1,1)})$  and  $p(u_1 | x^{(i_1,1)}, u_2)$  with  $|\mathcal{U}_1 \times \mathcal{U}_2| \leq |\mathcal{X}^{(i_1,1)}|$  and*

$$\begin{aligned} R(\{i_1\} \rightarrow \{j_1\}) + R(\{i_1\} \rightarrow \{j_1, j_2\}) &> I(X^{(i_1,1)}; U_1, U_2) \\ R(\{i_1\} \rightarrow \{j_1, j_2\}) &> I(X^{(i_1,1)}; U_2) \\ R(\{i_1, i_2\} \rightarrow \{j_1\}) + R(\{i_1, i_2\} \rightarrow \{j_1, j_2\}) &> I(X^{(i_1,1)}, X^{(i_2,1)}; Y^{(j_1,1)} | U_1, U_2, Y^{(j_2,1)}) \\ &\quad + I(X^{(i_1,1)}, X^{(i_2,1)}; Y^{(j_2,1)} | U_2) \\ R(\{i_1, i_2\} \rightarrow \{j_1, j_2\}) &> I(X^{(i_1,1)}, X^{(i_2,1)}; Y^{(j_2,1)} | U_2), \end{aligned}$$

*then  $\mathcal{C} \subseteq \mathcal{C}(\mathcal{R}_C)$ .*

*Proof.* See Appendix V ■

In the second bit-pipe model for the interference channel, node  $i_1$  again transmits two descriptions. Here the first is delivered to both receivers while the second is delivered only to  $j_2$ . Node  $v^{V_1}$  noiselessly receives both channel inputs and transmits one description to both receivers and the other only to  $j_2$ .

**Theorem 8** *Let*

$$\begin{aligned}\mathcal{C} &= (\mathcal{X}^{(i_1,1)} \times \mathcal{X}^{(i_2,1)}, p(y^{(j_1,1)}, y^{(j_2,1)} | x^{(i_1,1)}, x^{(i_2,1)}), \mathcal{Y}^{(j_1,1)} \times \mathcal{Y}^{(j_2,2)}) \\ \mathcal{C}(\mathcal{R}_\mathcal{C}) &= (\tilde{\mathcal{X}}^{(i_1,1)} \times \tilde{\mathcal{X}}^{(i_2,1)}, p(\tilde{y}^{(j_1,1)}, \tilde{y}^{(j_2,1)} | \tilde{x}^{(i_1,1)}, \tilde{x}^{(i_2,1)}), \tilde{\mathcal{Y}}^{(j_1,1)} \times \tilde{\mathcal{Y}}^{(j_2,1)})\end{aligned}$$

*be an interference channel and its rate- $\mathcal{R}_\mathcal{C}$  bit-pipe model. If for each distribution  $p(x^{(i_1,1)}, x^{(i_2,1)})$  there exist conditional distributions  $p(u_1 | x^{(i_1,1)})$  and  $p(u_2 | u_1, x^{(i_1,1)})$  with  $|\mathcal{U}_1 \times \mathcal{U}_2| \leq |\mathcal{X}^{(i_1,1)}|$  for which*

$$\begin{aligned}R^{\{\{i_1\} \rightarrow \{j_1, j_2\}\}} &> I(X^{(i_1,1)}; U_1) \\ R^{\{\{i_1\} \rightarrow \{j_1, j_2\}\}} + R^{\{\{i_1\} \rightarrow \{j_2\}\}} &> I(X^{(i_1,1)}; U_1, U_2) \\ R^{\{\{i_1, i_2\} \rightarrow \{j_1, j_2\}\}} &> I(X^{(i_1,1)}, X^{(i_2,1)}; Y^{(j_1,1)} | U_1) \\ R^{\{\{i_1, i_2\} \rightarrow \{j_1, j_2\}\}} + R^{\{\{i_1, i_2\} \rightarrow \{j_2\}\}} &> I(X^{(i_1,1)}, X^{(i_2,1)}; Y^{(j_1,1)} | U_1) \\ &\quad + I(X^{(i_1,1)}, X^{(i_2,1)}; Y^{(j_2,1)} | U_1, U_2, Y^{(j_1,1)})\end{aligned}$$

*then  $\mathcal{C} \subseteq \mathcal{C}(\mathcal{R}_\mathcal{C})$ .*

*Proof.* See Appendix VI ■

## VI. BOUNDING ACCURACY

The equivalence tools derived in Section IV yield upper and lower bounding models for a single independent channel  $\mathcal{C}$ . Repeated application of these tools on networks containing multiple independent channels allows us to bound the capacity of a network of noisy channels by bounding the capacity of another network in which some or all of the network's stochastic components have been replaced by bit-pipe models. To make this precise, let  $\mathcal{N}$  be a network containing some collection  $\mathcal{A}$  of independent channels. Then for any  $\mathcal{R}_L = (\mathcal{R}_{\mathcal{C},L} : \mathcal{C} \in \mathcal{A}) \in \prod_{\mathcal{C} \in \mathcal{A}} \mathcal{R}(\mathcal{C})$  and any  $\mathcal{R}_U = (\mathcal{R}_{\mathcal{C},U} : \mathcal{C} \in \mathcal{A}) \in \prod_{\mathcal{C} \in \mathcal{A}} \mathcal{E}(\mathcal{C})$ ,  $\mathcal{R}_{\mathcal{C},L}$  and  $\mathcal{R}_{\mathcal{C},U}$  describe lower and upper bounds for  $\mathcal{C}$  (i.e.,  $\mathcal{C}(\mathcal{R}_{\mathcal{C},L}) \subseteq \mathcal{C} \subseteq \mathcal{C}(\mathcal{R}_{\mathcal{C},U})$ ) for each  $\mathcal{C} \in \mathcal{A}$ . Let  $\mathcal{N}(\mathcal{R}_L)$  denote the network obtained by replacing each  $\mathcal{C} \in \mathcal{A}$  by its lower bounding model  $\mathcal{C}(\mathcal{R}_{\mathcal{C},L})$  and  $\mathcal{N}(\mathcal{R}_U)$  denote the network obtained by replacing each  $\mathcal{C} \in \mathcal{A}$  by its upper bounding model  $\mathcal{C}(\mathcal{R}_{\mathcal{C},U})$ . Then Lemma 3 and Theorem 4 imply

$$\mathcal{R}_L(\mathcal{N}) \subseteq \mathcal{R}(\mathcal{N}) \subseteq \mathcal{R}_U(\mathcal{N}),$$

where

$$\begin{aligned}\mathcal{R}_L(\mathcal{N}) &\stackrel{\text{def}}{=} \bigcup_{\mathcal{R}_L \in \prod_{C \in \mathcal{A}} \mathcal{R}(C)} \mathcal{R}(\mathcal{N}(\mathcal{R}_L)) \\ \mathcal{R}_U(\mathcal{N}) &\stackrel{\text{def}}{=} \bigcap_{\mathcal{R}_U \in \text{int}(\prod_{C \in \mathcal{A}} \mathcal{E}(C))} \mathcal{R}(\mathcal{N}(\mathcal{R}_U)).\end{aligned}$$

The discussion that follows finds multiplicative and additive bounds on the difference between  $\mathcal{R}_L(\mathcal{N})$  and  $\mathcal{R}_U(\mathcal{N})$ , thereby bounding the accuracy of  $\mathcal{R}_L(\mathcal{N})$  and  $\mathcal{R}_U(\mathcal{N})$  as approximations for  $\mathcal{R}(\mathcal{N})$ .

Lemma 9, below, shows that there exists a constant  $a \in [0, 1]$  such that  $\mathcal{R} \in \mathcal{R}_U(\mathcal{N})$  implies  $a\mathcal{R} \in \mathcal{R}_L(\mathcal{N})$ ; we henceforth use notation

$$\mathcal{R}_L(\mathcal{N}) \geq a\mathcal{R}_U(\mathcal{N}),$$

to specify this relationship. Lemma 9's strength is that it applies to all demand types and does not increase with the network size; its weakness that constant  $a$  is determined by the worst-case channel in  $\mathcal{A}$ . The following definition is used in that result. Recall from Section III that the models for vectors  $\mathcal{R}_{C,L} = (R_{C,L}^{(A \rightarrow B)} : (A, B) \in \mathcal{M}) \in \mathcal{R}(C)$  and  $\mathcal{R}_{C,U} = (R_{C,U}^{(A \rightarrow B)} : (A, B) \in \mathcal{M}) \in \mathcal{E}(C)$  are identical in their topologies (except for possible missing edges corresponding to rate-0 entries in  $\mathcal{R}_{C,L}$  or  $\mathcal{R}_{C,U}$ ).

We can therefore define the worst-case ratio between individual edges of these models as

$$\rho(C) \stackrel{\text{def}}{=} \sup_{(\mathcal{R}_{C,L}, \mathcal{R}_{C,U}) \in \mathcal{R}(C) \times \text{int}(\mathcal{E}(C))} \min_{(A,B) \in \mathcal{M}: R_{C,U}^{(A \rightarrow B)} \geq R_{C,L}^{(A \rightarrow B)}, R_{C,U}^{(A \rightarrow B)} > 0} \frac{R_{C,L}^{(A \rightarrow B)}}{R_{C,U}^{(A \rightarrow B)}}.$$

**Lemma 9**

$$\mathcal{R}_L(\mathcal{N}) \geq \left[ \min_{C \in \mathcal{A}} \rho(C) \right] \mathcal{R}_U(\mathcal{N})$$

*Proof.* Let  $a = \min_{C \in \mathcal{A}} \rho(C)$ , and for each  $C \in \mathcal{A}$  fix some sequence  $\{(\mathcal{R}_{C,L,k}, \mathcal{R}_{C,U,k})\}_{k=1}^{\infty}$  such that  $(\mathcal{R}_{C,L,k}, \mathcal{R}_{C,U,k}) \in \mathcal{R}(C) \times \text{int}(\mathcal{E}(C))$  for all  $k$  and ratio

$$a_{C,k} \stackrel{\text{def}}{=} \min_{(A,B) \in \mathcal{M}: R_{C,U,k}^{(A \rightarrow B)} \geq R_{C,L,k}^{(A \rightarrow B)}, R_{C,U,k}^{(A \rightarrow B)} > 0} \frac{R_{C,L,k}^{(A \rightarrow B)}}{R_{C,U,k}^{(A \rightarrow B)}}$$

monotonically approaches  $\rho(C)$  as  $k$  grows without bound. Let  $\mathcal{N}_{L,k}$ ,  $\mathcal{N}_{U,k}$ , and  $\mathcal{N}_{a_k U,k}$  be the networks that result when each channel  $C \in \mathcal{A}$  is replaced by bit-pipe model  $\mathcal{C}(\mathcal{R}_{C,L,k})$ ,  $\mathcal{C}(\mathcal{R}_{C,U,k})$ , and  $\mathcal{C}(a_k \mathcal{R}_{C,U,k})$ , respectively, where  $a_k = \min_{C \in \mathcal{A}} a_{C,k}$ . Then

$$\mathcal{R}(\mathcal{N}_{a_k U,k}) \subseteq \mathcal{R}(\mathcal{N}_{L,k}) \subseteq \mathcal{R}(\mathcal{N}) \subset \mathcal{R}(\mathcal{N}_{U,k})$$

since  $a_k \mathcal{R}_{C,U,k} \leq \mathcal{R}_{C,L,k}$  for all  $C$  by definition of  $a_k$ . Network  $\mathcal{N}_{a_k U,k}$  is identical to network  $\mathcal{N}_{U,k}$  except that the capacity of each bit-pipe model edge has been decreased by factor  $a_k$ . We next employ

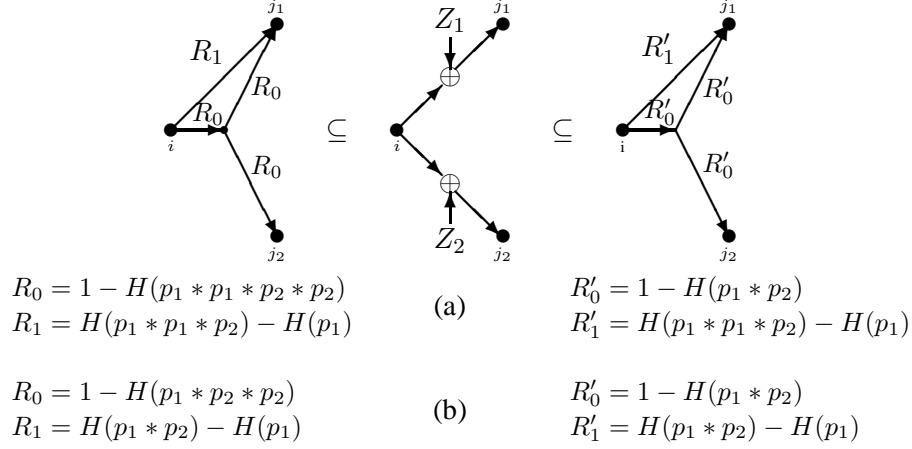

Fig. 7. Example upper and lower bounding models for the binary symmetric broadcast channel with error probabilities  $p_1$  and  $p_1 * p_2$  at its two receivers. The bit-pipe capacities given in (a) and (b) correspond to the independent noise and physically degraded cases, respectively.

*Theorem 1 to bound the difference between  $\mathcal{R}(\mathcal{N}_{a_k U, k})$  and  $\mathcal{R}(\mathcal{N}_{U, k})$ . Let  $\underline{\mathcal{N}}_{U, k}$  be the  $N$ -fold stacked network for  $\mathcal{N}_{U, k}$  and let  $\underline{\mathcal{N}}_{a_k U, k}$  be the  $\lceil N/a_k \rceil$ -fold stacked network for  $\mathcal{N}_{a_k U, k}$ . We can operate any  $(\mathcal{R}, \lambda)$  solution  $\mathcal{S}(\underline{\mathcal{N}}_{U, k})$  for  $\underline{\mathcal{N}}_{U, k}$  across network  $\underline{\mathcal{N}}_{a_k U, k}$  as follows. For each  $\mathcal{C} \in \mathcal{A}$ , transmit the  $N\mathcal{R}_{\mathcal{C}, U, k}$  bits intended for transmission across  $N$  copies of  $\mathcal{C}(\mathcal{R}_{\mathcal{C}, U, k})$  across the  $\lceil N/a_k \rceil$  copies of  $\mathcal{C}(a_k \mathcal{R}_{\mathcal{C}, U, k})$  in  $\underline{\mathcal{N}}_{a_k U, k}$ . Transmissions across the remainder of the network are sent unchanged. Applying  $\mathcal{S}(\underline{\mathcal{N}}_{U, k})$  across  $\underline{\mathcal{N}}_{a_k U, k}$  in this way delivers  $N\mathcal{R}$  bits over  $\lceil N/a_k \rceil$  layers with error probability  $\lambda$ . The rate  $N\mathcal{R}/\lceil N/a_k \rceil$  approaches  $a_k \mathcal{R}$  as  $N$  grows without bound. Letting  $k$  grow without bound achieves the desired result. ■*

By [9, Corollary 5], the best upper and lower bound for any memoryless point-to-point channel are the same. Thus  $\rho(\mathcal{C}) = 1$  for memoryless point-to-point channels. The following examples bound  $\rho(\mathcal{C})$  for binary broadcast and multiple access channels with additive noise.

**Example 3** Let  $\mathcal{C} = (\{0, 1\}, p(y^{(j_1, 1)}, y^{(j_2, 1)} | x^{(i, 1)}), \{0, 1\}^2)$  be a binary symmetric broadcast channel. Then  $Y^{(j_1, 1)} = X^{(i, 1)} \oplus Z_1$  and  $Y^{(j_2, 1)} = X^{(i, 1)} \oplus Z_2$  as shown in Figure 7. Let  $p_1 = EZ_1$  and  $p_1 * p_2 = p_1(1 - p_2) + p_2(1 - p_1) = EZ_2$ . Figure 7 shows example bounding networks. The lower bounding models correspond to points  $(R_0, R_1) = (1 - H(\alpha * p_1 * p_2), H(\alpha * p_1) - H(p_1))$  on the boundary of the capacity region. The upper bounds are obtained by evaluating Theorem 5. Thus

$$\rho(\mathcal{C}) \geq \begin{cases} \frac{1 - H(p_1 * p_1 * p_2 * p_2)}{1 - H(p_1 * p_2)} & \text{when the noise at the receivers is independent} \\ \frac{1 - H(p_1 * p_2 * p_2)}{1 - H(p_1 * p_2)} & \text{when the noise is physically degraded,} \end{cases}$$

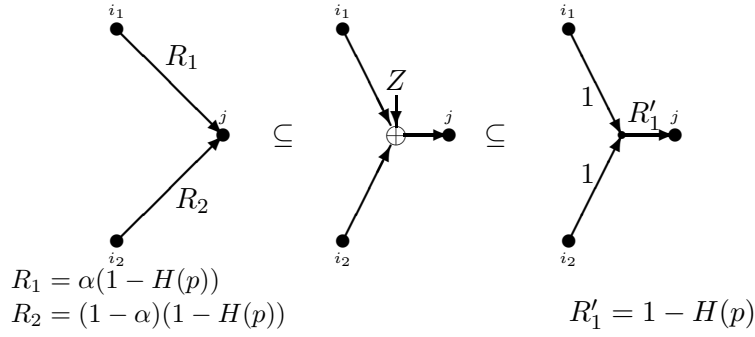

Fig. 8. Example upper and lower bounding models for the binary adder multiple access channel with error probability  $p$ .

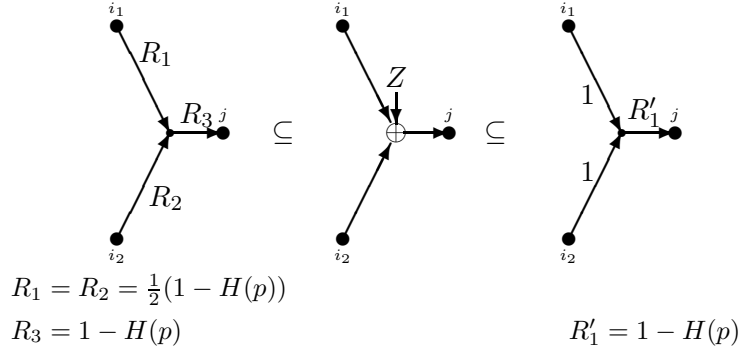

Fig. 9. A variation on the lower bounding model from Figure 8.

where the bounds are achieved by setting  $\alpha = p_1 * p_2$  and  $\alpha = p_2$ , respectively. Observing both  $Y_1$  and  $Y_2$  gives more information when  $Y_1$  and  $Y_2$  are independent, so  $\rho(\mathcal{C})$  is smaller in that case. ■

**Example 4** Let  $(\{0, 1\}^2, p(y^{(j,1)}|x^{(i_1,1)}, x^{(i_2,1)}), \{0, 1\})$  be a binary adder multiple access channel with  $Y^{(j,1)} = X^{(i_1,1)} \oplus X^{(i_2,1)} \oplus Z$ . Let  $EZ = p$ . Figure 8 shows lower and upper bounding models. Each lower bounding model comes from a point on the capacity region. The upper bound evaluates Theorem 6 with  $U = c$ . The models for this example are quite intuitive. For example, any code designed for network  $\mathcal{N}$  can be operated on the given upper bounding model by implementing a memoryless binary adder at the central node. In this case, the topologies of our upper and lower bounding models do not match, but they can be modified to match as shown in Figure 9. Thus

$$\rho(\mathcal{C}) \geq \frac{1 - H(p)}{2}.$$

■

Additive bounds are an alternative to the multiplicative bounds described above; this approach may be

particularly useful when  $R_{\mathcal{C},L}^{(A \rightarrow B)} = 0$  for some  $(A, B) \in \mathcal{M}$  such that  $R_{\mathcal{C},U}^{(A \rightarrow B)} > 0$  or when  $\mathcal{R}_{\mathcal{C},U}$  incorporates infinite capacity edges for some  $\mathcal{C} \in \mathcal{A}$ . We here restrict our attention to upper and lower bounding networks that are entirely deterministic – that is, we assume that the network is comprised of independent channels that have all been replaced by noiseless bit-pipe models. We also focus on demand types for which cut-set bounds are tight on networks of noiseless links. These include multicast demands, multi-source multicast demands, non-overlapping demands on single-source networks, and two-resolution multicast demands on single-source networks (see, for example, [14]).

Let  $\mathcal{R}_c(\mathcal{N})$  be the set of achievable rate vectors for demand types where cut-set bounds are tight on bit-pipe networks, and define

$$\begin{aligned}\mathcal{R}_{c,L}(\mathcal{N}) &\stackrel{\text{def}}{=} \bigcup_{\mathcal{R}_L \in \prod_{\mathcal{C} \in \mathcal{N}} \mathcal{R}(\mathcal{C})} \mathcal{R}_c(\mathcal{N}(\mathcal{R}_L)) \\ \mathcal{R}_{c,U}(\mathcal{N}) &\stackrel{\text{def}}{=} \bigcap_{\mathcal{R}_U \in \text{int}(\prod_{\mathcal{C} \in \mathcal{N}} \mathcal{E}(\mathcal{C}))} \mathcal{R}_c(\mathcal{N}(\mathcal{R}_U)).\end{aligned}$$

For any  $b > 0$ , we use

$$\mathcal{R}_{c,L}(\mathcal{N}) \geq \mathcal{R}_{c,U}(\mathcal{N}) - b$$

to specify that  $\mathcal{R} \in \mathcal{R}_{c,U}(\mathcal{N})$  implies  $[\mathcal{R} - b(1, \dots, 1)]^+ \in \mathcal{R}_{c,L}(\mathcal{N})$ . That is, for any  $\mathcal{R} \in \mathcal{R}_{c,U}(\mathcal{N})$ , reducing the rate for each demand by  $b$  yields an achievable rate vector from  $\mathcal{R}_{c,L}(\mathcal{N})$ . For any network  $\mathcal{N}$  of noiseless bit-pipes and any  $S \subset \{1, \dots, m\}$ , define  $\text{val}(\mathcal{N}, S)$  to be the sum of the capacities of all bit pipes with input in  $S$  and output in  $S^c$ . Since bit-pipe models incorporate internal nodes not present in the original network (and therefore not present in the cut-set definitions), we define the value of a cut across a bit-pipe model using the assignment of internal nodes that minimizes the cut's value. To make this precise, again let  $V_o = \{v^A : A \subseteq V_1, |A| > 1\}$  be the set of internal nodes for bit-pipe model  $\mathcal{C}(\mathcal{R}_C)$  for channel  $\mathcal{C}$ . For any  $\mathcal{C} \in \mathcal{N}$  and  $S \subseteq \{1, \dots, m\}$ , define

$$\text{val}(\mathcal{C}(\mathcal{R}_C), S) \stackrel{\text{def}}{=} \begin{cases} \min_{S' = S \cup T : T \subseteq V_o} \text{val}(\mathcal{C}(\mathcal{R}_C), S') & \text{if } S \cap V_1 \neq \emptyset \text{ and } S^c \cap V_2 \neq \emptyset \\ 0 & \text{otherwise.} \end{cases}$$

Finally, define  $\Delta(\mathcal{C}, S)$  as

$$\Delta(\mathcal{C}, S) = \min_{(\mathcal{R}_{c,L}, \mathcal{R}_{c,U}) \in \mathcal{R}(\mathcal{C}) \times \mathcal{E}(\mathcal{C})} [\text{val}(\mathcal{C}(\mathcal{R}_{c,U}), S) - \text{val}(\mathcal{C}(\mathcal{R}_{c,L}), S)].$$

**Lemma 10** For any network  $\mathcal{N}$  and any set  $S \subseteq \{1, \dots, m\}$ ,

$$\mathcal{R}_{c,L}(\mathcal{N}) \geq \mathcal{R}_{c,U}(\mathcal{N}) - \max_{S \subseteq \{1, \dots, m\}} \sum_{\mathcal{C} \in \mathcal{N}} \Delta(\mathcal{C}, S)$$

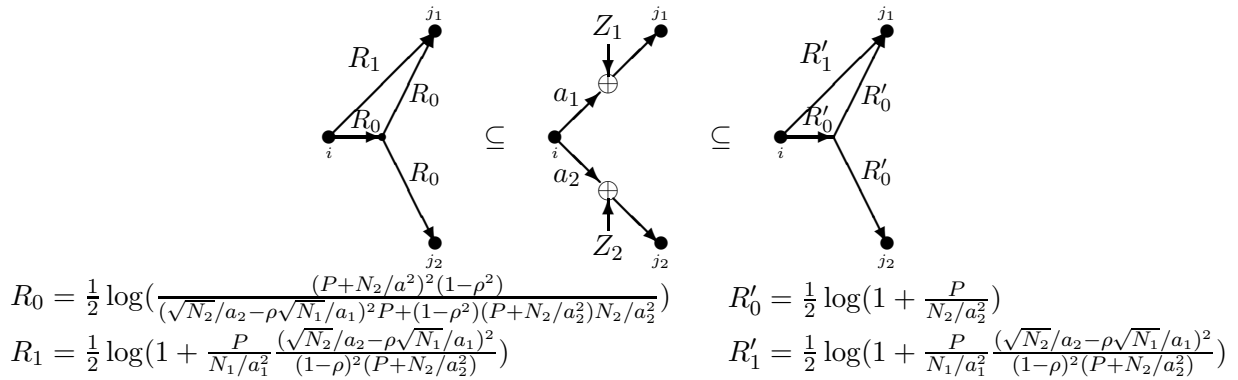

Fig. 10. Example models for the Gaussian broadcast channel.

*Proof.* Since cut-set bounds are tight for the given demand types by assumption, we bound the difference in capacities by bounding the difference in each cut-set using the best choice of the upper and lower bounding models for each cut. ■

Given bounds on  $\Delta(S, \mathcal{C})$  for some family of channels, Lemma 10 yields immediate bounds on the accuracy of the capacity bounds resulting from our models. These bounds take the same form as prior bounds in the literature (e.g., [15]). In particular capacity bounds resulting from our upper and lower bounding models differ from each other (and therefore from the true capacity) by a constant multiple of the number of channels in the network. For networks of Gaussian point-to-point, multiple access, and broadcast channels with independent noise at the receivers, this constant is bounded from above by 1/2, as shown by the examples that follow; the resulting capacity bounds agree precisely with [15] for unicast and multicast demands. The result here extends to other demand types where cut sets are tight, to tighter bounds outside the high-SNR region, and to corresponding results for networks containing broadcast channels with dependent noise at the receivers.

By [9],  $\Delta(\mathcal{C}, S) = 0$  for all memoryless point-to-point channels. Example 5 bounds  $\Delta(\mathcal{C}, S)$  for the Gaussian broadcast channel.

**Example 5** Let  $\mathcal{C}$  be a two-receiver Gaussian broadcast channel  $(\mathbb{R}, p(y^{(j_1,1)}, y^{(j_2,1)} | x^{(i,1)}), \mathbb{R}^2)$  with  $Y^{(j_1,1)} = a_1 X^{(i,1)} + Z_1$  and  $Y^{(j_2,1)} = a_2 X^{(i,1)} + Z_2$  for some jointly Gaussian random variables  $Z_1$  and  $Z_2$  with  $E[(X^{(i,1)})^2] \leq P$ ,  $E[Z_1^2] = N_1$ ,  $E[Z_2^2] = N_2$ ,  $E[Z_1 Z_2] = \rho\sqrt{N_1 N_2}$ , and  $N_1/a_1^2 \leq N_2/a_2^2$ . Figure 10 shows example upper and lower bounding models. The lower bounding model is found by



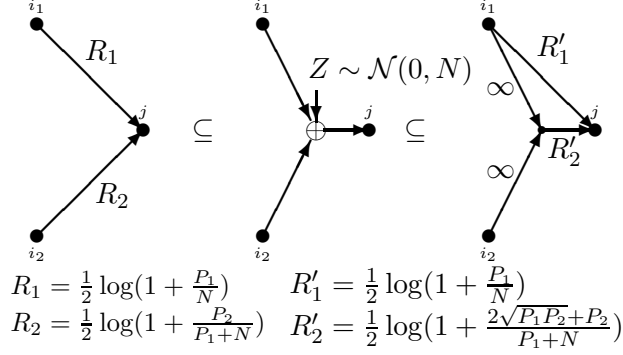

Fig. 11. Example models for the Gaussian multiple access channel with power constraints  $P_1 \geq P_2$  at transmitters 1 and 2 and variance- $N$  Gaussian noise.

evaluating the broadcast capacity bounds

$$\begin{aligned}
R_1 &= \frac{1}{2} \log\left(1 + \frac{(1-\alpha)P}{N_1/a_1^2}\right) \\
R_2 &= \frac{1}{2} \log\left(1 + \frac{\alpha P}{(1-\alpha)P + N_2/a_2^2}\right)
\end{aligned}$$

at

$$1 - \alpha = \frac{(\sqrt{N_2}/a_2 - \rho\sqrt{N_1}/a_1)^2}{(1-\rho)^2(a_2^2 P + N_2)}.$$

The upper bounding network is obtained by evaluating the model from Theorem 5. This upper and lower bound imply

$$\begin{aligned}
\Delta(\mathcal{C}, S) &\leq \frac{1}{2} \log\left(1 + \frac{P}{N_2/a_2^2}\right) - \frac{1}{2} \log\left(\frac{(P + N_2/a_2^2)^2(1-\rho^2)}{(\sqrt{N_2}/a_2 - \rho\sqrt{N_1}/a_1)^2 P + (1-\rho^2)(P + N_2/a_2^2)N_2/a_2^2}\right) \\
&= \frac{1}{2} \log\left(1 + \frac{P}{P + N_2/a_2^2} \frac{\left(1 - \rho\sqrt{\frac{N_1/a_1^2}{N_2/a_2^2}}\right)^2}{1-\rho^2}\right).
\end{aligned}$$

When  $Z_1$  and  $Z_2$  are independent,  $\rho = 0$  and the upper bound is

$$\Delta(\mathcal{C}, S) \leq \frac{1}{2} \log\left(1 + \frac{P}{P + N_2/a_2^2}\right),$$

which is at most 1/2 and significantly smaller in the low SNR region. ■

**Example 6** Let  $\mathcal{C} = (\mathbb{R}^2, p(y^{(j,1)} | x^{(i_1,1)}, x^{(i_2,1)}), \mathbb{R})$  be a Gaussian multiple access channel with  $Y^{(j,1)} = X^{(i_1,1)} + X^{(i_2,1)} + Z$ ,  $E[(X^{(i_1,1)})^2] \leq P_1$ ,  $E[(X^{(i_2,1)})^2] \leq P_2$ ,  $P_1 \geq P_2$ , and  $Z \sim \mathcal{N}(0, N)$ . Figure 11 shows upper and lower bounding models for the given multiple access channel. The lower bound is

chosen as the corner point

$$\begin{aligned} R_1 &= \frac{1}{2} \log \left( 1 + \frac{P_1}{N} \right) \\ R_2 &= \frac{1}{2} \log \left( 1 + \frac{P_1 + P_2}{N} \right) - \frac{1}{2} \log \left( 1 + \frac{P_1}{N} \right) = \frac{1}{2} \log \left( 1 + \frac{P_2}{P_1 + N} \right) \end{aligned}$$

of the multiple access capacity region.

The upper bounding network is obtained by evaluating Theorem 6 under the maximizing joint distribution on  $(X^{(i_1,1)}, X^{(i_2,1)})$  using a statistically dependent distortion- $D$  reproduction  $U$  of  $X^{(i_2,1)}$  similar to those used in lossy source coding. Precisely,

$$\begin{aligned} X^{(i_2,1)} &= X^{(i_1,1)} \sqrt{\frac{P_2}{P_1}} \\ U &= \frac{1}{(1 + \sqrt{P_2/P_1})} X^{(i_1,1)} + Z_1 \\ Z &= Z_1 + Z_2 \end{aligned}$$

where  $Z_1$  is a Gaussian random variable with mean 0 and variance  $N/(1 + \sqrt{P_2/P_1})^2$ ,  $Z_2$  is a Gaussian random variable with mean 0 and variance  $N(1 - 1/(1 + \sqrt{P_2/P_1})^2)$ , and  $(X_1, X_2)$ ,  $Z_1$ , and  $Z_2$  are mutually independent. Using this choice of  $U$ , the upper bound from Theorem 6 is

$$\begin{aligned} R_1 &= \frac{1}{2} \log \left( 1 + \frac{P_1}{N} \right) \\ R_2 &= \frac{1}{2} \log \left( \frac{(\sqrt{P_1} + \sqrt{P_2})^2 + N}{P_1 + N} \right) \end{aligned}$$

Using the given upper and lower bounds yields

$$\Delta(\mathcal{C}, S) \leq \frac{1}{2} \log \left( \frac{(\sqrt{P_1} + \sqrt{P_2})^2 + N}{P_1 + P_2 + N} \right),$$

which is at most 1/2 (and considerably smaller when the signal-to-noise ratio is small). ■

Examples 3, 4, 5 and 6 show that for some network types, the upper and lower bounds differ by at most an additive or multiplicative constant that depends on the statistics of the network's component channels. Given any network  $\mathcal{N}$  built from arbitrary point-to-point channels, binary symmetric broadcast channels (Example 3), and binary adder multiple access channels (Example 4), Lemma 9 shows that the capacities of the derived upper and lower bounding networks differ from the true capacity and each other by at most a multiplicative constant  $\rho^* = \max_{C \in \mathcal{N}} \rho(C)$ . This constant depends on the channel for which the distance between our upper and lower bounds is largest but not on the size of the network. Likewise, given any network  $\mathcal{N}$  built from arbitrary point-to-point channels, Gaussian broadcast channels (Example 5),

and additive Gaussian multiple access channels (Example 6), Lemma 10 shows that for all demand types for which cut-set bounds on the network coding capacity are tight, the capacities of the derived upper and lower bounding networks differ from the true capacity and each other by at most an additive constant equal to a constant multiple of the number of channels in the network. When the noise at the receivers of each broadcast channel is independent, this immediately extends the well-known 1/2-bit per component bounds to a variety of other demand types where cut-sets bounds on the network coding capacity are tight. It also gives tighter bounds outside the high-SNR region and derives the corresponding bounds for broadcast channels with statistically dependent noise at the receivers. Of course, examples 1 and 2 demonstrate that the lower and upper bounds for some channels are, by necessity, far apart. When such large gaps arise, they motivate the investigation of larger network components. For example, modeling the network from example 1 not as two independent components but instead as a single component with one input and one output yields matching lower and upper bounding models and therefore a precise network equivalence.

## VII. CONCLUSIONS

The equivalence tools introduced in this paper are proposed as one step in a new path towards the construction of computational tools for bounding the capacities of large networks. Unlike cut-set strategies, which investigate networks in their entirety, the approach proposed here is to bound capacities of networks by carefully characterizing the behaviors of the individual components from which they are built. As described in Lemma 3, the capacity region of an isolated component can be used to calculate lower bounds on the capacities of all networks in which the component may be employed. Since capacity regions of individual components cannot be used to derive upper bounds (see Example 1), Theorem 4 employs an alternative component characterization – here offered as a complement to the traditional capacity problem. Given an arbitrary channel, describe the family of bit-pipe models over which accurate channel emulation is possible. The question is essentially a source coding problem – for each vector  $\underline{X}^{V_1}$  at the channel input nodes  $V_1$ , we characterize the family of rate vectors  $(R^{(A \rightarrow B)} : A \subseteq V_1, B \subseteq V_2)$  sufficient for constructing a reproduction  $\underline{Y}^{V_2}$  at the channel output nodes  $V_2$  such that  $\underline{Y}^{V_2}$  appears to result from the operation of channel  $\mathcal{C}$  on input  $\underline{X}^{V_1}$ . The upper bounding models for the point-to-point, broadcast, multiple access, and interference channels are here offered as examples of this characterization strategy. Increasing the library of component models offers a route to studying capacities of larger and larger families of networks using computational tools for bounding network coding capacities.

APPENDIX I

AVERAGE VS. EXPECTED ERROR PROBABILITY IN CHANNEL CODING

Lemma 11, below, shows that given a blocklength- $N$  channel code with average error probability  $P_e^{(N)}$ , there exists an index assignment such that the code's expected error probability is no greater than  $P_e^{(N)}$ . This is obvious for channels with a single transmitter but more subtle for channels with multiple transmitters. The outline of this proof was suggested by [11]. The property is useful since messages transmitted across a channel  $\mathcal{C}$  in the middle of some large network  $\mathcal{N}$  need not be equally probable, which means that the expected error probability can equal the code's maximal error probability if the codeword indices are poorly assigned. We denote the average error probability under channel code  $(\alpha_N, \beta_N)$  as

$$P_e^{(N)} \stackrel{\text{def}}{=} \sum_{\tilde{\mathbf{x}}^{V_1} \in \tilde{\mathcal{X}}^{V_1}} \frac{1}{|\tilde{\mathcal{X}}^{V_1}|} \Pr(\beta_N(\underline{Y}^{V_2}) \neq \tilde{\mathbf{x}}^{V_1} | \underline{X}^{V_1} = \alpha_N(\tilde{\mathbf{x}}^{V_1}))$$

and the expected error probability of the same code as

$$\sum_{\tilde{\mathbf{x}}^{V_1} \in \tilde{\mathcal{X}}^{V_1}} p(\tilde{\mathbf{x}}^{V_1}) \Pr(\beta_N(\underline{Y}^{V_2}) \neq \tilde{\mathbf{x}}^{V_1} | \underline{X}^{V_1} = \alpha_N(\tilde{\mathbf{x}}^{V_1})).$$

This notation hides the independent operation of the encoders  $\alpha_N = (\alpha^{\{\{i\} \rightarrow B\}} : (\{i\}, B) \in \mathcal{M})$  and the decoders  $\beta_N = (\beta^{\{\{i\} \rightarrow B\}, j} : (\{i\}, B) \in \mathcal{M}, j \in B)$ . We relabel the codeword indices by applying a permutation  $\phi^{\{\{i\} \rightarrow B\}}$  on each message set. Given permutations  $\phi = (\phi^{\{\{i\} \rightarrow B\}} : (\{i\}, B) \in \mathcal{M})$ , we denote the expected error probability after relabeling the codeword indices by

$$\sum_{\tilde{\mathbf{x}}^{V_1} \in \tilde{\mathcal{X}}^{V_1}} p(\tilde{\mathbf{x}}^{V_1}) \Pr(\beta_N(\underline{Y}^{V_2}) \neq \phi(\tilde{\mathbf{x}}^{V_1}) | \underline{X}^{V_1} = \alpha_N(\phi(\tilde{\mathbf{x}}^{V_1}))),$$

where  $\phi(\tilde{\mathbf{x}}^{V_1}) = (\phi^{\{\{i\} \rightarrow B\}}(\tilde{\mathbf{x}}^{\{\{i\} \rightarrow B\}})) : (\{i\}, B) \in \mathcal{M}$ .

**Lemma 11 ([11])** *Let  $(\alpha_N, \beta_N)$  be a blocklength- $N$  channel code for channel  $\mathcal{C}$  with transmitters  $V_1$  and receivers  $V_2$ . For any distribution  $p(\cdot)$  on the space  $\tilde{\mathcal{X}}^{V_1} = \prod_{(\{i\}, B) \in \mathcal{M}} \tilde{\mathcal{X}}^{\{\{i\} \rightarrow B\}}$  of possible transmissions, there exist independent permutations  $\phi = (\phi^{\{\{i\} \rightarrow B\}} : (\{i\}, B) \in \mathcal{M})$  of the transmission indices for which*

$$\sum_{\tilde{\mathbf{x}}^{V_1} \in \tilde{\mathcal{X}}^{V_1}} p(\tilde{\mathbf{x}}^{V_1}) \Pr(\beta_N(\underline{Y}^{V_2}) \neq \phi(\tilde{\mathbf{x}}^{V_1}) | \underline{X}^{V_1} = \alpha_N(\phi(\tilde{\mathbf{x}}^{V_1}))) \leq P_e^{(N)}.$$

*Proof.* For each  $(\{i\}, B) \in \mathcal{M}$ , choose permutation  $\Phi^{\{\{i\} \rightarrow B\}}$  uniformly at random from the space of possible permutations on  $\underline{\mathcal{W}}^{\{\{i\} \rightarrow B\}}$ . Then, using  $E_\Phi[\cdot]$  to denote the expectation with respect to the random

permutation choice, the expected error probability of the resulting channel code is

$$\begin{aligned}
& E_{\Phi} \left[ \sum_{\tilde{\mathbf{x}}^{V_1} \in \tilde{\mathcal{X}}^{V_1}} p(\tilde{\mathbf{x}}^{V_1}) \Pr(\beta_N(\underline{Y}^{V_2}) \neq \Phi(\tilde{\mathbf{x}}^{V_1}) | \underline{X}^{V_1} = \alpha_N(\Phi(\tilde{\mathbf{x}}^{V_1}))) \right] \\
&= \sum_{\tilde{\mathbf{x}}^{V_1} \in \tilde{\mathcal{X}}^{V_1}} p(\tilde{\mathbf{x}}^{V_1}) E_{\Phi} [\Pr(\beta_N(\underline{Y}^{V_2}) \neq \Phi(\tilde{\mathbf{x}}^{V_1}) | \underline{X}^{V_1} = \alpha_N(\Phi(\tilde{\mathbf{x}}^{V_1})))] \\
&\stackrel{(a)}{=} \sum_{\tilde{\mathbf{x}}^{V_1} \in \tilde{\mathcal{X}}^{V_1}} p(\tilde{\mathbf{x}}^{V_1}) \left[ \sum_{\hat{\mathbf{x}}^{V_1} \in \hat{\mathcal{X}}^{V_1}} \frac{1}{|\hat{\mathcal{X}}^{V_1}|} \Pr(\beta_N(\underline{Y}^{V_2}) \neq \hat{\mathbf{x}}^{V_1} | \underline{X}^{V_1} = \alpha_N(\hat{\mathbf{x}}^{V_1})) \right] \\
&= P_e^{(N)}
\end{aligned}$$

where (a) holds since all codewords are equally probable under the uniform distribution on permutations. The result follows since the optimal choice of permutations  $(\phi^{\{\tilde{i}\} \rightarrow B}) : (\{i\}, B) \in \mathcal{M})$  achieves expected error probability no greater than that achieved by the given random permutation choice. ■

## APPENDIX II

### TYPICAL SET NOTATION AND TOOLS

The appendices that follow define typical sets for many combinations of random variables and many parameter values. The following definitions are useful for streamlining the exposition. Given a random variable  $Z$  drawn from distribution  $p(z)$  on alphabet  $\mathcal{Z}$  and an  $N$ -vector  $\underline{z} \in \underline{\mathcal{Z}}$ , define

$$f(\underline{z}) \stackrel{\text{def}}{=} \left| -\frac{1}{N} \log p(\underline{z}) - H(Z) \right|,$$

where  $p(\underline{z}) \stackrel{\text{def}}{=} \prod_{\ell=1}^N p(\underline{z}(\ell))$  and  $H(Z)$  is the (discrete or differential) entropy of random variable  $Z$ . The random variable and distribution are implicit, with  $f(\underline{x})$  and  $f(\underline{y})$  referring to random variables  $X$  and  $Y$ , respectively. For example, the usual jointly typical set for  $(X, Y)$  is here expressed as

$$A_{\epsilon}^{(N)} = \{(\underline{x}, \underline{y}) : f(\underline{x}) \leq \epsilon, f(\underline{y}) \leq \epsilon, f(\underline{x}, \underline{y}) \leq \epsilon\}.$$

For each collection of random variables for which we define a typical set, we also define a restricted typical  $\hat{A}_{\epsilon}^{(N)} \subseteq A_{\epsilon}^{(N)}$  and an indicator function  $K(\cdot)$  that equals one for values in  $\hat{A}_{\epsilon}^{(N)}$  and 0 otherwise. The formal definitions for the restricted typical sets are given in the appendices that follow. When multiple restricted typical sets are in use we distinguish between them either by context or by adding arguments. For example,  $(X, Y) \in \hat{A}_{\epsilon}^{(N)}$  and  $\hat{A}_{\epsilon}^{(N)}(X, Y)$  refer to the same restricted typical set. A summary of definitions and results from [9] follows.

Given any distribution  $p(u, v)$  and any constant  $\epsilon > 0$ , define

$$\begin{aligned} a(\epsilon) &\stackrel{\text{def}}{=} (1 + \epsilon) \cdot \inf \{ \epsilon' > 0 : p(f(\underline{V}) > \epsilon' \vee f(\underline{U}, \underline{V}) > \epsilon') \leq 2^{-N6\epsilon} \quad \forall N \text{ suffic. large} \} \\ A_\epsilon^{(N)} &\stackrel{\text{def}}{=} \{ (\underline{u}, \underline{v}) : f(\underline{u}) < \epsilon, f(\underline{v}) < a(\epsilon), f(\underline{u}, \underline{v}) < a(\epsilon) \} \\ \hat{A}_\epsilon^{(N)} &\stackrel{\text{def}}{=} \{ (\underline{u}, \underline{v}) \in A_\epsilon^{(N)} : p(f(\underline{V}) > a(\epsilon) \vee f(\underline{U}, \underline{V}) > a(\epsilon) | \underline{U} = \underline{u}) < 2^{-N3\epsilon} \} \\ K(\underline{x}, \underline{y}) &\stackrel{\text{def}}{=} \begin{cases} 1 & \text{if } (\underline{x}, \underline{y}) \in \hat{A}_\epsilon^{(N)} \\ 0 & \text{otherwise.} \end{cases} \end{aligned}$$

**Lemma 12** [9, Lemma 6] *Let  $(\underline{U}, \underline{V})$  be drawn i.i.d.  $p(u, v)$ . Then*

$$p((\hat{A}_\epsilon^{(N)}(\underline{U}, \underline{V}))^c) < 2^{-Nc(\epsilon)}$$

for some constant  $c(\epsilon) > 0$  and all  $N$  sufficiently large. Constant  $c(\epsilon)$  approaches 0 as  $\epsilon$  approaches 0.

Design random source code  $(\alpha_N, \beta_N)$  by drawing codewords  $\beta_N(1), \dots, \beta_N(2^{NR})$  i.i.d.  $p(\underline{v})$  and choosing  $\alpha_N(\underline{u})$  uniformly at random from the indices  $w \in \{1, \dots, 2^{NR}\}$  for which codeword  $\beta_N(w)$  satisfies  $(\underline{u}, \beta_N(w)) \in \hat{A}_\epsilon^{(N)}$ ;  $\alpha_N(\underline{u})$  is set to 1 if no index  $w$  satisfies this constraint. Define

$$\hat{p}(\underline{v}|\underline{u}) \stackrel{\text{def}}{=} \Pr(\beta_N(\alpha_N(\underline{u})) = \underline{v}),$$

and for any  $A \subseteq \underline{\mathcal{U}} \times \underline{\mathcal{V}}$ , let  $\hat{p}(A|\underline{u}) \stackrel{\text{def}}{=} \sum_{\underline{v}: (\underline{u}, \underline{v}) \in A} \hat{p}(\underline{v}|\underline{u})$ .

**Lemma 13** [9, Lemma 9] *For any  $(\underline{u}, \underline{v}) \in \hat{A}_\epsilon^{(N)}$ ,*

$$\hat{p}(\underline{v}|\underline{u}) \leq p(\underline{v}|\underline{u}) 2^{N(4a(\epsilon) + 2\epsilon + 1/N)}.$$

**Lemma 14** [9, Lemma 10]

$$\hat{p}((\hat{A}_\epsilon^{(N)})^c|\underline{u}) \leq p((\hat{A}_\epsilon^{(N)})^c|\underline{u}) + e^{-2^{N(R - I(\underline{U}, \underline{V}) - 2a(\epsilon) - \epsilon)}}$$

### APPENDIX III

#### BROADCAST CHANNELS

We begin by defining the typical sets used in the proof of Theorem 5. That proof appears later in this section. We here employ notation and results developed in Appendix II.

Given any  $p(x, y_1, y_2)$ , fix  $\epsilon = (\epsilon_1, \epsilon_2)$  with  $\epsilon_1, \epsilon_2 > 0$ , and let

$$a_1(\epsilon_1) \stackrel{\text{def}}{=} (1 + \epsilon_1) \cdot \inf \{ \epsilon' > 0 : p(f(\underline{Y}_2) > \epsilon' \vee f(\underline{X}, \underline{Y}_2) > \epsilon') \leq 2^{-N6\epsilon_1} \quad \forall N \text{ suff. large} \}.$$

For  $p(x, y_2)$  the typical set is

$$A_\epsilon^{(N)} \stackrel{\text{def}}{=} \left\{ (\underline{x}, \underline{y}_2) \in \underline{\mathcal{X}} \times \underline{\mathcal{Y}}_2 : f(\underline{x}) \leq \epsilon_1, f(\underline{y}_2) \leq a_1(\epsilon_1), f(\underline{x}, \underline{y}_2) \leq a_1(\epsilon_1) \right\},$$

which we restrict to

$$\hat{A}_\epsilon^{(N)} \stackrel{\text{def}}{=} \left\{ (\underline{x}, \underline{y}_2) \in A_\epsilon^{(N)} : p\left(\left(A_\epsilon^{(N)}(X, Y_2)\right)^c \middle| \underline{x}\right) \leq 2^{-3N\epsilon_1} \right\}.$$

Let

$$a_2(\epsilon_2) \stackrel{\text{def}}{=} (1 + \epsilon_2) \inf \left\{ \epsilon' > 0 : p(f(\underline{Y}_2) > \epsilon' \vee f(\underline{Y}_1, \underline{Y}_2) > \epsilon' \vee f(\underline{X}, \underline{Y}_2) > \epsilon' \vee f(\underline{X}, \underline{Y}_1, \underline{Y}_2) > \epsilon') \leq 2^{-N6\epsilon_2} \forall N \text{ suff. large} \right\}.$$

For distribution  $p(x, y_1, y_2)$ , the typical set is

$$A_\epsilon^{(N)} \stackrel{\text{def}}{=} \left\{ (\underline{x}, \underline{y}_1, \underline{y}_2) : f(\underline{y}_2) \leq a_2(\epsilon_2), f(\underline{x}, \underline{y}_2) \leq a_2(\epsilon_2), f(\underline{y}_1, \underline{y}_2) \leq a_2(\epsilon_2), f(\underline{x}, \underline{y}_1, \underline{y}_2) \leq a_2(\epsilon_2) \right\}$$

which we restrict to

$$\hat{A}_\epsilon^{(N)} \stackrel{\text{def}}{=} \left\{ (\underline{x}, \underline{y}_1, \underline{y}_2) \in A_\epsilon^{(N)} : p\left(\left(A_\epsilon^{(N)}(X, Y_1, Y_2)\right)^c \middle| \underline{x}, \underline{y}_2\right) \leq 2^{-3N\epsilon_2} \right\}.$$

By Lemma 15, the probability of observing atypical elements is asymptotically negligible.

**Lemma 15** *If  $(\underline{X}, \underline{Y}_1, \underline{Y}_2)$  are drawn i.i.d.  $p(x, y_1, y_2)$ , then*

$$\begin{aligned} p\left(\left(\hat{A}_\epsilon^{(N)}(X, Y_2)\right)^c\right) &\leq 2^{-Nc_1(\epsilon_1)} \\ p\left(\left(\hat{A}_\epsilon^{(N)}(X, Y_1, Y_2)\right)^c\right) &\leq 2^{-Nc_2(\epsilon_2)} \end{aligned}$$

for some constants  $c_1(\epsilon_1), c_2(\epsilon_2) > 0$  and all  $N$  sufficiently large. Constants  $c_1(\epsilon_1)$  and  $c_2(\epsilon_2)$  approach zero as  $\epsilon_1$  and  $\epsilon_2$ , respectively, decay to zero.

*Proof.* Like Lemma 12, the result follows from Chernoff's bound and the definition of  $\hat{A}_\epsilon^{(N)}$ . ■

**Proof of Theorem 5:** Since  $R^{\{\{i\} \rightarrow \{j_2\}\}}$  is not bounded from below, we set it to 0. For concision, we further define  $R_0 \stackrel{\text{def}}{=} R^{\{\{i\} \rightarrow \{j_1, j_2\}\}}$  and  $R_1 \stackrel{\text{def}}{=} R^{\{\{i\} \rightarrow \{j_1\}\}}$  and use  $\mathcal{C} = (\mathcal{X}, p(y_1, y_2|x), \mathcal{Y}_1 \times \mathcal{Y}_2)$  in place of  $\mathcal{C} = (\mathcal{X}^{(i,1)}, p(y^{(j_1,1)}, y^{(j_2,1)}|x^{(i,1)}), \mathcal{Y}^{(j_1,1)} \times \mathcal{Y}^{(j_2,2)})$  both in this proof and its supporting lemmas.

Fix  $(R_0, R_1)$  to satisfy the theorem constraints. Suppose that  $R_1 > I(X; Y_1|Y_2)$ ; for any rate pair satisfying the theorem assumptions but not satisfying this bound, we can operate the code as if this condition were satisfied by using part of the common rate to carry private information for receiver  $j_1$ .

By Theorem 4 it suffices to show that for any channel input distribution  $p(x)$  there exists a sequence of rate- $(R_0, R_1)$  random emulation codes  $(\alpha_N, \beta_N)$  for which the resulting emulation distribution

$$\hat{p}(\underline{y}_1, \underline{y}_2 | \underline{x}) \stackrel{\text{def}}{=} \Pr(\beta_N(\alpha_N(\underline{x})) = (\underline{y}_1, \underline{y}_2))$$

satisfies

$$P_e^{(N)}(\nu) = \sum_{\underline{x}, \underline{y}_1, \underline{y}_2} p(\underline{x}) \hat{p}(\underline{y}_1, \underline{y}_2 | \underline{x}) \mathbb{1} \left( \frac{1}{N} \log \left( \frac{\hat{p}(\underline{y}_1, \underline{y}_2 | \underline{x})}{p(\underline{y}_1, \underline{y}_2 | \underline{x})} \right) > \nu \right) < 2^{-N\eta(\nu)}$$

for some positive function  $\eta(\nu)$  dependent on  $p(x)$  for which  $\eta(\nu)$  goes to zero as  $\nu$  goes to zero.

We employ the definitions for the (restricted) typical set  $\hat{A}_\epsilon^{(N)}$  from the beginning of this section. We distinguish between these sets either by context (e.g.,  $(\underline{x}, \underline{y}_2) \in \hat{A}_\epsilon^{(N)}$  refers to the typical set for  $p_t(x, y_2)$ ) or by adding arguments (e.g.,  $\hat{A}_\epsilon^{(N)}(X, Y_2)$ ). Typical sets  $\hat{A}_\epsilon^{(N)}(X, Y_2)$  and  $\hat{A}_\epsilon^{(N)}(X, Y_1, Y_2)$  employ parameters  $\epsilon_1$  and  $\epsilon_2$ , respectively.

Next, we define codes  $(\alpha_N, \beta_N)$  to emulate the typical behavior of channel  $\mathcal{C}$  under input distribution  $p(\underline{x}) = \prod_{\ell=1}^N p(\underline{x}(\ell))$ . Recall that  $(\alpha_N, \beta_N)$  has encoders

$$\alpha_N = \left( \alpha_N^{(A \rightarrow B)} : (A, B) \in \mathcal{M} \right) = \left( \alpha_N^{\{\{i\} \rightarrow \{j_1\}\}}, \alpha_N^{\{\{i\} \rightarrow \{j_2\}\}}, \alpha_N^{\{\{i\} \rightarrow \{j_1, j_2\}\}} \right)$$

at rates  $R_1 = R^{\{\{i\} \rightarrow \{j_1\}\}}, R^{\{\{i\} \rightarrow \{j_2\}\}} = 0$ , and  $R_0 = R^{\{\{i\} \rightarrow \{j_1, j_2\}\}}$  and decoders  $\beta_N = (\beta_N^{(j_1)}, \beta_N^{(j_2)})$ .

Rate 0 requires no encoder. We abbreviate the notation for the remaining encoders to  $\alpha_N^{(1)} = \alpha_N^{\{\{i\} \rightarrow \{j_1\}\}}$  and  $\alpha_N^{(0)} = \alpha_N^{\{\{i\} \rightarrow \{j_1, j_2\}\}}$  and for the decoders to  $\beta_N^{(j_1)} = \beta_N^{(1)}$  and  $\beta_N^{(j_2)} = \beta_N^{(2)}$ . Thus

$$\begin{aligned} \alpha_N^{(0)} : \underline{\mathcal{X}} &\rightarrow \mathcal{W}_0 & \beta_N^{(1)} : \mathcal{W}_0 \times \mathcal{W}_1 &\rightarrow \underline{\mathcal{Y}}_1 \\ \alpha_N^{(1)} : \underline{\mathcal{X}} &\rightarrow \mathcal{W}_1 & \beta_N^{(2)} : \mathcal{W}_0 &\rightarrow \underline{\mathcal{Y}}_2. \end{aligned}$$

where  $\mathcal{W}_0 = \tilde{\underline{\mathcal{X}}}^{\{\{i\} \rightarrow \{j_1, j_2\}\}} = \{0, 1\}^{NR_0}$  and  $\mathcal{W}_1 = \tilde{\underline{\mathcal{X}}}^{\{\{i\} \rightarrow \{j_1\}\}} = \{0, 1\}^{NR_1}$ . For the random code design, first draw codewords  $\{\beta_N^{(2)}(w_0) : w_0 \in \mathcal{W}_0\}$  i.i.d. according to distribution  $\prod_{\ell=1}^N p(\underline{y}_2(\ell))$ . Then, for each  $w_0 \in \mathcal{W}_0$  draw codewords  $\{\beta_N^{(1)}(w_0, w_1) : w_1 \in \mathcal{W}_1\}$  i.i.d. according to  $\prod_{\ell=1}^N p(\underline{y}_1(\ell) | \beta_N^{(2)}(w_0, \ell))$ , where  $\beta_N^{(2)}(w_0, \ell)$  denotes the  $\ell$ th component of  $N$ -vector  $\beta_N^{(2)}(w_0)$ . For the random encoder design, choose index  $\alpha_N^{(0)}(\underline{x})$  uniformly at random from those  $w_0 \in \mathcal{W}_0$  for which  $(\underline{x}, \beta_N^{(2)}(w_0)) \in \hat{A}_\epsilon^{(N)}$ ; if there is no such  $w_0$ , then set  $\alpha_N^{(0)}(\underline{x})$  to 1. Let  $w_0 = \alpha_N^{(0)}(\underline{x})$ ; then choose index  $\alpha_N^{(1)}(\underline{x})$  uniformly at random from those  $w_1 \in \mathcal{W}_1$  for which  $(\underline{x}, \beta_N^{(1)}(w_0, w_1), \beta_N^{(2)}(w_0)) \in \hat{A}_\epsilon^{(N)}$ . If there is no such  $w_1$ , then set  $\alpha_N^{(1)}(\underline{x})$  to 1.

By Lemma 16, below,

$$\begin{aligned} \hat{p}(\underline{y}_2 | \underline{x}) &\leq 2^{N(4a_1(\epsilon_1) + 2\epsilon_1 + 1/N)} p(\underline{y}_2 | \underline{x}) \quad \forall (\underline{x}, \underline{y}_2) \in \hat{A}_\epsilon^{(N)} \\ \hat{p}(\underline{y}_1 | \underline{x}, \underline{y}_2) &\leq 2^{N(8a_2(\epsilon_2) + 1/N)} p(\underline{y}_1 | \underline{x}, \underline{y}_2) \quad \forall (\underline{x}, \underline{y}_1, \underline{y}_2) \in \hat{A}_\epsilon^{(N)}. \end{aligned}$$



Thus

$$\hat{p}(\underline{y}_1, \underline{y}_2 | \underline{x}) \leq 2^{N(4a_1(\epsilon_1) + 2\epsilon_1 + 8a_2(\epsilon_2) + 2/N)} p(\underline{y}_1, \underline{y}_2 | \underline{x})$$

for all  $(\underline{x}, \underline{y}_1, \underline{y}_2)$  for which  $(\underline{x}, \underline{y}_1) \in \hat{A}_\epsilon^{(N)}$  and  $(\underline{x}, \underline{y}_1, \underline{y}_2) \in \hat{A}_\epsilon^{(N)}$ . By Lemma 17, below,

$$\begin{aligned} \hat{p}((X, Y_2) \notin \hat{A}_\epsilon^{(N)} | \underline{x}) &\leq e^{-2^{N(R_0 - I(X; Y_2) - 2a_1(\epsilon_1) - \epsilon_1)}} + p((\hat{A}_\epsilon^{(N)}(X, Y_2))^c | \underline{x}) \\ \hat{p}((X, Y_1, Y_2) \notin \hat{A}_\epsilon^{(N)} | \underline{x}, \underline{y}_2) &\leq e^{-2^{N(R_1 - I(X; Y_1 | Y_2) - 4a_2(\epsilon_2))}} + p((\hat{A}_\epsilon^{(N)}(X, Y_1, Y_2))^c | \underline{x}, \underline{y}_2). \end{aligned}$$

By Lemma 15, above,

$$\begin{aligned} p\left((\hat{A}_\epsilon^{(N)}(X, Y_2))^c\right) &\leq 2^{-Nc_1(\epsilon_1)} \\ p\left((\hat{A}_\epsilon^{(N)}(X, Y_1, Y_2))^c\right) &\leq 2^{-Nc_2(\epsilon_2)} \end{aligned}$$

for some constants  $c_1(\epsilon_1)$  and  $c_2(\epsilon_2)$  that go to zero as  $\epsilon_1$  and  $\epsilon_2$  go to zero.

Thus when  $\nu = 4a_1(\epsilon_1) + 3\epsilon_1 + 8a_2(\epsilon_2)$  and  $N$  is sufficiently large,

$$\begin{aligned} P_e^{(N)}(\nu) &\leq \sum_{(\underline{x}, \underline{y}_1, \underline{y}_2): (\underline{x}, \underline{y}_2) \notin \hat{A}_\epsilon^{(N)} \vee (\underline{x}, \underline{y}_1, \underline{y}_2) \notin \hat{A}_\epsilon^{(N)}} p(\underline{x}) \hat{p}(\underline{y}_1, \underline{y}_2 | \underline{x}) \\ &\leq \sum_{\underline{x}} \hat{p}((\hat{A}_\epsilon^{(N)}(X, Y_2))^c | \underline{x}) p(\underline{x}) + \sum_{(\underline{x}, \underline{y}_1, \underline{y}_2): (\underline{x}, \underline{y}_2) \in \hat{A}_\epsilon^{(N)} \wedge (\underline{x}, \underline{y}_1, \underline{y}_2) \notin \hat{A}_\epsilon^{(N)}} \hat{p}(\underline{y}_1 | \underline{y}_2, \underline{x}) \hat{p}(\underline{y}_2 | \underline{x}) p(\underline{x}) \\ &\leq \sum_{\underline{x}} \left( e^{-2^{N(R_0 - I(X; Y_2) - 2a_1(\epsilon_1) - \epsilon_1)}} + p((\hat{A}_\epsilon^{(N)}(X, Y_2))^c | \underline{x}) \right) p(\underline{x}) \\ &\quad + \sum_{(\underline{x}, \underline{y}_2): (\underline{x}, \underline{y}_2) \in \hat{A}_\epsilon^{(N)}} \left( e^{-2^{N(R_1 - I(X; Y_1 | Y_2) - 4a_2(\epsilon_2))}} + p((\hat{A}_\epsilon^{(N)}(X, Y_1, Y_2))^c | \underline{x}, \underline{y}_2) \right) \hat{p}(\underline{y}_2 | \underline{x}) p(\underline{x}) \\ &\leq e^{-2^{N(R_0 - I(X; Y_2) - 2a_1(\epsilon_1) - \epsilon_1)}} + 2^{-Nc_1(\epsilon_1)} + e^{-2^{N(R_1 - I(X; Y_1 | Y_2) - 4a_2(\epsilon_2))}} \\ &\quad + 2^{N(4a_1(\epsilon_1) + 3\epsilon_1)} \sum_{(\underline{x}, \underline{y}_2)} p((\hat{A}_\epsilon^{(N)}(X, Y_1, Y_2))^c | \underline{x}, \underline{y}_2) p(\underline{y}_2 | \underline{x}) p(\underline{x}) \\ &\leq e^{-2^{N(R_0 - I(X; Y_2) - 2a_1(\epsilon_1) - \epsilon_1)}} + 2^{-Nc_1(\epsilon_1)} + e^{-2^{N(R_1 - I(X; Y_1 | Y_2) - 4a_2(\epsilon_2))}} + 2^{N(c_2(\epsilon_2) - 4a_1(\epsilon_1) - 3\epsilon_1)}. \end{aligned}$$

Thus for all  $N$  sufficiently large,  $P_e^{(N)}(\nu)$  can be made to decay exponentially to zero by choosing  $\epsilon_1$  such that  $2a_1(\epsilon_1) + \epsilon_1 < R_0 - I(X; Y_2)$  and  $\epsilon_2$  such that  $4a_2(\epsilon_2) < R_1 - I(X; Y_1 | Y_2)$  and  $c_2(\epsilon_2) > 4a_1(\epsilon_1)$ .

The resulting exponent decays to zero as  $\epsilon_1$  and  $\epsilon_2$  decay to zero. ■

Lemmas 16 and 17, below, bound the conditional probability of  $(\underline{Y}_1, \underline{Y}_2)$  given  $\underline{X}$  when we emulate the broadcast channel with the random code defined in the proof of Theorem 5.

**Lemma 16** If  $(\underline{x}, \underline{y}_2) \in \hat{A}_\epsilon^{(N)}$ , then

$$\hat{p}(\underline{y}_2 | \underline{x}) \leq 2^{N(4a_1(\epsilon_1) + 2\epsilon_1 + 1/N)} p(\underline{y}_2 | \underline{x});$$

if, further,  $(\underline{x}, \underline{y}_1, \underline{y}_2) \in \hat{A}_\epsilon^{(N)}$ , then

$$\hat{p}(\underline{y}_1 | \underline{x}, \underline{y}_2) \leq 2^{N(8a_2(\epsilon_2) + 1/N)} p(\underline{y}_1 | \underline{x}, \underline{y}_2).$$

*Proof.* The first bound is precisely Lemma 13 by the definition of  $\hat{A}_\epsilon^{(N)}$ . The proof of the second bound is almost identical except in this case codewords are drawn according to  $p(\underline{y}_1 | \underline{y}_2)$ . This leads to both the extra variable in the condition and the slightly larger exponent in the bound. ■

**Lemma 17**

$$\begin{aligned} \hat{p}((X, Y_2) \notin \hat{A}_\epsilon^{(N)} | \underline{x}) &\leq e^{-2^{N(R_0 - I(X; Y_2) - 2a_2(\epsilon_2) - \epsilon_2)}} + p((\hat{A}_\epsilon^{(N)}(X, Y_2))^c | \underline{x}) \\ \hat{p}((X, Y_1, Y_2) \notin \hat{A}_\epsilon^{(N)} | \underline{x}, \underline{y}_2) &\leq e^{-2^{N(R_1 - I(X; Y_1 | Y_2) - 4a_2(\epsilon_2))}} + p((\hat{A}_\epsilon^{(N)}(X, Y_1, Y_2))^c | \underline{x}, \underline{y}_2) \end{aligned}$$

*Proof.* The given code fails to find a jointly typical reproduction  $(\underline{Y}_1, \underline{Y}_2)$  for  $\underline{X}$  if either stage of its encoder fails. The first stage fails with probability

$$\hat{p}((\hat{A}_\epsilon^{(N)}(X, Y_2))^c | \underline{x}) \leq p((\hat{A}_\epsilon^{(N)}(X, Y_2))^c | \underline{x}) + e^{-2^{N(R_0 - I(X; Y_2) - 2a_2(\epsilon_2) - \epsilon_2)}}$$

by Lemma 14. Otherwise, let  $\underline{y}_2$  be the first-stage codeword with  $(\underline{x}, \underline{y}_2) \in \hat{A}_\epsilon^{(N)}$ . If  $(\underline{x}, \underline{y}_2)$  satisfies  $p((\hat{A}_\epsilon^{(N)}(X, Y_1, Y_2))^c | \underline{x}, \underline{y}_2) > 2^{-N3\epsilon_2}$ , then  $\hat{p}((\hat{A}_\epsilon^{(N)}(X, Y_1, Y_2))^c | \underline{x}, \underline{y}_2) = p((\hat{A}_\epsilon^{(N)}(X, Y_1, Y_2))^c | \underline{x}, \underline{y}_2) = 1$  by definition of  $\hat{A}_\epsilon^{(N)}$ . Otherwise  $(\underline{x}, \underline{y}_1, \underline{y}_2) \notin \hat{A}_\epsilon^{(N)}$  implies that encoder  $\alpha_N^{(1)}$  failed to find a jointly typical codeword  $\underline{y}_1$  for  $(\underline{x}, \underline{y}_2)$ . Thus

$$\hat{p}((\hat{A}_\epsilon^{(N)}((X, Y_1, Y_2)))^c | \underline{x}, \underline{y}_2) \leq \left( \sum_{\underline{y}_1} p(\underline{y}_1 | \underline{y}_2) (1 - K(\underline{x}, \underline{y}_1, \underline{y}_2)) \right)^{2^{nR_1}}.$$

When  $K(\underline{x}, \underline{y}_1, \underline{y}_2) = 1$ , the usual bounds on the probabilities of typical strings give

$$p(\underline{y}_1 | \underline{y}_2) = p(\underline{y}_1 | \underline{x}, \underline{y}_2) \frac{p(\underline{y}_1, \underline{y}_2) p(\underline{x}, \underline{y}_2)}{p(\underline{y}_2) p(\underline{x}, \underline{y}_1, \underline{y}_2)} \geq p(\underline{y}_1 | \underline{x}, \underline{y}_2) 2^{-N(I(X; Y_1 | Y_2) + 4a_2(\epsilon_2))}.$$

Therefore, since  $(1 - ab)^n \leq 1 - a + e^{-bn}$ ,

$$\begin{aligned} \hat{p}((\hat{A}_\epsilon^{(N)}(X, Y_1, Y_2))^c | \underline{x}, \underline{y}_2) &\leq \left( 1 - 2^{-N(I(X; Y_1 | Y_2) + 4a_2(\epsilon_2))} \sum_{\underline{y}_1} p(\underline{y}_1 | \underline{x}, \underline{y}_2) K(\underline{x}, \underline{y}_1, \underline{y}_2) \right)^{2^{nR_1}} \\ &\leq 1 - \sum_{\underline{y}_1} p(\underline{y}_1 | \underline{x}, \underline{y}_2) K(\underline{x}, \underline{y}_1, \underline{y}_2) + e^{-2^{N(R_1 - I(X; Y_1 | Y_2) - 4a_2(\epsilon_2))}} \\ &= p((\hat{A}_\epsilon^{(N)}(X, Y_1, Y_2))^c | \underline{x}, \underline{y}_2) + e^{-2^{N(R_1 - I(X; Y_1 | Y_2) - 4a_2(\epsilon_2))}}. \end{aligned}$$

■

APPENDIX IV  
MULTIPLE ACCESS CHANNELS

The following definitions, used in the proof of Theorem 6, below, rely on notation defined in Appendix II.

Given any  $p(u, x_1, x_2, y) = p(u|x_1)p(x_1, x_2)p(y|x_1, x_2)$ , fix  $\epsilon = (\epsilon_1, \epsilon_2)$  with  $\epsilon_1, \epsilon_2 > 0$ . Let

$$a_1(\epsilon_1) \stackrel{\text{def}}{=} (1 + \epsilon_1) \cdot \inf \{ \epsilon' > 0 : p(f(\underline{U}, \underline{X}_1) > \epsilon' \vee f(\underline{U}) > \epsilon') \leq 2^{-N6\epsilon_1} \ \forall N \text{ suff large} \}. \quad (5)$$

$$a_2(\epsilon_2) \stackrel{\text{def}}{=} (1 + \epsilon_2) \cdot \inf \{ \epsilon' > 0 : p(f(\underline{Y}) > \epsilon' \vee f(\underline{U}, \underline{Y}) > \epsilon' \vee f(\underline{U}, \underline{X}_1, \underline{X}_2) > \epsilon' \vee f(\underline{X}_1, \underline{X}_2, \underline{Y}) > \epsilon' \vee f(\underline{U}, \underline{X}_1, \underline{X}_2, \underline{Y}) > \epsilon') \leq 2^{-N6\epsilon_2} \ \forall N \text{ suff. large} \} \quad (6)$$

The typical sets for  $p(u, x_1)$ ,  $p(u, x_1, x_2, y)$ , and  $p(x_1, x_2, y)$  are

$$\begin{aligned} A_\epsilon^{(N)}(U, X_1) &\stackrel{\text{def}}{=} \{(\underline{u}, \underline{x}_1) : f(\underline{x}_1) \leq \epsilon_1, f(\underline{u}) \leq a_1(\epsilon_1), f(\underline{u}, \underline{x}_1) \leq a_1(\epsilon_1)\} \\ A_\epsilon^{(N)}(U, X_1, X_2, Y) &\stackrel{\text{def}}{=} \{(\underline{u}, \underline{x}_1, \underline{x}_2, \underline{y}) : f(\underline{u}, \underline{x}_1, \underline{x}_2) \leq a_2(\epsilon_2), f(\underline{u}, \underline{x}_1, \underline{x}_2, \underline{y}) \leq a_2(\epsilon_2), \\ &\quad f(\underline{u}, \underline{y}) \leq a_2(\epsilon_2), f(\underline{y}) \leq a_2(\epsilon_2)\} \\ A_\epsilon^{(N)}(X_1, X_2, Y) &\stackrel{\text{def}}{=} \{(\underline{x}_1, \underline{x}_2, \underline{y}) : f(\underline{x}_1, \underline{x}_2) \leq \epsilon_2, f(\underline{y}) \leq a_2(\epsilon_2), f(\underline{x}_1, \underline{x}_2, \underline{y}) \leq a_2(\epsilon_2)\}, \end{aligned}$$

which we restrict as

$$\begin{aligned} \hat{A}_\epsilon^{(N)}(U, X_1) &\stackrel{\text{def}}{=} \{(\underline{u}, \underline{x}_1) \in A_\epsilon^{(N)} : p\left(\left((A_\epsilon^{(N)}(U, X_1)^c\right)^c \mid \underline{x}_1\right) \leq 2^{-3N\epsilon_1}\} \\ \hat{A}_\epsilon^{(N)}(U, X_1, X_2, Y) &\stackrel{\text{def}}{=} \{(\underline{u}, \underline{x}_1, \underline{x}_2, \underline{y}) \in A_\epsilon^{(N)} : p\left(\left((A_\epsilon^{(N)}(U, X_1, X_2, Y))^c\right)^c \mid (\underline{u}, \underline{x}_1, \underline{x}_2)\right) \leq 2^{-3N\epsilon_2}\} \\ \hat{A}_\epsilon^{(N)}(X_1, X_2, Y) &\stackrel{\text{def}}{=} \{(\underline{x}_1, \underline{x}_2, \underline{y}) \in A_\epsilon^{(N)} : p\left(\left((A_\epsilon^{(N)}(X_1, X_2, Y))^c\right)^c \mid (\underline{x}_1, \underline{x}_2)\right) \leq 2^{-3N\epsilon_2}\}. \end{aligned}$$

Lemma 18 bounds the probability that i.i.d. samples from  $p(u, x_1, x_2, y)$  are atypical.

**Lemma 18** *If  $(\underline{U}, \underline{X}_1, \underline{X}_2, \underline{Y})$  are drawn i.i.d.  $p(u, x_1, x_2, y)$ , then*

$$\begin{aligned} p\left(\left(\hat{A}_\epsilon^{(N)}(U, X_1)\right)^c\right) &\leq 2^{-Nc_1(\epsilon_1)} \\ p\left(\left(\hat{A}_\epsilon^{(N)}(U, X_1, X_2, Y)\right)^c \cup \left(\hat{A}_\epsilon^{(N)}(X_1, X_2, Y)\right)^c\right) &\leq 2^{-Nc_2(\epsilon_2)} \end{aligned}$$

for some  $c_1(\epsilon_1), c_2(\epsilon_2) > 0$  and all  $N$  sufficiently large. Constants  $c_1(\epsilon_1)$  and  $c_2(\epsilon_2)$  approach 0 as  $\epsilon_1$  and  $\epsilon_2$ , respectively, approach 0.

*Proof.* Like Lemma 12, the result follows Chernoff's bound and the definition of  $\hat{A}_\epsilon^{(N)}$ .

**Proof of Theorem 6:** Since  $R^{\{\{i_2\} \rightarrow \{j\}\}}$  is not bounded from below, we set it to 0. For concision, we further define  $R_1 \stackrel{\text{def}}{=} R^{\{\{i_1\} \rightarrow \{j\}\}}$  and  $R_2 \stackrel{\text{def}}{=} R^{\{\{i_1, i_2\} \rightarrow \{j\}\}}$  and use  $\mathcal{C} = (\mathcal{X}_1 \times \mathcal{X}_2, p(y|x_1, x_2), \mathcal{Y})$  in place of  $\mathcal{C} = (\mathcal{X}^{(i_1,1)} \times \mathcal{X}^{(i_2,1)}, p(y^{(j,1)}|x^{(i_1,1)}, x^{(i_2,1)}), \mathcal{Y}^{(j,1)})$  both in this proof and its supporting lemmas.

Fix  $(R_1, R_2)$  to satisfy the theorem constraints. By Theorem 4, it suffices to show that for any channel input distribution  $p(x_1, x_2)$  there exists a sequence of rate- $(R_1, R_2)$  random emulation codes  $(\alpha_N, \beta_N)$  for which the resulting emulation distribution

$$\hat{p}(y|\underline{x}_1, \underline{x}_2) \stackrel{\text{def}}{=} \Pr(\beta_N(\alpha_N(\underline{x}_1, \underline{x}_2)) = (y))$$

satisfies

$$P_e^{(N)}(\nu) = \sum_{\underline{x}, \underline{y}_1, \underline{y}_2} p(\underline{x}) \hat{p}(\underline{y}_1, \underline{y}_2|\underline{x}) \mathbb{1} \left( \frac{1}{N} \log \left( \frac{\hat{p}(\underline{y}_1, \underline{y}_2|\underline{x})}{p(\underline{y}_1, \underline{y}_2|\underline{x})} \right) > \nu \right) < 2^{-N\eta(\nu)}$$

for some positive function  $\eta(\nu)$  dependent on  $p(x)$  for which  $\eta(\nu)$  goes to zero as  $\nu$  goes to zero.

Fix any  $p(x_1, x_2)$ , and then choose  $p(u|x_1)$  to satisfy the constraints on  $R_1$  and  $R_2$ . Let

$$p(u, x_1, x_2, y) \stackrel{\text{def}}{=} p(u|x_1)p(x_1, x_2)p(y|x_1, x_2).$$

Recall that  $(\alpha_N, \beta_N)$  has encoders

$$\alpha_N = \left( \alpha_N^{(A \rightarrow B)} : (A, B) \in \mathcal{M} \right) = \left( \alpha_N^{\{\{i_1\} \rightarrow \{j\}\}}, \alpha_N^{\{\{i_2\} \rightarrow \{j\}\}}, \alpha_N^{\{\{i_1, i_2\} \rightarrow \{j\}\}} \right)$$

at rates  $R_1 = R^{\{\{i_1\} \rightarrow \{j\}\}}$ ,  $R^{\{\{i_2\} \rightarrow \{j\}\}} = 0$ , and  $R_2 = R^{\{\{i_1, i_2\} \rightarrow \{j\}\}}$  and decoder  $\beta_N = \beta_N^{(j)}$ . Rate 0 requires no encoder. We abbreviate the notation for the remaining encoders to  $\alpha_N^{(1)} = \alpha_N^{\{\{i_1\} \rightarrow \{j\}\}}$  and  $\alpha_N^{(2)} = \alpha_N^{\{\{i_1, i_2\} \rightarrow \{j\}\}}$ . The code also relies on a mapping  $\gamma_N$ . Thus the code defines a collection of mappings

$$\begin{aligned} \alpha_N^{(1)} : \underline{\mathcal{X}}_1 &\rightarrow \mathcal{W}_1 & \beta_N^{(j)} : \mathcal{W}_1 \times \mathcal{W}_2 &\rightarrow \underline{\mathcal{Y}} \\ \alpha_N^{(2)} : \underline{\mathcal{X}}_1 \times \underline{\mathcal{X}}_2 &\rightarrow \mathcal{W}_2 & \gamma_N : \mathcal{W}_1 &\rightarrow \underline{\mathcal{U}}, \end{aligned}$$

where  $\mathcal{W}_1 = \tilde{\underline{\mathcal{X}}}^{\{\{i_1\} \rightarrow \{j\}\}} = \{0, 1\}^{NR_1}$  and  $\mathcal{W}_2 = \tilde{\underline{\mathcal{X}}}^{\{\{i_1, i_2\} \rightarrow \{j\}\}} = \{0, 1\}^{NR_2}$ . Encoder  $\alpha_N^{(1)}$  operates at node  $i_1$ . Encoder  $\alpha_N^{(2)}$  is operates at node  $x^{V_1}$  using inputs  $\underline{X}_1$  and  $\underline{X}_2$  losslessly received from nodes  $i_1$  and  $i_2$ . The decoder is operated at node  $j$ .

The random code design draws  $\{\gamma_N(w_1) : w_1 \in \mathcal{W}_1\}$  i.i.d. from the distribution  $p(\underline{u})$ . For each  $w_1 \in \mathcal{W}_1$  set  $\underline{u} = \gamma_N(w_1)$  and then draw  $\{\beta_N(w_1, w_2) : w_2 \in \mathcal{W}_2\}$  i.i.d. from  $p(\underline{y}|\underline{u}) = \prod_{\ell=1}^N p_t(\underline{y}(\ell)|\underline{u}(\ell))$ . For the random encoder design, choose  $\alpha_N^{(1)}(\underline{x}_1)$  uniformly at random from the indices  $w_1$  for which

$(\gamma_N(w_1), \underline{x}_1) \in \hat{A}_\epsilon^{(N)}$ . If there is no such  $w_1$ , then set  $\alpha_N^{(1)}(\underline{x}_1)$  to 1. For each  $(\underline{x}_1, \underline{x}_2)$ , let  $w_1 = \alpha_N^{(1)}(\underline{x}_1)$  and  $\underline{u} = \gamma_N(w_1)$ , and choose  $\alpha_N^{(2)}(\underline{x}_1, \underline{x}_2)$  uniformly at random from the indices  $w_2$  for which

$$\begin{aligned} (\underline{x}_1, \underline{x}_2, \beta_N(w_1, w_2)) &\in \hat{A}_\epsilon^{(N)}(X_1, X_2, Y) \\ (\underline{u}, \underline{x}_1, \underline{x}_2, \beta_N(w_1, w_2)) &\in \hat{A}_\epsilon^{(N)}(U, X_1, X_2, Y); \end{aligned}$$

if there is no such index, then  $\alpha_N^{(2)}(\underline{x}_1, \underline{x}_2) = 0$ .

By Lemma 19, below,

$$\hat{p}(\underline{y}|\underline{x}_1, \underline{x}_2) \leq 2^{N(4a_1(\epsilon_1)+2\epsilon_1+8a_2(\epsilon_2)+2/N)} p(\underline{y}|\underline{x}_1, \underline{x}_2).$$

for all  $(\underline{x}_1, \underline{x}_2, \underline{y}) \in \hat{A}_\epsilon^{(N)}$ . By Lemma 20, below,

$$\begin{aligned} \hat{p}((\hat{A}_\epsilon^{(N)}(X_1, X_2, Y))^c|\underline{x}_1, \underline{x}_2) &\leq \delta_1 + \delta_2 + p((\hat{A}_\epsilon^{(N)}(U, X_1))^c|\underline{x}_1) \\ &\quad + 2^{N(2\epsilon_1+4a_1(\epsilon_1)+1/N)} p((\hat{A}_\epsilon^{(N)}(U, X_1, X_2, Y))^c \cup (\hat{A}_\epsilon^{(N)}(X_1, X_2, Y))^c|\underline{x}_1, \underline{x}_2), \end{aligned}$$

where  $\delta_1 \stackrel{\text{def}}{=} e^{-2^N(R_1 - I(U; X_1) - \epsilon_1 - 2a_1(\epsilon_1))}$  and  $\delta_2 \stackrel{\text{def}}{=} e^{-2^N(R_2 - I(X_1, X_2; Y|U) - 4a_2(\epsilon_2))}$ . By Lemma 18, above,

$$\begin{aligned} p\left((\hat{A}_\epsilon^{(N)}(U, X_1))^c\right) &\leq 2^{-Nc_1(\epsilon_1)} \\ p\left((\hat{A}_\epsilon^{(N)}(U, X_1, X_2, Y))^c \cup (\hat{A}_\epsilon^{(N)}(X_1, X_2, Y))^c\right) &\leq 2^{-Nc_2(\epsilon_2)} \end{aligned}$$

for some constants  $c_1(\epsilon_1), c_2(\epsilon_2) > 0$  and all  $N$  sufficiently large; constants  $c_1(\epsilon_1)$  and  $c_2(\epsilon_2)$  go to zero as  $\epsilon_1$  and  $\epsilon_2$  go to zero.

Thus when  $\nu = 4a_1(\epsilon_1) + 3\epsilon_1 + 8a_2(\epsilon_2)$  and  $N$  is sufficiently large,

$$\begin{aligned} P_e^{(N)}(\nu) &\leq \sum_{(\underline{x}_1, \underline{x}_2, \underline{y}) \notin \hat{A}_\epsilon^{(N)}} p(\underline{x}_1, \underline{x}_2) \hat{p}(\underline{y}|\underline{x}_1, \underline{x}_2) \\ &\leq \sum_{(\underline{x}_1, \underline{x}_2)} p(\underline{x}_1, \underline{x}_2) \left( \delta_1 + \delta_2 + p((\hat{A}_\epsilon^{(N)}(U, X_1))^c|\underline{x}_1) \right. \\ &\quad \left. + 2^{N(2\epsilon_1+4a_1(\epsilon_1)+1/N)} p((\hat{A}_\epsilon^{(N)}(U, X_1, X_2, Y))^c \cup (\hat{A}_\epsilon^{(N)}(X_1, X_2, Y))^c|\underline{x}_1, \underline{x}_2) \right) \\ &\leq \delta_1 + \delta_2 + 2^{-Nc_1(\epsilon_1)} + 2^{N(c_2(\epsilon_2) - 2\epsilon_1 - 4a_1(\epsilon_1) - 1/N)}. \end{aligned}$$

Thus for all  $N$  sufficiently large,  $P_e^{(N)}(\nu)$  decays exponentially to zero provided that  $\epsilon_1$  is chosen to satisfy  $2a_1(\epsilon_1) + \epsilon_1 < R_1 - I(U; X_1)$  and  $\epsilon_2$  is chosen to satisfy  $4a_2(\epsilon_2) < R_2 - I(X_1, X_2; Y|U)$  and  $c(\epsilon_2) > 2\epsilon_1 + 4a_1(\epsilon_1)$ . The resulting exponent decays to zero as  $\epsilon_1$  and  $\epsilon_2$  decay to zero.

We next derive the bound on  $|\mathcal{U}|$ . For any fixed conditional distribution  $p(x_1|u)$  on an alphabet  $\mathcal{U}$  that is arbitrarily large, we can express the optimization of  $U$  as a minimization of the Lagrangian

$I(X_1; U) + \nu I(X_1, X_2; Y|U)$  over all  $p(u)$ ,  $u \in \mathcal{U}$ , satisfying the constraints  $p(u) \geq 0$  for all  $u \in \mathcal{U}$ ,  $\sum_{u \in \mathcal{U}} p(u) = 1$ , and  $\sum_{u \in \mathcal{U}} p(u)p(x_1|u) = p(x_1)$  for all but one  $x_1 \in \mathcal{X}_1$ ,<sup>3</sup> where  $\nu > 0$  is the Lagrangian constant. The Lagrangian and the constraints are linear in  $p(u)$ , so this is a linear program. For every linear program, there exists a solution on the boundary of the constrained region. Therefore, given  $|\mathcal{U}|$  variables, there exists a minimizing distribution  $p(u)$  that satisfies  $|\mathcal{U}|$  of the given constraints with equality. We have one constraint  $\sum_{u \in \mathcal{U}} p(u) = 1$  and  $|\mathcal{X}| - 1$  constraints of form  $\sum_{u \in \mathcal{U}} p(u)p(x_1|u) = p(x_1)$ , so at least  $|\mathcal{U}| - |\mathcal{X}|$  constraints of the form  $p(u) \geq 0$  are met with equality. This implies  $p(u) > 0$  for at most  $|\mathcal{X}|$  values of  $u$ , which gives the desired bound on  $|\mathcal{U}|$ . ■

**Lemma 19** For all  $(\underline{u}, \underline{x}_1) \in \hat{A}_\epsilon^{(N)}$ ,

$$\hat{p}(\underline{u}|\underline{x}_1) \leq 2^{N(4a_1(\epsilon_1)+2\epsilon_1+1/N)} p(\underline{u}|\underline{x}_1);$$

if, further,  $(\underline{u}, \underline{x}_1, \underline{x}_2, \underline{y}) \in \hat{A}_\epsilon^{(N)}$  and  $(\underline{x}_1, \underline{x}_2, \underline{y}) \in \hat{A}_\epsilon^{(N)}$ , then

$$\hat{p}(\underline{y}|\underline{u}, \underline{x}_1, \underline{x}_2) \leq 2^{N(8a_2(\epsilon_2)+1/N)} p(\underline{y}|\underline{u}, \underline{x}_1, \underline{x}_2).$$

Thus, for all  $(\underline{x}_1, \underline{x}_2, \underline{y}) \in \hat{A}_\epsilon^{(N)}$ ,

$$\hat{p}(\underline{y}|\underline{x}_1, \underline{x}_2) \leq 2^{N(4a_1(\epsilon_1)+2\epsilon_1+8a_2(\epsilon_2)+2/N)} p(\underline{y}|\underline{x}_1, \underline{x}_2).$$

*Proof.* The first bound follows immediately from Lemma 13. For the second bound, recall that the second encoder observes both  $\underline{x}_1$  and  $\underline{x}_2$  and looks for a match among codewords drawn according to  $p(\underline{y}|\underline{u})$ . The second bound follows an argument similar to the first, just accounting for these minor differences. Note that  $\hat{p}(\underline{u}|\underline{x}_1) = \hat{p}(\underline{u}|\underline{x}_1, \underline{x}_2)$  for the given code design. Likewise  $p(\underline{u}|\underline{x}_1) = p(\underline{u}|\underline{x}_1, \underline{x}_2)$  since  $U \rightarrow X_1 \rightarrow X_2$  forms a Markov chain. Note further that each encoder chooses an index 0 if it fails to find a matching codeword, and there is no codeword defined for this index; this choice guarantees that source code's  $(\underline{x}_1, \underline{x}_2)$  and output  $\underline{y}_1$  are jointly typical only if both encoders succeed in finding jointly typical codewords – that is, if the conditions of the first two inequalities are met. Therefore

$$\begin{aligned} \hat{p}(\underline{y}|\underline{x}_1, \underline{x}_2) &= \sum_{\underline{u}} \hat{p}(\underline{y}|\underline{u}, \underline{x}_1, \underline{x}_2) \hat{p}(\underline{u}|\underline{x}_1) \\ &\leq \sum_{\underline{u}} p(\underline{u}, \underline{y}|\underline{x}_1, \underline{x}_2) 2^{N(4a_1(\epsilon_1)+2\epsilon_1+8a_2(\epsilon_2)+2/N)}. \end{aligned}$$

■

<sup>3</sup>If  $\sum_{u \in \mathcal{U}} p(u) = 1$ ,  $\sum_{u \in \mathcal{U}} p(u)p(x_1|u) = p(x_1)$  for all but one  $x_1 \in \mathcal{X}_1$ , then  $\sum_{u \in \mathcal{U}} p(u)p(x_1|u) = p(x_1)$  for the remaining  $x_1 \in \mathcal{X}_1$  as well.

**Lemma 20** For all  $(\underline{x}_1, \underline{x}_2) \in \mathcal{X}_1 \times \mathcal{X}_2$ ,

$$\begin{aligned} \hat{p}((\hat{A}_\epsilon^{(N)}(X_1, X_2, Y))^c | \underline{x}_1, \underline{x}_2) &\leq \delta_1 + \delta_2 + p((\hat{A}_\epsilon^{(N)}(U, X_1))^c | \underline{x}_1) \\ &\quad + 2^{N(2\epsilon_1 + 4a_1(\epsilon_1) + 1/N)} p((\hat{A}_\epsilon^{(N)}(U, X_1, X_2, Y))^c \cup (\hat{A}_\epsilon^{(N)}(X_1, X_2, Y))^c | \underline{x}_1, \underline{x}_2), \end{aligned}$$

where  $\delta_1 \stackrel{\text{def}}{=} e^{-2N(R_1 - I(U; X_1) - \epsilon_1 - 2a_1(\epsilon_1))}$  and  $\delta_2 \stackrel{\text{def}}{=} e^{-2N(R_2 - I(X_1, X_2; Y|U) - 4a_2(\epsilon_2))}$ .

*Proof.* If  $p((A_\epsilon^{(N)}(X_1, X_2, Y))^c | (\underline{x}_1, \underline{x}_2)) > 2^{-3N\epsilon_2}$ , then  $\hat{p}((\hat{A}_\epsilon^{(N)})^c | \underline{x}_1, \underline{x}_2) = p((\hat{A}_\epsilon^{(N)})^c | \underline{x}_1, \underline{x}_2) = 1$  by the definition of  $\hat{A}_\epsilon^{(N)}(X_1, X_2, Y)$  and the bound is satisfied. Otherwise,  $(\underline{x}_1, \underline{x}_2, \underline{Y}) \notin \hat{A}_\epsilon^{(N)}$  implies that one or both of the encoders  $\alpha_N^{(1)}$  and  $\alpha_N^{(2)}$  failed to find a matching codeword for  $(\underline{x}_1, \underline{x}_2)$ . Encoder  $\alpha_N^{(1)}$  fails if there is no jointly typical codeword for  $\underline{x}_1$  in codebook  $\{\gamma_N(1), \dots, \gamma_N(2^{NR_1})\}$ . Otherwise, let  $w_1 = \alpha_N^{(1)}(\underline{x}_1)$  and  $\underline{u} = \gamma_N(w_1)$ . Then encoder  $\alpha_N^{(2)}$  fails if no codeword in  $\{\beta_N(w_1, 1), \dots, \beta_N(w_1, 2^{NR_1})\}$  is jointly typical with  $(\underline{u}, \underline{x}_1, \underline{x}_2)$ . Therefore

$$\begin{aligned} &p\left((\underline{X}_1, \underline{X}_2, \underline{Y}) \notin \hat{A}_\epsilon^{(N)} | (\underline{X}_1, \underline{X}_2) = (\underline{x}_1, \underline{x}_2)\right) \\ &\leq \left(\sum_{\underline{u}} p(\underline{u})(1 - K(\underline{u}, \underline{x}_1))\right)^{2^{NR_1}} + \sum_{\underline{u}: K(\underline{u}, \underline{x}_1)=1} \hat{p}(\underline{u} | \underline{x}_1) \left(\sum_{\underline{y}} p(\underline{y} | \underline{u})(1 - K(\underline{u}, \underline{x}_1, \underline{x}_2, \underline{y}))\right)^{2^{NR_2}}. \end{aligned}$$

By the usual probability bounds for elements of the typical set,

$$\begin{aligned} p(\underline{u}) &\geq p(\underline{u} | \underline{x}_1) 2^{-N(I(U; X_1) + \epsilon_1 + 2a_1(\epsilon_1))} && \text{when } K(\underline{u}, \underline{x}_1) = 1 \\ p(\underline{y} | \underline{u}) &\geq p(\underline{y} | \underline{u}, \underline{x}_1, \underline{x}_2) 2^{-N(I(X_1, X_2; Y|U) + 4a_2(\epsilon_2))} && \text{when } K(\underline{u}, \underline{x}_1, \underline{x}_2, \underline{y}) = 1. \end{aligned}$$

Applying these bounds, the bound  $(1 - ab)^n \leq 1 - a + e^{-bn}$ , and Lemma 19 gives

$$\begin{aligned} &p\left((\underline{X}_1, \underline{X}_2, \underline{Y}) \notin \hat{A}_\epsilon^{(N)} | (\underline{X}_1, \underline{X}_2) = (\underline{x}_1, \underline{x}_2)\right) \\ &\leq 1 - \sum_{\underline{u}} p(\underline{u} | \underline{x}_1) K(\underline{u}, \underline{x}_1) + e^{-2N(R_1 - I(U; X_1) - \epsilon_1 - 2a_1(\epsilon_1))} + \sum_{\underline{u}} K(\underline{u}, \underline{x}_1) \hat{p}(\underline{u} | \underline{x}_1) \\ &\quad \cdot \left(1 - \sum_{\underline{y}} K(\underline{u}, \underline{x}_1, \underline{x}_2, \underline{y}) K(\underline{x}_1, \underline{x}_2, \underline{u}, \underline{y}) p(\underline{y} | \underline{u}, \underline{x}_1, \underline{x}_2) + e^{-2N(R_2 - I(X_1, X_2; Y|U) - 4a_2(\epsilon_2))}\right) \\ &\leq p((\hat{A}_\epsilon^{(N)}(U, X_1))^c | \underline{x}_1) + e^{-2N(R_1 - I(U; X_1) - \epsilon_1 - 2a_1(\epsilon_1))} + e^{-2N(R_2 - I(X_1, X_2; Y|U) - 4a_2(\epsilon_2))} \\ &\quad + 2^{N(2\epsilon_1 + 4a_1(\epsilon_1) + 1/N)} p((\hat{A}_\epsilon^{(N)}(U, X_1, X_2, Y))^c | \underline{x}_1, \underline{x}_2). \end{aligned}$$

■

## APPENDIX V

### INTERFERENCE CHANNELS: MODEL 1

The following definitions, used in the proof of Theorem 7, below, rely on notation defined in Appendix II.

Given any distribution  $p(u_1, u_2, x_1, x_2, y_1, y_2) = p(u_2|x_1)p(u_1|u_2, x_1)p(x_1, x_2)p(y_1, y_2|x_1, x_2)$ , fix  $\epsilon = (\epsilon_1, \epsilon_2, \epsilon_3, \epsilon_4)$  with  $\epsilon_1, \epsilon_2, \epsilon_3, \epsilon_4 > 0$ . Define

$$\begin{aligned}
a_1(\epsilon_1) &\stackrel{\text{def}}{=} (1 + \epsilon_1) \cdot \inf \left\{ \epsilon' > 0 : p(f(\underline{U}_2) > \epsilon' \vee f(\underline{U}_2, \underline{X}_1) > \epsilon') \leq 2^{-N6\epsilon_1} \forall N \text{ suff. large} \right\} \\
a_2(\epsilon_2) &\stackrel{\text{def}}{=} (1 + \epsilon_2) \cdot \inf \left\{ \epsilon' > 0 : p(f(\underline{U}_1, \underline{U}_2) > \epsilon' \vee f(\underline{U}_1, \underline{U}_2, \underline{X}_1) > \epsilon') \leq 2^{-N6\epsilon_2} \forall N \text{ suff. large} \right\} \\
a_3(\epsilon_3) &\stackrel{\text{def}}{=} (1 + \epsilon_3(t)) \cdot \inf \left\{ \epsilon' > 0 : \Pr(f(\underline{U}_2) > \epsilon' \vee f(\underline{U}_2, \underline{Y}_2) > \epsilon' \vee f(\underline{U}_2, \underline{X}_1, \underline{X}_2) > \epsilon' \vee \right. \\
&\quad \left. f(\underline{U}_2, \underline{X}_1, \underline{X}_2, \underline{Y}_2) > \epsilon') \leq 2^{-N6\epsilon_3(t)} \forall N \text{ suff. large} \right\} \\
a_4(\epsilon_4) &\stackrel{\text{def}}{=} (1 + \epsilon_4(t)) \cdot \inf \left\{ \epsilon' > 0 : \Pr(f(\underline{U}_1, \underline{U}_2, \underline{Y}_2) > \epsilon' \vee f(\underline{U}_1, \underline{U}_2, \underline{Y}_1, \underline{Y}_2) > \epsilon' \vee \right. \\
&\quad \left. f(\underline{U}_1, \underline{U}_2, \underline{X}_1, \underline{X}_2, \underline{Y}_2) > \epsilon' \vee f(\underline{U}_1, \underline{U}_2, \underline{X}_1, \underline{X}_2, \underline{Y}_1, \underline{Y}_2) > \epsilon' \vee f(\underline{Y}_1, \underline{Y}_2) > \epsilon' \vee \right. \\
&\quad \left. f(\underline{X}_1, \underline{X}_2, \underline{Y}_1, \underline{Y}_2) > \epsilon') \leq 2^{-N6\epsilon_4(t)} \forall N \text{ suff. large} \right\}.
\end{aligned}$$

The corresponding typical sets are

$$\begin{aligned}
A_\epsilon^{(N)}(U_2, X_1) &\stackrel{\text{def}}{=} \{(\underline{u}_2, \underline{x}_1) : f(\underline{x}_1) \leq \epsilon_1, f(\underline{u}_2), f(\underline{u}_2, \underline{x}_1) \leq a_1(\epsilon_1)\} \\
A_\epsilon^{(N)}(U_1, U_2, X_1) &\stackrel{\text{def}}{=} \{(\underline{u}_1, \underline{u}_2, \underline{x}_1) : f(\underline{u}_2), f(\underline{u}_1, \underline{u}_2), f(\underline{x}_1, \underline{u}_2), f(\underline{u}_1, \underline{u}_2, \underline{x}_1) \leq a_2(\epsilon_2)\} \\
A_\epsilon^{(N)}(U_2, X_1, X_2, Y_2) &\stackrel{\text{def}}{=} \left\{ (\underline{u}_2, \underline{x}_1, \underline{x}_2, \underline{y}_2) : f(\underline{u}_2), f(\underline{u}_2, \underline{y}_2), f(\underline{u}_2, \underline{x}_1, \underline{x}_2), \right. \\
&\quad \left. f(\underline{u}_2, \underline{x}_1, \underline{x}_2, \underline{y}_2) \leq a_3(\epsilon_3) \right\} \\
A_\epsilon^{(N)}(U_1, U_2, X_1, X_2, Y_1, Y_2) &\stackrel{\text{def}}{=} \left\{ (\underline{u}_1, \underline{u}_2, \underline{x}_1, \underline{x}_2, \underline{y}_1, \underline{y}_2) : f(\underline{u}_1, \underline{u}_2, \underline{y}_2), f(\underline{u}_1, \underline{u}_2, \underline{y}_1, \underline{y}_2), \right. \\
&\quad \left. f(\underline{u}_1, \underline{u}_2, \underline{x}_1, \underline{x}_2, \underline{y}_2), f(\underline{u}_1, \underline{u}_2, \underline{x}_1, \underline{x}_2, \underline{y}_1, \underline{y}_2) \leq a_4(\epsilon_4) \right\} \\
A_\epsilon^{(N)}(X_1, X_2, Y_1, Y_2) &\stackrel{\text{def}}{=} \left\{ (\underline{x}_1, \underline{x}_2, \underline{y}_1, \underline{y}_2) : f(\underline{x}_1, \underline{x}_2) \leq \epsilon_4(t), \right. \\
&\quad \left. f(\underline{y}_1, \underline{y}_2), f(\underline{x}_1, \underline{x}_2, \underline{y}_1, \underline{y}_2) \leq a_4(\epsilon_4) \right\},
\end{aligned}$$

which we restrict as

$$\begin{aligned}
\hat{A}_\epsilon^{(N)}(U_2, X_1) &\stackrel{\text{def}}{=} \left\{ (\underline{u}_2, \underline{x}_1) \in A_\epsilon^{(N)} : \Pr \left( (A_\epsilon^{(N)}(U_2, X_1))^c | \underline{x}_1 \right) \leq 2^{-3N\epsilon_1} \right\} \\
\hat{A}_\epsilon^{(N)}(U_1, U_2, X_1) &\stackrel{\text{def}}{=} \left\{ (\underline{u}_1, \underline{u}_2, \underline{x}_1) \in A_\epsilon^{(N)} : \Pr \left( (A_\epsilon^{(N)}(U_1, U_2, X_1))^c | \underline{u}_2, \underline{x}_1 \right) \leq 2^{-3N\epsilon_2} \right\} \\
\hat{A}_\epsilon^{(N)}(U_2, X_1, X_2, Y_2) &\stackrel{\text{def}}{=} \left\{ (\underline{u}_2, \underline{x}_1, \underline{x}_2, \underline{y}_2) \in A_\epsilon^{(N)} : \Pr \left( (A_\epsilon^{(N)})^c | \underline{u}_2, \underline{x}_1, \underline{x}_2 \right) \leq 2^{-3N\epsilon_3(t)} \right\} \\
\hat{A}_\epsilon^{(N)}(U_1, U_2, X_1, X_2, Y_1, Y_2) &\stackrel{\text{def}}{=} \left\{ (\underline{u}_1, \underline{u}_2, \underline{x}_1, \underline{x}_2, \underline{y}_1, \underline{y}_2) \in A_\epsilon^{(N)} : \Pr \left( (A_\epsilon^{(N)})^c | \underline{u}_1, \underline{u}_2, \underline{x}_1, \underline{x}_2, \underline{y}_2 \right) \right. \\
&\quad \left. \leq 2^{-3N\epsilon_4(t)} \right\} \\
\hat{A}_\epsilon^{(N)}(X_1, X_2, Y_1, Y_2) &\stackrel{\text{def}}{=} \left\{ (\underline{x}_1, \underline{x}_2, \underline{y}_1, \underline{y}_2) \in A_\epsilon^{(N)} : \Pr \left( (A_\epsilon^{(N)})^c | \underline{x}_1, \underline{x}_2 \right) \leq 2^{-3N\epsilon_4(t)} \right\}.
\end{aligned}$$



**Lemma 21** If  $(\underline{U}_1, \underline{U}_2, \underline{X}_1, \underline{X}_2, \underline{Y}_1, \underline{Y}_2)$  are drawn i.i.d.  $p(u_1, u_2, x_1, x_2, y_1, y_2)$ , then there exist positive constants  $c_1(\epsilon_1)$ ,  $c_2(\epsilon_2)$ ,  $c_3(\epsilon_3)$ , and  $c_4(\epsilon_4)$  for which

$$\begin{aligned} \Pr\left(\left(\hat{A}_\epsilon^{(N)}(U_2, X_1)\right)^c\right) &\leq 2^{-Nc_1(\epsilon_1)} \\ \Pr\left(\left(\hat{A}_\epsilon^{(N)}(U_1, U_2, X_1)\right)^c\right) &\leq 2^{-Nc_2(\epsilon_2)} \\ \Pr\left(\left(\hat{A}_\epsilon^{(N)}(U_2, X_1, X_2, Y_2)\right)^c\right) &\leq 2^{-Nc_3(\epsilon_3)} \\ \Pr\left(\left(\hat{A}_\epsilon^{(N)}(U_1, U_2, X_1, X_2, Y_1, Y_2)\right)^c \cup \left(\hat{A}_\epsilon^{(N)}(X_1, X_2, Y_1, Y_2)\right)^c\right) &\leq 2^{-Nc_4(\epsilon_4)} \end{aligned}$$

for all  $N$  sufficiently large. Constant  $c_k(\epsilon, t)$  approaches 0 as  $\epsilon_k(t)$  decays to 0.

*Proof.* Like Lemma 12, the result follows from Chernoff's bound and the definition of  $\hat{A}_\epsilon^{(N)}$ . ■

**Proof of Theorem 7:** We set the rates  $R^{\{\{i_1\} \rightarrow \{j_2\}\}}$ ,  $R^{\{\{i_2\} \rightarrow \{j_1\}\}}$ ,  $R^{\{\{i_2\} \rightarrow \{j_2\}\}}$ ,  $R^{\{\{i_2\} \rightarrow \{j_1, j_2\}\}}$ , and  $R^{\{\{i_1, i_2\} \rightarrow \{j_2\}\}}$  for which no bounds are given to zero, simplify remaining notation as  $R_{11} \stackrel{\text{def}}{=} R^{\{\{i_1\} \rightarrow \{j_1\}\}}$ ,  $R_{12} \stackrel{\text{def}}{=} R^{\{\{i_1\} \rightarrow \{j_1, j_2\}\}}$ ,  $R_{21} \stackrel{\text{def}}{=} R^{\{\{i_1, i_2\} \rightarrow \{j_1\}\}}$ , and  $R_{22} \stackrel{\text{def}}{=} R^{\{\{i_1, i_2\} \rightarrow \{j_1, j_2\}\}}$  and use  $\mathcal{C} = (\mathcal{X}_1 \times \mathcal{X}_2, p(y_1, y_2 | x_1, x_2), \mathcal{Y}_1 \times \mathcal{Y}_2)$  instead of  $(\mathcal{X}^{(i_1,1)} \times \mathcal{X}^{(i_2,1)}, p(y^{(j_1,1)}, y^{(j_2,1)} | x^{(i_1,1)}, x^{(i_2,1)}), \mathcal{Y}^{(j_1,1)} \times \mathcal{Y}^{(j_2,2)})$  in this proof and its supporting lemmas.

Fix  $(R_{11}, R_{12}, R_{21}, R_{22})$  to satisfy the theorem constraints. Let  $p(x_1, x_2)$  be arbitrary, and choose  $p(u_2 | x_1)$  and  $p(u_1 | x_1, u_2)$  to satisfy the given bounds. Let

$$p(u_1, u_2, x_1, x_2, y_1, y_2) \stackrel{\text{def}}{=} p(u_2 | x_1) p(u_1 | x_1, u_2) p(x_1, x_2) p(y_1, y_2 | x_1, x_2).$$

We define corresponding (restricted) typical sets in Appendix V.

Excluding the rate-0 codes, four encoders and two decoders are required. We simplify their notation as

$$\begin{aligned} \alpha_N^{(11)} &= \alpha_N^{\{\{i_1\} \rightarrow \{j_1\}\}} & \alpha_N^{(21)} &= \alpha_N^{\{\{i_1, i_2\} \rightarrow \{j_1\}\}} & \beta_N^{(1)} &= \beta_N^{(j_1)} \\ \alpha_N^{(12)} &= \alpha_N^{\{\{i_1\} \rightarrow \{j_1, j_2\}\}} & \alpha_N^{(22)} &= \alpha_N^{\{\{i_1, i_2\} \rightarrow \{j_1, j_2\}\}} & \beta_N^{(2)} &= \beta_N^{(j_2)}, \end{aligned}$$

where

$$\begin{aligned} \alpha_N^{(11)} : \underline{\mathcal{X}}_1 &\rightarrow \mathcal{W}_{11} & \alpha_N^{(21)} : \underline{\mathcal{X}}_1 \times \underline{\mathcal{X}}_2 &\rightarrow \mathcal{W}_{21} & \beta_N^{(1)} : \mathcal{W}_{11} \times \mathcal{W}_{12} \times \mathcal{W}_{21} \times \mathcal{W}_{22} &\rightarrow \underline{\mathcal{Y}}_1 \\ \alpha_N^{(12)} : \underline{\mathcal{X}}_1 &\rightarrow \mathcal{W}_{12} & \alpha_N^{(22)} : \underline{\mathcal{X}}_1 \times \underline{\mathcal{X}}_2 &\rightarrow \mathcal{W}_{22} & \beta_N^{(2)} : \mathcal{W}_{12} \times \mathcal{W}_{22} &\rightarrow \underline{\mathcal{Y}}_2 \end{aligned}$$

and

$$\begin{aligned} \mathcal{W}_{11} &= \underline{\mathcal{X}}^{\{\{i_1\} \rightarrow \{j_1\}\}} = \{0, 1\}^{NR_{11}} & \mathcal{W}_{12} &= \underline{\mathcal{X}}^{\{\{i_1\} \rightarrow \{j_1, j_2\}\}} = \{0, 1\}^{NR_{12}} \\ \mathcal{W}_{21} &= \underline{\mathcal{X}}^{\{\{i_1, i_2\} \rightarrow \{j_1\}\}} = \{0, 1\}^{NR_{21}} & \mathcal{W}_{22} &= \underline{\mathcal{X}}^{\{\{i_1, i_2\} \rightarrow \{j_1, j_2\}\}} = \{0, 1\}^{NR_{22}} \end{aligned}$$

Encoder  $(\alpha_N^{(11)}, \alpha_N^{(12)})$  operates at node  $i_1$ , transmitting its rate  $R_{11}$  and  $R_{12}$  descriptions to node  $j_1$  and both nodes, respectively. Encoder  $(\alpha_N^{(21)}, \alpha_N^{(22)})$  operates at node  $v^V$ , receiving noiseless descriptions of

$\underline{x}_1$  and  $\underline{x}_2$  from nodes  $i_1$  and  $i_2$  and transmitting its rate  $R_{21}$  output to node  $j_1$  and its  $R_{22}$  to both nodes. The code also employs mappings  $\gamma_N^{(1)} : \mathcal{W}_{11} \times \mathcal{W}_{12} \rightarrow \mathcal{U}_1$  and  $\gamma_N^{(2)} : \mathcal{W}_{12} \rightarrow \mathcal{U}_2$

The random code design draws codewords  $\{\gamma_N^{(2)}(w_{12}) : w_{12} \in \mathcal{W}_{12}\}$  i.i.d. from distribution  $\prod_{\ell=1}^N p(\underline{u}_2(\ell))$ . For each  $w_{12} \in \hat{\mathcal{Y}}_{12}$ , let  $\underline{U}_2 = \gamma_N^{(2)}(w_{12})$  and draw codewords  $\{\gamma_N^{(1)}(w_{11}, w_{12}) : w_{11} \in \mathcal{W}_{11}\}$  i.i.d. from  $\prod_{\ell=1}^N p(\underline{u}_1(\ell)|\underline{U}_2(\ell))$  and codewords  $\{\beta_N^{(2)}(w_{12}, w_{22}) : w_{22} \in \mathcal{W}_{22}\}$  i.i.d. from  $\prod_{\ell=1}^N p(\underline{y}_2(\ell)|\underline{U}_2(\ell))$ . Finally, for each  $(w_{11}, w_{12}, w_{22}) \in \hat{\mathcal{Y}}_{11} \times \hat{\mathcal{Y}}_{12} \times \hat{\mathcal{Y}}_{22}$ , let

$$(\underline{U}_1, \underline{U}_2, \underline{Y}_2) = (\gamma_N^{(1)}(w_{11}, w_{12}), \gamma_N^{(2)}(w_{12}), \beta_N^{(2)}(w_{12}, w_{22})),$$

and draw  $\{\beta_N^{(1)}(w_{11}, w_{12}, w_{21}, w_{22}) : w_{21} \in \mathcal{W}_{21}\}$  i.i.d. from  $\prod_{\ell=1}^N p(\underline{y}_1(\ell)|\underline{U}_1(\ell), \underline{U}_2(\ell), \underline{Y}_2(\ell))$ . For the encoder design, choose  $\alpha_N^{(12)}(\underline{x}_1)$  uniformly at random from those  $w_{12} \in \hat{\mathcal{X}}_{12}$  for which  $(\gamma^{(2)}(w_{12}), \underline{x}_1) \in \hat{A}_\epsilon^{(N)}$ ; if there is no such  $w_{12}$ , then set  $\alpha_N^{(12)}(\underline{x}_1)$  to 0. Let  $w_{12}$  be the chosen index and  $\underline{U}_2 = \gamma_N^{(2)}(w_{12})$ . Choose  $\alpha_N^{(11)}(\underline{x}_1)$  uniformly at random from the set of  $w_{11} \in \hat{\mathcal{X}}_{11}$  for which  $(\gamma^{(1)}(w_{11}, w_{12}), \underline{U}_2, \underline{x}_1) \in \hat{A}_\epsilon^{(N)}$ ; if there is no such  $w_{11}$ , then set  $\alpha_N^{(11)}(\underline{x}_1)$  to 0. Let  $w_{11}$  be the chosen index and  $\underline{U}_1 = \gamma_N^{(1)}(w_{11}, w_{12})$ . Then choose  $\alpha_N^{(22)}(\underline{x}_1, \underline{x}_2)$  uniformly at random from the set of  $w_{22} \in \hat{\mathcal{X}}_{22}$  for which  $(\underline{U}_2, \underline{x}_1, \underline{x}_2, \beta_N^{(2)}(w_{12}, w_{22})) \in \hat{A}_\epsilon^{(N)}$ ; if this set is empty, set  $\alpha_N^{(22)}(\underline{x}_1, \underline{x}_2) = 0$ . Then let  $w_{22}$  be the chosen index and  $\underline{Y}_2 = \beta_N^{(2)}(w_{12}, w_{22})$ , and choose  $\alpha_N^{(21)}(\underline{x}_1, \underline{x}_2)$  uniformly at random from the set of  $w_{21} \in \hat{\mathcal{X}}_{21}$  for which

$$(\underline{U}_1, \underline{U}_2, \underline{x}_1, \underline{x}_2, \beta^{(1)}(w_{11}, w_{12}, w_{21}, w_{22}), \underline{Y}_2) \in \hat{A}_\epsilon^{(N)};$$

if this set is empty, set  $\alpha_N^{(21)}(\underline{x}_1, \underline{x}_2)$  to 0.

By Lemma 22, below,

$$\hat{p}(\underline{y}_1, \underline{y}_2 | \underline{x}_1, \underline{x}_2) \leq 2^{N(2\sum_{k=1}^4 b_k(\epsilon_k) + 4/N)} \quad \forall (\underline{x}_1, \underline{x}_2, \underline{y}_1, \underline{y}_2) \in \hat{A}_\epsilon^{(N)},$$

where  $b_1(\epsilon_1) = \epsilon_1 + 2a_1(\epsilon_1)$ , and  $b_k(\epsilon_k) = 4a_k(\epsilon_k)$  for  $k \in \{2, 3, 4\}$ . By Lemma 23, below,

$$\begin{aligned} & \hat{p}((\hat{A}_\epsilon^{(N)}(X_1, X_2, Y_1, Y_2))^c | \underline{x}_1, \underline{x}_2) \\ & \leq \delta_{11} + \delta_{12} + \delta_{21} + \delta_{22} + p((\hat{A}_\epsilon^{(N)}(U_2, X_1))^c | \underline{x}_1) + 2^{N(2b_1(\epsilon_1) + 1/N)} p((\hat{A}_\epsilon^{(N)}(U_1, U_2, X_1))^c | \underline{x}_1) \\ & \quad + 2^{N(2\sum_{k=1}^2 b_k(\epsilon_k) + 2/N)} p((\hat{A}_\epsilon^{(N)}(U_2, X_1, X_2, Y_2))^c) \\ & \quad + 2^{N(2\sum_{k=1}^3 b_k(\epsilon_k) + 3/N)} p((\hat{A}_\epsilon^{(N)}(U_1, U_2, X_1, X_2, Y_1, Y_2))^c \cup \hat{A}_\epsilon^{(N)}(X_1, X_2, Y_1, Y_2))^c, \end{aligned}$$

where

$$\begin{aligned} \delta_{11} &= e^{-2N(R_{11} - I(X_1; U_1 | U_2) - b_2(\epsilon_2))} & \delta_{21} &= e^{-2N(R_{21} - I(X_1, X_2; Y_1 | U_1, U_2, Y_2) - b_4(\epsilon_4))} \\ \delta_{12} &= e^{-2N(R_{12} - I(X_1; U_2) - b_1(\epsilon_1))} & \delta_{22} &= e^{-2N(R_{22} - I(X_1, X_2; Y_2 | U_2) - b_3(\epsilon_3))}. \end{aligned}$$

By Lemma 21, above,

$$\begin{aligned}
p\left(\left(\hat{A}_\epsilon^{(N)}(U_2, X_1)\right)^c\right) &\leq 2^{-Nc_1(\epsilon_1)} \\
p\left(\left(\hat{A}_\epsilon^{(N)}(U_1, U_2, X_1)\right)^c\right) &\leq 2^{-Nc_2(\epsilon_2)} \\
p\left(\left(\hat{A}_\epsilon^{(N)}(U_2, X_1, X_2, Y_2)\right)^c\right) &\leq 2^{-Nc_3(\epsilon_3)} \\
p\left(\left(\hat{A}_\epsilon^{(N)}(U_1, U_2, X_1, X_2, Y_1, Y_2)\right)^c \cup \left(\hat{A}_\epsilon^{(N)}(X_1, X_2, Y_1, Y_2)\right)^c\right) &\leq 2^{-Nc_4(\epsilon_4)}
\end{aligned}$$

for all  $N$  sufficiently large, where each  $c_k(\epsilon_k)$  approaches 0 as  $\epsilon_k$  approaches 0. So, if  $\nu = 3 \sum_{k=1}^4 b_k(\epsilon_k)$ ,

$$\begin{aligned}
P_e^{(N)}(\nu) &\leq \delta_{11} + \delta_{12} + \delta_{21} + \delta_{22} + 2^{-Nc_1(\epsilon_1)} + 2^{-N(c_2(\epsilon_2)-2b_1(\epsilon_1)-1/N)} \\
&\quad + 2^{-N(c_3(\epsilon_3)-2\sum_{k=1}^2 b_k(\epsilon_k)-2/N)} + 2^{-N(c_4(\epsilon_4)-2\sum_{k=1}^3 b_k(\epsilon_k)-3/N)}
\end{aligned}$$

for  $N$  sufficiently large. Thus sequentially choosing  $\epsilon_4, \epsilon_3, \epsilon_2$ , and  $\epsilon_1$  to satisfy

$$\begin{aligned}
b_4(\epsilon_4) &< R_{21} - I(X_1, X_2; Y_1|U_1, U_2, Y_2) \\
b_3(\epsilon_3) &< \min\{R_{22} - I(X_1, X_2; Y_2|U_2), c_4(\epsilon_4)/6\} \\
b_2(\epsilon_2) &< \min\{R_{11} - I(X_1; U_1|U_2), c_4(\epsilon_4)/6, c_3(\epsilon_3)/4\} \\
b_1(\epsilon_1) &< \min\{R_{12} - I(X_1; U_2), c_4(\epsilon_4)/6, c_3(\epsilon_3)/4, c_2(\epsilon_2)/2\}
\end{aligned}$$

yields an error probability  $P_e^{(N)}(\nu)$  that decays exponentially to zero. The exponent approaches 0 as  $\epsilon_1, \epsilon_2, \epsilon_3$ , and  $\epsilon_4$  approach 0, which gives the desired result by Theorem 4. ■

Lemmas 22 and 23 bound the emulation distribution and the conditional probability of observing atypical strings using the code defined in the proof of Theorem 7.

**Lemma 22** For all  $(\underline{u}_2, \underline{x}_1) \in \hat{A}_\epsilon^{(N)}$ ,

$$\hat{p}(\underline{u}_2|\underline{x}_1) \leq 2^{N(4a_1(\epsilon_1)+2\epsilon_1+1/N)} p(\underline{u}_1|\underline{x}_1);$$

if, in addition,  $(\underline{u}_1, \underline{u}_2, \underline{x}_1) \in \hat{A}_\epsilon^{(N)}$ , then

$$\hat{p}(\underline{u}_1|\underline{u}_2, \underline{x}_1) \leq 2^{N(8a_2(\epsilon_2)+1/N)} p(\underline{u}_1|\underline{u}_2, \underline{x}_1).$$

if, further,  $(\underline{u}_2, \underline{x}_1, \underline{x}_2, \underline{y}_2) \in \hat{A}_\epsilon^{(N)}$ , then

$$\hat{p}(\underline{y}_2|\underline{u}_2, \underline{x}_1, \underline{x}_2) \leq 2^{N(8a_3(\epsilon_3)+1/N)} p(\underline{y}_2|\underline{u}_2, \underline{x}_1, \underline{x}_2).$$

if, also,  $(\underline{u}_1, \underline{u}_2, \underline{x}_1, \underline{x}_2, \underline{y}_1, \underline{y}_2) \in \hat{A}_\epsilon^{(N)}$  and  $(\underline{x}_1, \underline{x}_2, \underline{y}_1, \underline{y}_2) \in \hat{A}_\epsilon^{(N)}$ , then

$$\hat{p}(\underline{y}_1|\underline{u}_1, \underline{u}_2, \underline{x}_1, \underline{x}_2, \underline{y}_2) \leq 2^{N(8a_4(\epsilon_4)+1/N)} p(\underline{y}_1|\underline{u}_1, \underline{u}_2, \underline{x}_1, \underline{x}_2, \underline{y}_2).$$

For all  $(\underline{x}_1, \underline{x}_2, \underline{y}_1, \underline{y}_2) \in \hat{A}_\epsilon^{(N)}$ ,

$$\hat{p}(\underline{y}_1, \underline{y}_2 | \underline{x}_1, \underline{x}_2) \leq 2^{N(4a_1(\epsilon_1) + 2\epsilon_1 + \sum_{k=2}^4 8a_k(\epsilon, t) + 4/N)} p(\underline{y}_1, \underline{y}_2 | \underline{x}_1, \underline{x}_2).$$

*Proof.* Applying Lemma 13 as in Lemmas 16 and 19 gives the first four bounds. We then apply the Markov structure imposed on  $\hat{p}(\cdot)$  by the code design and the Markovity of the underlying distribution

$$p(u_1, u_2, x_1, x_2, y_1, y_2) = p(x_1, x_2) p(u_1, u_2 | x_1) p(y_1, y_2 | x_1, x_2)$$

to obtain

$$\hat{p}(\underline{y}_1, \underline{y}_2 | \underline{x}_1, \underline{x}_2) \leq \sum_{\underline{u}_1, \underline{u}_2} p(\underline{u}_1, \underline{u}_2, \underline{y}_2, \underline{y}_1 | \underline{x}_1, \underline{x}_2) 2^{N(4a_1(\epsilon_1) + 2\epsilon_1 + 8 \sum_{k=2}^4 a_k(\epsilon, t) + 4/N)}.$$

■

**Lemma 23** Let  $b_1(\epsilon_1) = \epsilon_1 + 2a_1(\epsilon_1)$  and  $b_k(\epsilon_k) = 4a_k(\epsilon_k)$  for  $k = 2, 3$ . Then

$$\begin{aligned} & \hat{p}((\hat{A}_\epsilon^{(N)}(X_1, X_2, Y_1, Y_2))^c | \underline{x}_1, \underline{x}_2) \\ & \leq \delta_{11} + \delta_{12} + \delta_{21} + \delta_{22} + p((\hat{A}_\epsilon^{(N)}(U_2, X_1))^c | \underline{x}_1) + 2^{N(2b_1(\epsilon_1) + 1/N)} p((\hat{A}_\epsilon^{(N)}(U_1, U_2, X_1))^c | \underline{x}_1) \\ & \quad + 2^{N(2 \sum_{k=1}^2 b_k(\epsilon_k) + 2/N)} p((\hat{A}_\epsilon^{(N)}(U_2, X_1, X_2, Y_2))^c | \underline{x}_1, \underline{x}_2) \\ & \quad + 2^{N(2 \sum_{k=1}^3 b_k(\epsilon_k) + 3/N)} p((\hat{A}_\epsilon^{(N)}(U_1, U_2, X_1, X_2, Y_1, Y_2))^c \cup (\hat{A}_\epsilon^{(N)}(X_1, X_2, Y_1, Y_2))^c | \underline{x}_1, \underline{x}_2) \end{aligned}$$

where

$$\begin{aligned} \delta_{11} &= e^{-2^{N(R_{11} - I(X_1; U_1 | U_2) - b_2(\epsilon_2))}} & \delta_{12} &= e^{-2^{N(R_{12} - I(X_1; U_2) - b_1(\epsilon_1))}} \\ \delta_{21} &= e^{-2^{N(R_{21} - I(X_1, X_2; Y_1 | U_1, U_2, Y_2) - b_4(\epsilon_4))}} & \delta_{22} &= e^{-2^{N(R_{22} - I(X_1, X_2; Y_2 | U_2) - b_3(\epsilon_3))}} \end{aligned}$$

*Proof.* For notational brevity, let

$$\begin{aligned} K_1 &\stackrel{\text{def}}{=} K(\underline{u}_2, \underline{x}_1) & K_3 &\stackrel{\text{def}}{=} K(\underline{u}_2, \underline{x}_1, \underline{x}_2, \underline{y}_2) \\ K_2 &\stackrel{\text{def}}{=} K(\underline{u}_1, \underline{u}_2, \underline{x}_1) & K_4 &\stackrel{\text{def}}{=} K(\underline{u}_1, \underline{u}_2, \underline{x}_1, \underline{x}_2, \underline{y}_1, \underline{y}_2) \cdot K(\underline{x}_1, \underline{x}_2, \underline{y}_1, \underline{y}_2); \end{aligned}$$

we rely on context to specify the values of arguments.  $(\underline{x}_1, \underline{x}_2, \underline{y}_1, \underline{y}_2)$  not jointly typical implies that one of the four encoders failed to find a jointly typical codeword. We bound the probability of such a failure for

each encoder in turn and then apply Lemma 22 to bound  $\hat{p}(\cdot)$ , giving

$$\begin{aligned}
& \hat{p}((\hat{A}_\epsilon^{(N)}(X_1, X_2, Y_1, Y_2))^c | \underline{x}_1, \underline{x}_2) \\
& \leq \left( \sum_{\underline{u}_2} p(\underline{u}_2)(1 - K_1) \right)^{2^{NR_{12}}} + \sum_{\underline{u}_2} K_1 \hat{p}(\underline{u}_2) \left( \sum_{\underline{u}_1} p(\underline{u}_1 | \underline{u}_2)(1 - K_2) \right)^{2^{NR_{11}}} \\
& \quad + \sum_{\underline{u}_2} K_1 K_2 \hat{p}(\underline{u}_2) \left( \sum_{\underline{y}_2} p(\underline{y}_2 | \underline{u}_2)(1 - K_3) \right)^{2^{NR_{22}}} \\
& \quad + \sum_{\underline{u}_1, \underline{u}_2, \underline{y}_2} K_1 K_2 K_3 \hat{p}(\underline{u}_1, \underline{u}_2, \underline{y}_2) \left( \sum_{\underline{y}_1} p(\underline{y}_1 | \underline{u}_1, \underline{u}_2, \underline{y}_2)(1 - K_4) \right)^{2^{NR_{21}}} \\
& \leq p((\hat{A}_\epsilon^{(N)}(U_2, X_1))^c | \underline{x}_1) + e^{-2^{N(R_{12} - I(X_1; U_2) - b_1(\epsilon_1))}} \\
& \quad + 2^{N(2b_1(\epsilon_1) + 1/N)} p((\hat{A}_\epsilon^{(N)}(U_1, U_2, X_1))^c | \underline{x}_1) + e^{-2^{N(R_{11} - I(X_1; U_1, U_2) - b_2(\epsilon_2))}} \\
& \quad + 2^{N(2 \sum_{k=1}^2 b_k(\epsilon_k) + 2/N)} p((\hat{A}_\epsilon^{(N)}(U_2, X_1, X_2, Y_2))^c | \underline{x}_1, \underline{x}_2) + e^{-2^{N(R_{22} - I(X_1, X_2; Y_2 | U_2) - b_3(\epsilon_3))}} \\
& \quad + 2^{N(2 \sum_{k=1}^3 b_k(\epsilon, t) + 3/N)} p((\hat{A}_\epsilon^{(N)}(U_1, U_2, X_1, X_2, Y_1, Y_2))^c \cup (\hat{A}_\epsilon^{(N)}(X_1, X_2, Y_1, Y_2))^c | \underline{x}_1, \underline{x}_2) \\
& \quad + e^{-2^{N(R_{21} - I(X_1, X_2; Y_1 | U_1, U_2, Y_2) - b_4(\epsilon_4))}}.
\end{aligned}$$

■

## APPENDIX VI

### INTERFERENCE CHANNELS: MODEL 2

The following definitions, used in the proof of Theorem 8, below, rely on notation defined in Appendix II.

Given any distribution  $p(u_1, u_2, x_1, x_2, y_1, y_2) = p(u_1 | x_1) p(u_2 | u_1, x_1) p(x_1, x_2) p(y_1, y_2 | x_1, x_2)$ , fix  $\epsilon =$

$(\epsilon_1, \epsilon_2, \epsilon_3, \epsilon_4)$  with  $\epsilon_1, \epsilon_2, \epsilon_3, \epsilon_4 > 0$ . Fix  $\epsilon = (\epsilon_1, \epsilon_2, \epsilon_3, \epsilon_4)$  with  $\epsilon_k > 0$  for all  $k$ . Let

$$\begin{aligned}
a_1(\epsilon_1) &\stackrel{\text{def}}{=} (1 + \epsilon_1) \cdot \inf\{\epsilon' > 0 : \Pr(f(\underline{U}_1) > \epsilon' \vee f(\underline{U}_1, \underline{X}_1) > \epsilon') \leq 2^{-N6\epsilon_1} \forall N \text{ suff. large}\} \\
a_2(\epsilon_2) &\stackrel{\text{def}}{=} (1 + \epsilon_2) \cdot \inf\{\epsilon' > 0 : \Pr(f(\underline{U}_1) > \epsilon' \vee f(\underline{U}_1, \underline{X}_1) > \epsilon' \vee f(\underline{U}_1, \underline{U}_2) > \epsilon' \\
&\quad \vee f(\underline{U}_1, \underline{U}_2, \underline{X}_1) > \epsilon') \leq 2^{-N6\epsilon_2(t)} \forall N \text{ suff. large}\} \\
a_3(\epsilon_3) &\stackrel{\text{def}}{=} (1 + \epsilon_3(t)) \cdot \inf\{\epsilon' > 0 : \Pr(f(\underline{U}_1) > \epsilon' \vee f(\underline{U}_1, \underline{Y}_1) > \epsilon' \vee f(\underline{U}_1, \underline{X}_1, \underline{X}_2) > \epsilon' \vee \\
&\quad f(\underline{U}_1, \underline{X}_1, \underline{X}_2, \underline{Y}_1) > \epsilon') \leq 2^{-N6\epsilon_3(t)} \forall N \text{ suff. large}\} \\
a_4(\epsilon_4) &\stackrel{\text{def}}{=} (1 + \epsilon_4(t)) \cdot \inf\{\epsilon' > 0 : \Pr(f(\underline{U}_1, \underline{U}_2, \underline{Y}_1) > \epsilon' \vee f(\underline{U}_1, \underline{U}_2, \underline{Y}_1, \underline{Y}_2) > \epsilon' \vee \\
&\quad f(\underline{U}_1, \underline{U}_2, \underline{X}_1, \underline{X}_2, \underline{Y}_1) > \epsilon' \vee f(\underline{U}_1, \underline{U}_2, \underline{X}_1, \underline{X}_2, \underline{Y}_1, \underline{Y}_2) > \epsilon' \vee f(\underline{Y}_1, \underline{Y}_2) > \epsilon' \vee \\
&\quad f(\underline{X}_1, \underline{X}_2, \underline{Y}_1, \underline{Y}_2) > \epsilon') \leq 2^{-N6\epsilon_4(t)} \forall N \text{ suff. large}\}.
\end{aligned}$$

The typical sets are defined as

$$\begin{aligned}
A_\epsilon^{(N)}(U, X_1) &\stackrel{\text{def}}{=} \{(\underline{u}_1, \underline{x}_1) : f(\underline{x}_1) \leq \epsilon_1, f(\underline{u}_1), f(\underline{u}_1, \underline{x}_1) \leq a_1(\epsilon_1)\} \\
A_\epsilon^{(N)}(U_1, U_2, X) &\stackrel{\text{def}}{=} \{(\underline{u}_1, \underline{u}_2, \underline{x}_1) : f(\underline{u}_1), f(\underline{u}_1, \underline{u}_2), f(\underline{u}_1, \underline{x}_1), f(\underline{u}_1, \underline{u}_2, \underline{x}_1) \leq a_2(\epsilon_2)\} \\
A_\epsilon^{(N)}(U_1, X_1, X_2, Y_1) &\stackrel{\text{def}}{=} \{(\underline{u}_1, \underline{x}_1, \underline{x}_2, \underline{y}_1) : f(\underline{u}_1), f(\underline{u}_1, \underline{y}_1), f(\underline{u}_1, \underline{x}_1, \underline{x}_2), \\
&\quad f(\underline{u}_1, \underline{x}_1, \underline{x}_2, \underline{y}_1) \leq a_3(\epsilon_3)\} \\
A_\epsilon^{(N)}(U_1, U_2, X_1, X_2, Y_1, Y_2) &\stackrel{\text{def}}{=} \{(\underline{u}_1, \underline{u}_2, \underline{x}_1, \underline{x}_2, \underline{y}_1, \underline{y}_2) : f(\underline{u}_1, \underline{u}_2, \underline{y}_1), f(\underline{u}_1, \underline{u}_2, \underline{y}_1, \underline{y}_2), \\
&\quad f(\underline{u}_1, \underline{u}_2, \underline{x}_1, \underline{x}_2, \underline{y}_1), f(\underline{u}_1, \underline{u}_2, \underline{x}_1, \underline{x}_2, \underline{y}_1, \underline{y}_2) \leq a_4(\epsilon_4)\} \\
A_\epsilon^{(N)}(X_1, X_2, Y_1, Y_2) &\stackrel{\text{def}}{=} \{(\underline{x}_1, \underline{x}_2, \underline{y}_1, \underline{y}_2) : f(\underline{x}_1, \underline{x}_2) \leq \epsilon_4(t), f(\underline{y}_1, \underline{y}_2), \\
&\quad f(\underline{x}_1, \underline{x}_2, \underline{y}_1, \underline{y}_2) \leq a_4(\epsilon_4)\},
\end{aligned}$$

which we restrict as

$$\begin{aligned}
\hat{A}_\epsilon^{(N)}(U_1, X_1) &\stackrel{\text{def}}{=} \{(\underline{u}_1, \underline{x}_1) \in A_\epsilon^{(N)} : \Pr\left(\left(A_\epsilon^{(N)}(U_1, X_1)\right)^c | \underline{x}_1\right) \leq 2^{-3N\epsilon_1}\} \\
\hat{A}_\epsilon^{(N)}(U_1, U_2, X_1) &\stackrel{\text{def}}{=} \{(\underline{u}_1, \underline{u}_2, \underline{x}_1) \in A_\epsilon^{(N)} : \Pr\left(\left(A_\epsilon^{(N)}(U_1, U_2, X_1)\right)^c | \underline{u}_1, \underline{x}_1\right) \leq 2^{-3N\epsilon_2}\}. \\
\hat{A}_\epsilon^{(N)}(U_1, X_1, X_2, Y_1) &\stackrel{\text{def}}{=} \{(\underline{u}_1, \underline{x}_1, \underline{x}_2, \underline{y}_1) \in A_\epsilon^{(N)} : \Pr\left(\left(A_\epsilon^{(N)}(U_1, X_1, X_2, Y_1)\right)^c | \underline{u}_1, \underline{x}_1, \underline{x}_2\right) \\
&\quad \leq 2^{-3N\epsilon_3(t)}\} \\
\hat{A}_\epsilon^{(N)}(U_1, U_2, X_1, X_2, Y_1, Y_2) &\stackrel{\text{def}}{=} \{(\underline{u}_1, \underline{u}_2, \underline{x}_1, \underline{x}_2, \underline{y}_1, \underline{y}_2) \in A_\epsilon^{(N)} : \Pr\left(\left(A_\epsilon^{(N)}\right)^c | \underline{u}_1, \underline{u}_2, \underline{x}_1, \underline{x}_2, \underline{y}_1\right) \\
&\quad \leq 2^{-3N\epsilon_4(t)}\} \\
\hat{A}_\epsilon^{(N)}(X_1, X_2, Y_1, Y_2) &\stackrel{\text{def}}{=} \{(\underline{x}_1, \underline{x}_2, \underline{y}_1, \underline{y}_2) \in A_\epsilon^{(N)} : \Pr\left(\left(A_\epsilon^{(N)}\right)^c | \underline{x}_1, \underline{x}_2\right) \leq 2^{-3N\epsilon_4(t)}\}.
\end{aligned}$$

Lemma 24 bounds the probability of observing elements outside of those typical sets. We omit the proof, which follows the same outline as the corresponding examples in prior sections.

**Lemma 24** *If  $(\underline{U}_1, \underline{U}_2, \underline{X}_1, \underline{X}_2, \underline{Y}_1, \underline{Y}_2)$  are drawn i.i.d.  $p(u_1, u_2, x_1, x_2, y_1, y_2)$ , then there exist positive constants  $c_1(\epsilon_1)$  and  $c_2(\epsilon_2)$  for which*

$$\begin{aligned} \Pr \left( (\hat{A}_\epsilon^{(N)}(U_1, X_1))^c \right) &\leq 2^{-Nc_1(\epsilon_1)} \\ \Pr \left( (\hat{A}_\epsilon^{(N)}(U_1, U_2, X_1))^c \right) &\leq 2^{-Nc_2(\epsilon_2)} \\ \Pr \left( (\hat{A}_\epsilon^{(N)}(U_1, X_1, X_2, Y_1))^c \right) &\leq 2^{-Nc_3(\epsilon_3)} \\ \Pr \left( (\hat{A}_\epsilon^{(N)}(U_1, U_2, X_1, X_2, Y_1, Y_2))^c \cup (\hat{A}_\epsilon^{(N)}(X_1, X_2, Y_1, Y_2))^c \right) &\leq 2^{-Nc_4(\epsilon_4)} \end{aligned}$$

for all  $N$  sufficiently large. Constant  $c_k(\epsilon, t)$  approaches 0 as  $\epsilon_k(t)$  approaches 0. ■

**Proof of Theorem 8:** All rates not bounded in the theorem statement are set to zero. We simplify the remaining notation as  $R_{11} \stackrel{\text{def}}{=} R^{\{\{i_1\} \rightarrow \{j_1, j_2\}\}}$ ,  $R_{12} \stackrel{\text{def}}{=} R^{\{\{i_1\} \rightarrow \{j_2\}\}}$ ,  $R_{21} \stackrel{\text{def}}{=} R^{\{\{i_1, i_2\} \rightarrow \{j_1, j_2\}\}}$ , and  $R_{22} \stackrel{\text{def}}{=} R^{\{\{i_1, i_2\} \rightarrow \{j_2\}\}}$ . We use  $\mathcal{C} = (\mathcal{X}_1 \times \mathcal{X}_2, p(y_1, y_2 | x_1, x_2), \mathcal{Y}_1 \times \mathcal{Y}_2)$  in place of the formal channel definition  $(\mathcal{X}^{(i_1,1)} \times \mathcal{X}^{(i_2,1)}, p(y^{(j_1,1)}, y^{(j_2,1)} | x^{(i_1,1)}, x^{(i_2,1)}), \mathcal{Y}^{(j_1,1)} \times \mathcal{Y}^{(j_2,2)})$  in this proof and its supporting lemmas.

Fix  $(R_{11}, R_{12}, R_{21}, R_{22})$  to satisfy the theorem constraints. Let  $p(x_1, x_2)$  be arbitrary, and choose  $p(u_1 | x_1)$  and  $p(u_2 | u_1, x_1)$  to satisfy the given bounds. Let

$$p(u_1, u_2, x_1, x_2, y_1, y_2) \stackrel{\text{def}}{=} p(u_1 | x_1) p(u_2 | x_1, u_1) p(x_1, x_2) p(y_1, y_2 | x_1, x_2).$$

We apply the typical set definitions given above.

Excluding the rate-0 codes, four encoders and two decoders are required. We simplify their notation as

$$\begin{aligned} \alpha_N^{(11)} &= \alpha_N^{\{\{i_1\} \rightarrow \{j_1, j_2\}\}} & \alpha_N^{(21)} &= \alpha_N^{\{\{i_1, i_2\} \rightarrow \{j_1, j_2\}\}} & \beta_N^{(1)} &= \beta_N^{(j_1)} \\ \alpha_N^{(12)} &= \alpha_N^{\{\{i_1\} \rightarrow \{j_2\}\}} & \alpha_N^{(22)} &= \alpha_N^{\{\{i_1, i_2\} \rightarrow \{j_2\}\}} & \beta_N^{(2)} &= \beta_N^{(j_2)}, \end{aligned}$$

where

$$\begin{aligned} \alpha_N^{(11)} : \underline{\mathcal{X}}_1 &\rightarrow \mathcal{W}_{11} & \alpha_N^{(21)} : \underline{\mathcal{X}}_1 \times \underline{\mathcal{X}}_2 &\rightarrow \mathcal{W}_{21} & \beta_N^{(1)} : \mathcal{W}_{11} \times \mathcal{W}_{21} &\rightarrow \underline{\mathcal{Y}}_1 \\ \alpha_N^{(12)} : \underline{\mathcal{X}}_1 &\rightarrow \mathcal{W}_{12} & \alpha_N^{(22)} : \underline{\mathcal{X}}_1 \times \underline{\mathcal{X}}_2 &\rightarrow \mathcal{W}_{22} & \beta_N^{(2)} : \mathcal{W}_{11} \times \mathcal{W}_{12} \times \mathcal{W}_{21} \times \mathcal{W}_{22} &\rightarrow \underline{\mathcal{Y}}_2 \end{aligned}$$

and

$$\begin{aligned} \mathcal{W}_{11} &= \tilde{\underline{\mathcal{X}}}^{\{\{i_1\} \rightarrow \{j_1\}\}} = \{0, 1\}^{NR_{11}} & \mathcal{W}_{12} &= \tilde{\underline{\mathcal{X}}}^{\{\{i_1\} \rightarrow \{j_1, j_2\}\}} = \{0, 1\}^{NR_{12}} \\ \mathcal{W}_{21} &= \tilde{\underline{\mathcal{X}}}^{\{\{i_1, i_2\} \rightarrow \{j_1\}\}} = \{0, 1\}^{NR_{21}} & \mathcal{W}_{22} &= \tilde{\underline{\mathcal{X}}}^{\{\{i_1, i_2\} \rightarrow \{j_1, j_2\}\}} = \{0, 1\}^{NR_{22}} \end{aligned}$$

Encoder  $(\alpha_N^{(11)}, \alpha_N^{(12)})$  operates at node  $i_1$ , transmitting its rate  $R_{11}$  and  $R_{12}$  descriptions to both nodes and only  $j_2$ , respectively. Encoder  $(\alpha_N^{(21)}, \alpha_N^{(22)})$  operates at node  $v^{V_1}$ , receiving noiseless descriptions of  $\underline{x}_1$  and  $\underline{x}_2$  from nodes  $i_1$  and  $i_2$  and transmitting its rate  $R_{21}$  output to both nodes and its  $R_{22}$  output to only  $j_2$ . The code also employs mappings  $\gamma_N^{(1)} : \mathcal{W}_{11} \rightarrow \mathcal{U}_1$  and  $\gamma_N^{(2)} : \mathcal{W}_{11} \times \mathcal{W}_{12} \rightarrow \mathcal{U}_2$ .

The random code design draws  $\{\gamma_N^{(1)}(w_{11}) : w_{11} \in \mathcal{W}_{11}\}$  i.i.d. from the distribution  $\prod_{\ell=1}^N p(\underline{u}_1(\ell))$ . For each  $w_{11} \in \hat{\mathcal{Y}}_{11}$ , let  $\underline{U}_1 = \gamma_N^{(1)}(w_{11})$  and draw codewords  $\{\gamma_N^{(2)}(w_{11}, w_{12}) : w_{12} \in \mathcal{W}_{12}\}$  i.i.d. from  $\prod_{\ell=1}^N p(\underline{u}_2(\ell)|\underline{U}_1(\ell))$  and codewords  $\{\beta_N^{(1)}(w_{11}, w_{21}) : w_{21} \in \mathcal{W}_{21}\}$  i.i.d. from  $\prod_{\ell=1}^N p(\underline{y}_1(\ell)|\underline{U}_1(\ell))$ . Finally, for each  $(w_{11}, w_{12}, w_{21}) \in \hat{\mathcal{Y}}_{11} \times \hat{\mathcal{Y}}_{12} \times \hat{\mathcal{Y}}_{21}$ , let

$$(\underline{U}_1, \underline{U}_2, \underline{Y}_1) = (\gamma_N^{(1)}(w_{11}), \gamma_N^{(2)}(w_{11}, w_{12}), \beta_N^{(1)}(w_{11}, w_{21})),$$

and draw  $\{\beta_N^{(2)}(w_{11}, w_{12}, w_{21}, w_{22}) : w_{22} \in \mathcal{W}_{22}\}$  i.i.d. from  $\prod_{\ell=1}^N p(y_2(\ell)|\underline{U}_1(\ell), \underline{U}_2(\ell), \underline{Y}_1(\ell))$ . Choose  $\alpha_N^{(11)}(\underline{x}_1)$  uniformly at random from the indices  $w_{11} \in \hat{\mathcal{X}}_{11}$  for which  $(\gamma_N^{(1)}(w_{11}), \underline{x}_1) \in \hat{A}_\epsilon^{(N)}$ ; if there is no such index, then set  $\alpha_N^{(11)}(\underline{x}_1)$  to 1. Let  $w_{11}$  be the chosen index and  $\underline{U}_1 = \gamma_N^{(1)}(w_{11})$ . Choose  $\alpha_N^{(12)}(\underline{x}_1)$  uniformly at random from the indices  $w_{12} \in \hat{\mathcal{X}}_{12}$  for which  $(\underline{U}_1, \gamma_N^{(2)}(w_{11}, w_{12}), \underline{x}_1) \in \hat{A}_\epsilon^{(N)}$ ; if there is no such index  $w_{12}$ , then set  $\alpha_N^{(12)}(\underline{x}_1)$  to 1. Let  $w_{12}$  be the chosen index, and let  $\underline{U}_2 = \gamma_N^{(2)}(w_{11}, w_{12})$ . Choose  $\alpha_N^{(21)}(\underline{x}_1, \underline{x}_2)$  uniformly at random from the set of  $w_{21} \in \hat{\mathcal{X}}_{21}$  for which

$$(\underline{U}_1, x^{(i_1,1)}, x^{(i_2,1)}, \beta_N^{(1)}(w_{11}, w_{21n})) \in \hat{A}_\epsilon^{(N)};$$

if this set is empty, then  $\alpha_N^{(21)}(\underline{x}_1, \underline{x}_2)$  is set to 0. Let  $w_{21}$  be the chosen index and set  $\underline{Y}_1 = \beta_N^{(1)}(w_{11}, w_{21})$ ; choose  $\alpha_N^{(22)}(\underline{x}_1, \underline{x}_2)$  uniformly at random from the set of  $w_{22} \in \hat{\mathcal{X}}_{22}$  for which

$$(\underline{U}_1, \underline{U}_2, \underline{x}_1, \underline{x}_2, \underline{Y}_1, \beta_N^{(2)}(w_{11}, w_{12}, w_{21}, w_{22}))$$

is typical; if this set is empty, then  $\alpha_N^{(22)}(\underline{x}_1, \underline{x}_2)$  is set to 0.

For all  $(\underline{x}_1, \underline{x}_2, \underline{y}_1, \underline{y}_2) \in \hat{A}_\epsilon^{(N)}$ , Lemma 25, below,

$$\hat{p}(\underline{y}_1, \underline{y}_2 | \underline{x}_1, \underline{x}_2) \leq 2^{N(2 \sum_{k=1}^4 b_k(\epsilon_k) + 4/N)},$$

where  $b_1 = 2a_1(\epsilon_1) + \epsilon_1$  and  $b_k = 4a_k(\epsilon_k)$ ,  $k \in \{2, 3, 4\}$ . By Lemma 26, below,

$$\begin{aligned} & \hat{p}(\hat{A}_\epsilon^{(N)}((X_1, X_2, Y_1, Y_2))^c | \underline{x}_1, \underline{x}_2) \\ & \leq \delta_{11} + \delta_{12} + \delta_{21} + \delta_{22} + p((\hat{A}_\epsilon^{(N)}(U_1, X_1))^c | \underline{x}_1) + 2^{N(2b_1(\epsilon_1) + 1/N)} p((\hat{A}_\epsilon^{(N)}(U_1, U_2, X_1))^c | \underline{x}_1) \\ & \quad + 2^{N(2 \sum_{k=1}^2 b_k(\epsilon_k) + 2/N)} p((\hat{A}_\epsilon^{(N)}(U_1, X_1, X_2, Y_1))^c | \underline{x}_1, \underline{x}_2) \\ & \quad + 2^{N(2 \sum_{k=1}^3 b_k(\epsilon_k) + 3/N)} p((\hat{A}_\epsilon^{(N)}(U_1, U_2, X_1, X_2, Y_1, Y_2))^c | \underline{x}_1, \underline{x}_2), \end{aligned}$$



where

$$\begin{aligned}\delta_{11} &= e^{-2^N(R_{11}-I(X_1;U_1)-b_1(\epsilon_1))} & \delta_{12} &= e^{-2^N(R_{12}-I(X_1;U_2|U_1)-b_2(\epsilon_2))} \\ \delta_{21} &= e^{-2^N(R_{21}-I(X_1,X_2;Y_1|U_1)-b_3(\epsilon_3))} & \delta_{22} &= e^{-2^N(R_{22}-I(X_1,X_2;Y_2|U_1,U_2,Y_1)-b_4(\epsilon_4))}.\end{aligned}$$

Lemma 24, above, gives

$$\begin{aligned}p\left(\left(\hat{A}_\epsilon^{(N)}(U_1, X_1)\right)^c\right) &\leq 2^{-Nc_1(\epsilon_1)} \\ p\left(\left(\hat{A}_\epsilon^{(N)}(U_1, U_2, X_1)\right)^c\right) &\leq 2^{-Nc_2(\epsilon_2)} \\ p\left(\left(\hat{A}_\epsilon^{(N)}(U_1, X_1, X_2, Y_1)\right)^c\right) &\leq 2^{-Nc_3(\epsilon_3)} \\ p\left(\left(\hat{A}_\epsilon^{(N)}(U_1, U_2, X_1, X_2, Y_1, Y_2)\right)^c \cup \left(\hat{A}_\epsilon^{(N)}(X_1, X_2, Y_1, Y_2)\right)^c\right) &\leq 2^{-Nc_4(\epsilon_4)}\end{aligned}$$

for all  $N$  sufficiently large, where each  $c_k(\epsilon, t)$  approaches 0 as  $\epsilon_k(t)$  approaches 0. Thus setting  $\nu = 3 \sum_{k=1}^4 b_k(\epsilon_k)$  gives

$$\begin{aligned}P_e^{(N)}(\nu) &\leq \delta_{11} + \delta_{12} + \delta_{21} + \delta_{22} + 2^{-Nc_1(\epsilon_1)} + 2^{-N(c_2(\epsilon_2)-2b_1(\epsilon_1)-1/N)} \\ &\quad + 2^{-N(c_3(\epsilon_3)-2\sum_{k=1}^2 b_k(\epsilon_k)-2/N)} + 2^{-N(c_4(\epsilon_4)-2\sum_{k=1}^3 b_k(\epsilon_k)+3/N)}\end{aligned}$$

for  $N$  sufficiently large. Thus sequentially choosing  $\epsilon_4, \epsilon_3, \epsilon_2$ , and  $\epsilon_1$  to satisfy

$$\begin{aligned}b_4(\epsilon_4) &< R_{22} - I(X_1, X_2; Y_2|U_1, U_2, Y_1) \\ b_3(\epsilon_3) &< \min\{R_{21} - I(X_1, X_2; Y_1|U_1), c_4(\epsilon_4)/6\} \\ b_2(\epsilon_2) &< \min\{R_{12} - I(X_1; U_2|U_1), c_4(\epsilon_4)/6, c_3(\epsilon_3)/4\} \\ b_1(\epsilon_1) &< \min\{R_{11} - I(X_1; U_1), c_4(\epsilon_4)/6, c_3(\epsilon_3)/4, c_2(\epsilon_2)/2\}\end{aligned}$$

yields an error probability  $P_e^{(N)}(\nu)$  that decays exponentially to zero. The exponent approaches 0 as  $\epsilon_1, \epsilon_2, \epsilon_3$ , and  $\epsilon_4$  approach 0, which gives the desired result by Theorem 4. ■

**Lemma 25** For all  $(\underline{u}_1, \underline{x}_1) \in \hat{A}_\epsilon^{(N)}$ ,

$$\hat{p}(\underline{u}_1|\underline{x}_1) \leq 2^{N(4a_1(\epsilon_1)+2\epsilon_1+1/N)} p(\underline{u}_1|\underline{x}_1);$$

if, further,  $(\underline{u}_1, \underline{u}_2, \underline{x}_1) \in \hat{A}_\epsilon^{(N)}$  then

$$\hat{p}(\underline{u}_2|\underline{u}_1, \underline{x}_1) \leq 2^{N(8a_2(\epsilon_2)+1/N)} p(\underline{u}_2|\underline{u}_1, \underline{x}_1);$$

if, in addition,  $(\underline{u}_1, \underline{x}_1, \underline{x}_2, \underline{y}_1) \in \hat{A}_\epsilon^{(N)}$

$$\hat{p}(\underline{y}_1|\underline{u}_1, \underline{x}_1, \underline{x}_2) \leq 2^{N(8a_3(\epsilon_3)+1/N)} p(\underline{y}_1|\underline{u}_1, \underline{x}_1, \underline{x}_2).$$

if also  $(\underline{u}_1, \underline{u}_2, \underline{x}_1, \underline{x}_2, \underline{y}_1, \underline{y}_2) \in \hat{A}_\epsilon^{(N)}$ , then

$$\hat{p}(\underline{y}_2 | \underline{u}_1, \underline{u}_2, \underline{x}_1, \underline{x}_2, \underline{y}_1) \leq 2^{N(8a_4(\epsilon_4)+1/N)} p(\underline{y}_2 | \underline{u}_1, \underline{u}_2, \underline{x}_1, \underline{x}_2, \underline{y}_1).$$

Thus, if  $(\underline{x}_1, \underline{x}_2, \underline{y}_1, \underline{y}_2) \in \hat{A}_\epsilon^{(N)}$ ,

$$\hat{p}(\underline{y}_1, \underline{y}_2 | \underline{x}_1, \underline{x}_2) \leq 2^{N(4a_1(\epsilon_1)+\epsilon_1+\sum_{k=2}^4 8a_k(\epsilon_k)+4/N)}.$$

*Proof.* The proof follows the same outline as the preceding examples. ■

Lemma 26 bounds the probability of observing atypical strings using the code designed in Theorem 8.

**Lemma 26** Let  $b_1(\epsilon_1) = 4a_1(\epsilon_1) + 2\epsilon_1 + 1/N$  and  $b_k(\epsilon_k) = 8a_k(\epsilon_k) + 1/N$ ,  $k \in \{2, 3\}$ . Then

$$\begin{aligned} & \hat{p}(\hat{A}_\epsilon^{(N)}((X_1, X_2, Y_1, Y_2))^c | \underline{x}_1, \underline{x}_2) \\ & \leq \delta_{11} + \delta_{12} + \delta_{21} + \delta_{22} + p((\hat{A}_\epsilon^{(N)}(U_1, X_1))^c | \underline{x}_1) + 2^{Nb_1(\epsilon_1)} p((\hat{A}_\epsilon^{(N)}(U_1, U_2, X_1))^c | \underline{u}_1, \underline{x}_1) \\ & \quad + 2^{N\sum_{k=1}^2 b_k(\epsilon_k)} p((\hat{A}_\epsilon^{(N)}(U_1, X_1, X_2, Y_1))^c | \underline{x}_1, \underline{x}_2) \\ & \quad + 2^{N\sum_{k=1}^3 b_k(\epsilon_k)} p((\hat{A}_\epsilon^{(N)}(U_1, U_2, X_1, X_2, Y_1, Y_2))^c | \underline{x}_1, \underline{x}_2). \end{aligned}$$

where

$$\begin{aligned} \delta_{11} &= e^{-2N(R_{11}-I(X_1;U_1)-b_1(\epsilon_1))} & \delta_{12} &= e^{-2N(R_{12}-I(X_1;U_2|U_1)-b_2(\epsilon_2))} \\ \delta_{21} &= e^{-2N(R_{21}-I(X_1,X_2;Y_1|U_1)-b_3(\epsilon_3))} & \delta_{22} &= e^{-2N(R_{22}-I(X_1,X_2;Y_2|U_1,U_2,Y_1)-b_4(\epsilon_4))}. \end{aligned}$$

■

## REFERENCES

- [1] C. E. Shannon, "A mathematical theory of communication," *Bell Systems Technical Journal*, vol. 27, pp. 379–423, 623–656, 1948.
- [2] R. Ahlswede, "Multi-way communication channels," in *Proc. 2nd. Int. Symp. Information Theory (Tsahkadsor, Armenian S.S.R.)*, (Prague), pp. 23–52, Publishing House of the Hungarian Academy of Sciences, 1971.
- [3] H. Liao, *Multiple access channels*. Ph. D. Dissertation, Department of Electrical Engineering, University of Hawaii, Honolulu, 1972.
- [4] T. M. Cover, "Broadcast channels," *IEEE Transactions on Information Theory*, vol. IT-18, pp. 2–14, Jan. 1972.
- [5] L. Song, R. W. Yeung, and N. Cai, "Zero-error network coding for acyclic networks," *IEEE Transactions on Information Theory*, vol. 49, pp. 3129–3139, July 2003.
- [6] N. Harvey, R. Kleinberg, and A. R. Lehman, "On the capacity of information networks," *IEEE Transactions on Information Theory*, vol. 52, pp. 2345–2364, June 2006.
- [7] A. Subramanian and A. Thangaraj, "A simple algebraic formulation for the scalar linear network coding problem," *ArXiv e-prints*, July 2008.

- [8] R. Koetter, M. Effros, and M. Médard, "On a theory of network equivalence," in *Proceedings of the IEEE Information Theory Workshop*, (Volos, Greece), pp. 326–330, June 2009.
- [9] R. Koetter, M. Effros, and M. Médard, "A theory of network equivalence, Part i: Point-to-point channels," *IEEE Transactions on Information Theory*, 2010.
- [10] R. Dougherty and K. Zeger, "Nonreversibility and equivalent constructions of multiple-unicast networks," *IEEE Transactions on Information Theory*, vol. 52, no. 11, pp. 5067–5077, 2006.
- [11] M. Langberg Personal communication, 2010.
- [12] W.-H. Gu and M. Effros, "A strong converse for a collection of network source coding problems," in *Proceedings of the IEEE International Symposium on Information Theory*, (Seoul, Korea), pp. 2316–2320, June 2009.
- [13] W.-H. Gu, *On achievable rate regions for source coding networks*. Ph.D. dissertation, California Institute of Technology, Pasadena, CA, 2009.
- [14] R. Koetter and M. Médard, "An algebraic approach to network coding," *IEEE/ACM Transactions on Networking*, vol. 11, pp. 782–795, Oct. 2003.
- [15] A. Avestimehr, S. Diggavi, and D. Tse, "Approximate capacity of Gaussian relay networks," in *Proceedings of the IEEE International Symposium on Information Theory*, pp. 474–478, July 2008.