

AN INTRODUCTION TO THE VOLUME CONJECTURE

HITOSHI MURAKAMI

ABSTRACT. This is an introduction to the Volume Conjecture and its generalizations for nonexperts.

The Volume Conjecture states that a certain limit of the colored Jones polynomial of a knot would give the volume of its complement. If we deform the parameter of the colored Jones polynomial we also conjecture that it would also give the volume and the Chern–Simons invariant of a three-manifold obtained by Dehn surgery determined by the parameter.

I start with a definition of the colored Jones polynomial and include elementary examples and short description of elementary hyperbolic geometry.

1. INTRODUCTION

In 1995 Kashaev introduced a complex valued link invariant for an integer $N \geq 2$ by using the quantum dilogarithm [15] and then he observed that his invariant grows exponentially with growth rate proportional to the volume of the knot complement for several hyperbolic knots [16]. He also conjectured that this also holds for any hyperbolic knot, where a knot in the three-sphere is called hyperbolic if its complement possesses a complete hyperbolic structure with finite volume.

In 2001 J. Murakami and the author proved that Kashaev’s invariant turns out to be a special case of the colored Jones polynomial. More precisely Kashaev’s invariant is equal to $J_N(K; \exp(2\pi\sqrt{-1}/N))$, where $J_N(K; q)$ is the N -dimensional colored Jones polynomial associated with the N -dimensional irreducible representation of the Lie algebra $\mathfrak{sl}(2; \mathbb{C})$ and K is a knot (§ 2). We also generalized Kashaev’s conjecture to any knot (Volume Conjecture) by using the Gromov norm, which can be regarded as a natural generalization of the hyperbolic volume (§ 3). If it is true it would give interesting relations between quantum topology and hyperbolic geometry. So far the conjecture is proved only for several knots and some links but we have supporting evidence which is described in § 4.

In the Volume Conjecture we study the colored Jones polynomial at the N -th root of unity $\exp(2\pi\sqrt{-1}/N)$. What happens if we replace $2\pi\sqrt{-1}$ with another complex number? Recalling that the complete hyperbolic structure of a hyperbolic knot complement can be deformed by using a complex parameter [34], we expect that we can also relate the colored Jones polynomial evaluated at $\exp((2\pi\sqrt{-1} + u)/N)$ to the volume of the deformed hyperbolic structure. At least for the figure-eight knot this is true if u is small [30]. It is also true (for the figure-eight knot)

Date: May 28, 2018.

2000 Mathematics Subject Classification. Primary 57M27 57M25 57M50.

Key words and phrases. volume conjecture, knot, hyperbolic knot, quantum invariant, colored Jones polynomial, Chern–Simons invariant.

The author is supported by Grant-in-Aid for Challenging Exploratory Research (21654053).

that we can also get the Chern–Simons invariant, which can be regarded as the imaginary part of the volume, from the colored Jones polynomial (§ 5).

In general we conjecture that this is also true, that is, for any knot the asymptotic behavior of the colored Jones polynomial would determine the volume of a three-manifold obtained as the deformation associated with the parameter u .

The aim of this article is to give an elementary introduction to these conjectures including many examples so that nonexperts can easily understand. I hope you will join us.

Acknowledgments. The author would like to thank the organizers of the workshop and conference “Interactions Between Hyperbolic Geometry, Quantum Topology and Number Theory” held at Columbia University, New York in June 2009.

Thanks are also due to an immigration officer at J. F. Kennedy Airport, who knows me by papers, for interesting and exciting discussion about quantum topology.

2. LINK INVARIANT FROM A YANG–BAXTER OPERATOR

In this section I describe how we can define a link invariant by using a Yang–Baxter operator.

2.1. Braid presentation of a link. An n -braid is a collection of n strands that go downwards monotonically from a set of fixed n points to another set of fixed n points as shown in Figure 1. The set of all n -braids makes a group B_n with product

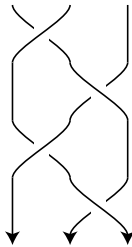

FIGURE 1. braid

of braids β_1 and β_2 given by putting β_2 below β_1 . It is well known (see for example [2]) that B_n is generated by $\sigma_1, \sigma_2, \dots, \sigma_{n-1}$ (Figure 2) with relations $\sigma_i \sigma_j = \sigma_j \sigma_i$ ($|i - j| > 1$) and $\sigma_k \sigma_{k+1} \sigma_k = \sigma_{k+1} \sigma_k \sigma_{k+1}$. See Figure 3 for the latter relation, which is called the braid relation. So we have the following group presentation of

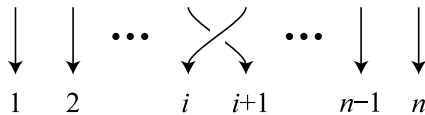

FIGURE 2. i th generator of the n -braid group B_n

B_n .

$$(2.1) \quad B_n = \langle \sigma_1, \sigma_2, \dots, \sigma_{n-1} \mid \sigma_i \sigma_j = \sigma_j \sigma_i \ (|i - j| > 1), \sigma_k \sigma_{k+1} \sigma_k = \sigma_{k+1} \sigma_k \sigma_{k+1} \rangle$$

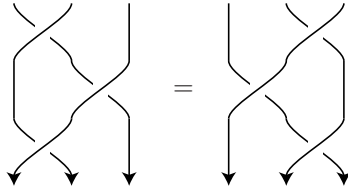

FIGURE 3. braid relation

It is known that any knot or link can be presented as the closure of a braid.

Theorem 2.1 (Alexander [1]). *Any knot or link can be presented as the closure of a braid.*

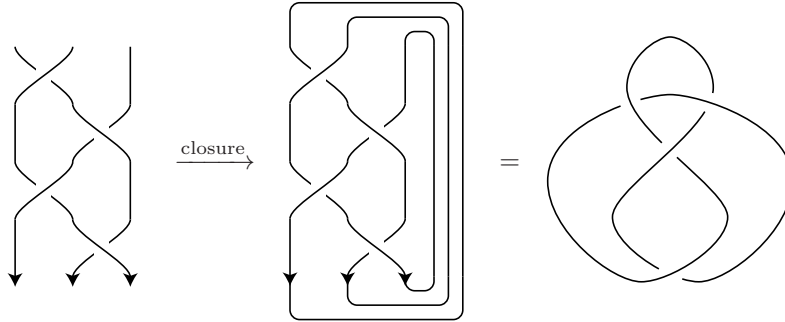

FIGURE 4. the figure-eight knot is presented as the closure of a braid

Here the closure of an n -braid is obtained by connecting the n points on the top with the n points on the bottom without entanglement as shown in the middle picture of Figure 4.

There are many braids that present a knot or link but if two braids present the same knot or link, they are related by a finite sequence of conjugations and (de-)stabilizations. In fact we have the following theorem.

Theorem 2.2 (Markov [19]). *If two braids β and β' give equivalent links, then they are related by a finite sequence of conjugations, stabilizations, and destabilizations. Here a conjugation replaces $\alpha\beta$ with $\beta\alpha$, or equivalently β with $\alpha^{-1}\beta\alpha$ (Figure 5), a stabilization replaces $\beta \in B_n$ with $\beta\sigma_n^{\pm 1} \in B_{n+1}$ (Figure 6), a destabilization replaces $\beta\sigma_n^{\pm 1} \in B_{n+1}$ with $\beta \in B_n$.*

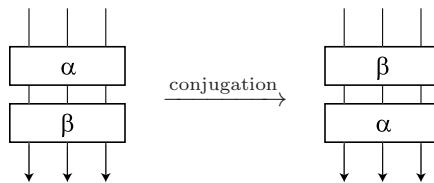

FIGURE 5. $\alpha\beta$ is conjugate to β .

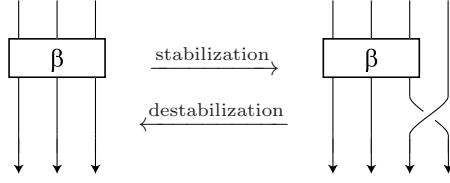

FIGURE 6. β ($\beta\sigma_n^\pm$, respectively) is stabilized (destabilized, respectively) to $\beta\sigma_n^\pm$ (β , respectively).

2.2. Yang–Baxter operator. Alexander’s theorem (Theorem 2.1) and Markov’s theorem (Theorem 2.2) can be used to define link invariants. I will follow Turaev [36] to introduce a link invariant derived from a Yang–Baxter operator.

Let V be an N -dimensional vector space over \mathbb{C} , R an isomorphism from $V \otimes V$ to itself, m an isomorphism from V to itself, and a and b non-zero complex numbers.

Definition 2.3. A quadruple (R, μ, a, b) is called an enhanced Yang–Baxter operator if it satisfies the following:

- (1) $(R \otimes \text{Id}_V)(\text{Id}_V \otimes R)(R \otimes \text{Id}_V) = (\text{Id}_V \otimes R)(R \otimes \text{Id}_V)(\text{Id}_V \otimes R)$,
- (2) $R(\mu \otimes \mu) = (\mu \otimes \mu)R$,
- (3) $\text{Tr}_2(R^{\pm 1}(\text{Id}_V \otimes \mu)) = a^{\pm 1}b \text{Id}_V$.

Here $\text{Tr}_k: \text{End}(V^{\otimes k}) \rightarrow \text{End}(V^{\otimes(k-1)})$ is defined by

$$\text{Tr}_k(f)(e_{i_1} \otimes e_{i_2} \cdots \otimes e_{i_{k-1}}) := \sum_{j_1, j_2, \dots, j_{k-1}, j=0}^{N-1} f_{i_1, i_2, \dots, i_{k-1}, j}^{j_1, j_2, \dots, j_{k-1}, j}(e_{j_1} \otimes e_{j_2} \otimes \cdots \otimes e_{j_{k-1}} \otimes e_j),$$

where $f \in \text{End}(V^{\otimes k})$ is given by

$$f(e_{i_1} \otimes e_{i_2} \otimes \cdots \otimes e_{i_k}) = \sum_{j_1, j_2, \dots, j_k=0}^{N-1} f_{i_1, i_2, \dots, i_k}^{j_1, j_2, \dots, j_k}(e_{j_1} \otimes e_{j_2} \otimes \cdots \otimes e_{j_k})$$

and $\{e_0, e_1, \dots, e_{N-1}\}$ is a basis of V .

Remark 2.4. The isomorphism R is often called an R -matrix, and the equation (1) is known as the Yang–Baxter equation.

Given an n -braid β , we can construct a homomorphism $\Phi(\beta): V^{\otimes n} \rightarrow V^{\otimes n}$ by replacing a generator σ_i with $\text{Id}_V^{\otimes(i-1)} \otimes R \otimes \text{Id}_V^{\otimes(n-i-1)}$, and its inverse σ_i^{-1} with $\text{Id}_V^{\otimes(i-1)} \otimes R^{-1} \otimes \text{Id}_V^{\otimes(n-i-1)}$ (Figure 7).

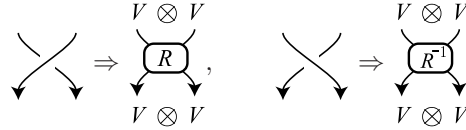

FIGURE 7. Replace a generator with the R -matrix.

Example 2.5. For the braid $\sigma_1\sigma_2^{-1}\sigma_1\sigma_2^{-1}$ the corresponding homomorphism is given as follows (Figure 8):

$$\Phi(\sigma_1\sigma_2^{-1}\sigma_1\sigma_2^{-1}) = (R \otimes \text{Id}_V)(\text{Id}_V \otimes R^{-1})(R \otimes \text{Id}_V)(\text{Id}_V \otimes R^{-1}).$$

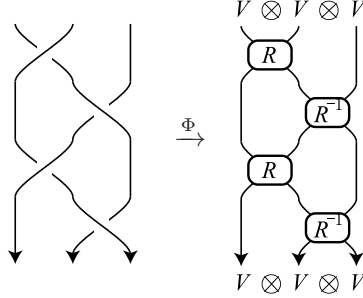

FIGURE 8. A braid and the corresponding homomorphism

2.3. Invariant. Let (R, μ, a, b) be an enhanced Yang–Baxter operator on an N -dimensional vector space V .

Definition 2.6. For an n -braid β , we define $T_{(R, \mu, a, b)}(\beta) \in \mathbb{C}$ by the following formula.

$$T_{(R, \mu, a, b)}(\beta) := a^{-w(\beta)} b^{-n} \text{Tr}_1 \left(\text{Tr}_2 \left(\cdots \left(\text{Tr}_n \left(\Phi(\beta) \mu^{\otimes n} \right) \right) \cdots \right) \right),$$

where $w(\beta)$ is the sum of the exponents in β . Note that $\text{Tr}_1: \text{End}(V) \rightarrow \mathbb{C}$ is the usual trace.

Example 2.7. For the braid $\sigma_1 \sigma_2^{-1} \sigma_1 \sigma_2^{-1}$, we have

$$\begin{aligned} & T_{(R, \mu, a, b)}(\sigma_1 \sigma_2^{-1} \sigma_1 \sigma_2^{-1}) \\ &= b^{-2} \text{Tr}_1 \left(\text{Tr}_2 \left(\text{Tr}_3 \left((R \otimes \text{Id}_V) (\text{Id}_V \otimes R^{-1}) (R \otimes \text{Id}_V) (\text{Id}_V \otimes R^{-1}) (\mu \otimes \mu \otimes \mu) \right) \right) \right) \end{aligned}$$

since $w(\sigma_1 \sigma_2^{-1} \sigma_1 \sigma_2^{-1}) = +1 - 1 + 1 - 1 = 0$ (Figure 9).

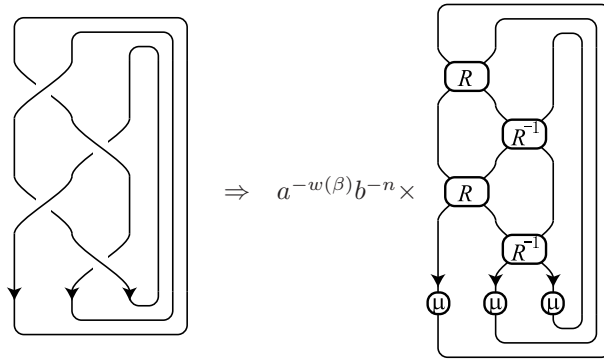

FIGURE 9. A braid and its invariant

We can show that $T_{(R, \mu, a, b)}$ gives a link invariant.

Theorem 2.8 (Turaev [36]). *If β and β' present the same link, then $T_{(R, \mu, a, b)}(\beta) = T_{(R, \mu, a, b)}(\beta')$.*

Sketch of a proof. By Markov's theorem (Theorem 2.2) it is sufficient to prove that $T_{R,\mu,a,b}$ is invariant under a braid relation, a conjugation and a stabilization.

The invariance under a braid relation $\sigma_i \sigma_{i+1} \sigma_i = \sigma_{i+1} \sigma_i \sigma_{i+1}$ follows from Figure 10. Note that the left hand side depicts a braid relation (2.1) and the right hand side depicts the corresponding Yang–Baxter equation (Definition 2.3 (1)).

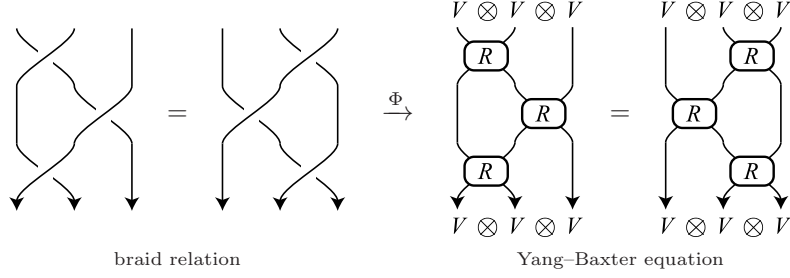

FIGURE 10. braid relation corresponds to the Yang–Baxter equation

The invariance under a conjugation follows from Figure 11. The first equality follows since Tr_k is invariant under a conjugation. The second equality follows since $(\mu \otimes \mu)R = R(\mu \otimes \mu)$ (Definition 2.3 (2)). Note that the equality $(\mu \otimes \mu)R = R(\mu \otimes \mu)$ means that a pair $\mu \otimes \mu$ can pass through a crossing.

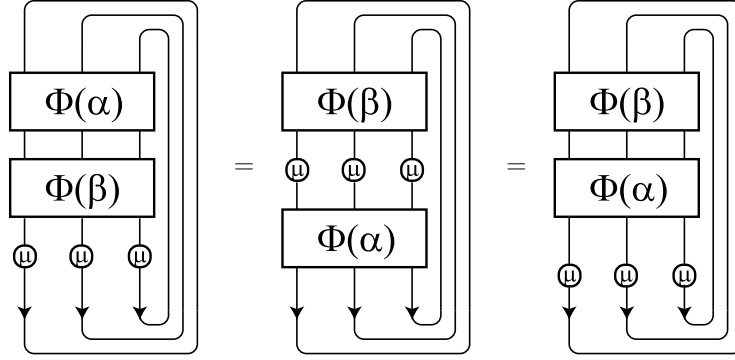

FIGURE 11. invariance under a conjugation

To prove the invariance under a stabilization, we first note that if a homomorphism $f: V^{\otimes n} \rightarrow V^{\otimes n}$ given by

$$f(e_{i_1} \otimes \cdots \otimes e_{i_n}) = \sum_{j_1, \dots, j_n=0}^{N-1} f_{i_1, \dots, i_n}^{j_1, \dots, j_n}(e_{j_1} \otimes \cdots \otimes e_{j_n}),$$

then its n -fold trace is given by

$$\text{Tr}_1(\cdots(\text{Tr}_n(f))\cdots) = \sum_{j_1, \dots, j_n} f_{j_1, \dots, j_n}^{j_1, \dots, j_n}.$$

Therefore if g is a homomorphism $g: V \otimes V \rightarrow V \otimes V$ given by $g_{l_1, l_2}^{k_1, k_2}$, then we have

$$\begin{aligned} \text{Tr}_1 \left(\cdots \left(\text{Tr}_n \left(\text{Tr}_{n+1} \left((f \otimes \text{Id}_V) (\text{Id}_V^{\otimes(n-1)} \otimes g) \right) \right) \right) \right) \\ = \sum_{j_1, \dots, j_n, k_n, k_{n+1}} f_{j_1, \dots, j_{n-1}, j_n}^{j_1, \dots, j_{n-1}, k_n} g_{k_n, k_{n+1}}^{j_n, k_{n+1}}, \end{aligned}$$

which coincides with the n -fold trace of the homomorphism $f(\text{Id}_V^{\otimes(n-1)} \otimes \text{Tr}_2(g)): V^{\otimes n} \rightarrow V^{\otimes n}$.

Therefore for $\beta \in B_n$ we have

$$\begin{aligned} & \text{Tr}_1 \left(\text{Tr}_2 \left(\cdots \left(\text{Tr}_n \left(\text{Tr}_{n+1} \left(\Phi(\beta \sigma_n^{\pm 1}) \mu^{\otimes(n+1)} \right) \right) \right) \right) \right) \\ &= \text{Tr}_1 \left(\text{Tr}_2 \left(\cdots \left(\text{Tr}_n \left(\text{Tr}_{n+1} \left((\mu^{\otimes n} \Phi(\beta) \otimes \text{Id}_V) (\text{Id}_V^{\otimes(n-1)} \otimes R^{\pm 1}(\text{Id}_V \otimes \mu)) \right) \right) \right) \right) \right) \\ &= \text{Tr}_1 \left(\text{Tr}_2 \left(\cdots \left(\text{Tr}_n \left((\mu^{\otimes n} \Phi(\beta)) (\text{Id}_V^{\otimes(n-1)} \otimes \text{Tr}_2(R^{\pm 1}(\text{Id}_V \otimes \mu))) \right) \right) \right) \right) \\ &= a^{\pm 1} b \text{Tr}_1 \left(\text{Tr}_2 \left(\cdots \left(\text{Tr}_n \left((\mu^{\otimes n} \Phi(\beta)) \right) \right) \right) \right) \\ &= a^{\pm 1} b \text{Tr}_1 \left(\text{Tr}_2 \left(\cdots \left(\text{Tr}_n \left((\Phi(\beta) \mu^{\otimes n}) \right) \right) \right) \right), \end{aligned}$$

since $\text{Tr}_2(R^{\pm 1}(\text{Id}_V \otimes \mu)) = a^{\pm 1} b \text{Id}_V$ (Definition 2.3 (3)) as depicted in Figure 12. Since $w(\beta \sigma_n^{\pm 1}) = w(\beta) \pm 1$, the invariance under a stabilization follows. \square

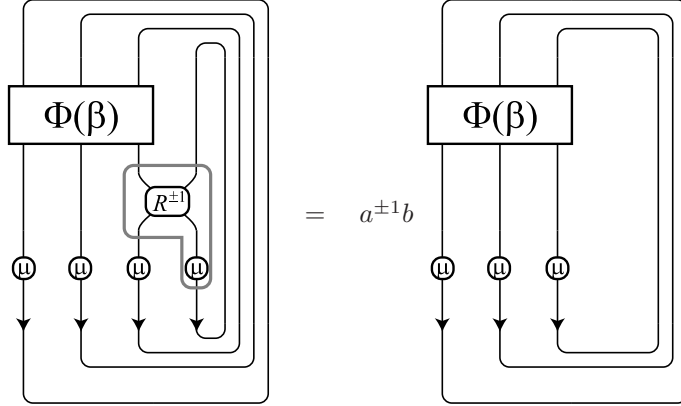

FIGURE 12. invariance under a stabilization

Therefore we can define a link invariant $T_{R, \mu, a, b}(L)$ to be $T_{R, \mu, a, b}(\beta)$ if L is the closure of β .

2.4. Quantum (\mathfrak{g}, V) invariant. One of the important ways to construct an enhanced Yang–Baxter operator is to use a quantum group, which is a deformation of a Lie algebra.

Let \mathfrak{g} be a Lie algebra. Then one can define a quantum group $U_q(\mathfrak{g})$ as a deformation of \mathfrak{g} with q a complex parameter ([4], [12]). Given a representation $\rho: \mathfrak{g} \rightarrow \mathfrak{gl}(V)$ of \mathfrak{g} one can construct an enhanced Yang–Baxter operator. The corresponding invariant is called the quantum (\mathfrak{g}, V) invariant. For details see [36].

To define the colored Jones polynomial we need the Lie algebra $\mathfrak{sl}_2(\mathbb{C})$ and its N -dimensional irreducible representation $\rho_N: \mathfrak{sl}_2(\mathbb{C}) \rightarrow \mathfrak{gl}(V_N)$. The quantum $(\mathfrak{sl}_2(\mathbb{C}), V_N)$ invariant is called the N -dimensional colored Jones polynomial $J_N(L; q)$.

A precise definition is as follows.

Put $V := \mathbb{C}^N$ and define the R -matrix $R: V \otimes V \rightarrow V \otimes V$ by

$$R(e_k \otimes e_l) := \sum_{i,j=0}^{N-1} R_{kl}^{ij} e_i \otimes e_j,$$

where

$$(2.2) \quad R_{kl}^{ij} := \sum_{m=0}^{\min(N-1-i,j)} \delta_{l,i+m} \delta_{k,j-m} \frac{\{l\}! \{N-1-k\}!}{\{i\}! \{m\}! \{N-1-j\}!} \\ \times q^{\binom{i-(N-1)/2}{i-(N-1)/2} \binom{j-(N-1)/2}{j-(N-1)/2} - m(i-j)/2 - m(m+1)/4},$$

with $\{e_0, e_1, \dots, e_{N-1}\}$ is the standard basis of V , $\{m\} := q^{m/2} - q^{-m/2}$ and $\{m\}! := \{1\}\{2\}\cdots\{m\}$. Here q is a complex parameter. A homomorphism $\mu: V \rightarrow V$ is given by

$$\mu(e_j) := \sum_{i=0}^{N-1} \mu_j^i e_i$$

with

$$\mu_j^i := \delta_{i,j} q^{(2i-N+1)/2}.$$

Then it can be shown that $(R, \mu, q^{(N^2-1)/4}, 1)$ gives an enhanced Yang–Baxter operator.

Definition 2.9 (colored Jones polynomial). For an integer $N \geq 1$, put $V := \mathbb{C}^N$ and define R and μ as above. The N -dimensional colored Jones polynomial $J_N(L; q)$ for a link L is defined as

$$J_N(L; q) := T_{(R, \mu, q^{(N^2-1)/4}, 1)}(\beta) \times \frac{\{1\}}{\{N\}},$$

where β is a braid presenting the link L .

Remark 2.10. Note that $J_N(\text{unknot}; q) = 1$ since

$$\text{Tr}_1(\mu) = \sum_{i=0}^{N-1} q^{(2i-N+1)/2} = \frac{\{N\}}{\{1\}}.$$

The two-dimensional colored Jones polynomial $J_2(L; q)$ is (a version) the original Jones polynomial [14] as shown below.

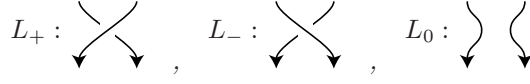

FIGURE 13. skein triple

Lemma 2.11. *Let L_+ , L_- , and L_0 be a skein triple, that is, they are the same links except for a small disk as shown in Figure 13. Then we have the following skein relation:*

$$qJ_2(L_+; q) - q^{-1}J_2(L_-; q) = (q^{1/2} - q^{-1/2})J_2(L_0; q).$$

Proof. By the definition, the R -matrix is given by

$$R = \begin{pmatrix} q^{1/4} & 0 & 0 & 0 \\ 0 & q^{1/4} - q^{-3/4} & q^{-1/4} & 0 \\ 0 & q^{-1/4} & 0 & 0 \\ 0 & 0 & 0 & q^{1/4} \end{pmatrix}$$

with respect to the basis $\{e_0 \otimes e_0, e_0 \otimes e_1, e_1 \otimes e_0, e_1 \otimes e_1\}$ of $V \otimes V$, and μ is given by

$$\mu = \begin{pmatrix} q^{-1/2} & 0 \\ 0 & q^{1/2} \end{pmatrix}$$

with respect to the basis $\{e_0, e_1\}$ of V .

Therefore we can easily see that

$$(2.3) \quad q^{1/4}R - q^{-1/4}R^{-1} = (q^{1/2} - q^{-1/2})\text{Id}_V \otimes \text{Id}_V.$$

Since L_+ , L_- , and L_0 can be presented by n -braids $\beta\sigma_i\beta'$, $\beta\sigma_i^{-1}\beta'$, and $\beta\beta'$ respectively, we have

$$\begin{aligned} & (qJ_2(L_+; q) - q^{-1}J_2(L_-; q)) \times \frac{\{2\}}{\{1\}} \\ &= q \times q^{-3(w(\beta\beta')+1)/4} \text{Tr}_1(\text{Tr}_2(\cdots(\text{Tr}_n(\Phi(\beta\sigma_i\beta')\mu^{\otimes n})))) \\ & \quad - q^{-1} \times q^{-3(w(\beta\beta')-1)/4} \text{Tr}_1(\text{Tr}_2(\cdots(\text{Tr}_n(\Phi(\beta\sigma_i^{-1}\beta')\mu^{\otimes n})))) \\ &= q^{-3w(\beta\beta')/4} \\ & \quad \times \left(q^{1/4} \text{Tr}_1(\text{Tr}_2(\cdots(\text{Tr}_n(\Phi(\beta\sigma_i\beta')\mu^{\otimes n})))) - q^{-1/4} \text{Tr}_1(\text{Tr}_2(\cdots(\text{Tr}_n(\Phi(\beta\sigma_i^{-1}\beta')\mu^{\otimes n})))) \right) \\ &= q^{-3w(\beta\beta')/4} \\ & \quad \times \left\{ \text{Tr}_1(\text{Tr}_2(\cdots(\text{Tr}_n(\Phi(\beta)(\text{Id}_V^{\otimes(i-1)} \otimes q^{1/4}R \otimes \text{Id}_V^{\otimes(n-i-1)})\Phi(\beta')\mu^{\otimes n})))) \right. \\ & \quad \left. - \text{Tr}_1(\text{Tr}_2(\cdots(\text{Tr}_n(\Phi(\beta)(\text{Id}_V^{\otimes(i-1)} \otimes q^{-1/4}R^{-1} \otimes \text{Id}_V^{\otimes(n-i-1)})\Phi(\beta')\mu^{\otimes n})))) \right\} \end{aligned}$$

(from (2.3))

$$= q^{-3w(\beta\beta')/4} (q^{1/2} - q^{-1/2}) \text{Tr}_1(\text{Tr}_2(\cdots(\text{Tr}_n(\Phi(\beta\beta')\mu^{\otimes n}))))$$

$$= (q^{1/2} - q^{-1/2})J_2(L_0; q) \times \frac{\{2\}}{\{1\}},$$

completing the proof. \square

Remark 2.12. The original Jones polynomial $V(L; q)$ satisfies

$$q^{-1}V(L_+; q) - qV(L_-; q) = (q^{1/2} - q^{-1/2})V(L_0; q)$$

[14, Theorem 12]. So we have $J_2(L; q) = (-1)^{\sharp(L)-1}V(L; q^{-1})$, where $\sharp(L)$ denotes the number of components of L .

2.5. Example of calculation. Put $\beta := \sigma_1\sigma_2^{-1}\sigma_1\sigma_2^{-1}$. Its closure E is a knot called the figure-eight knot (Figure 4). We will calculate $J_N(E; q)$.

Instead of calculating $\text{Tr}_1(\text{Tr}_2(\text{Tr}_3(\Phi(\beta)\mu^{\otimes 3}))) \in \mathbb{C}$, we will calculate $\text{Tr}_2(\text{Tr}_3(\Phi(\beta)(\text{Id} \otimes \mu \otimes \mu))) \in \text{End}(V)$, which is a scalar multiple by Schur's lemma (for a proof see [18, Lemma 3.9]). See Figure 14.

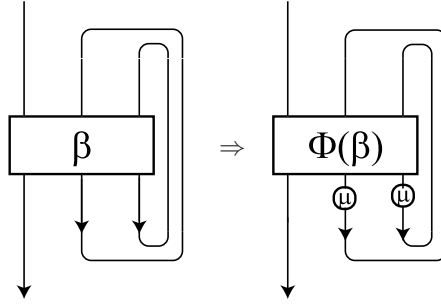

FIGURE 14. We close all the strings except for the first one.

Then $\text{Tr}_1(\text{Tr}_2(\text{Tr}_3(\Phi(\beta)\mu^{\otimes 3})))$ coincides with the trace of μ times the scalar S . Since

$$\begin{aligned} T_{(R, \mu, q^{(N^2-1)/4}, 1)}(\beta) &= q^{-w(\beta)(N^2-1)/4} \text{Tr}_1(\text{Tr}_2(\text{Tr}_3(\Phi(\beta)\mu^{\otimes 3}))) \\ &= q^{-w(\beta)(N^2-1)/4} \text{Tr}_1(S \text{Id}_V) \\ &= q^{-w(\beta)(N^2-1)/4} \sum_{i=0}^{N-1} S q^{(2i-N+1)/2} \\ &= q^{-w(\beta)(N^2-1)/4} \frac{\{N\}}{\{1\}} S, \end{aligned}$$

we have $J_N(L; q) = q^{-w(\beta)(N^2-1)/4} S = S$.

We need an explicit formula for the inverse of the R -matrix, which is given by

$$(2.4) \quad (R^{-1})_{kl}^{ij} = \sum_{m=0}^{\min(N-1-i, j)} \delta_{l, i-m} \delta_{k, j+m} \frac{\{k\}! \{N-1-l\}!}{\{j\}! \{m\}! \{N-1-i\}!} \\ \times (-1)^m q^{-\binom{i-(N-1)/2}{2} - \binom{j-(N-1)/2}{2} - m(i-j)/2 + m(m+1)/4}.$$

To calculate the scalar S , draw a diagram for the braid β and close it except for the first string (Figure 15). Fix a basis $\{e_0, e_1, \dots, e_{N-1}\}$ of \mathbb{C}^N .

Label each arc with a non-negative integer i less than N , which corresponds to a basis element e_i , where our braid diagram is divided into arcs by crossings so that at each crossing four arcs meet. Since the homomorphism $\text{Tr}_2(\text{Tr}_1(\Phi(\beta) \otimes 2))$ is a scalar multiple, we choose any basis for the first (top-left) arc of Figure 15 and

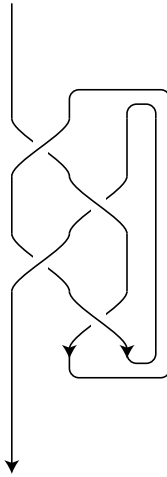

FIGURE 15. Draw the braid $\sigma_1 \sigma_2^{-1} \sigma_1 \sigma_2^{-1}$ and close it except for the left-most one.

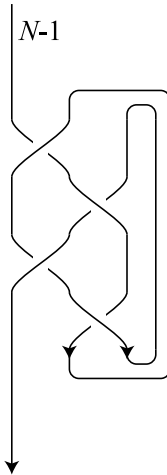

FIGURE 16. Label the first (top-left) arc with $N - 1$.

calculate the scalar. For simplicity we choose e_{N-1} and so we label the first arc with $N - 1$ (Figure 16).

Recall that we will associate the R -matrix or its inverse with each crossing as follows.

$$\begin{array}{c} i & j \\ \diagdown & / \\ k & l \end{array} \Rightarrow R_{kl}^{ij}, \quad \begin{array}{c} i & j \\ / & \diagdown \\ k & l \end{array} \Rightarrow (R^{-1})_{kl}^{ij}$$

Therefore we will label the other arcs following the following two rules:

- (i). At a positive crossing, the top-left label is less than or equal to the bottom-right label, the top-right label is greater than or equal to the bottom-left label, and their differences coincide (see (2.2)).

$$\begin{array}{c}
 i \quad j \\
 \swarrow \quad \searrow \\
 \downarrow \quad \downarrow \\
 k \quad l
 \end{array}
 : i + j = k + l, l \geq i, k \leq j,$$

- (ii). At a negative crossing, the top-left label is greater than or equal to the bottom-right label, the top-right label is less than or equal to the bottom-left label, and their differences coincide (see (2.4)).

$$\begin{array}{c}
 i \quad j \\
 \searrow \quad \swarrow \\
 \downarrow \quad \downarrow \\
 k \quad l
 \end{array}
 : i + j = k + l, l \leq i, k \geq j.$$

From Rule (i), the next arc should be labeled with $N - 1$, and the difference at the top crossing is 0 (Figure 17). This is why we chose $N - 1$ for the label of the first arc.

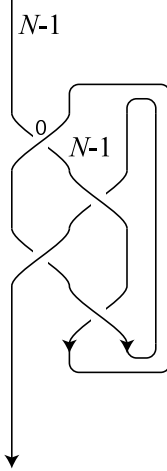

FIGURE 17. The label of the next arc should be $N - 1$, and the difference at the top crossing is 0

Label the top-right arc with i with $0 \leq i \leq N - 1$ (Figure 18).

The label of the left-middle arc should be i since the difference at the top crossing is 0.

Label the arcs indicated in Figure 20 with j and k with $0 \leq j \leq N - 1$ and $0 \leq k \leq N - 1$. Then the difference at the second top crossing is $N - k - 1$. Therefore the arc between the second top crossing and the second bottom crossing should be labeled with $N - k + j - 1$ from Rule (ii) (Figure 21). Since the label should be less than N , we have $j - k \leq 0$.

Look at the bottom-most crossing and apply Rule (ii). We see that $i \geq k$ and the difference at the bottom-most crossing is $i - k$. So the label of the arc between the second bottom crossing and the bottom-most crossing is $i + j - k$ (Figure 22). We also see that the label of the bottom-most arc is $N - 1$ as we expected.

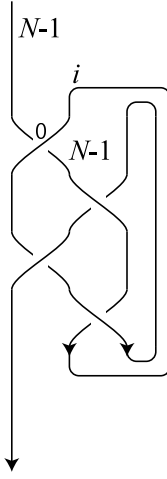

FIGURE 18. Label the top-right arc with i ($0 \leq i \leq N - 1$).

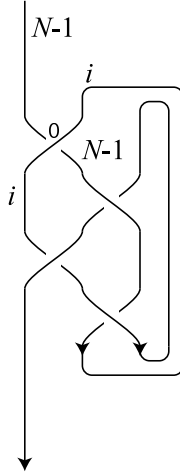

FIGURE 19. The label of the left-middle arc should be i since the difference at the top crossing is 0.

However from Rule (i) we have $j - k \geq 0$ and so $k = j$. Therefore we finally have the labeling as indicated in Figure 23.

Now we can calculate the colored Jones polynomial. We have

$$\begin{aligned}
 J_N(E; q) &= \sum_{i \geq j} R_{i, N-1}^{N-1, i} (R^{-1})_{N-1, j}^{N-1, j} R_{N-1, i}^{i, N-1} (R^{-1})_{i, j}^{i, j} \mu_j^j \mu_i^i \\
 &= \sum_{i \geq j} (-1)^{N-1+i} \frac{\{N-1\}! \{i\}! \{N-1-j\}!}{(\{j\}!)^2 \{i-j\}! \{N-1-i\}!} \\
 &\quad \times q^{(-i-i^2-2ij-2j^2+3N+6Ni+2Nj-3N^2)/4}.
 \end{aligned}$$

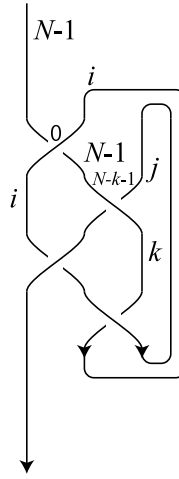

FIGURE 20. Choose j and k . Then the difference at the second top crossing is $N - k - 1$.

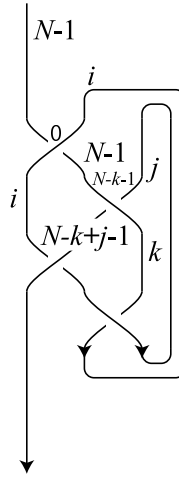

FIGURE 21. The label of the arc between the second top arc and the second bottom arc should be $N - k + j - 1$. Note that $j - k \leq 0$.

In this formula we need two summations. To get a formula involving only one summation we regard the figure-eight knot E as the closure of a tangle as shown in Figure 24. In this case we need to put μ at each local minimum where the arc goes from left to right, and μ^{-1} at each local maximum where the arc goes from right to left. See [18, Theorem 3.6] for details.

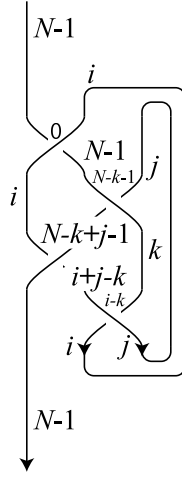

FIGURE 22. The label of the arc between the second bottom crossing and the bottom-most crossing should be $i + j - k$. Note that $j - k \geq 0$

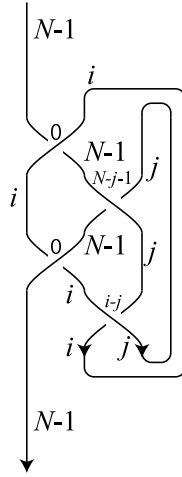

FIGURE 23. The label k should coincide with i .

From Figure 14, we have

$$\begin{aligned}
 & J_N(E; q) \\
 = & \sum_{\substack{0 \leq i \leq N-1, 0 \leq j \leq N-1 \\ 0 \leq i+j \leq N-1}} R_{0,i}^{i,0} (R^{-1})_{i+j,0}^{i,j} R_{i,j}^{0,i+j} (R^{-1})_{0,j}^{j,0} (\mu^{-1})_i^i \mu_j^j \\
 = & \sum_{\substack{0 \leq i \leq N-1, 0 \leq j \leq N-1 \\ 0 \leq i+j \leq N-1}} (-1)^i \frac{\{i+j\}!\{N-1\}!}{\{i\}!\{j\}!\{N-1-i-j\}!} q^{-(N-1)i/2+(N-1)j/2-i^2/4+j^2/4-3i/4+3j/4}.
 \end{aligned}$$

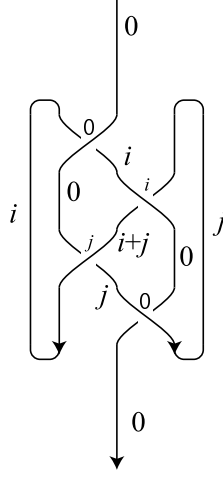

FIGURE 24. The figure-eight knot can also be regarded as the closure of a $(1, 1)$ -tangle.

Putting $k := i + j$, we have

$$J_N(E; q) = \sum_{k=0}^{N-1} \frac{\{N-1\}!}{\{N-1-k\}!} q^{k^2/4 + Nk/2 + k/4} \left(\sum_{i=0}^k (-1)^i \frac{\{k\}!}{\{i\}!\{k-i\}!} q^{-Ni - ik/2 - i/2} \right).$$

Using the formula (see [28, Lemma 3.2])

$$\sum_{i=0}^k (-1)^i q^{li/2} \frac{\{k\}!}{\{i\}!\{k-i\}!} = \prod_{g=1}^k (1 - q^{(l+k+1)/2 - g}),$$

we have the following simple formula with only one summand, which is due to Habiro and Lê (I learned this method from Lê).

$$(2.5) \quad J_N(E; q) = \frac{1}{\{N\}} \sum_{k=0}^{N-1} \frac{\{N+k\}!}{\{N-1-k\}!}.$$

3. VOLUME CONJECTURE

In this section we state the Volume Conjecture and then prove it for the figure-eight knot. We also give supporting evidence for the conjecture.

3.1. Statement of the Volume Conjecture. In [15] Kashaev introduced a link invariant $\langle L \rangle_N \in \mathbb{C}$ for an integer N greater than one and a link L by using the quantum dilogarithm. Then he observed in [16] that the limit $2\pi \lim_{N \rightarrow \infty} \log |\langle K \rangle_N|/N$ is equal to the hyperbolic volume of the knot complement if a knot K is hyperbolic. Here a knot in the three-sphere S^3 is called hyperbolic if its complement possesses a complete hyperbolic structure with finite volume. He also conjectured this would also hold for any hyperbolic knot.

In [28] J. Murakami and I proved that Kashaev's invariant equals the N -dimensional colored Jones polynomial evaluated at the N -th root of unity, that is, $\langle L \rangle_N = J_N(L; \exp(2\pi\sqrt{-1}/N))$ and proposed that Kashaev's conjecture would hold for any knot by using the simplicial volume.

Conjecture 3.1 (Volume Conjecture [16, 28]). *The following equality would hold for any knot K .*

$$2\pi \lim_{N \rightarrow \infty} \frac{\log |J_N(K; \exp(2\pi\sqrt{-1}/N))|}{N} = \text{Vol}(S^3 \setminus K).$$

To define the simplicial volume (or Gromov norm), we introduce the Jaco–Shalen–Johannson (JSJ) decomposition (or the torus decomposition) of a knot complement.

Definition 3.2 (Jaco–Shalen–Johannson decomposition [11, 13]). Let K be a knot. Then its complement $S^3 \setminus K$ can be uniquely decomposed into hyperbolic pieces and Seifert fibered pieces by a system of tori:

$$S^3 \setminus K = \left(\bigsqcup H_i \right) \sqcup \left(\bigsqcup E_j \right)$$

with H_i hyperbolic and E_j Seifert-fibered.

Then the simplicial volume of the knot complement is defined to be the sum of the hyperbolic volumes of the hyperbolic pieces.

Definition 3.3 (Simplicial volume (Gromov norm) [7]). If a knot complement $S^3 \setminus K$ is decomposed as above, then its simplicial volume $\text{Vol}(S^3 \setminus K)$ is defined as

$$\text{Vol}(S^3 \setminus K) := \sum_{H_i: \text{hyperbolic piece}} \text{Hyperbolic Volume of } H_i.$$

Example 3.4. Let us consider the (2,1)-cable of the figure-eight knot as shown in figure 25. Then its complement can be decomposed by a torus into two pieces

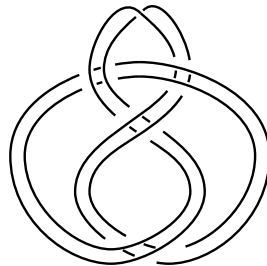

FIGURE 25. (2,1)-cable of the figure-eight knot

(Figure 26), one hyperbolic and one Seifert fibered. Therefore we have

$$\text{Vol} \left(\left(\text{Figure 25} \right) \right) = \text{Vol} \left(\left(\text{Figure 26} \right) \right).$$

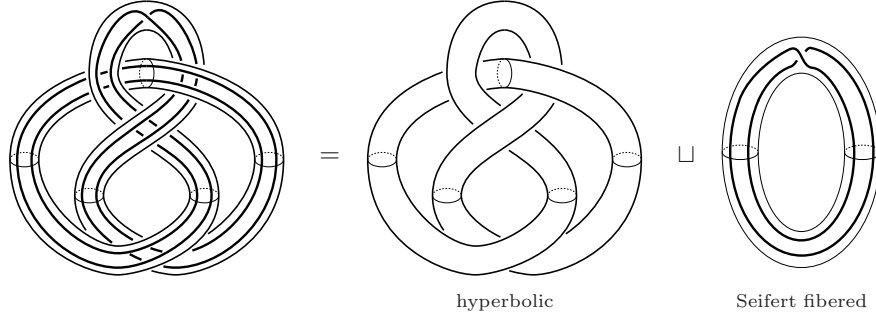

FIGURE 26. The JSJ decomposition of the $(2,1)$ -cable of the figure-eight knot

3.2. Proof of the Volume Conjecture for the figure-eight knot. We give a proof of the Volume Conjecture for the figure-eight knot due to T. Ekhholm.

3.2.1. Calculation of the limit. We use the formula (2.5) of the colored Jones polynomial for the figure-eight knot E due to Habiro and Lê. (See [8, 21] for Habiro's method.) By a simple calculation using it, we have

$$(3.1) \quad J_N(E; q) = \sum_{j=0}^{N-1} \prod_{k=1}^j \left(q^{(N-k)/2} - q^{-(N-k)/2} \right) \left(q^{(N+k)/2} - q^{-(N+k)/2} \right).$$

Replacing q with $\exp(2\pi\sqrt{-1}/N)$, we have

$$J_N(E; \exp(2\pi\sqrt{-1}/N)) = \sum_{j=0}^{N-1} \prod_{k=1}^j f(N; k)$$

where we put $f(N; k) := 4 \sin^2(k\pi/N)$. The graph of $f(N; k)$ is depicted in Figure 27.

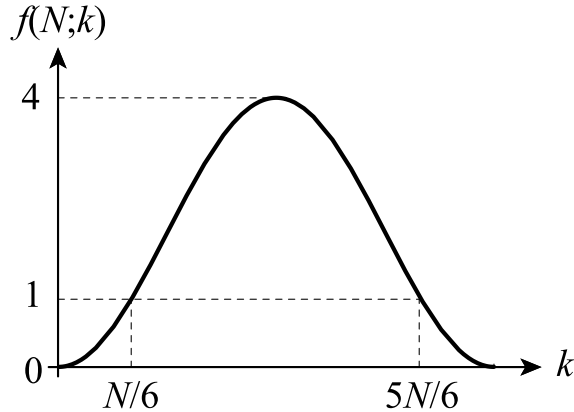

FIGURE 27. Graph of $f(N; k)$

Put $g(N; j) := \prod_{k=1}^j f(N; k)$ so that $J_N(E; \exp(2\pi\sqrt{-1}/N)) = \sum_{j=0}^{N-1} g(N; j)$. Then $g(N; j)$ decreases when $0 < j < N/6$ and $5N/6 < j$, and increases when

$N/6 < j < 5N/6$. Therefore $g(N; j)$ takes its maximum at $j = 5N/6$. (To be precise we need to take the integer part of $5N/6$.) See Table 1. Since there are N

j	0	...	$N/6$...	$5N/6$...	1
$f(N; k)$		< 1	1	> 1	1	< 1	
$g(N; j)$	1	\searrow		\nearrow	maximum	\searrow	

TABLE 1. table of $f(N; k)$ and $g(N; j)$

positive terms in $J_N(E; \exp(2\pi\sqrt{-1}/N)) = \sum_{j=0}^{N-1} g(N; j)$ and $g(N; 5N/6)$ is the maximum of these terms, we have

$$g(N; 5N/6) \leq J_N(E; \exp(2\pi\sqrt{-1}/N)) \leq N \times g(N; 5N/6).$$

Noting that each side is positive, we take their logarithms and divide them by N .

$$\frac{\log g(N; 5N/6)}{N} \leq \frac{\log J_N(E; \exp(2\pi\sqrt{-1}/N))}{N} \leq \frac{\log N}{N} + \frac{\log g(N; 5N/6)}{N}.$$

Since $\lim_{N \rightarrow \infty} (\log N)/N = 0$, we have

$$\lim_{N \rightarrow \infty} \frac{\log g(N; 5N/6)}{N} \leq \lim_{N \rightarrow \infty} \frac{\log J_N(E; \exp(2\pi\sqrt{-1}/N))}{N} \leq \lim_{N \rightarrow \infty} \frac{\log g(N; 5N/6)}{N}.$$

Therefore we have

$$\lim_{N \rightarrow \infty} \frac{\log J_N(E; \exp(2\pi\sqrt{-1}/N))}{N} = \lim_{N \rightarrow \infty} \frac{\log g(N; 5N/6)}{N}.$$

We can calculate the limit $\lim_{N \rightarrow \infty} (\log g(N; 5N/6))/N$ by integration. Since $g(N; j) = \prod_{k=1}^j f(N; k)$, we have

$$\begin{aligned} \lim_{N \rightarrow \infty} \frac{\log g(N; 5N/6)}{N} &= \lim_{N \rightarrow \infty} \frac{1}{N} \sum_{k=1}^{5N/6} \log f(N; k) \\ (3.2) \qquad &= 2 \lim_{N \rightarrow \infty} \frac{1}{N} \sum_{k=1}^{5N/6} \log(2 \sin(k\pi/N)) \\ &= \frac{2}{\pi} \int_0^{5\pi/6} \log(2 \sin x) dx. \end{aligned}$$

What does this mean? I will explain a geometric interpretation of this integral.

3.2.2. Lobachevsky function. The function defined by the integral in (3.2) is known as the Lobachevsky function. More precisely, we define the Lobachevsky function $\Lambda(\theta)$ as

$$\Lambda(\theta) := - \int_0^\theta \log |2 \sin x| dx$$

for $\theta \in \mathbb{R}$. By using this function, we can express the limit of the colored Jones polynomial as

$$(3.3) \qquad \lim_{N \rightarrow \infty} \frac{\log J_N(E; \exp(2\pi\sqrt{-1}/N))}{N} = -\frac{2}{\pi} \Lambda(5\pi/6)$$

We show some properties of the Lobachevsky function (see for example [23]).

Lemma 3.5. *The Lobachevsky function satisfies the following two properties.*

- (1) The Lobachevsky function is an odd function and has period π .
 (2) We have $\Lambda(2\theta) = 2\Lambda(\theta) + 2\Lambda(\theta + \pi/2)$. In general we have $\Lambda(n\theta) = n \sum_{k=1}^{n-1} \Lambda(\theta + k\pi/n)$.

Proof. The first property is easily shown by the periodicity of the sine function.

To prove the second, we use the double angle formula of the sine function: $\sin(2x) = 2 \sin x \cos x$. We have

$$\log |2 \sin(2x)| = \log |2 \sin x| + \log |2 \cos x| = \log |2 \sin x| + \log |2 \sin(x + \pi/2)|,$$

completing the proof. \square

From (1) we have

$$\Lambda(5\pi/6) = \Lambda(-\pi/6) = -\Lambda(\pi/6).$$

From (2) and (1) we also have

$$\Lambda(\pi/3) = 2\Lambda(\pi/6) + 2\Lambda(2\pi/3) = 2\Lambda(\pi/6) - 2\Lambda(\pi/3).$$

Therefore we have

$$\Lambda(5\pi/6) = -\frac{3}{2}\Lambda(\pi/3).$$

Returning to the limit of the Jones polynomial (3.3), we conclude that

$$2\pi \lim_{N \rightarrow \infty} \frac{\log J_N(E; \exp(2\pi\sqrt{-1}/N))}{N} = 6\Lambda(\pi/3).$$

Next we show how the Lobachevsky function is related to hyperbolic geometry.

3.2.3. Hyperbolic geometry. It is well known that the complement of the figure-eight knot can be decomposed into two ideal hyperbolic regular tetrahedra.

Theorem 3.6 (W. Thurston [34]). *The complement of the figure-eight knot can be obtained by gluing two ideal hyperbolic regular tetrahedra.*

I will explain what is an ideal hyperbolic regular tetrahedron later. Topologically, the theorem states that the complement of the figure-eight knot can be obtained by gluing two truncated tetrahedra as in Figure 28 (see also [24]). In Figure 28 we identify A with A' , B with B' , C with C' and D with D' . Note that edges with single arrows and edges with double arrows are also identified respectively.

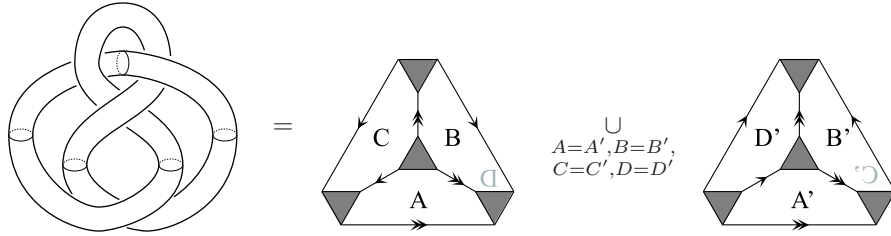

FIGURE 28. The complement of the figure-eight knot is decomposed into two ideal hyperbolic regular tetrahedra. Shaded triangles make the boundary of the knot complement.

Here I give a short introduction to hyperbolic geometry.

First consider the upper half space $\{(x, y, z) \in \mathbb{R}^3 \mid z > 0\}$ with hyperbolic metric $ds := \sqrt{dx^2 + dy^2 + dz^2}/z$ and denote it by \mathbb{H}^3 . It is known that a geodesic

line in \mathbb{H}^3 is a semicircle or a straight line perpendicular to the xy -plane, and that a geodesic plane is a hemisphere or a flat plane perpendicular to the xy -plane.

An ideal hyperbolic tetrahedron is a tetrahedron in \mathbb{H}^3 with geodesic faces with four vertices at infinity, that is, on the xy -plane or at the point at infinity ∞ . By isometry we may assume that one vertex is ∞ and the other three are on the xy -plane. So its faces consist of three perpendicular planes and a hemisphere as shown in Figure 29. If we see the tetrahedron from the top, it is a (Euclidean)

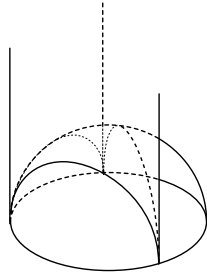

FIGURE 29. An ideal hyperbolic tetrahedron is the part above the hemisphere surrounded by three perpendicular planes.

triangle with angles α , β , and γ . It is known that an ideal hyperbolic tetrahedron

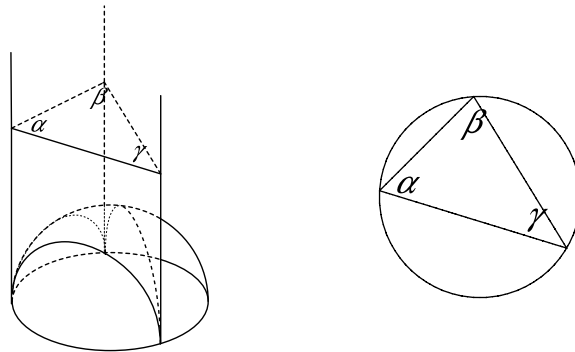

FIGURE 30. A top view (right) of the ideal hyperbolic tetrahedron (left)

is defined (up to isometry) by the similarity class of this triangle. Therefore we can parametrize an ideal hyperbolic tetrahedron by a triple of positive numbers (α, β, γ) with $\alpha + \beta + \gamma = \pi$. We denote it by $\Delta(\alpha, \beta, \gamma)$.

The hyperbolic volume $\text{Vol}(\Delta(\alpha, \beta, \gamma))$ can be expressed by using the Lobachevsky function $\Lambda(\theta)$. In fact it can be shown that

$$\text{Vol}(\Delta(\alpha, \beta, \gamma)) = \Lambda(\alpha) + \Lambda(\beta) + \Lambda(\gamma).$$

For a proof, see for example [34, Chapter 7].

Now we return to the decomposition of the figure-eight knot complement. Figure 28 shows that after identification we have two edges, edge with single arrow and edge with double arrow, each of them is obtained by identifying six edges. So if the ideal hyperbolic tetrahedra we are using are regular, that is, isometric to $\Delta(\pi/3, \pi/3, \pi/3)$ then the sum of dihedral angles around each edge becomes

2π . This means that if we use two ideal hyperbolic regular tetrahedra, our gluing is geometric, that is, the complement of the figure-eight knot is isometric to the union of two copies of $\Delta(\pi/3, \pi/3, \pi/3)$. In particular its volume equals $2 \text{Vol}(\Delta(\pi/3, \pi/3, \pi/3)) = 6\Lambda(\pi/3)$.

Thus we have proved

$$2\pi \lim_{N \rightarrow \infty} \frac{\log J_N(E; \exp(2\pi\sqrt{-1}/N))}{N} = 6\Lambda(\pi/3) = \text{Vol}(S^3 \setminus E),$$

which is the statement of the Volume Conjecture for the figure-eight knot.

3.3. Knots and links for which the Volume Conjecture is proved. As far as I know the Volume Conjecture is proved for

- (1) figure-eight knot by Ekholm,
- (2) 5_2 knot by Kashaev and Yokota,
- (3) Whitehead doubles of torus knots by Zheng [43],
- (4) torus knots by Kashaev and Tirkkonen [17],
- (5) torus links of type $(2, 2m)$ by Hikami [9],
- (6) knots and links with volume zero by van der Veen [37],
- (7) Borromean rings by Garoufalidis and Lê [6],
- (8) twisted Whitehead links by Zheng [43],
- (9) Whitehead chains by van der Veen [38],
- (10) a satellite link around the figure-eight knot with pattern the Whitehead link by Yamazaki and Yokota [39].

Note that (1) and (2) are for hyperbolic knots, (3) is for a knot whose JSJ decomposition consists of a hyperbolic piece and a Seifert fibered piece, (4)–(6) are for knots and links only with Seifert pieces, (7)–(9) are for hyperbolic links, and (10) is for a link whose JSJ decomposition consists of a hyperbolic piece and a Seifert fibered piece.

4. SUPPORTING EVIDENCE FOR THE VOLUME CONJECTURE

The Volume Conjecture is proved only for several knots and links but I think it is true possibly with some modification; for example we may need to replace the limit with the limit superior (see [38, Conjecture 2]). In this section I will explain why I think it is true.

Remark 4.1 (Caution!). Descriptions in this section are *not rigorous*.

4.1. Approximation of the colored Jones polynomial. Put $\xi_N := \exp(2\pi\sqrt{-1}/N)$ and I will give an interpretation of the R -matrix used to define the colored Jones polynomial. From (2.2) and (2.4) we have

$$(4.1) \quad \begin{aligned} R_{kl}^{ij} \Big|_{q=\xi_N} &= \sum_m (\text{a power of } \xi_N) \times \delta_{l, i+m} \delta_{k, j-m} \frac{\{l\}! \{N-1-k\}!}{\{i\}! \{m\}! \{N-1-j\}!}, \\ (R^{-1})_{kl}^{ij} \Big|_{q=\xi_N} &= \sum_m (\text{a power of } \xi_N) \times \delta_{l, i-m} \delta_{k, j+m} \frac{\pm \{k\}! \{N-1-l\}!}{\{j\}! \{m\}! \{N-1-i\}!}. \end{aligned}$$

Since

$$\{k\}! \Big|_{q=\xi_N} = (2\sqrt{-1})^k \sin(\pi/N) \sin(2\pi/N) \cdots \sin(k\pi/N),$$

we have

$$\begin{aligned}
& \{k\}!\{N-k-1\}! \Big|_{q:=\xi_N} \\
&= (2\sqrt{-1})^{N-1} \sin(\pi/N) \sin(2\pi/N) \cdots \sin(k\pi/N) \\
&\quad \times \sin((N-(k+1))\pi/N) \sin((N-(k+2))\pi/N) \cdots \sin((N-(N-1))\pi/N) \\
&= (-1)^{N-k-1} (\sqrt{-1})^{N-1} 2^{N-1} \sin(\pi/N) \sin(2\pi/N) \cdots \sin((N-1)\pi/N) \\
&= \varepsilon N
\end{aligned}$$

for $\varepsilon \in \{1, -1, \sqrt{-1}, -\sqrt{-1}\}$. For the last equality, see for example [28]. So if we put

$$\begin{aligned}
(\xi_N)_{k+} &:= (1 - \xi_N) \cdots (1 - \xi_N^k), \\
(\xi_N)_{k-} &:= (1 - \xi_N) \cdots (1 - \xi_N^{N-1-k}),
\end{aligned}$$

we have

$$\begin{aligned}
\{k\}! \Big|_{q:=\xi_N} &= (\text{a power of } \xi_N) \times (\xi_N)_{k+}, \\
\{N-1-k\}! \Big|_{q:=\xi_N} &= (\text{a power of } \xi_N) \times (\xi_N)_{k-}
\end{aligned}$$

and

$$(\xi_N)_{k+} (\xi_N)_{k-} = (\text{a power of } \xi_N) \times N.$$

Therefore from (4.1) the R -matrix and its inverse can be written as

$$\begin{aligned}
R_{kl}^{ij} \Big|_{q:=\xi_N} &= \sum_m \delta_{l,i+m} \delta_{k,j-m} \frac{(\text{a power of } \xi_N) \times N^2}{(\xi_N)_{m+} (\xi_N)_{i+} (\xi_N)_{k+} (\xi_N)_{j-} (\xi_N)_{l-}}, \\
(R^{-1})_{kl}^{ij} \Big|_{q:=\xi_N} &= \sum_m \delta_{l,i-m} \delta_{k,j+m} \frac{(\text{a power of } \xi_N) \times N^2}{(\xi_N)_{m+} (\xi_N)_{i-} (\xi_N)_{k-} (\xi_N)_{j+} (\xi_N)_{l+}}.
\end{aligned}$$

If we are given a knot K , we express it as a closed braid and calculate the colored Jones polynomial as described in §2.5. Then we have

$$\begin{aligned}
(4.2) \quad J_N(K; \xi_N) &= \sum_{\text{labelings}} \left(\prod_{\text{crossings}} (R^{\pm 1})_{kl}^{ij} \right) \\
&= \sum_{\text{labelings}} \left(\prod_{\text{crossings}} \frac{(\text{a power of } \xi_N) \times N^2}{(\xi_N)_{m+} (\xi_N)_{i\pm} (\xi_N)_{k\pm} (\xi_N)_{j\mp} (\xi_N)_{l\mp}} \right),
\end{aligned}$$

where the summation is over all the labelings with $\{0, 1, \dots, N-1\}$ corresponding to the basis $\{e_0, e_1, \dots, e_{N-1}\}$ and for a fixed labeling the product is over all the crossings, each of which corresponds to an entry R_{kl}^{ij} (or $(R^{-1})_{kl}^{i,j}$, respectively), determined by the four labeled arcs around the vertex, of the R -matrix (or its inverse, respectively).

We will approximate $(\xi_N)_{k+}$ for large N . By taking the logarithm, we have

$$\begin{aligned} \log(\xi_N)_{k+} &= \sum_{j=1}^k \log(1 - \xi_N^j) \\ &= \sum_{j=1}^k \log(1 - \exp(2\pi\sqrt{-1}j/N)). \end{aligned}$$

Putting $x := j/N$, we may replace the summation with the following integral for large N (this is *not rigorous*!).

$$\begin{aligned} \log(\xi_N)_{k+} &\underset{N \rightarrow \infty}{\approx} N \int_0^{k/N} \log(1 - \exp(2\pi\sqrt{-1}x)) dx \\ &= \frac{N}{2\pi\sqrt{-1}} \int_1^{\exp(2\pi\sqrt{-1}k/N)} \frac{\log(1-y)}{y} dy, \end{aligned}$$

where we put $y := \exp(2\pi\sqrt{-1}x)$ in the last equality and $\underset{N \rightarrow \infty}{\approx}$ means a very rough approximation (which may be not true at all) for large N .

This integral is known as the dilogarithm function. We put

$$\text{Li}_2(z) := - \int_0^z \frac{\log(1-y)}{y} dy$$

for $z \in \mathbb{C} \setminus [1, \infty)$. This is called dilogarithm since it has the Taylor expansion for $|z| < 1$ as

$$\sum_{n=1}^{\infty} \frac{z^n}{n^2}.$$

For more details about this function, see for example [42].

So by using the dilogarithm function, we have the following approximation:

$$\log(\xi_N)_{k+} \underset{N \rightarrow \infty}{\approx} \frac{N}{2\pi\sqrt{-1}} [\text{Li}_2(1) - \text{Li}_2(\xi_N^k)].$$

Since $\text{Li}_2(1)$, which equals $\zeta(2) = \pi^2/6$ ($\zeta(z)$ is the Riemann zeta function), can be ignored for large N , we have

$$(\xi_N)_{k+} \underset{N \rightarrow \infty}{\approx} \exp \left[-\frac{N}{2\pi\sqrt{-1}} \text{Li}_2(\xi_N^k) \right].$$

Similarly we have

$$(\xi_N)_{k-} \underset{N \rightarrow \infty}{\approx} \exp \left[-\frac{N}{2\pi\sqrt{-1}} \text{Li}_2(\xi_N^{-k}) \right].$$

Therefore from (4.2) the colored Jones polynomial can be (roughly) approximated as follows.

$$(4.3) \quad J_N(K; \xi_N) \underset{N \rightarrow \infty}{\approx} \sum_{\text{labelings}} \exp \left[\frac{N}{2\pi\sqrt{-1}} \times \left(\sum_{\text{crossings}} \left\{ \text{Li}_2(\xi_N^m) + \text{Li}_2(\xi_N^{\pm i}) + \text{Li}_2(\xi_N^{\mp j}) + \text{Li}_2(\xi_N^{\pm k}) + \text{Li}_2(\xi_N^{\mp l}) + \log \text{ terms} \right\} \right) \right],$$

where the log terms come from powers of ξ_N and N .

Since the term

$$(4.4) \quad \sum_{\text{crossings}} \left\{ \text{Li}_2(\xi_N^m) + \text{Li}_2(\xi_N^{\pm i}) + \text{Li}_2(\xi_N^{\mp j}) + \text{Li}_2(\xi_N^{\pm k}) + \text{Li}_2(\xi_N^{\mp l}) + \log \text{ terms} \right\}$$

can be regarded as a function of $\xi_N^{i_1}, \xi_N^{i_2}, \dots, \xi_N^{i_c}$ with i_1, i_2, \dots, i_c labelings of arcs, we can write it as $V(\xi_N^{i_1}, \xi_N^{i_2}, \dots, \xi_N^{i_c})$. Note that m can be expressed as a difference of two such labelings. So we have

$$(4.5) \quad J_N(K; \xi_N) \underset{N \rightarrow \infty}{\approx} \sum_{i_1, i_2, \dots, i_c} \exp \left[\frac{N}{2\pi\sqrt{-1}} V(\xi_N^{i_1}, \xi_N^{i_2}, \dots, \xi_N^{i_c}) \right].$$

We want to apply a method used in the proof for the figure-eight knot in §3.2. Recall that the point of the proof is to find the maximum term of the summand because the maximum dominates the asymptotic behavior. We will seek for the “maximum” term of the summation in (4.5).

To do that we first approximate this with the following integral:

$$(4.6) \quad J_N(K; \xi_N) \underset{N \rightarrow \infty}{\approx} \int_{J_1} \int_{J_2} \cdots \int_{J_c} \exp \left[\frac{N}{2\pi\sqrt{-1}} V(z_1, z_2, \dots, z_c) \right] dz_1 dz_2 \cdots dz_c,$$

where z_d corresponds to $\xi_N^{i_d}$ and J_1, J_2, \dots, J_c are certain contours. (The argument here is not rigorous. In particular I do not know how to choose the contours.)

Then we will find the maximum of the absolute value of the integrand. To be more precise we apply the steepest descent method. For a precise statement, see for example [20, Theorem 7.2.9]).

Theorem 4.2 (steepest descent method). *Under certain conditions for the functions f, g , and a contour C , we have*

$$\int_C g(z) \exp(N h(z)) dz \underset{N \rightarrow \infty}{\approx} \frac{\exp(N h(z_0)) \sqrt{2\pi} g(z_0)}{\sqrt{N} \sqrt{-h''(z_0)}} \underset{N \rightarrow \infty}{\approx} \exp(N h(z_0)),$$

where $h'(z_0) = 0$ and $\text{Re}(h(z))$ takes its positive maximum at z_0 .

Note that the symbol $\underset{N \rightarrow \infty}{\approx}$ means that the ratio of both sides converges to 1 when $N \rightarrow \infty$ and that we ignore the constant term and \sqrt{N} in the rough approximation $\underset{N \rightarrow \infty}{\approx}$ because $\exp(N h(z_0))$ grows exponentially when $N \rightarrow \infty$. (Recall that we want to know the limit of $\log |J_N(K, \xi_N)|/N$ and so polynomial terms will not matter.)

Remark 4.3. In general, to apply the steepest descent method, we need to change the contour C so that it passes through z_0 .

Now we apply (a multidimensional version of) this method to (4.6) and we will find the the maximum of $\{\text{Im } V(z_1, \dots, z_c) \mid (z_1, z_2, \dots, z_c) \in J_1 \times J_2 \cdots \times J_c\}$. Let (x_1, x_2, \dots, x_c) be such a point. Then we have

$$(4.7) \quad J_N(K; \xi_N) \underset{N \rightarrow \infty}{\approx} \exp \left[\frac{N}{2\pi\sqrt{-1}} V(x_1, x_2, \dots, x_c) \right]$$

and so we finally have

$$(4.8) \quad 2\pi\sqrt{-1} \lim_{N \rightarrow \infty} \frac{\log J_N(K; \xi_N)}{N} = V(x_1, x_2, \dots, x_c).$$

Note that the point (x_1, x_2, \dots, x_c) is a solution to the following equation:

$$(4.9) \quad \frac{\partial V}{\partial z_d}(z_1, z_2, \dots, z_c) = 0$$

for $d = 1, 2, \dots, c$.

Remember that our argument here is far from rigor! Especially I am cheating on the following points:

- Replacing a summation with an integral in (4.6). Here we do not know how to choose the multidimensional contour.
- Applying the steepest descent method in (4.7). In general, we have many solutions to the system of equations (4.9) but we do not know which solution gives the maximum. Moreover we may need to change the contour so that it passes through the solution that gives the maximum but we do not know whether this is possible or not.

4.2. Geometric interpretation of the limit. In this subsection I will give a geometric interpretation of the limit (4.8).

Since $V(z_1, z_2, \dots, z_c)$ is the sum of the terms as in (4.4), we first describe a geometric meaning of $\text{Li}_2(\zeta_N^{\pm i})$.

Recall that an ideal hyperbolic tetrahedron can be put in \mathbb{H}^3 . Regarding the xy -plane as the complex plain, we can assume that the three of the four (ideal) vertices are at 0, 1 and $z \in \mathbb{C}$ ($\text{Im } z > 0$), respectively (Figure 31). Thus the set

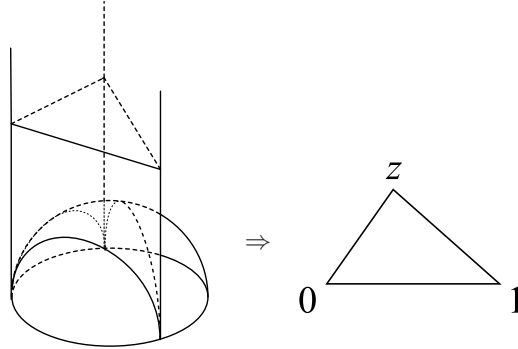

FIGURE 31. Parametrization of ideal hyperbolic tetrahedra

$\{z \in \mathbb{C} \mid \text{Im } z > 0\}$ gives a parametrization of ideal hyperbolic tetrahedra. We denote by $\Delta(z)$ the hyperbolic tetrahedron parametrized by z .

The volume of $\Delta(z)$ is given as follows (see for example [31, p. 324]):

$$(4.10) \quad \text{Vol}(\Delta(z)) = \text{Im } \text{Li}_2(z) + \log |z| \arg(1 - z).$$

So we expect $V(x_1, x_2, \dots, x_c)$ gives the sum of the volumes of certain tetrahedra related to the knot.

In fact we can express the volume of the knot complement in terms of $V(z_1, z_2, \dots, z_c)$ [33, 40].

We follow [33] to describe this.

We decompose the knot complement into topological, truncated tetrahedra. To do this we put an octahedron at each positive crossing as in Figure 32, where i , j , k and l are labeling of the four arcs around the vertex. Then decompose the

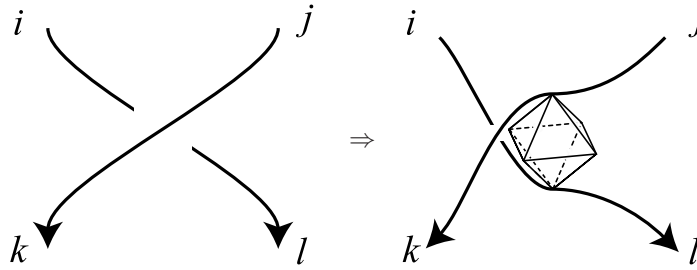

FIGURE 32. An octahedron put at a crossing

octahedron into five tetrahedra as in Figure 33, where the four of them are decorated with $\xi_N^i, \xi_N^{-j}, \xi_N^k$ and ξ_N^{-l} , respectively and the one in the center is decorated with ξ_N^m , where $m := l - i = j - k$. Here each truncated tetrahedron is just a topological one with some decoration.

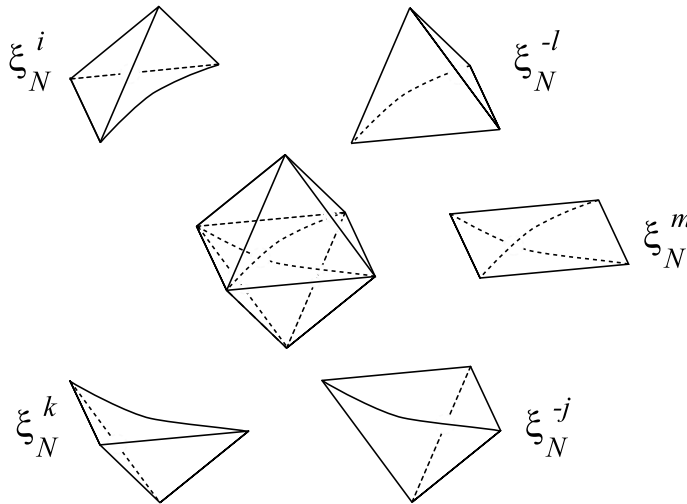
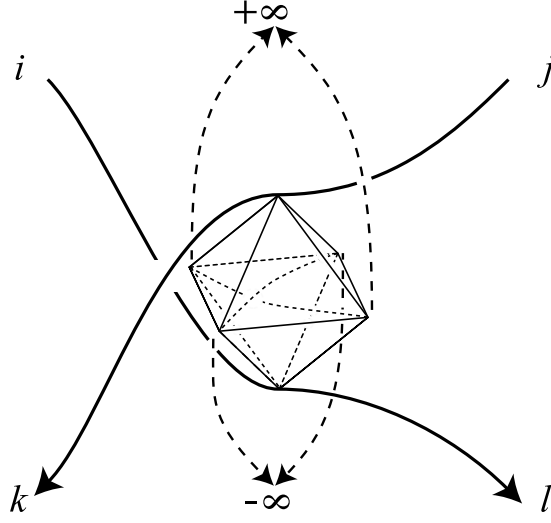

FIGURE 33. decomposition of the octahedron into five tetrahedra

Now only two of the vertices are attached to the knot. We pull the two of the remaining four vertices to the top ($+\infty$) and the other two to the bottom ($-\infty$) as shown in Figure 34. We attach five tetrahedra to every crossing (if the crossing is negative, we change them appropriately) in this way. At each arc two faces meet, and we paste them together. Thus we have a decomposition of $S^3 \setminus (K \cup \{+\infty, -\infty\})$. By deforming this decomposition a little we get a decomposition of $S^3 \setminus K$ by (topological) truncated tetrahedra, decorated with complex numbers $\xi_N^{\pm i_k}$ ($k=1,2,\dots,c$).

Next we want to regard each tetrahedron as an ideal hyperbolic one.

Recall that when we approximate the summation in (4.5) by the integral in (4.6) we replace $\xi_N^{i_k}$ with a complex variable z_k . Following this we replace the decoration $\xi_N^{i_k}$ for a tetrahedron with a complex number z_k . Then regard the tetrahedron decorated with z_k as an ideal hyperbolic tetrahedron parametrized by z_k .

FIGURE 34. Pull the vertices to $+\infty$ and $-\infty$.

So far this is just formal parametrizations. We need to choose appropriate values for parameters so that the tetrahedra fit together to provide a complete hyperbolic structure to $S^3 \setminus K$. To do this we choose z_1, z_2, \dots, z_c so that:

- Around each edge several tetrahedra meet. To make the knot complement hyperbolic, the sum of these dihedral angles should be 2π ,
- Even if the knot complement is hyperbolic, the structure may not be complete. To make it complete, the parameters should be chosen as follows.

Since we truncate the vertices of the tetrahedra, four small triangles appear at the places where the vertices were (see Figure 31 for the triangle associated with the vertex at infinity). After pasting these triangles make a torus which can be regarded as the boundary of the regular neighborhood of the knot K . Each triangle has a similarity structure provided by the parameter z_k . We need to make this boundary torus Euclidean.

See [34, Chapter 4], [31, § 2] for more details.

Surprisingly these conditions are the same as the system of equations (4.9) that we used in the steepest descent method! Therefore we can expect that a solution (x_1, x_2, \dots, x_c) to (4.9) gives the complete hyperbolic structure.

Then, what does $V(x_1, x_2, \dots, x_c) = 2\pi\sqrt{-1} \lim_{N \rightarrow \infty} \log(J_N(K, \xi_N))/N$ mean?

Recall the formula (4.10) and that $V(x_1, x_2, \dots, x_c)$ is a sum of dilogarithm functions and logarithm functions. Using these facts we can prove

$$\text{Im } V(x_1, x_2, \dots, x_c) = \text{Vol}(S^3 \setminus K),$$

that is,

$$\text{Im} \left(2\pi\sqrt{-1} \lim_{N \rightarrow \infty} \frac{\log(J_N(K, \xi_N))}{N} \right) = \text{Vol}(S^3 \setminus K).$$

So we have proved

$$2\pi \lim_{N \rightarrow \infty} \frac{\log |J_N(K, \xi_N)|}{N} = \text{Vol}(S^3 \setminus K),$$

which is the Volume Conjecture (Conjecture 3.1).

5. GENERALIZATIONS OF THE VOLUME CONJECTURE

In this section we consider generalizations of the Volume Conjecture.

5.1. Complexification. In [35] W. Thurston pointed out that the Chern–Simons invariant [3] can be regarded as an imaginary part of the volume. Neumann and Zagier gave a precise conjecture [31, Conjecture, p. 309] which was proved to be true by Yoshida [41]. For combinatorial approaches to the Chern–Simons invariant, see [32] and [44].

So it would be natural to drop the absolute value sign of the left hand side of the Volume Conjecture and add the Chern–Simons invariant to the right hand side.

Conjecture 5.1 (Complexification of the Volume Conjecture [29]). *If a knot K is hyperbolic, that is, its complement possesses a complete hyperbolic structure, then*

$$2\pi \lim_{N \rightarrow \infty} \frac{\log J_N(K; \exp(2\pi\sqrt{-1}/N))}{N} \equiv \text{Vol}(S^3 \setminus K) + \sqrt{-1} \text{CS}(S^3 \setminus K) \pmod{\pi^2 \sqrt{-1} \mathbb{Z}},$$

where CS is the Chern–Simons invariant defined for a three-manifold with torus boundary by Meyerhoff [22].

Remark 5.2. We may regard the left hand side as a definition of the Chern–Simons invariant for non-hyperbolic knots provided that the limit of Conjecture 5.1 exists.

5.2. Deformation of the parameter. In the Volume Conjecture (Conjecture 3.1) and its complexification (Conjecture 5.1), the (possible) limit corresponds to the complete hyperbolic structure of $S^3 \setminus K$ for a hyperbolic knot K . As described in [34, Chapter 4] the complete structure can be deformed to incomplete ones.

How can we perform this deformation in the colored Jones polynomial? If we deform the parameter $2\pi\sqrt{-1}$ in the Volume Conjecture, is the corresponding limits related to incomplete hyperbolic structures?

Let us consider the limit

$$\lim_{N \rightarrow \infty} \frac{\log J_N(K; \exp((u + 2\pi\sqrt{-1})/N))}{N}.$$

Note that when $u = 0$, this limit is considered in the (complexified) Volume Conjecture.

5.2.1. Figure-eight knot. Before stating a conjecture for general knots, I will explain what happens in the case of the figure-eight knot.

Theorem 5.3 ([30]). *Let E be the figure-eight knot. There exists a neighborhood $\mathcal{O} \subset \mathbb{C}$ of 0 such that if $u \in (\mathcal{O} \setminus \pi\sqrt{-1}\mathbb{Q}) \cup \{0\}$, then the following limit exists:*

$$\lim_{N \rightarrow \infty} \frac{\log J_N(E; \exp((u + 2\pi\sqrt{-1})/N))}{N}.$$

Moreover if we put

$$H(u) := (u + 2\pi\sqrt{-1}) \times (\text{the limit above}),$$

and

$$v := 2 \frac{dH(u)}{du} - 2\pi\sqrt{-1}$$

then we have

$$\begin{aligned} \text{Vol}(E_u) + \sqrt{-1} \text{CS}(E_u) \\ \equiv -\sqrt{-1}H(u) - \pi u + u v \sqrt{-1}/4 - \pi \kappa(\gamma_u)/2 \pmod{\pi^2 \sqrt{-1} \mathbb{Z}}. \end{aligned}$$

Here E_u is the closed hyperbolic three-manifold associated with the following representation of $\pi_1(S^3 \setminus E) \rightarrow SL(2; \mathbb{C})$:

$$(5.1) \quad \begin{aligned} \mu &\mapsto \begin{pmatrix} \exp(u/2) & * \\ 0 & \exp(-u/2) \end{pmatrix}, \\ \lambda &\mapsto \begin{pmatrix} \exp(v/2) & * \\ 0 & \exp(-v/2) \end{pmatrix}. \end{aligned}$$

Here μ is the meridian of E (a loop in $S^3 \setminus E$ that goes around the knot, which generates $H_1(S^3 \setminus E) \cong \mathbb{Z}$), λ is the longitude (a loop in $S^3 \setminus E$ that goes along the knot such that it is homologous to 0 in $H_1(S^3 \setminus E)$), and γ_u is the loop attached to $S^3 \setminus E$ when we complete the hyperbolic structure defined by u . We also put $\kappa(\gamma_u) := \text{length}(\gamma_u) + \sqrt{-1} \text{torsion}(\gamma_u)$, where $\text{length}(\gamma_u)$ is the length of the attached loop γ_u , and torsion is its torsion, which is defined modulo 2π as the rotation angle when one travels along γ_u . See [31] for details (see also [24]).

We will give a sketch of the proof in the following two subsections.

5.2.2. *Calculation of the limit.* First we calculate the limit. Note that here I give just a sketch of the calculation but it can be done rigorously. For details see [30].

From (3.1) we have

$$J_N(E; q) = \sum_{j=0}^{N-1} q^{jN} \prod_{k=1}^j (1 - q^{-N-k}) (1 - q^{-N+k}).$$

Put $q := \exp(\theta/N)$ for θ near $2\pi\sqrt{-1}$. If θ is not a rational multiple of $\pi\sqrt{-1}$ (but it can be $2\pi\sqrt{-1}$), we have

$$\begin{aligned} &\log \left(\prod_{k=1}^j (1 - q^{-N \pm k}) \right) \\ &= \sum_{k=1}^j \log (1 - \exp(\pm k\theta/N - \theta)) \\ &\stackrel{N \rightarrow \infty}{\approx} N \int_0^{j/N} \log(1 - \exp(\pm \theta s - \theta)) ds \\ &= \frac{\pm N}{\theta} \int_{\exp(-\theta)}^{\exp(\pm j\theta/N - \theta)} \frac{\log(1-t)}{t} dt \\ &= \frac{\pm N}{\theta} (\text{Li}_2(\exp(-\theta)) - \text{Li}_2(\exp(\pm j\theta/N - \theta))). \end{aligned}$$

So we have

$$\begin{aligned}
& J_N(E; \exp(\theta/N)) \\
& \underset{N \rightarrow \infty}{\approx} \sum_{j=0}^{N-1} \exp(j\theta) \exp \left[\frac{N}{\theta} (\text{Li}_2(\exp(-j\theta/N - \theta)) - \text{Li}_2(\exp(j\theta/N - \theta))) \right] \\
& = \sum_{j=0}^{N-1} \exp \left[\frac{N}{\theta} H(\exp(j\theta/N), \exp(\theta)) \right] \\
& \underset{N \rightarrow \infty}{\approx} \int_C \exp \left[\frac{N}{\theta} H(x, \exp(\theta)) \right] dx
\end{aligned}$$

for a suitable contour C . Here we put

$$(5.2) \quad H(\zeta, \eta) := \text{Li}_2(1/(\zeta\eta)) - \text{Li}_2(\zeta/\eta) + \log \zeta \log \eta.$$

To apply the steepest descent method (Theorem 4.2), we find the maximum of $\text{Re}(H(x, \exp(\theta))/\theta)$ over x . To do that we will find a solution y to the equation $dH(x, \exp(\theta))/dx = 0$, which is

$$\frac{\log[\exp(\theta) + \exp(-\theta) - x - x^{-1}]}{x} = 0.$$

We can show that appropriately chosen y gives the maximum and from the steepest descent method we have

$$J_N(E; \exp(\theta/N)) \underset{N \rightarrow \infty}{\approx} \exp \left[\frac{N}{\theta} H(y, \exp(\theta)) \right],$$

that is,

$$(5.3) \quad \theta \lim_{N \rightarrow \infty} \frac{J_N(E; \exp(\theta/N))}{N} = H(y, \exp(\theta)),$$

where y satisfies

$$y + y^{-1} = \exp(\theta) + \exp(-\theta) - 1.$$

5.2.3. Calculation of the volume. Next we will relate the limit to the volume of a three-manifold obtained by $S^3 \setminus E$.

As described in § 3.2.3, $S^3 \setminus E$ is obtained by gluing two ideal hyperbolic tetrahedra as in Figure 28. Here we assume that they are parametrized by complex numbers z and w . When $z = w = (1 + \sqrt{-3})/2$, $S^3 \setminus E$ has a complete hyperbolic structure as described in § 3.2.3. We assume that the left tetrahedron (with faces labeled with A, B, C and D) and the right tetrahedron (with faces labeled with A', B', C' and D') in Figure 28 are $\Delta(z)$ and $\Delta(w)$ respectively.

The boundary torus, which is obtained from the shadowed triangles in Figure 28, looks like Figure 35. Here the leftmost triangle is the one in the center of the picture of $\Delta(z)$ and the second leftmost one is the one in the center of the picture of $\Delta(w)$. Let α, β and γ be the dihedral angle between B and C, A and $B,$ and C and A respectively. Let α', β' and γ' be the dihedral angle between B' and D', A' and $B',$ and D' and A' respectively. As described in § 3.2.3, the sum of the dihedral angles

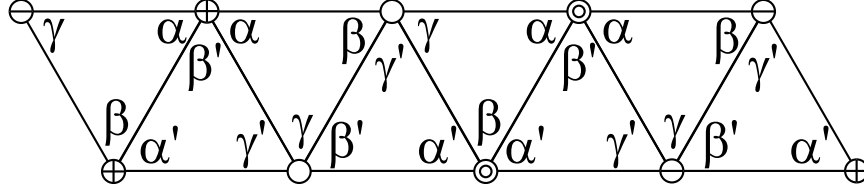

FIGURE 35. Identifying the sides as indicated by the circles, we get a triangulation of the boundary torus. Here the single circles denote the arrow head of the single arrow, the double circles denote the arrow head of the double arrow, the circles with $-$ denote the arrow tail of the single arrow, and the circles with $+$ denote the arrow tail of the double arrow in Figure 28. Note that we view this torus from outside of $S^3 \setminus E$.

around each edge should be 2π . So from Figure 35, we have

$$\begin{aligned} \beta + 2\gamma + \beta' + 2\gamma' &= 2\pi && \text{from the single circles,} \\ 2\alpha + \beta + 2\alpha' + \beta' &= 2\pi && \text{from the double circles,} \\ \beta + 2\gamma + \beta' + 2\gamma' &= 2\pi && \text{from the circles with } -, \\ 2\alpha + \beta + 2\alpha' + \beta' &= 2\pi && \text{from the circles with } +, \end{aligned}$$

which is equivalent to a single equation

$$2\alpha + \beta + 2\alpha' + \beta' = 2\pi$$

since $\alpha + \beta + \gamma = \alpha' + \beta' + \gamma' = \pi$.

Assume that $\alpha = \arg z$ and $\alpha' = \arg w$. Since $\beta = \arg(1 - 1/z)$ and $\beta' = \arg(1 - 1/w)$ (see Figures 30 and 31) this turns out to be

$$2 \arg z + \arg(1 - 1/z) + 2 \arg w + \arg(1 - 1/w) = 2\pi.$$

So we have

$$(5.4) \quad zw(z-1)(w-1) = 1.$$

Remark 5.4. This is just a condition that $S^3 \setminus E$ is hyperbolic. To make the metric complete we need to add the condition that the upper side and the lower side of the parallelogram in Figure 35 are parallel.

Now we introduce parameters x and y as

$$(5.5) \quad \begin{aligned} x &:= w(1-z), \\ y &:= -zw. \end{aligned}$$

Note that the following equality holds from (5.4):

$$(5.6) \quad y + y^{-1} = x + x^{-1} - 1.$$

Since $\Delta(z)$ and $\Delta(w)$ can also be parametrized as $\Delta(1 - 1/z)$ and $\Delta(1 - 1/w)$, we have

$$\begin{aligned} \text{Vol}(\Delta(z)) + \text{Vol}(\Delta(w)) \\ = \text{Im Li}_2(w') + \text{Im Li}_2(z') + \log |w'| \arg(1 - w') + \log |z'| \arg(1 - z'), \end{aligned}$$

from (4.10), where we put $z' := 1 - 1/z$ and $w' := 1 - 1/w$. Using the equation

$$\operatorname{Li}_2(z') + \operatorname{Li}_2(z'^{-1}) = -\frac{\pi^2}{6} - \frac{1}{2}(\log(-z'))^2$$

(see for example [42, § 1.2]), we have

$$\begin{aligned} (5.7) \quad & \operatorname{Vol}(\Delta(z)) + \operatorname{Vol}(\Delta(w)) \\ &= \operatorname{Im} \operatorname{Li}_2(w') - \operatorname{Im} \operatorname{Li}_2(z'^{-1}) + \log |w'| \arg(1 - w') - \log |z'^{-1}| \arg(1 - z'^{-1}) \\ & \quad (\text{since } w' = 1/(yx) \text{ and } z'^{-1} = y/x) \\ &= \operatorname{Im} \operatorname{Li}_2(1/(yx)) - \operatorname{Im} \operatorname{Li}_2(y/x) + \log |1/(yx)| \arg(1 - 1/(yx)) - \log |y/x| \arg(1 - y/x) \\ & \quad (\text{from (5.6)}) \\ &= \operatorname{Im} \operatorname{Li}_2(1/(yx)) - \operatorname{Im} \operatorname{Li}_2(y/x) + \log |y| \arg x + \log |x| \arg \frac{1 - y/x}{1 - 1/(yx)} \\ & \quad (\text{from (5.5) and (5.4)}) \\ &= \operatorname{Im} \operatorname{Li}_2(1/(yx)) - \operatorname{Im} \operatorname{Li}_2(y/x) + \log |y| \arg x + \log |x| \arg \frac{y}{z(z-1)} \\ & \quad (\text{from (5.2)}) \\ &= \operatorname{Im} H(y, x) - \log |x| \arg(z(z-1)). \end{aligned}$$

Putting

$$\begin{aligned} u &:= \log x = \log(w(1-z)), \\ v &:= 2 \log(z(1-z)), \\ H(u) &:= H(y, x), \end{aligned}$$

we have

$$(5.8) \quad \operatorname{Vol}(\Delta(z)) + \operatorname{Vol}(\Delta(w)) = \operatorname{Im} H(u) - \pi \operatorname{Re} u - \frac{1}{2} \operatorname{Re} u \operatorname{Im} v.$$

Moreover from (5.3), we have

$$(u + 2\pi\sqrt{-1}) \lim_{N \rightarrow \infty} \frac{\log J_N(E; \exp((u + 2\pi\sqrt{-1})/N))}{N} = H(u)$$

if we put $\theta = u + 2\pi\sqrt{-1}$ since $x = \exp(u) = \exp(\theta)$. Note that z , w , x , y and v are functions of u . Note also that v is given as

$$v = 2 \frac{dH(u)}{du} - 2\pi\sqrt{-1}$$

since $\frac{dH(u)}{du} = \log(z(z-1))$.

Remark 5.5. We need to be more careful about the arguments of variables. For details see [30].

I will give geometrical interpretation of u and v to relate the term $\operatorname{Re} u \operatorname{Im} v$ in (5.8) to the length of γ_u .

We first calculate $H_1(S^3 \setminus E) = H_1(\Delta(z) \cup \Delta(w))$. Since the interiors of three-simplices do not matter to the first homology, we can calculate it from the boundary

torus, the edges of $\Delta(z)$ and $\Delta(w)$, and the faces $A = A'$, $B = B'$, $C = C'$, and $D = D'$ (see Figures 28 and 35). From Figures 28, 35 and 36 one reads

$$\begin{aligned}\partial A = \partial A' &= \nearrow - e_7 + \rightharpoonup + e_{10} - \rightharpoonup - e_5, \\ \partial B = \partial B' &= -\nearrow - e_{11} - \rightharpoonup + e_6 + \rightharpoonup - e_9, \\ \partial C = \partial C' &= \rightharpoonup + e_4 + \nearrow + e_8 - \nearrow + e_1, \\ \partial D = \partial D' &= \nearrow + e_3 - \rightharpoonup + e_2 - \nearrow + e_{12},\end{aligned}$$

where \nearrow and \rightharpoonup mean the single arrowed edge and the double arrowed edge in Figure 28 respectively, and the e_i are the edges of the boundary torus as indicated in Figure 36. Since

$$\begin{aligned}e_7 &= e_6 + e_2, \\ e_{10} &= e_6, \\ e_5 &= e_1 + e_6, \\ e_{11} &= e_4 + e_{12} = e_4 + e_6, \\ e_9 &= e_3 + e_{10} = e_3 + e_6, \\ e_8 &= e_6, \\ e_{12} &= e_6\end{aligned}$$

in the first homology group, we have

$$\begin{aligned}\nearrow - e_1 - e_2 - e_6 &= 0, \\ -\nearrow - e_3 - e_4 - e_6 &= 0, \\ \rightharpoonup + e_1 + e_4 + e_6 &= 0, \\ -\rightharpoonup + e_2 + e_3 + e_6 &= 0.\end{aligned}$$

So if we put $\mu := e_6$, $\lambda := e_1 + e_2 + e_3 + e_4 + 2\mu$, then we see that the first homology group of the boundary torus is generated by μ and λ , that $H_1(S^3 \setminus E) \cong \mathbb{Z}$ is generated by μ , and that $\lambda = 0$ in $H_1(S^3 \setminus E)$. Therefore μ is the meridian and λ is the longitude.

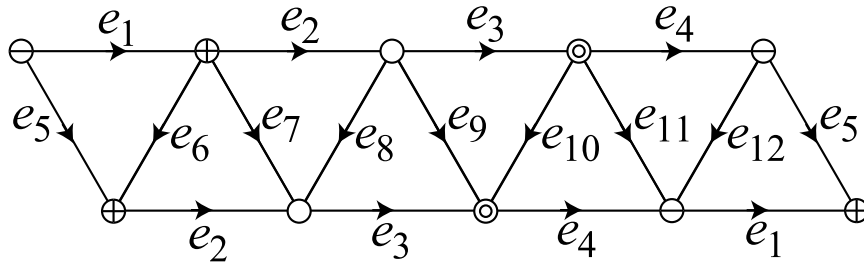

FIGURE 36. The cycle e_6 is the meridian and the cycle $e_1 + e_6 + e_2 + e_8 + e_3 + e_4$ is the longitude.

Now let us consider the universal cover $\widetilde{S^3 \setminus E}$ of $S^3 \setminus E = \Delta(z) \cup \Delta(w)$ which is \mathbb{H}^3 . We can construct it by developing $\Delta(z)$ and $\Delta(w)$ isometrically in \mathbb{H}^3 . Then each loop in $S^3 \setminus E$ is regarded as a covering translation of $\widetilde{S^3 \setminus E}$ and it defines an isometric translation of \mathbb{H}^3 . This defines a representation (holonomy

representation) of $\pi_1(S^3 \setminus E)$ at $PSL(2; \mathbb{C})$. Taking a lift to $SL(2; \mathbb{C})$, we can define a representation $\rho: \pi_1(S^3 \setminus E) \rightarrow SL(2; \mathbb{C})$.

We consider how $\rho(\mu)$ and $\rho(\lambda)$ act on $\partial\mathbb{H}^3 = S^2 = \mathbb{C} \cup \{\infty\}$. The image of the meridian $\rho(\mu)$ sends the top side to the bottom side. So it is the composition of a $-\alpha$ -rotation around the circle with $+$ in the top (between e_1 and e_2) and a γ' -rotation around the single circle in the bottom (between e_2 and e_3), which means a multiplication by $1/z \times 1/(1-w) = w(1-z)$ plus a translation from (5.4). Similarly $\rho(\lambda)$ acts as a multiplication by $z^2(1-z)^2$ plus a translation.

Therefore $u = \log(w(1-z))$ and $v = 2\log(z(1-z))$ can be regarded as the logarithms of the actions by the meridian μ and the longitude λ , respectively.

Since the meridian and the longitude commute in $\pi_1(S^3 \setminus E)$, their images can be simultaneously triangularizable. Recalling that μ and λ define multiplications by $\exp(u)$ and $\exp(v)$ plus translations on $\partial\mathbb{H}^3$, we may assume

$$\rho(\mu) = \begin{pmatrix} \exp(u/2) & * \\ 0 & \exp(-u/2) \end{pmatrix},$$

$$\rho(\lambda) = \begin{pmatrix} \exp(v/2) & * \\ 0 & \exp(-v/2) \end{pmatrix},$$

which is (5.1). This is a geometric interpretation of u and v .

Since u determines z and w , it defines a hyperbolic structure of $S^3 \setminus E$ as the union of $\Delta(z)$ and $\Delta(w)$. When $u \neq 0$ this hyperbolic structure is incomplete. We can complete this incomplete structure by attaching either a point or a circle.

Since v is not a real multiple of u when u is small, there exists a pair $(p, q) \in \mathbb{R}^2$ such that $pu + qv = 2\pi\sqrt{-1}$. The pair (p, q) is called the generalized Dehn surgery coefficient [34]. If p and q are coprime integers, then the completion is given by attaching a circle γ_u and the result is a closed hyperbolic three-manifold which we denote by E_u . (For other cases the completion is given by adding either a point or a circle. In the former case the regular neighborhood of the attached point is a cone over a torus, and in the latter case the regular neighborhood of the attached circle is topologically a solid torus but geometrically the angle around the core is not 2π .)

If p and q are coprime integers, the completion is nothing but the (p, q) -Dehn surgery along the knot, that is, we attach a solid torus D to $S^3 \setminus \text{Int}(N(E))$ so that the meridian of D coincides with the loop on the boundary of the regular neighborhood $N(E)$ of $E \subset S^3$ presenting $p\mu + q\lambda \in H_1(S^3 \setminus \text{Int}(N(E)))$, where Int denotes the interior (Figure 37). Then the circle γ_u can be regarded as the core of D .

To complete the proof of Theorem 5.3, we want to describe the length of the attached circle γ_u in terms of u and v . We will show

$$(5.9) \quad \text{length } \gamma_u = -\frac{1}{2\pi} \text{Im}(u\bar{v}).$$

When u is small and non-zero, we can assume that $\exp(u) \neq 1$ and $\exp(v) \neq 1$. So we can also assume that $\rho(\mu)$ and $\rho(\lambda)$ are both diagonal. This means that the image of μ is a multiplication by $\exp(u)$ and that the image of λ is a multiplication by $\exp(v)$ (with no translations). Note that now $\widetilde{S^3 \setminus E}$ is identified with \mathbb{H}^3 minus the z -axis, and the completion is given by adding the z -axis.

Since p and q are coprime, we can choose integers r and s so that $ps - qr = 1$. We push $\gamma_u \in D$ to the boundary of the solid torus ∂D and denote the resulting

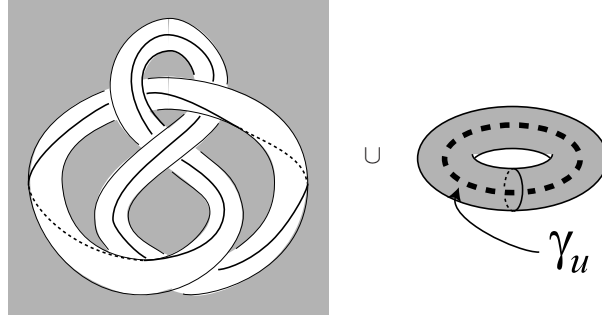

FIGURE 37. (2,1)-Dehn surgery along the figure-eight knot

circle by $\tilde{\gamma}_u$. Then we see that $[\tilde{\gamma}_u] = r\mu + s\lambda \in H_1(\partial(S^3 \setminus \text{Int}(N(E))); \mathbb{Z})$ since the meridian of D is identified with $p\mu + q\lambda$, and the images of the meridian and $\tilde{\gamma}_u$ make a basis of $H_1(\partial(S^3 \setminus \text{Int}(N(E))); \mathbb{Z})$.

Remark 5.6. Even if we use another pair (r', s') such that $ps' - qr' = 1$, we get the same manifold. This is because changing (r, s) corresponds to changing of $\tilde{\gamma}_u \in \partial D$. Observe that ambiguity of the choice of $\tilde{\gamma}_u$ is given by a twist of D and that it does not matter to the resulting manifold.

Therefore $\rho(\gamma_u)$ corresponds to a multiplication by $\exp(\pm(ru + sv))$. This means that if we identify the completion of $S^3 \setminus E$ with \mathbb{H}^3 , a fundamental domain of the lift of γ_u is identified with the segment $[1, \exp(\pm \text{Re}(ru + sv))]$ in the z -axis. Since the metric is given by $\sqrt{dx^2 + dy^2 + dz^2}/z$, the length of γ_u is given by

$$\begin{aligned}
 \text{length}(\gamma_u) &= \int_1^{\exp(\pm \text{Re}(ru + sv))} \frac{dz}{z} \\
 &= \pm \text{Re}(ru + sv) \\
 &= \pm \left(\frac{ps - 1}{q} \text{Re}(u) + s \text{Re}(v) \right) \\
 &= \pm \left(\frac{s}{q} (p \text{Re}(u) + q \text{Re}(v)) - \frac{1}{q} \text{Re}(u) \right) \\
 &= \mp \frac{\text{Re}(u)}{q} \\
 &= \frac{\mp 1}{2\pi} (\text{Re } u \text{ Im } v - \text{Im } u \text{ Re } v) \\
 &= \frac{\pm 1}{2\pi} \text{Im}(u\bar{v}),
 \end{aligned}$$

where the fourth and the sixth equalities follow from

$$\begin{pmatrix} \text{Re}(u) & \text{Re}(v) \\ \text{Im}(u) & \text{Im}(v) \end{pmatrix} \begin{pmatrix} p \\ q \end{pmatrix} = \begin{pmatrix} 0 \\ 2\pi \end{pmatrix}.$$

Since $v = u \times \frac{|v|^2}{u\bar{v}}$ and the orientation of (u, v) should be positive on \mathbb{C} , we see that $\text{Im}(u\bar{v})$ is negative (see [31] for details) and so (5.9) follows.

Therefore from (5.8) we finally have

$$\text{Vol}(E_u) = \text{Re} \left(-\sqrt{-1}H(u) - \pi u + \frac{1}{4}uv\sqrt{-1} - \frac{\pi}{2}\kappa(\gamma_u) \right).$$

The Chern–Simons invariant is obtained by Yoshida’s formula [41]. See [30] for details.

5.2.4. *General knots.* Here I propose a generalization of the Volume Conjecture for general knots.

Conjecture 5.7 ([26]). *For any knot K , there exists an open set $U \in \mathbb{C}$ such that if $u \in U$, then the following limit exists:*

$$\lim_{N \rightarrow \infty} \frac{\log J_N(K; \exp((u + 2\pi\sqrt{-1})/N))}{N}.$$

Moreover if we put

$$H(K; u) := (u + 2\pi\sqrt{-1}) \times (\text{the limit above}),$$

and

$$v := 2 \frac{dH(K; u)}{du} - 2\pi\sqrt{-1},$$

then we have

$$\text{Vol}(K; u) = \text{Im} H(K; u) - \pi \text{Re} u - \frac{1}{2} \text{Re} u \text{Im} v.$$

Here $\text{Vol}(K; u)$ is the volume function corresponding to the representation of $\pi_1(S^3 \setminus K)$ to $SL(2; \mathbb{C})$ as in Theorem 5.3.

Remark 5.8. In the case of a hyperbolic knot, we can also propose a similar conjecture with the imaginary part as in the case of the figure-eight knot. For a general knot, a relation to the Chern–Simons invariant is also expected by using a combinatorial description of the Chern–Simons invariant by Zickert [44].

Remark 5.9. Conjecture 5.7 is known to be true for the figure-eight knot [30] and for torus knots [26]. See also [27] and [10] for a possible relation to the Chern–Simons invariant.

Finally note that Garoufalidis and Lê proved the following result, which should be compared with Conjecture 5.7. (See also [25] for the case of the figure-eight knot.)

Theorem 5.10 (S. Garoufalidis and T. Lê [5]). *For any K , there exists $\varepsilon > 0$ such that if $|\theta| < \varepsilon$, we have*

$$\lim_{N \rightarrow \infty} J_N(K; \exp(\theta/N)) = \frac{1}{\Delta(K; \exp \theta)},$$

where $\Delta(K; t)$ is the Alexander polynomial of K .

REFERENCES

- [1] J. W. Alexander, *A lemma on systems of knotted curves.*, Proc. Nat. Acad. Sci. U.S.A. **9** (1923), no. 3, 93–95.
- [2] J. S. Birman, *Braids, links, and mapping class groups*, Princeton University Press, Princeton, N.J., 1974. MR MR0375281 (51 #11477)
- [3] S.-S. Chern and J. Simons, *Characteristic forms and geometric invariants*, Ann. of Math. (2) **99** (1974), 48–69. MR 50 #5811
- [4] V. G. Drinfel'd, *Quantum groups*, Proceedings of the International Congress of Mathematicians, Vol. 1, 2 (Berkeley, Calif., 1986) (Providence, RI), Amer. Math. Soc., 1987, pp. 798–820.
- [5] S. Garoufalidis and T. T. Q. Le, *An analytic version of the Melvin-Morton-Rozansky Conjecture*, arXiv:math.GT/0503641.
- [6] ———, *On the volume conjecture for small angles*, arXiv:math.GT/0502163.
- [7] M. Gromov, *Volume and bounded cohomology*, Inst. Hautes Études Sci. Publ. Math. (1982), no. 56, 5–99 (1983). MR 84h:53053
- [8] K. Habiro, *On the colored Jones polynomials of some simple links*, Sūrikaiseikikenkyūsho Kōkyūroku (2000), no. 1172, 34–43. MR 1 805 727
- [9] K. Hikami, *Quantum invariant for torus link and modular forms*, Comm. Math. Phys. **246** (2004), no. 2, 403–426. MR 2 048 564
- [10] K. Hikami and H. Murakami, *Representations and the colored jones polynomial of a torus knot*, arXiv:1001.2680, 2010.
- [11] W. H. Jaco and P. B. Shalen, *Seifert fibered spaces in 3-manifolds*, Mem. Amer. Math. Soc. **21** (1979), no. 220, viii+192. MR 81c:57010
- [12] M. Jimbo, *A q -difference analogue of $U(\mathfrak{g})$ and the Yang-Baxter equation*, Lett. Math. Phys. **10** (1985), no. 1, 63–69. MR MR797001 (86k:17008)
- [13] K. Johannson, *Homotopy equivalences of 3-manifolds with boundaries*, Lecture Notes in Mathematics, vol. 761, Springer, Berlin, 1979. MR 82c:57005
- [14] V. F. R. Jones, *A polynomial invariant for knots via von Neumann algebras*, Bull. Amer. Math. Soc. (N.S.) **12** (1985), no. 1, 103–111. MR 86e:57006
- [15] R. M. Kashaev, *A link invariant from quantum dilogarithm*, Modern Phys. Lett. A **10** (1995), no. 19, 1409–1418. MR 96j:81060
- [16] ———, *The hyperbolic volume of knots from the quantum dilogarithm*, Lett. Math. Phys. **39** (1997), no. 3, 269–275. MR 98b:57012
- [17] R. M. Kashaev and O. Tirkkonen, *A proof of the volume conjecture on torus knots*, Zap. Nauchn. Sem. S.-Peterburg. Otdel. Mat. Inst. Steklov. (POMI) **269** (2000), no. Vopr. Kvant. Teor. Polya i Stat. Fiz. 16, 262–268, 370. MR 1 805 865
- [18] R. Kirby and P. Melvin, *The 3-manifold invariants of Witten and Reshetikhin-Turaev for $sl(2, \mathbb{C})$* , Invent. Math. **105** (1991), no. 3, 473–545. MR 92e:57011
- [19] Markoff, A. (Markov, A. A.), *Über die freie Äquivalenz der geschlossenen Zöpfe. (German)*, Rec. Math. Moscou, n. Ser. 1 (1936), 73–78.
- [20] J. E. Marsden and M. J. Hoffman, *Basic complex analysis*, W. H. Freeman and Company, New York, 1987. MR 88m:30001
- [21] G. Masbaum, *Skein-theoretical derivation of some formulas of Habiro*, Algebr. Geom. Topol. **3** (2003), 537–556 (electronic). MR MR1997328 (2004f:57013)
- [22] R. Meyerhoff, *Density of the Chern-Simons invariant for hyperbolic 3-manifolds*, Low-dimensional topology and Kleinian groups (Coventry/Durham, 1984), Cambridge Univ. Press, Cambridge, 1986, pp. 217–239. MR 88k:57033a
- [23] J. Milnor, *Hyperbolic geometry: the first 150 years*, Bull. Amer. Math. Soc. (N.S.) **6** (1982), no. 1, 9–24. MR 82m:57005
- [24] H. Murakami, *The colored Jones polynomials of the figure-eight knot and the volumes of three-manifolds obtained by Dehn surgeries*, Fund. Math. **184** (2004), 269–289.
- [25] ———, *The colored Jones polynomials and the Alexander polynomial of the figure-eight knot*, JP J. Geom. Topol. **7** (2007), no. 2, 249–269. MR MR2349300 (2008g:57014)
- [26] ———, *A version of the volume conjecture*, Adv. Math. **211** (2007), no. 2, 678–683. MR MR2323541
- [27] ———, *An introduction to the volume conjecture and its generalizations*, Acta Math. Vietnam. **33** (2008), no. 3, 219–253. MR MR2501844

- [28] H. Murakami and J. Murakami, *The colored Jones polynomials and the simplicial volume of a knot*, Acta Math. **186** (2001), no. 1, 85–104. MR 2002b:57005
- [29] H. Murakami, J. Murakami, M. Okamoto, T. Takata, and Y. Yokota, *Kashaev's conjecture and the Chern-Simons invariants of knots and links*, Experiment. Math. **11** (2002), no. 3, 427–435. MR 1 959 752
- [30] H. Murakami and Y. Yokota, *The colored Jones polynomials of the figure-eight knot and its Dehn surgery spaces*, J. Reine Angew. Math. **607** (2007), 47–68. MR MR2338120
- [31] W. D. Neumann and D. Zagier, *Volumes of hyperbolic three-manifolds*, Topology **24** (1985), no. 3, 307–332. MR 87j:57008
- [32] W.D. Neumann, *Combinatorics of triangulations and the Chern-Simons invariant for hyperbolic 3-manifolds*, Topology '90 (Columbus, OH, 1990), de Gruyter, Berlin, 1992, pp. 243–271. MR 93i:57020
- [33] D. Thurston, *Hyperbolic volume and the Jones polynomial*, Lecture notes, École d'été de Mathématiques 'Invariants de noeuds et de variétés de dimension 3', Institut Fourier - UMR 5582 du CNRS et de l'UJF Grenoble (France) du 21 juin au 9 juillet 1999, <http://www.math.columbia.edu/~dpt/speaking/Grenoble.pdf>.
- [34] W. P. Thurston, *The Geometry and Topology of Three-Manifolds*, Electronic version 1.1 - March 2002, <http://www.msri.org/publications/books/gt3m/>.
- [35] W. P. Thurston, *Three-dimensional manifolds, Kleinian groups and hyperbolic geometry*, Bull. Amer. Math. Soc. (N.S.) **6** (1982), no. 3, 357–381.
- [36] V. G. Turaev, *The Yang-Baxter equation and invariants of links*, Invent. Math. **92** (1988), 527–553.
- [37] R. van der Veen, *A cabling formula for the colored jones polynomial*, (arXiv.org:0807.2679), 2008.
- [38] ———, *Proof of the volume conjecture for Whitehead chains*, Acta Math. Vietnam. **33** (2008), no. 3, 421–431. MR MR2501851
- [39] M. Yamazaki and Y. Yokota, *On the limit of the colored Jones polynomial of a non-simple link*, preprint, Tokyo Metropolitan University, 2009.
- [40] Y. Yokota, *On the potential functions for the hyperbolic structures of a knot complement*, Invariants of knots and 3-manifolds (Kyoto, 2001), Geom. Topol. Monogr., vol. 4, Geom. Topol. Publ., Coventry, 2002, pp. 303–311 (electronic). MR MR2002618 (2004g:57037)
- [41] T. Yoshida, *The η -invariant of hyperbolic 3-manifolds*, Invent. Math. **81** (1985), no. 3, 473–514. MR 87f:58153
- [42] D. Zagier, *The dilogarithm function*, Frontiers in number theory, physics, and geometry. II, Springer, Berlin, 2007, pp. 3–65. MR MR2290758 (2008h:33005)
- [43] H. Zheng, *Proof of the volume conjecture for Whitehead doubles of a family of torus knots*, Chin. Ann. Math. Ser. B **28** (2007), no. 4, 375–388. MR MR2348452
- [44] C. K. Zickert, *The volume and Chern-Simons invariant of a representation*, Duke Math. J. **150** (2009), no. 3, 489–532.

DEPARTMENT OF MATHEMATICS, TOKYO INSTITUTE OF TECHNOLOGY, OH-OKAYAMA, MEGURO,
TOKYO 152-8551, JAPAN

E-mail address: starshea@tky3.3web.ne.jp