

Quantum And Relativistic Protocols For Secure Multi-Party Computation

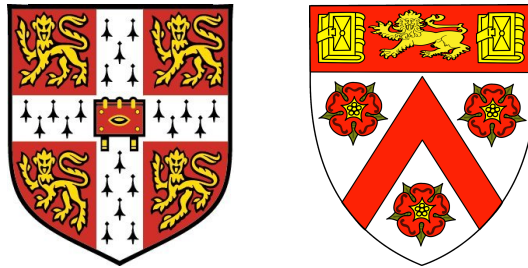

Roger Colbeck
Trinity College
University of Cambridge

A thesis submitted for the degree of

Doctor of Philosophy

December 2006

Declaration

This thesis is the result of my own work and includes nothing which is the outcome of work done in collaboration with others, except where specifically indicated in the text.

To my parents, Lorelei and John.



Acknowledgements

The work comprising this thesis was carried out over the course of three years at the Centre For Quantum Computation, DAMTP, Cambridge, under the supervision of Adrian Kent. I am indebted to him for support and guidance. Discussions with Adrian are always a pleasure and his eagerness to find loopholes in any new proposal is second to none. His clear thinking and attention to detail have had huge impact on my work, and indeed my philosophy towards research.

It is with great pleasure that I thank the members of the quantum information group for an enjoyable three years. Particular thanks go to Matthias Christandl, Robert König, Graeme Mitchison and Renato Renner for numerous useful discussions from which my work has undoubtedly benefited, and to Jiannis Pachos for his constant encouragement and support.

My two office co-inhabitants deserve special mention here, not least for putting up with me! Alastair Kay for withstanding (and almost always answering) a battering of questions on forgotten physics, \LaTeX , linux and much more besides, and Roberta Rodriguez for providing unrelenting emotional support on all matters from physics to life itself.

I am very grateful to the Engineering and Physical Sciences Research Council for a research studentship and to Trinity College, Cambridge for a research scholarship and travel money. A junior research fellowship from Homerton College, Cambridge has provided financial support during the final stages of writing this thesis.

Finally I would like to thank my examiners Robert Spekkens and Andreas Winter for their thorough analysis of this thesis.

Abstract

Secure multi-party computation is a task whereby mistrustful parties attempt to compute some joint function of their private data in such a way as to reveal as little as possible about it. It encompasses many cryptographic primitives, including coin tossing and oblivious transfer. Ideally, one would like to generate either a protocol or a no-go theorem for any such task.

Very few computations of this kind are known to be possible with unconditional security. However, relatively little investigation into exploiting the cryptographic power of a relativistic theory has been carried out. In this thesis, we extend the range of known results regarding secure multi-party computations. We focus on two-party computations, and consider protocols whose security is guaranteed by the laws of physics. Specifically, the properties of quantum systems, and the impossibility of faster-than-light signalling will be used to guarantee security.

After a general introduction, the thesis is divided into four parts. In the first, we discuss the task of coin tossing, principally in order to highlight the effect different physical theories have on security in a straightforward manner, but, also, to introduce a new protocol for non-relativistic strong coin tossing. This protocol matches the security of the best protocol known to date while using a conceptually different approach to achieve the task. It provides a further example of the use of entanglement as a resource.

In the second part, a new task, variable bias coin tossing, is introduced. This is a variant of coin tossing in which one party secretly chooses one of two biased coins to toss. It is shown that this can be

achieved with unconditional security for a specified range of biases, and with cheat-evident security for any bias. We also discuss two further protocols which are conjectured to be unconditionally secure for any bias.

The third section looks at other two-party secure computations for which, prior to our work, protocols and no-go theorems were unknown. We introduce a general model for such computations, and show that, within this model, a wide range of functions are impossible to compute securely. We give explicit cheating attacks for such functions.

In the final chapter we investigate whether cryptography is possible under weakened assumptions. In particular, we discuss the task of expanding a private random string, while dropping the assumption that the protocol's user trusts her devices. Instead we assume that all quantum devices are supplied by an arbitrarily malicious adversary. We give two protocols that we conjecture securely perform this task. The first allows a private random string to be expanded by a finite amount, while the second generates an arbitrarily large expansion of such a string.

Contents

1	Introduction	1
1.1	Preface	1
1.2	Synopsis	3
1.3	Preliminaries	5
1.3.1	Local Operations	5
1.3.2	Distinguishing Quantum States	7
1.3.3	Entanglement, Bell's Theorem And Non-locality	10
1.3.4	Entropy Measures	12
1.4	Quantum Key Distribution	17
1.4.1	Information Reconciliation	19
1.4.2	Privacy Amplification	20
1.5	Types Of Security	28
1.6	The Setting	30
1.7	Cryptographic Protocols	33
1.7.1	Non-Relativistic Protocols	33
1.7.2	Relativistic Protocols	34
1.8	Cryptographic Primitives	38
2	The Power Of The Theory – Strong Coin Tossing	41
2.1	Introduction	41
2.2	Definitions	42
2.3	Where Lies The Cryptographic Power?	43
2.4	Coin Tossing	45
2.4.1	Classical Non-Relativistic Protocols	45
2.4.2	Quantum Non-Relativistic Protocols	46

2.4.3	Relativistic Protocols	51
2.5	Discussion	52
3	Variable Bias Coin Tossing	53
3.1	Introduction	53
3.2	Secure Multi-Party Computation	54
3.3	Variable Bias Coin Tossing	57
3.3.1	Introduction	57
3.3.2	Definitions	60
3.4	VBCT Protocols	62
3.4.1	Protocol VBCT1	62
3.4.2	Protocol VBCT2	67
3.4.3	Protocol VBCT3	71
3.4.4	Protocol VBCT4	73
3.5	Summary	75
4	Secure Two-Party Classical Computation	77
4.1	Introduction	77
4.2	Security Definitions In Secure Multi-Party Computation	78
4.2.1	The Rôle Of The Simulator	84
4.2.2	Computational Model	87
4.3	Deterministic Functions	90
4.4	Non-Deterministic Functions	95
4.4.1	Two-Sided Case	95
4.4.2	One-Sided Case	97
4.4.3	Example: The Impossibility Of OT	98
4.5	Discussion	98
5	Private Randomness Expansion Under Relaxed Cryptographic Assumptions	103
5.1	Introduction	103
5.1.1	The Setting	105
5.1.2	Using Non-Local Correlations	106
5.2	Private Randomness Expansion	108

5.2.1	The Privacy Of A Random String	108
5.2.2	Definitions	109
5.2.3	Finite Expansion	110
5.2.4	Indefinite Expansion	115
5.3	Resource Considerations	116
5.3.1	Beyond The GHZ Test	118
5.4	Discussion	119
Conclusions		121
A Maximizing The Probability Of Distinguishing Between Two Quantum States		123
B A Zero Knowledge Protocol For Graph Non-Isomorphism		126
C The Complete Set Of Quantum States That Can Pass A GHZ Test		129
References		132

List of Figures

1.1	Sequence of operations for the implementation of a measurement in the z basis on the first part of a state followed by a two-qubit unitary dependent on the outcome in the case (a) where the measurement is performed explicitly, and (b) where the measurement is kept at the quantum level until the end. In the latter case an ancillary system indexed by A has been introduced, and the unitary operation is now controlled on this system. Note that the end result is the same in both cases.	8
1.2	Schematic showing information reconciliation. The release of $S = f(X, R)$ reduces Bob's uncertainty on Alice's string, X , to a negligible amount.	20
1.3	Schematic showing privacy amplification of string X to form S using a <i>universal</i> ₂ hash function.	24
1.4	Schematic of a non-relativistic protocol between two parties. A represents Alice's systems, B represents Bob's systems, and C is the channel. Alice and Bob alternately perform unitaries as the protocol proceeds.	35
1.5	Schematic of the setup for a relativistic protocol with two separated sites.	37
1.6	Alternative setup for a relativistic protocol with two separated sites.	38

4.1	The sequence of exchanges between Alice and Bob in the protocol for extending coin tosses (Protocol 4.1), where Bob interacts with a second device to choose his string. Device 1 is the supplier of perfect coin tosses, in the form of string R . In the original form of the protocol, device 2 is not used, and Bob sends a random string, b , of his own choosing to Alice.	86
5.1	Diagram of the steps in Protocol 5.1. Together devices 1–3 form a device triple.	112
5.2	Diagram of the steps in Protocol 5.2. The same string, x , is used to generate the input to each device triple. We have numbered each sub-lab in which instances of Protocol 5.1 occur.	117

Chapter 1

Introduction

“If you wish another to keep your secret, first keep it to yourself.” –
Lucius Annaeus Senec

1.1 Preface

Secrecy has been an important aspect of life since the birth of civilization, if not before – even squirrels hide their nuts. While the poor squirrel has to rely on unproven assumptions about the intelligence and digging power of its adversaries, we, today, seek a more powerful predicate. We demand unconditional security, that is security guaranteed by the laws of physics.

One common example is that of a base communicating with a field agent. In the standard incarnation of this problem, Alice, at base, uses a key to encrypt her data, before sending the encryption in the clear to agent Bob. An eavesdropper, Eve, hearing only the encrypted message can discover little about the data. Shannon’s pioneering work on information theory implies that to achieve perfect secrecy, so that, *even if she possesses the entire encrypted message*, Eve can do no better than simply guess Alice’s message, requires a key that is at least as long as the message.

This is an inconvenient result. Distributing, carrying and securely storing long keys is expensive. In the 1970s, a band of classical cryptographers came up with a set of practical ciphers to which they entrusted their private communications, and indeed many of us do today. These evade Shannon’s requirement on the

key by assuming something about the power of an eavesdropper. The Rivest, Shamir and Adleman cipher (RSA), for instance, assumes that an eavesdropper finds it hard to factor a large number into the product of two primes. Security then has a finite lifetime, the factoring time. Although for matters of national security, such a cryptosystem is inappropriate, it is of considerable use to protect short-lived secrets. For instance if it is known that a hacker takes 20 years to find out a credit card number sent over the internet, one simply needs to issue new credit card numbers at least every 20 years. But it is not that simple. It may take 20 years running the best known algorithm on the fastest computer available today to break the code, but this could change overnight. The problem with relying on a task such as factoring is that no one actually knows how hard it is. In some sense, we believe it is secure because very clever people have spent large amounts of time trying to find a fast factoring algorithm implementable on today's computers, and have failed. More alarmingly, we actually know of a factoring algorithm that works efficiently on a quantum computer. We are then relying for security on no one having successfully built such a computer. Perhaps one already exists in the depths of some shady government organization. There are bigger secrets than one's credit card numbers, and for these, we cannot risk such possibilities.

As we have mentioned, a quantum computer can efficiently break the cryptosystems we use today. Quantum technology also allows us to build cryptosystems with improved power, and in fact such that they are provably unbreakable within our assumptions. The usefulness of quantum mechanics in cryptography went un-noticed for many years. Wiesner made the first step in 1970 in a work that remained unpublished until 1983. In 1984, Bennett and Brassard extended Wiesner's idea to introduce the most notorious utilization of quantum mechanics in cryptography – quantum key distribution. This allows a key to be generated remotely between two parties with unconditional security, thus circumventing the problem of securely storing a long key. The principle behind Bennett and Brassard's scheme is that measuring a quantum state necessarily disturbs it. If an eavesdropper tries to tap their quantum channel, Alice and Bob can detect this. If a disturbance is detected, they simply throw away their key and start again. Any information Eve gained on the key is useless to her since this key will

be discarded. Alice and Bob can then be assured of their privacy. Remote key distribution is impossible classically, hence quantum mechanics is, at least in this respect, a cryptographically more powerful theory.

Other cryptographic primitives have been applied to the quantum setting. These so-called post cold war applications focus on exchange of information between potentially mistrustful parties. Multiple parties wish to protect their own data (perhaps only temporarily) while using it in some protocol. Bit commitment is one such example. In an everyday analogy of this primitive, Alice writes a bit on a piece of paper and locks it in a safe. She sends the safe to Bob, but keeps the key. At some later time Alice can unveil the bit to Bob by sending him the key, thus proving that she was committed to the bit all along. Of course, this scheme is not fundamentally secure—it relies on unproven assumptions about the size of sledgehammer available to Bob. Mayers, Lo and Chau showed that a large class of quantum bit commitment schemes are impossible. This cast major doubt on the possible success of other such primitives, but all was not lost. In 1999, Kent noticed that exploiting another physical theory might rescue the situation. (He was not in fact the first to consider using this theory, but seems to be the first to obtain a working result.) Special relativity¹ demands that information does not travel faster than the speed of light. The essence of its usefulness is that in a relativistic protocol, we can demand that certain messages be sent simultaneously by different parties. The receipt times can then be used to guarantee that these messages were generated independently. Coin tossing, for example becomes very straightforward. Alice and Bob simply simultaneously send one another a random bit. If the bits are equal, they assign heads, if different, they assign tails. Relativistic protocols have been developed to realise bit commitment with, at present, conjectured security.

1.2 Synopsis

This thesis is divided into five chapters.

¹Strictly, special relativity and the assumption of causality.

Introduction : The remainder of this chapter is used to introduce several concepts that will be important throughout the thesis. We discuss quantum key distribution, and in particular the use and security of *universal₂* hash functions as randomness extractors in privacy amplification. We introduce types of security, and discuss the assumptions underlying the standard cryptographic model, before describing the general physical frameworks in which our protocols will be constructed. Finally, we describe some important cryptographic primitives.

The Power Of The Theory – Strong Coin Tossing: We introduce the task of strong coin tossing and use it to highlight the fact that different physical theories generate different amounts of power in cryptography. Our contribution here is a new protocol applicable in the non-relativistic quantum case. It equals the best known bias to date for such protocols, but does so using a conceptually different technique to that of protocols found in the literature. It provides a further example of the use of entanglement as a resource. Our protocol, Protocol 2.2, and an analysis of its security has appeared in [1].

Variable Bias Coin Tossing: In this chapter we divide secure two-party computations into several classes before showing that a particular class is achievable using a quantum relativistic protocol. The simplest non-trivial computation in this class, a variable bias coin toss, will be discussed in detail. Such tasks have not been considered in the literature to date, so this chapter describes a new positive result in cryptography. We prove that this task can be achieved with unconditional security for a specified range of biases, and with cheat-evident security for any bias. We also discuss two further protocols which are conjectured to be unconditionally secure for any bias. Most of the work covered by this chapter has appeared in [2].

Secure Two-Party Computation: In this chapter, we study the remaining classes of two-party computation for which, prior to our work, neither protocols nor no-go theorems were known. We set up a general model for such computations, before giving a cheating attack which shows that a wide range of

functions within these classes are impossible to compute securely. The culmination of these results is given in Table 4.4 (see page 101). A publication on these results is in preparation.

Randomness Expansion Under Relaxed Cryptographic Assumptions: In the final chapter, we discuss a cryptographic task, expanding a private random string, while relaxing the standard assumption that each party trusts all of the devices in their laboratory. Specifically, we assume that all quantum devices are provided by a malicious supplier. We give two protocols that are conjectured to securely perform this task. The first allows a private random string to be expanded by a finite amount, while the second generates an arbitrarily large expansion of such a string. Constructing formal security proofs for our protocols is currently under investigation.

1.3 Preliminaries

The reader well versed in quantum information theory notions can skip this section; for the non-specialist reader, we provide an outline of some of the aspects that we draw upon regularly in the forthcoming chapters.

1.3.1 Local Operations

We will often talk of local operations. These describe any operation that a party can do on the part of the system they hold locally, as dictated by the laws of physics (specifically quantum mechanics). For quantum systems, these fall into three classes: altering the size of the system, performing unitary operations, and performing measurements. A local operation can comprise any combination of these.

System Size Alteration : This is operationally trivial. A system can be enlarged simply by combining it with another system, and contracted by discarding the other system. When systems are enlarged, the combined system then lives in the tensor product of the spaces of the original systems, and its state is given by the tensor product of the states of the two individual systems, which we denote with the symbol \otimes .

Unitary Operations : These are implemented by applying some Hamiltonian to the system in question, for example by placing it in an external field. The system's dynamics follow that of the time-dependent Schrödinger equation. This defines a unitary operation on the Hilbert space of the system. In theory, any unitary can be enacted on the system by varying external fields appropriately, and applying them for the correct time periods. However, technologically, this represents a considerable challenge.

Measurement : The most general type of measurement that one needs to consider is a projective measurement. Such a measurement is defined by a set of operators, $\{\Pi_i\}$ with the property that $\Pi_i^2 = \Pi_i$, and $\sum_i \Pi_i = \mathbb{1}$, the identity operator. The postulates of quantum mechanics demand the outcome of such a measurement on a system in state ρ to be i with probability $\text{tr}(\Pi_i \rho)$, and that the subsequent state of the system on measuring i is $\frac{\Pi_i \rho \Pi_i}{\text{tr}(\Pi_i \rho)}$.

While this is the most general type of measurement we need, it will often be convenient to use the positive operator valued measure (POVM) formalism, whereby a measurement is defined by a set of positive operators $\{E_i\}$ which obey $\sum_i E_i = \mathbb{1}$. An outcome i leaves the state of the system as $\frac{\sqrt{E_i} \rho \sqrt{E_i}}{\text{tr}(E_i \rho)}$ and occurs with probability $\text{tr}(E_i \rho)$.

Any POVM can be realized as the combination of an enlargement of the system, a unitary operation, and projective measurement (this result is often called Neumark's theorem [3]). The following is equivalent to performing the POVM with elements $\{E_i\}$ on a system in state ρ : Introduce an ancilla in state $|0\rangle$, and perform the unitary operation, U , given by $U |0\rangle |\psi\rangle = \sum_i (\mathbb{1} \otimes \sqrt{E_i}) |i\rangle |\psi\rangle$ ². Then measure the projector onto $\{|i\rangle\langle i| \otimes \mathbb{1}\}$ generating the state, $\frac{(\mathbb{1} \otimes \sqrt{E_i})(|i\rangle\langle i| \otimes \rho)(\mathbb{1} \otimes \sqrt{E_i})}{\text{tr}(E_i \rho)}$ with probability $\text{tr}(E_i \rho)$. On discarding the ancillary system, this operation is equivalent to that of the POVM.

Any combination of these operations forms what we term a local operation. It is easy to verify that any large sequence of such operations can be reduced to at most 4 steps: First, the system is enlarged, then it is measured, then a unitary

²This unitary is only partially specified, since we have only defined its operation when the first register is in the state $|0\rangle$. However, it is easily extended to a unitary over the entire space [4].

operation is performed on it (possibly one that depends on the result), and finally part of the system is discarded (again, possibly depending on the result).

Local operations have the property that for a system comprising subsystems Q and R , no local operation on Q can be used to affect the outcome probabilities of any measurement on system R , even if the two systems are entangled. This property means that quantum theory does not permit superluminal signalling.

Another important property of local operations is that on average they cannot increase entanglement between separated subsystems [4].

1.3.1.1 Keeping Measurements Quantum

Rather than perform a measurement as prescribed by a protocol, it turns out that one can instead introduce an ancillary register, and perform a controlled NOT between the system that was to be measured and this ancilla. The additional register in effect stores the result of the measurement, such that if it is later measured, the entire system collapses to that which would have been present if the measurement had been performed as the protocol prescribed. This result holds for any sequence of operations that occur on the system in the time between the controlled operation and the measurement on the ancilla. If one of these further operations should be dependent on the measurement outcome, then, instead, a controlled operation is performed with the outcome register as the control bit. The process of delaying a measurement in this way is often referred to as “keeping the measurement quantum”. Figure 1.1 illustrates this procedure.

1.3.2 Distinguishing Quantum States

The problem of how best to distinguish quantum states dates back several decades. For a good account see for example [5].

Alice is to prepare a state $\rho \in \{\rho_0, \rho_1, \dots, \rho_{n-1}\}$ and send it to Bob. She is to choose ρ_i with probability η_i . Bob, who knows the identity of the states $\{\rho_0, \rho_1, \dots, \rho_{n-1}\}$ and their probability distribution, is required to guess the value of i by performing any operations of his choice on ρ . It is well known that Bob cannot guess the value of i with guaranteed success, unless the states are orthogonal.

$$(a|0\rangle + b|1\rangle)|\psi\rangle \begin{cases} \xrightarrow{\text{probability } |a|^2} |0\rangle|\psi\rangle \xrightarrow{U_0} U_0(|0\rangle|\psi\rangle) \\ \xrightarrow{\text{probability } |b|^2} |1\rangle|\psi\rangle \xrightarrow{U_1} U_1(|1\rangle|\psi\rangle) \end{cases}$$

(a)

$$(a|0\rangle|\psi\rangle|0\rangle_A + b|1\rangle|\psi\rangle|1\rangle_A) \xleftarrow{\text{controlled NOT}} (a|0\rangle + b|1\rangle)|\psi\rangle|0\rangle_A$$

$$\downarrow U_0 \otimes |0\rangle\langle 0|_A + U_1 \otimes |1\rangle\langle 1|_A$$

$$aU_0(|0\rangle|\psi\rangle)|0\rangle_A + bU_1(|1\rangle|\psi\rangle)|1\rangle_A \begin{cases} \xrightarrow{\text{probability } |a|^2} U_0(|0\rangle|\psi\rangle)|0\rangle_A \\ \xrightarrow{\text{probability } |b|^2} U_1(|1\rangle|\psi\rangle)|1\rangle_A \end{cases}$$

(b)

Figure 1.1: Sequence of operations for the implementation of a measurement in the z basis on the first part of a state followed by a two-qubit unitary dependent on the outcome in the case (a) where the measurement is performed explicitly, and (b) where the measurement is kept at the quantum level until the end. In the latter case an ancillary system indexed by A has been introduced, and the unitary operation is now controlled on this system. Note that the end result is the same in both cases.

There are two flavours to this problem. One, sometimes called quantum hypothesis testing, involves maximizing the probability of guessing the state correctly. The other, unambiguous state discrimination, seeks to never make an error. This can be achieved only if the states to be distinguished are linearly independent, and at the expense that (unless the states are orthogonal) sometimes an inconclusive outcome will be returned. It is the first of these two problems that will be relevant to us.

It follows from the discussion of local operations in the previous section, and the fact that we don't need the system after the measurement that it is sufficient for Bob to simply do a POVM on ρ . This POVM should have n outcomes, with outcome i corresponding to a best guess of Alice's preparation being ρ_i ³. The task is to maximize

$$\sum_i \eta_i \text{tr}(E_i \rho_i) \tag{1.1}$$

over all POVMs $\{E_i\}$.

In general, it is not known how to obtain an analytic solution to this problem [5], although numerical techniques have been developed [6]. However, a solution is known for the case $n = 2$. In Appendix A, we give a proof that in this case, the maximum probability is $\frac{1}{2}(1 + \text{tr}|\eta_0\rho_0 - \eta_1\rho_1|)$ [7]. In the case $\eta_0 = \eta_1 = \frac{1}{2}$, this expression is usually written as $\frac{1}{2}(1 + D(\rho_0, \rho_1))$, where $D(\rho_0, \rho_1) \equiv \frac{1}{2}\text{tr}|\rho_0 - \rho_1|$ is the trace distance between the two density matrices.⁴

Other cases for which analytic results are known involve cases where the set of states to be distinguished are symmetric and occur with a uniform probability distribution. In such cases, the so-called square root measurement is optimal [8, 9]. Another result that we will find useful is the following theorem.

³It is clear that we can always put the optimal strategy in this form. For a general POVM, each element can be associated with a state that is the best guess for the outcome corresponding to that element. If two elements have the same best guess, we can combine their POVM elements by addition to give a new POVM. This generates a POVM with at most n outcomes. If there are fewer than n , then we can always pad the POVM with zero operators. A simple relabelling then ensures that outcome i corresponds to a best guess of ρ_i .

⁴This is a generalization of the classical distance between probability distributions, for which we also use the symbol D , see Section 1.7.

Theorem 1.1. [7, 10, 11] Consider using a set of M measurement operators, $\{E_j\}$, to discriminate between a set of M states, $\{\rho_j\}$, which occur with prior probabilities, $\{\eta_j\}$, where the outcome corresponding to operator E_j indicates that the best guess of the state is ρ_j . The set $\{E_j\}$ is optimal if and only if

$$E_j (\eta_j \rho_j - \eta_l \rho_l) E_l = 0 \quad \forall j, l \quad (1.2)$$

$$\sum_j E_j \eta_j \rho_j - \eta_l \rho_l \geq 0 \quad \forall l. \quad (1.3)$$

1.3.3 Entanglement, Bell's Theorem And Non-locality

The title of this section could easily be that of a book. A wealth of previous research exists in this area, and a number of debates still rage about the true nature of non-locality; some of which date back to the famous Einstein-Podolsky-Rosen paper of 1935 [12], or even before. There is no evidence to date that contradicts the predictions of quantum theory, but some find its philosophical consequences so outrageous that they seek alternative theories that are more closely aligned with what is ultimately their own beliefs. Furthermore, there exist experimental loopholes which sustain the belief that quantum theory could be local⁵. In this section I briefly discuss some aspects of what is often referred to as quantum non-locality.

The term entanglement describes the property of particles that leads to their behaviour being linked even if they have a large separation. Consider a pair of electrons created in a process which guarantees that their spins are opposite. According to quantum theory, until such a time that a measurement is made, the state of the entire system is $\frac{1}{\sqrt{2}}(|\uparrow_1 \downarrow_2\rangle + |\downarrow_1 \uparrow_2\rangle)$. Measuring either particle in the $\{\uparrow, \downarrow\}$ basis causes the state of the entire two particle system to collapse to either $|\uparrow_1 \downarrow_2\rangle$ or $|\downarrow_1 \uparrow_2\rangle$ with probability half each. What is philosophically challenging about this is that measuring the first particle affects the properties of the second particle *instantaneously*. If one were to perform the experiment, the natural conclusion would be that each particle was assigned to be in either the $|\uparrow\rangle$ or $|\downarrow\rangle$ state when they were created, and hence such results are not at all surprising: we

⁵No experiment to date has properly ensured space-like separation of measurements.

simply didn't know how the state was assigned until the measurement. A famous analogy is that of Bertlmann's socks [13]. Which colour he wears on a particular day is unpredictable, but his socks are never coloured the same. On seeing that his right sock is pink, *instantaneously* one knows that his left is not. Based on this experiment alone, both hypotheses are tenable.

It was Bell who realized a way in which these hypotheses can be distinguished [13]. He developed an inequality that any local realistic theory must obey⁶, before showing that suitable entangled quantum systems can violate this. The most common recasting of his ideas is the CHSH inequality (named after Clauser, Horne, Shimony and Holt). Consider the following abstract scenario. Two spatially separated boxes each have two possible settings (inputs), and two possible outputs, +1 and -1. We label the inputs P and Q for each box, and use $P_i \in \{1, -1\}$ and $Q_i \in \{1, -1\}$ to denote the output of the box for input P or Q respectively, with index $i \in \{1, 2\}$ corresponding to the box to which we are referring. (In a quantum mechanical context, the inputs represent choices of measurement basis, and the outputs the measurement result.) The CHSH test involves the quantity $\langle P_1P_2 + P_1Q_2 + Q_1P_2 - Q_1Q_2 \rangle$, where $\langle X \rangle$ denotes the expectation value of random variable X . The following theorem gives the limit of this quantity for local hidden variable theories.

Theorem 1.2. *There is no assignment of values $\{P_1, P_2, Q_1, Q_2\} \in \{\pm 1, \pm 1, \pm 1, \pm 1\}$ (and hence no local hidden variable theory), for which $\langle P_1P_2 + P_1Q_2 + Q_1P_2 - Q_1Q_2 \rangle > 2$*

Nevertheless, values as high as $2\sqrt{2}$ are possible using quantum systems [14] although these fall short of the maximum algebraic limit of 4. The achievability of $2\sqrt{2}$ rules out the possibility of a local hidden variable theory for explaining the data (modulo a few remaining loopholes, see for example [15–17] for discussions). A non-local but realistic theory can evade the theorem by allowing the value of quantities defined on one particle to change when a measurement is made on another, no matter how separated the particles are. It is not straightforward to drop the realistic assumption while keeping the theory local, since the concept of

⁶A local theory is one in which no influence can travel faster than light; a realistic theory is one in which values of quantities exist prior to being measured.

locality itself is inherently linked with realism. Hence it is common terminology in the literature to use the phrase “non-local effects” to allude to violations of Bell-type inequalities such as that of CHSH.

1.3.4 Entropy Measures

1.3.4.1 Random Events

When we discuss random events, we assume that they occur according to a pre-defined ensemble of possible outcomes and their associated probabilities. Event X is a single instance drawn from the ensemble $\{1, 2, \dots, |X|\}$ with probabilities $\{P_X(1), P_X(2), \dots, P_X(|X|)\}$. We call this probability distribution P_X . The terminology $X = x$ refers to a single instance drawn from this distribution taking the value x . One similarly defines distributions over more than one random variable. For instance, P_{XY} is the joint distribution of X and Y , and $P_{X|Y=y}$ is the distribution of X conditioned on the fact that Y takes value y .

1.3.4.2 Shannon Entropy

It was Shannon who pioneered the mathematical formulation of information [18]. In essence his insight was that an event that occurs with probability p could be associated with an amount of information $-\log p$.⁷ Consider many independent repetitions of random event X . The average information revealed by each instance of X is given by the Shannon entropy of X defined as follows.

Definition 1.1. The Shannon entropy associated with an event x drawn from random distribution X is $H(X) \equiv \sum_{x \in X} -P_X(x) \log P_X(x)$.

Likewise, one can define conditional Shannon entropies. $H(X|Y = y)$ denotes the Shannon entropy of X given Y . It measures the average amount of information one learns from a single instance of X if one possesses string $y \in Y$, where X, Y are chosen according to joint distribution P_{XY} . One can average this quantity to form $H(X|Y)$, the conditional Shannon entropy.

⁷In information theory, as in this thesis, all logarithms are taken in base 2 and hence entropies and related quantities are measured in bits.

Definition 1.2. The conditional Shannon entropy of an event X given Y is defined by $H(X|Y) \equiv \sum_{x \in X, y \in Y} -P_Y(y)P_{X|Y=y}(x) \log P_{X|Y=y}(x)$.

This leads one to define the mutual Shannon information between X and Y by $I(X : Y) \equiv H(X) - H(X|Y) = H(Y) - H(Y|X)$. In some sense, this is the amount of information in common to the two strings X and Y .

Shannon information was first used to solve problems of compression, and communication over a noisy channel, as given in the following theorems [18].

Theorem 1.3. (*Source coding theorem*) Consider a source emitting independent and identically distributed (IID) random variables drawn from distribution P_X . For any $\epsilon > 0$ and $R > H(X)$, there exists an encoder such that for sufficiently large N , any sequence drawn from P_X^N can be compressed to length NR , and a decoder such that, except with probability $< \epsilon$, the original sequence can be restored from the compressed string.

Furthermore, if one tries to compress the same source using $R < H(X)$ bits per instance, it is virtually certain that information will be lost.

Definition 1.3. For a discrete, memoryless channel, in which Alice sends a random variable drawn from X to Bob who receives Y , the *channel capacity* is defined by $C \equiv \max_{P_X} I(X : Y)$.

Theorem 1.4. (*Noisy channel coding theorem*) Consider Alice communicating with Bob via a discrete memoryless channel which has the property that if Alice draws from an IID source X , Bob receives Y . For any $\epsilon > 0$ and $R < C$, for large enough N , there exists an encoding of length N and a decoder such that $\geq RN$ bits of information are conveyed by the channel for each encoder-channel-decoder cycle, except with probability $< \epsilon$.

Notice that in the noisy channel coding theorem, the channel is memoryless, and Alice has an IID source. In other words, all uses of the channel are independent of one another. This is the situation in which Shannon information is useful. However, in cryptographic scenarios where the channel may be controlled by an eavesdropper, such an assumption is not usually valid. Instead, other entropy measures have been developed that apply for these cases, as discussed in the next section.

The relative entropy, which is a measure of the closeness of two probability distributions, will also be of use.

Definition 1.4. The relative entropy of P_X and Q_X is given by,

$$H(P_X||Q_X) \equiv \sum_x P_X(x) \log \frac{P_X(x)}{Q_X(x)}. \quad (1.4)$$

1.3.4.3 Beyond Shannon Entropy

Rényi [19] introduced the following generalization of the Shannon entropy.

Definition 1.5. The Rényi entropy of order α is defined by

$$H_\alpha(X) \equiv \frac{1}{1-\alpha} \log \sum_{x \in X} P_X(x)^\alpha. \quad (1.5)$$

We have, $H_1(X) \equiv \lim_{\alpha \rightarrow 1} H_\alpha(X) = H(X)$. Two other important cases are $H_0(X) = \log |X|$ and $H_\infty(X) = -\log \max_{x \in X} P_X(x)$. A useful property is that, for $\alpha \leq \beta$, $H_\alpha(X) \geq H_\beta(X)$.

$H_\infty(X)$ is sometimes called the min-entropy of X . We will see that it is important for privacy amplification. There, the presence of an eavesdropper means that it no longer suffices to consider each use of the channel as independent. The min-entropy represents the maximum amount of information that could be learned from the event X , so describes the worst case scenario. In a cryptographic application, one wants to be assured security even in the worst case.

In general, Rényi entropies are strongly discontinuous.⁸ However, smoothed versions of these quantities have been introduced which remove such discontinuities. In essence, these smoothed quantities involve optimizing such quantities over a small region of probability space. They have operational significance in cryptography in that they provide the relevant quantities for information reconciliation and privacy amplification as will be discussed in Section 1.4. It will be

⁸Consider the two distributions P_X and Q_X defined on $x \in \{1, \dots, 2^n\}$. Take $P_X(x=1) = 2^{-\frac{n}{4}}$, $P_X(x \neq 1) = \frac{1-2^{-\frac{n}{4}}}{2^n-1}$, and Q_X to be the uniform distribution. Comparing min-entropies gives $H_\infty^Q(X) - H_\infty^P(X) = \frac{3n}{4}$. In the large n limit, the two distributions have distance $\approx 2^{-\frac{n}{4}}$ (see Definition 1.21), which is exponentially small, while the difference in min-entropies becomes arbitrarily large.

the conditional versions of these entropies that concern us, hence we provide a definition of these directly.

Definition 1.6. [20] For a distribution P_{XY} , and smoothing parameter $\epsilon > 0$, we define the following smoothed Rényi entropies:

$$H_0^\epsilon(X|Y) \equiv \min_{\Omega} \max_y \log |\{x : P_{X\Omega|Y=y}(x) > 0\}| \quad (1.6)$$

$$H_\infty^\epsilon(X|Y) \equiv \max_{\Omega} \left(-\log \max_y \max_x P_{X\Omega|Y=y}(x) \right), \quad (1.7)$$

where Ω is a set of events with total probability at least $1 - \epsilon$, and $P_{X\Omega|Y=y}(x)$ denotes the probability that X takes the value x , and event Ω occurs given that Y takes the value y .

More generally, the smooth Rényi entropy of order α can be defined [20], but since, up to an additive constant these equal either H_0^ϵ (for $\alpha < 1$) or H_∞^ϵ (for $\alpha > 1$), we ignore such quantities in our discussion. It is also worth noting that for a large number of independent repetitions of the same experiment, the Rényi entropies tend to the Shannon entropy, that is,

$$\lim_{\epsilon \rightarrow 0} \lim_{n \rightarrow \infty} \frac{H_\alpha^\epsilon(X^n|Y^n)}{n} = H(X|Y). \quad (1.8)$$

1.3.4.4 Quantum Entropic Quantities

The entropy of a quantum state, ρ , is commonly expressed using the von Neumann entropy,

$$H(\rho) \equiv -\text{tr}(\rho \log \rho). \quad (1.9)$$

This is the quantum analogue of the Shannon entropy, and is equal to the Shannon entropy of the probability distribution formed if ρ is measured in its diagonal basis. Hence, if ρ is classical, that is $\rho = \sum_x P_X(x)|x\rangle\langle x|$, for some orthonormal basis, $\{|x\rangle\}$, then $H(\rho) = H(X)$.

In a similar way, one defines the quantum relative entropy between the states ρ and σ by,

$$H(\rho||\sigma) = \text{tr}(\rho \log \rho) - \text{tr}(\rho \log \sigma). \quad (1.10)$$

This again reduces to the classical version if σ and ρ have the same diagonal basis. It has the following important property [4].

Theorem 1.5. (*Klein's inequality*) $H(\rho|\sigma) \geq 0$, with equality if and only if $\rho = \sigma$.

The conditional von Neumann entropy can be defined by⁹

$$H(\rho_{AB}|\sigma_B) \equiv -\text{tr}(\rho_{AB}(\log \rho_{AB} - \log \mathbb{1}_A \otimes \sigma_B)) \quad (1.11)$$

$$= H(\rho_{AB}) - H(\rho_B) - H(\rho_B|\sigma_B), \quad (1.12)$$

where $\rho_B = \text{tr}_A \rho_{AB}$. We can also define a version for the extremal case $\sigma_B = \rho_B$,

$$H(\rho_{AB}|B) \equiv H(\rho_{AB}|\rho_B). \quad (1.13)$$

Likewise, we define quantum min-entropies,

$$H_\infty(\rho_A) \equiv -\log \lambda_{\max}(\rho_A), \quad (1.14)$$

$$H_\infty(\rho_{AB}|\sigma_B) \equiv -\log \lambda, \quad (1.15)$$

$$H_\infty(\rho_{AB}|B) \equiv \min_{\sigma_B} H_\infty(\rho_{AB}|\sigma_B), \quad (1.16)$$

where $\lambda_{\max}(\rho)$ is the largest eigenvalue of ρ , and λ is the minimum real number such that $\lambda \mathbb{1}_A \otimes \sigma_B - \rho_{AB} \geq 0$.

Lemma 1.1. Consider the case where system A is classical, that is, $\rho_{AB} = \sum_i P_I(i) |i\rangle\langle i| \otimes \rho_B^i$. For such states,

(a) $H_\infty(\rho_{AB}|B) \geq 0$, and

(b) $H_\infty(\rho_{AB}|B) = 0$ if there exists some j such that ρ_B^j is not contained within the support of $\{\rho_B^i\}_{i \neq j}$.

Proof. For a state of this form, $\lambda \mathbb{1}_A \otimes \sigma_B - \rho_{AB}$ is block diagonal with block entries $\lambda \sum_{i \neq j} P_I(i) \rho_B^i + (\lambda - 1) P_I(j) \rho_B^j$, for some j . If $\lambda > 1$, these are positive for all j , from which (a) then follows using the definition of $H_\infty(\rho_{AB}|B)$.

In order that $H_\infty(\rho_{AB}|B) = 0$, there must exist a j such that for all $\epsilon \equiv 1 - \lambda > 0$, $(1 - \epsilon) \sum_{i \neq j} P_I(i) \rho_B^i - \epsilon P_I(j) \rho_B^j$ is negative. This implies that for some j , ρ_B^j is not contained within the support of $\{\rho_B^i\}_{i \neq j}$, hence establishing (b). QED

⁹Alternative definitions are sometimes given, e.g. in [4], which do not contain the $H(\rho_B|\sigma_B)$ part [21]

Recall from Section 1.3.4.3 that the classical min-entropy can be associated with information content in the worst case scenario. The same is true here. In the extremal case, there exists some j such that ρ_B^j is not contained within the support of $\{\rho_B^i\}_{i \neq j}$. Then there exists some measurement on system B for which at least one outcome identifies the state of system A precisely, and the corresponding min-entropy is 0.

One can also define smoothed versions of these entropies. The ϵ -smooth min-entropy of ρ_{AB} given σ_B is given by

$$H_\infty^\epsilon(\rho_{AB}|\sigma_B) \equiv \min_{\bar{\rho}_{AB}} H_\infty(\bar{\rho}_{AB}|\sigma_B) \quad (1.17)$$

where the minimum is over the set of operators satisfying $D(\bar{\rho}_{AB}, \rho_{AB}) \leq \epsilon$, with $\text{tr}(\bar{\rho}_{AB}) \leq 1$. In other words, the smoothed version of the min-entropy is formed by considering density matrices close to ρ_{AB} . This is in direct analogy with the classical case, where nearby probability distributions were considered using parameter, Ω .

We also define

$$H_\infty^\epsilon(\rho_{AB}|B) \equiv \min_{\sigma_B} H_\infty^\epsilon(\rho_{AB}|\sigma_B), \quad (1.18)$$

where we give the second Hilbert space of the system to the eavesdropper.

1.4 Quantum Key Distribution

Quantum key distribution is one of the big success stories of quantum information theory. It allows two separated agents, Alice and Bob, to generate a shared random string about which an eavesdropper, Eve, has no information. Such a random string can form the key bits of a one-time pad, for example, and hence allow secure communication between Alice and Bob. This task is known to be impossible classically, without making computational assumptions, and is historically the first instance of a quantum protocol. Really the task should be called key expansion, since an initial shared random string is needed for authentication. We avoid this distinction by giving Alice and Bob shared authenticated classical channels (upon which Eve can only listen, but not modify), and a completely insecure quantum channel.

Eve can always perform a denial of service attack, blocking communication between Alice and Bob. However, we assume instead, that she wants to learn some part of their message. There are several steps common to most key distribution protocols. Exchange of information over the insecure channel, *reconciliation* of this information (i.e. error correction) and then *privacy amplification* (i.e. reducing Eve's information to a negligible amount).

Often, the quantum part of the protocol is restricted to the first step. A quantum channel is used to set up correlated random strings, after which classical reconciliation and privacy amplification procedures are used. In essence, the security of the protocol relies on the fact that an eavesdropper can neither copy a quantum state, nor learn anything about it without disturbance. We will not discuss the alternative approach, where these latter procedures are also quantum, and at the end of the protocol Alice and Bob possess shared singlets. For concreteness, we now outline Bennett and Brassard's 1984 protocol, BB84.

Protocol 1.1. Define 2 bases, $\mathcal{B}_0 \equiv \{|0\rangle, |1\rangle\}$, and $\mathcal{B}_1 \equiv \{|+\rangle, |-\rangle\}$, where $|\pm\rangle \equiv \frac{1}{\sqrt{2}}(|0\rangle \pm |1\rangle)$.

1. Alice selects a set of bits uniformly at random, $\{x_i\}$, along with a uniform random set of bases $\{A_i\}$, where $x_i \in \{0, 1\}$, and $A_i \in \{\mathcal{B}_0, \mathcal{B}_1\}$.
2. She encodes bit x_i using basis A_i , where 0 is encoded as $|0\rangle$ or $|+\rangle$, and we use $|1\rangle$ or $|-\rangle$ to encode 1.
3. Alice sends the encoded qubits to Bob through the quantum channel.
4. Bob selects a random set of bases $\{B_i\}$, with $B_i \in \{\mathcal{B}_0, \mathcal{B}_1\}$, and measures the i th incoming qubit in basis B_i .
5. Once Bob has made all his measurements, Alice announces the bases she used over the public channel, and Bob does the same.
6. (*sifting*) Alice and Bob discard all the measurements made using different bases. On average half the number of qubits sent by Alice remain. In the absence of noise and an eavesdropper the leftover strings are identical.

7. Alice and Bob compare the values of a subset of their bits, selected at random. This allows them to estimate the error rate. If too high, they abort.
8. Alice and Bob perform reconciliation and privacy amplification on the remaining bits.

1.4.1 Information Reconciliation

Information reconciliation is error correction. In essence, Alice wants to send error correction information to Bob so that he can make his partially correlated string identical to hers. Since this information will be sent over a public channel on which Eve has full access, Alice wishes to minimize the error correction information at the same time as providing a low probability of non-matching strings in the result.

The task of information reconciliation can be stated as follows. Alice has string X and Bob Y , these being chosen with joint distribution P_{XY} . Alice also possesses some additional independent random string R . What is the minimum length of string $S = f(X, R)$ that Alice can compute such that X is uniquely obtainable by Bob using Y , S and R , except with probability less than ϵ ?

In [20], this quantity is denoted $H_{enc}^\epsilon(X|Y)$ and is tightly bounded by the relation

$$H_0^\epsilon(X|Y) \leq H_{enc}^\epsilon(X|Y) \leq H_0^{\epsilon_1}(X|Y) + \log \frac{1}{\epsilon_2}, \quad (1.19)$$

where $\epsilon_1 + \epsilon_2 = \epsilon$.

It is intuitively clear why $H_0^\epsilon(X|Y)$ is the correct quantity. Recall the definition (1.6)

$$H_0^\epsilon(X|Y) \equiv \min_{\Omega} \max_y \log |\{x : P_{X\Omega|Y=y}(x) > 0\}|,$$

where Ω is a set of events with total probability at least $1 - \epsilon$. The size of the set of strings x that could have generated $Y = y$ given Ω is $|\{x : P_{X\Omega|Y=y}(x) > 0\}|$. Alice's additional information needs to point to one of these. It hence requires $\log |\{x : P_{X\Omega|Y=y}(x) > 0\}|$ bits to encode. Since Alice does not know y , she must assume the worst, hence we maximize on y . Furthermore, since some error is

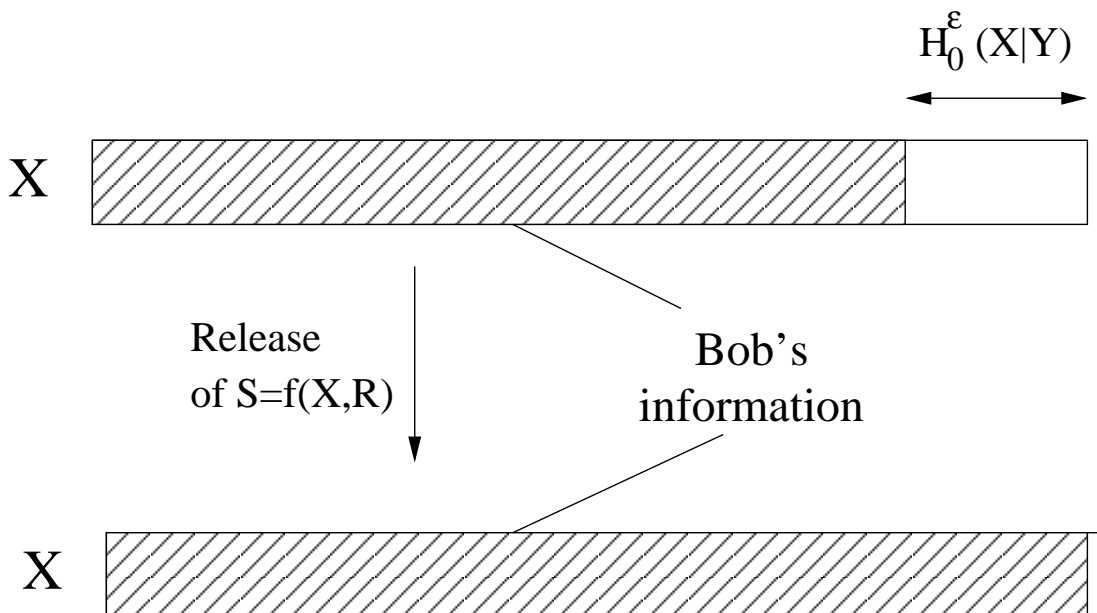

Figure 1.2: Schematic showing information reconciliation. The release of $S = f(X, R)$ reduces Bob's uncertainty on Alice's string, X , to a negligible amount.

tolerable, we minimize on Ω , by cutting away unlikely events from the probability distribution.

1.4.2 Privacy Amplification

In essence, this task seeks to find the maximum length of string Alice and Bob can form from their shared string such that Eve has no information on this string.

This task can be stated more formally as follows. Alice possesses string X and Eve Z ¹⁰, distributed according to P_{XZ} . Alice also has some uncorrelated random string R . What is the maximum length of a binary string $S = f(X, R)$, such that for a uniform random variable U that is independent of Y and R , we have $S = U$, except with probability less than ϵ ?

This quantity, denoted $H_{ext}^\epsilon(X|Z)$, has been bounded [20] as follows:

$$H_\infty^{\epsilon_1}(X|Z) - 2 \log \frac{1}{\epsilon_2} \leq H_{ext}^\epsilon(X|Z) \leq H_\infty^\epsilon(X|Z), \quad (1.20)$$

¹⁰For the moment we consider the case where Eve's information is classical.

where $\epsilon_1 + \epsilon_2 = \epsilon$.

Let us give a brief intuition as to why this is the correct quantity. Recall the definition

$$H_\infty^\epsilon(X|Z) \equiv \max_{\Omega} \left(-\log \max_z \max_x P_{X\Omega|Z=z}(x) \right)$$

Given that she holds $Z = z$, the minimum amount of information Eve could learn from X is $-\log \max_x P_{X|Z=z}(x)$. We can think of this as the information in X that is independent of $Z = z$ in the worst case. If we minimize this quantity on z , which corresponds to the worst possible case for Alice, we have $-\log \max_z \max_x P_{X|Z=z}(x)$. In many scenarios there is a small probability that an eavesdropper can guess Alice's string perfectly, in which case this quantity is zero. We hence maximize over sets of events Ω that have total probability at least $1 - \epsilon$. This introduces some probability of error, but gives a significant increase in the size of the min-entropy over its non-smoothed counterpart.

1.4.2.1 Extractors And *universal*₂ Hashing

Privacy amplification is often studied using the terminology of extractors. Roughly speaking, an extractor is a function that takes as input X , along with some additional uniformly distributed, and uncorrelated randomness, R , and returns $S = f(X, R)$ that is almost uniformly distributed. For a strong extractor, we have the additional requirement that S is independent of R . After defining a distance measure for classical probability distributions, we give a formal definition of a strong extractor.

Definition 1.7. The classical distance¹¹ between two probability distributions P and Q defined on the domain X is given by

$$D(P_X, Q_X) \equiv \frac{1}{2} \sum_{x \in X} |P_X(x) - Q_X(x)|. \quad (1.21)$$

¹¹This is a special case of the trace distance defined in Section 1.3.2 and hence we denote it by the same symbol, D . It is related to the maximum probability of successfully distinguishing the two distributions in the same way that the trace distance of two quantum states is related to the maximum probability of distinguishing them (cf. Appendix A).

Definition 1.8. Let U_S be the uniform distribution over the members of S . A strong (τ, κ, ϵ) -extractor is a function that takes inputs X and R and returns $S = f(X, R)$, where $|S| = 2^\tau$, such that if $H_\infty(X) \geq \kappa$, and R is uniformly distributed and independent of X , then $D(P_{SR}, P_{U_S}P_R) \leq \epsilon$, where P_{U_S} is the uniform distribution on S .

A small distance, ϵ , between two probability distributions is essentially the same as saying that the two distributions are equal, except with probability ϵ .

As an example of an extractor, consider a *universal₂* hash function [22, 23].

Definition 1.9. A set of hash functions, F from X to S is *universal₂* if, for any distinct x_1 and x_2 in X , then, for some function $f \in F$ picked uniformly at random, the probability that $f(x_1) = f(x_2)$ is at most $\frac{1}{|S|}$.

We now show that this satisfies the necessary requirements for a strong extractor.

Consider some probability distribution P_V on V , and take U_V to be the uniform distribution over the same set. We have

$$\begin{aligned} D(P_V, P_{U_V}) &= \frac{1}{2} \sum_{v \in V} \left| P_V(v) - \frac{1}{|V|} \right| \\ &\leq \frac{\sqrt{|V|}}{2} \sqrt{\sum_{v \in V} (P_V(v) - \frac{1}{|V|})^2} \\ &= \frac{\sqrt{|V|}}{2} \sqrt{\sum_{v \in V} P_V(v)^2 - \frac{1}{|V|}}, \end{aligned} \tag{1.22}$$

where we have used the Cauchy-Schwarz inequality.¹² Hence, the collision probability, $P_C(V) \equiv \sum_{v \in V} P_V(v)^2$, i.e. the probability that two events each drawn from P_V are identical, allows us to bound the distinguishability of P_V from uniform.

To show that a *universal₂* hash function is an extractor, we take V to be SR .

¹²The Cauchy-Schwarz inequality states that $|\mathbf{x} \cdot \mathbf{y}|^2 \leq |\mathbf{x}|^2 |\mathbf{y}|^2$. The version we use is for the case $\mathbf{y} = (1, 1, \dots, 1)$.

We have

$$\begin{aligned}
P_C(SR) &= P_C(R)P_C(S) \\
&\leq \frac{1}{|R|} \left(P_C(X) + \frac{1}{|S|} \right) \\
&= \frac{1}{|R|} \left(2^{-H_2(X)} + \frac{1}{|S|} \right), \tag{1.23}
\end{aligned}$$

where the inequality follows from the definition of a *universal*₂ hash function. Thus, using (1.22), we have

$$D(P_{SR}, P_{U_S}P_R) \leq \frac{\sqrt{|S|}}{2} 2^{-\frac{1}{2}H_2(X)}. \tag{1.24}$$

Since $H_2(X) \geq H_\infty(X)$, we have shown that a *universal*₂ hash function is a strong $(\tau, \kappa, \frac{1}{2}2^{\frac{1}{2}(\tau-\kappa)})$ -extractor. Alternatively, if we wish to use *universal*₂ hashing, and have $H_\infty(X) \geq \kappa$, then to ensure that the output is ϵ -close to the uniform distribution, we can extract a string whose length is bounded by

$$\tau \leq \kappa - 2 \log \frac{1}{2\epsilon}. \tag{1.25}$$

The use of a hash function for privacy amplification is illustrated in Figure 1.3.

The drawback of *universal*₂ hashing is that in order to pick a function randomly from the members of a *universal*₂ set requires a long random string, R . Many *universal*₂ classes require the string R to have length equal to that of the string being hashed, although more efficient classes are known for cases in which the final string is very short compared to the initial one [22, 23]. For more general extractors, constructions which require a much shorter R are known (see [24] for a recent review).

1.4.2.2 Privacy Amplification

In the context of privacy amplification, there is additional information held by Eve. We denote this using the random variable Z . Again, Alice wants to compress her string, X , using public randomness¹³, R , to form $S = f(X, R)$, such that

$$D(P_{SR|Z=z}, P_{U_S}P_R) \leq \epsilon. \tag{1.26}$$

¹³Her randomness is public because she needs to send it to Bob in order that he can do the same.

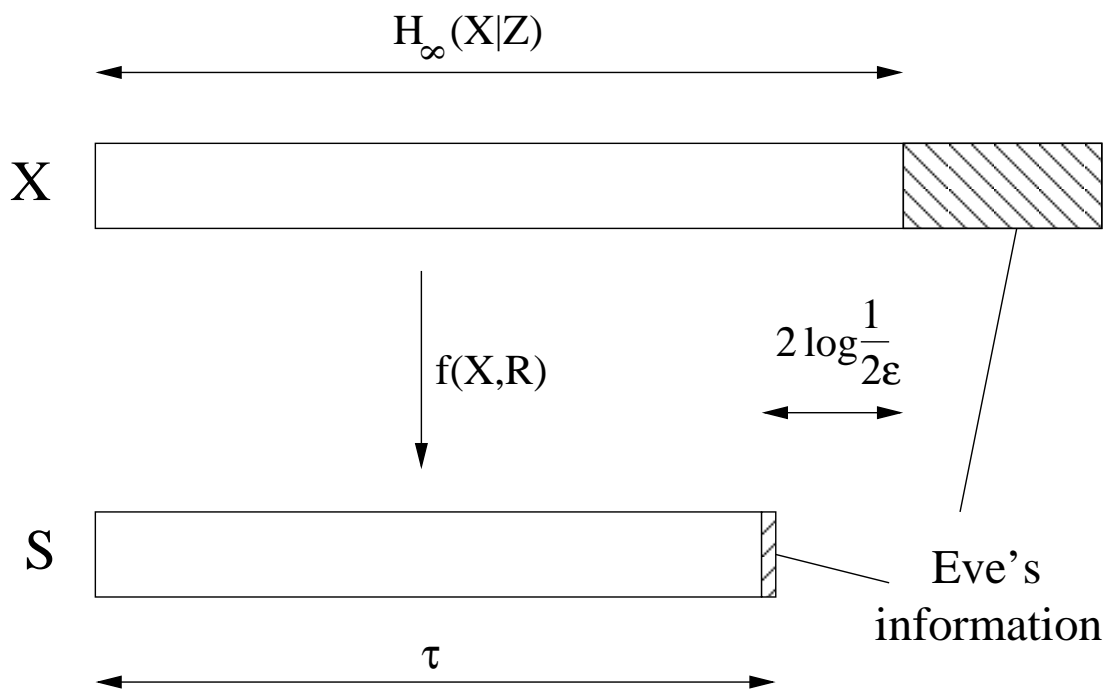

Figure 1.3: Schematic showing privacy amplification of string X to form S using a $universal_2$ hash function.

Consider applying the extractor property (see Definition 1.8) to the distribution $P_{X|Z=z}$. This gives that (1.26) is satisfied for $H_\infty(X|Z = z) \geq \kappa$. As we showed in the previous section, the string can be compressed to length $H_\infty(X|Z = z) - 2 \log \frac{1}{2\epsilon}$. Alice does not know the value of this quantity, since she does not know z . However, the following lemma allows us to derive a useful bound.

Lemma 1.2. *For a non-negative random variable, x , $-\log x > -\log \langle x \rangle - t$, except with probability less than 2^{-t} .*

Proof. The probability that $-\log x > -\log \langle x \rangle - t$ is the same as the probability that $x > 2^t \langle x \rangle$. Chebyshev's inequality then gives the result¹⁴. $\quad \text{QED}$

As a straightforward corollary to Lemma 1.2, we have $H_\infty(X|Z = z) \geq H_\infty(X|Z) - t$, except with probability 2^{-t} , where the conditional min-entropy is defined by

$$H_\infty(X|Z) \equiv -\log \sum_{z \in Z} P_Z(z) \max_x P_{X|Z=z}(x) \quad (1.27)$$

Hence, $H_\infty(X|Z) + \log \epsilon$ bounds $H_\infty(X|Z = z)$, except with probability ϵ .

In summary, Alice and Bob, by exchanging R publicly, can compress their shared random string X which is correlated with a string Z held by Eve, to a string S of length roughly equal to $H_\infty(X|Z)$, which is essentially uncorrelated with Z and R .

To gain an intuition about privacy amplification, it is helpful to consider an example. The set of all functions from k bits to $\tau < k$ bits forms a *universal*₂ set (albeit an extremely large one!). If one picks randomly from amongst this set, then (with high probability) the chosen function has the following property. If two strings are mapped under the chosen function, then the (Hamming) distance between the resulting strings is independent of that of the originals. Thus nearby strings are (with high probability) mapped to those which are not nearby. If Eve knows the original string, but with a few errors, then after it has been mapped, her error rate on the final string will likely be large. The probability of successful

¹⁴Chebyshev's inequality states that for a non-negative random variable, x , and positive α , $P(x \geq \alpha) \leq \frac{\langle x \rangle}{\alpha}$, and is straightforward to prove [25].

amplification is bounded by the probability that Eve can guess the initial string, since if she guesses correctly, she can discover the final one with certainty.

1.4.2.3 Significance Of Smoothed Entropies

The bounds we have presented on the length of secure key we can extract are not tight. In Section 1.4.2, we alluded to the fact that the length of extractable key is tightly bounded by smooth versions of the Rényi entropies (see Equation (1.20)). We briefly explain why this is the case. Recall the definition in (1.7)

$$H_\infty^\epsilon(X|Y) \equiv \max_{\Omega} \left(-\log \max_y \max_x P_{X\Omega|Y=y}(x) \right),$$

where Ω is a set of events with total probability at least $1 - \epsilon$.

The smooth entropy quantity is formed from the sharp version by cutting away small sections of the probability distribution, and hence only considering the events Ω . Since the events cut away occur with probability at most ϵ , there is only a small affect on the probability of error. This may lead to a significant change in the entropy quantity¹⁵, and hence a much larger key can be extracted than that implied by the sharp entropy quantity.

1.4.2.4 Quantum Adversaries

Everything we have discussed in this section so far has been with respect to an eavesdropper holding classical information (the string Z). More generally, and of particular relevance when discussing QKD, the eavesdropper may attack in such a way that at the end of the protocol she holds a quantum state that is correlated with Alice's string.

Alice and Bob's procedure remains unchanged, so their final state at the end of the protocol (after privacy amplification) is classical, and corresponds to a string S . Eve, on the other hand, possesses a quantum system in Hilbert space \mathcal{H}_E . Like in the classical case, security is ensured by constraining the trace distance. We demand

$$D(\rho_{SE}, \rho_{U_S} \otimes \rho_E) \leq \epsilon, \tag{1.28}$$

¹⁵See the discussion on the discontinuous nature of Rényi entropies in Section 1.3.4.3.

where ρ_{U_S} denotes the maximally mixed state in \mathcal{H}_S .

The trace distance cannot increase under trace-preserving quantum operations (i.e. unitary operations and alterations of system size), nor, on average, after measurements [4]. Hence, a key which satisfies (1.28) is secure in a *composable* manner. That is, the string S can be treated as random and uncorrelated with another system in any application, except with probability ϵ . We need to show how to turn the string X , correlated with Eve's quantum system, into the string S which is virtually uncorrelated. It turns out that a *universal*₂ hash function is suitable for this purpose, like in the classical case.

Including the classical spaces used to define the string X and the random string, R , used to choose the hash function, the state of the system is

$$\rho_{XER} = \sum_{r \in R} \sum_{x \in X} (P_R(r) P_X(x) |x\rangle\langle x| \otimes \rho_E^x \otimes |r\rangle\langle r|). \quad (1.29)$$

Having applied the hash function $f \in F$, the state becomes

$$\rho_{SER} = \sum_{r \in R} \sum_{s \in S} (P_R(r) P_S(s) |s\rangle\langle s| \otimes \rho_E^s \otimes |r\rangle\langle r|), \quad (1.30)$$

where $\rho_E^s = \sum_{x \in f^{-1}(s)} \rho_E^x$. Ideally, the state of the system in \mathcal{H}_S would look uniform from Eve's point of view, even if she was to learn R . The variation from this ideal can be expressed in terms of the trace distance, $D(\rho_{SER}, \rho_{U_S} \otimes \rho_{ER})$, and is bounded in the following theorem [21].

Theorem 1.6. *If f is chosen amongst a universal₂ set of hash functions, F , using random string R , and is used to map X to S as described above, then for $|S| = 2^\tau$, we have*

$$D(\rho_{SER}, \rho_{U_S} \otimes \rho_{ER}) \leq \frac{1}{2} 2^{-\frac{1}{2}(H_\infty(\rho_{XE|E}) - \tau)}. \quad (1.31)$$

Hence, like in the classical case, Alice and Bob can exchange a random string, R , publicly in order to compress their shared random string, X , which is partly correlated with a quantum system held by Eve to a string S of length roughly equal to $H_\infty(\rho_{XE|E})$, which is essentially uncorrelated with Eve's system and with R .

A similar relation in terms of the smoothed version of the quantum min-entropy (see Equation (1.18)) provides a better bound on the key length [21]. Specifically, Equation (1.31) in Theorem 1.6 is replaced by

$$D(\rho_{SER}, \rho_{U_S} \otimes \rho_{ER}) \leq \epsilon + \frac{1}{2} 2^{-\frac{1}{2}(H_\infty^\epsilon(\rho_{XE|E}) - \tau)}. \quad (1.32)$$

Other extractors more efficient in the length of random string required are known (see, for example [26], for ones that require order $\log n$ bits to compress an n bit string.) However, these extractors have not been proven to be secure against quantum attacks, and hence we choose not to use them in this thesis.

Note that privacy amplification using *universal*₂ hash functions has certain composability properties. That the final string produced looks uniform to Eve, means that even if all but one of the bits of the string are revealed, the final bit remains uniformly distributed from Eve's perspective.

1.5 Types Of Security

We outline here the various types of security to which we will refer:

1. **Unconditional Security:** Here the security relies only on the laws of physics being correct and applies even against a cheater with unlimited computational power (see for example [27–29]). A party can always cause the protocol to abort, but can never achieve any useful gain (i.e. can never discover any private information, or affect the outcome of the protocol).
2. **Cheat-evident Security [2, 30]:** The protocol is insecure in some way, but any useful cheating attack will be detected with certainty.
3. **Cheat-sensitive Security [31–33]:** The protocol has the property whereby any useful cheating attack by one party gives that party a non-zero probability of being detected.
4. **Technological Security:** Also known as *computational* security in many contexts, although technological security subsumes computational security. Assuming something about the technological (computational) power of the

adversary, they have no useful cheating attack. However, its security will cease if the technological power increases or when a slow algorithm has cracked the code. Users of RSA, for instance, are only offered temporary security: our best algorithms take several years to factor an appropriately-sized product of prime numbers, and if a quantum computer can be built, much less.

Let us briefly describe what we mean by *useful* cheating. We do not demand our protocols prevent any kind of deviation, rather we require that all deviations are useless, in the sense that they do not give the deviating party any private information, or allow that party to influence the outcome of the task. For instance, in any protocol, either party can always declare abort at any stage. We do not consider this to be a problem, unless at the time of abortion, some private information has been gleaned.

If we are happy with technological security, then much in the way of secure multi-party computation has been accomplished. Kilian has shown that (at least classically) oblivious transfer (described in Section 1.8) can be used to implement any two-party secure computation [34]. Since oblivious transfer protocols based on computational assumptions exist (see for example [35]), we can generate technologically secure protocols for two-party secure computations in the classical world.

Unconditional security is the holy grail of the field, and is the strongest type of security we could hope for, although, as we point out in Section 1.6, there are always additional assumptions involved. In many situations, cheat-evident security will suffice. This will be the case when being caught cheating accrues a large penalty. Consider the case of a bank engaging in a protocol with one of its clients. If the client catches the bank cheating, the resulting media scandal will certainly be detrimental for the bank, while the bank who catches its client cheating can impose some large fine. If the penalties are high enough, cheat-sensitive security could be sufficient to prevent a party from cheating.

In general, when discussing specific protocols, we will find that they may have one or more security parameters, $\{N_1, \dots, N_r\}$. A protocol is said to be *perfectly secure* if there exist fixed, finite values of the $\{N_i\}$ for which the security conditions

relevant to the protocol hold. In practice, we will tolerate some (sufficiently small) probability of failure. We say that a protocol is *secure* if the security conditions become increasingly close to holding as the $\{N_i\}$ tend to infinity. This means that, for any non-zero failure probability sought, there exist a set of values for the security parameters for which the protocol achieves this failure rate.

1.6 The Setting

In order to do cryptography, one has to set up a precise world in which actions take place. Such a world provides the framework in which one can make rigorous mathematical statements, and hence prove results about security. The actual security we can achieve in practice depends on how closely the actual environment in which we perform our protocol resembles our mathematically defined world. Ideally the two would coincide. In general though, we will introduce assumptions in order to create a simple mathematical framework.

The type of worlds that concern us will be distinguished as either *relativistic*, or *non-relativistic* (depending on whether we want to rely on the impossibility of super-luminal signalling for security), and either *quantum* or *classical* (depending on whether the users can create and manipulate quantum systems or not). Before discussing these distinctions, we give an overview of the set of assumptions that we will apply within all of our fictitious worlds.

It is impossible to do cryptography without assumptions: the challenge is to see what can be done assuming as little as possible. The weaker the terms of our assumptions, the more powerful the result. Although some assumptions are unrealistic in their literal form, they are often sufficient for realistic purposes. Take for example the following:

Assumption 1. *Each party has complete trust in the security of their laboratory.*

By this we mean that nothing within their laboratories can be observed by outsiders. Without this assumption, cryptography is pointless, and yet no laboratory in the world will satisfy such a property. Can anyone really be sure that there isn't a microscopic camera flying around their lab, reporting back data to their adversaries? As a matter of principle any laboratory must be coupled to the

environment in some way¹⁶, and this opens up a channel through which private information could flow. However, as a practical aside, most parties could set up a laboratory for which they would be happy that Assumption 1 holds to good enough approximation. In so doing, they are in essence making technological assumptions about their adversaries.

No matter what the setting, we will always assume Assumption 1. Then, when we talk about, for example, unconditional security, we implicitly mean unconditional security *given our assumptions* or unconditional security *within our model*. This caveat does not allow us to turn technologically secure protocols into unconditionally secure ones by making appropriate assumptions. A technologically secure protocol is always insecure from an information-theoretic point of view. For example, under the assumption that factoring is hard, we can say that the RSA cryptosystem is *technologically* secure, while without this assumption, it is insecure.

In the spirit of making the result as powerful as possible, we will also make the following assumption:

Assumption 2. *Each party trusts nothing outside their own laboratory.*

In particular, this precludes the possibility of doing cryptography using a trusted third party, or a source of trusted noise (a situation in which many cryptographic tasks are known to be achievable [36–38]).

If a protocol is secure under this assumption, then it is secure *even if our adversaries can control the rest of the universe*. In particular, we make no assumption about any other participants in the protocol. We allow for the possibility that they may have arbitrarily good technology, and arbitrarily powerful quantum computers. In addition, even if all the other players collude in the most appropriate way, the protocol must continue to protect any honest participants. We need not furnish such protection upon dishonest parties.

We choose to perform our protocols within perfect environments, so that all communications are noiseless, all instruments operate perfectly, and additional parties make no attempt to interfere with any communications (but the parties

¹⁶Interactions with a laboratory unable to exchange information with the outside world would be problematic!

with which we are trying to interact with might). We sum this up in the following assumption:

Assumption 3. *All communication channels and devices operate noiselessly.*

It is very convenient to make this assumption in cryptographic scenarios since it allows all errors that occur during the implementation of a protocol to be attributed to attacks by another party. In the real world, it will be necessary to drop this assumption, so proliferating the complications of otherwise much simpler protocols. This leads to a discussion of *reliability*. We say that a protocol is *perfectly reliable* if for some fixed finite values of the security parameters it has the property that if both parties are honest, the protocol succeeds without aborting. In the presence of noise, for finite values of the security parameters, there will always be some probability that an honest protocol aborts. The best we can hope for in such a situation is a *reliable* protocol, where, as the security parameters tend to infinity, the protocol tends towards perfect reliability. Given that we assume Assumption 3, we will always look for perfectly reliable protocols.

In the future, one might anticipate quantum technology to have become as widespread as classical technology is today. Local hardware retailer might act as a supplier of basic components (unitary gates, measurement devices etc.). A cavalier supplier might sell faulty goods. A malicious supplier might sell devices that would give him or her crucial information in a subsequent protocol. The following assumption rids us of such considerations

Assumption 4. *Each party has complete knowledge of the operation of the devices they use to implement a protocol.*

Assumptions 1–4 will be implicitly assumed in the protocols discussed in this dissertation, unless otherwise stated. In particular, in Chapter 5 we discuss a task where we drop Assumption 4, and assume instead that all of the devices used are sourced from a malicious supplier. Whether a particular set of assumptions are sufficiently accurate is ultimately a matter for the protocol’s user.

1.7 Cryptographic Protocols

A protocol is a series of instructions such that if each party follows the instructions precisely, a certain task is carried out. The protocol may permit certain parties to make inputs at various stages, and may allow them to call on random strings in their possession to make such inputs. If the protocol is complete, each party should have a specified response to cover any eventuality.

Each party in a protocol has a set of systems on which they interact. Systems on which more than one party can interact form the channel, which, in the case of more than two parties, may have distinct parts. In general, the channel system may be intercepted by a malicious party at any time. One can always assume that the size of the channel system is fixed throughout the protocol. A protocol in which this is not the case can be transformed into one with this property by first enlarging the channel system by adding ancillary systems, then replacing any operations where a system is added to the channel by swap operations between the system to be added and an ancilla in the channel.

1.7.1 Non-Relativistic Protocols

Non-relativistic protocols involve the exchange of classical or quantum information between parties whose locations are completely unconstrained. In such protocols, there is a set order in which the communications occur, and such communications may effectively be assumed instantaneous. No constraint is placed on the amount of time each party has to enact a given step of a protocol, and hence the surrounding spacetime in which the participants live is irrelevant.

Consider as an illustration a two party protocol between Alice and Bob. Suppose that the first communication in the protocol is from Alice to Bob. We denote Alice's Hilbert space by \mathcal{H}_A , Bob's by \mathcal{H}_B , and the channel's by \mathcal{H}_C . Any two party protocol then has the following form.

Protocol 1.2.

1. Alice creates a state of her choice in $\mathcal{H}_A \otimes \mathcal{H}_C$ and Bob creates a state of his choice in \mathcal{H}_B . We can assume that these states are pure, with each party enlarging their Hilbert space if required.

2. Alice sends the channel to Bob.
3. Bob performs a unitary of his choice on $\mathcal{H}_C \otimes \mathcal{H}_B$.
4. Bob sends the channel to Alice.
5. Alice performs a unitary of her choice on $\mathcal{H}_A \otimes \mathcal{H}_C$.
- ⋮
- N . At the end of the protocol, both parties measure certain parts of their spaces.

Note the following. It is sufficient for Alice and Bob to do unitaries on all systems in their possession at each step of the protocol. All system enlargement can be performed when creating the initial states in Step 1, and all measurements can be kept at the quantum level until the end of the protocol (see Section 1.3.1.1). If we label the unitary operations U_1, U_2, \dots , then prior to measurement, the protocol has implemented the unitary $((U_1 \otimes \mathbb{1}_B)(\mathbb{1}_A \otimes U_2) \dots)$ on the initial state. The measurement in Step N may be used both to check that the protocol took place correctly, and also to determine a classical output. This procedure is illustrated in Figure 1.4.

A classical non-relativistic protocol is a special case in which all states are replaced by classical data, unitary operations are replaced by classical functions of such data, and we give each party private randomness¹⁷.

1.7.2 Relativistic Protocols

In this dissertation, we will assume that relativistic protocols take place in a Minkowski spacetime. For practical purposes this is an over-simplification. In a more general spacetime the participants could adopt the protocols we offer providing they are confident in their knowledge of the structure of the surrounding spacetime and how it changes during the protocol to sufficient precision. A secure

¹⁷In a quantum protocol, private randomness comes for free since either party can create a state for which measurement in the computational basis yields the desired probability distribution.

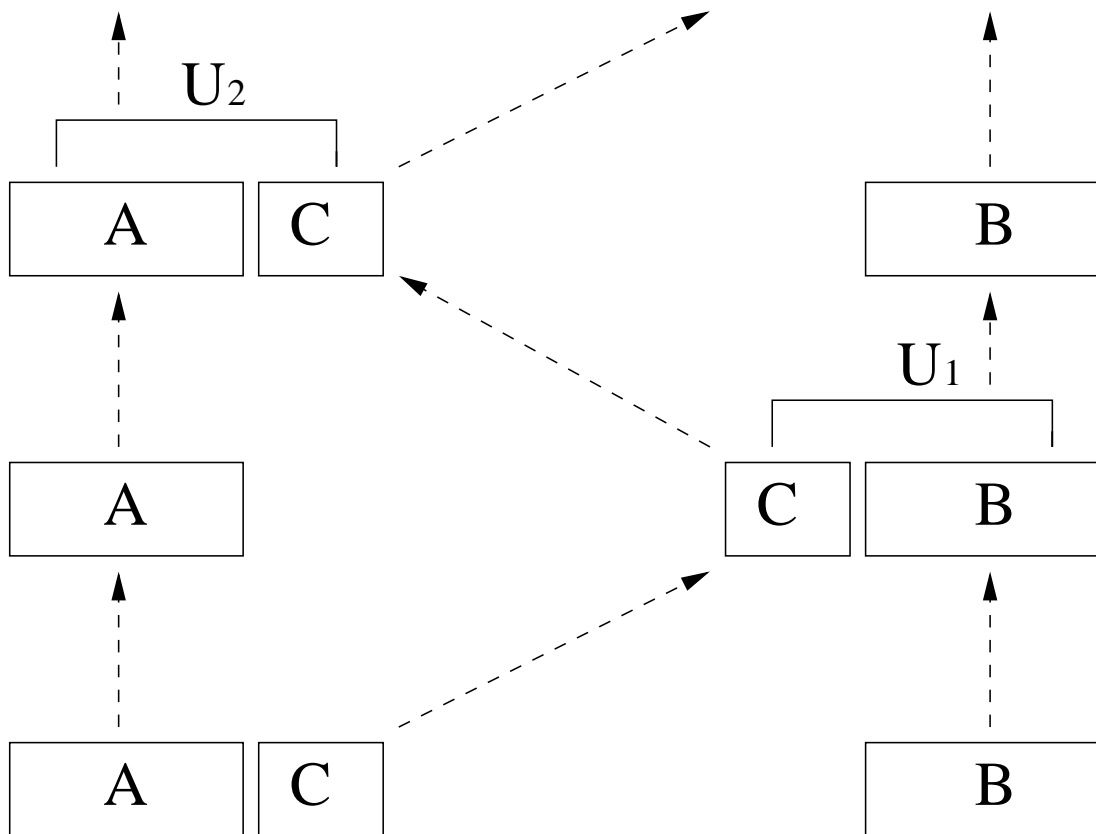

Figure 1.4: Schematic of a non-relativistic protocol between two parties. A represents Alice's systems, B represents Bob's systems, and C is the channel. Alice and Bob alternately perform unitaries as the protocol proceeds.

protocol could be built along the lines of the ones we present provided that bounds on the minimum light travel times between sets of separated sites are known for the duration of the protocol. Any protocols carried out on Earth would certainly fit such a criteria. To avoid a more elaborate discussion, detracting from the important features of our protocols, we restrict to unalterable Minkowski spacetimes. For notational simplicity, we will also restrict our discussion to the two-party case in the remainder of this section.

We use units in which the speed of light is unity and choose inertial coordinates, so that the minimum possible time for a light signal to go from one point in space to another is equal to their spatial separation. In a (two-party) relativistic protocol, Alice and Bob are required to each set up laboratories within an agreed distance, δ , of two specified locations¹⁸, \underline{x}_1 and \underline{x}_2 . Their separation is denoted $\Delta = |\underline{x}_1 - \underline{x}_2| \gg \delta$. No restrictions are placed on the size and shape of the laboratories, except that they do not overlap.

We refer to the laboratories in the vicinity of \underline{x}_i as A_i and B_i , for $i = 1$ or 2 . We use the same labels for the agents (sentient or otherwise) assumed to be occupying these laboratories. A_1 and A_2 operate with complete mutual trust and have completely prearranged agreements on how to proceed such that we identify them together simply as Alice; similarly B_1 and B_2 are identified as Bob. This setup is shown schematically in Figure 1.5.

To ensure in advance that their clocks are synchronized and that their communication channels transmit at sufficiently near light speed, the parties may check that test signals sent out from each of Bob's laboratories receive a response within time 4δ from Alice's neighbouring laboratory, and vice versa. However, the parties need not disclose the exact locations of their laboratories, or take it on trust that the other has set up laboratories in the stipulated regions (cf. Assumption 2). (A protocol which required such trust would, of course, be fatally flawed.) Each party can verify that the other is not significantly deviating from the protocol by checking the times at which signals from the other party arrive. These arrival times, together with the times of their own transmissions, can be used to guarantee that particular specified pairs of signals, going from Alice to

¹⁸This discussion generalizes in an obvious way to cover protocols, which require Alice and Bob to control three or more separate sites.

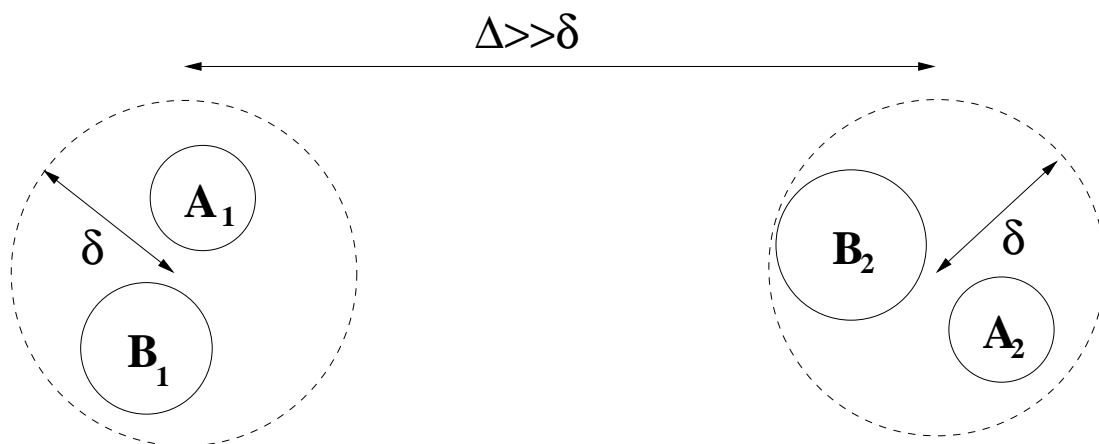

Figure 1.5: Schematic of the setup for a relativistic protocol with two separated sites.

Bob and from Bob to Alice, were generated independently. This guarantee is all that is required for security.

We also assume that A_1 and A_2 either have, or can securely generate, an indefinite string of random bits. This string is independently generated and identically distributed, with probability distribution defined by the protocol, and is denoted $\mathbf{x} \equiv \{x_i\}$. Similarly, B_1 and B_2 share a random string $\mathbf{y} \equiv \{y_i\}$. These random strings will be used to make all random choices as required by the protocol: as A_1 and A_2 , for instance, both possess the same string, \mathbf{x} , they know the outcome of any random choices made during the protocol by the other. We also assume the existence of secure authenticated pairwise channels between the A_i and between the B_i .¹⁹ These channels are not necessarily unjammable, but if an honest party fails to receive the signals as required by a protocol, they abort. Alternatively, one can think of Alice and Bob as occupying very long laboratories, as depicted in Figure 1.6.

A relativistic protocol will be defined within this framework by a prescribed schedule of exchanges of classical or quantum information between the various agents. In essence it involves two non-relativistic protocols, one played out at each

¹⁹Note that this is not an unreasonable assumption; these can easily be set up using the familiar QKD schemes, or simply by using the shared random strings as one-time pads, and in suitable authentication procedures.

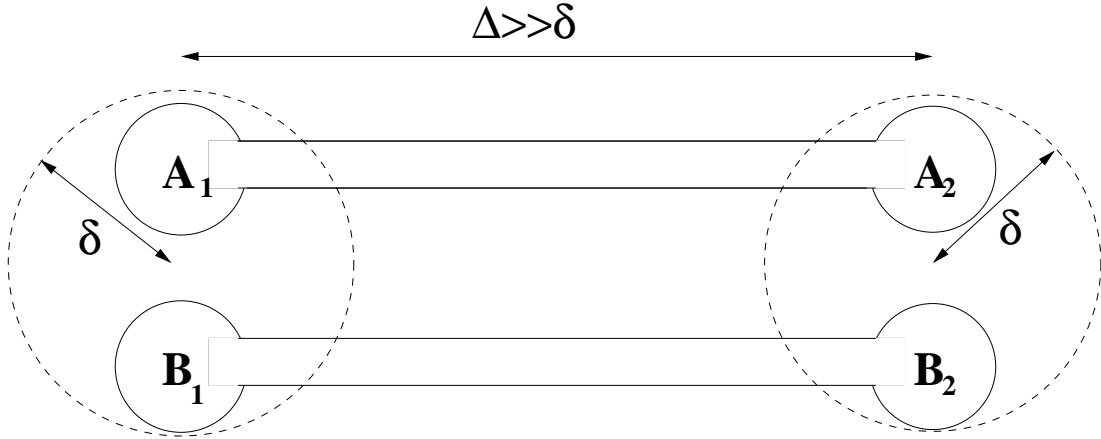

Figure 1.6: Alternative setup for a relativistic protocol with two separated sites.

of the separated locations. These protocols have a limited ability to communicate between one another. This generates a constraint on the unitaries that can be performed at various points in the protocol, since part of Alice’s Hilbert space may be in the secure channel between A_1 and A_2 , and hence temporarily inaccessible.

In a brief excursion to the real world, we note that the relativistic setup we have described is not unrealistic. A_1 , A_2 , B_1 and B_2 need not be humans performing measurements by hand; rather they can be machines performing millions of operations per second. At a separation of just 3m, one has around 10ns to do operations. This, admittedly, is a little unrealistic for today’s technology, but at 3km, we have roughly $10\mu\text{s}$ in which to act. Using an estimate of 10^8 gates per second, we can perform 10^3 operations in this time. We certainly do not need planetary separations for such schemes. There is also the matter of a trade-off between large distance and low noise, especially when considering quantum protocols, but because of Assumption 3, we will not be concerned by this.

1.8 Cryptographic Primitives

Three cryptographic primitives will be particularly relevant in this thesis: Coin tossing, oblivious transfer (OT) and bit commitment (BC). We give a brief outline of these tasks here.

Coin tossing protocols aim to generate a uniform random bit that is shared by two parties in such a way that neither party can influence the bit's value. They will be discussed in detail in Chapter 2.

OT comes in several flavours. In this thesis, we use OT to describe the following functionality. Alice sends a bit to Bob, either 1 or 0. Bob either learns Alice's bit, or he learns nothing, each with probability $\frac{1}{2}$. Alice does not learn whether Bob received her bit or not. It turns out that this task is sufficient to allow any secure multi-party computation [34]. Hence, OT is in some sense the holy grail of the field. However, it is known that OT is impossible [29]. We give a proof of this in Section 4.4.3.

BC is another important cryptographic primitive. A BC protocol involves two steps. In the first step, one party commits to a bit. In the second, which occurs at some later time chosen by the committer, this bit is revealed to a second party. Before revelation, the second party is oblivious to the value of the bit, while the first is unable to alter its value. One flavour of BC can be used to build a protocol for OT [39]. A BC of this type is impossible to construct, even in a relativistic world (the Mayers-Lo-Chau argument [28, 40] for non-relativistic protocols is easy to extend). Nevertheless, Kent has shown that a slightly different flavour of BC is possible in a classical, relativistic world [27, 41]. He further conjectures that this protocol remains secure in a quantum world, against the most general quantum attack, but presently this is unproven.

We will not go into the range of subtleties surrounding the various types of BC (the interested reader should refer to [27] for a longer discussion). Here we simply point out that Kent's BC schemes require sustained communications in order to maintain the commitment, and that they have the property of *retractability*, that is the party making the commitment can get their committed state returned if they later decide not to follow through with the unveiling. This latter feature is what scuppers the use of relativistic bit commitment (RBC) schemes for building Yao's OT scheme [27, 39].

We will use RBC as a subprotocol in some of the schemes we later discuss, so, for completeness, we outline a protocol for its implementation here. We choose the simplest of Kent's schemes, RBC1, in the case where Alice commits a bit to Bob:

Protocol 1.3. (RBC1)

1. B_1 sends to A_1 an ordered pair, $(n_{1,0}, n_{1,1})$ of random non-equal integers. These, along with all other integers used in the protocol, will be in the set $\{0, \dots, N - 1\}$, and all arithmetic performed is modulo $N = 2^p$, for integer p .
2. To commit to bit b , A_1 returns $n_{1,b} + m_1$ to B_1 .
3. To sustain the commitment, A_2 commits the binary form $a_{p-1}^1, a_{p-2}^1, \dots, a_0^1$ of m_1 to B_1 , by having B_1 send the random integer pairs $(n_{2,0}, n_{2,1}), (n_{3,0}, n_{3,1}), \dots, (n_{p+1,0}, n_{p+1,1})$, and returning the set $n_{2,a_{p-1}^1} + m_2, n_{3,a_{p-2}^1} + m_3, \dots, n_{p+1,a_0^1} + m_{p+1}$.
4. This procedure then iterates, with A_1 committing the binary form of m_2, \dots, m_{p+1} to B_1 in an analogous way.

At some later time, Alice can unveil on either or both sides. For A_1 to unveil, she sends to B_1 the list of random numbers, $\{m_i\}$, used by A_2 in her last set of commitments. (A_1 knows these because they were generated using the shared random string \mathbf{x} .) B_1 receives this list at such time that he can ensure they were sent in a causally disconnected manner to the receipt of the random pairs $\{(n_{i,0}, n_{i,1})\}$ by A_2 . B_1 and B_2 can then share all their data, and verify that it did correspond to a valid commitment of either 0 or 1.

This protocol has the undesirable feature that it requires an exponentially increasing rate of communication. However, Kent has also introduced a second protocol, RBC2 which combines RBC1 with a scheme due to Rudich, in order to achieve RBC with a constant transmission rate. The full details of this scheme can be found in [27], and are not presented in this thesis.

Chapter 2

The Power Of The Theory – Strong Coin Tossing

“A theory is acceptable to us only if it is beautiful” – Albert Einstein

2.1 Introduction

Landauer’s often quoted doctrine, *“information is physical”* succinctly expresses the fact that what can and cannot be done in terms of information processing is fundamentally dictated by physics. Information processing is performed by physical machines (abacuses, computers, human beings, etc.), and the power of these limits the information processing power. In light of the above, it is not of great surprise that new physical theories lead to changes in information processing power. Historically, though, more than 50 years elapsed between the development of quantum theory and the realization that it offers an increase in information processing power. This delay can surely be attributed, at least in part, to the failure of both physicists and information theorists to recognize the physical nature of information.

In this chapter, we illustrate the rôle of the physical theory in information processing power. We consider theories that are either quantum or classical, and are either relativistic or not. The relevance of the different theories for the construction of protocols has been described in Section 1.7. Here we give specific examples. As a focus for our discussion we use one of the simplest cryptographic

tasks: strong coin tossing. A classical non-relativistic theory cannot realize this task to any extent. Introducing quantum mechanics allows protocols with partial security, while relativistic protocols can realize the task perfectly.

Informally, a coin tossing protocol seeks to allow two separated parties to exchange information in such a way that they generate a shared random bit. The bit is random in the sense that (ideally) 0 or 1 occur with probability $\frac{1}{2}$ each, and neither party can increase the probability of either outcome by any method. In many physical models, this ideal cannot be achieved. In such cases one weakens the requirements of the protocol. It is demanded that if both participants are honest, the outcome is 0 or 1 with probability $\frac{1}{2}$ each. A protocol is then given a figure of merit in terms of the maximum cheating probability a dishonest party can achieve against an honest party. The quantity often used is the bias, the deviation of the maximum cheating probability from $\frac{1}{2}$. A strong coin tossing protocol seeks to protect an honest party from a dishonest party whose direction of bias is unknown, while a weak coin toss seeks to protect an honest party only against the dishonest party biasing towards one particular outcome. Commonly, coin tosses are of the latter form (e.g. Alice and Bob, having recently divorced, want to decide who keeps the car). Strong coin tosses are relevant in situations where there is knowledge asymmetry between the parties, so that it is not clear to one which way the other wishes to bias (e.g. Alice knows whether the car works but Bob does not).

In the next sections, we give formal definitions of the relevant coin tossing tasks before discussing how well they can be achieved in the various physical models of interest. Our contribution in this area is Protocol 2.2, for which no protocols are known with a better bias.

2.2 Definitions

In a coin tossing protocol, two separated and mistrustful parties, Alice and Bob, wish to generate a shared random bit. We consider a model in which they do not initially share any resources, but have access to trusted laboratories containing trusted error-free apparatus for creating and manipulating quantum states (cf.

2.3 Where Lies The Cryptographic Power?

Assumptions 1–4). In general, a protocol for this task may be defined to include one or more security parameters, which we denote N_1, \dots, N_r .

If both parties are honest, a coin tossing protocol guarantees that they are returned the same outcome, $b \in \{0, 1\}$ where outcome b occurs with probability $\frac{1}{2} + \zeta_b(N_1, \dots, N_r)$, or “abort” which occurs with probability $\zeta_2(N_1, \dots, N_r)$, and for each $j \in \{0, 1, 2\}$, $\zeta_j(N_1, \dots, N_r) \rightarrow 0$ as the $N_i \rightarrow \infty$. The *bias* of the protocol towards party $P \in \{A, B\}$ is denoted $\epsilon_P = \max(\epsilon_P^0, \epsilon_P^1)$, where P can deviate from the protocol in such a way as to convince the other (honest) party that the outcome is b with probability at most $\frac{1}{2} + \epsilon_P^b + \delta_P^b(N_1, \dots, N_r)$, and the $\delta_P^b(N_1, \dots, N_r) \rightarrow 0$ as the $N_i \rightarrow \infty$. We make no requirements of the protocol in the case where both parties cheat.

The *bias* of the protocol is defined to be $\max(\epsilon_A, \epsilon_B)$. A protocol is said to be *balanced* if $\epsilon_A^b = \epsilon_B^b$, for $b = 0$ and $b = 1$.

We define the following types of coin tossing:

Definition 2.1. (Ideal Coin Tossing) A coin tossing protocol is ideal if it has $\epsilon_A = \epsilon_B = 0$, that is, no matter what one party does to try to bias the outcome, their probability of successfully doing so is strictly zero. It is then said to be *perfectly secure* if for some finite values of N_1, \dots, N_r , the quantities $\zeta_j(N_1, \dots, N_r)$ and $\delta_P^b(N_1, \dots, N_r)$ are strictly zero, and otherwise is said to be *secure*.

Definition 2.2. (Strong Coin Tossing) A strong coin tossing protocol is parameterized by a bias, γ . The protocol has the property that $\epsilon_P^b \leq \gamma$ for all $P \in \{A, B\}$ and $b \in \{0, 1\}$, with equality for at least one combination of P and b .

Definition 2.3. (Weak Coin Tossing) A weak coin tossing protocol is also parameterized by a bias, γ . It has the property that $\epsilon_A^0 \leq \gamma$ and $\epsilon_B^1 \leq \gamma$, with equality in at least one of the two inequalities.

2.3 Where Lies The Cryptographic Power?

Cryptography involves secrets. One generally begins in a situation in which each party holds private data, and ends in a situation in which each party gains a

2.3 Where Lies The Cryptographic Power?

specified and often highly restricted piece of information on the inputs of the others. Let us specialize to the case of two party protocols. Kilian [34] sums up the difficulty of classical protocols for these on the grounds that at any point in such a protocol, one party knows exactly what information is available to the other, and vice-versa. If this knowledge symmetry can be broken (for example by assuming the existence of a black-box performing OT, or by using a trusted noisy channel [36–38]) then any secure multi-party computation can be performed [34].

Quantum mechanics also provides a way of generating knowledge asymmetry. For example, consider a protocol which involves Alice choosing one of two non-orthogonal bases at random to encode each bit. She sends the quantum states which store the encodings to Bob. Bob, being unaware of Alice’s bases, cannot reconstruct her bits with certainty. Likewise, if Bob measures each state he receives in one of the two encoding bases chosen at random, then Alice cannot tell exactly what Bob knows about her string. Therefore, information completeness is lost, and extra cryptographic power exists over protocols involving only classical systems.

The procedure described above acts like a noisy channel, but there is a key cryptographic difference between the two. The noise generated by a noisy channel comes from an outside system, while that generated by sending quantum states is inherent to the physics of the system. From a cryptographic point of view, the former is equivalent to assuming the existence of a trusted third party. If either party could tap into the system generating the noise, then security would be compromised. This is a by-product of the fundamental reversibility of classical processes—if the process causing the noise was reversed, the information would be recovered. This is not the case for a quantum mechanical measurement. The process by which it is generated is fundamentally irreversible, and hence such a security issue does not arise¹. This is not the only source of cryptographic power generated by quantum theory. Another comes from the so-called monogamy of entanglement, which provides security in Ekert’s variant of the BB84 protocol [42], and also in the protocols we discuss in Chapter 5.

¹It is the possibility of delaying measurement that prevents such a quantum system being used to build OT as the standard classical reductions [36–38] imply. However, provided at least one party behaves honestly, information completeness is lost.

Relativistic protocols allow short-lived perfectly binding and perfectly concealing commitments². When A_1 sends classical information to B_1 , she is perfectly committed to it (since B_1 knows it). However, from B_2 's point of view, this commitment is perfectly concealing for the light travel time. Anything B_2 sends to A_2 within this time he does in ignorance of A_1 's message. This is where the power lies in relativistic cryptography.

2.4 Coin Tossing

2.4.1 Classical Non-Relativistic Protocols

Coin tossing is a two person game. The “moves” of the game are the communications of the parties. In the classical and non-relativistic case, coin tossing can be studied using well-established techniques of game theory. It can be phrased as a zero-sum game, meaning that the payoffs for any outcome sum to zero. (We can assign +1 for a win, -1 for a loss, and 0 to abort for each party. Thus if Alice wins, she gets +1, while Bob gets -1 , these having zero sum. The exact payoffs may not be precisely these, but this should not affect the security of the computation.)

We present here a (sketch) proof of the impossibility of classical coin tossing based on a result of game theory. The result we need refers to complete information games, which are those for which each party knows all previous moves of all other parties prior to making theirs. The result states that all (finite) zero-sum complete-information 2-person games are strictly determined, i.e., one party following their optimal strategy can win against any strategy of the other.

Consider games in which there are no random moves. After the last move has been made, the game has a defined payout. Let us suppose that a positive payout favours Alice, and a negative one favours Bob³. Suppose Bob makes the last move. He will choose his move so as to minimize the payout. Assuming no degeneracy, the last move is determined by this. (If there is degeneracy, then Bob can choose freely from amongst the degenerate moves. Alternatively, one could construct

²From which longer-lived ones can be constructed, as discussed previously.

³Since the game is zero-sum, the payout to Alice is always opposite that of Bob.

a new game in which the degenerate moves are combined.) Since this move is determined, we can define a game with one fewer moves in which the payouts are defined by what results if Bob follows his optimal strategy. This shorter game has Alice making the final move, which she does so as to maximize the payout. Thus, if we assume Alice and Bob always make their best play at every opportunity, this process iterates so that the entire game is completely determined. That is, one player always has a winning strategy against any strategy of the other. Since the winning strategy works against any strategy of the other, it also works if the other makes random choices at certain points in the protocol. The above argument is formally proven in Chapter 15 of [43].

A classical non-relativistic coin tossing protocol is such a game, and hence one party can always win with certainty, i.e., the best achievable bias is $\frac{1}{2}$.

Note that both non-relativistic quantum protocols and relativistic protocols do not fit into this model. In a quantum protocol, if one party is allowed to choose their measurement basis, the other does not know what information they received. In a relativistic protocol, timing constraints can be used to ensure that one party must make a move without knowledge of those of the other party. It is therefore possible to construct protocols which are not information complete, and hence the above argument does not go through. We will demonstrate this below by giving coin tossing protocols whose bias is less than $\frac{1}{2}$.

2.4.2 Quantum Non-Relativistic Protocols

Such protocols, commonly abbreviated as quantum protocols, have been widely studied in the literature. That quantum coin tossing protocols offer some advantage over classical ones was realized by Aharonov et al. [31], who introduced a protocol achieving a bias of $\frac{1}{2\sqrt{2}}$ [31, 44]. For strong coin tossing, it has been shown by Kitaev that in any protocol, at least one party can achieve a bias greater than $\frac{1}{\sqrt{2}} - \frac{1}{2}$ [45]. It is not known whether this figure represents an achievable bias. The best known bias to date is $\frac{1}{4}$ [1, 46]. This bias is optimal for a large set of bit-commitment based protocols [47]. For weak coin tossing, Kitaev's bound is known not to apply and lower biases than $\frac{1}{\sqrt{2}} - \frac{1}{2}$ have been achieved (see for example [48] for the best bias to date). Moreover, Ambainis has shown that a

weak coin toss protocol with bias $\epsilon > 0$ must have a number of rounds that grows as $\Omega(\log \log \frac{1}{\epsilon})$ [46].

We present now the two protocols which achieve strong coin tossing with bias $\frac{1}{4}$. The first, due to Ambainis, is based on bit commitment.⁴ The second protocol is our contribution. It works by trying to securely share entanglement before exploiting the quantum correlations that result.

We give a brief description of Ambainis' protocol below. More details, including the proof that it has a bias of $\frac{1}{4}$ can be found in [46].

Protocol 2.1.

We define the states

$$|\phi_{b,x}\rangle = \begin{cases} \frac{1}{\sqrt{2}}(|0\rangle + |1\rangle) & b = 0, x = 0 \\ \frac{1}{\sqrt{2}}(|0\rangle - |1\rangle) & b = 0, x = 1 \\ \frac{1}{\sqrt{2}}(|0\rangle + |2\rangle) & b = 1, x = 0 \\ \frac{1}{\sqrt{2}}(|0\rangle - |2\rangle) & b = 1, x = 1 \end{cases} . \quad (2.1)$$

The protocol then proceeds as follows:

1. Alice picks two random bits $b \in \{0, 1\}$ and $x \in \{0, 1\}$, using a uniform distribution. She creates the corresponding qutrit state $|\phi_{b,x}\rangle$ and sends it to Bob.
2. Bob picks a random bit, $b' \in \{0, 1\}$ from a uniform distribution, and sends b' to Alice.
3. Alice sends b and x to Bob, who then checks that the state he received in Step 1 matches (by measuring it with respect to a basis consisting of $|\phi_{b,x}\rangle$ and two states orthogonal to it). If the outcome of the measurement is not the one corresponding to $|\phi_{b,x}\rangle$, Bob aborts.
4. Otherwise, the result of the coin flip is $b \oplus b'$.

⁴A bit commitment based coin tossing scheme has one party commit a bit, after which the other announces another bit. If the XOR of the two bits is 0, the outcome is heads, if 1 it is tails.

This protocol is based on bit commitment. Alice (imperfectly) commits a bit, b , to Bob by encoding it using one of two non-orthogonal pairs of states. Bob then sends a bit b' to Alice. The outcome is decided by the XOR of b and b' . Many of the coin tossing schemes considered in the literature are of this type. The security of such protocols is only as strong as the bit commitment on which they are based. Bounds on the possible biases achievable in bit commitment schemes are well known [47]. However, coin tossing is strictly weaker than bit commitment [49], hence bounds on the achievability of bit commitment do not imply similar ones for coin tossing. It is therefore of interest to search for schemes that do not rely on bit commitment. We describe one such protocol and give its complete security analysis below. This protocol has been published by us [1].

Protocol 2.2.

1. Alice creates 2 copies of the state $|\psi\rangle = \frac{1}{\sqrt{2}}(|00\rangle + |11\rangle)$ and sends the second qubit of each to Bob.
2. Bob randomly selects one of the states to be used for the coin toss. He informs Alice of his choice.
3. Alice and Bob measure their halves of the chosen state in the $\{|0\rangle, |1\rangle\}$ basis to generate the result of the coin toss.
4. Alice sends her half of the other state to Bob who tests whether it is the state it should be by measuring the projection onto $|\psi\rangle$. If his test fails, Bob aborts.

2.4.2.1 Alice's Bias

Assume Bob is honest. We will determine the maximum probability, p_A , that Alice can achieve outcome 0 (an analogous result follows by symmetry for the case that Alice wants to bias towards 1). Alice's most general strategy is as follows. She can create a state in an arbitrarily large Hilbert space, $|\Psi\rangle \in \mathcal{H}_A \otimes \mathcal{H}_{A_1} \otimes \mathcal{H}_{B_1} \otimes \mathcal{H}_{A_2} \otimes \mathcal{H}_{B_2}$, where \mathcal{H}_A represents the space of an ancillary system Alice keeps, \mathcal{H}_{B_1} and \mathcal{H}_{B_2} are qubit spaces sent to Bob in the first step of the protocol, and \mathcal{H}_{A_1} and \mathcal{H}_{A_2} are qubit spaces, one of which will be sent to Bob for

verification. On receiving Bob's choice of state in Step 2, Alice can do one of two local operations on the states in her possession, before sending Bob the relevant qubit for verification. Alice should choose her state and local operations so as to maximize the probability that Bob obtains outcome 0 and does not detect her cheating.

Let us denote the state of the entire system by

$$|\Psi\rangle = \sum_{i=0}^1 \sum_{j=0}^1 a_{ij} |\phi_{ij}\rangle_{AA_1A_2} |ij\rangle_{B_1B_2} \quad (2.2)$$

where $\{|\phi_{ij}\rangle_{AA_1A_2}\}_{i,j}$ are normalized states in Alice's possession, and $\{a_{ij}\}_{i,j}$ are coefficients. Suppose Bob announces that he will use the first state for the coin toss. There is nothing Alice can subsequently do to affect the probability of Bob measuring 0 on the qubit in \mathcal{H}_{B_1} . We can assume that Bob makes the measurement on this qubit immediately on making his choice. Let us also assume that Alice discovers the outcome of this measurement so that she knows the pure state of the entire system (we could add a step in the protocol where Bob tells her, for example⁵). If Bob gets outcome 1, then Alice cannot win. On the other hand, if Bob gets outcome 0, the state of the remaining system becomes

$$\frac{a_{00}}{\sqrt{|a_{00}|^2 + |a_{01}|^2}} |\phi_{00}\rangle_{AA_1A_2} |0\rangle_{B_2} + \frac{a_{01}}{\sqrt{|a_{00}|^2 + |a_{01}|^2}} |\phi_{01}\rangle_{AA_1A_2} |1\rangle_{B_2}, \quad (2.3)$$

and Alice can win if she can pass Bob's test in the final step of the protocol. Since entanglement cannot be increased by local operations, the system Alice sends to Bob in this case can be no more entangled than this state. Since measurements (on average) reduce entanglement, Alice's best operation is a unitary on her systems. Such an operation is equivalent to a redefinition of $\{a_{ij}\}$ and $\{|\phi_{ij}\rangle\}$, which Alice is free to choose at the start of the protocol anyway. Alice can do no better than by choosing the coefficients, $\{a_{ij}\}$, to be real and positive. The state which best maximizes the overlap of the system in the A_2B_2 subspace with $|\psi\rangle$ is then,

$$\frac{a_{00}}{\sqrt{a_{00}^2 + a_{01}^2}} |00\rangle_{A_2B_2} + \frac{a_{01}}{\sqrt{a_{00}^2 + a_{01}^2}} |11\rangle_{A_2B_2}. \quad (2.4)$$

⁵Such a step can only make it easier for Alice to cheat, so security under this weakened protocol implies security under the original one.

Alice therefore cannot fool Bob into thinking she was honest with probability greater than $\frac{(a_{00}+a_{01})^2}{2(a_{00}^2+a_{01}^2)}$. Using a similar argument for the case that Bob chooses the second state for the coin toss shows that Alice's overall success probability is at most $\frac{1}{4}(2a_{00}^2 + 2a_{00}a_{01} + 2a_{00}a_{10} + a_{01}^2 + a_{10}^2)$. Maximizing this subject to the normalization condition gives a maximum of $\frac{3}{4}$, hence we have the bound $p_A \leq \frac{3}{4}$. Equality is achievable within the original protocol (i.e., without the additional step we introduced) by having Alice use the state

$$\sqrt{\frac{2}{3}}|0000\rangle_{A_1B_1A_2B_2} + \frac{1}{\sqrt{6}}(|0011\rangle_{A_1B_1A_2B_2} + |1100\rangle_{A_1B_1A_2B_2}), \quad (2.5)$$

and simply sending \mathcal{H}_{A_1} or \mathcal{H}_{A_2} to Bob in the final step, depending on Bob's choice.

The protocol is cheat-sensitive towards Alice—*any* strategy which increases her probability of obtaining one outcome gives her a non-zero probability of being detected.

2.4.2.2 Bob's Bias

Assume Alice is honest. We will determine the maximum probability, p_B , that Bob can achieve the outcome 0. The maximum probability for outcome 1 follows by symmetry. Bob seeks to take the qubits he receives, perform some local operation on them, and then announce one of them to be the coin-toss state such that the probability that Alice measures 0 on her part of the state he announces is maximized.

Suppose that we have found the local operation maximizing Bob's probability of convincing Alice that the outcome is 0. Having performed this operation and sent the announcement to Alice, the outcome probabilities for Alice's subsequent measurement on the state selected by Bob in the $\{|0\rangle, |1\rangle\}$ basis are fixed. Bob's probability of winning depends only on this. It is therefore unaffected by anything Alice does to the other qubit, and, in particular, is unaffected if Alice measures both of her qubits in the $\{|0\rangle, |1\rangle\}$ basis before looking at Bob's choice. Such a measurement commutes with Bob's local operation, so could be done by Alice prior to Bob's operation without changing any outcome probabilities. If Alice does this measurement she gets outcome 1 on both qubits with probability $\frac{1}{4}$. In

such a case, Bob cannot convince Alice that the outcome is 0. Therefore, we have bounded Bob's maximum probability of winning via $p_B \leq \frac{3}{4}$.

To achieve equality, Bob can measure each qubit he receives in the $\{|0\rangle, |1\rangle\}$ basis, and if he gets one with outcome 0, choose this state as the one to use for the coin toss. There is no cheat sensitivity towards Bob; he can use this strategy without fear of being caught.

2.4.2.3 Discussion

In this section we have presented two non-relativistic quantum protocols for strong coin tossing. Each of which has bias $\frac{1}{4}$. The first, due to Ambainis, is based on bit commitment. The second is based on sharing entanglement. In terms of practicality, the key differences between the schemes are as follows. Firstly, Ambainis' protocol requires manipulation and communication of a single qutrit, while ours requires four qubits (two of which are communicated). Furthermore, there cannot be a bit-commitment based scheme of this type⁶ with a smaller dimensionality than Ambainis' since bit-commitment based protocols using qubits cannot achieve bias $\frac{1}{4}$ [47]. Secondly, Ambainis' protocol does not require the storage of quantum systems.

The question of whether Kitaev's bound can be reached remains open. That two protocols attempting to optimize the bias both have bias $\frac{1}{4}$ is evidence that this might be the best possible. One would like to construct a proof of this.

2.4.3 Relativistic Protocols

Such protocols allow coin tossing with zero bias, due to the bit commitment property they offer (cf. Section 2.3).

Protocol 2.3.

1. At time t_0 , A_1 sends a bit, $b \in \{0, 1\}$, to B_1 choosing b from a uniform distribution.
2. B_2 simultaneously sends a bit, b' , to A_2 .

⁶i.e. where all of the quantum systems are supplied by Alice.

3. B_1 checks that his received message arrived before time $t_0 + D$, and likewise, so does A_2 ⁷. If this is not the case, they abort.
4. The disconnected agents of Alice communicate with one another, as do those of Bob. Alice and Bob can then compute the coin toss outcome, $b \oplus b'$.

The impossibility of superluminal signalling prevents either party cheating in such a protocol.

2.5 Discussion

In this chapter, we have shown how the physical world in which our protocol operates has significant implications on its security, thus highlighting the fact that what can and cannot be done in terms of information processing tasks depends fundamentally on physics. In a non-relativistic, classical world, it is impossible to achieve unconditional security for any two-party protocol, because such protocols are information complete. In a non-relativistic quantum world, information completeness can be broken, as described in Section 2.3. This is sufficient to ensure partial security in coin tossing. Relativity introduces the possibility of stronger security still. The impossibility of superluminal signalling means that information can be completely concealed from one party, at least for the light travel time. This allows a zero-knowledge, finite-time commitment, which is sufficient for coin tossing.

In the forthcoming chapters we discuss the extent to which quantum and relativistic protocols can be used to achieve other cryptographic tasks. Chapter 3 will show that one additional task (variable bias coin tossing) is possible, while in Chapter 4 a large set of other tasks are shown to be impossible.

⁷Recall that we use units in which the speed of light is unity.

Chapter 3

Variable Bias Coin Tossing

“What does chance ever do for us?” – William Paley

3.1 Introduction

In a future version of society, etiquette has become so important that it is impinging on free will. Declining an invitation from an upstanding member of the community has become near impossible. A new social code has emerged to circumvent this, whereby the acceptance or otherwise of all invitations are resolved via a variable bias coin toss (VBCT). This task allows one party to secretly choose the bias of the coin within some prescribed range. If one wants to decline the invitation, one biases so as to maximize the probability of declination. Then, on receiving the (hopefully) negative outcome, one simply ascribes this to ill fortune. This new social code therefore restores some free will, at the expense that sometimes one has to decline favourable invitations.

In this chapter, we consider protocols for the task of variable bias coin tossing between two parties. The results presented here have been published by us in [2]. The aim of a VBCT protocol is to generate a shared random bit, as though by a biased coin whose bias is secretly chosen by one of the parties to take some value within a prescribed range. This is the two-faced case of the more general task of carrying out a variable bias n -faced die roll, in which one of n possible outcomes is randomly generated as though by a biased die, whose bias (i.e. list of outcome

probabilities) is secretly chosen by one of the parties to take some value within a prescribed convex set. Variable bias coin tossing and die rolling are themselves special cases of secure 2-party computations. To understand their significance, we first locate them within a general classification of secure computation tasks.

3.2 Secure Multi-Party Computation

A general secure classical computation involves N parties, labelled by i in the range $1 \leq i \leq N$, who each have some input, x_i , and wish to compute some (possibly non-deterministic) functions of their inputs, with the i th party receiving as output $f_i(x_1, \dots, x_N)$. We call this a classical computation because the inputs and outputs are classical, although we allow such computations to be implemented by protocols which involve the processing of quantum states¹. All of the computations we consider in this thesis are classical in this sense (although most of the protocols we discuss involve quantum information processing), and we will henceforth refer to these as computations, with the term “classical” taken as understood. A perfectly secure computation guarantees, for each i , each subset $J \subseteq \{1, \dots, N\}$, and each set of possible inputs x_i and $\{x_j\}_{j \in J}$, that if the parties J do indeed input $\{x_j\}_{j \in J}$ and then collaborate, they can gain no information about the input x_i other than what is implied by $\{x_j\}_{j \in J}$ and $\{f_j(x_1, \dots, x_N)\}_{j \in J}$.

Note that some tasks fall outside this model completely. Bit commitment, for example, requires that the output is at some time fixed, but is not revealed until a later time. Other computations with this delay feature also fall outside the scope of our model.

We restrict attention here to two types of two-party computation: *two-sided* computations in which the outputs prescribed for each party are identical, and *one-sided* computations in which one party gets no output. We use the term *single function computations* to cover both of these types, since, in both cases, only one function need be evaluated. We can classify single function computations by the number of inputs (by which we mean the number of parties making an input, as distinct from the size of the set of possible values of such inputs), by whether

¹Ones which do not, we call classical protocols: here we are considering quantum relativistic protocols for classical computations.

3.2 Secure Multi-Party Computation

they are deterministic or random, and by whether one or two parties receive the output.

We are interested in protocols whose unconditional security is guaranteed by the laws of physics. In particular, as is standard in these discussions, we do not allow any security arguments based on technological or computational bounds: each party allows for the possibility that the other may have arbitrarily good technology and arbitrarily powerful quantum computers. In addition, we assume that Assumptions 1–4 (see Section 1.6) hold. Under such assumptions, the known results for secure computations are summarized below.

Zero-input computations: Secure protocols for zero-input deterministic computations or zero-input random one-sided computations can be trivially constructed, since the relevant computations can be carried out by one or both parties separately. The most general type of zero-input two-sided random secure computation is a biased n -faced secure die roll. This can be implemented with unconditional security by generalizing the relativistic protocol for a secure coin toss given in Section 2.4.3 as follows.

Protocol 3.1.

For an n -faced die with distribution p_1, \dots, p_n ,

1. A_1 creates a string, $X \in \{1, \dots, n\}^N$, for which Np_i members are i for all $i \in \{1, \dots, n\}$ (N is such that Np_i is an integer for all i , or, if the chosen probabilities are irrational, we can get arbitrarily close to the correct distribution by taking N large). The permutation of elements in the string is chosen uniformly at random. A_1 sends this string to B_1 .²
2. B_2 simultaneously sends a random number, $j \in \{1, \dots, N\}$, to A_2 .
3. B_1 checks that his received message arrived before time $t_0 + D$, and likewise, so does A_2 . If this is not the case, they abort.
4. The disconnected agents of Alice communicate with one another, as do those of Bob.

²For example, in an unbiased coin toss, X is either $(0, 1)$ or $(1, 0)$. The second bit is redundant, hence the protocol can be simplified to Protocol 2.3, presented previously.

5. Bob checks that the string he received from Alice has the correct number of entries of each type. If not, he aborts. Otherwise the outcome of the die roll is the j th member of X .

One-input computations: Secure protocols for deterministic one-input computations are trivial; the party making the input can always choose it to generate any desired output on the other side and so might as well compute the function on their own and send the output directly to the other party.

The non-deterministic case is of interest. For one-sided computations, where the output goes to the party that did not make the input, the most general function is a one-sided variable bias n -faced die roll. The input simply defines a probability distribution over the outputs. In essence, one party chooses one from a collection of biased n -faced dice to roll (the members of the collection are known to both parties). The output of the roll goes to one party only, who has no other information about which die was chosen.

It is known that some computations of this type are impossible. Oblivious transfer falls into this class, for instance, and is shown to be impossible in Section 4.4.3.³ In Chapter 4, we discuss other computations of this type, and show that they are impossible to implement securely.

We call the two-sided case of a non-deterministic one-input function a variable bias n -faced die roll. This—and particularly the two-faced case, a variable bias coin toss—is the subject of the present chapter. We will give a protocol that implements the task with unconditional security for a limited range of biases, another which permits any range of biases but achieves only cheat-evident security, and two further protocols that allow any range of biases and which we conjecture are unconditionally secure. Such tasks are impossible in non-relativistic cryptography.

Two-input computations: Lo [50] considered the task of finding a secure nonrelativistic quantum protocol for a two-input, deterministic, one-sided

³To see that OT can be thought of as an example of a one-sided variable bias n -faced die roll, consider the probability table, Table 4.3, in Section 4.4.3. The computation can be thought of as having Alice pick one of two three sided die to roll (the three sides being labelled 0, 1 and ?).

function. He showed that if the protocol allows Alice to input i , Bob to input j , and Bob to receive $f(i, j)$, while giving Alice no information on j , then Bob can also obtain $f(i, j')$ for all j' . For any cryptographically nontrivial computation, there must be at least one i for which knowing $f(i, j')$ for all j' gives Bob more information than knowing $f(i, j)$ for just one value of j . As this violates the definition of security for a secure classical computation, it is impossible to implement any cryptographically nontrivial computation securely.

Lo's proof as stated applies to nonrelativistic protocols. He showed that there cannot exist a set of states $\{|\psi_{AB}^{i,j}\rangle\}_{i,j}$, shared between Alice and Bob that fulfil the requirements of such a computation. In a relativistic computation where all measurements are kept quantum until the end, the final state must again be an (i, j) -dependent pure state distributed between Alice and Bob. Lo's impossibility result therefore extends trivially to relativistic protocols⁴.

Lo also noted that some secure two-input deterministic, two-sided non-relativistic quantum computations are impossible, because they imply the ability to do non-trivial secure two-input, deterministic one-sided computations. This argument also extends trivially to relativistic protocols.

We will discuss further protocols in this class in detail in Chapter 4.

Table 3.1 summarizes the known results.

3.3 Variable Bias Coin Tossing

3.3.1 Introduction

We now specialize to the task of variable bias coin tossing (VBCT), the simplest case of a one-input, random, two-sided computation. We seek protocols whose security is guaranteed based on the laws of physics.

⁴Rudolph [29] has defined the notion of a *consistent* task as one for which there exist states shared between the parties, and local operations which could satisfy the security demands. Inconsistent tasks are then impossible whether or not the protocol is relativistic, hence Lo's proof also works in this scenario. Consistent tasks are not necessarily possible: they require a way to securely generate a shared state of the correct form. Whether this is achievable can depend on whether a relativistic protocol is used or not.

Type of computation		Securely Implementable	Comment
Zero-input	Deterministic	✓	Trivial
	Random one-sided	✓	Trivial
	Random two-sided	✓	Biased n -faced die roll
One-input	Deterministic	✓	Trivial
	Random one-sided	(✗)	One-sided variable bias n -faced die roll
	Random two-sided	✓*	Variable bias n -faced die roll
Two-input	Deterministic one-sided	✗	cf. Lo
	Deterministic two-sided	(✗)	cf. Lo
	Random one-sided	?	see Chapter 4
	Random two-sided	?	see Chapter 4

Table 3.1: Functions computable securely in two-party computations using (potentially) both quantum and relativistic protocols, when unconditional security is sought. ✓ indicates that all functions of this type are possible, ✗ indicates that all functions of this type are impossible, ✓* indicates that conjectures made later in this chapter imply that all functions of this type are possible, and (✗) indicates that some functions of this type are impossible. ? indicates an unknown result (to be discussed in Chapter 4). An updated version of this table, Table 4.4, is given at the end of Chapter 4.

3.3 Variable Bias Coin Tossing

The aim of a VBCT protocol is to provide two mistrustful parties with the outcome of a biased coin toss. We label the possible outcomes by 0 and 1 and define the *bias* to be the probability, p_0 , of outcome 0. The protocol should allow one party, by convention Bob, to fix the bias to take any value within a pre-agreed range, $p_{\min} \leq p_0 \leq p_{\max}$. The protocol should guarantee to both parties that the biased coin toss outcome is genuinely random, in the sense that Bob's only way of influencing the outcome probabilities is through choosing the bias, while Alice has no way of influencing the outcome probabilities at all. It should also guarantee to Bob that Alice can obtain no information about his bias choice beyond what she can infer from the coin toss outcome alone.

To illustrate the uses of VBCT, consider a situation in which Bob may or may not wish to accept Alice's invitation to a party, in a future world in which social protocol decrees that his decision⁵ is determined by a variable bias coin toss in which he chooses the bias within a prescribed range, let us say $p_{\min} = \frac{1}{11} \leq p_0 \leq p_{\max} = \frac{10}{11}$. Alice, who is both self-confident and a Bayesian, believes prior to the coin toss that the probability of Bob not wishing to accept is 10^{-n} , for some fairly large value of n . If Bob does indeed wish to accept, he can choose $p_0 = \frac{10}{11}$, ensuring a high probability of acceptance. If he does not, he can choose $p_0 = \frac{1}{11}$, ensuring a low probability of acceptance. If the invitation is declined, this social protocol allows both parties to express regret, ascribing the outcome to bad luck rather than to Bob's wishes. Alice's posterior probability estimate of Bob's not wishing to attend is approximately 10^{-n+1} , i.e., still close to zero.

For another illustration of the uses of VBCT, suppose that Bob has a large secret binary data set of size N . For example, this might be a binary encoding of a high resolution satellite image. He is willing to sell Alice a noisy image of the data set with a specified level of random noise. Alice is willing to purchase if there is some way of guaranteeing, at least to within tolerable bounds, that the noise is at the specified level and that it was genuinely randomly generated. In particular, she would like some guarantee that constrains Bob so that he cannot selectively choose the noise so as to obscure a significantly sized component of the data set which he (but not necessarily she) knows to be especially interesting.

⁵Naturally, a similar protocol, in which Alice chooses the bias, governs the decision about whether or not an invitation is issued.

Let us suppose also that the full data set will eventually become public, so that Alice will be able to check the noisy image against it, and that she will be able to enforce suitably large penalties against Bob if the noisy and true versions turn out not to be appropriately related. They may proceed by agreeing on parameters p_{\min} and $p_{\max} = 1 - p_{\min}$, and then running a variable bias coin toss for each bit in the image, with Bob choosing $p_0 = p_{\min}$ if the bit is 1 and $p_0 = p_{\max}$ if the bit is 0. Following this protocol honestly provides Alice with the required randomly generated noisy image. On the other hand, if Bob deviates significantly from these choices for more than $O(\sqrt{N})$ of the bits, Alice will almost certainly be able to unmask his cheating once she acquires the full data set.

3.3.2 Definitions

A VBCT protocol is defined by a prescribed series of classical or quantum communications between two parties, Alice and Bob. If the protocol is relativistic, it may also require that the parties each occupy two or more appropriately located sites and may stipulate which sites each communication should be made from and to. The protocol’s definition includes bias parameters p_{\min} and p_{\max} , with $p_{\min} < p_{\max}$, and may also include one or more security parameters N_1, \dots, N_r . It accepts a one bit input from one party, Bob, and must result in both parties receiving the same output, one of the three possibilities 0, 1 or “abort”. The output “abort” can arise only if at least one of the parties refuses to complete the protocol honestly.

We follow the convention that Bob can fix p to be p_{\min} or p_{\max} by choosing inputs 1 or 0 respectively (so that an input of bit value b maximizes the probability of output b). He can thus fix p anywhere in the range $p_{\min} \leq p \leq p_{\max}$ by choosing the input randomly with an appropriate weighting. Since any VBCT protocol gives Bob this freedom, we do not require a perfectly secure protocol to exclude other strategies which have the same result: i.e., a perfectly secure protocol may allow any strategy of Bob’s which causes p_0 to lie in the given range, so long as no other security condition is violated.⁶ However, if Bob is honest, he chooses either $p = p_{\min}$ or $p = p_{\max}$. This motivates the following security definitions.

⁶Similar statements hold, with appropriate epsilonics, for secure protocols: see below.

3.3 Variable Bias Coin Tossing

We say the protocol is *secure* if the following conditions hold when at least one party honestly follows the protocol. Let p_0 be the probability of the output being 0, and p_1 be the probability of the output being 1. Then, regardless of the strategy that a dishonest party may follow during the protocol, we have $p_0 \leq p + \epsilon(N_1, \dots, N_r)$ and $p_1 \leq (1 - p) + \epsilon(N_1, \dots, N_r)$, where $p_{\min} \leq p \leq p_{\max}$ and the protocol allows Bob to determine p to take any value in this range. Alice has probability less than $\zeta(N_1, \dots, N_r)$ of obtaining more than $\delta(N_1, \dots, N_r)$ bits of information that are not implied by the outcome. In addition, if Bob honestly follows the protocol and legitimately aborts before the coin toss outcome is known⁷, then Alice has probability less than $\zeta(N_1, \dots, N_r)$ of obtaining more than $\delta(N_1, \dots, N_r)$ bits of information about Bob's input.

(We should comment here on a technical detail that will be relevant to some of the protocols we later consider. It turns out, in some of our protocols, to be possible and useful for Bob to make supplementary security tests even after both parties have received information which would determine the coin toss outcome. The protocols are secure whether or not these supplementary tests are made, in the sense that the security criteria hold as the security parameters tend to infinity. However, the supplementary tests increase the level of security for any fixed finite value of the security parameters.

We need slightly modified definitions to cover this case, since the output of the protocol is defined to be “abort” if Bob aborts after carrying out supplementary security tests. If Bob honestly follows a protocol with supplementary tests, and legitimately aborts after the coin toss outcome is determined, then we require that Alice should have probability less than $\zeta(N_1, \dots, N_r)$ of obtaining more than $\delta(N_1, \dots, N_r)$ extra bits of information—i.e., beyond what is implied by the coin toss outcome.

Note that introducing supplementary security tests may allow Alice to follow the protocol honestly until she obtains the coin toss outcome, and then deliberately fail the supplementary tests in order to cause the protocol to abort. However, this may not give her useful extra scope for cheating. In a VBCT protocol in which the coin toss outcome has some real world consequence, for instance,

⁷We take this to be the point at which both parties have enough information (possibly distributed between their remote agents) to determine the outcome.

Alice can always follow the protocol honestly and then refuse to abide by the consequence dictated by its outcome: for example, she can decide not to invite Bob to her party, even if the variable bias coin toss suggests that she should. This unavoidable possibility has the same effect as her causing the protocol to abort after the coin toss outcome is determined.)

In all the above cases, we require $\delta(N_1, \dots, N_r) \rightarrow 0$, $\epsilon(N_1, \dots, N_r) \rightarrow 0$ and $\zeta(N_1, \dots, N_r) \rightarrow 0$ as the $N_i \rightarrow \infty$. We say the protocol is *perfectly secure* for some fixed values N_1, \dots, N_r if the above conditions hold with $\epsilon(N_1, \dots, N_r) = \delta(N_1, \dots, N_r) = \zeta(N_1, \dots, N_r) = 0$.

Suppose now that one party is honest and the other party fixes their strategy (which may be probabilistic and may depend on data received during the protocol) before the protocol commences, and suppose that the probability of the protocol aborting, given this strategy, is less than ϵ' . Since the only possible outcomes are 0, 1 and “abort”, it follows from the above conditions that, if Bob inputs 1, we have $p_{\min} - \epsilon(N_1, \dots, N_r) - \epsilon' < p_0 \leq p_{\min} + \epsilon(N_1, \dots, N_r)$ and $(1 - p_{\min}) - \epsilon(N_1, \dots, N_r) - \epsilon' < p_1 \leq (1 - p_{\min}) + \epsilon(N_1, \dots, N_r)$. Similarly, if Bob inputs 0, we have $p_{\max} - \epsilon(N_1, \dots, N_r) - \epsilon' < p_0 \leq p_{\max} + \epsilon(N_1, \dots, N_r)$ and $(1 - p_{\max}) - \epsilon(N_1, \dots, N_r) - \epsilon' < p_1 \leq (1 - p_{\max}) + \epsilon(N_1, \dots, N_r)$. In other words, unless a dishonest party is willing to accept a significant risk of the protocol aborting, they cannot cause the outcome probabilities for 0 or 1 to be significantly outside the allowed range. Moreover, no aborting strategy can increase the probability of 0 or 1 beyond the allowed maximum.

For an *unconditionally secure* VBCT protocol, the above conditions hold assuming only that the laws of physics are correct. In a *cheat-evidently secure* protocol, if any of the above conditions fail, then the non-cheating party is guaranteed to detect this, again assuming only the validity of the laws of physics.

3.4 VBCT Protocols

3.4.1 Protocol VBCT1

We consider first a simple relativistic quantum protocol, which implements VBCT with unconditional security, for a limited range of biases. The protocol requires

each party to have agents located at three appropriately separated sites.

Protocol VBCT1

1. B_1 , B_2 and B_3 agree on a random number n chosen from a Poisson distribution with large mean (or other suitable distribution).
2. A_1 sends a sequence of qubits $\{|\phi_i\rangle\}$ to B_1 , where each $|\phi_i\rangle \in \{|\psi_0\rangle, |\psi_1\rangle\}$ is chosen independently with probability half each, using the random string \mathbf{x} . The states $|\psi_0\rangle$ and $|\psi_1\rangle$ are agreed between Alice and Bob prior to the protocol, and the qubits are sent at regular intervals according to a previously agreed schedule, so that all the agents involved can coordinate their transmissions.
3. B_1 receives each qubit and stores it.
4. A_2 tells B_2 the sequence of states $\{|\phi_i\rangle\}$ sent, choosing the timings so that A_1 's quantum communication of the qubit $|\phi_i\rangle$ is spacelike separated from A_2 's classical communication of its identity. B_2 relays these communications to B_1 .
5. B_3 announces to A_3 that the n th state will be used for the coin toss. This announcement is made at a point spacelike separated from the n th rounds of communication between A_1 and B_1 and A_2 and B_2 . A_3 reports the value of n to A_1 and A_2 .
6. B_1 performs the measurement on $|\phi_n\rangle$ that optimally distinguishes $|\psi_0\rangle$ from $|\psi_1\rangle$, and then reveals n to A_1 , along with a bit b . If his measurement is indicative of the state being $|\psi_{b'}\rangle$, then Bob should select $b = b'$ if he wants outcome 0, or else select $b = \bar{b}'$. Let Alice's random choice for the n th state be $|\psi_a\rangle$: recall that A_2 reported the value of a to B_2 in Step 4.
7. Some time later, on receipt of the sequence sent by B_2 in Step 4, B_1 measures his remaining stored states to verify that they were correctly described by A_2 . If any error occurs, he aborts.

8. A_1 receives from A_3 the value of n sent by B_3 , confirming that B_1 was committed to guess the n th state, and B_1 receives from B_2 the value of a sent by A_2 . The outcome of the coin toss is $c = a \oplus b$.

It will be seen that this protocol is a variant of the familiar relativistic protocol for ordinary coin tossing. As in that protocol, Alice and Bob simultaneously exchange random bits. However, Alice's bit is here encoded in non-orthogonal qubits, which means that Bob can obtain some information about its value. Bob uses this information to affect the bias of the coin toss.

We use the bit w to represent Bob's wishes, with $w = 0$ representing Bob trying to produce the outcome 0 by guessing correctly, and $w = 1$ representing him trying to produce the outcome 1 by guessing wrongly. Security requires that

$$p(w|a, b, c) \approx p(w|c), \tag{3.1}$$

i.e. the bits a and b convey no information about Bob's wishes. Perfect security requires equality in the above equation.

3.4.1.1 Bob's Strategy

The choice of n need not be fixed by Bob at the start of the protocol: for example, it could be decided during the protocol by using an entangled state shared by the B_i . However, we may assume B_3 sends a classical choice of n to A_3 (A_3 will measure any quantum state he sends immediately in the computational basis, and hence we may assume, for the purposes of security analysis, that B_3 carries out this measurement). B_3 's announcement of n is causally disconnected from the sending of the n th state to B_1 and of its identity to B_2 . Therefore, no matter how it is selected, it does not depend on the value of the n th state. While it could be generated in such a way as to depend on some information about the sequence of states previously received, these states are uncorrelated with the n th state if Alice follows the protocol. Such a strategy thus confers no advantage, and we may assume, for the purposes of security analysis, that the choice of n is generated by an algorithm independent of the previous sequence of states. We may also assume that n is generated in such a way that B_1 and B_2 can obtain the value of n announced by B_3 with certainty: if not, their task is only made

harder. In summary, for the purposes of security analysis, we may assume that B_3 announces a classical value of n , pre-agreed with B_1 and B_2 at the beginning of the protocol.

B_1 is then committed to making a guess of the value of the n th state: if he fails to do so then Alice knows Bob has cheated. B_1 's best strategy is thus to perform some measurement on the n th state and use the outcome to make his guess. We define $|\psi_0\rangle = \cos\frac{\theta}{2}|0\rangle + \sin\frac{\theta}{2}|1\rangle$ and $|\psi_1\rangle = \cos\frac{\theta}{2}|0\rangle - \sin\frac{\theta}{2}|1\rangle$, where $0 \leq \theta \leq \frac{\pi}{2}$. Let the projections defining the optimal measurement be P_0 and P_1 . We say that the outcome corresponding to P_0 is ‘‘outcome 0’’, and similarly for the outcome corresponding to P_1 . Without loss of generality, we can take outcome 0 to correspond to the most likely state Alice sent being $|\psi_0\rangle$ and similarly outcome 1 to correspond to $|\psi_1\rangle$. Bob's probability of guessing correctly is then given by,

$$p_B = \frac{1}{2} (\langle\psi_0| P_0 |\psi_0\rangle + \langle\psi_1| P_1 |\psi_1\rangle) . \quad (3.2)$$

This is maximized for P_0 and P_1 corresponding to measurements in the $|\pm\rangle$ basis, where $|\pm\rangle = \frac{1}{\sqrt{2}}(|0\rangle \pm |1\rangle)$. The maximum value is,

$$p_B^{\max} = \frac{1}{2} (1 + \sin\theta) . \quad (3.3)$$

It is easy to see that the security criterion (3.1) is always satisfied. Furthermore, the outcome, c can be used by either party to simulate the intermediates produced in the protocol (i.e., a , b , and the set of quantum states), making it clear that no information is gained, other than that implied by the outcome (the rôle of simulatability in security will be discussed further in Section 4.2). The minimum probability of Bob guessing correctly is always $1 - p_B^{\max}$, which he can attain by following the same strategy but associating outcome b' with a guess of \bar{b} . The possible range of biases are those between $p_{\min} = \frac{1}{2}(1 - \sin\theta)$ and $p_{\max} = \frac{1}{2}(1 + \sin\theta)$. The protocol thus implements VBCT for all values of p_{\min} and p_{\max} with $p_{\min} + p_{\max} = 1$ (and no others).

3.4.1.2 Security Against Alice

Security against Alice is ensured by the fact that B_1 tests A_2 's statements about the identity of the states sent to B_1 .

We seek to show that if Alice attempts to alter the probability of B_1 measuring 0 or 1 with his measurement in Step 6, then in the limit of large n , either the probability of her being detected tends to 1, or her probability of successfully altering the probability tends to zero. Note that it may be useful for Alice to alter the probabilities in either direction: if she increases the probability that B_1 guesses correctly, she learns more information about Bob's bias than she should; if she decreases it, she limits Bob's ability to affect the bias.

We need to show that if, on the i th round, B_1 receives state ρ_i , for which the probability of outcome 0 differs from those dictated by the protocol, then the probability of B_1 not detecting Alice cheating on this state is strictly less than 1.

B_1 's projections are onto $\{|+\rangle, |-\rangle\}$ for the n th state. Alice's cheating strategy must ensure that for some subset of the states she sends to B_1 , there is a different probability of his measurement giving outcome 0. Suppose that ρ_i satisfies

$$\langle + | \rho_i | + \rangle = p_{\max} + \delta_1 \tag{3.4}$$

$$= p_{\min} + \delta_2, \tag{3.5}$$

where $\delta_1, \delta_2 \neq 0$. Then, if B_1 was to instead test Alice's honesty, the state which maximizes the probability of Alice passing the test, among those satisfying (3.4), is

$$(p_{\max} + \delta_1)^{\frac{1}{2}} |+\rangle + (1 - p_{\max} - \delta_1)^{\frac{1}{2}} |-\rangle, \tag{3.6}$$

and she should declare this state to be whichever of $|\phi_0\rangle$ or $|\phi_1\rangle$ maximizes the probability of passing Bob's test. We have

$$\left((p_{\max}(p_{\max} + \delta_1))^{\frac{1}{2}} + ((1 - p_{\max})(1 - p_{\max} - \delta_1))^{\frac{1}{2}} \right)^2 \leq 1 - \delta_1^2, \tag{3.7}$$

and a similar equation with p_{\min} replacing p_{\max} and δ_2 replacing δ_1 . Hence the probability of passing Bob's test is at most $1 - \delta^2$, where $\delta = \min(|\delta_1|, |\delta_2|)$. In order to affect B_1 's measurement probabilities with significant chance of success, there must be a significant fraction of states satisfying (3.4). If a fraction γ of states satisfy (3.4) with $\min(|\delta_1|, |\delta_2|) \geq \delta$ for some fixed $\delta > 0$, then this cheating strategy succeeds with probability at most $\gamma(1 - \delta^2)^{\gamma n}$. Hence, for any δ, γ , the probability of this technique being successful for Alice can be made arbitrarily

close to 0 if Bob chooses the mean of the Poisson distribution used in Step 1 (and hence the expected value of n) to be sufficiently large.

Note that, as this argument applies state by state to the ρ_i , it covers every possible strategy of Alice's: in particular, the argument holds whether or not the sequence of qubits she sends is entangled.

We hence conclude that the protocol is asymptotically secure against Alice.

3.4.2 Protocol VBCT2

We now present a relativistic quantum VBCT protocol which allows any range of biases, but achieves only cheat-evident security rather than unconditional security.

Protocol VBCT2

1. B_1 creates N states, each being either $|\psi_0\rangle = \alpha_0|00\rangle + \beta_0|11\rangle$ or $|\psi_1\rangle = \alpha_1|00\rangle + \beta_1|11\rangle$, with $\{\alpha_0, \alpha_1, \beta_0, \beta_1\} \in \mathbb{R}^+$, $\alpha_0^2 > \alpha_1^2$, and $\alpha_i^2 + \beta_i^2 = 1$. The states are chosen with probability half each. In the unlikely event that all the states are the same, B_1 rejects this batch and starts again. B_1 uses the shared random string \mathbf{y} to make his random choices, so that B_1 and B_2 both know the identity of the i th state. B_1 sends the second qubit of each state to A_1 . The values of $\alpha_0, \beta_0, \alpha_1$ and β_1 are known to both Alice and Bob. We define the bias of the state $|\psi_i\rangle$ to be α_i^2 , and write $p_{\min} = \alpha_1^2$ and $p_{\max} = \alpha_0^2$.
2. Alice decides whether to test Bob's honesty ($z = 1$), or to trust him ($z = 0$). She selects $z = 0$ with probability 2^{-M} . A_1 and A_2 simultaneously inform B_1 and B_2 of z , A_2 's communication being spacelike separated from the creation of the states by B_1 in Step 1.
3. (a) If $z = 1$, B_1 sends all of his qubits and their identities to A_1 , while B_2 sends the identities to A_2 . A_1 can then verify that they are as claimed and if so, the protocol returns to Step 1. If not, she aborts the protocol.

- (b) If $z = 0$, B_1 randomly chooses a state to use for the coin toss from among those with the bias he wants. B_2 simultaneously informs A_2 of B_1 's choice.
- 4. A_1 and B_1 measure their halves of the chosen state in the $\{|0\rangle, |1\rangle\}$ basis, and this defines the outcome of the coin toss.
- (5. As an optional supplementary post coin toss security test, B_1 may ask A_1 to send all her remaining qubits back to him, except for her half of the state selected for the coin toss. He can then perform projective measurements on these states to check that they correspond to those originally sent.)

An intuitive argument for security of this protocol is as follows. On the one hand, as $M \rightarrow \infty$, the protocol is secure against Bob since, in this limit, he always has to convince Alice that he supplied the right states which he can only do if he has been honest. But also, in the limit $N \rightarrow \infty$, we expect the protocol to be secure against Alice, since in this limit, she cannot gain any more information about the bias Bob selected than can be gained by performing the honest measurement.

The protocol can only provide cheat-evident security rather than unconditional security, since there are useful cheating strategies open to Alice, albeit ones which will certainly be detected. One such strategy is for A_1 to claim that $z = 0$ on some state, while A_2 claims that $z = 1$. This allows Alice to determine Bob's desired bias, since B_1 will tell A_1 the state to use, and B_2 will tell A_2 its identity. However, this cheating attack will be exposed once B_1 and B_2 communicate.

(Technically, Alice has another possible attack: she can follow the protocol honestly until she learns the outcome, and then intentionally try to fail Bob's tests in Step 5 by altering her halves of the remaining states in some way. By so doing, she can cause the protocol to abort after the coin toss outcome is determined. However, as discussed in Section 3.3, this gives her no advantage.)

3.4.2.1 Security Against Alice

Assume Bob does not deviate from the protocol. A_2 must announce the value of z without any information about the current batch of states sent to A_1 by B_1 . Alice therefore cannot affect the bias: once a given batch is accepted, she cannot affect B_1 's measurement probabilities on any state he chooses for the coin toss. While Alice's choices of z need not be classical bits determined before the protocol and shared by the A_i , we may assume, for the purposes of security analysis, that they are, by the same argument used in analyzing Bob's choice of n in VBCT1.

Once Bob has announced the state he wishes to use for the coin toss, though, Alice can perform any measurement on the states in her possession in order to gain information about Bob's chosen bias. It would be sufficient to show that any such attack that provides significant information is almost certain to be detected by Bob's tests in Step 3b; if so, the existence of such attacks would not compromise the cheat-evident security of the protocol. In fact, a stronger result holds: Alice cannot gain significant information by such attacks. From her perspective, if Bob selects a $|\psi_0\rangle$ state for the coin toss, the (un-normalized) mixed state of the remaining $(N - 1)$ qubits is,

$$\tilde{\sigma}_0 \equiv \sum_{m=0}^{N-2} \sum_{\substack{i_1, \dots, i_{N-1} \in \{0,1\} \\ \sum_{j=1}^{N-1} i_j = (N-1-m)}} \rho_{i_1} \otimes \rho_{i_2} \otimes \cdots \otimes \rho_{i_{N-1}}, \quad (3.8)$$

while if Bob selects a $|\psi_1\rangle$ state for the coin toss, the (un-normalized) mixed state of the remaining $(N - 1)$ qubits is

$$\tilde{\sigma}_1 \equiv \sum_{m=1}^{N-1} \sum_{\substack{i_1, \dots, i_{N-1} \in \{0,1\} \\ \sum_{j=1}^{N-1} i_j = (N-1-m)}} \rho_{i_1} \otimes \rho_{i_2} \otimes \cdots \otimes \rho_{i_{N-1}}, \quad (3.9)$$

where

$$\rho_i = \text{tr}_B(|\psi_i\rangle\langle\psi_i|) \quad \text{for } i = 0, 1.$$

We will use σ_0 and σ_1 to denote the normalized versions of $\tilde{\sigma}_0$ and $\tilde{\sigma}_1$ respectively.

We have

$$D(\rho_0 \otimes \sigma_0, \rho_1 \otimes \sigma_1) \leq D(\rho_0 \otimes \sigma_0, \rho_1 \otimes \sigma_0) + D(\rho_1 \otimes \sigma_0, \rho_1 \otimes \sigma_1) \quad (3.10)$$

As $N \rightarrow \infty$, we have $D(\sigma_0, \sigma_1) \rightarrow 0$ and so $D(\rho_0 \otimes \sigma_0, \rho_1 \otimes \sigma_1) \rightarrow D(\rho_0, \rho_1)$. Since the maximum probability of distinguishing two states is a function only of the trace distance (see Appendix A), the maximum probability of distinguishing $\rho_0 \otimes \sigma_0$ from $\rho_1 \otimes \sigma_1$ tends, as $N \rightarrow \infty$, to the maximum probability of distinguishing ρ_0 from ρ_1 . The measurement that attains this maximum is that dictated by the protocol. We hence conclude that, in the limit of large N , the excess information Alice can gain by using any cheating strategy tends to zero.

3.4.2.2 Security Against Bob

We now consider Bob's cheating possibilities, assuming that Alice does not deviate from the protocol. To cheat, Bob must achieve a bias outside the range permitted. Let us suppose he wants to ensure that the outcome probability of 0 satisfies $p_0 \geq p_{\max} + \delta$, for some $\delta > 0$ (the case $p_1 \geq 1 - p_{\min} + \delta$ can be treated similarly), and let us suppose this can be achieved with probability $\delta' > 0$.

For this to be the case, there must be some cheating strategy (possibly including measurements) which, with probability δ' , allows B_2 to identify a choice of i from the relevant batch of N qubits such that the state ρ_i of A_1 's i th qubit then satisfies

$$\langle 0 | \rho_i | 0 \rangle \geq p_{\max} + \delta. \quad (3.11)$$

If A_1 's i th qubit does indeed have this property, and she chooses to test Bob's honesty on the relevant batch, the probability of the i th qubit passing the test is at most $1 - \delta^2$. To see this, note that if (3.11) holds, the probability of passing the test is maximized if the i th state is

$$(p_{\max} + \delta)^{\frac{1}{2}} |00\rangle + (1 - p_{\max} - \delta)^{\frac{1}{2}} |11\rangle, \quad (3.12)$$

and B_1 declares that the i th state is $|\psi_0\rangle$. The probability is then

$$\left((p_{\max}(p_{\max} + \delta))^{\frac{1}{2}} + ((1 - p_{\max})(1 - p_{\max} - \delta))^{\frac{1}{2}} \right)^2 \leq 1 - \delta^2. \quad (3.13)$$

However, the probability of A_1 's measurement outcomes is independent of B_2 's actions. Hence this bound applies whether or not B_2 actually implements a cheating strategy on the relevant batch. Thus there must be a probability of at least $\delta'\delta^2$ of at least one member of the batch failing A_1 's tests. Hence, for any

given $\delta, \delta' > 0$, the probability that one of the $\approx 2^M$ batches for which $z = 1$ fails A_1 's tests can be made arbitrarily close to 1 by taking M sufficiently large.

3.4.3 Protocol VBCT3

Protocol VBCT2 can be improved by using bit commitment subprotocols to keep Bob's choice of state secret until he is able to compare the values of z announced by A_1 and A_2 . This eliminates the cheat-evident attack discussed in the last section, and defines a protocol which we conjecture is unconditionally secure. We use the relativistic bit commitment protocol RBC2 that is defined and reviewed in [27].

Protocol VBCT3

1. B_1 creates N states, each being either $|\psi_0\rangle = \alpha_0 |00\rangle + \beta_0 |11\rangle$ or $|\psi_1\rangle = \alpha_1 |00\rangle + \beta_1 |11\rangle$, with $\{\alpha_0, \alpha_1, \beta_0, \beta_1\} \in \mathbb{R}^+$, and $\alpha_i^2 + \beta_i^2 = 1$. The states are chosen with probability half each. B_1 and B_2 both know the identity of the i th state, since B_1 uses the shared random string \mathbf{y} to make his random choices. B_1 sends the second qubit of each state to A_1 . The values of $\alpha_0, \beta_0, \alpha_1$ and β_1 are known to both Alice and Bob.
2. Alice decides whether to test Bob's honesty, which she codes by choosing the bit value $z = 1$, or to trust him, coded by $z = 0$. She selects $z = 0$ with probability 2^{-M} . A_1 and A_2 simultaneously inform B_1 and B_2 of the choice of z .
3. B_1 and B_2 broadcast the value of z they received to one another.
4. If B_1 received $z = 1$ from A_1 , he sends the first qubit of each state to A_1 , along with a classical bit identifying the state as $|\psi_0\rangle$ or $|\psi_1\rangle$. If B_2 received $z = 1$ from A_2 , he sends A_2 a classical bit identifying the state as $|\psi_0\rangle$ or $|\psi_1\rangle$. These communications are sent quickly enough that Alice is guaranteed that each of the B_i sent their transmission before knowing the value of z sent to the other. A_2 broadcasts the classical data to A_1 who tests that the quantum states are those claimed in the classical communications

by carrying out the appropriate projective measurements. If not, she aborts. If so, the protocol restarts at Step 1: B_1 creates a new set of N states and proceeds as above.

5. If $z = 0$, A_2 waits for time $\frac{D}{2}$ in the stationary reference frame of B_2 before starting a series of relativistic bit commitment subprotocols of type RBC2 by sending the appropriate communication (a list of suitably chosen random integers) to B_2 . B_2 verifies the delay interval was indeed $\frac{D}{2}$, to within some tolerance.
6. B_2 continues the RBC2 subprotocols by sending A_2 communications which commit Bob to the value of i that defines the state to use for the coin toss.
7. B_1 and B_2 then wait a further time $\frac{D}{2}$, by which point they have received the signals sent in Step 3. They then check that the z values they received from the A_i are the same. If not, they abort the protocol.
8. B_1 and B_2 send communications to A_1 and A_2 which unveil the value of i to which they were committed, and hence reveal the state chosen for the coin toss. If the unveiling is invalid, Alice aborts.
9. A_1 and B_1 measure their halves of the i th state in the $\{|0\rangle, |1\rangle\}$ basis to define the outcome of the coin toss.
- (10. As an optional supplementary post coin toss security test, B_1 asks A_1 to return her qubits from all states other than the i th. He then tests that the returned states are those originally sent, by carrying out appropriate projective measurements. If the tests fail, he aborts the protocol.)

3.4.3.1 Security Against Alice

In this modification of Protocol VBCT2, there is no longer any advantage to Alice in cheating by arranging that one of the A_i sends $z = 0$ and the other $z = 1$. Such an attack will be detected with certainty, as is the case with Protocol VBCT2. Moreover, since Bob's chosen value of i is encrypted by a bit commitment, which is only unveiled once the B_i have checked that the values of z they received are

identical, Alice gains no information about Bob's chosen bias from the attack. The bit commitment subprotocol RBC2 is unconditionally secure against Alice [27], since the communications she receive are, from her perspective, uniformly distributed random strings.

(As in the case of VBCT2, technically speaking, Alice has another possible attack: she can follow the protocol honestly up to Step 10 and then, once she learns Bob's chosen state, intentionally try to fail Bob's tests by altering her halves of the remaining states in some way. By so doing, she can cause the protocol to abort after the coin toss outcome is known. Again, though, this gives her no advantage.)

The protocol therefore presents Alice with no useful cheating attack.

3.4.3.2 Security Against Bob

Intuitively, one might expect the proof that VBCT2 is secure against Bob to carry over to a proof that VBCT3 is similarly secure, for the following reasons. First, the only difference between the two protocols is that Bob makes a commitment to the value of i rather than announcing it immediately. Second, when the bit commitment protocol RBC2 is used, as here, just for a single round of communications, it is provably unconditionally secure against general (classical or quantum) attacks by Bob.

To make this argument rigorous, one would need to show that RBC2 and the other elements of VBCT3 are securely *composable* in an appropriate sense: i.e., that Bob has no collective quantum attack which allows him to generate and manipulate collectively the data used in the various steps of VBCT3 in such a way as to cheat. We conjecture that this is indeed the case, but have no proof.

3.4.4 Protocol VBCT4

Classical communications and information processing are generally less costly than their quantum counterparts, so much so that, in some circumstances, it is reasonable to treat classical resources as essentially cost free compared to quantum resources. It is thus interesting to note the existence of a classical relativistic protocol for VBCT, which is unconditionally secure against classical attacks, and

which we conjecture is unconditionally secure against quantum attacks. The protocol requires Alice and Bob each to have two appropriately located agents, A_1 , A_2 and B_1 , B_2 .

Protocol VBCT4

1. Bob generates a $2M \times N$ matrix of bits such that each row contains either $\alpha_0^2 N$ zero entries or $\alpha_1^2 N$ zero entries, these being positioned randomly throughout the row. The rows are arranged in pairs, so that, for m from 0 to $(M - 1)$, either the $2m$ th row contains $\alpha_0^2 N$ entries and the $(2m + 1)$ th contains $\alpha_1^2 N$, or vice versa. This choice is made randomly, equiprobably and independently for each pair. The matrix is known to both B_1 and B_2 but kept secret from Alice.
2. Bob then commits each element of the matrix separately to Alice using the classically secure relativistic bit commitment subprotocol RBC2 [27], initiated by communications between A_2 and B_2 .
3. A_1 then picks $M - 1$ pairs at random. She asks B_1 to unveil Bob's commitment for all of the bits in these pairs of rows.
4. The RBC2 commitments for the remaining bits are sustained while A_1 and A_2 communicate to verify that each unveiling corresponds to a valid commitment to either 0 or 1. Alice also checks that each unveiled pair contains one row with $\alpha_0^2 N$ zeros and one with $\alpha_1^2 N$ zeros. If Bob fails either set of tests, Alice aborts.
5. If Bob passes all of Alice's tests, B_1 picks the remaining row corresponding to the bias he desires, and A_2 simultaneously picks a random column. They inform A_1 and B_2 respectively, thus identifying a single matrix element belonging to the intersection.
6. Bob then unveils this bit, which is used as the outcome of the coin toss. The remaining commitments are never unveiled.

3.4.4.1 Security

The above protocol shows that, classically, bit commitment can be used as a subprotocol to achieve VBCT. The proof that RBC2 is unconditionally secure against classical attacks [27] can be extended to show that Protocol VBCT4 is similarly secure. RBC2 is conjectured, but not proven, to be secure against general quantum attacks. We conjecture, but have no proof, that the same is true of Protocol VBCT4.

3.5 Summary

We have defined the task of variable bias coin tossing, illustrated its use with a couple of applications, and presented four VBCT protocols. The first, VBCT1, allows VBCT for a limited range of biases, and is unconditionally secure against general quantum attacks. The second protocol, VBCT2, is defined for any range of biases and guarantees cheat-evident security against general quantum attacks. The third, VBCT3, extends the second by using a relativistic bit commitment subprotocol, and we conjecture that it is unconditionally secure against general quantum attacks.

The fourth protocol, VBCT4, is classical, and is based on multiple uses of a classical relativistic bit commitment scheme which is proven secure against classical attacks. It can be shown to be unconditionally secure against classical attacks. The relevant relativistic bit commitment scheme is conjectured secure against quantum attacks, and we conjecture that this is also true of Protocol VBCT4.

Variable bias coin tossing is a simple example of a random one-input two-sided secure computation. The most general such computation is what we have termed a variable bias n -faced die roll. In this case, there is a finite range of n outputs, with each of Bob's inputs leading to a different probability distribution over these outputs. In other words, Bob is effectively allowed to choose one of a fixed set of biased n -faced dice to generate the output, while Alice is guaranteed that Bob's chosen die is restricted to the agreed set.

The protocols VBCT2, VBCT3 and VBCT4 can easily be generalized to protocols defining variable bias n -faced die rolls. Thus, to adapt protocols VBCT2 and VBCT3 to variable bias die rolling, we require Bob to choose a series of states from the set $\{|\psi_i\rangle = \sum_{j=0}^{n-1} \alpha_i^j |jj\rangle\}_{i=1}^r$, where r is the number of dice in the allowed set and where $(\alpha_i^j)^2$ defines the probability of outcome j for the i th dice (we take $\{\alpha_i^j\}$ to be real and positive). The protocols then proceed similarly to those given above, defining protocols which we conjecture to be cheat-evidently secure and unconditionally secure respectively.

To adapt Protocol VBCT4, we require that the matrix rows contain appropriate proportions of entries corresponding to the various possible die roll outcomes. We conjecture that this protocol is unconditionally secure.

As we noted earlier, variable bias n -sided die rolling is the most general one-input random two-sided two party single function computation. Our conjectures, if proven, would thus imply that all such computations can be implemented with unconditional security.

Chapter 4

Secure Two-Party Classical Computation

“An essential element of freedom is the right to privacy, a right that cannot be expected to stand against an unremitting technological attack.” – Whitfield Diffie

4.1 Introduction

Two wealthy and powerful businessmen wish to know who is the richest. They are highly secretive about their bank balances, and do not wish to disclose more information than that necessarily implied by the outcome. Does there exist a sequence of exchanges of (quantum) information that implements this task? This is an example of a secure two-party computation. In this chapter, we consider a range of such computations and ask whether they can be implemented with unconditional security.

A general introduction to secure two-party computation has been given in Section 3.2. In this chapter, we continue to focus on *single function computations*. We will drop the qualifier *single function*—all functions in this chapter can be assumed to take this form unless otherwise stated. The main focus is on two-input functions for which the two-sided deterministic and the one-sided and two-sided non-deterministic cases will each be discussed separately (see Section 3.2

for definitions). We present a cheating attack that renders a large subset of these functions insecure on the grounds that this attack allows one party to gain more information about the other's input than is implied by the outcome of the computation.

4.2 Security Definitions In Secure Multi-Party Computation

Phrasing security definitions for secure multi-party computations requires some care. It is not sufficient (but is necessary), for example, to demand that the amount of information divulged to a dishonest party in an implementation of a protocol be less than that implied by the honest outcome, since the type of information may also be important. In this section, we discuss security definitions which sufficiently restrict both the amount and type of information. In essence, the idea is that a protocol is secure if any information one party can get by deviating from the protocol could have been derived from their output.

It may also be advantageous for one party to deviate from the protocol in order to influence its outcome, in effect changing the computation being performed. A secure protocol must also protect against this possibility. Furthermore, we would like a security definition which guarantees that when the protocol is used as a component of a larger protocol, it remains secure. The task of proving security of the larger protocol can then be reduced to that of its sub-protocols, together with an argument that the composition of such protocols performs the desired task.

The universal security framework of Canetti [51], and the reactive simulatability framework of Backes, Pfitzmann and Waidner [52, 53] try to capture this idea in a classical context and have recently been extended and used in quantum scenarios [54–56]. Following [57], we define the following types of security.

Definition 4.1. (Stand-alone security) For a proposed protocol, one gives an ideal behaviour. One then demands that for every attack against a real execution of the protocol, there is an equivalent attack against the ideal, in the following sense. Suppose we have a black box implementing the ideal. Then, for any

4.2 Security Definitions In Secure Multi-Party Computation

attack on the real protocol, there must exist a *simulator* which, when used in conjunction with the ideal protocol can generate exactly the same view¹ as present after the attack on the real execution. If some part of the view is probabilistic, the simulator must be able to generate a view whose joint distribution with the computation's input is identical to that of the real protocol. Furthermore, there must exist a simulator that can, in conjunction with a black box implementing the ideal, generate any intermediate states present in the real execution if both parties are honest.

Definition 4.2. (Universally composable security) The requirements of stand-alone security hold when the protocol is used in any environment (i.e., as a subprotocol of any larger protocol).

The additional requirement for universal composability allows us to replace the protocol by its ideal in any security analyses, and is hence highly desirable. However, such a requirement is rarely achievable, and often one has to make do with stand-alone security. The difficulty of satisfying universally composable security definitions is highlighted in Section 4.2.1.

In order to prove security under either the stand-alone or universally composable definitions, one needs to produce a suitable description for the behaviour of an ideal protocol. Such descriptions are often given by invoking a trusted third party (TTP). While such behaviours are called “ideal”, they may not be ideal in the sense of being the ultimate demands we might impose upon a protocol. Such demands often have to be weakened in order to find a set that are feasible. We give two ideals that might be used for computations involving any number of parties, before specializing to the two-party case. We begin with ideals relevant to classical protocols. Ideal Behaviour 1 represents a true ideal².

Ideal Behaviour 1.

1. *The TTP obtains all of the data from all of the parties.*

¹The *view* of one party is their complete set of quantum states and classical values.

²The ideals we give are phrased for general computations, but can easily be specialized to the single-function case.

4.2 Security Definitions In Secure Multi-Party Computation

2. *It extracts their correct input³ from this data and performs the computation.*
3. *The TTP returns to each party their individual outputs.*

It is clear that such a behaviour places unduly strong requirements on a protocol such that it could never be mimicked by a protocol in the real world. A party cannot even lie about their input in such a model! Instead, the following (weakened) model has been suggested [58] in order to capture some attacks that are impossible to avoid.

Ideal Behaviour 2.

1. *The dishonest parties share their original inputs and decide on replaced inputs which they send to the TTP. The honest parties send their inputs.*
2. *The TTP uses the inputs to determine the corresponding outputs, and sends them to the relevant parties.*
3. *The dishonest parties may collect their outputs of the TTP and compute some function dependent on these and their initial inputs.*

Let us emphasize two important points. Firstly, cheating in a protocol that satisfies the requirements of Ideal Behaviour 2 is only possible by make a replaced input. The dishonest parties are not allowed to coerce the TTP into generating a different functionality. Secondly, in a real implementation of such a protocol, each party will receive more than just their output. In a secure protocol, any additional data received must be of no use. This is captured in the security definition by the simulator.

For two-party protocols, it is known that such a behaviour cannot be realized, and hence Ideal Behaviour 2 is often only applied for the case of honest majority [58]. The reason is that one has to take into account each party's ability to abort within the ideal behaviour. In a real protocol, either party may abort, and, in particular, they may do so at such a point where they have a knowledge advantage over the other (except in the case of single output computations, where one of the

³For instance, in a computation, where one is supposed to input their bank balance, the correct input is the actual balance: an unscrupulous user may lie about their input.

4.2 Security Definitions In Secure Multi-Party Computation

parties should never gain any information). This attack falls outside the scope of Ideal Behaviour 2. Goldreich [58] introduces Ideal Behaviour 3 which tries to allow for this:

Ideal Behaviour 3.

1. *Each party sends its input to the TTP. A dishonest party may replace their input or send no input (abort).*
2. *TTP determines the corresponding outputs and sends the first output to the first party.*
3. *The first party may (if dishonest) tell the TTP to abort, otherwise it tells it to proceed.*
4. *If told to proceed, the TTP gives the second output to the second party. Otherwise it does nothing.*

It is known that, assuming the existence of enhanced trapdoor functions, protocols for any secure two-party computation can be constructed that emulate Ideal Behaviour 3 with computational security [58]. When unconditional security is sought, this ideal behaviour is suitable for a single-round protocol, or one in which no information is given away until the last step (in which case early abort is equivalent, in terms of the information gain of both parties, to not going through with the protocol). However, this ideal behaviour neglects the possibility that either party may abort *at any time*. One could imagine protocols in which information is built up gradually by each party in each round of communication, in such a way that one party can only have a small amount more than the other at any given time [50]. One might then invoke an instance of Ideal Behaviour 3 for each round of the protocol. This seems unduly cumbersome to build into a definition of a secure computation. An ideal whereby abort is allowed at any step is desirable.

We introduce the following ideal behaviour in order to capture this (specializing now to the two-party case):

Ideal Behaviour 4.

1. *Each party sends its input to the TTP, along with a number, a , representing an additional function to compute at the end (if desired). (If both parties submit numbers, the lowest is taken. Additionally, Alice can only submit even numbers, and Bob odd ones.)*
2. *The TTP performs the correct function based on the inputs supplied to generate the correct outputs, k_A and k_B .*
3. *The TTP applies a further function to each of the outputs before sending $(a, f_a(k_A))$ to Alice and $(a, g_a(k_B))$ to Bob.*

The additional function to be computed represents the output that would be generated by a protocol which is aborted after step a . The behaviour has been phrased above in order to emphasize that the output generated by early aborting gives no extra information and no other type of information than that generated by following the protocol honestly, in the sense that the correct final output can be used to simulate any of the intermediate ones.

When extending such definitions to quantum protocols, there are a number of additional considerations. The ideal behaviour in a quantum protocol may in many cases be weaker than its classical counterpart. This comes about because:

1. A real protocol cannot mimic a TTP that does measurements, since in the real implementation of a protocol, it is always possible to keep all measurements at the quantum level until the end. ⁴
2. A real protocol cannot perform classical certification of the inputs (i.e., cannot abort when a superposition is input instead of a single member of the computational basis) [59].

⁴Even though honest parties can be trusted to make measurements as the protocol progresses, it is equivalent when performing a security analysis to assume that they kept their measurements quantum until the end of the protocol, and hence we can restrict to protocols for which this is the case.

4.2 Security Definitions In Secure Multi-Party Computation

A classical protocol is able to circumvent such issues by implicitly making the (technological) assumption that all parties can only manipulate classical data.

Consider the following ideal behaviour for a quantum protocol implementing a computation:

Ideal Behaviour 5.

1. Both parties send their inputs to the TTP. If dishonest, the inputs may be quantum (i.e., superpositions) rather than members of an orthogonal basis.
2. The TTP does a unitary operation on the inputs. For example, in a two-sided deterministic computation the unitary might be defined by $U_f |i\rangle |j\rangle |0\rangle |0\rangle = |i\rangle |j\rangle |k\rangle |k\rangle$, where f indexes the function being computed, i is Alice's input, j is Bob's input and $k = f(i, j)$ is the corresponding output⁵.
3. The TTP returns the first and third Hilbert spaces to Alice, and the second and fourth ones to Bob.

This is in fact stronger than we can achieve because it does not allow for early abort. Following arguments we presented in the classical case, we should modify the steps to allow Alice to choose whether Bob gets his output, and make further modifications to account for early aborts, in the spirit of Ideal Behaviour 4.

Under Ideal Behaviour 5, cheating is restricted to making a dishonest input, and to making an alternative measurement on the output. We will show that such cheating is enough to break any reasonable requirements one might make for a large class of secure classical computations. Points 1 and 2 above ensure that one cannot weaken the ideal behaviour such that this attack fails. Hence quantum protocols for these classes of secure classical computation do not exist.

One special case is that of a one-input computation. In the two-party case, such a computation must be both random and two-sided (otherwise it is trivial). In Chapter 3, we conjectured that such computations (variable bias n -faced die rolls) are possible with unconditional security. Our definitions there were such that (if we ignore the supplementary tests, which asymptotically were not necessary for security) there are no useful ways to abort, and so the behaviour realized

⁵There are possible variants of the chosen unitary operation (see Section 4.2.2).

4.2 Security Definitions In Secure Multi-Party Computation

is that of Ideal Behaviour 2. (In Ideal Behaviour 2, either party can force the outcome to be abort by refusing to make an input to the TTP in the first place.)

Our protocols for variable bias n -faced die rolling were relativistic. Exploiting relativistic signalling constraints does not affect the type of behaviour realizable, in either quantum or classical protocols. Rather, using a relativistic protocol affects the range of computations possible within each model. For instance, we cannot mimic a TTP that performs coin tossing in a non-relativistic world, but can in a relativistic one. This is distinct from the types of behaviour in which we embed the TTP.

4.2.1 The Rôle Of The Simulator

Let us demonstrate the importance of the simulator for universally composable security definitions. For this we will use the task of extending coin tosses [57]. In such a task, Alice and Bob are given access to a finite source of coin tosses, guaranteed to be independent and uniformly distributed. Their goal is to exchange information and use this source in order to generate a shared random string longer than that which is available from the source alone.

The protocol takes place in a classical environment in which Alice and Bob are given access to the device supplying coin tosses. This device operates according to the following ideal.

Ideal Functionality 4.1.

1. *The TTP waits until it has been initialized by both parties, after which, it generates a random string, R .*
2. *If Alice is dishonest, she can choose when the TTP gives R to Bob, otherwise, the TTP does so immediately.*
3. *Similarly, if Bob is dishonest, he can choose when the TTP gives R to Alice, otherwise, the TTP does so immediately.*

The following classical non-relativistic protocol is employed to generate a shared random string longer than R , using a single call of the above ideal at the appropriate time.

4.2 Security Definitions In Secure Multi-Party Computation

Protocol 4.1.

1. Alice sends a random string, a , to Bob.
2. Bob receives Alice's string and sends a random string, b , to Alice. Strings a and b have the same length.
3. Alice and Bob supply initiation signals to a device (device 1) that supplies perfect coin tosses.
4. Device 1 supplies R to Alice and/or Bob in accordance with Ideal Functionality 4.1, i.e., depending on whether either party is dishonest.
5. Alice and Bob use R to perform privacy amplification on the concatenated string, (a, b) . This generates a final string, s , that is (virtually) uniform and independent of R , a and b . The final output of the protocol is the concatenation, (R, s) .

Security of this protocol is discussed in [57]. It relies on the fact that R is not known to Alice and Bob until after they have exchanged strings, and then follows from results on privacy amplification (see Section 1.4.2).

We will show that this protocol is not sufficient to realize a modification of Ideal Functionality 4.1, where R is replaced by (R, s) . This follows because there exists an interaction with a system in the environment that Bob can follow in the real protocol, but cannot implement in the ideal.

Consider an instance of the real protocol, and suppose Bob has access to an additional device (device 2) with which he interacts only once. He inputs a into this device and it returns b' to him, with b' being a function of a which he does not know. Bob sends b' to Alice in place of b , after which the protocol proceeds with both parties behaving honestly. If he follows this strategy, the final string s' is distributed uniformly, regardless of the function applied by the extra device. Given an implementation of the ideal protocol, which outputs s_I , it is easy for Bob to simulate a and b . However, if Bob simulates a , and then inputs this into device 2, the string b' he is returned will not necessarily be compatible with the string returned by the protocol (i.e. $(R, f_R(a, b'))$ may not equal s_I ⁶).

⁶More generally, the joint distributions over all variables are different in the two cases.

4.2 Security Definitions In Secure Multi-Party Computation

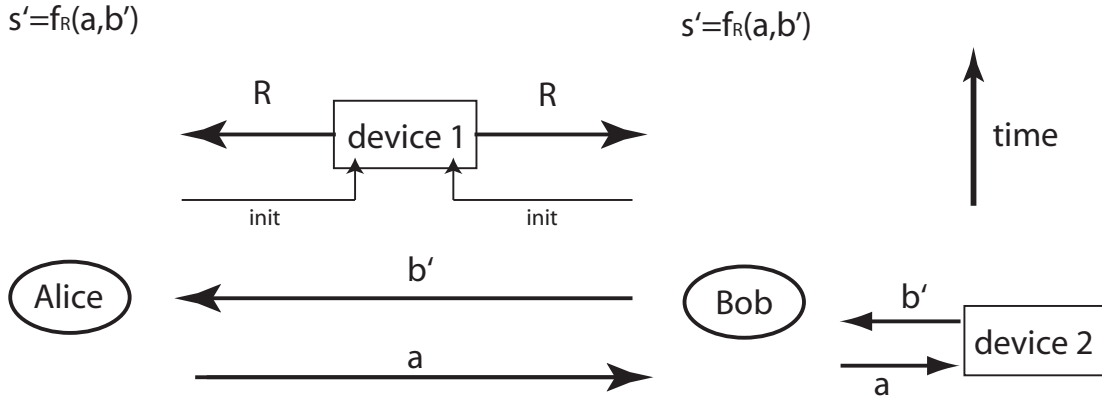

Figure 4.1: The sequence of exchanges between Alice and Bob in the protocol for extending coin tosses (Protocol 4.1), where Bob interacts with a second device to choose his string. Device 1 is the supplier of perfect coin tosses, in the form of string R . In the original form of the protocol, device 2 is not used, and Bob sends a random string, b , of his own choosing to Alice.

It is impossible to correctly simulate b' and hence the protocol does not satisfy universally composable security requirements. The entire procedure is shown in Figure 4.1.

While a cheating strategy of this kind is unlikely to present a problem in any future application, it is possible that more significant attacks exist. The universally composable security definition relieves us of such worries—if such a security definition is satisfied, then one can replace all instances of the protocol with the ideal without affecting security.

Unfortunately, it is rare that universally composable security can be realised. The type of attack given in this section is detrimental in many contexts. Protocols in which one party must respond to information received by the other are particularly vulnerable in this way. One exception is the case of a classical protocol to give a zero-knowledge proof for the graph non-isomorphism problem [60], which we discuss in Appendix B. The reason that this protocol escapes the aforementioned attack is that one party (the prover) always has the freedom to deterministically choose the output of the protocol.

Relativistic protocols can provide a way to avoid this type of attack. In a

4.2 Security Definitions In Secure Multi-Party Computation

non-relativistic situation in which one party can pass information they receive through an external device before responding, it may be possible to instead use a relativistic protocol in which the response is supplied by a distant agent of that party⁷. As an example, suppose we demanded that Step 2 of Protocol 4.1 occurs at spacelike separation to the point where Bob receives a (which can be done by having B_2 send it to A_2 in a relativistic protocol). The attack involving the second device cannot then be implemented in the real world and we do not need to provide a simulator for it in the ideal case.

4.2.2 Computational Model

We will use a black box model for secure computation. A black box is a hypothetical device that satisfies a certain set of ideal functionality requirements. It features an authentication system (e.g., an unalterable label) so that each party can be sure of the function it computes. We will give a security requirement, and show that even if black boxes satisfying Ideal Behaviour 5 were to exist, this requirement cannot, in general, be satisfied.

We now comment on the possible forms of unitary operation that could implement a particular computation. In a two-sided, non-deterministic computation, one seeks the functionality given by U_f , defined by

$$U_f |i\rangle_A |j\rangle_B |0\rangle |0\rangle = |i\rangle_A |j\rangle_B \sum_k \alpha_{i,j}^k |kk\rangle_{AB}. \quad (4.1)$$

In practice, a computation might generate additional states, and one should consider instead U'_f defined by

$$U'_f |i\rangle_A |j\rangle_B |0\rangle |0\rangle |0\rangle = |i\rangle_A |j\rangle_B \sum_k \alpha_{i,j}^k |kk\rangle_{AB} |\psi_{i,j}^k\rangle_{AB}, \quad (4.2)$$

where the final Hilbert space corresponds to an ancillary system the black box uses for the computation (and has arbitrary dimension). In the protocol mimicking such a box, this final state must be distributed between Alice and Bob in some

⁷This will only work for protocols in which the response is supposed to be independent of the received information.

4.2 Security Definitions In Secure Multi-Party Computation

way, such that the part that goes to Bob contains no information on Alice's input, and vice versa.

If this second unitary operation replaces that given in Ideal Behaviour 5, then again each party has two ways of cheating—inputting a superposition of honest states or using a different measurement on the output. We now show that under such attacks, insecurity of functions under U_f implies insecurity under U'_f , and hence we consider only the former.

Consider the case where Alice makes a superposed input, $\sum_i a_i |i\rangle$, rather than a single member of the computational basis. Then, at the end of the protocol, her reduced density matrix takes either the form

$$\sigma_j = \sum_{i,i',k} a_i a_{i'}^* \alpha_{i,j}^k (\alpha_{i',j}^k)^* |i\rangle\langle i'| \otimes |k\rangle\langle k|, \quad (4.3)$$

or

$$\sigma'_j = \sum_{i,i',k} a_i a_{i'}^* \alpha_{i,j}^k (\alpha_{i',j}^k)^* |i\rangle\langle i'| \otimes |k\rangle\langle k| \otimes \text{tr}_B |\psi_{i,j}^k\rangle\langle\psi_{i',j}^k|, \quad (4.4)$$

the first case applying to U_f , and the second to U'_f .

Alice is then to make a measurement on her state in order to distinguish between the different possible inputs Bob could have made, as best she could. We will show that there exists a trace-preserving quantum operation that Alice can use to convert σ'_j to σ_j for all j . Therefore Alice's ability to distinguish between $\{\sigma'_j\}_j$ is at least as good as her ability to distinguish between $\{\sigma_j\}_j$.

In order that the protocol functions correctly when both Alice and Bob are honest, we require $\text{tr}_B |\psi_{i,j}^k\rangle\langle\psi_{i,j}^k| \equiv \rho^{i,k}$ to be independent of j (otherwise Alice can gain more information on Bob's input than that implied by k by a suitable measurement on her part of this state). By expressing $\rho^{i,k}$ in its diagonal basis, $\rho^{i,k} = \sum_m \lambda_m^{i,k} U_A^{i,k} |m\rangle\langle m|_A (U_A^{i,k})^\dagger$, we have

$$|\psi_{i,j}^k\rangle = \sum_m \sqrt{\lambda_m^{i,k}} U_A^{i,k} |m\rangle_A \otimes U_B^{i,j,k} |m\rangle_B, \quad (4.5)$$

where $\{|m\rangle_A\}_m$ form an orthogonal basis set on Alice's system and likewise $\{|m\rangle_B\}_m$ is an orthogonal basis for Bob's system. Bob then holds

$$\text{tr}_A |\psi_{i,j}^k\rangle\langle\psi_{i,j}^k| = \sum_m \lambda_m^{i,k} U_B^{i,j,k} |m\rangle\langle m|_B (U_B^{i,j,k})^\dagger. \quad (4.6)$$

4.2 Security Definitions In Secure Multi-Party Computation

This must be independent of i , hence $\lambda_m^{i,k}$ and $U_B^{i,j,k}$ must be independent of i . Thus

$$|\psi_{i,j}^k\rangle = \sum_m \sqrt{\lambda_m^k} (U_A^{i,k} \otimes U_B^{j,k}) |m\rangle_A |m\rangle_B. \quad (4.7)$$

It hence follows that there is a unitary on Alice's system converting $|\psi_{i_1,j}^k\rangle$ to $|\psi_{i_2,j}^k\rangle$ for all i_1, i_2 , and that furthermore, this unitary is independent of j . Likewise, there is a unitary on Bob's system converting $|\psi_{i,j_1}^k\rangle$ to $|\psi_{i,j_2}^k\rangle$ for all j_1, j_2 , with this unitary being independent of i .

Returning now to the case where Alice makes a superposed input. The final state of the entire system can be written

$$\sum_{i,k} a_i \alpha_{i,j}^k |i\rangle_A |j\rangle_B |k\rangle_A |k\rangle_B (U_A^{i,k} |m\rangle_A) (U_B^{j,k} |m\rangle_B). \quad (4.8)$$

Alice can then apply the unitary

$$V = \sum_{i,k} |i\rangle\langle i|_A \otimes \mathbb{1}_B \otimes |k\rangle\langle k|_A \otimes \mathbb{1}_B \otimes (U_A^{i,k})^\dagger \otimes \mathbb{1}_B \quad (4.9)$$

to her systems leaving the state as

$$\sum_{i,k} a_i \alpha_{i,j}^k |i\rangle_A |j\rangle_B |k\rangle_A |k\rangle_B \sum_m \sqrt{\lambda_m^k} |m\rangle_A (U_B^{j,k} |m\rangle_B). \quad (4.10)$$

Alice is thus in possession of density matrix

$$\sum_{i,i',k} a_i a_{i'}^* \alpha_{i,j}^k (\alpha_{i',j}^k)^* |i\rangle\langle i'| \otimes |k\rangle\langle k| \otimes \rho_A^k, \quad (4.11)$$

where $\rho_A^k = \sum_m \lambda_m^k |m\rangle\langle m|_A$. Hence, on tracing out the final system, we are left with σ_j as defined by (4.3).

We have hence shown that there is a (j -independent) trace-preserving quantum operation Alice can perform which converts σ_j' to σ_j for all j . Hence Alice's ability to distinguish between Bob's inputs after computations of the type U_f' is at least as good as her ability to distinguish Bob's inputs after computations of the type U_f , and so, under the type of attack we consider, insecurity of computations specified by U_f implies insecurity of those specified by U_f' . We will therefore consider only type U_f in our analysis. An analogous argument follows

for the one-sided case, and likewise for the deterministic cases (which are special cases of the non-deterministic ones).

In this chapter we will show that the following security condition can be broken for a large class of computation.

Security Condition. Consider the case where Bob is honest. A secure computation is one for which there is no input, together with a measurement on the corresponding output that gives Alice a better probability of guessing Bob's input than she would have gained by following the protocol honestly and making her most informative input. This condition must hold for all forms of prior information Alice holds on Bob's input.

4.3 Deterministic Functions

We first focus on the deterministic case⁸. Lo showed that two-input deterministic one-sided computations are impossible to compute securely [50], hence only two-sided deterministic functions remain⁹. Suppose now that the outcome of such a protocol leads to some real-world consequence. In the dating problem [61], for example, one requires a secure computation of $k = i \times j$, where $i, j \in \{0, 1\}$. If the computation returns $k = 1$, then the protocol dictates that Alice and Bob go on a date. This additional real-world consequence is impossible to enforce, although naturally, both Alice and Bob have some incentive not to stand the other up, since this results in a loss of the other's trust. A cost function could be introduced to quantify this. Because suitable cost assignments must be assessed case by case, it is difficult to develop general results. To eliminate such an issue, we restrict to the case where the sole purpose of the computation is to learn something about the input of the other party. No subsequent action of either party based on this information will be specified.

We say that a function is *potentially concealing* if there is no input by Alice which will reveal Bob's input with certainty, and vice-versa. If the aim of the

⁸We refer the reader to Section 3.2 for descriptions of the various types of function we consider.

⁹Lo did not consider relativistic cryptography, but his results apply to this case as well (see the discussion in Section 3.2).

4.3 Deterministic Functions

computation is only to learn something about the input of the other party, and if Bob's data is truly private, he will not enter a secure computation with Alice if she can learn his input with certainty. We hence only consider potentially concealing functions in what follows. In addition, we will ignore *degenerate* functions in which two different inputs are indistinguishable in terms of the outcomes they afford. If the sole purpose of the computation is to learn something about the other party's input, then, rather than compute a degenerate function, Alice and Bob could instead compute the simpler function formed by combining the degenerate inputs of the original.

An alternative way of thinking about such functions is that they correspond to those in which there is cost for ignoring the real world consequence implied by the computation. At the other extreme, one could invoke the presence of an enforcer who would compel each party to go ahead with the computation's specified action. This would have no effect on security for a given function (a cheating attack that works without an enforcer also works with one) but introduces a larger set of functions that one might wish to compute. There exist functions within this larger set for which the attack we present does not work.

We specify functions by giving a matrix of outcomes. For convenience, the outputs of the function are labelled with consecutive integers starting with 0. We consider functions that satisfy the following conditions:

1. (Potentially concealing requirement) Each row and each column must contain at least two elements that are the same.
2. (Non degeneracy requirement) No two rows or columns should be the same.

For instance, if $i, j \in \{0, 1, 2\}$ (which we term a 3×3 function), the function $f(i, j) = 1 - \delta_{ij}$ is represented by

$f(i, j)$		i		
		0	1	2
	j	0	1	1
		1	0	1
		2	1	1
			0	0

This function is potentially concealing, and non-degenerate.

We consider the case of 3×3 functions. We first give a non-constructive proof that Alice can always cheat, and then an explicit cheating strategy.

Let us assume that we have a black box that can implement the protocol, i.e., one that performs the following operation:

$$U_f |i\rangle_A |j\rangle_B |0\rangle |0\rangle = |i\rangle_A |j\rangle_B |f(i, j)\rangle_A |f(i, j)\rangle_B. \quad (4.12)$$

The states $\{|i\rangle_A\}$ are mutually orthogonal, as are the members of the sets $\{|j\rangle_B\}$, $\{|f(i, j)\rangle_A\}$ and $\{|f(i, j)\rangle_B\}$. This ensures that Alice and Bob always obtain the correct output if both have been honest. The existence of such a black box would allow Alice to cheat in the following way. She can first input a superposition, $\sum_{i=0}^2 a_i |i\rangle_A$ in place of $|i\rangle_A$. Her output from the box is one of ρ_0, ρ_1, ρ_2 , the subscript corresponding to Bob's input, j , where (using the shorthand $\text{tr}_B(|\Psi\rangle) \equiv \text{tr}_B(|\Psi\rangle\langle\Psi|)$)

$$\rho_j \equiv \text{tr}_B \left(U_f \sum_{i=0}^2 a_i |i\rangle_A |j\rangle_B |0\rangle_A |0\rangle_B \right). \quad (4.13)$$

Alice can then attempt to distinguish between these using any measurement of her choice.

The main result of this section is the following theorem.

Theorem 4.1. *Consider the computation of a 3×3 deterministic function satisfying conditions 1 and 2. For each function of this type, there exists a set of co-efficients, $\{a_i\}$, such that when Alice inputs $\sum_{i=0}^2 a_i |i\rangle_A$ into the protocol, there exists a measurement that gives her a better probability of distinguishing the three possible (j dependent) output states than that given by her best honest strategy.*

Proof. We will rely on the following lemma.

Lemma 4.1. *All 3×3 functions satisfying conditions 1 and 2 can be put in the form of the function in Table 4.1.*

Proof. The essential properties of any function are unchanged under permutations of rows or columns (which correspond to relabelling of inputs), and under relabelling of outputs. In order that the function is potentially concealing, there

4.3 Deterministic Functions

$f(i, j)$		i		
		0	1	2
j	0	0	a	.
	1	0	b	.
	2	1	b	.

Table 4.1: This function can be taken as the most general 3×3 function satisfying conditions 1 and 2, where $a \neq b$, and $a = 0$ or $b = 0$ or $b = 1$. The dots represent unspecified (and not necessarily identical) entries consistent with the conditions.

can be at most one column whose elements are identical. By relabelling the columns if necessary, we can ensure that this corresponds to $i = 2$. Relabelling the outputs and rows, if necessary, the column corresponding to $i = 0$ has entries $(f(0, 0), f(0, 1), f(0, 2)) = (0, 0, 1)$. The column corresponding to $i = 1$ then must have entries (a, a, b) or (a, b, b) , with $a \neq b$. In the case (a, a, b) , the $i = 2$ column must have the form (c, d, d) , for $c \neq d$, in which case we can permute the $i = 1$ and $i = 2$ columns to recover the form (a, b, b) for the $i = 1$ column. Relabellings always put such cases into forms with $a = 0$ or $b = 0$ or $b = 1$. \mathcal{QED}

Suppose Alice inputs $\frac{1}{\sqrt{2}}(|0\rangle + |1\rangle)$ into a function of the form given in Table 4.1. After tracing out Bob's systems, Alice holds one of

$$\rho_0 = \frac{1}{2} (|00\rangle\langle 00| + \delta_{a,0} (|00\rangle\langle 10| + |10\rangle\langle 00|) + |1a\rangle\langle 1a|) \quad (4.14)$$

$$\rho_1 = \frac{1}{2} (|00\rangle\langle 00| + \delta_{b,0} (|00\rangle\langle 10| + |10\rangle\langle 00|) + |1b\rangle\langle 1b|) \quad (4.15)$$

$$\rho_2 = \frac{1}{2} (|01\rangle\langle 01| + \delta_{b,1} (|01\rangle\langle 11| + |11\rangle\langle 01|) + |1b\rangle\langle 1b|). \quad (4.16)$$

Measurement using the set $\{E_{i,k} = |ik\rangle\langle ik|\}$ in effect reverts to an honest strategy. The probability of correctly guessing Bob's input using this set is the same as that for Alice's best honest strategy. These operators can be combined to form just three operators, $\{E_{j'}\}$ such that a result corresponding to $E_{j'}$ means that

Alice's best guess of Bob's input is j' . Then

$$E_0 = \alpha_1|00\rangle\langle 00| + \delta_{a,0}|10\rangle\langle 10| + \delta_{a,1}|11\rangle\langle 11| + \delta_{a,2}|12\rangle\langle 12| + \delta_{a,3}|13\rangle\langle 13| \quad (4.17)$$

$$E_1 = (1 - \alpha_1)|00\rangle\langle 00| + \alpha_2\delta_{b,0}|10\rangle\langle 10| + \alpha_3\delta_{b,1}|11\rangle\langle 11| + \alpha_4\delta_{b,2}|12\rangle\langle 12| + \alpha_5\delta_{b,3}|13\rangle\langle 13| \quad (4.18)$$

$$E_2 = \mathbb{1} - E_0 - E_1, \quad (4.19)$$

where the $\{\alpha_l\}$ are arbitrary parameters, $0 \leq \alpha_l \leq 1$, and do not affect the success probability. We will show that such a measurement is not optimal to distinguish between the corresponding $\{\rho_j\}$. This follows from Theorem 1.1.

Equations (1.2) and (1.3) imply respectively,

$$\begin{aligned} &(\alpha_1 = 0 \text{ or } \alpha_2 = 0 \text{ or } b \neq 0) \quad \text{and} \quad (\alpha_1 = 1 \text{ or } a \neq 0) \quad \text{and} \\ &(\alpha_1 = 1 \text{ or } \alpha_2 = 1 \text{ or } b \neq 0) \quad \text{and} \quad (\alpha_3 = 0 \text{ or } b \neq 1), \end{aligned} \quad (4.20)$$

and,

$$\begin{aligned} &(\alpha_1 = 0 \text{ or } (b \neq 0 \text{ and } a \neq 0)) \quad \text{and} \quad (b = 1 \text{ or } \alpha_3 \geq \tfrac{1}{4}) \quad \text{and} \\ &(a = 1 \text{ or } \alpha_3 = 1 \text{ or } b \neq 1) \quad \text{and} \quad (b = 0 \text{ or } \alpha_2(1 - \alpha_1) \geq \tfrac{1}{4}) \quad \text{and} \\ &(\alpha_1 = 1 \text{ or } b \neq 0 \text{ or } \alpha_2 = 0). \end{aligned} \quad (4.21)$$

In addition, because the function is in the form given in Table 4.1, we also have

$$(a = 0 \text{ or } b = 0 \text{ or } b = 1) \quad \text{and} \quad a \neq b. \quad (4.22)$$

The system of equations (4.20–4.22) cannot be satisfied for any values of $a, b, \{\alpha_k\}$. Hence, the measurement operators (4.17–4.19) are not optimal for discriminating between Bob's inputs, so Alice always has a cheating strategy. \mathcal{QED}

Our proof of Theorem 4.1 is non-constructive—we have shown that cheating is possible, but not explicitly how it can be done. Except in special cases (e.g., where the states $\{\rho_j\}$ are symmetric), no procedure for finding the optimal POVM to distinguish between states is known [5, 6]. Nevertheless, we have found a construction based on the square root measurement [8, 9] that, while not being optimal, gives a higher probability of successfully guessing Bob's input than any honest strategy.

$p(0 i, j)$		i	
		0	1
j	0	p_{00}	p_{10}
	1	p_{01}	p_{11}

Table 4.2: The entries in the table give the probabilities of output 0 given inputs i, j . For example, if both parties input 0, then the output of the function is 0 with probability p_{00} , and 1 with probability $1 - p_{00}$.

The strategy applies to the states, σ_j , formed when Alice inputs the state $\frac{1}{\sqrt{3}}(|0\rangle + |1\rangle + |2\rangle)$ into the computation. The set of operators are those corresponding to the square root measurement, defined by

$$E_{j'} = \left(\sum_j \sigma_j \right)^{-\frac{1}{2}} \sigma_{j'} \left(\sum_j \sigma_j \right)^{-\frac{1}{2}}. \quad (4.23)$$

One can verify, case by case, that this strategy affords Alice a better guessing probability over Bob's input than any honest one for all functions of the form of Table 4.1. The Mathematica script which we have used to confirm this is available on the world wide web [62].

4.4 Non-Deterministic Functions

4.4.1 Two-Sided Case

Initially, we specialize to the case $i, j, k \in \{0, 1\}$. We specify such functions via a matrix of probabilities whose meaning is given in Table 4.2. For the two-sided case, the relevant black box implements the unitary, U , given by

$$U |i\rangle_A |j\rangle_B |0\rangle |0\rangle = |i\rangle_A |j\rangle_B (\sqrt{p_{ij}} |00\rangle_{AB} + \sqrt{1 - p_{ij}} |11\rangle_{AB}). \quad (4.24)$$

Suppose that Alice has prior information about Bob's input such that, from her perspective, he will input 0 with probability η_0 , and 1 with probability $\eta_1 = 1 - \eta_0$. The probability of correctly guessing Bob's input using the best honest strategy is

$$p_h = \max_i \left(\max_j (p_{ij} \eta_j) + \max_j ((1 - p_{ij}) \eta_j) \right). \quad (4.25)$$

Denote Alice's final state by ρ_j , where j is Bob's input. The optimal strategy to distinguish ρ_0 and ρ_1 is successful with probability

$$p_c = \frac{1}{2} (1 + \text{tr} |\eta_0 \rho_0 - \eta_1 \rho_1|) \quad (4.26)$$

(cf. Theorem 1.1).

Theorem 4.2. *Let Alice input $\frac{1}{\sqrt{2}}(|0\rangle + |1\rangle)$ and Bob input j into the computation given in (4.24). Let Alice implement the optimal measurement to distinguish the corresponding ρ_0 and ρ_1 and call the probability of a correct guess using this measurement p_c . Then, for all $\{p_{00}, p_{01}, p_{10}, p_{11}\}$, there exists a value of η_0 such that $p_c > p_h$, unless,*

1. $p_{00} = p_{10}$ and $p_{01} = p_{11}$, or
2. $p_{00} = p_{01}$ and $p_{10} = p_{11}$.

The two exceptional cases correspond to functions for which only one party can make a meaningful input. We hence conclude that all genuinely two-input functions of this type are impossible to compute securely.

Proof. Take $\eta_0 = 1 - \epsilon$. For sufficiently small $\epsilon > 0$, (4.25) implies $p_h = \eta_0$. We then seek p_c . The eigenvalues of $\eta_0 \rho_0 - \eta_1 \rho_1$ are

$$\lambda_{\pm} = \frac{1}{4} \left(a(\{p_{i,j}\}) \pm \sqrt{a^2(\{p_{i,j}\}) + b(\{p_{i,j}\})} \right) \quad (4.27)$$

$$\mu_{\pm} = \frac{1}{4} \left(a(\{\overline{p}_{i,j}\}) \pm \sqrt{a^2(\{\overline{p}_{i,j}\}) + b(\{\overline{p}_{i,j}\})} \right), \quad (4.28)$$

where $a(\{p_{i,j}\}) = (p_{00} + p_{10})\eta_0 - (p_{01} + p_{11})\eta_1$, $b(\{p_{i,j}\}) = 4(\sqrt{p_{01}p_{10}} - \sqrt{p_{00}p_{11}})^2 \eta_0 \eta_1$, and $\overline{p}_{ij} \equiv 1 - p_{ij}$.

For ϵ sufficiently small, we have $a \gg b > 0$. Using $\sqrt{1+x} \leq 1 + \frac{x}{2}$, we find, $\lambda_+ \geq \frac{1}{4}(2a(\{p_{i,j}\}) + \frac{b(\{p_{i,j}\})}{2a(\{p_{i,j}\})})$, $\lambda_- \leq -\frac{b(\{p_{i,j}\})}{8a(\{p_{i,j}\})}$, $\mu_+ \geq \frac{1}{4}(2a(\{\overline{p}_{i,j}\}) + \frac{b(\{\overline{p}_{i,j}\})}{2a(\{\overline{p}_{i,j}\})})$, and $\mu_- \leq -\frac{b(\{\overline{p}_{i,j}\})}{8a(\{\overline{p}_{i,j}\})}$, with equality iff $b(\{p_{i,j}\}) = 0$ and $b(\{\overline{p}_{i,j}\}) = 0$. We hence have $\frac{1}{2}(1 + \text{tr} |\eta_0 \rho_0 - \eta_1 \rho_1|) \geq \eta_0$ and so $p_c \geq p_h$, with equality iff $p_{00} = p_{10}$ and $p_{01} = p_{11}$, or $p_{00} = p_{01}$ and $p_{10} = p_{11}$. QED

The explicit construction for the optimal cheating measurement is given in Appendix A.

4.4.2 One-Sided Case

For one-sided computations of non-deterministic functions, Alice can cheat without inputting a superposed state. In this case, the black box performs the unitary

$$U |i\rangle_A |j\rangle_B |0\rangle = |i\rangle_A |j\rangle_B (\sqrt{p_{ij}} |0\rangle_A + \sqrt{1-p_{ij}} |1\rangle_A), \quad (4.29)$$

where the last qubit goes to Alice at the end of the protocol. The following theorem shows that such computations cannot be securely implemented.

Theorem 4.3. *Having made an honest input to the black box above, Alice's optimum procedure to correctly guess Bob's input is not given by a measurement in the $\{|0\rangle, |1\rangle\}$ basis, except if $\{p_{ij}\}_{ij} \in \{0, 1\}$ for all i, j .*

Proof. From (1.2) of Theorem 1.1, if Alice inputs $i = 1$, the measurement operators $\{|0\rangle\langle 0|, |1\rangle\langle 1|\}$ are optimal only if

$$\eta_0 \sqrt{p_{10}(1-p_{10})} = (1-\eta_0) \sqrt{p_{11}(1-p_{11})}. \quad (4.30)$$

For this to hold for all η_0 , we require that either $p_{11} = 0$ or $p_{11} = 1$, and either $p_{10} = 0$ or $p_{10} = 1$. Similarly, if Alice inputs $i = 0$, we require either $p_{01} = 0$ or $p_{01} = 1$, and either $p_{00} = 0$ or $p_{00} = 1$, in order that the specified measurement operators are optimal. QED

These exceptions correspond to functions that are deterministic, so do not properly fall into the class presently being discussed. Many are essentially single-input, hence trivial, and all such exceptions are either degenerate or not potentially concealing (see Section 4.3).

Our theorem also has the following consequence.

Corollary 4.1. *One-sided variable bias coin tossing (see Chapter 3) is impossible.*

Proof. A one-sided variable bias coin toss is the special case where both $p_{00} = p_{10}$ and $p_{01} = p_{11}$. These cases are not exceptions of Theorem 4.3, and hence are impossible. QED

$p(k i)$		i	
		0	1
k	0	$\frac{1}{2}$	0
	1	0	$\frac{1}{2}$
	?	$\frac{1}{2}$	$\frac{1}{2}$

Table 4.3: Probability table for oblivious transfer.

4.4.3 Example: The Impossibility Of OT

Here we show explicitly how to attack a black box that performs OT when used honestly. This is a second proof of its impossibility in a stand-alone manner (the first being Rudolph's [29]).¹⁰

The probability table for this task is given in Table 4.3.

In an honest implementation of OT, Bob is able to guess Alice's input with probability $\frac{3}{4}$. However, the final states after using the ideal black box are of the form $|\psi_b\rangle = \frac{1}{\sqrt{2}}(|b\rangle + |?\rangle)$, where $|0\rangle$, $|1\rangle$ and $|?\rangle$ are mutually orthogonal. These are optimally distinguished using the POVM $(E_0, \mathbb{1} - E_0)$, where

$$E_0 = \frac{1}{6} \begin{pmatrix} 2 + \sqrt{3} & -1 & 1 + \sqrt{3} \\ -1 & 2 - \sqrt{3} & 1 - \sqrt{3} \\ 1 + \sqrt{3} & 1 - \sqrt{3} & 2 \end{pmatrix}. \quad (4.31)$$

This POVM allows Bob to guess Alice's bit with probability $\frac{1}{2} \left(1 + \frac{\sqrt{3}}{2}\right)$, which is significantly greater than $\frac{3}{4}$.

4.5 Discussion

We have introduced a black box model of computation, and have given a necessary condition for security. Even if such black boxes were to exist as prescribed by the model, one party can always break the security condition. Specifically, by inputting a superposed state rather than a classical one, and performing an

¹⁰Impossibility had previously been argued on the grounds that OT implies BC and hence is impossible because BC is. However, while this argument rules out the possibility of a composable OT protocol, a stand-alone one is not excluded.

appropriate measurement on the outcome state, one party can always gain more information on the input of the other than that gained using an honest strategy. In the case of deterministic functions, this attack has only been shown to work if the function is non-degenerate and potentially concealing. In the case where the sole purpose of the function is to learn something about the other party's input, this class of function is the most natural to consider.

Our theorems deal only with the simplest cases of the relevant functions. However, the results can be extended to more general functions as described below.

Larger input alphabets: A deterministic function is impossible to compute securely if it possesses a 3×3 submatrix which is potentially concealing and satisfies the degeneracy requirement. This follows because Alice's prior might be such that she can reduce Bob to three possible values of j . This argument does not rule out the possibility of all larger functions, since some exist that are potentially concealing without possessing a potentially concealing 3×3 subfunction. Nevertheless, we conjecture that all potentially concealing functions have a cheating attack which involves inputting a superposition and then optimally measuring the outcome.

In the non-deterministic case, all functions with more possibilities for i and j values possess 2×2 submatrices that are ruled out by the attacks presented, or reduce to functions that are one-input. Therefore, no two-party non-deterministic computations can satisfy our security condition.

Larger output alphabets: In the non-deterministic case, we considered only binary outputs. We conjecture that the attacks we have presented work more generally on functions with a larger range of possible outputs.

We have not proven that the aforementioned attacks work for any function within the classes analysed, although we conjecture this to be the case. Furthermore, for any given computation, one can use the methods presented in this chapter to verify its vulnerability under such attacks.

Our results imply that there is no way to define an ideal suitable to realise secure classical computations in a quantum relativistic framework. Hence, without making additional assumptions, or invoking the presence of a trusted third party,

secure classical computation is impossible to realise using the usual notions of security. The quantum relativistic world, while offering more cryptographic power than the classical world, as exemplified in Chapter 2, still does not permit a range of computational tasks. Table 4.4 summarizes the known results for unconditionally secure two-party computation.

One reasonable form of additional assumption is that the storage power of an adversary is bounded. The so-called bounded storage model has been used in both classical and quantum settings. This model evades our no-go results because limiting the quantum storage power of an adversary forces them to make measurements. This collapses our unitary model of computation. In the classical bounded storage model, the adversary's memory size can be at most quadratic in the memory size of the honest parties in order to form secure protocols [63, 64]. However, if quantum protocols are considered, and an adversary's quantum memory is limited, a much wider separation is possible. Protocols exist for which the honest participants need no quantum memory, while the adversary needs to store half of the qubits transmitted in the protocol in order to cheat [65].

In the recent literature, there have been investigations into the cryptographic power afforded by theories that go beyond quantum mechanics. Such theories are often constrained to be non-signalling. Popescu and Rohrlich investigated violations of the CHSH inequality (see Section 1.3.3) in non-signalling theories [66]. Such theories are able to obtain the maximum algebraic value of the CHSH quantity, 4. The hypothetical device that achieves such a violation has subsequently been called a non-local box. Devices of this kind would allow substantial reductions in the communication complexity of distributed computing tasks [67] and have been shown to allow any two-party secure computation [68]. One might conclude that there is a further gap in cryptographic power between non-signalling theories and quantum ones. However, we argue that this is not justified for two reasons. Firstly, in non-local box cryptography, one gives such boxes for free to parties which need them. Secondly, no procedure for doing joint, or even alternative single measurements is prescribed to a non-local box setting. To make a fair comparison between non-local box cryptography and standard quantum cryptography, one should consider a quantum scenario in which separated parties are given shared singlets for free, and also constrain them to make one of two

Type of computation		Securely Implementable	Comment
Zero-input	Deterministic	✓	Trivial
	Random one-sided	✓	Trivial
	Random two-sided	✓	Biased n -faced die roll
One-input	Deterministic	✓	Trivial
	Random one-sided	✗*	One-sided variable bias n -faced die roll
	Random two-sided	✓*	Variable bias n -faced die roll
Two-input	Deterministic one-sided	✗	cf. Lo
	Deterministic two-sided	✗*	this chapter
	Random one-sided	✗*	this chapter
	Random two-sided	✗*	this chapter

Table 4.4: Functions computable securely in two-party computations using (potentially) both quantum and relativistic protocols, when unconditional security is sought. ✓ indicates that all functions of this type are possible, ✗ indicates that all functions of this type are impossible, ✓* indicates that a wide range of functions of this type are possible and conjectures made in Chapter 3 imply that all functions of this type are possible, and ✗* indicates that a wide range of functions of this type are impossible and conjectures made in this Chapter imply that all functions of this type are impossible. This is the version of Table 3.1 updated in light of our work.

measurements on each state they hold. Alternatively, one could find a new theory in which non-local boxes emerge as features. In the absence of such a theory, one should be cautious about making comparisons.

Recently, it has been shown that any non-signalling box whose correlations are non-separable is sufficient for bit commitment [69]. This includes the case where the correlations are quantum, or indeed weaker. Since quantum (non-relativistic) bit commitment is impossible, even given access to shared EPR pairs, the additional cryptographic power cannot be attributed to the presence of correlations above those that are possible using quantum mechanics alone. It remains an open question whether the same is true for OT.

We further remark that the cheating strategy we present for the non-deterministic case does not work for all assignments of Alice's prior over Bob's inputs—there exist functions and values of the prior for which it is impossible to cheat using the attack we have presented. This continues to be the case when we allow Alice to choose any input state, including ones entangled with some space that she keeps). As a concrete example, consider the set $(p_{00}, p_{01}, p_{10}, p_{11}) = (\frac{47}{150}, \frac{103}{150}, \frac{8}{9}, \frac{5}{9})$, with $\eta_0 = \frac{1}{2}$ in the two sided version. Hence, in practice, there could be situations in which Bob would be happy to perform such a computation, for example, if he was sure Alice had no prior information over his inputs.

Chapter 5

Private Randomness Expansion Under Relaxed Cryptographic Assumptions

“The generation of random numbers is too important to be left to chance.” – Robert R. Coveyou

5.1 Introduction

As a casino owner, Alice has a vested interest in random number generation. Her slot machines use pseudo-random numbers which she is eager to do away with. Alice has a sound command of quantum physics, and realises a way to produce guaranteed randomness. However, running a casino is not easy, and Alice has neither the time nor resources to construct the necessary quantum machinery herself. Instead, her local merchant, the shady Dr Snoop, offers to supply the necessary parts. Naturally Alice is suspicious, and would like some way of ensuring that Snoop’s equipment really is providing her with a source of private random bits.

Random numbers are important in a wide range of applications. In some, for example statistical sampling or computer simulations, pseudo-randomness may be sufficient. Pseudo-random sources satisfy many tests for randomness, but are

in fact deterministically generated from a much shorter seed. In applications such as gambling or cryptography, this may be detrimental. Since quantum measurements are the only physical processes we know of that are random, it is natural to construct random number generators based on these. Devices which generate randomness through quantum measurement have recently hit the marketplace, but what guarantee does the consumer have that these perform as claimed? In this chapter, we investigate protocols that guarantee private random number generation even when all the devices used in the process come from an untrusted source. This corresponds to relaxing Assumption 4 (see Section 1.6), that each party has complete knowledge of the operation of the devices they use to implement a protocol. We use the task of expanding a random string, that is, using a given random string in some procedure in order to generate a longer one¹, to illustrate that some cryptographic tasks are possible even when this assumption is dropped.

Expansion of randomness comes in two flavours. In the weakest form, one simply wants to guarantee that the lengthened string really is random and could not have been influenced by any outside source. If one also requires that no information on the lengthened string be accessible to another party, then a stronger protocol is needed. The latter task, we refer to as *private* randomness expansion, and is clearly sufficient for the former². The possession of guaranteed randomness is useful in many contexts. In a gambling scenario, for instance, several players may learn the outcome of a random event (e.g., the spin of a roulette wheel) but would be at a great advantage if they could influence it. The BB84 QKD scheme on the other hand requires a private random string to choose the bases to use. Private randomness expansion will be the focus of this chapter.

We give a protocol that uses an initial private random string, together with devices supplied by an adversary, to expand this initial string. Our protocol is such that any specified amount of additional randomness can be generated using

¹Note that this task involves only one party trying to expand a random string in contrast to the task of extending coin tosses discussed in Section 4.2.1, where both Alice and Bob must generate the same shared expansion.

²A string formed by measuring individual halves of singlets in some fixed basis is random, but not secret, since the holder of the other half can discover the random data.

a sufficiently long initial string. Further, we give a second protocol which allows a (sufficiently long) initial string to be expanded by any amount. The length of initial string required depends on the desired tolerance for successful cheating by Snoop. This second protocol has the undesirable feature of requiring a large set of sites that cannot communicate with one another. Our protocols are not optimized for efficiency, and at present do not have full security proofs.

5.1.1 The Setting

Let us now iterate the practical significance of dropping Assumption 4. Randomness expansion is a single party protocol. We assume that all quantum devices that the user, Alice, will use to perform the protocol were sourced by Snoop³. Snoop will supply devices that he claims function exactly as Alice prescribes⁴. The devices cannot send communications outside of Alice's lab unless she allows them to (cf. Assumption 1), and Alice can, if necessary, prevent them from communicating with each another.

To become confident that the devices have not been tampered with, Alice will perform some test on them. In keeping with Kerckhoff's principle [70], we assume that Snoop knows completely the details of such tests. If all of Alice's devices come from Snoop, there is an immediate no-go result. We idealize Alice's procedure for testing the devices as a sequence of operations generating a member of a set of possible outcomes. Certain outcomes result in her rejecting the devices, while others lead to their acceptance.

Theorem 5.1. *If Alice follows a deterministic procedure, and sources all of her devices from Snoop, then she cannot distinguish the case where Snoop's devices implement the procedure as intended from the case where his devices make pre-determined classical outputs.*

Proof. There exists a set of classical data that Alice will accept as a passing of her test. Snoop need simply provide devices that output this set of data as required by Alice's procedure. QED

³Since Alice herself is a classical information processing device, it is unreasonable to ask that Snoop created all classical devices.

⁴We assume that Snoop can construct any device consistent with the laws of physics, and that Alice does not ask for impossible devices.

To circumvent this no-go result, we give Alice an initial private random string. By using this string, she can ensure that Snoop does not know every detail of her test procedure. As we shall see, this string is enough to constrain Snoop such that Alice can generate random bits. Since she needs an initial source of bits, this task is randomness expansion.

5.1.2 Using Non-Local Correlations

We have shown that without the use of an initial random string, Alice cannot perform randomness expansion. However, it is also the case that without exploiting the non-local features of quantum mechanics, she cannot either. This is a corollary to the following theorem.

Theorem 5.2. *If Alice sources all of her devices from Snoop and follows a local procedure, then she cannot distinguish the case where Snoop's devices implement the procedure as intended from the case where his devices make classically generated outputs⁵.*

Proof. If all the processes occur locally, we can reduce any setup to the following. Snoop supplies a device into which Alice inputs her random string, before it produces an output. Snoop's cheating strategy in this case is simply to program his device with a correct output for each of Alice's possible inputs. QED

It then follows that since Snoop's devices can offer a one-to-one correspondence between Alice's input and their output, the amount of private randomness in Alice's possession remains constant.

Alice's tests need to exploit non-local effects in order to be of use. To see that these evade the no-go results above, consider two spatially separated devices, both inside Alice's laboratory. Alice inputs part of her random string into each device, and demands that the devices produce fast outcomes (i.e., within the light travel time between the two devices). Thus, the second device must follow a procedure that is independent of the random string input to the first, and vice-versa. If Alice is to test for non-classical correlations between the outcomes, then Snoop's

⁵A classically generated output is one formed from the input without use of quantum states or measurements.

potential to cheat is constrained. States which produce non-classical correlations possess some intrinsic randomness, and so, by verifying that Snoop's devices are producing such states, Alice can be sure that she derives genuine randomness from them.

The non-local nature of quantum mechanics is often exemplified using the CHSH test, as described in Section 1.3.3. However, the CHSH test is not well suited for our purposes because it is based on statistics generated over lots of runs. In a finite run, it is impossible to say for certain whether the value achieved was due to malicious behaviour or simply bad luck. Such a property is an inconvenience, but not fatal since, by increasing the number of runs, we can ensure that the probability of Snoop passing the test if he has deviated from it is arbitrarily small. The GHZ test, discussed below, has a much neater failure detection than this.

Consider instead the following test, which we call a GHZ test [71], after its inventors Greenberger, Horne and Zeilinger. Alice asks for three devices, each of which has two settings (which we label P and Q following Section 1.3.3) and can output either 1 or -1 . Alice is to consider the four quantities $P_1P_2P_3$, $P_1Q_2Q_3$, $Q_1P_2Q_3$ and $Q_1Q_2P_3$. She demands that the first of these is always -1 , while the remaining three are $+1$. That these cannot be satisfied by a classical assignment can be seen as follows. Consider the product of the four quantities, which according to Alice's demands must be -1 . However, the algebraic expression is $P_1^2P_2^2P_3^2Q_1^2Q_2^2Q_3^2$, which for a classical assignment must be positive. This is a contradiction, and so no classical assignment exists. If, instead, the $\{P_i\}$ and $\{Q_i\}$ are formed by the outcomes of measurements acting on an entangled quantum state, then such demands can always be met. In Appendix C, we describe the complete set of operators and states that achieve this. In essence, all such operators behave like Pauli σ_x and σ_y operators and the state behaves like a GHZ state, that is, the state $\frac{1}{\sqrt{2}}(|000\rangle - |111\rangle)$, up to local unitary invariance.

The GHZ test does not rely on the statistical properties of several runs. Rather, the outcome of each run is specified. If any run contradicts the specified value, then one can be sure that the state and operators are not the ones claimed. This is highly useful cryptographically, as it allows Alice to be certain when she has detected interference. GHZ tests have a further advantage over CHSH in

that they offer a higher rate of increase in randomness (we discuss this further in Section 5.3.1).

5.2 Private Randomness Expansion

5.2.1 The Privacy Of A Random String

Let us first consider the case where each party has classical information. Alice has string $x \in X$. Snoop has $z \in Z$, partially correlated with x , these strings having been drawn from a distribution P_{XZ} . Alice's string is private if $I(X : Z = z)$ is negligible, i.e., string X is essentially uniformly distributed from Snoop's point of view.

Now consider the case where Snoop's information on Alice's string is quantum. In general, it is not enough to demand that for any measurement Snoop performs, his resulting string z is such that $I(X : Z = z)$ is negligible. Such a definition does not ensure that Alice's string can be used in *any* further application. The reason is that Snoop need not measure his system to form a classical string, but can instead keep hold of his quantum system. He may be then able to acquire knowledge which constitutes cheating in the further application (see also the discussion in Section 4.2). For example, as a result of parameters revealed in the further application, Snoop might be able to identify a suitable measurement on his original quantum system that renders the further application insecure. (See [21, 72, 73] for a further discussion, and an explicit example.) Thus, a key with the property that for all measurements by Snoop $I(X : Z = z)$ is negligible, cannot be treated in the same way as a private random key.

Instead, as discussed in Chapter 4, security definitions are defined with reference to the properties of a suitable ideal. In an ideal protocol, the final state is of the form $\frac{1}{|A_n|} \sum_{i \in A_n} |i\rangle\langle i| \otimes \rho_Z \equiv \sigma_I$, where ρ_Z is Snoop's final system and is independent of i , A_n represents the set of strings of length n , and $|A_n| = 2^n$ is the size of set A_n . In a real implementation, the final state has the form $\sum_{i \in A_n} P_I(i) |i\rangle\langle i| \otimes \rho_Z^i \equiv \sigma_R$. A useful security definition is that $D(\sigma_I, \sigma_R) \leq \epsilon$, which implies that the two situations can be distinguished with probability at most ϵ (see Section 1.3.2). Moreover, since the trace distance is non-increasing

5.2 Private Randomness Expansion

under quantum operations [4], this condition must persist when the string is used in any application, and hence the string satisfies a stand-alone security definition (see Section 4.2). Since the protocol is non-interactive, and takes place entirely within Alice’s laboratory, it is clear that universally composable security is also realized.

In many applications, the string produced may not satisfy a security requirement of this kind without first undergoing privacy amplification. In Section 1.4.2, we discussed privacy amplification in a three party scenario, in which Alice and Bob seek to generate a shared random string on which Eve’s information is negligible. Alice and Bob are required to communicate during the amplification stage, and thus leak information about the amplification to Eve. Private randomness expansion, on the other hand, is a two party game. No information need be leaked in amplification since there is no second honest party needing to perform the same procedure. For instance, if *universal*₂ hashing is used, the adversary never gains any knowledge about the hash function. The randomness used to choose it remains private and hence acts catalytically.

5.2.2 Definitions

Let us denote Alice’s initial private uniform random string by $x \in X$. This string has length n bits. Alice expands x , generating the additional string $s \in S$. A protocol for private randomness expansion using devices supplied by Snoop is ϵ -secure if, for any strategy followed by Snoop whereby he holds Hilbert space \mathcal{H}_Z , we have

$$D(\rho_{SZ}, \rho_{U_S} \otimes \rho_Z) \leq \epsilon, \tag{5.1}$$

where ρ_{U_S} denotes the maximally mixed state in \mathcal{H}_S .

A protocol for the weaker task of randomness expansion is ϵ -secure if

$$D(\rho_S, \rho_{U_S}) \leq \epsilon. \tag{5.2}$$

Then, no restriction is placed on how much information the state in \mathcal{H}_Z provides on S . For instance, it could be entangled in such a way that Snoop can always find S . What is important is that Snoop cannot influence S in any way, except with probability ϵ .

Like in previous chapters, using N_1, \dots, N_r as security parameters, we say that a protocol is secure if $\epsilon \rightarrow 0$ as the $N_i \rightarrow \infty$, and that a protocol is perfectly secure if $\epsilon = 0$ for some fixed finite values of the N_i .

5.2.3 Finite Expansion

We now give a protocol which allows a private random string to be expanded. Before undergoing the protocol, Alice asks Snoop for three devices, each of which has two settings (inputs), (P_i and Q_i for the i th device) and can make two possible outputs, $+1$ or -1 . These devices cannot communicate with agents outside of Alice's laboratory (cf. Assumption 1), nor with one another. Alice asks that whenever these devices are used to measure one of the four GHZ quantities ($P_1P_2P_3$, $P_1Q_2Q_3$, $Q_1P_2Q_3$ and $Q_1Q_2P_3$), they return the outcomes specified in Section 5.1.2 (i.e., -1 , $+1$, $+1$ and $+1$ respectively).⁶ We call these three devices taken together a device triple. Alice uses her device triple in the following procedure.

Protocol 5.1.

1. Alice chooses security parameter ϵ , to give a sufficiently small probability of Snoop successfully cheating. She divides her string x into two strings x_1 and R , of equal length.
2. Alice uses 2 bits of x_1 to choose one of the four tests, via the assignment in Table 5.1.
3. She performs the corresponding test, by having each of three agents make inputs to their boxes and receive their outputs such that light could not have travelled between any pair of boxes between input and output⁷.

⁶In practice, Alice might ask for devices that measure either σ_x or σ_z , and for a further device that creates GHZ states. Of course, she will not be able to distinguish this scenario from one satisfying the test but using a different set of states and operators, hence we have kept the description as general as possible.

⁷Alternatively, Alice can avoid the need for large separations if she can ensure no communication between devices after the protocol begins, e.g. by putting each device in its own separate laboratory.

5.2 Private Randomness Expansion

bit sequence	00	01	10	11
input	$P_1P_2P_3$	$P_1Q_2Q_3$	$Q_1P_2Q_3$	$Q_1Q_2P_3$

(a)

output	- - -	- + +	+ - +	+ + -
	+ + +	+ - -	- + -	- - +
assignment	00	01	10	11

(b)

Table 5.1: Assignment table for (a) choosing the inputs to the three devices based on two random bits, and (b) assigning the outputs generated from the three devices to form two new random bits.

4. If she receives the wrong product of outputs, she aborts, otherwise she turns her output into a bit string using the assignments given in Table 5.1. In this way, Alice builds a random string $x' \in X'$.
5. Alice repeats steps 2–4 until she has depleted x_1 .
6. Alice bounds $H_\infty^\epsilon(\rho_{X'X_1Z}|X_1Z)$. Here,

$$\rho_{X'X_1Z} = \sum_{x', x_1} P_{X'X_1}(x', x_1) |x'x_1\rangle\langle x'x_1| \otimes \rho_Z^{x'x_1}, \quad (5.3)$$

and \mathcal{H}_Z is the Hilbert space held by Snoop. She then performs privacy amplification using a *universal*₂ hash function, where the random string R is used to choose the hash function. (Note that R has the same length as x' [22, 23].) If Alice's final string, s , has length τ , then Equation (1.32) implies that s can be distinguished from uniform with probability at most $\epsilon + \frac{1}{2}2^{-\frac{1}{2}(H_\infty^\epsilon(\rho_{X'X_1Z}|X_1Z) - \tau)}$.⁸

This protocol is illustrated in Figure 5.1. Note that Alice bounds the quantity $H_\infty^\epsilon(\rho_{X'X_1Z}|X_1Z)$, rather than $H_\infty^\epsilon(\rho_{X'Z}|Z)$. This ensures that if Snoop discovers

⁸Since it is only quantum devices that are supplied by Snoop, and hashing is a classical procedure, there is no security issue associated with this step.

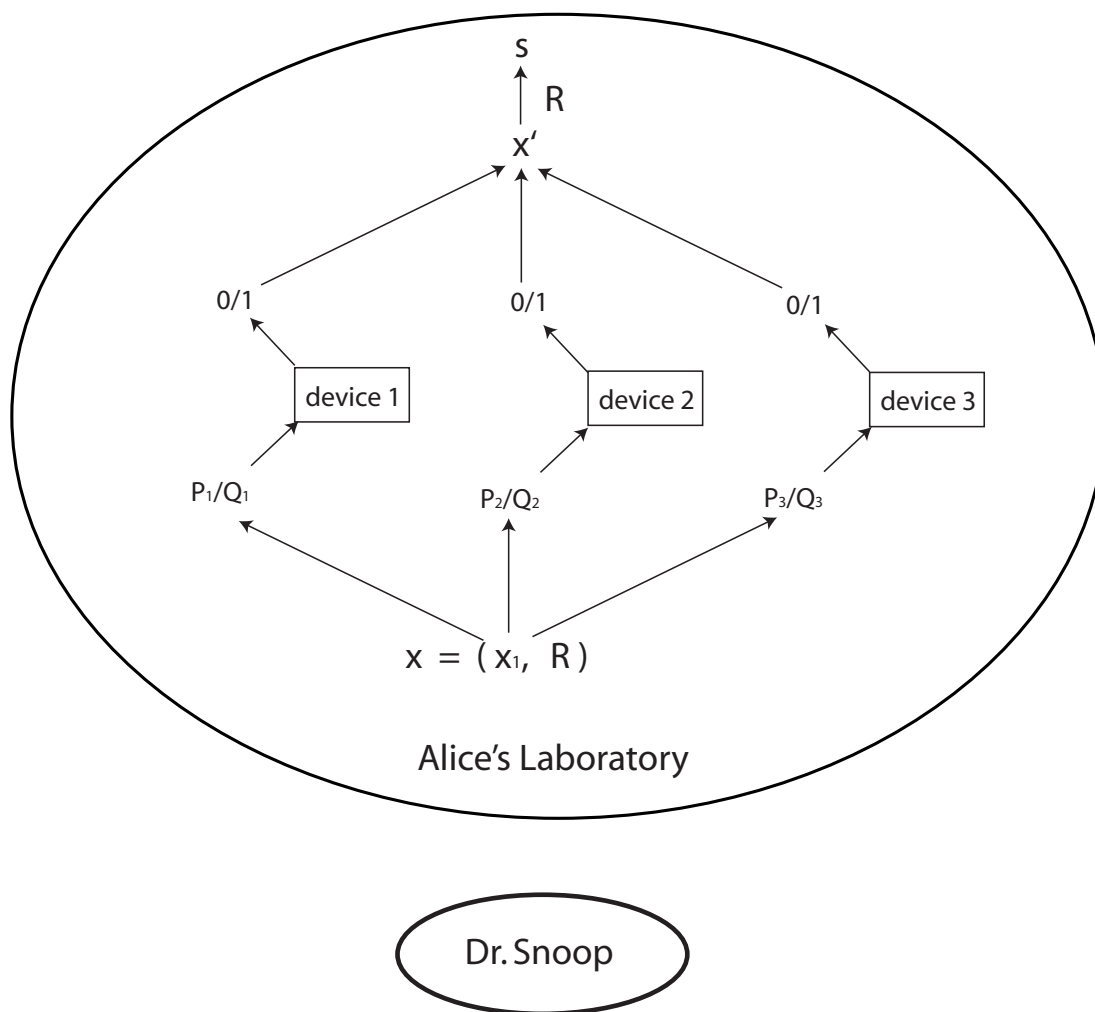

Figure 5.1: Diagram of the steps in Protocol 5.1. Together devices 1–3 form a device triple.

5.2 Private Randomness Expansion

x_1 after the protocol has taken place (e.g., perhaps it is used as part of some further application), the string s remains secure. This is important for the composability of Protocol 5.1. Following the discussion of privacy amplification in Section 1.4.2, the same is true if R is subsequently divulged. The concatenation (x, s) is the final private random string generated by the protocol. It is manifestly longer than the initial one. Moreover, if Snoop is honest, then Protocol 5.1 uses 2 bits of x while generating 2 new bits of randomness each time the loop (i.e., Steps 2–4) is run.

Although (x, s) is private with respect to the outside world, it is not private with respect to the devices, which, being malicious, may be programmed to remember their sequence of inputs and outputs. Snoop could then program her devices in the following way. The first time x is input, the devices behave honestly, using genuine GHZ states and suitable measurement operators. Alice's tests will then all pass. When x is input again (which the devices know, because we assume Snoop knows Alice's procedure), the devices can simply recall the output they made in the first (honest) run. With probability $\frac{1}{4}$ the devices output these directly, otherwise they randomly flip two of the three outputs. (The devices can be pre-programmed with shared private randomness in order to do this.) The outputs in this second run appear genuine from Alice's point of view, but in fact contain no additional private randomness. Therefore, the procedure cannot simply be repeated to generate an even longer string.

5.2.3.1 Security Against Classical Attacks

Consider the situation where Alice performs the protocol as described, while Snoop attempts to cheat. In so doing, Snoop limits himself to classical attacks (that is, to inserting known outcomes⁹). If he does this, his best attack has success probability $\frac{3}{4}$ per supposed GHZ state, and gains him 2 bits of Alice's sequence, x' .

Snoop can then have made a maximum of $m = \frac{\log \frac{1}{\epsilon}}{\log \frac{3}{4}}$ attacks, except with probability less than ϵ . So that his probability of successful attack is less than

⁹Snoop could distribute these outcomes according to some probability distribution, but this will not help. Additionally, he could make the output depend on the input, but since when we bound the smooth min-entropy we give Snoop the input, this also does not help.

5.2 Private Randomness Expansion

2ϵ , we require the hashing to reduce the string length by $2\left(\frac{1}{\log \frac{4}{3}} + 1\right) \log \frac{1}{\epsilon} - 2$ bits (see Equation (1.32)). This is independent of the number of GHZ tests performed. Provided the initial private random string has length greater than twice this, it can be expanded, except with probability less than 2ϵ .

In the cases where Snoop does not make an attack, two new pieces of randomness are generated for each bit of x_1 . Therefore, against classical attacks, this protocol increases the amount of private randomness by a factor of $\lesssim \frac{3}{2}$, for large initial amounts.

5.2.3.2 Quantum Attacks

Of course, limiting Snoop to classical attacks is an undesirable and unrealistic assumption, especially given the fact that he is able to produce Alice's quantum devices! If Snoop performs a quantum attack, then, before privacy amplification, the final state of the system takes the form

$$\sum_{x', x_1} P_{X'X_1}(x', x_1) |x'x_1\rangle\langle x'x_1|_A \otimes \rho_Z^{x'x_1}. \quad (5.4)$$

The length by which x' needs to be reduced depends on $H_\infty^\epsilon(\rho_{X'X_1Z}|X_1Z)$, and on ϵ . If Alice wants an overall error probability less than 2ϵ , then she can expand randomness provided that $H_\infty^\epsilon(\rho_{X'X_1Z}|X_1Z) > 2 \log \frac{1}{2\epsilon} - 2$ (see Equation (1.32)).

We have not been able to usefully bound $H_\infty^\epsilon(\rho_{X'X_1Z}|X_1Z)$. However, intuitively, we expect that if a large number of GHZ tests pass, Snoop's states must be close to GHZ states, except with probability exponentially small in the number of tests. In Appendix C, we give a complete description for the set of states that perfectly satisfy a GHZ test. Such states all generate 2 bits of private randomness per test. Hence, we suspect that conditioned on \mathfrak{M}_ζ GHZ tests passing, $H_\infty^\epsilon(\rho_{X'X_1Z}|X_1Z)$ is less than, but approximately equal to $2\mathfrak{M}_\zeta$. In fact, to ensure our result, we need a weaker conjecture, as follows.

Conjecture 5.1. *If Protocol 5.1 is followed exactly by Alice, then for all $\zeta > 0$, $\epsilon > 0$, there exists a sufficiently large integer, \mathfrak{M}_ζ , such that conditioned on \mathfrak{M}_ζ GHZ tests passing, $H_\infty^\epsilon(\rho_{X'X_1Z}|X_1Z) \geq \zeta$.*

5.2 Private Randomness Expansion

If we accept this conjecture, then any desired length of additional private random string can be generated using a sufficiently long initial string (but at present, we do not know how to relate the number of tests to the amount of additional randomness). This conjecture, together with Equation (1.32), implies that we can use Protocol 5.1 to generate τ additional random bits except with probability

$$\delta \leq \epsilon + \frac{1}{2}2^{-\frac{1}{2}(\zeta-\tau)}. \quad (5.5)$$

Conjecture 5.1 implies that for fixed ζ , increasing \mathfrak{M}_L reduces ϵ , while for fixed ϵ , increasing \mathfrak{M}_L increases ζ . Hence, δ can be made arbitrarily small for fixed τ , by increasing \mathfrak{M}_L , which in turn requires a longer initial string.

The capacity for generating any finite amount of additional randomness may be useful in itself, but what is more useful is the ability to take a string and expand it by an arbitrary amount. In the next section we give a protocol to do just that.

5.2.4 Indefinite Expansion

If we accept Conjecture 5.1, then, except with a probability exponentially small in the number of tests performed, the string generated in Protocol 5.1 is private and random. In this section, we introduce a protocol that we conjecture allows a sufficiently long initial random string to be expanded by an arbitrary amount.

As we have mentioned, one cannot simply feed the original string, x , twice into the same devices to double the amount of randomness gained. On the other hand, if a second device triple is supplied by Snoop, and can be assured no means of communication with the original (which is reasonable given Assumption 1), then the string (x, s) generated by the first triple is private and random with respect to the second, and hence can be used as input. One natural way to assure independence is simply to provide spatial separation between the device triples, in which case the same string x (but not (x, s)) can be used for each triple. The overall protocol is as follows.

Protocol 5.2.

1. Alice asks Snoop for N device triples.

2. She places each device triple within its own sub-lab of her laboratory such that no two can communicate.
3. Within each sub-lab, Alice uses her device triple to perform protocol 5.1 with the same initial string, x , being used for each. The output generated in lab i is string s_i , and we denote the intermediate (non-hashed) string in this lab x'_i . If any of the GHZ tests fail, the entire protocol aborts.
4. The strings $\{s_i\}$ are concatenated to form the final output.

This protocol is illustrated in Figure 5.2.

If we accept Conjecture 5.1, then each device triple, taken on its own generates a non-zero amount of private randomness, except with probability δ , as defined by Equation (5.5). From the discussion of privacy amplification in Section 1.4.2.1, this means that, for any system held by Snoop, he can distinguish Alice's string from a uniform one with probability at most δ . This includes the case where, after the protocol has taken place, Snoop learns x . Since this must hold for any system held by Snoop, we have that the strings $\{s_i\}$ are independent, since one possible strategy for Snoop is to keep the other $N - 1$ systems. Hence, this protocol generates N times as much randomness as Protocol 5.1. Thus, provided the initial private random string is sufficiently long that it would generate a longer string in Protocol 5.1, it can be used to generate an arbitrarily large amount of additional private randomness.

5.3 Resource Considerations

We have described two protocols for the expansion of random strings. For a given initial string, the first protocol has limited potential for expansion, while the second can be used to expand this string by an arbitrary amount, but requires a large supply of device triples in order to do so. We consider the following resources:

1. The number of bits forming the initial string, n , and
2. The number of sub-laboratories Alice must form, N .

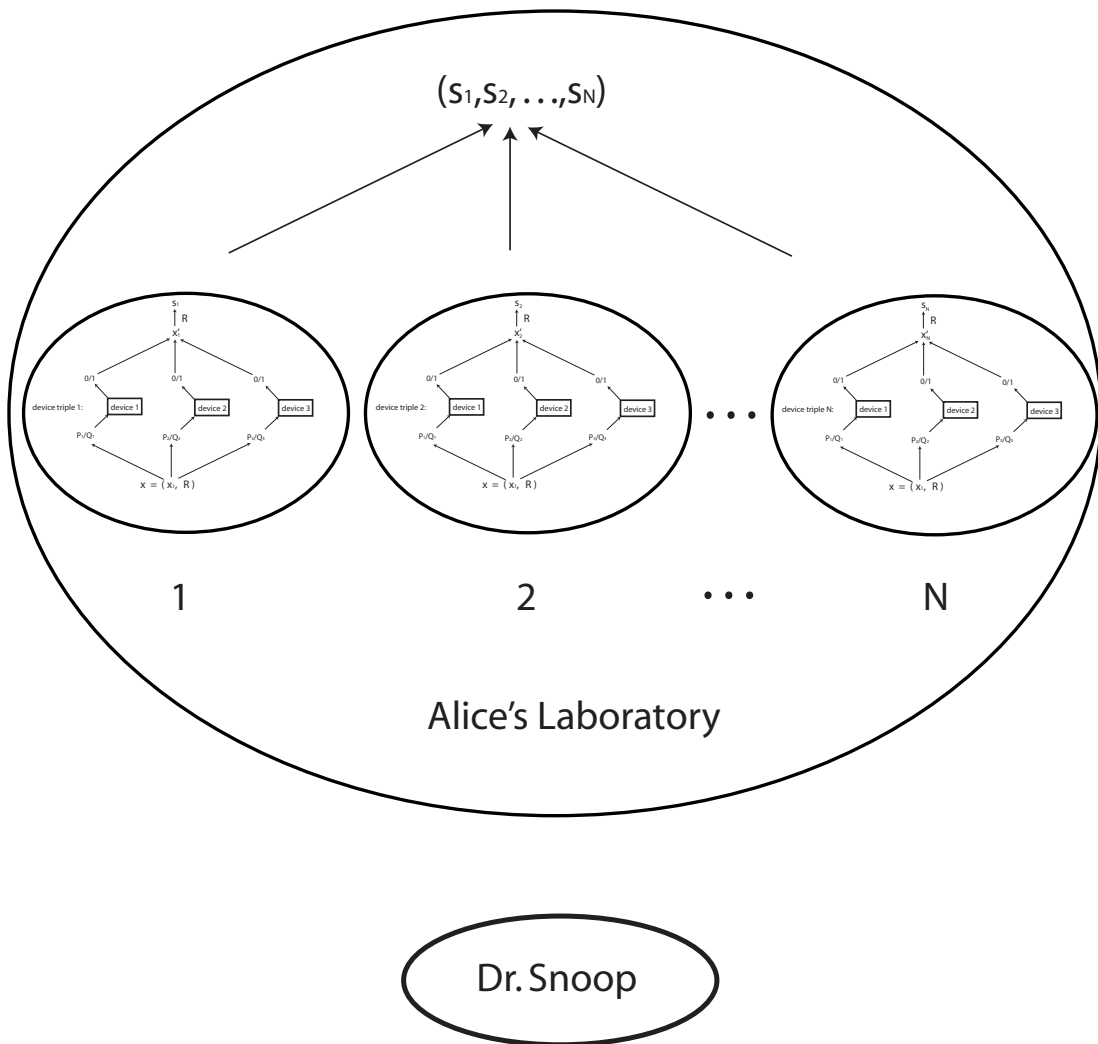

Figure 5.2: Diagram of the steps in Protocol 5.2. The same string, x , is used to generate the input to each device triple. We have numbered each sub-lab in which instances of Protocol 5.1 occur.

Such resources limit the amount of additional randomness that can be generated, as well as the probability of error achievable.

For a fixed initial string, Protocol 5.2 allows an arbitrary amount of randomness to be generated, provided that n is sufficient for the error tolerance required. On the other hand, if N is fixed as well, then there is some limit on the amount of expansion possible. Since Protocol 5.1 is called as a sub-protocol of Protocol 5.2, we look to enhance the former in order to improve efficiency.

There are two ways in which one might increase the amount of randomness generated over that given using Protocol 5.1. The first is to use a more efficient extractor than the *universal*₂ hash functions we have considered, so that the relative size of x_1 over R could be increased. The second is to use a more efficient test to generate the additional randomness. This latter consideration is discussed in the next section.

5.3.1 Beyond The GHZ Test

Consider the task of using an n bit initial string in some procedure in order to maximize the length of additional random string generated, while relying on *universal*₂ hashing for privacy amplification. We use *universal*₂ hash functions which require a random string equal in length to the string being hashed. Consider now a GHZ-like test whose output is ν times the length of the input. In order to use such a test to form a new string, the n bit string is partitioned into two strings, one of length $\frac{n}{1+\nu}$ and one of length $\frac{\nu n}{1+\nu}$. The first of these is used, via the GHZ-like test, to generate a string of length $\frac{\nu n}{1+\nu}$ which is hashed using the second to form the final string. In this way, the original n bit string has been used to form one of length $n \left(1 + \frac{\nu}{1+\nu}\right)$ (ignoring the reduction in length required for security, which, for large n , represents an arbitrarily small fraction of the length). In the limit $\nu \rightarrow \infty$, the original string can be doubled in length. This should be compared to an increase of $\frac{3}{2}$ times if the original GHZ test is used, or approximately 1.4 times if CHSH is used. ¹⁰

¹⁰In the GHZ case, choosing between each of the four quantities to test uses two bits of randomness, while the amount of randomness gained from a successful test is also two bits according to quantum theory (each of the four possible outcomes from any of the measurements (e.g., for $P_1P_2P_3$, the four are $---$, $++-$, $+ - +$ and $- + +$) are equally likely). Hence, for

Arbitrarily large values of ν are possible for appropriately constructed tests. One such construction was conceived by Pagonis, Redhead and Clifton [74]. They have presented a series of Bell-type tests which extend the GHZ test to more systems. In the seven system version, Alice asks for seven of the two input, two-output devices discussed previously, and is to consider the eight quantities

$$P_1Q_2Q_3Q_4Q_5Q_6Q_7, Q_1P_2Q_3Q_4Q_5Q_6Q_7, Q_1Q_2P_3Q_4Q_5Q_6Q_7, Q_1Q_2Q_3P_4Q_5Q_6Q_7, \\ Q_1Q_2Q_3Q_4P_5Q_6Q_7, Q_1Q_2Q_3Q_4Q_5P_6Q_7, Q_1Q_2Q_3Q_4Q_5Q_6P_7, P_1P_2P_3P_4P_5P_6P_7.$$

She demands that the first seven are always $+1$, while the last should be -1 . Again, it is easy to see that this is classically impossible. We conjecture that quantum mechanically, all states which satisfy these requirements are essentially seven system analogues of the GHZ state, i.e. $\frac{1}{\sqrt{2}}(|0000000\rangle - |1111111\rangle)$ (like in the GHZ case discussed in Appendix C), although this remains unproven¹¹. For this test, 3 bits of randomness are required to choose amongst the eight settings, while in a successful implementation of the test on this state, 6 bits of randomness are generated by the output. Higher dimensional versions of this test (see [74]) lead to larger increases still. In the k th version of this test, $4k - 1$ devices are required to measure one of $4k$ quantities. Such a test generates $4k - 2$ bits of randomness, and hence has an associated value $\nu = \frac{4k-2}{\log 4k}$.

Although these tests allow a larger amount of additional randomness per bit of original string, there is a tradeoff in that they generate lower detection probabilities in the event that Snoop cheats. This is easily illustrated by considering a classical attack. For a GHZ test, a classical attack can escape detection with probability $\frac{3}{4}$ per test, while in the seven system generalization, this figure is $\frac{7}{8}$ per test. However, without a relation between the smooth min-entropy and the number of tests, we cannot fully classify the tradeoff.

5.4 Discussion

In this chapter, we have introduced two protocols that we conjecture allow the expansion of a private random string using untrusted devices. The second of our

this test, $\nu = 1$.

¹¹The proof provided for the GHZ case does not generalize directly.

protocols provides an arbitrarily long private random string. This may be a useful primitive on which to base other protocols in the untrusted device scenario, and this is an interesting avenue of further work. Such a scenario is of interest in that it allows us to reduce our assumptions. More fundamentally, we can think of nature as our untrusted adversary which provides devices. One could then argue that our protocols strengthen the belief that nature behaves in a random way¹².

The untrusted devices scenario is a realistic one, and will become important if quantum computers become widespread. The ordinary user will not want to construct a quantum computer themselves and will instead turn to a supplier, in the same way that users of classical computers do today. The protocols in this chapter seek to provide such users a guarantee that the devices supplied are behaving in such a way that their outputs are private and random, to within a sufficient level of confidence.

¹²Of course, it is impossible to rule out cosmic conspiracy.

Conclusions

The cryptographic power present within a model depends fundamentally on the physical theory underlying it. Non-relativistic classical theory does not give much power and unproven technological assumptions often have to be employed in order to make cryptographic tasks possible. Non-relativistic quantum theory permits key distribution, but remains insufficient for a range of other tasks.

We have investigated quantum relativistic protocols, the most powerful allowed by current theory. Using such protocols, we have been able to widen the class of tasks known to be possible to include variable bias coin tossing. However, many remain impossible. The current state of the field for two-party protocols is summarized in Table 4.4 (see page 101). Nature itself has a built-in limit on the set of cryptographic tasks allowed. For some, it is fundamentally necessary to appeal to assumptions about the adversary in order that they be achieved. One might speculate that developments to our current theory (e.g. a theory of quantum gravity) could be such that they alter the set of allowed tasks.

We have also investigated cryptographic tasks outside the standard model. Specifically, we have dropped the usual assumption that each party trusts all the devices within their laboratory. In the untrusted devices model, any quantum devices used are assumed to be produced by a malicious adversary. Even within this highly restrictive scenario, some cryptographic procedures can succeed. We have discussed the task of expanding a private random string in detail, giving two protocols which we conjecture do just that.

Throughout this thesis, we have sought unconditional security. Our goal has been to use a minimal set of assumptions in order to do cryptography. Aside from its obvious practical benefits, a classification of tasks as possible or impossible is of intellectual interest as a way of giving insight into fundamental physics

itself. However, when considering real-world cryptography, unconditional security is unattainable in the way we have described. Our first assumption, that each party has complete trust in the security of their laboratory, for example, is at best an assumption about the power of an adversary, since an impenetrable laboratory is impossible to realize.

Trust is something of a commodity in cryptography. In practice, the overwhelming majority of users are much more trusting than we have allowed for. They will, for instance, accept the functionality of their devices on faith, taking the presence of a padlock symbol in the corner of their browser window as a guarantee that their communications are being encrypted. Furthermore, they provide any malicious code on their system with a high capacity channel (an internet connection) with which to release private data. Trusted suppliers are hence a virtual necessity in any large-scale cryptographic network.

Ultimately, it is not for us to say which assumptions a given user should accept and which they should not. Instead, we set up protocols and clearly state the assumptions under which they are secure. In this way, the responsibility of deciding whether a given protocol is of use in a particular situation is delegated to its user.

Appendix A

Maximizing The Probability Of Distinguishing Between Two Quantum States

Here we prove the following theorem [7]:

Theorem A.1. *Bob is in possession of one of two states whose density matrices are, ρ_0 and ρ_1 , for which the prior probability of ρ_0 is η_0 , and of ρ_1 is $\eta_1 = 1 - \eta_0$. The POVM which is optimal to distinguish these states does so with success probability $\frac{1}{2}(1 + \text{tr}|\eta_0\rho_0 - \eta_1\rho_1|)$.*

Proof. Our proof follows a similar argument to Nielsen and Chuang [4], but extends their result to the case of unequal prior probabilities.

Consider a POVM described by elements $\{E_i\}_{i=1}^N$, which satisfy $\sum_{i=1}^N E_i = \mathbb{1}$. Measurement with this POVM on the state provided generates outcomes according to one of two probability distributions. We have, $P_I(i) = \text{tr}(\rho_0 E_i)$ and $Q_I(i) = \text{tr}(\rho_1 E_i)$, where P_I occurs with probability η_0 and Q_I with prob-

ability η_1 . On measuring outcome i , our best guess of the distribution will be the one with $\max(\eta_0 P_I(i), \eta_1 Q_I(i))$, this guess being correct with probability $\frac{\max(\eta_0 P_I(i), \eta_1 Q_I(i))}{\eta_0 P_I(i) + \eta_1 Q_I(i)}$. The overall probability that we guess correctly using this POVM is then, $\sum_i \max(\eta_0 P_I(i), \eta_1 Q_I(i))$. Let us label the $\{P_I(i), Q_I(i)\}$ such that $P_I(i) \geq Q_I(i)$ for $i = 1, \dots, d$, and $P_I(i) < Q_I(i)$ for $i = d + 1, \dots, N$. Then,

$$\begin{aligned}
 \sum_{i=1}^N \max(\eta_0 P_I(i), \eta_1 Q_I(i)) &= \sum_{i=1}^d \eta_0 P_I(i) + \sum_{i=d+1}^N \eta_1 Q_I(i) \\
 &= \sum_{i=1}^N |\eta_0 P_I(i) - \eta_1 Q_I(i)| + \sum_{i=1}^d \eta_1 Q_I(i) + \sum_{i=d+1}^N \eta_0 P_I(i) \\
 &= \frac{1}{2} \left(1 + \sum_{i=1}^N |\eta_0 P_I(i) - \eta_1 Q_I(i)| \right) \tag{A.1}
 \end{aligned}$$

Let us now define positive operators Υ_0 and Υ_1 with orthogonal support such that $\eta_0 \rho_0 - \eta_1 \rho_1 = \Upsilon_0 - \Upsilon_1$, and hence, $|\eta_0 \rho_0 - \eta_1 \rho_1| = \Upsilon_0 + \Upsilon_1$.

We then have that,

$$\begin{aligned}
 \sum_{i=1}^N |\eta_0 P_I(i) - \eta_1 Q_I(i)| &= \sum_{i=1}^N |E_i(\eta_0 \rho_0 - \eta_1 \rho_1)| \\
 &\leq \text{tr} |\eta_0 \rho_0 - \eta_1 \rho_1|, \tag{A.2}
 \end{aligned}$$

where the final inequality follows from the fact that,

$$|\text{tr}(E_i(\Upsilon_0 - \Upsilon_1))| \leq \text{tr}(E_i(\Upsilon_0 + \Upsilon_1)) = \text{tr}(E_i |\eta_0 \rho_0 - \eta_1 \rho_1|),$$

and $\sum_i E_i = \mathbb{1}$.

It remains to show that a POVM exists that achieves equality in (A.2). The relevant POVM is $\{\Pi_0, \Pi_1\}$, where Π_0 is the projector onto the support of Υ_0 , and Π_1 is likewise the projector onto the support of Υ_1 . It is easy to show that this POVM has the desired properties. We have hence shown that the inequality (A.2) can be saturated, hence the result. QED

As a corollary to this theorem, if the states to be distinguished have equal priors, then they can be successfully distinguished with probability at most $\frac{1}{2}(1 + D(\rho_0, \rho_1))$, where $D(\rho_0, \rho_1) \equiv \frac{1}{2}\text{tr}|\rho_0 - \rho_1|$ is the trace distance between the two states.

Appendix B

A Zero Knowledge Protocol For Graph Non-Isomorphism

We use the task of providing a zero-knowledge proof for graph non-isomorphism as an illustration that universally composable security definitions can be satisfied, even in cryptographic protocols in which one party responds after having received information from another. The protocol we use is classical and is found in [60]. We discuss its universally composable properties here.

A zero-knowledge proof is a protocol involving a verifier and a prover. It ensures that if some statement is true, and the protocol is followed honestly, the prover is able to convince the verifier of its truth, without revealing any other information. Furthermore, if the statement is false, it is impossible to convince the verifier that it is true.

In this context, a graph is a series of nodes together with a defined connectivity. A zero-knowledge proof for graph non-isomorphism is one in which the prover can convince a verifier that two graphs are inequivalent under any permutation of their vertices. In our protocol, we assume that the prover has a device which solves the graph isomorphism problem (i.e., a device which when give two graphs decides whether they are isomorphic or not), but that the (computationally bounded) verifier cannot solve this problem.

Protocol B.1.

We label the two graphs G_0 and G_1 . These are known to both the prover and verifier.

1. The verifier picks either G_0 or G_1 at random and applies a random permutation, Ξ , to it. This permuted graph is sent to the prover.
2. The prover tests to see whether the graph is a permutation of G_0 or G_1 , and returns 0 or 1 to the verifier accordingly.
3. The verifier checks whether the prover was correct. If so, this process is repeated until a sufficient confidence level is reached. If not, then no proof has been provided that the graphs are non-isomorphic.
4. We denote the outcome of the protocol $a = 1$ if the proof is accepted, and $a = 0$ if it is not.

The ideal functionality has the following behaviour.

Ideal Functionality B.1. *If the graphs are non-isomorphic, the prover can choose whether to prove the non-isomorphism or not (i.e., whether the ideal will output $a = 1$ or $a = 0$ to the verifier). If they are isomorphic, the ideal can only output $a = 0$ to the verifier.*

Consider now a scenario in which the prover has access to an additional device into which she inputs the permutation, and the device returns either $c = 0$ or $c = 1$. This device is analogous to the additional device used by Bob in Section 4.2.1 and uses an algorithm unknown to the prover. There, the additional device broke the requirements for universally composable security. However, here it does not. We show that a dishonest prover can use this device and a device performing the ideal functionality in order to simulate all the data she would gain by using

this device in the real protocol. The prover simply simulates each permutation and inputs the permuted graph into the additional device. The outcomes either correspond to correct identification of the chosen graph, or they do not. If they do, the prover simply tells the ideal functionality to output $a = 1$, otherwise she tells it to output $a = 0$.

It is important that the inputs to the additional device are made prior to the ideal being used. Once the ideal has been executed, the simulator cannot then generate pairs (Ξ, c) that are correctly distributed with a .

Appendix C

The Complete Set Of Quantum States That Can Pass A GHZ Test

The technique that we follow in this section is similar to that used to find the complete set of states and measurements producing maximal violation of the CHSH inequality [75].

We seek the complete set of tripartite states (in finite dimensional Hilbert spaces), and two-setting measurement devices that output either 1 or -1 , such that, denoting the settings of device i by P_i and Q_i , we have,

1. If all three detectors measure P_i , then the product of their outcomes is $+1$.
2. If two detectors measure Q_i and one measures P_i , then the product of their outcomes is -1 .

These are equivalent to demanding

$$P_1 \otimes P_2 \otimes P_3 |\Psi\rangle = -|\Psi\rangle \quad (\text{C.1})$$

$$Q_1 \otimes Q_2 \otimes P_3 |\Psi\rangle = |\Psi\rangle \quad (\text{C.2})$$

$$Q_1 \otimes P_2 \otimes Q_3 |\Psi\rangle = |\Psi\rangle \quad (\text{C.3})$$

$$P_1 \otimes Q_2 \otimes Q_3 |\Psi\rangle = |\Psi\rangle, \quad (\text{C.4})$$

where $|\Psi\rangle$ is the tripartite state. We then have

$$F|\Psi\rangle \equiv \frac{1}{4} (P_1 \otimes Q_2 \otimes Q_3 + Q_1 \otimes P_2 \otimes Q_3 + Q_1 \otimes Q_2 \otimes P_3 - P_1 \otimes P_2 \otimes P_3) |\Psi\rangle = |\Psi\rangle. \quad (\text{C.5})$$

$|\Psi\rangle$ is thus an eigenstate of F with eigenvalue 1, so that $F^2|\Psi\rangle = |\Psi\rangle$. This is equivalent to

$$(i[P_1, Q_1] \otimes i[P_2, Q_2] \otimes \mathbb{1} + i[P_1, Q_1] \otimes \mathbb{1} \otimes i[P_3, Q_3] + \mathbb{1} \otimes i[P_2, Q_2] \otimes i[P_3, Q_3]) |\Psi\rangle = 12 |\Psi\rangle. \quad (\text{C.6})$$

The maximum eigenvalue of $i[P_1, Q_1]$ is 2, hence

$$i[P_1, Q_1] \otimes i[P_2, Q_2] \otimes \mathbb{1} |\Psi\rangle = 4 |\Psi\rangle \quad (\text{C.7})$$

and similar relations for the other permutations. We hence have

$$i[P_1, Q_1] \otimes \mathbb{1} \otimes \mathbb{1} |\Psi\rangle = 2 |\Psi\rangle \quad (\text{C.8})$$

from which it follows that

$$\langle \Psi | (\{P_1, Q_1\} \otimes \mathbb{1} \otimes \mathbb{1})^2 | \Psi \rangle = 0 \quad (\text{C.9})$$

and hence that

$$(\{P_1, Q_1\} \otimes \mathbb{1} \otimes \mathbb{1}) |\Psi\rangle = 0. \quad (\text{C.10})$$

Consider the following Schmidt decomposition [4]: $|\Psi\rangle = \sum_{i=1}^n \lambda_i |i_1\rangle |i_{23}\rangle$, where $\lambda_i \geq 0 \forall i$, and n is the dimensionality of the first system. Then, if $\lambda_i \neq 0 \forall i$, the $\{|i_1\rangle\}$ are n eigenstates of $\{P_1, Q_1\}$, each having eigenvalue 0. Since there are only n eigenstates, we must have $\{P_1, Q_1\} = 0$.

If some of the λ_i are zero, then we can define a projector onto the non-zero subspace. Call this Π_1 , and define $p_1 = \Pi_1 P_1 \Pi_1$ and $q_1 = \Pi_1 Q_1 \Pi_1$. Similarly, define projectors Π_2 and Π_3 , and hence operators p_2, q_2 and p_3, q_3 by taking the Schmidt decomposition for systems (1,3) and 2, and (1,2) and 3, respectively. It is then clear that

$$\frac{1}{4} (p_1 \otimes q_2 \otimes q_3 + q_1 \otimes p_2 \otimes q_3 + q_1 \otimes q_2 \otimes p_3 - p_1 \otimes p_2 \otimes p_3) |\Psi\rangle = |\Psi\rangle \quad (\text{C.11})$$

holds for the projected operators, and hence, these satisfy $\{p_i, q_i\} = 0$ for $i = 1, 2, 3$.

The relationships, $p_i^2 = \mathbb{1}$, $q_i^2 = \mathbb{1}$, $\{p_i, q_i\} = 0$ then apply for the Hilbert space restricted by $\{\Pi_i\}$. These imply that p_i, q_i and $\frac{i}{2}[q_i, p_i]$ transform like the generators of $SU(2)$. The operators may form a reducible representation, in which case we can construct a block diagonal matrix with irreducible representations on the diagonal. The anticommutator property means that only the two-dimensional representation can appear, hence we can always pick a basis such that $p_i = \mathbb{1}_{d_i} \otimes \sigma_{xi}$ and $q_i = \mathbb{1}_{d_i} \otimes \sigma_{yi}$ for some dimension, d_i , of identity matrix. Our state then needs to satisfy

$$\mathbb{1}_{d_1} \otimes \sigma_{x1} \otimes \mathbb{1}_{d_2} \otimes \sigma_{x2} \otimes \mathbb{1}_{d_3} \otimes \sigma_{x3} |\Psi\rangle = - |\Psi\rangle, \quad (\text{C.12})$$

and similar relations for the other combinations analogous to (C.2–C.4). By an appropriate swap operation, this becomes

$$\mathbb{1}_{d_1 d_2 d_3} \otimes \sigma_{x1} \otimes \sigma_{x2} \otimes \sigma_{x3} |\Psi\rangle = - |\Psi\rangle, \quad (\text{C.13})$$

etc., which makes it clear that the system can be divided into subspaces, each of which must satisfy the GHZ relation (C.5). In an appropriate basis, we can write

$$|\Psi\rangle = \begin{pmatrix} a_1 |\psi_{\text{GHZ}}\rangle \\ a_2 |\psi_{\text{GHZ}}\rangle \\ \vdots \end{pmatrix}, \quad (\text{C.14})$$

where $|\psi_{\text{GHZ}}\rangle = \frac{1}{\sqrt{2}}(|000\rangle - |111\rangle)$ ¹, and the complex co-efficients $\{a_j\}$ simply weight each subspace and satisfy $\sum_j |a_j|^2 = 1$. We have hence obtained the complete set of states and operators satisfying (C.1–C.4), up to local unitaries.

¹This is the only solution to $(\sigma_{x1} \otimes \sigma_{y2} \otimes \sigma_{y3} + \sigma_{y1} \otimes \sigma_{x2} \otimes \sigma_{y3} + \sigma_{y1} \otimes \sigma_{y2} \otimes \sigma_{x3} - \sigma_{x1} \otimes \sigma_{x2} \otimes \sigma_{x3}) |\psi_j\rangle = 4 |\psi_j\rangle$, up to global phase.

References

- [1] Roger Colbeck. An entanglement-based protocol for strong coin tossing with bias $1/4$. *Physics Letters A*, 362(5–6):390–392, 2007.
- [2] Roger Colbeck and Adrian Kent. Variable bias coin tossing. *Physical Review A*, 73(3):032320, 2006.
- [3] Asher Peres. *Quantum Theory: Concepts and Methods*. Springer, 1995.
- [4] M. A. Nielsen and I. L. Chuang. *Quantum Computation and Quantum Information*. CUP, 2000.
- [5] Anthony Chefles. Quantum state discrimination. *Contemporary Physics*, 41(6):401–424, 2000.
- [6] M. Ježek, J. Řeháček, and J. Fiurášek. Finding optimal strategies for minimum-error quantum-state discrimination. e-print quant-ph/0201109, 2002.
- [7] Carl W. Helstrom. *Quantum Detection and Estimation Theory*. Academic Press, London, 1976.
- [8] Paul Hausladen and William K. Wootters. A ‘pretty good’ measurement for distinguishing quantum states. *Journal of Modern Optics*, 41(12):2385–2390, 1994.
- [9] Lane P. Hughston, Richard Jozsa, and William K. Wootters. A complete classification of quantum ensembles having a given density matrix. *Physics Letters A*, 183:14–18, 1993.

-
- [10] Alexander S. Holevo. Statistical decision theory for quantum systems. *Journal of Multivariate Analysis*, 3(4):337–394, 1973.
- [11] H. P. Yuen, R. S. Kennedy, and M. Lax. Optimum testing of multiple hypotheses in quantum detection theory. *IEEE Transactions on Information Theory*, IT-21(2):125–134, 1975.
- [12] A. Einstein, B. Podolsky, and N. Rosen. Can quantum-mechanical description of physical reality be considered complete? *Physical Review*, 47(10):777–780, 1935.
- [13] J. S. Bell. *Speakable and unspeakable in quantum mechanics*. Cambridge University Press, 1987.
- [14] B.S. Cirel'son. Quantum generalizations of Bell's inequality. *Letters in Mathematical Physics*, 4(2):93–100, 1980.
- [15] Alain Aspect. Bell's inequality test: More ideal than ever. *Nature*, 398(6724):189–190, 1999.
- [16] Jonathan Barrett, Daniel Collins, Lucien Hardy, Adrian Kent, and Sandu Popescu. Quantum nonlocality, Bell inequalities, and the memory loophole. *Physical Review A*, 66(4):042111, 2002.
- [17] Adrian Kent. Causal quantum theory and the collapse locality loophole. *Physical Review A*, 72:012107, 2005.
- [18] C. E. Shannon. A mathematical theory of communication. *Bell System Technical Journal*, 27:379–423, 1948.
- [19] A. Rényi. On measures of information and entropy. In *Proceedings of the 4th Berkeley Symposium on Mathematics, Statistics and Probability*, volume 1, 1961.
- [20] Renato Renner and Stefan Wolf. Simple and tight bounds for information reconciliation and privacy amplification. In Bimal Roy, editor, *Advances in Cryptology — ASIACRYPT 2005*, volume 3788, pages 199–216. Springer-Verlag, 2005.

- [21] Renato Renner. *Security of Quantum Key Distribution*. PhD thesis, Swiss Federal Institute of Technology, Zurich, 2005. Also available at <http://arxiv.org/abs/quant-ph/0512258>.
- [22] J. L. Carter and M. N. Wegman. Universal classes of hash functions. *Journal of Computer and System Sciences*, 18:143–154, 1979.
- [23] M. N. Wegman and J. L. Carter. New hash functions and their use in authentication and set equality. *Journal of Computer and System Sciences*, 22:265–279, 1981.
- [24] Ronen Shaltiel. Recent developments in explicit constructions of extractors. *Bulletin of the EATCS*, 77:67–95, 2002.
- [25] D. J. C. MacKay. *Information Theory, Inference, and Learning Algorithms*. Cambridge University Press, 2003.
- [26] Chi-Jen Lu, Omer Reingold, Salil Vadhan, and Avi Wigderson. Extractors: optimal up to constant factors. In *STOC '03: Proceedings of the thirty-fifth annual ACM symposium on Theory of computing*, pages 602–611, New York, NY, USA, 2003. ACM Press.
- [27] Adrian Kent. Secure classical bit commitment over finite channels. *Journal of Cryptology*, 18, 2005.
- [28] Dominic Mayers. Unconditionally secure quantum bit commitment is impossible. *Physical Review Letters*, 78(17):3414–3417, 1997.
- [29] T. Rudolph. The laws of physics and cryptographic security. e-print quant-ph/0202143, 2002.
- [30] Adrian Kent. Talk presented at workshop *Quantum Information Theory: Present Status and Future Directions*, Isaac Newton Institute, Cambridge, UK, August 2004.
- [31] Dorit Aharonov, Amnon Ta-Shma, Umesh V. Vazirani, and Andrew C. Yao. Quantum bit escrow. In *Proceedings of the 32nd annual ACM symposium*

-
- on Theory of computing (STOC-00)*, pages 705–714, New York, NY, USA, 2000. ACM Press.
- [32] Lucien Hardy and Adrian Kent. Cheat sensitive quantum bit commitment. *Physical Review Letters*, 92(15):157901, 2004.
- [33] R. W. Spekkens and Terry Rudolph. Quantum protocol for cheat-sensitive weak coin flipping. *Physical Review Letters*, 89(22):227901, 2002.
- [34] J. Kilian. Founding cryptography on oblivious transfer. In *Proceedings of the 20th Annual ACM Symposium on Theory of Computing*. ACM, New York, 1988.
- [35] M. Naor and B. Pinkas. Computationally secure oblivious transfer. *Journal of Cryptology*, 18(1):1–35, 2005.
- [36] C. Crépeau and J. Kilian. Achieving oblivious transfer using weakened security assumptions. In *Proceedings of the 29th IEEE Symposium on Foundations of Computer Science*, pages 42–52. IEEE Computer Society Press, 1988.
- [37] Ivan Damgård, Joe Kilian, and Louis Salvail. On the (im)possibility of basing oblivious transfer and bit commitment on weakened security assumptions. In Jacques Stern, editor, *Advances in Cryptology: Proceedings of Crypto 1999*, volume 1592 of *Lecture Notes in Computer Science*, pages 56–73. Springer, 1999.
- [38] Ivan Damgård, Serge Fehr, Kirill Morozonov, and Louis Salvail. Unfair noisy channels and oblivious transfer. In M. Naor, editor, *Theory of Cryptography Conference - TCC 04*, volume 2951 of *Lecture Notes in Computer Science*, pages 355–373. Springer-Verlag, 2004.
- [39] A.C.C. Yao. Security of quantum protocols against coherent measurements. In *ACM Symposium on the Theory of Computing*, pages 67–75, May 1995.
- [40] Hoi-Kwong Lo and H. F. Chau. Why quantum bit commitment and ideal quantum coin tossing are impossible. *Physica D*, 120:177–187, 1998.

- [41] Adrian Kent. Unconditionally secure bit commitment. *Physical Review Letters*, 83(7):1447–1450, 1999.
- [42] Artur K. Ekert. Quantum cryptography based on Bell’s theorem. *Physical Review Letters*, 67(6):661–663, 1991.
- [43] John von Neumann and Oskar Morgenstern. *Theory of Games and Economic Behavior*. Princeton University Press, 1947.
- [44] R. W. Spekkens and T. Rudolph. Optimization of coherent attacks in generalizations of the BB84 quantum bit commitment protocol. *Quantum Information and Computation*, 2(1):66–96, 2001.
- [45] Alexei Kitaev. (unpublished), proof recreated in [76].
- [46] Andris Ambainis. A new protocol and lower bounds for quantum coin flipping. *Journal of Computer and System Sciences*, 68(2):398–416, March 2004.
- [47] R. W. Spekkens and T. Rudolph. Degrees of concealment and bindingness in quantum bit commitment protocols. *Physical Review A*, 65:012310, 2001.
- [48] Carlos Mochon. Large family of quantum weak coin-flipping protocols. *Physical Review A*, 72(2):022341, 2005.
- [49] Adrian Kent. Coin tossing is strictly weaker than bit commitment. *Physical Review Letters*, 83(25):5382–5384, 1999.
- [50] Hoi-Kwong Lo. Insecurity of quantum secure computations. *Physical Review A*, 56(2):1154–1162, 1997.
- [51] Ran Canetti. Security and composition of multiparty cryptographic protocols. *Journal of Cryptology*, 13(1):143–202, 2000.
- [52] Michael Backes, Birgit Pfitzmann, and Michael Waidner. A general composition theorem for secure reactive systems. In *TCC*, pages 336–354, 2004.

-
- [53] Birgit Pfitzmann and Michael Waidner. A model for asynchronous reactive systems and its application to secure message transmission. In *Proceedings of the 2001 IEEE Symposium on Security and Privacy (SP01)*, pages 184–201, Washington, DC, USA, 2001. IEEE Computer Society.
- [54] Michael Ben-Or and Dominic Mayers. General security definition and composability for quantum & classical protocols. e-print quant-ph/0409062, 2004.
- [55] Claude Crépeau, Daniel Gottesman, and Adam Smith. Secure multi-party quantum computation. In *Proceedings of the 34th annual ACM symposium on Theory of computing (STOC-02)*, pages 643–652, New York, NY, USA, 2002. ACM Press.
- [56] Dominique Unruh. Simulatable security for quantum protocols. e-print quant-ph/0409125, 2004.
- [57] Dennis Hofheinz, Jörn Müller-Quade, and Dominique Unruh. On the (im)possibility of extending coin toss. Cryptology ePrint Archive, Report 2006/177, 2006.
- [58] Oded Goldreich. *Foundations Of Cryptography*, volume 2, chapter 7. Cambridge University Press, 2006. Draft available online at <http://www.wisdom.weizmann.ac.il/oded/books.html>.
- [59] Adrian Kent. Promising the impossible: Classical certification in a quantum world. e-print quant-ph/0409029, 2004.
- [60] Oded Goldreich, Silvio Micali, and Avi Wigderson. Proofs that yield nothing but their validity or all languages in NP have zero-knowledge proofs. *Journal of the ACM*, 38(1):691–729, 1991.
- [61] Daniel Gottesman and Hoi-Kwong Lo. From quantum cheating to quantum security. *Physics Today*, 53(11), 2000.
- [62] Mathematica script available at <http://qubit.damtp.cam.ac.uk/users/roger/script/PGP.nb>.

-
- [63] Christian Cachin, Claude Crépeau, and Julien Marcil. Oblivious transfer with a memory-bounded receiver. In *FOCS '98: Proceedings of the 39th Annual Symposium on Foundations of Computer Science*, pages 493–502, Washington, DC, USA, 1998. IEEE Computer Society.
- [64] Yan Zong Ding, Danny Harnik, Alon Rosen, and Ronen Shaltiel. Constant-round oblivious transfer in the bounded storage model. In Moni Naor, editor, *Proceedings of the First Theory of Cryptography Conference (TCC04)*, volume 2951 of *Lecture Notes in Computer Science*, pages 446–472. Springer, 2004.
- [65] Ivan Damgård, Serge Fehr, Louis Salvail, and Christian Schaffner. Cryptography in the bounded quantum-storage model. In *FOCS '05: Proceedings of the 46th Annual IEEE Symposium on Foundations of Computer Science*, pages 449–458, Washington, DC, USA, 2005. IEEE Computer Society.
- [66] Sandu Popescu and Daniel Rohrlich. Quantum nonlocality as an axiom. *Foundations of Physics*, 24(3):379–385, 1994.
- [67] Wim van Dam. Implausible consequences of superstrong nonlocality. e-print quant-ph/0501159, 2005.
- [68] Harry Buhrman, Matthias Christandl, Falk Unger, Stephanie Wehner, and Andreas Winter. Implications of superstrong nonlocality for cryptography. *Proceedings of the Royal Society A*, 462(2071):1919–1932, 2006.
- [69] Stefan Wolf and Jürg Wullschlegler. Bit commitment from weak non-locality. e-print quant-ph/0508233, 2005.
- [70] Auguste Kerckhoff. La cryptographie militaire. *Journal Des Sciences Militaires*, IX, 1883.
- [71] D. M. Greenberger, M. Horne, and A. Zeilinger. Going beyond Bell’s theorem. In M. Kafatos, editor, *Bell’s Theorem, Quantum Mechanics and Conceptions of the Universe*, pages 69–72. Kluwer Academic, Dordrecht, The Netherlands, 1989.

- [72] M. Ben-Or, Michal Horodecki, D. W. Leung, D. Mayers, and J. Oppenheim. The universal composable security of quantum key distribution. In *Second Theory of Cryptography Conference*, volume 3378, pages 386–406. Springer, 2005.
- [73] Renato Renner and Robert Koenig. Universally composable privacy amplification against quantum adversaries. In Joe Kilian, editor, *Second Theory of Cryptography Conference*, volume 3378, pages 407–425. Springer, 2005.
- [74] Constantine Pagonis, Michael L.G. Redhead, and Robert K. Clifton. The breakdown of quantum non-locality in the classical limit. *Physics Letters A*, 155(8,9):441–444, 1991.
- [75] Sandu Popescu and Daniel Rohrlich. Which states violate Bell’s inequality maximally? *Physics Letters A*, 169(6):411–414, 1992.
- [76] A. Ambainis, H. Buhrman, Y. Dodis, and H. Röhrig. Multiparty quantum coin flipping. In *Proceedings of the 19th IEEE Annual Conference on Complexity*, pages 250–259. IEEE Computer Society, 2004.