

Mathematical Proofs of Two Conjectures: The Four Color Problem and The Uniquely 4-colorable Planar Graph

Jin Xu

Version 1.0, 2009/11/8

Abstract

The famous four color theorem states that for all planar graphs, every vertex can be assigned one of 4 colors such that no two adjacent vertices receive the same color. Since Francis Guthrie first conjectured it in 1852, it is until 1976 with electronic computer that Appel and Haken first gave a proof by finding and verifying 1936 reducible unavoidable sets, and a simplified proof of Robertson, Sanders, Seymour and Thomas in 1997 only involved 633 reducible unavoidable sets, both proofs could not be realized effectively by hand. Until now, finding the reducible unavoidable sets remains the only successful method to use, which came from Kempe's first "proof" of the four color problem in 1879. An alternative method only involving 4 reducible unavoidable sets for proving the four color theorem is used in this paper, which takes form of mathematical proof rather than a computer-assisted proof and proves both the four color conjecture and the uniquely 4-colorable planar graph conjecture by mathematical method. Our work mainly includes the following four parts: the first part sets up some basic theory on the chromatic polynomial for maximal planar graphs; the second part introduces the concept of the uniquely *near k*-colorable graph, and gives the necessary and sufficient condition for this kind of graph; the uniquely 4-colorable planar graph is characterized in detail in the third part, namely a 4-colorable planar graph G is uniquely 4-colorable if and only if the graph G is the so-called recursive maximal planar graph. Naturally, the result solves the Frieini-Wilson-Fisk conjecture and the Jensen-Toft conjecture on the uniquely 4-colorable planar graph; based on the previous three parts, the last part gives the following result: for any maximal planar graph G , its chromatic polynomial $f(G, t)$ satisfies $f(G, 4) > 0$. Therefore, we give a brief mathematical proof of the four color theorem.

Key Words: the four color problem, planar graph, maximal planar graph, recursive maximal planar graph(FWF graph), uniquely 4-colorable planar graph, uniquely near k -colorable graph, chromatic polynomial

Contents

1. Introduction
 2. Notations
 - 2.1. Basic notations
 - 2.2. Graph coloring problem
 - 2.3. Maximal planar graph
 3. Chromatic polynomial of a maximal planar graph
 - 3.1. Introduction
 - 3.2. Some related results on chromatic polynomial
 - 3.3. Delete-One-Vertex recursion formula for maximal planar graphs
 4. Uniquely near k -colorable graph
 - 4.1. Some related notations
 - 4.2. Several useful lemmas
 - 4.3. A necessary and sufficient condition
 5. A necessary and sufficient condition for the uniquely 4-colorable planar graph
 - 5.1. Advances on the uniquely 4-colorable planar graph
 - 5.1.1. General results of unique vertex coloring
 - 5.1.2. Uniquely edge colorable graphs
 - 5.1.3. Uniquely colorable planar graphs
 - 5.2. Recursive maximal planar graph(FWF graph)
 - 5.2.1. Basic properties
 - 5.2.2. The (2,2)-FWF graph
 - 5.3. The color sequence of a (2,2)-FWF graph
 - 5.4. The extending 4-wheel operation
 - 5.4.1. Definitions and properties
 - 5.4.2. The coloring of the induced graph obtained by extending 4-wheel operation
 - 5.5. The FWF conjecture and the JT conjecture have been solved
 6. The mathematical proof of the four color conjecture
 7. Conclusion
- Acknowledgements
- References

1 Introduction

In 1852, Francis Guthrie [31] proposed the four color conjecture [54, 43, 32, 7, 6, 64, 19]: four colors are sufficient to color any map drawn in the plane or on a sphere so that no two regions with a common boundary line are colored with the same color, where two regions which have a point or a finite number of points in common are permitted to have the same color. It is also required that all regions be connected together. This problem can be converted to the vertex coloring problem for a graph easily. The specific method is as follows:

Place a point, or *vertex*, in the middle of each country of a map M , and join two vertices with a line, or *edge*, whenever two countries have a common border to obtain a dual graph, which is planar. Therefore, the four color map problem can be converted into the 4-vertex-coloring problem for a planar graph equivalently. The similar conjecture is shown as follows:

Conjecture 1.1 (The Four Color Conjecture). *For any planar graph G , its vertices can be colored with 4 colors. Or for short, G is 4-colorable.*

This conjecture was submitted to the London Mathematical Society in 1878 by Cayley, one of the most famous British mathematicians[15, 16]. From then on, it became the spotlight in the mathematical world. Nextly, Kempe [45, 46] and Tait[62] gave two different "proofs" for the four color conjecture respectively in 1879 and 1880. Although two proofs were both incorrect, Kempe's work laid the foundation for the computer-assisted proof[3, 4, 5] in 1976.

The concept of "**configuration**" was introduced by Kempe in his proof [45, 46]. He proved that in every normal map, the number of countries adjacent to a country may be two, three, four or five, but not all the countries are adjacent to six or more countries. In other words, the "configurations" composed of 2 to 5 countries are unavoidable. Each map contains at least one of these four kinds of configurations. Another concept implicitly given by Kempe was "**reducibility**", which also came from his proof[45, 46]. He proved that if one country is adjacent to four countries in a colored map with 5 colors, then the number of countries in this map can be reduced. Since introducing the concepts of "configuration" and "reducibility", several standard methods have been developed eventually to check the reducibility of configurations. So it is important for proofs of the four color theorem to find the unavoidable sets of reducible configurations. But the proof for larger reducible configuration needs to check large numbers of cases in detail, which is rather complicated. In a sense, the later computer-assisted proofs of the four color theorem were gradually developed from the above two concepts and related methods.

In 1890, Heawood[42] pointed out a fatal error in Kempe's proof by constructing a counterexample. Nextly, he obtained the five color theorem by Kempe's method: All planar graphs can be normally colored with no more than five colors. Kempe admitted Heawood's counterexample, but none of them could correct the error. In the following 60 years, Heawood devoted himself exclusively to the research on the four color problem[19].

Another incorrect proof of four color problem[62] was given by Tait in 1880. His proof was based on the false assumption that each 3-connected planar graph is Hamiltonian, in which an important notion of 3-edge-coloring of a cubic plane graph was introduced. After 11 years, Petersen[57] pointed out the assumption of Tait's proof was incorrect. The 3-edge-coloring of a 3-regular graph is called Tait coloring. Tait proved that every 3-regular Hamiltonian graph contains Tait coloring, and thus believed that he had solved the four color problem based on the above false assumption. Although his error was found by Petersen[57], the explicit counterexample was not given until 1946[68]. In 1968, Grinberg obtained a necessary condition for a planar graph to have a Hamiltonian cycle[39].

The result had been widely used to construct the non-Hamiltonian planar graph. It turns out that Tait's work has an important impact on graph theory, particularly for edge coloring.

After Heawood's work, the process for solving the four color problem slowed down. The subsequent efforts were further deepening, refinement and improvement with Kempe's thought. The basic method was the smallest counterexample method, and the basic idea was to **find unavoidable sets of reducible configurations**.

The research for avoidable sets started with Wernicke's work[74] in 1904. Further, the concept of reducibility was explicitly introduced by Birkhoff[9] in 1913. Combining Kempe's idea with a new idea of himself, Birkhoff proved some larger configurations are reducible. Next, in 1922 Franklin proved that the four color conjecture is true for maps with at most 25 regions [29]; The number was increased to 27 by Reynolds in 1926[59], to 32 by Franklin in 1937[30], to 35 by Winn in 1940[76], to 39 by Ore and Stemple in 1970[55], and finally to 95 by Mayer in 1976[48]. Obviously, this method developed very slowly, and it helped little for the final solution to the four color problem.

If G is a maximal planar graph of order $n \geq 3$, then G is triangulated, that is, every face of a plane has a boundary of exactly three edges. A **configuration** of the maximal planar graph is the boundary cycle and inside part. For the four color conjecture, a set of configurations is **unavoidable** if any minimum counterexamples must contain one configuration in the set. A configuration is said to be **reducible**, if it is not contained in a planar graph which is triangulation of any minimum counterexamples.

On the research for finding unavoidable sets of reducible configurations, the great contribution was made by German mathematician Heesch[43], which became the foundation for the final solution with computer in 1976[3, 4, 5]. Heesch put forward a more systematized method which could solve the four color problem effectively. It was given to the public by him in a seminar at Hamburg University and Keele University, which attracted Haken's attention. He predicted that it might contain ten thousands of unavoidable sets of reducible configurations. But it was impossible to check the reducibility of all the configurations by hand. Moreover, he proposed another method "discharging" to prove the reducibility, which pushed forward the proof of the four color problem greatly. From 1960 to 1976, the research focused on finding unavoidable sets of reducible configurations by computer. The main contributors in the 1960s were Heesch, Haken, Durre and Shimamoto etc. And in the 1970s, Heesch, Allaire, Swart, Bernhart, Haken and Tutte etc. made great contributions on the four color problem. Among them, Shimamoto was frustrated by checking that one of his configurations was not D-reducible with computer[19].

The algorithm for checking "reducible obstacle" was proposed by Appel and Haken, which could reduce computing time greatly. With the help of John Koch, they constructed successfully a complete proof which contained unavoidable sets of 1936 kinds of reducible configurations (later reduced to 1476 kinds) in 1976[3, 4, 5]. Each configuration needs to be checked one by one with computer. This proof was rechecked independently with different programs in dif-

ferent computers. Therefore, it took about 1200 hours with three computers to validate the four color conjecture, in which the number of judgments was about 10,000,000,000.

In 1997, a simplified proof[60, 61] with the similar idea as Appel and Haken was given by Robertson, Sander, Seymour and Thomas, in which only 633 configurations in the unavoidable sets were needed to check by computer. Additionally, a new computer-assisted proof[34] was given by Georges Gonthier with general purpose theorem proving software *Coq* in 2005.

However, these proofs were all computer-assisted and hard to check by hand. Thus, a computer-free method to solve the four color problem concisely is still concerned by the whole mathematical community.

In fact, vertex coloring problem is to classify all the vertices in a graph with different colors under two constraints: one is the adjacent vertices need to receive different colors; the other one is to minimum the number of colors, that is, the number of classes in the vertex-classification. Obviously, each color class corresponds to an independent set of a graph.

In this paper, let t be the number of colors used to color the graph G , $\chi(G)$ be the chromatic number of the graph G , $f(G, t)$ be the number of all possible colorings for the labeled graph G with t colors. Obviously, if $t < \chi(G)$, the graph G can not be colored properly, so $f(G, t) = 0$; But if $\chi(G) \leq t$, the number for this coloring must exist, that is $f(G, t) > 0$. For every given planar graph G , when $t = 4$, the four color problem is equal to prove the inequality $f(G, 4) > 0$. This idea was proposed by Birkhoff to attack the four color problem in 1912[8, 9]. Later on, it was found that $f(G, t)$ is a polynomial in the number t , called the **chromatic polynomial** of the graph, which has become a fascinating branch in the field of graph theory until now[24]. But it was a pity that Birkhoff's aim had not been reached. The best result given by Tutte[69] was that if $t = \tau\sqrt{5} = 3.618\dots$ and $\tau = \frac{1}{2}(1 + \sqrt{5})$, then $f(G, \tau\sqrt{5}) > 0$. Although his result was indeed beautiful, it brushed past the four color problem, because the four color conjecture needs to prove $f(G, 4) > 0$.

An important tool used in this paper is the chromatic polynomial, which is the key to solve the four color conjecture. Some related researches are shown and discussed in Section 3 in order to make a systematic description.

Related theory and methods of the uniquely colorable graph, especially for the uniquely 4-colorable planar graph and the uniquely near k -colorable graph are the essential tool for proving the two conjectures in this paper. Similarly as the chromatic polynomial in Section 3, the advances of this field are introduced in Section 5.

Different from previous proofs, we give a novel method to prove the two conjectures in this paper, which combines the uniquely colorable graph with the chromatic polynomial. The main idea is built on the mathematical induction. First, the Delete-One-Vertex recursion formulas of chromatic polynomials are built up on the vertices of degree 4 and 5 in a maximal planar graph, respectively. And then the concept of uniquely near k -colorable graph is introduced and its basic characterization is described comprehensively. In this way, we obtain the necessary and sufficient condition for the uniquely near k -colorable graph. Fur-

thermore, the basic characterization for an uniquely 4-colorable graph is studied in detail. And we give the necessary and sufficient condition for the uniquely 4-colorable graph, which naturally solves the Frioini-Wilson-Fisk Conjecture and the Jensen-Toft Conjecture on the uniquely 4-colorable graph. Based on the results obtained above, we prove that for any maximal planar graph G , its chromatic polynomial $f(G, t)$ satisfies $f(G, 4) > 0$. Therefore, a short but strict mathematical proof is given here for the four color conjecture.

2 Relational definitions and notations

2.1 Basic notation

We begin with definitions of some useful terms we used in this paper, several of which may be non-standard. All graphs in this paper are restricted to the finite, simple and undirected ones.

In a given graph G , $V(G)$, $E(G)$, $d_G(u)$ and $\Gamma_G(u)$ denote the vertex-set, the edge-set, the vertex u 's degree and the vertices set adjacent to u respectively, which can be written as V , E , $d(u)$ and $\Gamma(u)$ for short. The number of vertices is called order of the graph G and the number of edges is called size of the graph G . Let H denote a subgraph of G if $V(H) \subseteq V(G)$, $E(H) \subseteq E(G)$, and whenever $u, v \in V(H)$ are adjacent in the graph G , they are also adjacent in the graph H . H is also called the vertex induced subgraph of G . An induced subgraph of G with vertex set V' is denoted by $G[V']$. Let u, v be two different vertices in $V(G)$, the distance between u and v is the shortest path from u to v , denoted by $d_G(u, v)$. The graph G and H are disjoint if they have no vertex in common. By starting with a disjoint union of G and H , and adding edges to make each vertex of G adjacent to each vertex of H , We can obtain the join $G \vee H$. The join $C_n \vee K_1$ which forms with a cycle and a single vertex, can be referred as a **wheel** with n spokes, denoted by W_n (the examples W_2, W_3, W_4, W_5 are shown in Figure 2.1). A graph is k -regular if all of its vertices have the same degree k . A 3-regular graph is usually called the cubic graph.

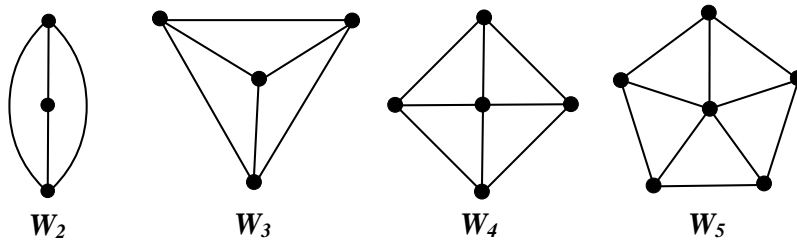

Figure 2.1. Four wheel graphs W_2, W_3, W_4, W_5 .

In order to **identify** the nonadjacent vertices u and v , it needs to replace these two vertices by a single vertex, and make it adjacent to all the edges

incident to u or v . The **contraction** of an edge $e = uv$ is to replace the end-vertex u and v with a new single vertex, connect it with other vertices which were adjacent to u or v . The resulting graph can be denoted by $G \circ e$ (or $G \circ \{u, v\}$).

2.2 Graph coloring

A **vertex coloring** of a graph G is an assignment from color-set to its vertex-set such that no two distinct adjacent vertices have the same color. A *k -vertex-coloring*, or simply a *k -coloring*, of a graph G is a mapping f from the vertex set V to the color sets $C(k) = \{1, 2, \dots, k\}$ such that $f(x) \neq f(y)$ if vertex x is adjacent to vertex y .

A graph G is *k -colorable* if it has a k -coloring. The minimum k for which a graph G is k -colorable is called its **chromatic number**, denoted by $\chi(G)$. If $\chi(G) = k$, then the graph G can be colored with k colors, but not with $k - 1$ colors. Alternatively, each k -coloring f of G can be viewed as a partition $\{V_1, V_2, \dots, V_k\}$ of V , where V_i denotes the set of vertices assigned color i . So it can be written as $f = (V_1, V_2, \dots, V_k)$. In other words, that is

$$V(G) = \bigcup_{i=1}^k V_i, V_i \neq \emptyset, V_i \cap V_j = \emptyset, i \neq j, i, j = 1, 2, \dots, k \quad (2.1)$$

where V_i is an independent set of G , $i = 1, 2, \dots, k$. The set of all k -colorings of a graph G can be denoted by $C_k(G)$. A k -colorable graph G is called **uniquely k -colorable** if each k -coloring of G induces the same partition of the vertex set V into k -independent sets.

Similarly, an **edge coloring** of a graph G [26, 27] is an assignment from color-set to its edge-set such that no two distinct adjacent edges have the same color. An *k -edge-coloring* of a graph G is an edge-coloring with k colors. A graph G is *k -edge-colorable* if it has an k -edge-coloring. The edge chromatic number, $\chi'(G)$, of G is the minimum number k for which G is k -edge-colorable. A graph G is called **uniquely k -edge-coloring** if there is unique k -edge-coloring such that any other colorings are equivalent to it. Alternatively, a graph G is uniquely k -edge-coloring if there is exactly one partition of the edge-set $E(G)$ into k matchings.

In this paper, two isomorphic graphs G and H can be written as $G \cong H$. A graph G is labeled if each vertices assign different labels, traditionally represented by integers. For a labeled graph G , two colorings are different if there is at least one vertex receives different colors. We use $f(G, t)$ to denote the number of t -colorings for a labeled graph G . It is called the **chromatic polynomial** of a graph G , which is introduced by Brikhoff to attack the four color problem in 1912[8]. More detailed researches can be found in the literatures [10, 58, 6, 69, 70, 71, 78, 77, 24].

2.3 Maximal planar graph

The **maximal planar graph** is a planar graph to which no new edges can be added without violating planarity. A **triangulation** is a planar graph in which every face is bounded by three edges(including infinite face). It can be easily proved that the maximal planar graph is equivalent to a triangulation. Thus, we can say that each maximal planar graph is a triangulation.

There exists one kind of uniquely 4-colorable planar graph G , which is called the **recursive maximal planar graph**. The graph G can be obtained from K_4 , embedding a 3-degree vertex in each triangular face continuously.

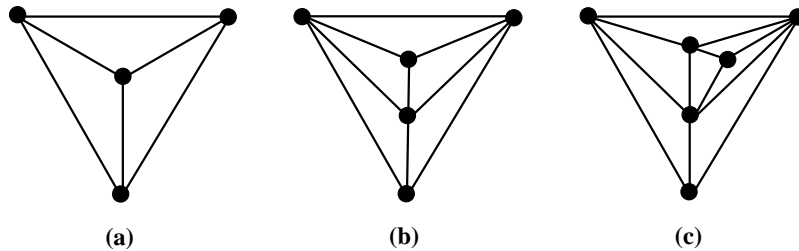

Figure 2.2. Three recursive maximal planar graphs of minimal order.

The set of all the recursive maximal planar graphs is denoted by Λ . All of this graphs with n vertices can be written as Λ_n . Let $\gamma_n = |\Lambda_n|$. Obviously, $\gamma_4 = \gamma_5 = \gamma_6 = 1$. The corresponding recursive maximal planar graphs are shown in Figure 2.2.

Each face of any maximal planar graphs is a triangle. The vertex embedding operation in the triangular face $a - b - c$ is to add the vertex u in this face, and make it adjacent to the vertices a, b, c , which can form a new maximal planar graph. This operation is denoted by $G + u$, shown in Figure 2.3.

Another operation often used in the paper is to delete the 3-degree vertex. Let G' be a maximal planar graph, and u be a 3-degree vertex. The operation for deleting 3-degree vertex u needs to delete the vertex u and all the edges incident to it. For example, the graph G can be obtained from $G' = G + u$ by deleting the 3-degree vertex u (shown in Figure 2.3).

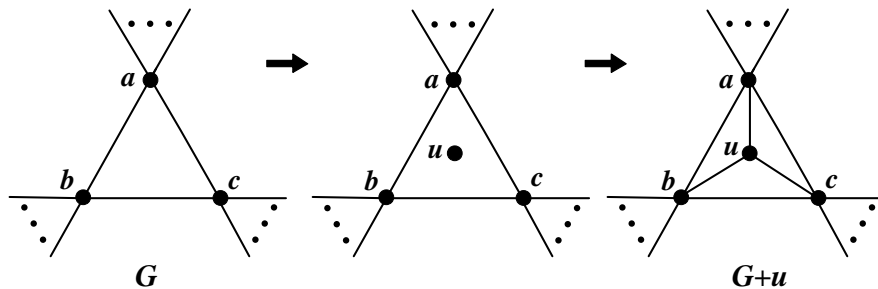

Figure 2.3. Two operations of embedding and deleting 3-degree vertex.

The definitions and notations not mentioned can be found in Boudy's new book[14].

3 Chromatic polynomial of a maximal planar graph

3.1 Introduction

Map coloring actually is a classification mode for all the countries in a map such that no two adjacent countries assigned the same color; If we convert a map into a planar graph by dual transform, then this problem will be changed into the vertex-coloring problem of a planar graph equivalently. Certainly, the vertex coloring problem of a graph is a mode of vertex partition, in which adjacent vertices must receive different colors. Accordingly, the basic scheme to attack the four color conjecture is the partition of color class for a graph. And this idea can be realized by the chromatic polynomial, which is a much useful mathematical tool. Although it is introduced for the labeled graph, which will generate a much larger number of colorings, the chromatic polynomial contains all the information on the partition of color class. Therefore, chromatic polynomial may be a preferable tool to prove the four color problem. Based on this tool, several scholars had made important contributions to attack the four color conjecture, mainly including Birkhoff[8, 9, 10], Tutte[69, 70, 71], Read[58], Whitney[75]. Among them, the best result is that for any planar graph G , the chromatic polynomial $f(G, \tau\sqrt{5}) > 0, \tau\sqrt{5} = 3.618\dots$. However, it is a pity that his result brushed past the four color problem, because the four color conjecture needs to prove $f(G, 4) > 0$.

In order to prove the four color problem, the basic idea on the chromatic polynomial proposed in this paper is to study the recurrence equations for the chromatic polynomial of a maximal planar graph directly when color number $t = 4$. Especially, the result for recurrence equations when the minimal degree $\delta(G) = 5$ points out the direction to the mathematical proof of the four color problem. These recurrence equations are not only the foundation for the final proof of the four color conjecture, but also the base to prove the necessary and sufficient condition for uniquely 4-colorable planar graphs. With the guide of the recurrence equation, we have to accomplish two tasks: one is the concept of the uniquely near k -colorable graph and the basic characterization for this graph. That is, the necessary and sufficient condition has been given for a uniquely near k -colorable graph. The other is the necessary and sufficient condition for the uniquely 4-colorable planar graph. This latter task was an unsolved conjecture proposed in 1977[26, 28]. Although F.Thomas had given a computer-assisted proof [65] in 1998, his proof was not satisfied by mathematicians. In this paper, the mathematical proofs of these two conjectures will be given, which cost me 18 years' attempt. Related results will be given in Section 3.3, 4 and 5 respectively.

3.2 Some related results on chromatic polynomial

In a given graph G , the number of t -colorings can be computed by $f(G, t)$. It was introduced by Birkhoff in 1912[8]. He hoped it is helpful to solve the four color problem, which can be stated as follows:

Theorem 3.1. *For any planar graph G without loops, it is 4-colorable if and only if $f(G, 4) > 0$.*

So far, this attempt has not been realized, but the research on chromatic polynomial attracts many scholars' interests. More detailed work on this field can be found from Birkhoff, Lewis, Read, Tutte and F.M.Dong[8, 9, 75, 58, 24]. In order to calculate the chromatic polynomial for a given graph, the basic tool is the Deletion-Contract Edge Formula.

Here the result graphs obtained by deleting and contracting edge e are denoted by $G - e$ and $G \circ e$. In the contracting operation, the graphs are assumed to be simple graph(except in one case W_2 , shown in Figure 2.1).

Lemma 3.2. [The Deletion-Contract Edge Formula.] *For a given graph G and an edge e , then:*

$$f(G, t) = f(G - e, t) - f(G \circ e, t) \quad (3.1)$$

Lemma 3.3. *Let G be the union of two subgraphs G_1 and G_2 , whose intersection is a complete graph of order k , then*

$$f(G, t) = \frac{f(G_1, t) \times f(G_2, t)}{t(t-1) \dots (t-k-1)} \quad (3.2)$$

Moreover, the recursive formula by vertex deletion[78] and the chromatic polynomial between graph and its complement[77] were given by us several years ago.

Birkhoff introduced the chromatic polynomial in order to solve the four color problem. So it is meaningful to study the chromatic polynomial of the maximal planar graph. Another beautiful work had been made by Tutte, as follows:

Theorem 3.4. [the Vertex-Elimination Formula.] *Let G be a planar graph with a wheel graph W_m as its subgraph. Then*

$$f(G, \tau^2) = (-1)^m \tau^{1-m} f(G - \nu, \tau^2) \quad (3.3)$$

where $\tau^2 = \frac{3+\sqrt{5}}{2}$

Theorem 3.5. *If G is a maximal planar graph with n vertices, then*

$$|f(G, t)| \leq \tau^{5-n}. \quad (3.4)$$

We now introduce three operations on graphs. Let G be a planar graph with a 4-circuit $C = xyzlx$. There does not exist any vertices or edges inside the circuit except a diagonal edge $e = xz$. Define θ_e as the "twisting" operation, which replaces the edge xz with the edge yl . Another operation $\varphi_e(G)$ contracts the edge xz to a single vertex x' , and deletes one member of each pair of double edges. The final operation $\Psi_e(G)$, similar as $\theta_e(G)$, contracts the edge yl instead of the edge xz . These operations are shown in Figure 3.1.

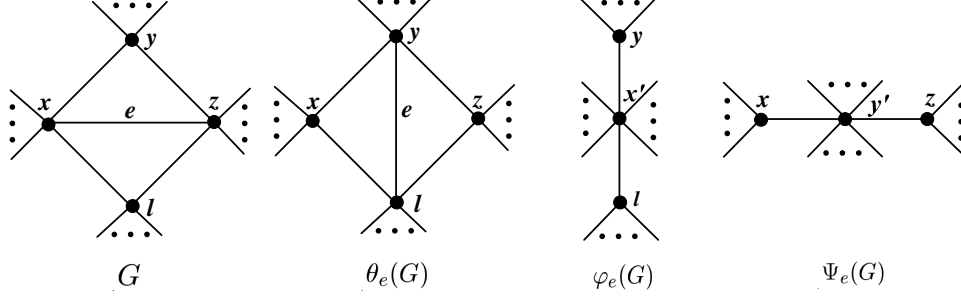

Figure 3.1. Three kinds of operations introduced for this planar graph.

With Lemma 3.1, it is easy to prove that

$$f(G, t) - f(\theta_e(G), t) = f(\Psi_e(G), t) - f(\varphi_e(G), t) \quad (3.5)$$

It holds for all the t . Let $t = \tau^2$. It can be obtained easily that

Theorem 3.6.

$$f(G, \tau^2) + f(\theta_e(G), \tau^2) = \tau^{-3} \{f(\Psi_e(G), \tau^2) + f(\varphi_e(G), \tau^2)\} \quad (3.6)$$

Notice that $\tau = \frac{1+\sqrt{5}}{2}$. So $\tau\sqrt{5} = \frac{5+\sqrt{5}}{2} = \tau + 2$. In this way, we can get

Theorem 3.7. [Golden Identity.] *Let G be a triangulation with n vertices. Then*

$$f(G, \tau\sqrt{5}) = \sqrt{5} \times \tau^{3(K-3)} f^2(G, \tau^2) \quad (3.7)$$

Theorem 3.8. *Let G be a triangulation with n vertices. Then*

$$f(G, \tau\sqrt{5}) = \sqrt{5} \times \tau^{3(K-3)} f^2(G, \tau^2) \quad (3.8)$$

Theorem 3.9. *Let G be a connected graph with at least one edge. Then $f(G, \tau + 1)$ is non-zero.*

Based on the work of Theorem (3.8) and Theorem (3.9), Tutte obtained an interesting result as follows:

$$f(G, \tau\sqrt{5}) > 0 \quad (3.9)$$

It is clear that this result is very closer to the four color theorem, which is equivalent to $f(G, 4) > 0$. But $\tau\sqrt{5} = 3.618\dots$, which is close to 4 but not 4. What a pity it is! One small false step will make a great difference.

Although Tutte's result is perfect, once it was thought that it is impossible to attack the four color problem by chromatic polynomial. Nevertheless, our works below give new hopes to solve the four color problem by chromatic polynomial.

3.3 Delete-One-Vertex recursion formula for maximal planar graphs

Here we give some useful results for the chromatic polynomial of maximal planar graphs.

Theorem 3.10. (The chromatic polynomial for the vertex contraction with 4 degree vertex) *Let G be a maximal planar graph, v a 4-degree vertex of G , and $\Gamma(v) = \{v_1, v_2, v_3, v_4\}$ (shown in Figure 3.2).*

Then

$$f(G, 4) = f(G_1, 4) + f(G_2, 4) \tag{3.10}$$

where $G_1 = (G - v) \circ \{v_1, v_3\}$, and $G_2 = (G - v) \circ \{v_2, v_4\}$

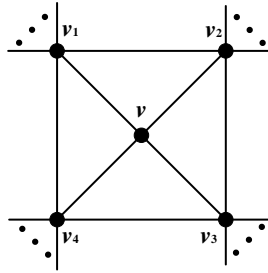
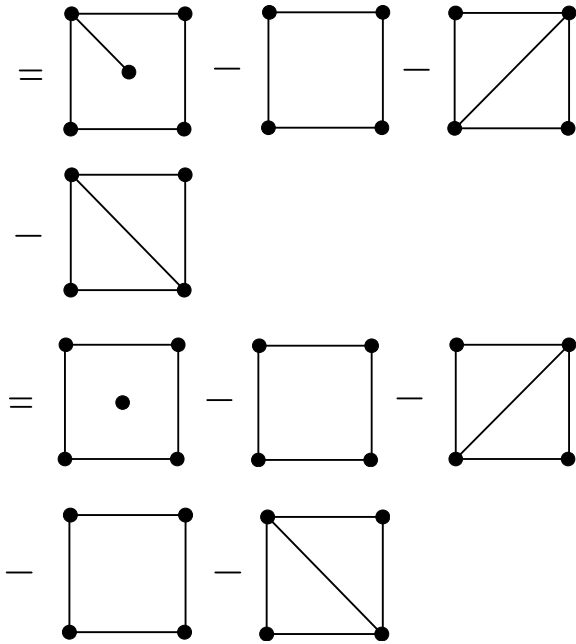

Figure 3.2. A maximal planar graph with a 4-degree vertex.

Proof. Let $v \in V(G)$, $d(v) = 4$, $\Gamma(v) = \{v_1, v_2, v_3, v_4\}$. Notice that the graph G is denoted by $G[\Gamma(v)]$ in the following derivation. Now we first compute the chromatic polynomial of the graph G by the Lemma (3.2). In ease to understand, a method introduced by Zykov is used here[82], where the chromatic polynomials are represented by the corresponding graphical graphs which appear in the chromatic polynomials in t . More details can be found in[43, 58].

$$\begin{aligned}
 f(G, t) &= \begin{array}{c} v_1 \quad v_2 \\ \bullet \quad \bullet \\ \diagdown \quad \diagup \\ \bullet \quad \bullet \\ \diagup \quad \diagdown \\ \bullet \quad \bullet \\ v_4 \quad v_3 \end{array} \\
 &= \begin{array}{c} \bullet \quad \bullet \\ \diagdown \quad \diagup \\ \bullet \quad \bullet \\ \diagup \quad \diagdown \\ \bullet \quad \bullet \end{array} - \begin{array}{c} \bullet \quad \bullet \\ \diagdown \quad \diagup \\ \bullet \quad \bullet \\ \bullet \quad \bullet \end{array} \\
 &= \begin{array}{c} \bullet \quad \bullet \\ \diagdown \quad \diagup \\ \bullet \quad \bullet \\ \bullet \quad \bullet \end{array} - \begin{array}{c} \bullet \quad \bullet \\ \bullet \quad \bullet \\ \bullet \quad \bullet \end{array} - \begin{array}{c} \bullet \quad \bullet \\ \bullet \quad \bullet \\ \bullet \quad \bullet \\ \diagdown \quad \diagup \\ \bullet \quad \bullet \end{array}
 \end{aligned}$$



By Lemma (3.3), the chromatic polynomial of the first subgraph is $t f(G - v, t)$. Therefore,

$$f(G, t) = (t - 2) \left(\begin{array}{c} \bullet \\ \bullet \\ \bullet \end{array} - \begin{array}{c} \bullet \\ \diagdown \\ \bullet \\ \diagup \\ \bullet \end{array} - \begin{array}{c} \bullet \\ \diagup \\ \bullet \\ \diagdown \\ \bullet \end{array} \right)$$

When $t=4$, we can get that

$$\begin{aligned}
f(G, 4) &= \left(\begin{array}{c} \bullet \\ \bullet \\ \bullet \end{array} - \begin{array}{c} \bullet \\ \diagdown \\ \bullet \\ \diagup \\ \bullet \end{array} \right) \\
&+ \left(\begin{array}{c} \bullet \\ \bullet \\ \bullet \end{array} - \begin{array}{c} \bullet \\ \diagup \\ \bullet \\ \diagdown \\ \bullet \end{array} \right) \\
&= \left(\begin{array}{c} \bullet \\ \bullet \\ \bullet \end{array} - \begin{array}{c} \bullet \\ \bullet \\ \bullet \end{array} + \begin{array}{c} v_2 \\ \bullet \\ \bullet \\ \bullet \\ v_4 \end{array} \right)
\end{aligned}$$

$$\begin{aligned}
& + \left(\begin{array}{c} \bullet \quad \bullet \\ | \quad | \\ \bullet \quad \bullet \\ | \quad | \\ \bullet \quad \bullet \end{array} - \begin{array}{c} \bullet \quad \bullet \\ | \quad | \\ \bullet \quad \bullet \\ | \quad | \\ \bullet \quad \bullet \end{array} + \begin{array}{c} v_1 \quad \{v_2, v_4\} \quad v_3 \\ \bullet \quad \bullet \quad \bullet \end{array} \right) \\
& = \begin{array}{c} v_2 \quad \{v_1, v_3\} \quad v_4 \\ \bullet \quad \bullet \quad \bullet \end{array} + \begin{array}{c} v_1 \quad \{v_2, v_4\} \quad v_3 \\ \bullet \quad \bullet \quad \bullet \end{array}
\end{aligned}$$

Notice that two graphs at the last line above denote $(G - v) \circ \{v_1, v_3\}$ and $(G - v) \circ \{v_2, v_4\}$ respectively, in which “ \circ ” represents the operation of vertex contraction in a graph. It is easily proved that they are both maximal planar graphs of order $n - 2$. Thus, we obtain that

$$f(G, t) = f((G - v) \circ \{v_1, v_3\}, t) + f((G - v) \circ \{v_2, v_4\}, t) = f(G_1, t) + f(G_2, t)$$

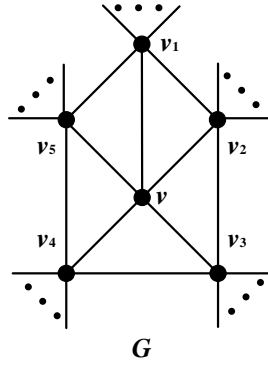

Figure 3.3. A maximal planar graph with a 5-degree vertex.

Theorem 3.11. (The chromatic polynomial for the vertex contraction with the 5-degree vertex) Let G be a maximal planar graph, v a 5-degree vertex of G , and $\Gamma(v) = \{v_1, v_2, v_3, v_4, v_5, v\}$ (shown in Figure 3.3).

Then

$$\begin{aligned}
f(G, 4) = & [f(G_1, t) - f(G_1 \cup \{v_1 v_4, v_1 v_3\}, t)] + [f(G_2, t) - f(G_2 \cup \{v_3 v_1, v_3 v_5\}, t)] \\
& + [f(G_3, t) - f(G_1 \cup \{v_4 v_1\}, t)]
\end{aligned}$$

where $G_1 = (G - v) \circ \{v_2, v_5\}$, $G_2 = (G - v) \circ \{v_2, v_4\}$, $G_3 = (G - v) \circ \{v_3, v_5\}$.

Proof. Let $v \in V(G)$, $d(v) = 5$, $\Gamma(v) = \{v_1, v_2, v_3, v_4, v_5\}$, in which adjacent relations are shown in Figure 3.3. The chromatic polynomial of graph G can be calculated by applying Lemma 3.2 repeatedly. If parallel edges appear in the process, reserve only one edge and use wheel graph W_5 to represent the chromatic polynomial of a maximal planar graph. In this way, we can obtain that

$$\begin{aligned}
 f(G,t) &= \begin{array}{c} \text{v1} \\ \bullet \\ \text{v5} \quad \bullet \quad \text{v2} \\ \quad \bullet \quad \text{v} \\ \text{v4} \quad \bullet \quad \text{v3} \end{array} \\
 &= \begin{array}{c} \bullet \\ \bullet \quad \bullet \\ \bullet \quad \bullet \\ \bullet \end{array} - \begin{array}{c} \bullet \\ \bullet \quad \bullet \\ \bullet \quad \bullet \\ \bullet \end{array} \\
 &= \begin{array}{c} \bullet \\ \bullet \quad \bullet \\ \bullet \quad \bullet \\ \bullet \end{array} - \begin{array}{c} \bullet \\ \bullet \quad \bullet \\ \bullet \quad \bullet \\ \bullet \end{array} - \begin{array}{c} \bullet \\ \bullet \quad \bullet \\ \bullet \quad \bullet \\ \bullet \end{array} \\
 &= \begin{array}{c} \bullet \\ \bullet \quad \bullet \\ \bullet \quad \bullet \\ \bullet \end{array} - \begin{array}{c} \bullet \\ \bullet \quad \bullet \\ \bullet \quad \bullet \\ \bullet \end{array} - \begin{array}{c} \bullet \\ \bullet \quad \bullet \\ \bullet \quad \bullet \\ \bullet \end{array} \\
 &- \begin{array}{c} \bullet \\ \bullet \quad \bullet \\ \bullet \quad \bullet \\ \bullet \end{array}
 \end{aligned}$$

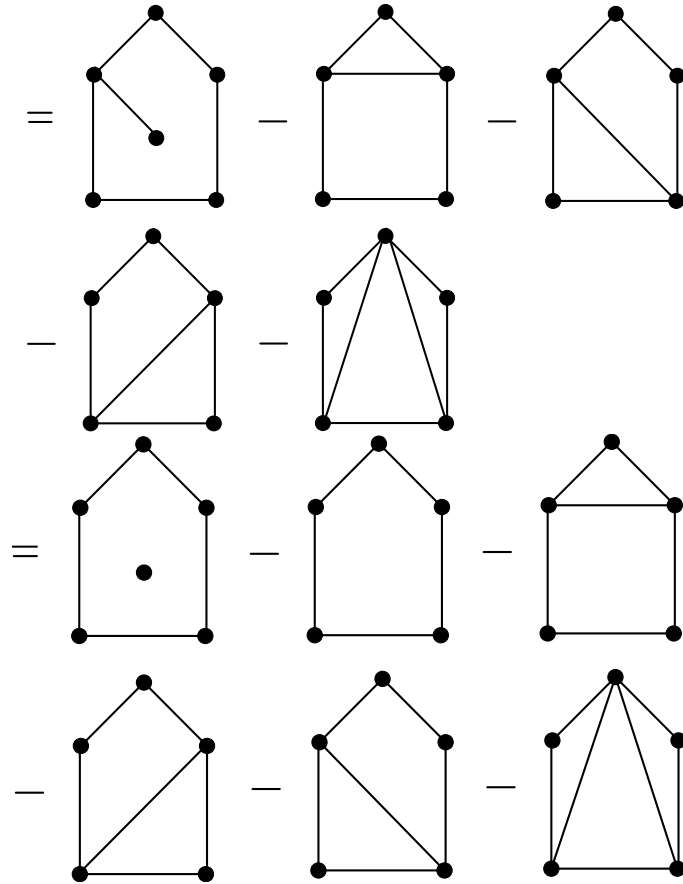

By Lemma (3.3), the chromatic polynomial of the first graph at the righthand of the last equation is $tf(G - v, t)$. Therefore, we can obtain that

$$f(G,t) = (t-1) \left(\begin{array}{c} \bullet \\ \diagup \quad \diagdown \\ \bullet \quad \bullet \\ | \quad | \\ \bullet \quad \bullet \end{array} \right) - \left(\begin{array}{c} \bullet \\ \diagup \quad \diagdown \\ \bullet \quad \bullet \\ \hline \bullet \quad \bullet \\ | \quad | \\ \bullet \quad \bullet \end{array} \right) \\
- \left(\begin{array}{c} \bullet \\ \diagup \quad \diagdown \\ \bullet \quad \bullet \\ | \quad | \\ \bullet \quad \bullet \\ \diagup \\ \bullet \end{array} \right) - \left(\begin{array}{c} \bullet \\ \diagup \quad \diagdown \\ \bullet \quad \bullet \\ | \quad | \\ \bullet \quad \bullet \\ \diagdown \\ \bullet \end{array} \right) - \left(\begin{array}{c} \bullet \\ \diagup \quad \diagdown \\ \bullet \quad \bullet \\ | \quad | \\ \bullet \quad \bullet \\ \diagup \quad \diagdown \\ \bullet \quad \bullet \end{array} \right)$$

when $t = 4$, the following equation holds:

$$f(G,4) = \left(\begin{array}{c} \bullet \\ \diagup \quad \diagdown \\ \bullet \quad \bullet \\ | \quad | \\ \bullet \quad \bullet \end{array} \right) - \left(\begin{array}{c} \bullet \\ \diagup \quad \diagdown \\ \bullet \quad \bullet \\ \hline \bullet \quad \bullet \\ | \quad | \\ \bullet \quad \bullet \end{array} \right) + \left(\begin{array}{c} \bullet \\ \diagup \quad \diagdown \\ \bullet \quad \bullet \\ | \quad | \\ \bullet \quad \bullet \end{array} \right) \\
- \left(\begin{array}{c} \bullet \\ \diagup \quad \diagdown \\ \bullet \quad \bullet \\ | \quad | \\ \bullet \quad \bullet \\ \diagup \\ \bullet \end{array} \right) + \left(\begin{array}{c} \bullet \\ \diagup \quad \diagdown \\ \bullet \quad \bullet \\ | \quad | \\ \bullet \quad \bullet \end{array} \right) - \left(\begin{array}{c} \bullet \\ \diagup \quad \diagdown \\ \bullet \quad \bullet \\ | \quad | \\ \bullet \quad \bullet \\ \diagdown \\ \bullet \end{array} \right) \\
- \left(\begin{array}{c} \bullet \\ \diagup \quad \diagdown \\ \bullet \quad \bullet \\ | \quad | \\ \bullet \quad \bullet \\ \diagup \quad \diagdown \\ \bullet \quad \bullet \end{array} \right)$$

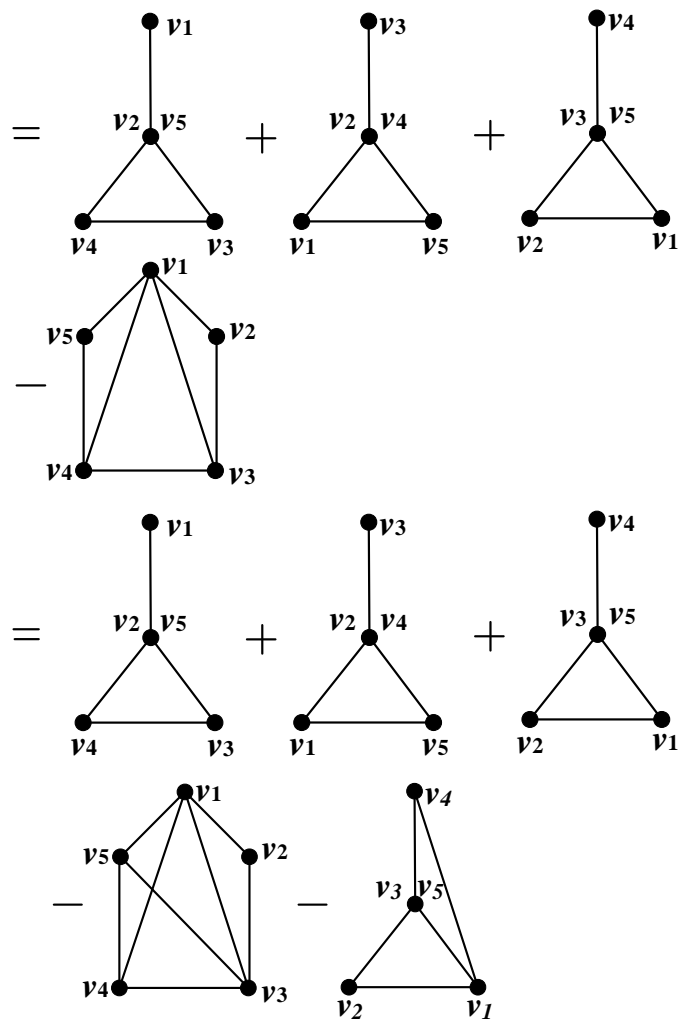

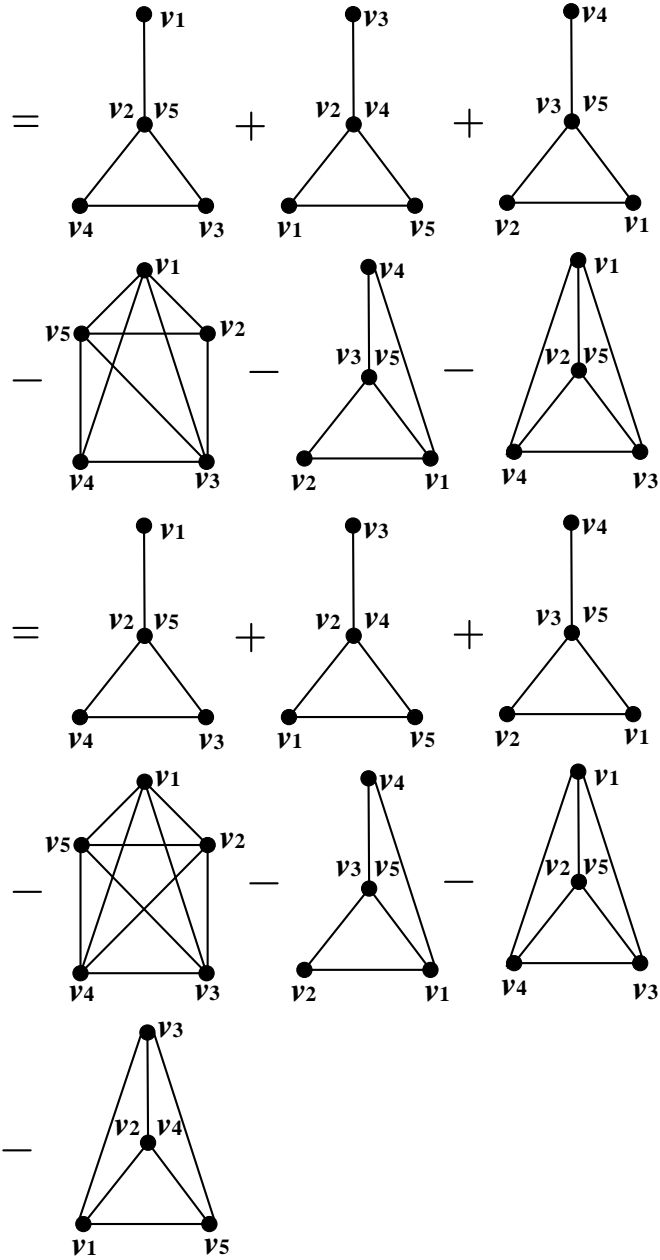

Notice that the fourth graph at the righthand of the last equation, denoted by G' , contains subgraph K_5 and so $f(G', 4) = 0$. Thus, we can obtain that

$$\begin{aligned}
f(G,4) = & \left(\begin{array}{c} \bullet v_1 \\ | \\ \bullet v_2 \bullet v_5 \\ / \quad \backslash \\ \bullet v_4 \quad \bullet v_3 \end{array} - \begin{array}{c} \bullet v_1 \\ / \quad \backslash \\ \bullet v_2 \bullet v_5 \\ / \quad \backslash \\ \bullet v_4 \quad \bullet v_3 \end{array} \right) + \left(\begin{array}{c} \bullet v_3 \\ | \\ \bullet v_2 \bullet v_4 \\ / \quad \backslash \\ \bullet v_1 \quad \bullet v_5 \end{array} \right. \\
& - \begin{array}{c} \bullet v_3 \\ / \quad \backslash \\ \bullet v_2 \bullet v_4 \\ / \quad \backslash \\ \bullet v_1 \quad \bullet v_5 \end{array} \left. \right) + \left(\begin{array}{c} \bullet v_4 \\ | \\ \bullet v_3 \bullet v_5 \\ / \quad \backslash \\ \bullet v_2 \quad \bullet v_1 \end{array} - \begin{array}{c} \bullet v_4 \\ / \quad \backslash \\ \bullet v_3 \bullet v_5 \\ / \quad \backslash \\ \bullet v_2 \quad \bullet v_1 \end{array} \right)
\end{aligned}$$

Actually, the first graph in the first bracket of the equation is $G_1 = (G - v) \circ \{v_2, v_5\}$; the first graph in the second bracket is $G_2 = (G - v) \circ \{v_2, v_4\}$; and the first graph in the third bracket is $G_3 = (G - v) \circ \{v_3, v_5\}$. This result is very important to the proof of the four color theorem, for all resulted values of each bracket are no less than zero. Obviously, The four color theorem can be proved if any bracket's value is greater than zero. It may hold for every bracket's values. Moreover, it is known that the graphs G_1, G_2 and G_3 is 4 colorable by induction, all of which are maximal planar graphs. Take the graph in the first bracket for example. In the second graph of the first bracket, the vertices v_1, v_3, v_4 and v'_2 (which is the new vertex from v_2 and v_5) can form a complete subgraph of order 4, so they have to be colored with different colors. Therefore, the four color theorem holds if there exists one kind of coloring in $C_4(G_1)$, which makes the vertex v_1 and v_3 , or vertex v_1 and v_4 receive different colors. However, it is not an easy task for proving it, which will be given on the basic of Section 4 and Section 5.

4 Uniquely near k -colorable graph

In this section, the so-called uniquely near k -colorable graphs are introduced. Their basic characters will be described in detail, including a sufficient and necessary condition for a graph to be uniquely near k -colorable. The condition is that there exist k vertices v_1, v_2, \dots, v_k in the graph G , for all the colorings $f \in C_k(G)$, the values of $f(v_1), f(v_2), \dots, f(v_k)$ are all different. This result plays an important role on the mathematical proof of the four color problem. More details will be shown in Section 6.

4.1 Some related concepts

Generally speaking, not every k -colorable graph is always an uniquely k -colorable graph. Thus, in each k -colorable graph G , does there certainly exist an induced subgraph which is uniquely k -colorable? The answer is negative. For instance,

for every odd cycle $C_{2n+1}(n \geq 2)$, its chromatic number $\chi(C_{2n+1}) = 3$. But it does not contain any uniquely 3-colorable induced subgraphs. Certainly, in a k -colorable graph G , its vertex induced subgraph H may be uniquely k -colorable.

Let the graph G be k -colorable. It is called an **uniquely near k -colorable graph** if its induced subgraph $G[V']$ has a unique k -coloring, where $V' \subset V(G)$.

Take the graph G shown in Figure 4.1 for example. It is easily known that it is a 4-colorable planar graph, but can not be uniquely 4-colorable. $V' = \{1, 2, 3, 4, 5, 6, 7\}$ is a vertex subset in the graph G . Thus, the subgraph $G[V']$ induced by V' has a unique 4-coloring. Thus, the graph G is an uniquely near 4-colorable graph, which is also planar.

In this section, the constructive method is used to describe the basic characters of an uniquely near k -colorable graph. And we will introduce a necessary and sufficient condition for a graph to be uniquely near k -colorable. Therefore, it is necessary to study deeply on $C_k(G)$. First, we need to introduce the concept of **chromatic isomorphism** by an example.

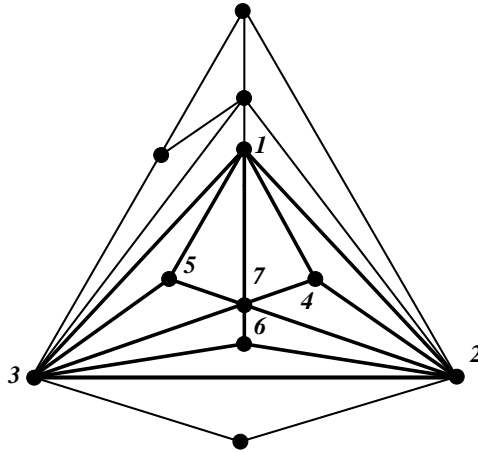

Figure 4.1. An uniquely near 4-colorable graph.

The graph shown in the Figure 4.2(x) is a 3-colorable graph with 6 vertices. Its induced subgraph by $V' = \{v_1, v_2, v_3, v_4\}$ has a unique 3-coloring. The color set is denoted by $\{1, 2, 3\}$ (shown in Figure 4.2(z)).

For the subgraph shown in Figure 4.2(y), its unique partition of color class is $\{v_1\}, \{v_2, v_4\}, \{v_3\}$. Let them receive different colors, denoted by 1, 2, 3 respectively. That is

$$\{v_1\} \rightarrow 1, \{v_2, v_4\} \rightarrow 2, \{v_3\} \rightarrow 3 \quad (4.1)$$

So we can obtain 3 kinds of colorings for the graph G (Shown in Figure 4.2(x)), denote by f_a, f_b, f_c respectively.

$$f_a = \begin{pmatrix} v_1 & v_2 & v_3 & v_4 & v_5 & v_6 \\ 1 & 2 & 3 & 2 & 1 & 2 \end{pmatrix}$$

$$f_b = \begin{pmatrix} v_1 & v_2 & v_3 & v_4 & v_5 & v_6 \\ 1 & 2 & 3 & 2 & 3 & 1 \end{pmatrix}$$

$$f_c = \begin{pmatrix} v_1 & v_2 & v_3 & v_4 & v_5 & v_6 \\ 1 & 2 & 3 & 2 & 3 & 2 \end{pmatrix}$$

These 3 kinds of colorings are shown in Figure 4.2(a),(b),(c). With the change of colors in (4.1), the corresponding new colorings are generated, similar as f_a, f_b, f_c . This graph has 18 kinds of colorings, shown in Figure 4.2. In fact, it only has 3 kinds of different partitions of color class, shown in Figure 4.2(a),(b),(c). Other colorings can be obtained by permutation with these three colorings. Here we introduce the notion of chromatic isomorphism.

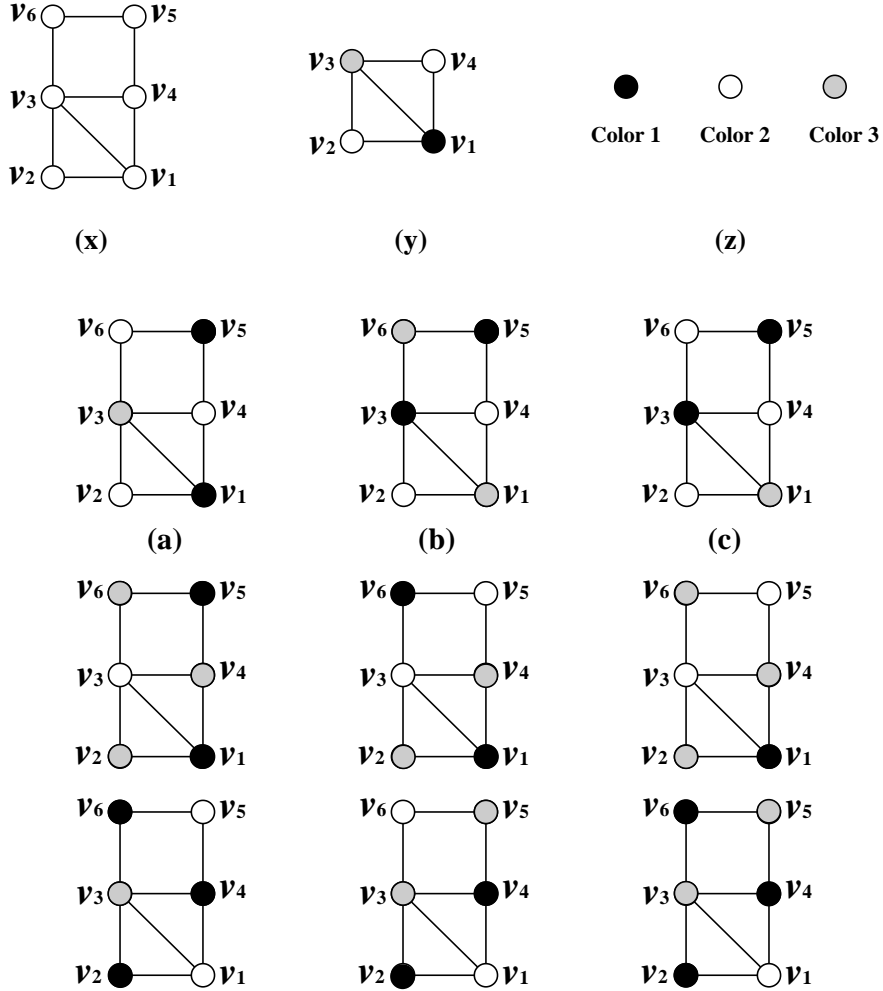

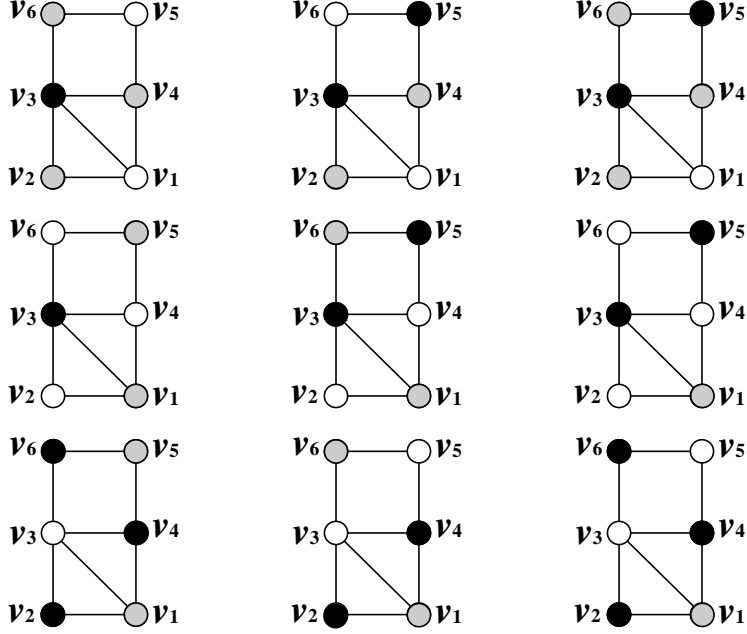

Figure 4.2. The graph G with 6 vertices and its 18 kinds of 3-colorings.

Let G be a k -colorable graph. $f_1, f_2 \in C_k(G)$. f_1, f_2 is called **chromatic isomorphic** if their partitions of coloring class are the same. One representation is taken from every chromatic isomorphic set, and the set of all the representations is called **the non-labeling coloring class** or **the chromatic isomorphic class**, denoted by $C_k^0(G)$ in this paper.

If two colorings of a graph are chromatic isomorphic, then they can be easily interconverted when their colors are adjusted properly. Therefore, these two colorings can be viewed as the same coloring. We just need to choose one of them. In Figure 4.2, it is easy to see that six colorings in every column have the same partitions of color class. Therefore, all the colorings in every column are chromatic isomorphic. So the graph G in Figure 4.2 only has three kinds of different colorings, represented by three colorings in the first row.

It is easy to prove the following theorem:

Theorem 4.1. *Let G be a k -colorable graph, which is simple and undirected. The isomorphic class of this k -colorable graph G is denoted by $C_k^0(G)$. The set of all the colorings in the graph G is denoted by $C_k(G)$. Then,*

$$|C_k(G)| = k!|C_k^0(G)| \quad (4.2)$$

Therefore, when we discuss some properties of all the k -colorings in $C_k(G)$, we only need to consider the isomorphic color class $C_k^0(G)$.

Let G be a k -colorable graph. If there exist k vertices v_1, v_2, \dots, v_k in G , for any coloring $f \in C_k(G)$, the values of $f(v_1), f(v_2), \dots, f(v_k)$ are all different.

It means that no two of these k vertices belong to the same color class for all the partitions of color class. Without loss of generality, for each partition of $C_k^0(G)$, $V(G) = V_1 \cup V_2 \cup \dots \cup V_k$, $V_i \cap V_j = \emptyset$, where $i, j = 1, 2, \dots, k$, and $V_i, i = 1, 2, \dots, k$ denote independent sets. Let v_i in the color class i , $i = 1, 2, \dots, k$. In other word, for all the functions $f \in C_k^0(G)$,

$$f(v_i) = i, i = 1, 2, \dots, k \quad (4.3)$$

The vertices v_1, v_2, \dots, v_k is called **the color coordinates** in the graph G , in which every vertex v_i is called the i -th color axis, and a k -colorable graph G is called **the k -colorable coordinated graph**. Let the graph G be a k -colorable coordinated graph. The vertices in $C_k^0(G)$ which has the same color with color axis can form a new set, denoted by V'_i . That is, it includes all the vertices in the same color class as $v_i, i = 1, 2, \dots, k$. More precisely,

$$V'_i = \bigcap_{f \in C_k^0} V_{if}, i = 1, 2, \dots, k \quad (4.4)$$

where V_{if} is the i -th color class under the coloring f , for any $f \in C_k^0(G)$.

Since that for all $f \in C_k^0(G)$, we have $v_i \in V_{if}(i = 1, 2, \dots, k)$, so $V'_i \neq \emptyset$. Let

$$V' = V'_1 \cup V'_2 \cup \dots \cup V'_k \quad (4.5)$$

$$V^c = V(G) - V' \quad (4.6)$$

4.2 Several useful lemmas

In order to describe the basic characters for a near- k colorable graph, some important lemmas are given here.

Lemma 4.2. *Let the graph G be a k -colorable coordinated graph. Let the vertices v_1, v_2, \dots, v_k be the color axis in this graph. The definitions of V' and V^c are given in (4.5) and (4.6). Then, $\forall u \in V^c$, the vertex u is adjacent to at most $k - 2$ vertices in different color classes.*

Proof. If vertex u is adjacent to other k vertices $u_1, u_2, \dots, u_k (u_i \in V'_i, i = 1, 2, \dots, k)$, then it receives a color different from other vertices u_1, u_2, \dots, u_k , which contradicts with the fact that the graph G is k -colorable. Without loss of generality, assume vertex u is adjacent to $u_1, u_2, \dots, u_{k-1} (u_i \in V'_i, i = 1, 2, \dots, k-1)$. Then for all $f \in C_k^0(G)$, $f(u) \notin \{1, 2, \dots, k-1\}$. Since the graph G is k -colorable, $f(u) = k$. So we can obtain $u \in V'_k$, which contradicts with the fact that $u \in V^c = V(G) - V'$. So the conclusion holds.

Lemma 4.3. *For all $u \in V^c$, let u be adjacent to u_1, u_2, \dots, u_m , where $u_i \in V'_i, 1 \leq i \leq m$. Then $G' = G + uv_{m+1}$ is k -colorable, where $v_{m+1} \in V'_{m+1}$.*

Proof. Assume for all $f \in C_k(G)$, $f(u) = m + 1$. Then u belongs to V'_{m+1} , which contradicts with the fact that $u \in V^c$. So there exists $f_0 \in C_k(G)$, in which $f_0(u) \in \{m + 2, \dots, k\}$. This shows that the graph $G' = G + uv_{m+1}$ is k -colorable.

Lemma 4.4. *Let G be an uniquely k -colorable graph with n vertices, and the color classes are $V(G) = V_1 \cup V_2 \cup \dots \cup V_k$. If there exists a color class with only one vertex in the unique partition of color class, denoted by $V_1 = \{v\}$, and $d_G(v) = n - 1$, then $G - v$ is an uniquely $(k - 1)$ -colorable graph, whose unique partition of color class is $V(G - v) = V_2 \cup V_3 \cup \dots \cup V_k$.*

Proof. Assume $G - v$ is not uniquely $(k - 1)$ -colorable, namely besides the partition of $(k - 1)$ -color classes $V_2 \cup V_3 \cup \dots \cup V_k$, there exists another different partition of $(k - 1)$ -color classes:

$$U_2 \cup U_3 \cup \dots \cup U_k.$$

That is $U_2 \cup U_3 \cup \dots \cup U_k = V(G - v)$, where $U_i \neq \emptyset$, U_i is an independent set of $G - v$, $i = 2, 3, \dots, k$, and $U_i \cap U_j = \emptyset$. The graph G is obtained by adding the vertex v to the graph $G - v$, making v connect with every vertices in $G - v$. Let $V_1 = \{v\}$, then $V_1 \cup V_2 \cup V_3 \cup \dots \cup V_k, V_1 \cup U_2 \cup U_3 \cup \dots \cup U_k$ are both two different partitions of k -coloring classes, which contradicts with the fact that G is uniquely k -colorable. In this way, $G - v$ is an unique $(k - 1)$ -colorable graph, and its unique partition of color classes is $V(G - v) = V_2 \cup V_3 \cup \dots \cup V_k$.

4.3 A necessary and sufficient condition

Now we prove the main result in this section, namely a necessary and sufficient condition for an uniquely near k -colorable graph.

First, if the vertex v in V^c is adjacent to some one in V'_i , we call it adjacent to V'_i .

Theorem 4.5. *The necessary and sufficient condition for a k -colorable graph G ($k \geq 2$) to be uniquely near k -colorable is that:*

There exist k vertices v_1, v_2, \dots, v_k in the graph G , for all colorings $f \in C_k(G)$, $f(v_i) \neq f(v_j)$, $i, j = 1, 2, \dots, k$.

Proof. First, we know the necessary condition holds obviously. So we give the proof of the sufficient condition, that is the graph G contains an uniquely k -colorable subgraph if it contains k vertices $v_1, v_2, \dots, v_k, \forall f \in C_k(G)$, $f(v_i) \neq f(v_j)$, $i, j = 1, 2, \dots, k$.

Our proof restricts the set $C_k(G)$ to $C_k^0(G)$. For these k vertices, for all colorings $f \in C_k^0(G)$, the values of $f(v_1), f(v_2), \dots, f(v_k)$ are all different. Here we restrict the coloring f satisfies (4.4) for all the colorings $f \in C_k^0(G)$. $V'_i, i = 1, 2, \dots, k$, V' and V^c are given in (4.5), (4.6) and (4.7) respectively.

Now we prove that induced subgraph $G[V']$ is uniquely colorable by induction on the order of V^c . If $|V^c| = 0$, this theorem holds obviously; if $|V^c| = 1$, $v \in V^c$, by lemma 4.1, v is adjacent to at most $k - 2$ color classes $V' = V'_1 \cup V'_2 \cup \dots \cup V'_k$.

Assume v is adjacent to m sets in $V'_1, V'_2, \dots, V'_k (m \leq k - 2)$. Without loss of generality, let v be adjacent to V'_1, V'_2, \dots, V'_m , the $k - m$ partitions of color classes are shown as follows:

$$\left\{ \begin{array}{l} V'_1, V'_2, \dots, V'_m, V'_{m+1} \cup \{v\}, V'_{m+2}, \dots, V'_k; \\ V'_1, V'_2, \dots, V'_{m+1}, V'_{m+2} \cup \{v\}, V'_{m+3}, \dots, V'_k; \\ V'_1, V'_2, \dots, V'_{m+2}, V'_{m+3} \cup \{v\}, V'_{m+4}, \dots, V'_k; \\ \dots, \dots, \dots, \dots, \dots; \\ V'_1, V'_2, \dots, V'_m, V'_{m+1}, \dots, V'_{k-1}, V'_k \cup \{v\}. \end{array} \right.$$

So we need to consider about all kinds of cases as follows:

Case 1. Without loss of generality, let v be adjacent to a vertex u in V'_1 , namely $d_G(v) = 1$ (shown in Figure 4.3(a)). Here we prove that $G[V']$ is uniquely k -colorable. Assume it is not, there is at least another partitions of color class besides (4.6):

$$V' = V''_1 \cup V''_2 \cup \dots \cup V''_k \quad (4.9)$$

Since that the vertex v has degree 1, assume it adjacent to $u \in V''_1$. From (4.9), the vertex v can be colored with color $2, 3, \dots, k$. This result contradicts with the fact that $\forall f \in C_k(G)$, the partition of color classes for V'_1, V'_2, \dots, V'_k keeps unchanged. So the condition is established for Case 1.

Case 2. Assume v is adjacent to r vertices in V'_1 ($2 \leq r \leq |V'_1|$). Without loss of generality, two in these r vertices is u, u' , as shown in Figure 4.3(b):

All the partitions of color class are given in (4.8) in this case. Notice that in these partitions:

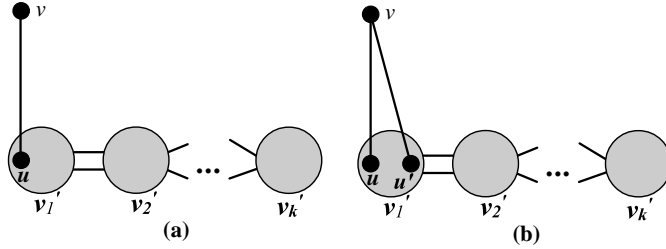

Figure 4.3. Two schematic diagrams for Case 1 and Case 2.

(1) Vertex u is not adjacent to u' in all the partitions. They also belong to the same color class.

(2) Vertex v is adjacent to u and u' , namely $vu, vu' \in E(G)$; that is, vertex v belongs to different color classes with u or u' .

Now we need to prove that the partition of color class in the graph G is equal to $G_1 = G - vu'$. That is,

$$C_k^0(G) = C_k^0(G_1 = G - vu') \quad (4.10)$$

The partition of color class in graph G can be obtained by the partition of the graph $G_1 = G - vu'$ subtracts that of the graph $G_2 = G \circ vu'$. That is,

$$C_k^0(G) = C_k^0(G_1 = G - vu') - C_k^0(G \circ vu')$$

But in $G_2 = G \circ vu'$, the vertex v receives the same color as u' ; and the vertex u is not adjacent to u' in all the partitions, which belong to the same color

class. Therefore, the vertices v, u and u' belong to the same color class, which contradicts the fact that $vu' \in E(G)$. It means the vertex v should receive a different color from the vertex u . In this way, the chromatic number of $G_2 = G \circ vu'$ is $k + 1$. So $C_k^0(G \circ vu') = \emptyset$, which proves (4.10).

By (4.10), we can obtain the following conclusion:

$$|V'_i| = t_i \geq 1, i = 1, 2, \dots, m$$

The number of vertices adjacent to v in V'_i is $r_i (1 \leq r_i \leq t_i), i = 1, 2, \dots, m$, for any values of r_1, r_2, \dots, r_m satisfied the conditions above, the partition of color class keeps unchanged. That is,

$$C_k^0(r_1, r_2, \dots, r_m) = C_k^0(1, 1, \dots, 1)$$

Where $C_k^0(r_1, r_2, \dots, r_m)$ denotes a set of all the k -partitions of color class in G when the number of vertices adjacent to v in V'_i is $r_i (1 \leq r_i \leq t_i)$. And this set satisfies the partition of color class V'_1, V'_2, \dots, V'_k for all colorings $f \in C_k(G)$.

Here only one case $C_k^0(1, 1, \dots, 1)$ is needed to consider about. That is, the number of vertices in V'_i adjacent to v is 1, where $i = 1, 2, \dots, m$.

This result can be obtained by contradiction. Assume $G[V']$ can not be uniquely colorable. It means there exists another partition of color class besides (4.6), that is

$$V' = V''_1 \cup V''_2 \cup \dots \cup V''_k$$

Since that the degree of vertex v is $m \leq k - 2$, in two colorings of $G[V']$, there exist at most $k - 2$ color classes adjacent to v . So it can be k -colorable, which contradicts the fact that the partition of color class of V'_1, V'_2, \dots, V'_k keeps unchanged. So the conclusion holds when $|V^c| = 1$.

Assume the conclusion holds when $|V^c| = p$. Now we need to consider about the case when $|V^c| = p + 1$. In this part, a constructive method is used to add edges to the graph repeatedly. Obviously, each time add one edge to the no-adjacent vertices in the original graph, the number of the possible colorings may only reduce. Therefore, some basic characters in the original graph keep unchanged, such as for all colorings $f \in C_k^0(G), f(V'_i) = i, i = 1, 2, \dots, k$

Let $u \in V^c$. Without loss of generality, let vertex u be adjacent to $m(1 \leq m \leq k - 2)$ vertices in $V'_i, i = 1, 2, \dots, m$. The constructive method is given by 4 steps as follows:

Step 1: If u is not adjacent to all the vertices in V'_1 , let u be not adjacent to $a_1 \in V'_1$. Now we connect u with a_1 by an edge, which can form a new graph $G_1 = G + ua_1$. By lemma 4.2, it can be k -colorable. And it is different from G by adding only one edge from u and a_1 . So its color classes $C_k^0(G_1)$ can be obtained by $C_k^0(G)$, and delete all the sets where vertex u and a_1 receive the same color. Since vertex u is adjacent to V'_1, u can not receive color 1 in $C_k^0(G)$. But $a_1 \in V'_1$, that is, it receives color 1 in $C_k^0(G)$. So vertex u and a_1 receive different colors in $C_k^0(G)$. It means that $C_k^0(G_1) = C_k^0(G)$.

Similarly, let u connect with all the non-adjacent vertices in V'_1 , which forms a new graph $G + uV'_1$, denoted by G_1 . Thus, $C_k^0(G_1) = C_k^0(G)$. That is, G_1 has the same partition of color class as G , namely

$$\forall f \in C_k^0(G_1), f(V'_i) = i, i = 1, 2, \dots, k$$

In the graph G , let u adjacent to all the non-adjacent vertices in V'_1, V'_2, \dots, V'_m . The obtained graph is also denoted by G_1 , namely $G_1 = G + uV'_1 + uV'_2 + \dots + uV'_m$. It satisfies $C_k^0(G_1) = C_k^0(G)$, namely

$$\forall f \in C_k^0(G_1), f(V'_i) = i, i = 1, 2, \dots, k$$

Step 2: In the graph G_1 , let u connect to any one vertex a_{m+1} in V'_{m+1} with a new edge, which forms a new graph $G_2 = G_1 + ua_{m+1}$.

These two vertices are not adjacent in G_1 , and they may belong to the same color class. So compared with $C_k^0(G_1)$, $C_k^0(G_2)$ does not contain the color class $V'_{m+1} \cup \{u\}$. The color class which contains $V'_{m+1} \cup \{u\}$ is denoted by $S(V'_{m+1} \cup \{u\})$. So we can obtain that

$$C_k^0(G_2) = C_k^0(G_1) - S(V'_{m+1} \cup \{u\})$$

Obviously, other color classes keep unchanged. So in the graph G_2 ,

$$\forall f \in C_k^0(G_2), f(V'_i) = i, i = 1, 2, \dots, k$$

Similarly as Step 1, it is easy to see in G_2 that the graph $G_1 + ua'_{m+1}$ obtained by connecting u with other nonadjacent vertex a'_{m+1} in V'_{m+1} has the same partition of color class as G_2 . Naturally, the graph $G_1 + uV'_{m+1}$ obtained by connecting u with all the nonadjacent vertices in V'_{m+1} has the same partition of color class as G_2 . That is, $C_k^0(G_1 + uV'_{m+1}) = C_k^0(G_2)$. Here $G_1 + uV'_{m+1}$ is still denoted by G_2 . Therefore, in the graph G_2 ,

$$\forall f \in C_k^0(G_2), f(V'_i) = i, i = 1, 2, \dots, k$$

Based on lemma 4.2, a similar method is given to add edges from u to other nonadjacent vertices in V'_{m+1} . Let vertex u adjacent to its nonadjacent vertices in $V'_{m+2}, V'_{m+3}, \dots, V'_{k-2}$ by adding new edges. The obtained graph is denoted by G_2 , namely

$$G_2 = G + uV'_1 + uV'_2 + \dots + uV'_m + uV'_{m+1} + \dots + uV'_{k-2} = G_1 + uV'_{m+1} + \dots + uV'_{k-2}.$$

So G_2 can be k -colorable, which satisfies that $\forall f \in C_k^0(G_2), f(V'_i) = i, i = 1, 2, \dots, k$.

Step 3: In the graph G_2 , u is not adjacent to V'_{k-1} . Now add a new edge to make vertex u adjacent to any one in V'_{k-1} , denoted by a_{k-1} . The obtained graph is G_3 , that is, $G_3 = G_2 + ua_{k-1}$. By lemma 4.2, we know that the graph G_3 is k -colorable, and it also satisfies that

$$\forall f \in C_k^0(G_3), f(V'_i) = i, i = 1, 2, \dots, k$$

However, $u \notin V^c$, so $u \in V'_k$.

Similarly, the graph G_3 , denoted by $G_3 = G_2 + uV'_{k-1}$, which is k -colorable, $u \notin V^c$, and $\forall f \in C_k^0(G_3), f(V'_i) = i, i = 1, 2, \dots, k, f(u) = k$.

Step 4: In the graph G_3 , let u be adjacent to any one a_k in V'_k , which can form a new graph G_4 . G_4 is not a k -colorable graph but a $(k + 1)$ -colorable graph. Because $C_k^0(G_3)$ denotes its all possible partitions of color class. But in the graph G_3 , u and a_k belong to the same color class V'_k . Therefore, the graph G_4 can be $(k + 1)$ -colorable. Without loss of generality, let $u = V'_{k+1}$, that is the vertex u receives the color $k + 1$. Obviously, G_4 has the following properties:

$$\forall f \in C_k^0(G_4), f(V'_i) = i, i = 1, 2, \dots, k + 1.$$

$$\begin{aligned} V'(G_4) &= V'_1 \cup V'_2 \cup \dots \cup V'_k \cup V'_{k+1} = V'_1 \cup V'_2 \cup \dots \cup V'_k \cup \{u\} = V'(G) \cup \{u\} \\ V^c(G_4) &= V^c(G) - \{u\} \end{aligned}$$

Similarly, connect vertex u with all the non-adjacent vertices in V'_k by new edges, we can obtain a new graph, still called G_4 , which has properties mentioned above.

Notice that $|V^c(G_4)| = |V^c(G) - \{u\}| = p + 1 - 1 = p$. By the assumption, the graph $G_4[V']$ is uniquely $(k + 1)$ -colorable graph, and its unique partition of color class is

$$V'(G_4) = V'_1 \cup V'_2 \cup \dots \cup V'_k \cup V'_{k+1} = V'_1 \cup V'_2 \cup \dots \cup V'_k \cup \{u\}$$

From the whole proof, we can know there is only one vertex u in color class $k + 1$ in the uniquely $(k + 1)$ -colorable graph $G_4[V'(G_4)]$, and the vertex u is adjacent to all the other vertices in $G_4[V'(G_4)]$. By lemma 4.3, we can conclude that $G_4[V'(G_4)] - u = G[V'(G)] = G[V']$ is an uniquely k -colorable graph. So we finish our proof.

5 A necessary and sufficient condition for the uniquely 4-colorable planar graph

This section, as a key to this paper, describes the characters for the uniquely 4-colorable planar graph. A sufficient and necessary condition for uniquely near 4-colorable graphs is given, namely the graph G is a recursive maximal planar graph. This work not only solves the Fiorini-Wilson-Fisk conjecture and the equivalent open conjecture proposed by Jensen-Toft on uniquely 4-colorable graph, but also is the foundation to our proof of the four color theorem in next section.

5.1 Advances on the uniquely 4-colorable planar graph

5.1.1 General results about unique vertex coloring

The definition of uniquely colorable graph came from one paper[20] of Cartwright and Harary in 1968, as well as a 1967 paper [35] of Gleason and Cartwright. A graph is uniquely colorable if there is exactly one partition of vertex set into color classes. Cartwright and Harary established some sufficient conditions for a

labeled graph to have an unique coloring. They also showed that if graph G has an unique coloring with t colors, then $t = \chi(G)$, where $\chi(G)$ is the chromatic number of G , the smallest positive integer s for which there is a coloring of G using exactly s colors. Since that, many useful work has been made in this field.

Some useful and basic properties on uniquely k -colorable graph are given by Harary, Hedetniemi and Robinson[40] in 1969, which are shown as follows:

(1) If the graph G is uniquely vertex colorable, then for all $i \neq j, i, j \in 1, 2, \dots, k$, the graph $G_{i,j}$ is connected, where $G_{i,j}$ is the induced subgraph of two color class V_i and V_j .

(2) Every k -chromatic graph of order n is $(k - 1)$ -connected, and it has at least $(k - 1)n - \frac{1}{2}k(k - 1)$ edges.

(3) For all $k \geq 3$, there exists an uniquely k -colorable graph which does not contain any subgraphs isomorphic to K_k .

(4) If G is uniquely k -colorable, H is the homomorphic image of G such that $\chi(H) = k$, then H is uniquely k -colorable.

Naturally, we may propose the problem whether there exists a uniquely k -colorable graph without K_3 , for $k \geq 3$. Until now this problem have not been solved.

In 1972, Nešetřil studied the properties of critical uniquely colorable graphs [52, 53]. Investigations about edge-critical uniquely colorable graphs were carried out by Müller[50, 51], Aksionov[2] and Melnikov & Steinberg[49].

In 1973, Wang and Artzy [73] obtained a useful conclusion that “For $k \geq 3$, if there exists a uniquely k -colorable graph which does not contain any subgraph isomorphic to K_3 , the number of vertices should be strictly greater than $k^2 + k - 1$ ”.

In 1974, Osterweil [56] constructed a kind of uniquely 3-colorable graphs, which is called 6-*cliquerings*. Moreover, he demonstrated how this techniques used to produce uniquely k -colorable graphs $k > 3$.

In 1976, Bollobas and Sauer [13] proved that “For all $k \geq 2, g \geq 3$, there exists an uniquely k -colorable graph with the girth of at least g ”. The concept of the critically uniquely k -colorable graph was introduced by Tutte and Erdos. They obtained the result that there is a critically uniquely k -colorable graph with at least n vertices. Bollobas’s result [12] was generalized by Dmitriev [21] in 1980.

In 1982, Dmitriev [23] gave some useful properties of uniquely colorable graph, such as the minimum degree, the number of edges.

In 1990, S.J Xu [80] proved that “if G is a uniquely k -colorable graph with order n and size m , then $m \geq (k - 1)n - \frac{1}{2}k(k - 1)$, which is the best possible bound”. And he gave a famous conjecture that “If G is a uniquely k -colorable graph with order n and size $(k - 1)n - \frac{1}{2}k(k - 1)$ ”, then G contains a K_k as its subgraph. At that time, Chao and Chen [17] showed that “For each integer $n \geq 12$, there exists a uniquely 3-colorable graph of order n without any triangles”.

In 2001, Akbari, Mirrokni and Sadjad negated Xu’s conjecture[1]. They gave that “There exists a K_3 -free uniquely 3-colorable graph G with 24 vertices and $SH(G) = 45$ ” edges, where $SH(G) = (k - 1)n - \frac{1}{2}k(k - 1)$ ”.

5.1.2 Uniquely edge colorable graphs

Uniquely edge colorable graphs are introduced by Greenwell and Kronk [38] in 1973. They proposed an influential conjecture that “If G is a uniquely edge-3-colorable cubic graph, then G is a planar graph with a triangle”. In 1975, Fiorini [25] independently studied the problem on uniquely edge colorable graphs. He got some similar results like Greenwell and Kronk. After that, this class of graphs was discussed detailedly by Thomason [66, 67], Fiorini and Wilson [26], C.Q Zhang [81], Goldwasser&C.Q Zhang [36, 37] and Kriesell[47].

5.1.3 Uniquely colorable planar graphs

In 1969, Chartrand and Geller [18] started to investigate uniquely colorable planar graphs. They showed that “Uniquely 3-colorable planar graphs with at least four vertices contain at least two triangles, uniquely 4-colorable planar graphs are maximal planar graphs, and uniquely 5-colorable planar graphs do not exist”.

For convenience, a useful theorem is listed as follows:

Theorem 5.1. *If G is a uniquely 4-colorable planar graph, then it is a maximal planar graph.*

Naturally, some problems on maximal planar graphs are proposed, such as the basic characters of uniquely 4-colorable planar graphs, the necessary and sufficient condition of uniquely 4-colorable planar graphs. These problems are the primary concerns about this class of graphs. Many scholars have made important contributions in this field[11, 21, 79, 80].

In 1977, Fiorini and Wilson [26] gave the following conjecture:

Theorem 5.2. *Every 3-edge-colorable cubic planar graph with at least 4 vertices contains a triangle.*

In the same year, an equivalent form was proposed as an unsolved problem by Fisk[28], so this conjecture is called the Fiorini-Wilson-Fisk Conjecture. More work on this problem can be found in the literature[28, 29, 30, 31, 32, 34]. Especially, Thomas gave a computer-assisted proof of this conjecture[65], where the method was similar as that of the four color problem. However, a strict and exact mathematical proof can not be found until now.

Uniquely 4-colorable planar graphs had attracted the interests of Jensen and Toft, whose early work had mentioned the characters of uniquely 4-colorable planar graphs. In 1995, they gave a structural characterization of uniquely 3- and 4-colorable planar graphs [44].

A class of uniquely 4-colorable planar graphs is easy to construct, denoted by Λ . It can be obtained from K_4 by repeatedly inserting new vertices of degree 3 in triangular faces. Obviously, the graphs in Λ are planar and uniquely colorable. They thought that there does not exist any planar uniquely 4-colorable graphs not belong to Λ . So they gave the following conjecture:

Theorem 5.3. *Every uniquely 4-colorable planar graph belongs to Λ .*

In 1998, Thomas [65] gave a computer-assisted proof of Conjecture 5.1 in his PHD thesis. The mathematical problems for these two conjectures have not been found until now. In this paper, we will give the mathematical proof of Conjecture 5.2.

From 1969, Chartrand and Geller [18] made important works on unique coloring of planar graph, especially for the unique colorings of 3-colorable, 4-colorable and 5-colorable graphs. Some important results were obtained as follows:

Theorem 5.4. *Let G be a planar graph whose chromatic number $\chi(G) = 3$. If G contains a triangle T such that for any vertex v in G there is a triangle sequence T, T_1, T_2, \dots, T_m , in which adjacent triangles have a common edge and $v \in T_m$, then G can be uniquely 3-colorable.*

Theorem 5.5. *If a graph G is a uniquely 3-colorable planar graph with at least 4 vertices, then it contains at least two triangles.*

Until now, the basic characters of uniquely 3-colorable graph is still unclearly. The work on uniquely 5-colorable graph is shown as follows:

Theorem 5.6. *There exists no uniquely 5-colorable planar graphs.*

In the field of uniquely 4-colorable planar graph, Chartrand and Geller obtained the following important result:

Theorem 5.7. *If G is a uniquely 4-colorable planar graph, then it is a maximal planar graph.*

However, we did not know more about whether all the maximal planar graphs are uniquely 4-colorable, and what is the basic character of uniquely 4-colorable graphs.

In 1995, Jensen and Toft gave the following conjecture[44]:

Theorem 5.8. *Every uniquely 4-colorable planar graph is a recursive maximal planar graph. That is, all the uniquely 4-colorable planar graphs of order n belong to Λ_n , denoted by $G \in \Lambda_n$. Λ_n denotes the set of recursive maximum planar graphs with n vertices.*

The recursive maximum planar graph can be obtained from K_4 , embedding new vertices of degree 3 repeatedly in triangular faces. More details can be found in next section.

In fact, an equivalent form was proposed by Fiorini and Wilson in 1977[26].

Theorem 5.9. *Every uniquely 3-edge colorable cubic planar graph with at least four vertices contains a triangle.*

In the same year, this conjecture was also proposed by Fisk[28]. Therefore, this conjecture is called the Fiorini-Wilson-Fisk conjecture (or simply the FWF conjecture). Easy to prove, these two conjectures are equivalent to each other.

In 1998, Böhme, Stiebitz and Voigt [11] proved that the minimum counterexample for conjecture 5.3 was 5-connected.

The FWF conjecture was proved by Thomas in 1998 by a computer-assisted method similar as in the proof of four color conjecture in 1997. In this paper, the structure of a recursive maximal planar graph is studied in depth. The idea of counting by partition of color class is used to prove that the necessary and sufficient condition of a uniquely 4-colorable planar graph G is that it is a recursive maximal planar graph. In this way, we can obtain a short logical and mathematical proof for the Jensen-Toft conjecture, and also solve the FWF conjecture naturally.

5.2 Recursive maximal planar graph(FWF graph)

In this section, we will prove that the necessary and sufficient condition for a uniquely 4-colorable planar graph G is being a recursive maximal planar graph. The foundation to attack this conjecture is to analyze the properties of recursive maximal planar graphs. This kind of graph is also called the FWF graph. Here we introduce one class of graphs called the (2,2)-FWF graph to prove this conjecture. Below, we give some related properties of the FWF graph, especially for the (2,2)-FWF graph.

5.2.1 Basic properties

Theorem 5.10. *If G is a FWF graph of order n , then it has at least two vertices of degree 3. And when $n \geq 5$, any two vertices of degree 3 are not adjacent to each other.*

Proof. Here we prove it by induction on the number of vertices. When $n = 4, 5$, $\gamma_4 = \gamma_5 = 1$; And the corresponding graphs are shown in the Figure 5.1.

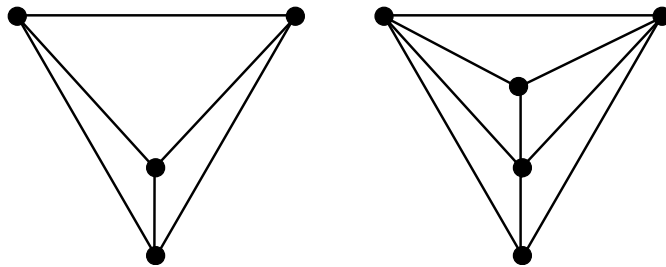

Figure 5.1. Two unique FWF graphs with 4 and 5 vertices.

So the theorem holds obviously. Assume that it holds when the number of vertices is n . That is, for any FWF graph G with n vertices, it has at least two 3-degree vertices, and all the vertices of degree 3 are not adjacent each other. Now we consider the case that the number of vertices is $n + 1$.

If a graph $G \in \Lambda_{n+1}$, then G is constructed by adding a 3-degree vertex v in any triangular face of a FWF graph with n vertices. If G has only one vertex of

degree 3, let $\Gamma_G(v) = \{v_1, v_2, v_3\}$, then $G - v$ should be a FWF graph of order n . It has at least two vertices of degree 3, and all of them are not adjacent to each other. This comes to a contradiction. Since two vertices of degree 3 in $G - v$ must be any two in $\{v_1, v_2, v_3\}$, but they are adjacent to each other. It means that there exists at least one vertex $u \notin \{v_1, v_2, v_3\}$ in $G - v$. The vertex u is a 3-degree vertex. Naturally, v is another 3-degree vertex, which is not adjacent to v . So this theorem holds.

Theorem 5.11. (1) *There exists no maximal planar graph exactly having two adjacent vertices of degree 3.*

(2) *There exists no maximal planar graph exactly having three vertices of degree 3, and each two of them are adjacent.*

Proof. Assume that G is a maximal planar graph, where $u, v \in V(G)$, $d(u) = d(v) = 3$, and $uv \in E(G)$. Since vertex u is also a 3-degree vertex, $\Gamma(u) = \{v, x, y\}$. Notice that G is a maximal planar graph, vertex u must be in the triangular face which consists of the vertices v, x and y . In other words, vertex v is adjacent to vertices x and y . These four vertices can form a subgraph K_4 (shown in Figure 5.2). Since G is a maximal planar graph, if there exist any other vertex, then it can form a triangle with u or v . It contradicts the fact that $d(u) = d(v) = 3$. Otherwise, if there exists no other vertices, then G is isomorphism to K_4 with four vertices of degree 3. Therefore, there exists no maximal planar graph with two adjacent vertices of degree 3.

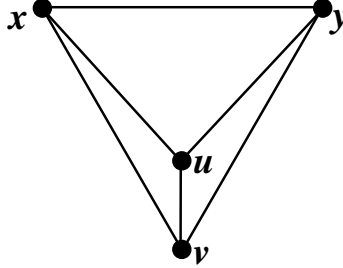

Figure 5.2. The schematic for the proof of Theorem 5.2.

Similarly, we can conclude that there exists no maximal planar graph having exactly three vertices of degree 3, and each two of them are adjacent. Let $u, v, x \in V(G)$, $d(u) = d(v) = d(x) = 3$, and $uv, ux, vx \in E(G)$. There exist three vertices in $\Gamma(u)$, two of which are v and x . Let y denote the other vertex adjacent to u . So $\Gamma(u) = \{v, x, y\}$. Since a face can be constructed with three vertices v, x and y , each two of them are adjacent. They can form an induced subgraph K_4 as shown in Figure 5.2. Since G is a maximal planar graph, if there exists any other vertex, it can form triangles with vertices u, v or x . It contradicts with the fact that $d(u) = d(v) = 3$. Otherwise, $G \cong K_4$. Obviously, K_4 contains four vertices of degree 3. Thus, there exists no maximal planar graph with three vertices of degree 3, any two of which are adjacent.

Theorem 5.12. *Let G be a maximal planar graph having only one vertex of degree 3. A subgraph without any 3-degree vertex can be obtained by deleting 3-degree vertices repeatedly.*

Proof. Let v be a unique vertex of degree 3 in graph G , and $\Gamma_G(v) = \{u_1, u_2, u_3\}$. Thus, these three vertices can form a triangle, each two of which are adjacent. Let G_1 denote $G - v$. So it is also a maximal planar graph. There are four cases may exist as follows:

- (1) $\delta(G_1) \geq 4$;
- (2) There exists only one 3-degree vertex;
- (3) There exist two 3-degree vertices;
- (4) There exist three 3-degree vertices.

For case (1), the theorem holds naturally. For case (3) and (4), we know they do not exist by Theorem 5.7. So we just need to consider about case (2). In this case, there exists a 3-degree vertex in subgraph G_1 , denoted by v_1 . Let $G_2 = G_1 - v_1$. Like the method mentioned above, if $\delta(G_2) \geq 4$, then the theorem holds. Otherwise, the graph G_2 must contain a 3-degree vertex. In this way, we can get $\delta(G_m) \geq 4$ in finite steps m . Otherwise, $G_m \cong K_4$ if G_m contains only four vertices. It means the graph G is a FWF graph. But it contains only one 3-degree vertex. It is contradicted with Theorem 5.6. Therefore, this theorem holds.

5.2.2 The (2,2)-FWF graph

In this section, we introduce and study the (2,2)-FWF graph, which is a special kind of the FWF graph. The FWF graph is called the (2,2) -FWF graph if it contains only two vertices of degree 3, and the distance between them is 2. To understand the structure of a (2,2)-FWF graph, the complete graph K_4 is divided into three regions, and then its vertices are labeled correspondingly. As is shown in Figure 5.3, the triangle is called **the outside triangle** when its vertices are labeled by 1, 2, 3, and the vertex u (also labeled by 4) is called **the central vertex**. Here we define that the vertex 1-4 are colored by yellow, green, blue and red respectively. The four vertices and their corresponding colorings are called **the basic axes in the color coordinate** of a (2,2)-FWF graphs. Four color axes are 1 (yellow), 2 (green), 3 (blue) and u (red). Obviously, there exists no (2,2)-FWF graph of order 4; and there is only one (2,2)-FWF graph with 5 vertices under isomorphism, which can be obtained by embedding a 3-degree vertex in the region *I*, *II* or *III* of the graph K_4 (shown in Figure 5.3).

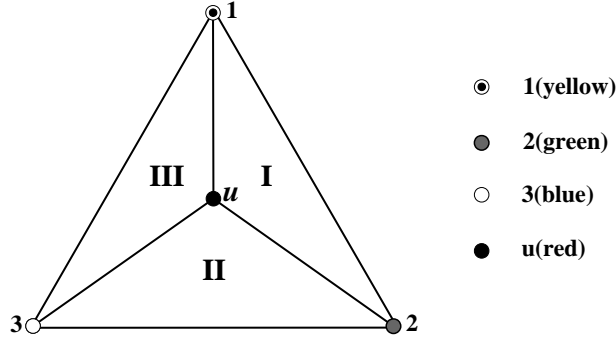

Figure 5.3. The basic framework of the color coordinates.

Without loss of generality, new vertices are added in the region *II*. Thus, the vertex is colored by yellow (Figure 5.4 (a)); the non-isomorphic (2,2)-FWF graphs of 6-order can be obtained by embedding a 3-degree vertex in any region of the (2,2)-FWF graph of 5-order. It is easy to prove that this kind of graphs with 6 vertices obtained by embedding new vertices in any face is isomorphic. Therefore, the (2,2)-FWF graphs with 6 vertices are also unique. In general, we make an agreement that the 6th vertex is embedded in the face composed of the vertices 2, 4, 5 (i.e. the sub-region *I* of the region *II*), which is colored by blue. (Figure 5.4 (b)). Apparently, the agreement makes that new vertices are added in the region *I* and *II*, but not in the region *III* of the (2,2)-FWF graphs of higher order.

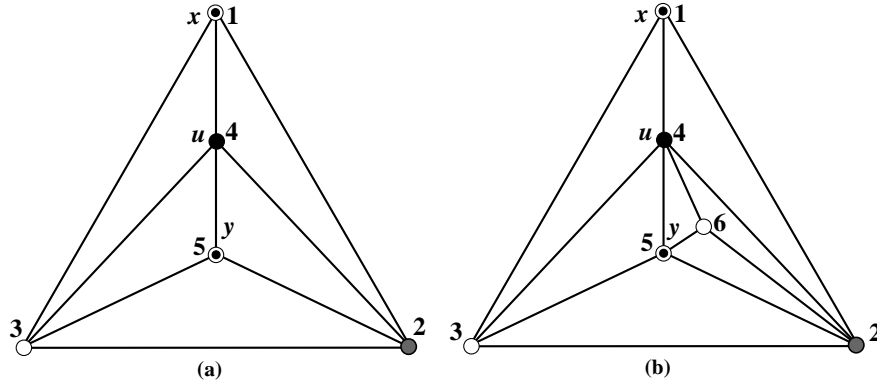

Figure 5.4. Two (2,2)-FWF graphs.
(a) a graph of order 5; (b) a graph of order 6.

Based on the definitions above, we discuss about the classification of (2,2)-FWF graphs. Two methods are introduced as follow.

The first is based on the region where the 3-degree vertices are embedded: (1) The (2,2)-FWF graphs are obtained by successively embedding the 3-degree vertices only in the region *II*. The graphs belong to this type are shown in Figure 5.5; (2) They are obtained by successively and randomly embedding the

3-degree vertices in the region I and II , as shown in Figure 5.6. An easily known fact about planar graphs is:

Proposition 5.13. *Any face in the (maximal) planar graph can become the infinite outside face.*

That is, the (2,2)-FWF graphs mentioned above are obtained by embedding 3-degree vertices randomly in the region I and II . We can transform any one 3-degree vertex in the region I or II to the outside triangular face by proposition 5.5, which is equivalent to the first classification. It means that this kind of (2,2)-FWF graphs are obtained by successively embedding 3-degree vertices only in the region II . Therefore, we only consider about this kind of graphs in the following sections.

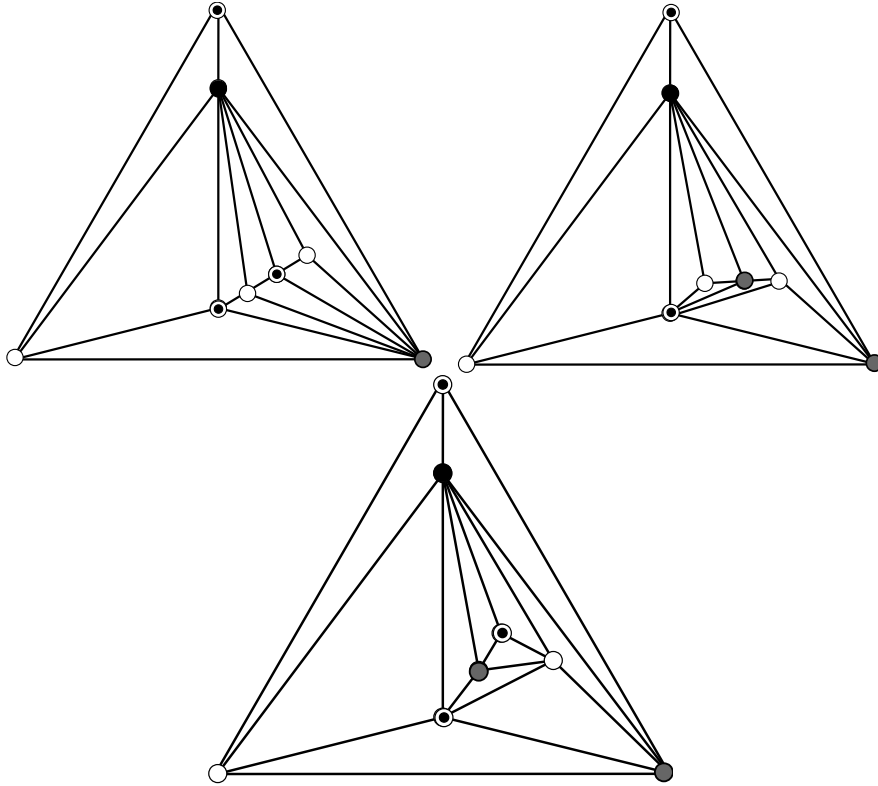

Figure 5.5. The (2,2)-FWF graphs obtained by embedding 3-degree vertices only in the region II ,
(a) the adjacent type;(b) the non-adjacent type.

The second classification is based on whether there exists a common edge between the two triangular surfaces of two 3-degree vertices. It is called the adjacent type if there is a common edge; otherwise, the non-adjacent type. As

shown in Figure 5.5, the first graph belongs to the adjacent type, while the last two graphs belong to the non-adjacent type.

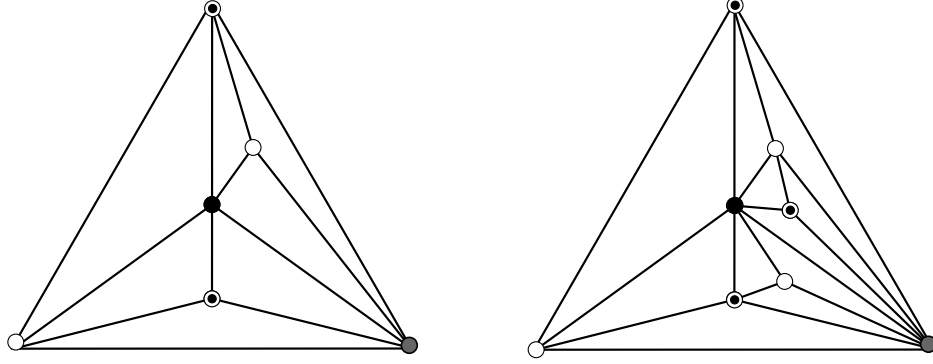

Figure 5.6. The (2,2)-FWF graphs obtained by embedding the 3-degree vertices in the region *I* and *II* randomly.

The following theorem can be deduced easily:

Theorem 5.14. (1) Every (2,2)-FWF graph G of order n has one and only one $(n - 1)$ -degree vertex, it is called **the central vertex** of the graph G , denoted by u . And in any partitions of color class in the (2,2)-FWF graph G , only the central vertex is colored by red; (2) For the adjacent type of the (2,2)-FWF graphs obtained by embedding the 3-degree vertices only in the region *II*, not only its central vertex is colored by red, but also the vertex 2 of the color axis is colored by green.

5.3 The color sequence of a (2,2)-FWF graph

Without loss of generality, we can always assume that the (2,2)-FWF graph G is obtained by embedding the 3-degree vertices only in the region *II* in the following. Thus, a (2,2)-FWF graph G can be uniquely represented by its color sequence. The specific method is shown as follows:

Let $V(G) = \{1, 2, 3, 4 = u, 5, \dots, n\}$, where vertex $1 = x$ indicates the first fixed 3-degree vertex, while the vertex $n = y$ indicates the second 3-degree vertex; the vertices $1 = x$, 2 , 3 , and $4 = u$ indicate the 1st, 2nd, 3rd, 4th color axis respectively; while the vertex $4 = u$ is the central vertex; the vertex $n - 1$ signifies the 3-degree vertex of the subgraph $G_{n-1} = G - n$; the vertex $n - 2$ denotes the 3-degree vertex of the subgraph $G_{n-1} - (n - 1)$; the rest may be deduced by analogy. The sequence $c_1 c_2, \dots, c_n$ is used to indicate the corresponding color sequence of the sequence $(1, 2, 3, 4 = u, 5, \dots, n)$, and the parameter c_i is the color of the vertex i in the (2,2)-FWF graph G . So we can obtain that

$$c_i \in \{1 = y(\text{yellow}), 2 = g(\text{green}), 3 = b(\text{blue}), 4 = r(\text{red})\}$$

According to the definition of the (2,2)-FWF graph, we can know that this representation can also determine the structure of a graph uniquely. This structure starts from K_4 (shown in Figure 5.3), and selects a triangular face embedded the vertices according to the coloring of each vertex. **Example 5.1.** For the color sequence $c_1c_2c_3c_4c_5c_6c_7c_8c_9 = ygbrybggyg$, its corresponding (2,2)-FWF graph can be analyzed easily, shown in Figure 5.7.

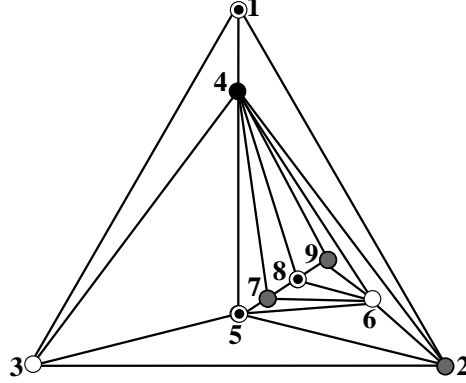

Figure 5.7. A color sequence $c_1c_2c_3c_4c_5c_6c_7c_8c_9 = ygbrybggyg$ and its corresponding (2,2)-FWF graph.

For the color sequence of a (2,2)-FWF graph, we can obtain the following theorem:

Theorem 5.15. *Let $c_1c_2 \dots c_n$ be the color sequence of a (2,2)-FWF graph. With the agreement in section 5.2, the colors of the first six vertices in this sequence is determined, namely $c_1 = y, c_2 = g, c_3 = b, c_4 = r, c_5 = y, c_6 = b$; if G belongs to the adjacent type, then $c_7 = y$; otherwise, $c_7 = g$.*

5.4 The extending 4-wheel operation

In this section, we introduce a new operation called extending 4-wheel operation, which is the inverse operation of vertex contraction. This operation is introduced to analyze the unique coloring of a (2,2)-FWF graph. To be precise, it is used to prove theorem 5.11, which is the key theorem in this paper. In this section, we will prove that the graphs obtained from a (2,2)-FWF graph by the operation of extending 4-wheel can not be uniquely 4-colorable.

5.4.1 Definitions and properties

Let G be a graph with a path of length 2. $x, u, y \in V(G)$, $x - u - y$ is a path of length 2 in G . The extending 4-wheel operation on the path $x - u - y$ is to add a new vertex u' and two edges $xu', u'y$, and then divide the edges incident to u into two parts, each part is wholly contained in one side of the path $x - u - y$ and made incident with u or u' respectively, in this way a new face $xuyu'x$ is formed

and a new 4-degree vertex v is embedded in this face. The whole process and the resulted graph are illustrated in Figure 5.8. The obtained graph is called the induced graph by extending 4-wheel operation, denoted as $G * xuy$. Here we can easily prove the following proposition:

Proposition 5.16. *If G denotes a maximal planar graph, let $x, u, y \in V(G)$, and $x-u-y$ be a path of length 2 in this graph. Then, the induced graph $G * xuy$ obtained by extending 4-wheel operation is also a maximal planar graph.*

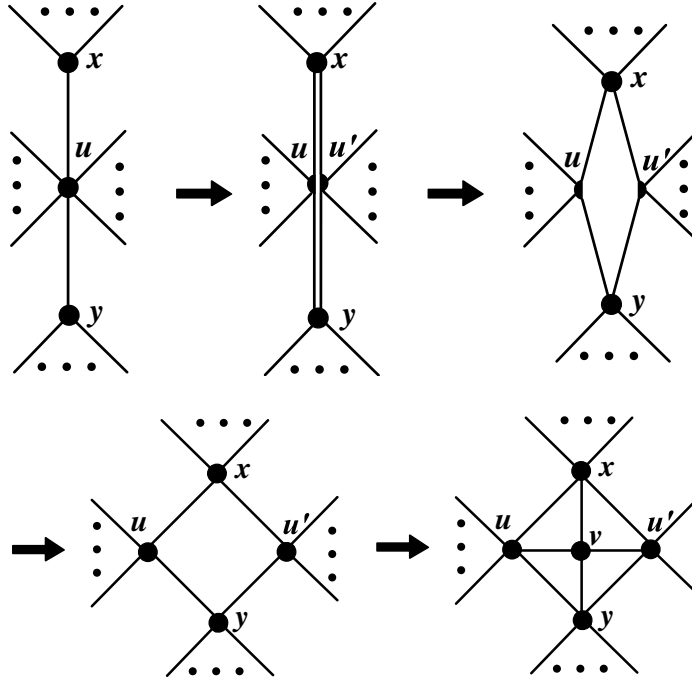

Figure 5.8. The illustration of the extending 4-wheel operation.

5.4.2 The coloring of the induced graph obtained by extending 4-wheel operation

In this section, we just discuss the vertex coloring problem of the induced graph from a (2,2)-FWF graph by extending 4-wheel operation. We know that a given (2,2)-FWF graph is uniquely 4-colorable, and according to the definition of the color coordinate in the section 4.1, every vertex can be also colored determinately. The vertex v is the central vertex of a (2,2)-FWF graph G , and two 3-degree vertices adjacent to it are the vertices x and y respectively. Obviously, the induced graph $G * xuy$ is 4-colorable, where $G * xuy$ is constructed from G by extending 4-wheel operation. This kind of coloring is called **natural coloring**. Its definition is introduced as follows:

Definition 5.1. Let G be a (2,2)-FWF graph, and $x-u-y$ is a path of length 2 in G . A natural 4-coloring of the induce graph $G * xuy$ means that vertex v

has color different from that of the vertices x , y and u , and the color of vertex u' is the same as vertex u , and other vertices have colors unchanged. Obviously, it is a 4-coloring of the graph $G * xuy$, which is called **natural 4-coloring**.

Naturally, one question is proposed whether the induced graph $G * xuy$ obtained by extending 4-wheel operation graph is uniquely 4-colorable. This question is discussed as a key problem in this section. The answer is negative, that is, $|C_4^0(G * xuy)| > 1$. Here the definition of the color neighborhood is introduced as follows:

Definition 5.2. Let G denote a k -colorable graph, and $f \in C_k(G), u \in V(G)$. The **color neighborhood** of vertex u on coloring f is a set which contains the colors of all vertices adjacent to vertex u , denoted as $C(f, \Gamma(u))$.

Theorem 5.17. *Let G be a (2,2)-FWF graph with n vertices. The vertices x , y are two vertices of degree 3 and the vertex u is the central vertex. Then, the induced graph $G * xuy$ is not uniquely 4-colorable.*

Proof. Obviously, if vertex x and y are in the same color class, since the vertices u and u' are colored by red, the vertex v in the graph G has two possible colors to choose. Hence, the graph $G * xuy$ is not uniquely 4-colorable. So we only need to consider the case that x and y belong to different color classes.

According to the classification in the subsection 5.2, all the (2,2)-FWF graphs can be classified into two types: the adjacent type and non-adjacent type both only in the region II . We treat them respectively as follows:

Case 1 : the adjacent type only in the region II .

For the graph G belong to the adjacent type only in the region II , based on the structure in Figure 5.3 and the structure in Figure 5.5(a), we know that vertex $x, 2, 3$ are coordinate axes 1, 2, 3, colored by yellow, green and blue respectively; and the central vertex u is colored by red. Since all the 3-degree vertices can only be embedded in the subregion I of the region II , the vertex y can be colored by yellow or blue, illustrated by Figure 5.9(a). But when the vertex y is colored by yellow, which is the same with vertex x , this case is not needed to consider about. So we only discuss the case that the vertex y is colored by blue. With the definition of extending 4-wheel operation, for (2,2)-FWF graph G belongs to the adjacent type only in region II , we can do an extending 4-wheel operation on the path $x - u - y$, result in a graph $G * xuy$.

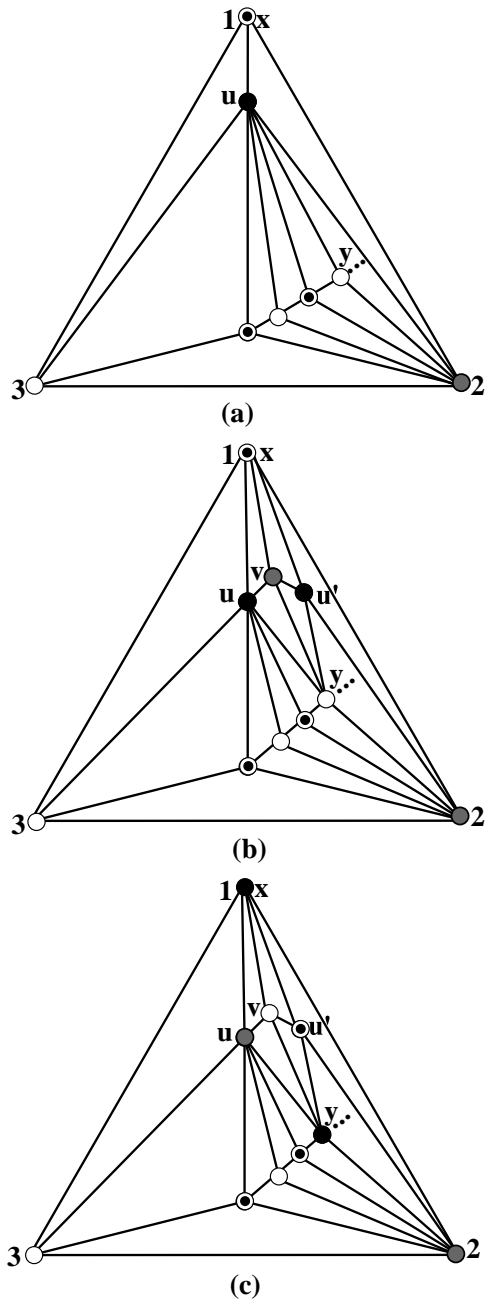

Figure 5.9. A graph belong to adjacent type only in region *II* and two colorings of its induced graph by extending 4-wheel operation.

We can easily obtain two colorings of this graph: One is the natural 4-coloring given by definition 5.1, in which the vertex u' is colored by red and the vertex v embedded newly is colored by green. And the colorings of other vertices remain unchanged. Obviously, it is a coloring of the graph $G * xuy$, illustrated in figure 5.9(b). Besides, by the discussion above, in the natural 4-coloring of $G * xuy$, in the color neighborhood of the central vertex u , the green color class has only one vertex v ; and in the color neighborhood of the vertex u' , the yellow color class has only one vertex x ; the vertices u and u' both have red colors in the graph $G * xuy$. Therefore, in the natural 4-coloring of $G * xuy$, let the vertices u, u', x, y and v be colored by green, yellow, red, red and blue respectively, other vertices remain unchanged. Clearly, this is a 4-coloring of the graph $G * xuy$, for there is only one vertex v of green color in the color neighborhood of the vertex u . Then change the color of vertex u from red to green, only vertex v has the same green color. Similarly, there is only one vertex x of yellow color in the color neighborhood of the vertex u' , so change the color of vertex u' from red to yellow, only vertex x has the same yellow color. Then these two non-adjacent vertices x and y are colored by red, the vertex v is colored by blue instead of green, and other vertices remain unchanged. It is another 4-coloring of the graph $G * xuy$, as shown in Figure 5.9(c). These two colorings are different apparently. Hence, the case 1 is proved.

Case 2: Non-adjacent type only in region II .

According to Theorem 5.10, the first six vertices of all the (2,2)-FWF graphs are colored in the same way, illustrated as follows:

$$\begin{pmatrix} 1 & 2 & 3 & 4 & 5 & 6 & \dots \\ y & g & b & r & y & b & \dots \end{pmatrix} \quad (5.1)$$

The color coordinate axes vertex 1(or vertex x), 2, 3 and 4(or vertex u) have yellow, green, blue, and red colors respectively. Vertex 1 has degree 3 and adjacent vertices of the red central vertex 4, the green vertex 2 and the blue vertex 3. Therefore, vertex 1 has degree 5 in the graph $G * xuy$, and in the natural coloring has adjacent vertices of the green vertex 2, the blue vertex 3, the red vertex 4(or vertex u), the red vertex u' and the blue vertex v respectively.

Since the graph G belongs to non-adjacent type, so the vertices $7, 8, \dots, n$ must be added in the triangular face formed by vertices 4, 5 and 6, as shown in the Figure 5.3 and Figure 5.10(a). According to Theorem 5.10, the 7th vertex only can be colored by green, illustrated as follows:

$$\begin{pmatrix} 1 & 2 & 3 & 4 & 5 & 6 & 7 & \dots \\ y & g & b & r & y & b & g & \dots \end{pmatrix} \quad (5.2)$$

Then, we can know that the green vertex 2, which is also a coordinate axis, is a 5-degree vertex. The neighborhoods of vertex 2 are vertex 1(yellow), vertex 3(blue), vertex 5(yellow), vertex u' (red) and vertex 6(blue). They are shown as follows.

$$C(f, \Gamma(1)) = \{g\{2\}, b\{3, v\}, r\{u, u'\}\} \quad (5.3)$$

$$C(f, \Gamma(2)) = \{y\{1, 5\}, b\{3, 6\}, r\{u'\}\} \quad (5.4)$$

Now we take the representative graph in Figure 5.10(a) for example, give a computing process to get a new 4-coloring from the natural 4-coloring (Figure 5.10(b)) of the induced graph $G * xuy$ by extending 4-wheel operation.

Firstly, in the natural 4-coloring of $G * xuy$, the vertex 1 is colored by green instead of yellow. By formula (5.3), the two end-vertices are both colored by green, which is a unique edge with so-called pseudo color. Other vertices are colored properly, illustrated by Figure 5.10(c).

Secondly, the vertex 2 is colored by red instead of green. Thus, the edge (1,2) is no longer with pseudo color. But the edge $(u',2)$ becomes pseudo color, for these two end-vertices are colored by red. Other vertices are all proper, illustrated by Figure 5.10(d).

Thirdly, the vertex u' is colored yellow instead of red. Thus, the pseudo color edge $(u',2)$ becomes proper. There may be several vertices colored by yellow in the color neighborhood of vertex u' , which can form a set $C_4(u', yellow)$. Therefore, this step generates several pseudo color edges whose number is $|C_4(u', yellow)|$. Obviously, other edges are all proper, illustrated by Figure 5.10(e).

Fourthly, all the vertices in $C_4(u', yellow)$ are changed to red color. Since in the 4-coloring of the third step, only two vertices u and 2 are colored by red. Obviously, $C_4(u', yellow) \subset \Gamma(u')$. So all the vertices in $C_4(u', yellow)$ are not adjacent to the vertex u . In the vertex set adjacent to vertex 2 after the third step, the vertices 1, 3 and 6 are colored by green, blue and blue. Although the vertex 5 is colored by yellow, it is a 5-degree vertex and not in $C_4(u', yellow)$. Therefore, the edges between vertex 2 and all the red vertices in $C_4(u', yellow)$ are not pseudo. Moreover, the vertices in $C_4(u', yellow)$ form an independent set of the graph. So they can not generate pseudo color edges by themselves. This step is illustrated by Figure 5.10(f).

Thus, based on the natural 4-coloring of the graph $G * xuy$, we can obtain a new coloring different from the natural 4-coloring. It means that the induced graph constructed from non-adjacent (2,2)-FWF graph by extending 4-wheel operation is not uniquely 4-colorable.

To sum up the case 1 and 2, this theorem is proved.

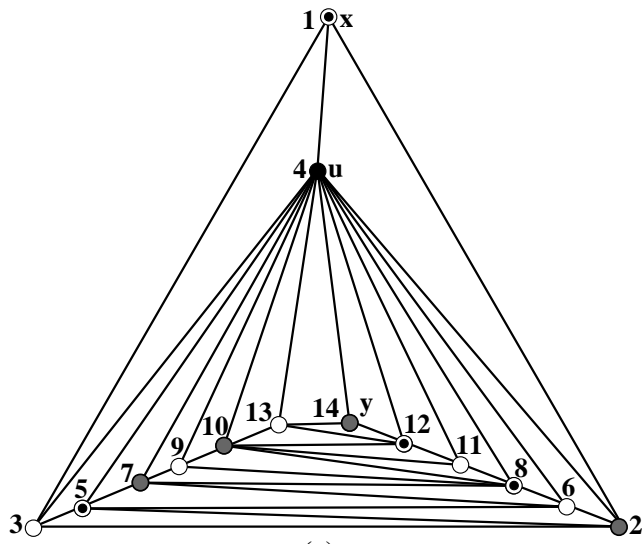

(a)
 (a): A representative (2,2)-FWF G .

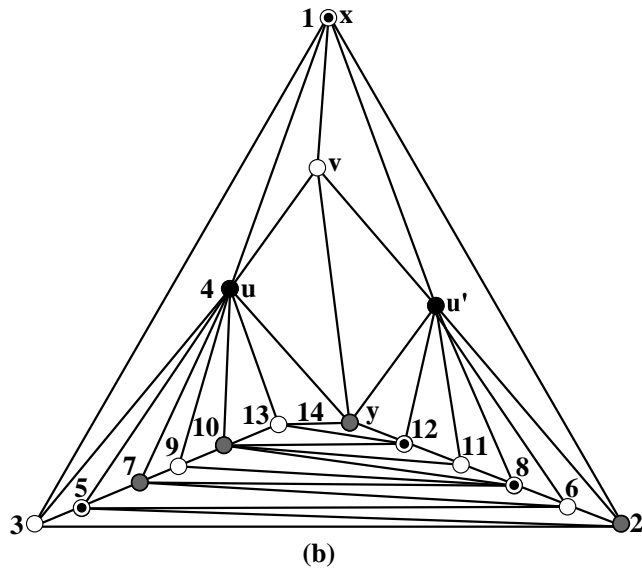

(b): The natural 4-coloring of the induced graph $G * xuy$ by extending 4-wheel operation.

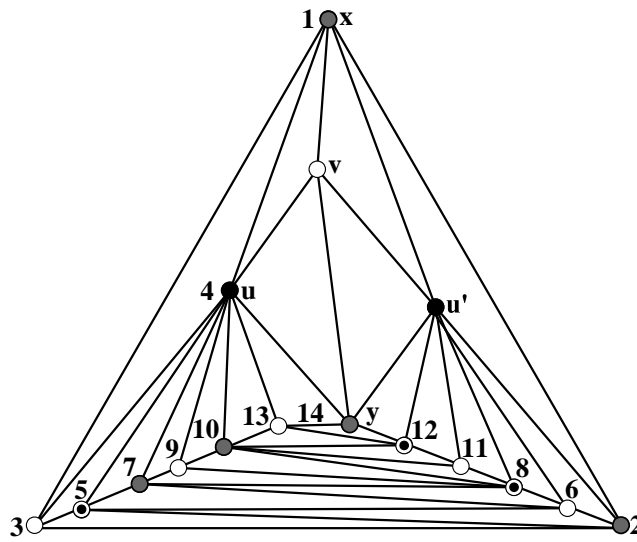

(c)

(c): The coloring of the induced graph $G * xuy$ when vertex 1 is colored by green instead of yellow, which generates a pseudo color edge $\{1,2\}$.

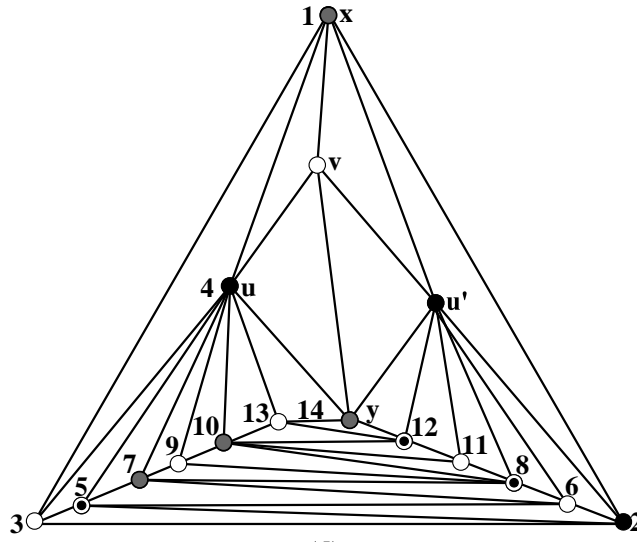

(d)

(d): The coloring of the induced graph $G * xuy$ based on the step(c) when vertex 2 is colored by red instead of green, which generates a pseudo color edge $\{u',2\}$.

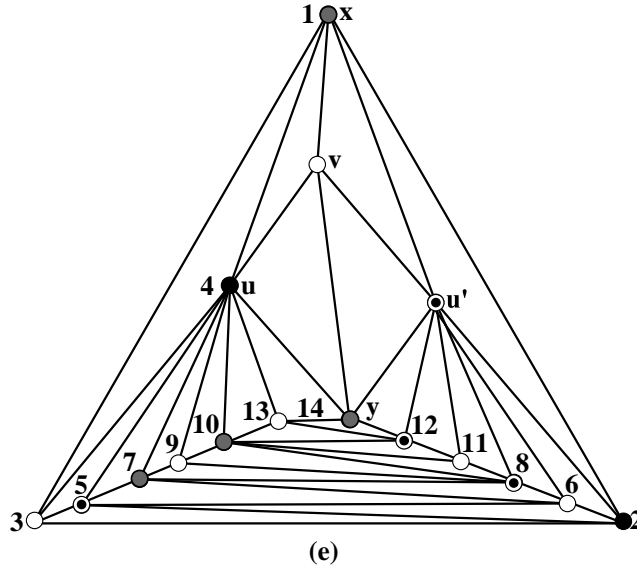

(e): The coloring of the induced graph $G * xy$ based on the step (d) when vertex u' is colored by yellow instead of red, which has several pseudo color edges $\{\{u', e''\}, u'' \in C_4(u', yellow)\}$.

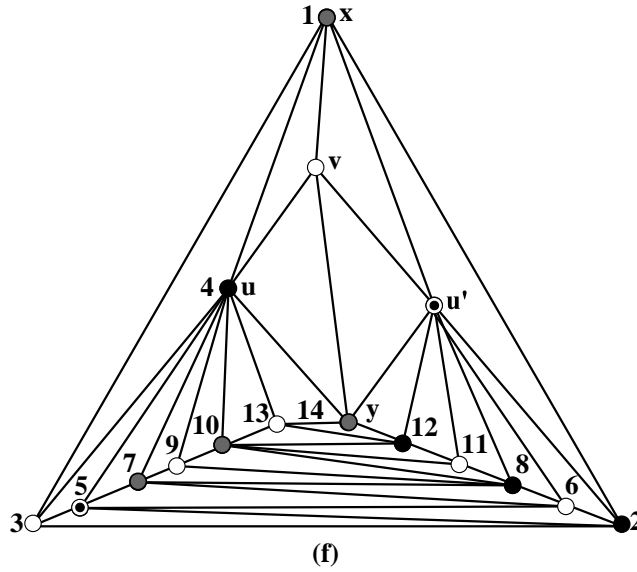

(f): Another new coloring of the induced graph $G * xy$ based on the step(e) when the vertices in the set $C_4(u', yellow)$ are colored by red.

Figure 5.10. A graph belong to adjacent type only in region II and two colorings of its induced graph by extending 4-wheel operation.

5.5 The FWF conjecture and the JT conjecture have been solved

On the basis of the previous sections, we now characterize the uniquely vertex-4-colorable planar graphs, and give a positive proof of the Jensen-Toft conjecture, and naturally also a positive proof of the FWF conjecture.

Theorem 5.18. *Let G be a 4-colorable maximal planar graph with minimum degree $\delta(G) \geq 4$, then G is not uniquely 4-colorable.*

Proof. By induction on the number of vertices n . The minimum graph which satisfies the precondition is the regular octahedron, as shown in the Figure 5.11(a). It is 3-colorable, so can not be uniquely 4-colorable. The required graph with minimum degree 5 is the regular icosahedron and not uniquely 4-colorable. Two 4-colorings of it are illustrated in Figure 5.11(b) and (c).

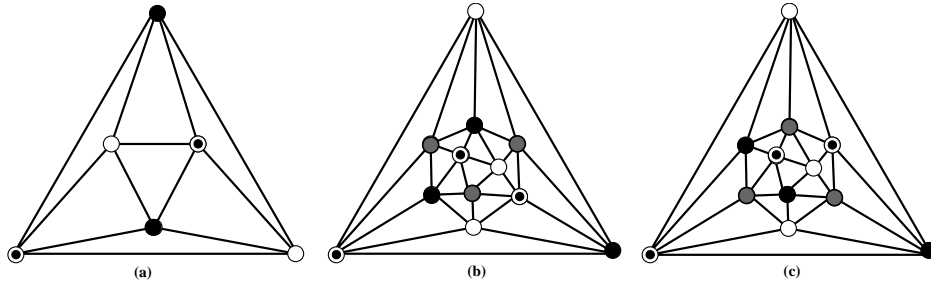

Figure 5.11. (a). A 3-coloring of the regular octahedron; (b)(c): Two colorings of the regular icosahedron.

Assume that the conclusion holds for any graph with n vertices ($n \geq 6$), we need to consider the case when the number of vertices is $n + 1$. Let G be a maximal planar graph with $n + 1$ vertices, which is 4-colorable and $\delta(G) \geq 4$. Two cases are to be considered as follows:

Case 1: $\delta(G) = 4$.

Let $v \in V(G)$, $d(v) = 4$ and $\Gamma(v) = \{v_1, v_2, v_3, v_4\}$. Notice that $G[\overline{\Gamma(v)}]$ denotes the graph G in our deduction below. Here we analyze the chromatic polynomial of the graph G .

By Theorem 3.8, we can obtain that

$$f(G, 4) = f((G - v) \circ \{v_1, v_3\}, 4) + f((G - v) \circ \{v_2, v_4\}) \quad (5.5)$$

Let $G_1 = (G - v) \circ \{v_1, v_3\}$, $G_2 = (G - v) \circ \{v_2, v_4\}$. The graph G is 4-colorable, so

$$f(G, 4) = f(G_1, 4) + f(G_2, 4) > 0 \quad (5.6)$$

By theorem 3.8, $f(G_i, 4) \geq 0, i = 1, 2$. There are two possible subcases to be considered, which are listed as follows:

Subcase 1.1: $f(G_i, 4) > 0$, for $i = 1, 2$.

In this case, without loss of generality, assume that for all colorings in $C_4(G)$, either vertex v_1 and v_3 or vertex v_2 and v_4 are in different colors, since otherwise G is not uniquely 4-colorable. There are two different partitions of color class for $C_4(G)$, one is $\{v_2, \dots\}, \{v_4, \dots\}, \{v_1, v_3, \dots\}$ and $\{v, \dots\}$ with respect to graph G_1 ; the other one is $\{v_1, \dots\}, \{v_3, \dots\}, \{v_2, v_4, \dots\}$ and $\{v, \dots\}$ with respect to graph G_2 . Obviously, these two kinds of partitions are different. Hence, the theorem holds.

Subcase 1.2: $f(G_1, 4) > 0, f(G_2, 4) = 0$; or $f(G_2, 4) > 0, f(G_1, 4) = 0$.

For all $f \in C_4(G)$, the condition $f(G_2, 4) = 0$ holds only if $f(v_2) \neq f(v_4)$. Here only the graph G_1 is needed to consider. We analyze the degrees of all the vertices in G_1 and G . They are shown as follows:

$$d_{G_1}(v_2) = d_G(v_2) - 2;$$

$$d_{G_1}(v_4) = d_G(v_4) - 2;$$

$$d_{G_1}(v'_2) = d_G(v_1) + d_G(v_3) - 4;$$

$$d_{G_1}(v_i) = d_G(v_i), i = 5, 6, \dots, n;$$

Since $\delta(G) \geq 4$, $d_{G_1}(v'_2) = d_G(v_1) + d_G(v_3) - 4 \geq 4$; for two vertices v_2, v_4 in G_1 , owing to $d_G(v_2) \geq 4$ and $d_G(v_4) \geq 4$, we can obtain that

$$2 = 4 - 2 \leq d_G(v_2) - 2 = d_{G_1}(v_2), 2 = 4 - 2 \leq d_G(v_4) - 2 = d_{G_1}(v_4).$$

Hence, there exist 4 subsubcases as follows:

Subsubcase 1.2.1: $d_{G_1}(v_2) \geq 4, d_{G_1}(v_4) \geq 4$;

Subsubcase 1.2.2: $d_{G_1}(v_2) = 2$ or $d_{G_1}(v_4) = 2$;

Subsubcase 1.2.3: $d_{G_1}(v_2) = 3, d_{G_1}(v_4) \geq 4$ or $d_{G_1}(v_2) \geq 4, d_{G_1}(v_4) = 3$;

Subsubcase 1.2.4: $d_{G_1}(v_2) = 3, d_{G_1}(v_4) = 3$;

Now we analyze these four subsubcases mentioned above respectively.

Subsubcase 1.2.1: Since $d_{G_1}(v_2) = d_G(v_2) - 2 \geq 4, d_{G_1}(v_4) = d_G(v_4) - 2 \geq 4$, The graph G_1 is a maximal planar graph with $n - 2$ vertices, in which the degrees of every vertex are equal or larger than 4. Since $n - 2 < n$, by the induction hypothesis, the graph G_1 is not uniquely 4-colorable. It can be easily proved that the following process can obtain another 4-coloring of G from each 4-coloring of G_1 in a reverse order $(d) \rightarrow (c) \rightarrow (b)$ (shown in Figure 5.10). The process starts from adding a new vertex v to the graph G_1 , then put it adjacent to v_2, v_4 and v'_2 , color the vertex v with a color (say red) different from these of v_2, v_4 and v'_2 . Then, split the vertex v'_2 into two vertices v_1 and v_3 as shown by Figure 5.10(b), and make them adjacent to the vertex v , thus we obtain a coloring of the graph G . Obviously, different colorings of the G_1 lead to different colorings of the graph G , this proves that the theorem holds for graphs of order $n + 1$ in this subsubcase.

Subsubcase 1.2.2: If any one of the degrees $d_{G_1}(v_2) = d_G(v_2) - 2$ and $d_{G_1}(v_4) = d_G(v_4) - 2$ is equal to 2, the graph G_1 is not uniquely colorable, the process is the same as the reverse order $(d) \rightarrow (c) \rightarrow (b)$ in Figure 5.10. Thus, the theorem holds for this subsubcase.

Subsubcase 1.2.3: If exact one of the degrees $d_{G_1}(v_2) = d_G(v_2) - 2$ and $d_{G_1}(v_4) = d_G(v_4) - 2$ is three, by theorem 3.8, by deleting 3-degree vertices repeatedly we can always obtain a subgraph G_m without 3-degree vertices. Hence, $\delta(G_m) \geq 4$. By the induction hypothesis, we use the similar methods as subsubcases 1.2.1 and 1.2.2. Thus, the graph G_m is not uniquely 4-colorable.

Subsubcase 1.2.4: If both of the degrees $d_{G_1}(v_2) = d_G(v_2) - 2$ and $d_{G_1}(v_4) = d_G(v_4) - 2$ are equal to three, then these two vertices v_2 and v_4 are not adjacent to each other. When the graph G_1 is not a FWF graph, the 3-degree vertices are deleted repeatedly until we can obtain a graph where all the vertices are of degrees no less than 4. By the induction hypothesis, the resulted subgraph is not uniquely 4-colorable. We can use a similar method as in above subsubcases to prove that the graph G is not uniquely 4-colorable. But when the graph G_1 is a FWF graph, it contains exact two 3-degree vertices, and the distance between them is 2. Hence, the graph G_1 is a (2,2)-FWF graph, and the graph G is the induced graph from the graph G_1 by the extending 4-wheel operation on the path of $v_2 - v'_2 - v_4$. So it is not uniquely 4-colorable by the theorem 5.11.

To sum up the above four subsubcases, the theorem holds when $\delta(G) = 4$.

Case 2: $\delta(G) = 5$.

Let $v \in V(G)$, $d(v) = 5$, $\Gamma(v) = \{v_1, v_2, v_3, v_4, v_5\}$. The adjacency relation of this graph is shown in Figure 3.3. By theorem 3.11, we can obtain that

$$\begin{aligned} f(G, 4) &= [f(G_1, t) - f(G_1 \cup \{v_1v_4, v_1v_3\}, t)] \\ &\quad + [f(G_2, t) - f(G_2 \cup \{v_3v_1, v_3v_5\}, t)] \\ &\quad + [f(G_3, t) - f(G_1 \cup \{v_4v_1\}, t)] \end{aligned} \quad (5.7)$$

where $G_1 = (G - v) \circ \{v_2, v_5\}$, $G_2 = (G - v) \circ \{v_2, v_4\}$ and $G_3 = (G - v) \circ \{v_3, v_5\}$.

Since the graph G is 4-colorable, $f(G, 4) > 0$. Hence, at least one of these equations $f(G_1, 4) > 0$, $f(G_2, 4) > 0$, $f(G_3, 4) > 0$ holds.

Without loss of generality, assume the first holds, namely $f(G_1, 4) > 0$. So G_1 can be 4-colorable. Now we discuss about the first subgraph G_1 . It is easy to prove the following conclusions:

- (1) G_1 is a maximum planar graph with $n - 2$ vertices.
- (2) The degrees of G_1 and G satisfy the following equations:
 - $d_{G_1}(v_1) = d_G(v) - 2$;
 - $d_{G_1}(v_2) = d_G(v_2) + d_G(v_5) - 3$;
 - $d_{G_1}(v_3) = d_G(v_3) - 1$;
 - $d_{G_1}(v_4) = d_G(v_4) - 1$.

Since there is only one 3-degree vertex in G_1 , by Theorem 5.8, by deleting 3-degree vertices repeated in a finite (say m) times, the resulted graph is denoted by G_m such that $\delta(G_m) \geq 4$. By the induction hypothesis, G_m is not uniquely 4-colorable. So the graph G_1 is not uniquely 4-colorable by reverse deduction.

To sum up the case 1 and 2, this theorem holds.

Lemma 5.19. *Let the graph G be a maximal planar graph, but not a FWF graph. Then, it is not uniquely 4-colorable.*

Proof. If the graph G does not contain 3-degree vertex, we can get the conclusion by Theorem 5.12. Otherwise, the 3-degree vertices can be deleted repeatedly and the resulted subgraph has no 3-degree vertex. When it comes to a maximum planar graph of order 4, it must be the complete graph K_4 , contradicted with the fact that G is not a FWF graph. Therefore, it is proved that the degree of the resulted subgraph by deleting vertices is no less than 4. This subgraph is not uniquely 4-colorable by Theorem 5.12 above. Then we add back all the deleted vertices and set colors to them properly, so that G is not uniquely 4-colorable either.

Based on the lemma 5.1 above and the fact that each FWF graph is uniquely 4-colorable, we can obtain the following theorem.

Theorem 5.20. *A necessary and sufficient condition for a planar graph G to be uniquely 4-colorable is that G is a FWF graph. In other words, a necessary and sufficient condition for a planar graph G of order n to be uniquely 4-colorable is that $G \in \Lambda_n$.*

6 The mathematical proof of the four color theorem

Based on works in section 3, 4 and 5, we give the mathematical proof of four color theorem in this section.

Theorem 6.1. *Let G be a maximal planar graph. Then, $f(G, 4) > 0$.*

Proof. By induction on the number of vertices n .

When $n = 3, 4, 5$, this theorem holds obviously.

Assume that this theorem holds when the graph order is no less than 5 and no larger than $n - 1$. We consider the case that the order of graphs is n . We only consider the simple maximal planar graph. For any maximal planar graph G , it satisfies $3 \leq \delta(G) \leq 5$. So we need to consider these three cases based on the minimum degree.

Case 1: $\delta(G) = 3$;

Let $v \in V(G)$, $d(v) = 3$, and $G_1 = G[\overline{\Gamma(v)}]$, $G_2 = G - v$. Then we can obtain that

$$G_1 \cap G_2 = G[\Gamma(v)] \cong K_3 \tag{6.1}$$

Notice that $G_1 = G[\overline{\Gamma(v)}] \cong K_4$, we can obtain the following result by Lemma 3.2:

$$f(G, t) = f(G_1 \cup G_2, t) = \frac{f(G_1, t) \times f(G_2, t)}{f(K_3, t)} = (t - 3)f(G_2, t) \tag{6.2}$$

By the hypothesis of induction, $f(G_2, 4) > 0$. Thus, $f(G, 4) = f(G_2, 4) > 0$.

Hence, the theorem holds when $\delta(G) = 3$.

Case 2: $\delta(G) = 4$;

Let $v \in V(G)$, $d(v) = 4$, $\Gamma(v) = \{v_1, v_2, v_3, v_4\}$. This case is shown in Figure 3.2. Notice that we use $G[\overline{\Gamma(v)}]$ to denote G . By Theorem 3.8, we can obtain that $f(G, 4) = f(G_1, 4) + f(G_2, 4)$, where $G_1 = (G - v) \circ \{v_1, v_3\}$ and $G_2 = (G - v) \circ \{v_2, v_4\}$. It is easy to prove that the graph G_1 and the graph G_2 are both maximal planar graphs with $n - 2$ vertices. By the induction's hypothesis, we can obtain:

$$f(G_1, 4) = f((G - v) \circ \{v_1, v_3\}, 4) > 0 \quad (6.3)$$

$$f(G_2, 4) = f((G - v) \circ \{v_2, v_4\}, 4) > 0 \quad (6.4)$$

Therefore,

$$f(G, 4) = f(G_1, 4) + f(G_2, 4) > 0 \quad (6.5)$$

Hence, the theorem holds when $\delta(G) = 4$.

Case 3: $\delta(G) = 5$;

Let $v \in V(G)$, $d(v) = 5$, $\Gamma(v) = \{v_1, v_2, v_3, v_4, v_5\}$. The adjacent relation is shown in Figure 3.3. By Theorem 3.9, we can obtain

$$\begin{aligned} f(G, 4) &= [f(G_1, 4) - f(G_1 \cup \{v_1v_4, v_1v_3\}, 4)] \\ &\quad + [f(G_2, 4) - f(G_2 \cup \{v_3v_1, v_3v_5\}, 4)] \\ &\quad + [f(G_3, 4) - f(G_1 \cup \{v_4v_1\}, 4)] \end{aligned} \quad (6.6)$$

where $G_1 = (G - v) \circ \{v_2, v_5\}$, $G_2 = (G - v) \circ \{v_2, v_4\}$ and $G_3 = (G - v) \circ \{v_3, v_5\}$.

Now we consider about the graph $G_1 = (G - v) \circ \{v_2, v_4\}$. It is easy to prove the following conclusions:

- (1) G_1 is a maximal planar graph with $n - 2$ vertices.
- (2) The degrees of the vertex in G_1 and G satisfy the following equations:

$$d_{G_1}(v_1) = d_G(v) - 2;$$

$$d_{G_1}(v_2) = d_G(v_2) + d_G(v_5) - 3;$$

$$d_{G_1}(v_3) = d_G(v_3) - 1;$$

$$d_{G_1}(v_4) = d_G(v_4) - 1.$$

Therefore, G_1 can be 4-colorable by the hypothesis of induction.

Notice that the graph $G_1 \cup \{v_1v_4, v_1v_3\}$ is obtained by only adding two edges v_1v_3, v_1v_4 in the graph G_1 . So if we can prove $\exists f \in C_4(G_1)$ such that $f(v_1) = f(v_3)$ or $f(v_1) = f(v_4)$, then we can obtain

$$f(G_1, 4) > f(G_1 \cup \{v_1v_3, v_1v_4\}, 4) \quad (6.7)$$

Then,

$$f(G, 4) = [f(G_1, t) - f(G_1 \cup \{v_1v_4, v_1v_3\}, t)]$$

$$\begin{aligned}
&+[f(G_2, t) - f(G_2 \cup \{v_3v_1, v_3v_5\}, t)] \\
&+[f(G_3, t) - f(G_1 \cup \{v_3v_1\}, t)]
\end{aligned} \tag{6.8}$$

where $f(G_2) - f(G_2 \cup \{v_3v_1, v_3v_5\}, t) \geq 0$, $f(G_3, t) - f(G_1 \cup \{v_3v_1\}, t) \geq 0$. But $f(G_1, t) - f(G_1 \cup \{v_1v_4, v_1v_3\}, t) > 0$. Therefore, $f(G, 4) > 0$.

Now we need to prove that such a coloring f exists.

Assume that $\forall f \in C_4(G_1)$, the values of $f(v_1), f(v_2), f(v_3), f(v_4)$ are different from each other. Let $f(v_i) = i, (i = 1, 2, 3, 4)$. By Theorem 4.2, we can know that there exists a vertex subset V' which contains vertices v_1, v_2, v_3 and v_4 in the graph G_1 . And its induced subgraph is uniquely 4-colorable. If the graph G_1 is uniquely 4-colorable, that is, $G'_1 = G_1[V'] = G_1$. By Theorem 5.13, we can know that graph G_1 is a recursive maximal planar graph. From Theorem 5.6, it at least contains two 3-degree vertices. But for $\delta(G) = 5$ and the analysis above, the graph G_1 contains at most one 3-degree vertex(v_1). It becomes a contradiction. It indicates that it is not correct for the hypothesis that any two values of $f(v_1), f(v_2), f(v_3), f(v_4)$ are all different. Notice that vertex v_2 is adjacent to the vertices v_1, v_3, v_4 in the graph G_1 . Thus, $\exists f \in C_4(G_1)$ such that $f(v_1) = f(v_3)$ or $f(v_1) = f(v_4)$.

If the graph G_1 is not uniquely 4-colorable, the induced subgraph $G'_1 = G_1[V']$ by G_1 is a proper subset of G_1 . Notice that $G'_1 = G_1[V']$ is an uniquely 4-colorable maximal planar graph. So it is also a FWF graph. Thus, the boundary of $G'_1 = G_1[V']$ in G_1 is a triangle(a triangle including the infinite face). Let u_1, u_2, u_3 be three vertices of this triangle. Then, $v_1, v_3, v_4 \notin \{u_1, u_2, u_3\}$ (shown in Figure 6.1).

Next we will prove that $G_1[V']$ is not a FWF graph actually.

Case 1: If $G_1[V']$ at most contains only one 3-degree vertex, it is certainly not a FWF graph;

Case 2: There exists at most one 3-degree vertex in $\{u_1, u_2, u_3\}$. Let u_1 be the 3-degree vertex. Then, there may exist any vertices of degree 3, denoted by v_1 . $d(v_1) = 3$. But in the graph $G'_1[V'] - v_1$, there exists only one 3-degree vertex u_1 . Therefore, $G_1[V'] - v_1$ is not a FWF graph. And the graph $G_1[V']$ is not either.

Case 3: There exist at least two vertices of degree 3 in $\{u_1, u_2, u_3\}$ in $G_1[V']$. But this case does not exist by Theorem 5.7.

To sum up the case 1, 2 and 3, we know that $G_1[V']$ is not a recursive maximal planar graph. It means that the hypothesis that all the values of $f(v_1), f(v_2), f(v_3)$ and $f(v_4)$ are different is not correct. From the proof above, $\exists f \in C_4(G_1)$, the equations $f(v_1) = f(v_3)$ or $f(v_1) = f(v_4)$ holds.

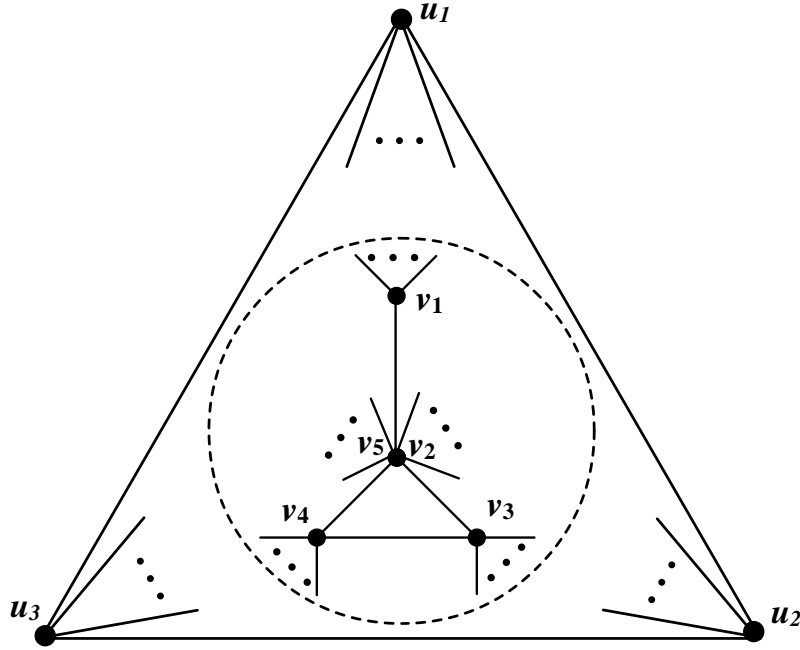

Figure 6.1. The schematic for the proof of Theorem 6.1.

In the same way, we can prove that the value of the second bracket is larger than zero. Obviously, the difference of two chromatic polynomials in the third bracket is no less than zero. So the conclusion holds when $\delta(G) = 5$. Therefore, the four color theorem is proved completely.

7 Conclusion

In this paper, with the idea of the color class partition as main thread, with the vertex contraction formula of the chromatic polynomials (Theorem 3.8 and 3.9) as basic tool, we first mathematically prove the conjecture of uniquely 4-colorable planar graphs, namely a necessary and sufficient condition for a 4-colorable maximal planar graph G to be uniquely 4-colorable is that G is a recursive maximal planar graph. This conjecture was put forward independently by several scholars in 1977 [26, 28]. In order to prove the four color conjecture, the concept of uniquely near k -colorable graphs is proposed, the basic characters of these graphs are studied, and a necessary and sufficient condition for a graph to be uniquely near k -colorable is obtained that there exist k vertices belong to different color classes in any k -coloring partition. The mathematical proof of four color conjecture is based on these three aspects: Theorem 3.8 and Theorem 3.9; the necessary and sufficient condition of uniquely 4-colorable planar graph; and the necessary and sufficient condition of uniquely near k -colorable graph.

In fact, in this paper we prove that the configuration W_5 is reducible, in other words, we find four reducible unavoidable configurations W_2, W_3, W_4 and W_5 as shown by Figure 2.1. Apparently, they constitute a minimum reducible unavoidable configuration set.

The four color conjecture was put forward in 1852 (some investigations were even earlier, in about 1840), so far it has passed 157 years. Although the computer-assisted proof was given in 1976 and in fact was admitted by some mathematicians, especially by Tutte, a more brief proof with mathematical and logical reasoning is expected by most or even all of mathematicians. The work in this paper should fulfil this expectation.

Through the proof of the four color conjecture in this paper, we can obtain a useful “perception” that to attack any mathematical problem and even non-mathematical problem, the best way might be to start from the very original point of it. As mentioned before, the graph coloring problem is just to classify the vertices in a graph, subject to constraints of number of colors and that adjacent vertices have different colors. In fact, the original proof idea in this paper is firmly around the most fundamental concept that all these information is contained in chromatic polynomials. With this thought, can the Total-coloring Conjecture of graphs be solved?

Acknowledgements

The first draft of this paper was written in 1991, when I worked in the mathematics department of Shaanxi Normal University, my Alma Mater. I reported my work to several professors there, including Prof. Xiansun Wei, Prof. Zhongqiang Yang, Prof. Taihe Fan, Prof. Baolin Guo and Prof. Wanmin Zhang. All of them gave me some useful advices, especially Prof. Zhongqiang Yang pointed out a fatal error, which was a necessary and sufficient condition for uniquely 4-colorable planar graphs, in other words, there were some errors in the proof of the FWF conjecture. To overcome it, I have spent eighteen years on this problem until August 6th, 2009.

I would like to thank my teachers Prof. Guojun Wang, Prof. Xiansun Wei, Prof. Xinmin Wang, Prof. Hongke Du for their encouragement and support on my work in 1991, especially Prof. Hongke Du has been encouraging and directing me on it since then. Here I would like to thank them all deeply.

During the drafting of a new version of this paper, my students Fang Xi, Mei Chen, Enqiang Zhu, Jingming Liu, Zhen Chen, Yufang Huang, Ziqi Wei and Dongming Zhao spent a lot of time on this paper, from translation, drawing, typewriting to proofreading. Especially, as the superintendent of the final drafting, Fang Xi often worked very late into the night. Here I would like to express my deep thanks to them.

After that, my college Prof. Tian Liu also read this new version and gave some useful comments, especially for text-smoothing and sentence-retranslating. Here I would like to express my thank to him.

Here, I would like to thank my tutors Prof. Ziguo Wang, Prof. Yingluo Wang (fellow of Chinese Academy of Engineering) and Prof. Zheng Bao (fellow of Chinese Academy of Sciences) for their advice and help for many years.

Finally, I would like to thank our former leader Mr. Xiaoping Deng. Without him, I could have no chance to enter into universities, much less to prove the four color conjecture.

References

- [1] S.Akbari, V.S.Mirroknj and B.S.Sadjad, K_r -free uniquely vertex colorable graphs with minimum possible edges, *J Combin.Theory*, Series B, 82(2001):316-318.
- [2] V.A.Aksionov, Chromatically connected vertices in plane graphs, *Diskret.Analiz*,31 (1977):5-16 (in Russian).
- [3] K.Appel and W.Haken, The Solution of the Four-Color Map Problem, *Sci.Amer.*,237 (1977):108-121.
- [4] K.Appel and W.Haken, Every Planar Map is Four-Colorable, II: Reducibility, *Illinois J. Math.*, 21(1977):491-561.
- [5] K.Appel and W.Haken and J.Koch, Every Planar Map is Four Colorable, I: Discharging, *Illinois J. Math.*, 21(1977):429-490.
- [6] L.W.Beineke and R.J.Wilson, Selected Topics in Graph Theory(I), *Academic Press*, London, New York, San Francisco, 1978.
- [7] N.L.Biggs, E.K.Lloyd and R.J.Wilson, Graph Theory 1736-1936, *Clarendon Press*, Oxford, 1976.
- [8] G.D.Birkhoff, A determinantal formula for the number of ways of coloring a map, *Ann.Of Math*,14(1912):42-46.
- [9] G.D.Birkhoff, The reducibility of maps, *Amer.J.Math*, 35(1913):114-128.
- [10] G.D.Birkhoff and D.Lewis, Chromatic Polynomials, *Trans.Amer.Math.Soc.*, 60(1946): 355-451.
- [11] T.Böhme, M.Stiebitz, M.Voigt, On uniquely 4-colorable planar graphs, Preprint No.M 10/98, TU Ilmenau, 1998.
- [12] B.Bollobas, Uniquely colorable graphs,*J.Comb.Theory*, Series B, 25(1978): 54-61.
- [13] B.Bollobas and N.W.Sauer, Uniquely colourable graphs with large girth, *Canad.J.Math*, 28(1976):1340-1344.
- [14] J.A.Bondy and U.S.R.Murty, Graph Theory, *Springer*, 2008.

- [15] A.Cayley, the solution of a problem which recently achieved some renown, *Nature*, 18(1878):294.
- [16] A.Cayley, On the colour of maps, *Proc.R.Geogr.Soc*,1(1879):259-261.
- [17] C.Chao and Z.Chen, On uniquely 3-colorable graphs, *Discrete Math.*,112 (1993):21-27.
- [18] G.Chartrand and D.Geller, Uniquely colorable planar graphs, *J.Comb.Theory*, 6(1969) :271-278.
- [19] G.Chartrand and P.Zhang, Introduction to Graph Theory, *McGraw-Hill Companies Inc*, Singapore, 2005.
- [20] F.D.Chartwright and F.Harary, on the coloring of signed graphs, *Elem.Math.*, 23(1968) :85-89.
- [21] D.P.Dailey, Uniqueness of Colorability and Colorability of Planar 4-regular Graphs are NP-complete, *Discrete Mathematics*,30(1980):289-293.
- [22] I.G.Dmitriev, Weakly cyclic graphs with integral chromatic number. *Metody Diskret. Analiz.*, 34(1980):3-7.
- [23] I.G.Dmitriev, Characterization of a class of k -trees, *Metody Diskret. Analiz.*,38(1982):9-18.
- [24] F.M.Dong, K.M.Koh and K.L.Teo, Chromatic Polynomials and Chromaticity of Graphs, *World Scientific*, Singapore, 2005.
- [25] S.Fiorini, On the chromatic index of a graph, III: Uniquely edge-colorable graphs, *Quart. J. Math.(Oxford)*, (3)26(1975):129-140.
- [26] S.Fiorini and R.J.Wilson, Edge colouring of graphs, *Research Notes in Math.*,16(1977).
- [27] S.Fiorini and R.J.Wilson, Edge colourings of graphs, Selected Topics in Graph Theory, *Academic Press*, New York (1978):103-126.
- [28] S.Fisk, Geometric coloring theory, *Adv.in Math.*,24(1977):298-340.
- [29] P.Franklin, The Four Color Problem,*Am.J.Math.*,44(1922):225-236.
- [30] P.Franklin, Note on the Four Color Problem,*J.Math.and Phys.*, 16 (1938):172-184.
- [31] G.Frederick, Note on the colouring of maps,*Proc.R.Soc.Edinb*, 10 (1880):727-728.
- [32] R.Fritsch and G.Fritsch ,The Four-Color Theorem,*Springer*,1998.
- [33] M.R.Garey, D.S.Johnson and L.J.Stockmeyer, Some simplified NP-complete graph problems, *Theor.Comput.Sci.*,1(1976):237-267.

- [34] G.Georges, Formal Proof–The Four Color Theorem, *Notice of AMS*, 55(2008): 1382-1393.
- [35] T.C.Gleason, Cartwright.D, A note on a matrix criterion for unique colorability of a signed graph, *Psychometrika*, 32(1967):291-296.
- [36] J.L.Goldwasser and C.Q.Zhang, On the minimal counterexamples to a conjecture about unique edge-3-coloring, *Congr.Numer.*,113(1996):143-152. (The result is the same as **Theorem 3.1.**)
- [37] J.L.Goldwasser and C.Q.Zhang, Uniquely edge-colorable graphs and Snarks, *Graphs and Combinatorics*, 16(2000):257-267.
- [38] D.Greenwell and H.V.Kronk, Uniquely line-colorable graphs, *Canad.Math.Bull*, 16 (1973):525-529.
- [39] E.J.Grinberg,Plane homogeneous graphs of degree three without Hamiltonian circuits, *Latvian Math.*,(5)1968:51-58.
- [40] F.Harary,S.T.Hedetniemi and R.W.Robinson, Uniquely colorable graphs, *J.Combin. Theory*,6(1969):264-270.
- [41] F.Harary, Graph Theory, *Addison-Wesley*, Reading, 1969.
- [42] P.J.Heawood, Map colour theorem, *Q.J.Math.Oxf*,24(1890):332-338.
- [43] H.Heesch, Untersuchungen zum Vierfarbenproblem, *Bibliographisches Institut*, Mannheim/Wien/Zürich, 1969.
- [44] T.R.Jensen and B.Toft, Graph Coloring Problems, *John Wiley Sons*,New York,(1995) :48-49.
- [45] A.B.Kempe, on the geographical problem of the four color, *Am.J.Math*,2(1879):193-200.
- [46] A.B.Kempe, how to colour a map with four colours,*Nature*,21(1879):399-400.
- [47] M.Kriesell, Contractible non-edges in 3-connected graphs, *J Comb.Theory*, Series B, 4 (1998):192-201.
- [48] J.Mayer, Une propriété des graphes minimaux dans le problème des quatre couleurs, *Problèmes Combinatoires et Thorie des Graphes*, Colloques internationaux CNRS No.260, Paris, 1978.
- [49] L.S.Melnikov and R.Steinberg, one counterexample for two conjectures on three coloring, *Discrete Mathematics*, 20(1977):203-206.
- [50] V.Müller, On colorable critical and uniquely colorable critical graphs,*Recent Advances in Graph Theory*, Prague,(1974):385-386.

- [51] V.Müller, On colorings of graphs without short cycles, *Discrete Math.*,26(1979):165-176.
- [52] J.Nešetřil, On critical uniquely colorable graphs, *Arch. Math. (Basel)*, 23 (1972):210-213.
- [53] J.Nešetřil, On uniquely colorable graphs without short cycles, *Casopis Pest. Math.*, 98(1973):122-125.
- [54] O.Ore, The four color problem, *Academic Press*, New York, 1967.
- [55] O.Ore and J.Stemple, Numerical Calculations on the Four-Color Problem, *J Combin.Theory* ,8(1970):65-78.
- [56] L.J.Osterweil, Some classes of uniquely 3-colorable graphs, *Discrete Math.*, 8(1974):59-69.
- [57] J.Petersen, Sur le théorème de Tait, *L'intermédiaire des Mathématiciens*, 5 (1898):225-227.
- [58] R.C.Read, An introduction to chromatic polynomials, *J. Combin. Theory*, 4(1968):52-71.
- [59] C.Reynolds, On the problem of coloring maps in four colors, *Ann.of Math.*, 28(1926-27):477-492.
- [60] N.Robertson, D.P.Sanders, P.D.Seymour and R. Thomas, A new proof of the four colour theorem, *Electron.Res. Announc. Amer. Math. Soc.*, 2(1996):17-25.
- [61] N.Robertson, D.P.Sanders, P.D.Seymour and R.Thomas, The four color theorem, *J. Combin. Theory*, Series B, 70(1997):2-44.
- [62] P.G.Tait, Remarks on the colouring of maps, *Proc. R. Soc. Edinburgh*, 10 (1880):501-503.
- [63] L.S.Thomas, Thirteen colorful variations on Guthrie's four color conjecture, *America Mathematical monthly*, 79(1972):2 43.
- [64] L.S.Thomas and P.C.Kainen, The Four-color problem, *Dover Publications Inc.*, New York, 1986.
- [65] T.G.Thomas, Unique coloring of planar graphs, Ph.D.thesis, *Georgia Institute Technology*, 1998.
- [66] A.G.Thomason, Hamiltonian cycles and uniquely edge colorable graphs, *Ann. Discrete Math.*, 3(1978):259-268.
- [67] A.G.Thomason, Cubic graphs with three Hamiltonian cycles are not always uniquely edge Colorable, *Journal of Graph Theory*, 6(1982):219-221.

- [68] W.T.Tutte, On Hamiltonian Circuits, *J.London Math.Soc.*,21(1946):98-101.
- [69] W.T.Tutte, On chromatic polynomials and the golden ratio, *J.Combin.Theory*, 9(1970):289-296.
- [70] W.T.Tutte, More about chromatic polynomials and the golden ratio, Combinatorial Structures and their Applications (ed R. K. Guy et al.), *Gordon and Breach*, New York, 1970:439-453.
- [71] W.T.Tutte, Chromatic sums for planar triangulations, V:Special equations, *Canad. J.Math.*,26(1974):893-907.
- [72] W.T.Tutte, Hamiltonian circuits, In: Colloquio Internazionale sulle teorie Combinatorie, Roma I, *Accademia Nazionale dei Lincei*,1976:193-199.
- [73] C.C.Wang and E.Artzy, Note on the uniquely colorable graphs, *Journal of Combin.Theory*, Series B, 15(1973):204-206.
- [74] P.Wernicke, Über den kartographischen Vierfarbensatz, *Math. Ann.*,58(1904):479.
- [75] H.Whitney, On the coloring of graphs, *Ann. of Math.*,33(1932):688-718.
- [76] C.E.Winn, On the minimum number of polygons in an irreducible map, *American Journal of Mathematics*, 62(1940):406-416.
- [77] J.Xu, Recursive formula for calculating the chromatic polynomial of a graph by vertex deletion, *Acta Mathematica Scientia*, 4(2004):577-582.
- [78] J.Xu and Z.Liu, The chromatic polynomial between graph and its complement, *Graph and Combinatorics*, 11(1995):337-345.
- [79] J.Xu and X.S.Wei, Theorems of uniquely k-colorable graphs, *Journal of Shaanxi Normal University (Natural Science Edition)*, 23(1995):59-62.
- [80] S.J.Xu, The size of uniquely colorable graphs, *J.Combin.Theory*, Series B, 50(1990):319-320.
- [81] C.Q.Zhang, Hamiltonian weights and unique edge-3-colorings of cubic graphs, *Journal of Graph Theory*, 20(1995):91-99.
- [82] A.A.Zykov, On some properties of linear complexes, *Mat.Sb.*, 24 (1949):163-168(in. Russian); English translation in *Amer.Math.Soc.Tran.*, 79 (1952).