

# The Group Structure of Pivot and Loop Complementation on Graphs and Set Systems

Robert Brijder<sup>a,\*</sup>, Hendrik Jan Hoogeboom<sup>b</sup>

<sup>a</sup>*Hasselt University and Transnational University of Limburg, Belgium*

<sup>b</sup>*Leiden Institute of Advanced Computer Science,  
Leiden University, The Netherlands*

---

## Abstract

We study the interplay between principal pivot transform (pivot) and loop complementation for graphs. This is done by generalizing loop complementation (in addition to pivot) to set systems. We show that the operations together, when restricted to single vertices, form the permutation group  $S_3$ . This leads, e.g., to a normal form for sequences of pivots and loop complementation on graphs. The results have consequences for the operations of local complementation and edge complementation on simple graphs: an alternative proof of a classic result involving local and edge complementation is obtained, and the effect of sequences of local complementations on simple graphs is characterized.

*Keywords:* local complementation, principal pivot transform, circle graph, interlace polynomial, delta-matroid, algebraic graph theory

---

## 1. Introduction

Principal pivot transform (PPT, or simply pivot), due to Tucker [21], partially inverts a given matrix. Its definition is originally motivated by the extensively studied linear complementarity problem [11]. However, there are many other application areas for PPT, see [20] for an overview. We consider pivots on graphs where loops are allowed (i.e., symmetric matrices over  $\mathbb{F}_2$ ). It is shown by Bouchet [4] that, in this case, the pivot operation satisfies an equivalent definition in terms of set systems (more specifically, in terms of delta-matroids due to a specific exchange axiom that they fulfill).

Pivot operations on graphs (where loops are allowed) can be decomposed into two types of elementary pivots: local complementation and edge complementation. The names “local complementation” and “edge complementation” are due to similar operations on simple graphs. Local complementation on simple graphs has originally been considered in [16] and edge complementation has

---

\*Corresponding author

*Email address:* robert.brijder@uhasselt.be (Robert Brijder)

subsequently been defined in terms of local complementation in [5]. There these operations were motivated by circle graphs (or overlap graphs), where local and edge complementation model natural transformations on the underlying interval segments (or, equivalently, on Euler tours within a 4-regular graph). Many other application areas have since been identified. For example, local complementation on simple graphs retains the entanglement of the corresponding graph states in quantum computing [22], and this operation is of main interest in relation to rank-width in the vertex-minor project initiated in [17]. Moreover, edge complementation is fundamentally related to the interlace polynomial [2, 3, 1], the definition of which is motivated by the computation of the number of  $k$ -component circuit partitions in a graph. Elementary pivots on graphs naturally appear in the formal study of gene assembly in ciliates [12, 8] (a research area of computational biology).

Surprisingly, the similarity between local and edge complementation for simple graphs on the one hand and pivots on matrices (or graphs) on the other hand has been largely unnoticed (although it is observed in [13]), and as a result they have been studied almost independently.

In this paper we consider the interplay between pivots and loop complementation (flipping the existence of loops for a given set of vertices) on graphs. By generalizing loop complementation to set systems, we obtain a common viewpoint for the two operations: pivots and loop complementations are elements of order 2 (i.e., involutions) in the permutation group  $S_3$  (by restricting to single vertices). We find that the dual pivot from [9] corresponds to the third element of order 2 in  $S_3$ . We obtain a normal form for sequences of pivots and loop complementations on graphs. As a consequence a number of results for local and edge complementations on simple graphs are obtained including an alternative proof of a classic result [5] relating local and edge complementation (see Proposition 23). Finally we characterize the effect of sequences of local complementations on simple graphs. In this way we find that, surprisingly, loops are the key to fully understand local and edge complementation on simple (i.e., loopless) graphs, as they bridge the gap in the definitions of local and edge complementation for graphs on the one hand and simple graphs on the other.

An extended abstract of this paper containing selected results without proofs was presented at TAMC 2010 [10].

## 2. Notation and Terminology

In this paper matrix computations (except for the first part of Section 3) will be over  $\mathbb{F}_2$ , the field consisting of two elements. We will often consider this field as the Booleans, and its operations addition and multiplication are as such equal to the logical exclusive-or and logical conjunction, which are denoted by  $\oplus$  and  $\wedge$  respectively. These operations carry over to sets, e.g., for sets  $A, B \subseteq V$  and  $x \in V$ ,  $x \in A \oplus B$  iff  $(x \in A) \oplus (x \in B)$ .

A *set system* (over  $V$ ) is an ordered pair  $M = (V, D)$  with  $V$  a finite set and  $D$  a family of subsets of  $V$ . We write simply  $Y \in M$  to denote  $Y \in D$ . For  $X \subseteq V$ ,  $X$  is *minimal* (*maximal*, resp.) in  $D$  w.r.t. inclusion iff both  $X \in D$

and  $Y \notin D$  for every  $Y \subset X$  ( $Y \supset X$ , resp.). The set of minimal (maximal, resp.) elements of  $D$  (w.r.t. inclusion) is denoted by  $\min(D)$  ( $\max(D)$ , resp.). Moreover, we write  $\min(M) = \min(D)$  and  $\max(M) = \max(D)$ .

For a  $V \times V$ -matrix  $A$  (the columns and rows of  $A$  are indexed by finite set  $V$ ) and  $X \subseteq V$ ,  $A[X]$  denotes the principal submatrix of  $A$  w.r.t.  $X$ , i.e., the  $X \times X$ -matrix obtained from  $A$  by restricting to rows and columns in  $X$ .

We consider undirected graphs without parallel edges, however we do allow loops. For graph  $G = (V, E)$  we use  $V(G)$  and  $E(G)$  to denote its set of vertices  $V$  and set of edges  $E$ , respectively, where for  $x \in V$ ,  $\{x\} \in E$  iff  $x$  has a loop. For  $X \subseteq V$ , we denote the subgraph of  $G$  induced by  $X$  as  $G[X]$ .

With a graph  $G$  one associates its adjacency matrix  $A(G)$ , which is a  $V \times V$ -matrix  $(a_{u,v})$  over  $\mathbb{F}_2$  with  $a_{u,v} = 1$  iff  $\{u, v\} \in E$  (we have  $a_{u,u} = 1$  iff  $\{u\} \in E$ ). In this way, the family of graphs with vertex set  $V$  corresponds precisely to the family of symmetric  $V \times V$ -matrices over  $\mathbb{F}_2$ . Therefore we often make no distinction between a graph and its matrix, so, e.g., by the determinant of graph  $G$ , denoted  $\det G$ , we will mean the determinant  $\det A(G)$  of its adjacency matrix (computed over  $\mathbb{F}_2$ ). By convention,  $\det(G[\emptyset]) = 1$ .

For graph  $G$ , the *loop complementation* operation on a set of vertices  $X \subseteq V$ , denoted by  $G + X$ , removes loops from the vertices of  $X$  when present in  $G$  and adds loops to vertices of  $X$  when not present in  $G$ . Hence the adjacency matrix of  $G + X$  is obtained from  $A(G)$  by adding 1 to each diagonal element  $a_{xx}$ ,  $x \in X$ , of  $A(G)$ . Clearly,  $(G + X) + Y = G + (X \oplus Y)$  for  $X, Y \subseteq V$ .

### 3. Pivots

In general the pivot operation is defined for matrices over arbitrary fields, e.g., as done in [20]. In this paper we restrict to symmetric matrices over  $\mathbb{F}_2$ , which leads to a number of additional viewpoints to the same operation, and for each of them an equivalent definition of the pivot operation.

*Matrices.* Let  $A$  be a  $V \times V$ -matrix (over an arbitrary field), and let  $X \subseteq V$  be such that the corresponding principal submatrix  $A[X]$  is nonsingular, i.e.,  $\det A[X] \neq 0$ . The *pivot* of  $A$  on  $X$ , denoted by  $A * X$ , is defined as follows. If  $P = A[X]$  and  $A = \begin{pmatrix} P & Q \\ R & S \end{pmatrix}$ , then

$$A * X = \begin{pmatrix} P^{-1} & -P^{-1}Q \\ RP^{-1} & S - RP^{-1}Q \end{pmatrix}.$$

The pivot can be considered a partial inverse, as  $A$  and  $A * X$  satisfy the following characteristic relation, where the vectors  $x_1$  and  $y_1$  correspond to the elements of  $X$ .

$$A \begin{pmatrix} x_1 \\ x_2 \end{pmatrix} = \begin{pmatrix} y_1 \\ y_2 \end{pmatrix} \text{ iff } A * X \begin{pmatrix} y_1 \\ x_2 \end{pmatrix} = \begin{pmatrix} x_1 \\ y_2 \end{pmatrix} \quad (1)$$

Equality (1) can be used to define  $A * X$  given  $A$  and  $X$ : any matrix  $B$  satisfying this equality is of the form  $B = A * X$ , see [20, Theorem 3.1], and therefore such a

$B$  exists precisely when  $\det A[X] \neq 0$ . Note that if  $\det A \neq 0$ , then  $A * V = A^{-1}$ . Also note that by Equation (1) a pivot operation is an involution (operation of order 2), and more generally, if  $(A * X) * Y$  is defined, then  $A * (X \oplus Y)$  is defined and they are equal.

It is easy to verify that  $A * X$  is skew-symmetric whenever  $A$  is. In particular, computed over  $\mathbb{F}_2$ , if  $A$  is a graph (i.e., a symmetric matrix over  $\mathbb{F}_2$ ), then  $A * X$  is also a graph.

The following fundamental result on pivots is due to Tucker [21] (see also [18] or [11, Theorem 4.1.1] for an elegant proof using Equality (1)).

**Proposition 1 ([21]).** *Let  $A$  be a  $V \times V$ -matrix, and let  $X \subseteq V$  be such that  $\det A[X] \neq 0$ . Then, for  $Y \subseteq V$ ,  $\det(A * X)[Y] = \det A[X \oplus Y] / \det A[X]$ .*

In particular, assuming that  $A * X$  is defined,  $(A * X)[Y]$  is nonsingular iff  $A[X \oplus Y]$  is nonsingular.

*Set Systems.* Let  $M$  be a set system over  $V$ . We define, for  $X \subseteq V$ , the *pivot* (often called *twist* in the literature, see, e.g., [13])  $M * X = (V, D * X)$ , where  $D * X = \{Y \oplus X \mid Y \in D\}$ .

For  $V \times V$ -matrix  $A$ , let  $\mathcal{M}_A = (V, D_A)$  be the set system with  $D_A = \{X \subseteq V \mid \det A[X] \neq 0\}$ . As observed in [4] we have, by Proposition 1,  $Z \in \mathcal{M}_{A * X}$  iff  $\det((A * X)[Z]) \neq 0$  iff  $\det(A[X \oplus Z]) \neq 0$  iff  $X \oplus Z \in \mathcal{M}_A$  iff  $Z \in \mathcal{M}_A * X$ . Hence  $\mathcal{M}_{A * X} = \mathcal{M}_A * X$ .

From now on we restrict to graphs  $G$  and we work over  $\mathbb{F}_2$ . Given set system  $\mathcal{M}_G = (V(G), D_G)$ , one can (re)construct the graph  $G$ :  $\{u\}$  is a loop in  $G$  iff  $\{u\} \in D_G$ , and  $\{u, v\}$  is an edge in  $G$  iff  $(\{u, v\} \in D_G) \oplus ((\{u\} \in D_G) \wedge (\{v\} \in D_G))$ , see [7, Property 3.1]. Hence the function  $\mathcal{M}_{(\cdot)}$  which assigns to each graph  $G$  its set system  $\mathcal{M}_G$  is injective. In this way, the family of graphs (with set  $V$  of vertices) can be considered as a subset of the family of set systems (over set  $V$ ).

**Remark 2.** Note that  $\mathcal{M}_{(\cdot)}$  is not injective for binary matrices (i.e., matrices over  $\mathbb{F}_2$ ) in general: e.g., for fixed  $V$  with  $|V| = 2$ , the  $2 \times 2$  zero matrix and the matrix  $\begin{pmatrix} 0 & 1 \\ 0 & 0 \end{pmatrix}$  correspond to the same set system. Also,  $\mathcal{M}_{(\cdot)}$  is not surjective: we have, e.g.,  $\emptyset \in \mathcal{M}_A$  for every matrix  $A$ . Consequently, the notions of binary matrix and set system are incomparable (i.e., one is not more general than the other) w.r.t.  $\mathcal{M}_{(\cdot)}$ .

As  $\mathcal{M}_{G * X} = \mathcal{M}_G * X$ , the pivot operation for graphs coincides with the pivot operation for set systems. Therefore, pivot on set systems forms an alternative definition of pivot on graphs. Note that while for a set system  $M$  over  $V$ ,  $M * X$  is defined for all  $X \subseteq V$ , for a graph  $G$ ,  $G * X$  is defined precisely when  $\det G[X] = 1$ , or equivalently, when  $X \in D_G$ , which in turn is equivalent to  $\emptyset \in D_G * X$ .

It turns out that  $\mathcal{M}_G$  has a special structure, that of a *delta-matroid* [4]. A delta-matroid is a set system  $M$  that satisfies the symmetric exchange axiom:

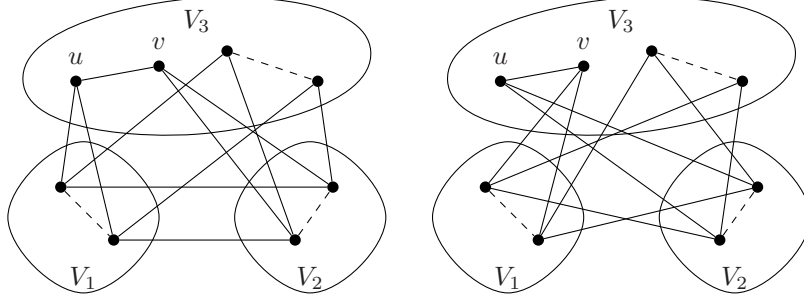

Figure 1: Pivot on an edge  $\{u, v\}$  in a graph. Adjacency between vertices  $x$  and  $y$  is toggled iff  $x \in V_i$  and  $y \in V_j$  with  $i \neq j$ . Note that  $u$  and  $v$  are adjacent to all vertices in  $V_3$  — these edges are omitted in the diagram. The operation does not affect edges adjacent to vertices outside the sets  $V_1, V_2, V_3$ , nor does it change any of the loops.

For all  $X, Y \in M$  and all  $x \in X \oplus Y$ , we have  $X \oplus \{x\} \in M$  or there is a  $y \in X \oplus Y$  with  $y \neq x$  such that  $X \oplus \{x, y\} \in M^1$ . In this paper we will not use this property. In fact, we will consider an operation on set systems that does not retain this property of delta-matroids, cf. Example 10.

*Graphs.* The pivots  $G * X$  where  $X \in \min(D_G \setminus \{\emptyset\})$  are called *elementary*. It is noted by Geelen [13] that an elementary pivot  $X$  corresponds to either a loop,  $X = \{u\} \in E(G)$ , or to an edge,  $X = \{u, v\} \in E(G)$ , where (distinct) vertices  $u$  and  $v$  are both non-loops. Thus for  $Y \in \mathcal{M}_G$ , if  $G[Y]$  has elementary pivot  $X_1$ , then  $Y \setminus X_1 = Y \oplus X_1 \in \mathcal{M}_{G * X_1}$ . By iterating this argument, each  $Y \in \mathcal{M}_G$  can be partitioned  $Y = X_1 \cup \dots \cup X_n$  such that  $G * Y = G * (X_1 \oplus \dots \oplus X_n) = (\dots (G * X_1) \dots * X_n)$  is a composition of elementary pivots. Consequently, a direct definition of the elementary pivots on graphs  $G$  is sufficient to define the (general) pivot operation on graphs.

The elementary pivot  $G * \{u\}$  on a loop  $\{u\}$  is called *local complementation*. It is the graph obtained from  $G$  by “toggling” the edges in the neighbourhood  $N_G(u) = \{v \in V \mid \{u, v\} \in E(G), u \neq v\}$  of  $u$  in  $G$ : for each  $v, w \in N_G(u)$ ,  $\{v, w\} \in E(G)$  iff  $\{v, w\} \notin E(G * \{u\})$ , and  $\{v\} \in E(G)$  iff  $\{v\} \notin E(G * \{u\})$  (the case  $v = w$ ). The other edges are left unchanged.

We now recall *edge complementation*  $G * \{u, v\}$  on an edge  $\{u, v\}$  between non-loop vertices. For a vertex  $x$  consider its closed neighbourhood  $N'_G(x) = N_G(x) \cup \{x\}$ . The edge  $\{u, v\}$  partitions the vertices of  $G$  adjacent to  $u$  or  $v$  into three sets  $V_1 = N'_G(u) \setminus N'_G(v)$ ,  $V_2 = N'_G(v) \setminus N'_G(u)$ ,  $V_3 = N'_G(u) \cap N'_G(v)$ . Note that  $u, v \in V_3$ .

The graph  $G * \{u, v\}$  is constructed by “toggling” all edges between different  $V_i$  and  $V_j$ : for  $\{x, y\}$  with  $x \in V_i$  and  $y \in V_j$  ( $i \neq j$ ):  $\{x, y\} \in E(G)$  iff

<sup>1</sup>The explicit formulation of the case  $X \oplus \{x\} \in M$  is often omitted in the definition of delta-matroids. It is then understood that  $y$  may be equal to  $x$  and  $\{x, x\} = \{x\}$ . To avoid confusion we will not use this convention here.

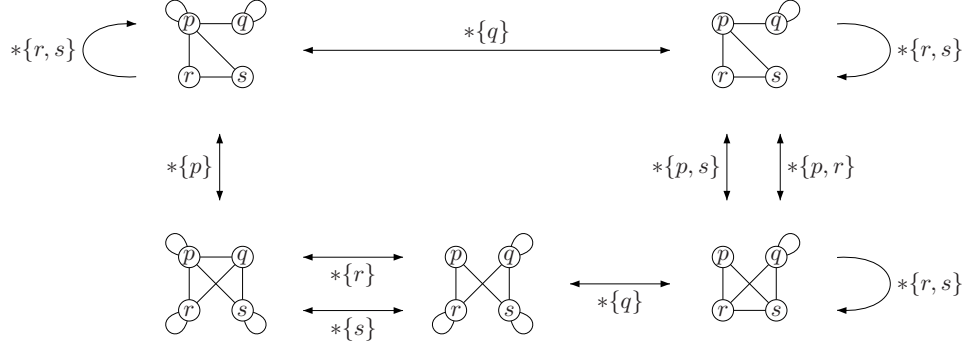

Figure 2: The orbit of  $G$  of Example 3 under pivot. Only the elementary pivots are shown.

$\{x, y\} \notin E(G * \{u, v\})$ , see Figure 1. The other edges remain unchanged. Note that, as a result of this operation, the neighbours of  $u$  and  $v$  are interchanged.

**Example 3.** Let  $G$  be the graph depicted in the upper-left corner of Fig-

ure 2. We have  $A(G) = \begin{matrix} & \begin{matrix} p & q & r & s \end{matrix} \\ \begin{matrix} p \\ q \\ r \\ s \end{matrix} & \begin{pmatrix} 1 & 1 & 1 & 1 \\ 1 & 1 & 0 & 0 \\ 1 & 0 & 0 & 1 \\ 1 & 0 & 1 & 0 \end{pmatrix} \end{matrix}$ . Graph  $G$  corresponds to  $\mathcal{M}_G = (\{p, q, r, s\}, D_G)$ , where

$$D_G = \{\emptyset, \{p\}, \{q\}, \{p, r\}, \{p, s\}, \{r, s\}, \{p, q, r\}, \{p, q, s\}, \{p, r, s\}, \{q, r, s\}\}.$$

For example,  $\{p, r\} \in D_G$  since  $\det(G[\{p, r\}]) = \det \begin{pmatrix} 1 & 1 \\ 1 & 0 \end{pmatrix} = 1$ . The orbit of  $G$  under pivot as well as the applicable elementary pivots (i.e., local and edge complementation) are shown in Figure 2. For example,  $G * \{p, q, r\}$  is shown on the lower-right in the same figure. Note that  $D_G * \{p, q, r\} =$

$$\{\emptyset, \{q\}, \{p, r\}, \{p, s\}, \{q, r\}, \{q, s\}, \{r, s\}, \{p, q, r\}, \{p, q, s\}, \{q, r, s\}\}$$

indeed corresponds to  $G * \{p, q, r\}$ .

#### 4. Unifying Pivot and Loop Complementation

We now introduce a class of operations on set systems. As we will show, it turns out that this class contains both the pivot and (a generalization of) loop complementation. Each operation is a linear transformation, where the input and output vectors indicate the presence (or absence) of sets  $Z$  and  $Z \setminus \{j\}$  in the original and resulting set systems.

**Definition 4.** Let  $M = (V, D)$  be a set system, and let  $\alpha$  be a  $2 \times 2$ -matrix over  $\mathbb{F}_2$ . We define, for  $j \in V$ , the *vertex flip*  $\alpha$  of  $M$  on  $j$ , denoted by  $M\alpha^j = (V, D')$ , where, for all  $Z \subseteq V$  with  $j \in Z$ , the membership of  $Z$  and  $Z \setminus \{j\}$  in  $D'$  is determined as follows:

$$\alpha(Z \in D, Z \setminus \{j\} \in D)^T = (Z \in D', Z \setminus \{j\} \in D')^T.$$

In the above definition, we regard the elements of the vectors as Boolean values, e.g., the expression  $Z \in D$  obtains either true (1) or false (0). To be more explicit, let  $\alpha = \begin{pmatrix} a_{11} & a_{12} \\ a_{21} & a_{22} \end{pmatrix}$ . Then we have for all  $Z \subseteq V$ ,  $Z \in D'$  iff

$$\begin{cases} (a_{11} \wedge Z \in D) \oplus (a_{12} \wedge Z \setminus \{j\} \in D) & \text{if } j \in Z \\ (a_{21} \wedge Z \cup \{j\} \in D) \oplus (a_{22} \wedge Z \in D) & \text{if } j \notin Z \end{cases}.$$

Note that in the above statement we may replace both  $Z \cup \{j\} \in D$  and  $Z \setminus \{j\} \in D$  by  $Z \oplus \{j\} \in D$  as in the former we have  $j \notin Z$  and in the latter we have  $j \in Z$ . Thus, the operation  $\alpha^j$  decides whether or not set  $Z$  is in the new set system, based on the fact whether or not  $Z$  and  $Z \oplus \{j\}$  belong to the original system.

Note that if  $\alpha$  is the identity matrix, then  $\alpha^j$  is simply the identity operation. Moreover, with  $\alpha_* = \begin{pmatrix} 0 & 1 \\ 1 & 0 \end{pmatrix}$  we have  $M\alpha_*^j = M * \{j\}$ , the pivot operation on a single element  $j$ .

By definition, a composition of vertex flips on the same element corresponds to matrix multiplication. Moreover, the following lemma shows that vertex flips on different elements commute.

**Lemma 5.** *Let  $M$  be a set system over  $V$ , and let  $j, k \in V$ . We have that  $(M\alpha^j)\beta^j = M(\beta\alpha)^j$ , where  $\beta\alpha$  denotes matrix multiplication of  $\beta$  and  $\alpha$ . Moreover  $(M\alpha^j)\beta^k = (M\beta^k)\alpha^j$  if  $j \neq k$ .*

PROOF. The fact that  $(M\alpha^j)\beta^j = M(\beta\alpha)^j$  follows directly from Definition 4.

Let  $M = (V, D)$ , and assume that  $j \neq k$ . Let  $M\alpha^j = (V, D')$ , and let  $M\beta^k = (V, D'')$ . For any set  $Z \subseteq V$  with  $j, k \in Z$ , we consider the sets  $Z$ ,  $Z \setminus \{j\}$ ,  $Z \setminus \{k\}$ , and  $Z \setminus \{j, k\}$ . Now, for any family  $Q$  of subsets of  $V$ , let  $v_Q = (Z \in Q, Z \setminus \{j\} \in Q, Z \setminus \{k\} \in Q, Z \setminus \{j, k\} \in Q)^T$ . The  $4 \times 4$ -matrices  $\alpha'$  and  $\beta'$  such that  $\alpha'v_D = v_{D'}$  and  $\beta'v_D = v_{D''}$ , are

$$\alpha' = \begin{pmatrix} a_{11} & a_{12} & 0 & 0 \\ a_{21} & a_{22} & 0 & 0 \\ 0 & 0 & a_{11} & a_{12} \\ 0 & 0 & a_{21} & a_{22} \end{pmatrix} \text{ and } \beta' = \begin{pmatrix} b_{11} & 0 & b_{12} & 0 \\ 0 & b_{11} & 0 & b_{12} \\ b_{21} & 0 & b_{22} & 0 \\ 0 & b_{21} & 0 & b_{22} \end{pmatrix},$$

where

$$\alpha = \begin{pmatrix} a_{11} & a_{12} \\ a_{21} & a_{22} \end{pmatrix} \text{ and } \beta = \begin{pmatrix} b_{11} & b_{12} \\ b_{21} & b_{22} \end{pmatrix}.$$

Equivalently, focussing on the  $2 \times 2$  blocks, we have  $\alpha' = \begin{pmatrix} \alpha & 0 \\ 0 & \alpha \end{pmatrix}$  and  $\beta' = \begin{pmatrix} b_{11}I & b_{12}I \\ b_{21}I & b_{22}I \end{pmatrix}$ . It is easy to see these matrices commute. Multiplication

(in either order) yields the  $4 \times 4$ -matrix  $\alpha' \beta' = \beta' \alpha' = \begin{pmatrix} (b_{11}I)\alpha & (b_{12}I)\alpha \\ (b_{21}I)\alpha & (b_{22}I)\alpha \end{pmatrix}$ .

□

To simplify notation, we assume left associativity of the vertex flip, and write  $M\varphi_1\varphi_2 \cdots \varphi_n$  to denote  $(\cdots((M\varphi_1)\varphi_2)\cdots)\varphi_n$ , where  $\varphi_1\varphi_2 \cdots \varphi_n$  is a sequence of vertex flip operations applied to set system  $M$ . Hence, as a special case of the vertex flip, the pivot operation is also written in the simplified notation. We carry this simplified notation over to graphs  $G$ .

Due to the commutative property shown in Lemma 5 we (may) define, for a set  $X = \{x_1, \dots, x_n\} \subseteq V$ ,  $M\alpha^X = M\alpha^{x_1}\alpha^{x_2} \cdots \alpha^{x_n}$ , where the result is independent of the order in which the operations are applied. Moreover, if  $\alpha$  is of order 2 (i.e.,  $\alpha\alpha$  is the identity matrix), then  $(M\alpha^X)\alpha^Y = M\alpha^{X \oplus Y}$ .

Now consider  $\alpha_+ = \begin{pmatrix} 1 & 1 \\ 0 & 1 \end{pmatrix}$ . The matrices  $\alpha_+$  and  $\alpha_*$  given above generate the group  $\text{GL}_2(\mathbb{F}_2)$  of  $2 \times 2$  matrices with non-zero determinant. In fact  $\text{GL}_2(\mathbb{F}_2)$  is isomorphic to the group  $S_3 = \{1, a, b, c, f, g\}$  of permutations of three elements, where 1 is the identity,  $a, b$ , and  $c$  are the elements of order 2, and  $f$  and  $g$  are the elements of order 3. The matrices  $\alpha_+$  and  $\alpha_*$  are both of order 2 and we may identify them with any two (distinct) elements of  $S_3$  of order 2. The generators  $\alpha_+$  and  $\alpha_*$  satisfy the relations  $\alpha_+^2 = 1$ ,  $\alpha_*^2 = 1$ , and  $(\alpha_*\alpha_+)^3 = 1$ .

As, by Lemma 5, vertex flips on  $j$  and  $k$  with  $j \neq k$  commute, we have that the vertex flips form the group  $(S_3)^V$  of functions  $f : V \rightarrow S_3$  where composition/multiplication is point wise:  $(fg)(j) = f(j)g(j)$  for all  $j \in V$ . Note that by fixing a linear order of  $V$ ,  $(S_3)^V$  is isomorphic to  $(S_3)^n$  with  $n = |V|$ , the direct product of  $n$  times group  $S_3$ . The vertex flips form an action of  $(S_3)^V$  on the family of set systems over  $V$ .

## 5. Loop Complementation and Set Systems

In this section we focus on vertex flips of matrix  $\alpha_+$  (defined in the previous section). We will show that this operation is a generalization to set systems of loop complementation for graphs (cf. Theorem 8). Consequently, we will call it *loop complementation* as well.

Let  $M = (V, D)$  be a set system and  $j \in V$ . We denote  $M\alpha_+^j$  by  $M + \{j\}$ . Hence, we have  $M + \{j\} = (V, D')$  where, for all  $Z \subseteq V$ ,  $Z \in D'$  iff

$$\begin{cases} (Z \in D) \oplus (Z \setminus \{j\} \in D) & \text{if } j \in Z \\ Z \in D & \text{if } j \notin Z \end{cases}$$

The definition of loop complementation can be reformulated as follows:  $D' = D \oplus \{X \cup \{j\} \mid X \in D, j \notin X\}$ .

**Example 6.** Let  $V = \{1, 2, 3\}$  and  $M = (V, \{\emptyset, \{1\}, \{1, 2\}, \{3\}, \{1, 2, 3\}\})$  be a set system. We have  $M + \{3\} = (V, \{\emptyset, \{1\}, \{1, 2\}, \{3\}, \{1, 2, 3\}\} \oplus \{\{3\}, \{1, 3\}, \{1, 2, 3\}\}) = (V, \{\emptyset, \{1\}, \{1, 2\}, \{1, 3\}\})$ .



We denote, for  $X \subseteq V$ ,  $M\alpha_+^X$  by  $M + X$ . Moreover, as  $\alpha_+$  is of order 2, we have, similar to the pivot operation,  $(M + X) + Y = M + (X \oplus Y)$ . Also, by the commutative property of vertex flip in Lemma 5, we have for  $X, Y \subseteq V$  with  $X \cap Y = \emptyset$ ,  $M * X + Y = M + Y * X$ .

We now provide a characterization of loop complementation which describes how successive applications of loop complementation in set systems interact.

**Theorem 7.** *Let  $M$  be a set system and  $X, Y \subseteq V$ . We have  $Y \in M + X$  iff  $|\{Z \in M \mid Y \setminus X \subseteq Z \subseteq Y\}|$  is odd.*

PROOF. The proof is by induction on  $|X|$ . First consider the case  $X = \emptyset$ .  $Y \in M + \emptyset$  iff  $Y \in M$  iff  $|\{Z \in M \mid Z = Y\}|$  is odd.

Now consider  $X \cup \{y\}$  with  $y \notin X$  in the induction step.

If  $y \notin Y$ , then  $Y \in M + X + \{y\}$  iff  $Y \in M + X$  iff  $|\{Z \in M \mid Y \setminus X \subseteq Z \subseteq Y\}|$  is odd iff  $|\{Z \in M \mid (Y \setminus X) \setminus \{y\} \subseteq Z \subseteq Y\}|$  is odd, as  $Y \setminus X = (Y \setminus X) \setminus \{y\}$ .

Now assume that  $y \in Y$ . Let  $C_1 = \{Z \in M \mid (Y \setminus \{y\}) \setminus X \subseteq Z \subseteq Y \setminus \{y\}\}$  and let  $C_2 = \{Z \in M \mid Y \setminus X \subseteq Z \subseteq Y\}$ . Elements in  $C_1$  do not contain  $y$  whereas those in  $C_2$  do. Thus  $C_1$  and  $C_2$  are disjoint, and  $C_1 \cup C_2 = \{Z \in M \mid Y \setminus (X \cup \{y\}) \subseteq Z \subseteq Y\}$ . Moreover  $|C_1 \cup C_2|$  is odd iff exactly one of  $|C_1|$  and  $|C_2|$  is odd.

By definition of loop complementation  $Y \in (M + X) + y$  iff  $(Y \setminus \{y\} \in M + X) \oplus (Y \in M + X)$ . According to the induction hypothesis this means that exactly one of  $|C_1|$  and  $|C_2|$  is odd, i.e.,  $|\{Z \in M \mid Y \setminus (X \cup \{y\}) \subseteq Z \subseteq Y\}|$  is odd, as required.  $\square$

The next result implies that indeed the notion of loop complementation for set systems is a generalization of the notion of loop complementation for graphs.

**Theorem 8.** *Let  $A$  be a  $V \times V$ -matrix over  $\mathbb{F}_2$  and  $X \subseteq V$ . Then  $\mathcal{M}_{A+X} = \mathcal{M}_A + X$ .*

PROOF. It suffices to show the result for  $X = \{j\}$  with  $j \in V$ , as the general case follows by the commutative property of vertex flip (Lemma 5). Let  $Z \subseteq V$ . We compare  $\det A[Z]$  with  $\det(A + \{j\})[Z]$ . First assume that  $j \notin Z$ . Then  $A[Z] = (A + \{j\})[Z]$ , thus  $\det A[Z] = \det(A + \{j\})[Z]$ . Now assume that  $j \in Z$ , which implies that  $A[Z]$  and  $(A + \{j\})[Z]$  differ in exactly one position:  $(j, j)$ . We may compute determinants by Laplace expansion over the  $j$ -th column, and summing minors. As  $A[Z]$  and  $(A + \{j\})[Z]$  differ at only the matrix-element  $(j, j)$ , these expansions differ only in the inclusion of minor  $\det A[Z \setminus \{j\}]$ . Thus  $\det(A + \{j\})[Z]$  equals  $\det A[Z] \oplus \det A[Z \setminus \{j\}]$ , from which the statement follows.  $\square$

Surprisingly, this natural definition of loop complementation on set systems is not found in the literature.

**Example 9.** The set system  $M = (\{1, 2, 3\}, \{\emptyset, \{1\}, \{1, 2\}, \{3\}, \{1, 2, 3\}\})$  of Example 6 has a graph representation  $G$ :  $M = \mathcal{M}_G$  and  $G$  are given on the

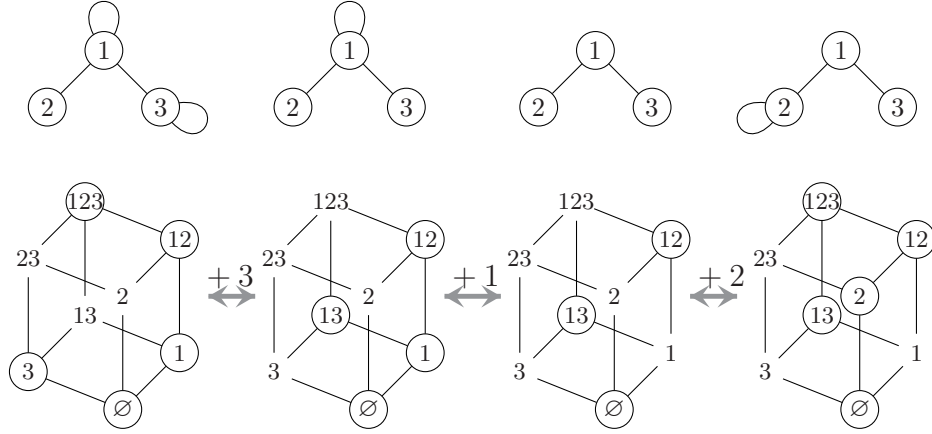

Figure 3: Toggling one-by-one loops on the vertices of a graph, and the corresponding set systems.

left-hand side in Figure 3. The figure also contains some other set systems obtainable from  $M$  through loop complementation. Notice that  $M + \{3\} = (\{1, 2, 3\}, \{\emptyset, \{1\}, \{1, 2\}, \{1, 3\}\})$  of Example 6 corresponds to graph  $G + \{3\}$ .

While for a set system the property of being a delta-matroid is closed under pivot, the next example shows that it is *not* closed under loop complementation.

**Example 10.** Let  $V = \{1, 2, 3\}$  and  $M = (V, D)$  with  $D = \{\emptyset, \{1\}, \{2\}, \{3\}, \{1, 2\}, \{2, 3\}, \{3, 1\}\}$  be a set system. It is shown in [7, Section 3] that  $M$  is a delta-matroid without graph representation. Consider  $\{1\} \subseteq V$ . Then  $M + \{1\} = (V, D')$  with  $D' = \{\emptyset, \{2\}, \{3\}, \{2, 3\}, \{1, 2, 3\}\}$  is not a delta-matroid: for  $X = \emptyset, Y = \{1, 2, 3\} \in D'$ , and  $x = 1 \in X \oplus Y$ , we have  $X \oplus \{x\} = \{1\} \notin D'$  and there is no  $y \in X \oplus Y$  such that  $X \oplus \{x, y\} \in D'$ .

## 6. Compositions of Loop Complementation and Pivot

In this section we study sequences of loop complementation and pivot operations. As we may consider both operations as vertex flips, we obtain in a straightforward way general equalities involving loop complementation and pivot.

**Theorem 11.** *Let  $M$  be a set system over  $V$  and  $X \subseteq V$ . Then  $M + X * X + X = M * X + X * X$ .*

PROOF. In group  $S_3$  we have  $aba = bab = c$ . Hence  $\alpha_+ \alpha_* \alpha_+ = \alpha_* \alpha_+ \alpha_*$ . Now by Lemma 5, we have  $M + \{j\} * \{j\} + \{j\} = M * \{j\} + \{j\} * \{j\}$  for any  $j \in V$ . By the commutative property of vertex flip in Lemma 5, this can be generalized to sets  $X \subseteq V$ , and hence we obtain the desired result.  $\square$

Let us denote  $\alpha_{\bar{*}} = \alpha_+ \alpha_* \alpha_+$  and denote, for  $X \subseteq V$ ,  $M\alpha_{\bar{*}}^X$  by  $M\bar{*}X$ . We will call the  $\bar{*}$  operation the *dual pivot*. As  $\alpha_+$  is of order 2, we have, similar to the pivot operation and loop complementation,  $(M\bar{*}X)\bar{*}Y = M\bar{*}(X \oplus Y)$ . The dual pivot together with pivot and loop complementation correspond precisely to the elements of order 2 in  $S_3$ .

We now obtain a normal form for sequences of pivots and loop complementations.

**Theorem 12.** *Let  $M$  be a set system over  $V$ , and let  $\varphi$  be any sequence of pivot and loop complementation operations on elements in  $V$ . We have that  $M\varphi = M + X * Y + Z$  for some  $X, Y, Z \subseteq V$  with  $X \subseteq Y$ .*

PROOF. Again we can consider the operations with respect to a single element  $j$ , as the generalization to sets follows by the commutative property of Lemma 5.

The 6 elements of  $\text{GL}_2(\mathbb{F}_2)$  are 1,  $\alpha_+$ ,  $\alpha_*$ ,  $\alpha_+ \alpha_*$ ,  $\alpha_* \alpha_+$ , and  $\alpha_+ \alpha_* \alpha_+$ . Hence any sequence of pivot and loop complementation over  $j$  reduces to one of these six elements, each of which can be written in the form of the statement (with  $X, Y, Z$  either equal to  $\{j\}$  or to the empty set).  $\square$

Because local and edge complementation operations are special cases of pivot the normal form of Theorem 12 is equally valid for any sequence  $\varphi$  of local, edge, and loop complementation operations.

The central interest of this paper is to study compositions of pivot and loop complementation on graphs. As explained in Section 3, the pivot operations for set systems and graphs coincide, i.e.,  $\mathcal{M}_{G*X} = \mathcal{M}_G * X$ , and we have taken care that the same holds for loop complementation, cf. Theorem 8. Hence results that hold for set systems in general, like Theorem 11, subsume the special case where the set system  $M$  represents a graph (i.e.,  $M = \mathcal{M}_G$  for some graph  $G$ ) — recall that the injectivity of  $\mathcal{M}_{(\cdot)}$  allows one to view the family  $\mathcal{G}$  of graphs (over  $V$ ) as a subset of the family of set systems (over  $V$ ). We only need to make sure that we “stay” in  $\mathcal{G}$ , i.e., by applying a pivot or loop complementation operation to  $\mathcal{M}_G$  we obtain a set system  $M$  such that  $M = \mathcal{M}_{G'}$  for some graph  $G'$ . For loop complementation this will always hold, however care must be taken for pivot as  $\mathcal{M}_G * X$ , which is defined for all  $X \subseteq V$ , only represents a graph if  $\det G[X] = 1$ . Hence when restricting a general result (on pivot or local complementation for set systems) to graphs, we add the condition of applicability of the operations.

It is useful to explicitly state Theorem 11 restricted to graphs. This is a fundamental result for pivots on graphs (or, equivalently, symmetric matrices over  $\mathbb{F}_2$ ) not found in the literature. We will study some of its consequences in the remainder of this paper.

**Corollary 13.** *Let  $G$  be a graph and  $X \subseteq V$ . Then  $G + X * X + X = G * X + X * X$  when both sides are defined.*

In the particular case of Corollary 13 it is not necessary to verify the applicability of both sides: it turns out that the applicability of the right-hand side implies the applicability of the left-hand side of the equality.

**Lemma 14.** *Let  $G$  be a graph and  $X \subseteq V$ . If  $G * X + X * X$  is defined, then  $G + X * X + X$  is defined.*

PROOF. Assume that  $G * X + X * X$  is defined. Thus,  $G_2 = G_1 + X * X + X * X + X$  is defined for  $G_1 = G + X$ . Now consider  $\mathcal{M}_{G_2}$ . We have that  $\mathcal{M}_{G_2} * X = \mathcal{M}_{G_1}$  by Theorem 11. Since the pivot operation is of order 2,  $\mathcal{M}_{G_1} * X = \mathcal{M}_{G_2}$ . Hence,  $\mathcal{M}_{G_1} * X$  has a graph representation (graph  $G_2$ ), and thus  $\emptyset$  is in set system  $\mathcal{M}_{G_1} * X$ . Consequently,  $X$  is in set system  $\mathcal{M}_{G_1}$ , thus  $\det G_1[X] = 1$ , and so  $G_1 * X = (G + X) * X$  is defined.  $\square$

The reverse implication of Lemma 14 does not hold: take, e.g.,  $G$  to be the connected graph of two vertices with each vertex having a loop.

We now state Theorem 12 restricted to graphs.

**Corollary 15.** *Let  $G$  be a graph, and let  $\varphi$  be a sequence of local, edge, and loop complementation operations applicable to  $G$ . We have that  $G\varphi = G + X * Y + Z$  for some  $X, Y, Z \subseteq V$  with  $X \subseteq Y$ .*

PROOF. By Theorem 12,  $\mathcal{M}_G\varphi = \mathcal{M}_G + X * Y + Z$  for some  $X, Y, Z \subseteq V$  with  $X \subseteq Y$ . It suffices to show now that  $G + X * Y + Z$  is defined, i.e., show that  $*Y$  is applicable to  $G + X$ . As  $\mathcal{M}_G + X * Y + Z$  represents a graph (the graph  $G\varphi$ ),  $\mathcal{M}_G + X * Y$  also represents a graph (the graph  $G\varphi + Z$ ). Therefore,  $\emptyset$  is in  $\mathcal{M}_G + X * Y$  and thus  $Y$  is in  $\mathcal{M}_G + X$ . Consequently,  $*Y$  is indeed applicable to  $G + X$ .  $\square$

Corollary 13 can also be proven directly using Equality (1), i.e., the partial inverse property of pivots. This is shown in the next theorem which also provides a direct definition of the dual pivot for matrices.

Let  $A$  be a  $V \times V$ -matrix and let  $X \subseteq V$ . We write  $A(x, y)^T$  to denote the application of  $A$  to the vector  $\begin{pmatrix} x \\ y \end{pmatrix}$ , where it is understood that  $x$  corresponds to the  $X$ -coordinates, and  $y$  to the remaining coordinates. We make now an exception and consider arbitrary matrices, instead of symmetric matrices, over  $\mathbb{F}_2$ . In this way the next result provides another generalization (in addition to the generalization to set systems of Theorem 11) of the concept of dual pivot on graphs.

**Theorem 16.** *Let  $A$  be a  $V \times V$ -matrix over  $\mathbb{F}_2$  and let  $X \subseteq V$ . Then  $A + X * X + X = A * X + X * X$  (if both sides are defined), and moreover  $A(x_1, y_1)^T = (x_2, y_2)^T$  iff  $(A + X * X + X)(x_1 + x_2, y_1)^T = (x_2, y_2)^T$  (if  $A + X * X$  is defined). In addition, any matrix  $B$  with this property is of the form  $B = A + X * X + X$ .*

PROOF. The pivot operation acts as a partial inverse, cf. (1). Hence  $A(x_1, y_1)^T = (x_2, y_2)^T$  iff  $(A * X)(x_2, y_1)^T = (x_1, y_2)^T$ . The loop complementation adds 1 to the diagonal elements corresponding to  $X$ , thus  $A(x_1, y_1)^T = (x_2, y_2)^T$  iff  $(A + X)(x_1, y_1)^T = (x_1 + x_2, y_2)^T$ .

We simply chain these equalities:  $A(x_1, y_1)^T = (x_2, y_2)^T$  iff  $(A + X)(x_1, y_1)^T = (x_1 + x_2, y_2)^T$  iff  $(A + X * X)(x_1 + x_2, y_1)^T = (x_1, y_2)^T$  iff  $(A + X * X + X)(x_1 + x_2, y_1)^T = (x_2, y_2)^T$ .

$X)(x_1 + x_2, y_1)^T = (x_2, y_2)^T$ . We get a similar result by chaining the equalities for  $A * X + X * X$  instead of  $A + X * X + X$ .

Finally, if a matrix  $B$  exists with  $B(x_1 + x_2, y_1)^T = (x_2, y_2)^T$  given the matrix  $A$  with  $A(x_1, y_1)^T = (x_2, y_2)^T$ , then  $(B + X)(x_1 + x_2, y_1)^T = (x_1, y_2)^T$  and  $(A + X)(x_1, y_1)^T = (x_1 + x_2, y_2)^T$ . Thus, by the definition of pivot given by Equality (1) in Section 3, we have  $A + X * X = B + X$ , and so  $B = A + X * X + X$ .  $\square$

It is interesting to consider Theorem 16 for the case  $X = V$ . Recall that for matrix  $A$ ,  $A * V$  is the inverse  $A^{-1}$  of  $A$ . Also,  $A + V$  simply means adding the identity matrix (often denoted by  $I$ ) to  $A$ . Therefore, by Theorem 16, we see that over  $\mathbb{F}_2$  addition of  $I$  and matrix inversion together form the group  $S_3$ . In particular,  $((A^{-1} + I)^{-1} + I)^{-1} + I = A$  (assuming that the left-hand side is defined).

## 7. Maximal Pivots

In this section we show that the dual pivot retains the maximal elements  $\max(M)$  (w.r.t. inclusion) for any set system  $M$ , i.e.,  $\max(M) = \max(M \bar{*} X)$  for any  $X \subseteq V$ . In this way we generalize and provide an alternative proof for the main result of [9] where this result is shown for graphs (i.e., the case  $M = \mathcal{M}_G$ ):  $\max(\mathcal{M}_G) = \max(\mathcal{M}_{G \bar{*} X})$  for graph  $G$  and  $X \subseteq V(G)$  such that  $G \bar{*} X$  is defined.

**Remark 17.** More precisely, in [9] the operation  $G + V * X + V$  is considered instead of  $G \bar{*} X = G + X * X + X$ . Now as pivot and loop complementation on disjoint sets commute (see just below Example 6),  $G + V * X + V = G + X * X + X$  (as  $V \setminus X$  and  $X$  are disjoint, and the left-hand side is defined iff the right-hand side is defined). Hence, this operation is precisely the dual pivot  $G \bar{*} X$  restricted to graphs  $G$ . In fact,  $M \bar{*} X$  defined in this paper is named dual pivot as the corresponding graph operation  $G + V * X + V$  in [9] is called dual pivot as well.

First we define the dual pivot explicitly for set systems. We have  $\alpha_{\bar{*}} = \begin{pmatrix} 1 & 0 \\ 1 & 1 \end{pmatrix}$ . Hence, for  $j \in V$ ,  $M \bar{*} \{j\} = (V, D')$  where, for all  $Z \subseteq V$ ,  $Z \in D'$  iff

$$\begin{cases} Z \in D & \text{if } j \in Z \\ (Z \cup \{j\} \in D) \oplus (Z \in D) & \text{if } j \notin Z \end{cases} \quad (2)$$

Similarly as for loop complementation, we can reformulate the definition of the dual pivot. If we let  $M = (V, D)$ , then  $M \bar{*} \{j\} = (V, D')$  with  $D' = D \oplus \{Z \setminus \{j\} \mid j \in Z \in D\}$ . Moreover, we may provide a characterization of dual pivot similar to the characterization of loop complementation in Theorem 7.

**Theorem 18.** *Let  $M$  be a set system and  $X, Y \subseteq V$ . We have  $Y \in M \bar{*} X$  iff  $|\{Z \in M \mid Y \subseteq Z \subseteq Y \cup X\}|$  is odd.*

PROOF. We apply Theorem 7 to  $M \bar{*} X = M * V + X * V$  and use the fact that the operation  $* V$  complements the sets of a set system. We have  $Y \in M \bar{*} X$  iff  $V \setminus Y \in M * V + X$  iff the set  $\{Z \in M * V \mid (V \setminus Y) \setminus X \subseteq Z \subseteq V \setminus Y\} = \{Z \in M \mid (V \setminus Y) \setminus X \subseteq V \setminus Z \subseteq V \setminus Y\} = \{Z \in M \mid Y \subseteq Z \subseteq X \cup Y\}$  is of odd cardinality (where in the first equality we have changed the variable  $Z := Z \oplus V$ , and in the second equality we applied  $\oplus V$  to invert both inclusions).  $\square$

The following result is almost a direct consequence of Theorems 7 and 18.

**Theorem 19.** *Let  $M$  be a set system over  $V$  and  $X \subseteq V$ . Then  $\max(M) = \max(M \bar{*} X)$  and  $\min(M) = \min(M + X)$ .*

PROOF. If  $Y \in \max(M)$ , then  $Y \in M \bar{*} X$  by Theorem 18 (as  $\{Z \in M \mid Y \subseteq Z \subseteq Y \cup X\} = \{Y\}$ ). Let  $M' = M \bar{*} X$ . By exactly the same reasoning as before, we find that  $Y \in \max(M')$  implies that  $Y \in M' \bar{*} X = M$ . Hence  $\max(M) = \max(M \bar{*} X)$ .

Similarly, the equality  $\min(M) = \min(M + X)$  follows from Theorem 7.  $\square$

**Example 20.** Let  $V = \{p, q, r, s\}$  and  $M = (V, D)$  with

$$D = \{\emptyset, \{p\}, \{q\}, \{p, r\}, \{p, s\}, \{r, s\}, \{p, q, r\}, \{p, q, s\}, \{p, r, s\}, \{q, r, s\}\}.$$

Then  $M \bar{*} \{r\} = (V, D')$  with

$$D' = \{\emptyset, \{q\}, \{s\}, \{p, q\}, \{p, r\}, \{q, s\}, \{r, s\}, \{p, q, r\}, \{p, q, s\}, \{p, r, s\}, \{q, r, s\}\}.$$

Thus indeed  $\max(M) = \{\{p, q, r\}, \{p, q, s\}, \{p, r, s\}, \{q, r, s\}\} = \max(M \bar{*} \{r\})$ . Note that the maximal elements may differ dramatically when performing (regular) pivot or loop complementation: e.g.,  $\max(M * \{q\}) = \{\{p, q, r, s\}\}$ .

The corresponding result restricted to graphs is given below for completeness. The result is shown in [9] using linear algebra techniques, while in this paper it is almost a direct consequence of the definition of dual pivot on set systems. Note that for graph  $G$  and  $X \subseteq V(G)$ ,  $X \in \max(\mathcal{M}_G)$  iff both  $\det G[X] = 1$  and  $\det G[Y] = 0$  for every  $Y \supset X$ .

**Corollary 21 ([9]).** *Let  $G$  be a graph, and let  $X \subseteq V(G)$ . Then  $\max(\mathcal{M}_G) = \max(\mathcal{M}_{G \bar{*} X})$  if the right-hand side is defined (i.e.,  $\det(G + X)[X] = 1$ ).*

While the result  $\min(M) = \min(M + X)$  (in Theorem 19) may be relevant for arbitrary set systems, the result is trivial when restricted to graphs. Indeed, for a graph  $G$  we have  $\min(\mathcal{M}_G) = \{\emptyset\}$  and since  $\mathcal{M}_G + X$  represents a graph (it is the graph  $G + X$ ) we have  $\min(\mathcal{M}_{G + X}) = \{\emptyset\}$ .

**Example 22.** Set system  $M$  of Example 20 corresponds to graph  $G$  on the upper-left corner of Figure 2. For  $X = \{r\}$ ,  $\det(G + X)[X] = 1$  holds as  $\{r\}$  is a loop in  $G + \{r\}$ . Graphs  $G$  and  $G \bar{*} \{r\}$  are given in Figure 4.

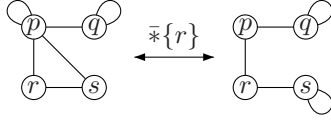

Figure 4: Dual pivot  $\bar{*}\{r\}$  on graph  $G$  from the upper-left corner of Figure 2.

The proof of Corollary 21 in [9] relies heavily on the fact that the elements of  $\max(\mathcal{M}_G)$  are all of cardinality equal to the rank of (the adjacency matrix of)  $G$ , a consequence of the Strong Principal Minor Theorem, see [15, Theorem 2.9]. This property of  $\max(\mathcal{M}_G)$  turns out to be irrelevant for Corollary 21 as its generalization, Theorem 19, holds for set systems in general where this property of  $\max(\mathcal{M}_G)$  of course does not hold.

In [9] it was also noted that the kernel (null space) of a graph is invariant under dual pivot. It is straightforward to verify now using Theorem 16 that this holds for arbitrary matrices over  $\mathbb{F}_2$ : if  $A(x_1, y_1)^T = (0, 0)$ , then  $A\bar{*}X(x_1 + 0, y_1)^T = (0, 0)$ . Therefore,  $A\bar{*}X(x_1, y_1)^T = (0, 0)$ . The converse holds as dual pivot is an involution (operation of order 2). In particular, the rank of  $A$  is invariant w.r.t. the dual pivot.

As observed in [9], as a graph transformation operation, the dual pivot is similar to the (regular) pivot. More precisely, the elementary dual pivots  $G\bar{*}X$  are either of the form (1)  $X = \{u\}$  where  $u$  does not have a loop in  $G$  or of the form (2)  $X = \{u, v\}$  where  $\{u, v\}$  is an edge of  $G$  where both  $u$  and  $v$  have loops. The effect of elementary pivot  $\bar{*}\{u\}$  is the same as that of  $*\{u\}$ , complementing its neighbourhood. Similarly for elementary pivot  $\bar{*}\{u, v\}$ . Only the conditions for applying of elementary dual pivots are different compared to those for (regular) elementary pivots: the effect of the operation is the same.

## 8. Consequences for Simple Graphs

In this section we consider simple graphs, i.e., undirected graphs without loops or parallel edges. Local complementation was first studied on simple graphs [16]: local complementation on a vertex  $u$ , by abuse of notation denoted by  $*\{u\}$ , complements the edges in the neighbourhood of  $u$ , thus it is the same operation as for graphs (loops allowed) except that applicability is not dependent on the presence of a loop on  $u$ , and neither are loops added or removed in the neighbourhood. Also edge complementation  $*\{u, v\}$  on edge  $\{u, v\}$  for simple graphs is defined as for graphs, inverting certain sets of edges, cf. Figure 1, but again the absence of loops is not an (explicit) requirement for applicability.

The “curious” identity  $*\{u, v\} = *\{u\}*\{v\}*\{u\}$  for simple graphs shown by Bouchet [5, Corollary 8.2] and found in standard textbooks, see, e.g., [14, Theorem 8.10.2], can be proven by a straightforward (but slightly tedious) case analysis involving  $u, v$  and all possible combinations of their neighbours. Here it is obtained, cf. Proposition 23, as a consequence of Theorem 11.

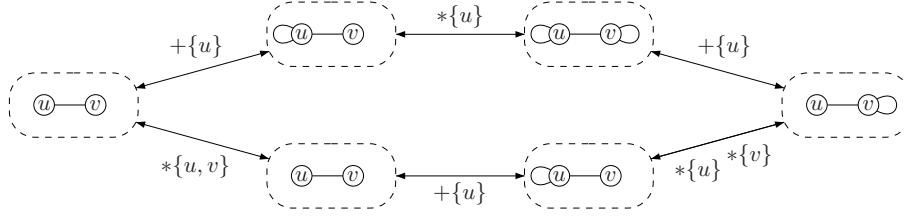

Figure 5: Verification of applicability of  $*\{u, v\} + \{u\} * \{u\} * \{v\} + \{u\} * \{u\} + \{u\}$  to any graph  $F$  having an edge  $\{u, v\}$  with both  $u$  and  $v$  non-loop vertices.

**Proposition 23.** *Let  $H$  be a simple graph having an edge  $\{u, v\}$ . We have  $H * \{u, v\} = H * \{u\} * \{v\} * \{u\} = H * \{v\} * \{u\} * \{v\}$ .*

PROOF. Let  $M$  be a set system, and  $u$  and  $v$  two distinct elements from its domain. Define  $\varphi = *\{u, v\} + \{u\} * \{u\} * \{v\} + \{u\} * \{u\} + \{u\}$ . Recall that for set systems we have  $*\{u, v\} = *\{u\} * \{v\}$  and that the operations on different elements commute, e.g.  $*\{v\} + \{u\} = +\{u\} * \{v\}$ . We have therefore  $\varphi = *\{u\} * \{v\} + \{u\} * \{u\} * \{v\} + \{u\} * \{u\} + \{u\} = *\{u\} + \{u\} * \{u\} + \{u\} * \{v\} + \{u\} = *\{u\} + \{u\} * \{u\} + \{u\} = \text{id}$ , where in the last equality we used Theorem 11. Therefore,  $M\varphi = M$  for any set system  $M$  having  $u$  and  $v$  in its domain.

Hence, any graph  $G$  for which  $\varphi$  is applicable to  $G$ , we have  $G\varphi = G$ . Assume now that  $G$  is a graph (allowing loops) having the edge  $\{u, v\}$  where both  $u$  and  $v$  do not have a loop. By Figure 5 we see that  $\varphi$  is applicable to  $G$ , and therefore  $G\varphi = G$ .

Now, modulo loops, i.e., considering simple graphs  $H$ , we no longer worry about the presence of loops, and we may omit the loop complementation operations from  $\varphi$ . Hence  $*\{u, v\} * \{u\} * \{v\} * \{u\}$  is the identity on simple graphs, and therefore  $*\{u, v\} = *\{u\} * \{v\} * \{u\}$ . By symmetry of the  $*\{u, v\}$  operation we also have that  $*\{u, v\} = *\{v\} * \{u\} * \{v\}$ .  $\square$

Thus, for set systems we have the decomposition  $*\{u, v\} = *\{u\} * \{v\}$ , whereas for simple graphs the decomposition of edge complementation into local complementation takes the form  $*\{u, v\} = *\{u\} * \{v\} * \{u\}$ . The rationale behind this last equality is hidden, as in fact the equality  $*\{u, v\} = +\{u\} * \{u\} + \{u\} * \{v\} * \{u\} + \{u\}$  is demonstrated for graphs (loops allowed) (see the proof of Proposition 23). The fact that the equality of Proposition 23 does not hold for graphs (with loops allowed) is a consequence of the added requirement of applicability of the operations. Applicability depends on the presence or absence of loops, and it is curious that loops are necessary to fully understand these operations for simple graphs (which are loopless by definition)!

A second remark concerns Figure 5 and its role in the proof. Following the operations around the loop in the diagram, starting and ending at the same point, we obtain the identity operation (on set systems). The diagram in the figure does not show that the identity holds, it merely concerns *applicability* of the operations (in graphs). It is possible to graphically verify that composing the



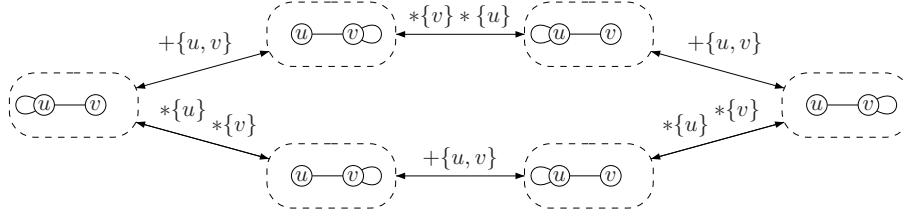

Figure 6: Verification of applicability of  $(*\{u\} * \{v\} + \{u, v\})^3$  to a graph  $G$  having an edge  $\{u, v\}$  with a loop on vertex  $u$ .

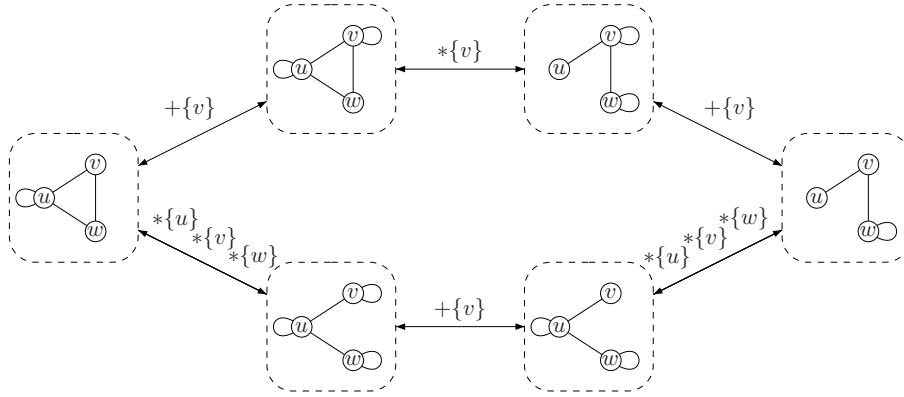

Figure 7: Verification of applicability of a sequence of local and loop complementations from Corollary 24 to a graph  $G$  where  $G[\{u, v, w\}]$  is the left-most graph in the figure.

operations around the loop forms the identity: one has to add several “generic” vertices  $q$  each representing a specific case of whether or not  $u$  and whether or not  $v$  is in the neighbourhood of  $q$ . However, the number of vertices  $q$  grows exponentially in the number of vertices of the subgraph (in this case an edge consisting of vertices  $u$  and  $v$ ) under consideration. Here, verifying the applicability of  $\varphi$  on the subgraph induced by  $u$  and  $v$  suffices.

Incidentally, the equality  $*\{u\} * \{v\} * \{u\} = *\{v\} * \{u\} * \{v\}$  can also be verified directly by using Figure 6 instead of Figure 5 in the proof of Proposition 23, and observing that that  $(*\{u\} * \{v\} + \{u, v\})^3$  is the identity (in set systems). This does not show the equality to  $*\{u, v\}$  in simple graphs.

In addition to providing a new proof for Proposition 23, the presented method allows one to obtain many more curious equalities involving local complementation and/or edge complementation. The steps are as follows. One starts with an identity for set systems, involving pivot and loop complementation. Then one shows applicability for (general) graphs for the sequence of operations. Finally one drops the loop complementation operations to obtain an identity for simple graphs.

We illustrate this by stating one such equality. Proposition 23 considers the case where  $u, v \in V(H)$  is such that the subgraph of  $H$  induced by  $\{u, v\}$  is a

complete graph (i.e.,  $\{u, v\}$  is an edge in  $H$ ). We now deduce an equality where three vertices induce a complete graph.

**Corollary 24.** *Let  $H$  be a simple graph, and let  $u, v, w \in V(H)$  be such that the subgraph of  $H$  induced by  $\{u, v, w\}$  is a complete graph. Then  $H(*\{u\}*\{v\}*\{w\})^2 = H*\{v\}$ .*

PROOF. The proof of this lemma is very similar to the proof of Proposition 23. We have  $*\{u\}*\{v\}*\{w\} + \{v\}*\{u\}*\{v\}*\{w\} = *\{v\} + \{v\}*\{v\}$  as pivot and loop complementation on disjoint sets commute. Moreover,  $*\{v\} + \{v\}*\{v\} = +\{v\}*\{v\} + \{v\}$  by Theorem 11.

By Figure 7 we see that both  $*\{u\}*\{v\}*\{w\} + \{v\}*\{u\}*\{v\}*\{w\}$  and  $+\{v\}*\{v\} + \{v\}$  are applicable to any graph  $G$  where  $G[\{u, v, w\}]$  (the left-most graph in the figure) has loop  $\{u\}$  and edges  $\{u, v\}$ ,  $\{u, w\}$ , and  $\{v, w\}$ . The result follows by considering the equality modulo loops, i.e., “forgetting” about loops.  $\square$

**Remark 25.** Sabidussi [19] studies local complementation on simple graphs with bicoloured vertices. Local complementation on a vertex  $u$  then also toggles the colours of the vertices adjacent to  $u$ . By modelling the two colours by the existence or nonexistence of loops, we find that this operation is exactly local complementation in graphs, where we additionally allow local complementation to be applied on non-looped vertices. Let us denote this operation on a vertex  $u$  by  $\tilde{*}\{u\}$ . Hence,  $\tilde{*}\{u\}$  is equal to  $*\{u\}$  if  $u$  has a loop and equal to  $\bar{*}\{u\}$  if  $u$  has a no loop.

In this context, we may reconsider the equality  $G(*\{u\}*\{v\} + \{u, v\})^3 = G$  from Figure 6 where  $G$  has an edge  $\{u, v\}$  with  $u$  and  $v$  non-looped vertices. We have that  $\tilde{*}\{u\}$  and  $+\{u\}$  commute as a loop is of no consequence for applicability of  $\tilde{*}$  (or more formally, as  $*\{u\} + \{u\} = +\{u\}\bar{*}\{u\}$ ). We infer that  $G(\tilde{*}\{u\}\tilde{*}\{v\})^3 = G + \{u, v\}$ , and obtain in this way [19, Lemma 1].

Similarly the equality  $G*\{u\}*\{v\}*\{w\} + \{v\}*\{u\}*\{v\}*\{w\} = G + \{v\}*\{v\} + \{v\}$  where  $G$  has a triangle, as proved in Corollary 24, see Figure 7, reduces to  $G\tilde{*}\{v\}(\tilde{*}\{w\}\tilde{*}\{v\}\tilde{*}\{u\})^2 = G + \{v\}$ . Thus we also have obtained in this way [19, Lemma 2].

Together these two results form the core of the central result in [19] that any bicoloured simple graph may be colour reversed by a linear number of local complementation operations. Equivalently,  $G + V$  can be obtained from  $G$  by a sequence of  $\tilde{*}$  operations (of length linear in  $|V|$ ).

In the next result, Theorem 27, we go back-and-forth between the notions of simple graph and graph. To avoid confusion, we explicitly formalize these transitions. For a simple graph  $H$ , we define  $i(H)$  to be  $H$  regarded as a *graph* (i.e., symmetric matrix over  $\mathbb{F}_2$ ) having no loops. Similarly, for graph  $G$ , we define  $\pi(G)$  to be the simple graph obtained from  $G$  by removing the loops. Thus,  $i(H)$  is the obvious injection from the set of simple graphs to the set of graphs, while  $\pi(G)$  is the obvious projection from the set of graphs to the set of simple graphs. We will use the following identities.

**Lemma 26.** *For simple graph  $H$ ,  $\pi(i(H)) = H$ . For graph  $G$  and elementary pivot  $G * X$  (hence  $*X$  is either local or edge complementation),  $\pi(G * X) = \pi(G) * X$ . Moreover, for  $Y \subseteq V(G)$ ,  $\pi(G + Y) = \pi(G)$ .*

If  $\varphi$  is a sequence of edge complementation operations applicable to graph  $G$ , then  $\varphi(G) = G * Y$  for some  $Y \subseteq V(G)$ , see [8] (or alternatively, it may deduced from [6, Section 2], [4], and observing that the matrix operation considered in these papers is, modulo  $\mathbb{F}_2$ , equal to principal pivot transform). The converse also holds: if graph  $G$  does not have loops, then  $G * Y$  is applicable iff  $Y$  can be decomposed into a sequence of applicable edge complementation operations (i.e., all elementary pivot operations are edge complementations). Similarly, as a consequence of Theorem 12, the following result characterizes the effect of sequences of local complementations on simple graphs.

**Theorem 27.** *Let  $H$  be a simple graph, and let  $\varphi$  be a sequence of local complementation operations applicable to  $H$ . Then  $H\varphi = \pi(i(H) + X * Y)$  for some  $X, Y \subseteq V$  with  $X \subseteq Y$ .*

*Conversely, for graph  $G$ , if  $G + X * Y$  is defined for some  $X, Y \subseteq V$ , then there is a sequence  $\varphi$  of local complementation operations applicable to  $\pi(G)$  such that  $\pi(G)\varphi = \pi(G + X * Y)$ .*

PROOF. We first prove the first statement of the theorem. Let  $\varphi = *\{v_1\} \cdots *\{v_n\}$ . We have, for any graph  $G$  and  $u \in V(G)$ , either  $G * \{u\}$  is defined or  $G + \{u\} * \{u\}$  is defined (but not both). Thus there is a (unique)  $\varphi' = \varphi'_1 \varphi'_2 \cdots \varphi'_n$ , where  $\varphi'_i$  is either  $*\{v_i\}$  or  $+\{v_i\} * \{v_i\}$  for all  $i \in \{1, \dots, n\}$ , such that  $\varphi'$  is defined on (applicable to)  $i(H)$ . By Corollary 15,  $i(H)\varphi' = i(H) + X * Y + Z$  for some  $X, Y, Z \subseteq V$  with  $X \subseteq Y$ . By Lemma 26,  $\pi(i(H) + X * Y) = \pi(i(H) + X * Y + Z) = \pi(i(H)\varphi') = H\varphi$  and we have the first statement of the theorem.

Now assume  $G + X * Y$  is defined for some  $X, Y \subseteq V$ . Partition  $Y = Y_1 \cup \cdots \cup Y_n$  such that  $G + X * Y = G + X * Y_1 \cdots * Y_n$  is a sequence of elementary pivots on  $G + X$ . By Lemma 26,  $\pi(G + X * Y) = \pi(G + X * Y_1 \cdots * Y_n) = \pi(G) * Y_1 \cdots * Y_n$ . By replacing each edge complementation  $*Y_i$  with  $Y_i = \{u_i, v_i\}$  by either sequence  $*\{u_i\} * \{v_i\} * \{u_i\}$  or sequence  $*\{v_i\} * \{u_i\} * \{v_i\}$ , see Proposition 23, we have a desired sequence  $\varphi$  of local complementations applicable to  $\pi(G)$  with  $\pi(G)\varphi = \pi(G + X * Y)$ .  $\square$

## 9. Discussion

We have considered loop complementation  $+X$ , pivot  $*X$ , and dual pivot  $\bar{*}X$  on both set systems and graphs, and have shown that they can be seen as elements of order 2 in the permutation group  $S_3$ . This group structure, in addition to the commutation property in Lemma 5, leads to the identity  $(+X * X)^3 = \text{id}$ , cf. Theorem 11, and to a normal form w.r.t. sequences of pivots and loop complementation, cf. Theorem 12.

Although the three operations are equivalent as elements of  $S_3$ , they are quite different for set systems and graphs. Indeed, for set systems, the definition of pivot is much less involved than the (symmetrical) definitions of loop

complementation and dual pivot. In contrast, for graphs, the definition of loop complementation is much less involved than the (symmetrical) definitions of pivot and dual pivot. As a direct consequence of the definitions of loop complementation and dual pivot on set systems we notice that these operations retain the minimal and maximal elements, respectively, of the set system.

Moreover, we obtain as a special case “modulo loops” a classic relation involving local and edge complementation on simple graphs, cf. Proposition 23. Other relations may be easily deduced, cf. Corollary 24.

Since the notions of binary matrix and set system are incomparable w.r.t.  $\mathcal{M}_{(\cdot)}$ , the operations of pivot and loop complementation for binary matrices and set systems are also incomparable. It remains open whether or not one may combine and generalize the two notions and its operations of pivot and loop complementation in a natural way.

#### *Acknowledgements*

We thank the referees for their valuable comments on the paper, and in particular for bringing [19] to our attention. R.B. is supported by the Netherlands Organization for Scientific Research (NWO), project “Annotated graph mining”.

#### **References**

- [1] M. Aigner and H. van der Holst. Interlace polynomials. *Linear Algebra and its Applications*, 377:11–30, 2004.
- [2] R. Arratia, B. Bollobás, and G.B. Sorkin. The interlace polynomial: a new graph polynomial. In *SODA '00: Proceedings of the Eleventh Annual ACM-SIAM Symposium On Discrete Algorithms*, pages 237–245, Philadelphia, PA, USA, 2000. Society for Industrial and Applied Mathematics.
- [3] R. Arratia, B. Bollobás, and G.B. Sorkin. The interlace polynomial of a graph. *Journal of Combinatorial Theory, Series B*, 92(2):199–233, 2004.
- [4] A. Bouchet. Representability of  $\Delta$ -matroids. In *Proc. 6th Hungarian Colloquium of Combinatorics, Colloquia Mathematica Societatis János Bolyai*, volume 52, pages 167–182. North-Holland, 1987.
- [5] A. Bouchet. Graphic presentations of isotropic systems. *Journal of Combinatorial Theory, Series B*, 45(1):58–76, 1988.
- [6] A. Bouchet. Multimatroïds III. Tightness and fundamental graphs. *European Journal of Combinatorics*, 22(5):657–677, 2001.
- [7] A. Bouchet and A. Duchamp. Representability of  $\Delta$ -matroids over  $GF(2)$ . *Linear Algebra and its Applications*, 146:67–78, 1991.
- [8] R. Brijder, T. Harju, and H.J. Hoogeboom. Pivots, determinants, and perfect matchings of graphs. Submitted, [arXiv:0811.3500], 2008.

- [9] R. Brijder and H.J. Hoogeboom. Maximal pivots on graphs with an application to gene assembly. *Discrete Applied Mathematics*, 158(18):1977–1985, 2010.
- [10] R. Brijder and H.J. Hoogeboom. Pivot and loop complementation on graphs and set systems. In J. Kratochvil and A. Li, editors, *TAMC 2010*, volume 6108 of *Lecture Notes in Computer Science*, pages 151–162. Springer, 2010.
- [11] R.W. Cottle, J.-S. Pang, and R.E. Stone. *The Linear Complementarity Problem*. Academic Press, San Diego, 1992.
- [12] A. Ehrenfeucht, T. Harju, I. Petre, D.M. Prescott, and G. Rozenberg. *Computation in Living Cells – Gene Assembly in Ciliates*. Springer Verlag, 2004.
- [13] J.F. Geelen. A generalization of Tutte’s characterization of totally unimodular matrices. *Journal of Combinatorial Theory, Series B*, 70:101–117, 1997.
- [14] C. Godsil and G. Royle. *Algebraic Graph Theory*. Springer, 2001.
- [15] V. Kodiyalam, T. Y. Lam, and R. G. Swan. Determinantal ideals, Pfaffian ideals, and the principal minor theorem. In *Noncommutative Rings, Group Rings, Diagram Algebras and Their Applications*, pages 35–60. American Mathematical Society, 2008.
- [16] A. Kotzig. Eulerian lines in finite 4-valent graphs and their transformations. In *Theory of graphs, Proceedings of the Colloquium, Tihany, Hungary, 1966*, pages 219–230. Academic Press, New York, 1968.
- [17] S. Oum. Rank-width and vertex-minors. *Journal of Combinatorial Theory, Series B*, 95(1):79–100, 2005.
- [18] T.D. Parsons. Applications of principal pivoting. In H.W. Kuhn, editor, *Proceedings of the Princeton Symposium on Mathematical Programming*, pages 567–581. Princeton University Press, 1970.
- [19] G. Sabidussi. Color-reversal by local complementation. *Discrete Mathematics*, 64(1):81–86, 1987.
- [20] M.J. Tsatsomeris. Principal pivot transforms: properties and applications. *Linear Algebra and its Applications*, 307(1-3):151–165, 2000.
- [21] A.W. Tucker. A combinatorial equivalence of matrices. In *Combinatorial Analysis, Proceedings of Symposia in Applied Mathematics*, volume X, pages 129–140. American Mathematical Society, 1960.
- [22] M. Van den Nest, J. Dehaene, and B. De Moor. Graphical description of the action of local clifford transformations on graph states. *Physical Review A*, 69(2):022316, 2004.