

Frobenius Modules and Essential Surface Cobordisms*

J. Scott Carter
University of South Alabama

Masahico Saito
University of South Florida

December 31, 2013

Abstract

An algebraic system is proposed that represent surface cobordisms in thickened surfaces. Module and comodule structures over Frobenius algebras are used for representing essential curves. The proposed structure gives a unified algebraic view of states of categorified Jones polynomials in thickened surfaces and virtual knots. Constructions of such system are presented.

1 Introduction

In this article, we propose a formulation of an algebraic structure that describes surface cobordisms in thickened surfaces that have both inessential and essential circles. Thus the structure we propose is a refinement of a $(1+1)$ -TQFT. Our motivation comes from the differentials of generalizations of Khovanov homology [10] defined in [3, 16] for thickened surfaces and those for virtual knots [7, 14]. Although the use of a Frobenius algebra structure is explicit in [7, 16], we propose a more detailed distinction between the vector spaces that are assigned to trivial circles and essential circles in thickened surfaces. In this way, we will construct an algebraic system that provides a unified view of the states and differentials used in these theories. We propose that essential circles can be studied by means of a module and comodule structure over a Frobenius algebra.

The well-definedness of the differential ($d^2 = 0$) in the Khovanov homology for classical knots depends mainly on a $(1+1)$ -TQFT structure and therefore upon a Frobenius algebra [11]. Variations of a $(1+1)$ -TQFT structure have been studied ([4, 13], for example) for refinements of the Khovanov homology. Studies of generalizations of TQFT to surfaces in 3-manifolds were suggested also by C. Frohman. In [3], the authors adapt the description of [17] and define differentials in a combinatorial fashion by using signs (\pm) and enhanced states to define their differentials. In particular, they don't use an explicit Frobenius algebra. On the other hand, an algebraic formulation creates the advantage of enabling systematic generalizations and streamlining the proofs of well-definedness [11]. Meanwhile, in [7, 16] a Frobenius algebra is used to generalize Khovanov homology to virtual knots and thickened surfaces, respectively. Herein, we provide a single algebraic approach that envelopes both theories, and we provide constructions and examples for our approach.

The paper is organized as follows. In Section 2, we review necessary materials and establish notation. In Section 3, we define the algebraic structure called “commutative Frobenius pairs” and

*MRCN:16W30;57M99;55u99;18A99

present examples. We show in Section 4 that these structures naturally arises in $(1 + 1)$ -TQFTs. In Section 5, we provide new methods of constructions.

2 Preliminaries

2.1 Frobenius algebras and their diagrams

Frobenius algebras are assumed to be as described in [12], Section 1.3, and we give a brief summary here. A *Frobenius algebra* is an (associative) algebra (with multiplication $\mu : A \otimes A \rightarrow A$ and unit $\eta : k \rightarrow A$) over a unital commutative ring k with a nondegenerate associative pairing $\beta : A \otimes A \rightarrow k$. The pairing β is also expressed by $\langle x|y \rangle = \beta(x \otimes y)$ for $x, y \in A$, and it is *associative* in the sense that $\langle xy|z \rangle = \langle x|yz \rangle$ for any $x, y, z \in A$.

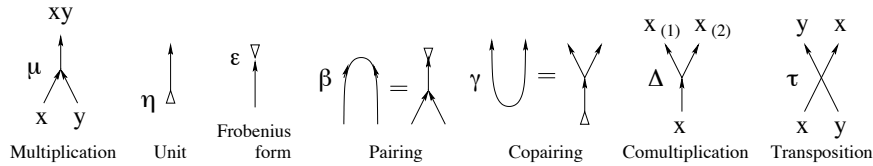

Figure 1: Diagrams for Frobenius algebra maps

A Frobenius algebra A has a linear functional $\epsilon : A \rightarrow k$, called the *Frobenius form*, or a *counit*, such that the kernel contains no nontrivial left ideal. It is defined from β by $\epsilon(x) = \beta(x \otimes 1)$, and conversely, a Frobenius form gives rise to a nondegenerate associative pairing β by $\beta(x \otimes y) = \epsilon(xy)$, for $x, y \in A$. A Frobenius form has a unique copairing $\gamma : k \rightarrow A \otimes A$ characterized by

$$(\beta \otimes |)(| \otimes \gamma) = | = (| \otimes \beta)(\gamma \otimes |),$$

which we call the *cancelation* of β and γ . See the middle entry in the bottom row of Fig. 2. Here and below, we denote by $|$ the identity homomorphism on the algebra. This notation will distinguish this function from the identity element $1 = 1_A = \eta(1_k)$ of the algebra that is the image of the identity of the ground ring. A Frobenius algebra A determines a coalgebra structure with A -linear (coassociative) comultiplication and the counit defined using the Frobenius form. The comultiplication $\Delta : A \rightarrow A \otimes A$ is defined by

$$\Delta = (\mu \otimes |)(| \otimes \gamma) = (| \otimes \mu)(\gamma \otimes |).$$

The multiplication and comultiplication satisfy the following equality:

$$\Delta\mu = (\mu \otimes |)(| \otimes \Delta) = (| \otimes \mu)(\Delta \otimes |)$$

which we call the *Frobenius compatibility condition*. In Fig. 1, diagrammatic conventions of various maps that appear for Frobenius algebras are depicted. The diagrams are read from bottom to top, and each line segment represents a tensor factor of A . In Fig. 2, the axioms and relations among compositions of these maps are represented by these diagrams.

A Frobenius algebra is *commutative* if it is commutative as an algebra. It is known ([12] Prop. 2.3.29) that a Frobenius algebra is commutative if and only if it is cocommutative as a coalgebra.

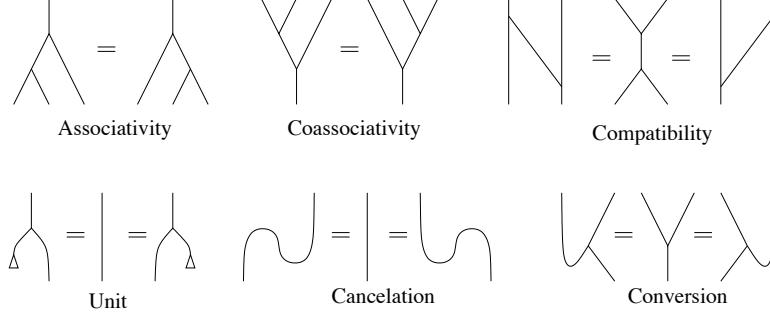

Figure 2: Equalities among Frobenius algebra maps

The map $\mu\Delta$ of a Frobenius algebra is called the *handle operator*, and corresponds to multiplication by a central element called the *handle element* $\delta_h = \mu\Delta(1)$ ([12], page 128).

Example 2.1 This example appears in universal Khovanov homology [10]. Let $A = \mathbb{Z}[X, h, t]/(X^2 - hX - t)$, with unit $\eta(1) = 1$, counit $\epsilon(1) = 0$, $\epsilon(X) = 1$, multiplication being the polynomial multiplication, comultiplication defined by

$$\begin{aligned}\Delta(1) &= 1 \otimes X + X \otimes 1 - h 1 \otimes 1 \\ \Delta(X) &= X \otimes X + t 1 \otimes 1.\end{aligned}$$

2.2 Modules and comodules

In this paper we focus on commutative, cocommutative algebras and bimodules and bicomodules, and assume the following conditions. Let k be a unital commutative ring. A commutative algebra is a ring $A = (A, \mu, \eta)$, that is a k -module A k -linear multiplication $\mu : A \otimes A \rightarrow A$ is associative, with its k -linear unit map denoted by $\eta = \eta_A : k \rightarrow A$. We also use the notations $1 = 1_k$, $1_A = \eta(1)$. By a *commutative bimodule* E over A , we mean that E is an A -bimodule, and the left and right actions $\mu = \mu_{A,E}^E : A \otimes E \rightarrow E$ (denoted by $a \otimes x \mapsto ax = \mu(a \otimes x)$), $\mu = \mu_{E,A}^E : E \otimes A \rightarrow E$ (denoted by $x \otimes a \mapsto xa = \mu(x \otimes a)$) satisfy $ax = xa$ for any $a \in A$, $x \in E$. Recall that the module conditions include that $a(bx) = (ab)x$ and $1_A x = x$ for all $a, b \in A$ and $x \in E$.

In diagrams, we represent the A -module E by thick dotted lines as depicted in Fig. 3. In the figure, the following maps and formulas are depicted for $a, b \in A$ and $x \in E$: (1) the action $a \otimes x \mapsto ax$, (2) $a(bx) = (ab)x$, (3) $(1_A) \cdot x = x$, and (4) $ax = xa$.

Let V, W be free k -modules of finite rank for a unital commutative ring k . Denote by $\tau_{V,W} : V \otimes W \rightarrow W \otimes V$ for k -modules V, W the k -linear map induced from the transposition $\tau(\sum v \otimes w) = \sum w \otimes v$.

Let $B = (B, \Delta, \epsilon)$ be a cocommutative coalgebra over k with coassociative comultiplication Δ and counit map $\epsilon : B \rightarrow k$. By a *cocommutative bicomodule* E over B , we mean that E is a bicomodule over A , and the coactions (k -linear maps) $\Delta = \Delta_E^{B,E} : E \rightarrow B \otimes E$ (denoted by $x \mapsto \sum x_{(0)} \otimes x_{(1)}$), $\Delta = \Delta_E^{E,B} : E \rightarrow E \otimes B$ (denoted by $x \mapsto \sum x'_{(1)} \otimes x'_{(0)}$), satisfy $\tau(\sum x_{(0)} \otimes x_{(1)}) = \sum x'_{(1)} \otimes x'_{(0)}$ for any $a \in A$, $x \in E$. The corresponding figures are upside-down diagrams of Fig. 3.

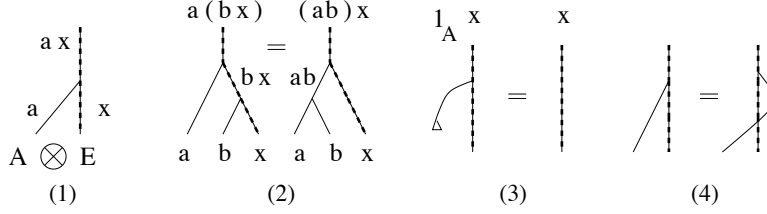

Figure 3: Bimodule maps and their relations

3 Frobenius pairs

In this section, we give the definitions of the algebraic structures that are studied in this paper. Our diagrammatic convention to represent these maps in the definition below is depicted in Fig.4. The ring A and the A -module E are represented by solid and dotted lines, respectively, and variety of multiplication and comultiplication are depicted by trivalent vertices, read from bottom to top. We note that the possibilities of trivalent vertices are summarized by saying that the dotted line does not end at a trivalent vertex, while a solid line can. The definition below is motivated from surface cobordisms, and the correspondence is exemplified in Fig. 5. Briefly, the elements of E are associated to essential curves in the surface cobordism and the elements of A are associated to compressible curves. More details on the correspondence are given in Section 4.

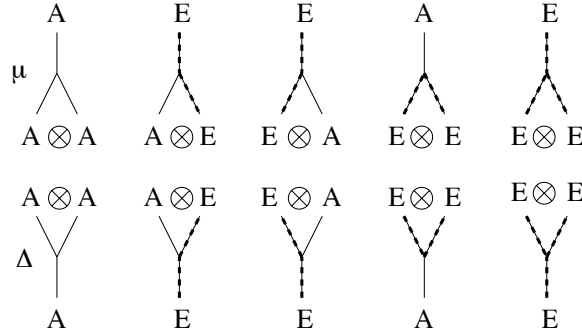

Figure 4: Generating maps

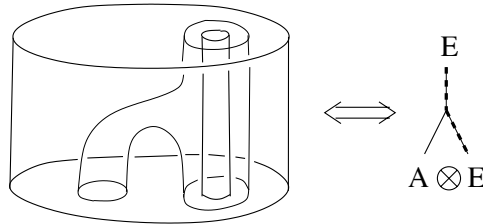

Figure 5: A cobordism with essential curves and module action

Definition 3.1 A commutative Frobenius pair (A, E) is defined as follows.

- (i) $A = (\mu_A, \Delta_A, \eta_A, \epsilon_A)$ is a commutative Frobenius algebra over k with multiplication μ_A , comultiplication Δ_A , unit η_A and counit ϵ_A .
- (ii) E is an A -bimodule and A -bicomodule, with the same right and left actions and coactions.



Figure 6: Cancellation relations

- (iii) The action and coaction satisfy the canceling conditions with the pairing and copairing as follows: $(\beta \otimes |)(| \otimes \Delta_E^{A,E}) = \mu_{A,E}$, $(| \otimes \mu_{A,E}^E)(\gamma \otimes |) = \Delta_E^{A,E}$. The situation is depicted in Fig. 6.
- (iv) E has an associative, commutative multiplication $\mu_E : E \otimes E \rightarrow E$ and a coassociative commutative comultiplication $\Delta_E : E \rightarrow E \otimes E$, that are A -bimodule and A -bicomodule maps, such that the maps μ_E and Δ_E satisfy the compatibility condition:

$$(| \otimes \mu_E)(\Delta_E \otimes |) = \Delta_E \mu_E = (\mu_E \otimes |)(| \otimes \Delta_E).$$

The diagrams for these relations are the same as associativity for μ_A , except that all segments are dotted.

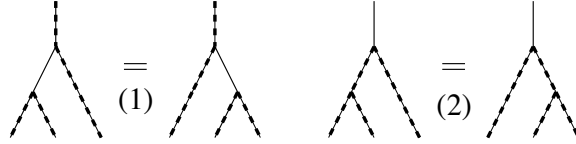

Figure 7: Analogs of associativity

- (v) There are A -bimodule, A -bicomodule maps $\mu_{E,E}^A : E \otimes E \rightarrow A$ and $\Delta_A^{E,E} : A \rightarrow E \otimes E$ that are associative and coassociative, respectively:

$$\begin{aligned} \mu_{A,E}^E(\mu_{E,E}^A \otimes |_E) &= \mu_{E,A}^E(|_E \otimes \mu_{E,E}^A) & : & E \otimes E \otimes E \rightarrow E, \\ \mu_{E,E}^A(\mu_E \otimes |_E) &= \mu_{E,E}^A(|_E \otimes \mu_E) & : & E \otimes E \otimes E \rightarrow A, \\ (\Delta_A^{E,E} \otimes |_E)\Delta_E^{A,E} &= (|_E \otimes \Delta_A^{E,E})\Delta_E^{E,A} & : & E \rightarrow E \otimes E \otimes E, \\ (\Delta_E \otimes |_E)\Delta_A^{E,E} &= (|_E \otimes \Delta_E)\Delta_A^{E,E} & : & A \rightarrow E \otimes E \otimes E. \end{aligned}$$

The first two are depicted in Fig. 7, and the last two are their upside-down diagrams.

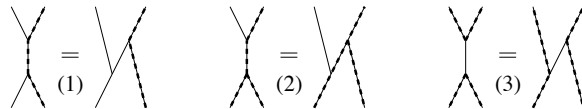

Figure 8: Compatibility conditions

(vi) These maps satisfy the compatibility condition depicted in Fig. 8, that are analogs of the compatibility condition of multiplication and comultiplication of Frobenius algebras. Specifically,

$$\begin{aligned}\Delta_E^{A,E} \mu_{A,E}^E &= (|_A \otimes \mu_{A,E}^E)(\Delta_A \otimes |_E), \\ \Delta_E^{A,E} \mu_{E,E}^E &= (|_A \otimes \mu_{E,E}^E)(\Delta_E^{A,E} \otimes |_E) \\ \Delta_A^{E,E} \mu_{E,E}^A &= (|_E \otimes \mu_{A,E}^E)(\Delta_E^{E,A} \otimes |_E).\end{aligned}$$

We also include the equalities represented by upside-down and mirror image diagrams of Fig. 8.

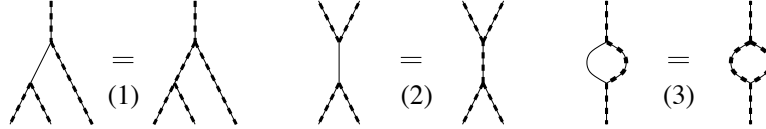

Figure 9: Consistency conditions

(vii) The following relations, called *consistency conditions*, are satisfied:

$$\begin{aligned}\mu_{A,E}^E(\mu_{E,E}^A \otimes |_E) &= \mu_E(\mu_E \otimes |_E), \\ \Delta_A^{E,E} \mu_{E,E}^A &= \Delta_E \mu_E, \\ \mu_{A,E}^E \Delta_E^{A,E} &= \mu_E \Delta_E.\end{aligned}$$

These relations are depicted in Fig. 9 (1), (2), and (3), respectively.

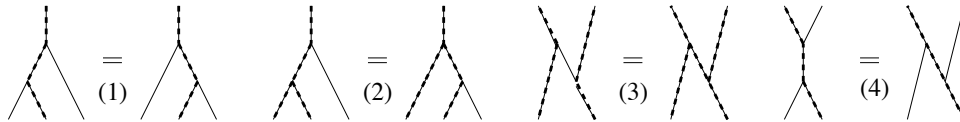

Figure 10: Equalities that follow from definitions

It is left as an exercise to prove that the relations depicted in Fig. 10, as well as their upside-down and mirror image diagrams, follow from the definitions.

Definition 3.2 Let (A, E) be a commutative Frobenius pair. Three k -linear maps $\nu_A^E : A \rightarrow E$, $\nu_E^A : E \rightarrow A$ and $\nu_E^E : E \rightarrow A$ are called *Möbius maps* if they satisfy the following conditions.

$$\begin{aligned}\nu_E^A \nu_A^E &= \mu_A \Delta_A = \mu_{E,E}^A \Delta_A^{E,E} : A \rightarrow A, & (\nu_E^E)^2 &= \mu_E \Delta_E : E \rightarrow E, \\ \mu_{E,A}^E(\nu_A^E \otimes |_E) &= \nu_A^E \mu_A : A \otimes E \rightarrow E, & (\nu_E^A \otimes |_A) \Delta_E^{E,A} &= \Delta_A \nu_E^A : E \rightarrow A \otimes A, \\ \mu_A(\nu_E^A \otimes |_A) &= \nu_E^A \mu_{A,E}^E : E \otimes A \rightarrow E, & (\nu_A^E \otimes |_A) \Delta_A &= \Delta_E^{E,A} \nu_A^E : A \rightarrow E \otimes A, \\ \mu_E(\nu_A^E \otimes |_E) &= \nu_E^E \mu_{A,E}^E : A \otimes E \rightarrow E, & (\nu_E^A \otimes |_E) \Delta_A^{E,E} &= (|_A \otimes \nu_A^E) \Delta_A : A \rightarrow A \otimes E, \\ \mu_E(\nu_A^E \otimes |_E) &= \nu_E^E \mu_{A,E}^E : A \otimes E \rightarrow E, & (\nu_E^A \otimes |_E) \Delta_E &= \Delta_E^{A,E} \nu_E^E : E \rightarrow A \otimes E, \\ \nu_A^E \mu_E &= \mu_{E,E}^A : E \otimes E \rightarrow A, & \Delta_E \nu_E^E &= (\nu_E^E \otimes |_E) \Delta_A^{E,E} : A \rightarrow E \otimes E,\end{aligned}$$

$$\begin{aligned} \mu_{A,E}^A(|_A \otimes \nu_E^E) &= \nu_E^E \mu_{A,E}^E : A \otimes E \rightarrow A, & (|_A \otimes \nu_E^E) \Delta_E^{A,E} &= \Delta_E^{A,E} \nu_E^E : E \rightarrow A \otimes E, \\ \mu_E(\nu_E^E \otimes |_E) &= \nu_E^E \mu_E : E \otimes E \rightarrow E, & (\nu_A^E \otimes |_E) \Delta_E &= \Delta_E \nu_E^E : A \rightarrow A \otimes E, \end{aligned}$$

Diagrams for the Möbius maps ν_A^E , ν_E^A and ν_E^E are depicted in Fig. 11 at the top left. The required equalities are depicted in the same figure: items (1) through (3) are written at the top line of this equation array. The right-hand relations are depicted in (4) through (10) while the left-hand relations are the upside-down versions of these diagrams.

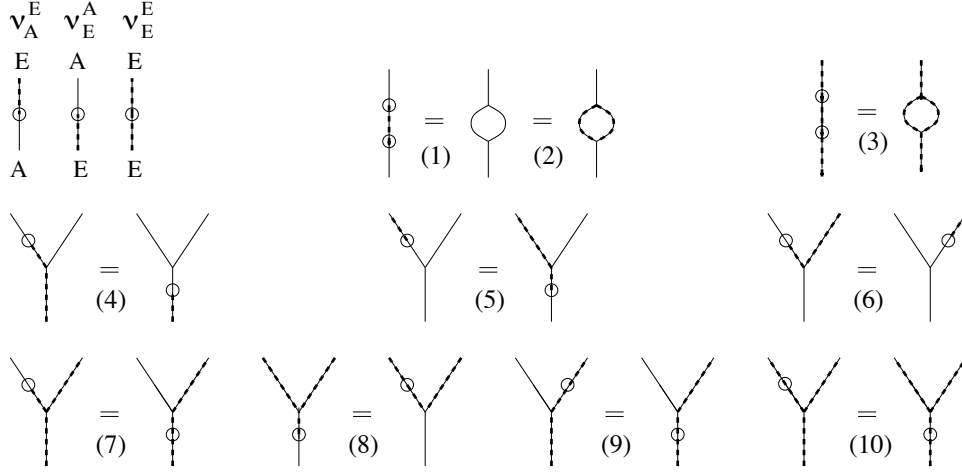

Figure 11: Möbius maps and their relations

We abuse the notation for m and Δ by dropping subscripts if no confusion occurs. Thus, $m : (A \otimes A) \oplus (A \otimes E) \oplus (E \otimes E) \rightarrow A \oplus E$ represents $\mu_A + \mu_{A,E}^E + \mu_E$ and $\Delta : A \oplus E \rightarrow (A \otimes A) \oplus (A \otimes E) \oplus (E \otimes E)$ represents $\Delta_A + \Delta_A^{E,E} + \Delta_E$.

Example 3.3 Let $A = \mathbb{Z}[X]/(X^2)$ with usual Frobenius algebra structure of truncated polynomial rings, and $E = \langle Y, Z \rangle_{\mathbb{Z}}$ with multiplications defined on basis elements by $XY = XZ = Y^2 = Z^2 = 0$ and $YZ = X$. Comultiplications are defined by

$$\begin{aligned} \Delta(1) &= (1 \otimes X + X \otimes 1)_{A \otimes A} + (Y \otimes Z + Z \otimes Y)_{E \otimes E}, \\ \Delta(X) &= X \otimes X, \\ \Delta(Y) &= X \otimes Y, \\ \Delta(Z) &= X \otimes Z. \end{aligned}$$

To aid the reader, in the definition of $\Delta(1)$, we indicated the image of the tensorands. The Möbius map ν is defined by $\nu(1) = Y + Z$, $\nu(X) = 0$, and $\nu(Y) = \nu(Z) = X$. This is the structure used in [3]. The correspondence between the above defined structure and their symbols are given by $1 \leftrightarrow -$, $X \leftrightarrow +$, $Y \leftrightarrow -0$, $Z \leftrightarrow +0$.

Example 3.4 This is an example that appears in [16]. Let $A = E = \mathbb{Z}_2[X, \lambda^{\pm 1}]/(X^2 - \lambda^2 X)$ be the Frobenius algebra in Example 2.1 with $h = \lambda^2$, with $t = 0$, and with the coefficient \mathbb{Z} replaced

by \mathbb{Z}_2 . All multiplications and comultiplications are those of A . All Möbius maps are defined by multiplication by λ . Then (A, E) gives rise to a commutative Frobenius pair.

Note that the handle element is $\phi = h = \lambda^2$, so that the Möbius maps are multiplication by the square root of the handle element. Thus the relation in Fig. 11 (1) and (2) follow immediately, and all the others in the figure are automatically satisfied, as the maps are multiplication by a constant. This definition of the Möbius maps is derived from their construction of an unoriented TQFT.

Remark 3.5 The above two examples show that commutative Frobenius pairs describe the states of categorified Jones polynomials for knots in thickened surfaces that are defined in [3, 16]. We now compare the structures used in [7] for virtual knots and commutative Frobenius pairs.

Let $A = \mathbb{Q}[X, t^{\pm 1}]/(X^2 - t)$ be the Frobenius algebra derived from Example 2.1. Thus

$$\begin{aligned}\Delta(1) &= 1 \otimes X + X \otimes 1, \\ \Delta(X) &= X \otimes X + t 1 \otimes 1,\end{aligned}$$

and $\eta(1) = 1$. Set $E = A$, and define operations as follows. Let ϕ be the invertible handle element $2X$, so that $\mu_A \Delta_A = \phi|_A$. Note that $(2X)^2 = 4X^2 = 4t$ is invertible, and so is ϕ . Define $m_{A,E}^E = \mu_{E,A}^E = \mu_A$, $\Delta_E^{A,E} = \Delta_E^{E,A} = \Delta_A$. Define further $\mu_{E,E}^A = \phi^{-1} \mu_A$, $\Delta_A^{E,E} = \phi \Delta_A$, $\nu_A^E = \phi |$, and $\nu_E^A = \nu_E^E = |$. Then (A, E) satisfies most of the axioms of a commutative Frobenius pair, but this has the following difference: the maps μ_E and Δ_E are not defined, but if they were then the identity of Fig. 9 would not be satisfied.

4 TQFTs and commutative Frobenius pairs

In this section, we relate commutative Frobenius pairs to topological quantum field theories (TQFTs) of surfaces. A $(1+1)$ -TQFT is a functor from 2-dimensional orientable cobordisms to modules. It is known that the image of the functor forms a Frobenius algebra [1, 12]. Some aspects of surface cobordisms in 3-manifolds are studied in [8] in relation to TQFTs and surface skein modules [2] of 3-manifolds. The novel aspects of this paper are to propose commutative Frobenius pairs for describing TQFTs in thickened surfaces, and to include non-orientable surfaces by Möbius maps. We do not assume that surfaces are orientable throughout this section. Let C be a properly embedded compact surface in a thickened surface $M = F \times I$, where F is a compact surface and $I = [0, 1]$. We assume that F is not homeomorphic to the projective plane. Let $C_0 \sqcup C_1 \subset C$ be the boundary $C_i \subset F \times \{i\}$ for $i = 0, 1$, and C is regarded as a cobordism from C_0 to C_1 . Let $\mathbf{Cob}_{F \times I}$ be the category of cobordisms of properly embedded surfaces in a thickened surface $F \times I$ up to ambient isotopy. Observe that if $\partial F \neq \emptyset$, then C_0 and C_1 are embedded in $\text{int} F \times \{0, 1\}$.

We may assume that the height function $\pi : F \times I \rightarrow I$ restricted to C is a generic Morse function. Except at isolated critical levels, $C_t = \pi^{-1}(t) \cap C$, $t \in [0, 1]$, is a set of finite simple closed curves. A simple closed curve in $F \times \{t\}$ is called *inessential* if it is null-homotopic in $F \times \{t\}$, otherwise *essential*. Let $C_t = C_t^A \sqcup C_t^E$, $t \in I$, be the partition of C_t into inessential curves C_t^A and essential curves C_t^E . In general, for any set γ of simple closed curves in F , define $\gamma = \gamma^A \sqcup \gamma^E$ similarly. Let \mathbf{Mod}_k be the category of modules over a commutative unital ring k .

Proposition 4.1 *Let $\mathcal{F} : \mathbf{Cob}_{F \times I} \rightarrow \mathbf{Mod}_k$ be a TQFT. Then the image $\mathcal{F}(\mathbf{Cob}_{F \times I})$ is a commutative Frobenius pair with Möbius maps.*

Proof Sketch. The assignments for surface cobordisms to modules and their homomorphisms by a TQFT are made as follows. Let $C_0 = C_t^A \sqcup C_t^E$ be as above for $t = 0, 1$. Let $C_0^A = \{\gamma_1^A, \dots, \gamma_m^A\}$ and $C_0^E = \{\gamma_1^E, \dots, \gamma_n^E\}$, for some non-negative integer m, n (if m or n is 0, the set is empty). Suppose the functor defined on objects $C_0 = C_0^A \sqcup C_0^E$ assigns $A^{\otimes m}$ to $C_0^A = \{\gamma_1^A, \dots, \gamma_m^A\}$ and $E^{\otimes n}$ to $C_0^E = \{\gamma_1^E, \dots, \gamma_n^E\}$, where each tensor factor of A and E is assigned to γ_i^A and γ_j^E for $i = 1, \dots, m$, $j = 1, \dots, n$, hence $\mathcal{F}(\{\gamma_1^A, \dots, \gamma_m^A\}) = A^{\otimes m}$ and $\mathcal{F}(\{\gamma_1^E, \dots, \gamma_n^E\}) = E^{\otimes n}$. As in the case of $(1+1)$ -TQFTs, saddle points of a cobordism correspond to multiplications and comultiplications, and isotopies correspond to relations such as associativity and coassociativity. The rest of the proof is to check that switches of critical levels induce the axioms of a commutative Frobenius pair.

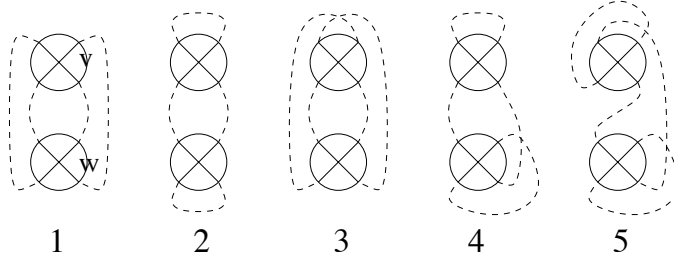

Figure 12: The list of two-crossing connections from Reference [3]

The axioms are checked using cobordisms with generic Morse functions, using the list in [3]. We illustrate the gist of the argument. In Fig. 12, we copied the list in [3] of all possible connections of a pair of crossings for link diagrams in $F \times I$.

The crossing can be viewed as a non-generic cross section at a saddle point. Thus the diagram 1 of Fig. 12 can be thought of as being expanded to the diamond illustrated in Fig. 13. There are four possible generic perturbations of this diagram that are indicated by the vertices of the diamond (1A through 1D). The edges of the diamond represent passing through the corresponding saddle point. The positively sloped edges are passing through the upper saddle point v , and the negatively sloped edges are passing through the lower saddle point w .

In the right of Fig. 13, diagrams are depicted that represent the maps corresponding to the cobordisms of surfaces. For example, the top left diagram starts with 1A that has a single foot, then separates into two arcs and merges to a single arc, representing 1A is connected, 1B has two components, and 1D has one component. Then as a cobordism this is equal to the cobordism corresponding to $1A - 1C - 1D$, which is depicted in the right of the equality.

If the curve in Figure 1A is inessential, then the two curves after the first smoothing along the (ABD) -path are either both inessential or both essential. So the (ABD) -path maps to either the composition $\mu_A \circ \Delta_A$ or the composition $\mu_{E,E}^A \circ \Delta_A^{E,E}$. Meanwhile, (ACD) -path is the opposite composition. In this case, the equality in Fig. 11 (2) applies.

If the curve in Figure 1A is essential, it either splits into two essential curves and these merge to an essential curve, or it splits into an essential curve and an inessential curve that merge to an essential curve. In this case, the identity of Fig. 9 (3) applies.

Similarly, we compare the paths (BAC) and (BDC) , and test the equality represented in the bottom right of Fig. 13. There are many cases to consider: both feet of the 1B state are essential ($E \otimes E$), both are inessential ($A \otimes A$) or a mixed state ($E \otimes A$). After the merger, the center curve

can be either essential or inessential. Most often the equality holds by default, however the case represented in Fig. 9 (2) can also occur.

The condition that F is not a projective plane is necessary from the following fact: when a connected circle goes through a saddle and becomes another connected curve, at least one of them (before or after the saddle) must be essential under the assumption that F is not a projective plane.

The rest of the proof involves considering all the possible cases represented in Fig. 12, comparing paths in the corresponding smoothing square, and examining the cases among essential and inessential curves. All the conditions are satisfied by axioms, or their consequences such as those in Fig. 10. \square

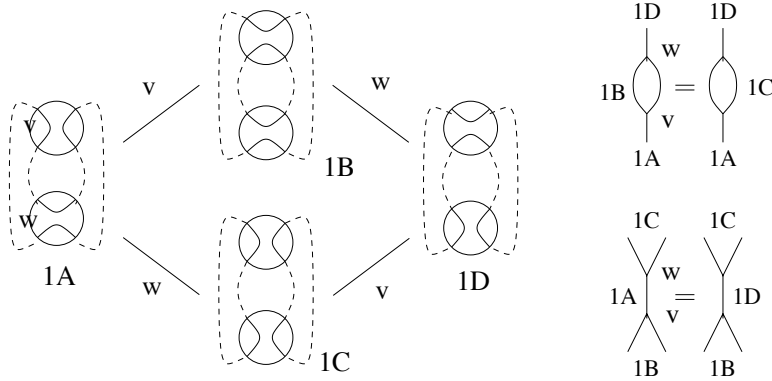

Figure 13: Case 1 from Reference [3]

In the remaining of this section, we relate commutative Frobenius pairs to surface cobordisms with poles that appear in Miyazawa polynomials [15] and extended bracket [9] for virtual knots. In the skein relation of the Miyazawa polynomial [15] (see also [9]) smoothings of crossings with *poles* were used. When the smoothing that does not respect orientations of arcs is performed, a pair of short segments, called poles, are placed at arcs after the smoothing (see Fig. 14). In defining their invariants, the relations satisfied between poles and virtual crossings are depicted in Fig. 15 (1) and (2). In (3), a relation that is not imposed is depicted.



Figure 14: Smoothings for the Miyazawa polynomial

Definition 4.2 A set of *virtual circles with poles* is a virtual link diagram on the plane without classical (over-under) crossings, with an even number (possibly zero) of poles attached.

Two sets of virtual circles with poles are *equivalent* if they are related by a finite sequence of virtual Reidemeister moves without classical crossings, cancelation/creation of a pair of adjacent poles on the same side as depicted in Fig. 15 (2), and plane ambient isotopies.

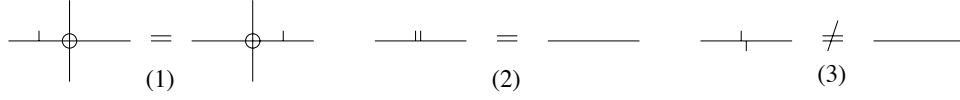

Figure 15: Poles in the Miyazawa polynomial

Definition 4.3 A pair of adjacent poles on opposite sides are not canceled as depicted in Fig. 15 (3), and the number of such pairs on a transverse component C , after canceling poles on the same side as depicted in Fig. 15 (2), is called the *degree*, and denoted by $\deg(C)$.

The sum of the degrees of all components of a set \mathcal{V} of virtual circles with poles is called the degree of \mathcal{V} and denoted by $\deg(\mathcal{V})$. The degree is well-defined up to equivalence of virtual circles with poles.

A set of virtual circles with poles is *essential* if $\deg(\mathcal{V}) > 0$, inessential otherwise.

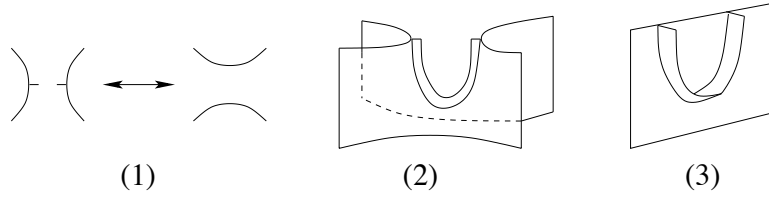

Figure 16: A saddle guided by poles

Definition 4.4 Two sets of virtual circles with poles are *related by a poled saddle* if they are identical except a small disk neighborhood in which they are as depicted in the left and right of Fig. 16 (1).

Two sets of virtual circles with poles are *pole cobordant* if they are related by a *pole cobordism*: a finite sequence of equivalences, poled saddles, and birth/death of trivial inessential curves.

It is known [6] that Reidemeister moves are derived from cross sections of surface cobordisms of generic surfaces. Thus a pole cobordism is regarded as a surface cobordism of a generic surface in $\mathbb{R}^2 \times [0, 1]$ with the continuous images of poles added along saddles, *etc.*. These vestigial surfaces are called *hems*. This is expressed in Fig. 16 (2) for a saddle point corresponding to a poled saddle. There is a poled saddle with the upside-down picture. The hem is always on the negatively curved side of a saddle. In Fig. 16 (3), a cancelation of a pair of poles on the same side that corresponds to a minimal point of hem is depicted.

Definition 4.5 Let the category of virtual cobordisms \mathbf{VCob} be the category with the objects the finite sets of virtual circles with poles, and the morphisms generated by the finite sets of pole cobordisms.

Proposition 4.6 Let $\mathcal{F}' : \mathbf{VCob} \rightarrow \mathbf{Mod}_k$ be a TQFT. Then the image $\mathcal{F}'(\mathbf{VCob})$ is a commutative Frobenius pair with Möbius maps.

Sketch Proof. Assignments are made from virtual circles with poles to modules A and E in the same way as in Proposition 4.1. Then axioms are checked for all cases of [3] as in the proof of Proposition 4.1. \square

Let (A, E) be a commutative Frobenius pair over k . Let $\mathbf{FP}(A, E)$ be the subcategory of Mod_k whose objects are generated by $A^{\otimes m} \otimes E^{\otimes n}$ for non-negative integers m and n , and morphisms generated by the maps $m, \Delta, \eta, \epsilon, \tau$ of the commutative Frobenius pair (A, E) , and its Möbius maps.

We conjecture that there are functors $\mathcal{F} : \mathbf{Cob}_{F \times I} \rightarrow \mathbf{FP}(A, E)$ and $\mathcal{F}' : \mathbf{VCob} \rightarrow \mathbf{FP}(A, E)$ as defined in the proofs of Propositions 4.1 and 4.6, respectively.

Typically, to prove such a conjecture it is shown that the stated set of relations is sufficient to describe isotopy which, in turn, is proved by using relations to deform a given cobordism to a standard form.

5 Constructions of commutative Frobenius pairs

We consider commutative Frobenius pairs (A, E) for $A = \mathbb{Z}[X, h, t]/(X^2 - hX - t)$, as this appears in the universal Khovanov homology [11]. See Example 2.1 for the Frobenius algebra structure.

Suppose E is of rank 2, and denote by Y, Z the basis elements of E . Motivated from Example 3.3, we characterize the case when the multiplication on E is trivial: $\mu_{E,E}^E = \Delta_{E,E}^{E,E} = 0$.

Theorem 5.1 *Let $A = \mathbb{Z}[X, h, t]/(X^2 - hX - t)$ and $E = \langle Y, Z \rangle$. If (A, E) is a commutative Frobenius pair with $\mu_{E,E}^E = \Delta_{E,E}^{E,E} = 0$, then A must be of the form $A = \mathbb{Z}[X, a]/(X - a)^2$, so that $h = 2a$ and $t = -a^2$.*

Let $A = \mathbb{Z}[X, a]/(X - a)^2$, $E = \langle Y, Z \rangle$ and assume $\mu_{E,E}^E = \Delta_{E,E}^{E,E} = 0$. Then (A, E) is a commutative Frobenius pair with Möbius maps if and only if the following conditions are satisfied. The multiplications and actions are defined by

$$XY = aY, \quad XZ = aZ, \quad Y^2 = c_{YY}(X - a), \quad YZ = c_{YZ}(X - a), \quad Z^2 = c_{ZZ}(X - a),$$

for some constants c_{YY}, c_{YZ} , and c_{ZZ} that satisfy the conditions below. The comultiplications and coactions are defined by

$$\begin{aligned} \Delta_E^{A,E}(Y) &= (X - a) \otimes Y, \\ \Delta_E^{A,E}(Z) &= (X - a) \otimes Z, \\ \Delta_A^{E,E}(1) &= d_{YY}Y \otimes Y + d_{YZ}Y \otimes Z + d_{YZ}Z \otimes Y + d_{ZZ}Z \otimes Z, \\ \Delta_A^{E,E}(X) &= a \Delta_A^{E,E}(1), \end{aligned}$$

for some constants d_{YY}, d_{YZ}, d_{ZZ} that satisfy the conditions below.

The Möbius maps are defined by

$$\nu_E^E = 0, \quad \nu_E^A(Y) = e_Y(X - t), \quad \nu_E^A(Z) = e_Z(X - a), \quad \nu_A^E(1) = f_Y Y + f_Z Z.$$

The coefficients satisfy the following conditions. Let C be the 2×2 symmetric integral matrices with entries c_{ij} with $\{i, j\} = \{Y, Z\}$, respectively, and let $\vec{e} = [e_Y, e_Z]^T$, $\vec{f} = [f_Y, f_Z]^T$ be column vectors. Then they satisfy

$$C\vec{f} = \vec{e}, \quad \vec{e} \cdot \vec{f} = 2, \quad c_{YY}d_{YY} + 2c_{YZ}d_{YZ} + c_{ZZ}d_{ZZ} = 2 \pmod{(X - a)}.$$

Proof. First we prove the following lemmas.

Lemma 5.2 *Suppose that $A = \mathbb{Z}[X, h, t]/(X^2 - hX - t)$, and that $E = \langle Y, Z \rangle$ is a left module for A , where k is an integral domain. Let $\mu_{A,E}^E(X \otimes Y) = XY = a_0Y + a_1Z$, and $\mu_{A,E}^E(X \otimes Z) = XZ = b_0Y + b_1Z$. Then*

$$\begin{aligned} a_0^2 + a_1b_0 - a_0h - t &= 0, & (a_0 + b_1 - h)a_1 &= 0, \\ a_1b_0 + b_1^2 - hb_1 - t &= 0, & (a_0 + b_1 - h)b_0 &= 0. \end{aligned}$$

Proof. The first two equations follow from the equation $X(XY) = X^2Y$, and the last two follow from $X(XZ) = (X^2)Z$. \square

Remark 5.3 For a commutative Frobenius pair (A, E) as in Lemma 5.2, the conditions $\Delta_E^{A,E} = (|_A \otimes \mu_{A,E}^E)(\Delta_A(1) \otimes |_E)$ and $\Delta_E^{A,E} \mu_{A,E}^E = (\mu_{A,A}^A \otimes |_E)(|_A \otimes \Delta_E^{A,E})$ applied to $X \otimes Y$ and $X \otimes Z$ to give the same relations.

Lemma 5.4 *Suppose that the commutative Frobenius pair (A, E) satisfies the hypotheses of Lemma 5.2, and suppose further that $\mu_{E,E}^E = \Delta_E^{E,E} = 0$. Then there are constants $a, c_{Y Y}, c_{Y Z}$ and $c_{Z Z}$ such that $h = 2a, t = -a^2$ and the following hold: $XY = aY, XZ = aZ, Y^2 = c_{Y Y}(X - a), YZ = c_{Y Z}(X - a)$ and $Z^2 = c_{Z Z}(X - a)$.*

Proof. First we show that $h^2 + 4t = 0$, and $XY = aY, XZ = aZ$, where $h = 2a, t = -a^2$. The assumption and the relation depicted in Fig. 9 (3) implies $\mu_{A,E}^E \Delta_E^{A,E} = \mu_{E,E}^E \Delta_E^{E,E} = 0$. On the other hand,

$$\mu_{A,E}^E \Delta_E^{A,E}(Y) = \mu_{A,E}^E(|_A \otimes \mu_{A,E}^E)(\Delta_A(1) \otimes |_E)(Y) = 2XY - hY,$$

so that we have $2(a_0Y + a_1Z) - hY = 0$, and similarly for Z we obtain $2(b_0Y + b_1Z) - hY = 0$. Thus we have $2a_0 = h = 2b_1, 2a_1 = 0 = 2b_0$. It follows that $a_1 = b_0 = 0$, and from $a_0^2 + a_1b_0 - a_0h - t = 0$ in Lemma 5.2, we have $a_0^2 + t = 0 = b_1^2 + t$. Set $a = a_0 = b_1$, and we obtain the result.

Set $XY = aY$ and $XZ = aZ$, where $h = 2a$ and $t = -a^2$ as above. Set $Y^2 = b_{Y Y} 1_A + c_{Y Y} X$. Here we abused the notation for Y^2 to be $\mu_{E,E}^A(Y \otimes Y)$ as we assumed $\mu_{E,E}^E = 0$. We compute

$$\begin{aligned} (XY)Y &= aY^2 = a(b_{Y Y} 1_A + c_{Y Y} X) \\ X(Y^2) &= X(b_{Y Y} 1_A + c_{Y Y} X) = b_{Y Y} X + c_{Y Y}(hX + t) \\ &= (b_{Y Y} + c_{Y Y}h)X + c_{Y Y}t, \end{aligned}$$

hence $b_{Y Y} + c_{Y Y}(h - a) = b_{Y Y} + c_{Y Y}a = 0$ and $ab_{Y Y} - c_{Y Y}t = a(b_{Y Y} + c_{Y Y}a) = 0$. This implies $a = 0$ or $b_{Y Y} = -ac_{Y Y}$. Set $YZ = b_{Y Z} 1_A + c_{Y Z} X$ and $Z^2 = b_{Z Z} 1_A + c_{Z Z} X$. A similar argument for XZ^2 and XYZ shows that [$a = 0$ or $b_{Y Z} = -ac_{Y Z}$], and [$a = 0$ or $b_{Z Z} = -ac_{Z Z}$], respectively. If $a = 0$, then $h = t = 0$ and $b_{Y Y} = b_{Y Z} = b_{Z Z} = 0$. If $a \neq 0$, then $Y^2 = c_{Y Y}(X - a), YZ = c_{Y Z}(X - a)$ and $Z^2 = c_{Z Z}(X - a)$. Either way the result follows. \square

Proof (of Theorem 5.1) continued. First we determine comultiplications. From Lemma 5.4, we have $h = 2a, t = -a^2, XY = aY, XZ = aZ, Y^2 = c_{Y Y}(X - a), YZ = c_{Y Z}(X - a)$ and $Z^2 = c_{Z Z}(X - a)$. Note that $X^2 - hX - t = (X - a)^2$. Since $\Delta_A^{E,E} m_{E,E}^A(Y \otimes Y) = \Delta_E^{E,E} m_{E,E}^E(Y \otimes Y) = 0$ (see Fig. 9

(2)), we obtain $c_{YY}\Delta_A^{E,E}(X-a) = 0$. If $\Delta_A^{E,E}(X-a) \neq 0$, then $Y^2 = YZ = Z^2 = 0$, and the equality

$$\mu_{E,E}^A\Delta_A^{E,E}(1) = \mu_{A,A}^A\Delta_A^{A,A}(1) = 2X - h = 2(X-a)$$

in Fig. 11 (2) leads to a contradiction. Hence $\Delta_A^{E,E}(X-a) = 0$, so that $\Delta_A^{E,E}(X) = a\Delta_A^{E,E}(1)$. Note also that at least one of c_{YY} , c_{YZ} and c_{ZZ} is non-zero. From $\Delta_E^{A,E}(Y) = (|_A \otimes \mu_{A,E}^E)(\Delta_A(1) \otimes |_E)(Y)$ (see Fig. 6), we obtain $\Delta_E^{A,E}(Y) = (X-a) \otimes Y$, and similarly, $\Delta_E^{A,E}(Z) = (X-a) \otimes Z$. Let

$$\Delta_A^{E,E}(1) = d_{YY}Y \otimes Y + d_{YZ}Y \otimes Z + d_{YZ}Z \otimes Y + d_{ZZ}Z \otimes Z.$$

Here we used the cocommutativity. Then from Fig. 11 (2), we obtain

$$(c_{YY}d_{YY} + 2c_{YZ}d_{YZ} + c_{ZZ}d_{ZZ})(X-a) = 2(X-a).$$

Hence $c_{YY}d_{YY} + 2c_{YZ}d_{YZ} + c_{ZZ}d_{ZZ} = 2 + c(X-a)$ for some constant c , i.e., $c_{YY}d_{YY} + 2c_{YZ}d_{YZ} + c_{ZZ}d_{ZZ} = 2$ modulo $(X-a)$.

Next we determine Möbius maps. From Fig. 11 (7), we have $\nu_E^E = 0$. From the up-side down diagram of Fig. 11 (4) with input $1 \otimes X$, we have $\nu_A^E(X) = X\nu_A^E(1) = a\nu_A^E(1)$ since $XY = aY$ and $XZ = aZ$. Set $\nu(1) = f_Y Y + f_Z Z$. From the up-side down diagram of Fig. 11 (5) with input $X \otimes Y$, we have $X\nu_E^A(Y) = \nu_E^A(XY) = \nu_E^A(aY) = a\nu_E^A(Y)$, so that $\nu_E^A(Y)(X-a) = 0$, and we obtain $\nu_E^A(Y) = e_Y(X-a)$ for some constant e_Y . Similarly, $\nu_E^A(Z) = e_Z(X-a)$. From Fig. 11 (1) with input 1, we have $(e_Y f_Y + e_Z f_Z)(X-a) = 2(X-a)$, hence $\vec{e} \cdot \vec{f} = 2$ modulo $(X-a)$. The up-side down diagram of Fig. 11 (6) with inputs $1 \otimes Y$ and $1 \otimes Z$ gives $C\vec{f} = \vec{e}$ modulo $(X-a)$.

Thus the conditions stated in this theorem are necessary, and it is checked that they are also sufficient. \square

Remark 5.5 Example 3.3 is the case when $\vec{e} = \vec{f} = [1, 1]^T$, $c_{YY} = c_{ZZ} = d_{YY} = d_{ZZ} = 0$, $c_{YZ} = d_{YZ} = 1$.

Theorem 5.6 *Let A be a commutative Frobenius algebra over a commutative unital ring k with handle element ϕ , such that there exists an element $\xi \in A$ with $\xi^2 = \phi$. Then there exists a commutative Frobenius pair with Möbius maps.*

Proof. Define all multiplications, comultiplications, action and coaction by those of A . Then all axioms for these operations are satisfied, and only the Möbius maps remain to be defined and their axioms checked. Define all the Möbius maps by multiplication by ξ . The relations (1) and (2) in Fig. 11 involving Möbius maps and the handle element ϕ are satisfied since $\xi^2 = \phi$. Other relations in Fig. 11 involving Möbius maps and (co)multiplications are satisfied since the former are assigned multiplication by a constant. This construction was inspired by Example 3.4. \square

Example 5.7 One of the examples of Frobenius algebras used in [16] is $k = \mathbb{F}_2[\lambda]$ and $A = k[X]/(X^2 - \lambda^2 X)$. The handle element is indeed λ^2 , and we can take $\xi = \lambda$.

Corollary 5.8 *Let $A = E = k[X]/(X^2 - hX - t)$, where $k = \mathbb{Z}[a^{\pm 1}, b^{\pm 1}]$, and $h = -2b^{-1}(a - b^{-1})$, $t = -b^{-2}(a^2 + h)$. Then (A, E) gives rise to a commutative Frobenius pair with Möbius maps.*

Proof. Let $\xi = a + bX$, and one computes that $\xi^2 = \phi = 2X - h$. \square

Theorem 5.9 *If A is a commutative Frobenius algebra over a commutative unital ring k , such that its handle element $\phi \in A$ is invertible, then there exists a commutative Frobenius pair (A, E) with Möbius maps.*

Proof. Let $E = A \otimes A$. Then define various multiplications, actions and Möbius maps as depicted in Fig. 17. In the figure, powers of ϕ are indicated for assignments, whose exponents are specified below. Each assigned map is the map indicated by the diagrams multiplied by the specified power of ϕ . Specifically, they are defined by

$$\begin{aligned}\mu_{A,E}^E &= \phi^{e_0} \Delta_A \mu_A(| \otimes \mu_A), \\ \mu_{E,E}^A &= \phi^{e_1} \mu_A(\mu_A \otimes \mu_A)(| \otimes \tau \otimes |), \\ \mu_{E,E}^E &= \phi^{e_2} \Delta_A \mu_A(\mu_A \otimes \mu_A)(| \otimes \tau \otimes |), \\ \nu_A^E &= \phi^{\nu_0} \Delta_A, \\ \nu_E^A &= \phi^{\nu_1} \mu_A, \\ \nu_E^E &= \phi^{\nu_2} \Delta_A \mu_A.\end{aligned}$$

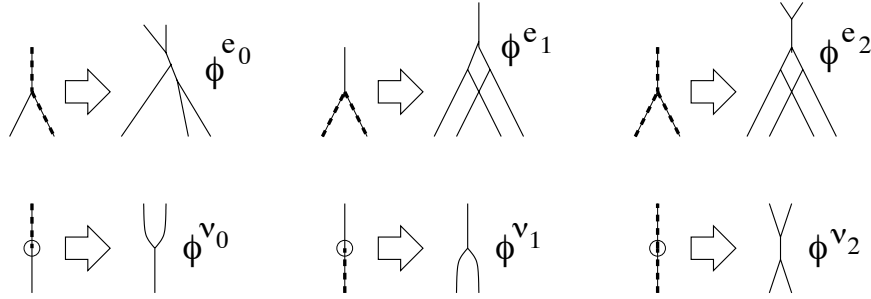

Figure 17: Double tensor assignments on E

The assignment for comultiplications and coactions are defined by up-side down diagrams of multiplications without ϕ factors. Then the axioms of the commutative Frobenius pairs are satisfied with the unique choice $e_0 = -1$, $e_1 = e_2 = -2$, $\nu_0 = 1$, $\nu_1 = -1$ and $\nu_2 = 0$. The assignment of ϕ factors is inspired by construction in [7] as described in Remark 3.5. \square

Corollary 5.10 *For $A = k[X]/(X^2 - hX - t)$, where h, t are variables taking values in k , if $4t + h^2 \in k$ is invertible, then there exists a commutative Frobenius pair (A, E) with Möbius maps.*

Proof. The handle element is computed as $\phi = m\Delta(1) = 2X - h$. Then one computes $\phi^2 = 4t + h^2$, which is assumed to be invertible, so that $\phi^{-1} = (4t + h^2)^{-1}\phi$, and the result follows from Theorem 5.9. \square

Acknowledgments

JSC was supported in part by NSF Grant DMS #0603926. MS was supported in part by NSF Grants DMS #0603876.

References

- [1] L. Abrams, *Two-dimensional topological quantum field theories and Frobenius algebras*, J. Knot Theory Ramifications **5** (1996) 596–587.
- [2] M. Asaeda; C. Frohman, *A note on the Bar-Natan skein module*, arXiv:math/0602262.
- [3] M.M. Asaeda; J.H. Przytycki; A.S. Sikora, *Categorification of the Kauffman bracket skein module of I-bundles over surfaces*, Algebr. Geom. Topol. **4** (2004) 1177–1210.
- [4] C. Caprau, *Twin TQFTs and Frobenius algebras*, arXiv:0901.2979.
- [5] J.S. Carter; A. Crans; M. Elhamdadi; M. Saito, *Cohomology of Categorical Self-Distributivity*, J. Homotopy Relat. Struct. **3** (2008) 13–63.
- [6] J.S. Carter; M. Saito, *Knotted surfaces and their diagrams*, Surveys and monographs, vol. 55, A.M.S., 1998.
- [7] A. Ishii; K. Tanaka, *A categorification of the one-variable Kamada-Miyazawa polynomial*, to appear, talk presented in 2008.
- [8] U. Kaiser, *Frobenius algebras and skein modules of surfaces in 3-manifolds*, arXiv:0802.4068v1.
- [9] L.H. Kauffman, *An extended bracket polynomial for virtual knots and links*, arXiv:0712.2546.
- [10] M. Khovanov, *A categorification of the Jones polynomial*, Duke Math. J. **101(3)** (1999) 359–426.
- [11] M. Khovanov, *Link homology and Frobenius extensions*, Fundamenta Mathematicae **190** (2006) 179–190.
- [12] J. Kock, *Frobenius algebras and 2D topological quantum field theories*, London Mathematical Society Student Texts (No. 59), Cambridge University Press (2003).
- [13] A. Lauda; H. Pfeiffer, *Open-closed strings: two-dimensional extended TQFTs and Frobenius algebras*, Topology Appl. **155** (2008) 623–666.
- [14] V.O. Manturov, *Khovanov homology for virtual knots with arbitrary coefficients*, J. Knot Theory Ramifications **16** (2007) 345–377.
- [15] Y. Miyazawa, *Magnetic graphs and an invariant for virtual links*, J. Knot Theory Ramifications **15** (2006) 1319–1334.
- [16] V. Turaev; P. Turner, *Unoriented topological quantum field theory and link homology*, arXiv:math/0506229.
- [17] O.Ya. Viro, *Khovanov homology, its definitions and ramifications*, Fund. Math. **184** (2004) 317–342.