

# Self-Assembly of a Statistically Self-Similar Fractal

Aaron Sterling\*

Laboratory for Nanoscale Self-Assembly, Department of Computer Science, Iowa State University  
sterling@cs.iastate.edu

**Abstract.** We demonstrate existence of a tile assembly system that self-assembles the statistically self-similar Sierpinski Triangle in the Winfree-Rothemund Tile Assembly Model. This appears to be the first paper that considers self-assembly of a random fractal, instead of a deterministic fractal or a finite, bounded shape. Our technical contributions include a way to remember, and use, unboundedly-long prefixes of an infinite coding sequence at each stage of fractal construction; a tile assembly mechanism for nested recursion; and a definition of “almost-everywhere local determinism,” to describe a tileset whose assembly is locally determined, conditional upon a zeta-dimension zero set of (infinitely many) “input” tiles. This last is similar to the definition of randomized computation for Turing machines, in which an algorithm is deterministic relative to an oracle sequence of coin flips that provides advice but does not itself compute. *Keywords:* tile self-assembly, statistically self-similar Sierpinski Triangle.

## 1 Introduction

It is now more than a decade since Winfree [15] first noted that DNA nanostructures created by Seeman [12] could be mathematically abstracted as tiles on the integer plane. Since then, theorists and practitioners have pursued several research directions in algorithmic nanotile self-assembly, including: the minimum number of distinct tile types needed to build finite structures [11], techniques to minimize molecular binding errors [2] [13], reduction of complexity by using randomness and building the target shape with “only” high probability [1] [5], and exploring the absolute theoretical limits of the Winfree-Rothemund tile assembly model [7] [9]. While varied in focus, this research shares a common characteristic: the purpose of each tileset is to build a specific shape, predetermined *ab initio*. Macroscale computers, by contrast, receive information, store that information, and take steps adaptively, based upon the information received. The main contribution of this paper is to demonstrate existence of a tileset that (in theory) does the same thing at the nano scale.

“Tileset” in this context means a finite set of unique types of four-sided tiles. We assume there are infinitely many tiles of each tile type, and these tiles combine “in solution” in a nondeterministic, asynchronous manner. Tiles with complementary sides can bind to one another and form stable configurations through a random process of self-assembly.

We show there is a finite tileset that self-assembles the statistically self-similar Sierpinski Triangle in the standard Winfree-Rothemund tile assembly model. The statistically self-similar Sierpinski triangle (sssST) is an infinite fractal structure that generalizes the well-known discrete Sierpinski Triangle. A formal definition of the sssST appears in Section 2.2, but, in brief, it is built in stages, with a random “three-sided” coin flipped at each stage. The construction of the next stage depends on the entire history of ternary coin flips. We model this in tiles by starting each new stage with a “decision point” that permits the binding of one of three different tile types, each with  $1/3$  binding probability. The identity of the tile type that binds is then propagated through the structure so

---

\* This research was supported in part by National Science Foundation Grants 0652569 and 0728806.

the history of previous stages is available to all future stages. In this way, a bounded number of tile types can produce a structure with unbounded memory—by using the increasing size of the tile configuration to transmit progressively more information.

Winfree was the first to construct a tiling that self-assembled into a fractal structure, when he showed that seven tile types computing the XOR operation would build the discrete Sierpinski Triangle [15]. He implemented that tiling in wetlab experiments [16]. In recent theoretical work, both Patitz and Summers [10] and Kautz and Lathrop [6] have presented methods to construct tilings for broad classes of self-similar fractals. The current paper appears to be the first work to consider self-assembly of a fractal that is statistically self-similar, not deterministically self-similar. In fact, we need to extend the current definitions in the literature in order to formalize the main result of this paper, which is, “There is a tile assembly system that computes the statistically self-similar Sierpinski Triangle.” We make that statement rigorous in Section 3.3.

Becker *et al.* [1] were the first to define a tile assembly model in which different tile types were assigned different concentrations “in solution,” so a particular location could bind to any of several tile types, each tile type with its own binding probability. Kao and Schweller subsequently refined this concentration model [5], and Doty has recently extended their work [3]. Each of those papers focuses on randomized algorithms to build an  $n \times n$  square for finite  $n$ .

Our overall motivation for the current paper is to build a theory of randomized computation for self-assembling networks considered as evolving, distributed systems. We believe randomization will be an important tool for solving problems of fault tolerance in self-assembly, much as randomized algorithms have been able to overcome impossibility barriers faced by deterministic distributed systems that admit faults.

The rest of this paper is structured as follows. In Section 2, we provide background in tile self-assembly, and the statistically self-similar Sierpinski Triangle. In Section 3, we present the fractal construction. Section 4 concludes the paper, and suggests a direction for future research.

## 2 Background

### 2.1 Tile assembly background

Tiles have four sides (often referred to as north, south, east and west) and exactly one orientation, *i.e.*, they cannot be rotated. A tile assembly system  $\mathcal{T}$  is a 5-tuple  $(T, \sigma, \Sigma, \tau, R)$ , where  $T$  is a finite set of tile types;  $\sigma$  is the *seed tile* or *seed assembly*, the “starting configuration” for assemblies of  $\mathcal{T}$ ;  $\tau : T \times \{N, S, E, W\} \rightarrow \Sigma \times \{0, 1, 2\}$  is an assignment of symbols (“glue names”) and a “glue strength” (0, 1, or 2) to the north, south, east and west sides of each tile; and a symmetric relation  $R \subseteq \Sigma \times \Sigma$  that specifies which glues can bind with nonzero strength. In this model, there are no negative glue strengths, *i.e.*, two tiles cannot repel each other.

A *configuration of  $\mathcal{T}$*  is a set of tiles, all of which are tile types from  $\mathcal{T}$ , that have been placed in the plane, and the configuration is *stable* if the binding strength (from  $\tau$  and  $R$  in  $\mathcal{T}$ ) at every possible cut is at least 2. An *assembly sequence* is a sequence of single-tile additions to the frontier of the assembly constructed at the previous stage. Assembly sequences can be finite or infinite in length. The *result* of assembly sequence  $\vec{\alpha}$  is the union of the tile configurations obtained at every finite stage of  $\vec{\alpha}$ . The *assemblies produced by  $\mathcal{T}$*  is the set of all stable assemblies that can be built by starting from the seed assembly of  $\mathcal{T}$  and legally adding tiles. If  $\alpha$  and  $\beta$  are configurations of  $\mathcal{T}$ , we write  $\alpha \rightarrow \beta$  if there is an assembly sequence that starts at  $\alpha$  and produces  $\beta$ . An assembly of  $\mathcal{T}$  is *terminal* if no tiles can be stably added to it.

Intuitively, tiles bind stably exactly when they share complementary sides with the same labels and glue strengths, as long as the total binding strength adds up to at least 2. Figure 1 shows how a tile is represented graphically, and Figure 2 provides an example of four tiles binding to form a stable configuration.

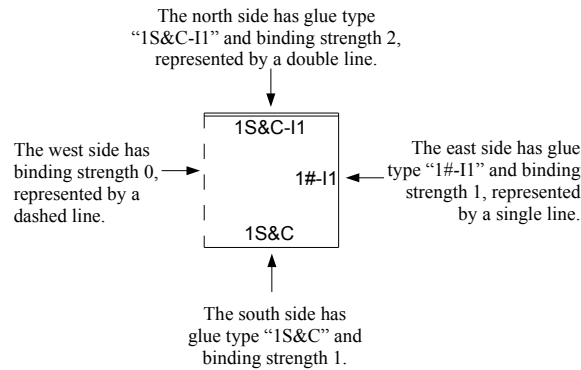


Fig. 1. An example tile with explanation.

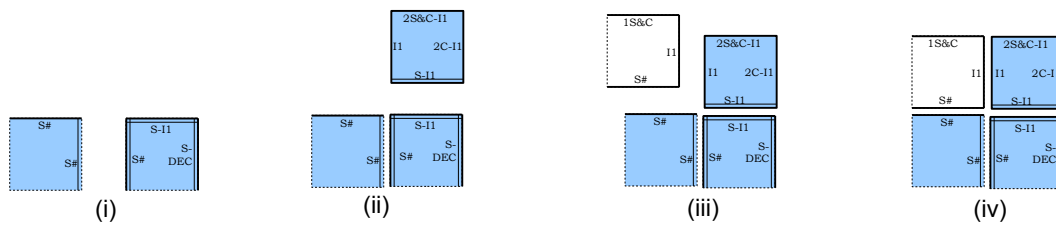


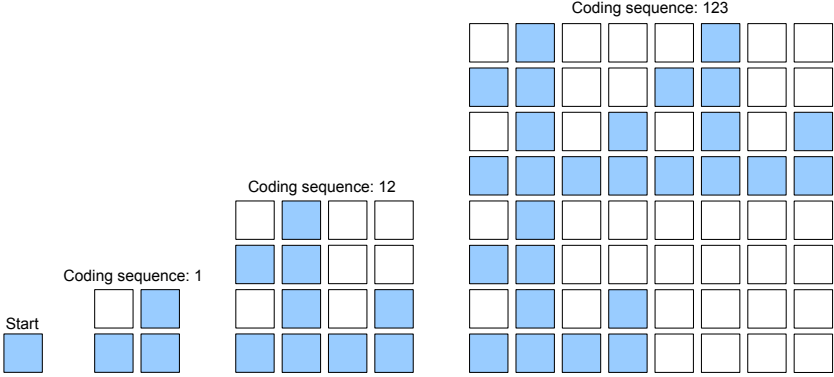
Fig. 2. An example of how tiles bind in a system of temperature 2. In (i), a seed tile (at left) is approached by a tile with a strength 2 bond on its west side, and that glue matches the strength two glue of the east side of the seed tile. In (ii), a tile approaches from the north, and binds with strength 2 on a single side. In (iii), we see an example of cooperation by two different strength one glues, in order to provide a strength 2 bond to the approaching tile. The final, stable, tile configuration appears in (iv). In this example, three tiles are colored blue, and one is colored white. It is the differing colors of the tiles that give rise to a self-assembled “shape.”

## 2.2 Statistically self-similar Sierpinski Triangle

To build the discrete Sierpinski Triangle in the first quadrant of the plane, place a single colored tile at the origin (stage 0), then colored tiles immediately north and east and a colorless tile northeast (stage 1). More generally, at stage  $n + 1$ , copy the tile configuration obtained at stage  $n$  to the north

and east, and place colorless tiles to the east and north of those copies, to fill in a square of  $2^n \times 2^n$  tiles. Construction of the discrete sssST generalizes this process. Instead of always selecting the northeast area as the area to mask out, at each stage  $n > 0$ , select one area (north, northeast, or east) uniformly at random, mask out the area selected, and copy the configuration achieved at stage  $n - 1$  to the unselected areas. (A more formal definition of the sssST appears in the Appendix.)

In what follows, we will refer to the north, northeast and east areas as Area 1, 2, and 3, respectively. Figure 3 illustrates the first three stages of construction of the sssST for a particular coding sequence. We now define formally what it means for a tile assembly system to self-assemble the sssST. Intuitively, we want all possible configurations of the sssST to be achievable, only sssST configurations to be achievable, and each configuration to be achievable with equal likelihood.



**Fig. 3.** The start and first three stages of construction of (one possible configuration of) the statistically self-similar Sierpinski Triangle. Each stage of construction depends on the coding sequence of the previous stage. The “traditional” Sierpinski Triangle has coding sequence  $22222\dots$

**Definition 1.** Let  $\mathcal{T}$  be a tile assembly system. We say  $\mathcal{T}$  self-assembles the statistically self-similar Sierpinski Triangle if the following conditions hold:

1. For every infinite ternary coding sequence  $S \in \{1, 2, 3\}^\infty$ , there is an assembly sequence  $\vec{\alpha}$  of  $\mathcal{T}$  whose terminal assembly is the configuration of the sssST with coding sequence  $S$ .
2. If  $A$  is a terminal assembly of  $\mathcal{T}$ , then there is a sequence  $S \in \{1, 2, 3\}^\infty$  such that  $A$  is the configuration of the sssST with coding sequence  $S$ .
3. For any finite coding sequence prefix  $s \in \{1, 2, 3\}^n$  of length  $n$ , the probability that a terminal assembly of  $\mathcal{T}$  will be a configuration of the sssST whose coding sequence extends  $s$ , is  $3^{-n}$ .

### 3 Fractal self-assembly

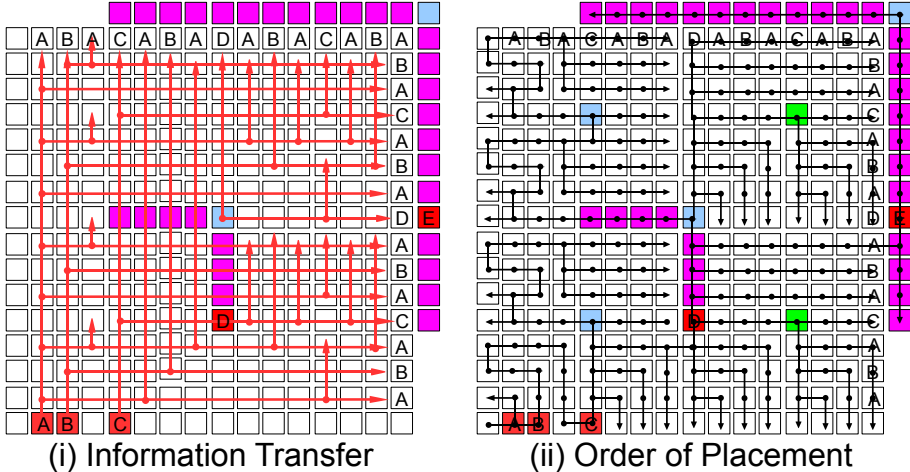
#### 3.1 The first four stages of construction

We will build the sssST from a single seed tile, using a tile assembly system with temperature 2. It will be important for the proof of correctness that each tile binds with exactly strength 2, as that is a necessary condition for local determinism (a condition defined in the Appendix that guarantees a tile assembly system has a unique terminal assembly). There are finitely many distinct



properly colored tile is placed each time; and (3) let  $A, B, C$  and  $D$  represent the values of coding decisions 1, 2, 3 and 4, respectively; then, once assembled, the configuration transmits north the sequence  $\langle ABACABADABACABA \rangle$  (reading from west to east), and transmits the same sequence east (reading from south to north).

*Proof.* We can design a tileset that satisfies (1) and (2), using techniques similar to the tileset used in the formal proof of Lemma 1. To see that (3) is true, consider Figure 5(i). The transmission of decision information is consistent with the statement of the Lemma, and, as before, we can verify by inspection that the graph of information transfer is consistent with the actual placement of tiles in the plane, as shown in Figure 5(ii).



**Fig. 5.** Two views of the first four stages of construction of the sssST (and the beginning of the fifth). The decision tiles are red, the crawlback tiles are magenta (light purple), and the popup tiles are purple. In (i), the red arrows show the flow of information from decision points to the frontier sequence  $F_4$ . The first decision-value is labeled “A,” the second “B,” and so forth. In (ii), the black arrows indicate the order of tile placement as the recursion progresses.

Even though most of the recursion flows from west to east, and from south to north, when a new decision tile (colored red in Figure 5) binds, it contains the information of which area should be masked, which needs to be conveyed to all three areas. Regardless of where the decision location is placed, in order to get to the “bottom left” of some area, to communicate the new information, it is necessary to place tiles “out of order,” without having full knowledge of the coding sequence. This is a bandwidth problem: any location can receive only a constant-size amount of information, and the coding sequence grows without bound. Tiles placed in that way are *crawlback tiles*, and bind from west to east, or north to south, in our construction.

To ensure binding of crawlback tiles of the correct color (*i.e.*, colored correctly in or out of the sssST configuration we are trying to build), we pass an additional bit northward along each column, and eastward along each row, that communicates whether the crawlback tile in that column/row is ON or OFF.

Figure 5(ii) shows how, once enough tiles bind to create a square of dimension  $2^n \times 2^n$  for  $n \in \{2, 3, 4\}$ , a *popup tile* (colored blue) binds at the northeast corner of the square (due north of the crawlback tiles) with strength 2 on a single side, to start the process of assembling the next stage of the fractal. The popup tile also computes and transmits the initial value of the *masked* flag, as we will see in the next subsection.

### 3.2 The main recursion

We now show that a tileset exists that executes Algorithm 1, when assembling at temperature 2.

---

#### Algorithm 1 Main algorithm to self-assemble the sssST

---

**Require:** Current location is  $(x, y)$ , and is colored ON iff  $(x, y)$  is in all versions of the sssST that extend the coding sequence prefix decided so far.

- 1: **if**  $(0 < x \leq 4)$  or  $(0 < y \leq 4)$  **then**
  - 2:   use the `4x4basecase` method to determine which tile to place at  $(x, y)$
  - 3: **else if** *crawlbackeastwest* or *crawlbacknorthsouth* **then** {either the east or north neighbor reports  $(x, y)$  should contain a crawlback tile}
  - 4:   use the `crawlback` method to determine which tile to place at  $(x, y)$
  - 5: **else if** *masked* **then**
  - 6:   color  $(x, y)$  OFF
  - 7: **else**
  - 8:   color  $(x, y)$  ON or OFF, depending on the one or two coding sequence trits received from neighbors, and the relative location of  $(x, y)$  in the  $4 \times 4$  square currently being assembled
  - 9: **end if**
- 

**Lemma 3.** *Line 1 of Algorithm 1 can be executed by a tile assembly system. Further, there is a well-defined basecase method that will correctly lay out tiles for any  $0 < x \leq 4$ , or  $0 < y \leq 4$ . (So a tile assembly system can execute Line 2 as well.)*

*Proof.* We can send a Boolean flag north in each column, and the flag is only TRUE in the column  $x = 4$ ; similarly for the row  $y = 4$ . By slightly altering the tileset that performs the layout in Figure 5, we obtain the ability to tile the westmost four columns, and southmost four rows, of the sssST. The Appendix discusses this in more detail.

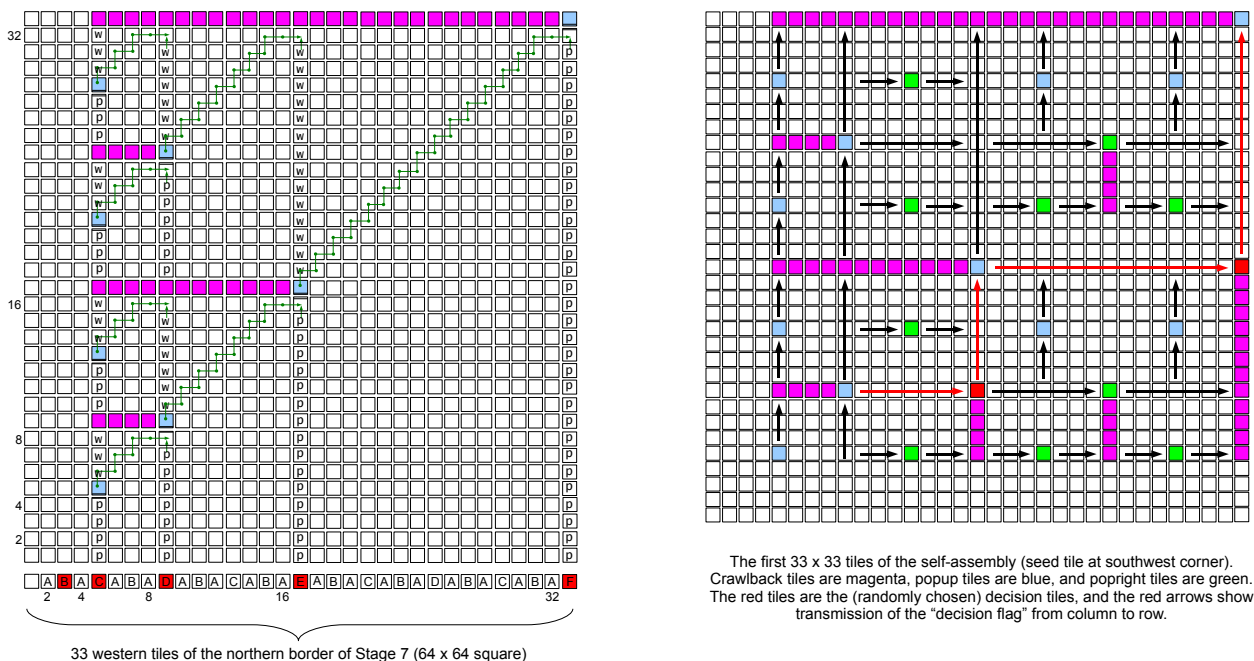
**Lemma 4.** *Lines 3 and 4 of Algorithm 1 can be executed by a tile assembly system.*

*Proof.* As already discussed, by appending the value of one bit to eastern or northern glue names, as appropriate, it is possible to place a crawlback tile of the appropriate color at location  $(x, y)$ . We only need finitely many distinct crawlback tile types, as each one is responsible for transmitting only one coding sequence trit, and, if the tiles count modulo 4 as they are placed, they can transfer relative location information needed in line 8 of Algorithm 1. Further implementation details appear in the Appendix.

**Lemma 5.** *It is possible to execute Line 5 of Algorithm 1 (i.e., to compute the masked flag) in tile assembly.*

*Proof.* Consider the left side of Figure 6. It shows how the delimiters interact with the “area-border columns” (i.e., columns whose  $x$  coordinate is  $2^k$  for some  $k \in \mathbb{N}$ ), and their corresponding “decision

columns” (where  $x = 2^k + 1$ ). Each decision column toggles between two states: a POP state, and a WAIT-TO-POP state. If the delimiter flag gets transferred east, through the eastmost column, to a location  $(a, b)$  receiving a WAIT-TO-POP flag from the south, then construction for that area is completed, and we place a tile at that location with strength one on all four sides. However, if  $(a, b)$  is receiving POP from the south, then we place a tile at  $(a, b)$  with a strength 2 glue on the north side, so a popup tile can attach to it, and start construction of the areas to the north and northeast. We compute the value of *masked* with constant-size messages as follows. A decision tile



**Fig. 6.** Illustration of the interaction between delimiters, area-border columns (columns of form  $x = 2^k$ ), and decision columns (columns of form  $x = 2^k + 1$ ). The left diagram shows how a delimiter starts at a popup tile and climbs northeast until it encounters an area-border column, then connects with the decision column due east. If the decision column is in state POP (shown with a “p”), we place a popup tile due north of the connection point, and toggle the column to state WAIT-TO-POP (shown with a “w”). If the column is in state WAIT-TO-POP, then we know that we have built the current area to its maximum height, and the next row should be one of crawback tiles. The right diagram shows the skeleton of the nested recursion that builds each area at each stage. In addition to the existing column and delimiter mechanisms, we also use a row-and-popright-tile mechanism, obtained by rotating the original mechanisms  $90^\circ$  to the right, and reflecting them from bottom to top. The diagram shows how the popup and popright and tiles interact, with delimiters invisible for clarity. Note the one asymmetry of the recursion is the red “decision flag” transmitted from column to row, so a decision tile binds to the configuration at the start of each new stage.

determines which of the new areas to build will be masked completely, and transfer that to the rest of its column, including the popup tile. From the popup tile, the correct value of *masked* is sent west and east, to build Areas 1 and 2. If we are building an unmasked area, we set *masked*

to TRUE if, when laying the crawlback tiles, we see a coding trit in a former decision column that implies that area should be masked off. Once *masked* is set to TRUE, it remains true for all other contiguous crawlback tiles. Because of how the coding sequence prefix is laid out, as we lay the crawlback tiles we can compute the correct value of *masked*, and build until the delimiter and popup (or popright) mechanisms inform us we have come to the end of the masked area.

**Lemma 6.** *Line 8 of Algorithm 1 can be computed by a tile assembly system.*

*Proof.* The right side of Figure 6 exhibits a nested recursion by popup and *popright* tiles that delimit progressively smaller areas, down to  $4 \times 4$  squares. As the construction of  $4 \times 4$  squares is hardcoded into the construction, and the coding sequence prefix is transferred so *masked* can be computed correctly, and the first two decision values are available, from either the west or the south, when deciding how to color an unmasked  $4 \times 4$  square, we can color each square correctly. Finally, as the construction builds one  $2^k \times 2^k$  stage at a time, we will tile every location in the first quadrant.

**Theorem 1.** *There exists a tile assembly system that self-assembles the statistically self-similar Sierpinski Triangle.*

### 3.3 The tileset computes

To show that a tileset *computes* the sssST, we need to prove that the tileset is actually “doing the work,” and not receiving “too much help” from the randomly chosen decision tiles (*e.g.*, the set of decision tiles do not themselves fill the plane). We achieve this by applying zeta dimension.

**Definition 2.** *Let  $S \subseteq \mathbb{Z} \times \mathbb{Z}$  be a set of locations in the integer plane. Define the  $S$ -zeta-function  $\zeta_S : [0, \infty) \rightarrow [0, \infty)$  by  $\zeta_S(s) = \sum_{(0,0) \neq (x,y) \in S} \left(\sqrt{x^2 + y^2}\right)^{-s}$  and define the zeta dimension of  $S$ , written  $\dim_\zeta(S)$ , as follows:  $\dim_\zeta(S) = \inf\{s \mid \zeta_S(s) < \infty\}$ .*

Zeta dimension is a natural measure of the “size” of a set of discrete lattice points, and has been rediscovered (and renamed) by many researchers, since the nineteenth century. Discussion of this history, and a survey of some classical and computer science applications, can be found in [4]. Our interest in the definition is due to the fact that sets with zeta dimension zero are “negligible.”

An assembly sequence  $\vec{\alpha}$  is *locally deterministic* [14] if (1) each tile added in  $\vec{\alpha}$  binds with the minimum strength required for binding; (2) if there is a tile of type  $t_0$  at location  $l$  in the result of  $\alpha$ , and  $t_0$  and the immediate “OUT-neighbors” of  $t_0$  are deleted from the result of  $\vec{\alpha}$ , then no other tile type in  $\mathcal{T}$  can legally bind at  $l$ ; the result of  $\vec{\alpha}$  is terminal.

**Definition 3.** *Let  $\mathcal{T}$  be a tile assembly system with temperature 2, such that all possible terminal assemblies of  $\mathcal{T}$  are contained in the area  $A \subseteq \mathbb{Z} \times \mathbb{Z}$  of the integer plane. We say  $\mathcal{T}$  is almost-everywhere locally deterministic if  $\mathcal{T}$  is locally deterministic except for a set of locations with zeta dimension zero.*

Informally, we can say that if  $\mathcal{T}$  is almost-everywhere locally deterministic, then it computes deterministically, except for an “advice tileset” of negligible size. This is analogous to one definition of randomized computation, in which an oracle Turing machine computes deterministically, but has access to an infinite binary oracle string, for the purpose of generating coin flips. Since the set of decision locations has zeta dimension zero, we are finally able to state our main result, which is the following corollary of Theorem 1.

**Corollary 1.** *There is an almost-everywhere locally deterministic tile assembly system that self-assembles the statistically self-similar Sierpinski Triangle.*

## 4 Conclusion

We have demonstrated the existence of a tile assembly system that self-assembles a random fractal, the statistically self-similar Sierpinski Triangle. Our algorithm made use of novel mechanisms for information transfer and locally computed nested recursion. However, the tile assembly model used throughout this paper is error-free, and the algorithm presented is fragile with respect to errors. Any break in the paths of information-flow causes the entire construction to repeat incorrectly forever, or to halt. One direction for future investigation would be to construct a tile assembly system that builds a random fractal in a way that is robust against binding errors.

## Acknowledgements

I am grateful to James Lathrop, Jack Lutz, Matthew Patitz and Scott Summers for helpful discussions. Jack Lutz initially suggested this problem to me. During the preparation of this paper, I used the tile assembly simulation programs TileSimulator3.2.2.1 by James Lathrop, and ISU TAS by Matthew Patitz [8].

## References

- [1] BECKER, F., RAPAPORT, I., AND RÉMILA, E. Self-assembling classes of shapes with a minimum number of tiles, and in optimal time. In *FSTTCS (2006)*, S. Arun-Kumar and N. Garg, Eds., vol. 4337 of *Lecture Notes in Computer Science*, Springer, pp. 45–56.
- [2] CHEN, H.-L., AND GOEL, A. Error free self-assembly using error prone tiles. In *DNA (2004)*, C. Ferretti, G. Mauri, and C. Zandron, Eds., vol. 3384 of *Lecture Notes in Computer Science*, Springer, pp. 62–75.
- [3] DOTY, D. Randomized self-assembly for exact shapes. Tech. Rep. 0901.1849, Computing Research Repository, 2009.
- [4] DOTY, D., GU, X., LUTZ, J. H., MAYORDOMO, E., AND MOSER, P. Zeta-dimension. In *MFCS (2005)*, J. Jedrzejowicz and A. Szepietowski, Eds., vol. 3618 of *Lecture Notes in Computer Science*, Springer, pp. 283–294.
- [5] KAO, M.-Y., AND SCHWELLER, R. T. Randomized self-assembly for approximate shapes. In *ICALP (1) (2008)*, L. Aceto, I. Damgård, L. A. Goldberg, M. M. Halldórsson, A. Ingólfssdóttir, and I. Walukiewicz, Eds., vol. 5125 of *Lecture Notes in Computer Science*, Springer, pp. 370–384.
- [6] KAUTZ, S. M., AND LATHROP, J. I. Self-assembly of the discrete Sierpinski carpet and related fractals. In *FNANO (2009)*.
- [7] LATHROP, J. I., LUTZ, J. H., PATITZ, M. J., AND SUMMERS, S. M. Computability and complexity in self-assembly. In *CiE (2008)*, A. Beckmann, C. Dimitracopoulos, and B. Löwe, Eds., vol. 5028 of *Lecture Notes in Computer Science*, Springer, pp. 349–358.
- [8] PATITZ, M. J. Simulation of self-assembly in the abstract tile assembly model with ISU TAS. In *FNANO (2009)*.
- [9] PATITZ, M. J., AND SUMMERS, S. M. Self-assembly of decidable sets. In *UC (2008)*, C. S. Calude, J. F. Costa, R. Freund, M. Oswald, and G. Rozenberg, Eds., vol. 5204 of *Lecture Notes in Computer Science*, Springer, pp. 206–219.
- [10] PATITZ, M. J., AND SUMMERS, S. M. Self-assembly of discrete self-similar fractals. In *DNA (2008)*.
- [11] ROTHEMUND, P. W. K., AND WINFREE, E. The program-size complexity of self-assembled squares (extended abstract). In *STOC (2000)*, pp. 459–468.
- [12] SEEMAN, N. C. De novo design of sequences for nucleic acid structural engineering. *Journal of biomolecular structure and dynamics* 8, 3 (1990), 573–581.

- [13] SOLOVEICHIK, D., COOK, M., AND WINFREE, E. Combining self-healing and proofreading in self-assembly. *Natural Computing* 7, 2 (2008), 203–218.
- [14] SOLOVEICHIK, D., AND WINFREE, E. Complexity of self-assembled shapes. *SIAM J. Comput.* 36, 6 (2007), 1544–1569.
- [15] WINFREE, E. *Algorithmic Self-Assembly of DNA*. PhD thesis, California Institute of Technology, 1998.
- [16] WINFREE, E. Algorithmic self-assembly of DNA: Theoretical motivations and 2d assembly experiments. *Journal of Biomolecular Structure and Dynamics* 11, S2 (2000), 263–270.

## A Proof of Lemma 1

We restate the lemma for clarity.

**Lemma 7.** *There is a tileset that self-assembles the first two stages of the sssST such that (1) each tile binds with strength exactly 2; (2) the first two decisions of the coding sequence can be transmitted to each location in advance of a tile being placed there, so the properly colored tile is placed each time; and (3) once assembled, the configuration transmits north the sequence “decision 1, decision 2, decision 1,” and transmits the same sequence east.*

*Proof.* Figures 7, 8 and 9 exhibit a tileset of 84 tiles that self-assembles the first two stages ( $4 \times 4$  square) of the sssST, consistent with the order of placement and the information transfer graph in Figure 4. We can see this explicitly in Figure 10, which shows the order of placement, starting with the seed tile, of a  $4 \times 4$  square with coding sequence prefix  $\langle 12 \rangle$ .

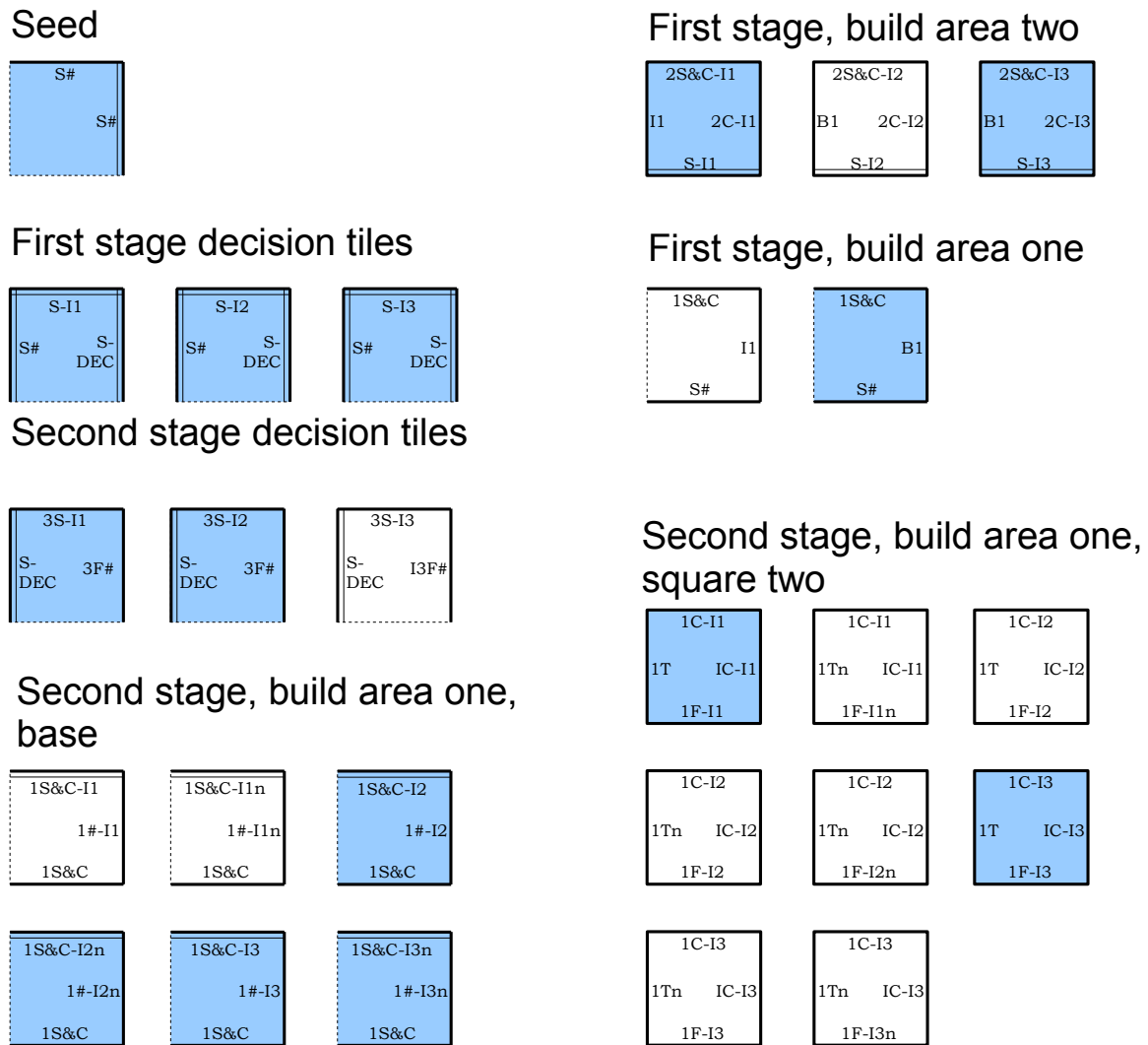
## B Crawlback tiles and the basecase method

Recall that the crawlback tiles are placed “out of order” to build the southern row of a new Area 1, or the western column of a new Area 2 or Area 3. We don’t have access to the first decisions in the coding sequence prefix before we have to decide how to color the tile that binds to the crawlback location. Therefore, we make use of the fact that, when drawing the new base row of Area 1, or the base column of Areas 2 or 3, it is identical to the baserow (or leftmost column) of the configuration achieved so far. The purpose of these additional bits is to copy the original baserow (leftmost column) identically into the new area. This information can be transferred with constant size (1-bit) messages. We implemented this in tiles by appending “\*on” or “\*off” to the names of northern and eastern glues. Figure 11 illustrates the crawlback mechanism in more detail.

There are two **basecase** methods: one to construct  $4 \times 4$  squares along the western edge of the fractal, and the other to construct  $4 \times 4$  squares along the southern edge. The tilesets that perform these methods are identical, except that one is a rotation and reflection of the other. Figure 12 illustrates operation of the western edge **basecase** method given coding sequence prefix  $\langle 12 \rangle$ . Note that the tile types, and the order of tile placement, are very similar to the tileset used for the first two stages of construction (*i.e.*, to prove Lemma 1).

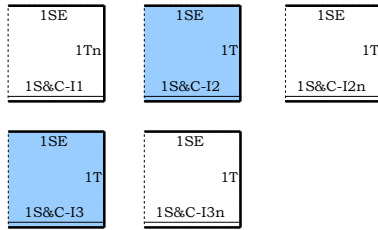
## C Delimiters, popup tiles and popright tiles

It is essential to know when to *stop* building a particular area—for example, when an area to mask is nested inside a larger area that is not completely masked out. We achieve this control by allowing a decision column to grow a popup tile only every other time that a delimiter encounters it as the

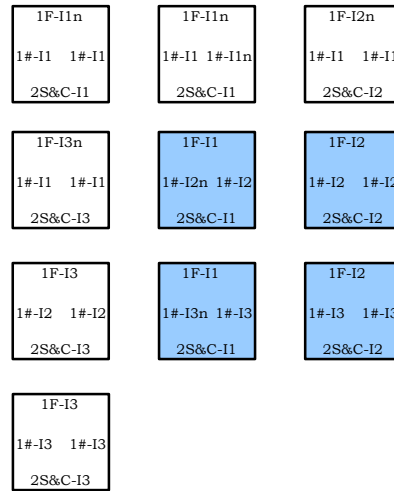


**Fig. 7.** Combined with Figures 8 and 9 this Figure exhibits a set of 84 tile types that implements self-assembly of the first two stages of the sssST.

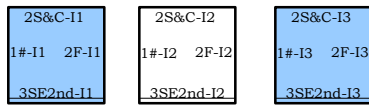
Second stage, build area one, square one



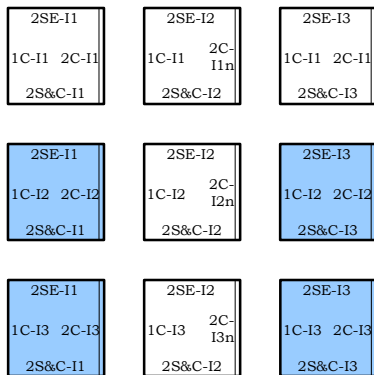
Second stage, build area one, square three



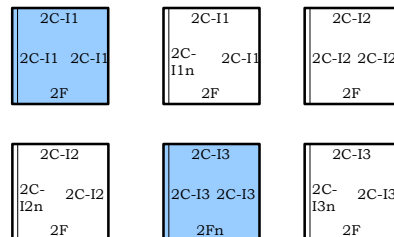
Second stage, build area two, base



Second stage, build area two, square one

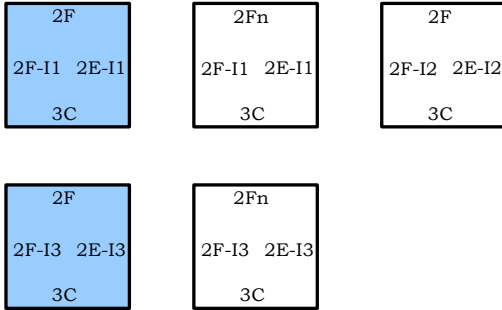


Second stage, build area two, square two

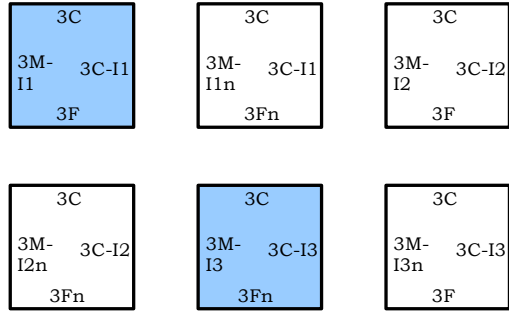


**Fig. 8.** Combined with Figures 7 and 9 this Figure exhibits a set of 84 tile types that implements self-assembly of the first two stages of the sssST.

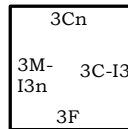
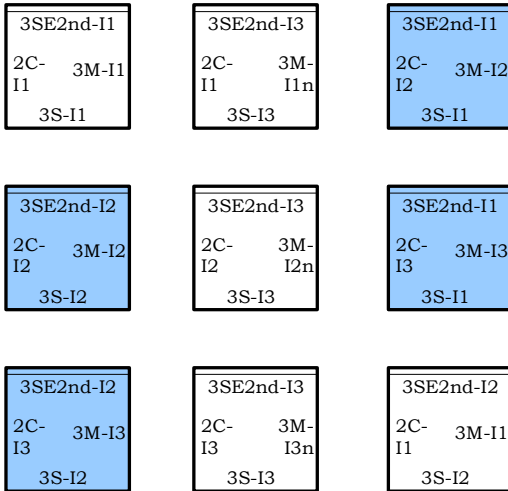
Second stage, build area two, square three



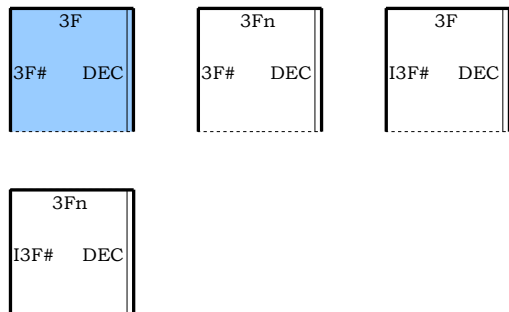
Second stage, build area three, square two



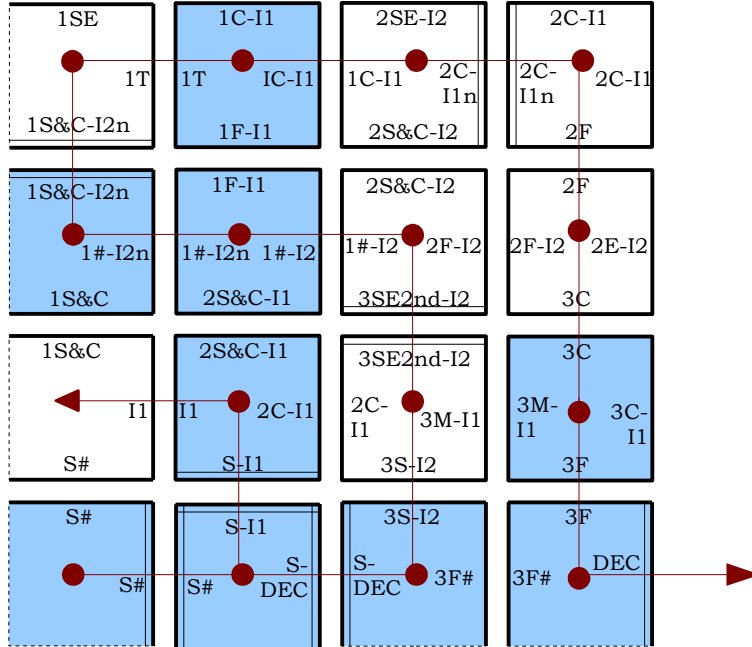
Second stage, build area three, square one



Second stage, build area three, square three



**Fig. 9.** Combined with Figures 7 and 8 this Figure exhibits a set of 84 tile types that implements self-assembly of the first two stages of the sssST.



**Fig. 10.** An implementation of the self-assembly of coding sequence 12, using the tileset presented in Figures 7, 8 and 9. The red lines show the order of tile placement on the plane.

assembly sequence progresses. When a decision tile binds at a decision point, it sends two pieces of information northward: the decision-value of the column, and the state that it should pop up when a delimiter encounters it. Once the popup tile binds, the column sends the decision-value north as before, but also a WAIT-TO-POP state, that is toggled back to POP by the next delimiter (and the crawlback tile that binds to the decision column, just north of the location where the delimiter reaches the decision column).

There are two rules placed on delimiters to prevent them from propagating for too long: a delimiter stops propagating once it sets a decision column back to the state POP; and a delimiter stops propagating if it encounters crawlback tiles. These rules stop a delimiter from extending beyond the Area it is intended to delimit.

The delimiters as we have described them will correctly reproduce nested recursions for nested Area 1's, and also permit the binding of a popup tile to a new decision column, to continue the next stage of self-assembly. To obtain nested recursions for Areas 2 and 3, we “rotate” these delimiter rules ninety degrees to the right, and reflect them across the  $x$ -direction. Instead of decision columns, we consider decision rows that bind “popright” tiles to the east when the proper delimiter encounters the decision row. (Such a “rotation” is technically the definition of a new group of tile types whose glue types are a rotated and reflected version of the appropriate tile types used in Area 1.) As before, these delimiters cannot cross crawlback tiles. In addition, a delimiter cannot cross from Area 3 to Area 2. That can be detected locally and with a constant-size message, by encountering the row encoded to produce a new decision point.

Figure 13 provides an example of implementation of an Area 1 delimiter.





While the tilesets to build Areas 2 and 3 perform essentially the same operations, there is an important asymmetry between them: the placement of the decision tile that begins the next stage of construction. From stage four of construction onward, we pass a flag north from a decision tile, to the first popup tile, and then east along the base column of Area 3. This flag transmission is shown with red arrows in the right side diagram of Figure 6, and in Figure 15. We implemented this in tiles by including “dec” in the glue names responsible for flag transmission.

We recognize it is time to attach a new decision tile to the configuration, when an Area 3 delimiter that started with the decision row popright tile connects with the top row of Area 3. (See Figure 14.) This means that the construction of Area 2 must differ from Area 3, because some tiles in the baserow of Area 2 need to be able to receive input from the south. Also, it is important for the proof of correctness of the algorithm that every tile in the construction bind with strength exactly 2. Therefore, we modify the way the baserow tiles of Area 2 bind; unlike Area 3, they are not an exact translation and rotation of the basecase tiles of Area 1. Instead, in columns of form  $x = 2^k + 4m$  for  $m > 0$  a natural number, the tile that binds at location  $(x, 2^k + 1)$  will have glue strength zero on its southern edge. Every fourth tile in the baserow of Area 2 binds with strength 1 from the west, and strength 1 from the south, so the location can receive information from the south. Otherwise, the Area 2 basecase method is identical to Area 3’s.

For reasons of space, we used a  $32 \times 32$  diagram in the main body of the paper to show the relation between popup and popright tiles. However, it may be more useful to consider Figure 15, which shows the construction after  $65 \times 65$  tiles have been placed, because it shows both popup columns and popright rows that have “periods” 4, 8, and 16—where a column’s or row’s period is the number of tiles from one popup or popright tile to the next. Just like popup columns, popright rows toggle between POP and WAIT-TO-POP states, and the state changes when a popright delimiter encounters the row.

The critical fact that allows this nested recursion to be programmed in tile assembly is that no location needs to transmit (or recognize) more than two delimiters: a popup delimiter, and a popright delimiter. (There are two types of popright delimiter, one of which is used for placement of the next decision tile.) Therefore, the entire recursion can be computed using a fixed number of tile types, and the underlying geometry of the configuration being built.

## D Proof of correctness of Algorithm 1

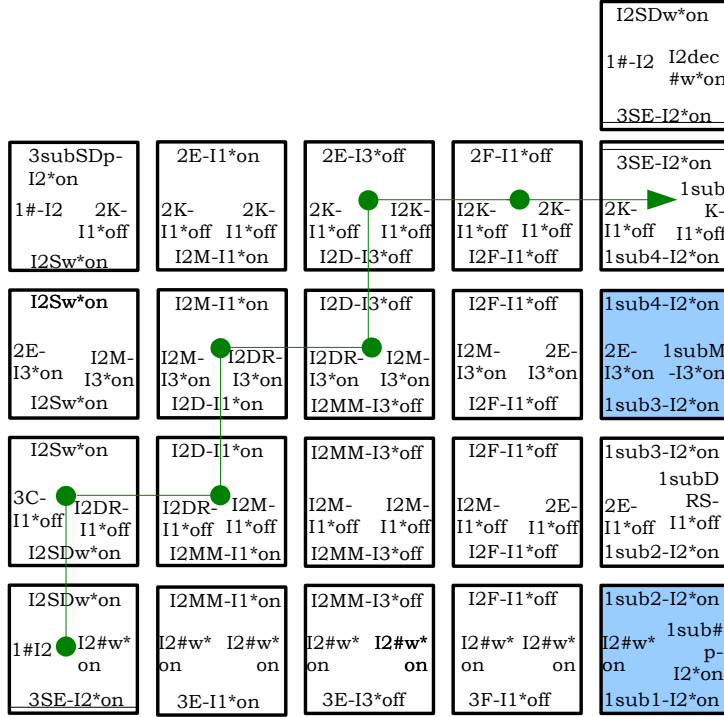
**Definition 4.** Let  $S \subseteq \{1, 2, 3\}^\infty$  be enumerated as  $S = \langle s_1, s_2, s_3, \dots \rangle$ . The statistically self-similar Sierpiński Triangle relative to coding sequence  $S$  is the set  $T|S$  with the following recursive definition.

1.  $(1, 1) \in T|S$ .
2. For  $j, k, x, y \in \mathbb{N}$  such that  $2^{j-1} + 1 \leq x \leq 2^j$  and  $2^{k-1} + 1 \leq y \leq 2^k$

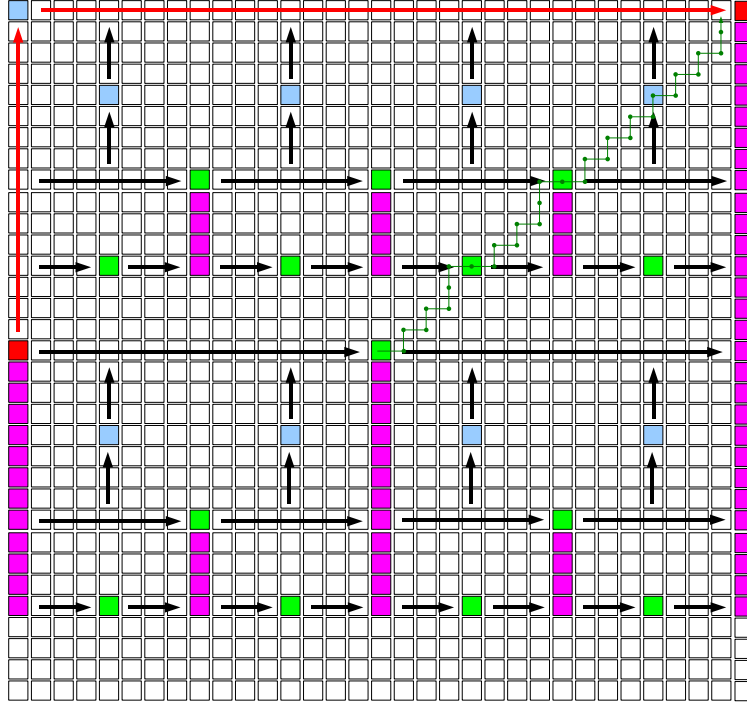
$$(x, y) \in T|S \Leftrightarrow \begin{cases} s_k \neq 1 \text{ and } (x, y - 2^{k-1}) \in T|S & j < k \\ s_k \neq 2 \text{ and } (x - 2^{j-1}, y - 2^{k-1}) \in T|S & j = k \\ s_k \neq 3 \text{ and } (x - 2^{j-1}, y) \in T|S & j > k. \end{cases}$$

We now restate Definition 1 with respect to Definition 4.

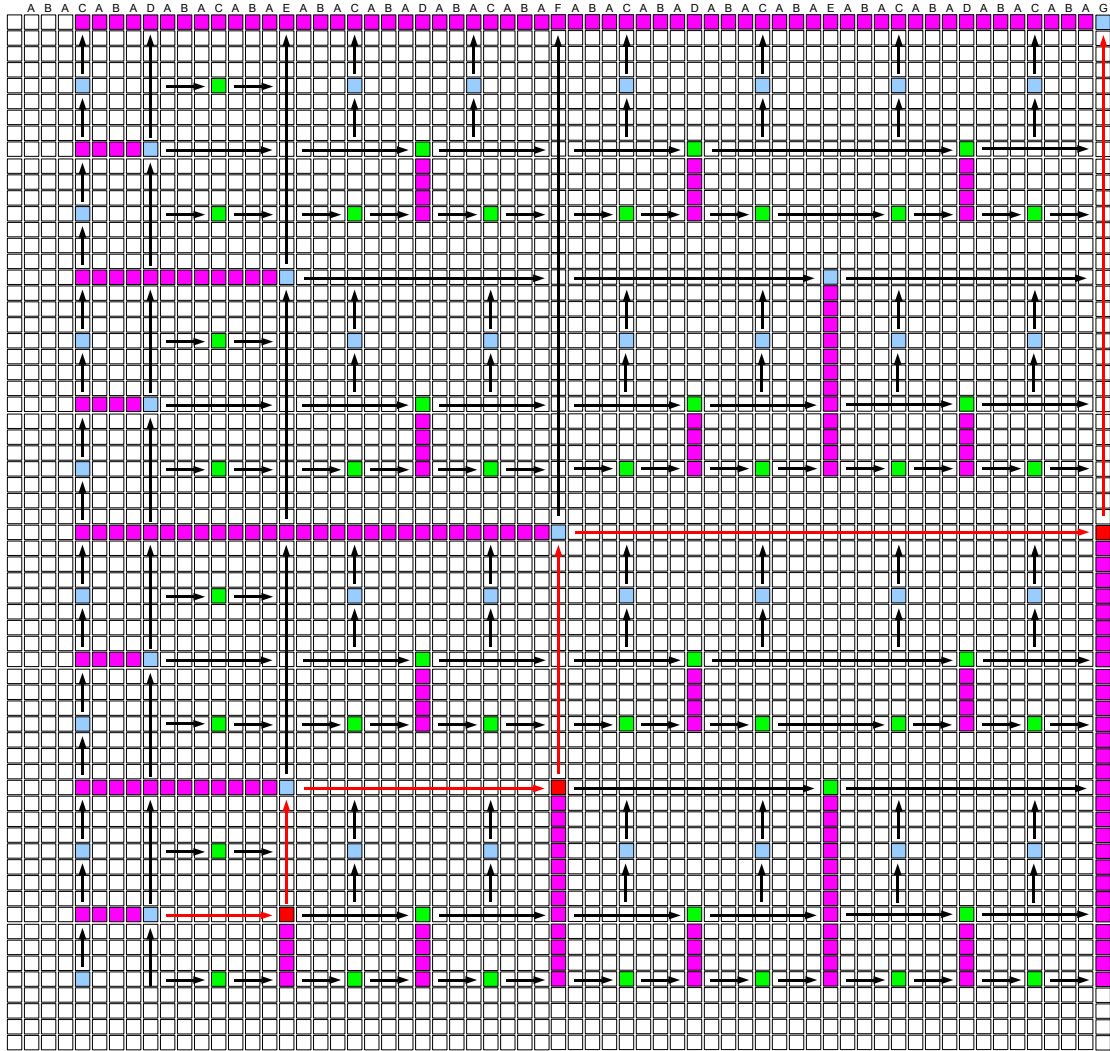
**Definition 5.** Let  $\mathcal{T}$  be a tile assembly system. We say  $\mathcal{T}$  self-assembles the statistically self-similar Sierpiński Triangle if the following conditions hold:



**Fig. 13.** An example implementation of popup tile delimiters. This is the delimiter created while building Area 2 during stage three of construction (*i.e.*, the northeast  $4 \times 4$  grid of the first  $8 \times 8$  squares). Area 2 is masked (invisible) in this example, which is why glue names begin with “I”. A tile passes a delimiter northward by using a “D” in the glue name, and eastward with a “DR” (for “delimiter right”) in the glue name. Use of “K” in the glue name indicates we have built the upper right corner of the Area. The “dec” in the east glue name of the popup tile transmits the decision flag eastward. (“Dec” does not appear in the column below the popup tile, because this is the stage in which the decision flag is first created, so production of the decision flag is hard coded to begin at that point.)



**Fig. 14.** This is a closeup of Area 3 from Figure 15, in order to highlight operation of the special delimiter (shown with a green arrow), by means of which we know to add a new decision tile. The delimiter originating at the popright tile of the previous decision row is the one that cues the next decision row that construction of the current stage of Area 3 has finished. Note the technical point that the delimiter must travel east through the popright tile, and north through the popup tile, because of the order of tile placement: crawlback tiles are placed after popright tiles, not before.



**Fig. 15.** A schematic of popup tiles and popright tiles after the first six stages of construction. This shows a  $65 \times 65$  square, and includes the seventh decision tile (*i.e.*, decision  $G$ ), and the associated popup tile and crawlback tiles. The coding sequence prefix transmitted north appears at the top. An identical prefix (enumerated from south to north) is also transmitted to the eastern border of the configuration.

**Liveness condition:** For every infinite ternary coding sequence  $S \in \{1, 2, 3\}^\infty$ , there is an assembly sequence  $\vec{\alpha}$  of  $\mathcal{T}$  whose terminal assembly is  $T|S$ .

**Safety condition:** If  $A$  is a terminal assembly of  $\mathcal{T}$ , then there is a sequence  $S \in \{1, 2, 3\}^\infty$  such that  $A = T|S$ .

**Fairness condition:** For any finite coding sequence prefix  $s \in \{1, 2, 3\}^n$  of length  $n$ , the probability that a terminal assembly of  $\mathcal{T}$  will be a configuration of some  $T|S$  such that  $S$  extends  $s$ , is  $3^{-n}$ .

We are interested in being able to prove that a certain tile assembly system always achieves a certain output. In [14], Soloveichik and Winfree presented a strong technique for this: local determinism. An assembly sequence  $\vec{\alpha}$  is *locally deterministic* if (1) each tile added in  $\vec{\alpha}$  binds with the minimum strength required for binding; (2) if there is a tile of type  $t_0$  at location  $l$  in the result of  $\alpha$ , and  $t_0$  and the immediate “OUT-neighbors” of  $t_0$  are deleted from the result of  $\vec{\alpha}$ , then no other tile type in  $\mathcal{T}$  can legally bind at  $l$ ; the result of  $\vec{\alpha}$  is terminal. Local determinism is important because of the following result.

**Theorem 2 (Soloveichik and Winfree [14]).** *If  $\mathcal{T}$  is locally deterministic, then  $\mathcal{T}$  has a unique terminal assembly.*

The objective of this section of the Appendix is to prove the following theorem.

**Theorem 3.** *Let  $\mathcal{T}$  be a tile assembly system that executes Algorithm 1. Then  $\mathcal{T}$  self-assembles the statistically self-similar Sierpinski Triangle.*

*Proof.* Suppose, for contradiction, that the Safety condition is violated, and there exists a tile assembly sequence  $\vec{\alpha}$  with terminal assembly  $A$  of  $\mathcal{T}$  such that  $A \neq T|S$  for any  $S \subseteq \{1, 2, 3\}^\infty$ . Let  $A_t$  be the tile configuration obtained when the first tile in  $\vec{\alpha}$  is placed such that no terminal assembly legally obtainable from  $A_t$  is of form  $T|S$  for any  $S \in \{1, 2, 3\}^\infty$ . Let  $t$  be the final tile placed in  $A_t$ . Let  $k$  be the last stage built correctly before placement of  $t$ . From Lemma 2, and the characteristics of the popup and popright tile mechanisms discussed in Section C, we know that the information transfer graph before placement of  $t$  transmits a frontier of form  $\langle S_{k-1}d_k S_{k-1}d_{k+1} \rangle$ , where  $S_{k-1}$  is the coding sequence prefix of stage  $k-1$ .

We know from Lemma 6 that Algorithm 1 correctly colors a location, based on coding sequence trits received from its neighbors. The frontier transmitted from stage  $k$  is designed precisely so the tiles can execute a local algorithm that mimics the recursive definition of the sssST in Definition 4. So the only way  $t$  could be laid in a way that violates construction of some  $T|S$  in Line 8 of Algorithm 1, would be if there was already an error at some earlier stage. Since  $t$  is the first such error, that is not possible. We know from Lemmas 3, 4 and 5 that  $t$  cannot be placed in error at other points in the algorithm. Because each tile binds to the configuration with strength exactly 2, we are guaranteed a unique terminal assembly, if we fix which decision tiles bind at decision points, because of local determinism. So the Safety condition cannot be violated.

For the Liveness condition to be violated, there would have to be some  $S$  such that  $T|S$  could never be built. Then there would be some minimal finite ternary string  $\sigma$  such that  $\sigma \sqsubseteq S$ . Since the Safety condition holds, this could only happen if one of the three decision tile types could not bind at the  $|\sigma|$ -th decision point of the construction, which is contrary to the assumption that each tile type binds with  $1/3$  probability at any location where a given tile type might bind.

Since the Safety and Liveness conditions hold, and each decision point accepts the bond of a tile that encodes “1,” “2” or “3” with equal probability, the Fairness condition holds as well.

As a final note, a key direction for future research is the design of programming tools that make it possible to implement algorithms for nested recursion in macroscale and nanoscale self-assembly. We designed several tile assembly systems using the tile assembly simulators of Lathrop and Patitz. At first, this was to gain an intuition for programming self-assembling networks. Later, it was to verify the accuracy of technical aspects of the proofs we presented in this paper. We have not implemented the full construction of the sssST in tiles, and anticipate that our implementation would require a tile assembly system with approximately 5,000 tile types. The current state of the art in tile assembly programming (except for a handful of specific tasks) is to use a GUI to design each tile type individually [8]. We believe this implementation problem raises two critical—and wide-open—research areas: (1) lower bound proofs for the number of tile types required to execute recursions, and to store and transmit information; and (2) a shape compiler that can automate creation of tile types when given graphical input from a user.