

Success Exponent of Wiretapper: A Tradeoff between Secrecy and Reliability

Chung Chan

Abstract—Equivocation rate has been widely used as an information-theoretic measure of security after Shannon[12]. It simplifies problems by removing the effect of atypical behavior from the system. In [11], however, Merhav and Arikan considered the alternative of using guessing exponent to analyze the Shannon’s cipher system. Because guessing exponent captures the atypical behavior, the strongest expressible notion of secrecy requires the more stringent condition that the size of the key, instead of its entropy rate, to be equal to the size of the message.¹ The relationship between equivocation and guessing exponent are also investigated in [8][9] but it is unclear which is a better measure, and whether there is a unifying measure of security.

Instead of using equivocation rate or guessing exponent, we study the wiretap channel in [2] using the success exponent, defined as the exponent of a wiretapper successfully learn the secret after making an exponential number of guesses to a sequential verifier that gives yes/no answer to each guess. By extending the coding scheme in [2][6] and the converse proof in [4] with the new Overlap Lemma V.2, we obtain a tradeoff between secrecy and reliability expressed in terms of lower bounds on the error and success exponents of authorized and respectively unauthorized decoding of the transmitted messages. From this, we obtain an inner bound to the region of strongly achievable public, private and guessing rate triples for which the exponents are strictly positive. The closure of this region contains the region in Theorem 1 of [2] when we treat equivocation rate as the guessing rate. It would be surprising if one can show that the subset relationship is strict, the region is tight, or a better coding scheme exists.

ACKNOWLEDGMENT

I would like to thank Professor Lizhong Zheng for his guidance and valuable comments; and above all, my family for their support and encouragements.

I. INTRODUCTION

The basic model of a cryptographic/secrecy system involves a sender Alice who wants to send a message S as *secretly as possible* to the intended receiver Bob. The basic model of a cryptanalytic attack, on the other hand, involves a cryptanalyst/wiretapper Eve who attempts to learn the secret as *much as possible* based on her observation Z . How secretly a message is sent, or how much information is leaked, must therefore be quantified before one can design and optimize a cryptographic system or a cryptanalytic attack for the respective purposes.

Manuscript written on May 23, 2008.

Chung Chan (chungc@mit.edu) is with the Laboratory of Information and Decision Systems, Department of Electrical Engineering and Computer Science, Massachusetts Institute of Technology.

¹This is the condition for a finite system to achieve perfect secrecy as pointed out by Shannon[12].

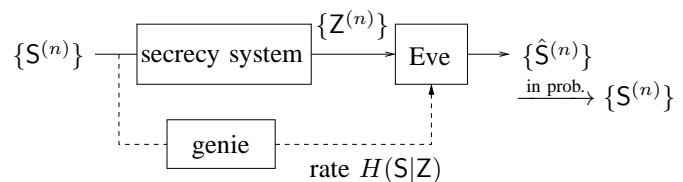

Fig. 1. Genie-aided correction channel

The a posteriori probability function $P_{S|Z}$ is a sufficient statistics of the security of the system as it gives all the possible values of the secret and their associated probabilities for every possible realization of the wiretapper’s observation. In particular, the important notion of a system being perfectly secure, referred to as *perfect secrecy* by Shannon[12], can be characterized as the a posteriori probability equal to the prior, i.e. $P_{S|Z} = P_S$. In other words, Eve’s observation is independent of the secret, or equivalently, the system is at the same level of security whether Z is observed or not.

It is convenient to summarize the a posteriori probability function by the index called *equivocation* $H(S|Z)$. It is roughly the amount of information the wiretapper needs to gather in addition to Z to perfectly recover S . One precise operational meaning of equivocation, as illustrated in Fig. 1, is the minimum achievable rate for source coding an iid sequence of $S^{(n)}$ with the iid sequence of $Z^{(n)}$ as side information at the decoder.² To achieve perfect secrecy, it is necessary and sufficient to have $H(S|Z) = H(S)$. Alice can also try to protect the secret up to an equivocation $H(S|Z)$ below $H(S)$ if perfect secrecy is costly and unnecessary.

The amount of additional information Eve needs to gather to break the system may not reflect how difficult it is to obtain them. For example, getting just one bit of information from Alice or someone who know the secret may require significant effort in the search for that person, followed by lengthy interrogation. In some situations, Eve does not play a passive role of receiving additional information that is concisely stated (i.e. maximally compressed by a genie), but instead plays an active role in identifying and extracting relevant information from disorganized sources. Thus, one should question whether equivocation is applicable for the case of interest, albeit its mathematical convenience.

A natural alternative measure of security, as investigated by Merhav and Arikan[11], is roughly the *ability* that Eve perfectly learn the secret from yes/no answers to “Is the secret

²This is the correction data model originally proposed by Shannon[12] except that the genie does not need to know Z nor any decision feedback from Bob.

equal to ...?” type of questions. In the model, Eve sequentially verify her guesses of the secret by asking yes/no questions. The number of guesses and verifications she needs to make until she is within some probability of guessing the secret correctly indicates her effort and ability to extract information about the secret. Sometimes the system itself provides such a verifier which help correct careless mistakes made by the authorized user. This potentially leaks information to unauthorized users who also have access to the verifier, just as in the case of a login system. As a system designer, he may be interested to know how many wrong passwords should be allowed for each session so that the chances of successfully breaking into the account is reasonably small. Although this success probability does not have a way to express the notion of perfect secrecy in general (See Example A.1), it is a natural fit for this problem as it provides the number of trials as an additional parameter to optimize.

In the sequel, we will consider the wiretap channel problem in [2]. A key result from [2] is the single letter characterization of the secrecy capacity, defined as the maximum rate at which the secret can be transmitted to Bob by a block coding scheme with arbitrarily small error probability and the equivocation rate equal to the message rate. Transmitting at rate above this secrecy capacity, one faces the trade-off a lower equivocation rate. Transmitting at rate below the secrecy capacity, however, equivocation rate is capped at the message rate. There seems to be little point in further reducing the rate below secrecy capacity. If one also cares about delay, i.e. how fast the error probability converges to zero, further reducing the rate below secrecy capacity can be beneficial. What is the tradeoff then?

Secrecy comes with a cost of *reliability* of the authorized decoding. To characterize which level of secrecy and reliability are simultaneously achievable for each rate, we will use the standard notion of *error exponents* for Bob and Eve in decoding their messages as a measure of reliability. For secrecy, we will use the exponent of the success probability, or *success exponent* for short, that Eve learns the secret within an exponential number of guesses.

The rest of the paper will be organized as follows. Section III defines the wiretap channel problem we consider. Section IV describes the proposed coding scheme. Section V explains the computation of the success exponent using a technique we call the Overlap Lemma V.2. Section VI explains the computation of the error exponents using the Packing Lemma[3]. Finally, the desired lower bounds on the exponents will be stated in Section VII. Section VIII gives the conclusion and some open problems. For readers who would like to skip to the main result, Section II provides a brief summary of notations.

II. PRELIMINARIES

Calligraphic font denotes a set, e.g. \mathcal{A} , which is always assumed finite unless otherwise stated. $2^{\mathcal{A}}$ and \mathcal{A}^c denote the power set and complement of \mathcal{A} respectively. $\mathcal{A} \cup \mathcal{B}$, $\mathcal{A} \cap \mathcal{B}$ and $\mathcal{A} \setminus \mathcal{B}$ denotes the usual set operations, which are the union, intersection, and difference respectively. $\text{Avg}_{a \in \mathcal{A}}$ (or Avg_a for short) denote the averaging operation $\frac{1}{|\mathcal{A}|} \sum_{a \in \mathcal{A}} \cdot \mathbb{R}$,

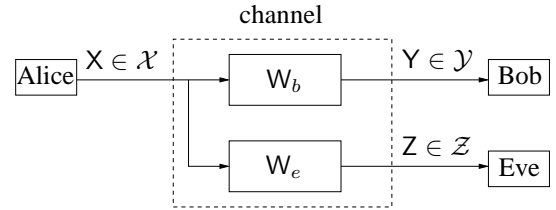

Fig. 2. Wiretap channel model

\mathbb{R}_+ and \mathbb{Z}^+ denotes the set of real numbers, non-negative real numbers, and positive integers. Occasionally without ambiguity, a positive integer L will also be used to denote the set $\{1, \dots, L\}$ as in $l \in L$. Bold letter such as \mathbf{x} denotes an n -sequence $\{x^{(i)}\}_{i=1}^n = (x^{(1)}, \dots, x^{(n)})$; and $\mathbf{u} \circ \mathbf{x}$ denotes element-wise concatenation $\{(u^{(i)}, x^{(i)})\}_{i=1}^n$.

San serif font is used for random variables and stochastic functions, e.g. X , f and W_b . $\mathcal{P}(\mathcal{Y})^{\mathcal{X}}$ denotes the set of all possible conditional probability distributions $P_{Y|X}$ of a random variable Y taking values from \mathcal{Y} , denoted as $Y \in \mathcal{Y}$, given a random variable $X \in \mathcal{X}$. The (conditional) probability distribution will also be viewed as a row vector (matrix). e.g. $P_X P_{Y|X}$ denotes the matrix multiplication, which gives the marginal distribution P_Y . $P_X \circ P_{Y|X}$ denotes the direct product, which gives the joint distribution $P_{X,Y}$ of the pair (X, Y) in this case. P_X^n denotes the n -th direct product such that $P_X(\mathbf{x}) = \prod_{i=1}^n P_X(x_i)$. For any subset $\mathcal{A} \subset \mathcal{X}$, $P_X(\mathcal{A}) = \sum_{x \in \mathcal{A}} P_X(x)$. $\mathbb{E}(X)$ denote the expectation of X . $\delta_{\text{var}}(P, Q)$ denotes the variation distance (25) between P and Q .

Following the notations in [3] for the *method of types*, $P_{\mathbf{x}}$ and $P_{\mathbf{y}|\mathbf{x}}$ denotes the type (6) and respectively canonical conditional type (8). ‘Canonical’ refers to the constraint (for convenience) that $P_{\mathbf{y}|\mathbf{x}}(y|x) = 1/|\mathcal{Y}|$ if $P_{\mathbf{x}}(x) = 0$ for all $(x, y) \in \mathcal{X} \times \mathcal{Y}$. $T_Q^{(n)}$ or T_Q for short denotes the class of n -sequences of type Q . $T_V(\mathbf{x})$ denotes the V -shell of \mathbf{x} . $\mathcal{P}_n(\mathcal{X})$ denotes the set of all types for sequences in \mathcal{X}^n . $\mathcal{V}_n(Q, \mathcal{Y})$ ($\mathcal{V}_n(Q)$ or \mathcal{V}_n for short) denotes the set of all canonical conditional types V for sequences in \mathcal{Y}^n . $I(Q, V|P)$, $D(V||W|Q)$, and $H(V|P)$ are the conditional mutual information (29), divergence (10) and entropy (11) respectively. $I(\mathbf{x} \wedge \mathbf{y})$ (20) denotes the empirical mutual information. Equivalently, we write $T_X := T_{P_X}$ and $T_{Y|X} := T_{P_{Y|X}}$, which are non-empty if the corresponding distributions are valid (conditional) types. $|T_{Y|X}|$ denote $|T_{P_{Y|X}}(\mathbf{x})|$ with $\mathbf{x} \in T_X$.

To express inequality in the exponent for functions in n , we use $a_n \lesssim b_n$ to denote $\limsup_{n \rightarrow \infty} \frac{1}{n} \log a_n$ is no larger than $\liminf_{n \rightarrow \infty} \frac{1}{n} \log b_n$. A piecewise function will be expressed in terms of $|a|^+ := \max\{0, a\}$ and $|a|^- := \min\{0, a\}$.

III. PROBLEM FORMULATION

A. Transmission model

Fig. 2 illustrates a single use of the discrete memoryless wiretap channel (W_b, W_e) using the dummy random variables X, Y and Z . Alice sends a random variable X through the channel. $P_X \in \mathcal{P}(\mathcal{X})$ is the probability distribution function/vector of X over the finite set \mathcal{X} , such that $P_X = \Pr\{X = x\}$ ($x \in \mathcal{X}$) and $P_X(\mathcal{A}) = \Pr\{X \in \mathcal{A}\}$ ($\mathcal{A} \subset \mathcal{X}$).

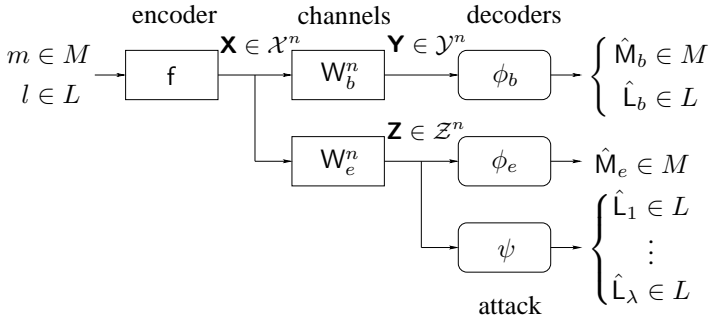

Fig. 3. Transmission model

The channel is denoted by the pair $(W_b \in \mathcal{P}(\mathcal{Y})^{\mathcal{X}}, W_e \in \mathcal{P}(\mathcal{Z})^{\mathcal{X}})$ of conditional probability distributions. We write $W_b(\mathbf{X})$ and $W_e(\mathbf{X})$ as the channel output \mathbf{Y} and resp. \mathbf{Z} observed by Bob and resp. Eve. The conditional distribution $P_{\mathbf{Y}|\mathbf{X}}(y|x) := \Pr\{\mathbf{Y} = y | \mathbf{X} = x\}$ equals $W_b(y|x)$ for all $(x, y) \in \mathcal{X} \times \mathcal{Y}$, and similarly for $P_{\mathbf{Z}|\mathbf{X}}$. For the case of interest, all sets \mathcal{X} , \mathcal{Y} and \mathcal{Z} are finite and the correlation between \mathbf{Y} and \mathbf{Z} given \mathbf{X} need *not* be specified.

To transmit information through this channel, we will consider the (data) transmission model illustrated in Fig. 3 with *block length* n . Following [2], we consider n uses of the channel with *stochastic encoding*, and deterministic decoders at the receivers. As pointed out in [2], stochastic encoding, i.e. randomization in the encoder *during transmission*, increases secrecy by adding noise as a *physical barrier* to eavesdropping while deterministic decoding does not lose optimality for the case of interest.

As shown in Fig. 3, Alice chooses a *public/common message* m out of a set of M possible messages to convey to both Bob and Eve, and a *private/secret/confidential message* $l \in L$ only to Eve. ($l \in L$ is a short-hand notation for $l \in \{1, \dots, L\}$.) Since the message m for Eve is a degraded version of the message (m, l) to Bob, this is identical to the *asymmetric broadcasting of degraded message sets*[3] except for the additional secrecy concern.

In the *transmission phase*, Alice first passes the message through a stochastic encoder denoted by the conditional probability distribution $f \in \mathcal{P}(\mathcal{X}^n)^{M \times L}$. We write $f(m, l)$ as the output codeword, which is denoted by the dummy random n -sequence $\mathbf{X} := \{X^{(i)}\}_{i=1}^n$ in Fig. 3. The encoder can be viewed as an artificial channel, through which the output codeword \mathbf{X} of the message (m, l) must satisfy $\Pr\{\mathbf{X} = \mathbf{x}\} = f(\mathbf{x}|m, l)$. It effectively adds additional noise to make it hard for Eve to learn the secret. This artificial noise also affects Bob since he does not know it a priori.

Alice then transmits the random codeword \mathbf{X} through n uses of the wiretap channel. The n -th extension of the wiretap channel is characterized by the n -th direct power (W_b^n, W_e^n) , where $W_b^n(\mathbf{y}|\mathbf{x}) = \prod_{i=1}^n W_b(y^{(i)}|x^{(i)})$ and similarly for W_e^n . Bob uses his channel output \mathbf{Y} to decode both the public and private messages with a deterministic decoder $\phi_b : \mathcal{Y}^n \mapsto M \times L$. $\Phi_b : M \times L \mapsto 2^{\mathcal{Y}^n}$ denotes the *decision region* so that

$$(1) \quad \phi_b(\mathbf{y}) = (m, l) \iff \mathbf{y} \in \Phi_b(m, l)$$

Similarly, Eve uses her channel output \mathbf{Z} to decode the public

message with decoder $\phi_e : \mathcal{Z}^n \mapsto M$ and decision region $\Phi_e : M \mapsto 2^{\mathcal{Z}^n}$. She, however, also generates an unordered set of $\lambda \leq L$ distinct guesses of the secret using a list decoder $\psi : \mathcal{Z}^n \mapsto \{\mathcal{A} \subset L : |\mathcal{A}| = \lambda\}$, which is a *correspondence*. The decision region $\Psi : L \mapsto 2^{\mathcal{Z}^n}$ satisfies

$$(2) \quad l \in \psi(\mathbf{z}) \iff \mathbf{z} \in \Psi(l)$$

The triple (f, ϕ_b, ϕ_e) will be called an $(n$ -block) *wiretap channel code*, while the list decoder ψ will be called the *list decoding attack* (with deterministic list size). The quadruple $(f, \phi_b, \phi_e, \psi)$ will be called an $(n$ -block) *transmission (model)* for the wiretap channel.

B. Achievable rate and exponent triples

The performance of a wiretap channel code with respect to a list decoding attack is evaluated based on the following fault events.

Definition III.1 (Fault events). Let $\mathcal{E}_b(m, l)$, $\mathcal{E}_e(m, l)$ and $\mathcal{S}_e(m, l)$ be the fault events that Bob decodes (m, l) wrong, Eve decodes m wrong, and Eve successfully guesses l respectively when (m, l) is the public and private message pair. i.e.

$$\begin{aligned} \mathcal{E}_b(m, l) &:= \{\phi_b(W_b^n(f(m, l))) \neq (m, l)\} \\ \mathcal{E}_e(m, l) &:= \{\phi_e(W_e^n(f(m, l))) \neq m\} \\ \mathcal{S}_e(m, l) &:= \{l \in \psi(W_e^n(f(m, l)))\} \end{aligned}$$

The corresponding (*average*) *fault probabilities* (over the message set $M \times L$), e_b , e_e and s_e can be computed as follows.

$$(3a) \quad e_b = \text{Avg}_{m \in M, l \in L} \sum_{\mathbf{x} \in \mathcal{X}^n} W_b^n(\Phi_b^c(m, l)|\mathbf{x}) f(\mathbf{x}|m, l)$$

$$(3b) \quad e_e = \text{Avg}_{m \in M, l \in L} \sum_{\mathbf{x} \in \mathcal{X}^n} W_e^n(\Phi_e^c(m)|\mathbf{x}) f(\mathbf{x}|m, l)$$

$$(3c) \quad s_e = \text{Avg}_{m \in M, l \in L} \sum_{\mathbf{x} \in \mathcal{X}^n} W_e^n(\Psi(l)|\mathbf{x}) f(\mathbf{x}|m, l)$$

where $\Phi_b^c(m, l)$ and $\Phi_e^c(m)$ are the complements of the $\Phi_b(m, l)$ and $\Phi_e(m)$ respectively; and $\text{Avg}_{m \in M, l \in L}$ denotes $\frac{1}{ML} \sum_{m \in M, l \in L}$. When there is ambiguity, we will write $e_b(f, \phi_b, W_b)$ etc. to explicitly state its dependencies.

We study the asymptotic properties when the sizes M and L of the message sets and λ of Eve's guessing list grow exponentially while the fault probabilities decay exponentially in n . The exponential rates are defined as follows.

Definition III.2. Consider a sequence of n -block transmissions $(f^{(n)}, \phi_b^{(n)}, \phi_e^{(n)}, \psi^{(n)})$ ($n \in \mathbb{Z}^+$) over the wiretap channel (W_b, W_e) , the *public message rate* R_M , *private message rate* R_L and the *guessing rate* R_λ are defined as,

$$(4a) \quad R_M := \liminf_{n \rightarrow \infty} \frac{1}{n} \log M^{(n)}$$

$$(4b) \quad R_L := \liminf_{n \rightarrow \infty} \frac{1}{n} \log L^{(n)}$$

$$(4c) \quad R_\lambda := \limsup_{n \rightarrow \infty} \frac{1}{n} \log \lambda^{(n)}$$

The exponents of the fault probabilities (3) are defined as,

$$(5a) \quad E_b := \liminf_{n \rightarrow \infty} -\frac{1}{n} \log e_b^{(n)}$$

$$(5b) \quad E_e := \liminf_{n \rightarrow \infty} -\frac{1}{n} \log e_e^{(n)}$$

$$(5c) \quad S_e := \liminf_{n \rightarrow \infty} -\frac{1}{n} \log s_e^{(n)}$$

where $e_b^{(n)}$ and alike denotes e_b evaluated with respect to the n -block transmission. For simplicity, the superscript (n) will be omitted hereafter if there is no ambiguity.

In the *code design phase* prior to the transmission phase, Alice chooses (f, ϕ_b, ϕ_e) without knowledge of ψ and then Eve chooses ψ knowing Alice's choice. In particular, Eve chooses ψ to minimize S_e so that her success probability $s_e^{(n)}$ decays to zero as slowly as possible, while Alice chooses (f, ϕ_b, ϕ_e) to make E_b , E_e and S_e large so that the error probabilities $e_b^{(n)}$ and $e_e^{(n)}$ decay to zero fast for reliability, and the probability $s_e^{(n)}$ of successful attack by Eve decays to zero fast for secrecy. The *tradeoff between secrecy and reliability* for Alice can be expressed in terms of the set of achievable rate and exponent triples defined as follows.

Definition III.3 (Achievable rate and exponent triples). The rate triple $(R_1, R_2, R_3) \in \mathbb{R}_+^3$, where $\mathbb{R}_+ := \{a \in \mathbb{R} : a \geq 0\}$, is *achievable* if there exists a sequence of wiretap channel codes (f, ϕ_b, ϕ_e) with rates,

$$R_M \geq R_1 \quad \text{and} \quad R_L \geq R_2$$

such that for *any sequence* of list decoding attack ψ with guessing rate $R_\lambda \leq R_3$, the probabilities e_b , e_e and s_e converge to zero as $n \rightarrow \infty$.

The exponent triple $(E_1, E_2, E_3) \in \mathbb{R}_+^3$ is *achievable* with respect to the rate triple if in addition that,

$$E_b \geq E_1 \quad \text{and} \quad E_e \geq E_2 \quad \text{and} \quad S_e \geq E_3$$

If the achievable exponents are strictly positive, the rate triple is said to be *strongly achievable*.

In the sequel, we will obtain an inner bound to the set of achievable exponent triples in the form of parameterized single-letter lower bounds, one for each exponent.³ From this, an inner bound to the set of strongly achievable rate triples will be obtained, which contains the achievable region in Theorem 1 of [2] when the guessing rate is treated as equivocation rate.

³In response to the question of using average instead of maximum error probabilities (over the message set), we would like to point out that the particular inner bound to be derived also holds when e_b and e_e are defined as the corresponding maximum error probabilities and s_e as the average success probability. It follows from the usual argument of successively expurgating worst half of the codewords as in [6], which turns out to preserve the desired *overlap property* of the code and hence the bound for the success exponent. (see Section V) If one defined s_e as the maximum probability however, the problem becomes degenerate since there is an obvious strategy for Eve to achieve $s_e = 1$.

IV. CODING SCHEME

The coding scheme (i.e. the specification of the sequence of wiretap channel codes (f, ϕ_b, ϕ_e) , see Fig. 3) considered here is a merge of the schemes in [2] and [6] using the *method of types* developed by Csiszár[3]. We will describe each key component of the code in succession and explain how each of them simplifies the analysis of the fault events (see Definition III.1).

A. Constant composition code

As a first step, output of the stochastic encoder is restricted to *constant composition code*[3] defined as follows. Let $N(x|\mathbf{x})$ denote the number of occurrences of symbol $x \in \mathcal{X}$ in the n -sequence $\mathbf{x} \in \mathcal{X}^n$. The *type* or *empirical distribution* $P_{\mathbf{x}}$ of \mathbf{x} is defined as the probability mass function,

$$(6) \quad P_{\mathbf{x}}(x) = \frac{N(x|\mathbf{x})}{n} \quad \forall x \in \mathcal{X}$$

Let $\mathcal{P}_n(\mathcal{X}) := \{P_{\mathbf{x}} : \mathbf{x} \in \mathcal{X}^n\}$ denote the set of all possible types of an n -sequence in \mathcal{X}^n . The type class $T_Q^{(n)} := \{\mathbf{x} : P_{\mathbf{x}} = Q\}$ or T_Q for short denotes the set of all n -sequences \mathbf{x} having type $Q \in \mathcal{P}_n(\mathcal{X})$. An *n -block constant composition code* θ on \mathcal{X} is an ordered tuple of codewords all from the same type class on \mathcal{X} . i.e. $\exists Q \in \mathcal{P}_n(\mathcal{X}), \theta \subset T_Q$.

Suppose θ is the constant composition code of type Q for the stochastic encoder f . Then, $f(\mathbf{x}|m, l) = 0$ for all $\mathbf{x} \notin \theta$. From (3a),

$$(7) \quad e_b = \text{Avg}_{m \in M, l \in L} \sum_{c \in \theta} W_b^n(\Phi_b^c(m, l)|c) f(c|m, l)$$

and similarly for other probabilities in (3). To further simplify the expressions, define the *canonical conditional type* $P_{\mathbf{y}|\mathbf{x}}$ of \mathbf{y} given \mathbf{x} as,

$$(8) \quad P_{\mathbf{y}|\mathbf{x}}(y|x) := \begin{cases} 1/|\mathcal{Y}| & , N(x|\mathbf{x}) = 0 \\ \frac{N(x, y|\mathbf{x}, \mathbf{y})}{N(x|\mathbf{x})} & , \text{otherwise} \end{cases}$$

for all $x \in \mathcal{X}, y \in \mathcal{Y}$, where $N(x, y|\mathbf{x}, \mathbf{y})$ is the number of occurrences of the pair (x, y) in the n -sequence $\{(x^{(i)}, y^{(i)})\}_{i=1}^n$ of pairs. The canonical conditional type of \mathbf{y} given \mathbf{x} exists and is unique by definition.⁴ However, with a canonical conditional type V given \mathbf{x} specified, there can be more than one \mathbf{y} satisfying it.⁵ If $V : \mathcal{X} \mapsto \mathcal{Y}$ is the conditional type of \mathbf{y} given \mathbf{x} , \mathbf{y} is said to lie in $T_V(\mathbf{x})$, referred to as the *V -shell* of \mathbf{x} or the *conditional type class* of V given \mathbf{x} . In other words, $T_V(\mathbf{x})$ is the set of all $\mathbf{y} \in \mathcal{Y}^n$ with conditional type V given \mathbf{x} .

Writing $W_b^n(\mathbf{y}|c)$ as the product $\prod_{x,y} W_b(y|x)^{N(x,y|c,\mathbf{y})}$, Lemma 1.2.6 of [3] gives, for all $\mathbf{y} \in T_V(c)$,

$$(9a) \quad W_b^n(\mathbf{y}|c) = \exp \{-n[D(V||W_b|Q) + H(V|Q)]\}$$

$$(9b) \quad = \frac{W_b^n(T_V(c)|c)}{|T_V(c)|} \quad \because (9a) \text{ is uniform}$$

⁴ This is a minor modification of the conditional type defined in Definition 1.2.4 of [3], according to which \mathbf{y} may have a continuum of conditional types V given \mathbf{x} since $V(y|x)$ can be arbitrary when $N(x|\mathbf{x}) = 0$.

⁵For example, the binary sequences 1100 and 0011 have the same canonical conditional type given 1111, i.e. $[\cdot 5 \quad \cdot 5]$. Similarly, 1111 has the same canonical conditional type whether it is given 1100 or 0011, i.e. $[0 \quad 1]$.

where the *conditional information divergence* $D(V\|W_b|Q)$ and *conditional entropy* $H(V|Q)$ are defined as,

$$(10) \quad D(V\|W|Q) := \sum_{(x,y) \in \mathcal{X} \times \mathcal{Y}} Q(x)V(y|x) \ln \frac{V(y|x)}{W(y|x)}$$

$$(11) \quad H(V|Q) := \sum_{(x,y) \in \mathcal{X} \times \mathcal{Y}} Q(x)V(y|x) \ln \frac{1}{V(y|x)}$$

The key implication is that $W_b^n(\mathbf{y}|\mathbf{c})$ depends on \mathbf{y} only through the conditional type $P_{\mathbf{y}|\mathbf{c}}$ and channel output $W_b^n(\mathbf{c})$ is uniformly distributed within every V -shell $T_V(\mathbf{c})$.

Let $\mathcal{V}_n(Q, \mathcal{Y}) := \{P_{\mathbf{y}|\mathbf{x}} : \mathbf{x} \in T_Q, \mathbf{y} \in \mathcal{Y}^n\}$ ($\mathcal{V}_n(Q)$ or \mathcal{V}_n for short) be the set of all possible canonical conditional types of \mathbf{y} given \mathbf{c} . This set depends on \mathbf{c} only through the type Q of \mathbf{c} .⁶ $\{T_V(\mathbf{c}) : V \in \mathcal{V}_n(Q)\}$ is a partitioning of \mathcal{Y}^n for every $\mathbf{c} \in \theta$ because every \mathbf{y} has a unique canonical conditional type given \mathbf{c} . We can therefore partition the probabilities by $\mathcal{V}_n(Q)$ as follows. From (7),

$$\begin{aligned} e_b &= \text{Avg}_{m,l} \sum_{\mathbf{c} \in \theta} \sum_{V \in \mathcal{V}_n} W_b^n(\Phi_b^c(m,l) \cap T_V(\mathbf{c})|\mathbf{c}) f(\mathbf{c}|m,l) \\ &= \sum_{V \in \mathcal{V}_n} \sum_{\mathbf{c} \in \theta} W_b^n(T_V(\mathbf{c})|\mathbf{c}) \text{Avg}_{m,l} \frac{|\Phi_b^c(m,l) \cap T_V(\mathbf{c})|}{|T_V(\mathbf{c})|} f(\mathbf{c}|m,l) \end{aligned}$$

where the last equality is due to the piecewise uniform distribution of the channel output $W_b^n(\mathbf{c})$ implied by (9). By Lemma 1.2.6 of [3],⁷

$$(12) \quad W_b^n(T_V(\mathbf{c})|\mathbf{c}) \leq \exp\{-nD(V\|W_b|Q)\}$$

Thus, e_b can be upper bounded as,

$$(13) \quad e_b \leq \sum_{V \in \mathcal{V}_n(Q)} \exp\{-nD(V\|W_b|Q)\} \times \sum_{\mathbf{c} \in \theta} \sum_{m \in M, l \in L} \text{Avg} \frac{|\Phi_b^c(m,l) \cap T_V(\mathbf{c})|}{|T_V(\mathbf{c})|} f(\mathbf{c}|m,l)$$

B. Transmission of junk data and prefix DMC

In the previous section, the use of constant composition code simplifies the probability (3a) to (13) and similarly for other probabilities in (3). In this section, we shall specify the structure of the stochastic encoder f and its uniform randomization over junk data as follows.

Consider indexing the codewords in θ as \mathbf{c}_{jlm} by $j \in J$, $l \in L$ and $m \in M$. i.e.

$$(14) \quad \theta := \{\mathbf{c}_{jlm}\}_{j \in J, l \in L, m \in M}$$

Set $f(m,l) = \mathbf{c}_{Jlm}$ where the junk data J is a random variable Alice chooses uniformly randomly from $\{1, \dots, J\}$.

⁶For example, if $\mathbf{y} = 011$ is in the V -shell of $\mathbf{c} = 011$, then permutation $\mathbf{y}' = 110$ of \mathbf{y} is in the V -shell of the same permutation $\mathbf{c}' = 110$ of \mathbf{c} . In general, if V is a canonical type of some sequence $\mathbf{y} \in \mathcal{Y}^n$ given $\mathbf{c} \in \theta$ then the V -shell of another codeword $\mathbf{c}' \in \theta$ must contain a sequence $\mathbf{y}' \in \mathcal{Y}^n$, namely the sequence obtained from \mathbf{y} by the same permutation of $\mathbf{c} \in \theta$ to $\mathbf{c}' \in \theta$. Thus, the set of all possible canonical conditional types are the same if the conditioning sequences have the same type.

⁷The key step in the derivation is that $V^n(T_V(\mathbf{c})|\mathbf{c}) \leq 1$ implies $|T_V(\mathbf{c})| \leq \exp\{nH(V|Q)\}$ by (9) with W_b replaced by V .

The conditional probability f is,

$$(15) \quad f(\mathbf{c}|m,l) = \begin{cases} \frac{1}{J} & , \text{ if } \mathbf{c} \in \{\mathbf{c}_{jlm} : j \in J\} \\ 0 & , \text{ otherwise} \end{cases}$$

This approach of providing secrecy, illustrated in Example A.2 in the Appendix, will be called *transmission of (uniformly random) junk data* because J is not meant to be a message although it is encoded like one.⁸ Substituting this into the upper bound of e_b in (13) and similarly for the other fault probabilities gives the following expressions.

Lemma IV.1 (Constant composition code, transmission of junk data). *Using n -block constant composition code θ in (14) of type $Q \in \mathcal{P}(\mathcal{X})$ and the transmission of junk data approach (15), the probabilities in (3) can be upper bounded as follows,*

$$(16a) \quad e_b \leq \sum_{V \in \mathcal{V}_n(Q)} \exp\{-nD(V\|W_b|Q)\} \text{Avg}_{j,l,m} \frac{|\Phi_b^c(m,l) \cap T_V(\mathbf{c}_{jlm})|}{|T_V(\mathbf{c}_{jlm})|}$$

$$(16b) \quad e_e \leq \sum_{V \in \mathcal{V}_n(Q)} \exp\{-nD(V\|W_e|Q)\} \text{Avg}_{j,l,m} \frac{|\Phi_e^c(m) \cap T_V(\mathbf{c}_{jlm})|}{|T_V(\mathbf{c}_{jlm})|}$$

$$(16c) \quad s_e \leq \sum_{V \in \mathcal{V}_n(Q)} \exp\{-nD(V\|W_e|Q)\} \text{Avg}_{j,l,m} \frac{|\Psi(l) \cap T_V(\mathbf{c}_{jlm})|}{|T_V(\mathbf{c}_{jlm})|}$$

where $\text{Avg}_{j,l,m}$ is over $j \in J$, $l \in L$ and $m \in M$.

Note that the randomization in the encoder is equivalent to the averaging over the message augmented with junk data.

Another approach of randomization introduced in [2] is the *prefix discrete memoryless channel (prefix DMC)*, which is characterized by the conditional probability distribution $\tilde{V} \in \mathcal{P}(\mathcal{X})^{\tilde{\mathcal{X}}}$ from some finite set $\tilde{\mathcal{X}}$. The stochastic encoder first maps (m,l) into an n -sequence in $\tilde{\mathcal{X}}^n$, which is then fed through the extended prefix DMC \tilde{V}^n before being transmitted through the channel. To combine this with the transmission of junk data approach, let \tilde{f} be the original stochastic encoder defined in (15) except that \mathcal{X} is replaced by $\tilde{\mathcal{X}}$, and θ is a constant composition code with type Q on \mathcal{X} . Then, the new encoder is,

$$f(\mathbf{x}|m,l) := \sum_{\mathbf{c} \in \theta} \tilde{V}^n(\mathbf{x}|\mathbf{c}) \tilde{f}(\mathbf{c}|m,l) \quad \forall m \in M, l \in L, \mathbf{x} \in \mathcal{X}^n$$

This is illustrated in Fig. 4(a).

The prefix DMC can be viewed as part of the wiretap channel instead of the encoder as in Fig. 4(b) because the wiretap channel (W_b, W_e) prefixed with any discrete memoryless channel \tilde{V} is just another wiretap channel $(\tilde{V}W_b, \tilde{V}W_e)$, where the product $\tilde{V}W_b$ is the matrix multiplication. Thus, any performance metric, say $e(W_b, W_e)$, that one obtains without prefix discrete memoryless channel can be converted to the performance metric with prefixing discrete memoryless channel as $e(\tilde{V}W_b, \tilde{V}W_e)$.

Because of this simplicity in extending any performance metrics with prefix DMC, we will *leave this prefixing procedure to the very end and use the encoder defined in (15)*

⁸It turns out that J can also be reliably decoded by Bob with lower level of secrecy. Thus, one may choose J to be meaningful private data to achieve a new notion of *unequal security protection*. However, it suffices for our case of interest to treat J as meaningless.

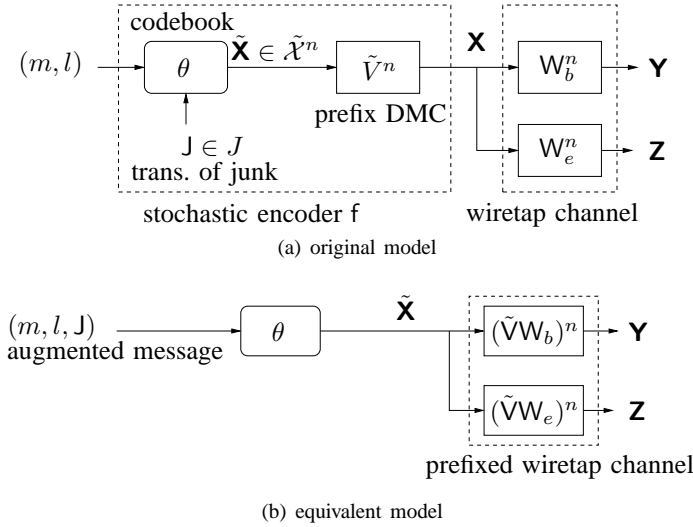

Fig. 4. Stochastic encoding with transmission of junk data and prefix DMC

for the main analysis. For a simple comparison between the prefix DMC and transmission of junk data approach, readers can refer to Example A.2 and A.3 in the Appendix.

C. Random code construction and MMI decoding

As a summary, encoder f encodes the public and private messages m and respectively l , and the junk data J into a codeword \mathbf{c}_{jlm} in the constant composition code θ of type Q . The codeword is then transmitted through the wiretap channel (W_b, W_e) , to which a prefix a DMC $\{\tilde{V}\}$ will be added in the end. The fault probabilities simplify to (16), with (W_b, W_e) replaced by $(\tilde{V}W_b, \tilde{V}W_e)$ for the prefix DMC. It remains to specify how the codebook θ and decoders (ϕ_b, ϕ_e) should be constructed.

Csiszár and Körner[2] consider maximal code construction with typical set decoding for the wiretap channel. This cannot be used here since typical set decoding fails to give exponential decay rate for the error probabilities. We will adopt the *random code construction scheme with maximum mutual information (MMI) decoding* in [6] instead.

As a preliminary for the random code construction, some finite set \mathcal{U} is chosen. The wiretap channel is *trivially extended* with an additional input symbol from \mathcal{U} to $(W_b \in \mathcal{P}(\mathcal{Y})^{\mathcal{U} \times \mathcal{X}}, W_e \in \mathcal{P}(\mathcal{Z})^{\mathcal{U} \times \mathcal{X}})$, where

$$(17) \quad \begin{aligned} W_b(y|u, x) &:= W_b(y|x) \\ W_e(y|u, x) &:= W_e(y|x) \end{aligned}$$

for all $(u, x) \in \mathcal{U} \times \mathcal{X}$. In the form of the stochastic transition function, $W_b(u, x) := W_b(x)$ and $W_e(u, x) := W_e(x)$, which means that the extended channel simply ignores the additional input symbol. Thus, this trivial extension is purely conceptual and does not change the original problem.

As the first step in the random code construction, a type $Q_0 \in \mathcal{P}_n(\mathcal{U})$ on \mathcal{U} is chosen for the constraint length n . Then, each of the set $\Theta_0 := \{\mathbf{U}_m\}_{m \in M}$ of n -sequences is uniformly randomly and independently (u.i.) chosen from the

type class T_{Q_0} . i.e.

$$P_{\mathbf{U}_m}(\mathbf{u}) = \begin{cases} \frac{1}{|T_{Q_0}|} & , \mathbf{u} \in T_{Q_0} \\ 0 & , \text{otherwise} \end{cases} \quad \forall m \in M$$

Next, a conditional type $Q_1 (\in \mathcal{V}_n(Q_0, \mathcal{X}))$ is chosen. For each \mathbf{U}_m generated, consider its Q_1 -shell $T_{Q_1}(\mathbf{U}_m)$. Each of the set $\Theta_1(m) := \{\mathbf{X}_{jlm}\}_{j \in J, l \in L}$ of n -sequences is chosen u.i. from $T_{Q_1}(\mathbf{U}_m)$. i.e.

$$P_{\mathbf{X}_{jlm}|\mathbf{U}_m}(\mathbf{x}|\mathbf{u}) = \begin{cases} \frac{1}{|T_{Q_1}(\mathbf{u})|} & , \mathbf{x} \in T_{Q_1}(\mathbf{u}) \\ 0 & , \text{otherwise} \end{cases}$$

for all $(j, l, m) \in J \times L \times M, \mathbf{u} \in T_{Q_0}$.

Finally, $\mathbf{U}_m := \{\mathbf{U}_m^{(i)}\}_{i=1}^n$ and $\mathbf{X}_{jlm} := \{\mathbf{X}_{jlm}^{(i)}\}_{i=1}^n$ are combined into one codeword $\mathbf{C}_{jlm} := \mathbf{U}_m \circ \mathbf{X}_{jlm}$, where \circ denotes the element-wise concatenation. i.e.

$$(18) \quad \mathbf{U}_m \circ \mathbf{X}_{jlm} = \{(\mathbf{U}_m^{(i)}, \mathbf{X}_{jlm}^{(i)})\}_{i=1}^n$$

The i -th term $\mathbf{C}_{jlm}^{(i)} := (\mathbf{U}_m^{(i)}, \mathbf{X}_{jlm}^{(i)})$ is transmitted in the i -th use of the (extended) wiretap channel. The random code Θ is defined as the ordered structure $\{\mathbf{C}_{jlm}\}_{j \in J, l \in L, m \in M}$. Its type is denoted as $Q \in \mathcal{P}_n(\mathcal{U}, \mathcal{X})$ where $Q(u, x) := Q_0(u)Q_1(x|u)$ ($(u, x) \in \mathcal{U} \times \mathcal{X}$). We write $Q = Q_0 \circ Q_1$ where \circ denotes the direct product.

Definition IV.1 (Random code). The random code Θ of type $Q := Q_0 \circ Q_1$ ($Q_0 \in \mathcal{P}_n(\mathcal{U}), Q_1 \in \mathcal{V}_n(Q_0, \mathcal{X})$) for the extended wiretap channel (17) is defined as follows,

$$\begin{aligned} \Theta &:= \{\mathbf{C}_{jlm}\}_{jlm} \\ \mathbf{C}_{jlm} &:= \mathbf{U}_m \circ \mathbf{X}_{jlm} \\ \Theta_0 &:= \{\mathbf{U}_m\}_m \xleftarrow{\text{u.i.}} T_{Q_0} \\ \Theta_1(m) &:= \{\mathbf{X}_{jlm}\}_{jlm} \xleftarrow{\text{u.i.}} T_{Q_1}(\mathbf{U}_m) \end{aligned}$$

In words, it is the set of codewords \mathbf{C}_{jlm} indexed by the messages $j \in J, l \in L$ and $m \in M$. Each codeword consists of an n -sequence \mathbf{U}_m that belong to the random codebook Θ_0 , and an n -sequence \mathbf{X}_{jlm} that belongs to the random codebook $\Theta_1(m)$. The codewords from Θ_0 are selected u.i. from the type class T_{Q_0} and the codewords from $\Theta_1(m)$ are selected u.i. from the Q_1 -shell $T_{Q_1}(\mathbf{U}_m)$ of \mathbf{U}_m .

This approach of random code construction is well-known in the asymmetric broadcasting channel setting. Θ_0 is used to partition \mathcal{X}^n into cells/clouds $\{T_{Q_1}(\mathbf{U}_m)\}_m$ that are intended to be well distinguishable through the channels of both Bob and Eve, and $\Theta_1(m)$ are the set of codewords selected from the containing cell that are intended to be well distinguishable by Bob but not necessarily so by Eve. The addition of input symbol from \mathcal{U} gives an additional degree of freedom in optimizing the average performance of the code.

It is important to note that, unlike the randomness in the stochastic encoding, the randomness in the codebook is known to all parties (Alice, Bob and Eve). The randomization happens in the code design phase before the public and private messages are generated for the transmission phase.

With the structure of the codebook defined, we can now complete the specification of the coding scheme with the

maximum mutual information (MMI) decoder for Bob and Eve. Consider a particular realization θ of the random code Θ . Let $I(Q, V)$ denote the mutual information,

$$(19) \quad I(Q, V) := H(Q) - H(V|Q) \quad \text{see (11)}$$

Then, $I(\mathbf{c} \wedge \mathbf{y})$, referred to as the empirical mutual information between \mathbf{x} and \mathbf{y} , are defined as,

$$(20) \quad I(\mathbf{x} \wedge \mathbf{y}) := I(P_{\mathbf{x}}, P_{\mathbf{y}|\mathbf{x}}) \quad \text{see (19),(6),(8)}$$

Suppose Bob observes $\mathbf{y} \in \mathcal{Y}^n$ through his channel. He searches for the codeword $\mathbf{c} \in \theta$ that maximizes the empirical mutual information $I(\mathbf{c} \wedge \mathbf{y})$.⁹ If there is a unique \mathbf{c}_{jlm} that achieves the maximum, he declares m as the public message and l as the private message. More precisely,

$$(21) \quad \phi_b(\mathbf{y}) = (m, l) \iff \exists!(m, l, j), I(\mathbf{c}_{jlm} \wedge \mathbf{y}) = \max_{\mathbf{c} \in \theta} I(\mathbf{c} \wedge \mathbf{y})$$

Similarly, suppose Eve receives \mathbf{z} . She searches for the unique \mathbf{u}_m that achieves the maximum $\max_{\mathbf{u} \in \theta_0} I(\mathbf{u} \wedge \mathbf{z})$.¹⁰ i.e.

$$(22) \quad \phi_e(\mathbf{z}) = m \iff \exists!m, I(\mathbf{u}_m \wedge \mathbf{z}) = \max_{\mathbf{u} \in \theta_0} I(\mathbf{u} \wedge \mathbf{z})$$

We will not need to assume any structure for ψ other than the fact it has to be a deterministic list decoder with fixed list size λ .¹¹ The coding scheme without prefix DMC can now be summarized as follows.

Definition IV.2 (Coding scheme). The coding scheme *without* prefix DMC for a realization θ of the random code in Definition IV.1 is defined as follows.

Encoding: Alice generates the junk data J uniformly randomly from $\{1, \dots, J\}$ and encodes the common message $m \in M$ and secret $l \in L$ into $(\mathbf{u}_m, \mathbf{x}_{Jlm}) \in \theta$. She only transmits \mathbf{x}_{Jlm} through the channel. The encoding function is therefore,

$$f(\mathbf{x}|m, l) := \begin{cases} \frac{1}{J} & \mathbf{x} \in \{\mathbf{x}_{jlm}\}_{j \in J} \\ 0 & \text{, otherwise} \end{cases}, \text{ or equivalently} \\ f(m, l) := \mathbf{x}_{Jlm} \in \theta_1(m), \forall m \in M, l \in L$$

Decoding: If Bob receives \mathbf{y} , he finds a codeword $\mathbf{c} \in \theta$ that maximizes the empirical mutual information $I(\mathbf{c} \wedge \mathbf{y})$ and use its location in θ to decode (m, l) . The decoding function can be defined as,

$$\phi_b(\mathbf{y}) = (m, l) \iff \exists!(m, l, j), I(\mathbf{c}_{jlm} \wedge \mathbf{y}) = \max_{\mathbf{c} \in \theta} I(\mathbf{c} \wedge \mathbf{y})$$

Similarly, Eve locates the mutual information maximizing codeword in θ_0 to decode m as follows,

$$\phi_e(\mathbf{z}) = m \iff \exists!m, I(\mathbf{u}_m \wedge \mathbf{z}) = \max_{\mathbf{u} \in \theta_0} I(\mathbf{u} \wedge \mathbf{z})$$

⁹Note that the optimal decoding rule is the maximum likelihood decoding instead. MMI decoding is adopted here for simplicity.

¹⁰One may think that Eve can search for the unique \mathbf{c}_{jlm} that achieves the maximum $\max_{\mathbf{c} \in \theta} I(\mathbf{c} \wedge \mathbf{z})$, and declare m as the public message. Because of the suboptimality of the MMI decoding and the random code construction, this choice turns out to be unfavorable.

¹¹It is clear, however, that the optimal ψ is an extension of the maximum likelihood decoding rule with λ estimates instead of one.

The encoder and decoders are functions of the codebook θ , i.e. $f[\theta](m, l|c)$, $\phi_b[\theta](\mathbf{y})$ and $\Phi_b[\theta](z; \theta)$ etc.. However, for notational simplicity, the dependence on θ will be omitted.

Using the random coding scheme, we can further bound the fault probabilities (16) with the expected fault probabilities over the random code ensemble as follows. From (16a), the expectation of e_b over the random code Θ is,

$$\begin{aligned} E(e_b(\Theta)) &\leq \sum_{V \in \mathcal{V}_n(Q)} \exp\{-nD(V||W_b|Q)\} \times \\ &\quad \times \mathbb{E} \left(\overbrace{\text{Avg}_{j \in J, l \in L, m \in M} \frac{|\Phi_b^c(m, l) \cap T_V(\mathbf{C}_{jlm})|}{|T_V(\mathbf{C}_{jlm})|}}^{\beta(V, \Theta, \Phi_b^c)} \right) \\ &\leq |\mathcal{V}_n(Q)| \max_{V \in \mathcal{V}_n(Q)} \exp\{-nD(V||W_b|Q)\} \beta(\Theta, \Phi_b^c) \\ &\leq (n+1)^{|\mathcal{X}||\mathcal{Y}|} \overbrace{\max_{V \in \mathcal{V}_n(Q)} \exp\{-nD(V||W_b|Q)\} \beta(\Theta, \Phi_b^c)}^{s(W_b, \Theta, \Phi_b^c)} \end{aligned}$$

where the last inequality is due to the *Type Counting Lemma* $|\mathcal{V}_n(Q)| \leq (n+1)^{|\mathcal{X}||\mathcal{Y}|}$.¹² The expectation of e_e and s_e can be upper bounded similarly. By the union bound,

$$\begin{aligned} \Pr\{e_b(\Theta) > 3E(e_b(\Theta)) \text{ or } e_e(\Theta) > 3E(e_e(\Theta)) \text{ or } s_e(\Theta) > 3E(s_e(\Theta))\} \\ \leq \Pr\{e_b(\Theta) > 3E(e_b(\Theta))\} + \Pr\{e_e(\Theta) > 3E(e_e(\Theta))\} \\ + \Pr\{s_e(\Theta) > 3E(s_e(\Theta))\} \end{aligned}$$

which is < 1 due to the Markov inequality $\Pr(A > \alpha E(A)) < 1/\alpha$ for non-negative random variable A and $\alpha > 0$. Thus, the complement of the event has positive probability, which implies existence of a realization θ of Θ such that the fault probabilities can be bounded simultaneously as follows,

$$(23a) \quad e_b(\theta) \leq 3(n+1)^{|\mathcal{X}||\mathcal{Y}|} s(W_b, \Theta, \Phi_b^c)$$

$$(23b) \quad e_e(\theta) \leq 3(n+1)^{|\mathcal{X}||\mathcal{Y}|} s(W_e, \Theta, \Phi_e^c)$$

$$(23c) \quad s_e(\theta) \leq 3(n+1)^{|\mathcal{X}||\mathcal{Y}|} s(W_e, \Theta, \Psi)$$

where s is defined as follows,

$$(24a) \quad \beta(V, \Theta, \Phi) := \mathbb{E} \left(\text{Avg}_{j \in J, l \in L, m \in M} \frac{|\Phi(m, l) \cap T_V(\mathbf{C}_{jlm})|}{|T_V(\mathbf{C}_{jlm})|} \right)$$

$$(24b) \quad s(W, \Theta, \Phi) := \max_{V \in \mathcal{V}_n(Q)} \exp\{-nD(V||W|Q)\} \beta(V, \Theta, \Phi)$$

and $\Phi_e(m, l) := \Phi_e(m)$, $\Psi(m, l) := \Psi(l)$ are the trivial extensions for all $(m, l) \in M \times L$.

To compute the desired exponents, we consider a sequence of random codes defined as follows.

Definition IV.3 (Sequence of random codes). $\{\Theta^{(n)}\}$ or simply Θ denotes a sequence of random codes $\Theta^{(n)}$ (see Definition IV.1) of type $Q^{(n)} = Q_0^{(n)} \circ Q_1^{(n)}$ ($Q_0^{(n)} \in \mathcal{P}_n(\mathcal{U}), Q_1^{(n)} \in \mathcal{V}_n(Q_0^{(n)}, \mathcal{X})$) that converges to distribution $Q = Q_0 \circ Q_1$ ($Q_0 \in \mathcal{P}(\mathcal{U}), Q_1 \in \mathcal{P}(\mathcal{X})^{\mathcal{U}}$) in variation distance. i.e. $\delta_{\text{var}}(Q^{(n)}, Q) \rightarrow 0$, where

$$(25) \quad \delta_{\text{var}}(P, Q) := \max_{A \subset \mathcal{X}} P(A) - Q(A)$$

¹²This follows from the definition (8) that there are at most $n+1$ possible values for each entry of a canonical conditional type. (see Type Counting Lemma 2.2 of [3].)

Furthermore, $J^{(n)}$ grows exponentially at the junk data rate

$$(26) \quad \lim_{n \rightarrow \infty} \frac{1}{n} \log J^{(n)} = R_J \geq 0$$

If one can find $\gamma_b(V, Q)$ continuous in $Q \circ V$ in variation distance such that,

$$\liminf_{n \rightarrow \infty} -\frac{1}{n} \log \beta(V, \Theta^{(n)}, (\Phi_b^{(n)})^c) \geq \gamma(V, Q)$$

then Bob's error exponent (5a) can be lower bounded as,

$$\begin{aligned} E_b(\theta) &= \liminf_{n \rightarrow \infty} -\frac{1}{n} \log s(V, \Theta^{(n)}, (\Phi_b^{(n)})^c) \\ &\geq \min_{V \in \mathcal{P}(\mathcal{Y})^{U \times X}} D(V \| W_b | Q) + \gamma_b(V, Q) \end{aligned}$$

and similarly for other exponents E_e and S_e in (5).

Lemma IV.2. *If $\gamma_b(V, Q)$, $\gamma_e(V, Q)$ and $\gamma(V, Q)$ are continuous in the joint distribution $Q \circ V$ (with respect to the variation distance (25)) and lower bound the exponent,*

$$\liminf_{n \rightarrow \infty} -\frac{1}{n} \log \beta(V, \Theta, \Phi)$$

for random code Θ and the cases Φ equal to Φ_b^c , Φ_e^c and S respectively, then there exists a realization θ of Θ such that

$$(27a) \quad E_b(\theta) \geq \min_{V \in \mathcal{P}(\mathcal{Y})^{U \times X}} D(V \| W_b | Q) + \gamma_b(V, Q)$$

$$(27b) \quad E_e(\theta) \geq \min_{V \in \mathcal{P}(\mathcal{Z})^{U \times X}} D(V \| W_e | Q) + \gamma_e(V, Q)$$

$$(27c) \quad S_e(\theta) \geq \min_{V \in \mathcal{P}(\mathcal{Z})^{U \times X}} D(V \| W_e | Q) + \gamma(V, Q)$$

In the sequel, we will compute γ_b , γ_e and γ to obtain the desired lower bounds of the exponents.

V. SUCCESS EXPONENT

From Lemma IV.2, to obtain a lower bound of the achievable¹³ success exponent S_e (5c), it suffices to compute a lower bound $\gamma(V)$ on the exponent of the expected average fraction $\beta(V, \Theta, \Psi)$ for any Ψ satisfying the guessing rate (4c).

Consider first some realization θ of the random code Θ in Definition IV.1.

$$\beta(V, \theta, \Psi) = \frac{1}{J |T_V(\mathbf{c}_{111})|} \text{Avg}_{l,m} \sum_{j \in J} |\Psi(l) \cap T_V(\mathbf{c}_{jlm})| \quad \text{by (24a)}$$

since $|T_V(\mathbf{c}_{jlm})|$ depends on \mathbf{c}_{jlm} only through its type Q (and n). The fraction can be made small if $\sum_j |\Psi(l) \cap T_V(\mathbf{c}_{jlm})|$ on the R.H.S. is made small for each l and m . Imagine $\Psi(l)$ as a net that Eve uses to cover the shells $\{T_V(\mathbf{c}_{jlm}) : j \in J\}$ owned by Alice as much as possible. Roughly speaking, since the net cannot be too large due to the list size constraint, Alice should spread out the shells as much as possible to minimize her loss. We will refer to this heuristically desired property of θ that the V -shells $\{T_V(\mathbf{c}_{jlm}) : j \in J\}$ spread out for every V , m and l as the *overlap property*.¹⁴ This is illustrated in Fig. 5, in which the configuration on the left has $\sum_{j=1}^3 |\Psi(1) \cap T_V(\mathbf{c}_{j11})|$ three times larger than the one on the right.

¹³Achievable here does *not* refer to achievable by Eve, but achievable by Alice as defined in Definition III.3.

¹⁴Though not explicitly stated, this notion of overlap property is also evident in [2] for the typical case when V is close to W_e . (See Lemma 2 of [2]) For the purpose of computing the exponent, we extend it to the atypical case of V and relax the extent that the shells have to spread out by allowing subexponential amount of overlap.

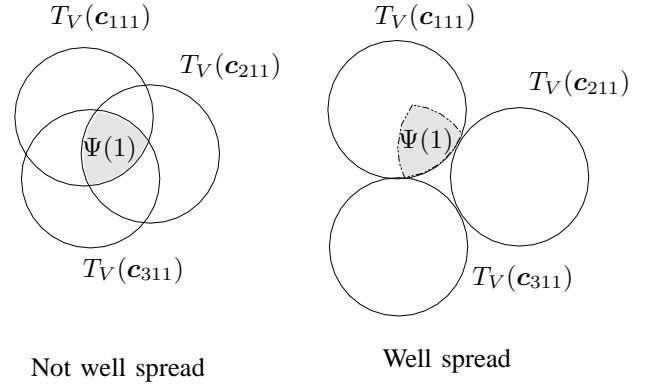

Fig. 5. Effectiveness of stochastic encoding

Intuitively, random code has the *overlap property* on average since it uniformly spaces out the codewords. This is made precise with the following *Overlap Lemma*.

Lemma V.1 (Overlap). *Let \mathbf{X}_j ($j = 1, \dots, J$) be an n -sequence uniformly and independently drawn from $T_Q^{(n)} \subset \mathcal{X}^n$. For all $J \in \mathbb{Z}^+$, $\delta > 0$, $n \geq n_0(\delta, |\mathcal{X}| |\mathcal{Z}|)$, $\mathbf{z} \in \mathcal{Z}^n$, $Q \in \mathcal{P}_n(\mathcal{X})$, $V \in \mathcal{V}_n(Q, \mathcal{Z})$ such that $\lfloor \exp\{nI(Q, V)\} \rfloor \geq J$, we have,*

$$\Pr \left\{ \sum_{j \in J} \mathbb{1}\{\mathbf{z} \in T_V(\mathbf{X}_j)\} \geq \exp(n\delta) \right\} \leq \exp(-\exp(n\delta))$$

where $\mathbb{1}$ is the indicator function and n_0 is some integer-valued function that depends only on δ and $|\mathcal{X}| |\mathcal{Z}|$.

In words, the lemma states that the chance of having exponentially ($\exp(n\delta)$) many shells (from $\{T_V(\mathbf{X}_j) : j \in J\}$) overlapping at a spot (\mathbf{z}) is doubly exponentially decaying ($\exp(-\exp(n\delta))$), provided that the shells are not enough to fill the entire space ($T_{QV} \subset \mathcal{Z}^n$) they can possibly reside. (i.e. $J \leq \lfloor \exp\{nI(Q, V)\} \rfloor$) For the case of interest, we will prove the following more general form of the lemma with conditioning.

Lemma V.2 (Overlap (with conditioning)). *Let $Q := Q_0 \circ Q_1$ ($Q_0 \in \mathcal{P}_n(\mathcal{U})$, $Q_1 \in \mathcal{V}_n(Q_0, \mathcal{X})$) be a joint type, \mathbf{U} be a random variable distributed over T_{Q_0} , and \mathbf{X}_j ($j = 1, \dots, J$) be an n -sequence uniformly and independently drawn from $T_{Q_1}(\mathbf{U}) \subset \mathcal{X}^n$. For all $J \in \mathbb{Z}^+$, $\delta > 0$, $n \geq n_0(\delta, |\mathcal{U}| |\mathcal{X}|)$, $\mathbf{z} \in \mathcal{Z}^n$, $Q := Q_0 \circ Q_1$, $V \in \mathcal{V}_n(Q, \mathcal{Z})$ such that $\lfloor \exp\{nI(Q_1, V | Q_0)\} \rfloor \geq J$, we have,*

$$(28) \quad \Pr \left\{ \sum_{j \in J} \mathbb{1}\{\mathbf{z} \in T_V(\mathbf{U} \circ \mathbf{X}_j)\} \geq \exp(n\delta) \right\} \leq \exp\{-\exp(n\delta)\}$$

where \circ denotes element-wise concatenation (18), and

$$(29) \quad \begin{aligned} I(Q_1, V | Q_0) &:= H(Q_1 | Q_0) - H(V | Q_0 \circ Q_1) \\ &= H(Q_1 | Q_0) - H(V | Q) \end{aligned}$$

denotes the conditional mutual information. (cf. (19))

Proof: For notational simplicity, consider the case when $\exp(n\delta)$ and $\exp\{nI(Q_1, V|Q_0)\}$ are integers.¹⁵ Consider some subset \mathcal{J} of $\{1, \dots, J\}$ with $|\mathcal{J}| = \exp(n\delta)$. Since the events $\mathbf{z} \in T_V(\mathbf{U} \circ \mathbf{X}_j)$ ($j = 1, \dots, J$) are conditionally mutually independent given $\mathbf{U} = \mathbf{u} \in T_{Q_0}$,

$$\begin{aligned} \Pr \left\{ \mathbf{z} \in \bigcap_{j \in \mathcal{J}} T_V(\mathbf{U} \circ \mathbf{X}_j) \right\} &= \sum_{\mathbf{u} \in T_{Q_0}} P_{\mathbf{U}}(\mathbf{u}) \Pr \{ \mathbf{z} \in T_V(\mathbf{u} \circ \mathbf{X}_j) \}^{\exp(n\delta)} \\ &\leq \exp \left\{ -n \left[I(Q_1, V|Q_0) - \frac{\delta}{2} \right] \exp(n\delta) \right\} \end{aligned}$$

for $n \geq n'_0(\delta, |\mathcal{U}|, |\mathcal{X}|)$, where the last inequality is by Lemma A.1 using the uniform distribution of \mathbf{X}_j and Lemma 1.2.5 of [3] on the cardinality bounds of conditional type class. Since $\exp\{nI(Q_1, V|Q_0)\} \geq J$, the number of distinct choices of \mathcal{J} is,

$$\begin{aligned} \binom{J}{\exp(n\delta)} &\leq \binom{\exp(nI(Q_1, V|Q_0))}{\exp(n\delta)} \\ &\leq \exp \{ [\log e + n(I(Q_1, V|Q_0) - \delta)] \exp(n\delta) \} \end{aligned}$$

where the last inequality is by Lemma A.2. By the union bound, L.H.S. of (28) is upper bounded by the product of the last two expressions, i.e.

$$\binom{J}{\exp(n\delta)} \Pr \left\{ \mathbf{z} \in \bigcap_{j \in \mathcal{J}} T_V(\mathbf{U} \circ \mathbf{X}_j) \right\}$$

Substituting the previously derived bounds for each term gives the desired upper bound $\exp(-\exp(n\delta))$ when $n \geq n_0(\delta, |\mathcal{U}|, |\mathcal{X}|)$. ■

Consider now a sequence of random codes $\Theta^{(n)}$ defined in Definition IV.3. The desired bound on the exponent of $\beta(V, \Theta, \Psi)$ can be computed as follows using the Overlap Lemma.

Lemma V.3 (Success exponent). *Consider the random code sequence Θ defined in Definition IV.3. For any sequence of list decoding attack ψ satisfying the guessing rate R_λ (4c),*

$$\begin{aligned} \liminf_{n \rightarrow \infty} -\frac{1}{n} \log \beta(V, \Theta, \Psi) &\geq |R_L - R_\lambda + |R_J - I(Q_1, V|Q_0)|^-|^+ \end{aligned}$$

where $|a|^+ := \max\{0, a\}$ and $|a|^- := \min\{0, a\}$.

Proof: By the Overlap Lemma V.2, for any $\delta > 0$ and $n \geq n_0(\delta)$,

$$\Pr \left\{ \sum_{j \in \mathcal{J}_k(V)} \mathbb{1} \{ \mathbf{z} \in T_V(\mathbf{C}_{jlm}) \} \geq \exp(n\delta) \mid \Theta_0 = \theta_0 \right\} \leq \exp\{-\exp(n\delta)\}$$

where Θ_0 is the codebook $\{\mathbf{U}_m\}_{m \in M}$, θ_0 is an arbitrary realization, and $\{\mathcal{J}_k(V)\}_{k \in K_V}$ is a partitioning of $\{1, \dots, J\}$

¹⁵The case when $\exp(n\delta)$ and $I(Q_1, V|Q_0)$ are not integers can be derived by taking their ceilings or floors and grouping the fractional increments into some dominating terms.

defined as,

$$\begin{aligned} \mathcal{J}_k(V) &:= \{(k-1)J_V + 1, \dots, \min\{kJ_V, J\}\} \\ J_V &:= \lfloor \exp\{nI(Q_1, V|Q_0)\} \rfloor \\ K_V &:= \lceil J/J_V \rceil \end{aligned}$$

The expectation of the sum of indicators on the left can then be bounded as follows,

$$\begin{aligned} \mathbb{E} \left(\sum_{j \in \mathcal{J}_k(V)} \mathbb{1} \{ \mathbf{z} \in T_V(\mathbf{C}_{jlm}) \} \mid \Theta_0 = \theta_0 \right) &\leq \exp(n\delta) \cdot 1 + J \cdot \exp\{-\exp(n\delta)\} \\ &\leq \exp(n2\delta) \end{aligned}$$

where the last inequality is true for $n \geq n_0(\delta, R_J, |\mathcal{U}|, |\mathcal{X}|)$ by (26). Since $T_V(\mathbf{C}_{jlm})$ is contained by $T_{Q_1V}(\mathbf{U}_m)$,

$$\begin{aligned} \sum_{\mathbf{z} \in \Psi(l)} \mathbb{E} \left(\sum_{j \in \mathcal{J}_k(V)} \mathbb{1} \{ \mathbf{z} \in T_V(\mathbf{C}_{jlm}) \} \mid \Theta_0 = \theta_0 \right) &= \sum_{\mathbf{z} \in \Psi(l) \cap T_{Q_1V}(\mathbf{u}_m)} \mathbb{E} \left(\sum_{j \in \mathcal{J}_k(V)} \mathbb{1} \{ \mathbf{z} \in T_V(\mathbf{C}_{jlm}) \} \mid \Theta_0 = \theta_0 \right) \\ &\leq \exp(n2\delta) |\Psi(l) \cap T_{Q_1V}(\mathbf{u}_m)| \end{aligned}$$

By linearity of expectation,

$$\begin{aligned} \mathbb{E} \left(\sum_{j \in \mathcal{J}_k(V)} |\Psi(l) \cap T_V(\mathbf{C}_{jlm})| \mid \Theta_0 = \theta_0 \right) &\leq \exp(n2\delta) |\Psi(l) \cap T_{Q_1V}(\mathbf{u}_m)| \end{aligned}$$

Summing both sides over $k \in K_V$,

$$\begin{aligned} \mathbb{E} \left(\sum_{j \in J} |\Psi(l) \cap T_V(\mathbf{C}_{jlm})| \mid \Theta_0 = \theta_0 \right) &\leq \exp(n2\delta) K_V |\Psi(l) \cap T_{Q_1V}(\mathbf{u}_m)| \end{aligned}$$

Summing both sides over $l \in L$ and applying the list size constraint on Ψ in Lemma A.3 to the R.H.S.,

$$\begin{aligned} \mathbb{E} \left(\sum_{j \in J, l \in L} |\Psi(l) \cap T_V(\mathbf{C}_{jlm})| \mid \Theta_0 = \theta_0 \right) &\leq \exp(n2\delta) K_V \lambda |T_{Q_1V}(\mathbf{u}_m)| \end{aligned}$$

Averaging both sides over $m \in M$, dividing by the constant $JL |T_V(\mathbf{C}_{jlm})|$ and taking the expectation over all possible realizations of θ_0 gives,

$$\beta(V, \Theta, \Psi) \leq \exp(n2\delta) \frac{K_V \lambda |T_{Q_1V}(\mathbf{u}_1)|}{JL |T_V(\mathbf{c}_{111})|}$$

To compute the desired exponent from the last inequality, denote the inequality in the exponent \leq as follows,

$$(30) \quad a_n \leq b_n \iff \limsup_{n \rightarrow \infty} \frac{1}{n} \log a_n \leq \liminf_{n \rightarrow \infty} \frac{1}{n} \log b_n$$

Then, $K_V \leq \exp\{n[R_J - I(Q_1, V|Q_0)]^+\}$, $J \leq \exp\{nR_J\}$ by (26), $L \geq \exp\{nR_L\}$ by (4b), $\lambda \leq \exp\{nR_\lambda\}$ by (4c), and $|T_{Q_1V}(\mathbf{u}_1)| / |T_V(\mathbf{c}_{111})|$ is $\leq \exp\{nI(Q_1, V|Q_0)\}$. Combining these, $\beta(V, \Theta, \Psi)$ is \leq the following expression,

$$\begin{aligned} \exp\{n[R_L - R_\lambda + |R_J - I(Q, V|Q_0)|^-]^+ \} & \end{aligned}$$

To obtain the desired bound, simplify this with the identity $|a|^- \equiv a - |a|^+$, and the fact that $\beta(V, \Theta, \Psi) \leq 1$. ■

VI. ERROR EXPONENTS

The desired error exponents can be obtained directly from the achievability result in [6] by grouping $(j, l) \in J \times L$ as one private message for Bob. This is because the error exponent that Bob decodes the private message wrong lower bounds the exponent that Bob decodes the secret wrong.¹⁶ For completeness, we provide a similar derivation in this section. Readers familiar with [6] and may skip to the next section.

In essence of Lemma IV.2, the error exponents for Bob and Eve can be obtained by lower bounding the exponents of the fractions $\beta(V, \Theta, \Phi_b^c)$ and respectively $\beta(V, \Theta, \Phi_e^c)$. Thus, the objective is to prove the following lemma.

Lemma VI.1 (Error exponents). *Consider the sequence of random code Θ in Definition IV.3, and the MMI decoder (decision region map) ϕ_b (Φ_b) (21) and ϕ_e (Φ_e) (22) for Bob and respectively Eve. Then,*

$$\begin{aligned} & \liminf_{n \rightarrow \infty} -\frac{1}{n} \log \beta(V, \Theta, \Phi_b^c) \\ & \leq \left| I(Q_1, V|Q_0) - R_J - R_L + |I(Q_0, Q_1V) - R_M| \right|^+ \\ & \liminf_{n \rightarrow \infty} -\frac{1}{n} \log \beta(V, \Theta, \Phi_e^c) \leq |I(Q_0, Q_1V) - R_M|^+ \end{aligned}$$

A. Exponent for Bob

In essence of Lemma IV.2, the error exponent for Bob can be obtained by lower bounding the exponent of the fraction,

$$\beta(V, \Theta, \Phi_b^c) = \mathbb{E} \left(\text{Avg}_{j \in J, l \in L, m \in M} \frac{|\Phi_b^c(m, l) \cap T_V(\mathbf{C}_{jlm})|}{|T_V(\mathbf{C}_{jlm})|} \right)$$

where Θ is the sequence of random codes in Definition IV.3 and Φ_b is the decision region of the MMI decoder ϕ_b in (21). $\Phi_b^c(m, l) \cap T_V(\mathbf{C}_{jlm})$ is the set of bad observations in the V -shell of \mathbf{C}_{jlm} that lead to error if \mathbf{C}_{jlm} is transmitted. With the MMI decoder (21), this corresponds to the set of $\mathbf{y} \in T_V(\mathbf{C}_{jlm})$ that has $I(\mathbf{C}_{jlm} \wedge \mathbf{y})$ no larger than $I(\mathbf{C}_{j'l'm'}) \wedge \mathbf{y}$ for some misleading codeword $\mathbf{C}_{j'l'm'}$ where $j' \in J$ and $(l', m') \in L \times M \setminus \{l, m\}$. i.e.

$$\begin{aligned} \Phi_b^c(m, l) \cap T_V(\mathbf{C}_{jlm}) &= \{\mathbf{y} \in T_V(\mathbf{C}_{jlm}) \cap T_{V'}(\mathbf{C}_{j'l'm'}) : \\ & (j', l', m') \in \mathcal{W}_b^{(1)}(m) \cup \mathcal{W}_b^{(2)}(m, l), V' \in \mathcal{V}_b(V)\} \end{aligned}$$

where

$$\mathcal{V}_b(V) := \{V' \in \mathcal{V}_n(Q) : I(Q, V') \geq I(Q, V)\}$$

$$\mathcal{W}_b^{(1)}(m) := \{(j', l', m') : j' \in J, l' \in L, m' \in M \setminus \{m\}\}$$

$$\mathcal{W}_b^{(2)}(m, l) := \{(j', l', m) : j' \in J, l' \in L \setminus \{l\}\}$$

(The dependence on V , m and l will be omitted if there is no ambiguity.) \mathcal{V}_b is the set of *problematic conditional type* that can lead to error. $(\mathcal{W}_b^{(1)}, \mathcal{W}_b^{(2)})$ forms a partition of the set of *indices for the misleading codewords*. In particular, $\mathcal{W}_b^{(1)}$ corresponds to the indices of misleading codewords that result in decoding the public message wrong if the observation lies in

¹⁶Since Bob can also decode the junk data as reliably as the secret, one may potentially transmit meaningful data instead of the junk provided that the data is uniformly random and need not be secured at the same level as the secret.

a problematic V' -shell of the misleading codeword. Similarly, $\mathcal{W}_b^{(2)}$ corresponds to the indices of misleading codewords that result in decoding the private message wrong but decoding the public message correctly.¹⁷ By the union bound,

$$\begin{aligned} & |\Phi_b^c(m, l) \cap T_V(\mathbf{C}_{jlm})| \\ & \leq \sum_{V' \in \mathcal{V}_b} \sum_{(j'l'm') \in \mathcal{W}_b^{(1)}} |T_V(\mathbf{C}_{jlm}) \cap T_{V'}(\mathbf{C}_{j'l'm'})| \\ & \quad + \sum_{V' \in \mathcal{V}_b} \sum_{(j'l'm') \in \mathcal{W}_b^{(2)}} |T_V(\mathbf{C}_{jlm}) \cap T_{V'}(\mathbf{C}_{j'l'm'})| \end{aligned}$$

Consider the second summation where $\mathbf{U}_{m'} = \mathbf{U}_m$ because $m' = m$. Since $T_V(\mathbf{C}_{jlm}) \cap T_{V'}(\mathbf{C}_{j'l'm'})$ is contained by

$$T_{Q_1V}(\mathbf{U}_m) \cap T_{Q_1V'}(\mathbf{U}_m) \subset T_{Q_1V} \cap T_{Q_1V'}$$

the summand is zero if $QV \neq QV'$ or $Q_1V \neq Q_1V'$ by the uniqueness of (canonical conditional) types. Since the premise implies $I(Q_0, Q_1V) = I(Q_0, Q_1V')$, we can impose this constraint (temporarily) in the second summation without affecting the sum. Under this equality constraint, however, the inequality constraint $I(V|Q) \geq I(V'|Q)$ on V' can be replaced by $I(Q_1, V|Q_0) \geq I(Q_1, V'|Q_0)$. Withdrawing the equality constraint gives the following upper bound,

$$\begin{aligned} & |\Phi_b^c(m, l) \cap T_V(\mathbf{C}_{jlm})| \\ & \leq \sum_{\substack{V' \in \mathcal{V}(Q): \\ I(Q, V) \geq I(Q, V')}} \sum_{(j'l'm') \in \mathcal{W}_b^{(1)}} |T_V(\mathbf{C}_{jlm}) \cap T_{V'}(\mathbf{C}_{j'l'm'})| \\ & \quad + \sum_{\substack{V' \in \mathcal{V}(Q): I(Q_1, V|Q_0) \\ \geq I(Q_1, V'|Q_0)}} \sum_{(j'l'm') \in \mathcal{W}_b^{(2)}} |T_V(\mathbf{C}_{jlm}) \cap T_{V'}(\mathbf{C}_{j'l'm'})| \end{aligned}$$

To bound the expectation on the left, it suffices to bound the expectation of $|T_V(\mathbf{C}_{jlm}) \cap T_{V'}(\mathbf{C}_{j'l'm'})|$ on the right by the Packing Lemma[3], which is stated in a convenient form with conditioning in Lemma A.4.

If $(j', l', m') \in \mathcal{W}_b^{(1)}(m)$, then \mathbf{C}_{jlm} is independent of $\mathbf{C}_{j'l'm'}$. Applying the Packing Lemma without conditioning gives, for all $\delta > 0$, $n > n_0(\delta, |\mathcal{U}||\mathcal{X}|)$,

$$\mathbb{E} \left(\frac{|T_V(\mathbf{C}_{jlm}) \cap T_{V'}(\mathbf{C}_{j'l'm'})|}{|T_V(\mathbf{C}_{jlm})|} \right) \leq \exp \{-n[I(Q, V') - \delta]\}$$

If $(j', l', m') \in \mathcal{W}_b^{(2)}(m, l)$ instead, then \mathbf{C}_{jlm} is conditionally independent of $\mathbf{C}_{j'l'm'}$ given \mathbf{U}_m . The Packing Lemma gives,

$$\mathbb{E} \left(\frac{|T_V(\mathbf{C}_{jlm}) \cap T_{V'}(\mathbf{C}_{j'l'm'})|}{|T_V(\mathbf{C}_{jlm})|} \right) \leq \exp \{-n[I(Q_1, V'|Q_0) - \delta]\}$$

Combining the last three inequalities, we have for n sufficiently large that,

$$\begin{aligned} \mathbb{E} \left(\frac{|\Phi_b^c(m, l) \cap T_V(\mathbf{C}_{jlm})|}{|T_V(\mathbf{C}_{jlm})|} \right) &\leq JLM \exp\{-n[I(Q, V) - \delta]\} \\ &\quad + JL \exp\{-n[I(Q_1, V|Q_0) - \delta]\} \end{aligned}$$

where we have used the fact that $|\mathcal{W}^{(1)}(m)| = JL(M-1)$ and $|\mathcal{W}^{(2)}(m, l)| = J(L-1)$; replaced $I(Q, V')$ and $I(Q_1, V'|Q_0)$ by their minima $I(Q, V)$ and respectively $I(Q_1, V|Q_0)$ which

¹⁷The reason for this separation is that the two types of error lead to two different exponents.

correspond to the most slowly decaying terms; and applied the Type Counting Lemma to $|\mathcal{Y}_n(Q)|$. Hence,

$$\begin{aligned} & \liminf_{n \rightarrow \infty} -\frac{1}{n} \log \beta(V, \Theta, \Phi_b^c) \\ & \geq |\min\{I(Q, V) - R_M, I(Q_1, V|Q_0)\} - R_J - R_L|^+ \\ & = |I(Q_1, V|Q_0) - R_J - R_L + |I(Q_1 V|Q_0) - R_M|^-|^+ \end{aligned}$$

because $\min\{a, b\} = b + \min\{0, a - b\}$.

B. Exponent for Eve

The exponent of $\beta(V, \Theta, \Phi_e^c)$ for Eve can be calculated analogously. With MMI decoding $\Phi_e^c(m) \cap T_V(\mathbf{C}_{jlm})$ is the set of $\mathbf{z} \in T_V(\mathbf{C}_{jlm})$ that has $I(\mathbf{U}_m \wedge \mathbf{z})$ no larger than $I(\mathbf{U}_{m'} \wedge \mathbf{z})$ for some misleading codeword $\mathbf{U}_{m'}$ where $m' \in M \setminus \{m\}$, i.e.

$$\Phi_e^c(m) \cap T_V(\mathbf{C}_{jlm}) = \{\mathbf{z} \in T_V(\mathbf{C}_{jlm}) \cap T_{Q_1 V'}(\mathbf{U}_{m'}) : \text{else } m' \in M \setminus \{m\}, V' \in \mathcal{V}_e(V)\}$$

where the set of problematic conditional types for Eve is $\mathcal{V}_e(V) := \{V' \in \mathcal{V}(Q) : I(Q_0, Q_1 V') \geq I(Q_0, Q_1 V)\}$. By the union bound,

$$|\Phi_e^c(m) \cap T_V(\mathbf{C}_{jlm})| \leq \sum_{V' \in \mathcal{V}_e(V)} \sum_{m' \in M \setminus \{m\}} |T_V(\mathbf{C}_{jlm}) \cap T_{Q_1 V'}(\mathbf{U}_{m'})|$$

Since \mathbf{C}_{jlm} is independent of $\mathbf{U}_{m'}$ where $m' \neq m$, the Packing Lemma A.4 without conditioning (but with \hat{Q} assigned as Q_0 , and \hat{V} assigned as $Q_1 V'$) gives, for all $n \geq n_0(\delta, |\mathcal{U}|)$,

$$\mathbb{E} \left(\frac{|T_V(\mathbf{C}_{jlm}) \cap T_{Q_1 V'}(\mathbf{U}_{m'})|}{|T_V(\mathbf{C}_{jlm})|} \right) \leq \exp\{-n[I(Q_0, Q_1 V') - \delta]\}$$

Substituting this into the previous inequality, we have for n sufficiently large that,

$$\mathbb{E} \left(\frac{|\Phi_e^c(m) \cap T_V(\mathbf{C}_{jlm})|}{|T_V(\mathbf{C}_{jlm})|} \right) \leq M \exp\{-n[I(Q_0, Q_1 V) - \delta]\}$$

where we have replaced $I(Q_0, Q_1 V')$ by its minimum $I(Q_0, Q_1 V)$. The exponent is therefore,

$$\liminf_{n \rightarrow \infty} -\frac{1}{n} \log \beta(V, \Theta, \Phi_e^c) \geq |I(Q_0, Q_1 V) - R_M|^+$$

which completes the proof the Lemma VI.1

VII. RESULT

The exponents of $\beta(V, \Theta, \Psi)$, $\beta(V, \Theta, \Phi_b^c)$ and $\beta(V, \Theta, \Phi_e^c)$ calculated in Lemma V.3 and Lemma VI.1 using the random code in Definition IV.3 and the coding scheme in Definition IV.2 give an initial set of lower bounds to the exponents by Lemma IV.2. As discussed in Section IV-B, the bounds can then be extended with prefixed DMC \tilde{V} by rewriting (W_b, W_e) as $(\tilde{V}W_b, \tilde{V}W_e)$.

To obtain the final version of the bounds, consider the following rate reallocation: move the first $R \in [0, R_L]$ bits of the secret to the end of the public message, and encode them with a wiretap channel code at rate $(R_M + R, R_L - R)$.

Theorem VII.1 (Inner bound of achievable exponent triples). *For every rate triple (R_M, R_L, R_λ) , we have for all $R \in [0, R_L]$, $R_J \geq 0$, finite sets \mathcal{U} and $\tilde{\mathcal{X}}$, distribution $Q := Q_0 \circ Q_1$ ($Q_0 \in \mathcal{P}(\mathcal{U})$, $Q_1 \in \mathcal{P}(\mathcal{X})^{\mathcal{U}}$), transitional probability*

matrix $\tilde{V} \in \mathcal{P}(\mathcal{X})^{\mathcal{U} \times \tilde{\mathcal{X}}}$, the exponent triple (E_b, E_e, S_e) satisfying the following is achievable (see Definition III.3) for the wiretap channel $\{W_b, W_e\}$.

$$\begin{aligned} E_b & \geq \min_{V \in \mathcal{P}(\mathcal{Y})^{\mathcal{U} \times \mathcal{X}}} D(V \| \tilde{V}W_b | Q) \\ & \quad + |I(Q_1, V|Q_0) - R_J - R_L + R \\ & \quad \quad + |I(Q_0, Q_1 V) - R_M - R|^-|^+ \\ E_e & \geq \min_{V \in \mathcal{P}(\mathcal{Z})^{\mathcal{U} \times \mathcal{X}}} D(V \| \tilde{V}W_e | Q) \\ & \quad + |I(Q_0, Q_1 V) - R_M - R|^-|^+ \\ S_e & \geq \min_{V \in \mathcal{P}(\mathcal{Z})^{\mathcal{U} \times \mathcal{X}}} D(V \| \tilde{V}W_e | Q) \\ & \quad + \left| R_L - R - R_\lambda + |R_J - I(Q_1, V|Q_0)|^- \right|^+ \end{aligned}$$

From this, we can compute an inner bound to the region of strongly achievable rate triple for which above inner bound to the achievable exponent triple are all strictly positive. To simplify notation, let $(\mathbf{U}, \tilde{\mathbf{X}}, \mathbf{X}, \mathbf{Y}, \mathbf{Z})$ be some random variables distributed as $Q_0(u)Q_1(\tilde{x}|u)\tilde{V}(x|u, \tilde{x})W_b(y|x)W_e(z|x)$. (Note that $(\mathbf{U}, \tilde{\mathbf{X}}) \rightarrow \mathbf{X} \rightarrow \mathbf{YZ}$.) Since information divergence $D(V \| W)$ is zero at $V = W$ and positive otherwise, the exponents are positive iff, for $R \in [0, R_L]$ and $R_J \geq 0$

$$\begin{aligned} (31a) \quad & R_J + R_L - R < I(\tilde{\mathbf{X}} \wedge \mathbf{Y} | \mathbf{U}) \\ (31b) \quad & R_J + R_L + R_M < I(\mathbf{U} \tilde{\mathbf{X}} \wedge \mathbf{Y}) \\ (31c) \quad & R_M + R < I(\mathbf{U} \wedge \mathbf{Z}) \\ (31d) \quad & R_L - R > R_\lambda \\ (31e) \quad & R_L - R + R_J > R_\lambda + I(\tilde{\mathbf{X}} \wedge \mathbf{Z} | \mathbf{U}) \end{aligned}$$

R and R_J can be eliminated without loss of optimality by the Fourier-Motzkin elimination[10] (see Lemma A.5), which gives the following.

Theorem VII.2 (Inner bound of strongly achievable rate triples). *(R_M, R_L, R_λ) is strongly achievable for the wiretap channel $\{W_b : \mathcal{X} \mapsto \mathcal{Y}, W_e : \mathcal{X} \mapsto \mathcal{Z}\}$ if*

$$\begin{aligned} (32a) \quad & 0 \leq R_\lambda < R_L \\ (32b) \quad & R_\lambda < I(\tilde{\mathbf{X}} \wedge \mathbf{Y} | \mathbf{U}) - I(\tilde{\mathbf{X}} \wedge \mathbf{Z} | \mathbf{U}) \\ (32c) \quad & 0 \leq R_M < I(\mathbf{U} \wedge \mathbf{Z}) \\ (32d) \quad & R_M + R_\lambda < I(\mathbf{U} \tilde{\mathbf{X}} \wedge \mathbf{Y}) - I(\mathbf{U} \wedge \mathbf{Z}) \\ (32e) \quad & R_M + R_L < I(\tilde{\mathbf{X}} \wedge \mathbf{Y} | \mathbf{U}) + \min\{I(\mathbf{U} \wedge \mathbf{Y}), I(\mathbf{U} \wedge \mathbf{Z})\} \end{aligned}$$

for some $(\mathbf{U}, \tilde{\mathbf{X}}) \rightarrow \mathbf{X} \rightarrow \mathbf{YZ}$ with $P_{\mathbf{Y}|\mathbf{X}} = W_b$ and $P_{\mathbf{Z}|\mathbf{X}} = W_e$. It is admissible to have \mathbf{U} as a deterministic function of $\tilde{\mathbf{X}}$ and

$$\begin{aligned} |\mathcal{U}| & \leq 4 + \min\{|\mathcal{X}| - 1, |\mathcal{Y}| + |\mathcal{Z}| - 2\} \\ |\tilde{\mathcal{X}}| & \leq |\mathcal{U}| (2 + \min\{|\mathcal{X}| - 1, |\mathcal{Y}| + |\mathcal{Z}| - 2\}) \end{aligned}$$

which implies $\mathbf{U} \rightarrow \tilde{\mathbf{X}} \rightarrow \mathbf{X} \rightarrow \mathbf{YZ}$ and $I(\mathbf{U} \tilde{\mathbf{X}} \wedge \mathbf{Y}) = I(\tilde{\mathbf{X}} \wedge \mathbf{Y})$.

The admissible constraints are obtained from [2] as described in Lemma A.6. They can be imposed without changing the inner bound. Note that the closure of the rate region of (R_M, R_L, R_λ) here contains the rate region of (R_0, R_1, R_e)

in Theorem 1 of [2].¹⁸ This is because (32d) can be replaced by $R_M \leq I(U \wedge Y)$ under (32b). Example A.4 illustrates how to compute an inner bound of the achievable rate tuples using the Multi-Parametric Toolbox[7] in Matlab.

VIII. CONCLUSION

In doubt of a unifying measure of security, we have considered success exponent as an alternative to equivocation rate. Not only does it provide the system designer an additional parameter of list size to optimize, it also allow us to obtain a new tradeoff between reliability and secrecy for the wiretap channel considered in [2].

To achieve good reliability, we replace the maximal code construction and typical set decoding in [2] with the random coding scheme and maximum empirical mutual information decoding in [6]. The lower bounds on the error exponents follow from [6] with the well-known Packing Lemma (see Lemma A.4), while the lower bound on the success exponent is obtained with the approach of [4] and a technique we call the Overlap Lemma (see Lemma V.2). This lemma gives a doubly exponential behavior that enables us to guarantee good realization of the random code for effective stochastic encoding by transmission of junk data (see Section IV-B). Combining with the prefix DMC technique in [2] that adds artificial memoryless noise to the channel input symbols, and a rate reallocation step of transferring some secret bits to the public message before encoding (see Section VII), we obtain the final inner bound of the achievable exponent triples in Theorem VII.1 with the corresponding strongly achievable rate triples in Theorem VII.2.

It is a straightforward extension to consider the maximum error exponents and average success exponent over the messages. The same bound follows by the usual expurgation argument and a more careful application of the doubly exponential behavior of the Overlap Lemma. Whether this tradeoff is optimal, however, is unclear. It is also unclear whether the inner bound to the achievable rate region in Theorem VII.2 is tight or whether it strictly contains the region achievable rate triple in Theorem 1 of [2]. It would be surprising if one could further improve the tradeoff by improving the coding scheme.

Another extension would be to consider *unequal security protection*, in which different data has different security or reliability requirement. Transmission of junk data can be viewed as a special case when the junk data need not be secured, nor reliably transmitted.

APPENDIX

Example A.1 (Maximum a priori and a posteriori success probability). Consider the following probability matrix,

$$P_Z := \begin{bmatrix} \frac{5}{8} & \frac{3}{8} \\ \frac{4}{5} & \frac{1}{5} \end{bmatrix}$$

$$P_{S|Z} := \begin{bmatrix} \frac{4}{5} & \frac{1}{5} \\ \frac{2}{3} & \frac{1}{3} \end{bmatrix}$$

¹⁸It is unclear if the subset relationship is strict and whether the region is convex. If the region is not convex, its convex hull will give a better inner bound by the time-sharing argument. Similarly, the inner bound to the achievable exponent triples can also be improved.

from which the a priori probability is $P_S = [\frac{3}{4} \quad \frac{1}{4}]$. Without knowing Z, Eve guesses S successfully with probability at most $\frac{3}{4}$ if one guess is allowed, and 1 if two guesses are allowed. If she knows Z, she still has the same maximum probability of success in each case because the most probable candidate for the secret is the same regardless of whether Z is observed. Hence, Eve cannot achieve a better success probability regardless of Z, even though Z is *not* independent of S. Success probability fails to express the notion of perfect secrecy in this sense.

Example A.2 (Transmission of junk data). Consider the case when there is no public message, and the coding is not restricted to constant composition code. Fig. 6 illustrates the approach of transmission of junk data through a wiretap channel, which consists of a binary noiseless channel for Bob and a binary erasure channel for Eve. While the channel

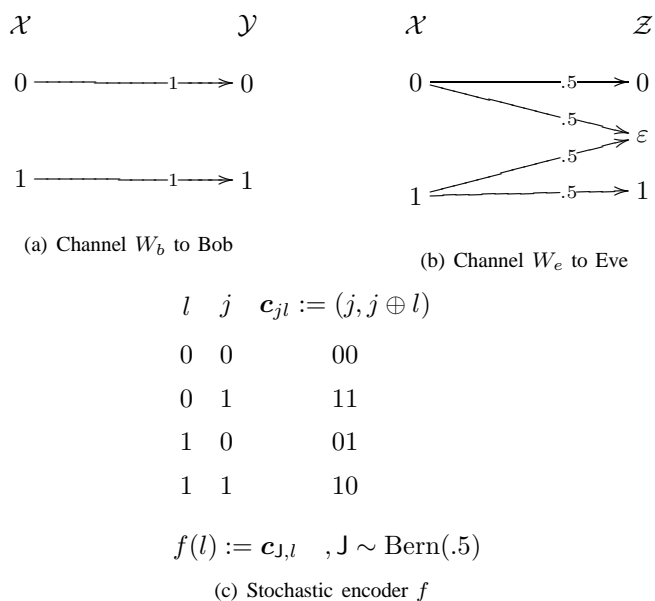

Fig. 6. An example of transmission of junk data

input is perfectly observed by Bob, half of it is erased on average before it reaches Eve. Alice exploits this by sending one bit of junk J uniformly distributed in $\{0, 1\}$ together with one bit of secret $l \in \{0, 1\}$ in two channel uses. The channel input is $\mathbf{X} = (J, J \oplus l)$ where \oplus denotes the XOR operation. Bob can recover the secret perfectly by the decoder $\phi_b(\mathbf{y}) := y^{(1)} \oplus y^{(2)}$ since his observation \mathbf{Y} is equal to \mathbf{X} . Eve can use the same decoding if there is no erasure. However, if there is one or more erasures, her observation \mathbf{Z} becomes independent of the secret, in which case she should uniformly randomly pick 0 or 1 as her guess to minimize the conditional error probability, provided that she can only make one guess.¹⁹ Thus, the conditional error probability is 0 if there is no erasure, which happens with probability 1/4, and 1/2 otherwise. The overall conditional error probability is 3/8.

Note that if Alice uses a prefix DMC as described in Section IV-B, Bob cannot achieve zero error probability. In

¹⁹We allow stochastic decoding here since the focus is the probability at block length $n = 2$ instead of the exponent when $n \rightarrow \infty$.

other words, prefix DMC is strictly inferior in this case.²⁰

Example A.3 (Prefix discrete memoryless channel). Consider prefixing the wiretap channel $\{W_b : \mathcal{X} \mapsto \mathcal{Y}, W_e : \mathcal{X} \mapsto \mathcal{Z}\}$ with the discrete memoryless channel $\{\tilde{V}\}$ defined in Fig. 7. Each arrow connects an input alphabet to an output alphabet if the corresponding transition probability, labeled in the arrow, is non-zero. Consider the case without prefixing the wiretap

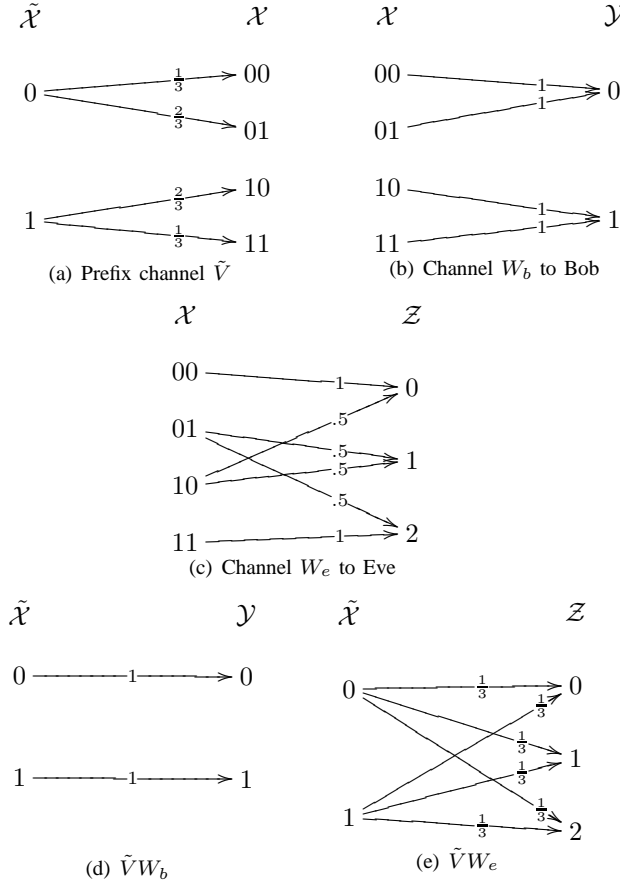

Fig. 7. An example of prefix discrete memoryless channel

channel with \tilde{V} . Since W_b is a weakly symmetric channel, the capacity is 1 bit by the capacity formula for weakly symmetric in Theorem 8.2.1 of [1]. Bob can achieve the capacity of 1 bit with zero error probability and a single use of the channel iff Alice encodes 1 bit of information using any of the following codebooks $\theta(1) := \{00, 10\}$, $\theta(2) := \{00, 11\}$, $\theta(3) := \{01, 10\}$ and $\theta(4) := \{01, 11\}$. If Alice wants to have zero error probability for Bob in n channel uses with rate n bits, the codebook has to be some concatenation of codebooks from $\{\theta(i)\}_{i=1}^4$. However, the channel input X^n would not be independent of the channel output Z^n to Eve. To argue this, consider the i -th channel use only. Suppose Alice uses $\theta(1)$ to encode a uniformly random bit at that time slot. Then, given $Z^{(i)} = 0$, we have $X^{(i)} = 10$ with probability $2/3$ rather than the prior probability $1/2$. The other cases can be argued similarly. In short, not randomizing over the

²⁰It would be more interesting to find an example in which prefix DMC is inferior even if Bob's probability of error cannot be made to 0 by adding noise with memory like what the transmission of junk data does.

code unavoidably leaks information to Eve. However, if the randomization is done by transmitting junk data, the useful data rate would drop below the capacity 1 bit.

Consider prefixing the wiretap channel with \tilde{V} . The prefixed channel $\tilde{V}W_b$ to Bob is a noiseless binary channel as shown in Fig. 7(d). The prefixed channel $\tilde{V}W_e$ to Eve, however, is completely noisy as shown in Fig. 7(e). One can check that the channel output Z is independent of X for any input distribution on X . Thus, Alice can transmit at the capacity 1 bit with zero error probability for Bob but without leaking any information to Eve. Prefixing discrete memoryless channel is strictly better than transmitting junk data in this case.

Lemma A.1 (random codeword). For $\delta > 0$, $n \in \mathbb{Z}^+$, $Q := Q_0 \circ Q_1$ ($Q_0 \in \mathcal{P}_n(\mathcal{U})$, $Q_1 \in \mathcal{V}_n(Q_0, \mathcal{X})$), $V \in \mathcal{V}_n(Q, \mathcal{Z})$, $\mathbf{u} \in T_{Q_0}$, n -sequence \mathbf{X} uniformly randomly chosen from $T_{Q_1}(\mathbf{u})$, then

$$\Pr\{z \in T_V(\mathbf{u} \circ \mathbf{X})\} = \frac{|T_{X|U,Z}(\mathbf{u}, z)|}{|T_{X|U}(\mathbf{u})|} \leq \exp\{-n[I(Q_1, V|Q_0) - \delta]\}$$

where the last inequality holds for all $n \geq n_0(\delta, |\mathcal{U}|, |\mathcal{X}|)$; (U, X, Z) in the first equality is a random tuple with joint distribution $P_{U,X,Z} := Q_0 \circ Q_1 \circ V$; $T_{X|U,Z}$ is denoted by $T_{X|U,Z}$ and similarly for others; and $|T_{X|U,Z}(\mathbf{u}, z)|$ with $(\mathbf{u}, z) \in T_{U,Z}$ is denoted by $|T_{X|U,Z}|$.

Proof: Consider $z \in T_{QV}$, for which the desired probability is non-zero. Since $\mathbf{u} \in T_U$, $\mathbf{X} \in T_{X|U}(\mathbf{u})$, and $z \in T_Z$, the event that $\{z \in T_V(\mathbf{u} \circ \mathbf{X})\}$, or equivalently, $\{z \in T_{Z|U,X}(\mathbf{u} \circ \mathbf{X})\}$, happens iff $(\mathbf{u}, \mathbf{X}, z) \in T_{U,X,Z}$. This happens iff $\mathbf{X} \in T_{X|U,Z}(\mathbf{u}, z)$. Hence, for all $z \in T_Z$,

$$\Pr\{z \in T_V(\mathbf{u} \circ \mathbf{X})\} = \Pr\{\mathbf{X} \in T_{X|U,Z}(\mathbf{u}, z)\} = \frac{|T_{X|U,Z}(\mathbf{u}, z)|}{|T_{X|U}(\mathbf{u})|} \leq \exp\{-n[I(X \wedge Z|U) + \delta]\}$$

where the last inequality is true for all $n \geq n_0(\delta, |\mathcal{U}|, |\mathcal{X}|)$ due to Lemma 1.2.5 of [3] that

$$|T_{X|U,Z}(\mathbf{u}, z)| \leq \exp\{nH(X|U, Z)\} \\ |T_{X|U}(\mathbf{u})| \geq (n+1)^{-|\mathcal{U}||\mathcal{X}|} \exp\{nH(X|U)\}$$

Since $I(X \wedge Z|U) = I(Q_1, V|Q_0)$, this gives the desired bound. ■

Lemma A.2. For all n , $\exp(nR), \exp(n\delta) \in \mathbb{Z}^+$

$$\left(\frac{\exp(nR)}{\exp(n\delta)} \right) \leq \exp\{(\log e + n(R - \delta)) \exp(n\delta)\}$$

Proof: Let $a := \exp(nR)$ and $b := \exp(n\delta)$. Then, we have the well-known inequality that $\binom{a}{b} \leq \left(\frac{a}{b}\right)^b$, which gives the R.H.S. of the bound as desired. To derive this, note that $e^x \geq (1+x)$ for all $x \geq 0$. Thus,

$$e^{ax} \geq (1+x)^a = \sum_{i=1}^a \binom{a}{i} x^i \implies \binom{a}{b} \leq e^{ax-b \ln x}$$

Setting $x = b/a$ gives the desired inequality. ■

Lemma A.3 (list size constraint). *For any subset $\mathcal{S} \subset \mathcal{Z}^n$ of observations and list decoder ψ with list size λ , the corresponding decision region map $\Psi : L \mapsto 2^{\mathcal{Z}^n}$ satisfies,*

$$(33) \quad \sum_{l \in L} |\Psi(l) \cap \mathcal{S}| = \lambda |\mathcal{S}|$$

Proof: The proof is by the *double counting* principle,

$$\sum_{l \in L} |\Psi(l) \cap \mathcal{S}| = \sum_{z \in \mathcal{S}} \sum_{l \in L} \mathbb{1}\{l \in \psi(z)\} = \sum_{z \in \mathcal{S}} \lambda = \lambda |\mathcal{S}|$$

■

Lemma A.4 (Packing (with conditioning)). *Consider some finite sets \mathcal{U} , \mathcal{X} and \mathcal{Y} , type $Q_0 \in \mathcal{P}_n(\mathcal{U})$, and canonical conditional types $Q_1 \in \mathcal{V}(Q_0, \mathcal{X})$ and $\hat{Q}_1 \in \mathcal{V}(Q_0, \hat{\mathcal{X}})$. Let $Q := Q_0 \circ Q_1$ and $\hat{Q} := Q_0 \circ \hat{Q}_1$ be the corresponding joint types; \mathbf{U} be some random n -sequence distributed over T_{Q_0} ; \mathbf{X} and $\hat{\mathbf{X}}$ be independently and uniformly randomly drawn from $T_{Q_1}(\mathbf{U})$ and $T_{\hat{Q}_1}(\mathbf{U})$ respectively; $\mathbf{C} := \mathbf{U} \circ \mathbf{X}$ and $\hat{\mathbf{C}} := \mathbf{U} \circ \hat{\mathbf{X}}$ denote the element-wise concatenations. Then, for all $\delta > 0$, $n \geq n_0(\delta, |\mathcal{U}|, |\mathcal{X}|)$, $V \in \mathcal{V}_n(Q, \mathcal{Y}) \cap \mathcal{V}_n(\hat{Q}, \mathcal{Y})$,*

$$\mathbb{E} \left(\frac{|T_V(\mathbf{C}) \cap T_{\hat{V}}(\hat{\mathbf{C}})|}{|T_V(\mathbf{C})|} \right) \leq \exp \left\{ -n [I(\hat{Q}_1, \hat{V} | Q_0) - \delta] \right\}$$

Proof: Consider some realization $\mathbf{u} \in T_{Q_0}$ of \mathbf{U} . By conditional independence between \mathbf{X} and $\hat{\mathbf{X}}$,

$$\begin{aligned} & \mathbb{E} \left(|T_V(\mathbf{C}) \cap T_{\hat{V}}(\hat{\mathbf{C}})| \mid \mathbf{U} = \mathbf{u} \right) \\ &= \sum_{\mathbf{y} \in T_{Q_1 V}(\mathbf{u})} \Pr \{ \mathbf{y} \in T_V(\mathbf{u} \circ \mathbf{X}) \} \Pr \{ \mathbf{y} \in T_{\hat{V}}(\mathbf{u} \circ \hat{\mathbf{X}}) \} \\ &\leq \sum_{\mathbf{y} \in T_{Q_1 V}(\mathbf{u})} \frac{|T_{\mathbf{X}|\mathbf{U}, \mathbf{Y}}|}{|T_{\mathbf{X}|\mathbf{U}}|} \exp \{ -n [I(\hat{Q}_1, \hat{V} | Q_0) - \delta] \} \\ &= \frac{|T_{\mathbf{Y}|\mathbf{U}}| |T_{\mathbf{X}|\mathbf{U}, \mathbf{Y}}|}{|T_{\mathbf{X}|\mathbf{U}}|} \exp \{ -n [I(\hat{Q}_1, \hat{V} | Q_0) - \delta] \} \end{aligned}$$

where the first inequality follows from Lemma A.1 (both the equality and inequality cases) $\forall n \geq n_0(\delta, |\mathcal{U}|, |\mathcal{X}|)$ with \mathbf{U} , \mathbf{X} and \mathbf{Y} and $T_{\mathbf{X}|\mathbf{U}, \mathbf{Y}}$ etc. defined analogously. Divide both sides by $|T_V(\mathbf{u} \circ \mathbf{X})| = |T_{\mathbf{Y}|\mathbf{U}, \mathbf{X}}|$, and apply that fact that $|T_{\mathbf{Y}|\mathbf{U}}| |T_{\mathbf{X}|\mathbf{U}, \mathbf{Y}}| = |T_{\mathbf{X}|\mathbf{U}}| |T_{\mathbf{Y}|\mathbf{U}, \mathbf{X}}|$,

$$\mathbb{E} \left(\frac{|T_V(\mathbf{C}) \cap T_{\hat{V}}(\hat{\mathbf{C}})|}{|T_V(\mathbf{C})|} \mid \mathbf{U} = \mathbf{u} \right) \leq \exp \{ -n [I(\hat{Q}_1, \hat{V} | Q_0) - \delta] \}$$

Averaging both sides over \mathbf{U} gives the desired bound. ■

Lemma A.5 (Fourier-Motzkin). *The rate constraints in (31) with $R \in [0, R_L]$ and $R_J > 0$ defines the same region of (non-negative) rate triples (R_M, R_L, R_λ) as the rate constraints in (32) do.*

Proof: Consider applying the Fourier-Motzkin elimina-

tion. From (31) and $R \in [0, R_L]$, we have,

$$\begin{aligned} -R &< 0 \\ -R + R_J + R_L &< I(\tilde{\mathbf{X}} \wedge \mathbf{Y} | \mathbf{U}) \\ R - R_L &\leq 0 \\ R + R_M &< I(\mathbf{U} \wedge \mathbf{Z}) \\ R - R_L + R_\lambda &< 0 \\ R - R_J - R_L + R_\lambda &< -I(\tilde{\mathbf{X}} \wedge \mathbf{Z} | \mathbf{U}) \\ R_J + R_L + R_M &< I(\mathbf{U} \tilde{\mathbf{X}} \wedge \mathbf{Y}) \end{aligned}$$

Adding each of the first two inequalities to the next four eliminates R , which, together with $R_J \geq 0$, gives,

$$\begin{aligned} -R_J &\leq 0 \\ -R_J - R_L + R_\lambda &< -I(\tilde{\mathbf{X}} \wedge \mathbf{Z} | \mathbf{U}) \\ R_J + R_L + R_M &< I(\mathbf{U} \wedge \mathbf{Z}) + I(\tilde{\mathbf{X}} \wedge \mathbf{Y} | \mathbf{U}) \\ R_J + R_\lambda &< I(\tilde{\mathbf{X}} \wedge \mathbf{Y} | \mathbf{U}) \\ R_J + R_L + R_M &< I(\mathbf{U} \tilde{\mathbf{X}} \wedge \mathbf{Y}) \\ R_M &< I(\mathbf{U} \wedge \mathbf{Z}) \\ -R_L + R_\lambda &< 0 \\ R_\lambda &< I(\tilde{\mathbf{X}} \wedge \mathbf{Y} | \mathbf{U}) - I(\tilde{\mathbf{X}} \wedge \mathbf{Z} | \mathbf{U}) \end{aligned}$$

where we have removed some inactive constraints. Adding each of the first two inequalities to the next three inequalities eliminates R_J , which gives (32) as desired. ■

Example A.4 (Inner bound of strongly achievable rate triples). Consider the following wiretap channel and prefix DMC.

```
% wiretap channel
p=0.1; PYX=[1-p p; p 1-p; .5 .5]; % PY|X
r=.4; PZX=[1 0; 1-r r; r 1-r]; % PZ|X
% input distributions and prefix DMC
PX=[.25 .25 .5]; PtX=PX; % PX, PX̃ and PX|X̃
q=.3; PUtX=[1-q q; 1 0; 0 1]; % PU|X̃
```

The prefix DMC is noiseless, i.e. $\mathbf{X} = \tilde{\mathbf{X}}$. The channel and \mathbf{U} are constructed based on Counter-example 2 in [5] with slight modifications.²¹ Define the Bayes' rule, conditional mutual information and entropy functions as follows.

```
function PXY=bayes(PYX,PX)
% compute PX|Y from PY|X and PX
PXY=repmat(PX, size(PYX,2),1).*PYX';
PXY=PXY./repmat(sum(PXY,2),1,size(PXY,2));
```

```
function IQVP=I(Q,V,P) % compute I(Q,V|P)
if nargin<3
    P=ones(1,size(Q,1))./size(Q,1);
end
IQVP=H(Q*V,P)-H(V,P*Q);
```

```
function h=H(Q,P) % compute H(Q|P)
Q(Q=0)=1;
h=-P*sum(log2(Q).*Q,2);
```

Then, the mutual information expressions required for the rate region can be computed as follows.

```
% derived values
PU = PtX*PUtX; PtXU = bayes(PUtX,PtX); % PU and PX|U
PYtX=PtX*PYX; PYU=PtXU*PYtX; % PY|X̃ and PY|U
PZtX=PtX*PZX; PZU=PtXU*PZtX; % PZ|X̃ and PZ|U
IUy=I(PU,PYU); ItXYU=I(PtXU,PYtX,PU); % I(U ∧ Y) and I(X̃ ∧ Y|U)
IUZ=I(PU,PZU); ItXZU=I(PtXU,PZtX,PU); % I(U ∧ Z) and I(X̃ ∧ Z|U)
```

²¹This is such that the resulting constraints (32) on the rate region are not redundant for the purpose of illustration.

Using the Multi-Parametric Toolbox[7], we first define the polytope satisfying the constraints from (31) on $(R, R_J, R_M, R_L, R_\lambda)$; and then project it to (R_M, R_L, R_λ) , which should give the desired region in (32).

```
% constraints from (31) on (R, R_J, R_M, R_L, R_\lambda)
A=[-eye(5); -1 1 0 1 0; 1 0 0 -1 0; 1 0 1 0 0;
  1 0 0 -1 1; 1 -1 0 -1 1; 0 1 1 1 0];
b=[zeros(1,5) ItXYU 0 IUZ 0 -ItXZU IUy+ItXYU]';
P=polytope(A,b);
R=projection(P,[3 4 5]); % Project to (R_M, R_L, R_\lambda) to obtain (32)
```

Finally, plotting the region gives Fig. 8.

```
options.wire=1; plot(R,options);
xlabel('R_M'); ylabel('R_L'); zlabel('R_\lambda');
set(gca,'CameraPosition',[1.5 -0.5 1],
'CameraUpVector',[-0.5 0.2 0.8],'DataAspectRatio',[1 1 1]);
```

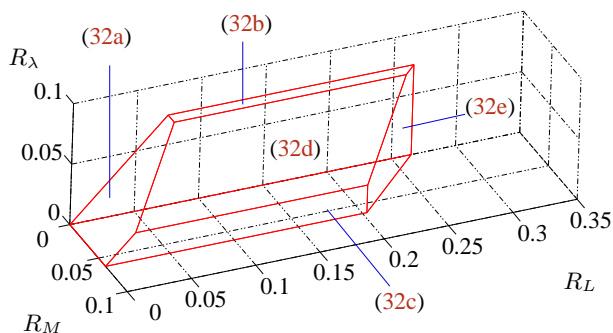

Fig. 8. An example of an inner bound to strongly achievable rate tuples

As expected, each facet corresponds to a constraint in (32), indicated in the figure.

Lemma A.6 (admissible constraints). *Consider some random variables in the Markov chain $U \tilde{X}' \rightarrow X' \rightarrow YZ$ distributed over the finite sets \mathcal{U}' , $\tilde{\mathcal{X}}'$, \mathcal{X} , \mathcal{Y} and \mathcal{Z} respectively. Then there exists $U \rightarrow \tilde{X} \rightarrow X \rightarrow YZ$ with,*

$$\begin{aligned} P_{Y|X}(y|x) &= P_{Y|X'}(y|x) & , \forall (x, y) \in \mathcal{X} \times \mathcal{Y} \\ P_{Z|X}(z|x) &= P_{Z|X'}(z|x) & , \forall (x, z) \in \mathcal{X} \times \mathcal{Z} \end{aligned}$$

and

$$(34a) \quad I(U \wedge Y) = I(U' \wedge Y)$$

$$(34b) \quad I(U \wedge Z) = I(U' \wedge Z)$$

$$(34c) \quad I(\tilde{X} \wedge Y|U) = I(\tilde{X}' \wedge Y|U')$$

$$(34d) \quad I(\tilde{X} \wedge Z|U) = I(\tilde{X}' \wedge Z|U')$$

and

$$(35a) \quad |\mathcal{U}| = 4 + \min\{|\mathcal{X}'| - 1, |\mathcal{Y}| + |\mathcal{Z}| - 2\}$$

$$(35b) \quad |\tilde{\mathcal{X}}| = |\mathcal{U}| (2 + \min\{|\mathcal{X}'| - 1, |\mathcal{Y}| + |\mathcal{Z}| - 2\})$$

$$(35c) \quad H(U|\tilde{X}) = 0$$

Furthermore, $X = X'$ if $|\mathcal{X}'| - 1 \leq |\mathcal{Y}| + |\mathcal{Z}| - 2$.

Proof: Since the following proof is a minor extension to [2, (A.22)], we will give only the changes as follows. Readers should refer to [2] for details.

With $\tilde{X}'' := (U, \tilde{X}')$, we have $I(\tilde{X}'' \wedge Y|U) = I(\tilde{X}' \wedge Y|U)$ and similarly for $I(\tilde{X}'' \wedge Z|U)$. It suffices to show the desired existence with \tilde{X}' replaced by \tilde{X}'' on the R.H.S. of (34).

Consider the case $|\mathcal{X}'| - 1 \leq |\mathcal{Y}| + |\mathcal{Z}| - 2$. The admissible constraint (35) is equivalent to [2, (A.22)]. (n.b. \mathcal{V} in [2] is

$\tilde{\mathcal{X}}$ here.) The proof therein also implies $X = X'$. because (X', Y, Z) need not be changed.

Suppose $|\mathcal{X}'| - 1 > |\mathcal{Y}| + |\mathcal{Z}| - 2$ instead. To achieve $H(Y)$ and $H(Z)$ in [2, (A.24), (A.25)], one can replace (A.23) by

$$(36) \quad \begin{aligned} \Pr(Y = y) &= \sum_{u \in \mathcal{U}} \Pr\{U = u\} f_y(\bar{p}_u) \\ \Pr(Z = z) &= \sum_{u \in \mathcal{U}} \Pr\{U = u\} f_z(\bar{p}_u) \end{aligned}$$

where, using the notation in [2],

$$f_y(\bar{p}) := \bar{p}^Y(y) \quad \text{and} \quad f_z(\bar{p}) := \bar{p}^Z(z)$$

Only $|\mathcal{Y}| - 1$ of the functions $f_y(\bar{p})$ and $|\mathcal{Z}| - 1$ of the functions $f_z(\bar{p})$ are considered. Thus, as a consequence of the Eggleton-Carathéodory Theorem, U takes at most $(|\mathcal{Y}| + |\mathcal{Z}| - 2) + 4$ different values to preserve (A.24) to (A.27) in [2] and (36) defined above. Similarly, (A.28) can be replaced by the corresponding expressions on $\Pr(Y = y|U = u)$ and $\Pr(Z = z|U = u)$. For every fixed u , there exists a random variable V_u with no more than $(|\mathcal{Y}| + |\mathcal{Z}| - 2) + 2$ values preserving the set of desired equalities. With \tilde{X} here playing the role of the new V in [2], (35) follows. ■

REFERENCES

- [1] Thomas M. Cover and Joy A. Thomas. *Elements of Information Theory*. A Wiley-Interscience Publication, 1991. ISBN:0-471-06259-6.
- [2] Imre Csiszár and János Körner. Broadcast channels with confidential messages. *IEEE Transactions on Information Theory*, IT-24(3):339–348, May 1978. doi:10.1109/TIT.1978.1055892.
- [3] Imre Csiszár and János Körner. *Information Theory: Coding Theorems for Discrete Memoryless Systems*. Akadémiai Kiadó, Budapest, 1981. ISBN:0-12-198450-8.
- [4] Güther Dueck and János Körner. Reliability function of a discrete memoryless channel at rates above capacity. *IEEE Transactions on Information Theory*, IT-25(1):82–85, January 1979. doi:10.1109/TIT.1979.1056003.
- [5] J. Körner and K. Marton. The comparison of two noisy channels. In I. Csiszár and P. Elias, editors, *Topics in Information Theory*, pages 411–423. Colloquia Mathematica Societatis János Bolyai, North Holland, Amsterdam, 1975.
- [6] János Körner and Andrea Sgarro. Universally attainable error exponents for broadcast channels with degraded message sets. *IEEE Transactions on Information Theory*, IT-26(6):670–679, November 1980. doi:10.1109/TIT.1980.1056275.
- [7] M. Kvasnica, P. Grieder, and M. Baotić. Multi-Parametric Toolbox (MPT), 2004. Available from: <http://control.ee.ethz.ch/~mpt/>.
- [8] David Malone and Wayne Sullivan. *Guesswork is not a Substitute for Entropy*. In *Proceedings of the Information Technology and Telecommunications Conference*, October 2005.
- [9] J. L. Massey. Guessing and entropy. In *ISIT: Proceedings IEEE International Symposium on Information Theory, sponsored by The Information Theory Society of The Institute of Electrical and Electronic Engineers*, 1994. doi:10.1109/ISIT.1994.394764.
- [10] Jiří Matoušek and Bernd Gärtner. *Understanding and Using Linear Programming*. Springer Berlin Heidelberg New York, 2007. ISBN:3-540-30697-8.
- [11] Neri Merhav and Erdal Arıkan. The shannon cipher system with a guessing wiretapper. *IEEE Transactions on Information Theory*, 45(6):1860–1866, September 1999. doi:10.1109/18.782106.
- [12] C. E. Shannon. A mathematical theory of communication. *The Bell System Technical Journal*, 27:379–423, 623–656, October 1984. doi:10.1145/584091.584093.