

Uniqueness, intractability and exact algorithms: reflections on level- k phylogenetic networks*

Leo van Iersel¹, Steven Kelk² and Matthias Mnich¹

¹ Department of Mathematics and Computer Science, Technische Universiteit Eindhoven, P.O. Box 513, 5600 MB Eindhoven, The Netherlands, {l.j.j.v.iersel,m.mnich}@tue.nl

² Centrum voor Wiskunde en Informatica (CWI), P.O. Box 94079, 1090 GB Amsterdam, The Netherlands, s.m.kelk@cwi.nl

Abstract Level- k phylogenetic networks provide a way to describe and visualise evolutionary histories that have undergone so-called reticulate evolutionary events such as recombination, hybridisation or horizontal gene transfer. The level k of the network determines how non-treelike the evolution is allowed to be, with level-0 networks being trees. We study the problem of constructing level- k phylogenetic networks from triplets, i.e. phylogenetic trees for three leaves (taxa). We give, for each k , a level- k network that is uniquely defined by its triplets. We demonstrate the applicability of this result by using it to prove that (1) for all $k \geq 1$ it is NP-hard to construct a level- k network consistent with all input triplets and (2) for all $k \geq 0$ it is NP-hard to construct a level- k network consistent with a maximum number of input triplets, even when the input is dense. As a response to this intractability we give an exponential-time exact algorithm for constructing level-1 networks consistent with a maximum number of input triplets.

1 Introduction

A central problem in biology is to accurately reconstruct plausible evolutionary histories. This area of research is called phylogenetics and provides fascinating challenges for both biologists and mathematicians. Throughout most of the history of phylogenetics researchers have concentrated on constructing phylogenetic *trees*. In recent years however, more and more attention is devoted to phylogenetic *networks*. From a biological point of view, networks are able to explain and visualise more complex evolutionary scenarios, since they take into account biological phenomena that cannot be displayed in a tree. These phenomena are so-called reticulate evolutionary events such as hybridisation, recombination and horizontal gene transfer. From a mathematical point of view however, phylogenetic networks pose formidable challenges. Irrespective of the exact model being used, many problems that are computationally tractable for trees (i.e. solvable in polynomial time) become intractable (NP-hard) for networks. Huson and Bryant wrote a detailed discussion of phylogenetic networks and their application [12].

A great variety of approaches have been proposed for phylogenetic reconstruction. They include methods like Maximum Parsimony, Maximum Likelihood, Monte Carlo Markov Chain, quartet-based methods, Bayesian methods, distance-based methods (such as Neighbour Joining and UPMGA) and many others. They all have their advantages and drawbacks [4][11][18][20].

In this article we consider a triplet-based approach. We take as input a collection of triplets, which are phylogenetic trees on size-3 subsets of the taxa. These triplets can be constructed by existing methods, such as Maximum Parsimony or Maximum Likelihood, that work accurately and fast for small numbers of taxa. We then attempt to combine these triplets into a single, large phylogenetic network for all taxa.

It has been shown that, with enough interwoven reticulation events, it is always possible to construct a phylogenetic network that is consistent with the input triplets [17]. This, however, does not lead to plausible evolutionary hypotheses. Therefore, we study the *level* of networks, which restricts how interwoven the reticulations can be. In trees (i.e. level-0 networks) no reticulation events are allowed. In level-1 networks there

* Part of this research has been funded by the Dutch BSIK/BRICKS project.

can be reticulations but all reticulation cycles (in the underlying undirected graph) must be disjoint. The higher the level of the network, the more freedom in reticulation is allowed. Formally, a level- k network is a phylogenetic network in which each biconnected component contains at most k reticulation events. Level-1 networks have also been called *galled trees* [10], *gt-networks* [19] and *galled networks* [16]. General level- k networks were first introduced by Choy, Jansson, Sadakane and Sung [7].

Triplet-based methods have been extensively studied in the literature. Aho et al. [1] gave a polynomial-time algorithm that can be used to construct a tree from triplets if there exists a tree that is consistent with all input triplets. This positive result provided the stimulus for studying the applicability of triplet-based methods to networks. Unfortunately, it has been shown that for level-1 [16] and level-2 [13][14] networks the corresponding problem becomes NP-hard. However, the same articles give polynomial-time algorithms for the problem where the input is *dense*, i.e. there is at least one triplet in the input for every size-3 subset of the taxa. A related problem that accommodates errors in the triplets is finding a tree consistent with as many input triplets as possible. This problem is also NP-hard [3][15][21] and approximation algorithms have been explored both for the construction of trees [9] and level-1 networks [5][16].

In this paper we study the structure and construction of level- k networks. First, we analyse how high the level k has to be to ensure that for each input triplet set on n leaves there exists a level- k network consistent with all triplets (in Sect. 3). Then we use this analysis to give, for each k , a level- k network that is uniquely defined by the set of triplets it is consistent with, i.e. no other level- k network is consistent with that set of triplets (in Sect. 4). We use these networks to give two NP-hardness results in Sect. 5. We prove that constructing level- k networks consistent with all input triplets is NP-hard for every $k \geq 1$. This was already known for $k \in \{1, 2\}$ (see above), but our generalisation to $k > 2$ is not obvious. In addition, we show that constructing a level- k network consistent with a maximum number of input triplets is NP-hard for all $k \geq 0$, even if the input triplet set is dense. This means that it is even NP-hard to construct a phylogenetic tree consistent with a maximum number of triplets from a dense triplet set. We respond to the aforementioned intractability results with a positive result: we give an exact algorithm for constructing level-1 phylogenetic networks in Sect. 6. This algorithm runs in time $O(m4^n)$ (for n leaves and m triplets) and can also be used for the weighted version of the problem. We conclude with a discussion of open problems.

2 Preliminaries

A *phylogenetic network* (*network* for short) is defined as a directed acyclic graph in which exactly one vertex has indegree 0 and outdegree 2 (the root) and all other vertices have either indegree 1 and outdegree 2 (*split vertices*), indegree 2 and outdegree 1 (*reticulation vertices*) or indegree 1 and outdegree 0 (*leaves*), where the leaves are distinctly labelled. We let $L(N)$ denote the set of leaves of a network N .

A directed acyclic graph is *connected* (also called “weakly connected”) if there is an undirected path between any two vertices and *biconnected* if it contains no vertex whose removal disconnects the graph. A *biconnected component* of a network is a maximal biconnected subgraph and is called *trivial* if it is equal to two vertices connected by an arc. We call an arc $a = (u, v)$ of a network N a *cut-arc* if its removal disconnects N and call it *trivial* if v is a leaf. We say that a vertex is *below* a if it is reachable from v .

Definition 1. *A network is said to be a level- k network if each biconnected component contains at most k reticulation vertices.*

To avoid “redundant” networks, in this paper we only allow networks for which every nontrivial biconnected component has at least three outgoing arcs. A level- k network is a *strict* level- k network if it is not a level- $(k - 1)$ network. We call the class of level-0 networks *phylogenetic trees* (*trees* for short); they have no reticulation vertices.

A *triplet* $xy|z$ is a phylogenetic tree on the leaves x , y and z such that the lowest common ancestor of x and y is a proper descendant of the lowest common ancestor of x and z , see Fig. 1. Throughout this paper we use L to denote the set of all leaves of all triplets and use n to denote the size of L . A set of triplets is

dense if it contains at least one triplet for each size-3 subset of L . For a set of triplets T and $L' \subseteq L$ we denote by $T|L'$ the set of triplets $t \in T$ with $L(t) \subseteq L'$.

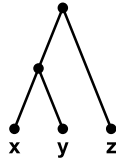

Figure 1. One of the three possible triplets on the leaves x , y and z . Note that, as with all figures in this article, all arcs are directed downwards, away from the root.

Definition 2. A triplet $xy|z$ is consistent with a network N (interchangeably: N is consistent with $xy|z$) if N contains a subdivision of $xy|z$, i.e. if N contains vertices $u \neq v$ and pairwise internally vertex-disjoint paths $u \rightarrow x$, $u \rightarrow y$, $v \rightarrow u$ and $v \rightarrow z$.

By extension, a set of triplets T is said to be consistent with N (interchangeably: N is consistent with T) if every triplet in T is consistent with N .

For example, in Fig. 2 is a level-1 network with two nontrivial biconnected components, each of them containing one reticulation vertex. This network is consistent with (amongst others) the triplets $bc|a$, $bd|h$, $hd|b$ and $gi|k$, but is not consistent with $dg|k$, $ab|c$, $gk|i$ or $cd|f$.

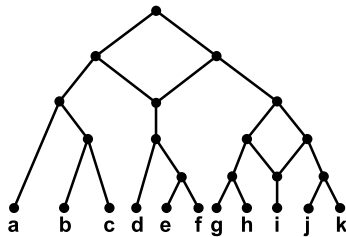

Figure 2. An example of a level-1 network.

We now introduce a class of level- k networks that we name *simple level- k networks*. Intuitively, these are the basic building blocks of level- k networks in the sense that each nontrivial biconnected component of a level- k network is in essence a simple level- l network, for some $l \leq k$. We first define simple level- k generators.

Definition 3. A simple level- k generator, for $k \geq 1$, is a directed acyclic biconnected multigraph, which has a single root (indegree 0, outdegree 2), precisely k reticulation vertices (indegree 2, outdegree at most 1) and apart from that only split vertices (indegree 1, outdegree 2).

A simple case-analysis shows that there is only one simple level-1 generator and that there are four simple level-2 generators [14], depicted in Fig. 3. Computer calculations have shown that there are 65 simple level-3 generators [22].

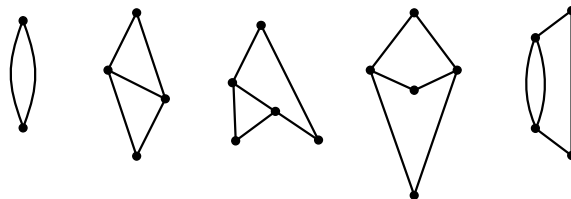

Figure 3. The only simple level-1 generator and all four simple level-2 generators.

Definition 4. A simple level- k network N , for $k \geq 1$, is a network that can be obtained by applying the following transformation to some simple level- k generator such that the resulting graph is a valid network:

1. replace each arc by a path and for each internal vertex v of the path add a new leaf x and an arc (v, x) ; and
2. for each vertex w of indegree 2 and outdegree 0 add a new leaf y and an arc (w, y) .

Note that in the above definition a path used to replace an arc possibly contains no internal vertices (an exception to this, however, is that whenever there are multiple arcs, we replace at least one of them by a path of at least three vertices). A network is called *simple* if it is a simple level- k network for some k .

There is an elegant characterisation of simple level- k networks:

Lemma 1 ([14]). A strict level- k network is a simple level- k network if and only if it contains no nontrivial cut-arcs.

3 Sufficiency and necessity of network level

In this section we prove that any triplet set on n leaves is consistent with a level- $(n-1)$ network. In addition, we show that this bound is tight by giving a triplet set on n leaves that is not consistent with any network with a level lower than $n-1$.

Let $T_1(n)$ be the set of all $3\binom{n}{3}$ triplets possible on n leaves. We call this the *full triplet set* on n leaves.

Theorem 1. For any triplet set T on n leaves there exists a level- $(n-1)$ network consistent with T .

Proof. Consider the network in Fig. 4. It is easy to check that this level- $(n-1)$ network is consistent with every triplet in $T_1(n)$. Given that $T \subseteq T_1(n)$ the result follows. \square

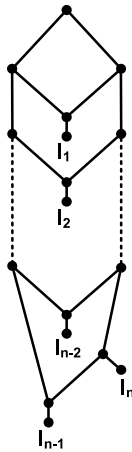

Figure 4. A level- $(n-1)$ network consistent with every triplet set on n leaves.

Lemma 2. Any network consistent with the full triplet set must be simple.

Proof. Let N be consistent with $T_1(n)$. If N is not simple then, by Lemma 1, it contains a nontrivial cut-arc $a = (u, v)$. If there is only one leaf below a or all the leaves are below a then N is not a valid network because it contains a biconnected component with only one outgoing arc, which we do not allow. Hence there are leaves x and y below a and a leaf z not below a . This leads to a contradiction because then the triplet $xz|y$ is not consistent with N . \square

Let a *reticulation leaf* be defined as a leaf whose parent is a reticulation vertex. Simple level- k networks have, following from their definition, at least one and at most k reticulation leaves.

Theorem 2. *The full triplet set on $n \geq 3$ leaves is not consistent with any level- k network with $k < n - 1$.*

Proof. The proof is by induction on n . First observe that the theorem holds for $n = 3$, since the network must be simple by Lemma 2 and any simple level-1 network on three leaves is consistent with only two triplets. Now, suppose that there exists a level- k network N consistent with $T_1(n)$ with $k < n - 1$. We know from Lemma 2 that N must be a simple level- k network and hence contains a reticulation leaf. Deleting this leaf and its parent and suppressing the two vertices with indegree and outdegree one we obtain a level- $(k - 1)$ network consistent with $T_1(n - 1)$. This contradicts the induction hypothesis. \square

4 A unique level- k network

In the construction and analysis of triplet methods, it is often important to know that a certain network is uniquely defined by a set of triplets. In this section we give, for each k , a level- k network N^k that is unique in the sense that it is the only level- k network that is consistent with all triplets that are consistent with N^k . We will use the uniqueness of this network in the next section to show the intractability of constructing level- k networks from triplets.

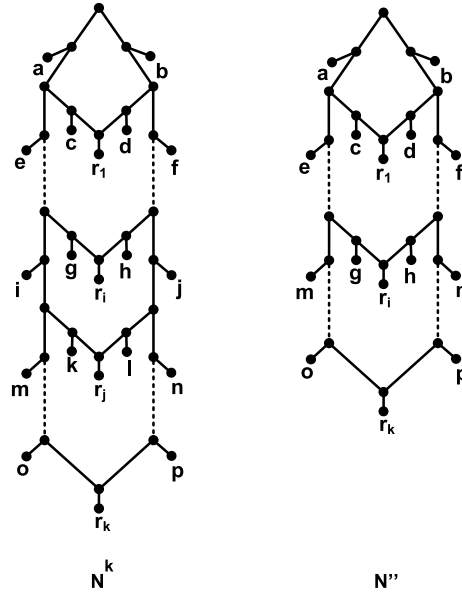

Figure 5. The networks N^k and N'' .

Let N^k be the network in Fig. 5 and let T^k be the set of triplets that are consistent with N^k .

Theorem 3. *For each $k \geq 2$, the network N^k is the only level- k network consistent with T^k .*

Proof. We start by proving the following claims.

Claim (1). Any network consistent with T^k is a simple level- k network.

Proof (of Claim (1)). First observe that all triplets over the leaves $\{r_1, \dots, r_k, o\}$ are in T^k . From Theorem 2 then follows that any network consistent with T^k cannot have a level lower than k . Now suppose that some network N' is consistent with T^k but is not a simple level- k network. Then by Lemma 1, N' contains a nontrivial cut-arc a . Let B be the set of leaves below a and $A = L \setminus B$. Because a is a nontrivial cut-arc, B contains at least two leaves. For every two leaves x and y in B and for every leaf z in A there is only one

triplet on these three leaves that is consistent with the network. This holds for all $x, y \in B$ and for all $z \in A$. However, for r_k there are no two leaves such that there is only one triplet over these three leaves. It follows that r_k cannot be in A , nor in B . This gives a contradiction. \square

Claim (2). In any network consistent with T^k , at least one of the vertices r_1, \dots, r_k is a reticulation leaf.

Proof (of Claim (2)). Suppose there is some network N' consistent with T^k but which does not have one of r_1, \dots, r_k as a reticulation leaf. Observe that all triplets over the leaves $\{r_1, \dots, r_k, o\}$ are in T^k . Theorem 2 tells us that any network consistent with all triplets over $\{r_1, \dots, r_k, o\}$ cannot have a level lower than k . By the previous claim we know that N' is a simple level- k network and hence contains a reticulation leaf. Suppose that there is a reticulation leaf that is not in $\{r_1, \dots, r_k, o\}$. Then we can remove this reticulation leaf and obtain a level- $(k-1)$ network consistent with all triplets over $\{r_1, \dots, r_k, o\}$, yielding a contradiction. It follows that only o can be a reticulation leaf. However, we can argue in exactly the same way for the set $\{r_1, \dots, r_k, p\}$ and obtain that only p can be a reticulation leaf. This is a contradiction and the claim follows. \square

We are now ready to prove the theorem. The proof is by induction on k . The induction basis, for $k = 2$, has been proven by Van Iersel et al. [14, Lemma 18]. Consider a network N' consistent with T^k that has r_j as reticulation leaf. We will show that N' is equal to N^k . Since this holds for any $1 \leq j \leq k$ the theorem follows.

Let T' be the result of removing all triplets containing at least one of i, j, k, l, r_j from T^k , i.e. $T' = T^k \setminus \{i, j, k, l, r_j\}$. This triplet set T' is consistent with a relabelling of N^{k-1} , see the network on the right in Fig. 5. Let us denote this network by N'' . Because T' equals the set of all triplets that are consistent with N'' , we know from the induction hypothesis that N'' is the only level- $(k-1)$ network consistent with T' . If we remove l, k, r_j, j and i from N' we obtain (after suppressing vertices with indegree and outdegree one) a network that is a level- $(k-1)$ network, since r_j was a reticulation leaf. This network must hence be equal to N'' . We can now reconstruct N' from N'' by applying the reverse of the operation that removed the leaves l, k, r_j, j and i .

First note that removing leaves can lead to multiple arcs, say between v_1 and v_2 . However, this then decreases the number of reticulation vertices (because one of the two arcs must be deleted.) This means that v_2 must be the parent of r_j because otherwise the number of reticulation vertices would have decreased by two, whilst the level of N'' is only one lower than the level of N' . But from this it follows that the arc entering v_1 is a nontrivial cut-arc in N' . This is a contradiction with the fact that N' is a simple level- k network. We conclude that removing the leaves l, k, r_j, j and i cannot have lead to any multiple arcs.

We will now reconstruct N' from N'' by processing the leaves l, k, r_j, j and i in reverse order and hence we start by adding i back in. Since there are already $k-1$ reticulation leaves in N'' and r_j also has to become a reticulation leaf we know that i must be a leaf below a split vertex. Hence we have to put i back in the network by subdividing an arc and making i a leaf below the new vertex. The same holds for j . Because r_j was a reticulation leaf in N' we have to put it in the network by subdividing two arcs (u_1, v_1) and (u_2, v_2) into (u_1, w_1) , (w_1, v_1) , (u_2, w_2) and (w_2, v_2) and adding a new reticulation vertex x and arcs (w_1, x) , (w_2, x) and (x, r_j) . Subsequently, we have to put k and l back into the network by subdividing arcs and putting these leaves below the new vertices. It remains to show which arcs to subdivide.

Because $im|g \in T^k$ and $om|i \in T^k$ it follows that i must be placed in the network by subdividing the arc entering the parent of m . Symmetrically, j must be placed in the network by subdividing the arc entering the parent of n . Now we will consider how r_j can be put in the network. From the triplets $r_j m|i$ and $om|r_j$ follows that we have to subdivide the arc between the parents of i and m . And for symmetric reasons we also have to subdivide the arc between the parents of j and n . So we subdivide these arcs and make r_j a reticulation leaf below them (as described in detail in the previous paragraph). Now it follows that k and l can only be put in the network by subdividing the arcs entering the parents of r_j , since $mk|r_j, r_j k|m \in T^k$ and $nl|r_j, r_j l|n \in T^k$. \square

Note that for level-1 the network N^1 (containing three leaves a, b and r_1) is not the unique network consistent with T^1 . However, there does indeed exist a level-1 network that is unique in this sense. Consider a level-1

network $N^{1'}$ with a single reticulation vertex, two leaves on the left side of the cycle, one leaf on the right side and a reticulation leaf below it. It is not too difficult to argue that $N^{1'}$ is the only level-1 network that is consistent with all triplets that are consistent with $N^{1'}$. For level-0 it is trivial that the only tree consistent with a single triplet is the triplet itself.

5 From uniqueness to the intractability of constructing level- k networks

In this section we show how the unique networks from the previous section can be used in the analysis of triplet methods. We demonstrate this in two NP-hardness proofs. First we show that it is NP-hard, for each $k \geq 1$, to decide whether a given triplet set is consistent with some level- k network. Secondly, we show that the maximisation variant of this problem is NP-hard for each $k \geq 0$ even when the input triplet set is dense.

We start with the proof that it is NP-hard to construct a level- k network consistent with all input triplets. Hardness was already known for $k = 1$ [16] and $k = 2$ [14]. However, note that the uniqueness result from the previous section plays a crucial role in the subsequent NP-hardness proof for level- k and that this NP-hardness is not a consequence of the hardness of level-1 and level-2.

Theorem 4. *For each $k \geq 2$, it is NP-hard to decide whether for a given set of triplets T there exists some level- k network N consistent with T .*

Proof. We reduce from the following NP-hard problem [8].

Problem: Set Splitting.

Instance: A set $S = \{s_1, \dots, s_n\}$ and a collection $C = \{C_1, \dots, C_m\}$ of cardinality-3 subsets of S .

Question: Can S be partitioned into sets S_1 and S_2 (a set splitting) such that C_j is not a subset of S_1 or S_2 for all $1 \leq j \leq m$?

From an instance (S, C) of Set Splitting we construct a set of triplets T as follows. We start with the triplets T^k and for each set $C_j = \{s_a, s_b, s_c\} \in C$ (with $1 \leq a < b < c \leq n$) we add triplets $s_a^j r_1 | s_b^j$, $s_b^j r_1 | s_c^j$ and $s_c^j r_1 | s_a^j$. In addition, for every $s_i \in S$ and $1 \leq j \leq m$ we add triplets $r_1 s_i^j | a$, $r_1 s_i^j | b$, $r_1 e | s_i^j$, $r_1 f | s_i^j$ and (if $j \neq m$) $s_i^j s_i^{j+1} | r_1$. This completes the construction of T . We claim that T is consistent with some level- k network if and only if there exists a set splitting $\{S_1, S_2\}$ of (S, C) . Using Theorem 3, this can be proven analogous to the level-2 case [14, Theorem 5]. \square

For dense triplet sets one can decide in polynomial time whether there exists a level-1 [16] or level-2 [13][14] network consistent with all input triplets. However, using the uniqueness result from the previous section, we can prove that the following maximisation variant of the problem is NP-hard, even for dense triplet sets, for each $k \geq 0$. This means that the problem is even NP-hard for the construction of trees.

Problem: Maximum Consistent Level- k network (MCL- k) on dense triplet sets.

Input: a dense set of triplets T .

Output: a level- k network N that maximises the number of triplets in T consistent with N .

Theorem 5. *The problem MCL- k on dense triplet sets is NP-hard for all $k \geq 0$.*

Proof. Deferred to the appendix. \square

6 An exact algorithm for constructing level-1 networks

Given the intractability results from the previous section, there is no hope (unless $P = NP$) for optimal polynomial-time algorithms for these problems. If we do want to solve them, then the algorithm will either not always give an optimal solution, or it will have to use superpolynomial time. In this section we consider the latter approach. Wu described an exact algorithm [21] that finds a tree consistent with a maximum number of input triplets in $O(3^n(n^2 + m))$ time, with m the number of triplets and n the number of leaves.

We further extend this approach for reconstructing evolutions that are not tree-like, but where reticulation cycles are disjoint. We do this by describing an exact algorithm that runs in $O(m4^n)$ time and solves the following problem (which is NP-hard by Theorem 5).

Problem: Maximum Consistent Level-1 network (MCL-1).

Input: a set of triplets T .

Output: a level-1 network N that maximises the number of triplets in T consistent with N .

Note that the problem MCL-1 does not only ask if there exists a level-1 network consistent with *all* input triplets; it asks us to find a level-1 network that is consistent with a maximum number of them. This implies that an algorithm for MCL-1 always finds a solution, no matter how bad the data is we are confronted with. This contrasts with existing algorithms [1][13][17] that only find a solution if a network exists that is consistent with all input triplets. Moreover, the algorithm described in this section is more powerful in that it also works for non-dense triplet sets. Hence the algorithm can be used even if for some combinations of three taxa it is difficult to find the right triplet. The downside however, is that the algorithm needs exponential time and can therefore only be used for a relatively small number of leaves at a time. We note that exactly the same approach can also be used for the weighted version of the problem.

The intuition behind our algorithm is the following. There are three different shapes possible for the optimal network. Either the arcs leaving the root are cut-arcs, like in Fig. 6(b), or the root is part of a cycle, which can be “skew” like the cycle in Fig. 7(a) or “non-skew” like in Fig. 7(b). We can try to construct a network of each type separately. Given the bi- or tripartition indicated in the figure, it turns out to be possible to reconstruct the optimal network by combining optimal smaller networks for X' , Y' , $X' \cup Z'$ and $Y' \cup Z'$. Critical is that these smaller networks for $X' \cup Z'$ and $Y' \cup Z'$ must be such that combining the different networks does not create biconnected components with more than one reticulation vertex.

To achieve this, we introduce the notion of “non-cycle-reachable”-arc, or n.c.r.-arc for short. We call an arc $a = (u, v)$ an *n.c.r.-arc* if v is not reachable from any vertex in an (undirected) cycle. To describe the algorithm in detail we need three more important definitions. We write $R[a]$ to denote the set of leaves below v . We also use $f_T(N)$ to denote the number of triplets in T consistent with N and $g_T(N, Z)$ to denote the number of triplets in T that are consistent with N and are not of the form $xy|z$ with $z \in Z$ and $x, y \notin Z$. We write $f(N)$ as short for $f_T(N)$ and $g(N, Z)$ for $g_T(N, Z)$.

The algorithm is as follows. Loop through all subsets $L' \subseteq L$ from small to large and consider each tripartition $\pi = (X, Y, Z)$ of L' (with $X, Y \neq \emptyset$). The following networks have already been computed in previous iterations of the algorithm:

- a network N^X that maximises $f(N)$ over all level-1 networks N with $L(N) = X$;
- a network N^Y that maximises $f(N)$ over all level-1 networks N with $L(N) = Y$;
- a network N^{XZ} that maximises $g(N, Z)$ over all level-1 networks N with $L(N) = X \cup Z$ that contain an n.c.r.-arc a with $Z = R[a]$;
- a network N^{YZ} that maximises $g(N, Z)$ over all level-1 networks N with $L(N) = Y \cup Z$ that contain an n.c.r.-arc a with $Z = R[a]$.

Proceed as follows:

1. combine N^{XZ} and N^{YZ} into a new network N_π^1 by creating a “non-skew” cycle as follows (if $Z \neq \emptyset$): add a new root and connect it to the roots of N^{XZ} and N^{YZ} . Let $a = (u, v)$ and $a' = (u', v')$ be the n.c.r.-arcs such that $Z = R[a]$ in N^{XZ} and $Z = R[a']$ in N^{YZ} . Subdivide a into (u, w) and (w, v) , delete everything below u' and add an arc (u', w) ;
2. if $Z \neq \emptyset$, combine N^X and N^{YZ} into a new network N_π^2 by adding a new root and connecting it to the roots of N^X and N^{YZ} ; if $Z = \emptyset$, combine N^X and N^Y into a new network N_π^2 by adding a new root and connecting it to the roots of N^X and N^Y ;
3. create N_π^3 from N_π^2 by creating a “skew” cycle as follows (if $Z \neq \emptyset$): let $a = (u, v)$ be the n.c.r.-arc with $Z = R[a]$. Subdivide a into (u, w) and (w, v) , add a new root and connect it to the old root and to w .

Let $N(L')$ be a network that maximises $f(N)$ over the networks N_π^1, N_π^2 and N_π^3 over all tripartitions π . In addition, for each $\bar{Z} \subset L'$, let $N^2(L', \bar{Z})$ be a network that maximises $g(N_\pi^2, \bar{Z})$ over the networks N_π^2 over all tripartitions $\pi = (X, Y, Z)$ with $Z = \bar{Z}$. We claim that $N(L')$ maximises $f(N)$ over all level-1 networks N with $L(N) = L'$. In addition, we claim that $N^2(L', \bar{Z})$ maximises $g(N, \bar{Z})$ over all level-1 networks N with $L(N) = L'$ that contain an n.c.r.-arc a with $\bar{Z} = R[a]$.

To prove this by induction, consider a subset L' of the leaves and assume that the above statements hold for all subsets of size smaller than $|L'|$. We will show that the statements are then also true for L' . Observe that from the induction hypothesis follows that we may take $N(X)$ to be N^X , which has hence indeed been computed in a previous iteration of the algorithm. Similarly, we may take $N^2(X \cup Z, Z)$ and $N^2(Y \cup Z, Z)$ to be N^{XZ} and N^{YZ} , respectively, which have also indeed been computed in a previous iteration of the algorithm. The induction step then follows from the following two lemmas.

Lemma 3. *For every $\bar{Z} \neq \emptyset$, the network $N^2(L', \bar{Z})$ maximises $g(N, \bar{Z})$ over all level-1 networks N with $L(N) = L'$ that contain an n.c.r.-arc a with $\bar{Z} = R[a]$.*

Proof. Suppose that network N' contains an n.c.r.-arc a with $\bar{Z} = R[a]$ and suppose that $g(N', \bar{Z}) > g(N^2(L', \bar{Z}), \bar{Z})$. Because N' contains an n.c.r.-arc, the root of N' cannot be in a cycle. Let a_1 and a_2 be the two cut-arcs leaving the root such that the leaves in \bar{Z} are reachable from a_2 . Let $X' = R[a_1]$ and $Y' = R[a_2] \setminus \bar{Z}$, see Fig. 6(a). Because $N^2(L', \bar{Z})$ maximises $g(N_\pi^2, \bar{Z})$ over all tripartitions (X, Y, Z) of L' with $Z = \bar{Z}$, it is certainly at least as good as $N_{(X', Y', \bar{Z})}^2$. That is, $g(N^2(L', \bar{Z}), \bar{Z}) \geq g(N_{(X', Y', \bar{Z})}^2, \bar{Z})$. Let us write $N^{2'}$ as short for $N_{(X', Y', \bar{Z})}^2$. We compare the triplets consistent with N' , with those consistent with $N^{2'}$.

- There are at least as many triplets in $T|X'$ consistent with $N^{2'}$ as with N' , because $N^{X'}$ is a subgraph of $N^{2'}$ and $N^{X'}$ maximises $f(N)$ over all networks N with $L(N) = X'$.
- There are at least as many triplets in $T|(Y' \cup \bar{Z})$ that are not of the form $y_1 y_2 | z$ ($y_1, y_2 \in Y', z \in \bar{Z}$) consistent with $N^{2'}$ as with N' , because $N^{Y' \bar{Z}}$ is a subgraph of $N^{2'}$ and $N^{Y' \bar{Z}}$ maximises $g(N, \bar{Z})$ over all networks N with $L(N) = Y' \cup \bar{Z}$ that contain an n.c.r.-arc a with $\bar{Z} = R[a]$.
- All triplets of the form $ab|c$ with $a, b \in X', c \in Y' \cup \bar{Z}$ or $a, b \in Y' \cup \bar{Z}, c \in X'$ are consistent with both $N^{2'}$ and N' .
- All triplets of the form $ab|c$ with $a, c \in X', b \in Y' \cup \bar{Z}$ or $a, c \in Y' \cup \bar{Z}, b \in X'$ are consistent with neither $N^{2'}$ nor N' .

Hence it cannot be true that $g(N', \bar{Z}) > g(N^{2'}, \bar{Z})$ and hence not that $g(N', \bar{Z}) > g(N^2(L', \bar{Z}), \bar{Z})$. □



Figure 6. Network N' in (a) the proof of Lemma 3 and (b) the first case in the proof of Lemma 4.

Lemma 4. *The network $N(L')$ maximises $f(N)$ over all level-1 networks N with $L(N) = L'$.*

Proof. Suppose that network N' with $L(N) = L'$ is consistent with more triplets in T than $N(L')$. We distinguish three cases.

The first case is that the two arcs leaving the root of N' are cut-arcs a_1 and a_2 . In this case let $X' = R[a_1]$, $Y' = R[a_2]$ and $Z' = \emptyset$, see Fig. 6(b), and compare N' to $N_{(X',Y',Z')}^2$. The latter network contains at least as many triplets from $T|X'$ because it contains $N^{X'}$ as a subnetwork and $N^{X'}$ maximises $f(N)$ over all networks N with $L(N) = X'$. In the same way we argue that $N_{(X',Y',Z')}^2$ contains at least as many triplets over $T|Y'$ as N' . All other triplets are either consistent with both or with none of these networks. Hence $N_{(X',Y',Z')}^2$ is consistent with at least as many triplets as N' . Because $N(L')$ is consistent with at least as many triplets as $N_{(X',Y',Z')}^2$ it follows that $N(L')$ is also consistent with at least as many triplets as N' and we obtain a contradiction.

The second case is that one child of the root of N' is a reticulation vertex. Let $a_1 = (r, v_1)$ and $a_2 = (r, v_2)$ be the two arcs leaving the root of N' and suppose that v_2 is a reticulation vertex. Let a_3 and a_4 be the two arcs leaving v_1 . Because N' is a level-1 network, one of these arcs is a cut-arc. Suppose that this is a_3 . In this case take $X' = R[a_3]$, $Y' = R[a_4] \setminus R[a_2]$ and $Z' = R[a_2]$, see Fig. 7(a). We will compare N' to $N_{(X',Y',Z')}^3$. First we consider triplets in $T|X'$. Network $N_{(X',Y',Z')}^3$ is clearly consistent with at least as many of these as N' , because it contains $N^{X'}$ as a subgraph. Now consider triplets in $T|(Y' \cup Z')$ that are not of the form $y_1y_2|z$ ($y_1, y_2 \in Y', z \in Z'$). We will show that $N_{(X',Y',Z')}^3$ is consistent with at least as many of these triplets as N' . First recall that $N_{(X',Y',Z')}^3$ contains a subdivision of $N^{Y'Z'}$, which maximises $g(N, Z')$ over all networks with $L(N) = Y' \cup Z'$ that contain an n.c.r.-arc a with $Z' = R[a]$. The network N' does not contain such an n.c.r.-arc, but we will modify it to a network that does contain such an n.c.r.-arc and is consistent with the same number of the considered triplets. Let N'' be the result of removing a_2 from N' . Observe that $g(N'', Z') = g(N', Z')$. From this it follows that $N_{(X',Y',Z')}^3$ is consistent with at least as many of the considered triplets as N' . All other triplets are either consistent with both networks or with none. Hence $N_{(X',Y',Z')}^3$ is consistent with at least as many triplets as N' . Because $N(L')$ is consistent with at least as many triplets as $N_{(X',Y',Z')}^3$ it follows that $N(L')$ is also consistent with at least as many triplets as N' and we obtain a contradiction.



Figure 7. Network N' in (a) the second case and (b) the third case in the proof of Lemma 4.

The last case is that the two arcs a_1 and a_2 leaving the root of N' are no cut-arcs and are also not leading to reticulation vertices. In this case let $X' = R[a_1] \setminus R[a_2]$, $Y' = R[a_2] \setminus R[a_1]$ and $Z' = R[a_1] \cap R[a_2]$, see Fig. 7(b). We compare N' to $N_{(X',Y',Z')}^1$. First consider triplets in $T|(X' \cup Z')$ that are not of the form $x_1x_2|z$ ($x_1, x_2 \in X', z \in Z'$). We will show that $N_{(X',Y',Z')}^1$ is consistent with at least as many of these triplets as N' . First recall that $N_{(X',Y',Z')}^1$ contains a subdivision of $N^{X'Z'}$, which maximises $g(N, Z')$ over all networks with $L(N) = X' \cup Z'$ that contain an n.c.r.-arc a with $Z' = R[a]$. The network N' does not contain such an

n.c.r.-arc, but we will modify it to a network that does contain such an n.c.r.-arc and is consistent with the same number of the considered triplets. Consider N' and the cut-arc $a = (u, v)$ with $Z' = R[a]$. Let N'' be the result of removing from N' the arc a' leading to u that is reachable from a_2 . Observe that N'' is consistent with the same number of the considered triplets as N' . From this it follows that $N_{(X', Y', Z')}^1$ is consistent with at least as many of the considered triplets as N' . We can argue in the same manner that $N_{(X', Y', Z')}^1$ is consistent with at least as many triplets in $T|(Y' \cup Z')$ that are not of the form $y_1 y_2 | z$ ($y_1, y_2 \in Y', z \in Z'$). All other triplets are either consistent with both networks or with none. Hence $N_{(X', Y', Z')}^1$ is consistent with at least as many triplets as N' . Because $N(L')$ is consistent with at least as many triplets as $N_{(X', Y', Z')}^1$ it follows that $N(L')$ is also consistent with at least as many triplets as N' and we obtain a contradiction. \square

Theorem 6. *Given a set T of m triplets over n leaves, a level-1 network consistent with a maximum number of triplets in T can be constructed in $O(m4^n)$ time and $O(n3^n)$ space.*

Proof. To achieve a small polynomial factor in the complexity, we first use dynamic programming to compute the optimal value of the solution as well as the partitions we have to choose in each step. Then a backtracking algorithm is used to construct an optimal network. To be precise, the dynamic programming algorithm finds, for all $L' \subseteq L$, the maximum number $\hat{f}(L')$ of triplets in T consistent with a level-1 network with leaves $L' \subseteq L$. It also computes, for all $\bar{Z} \subset L'$, the maximum value $\hat{g}(L', \bar{Z})$ of $g(N, \bar{Z})$ over all level-1 networks N with leaves L' that contain an n.c.r.-arc a with $\bar{Z} = R[a]$. The algorithm loops through all the subsets $L' \subseteq L$ from small to large and considers all tripartitions $\pi = (X, Y, Z)$ of L' . For each such partition, the values $\hat{f}(X)$, $\hat{f}(Y)$, $\hat{f}(Z)$, $\hat{g}(X \cup Z, Z)$ and $\hat{g}(Y \cup Z, Z)$ are readily available from previous iterations. To compute the values $\hat{f}(L')$ and $\hat{g}(L', Z)$ it only remains to count certain triplets in T , whose consistency with a network only depends on the tripartition (X, Y, Z) and the network type (N_π^1 , N_π^2 or N_π^3). This can be done by first checking membership of X , Y and Z for each leaf in L' (in $O(n)$ time) and then looping through all triplets only once. Hence this counting can be done in $O(n + m) = O(m)$ time. The algorithm's overall running time is thus bounded by

$$O(m) \sum_{\ell=1}^n \binom{n}{\ell} O(3^\ell) = O(m4^n) .$$

For each leaf set $L' \subseteq L$ we store the optimal tripartition and the optimal type of network (N_π^1 , N_π^2 or N_π^3). In addition we have to store an optimal bipartition for all $L' \subseteq L$ and $\bar{Z} \subset L'$. This yields a total space complexity of $O(n3^n)$.

Once all values of $\hat{f}(L')$ and $\hat{g}(L', \bar{Z})$ have been computed and all optimal tripartitions and bipartitions stored, a maximum consistent level-1 network N can be constructed by backtracking in polynomial time. Optimality of the algorithm follows from Lemmas 3 and 4. \square

7 Open problems

The obvious question to ask is whether the $O(m4^n)$ running time of our exact algorithm in Sect. 6 can be improved. The same question can be asked about the $O(3^n(n^2 + m))$ algorithm [21] for maximum consistent trees. It would also be interesting to extend the exact approach to level-2.

Positive results for level-3 and higher networks have so far remained out of reach. We fear that algorithms for constructing level-3 networks (and higher) will almost certainly not be possible by using approaches similar to the ones in Sect. 6 or for the dense level-2 case [13], since these explicitly use the structure of the different level- k generators. For level-3 there are already 65 generators [22] and this number grows extremely fast in k , so there is definitely a need for algorithms that do not rely on knowing the explicit structure of these generators. Tantalisingly, however, it remains a possibility that for each $k \geq 0$ it is polynomial-time solvable to determine whether there is a level- k network consistent with a dense set of input triplets.

The approximability of Maximum Consistent Level- k network (MCL- k) also needs to be further explored. It was shown [5] to be APX-complete for $k = 0$, meaning that under very strong complexity assumptions a

Polynomial Time Approximation Scheme (PTAS) for the problem will not be possible. It would be interesting to attempt to extend this result to $k > 0$. On the other hand, the best known approximation ratios are $\frac{1}{3}$ for MCL-0 [9] and 0.48 for MCL-1 [5], leaving (potentially) much room for improvement. It is also of high relevance to establish (better) approximation results for MCL- k on dense input sets.

From a more practical point of view, it is interesting to study the actual level of real evolutionary histories. This will also tell us for which values of k it remains important to construct level- k networks.

References

1. A.V. Aho, Y. Sagiv, T.G. Szymanski and J.D. Ullman, Inferring a Tree from Lowest Common Ancestors with an Application to the Optimization of Relational Expressions, *SIAM J. Comput.*, 10 (3), pp. 405-421 (1981).
2. N. Alon, Ranking Tournaments, *SIAM J. Discr. Math.*, 20 (1), pp. 137-142 (2006).
3. D. Bryant, Building Trees, Hunting for Trees, and Comparing Trees: Theory and Methods in Phylogenetic Analysis, Ph.D. thesis, University of Canterbury, Christchurch, New Zealand (1997).
4. D. Bryant and M. Steel, Constructing Optimal Trees from Quartets, *J. Algorithms*, 38 (1), pp. 237-259 (2001).
5. J. Byrka, S.M. Kelk and K.T. Huber, Worst-case optimal approximation algorithms for maximizing triplet consistency within phylogenetic networks, preprint, <http://arxiv.org/abs/0710.3258> (2007).
6. P. Charbit, S. Thomassé and A. Yeo, The minimum feedback arc set problem is NP-hard for tournaments, *Comb. Prob. Comput.*, 16 (1), pp. 1-4 (2007).
7. C. Choy, J. Jansson, K. Sadakane and W.-K. Sung, Computing the Maximum Agreement of Phylogenetic Networks, *Theor. Comput. Sci.*, 335 (1), pp. 93-107 (2005).
8. M.R. Garey and D.S. Johnson, Computers and Intractability – A Guide to the Theory of NP-Completeness, W. H. Freeman, New York (1979).
9. L. Gąsieniec, J. Jansson, A. Lingas and A. Östlin, On the complexity of constructing evolutionary trees, *J. Comb. Optim.*, 3, pp. 183-197 (1999).
10. D. Gusfield, S. Eddhu and C. Langley, Optimal, efficient reconstruction of phylogenetic networks with constrained recombination, *J. Bioinform. Comput. Biol.*, 2, pp. 173-213 (2004).
11. M. Holder and P.O. Lewis, Phylogeny estimation: traditional and bayesian approaches, *Nat. Rev. Genet.*, 4, pp. 275-284 (2003).
12. D.H. Huson and D. Bryant, Application of Phylogenetic Networks in Evolutionary Studies, *Mol. Biol. Evol.*, 23 (2), pp. 254-267 (2006).
13. L.J.J. van Iersel, J.C.M. Keijsper, S.M. Kelk, L. Stougie, F. Hagen and T. Boekhout, Constructing Level-2 Phylogenetic Networks from Triplets, in Proceedings of the 12th Annual International Conference on Research in Computational Molecular Biology (RECOMB 2008), to appear (2008).
14. L.J.J. van Iersel, J.C.M. Keijsper, S.M. Kelk and L. Stougie, Constructing Level-2 Phylogenetic Networks from Triplets, preprint, <http://arxiv.org/abs/0707.2890> (2007).
15. J. Jansson, On the complexity of inferring rooted evolutionary trees, in Proceedings of the Brazilian Symposium on Graphs, Algorithms, and Combinatorics (GRACO 2001), *Electron. Notes Discrete Math.* 7, pp. 121-125 (2001).
16. J. Jansson, N.B. Nguyen and W.-K. Sung, Algorithms for Combining Rooted Triplets into a Galled Phylogenetic Network, *SIAM J. Comput.*, 35 (5), pp. 1098-1121 (2006).
17. J. Jansson and W.-K. Sung, Inferring a Level-1 Phylogenetic Network from a Dense Set of Rooted Triplets, *Theor. Comput. Sci.*, 363, pp. 60-68 (2006).
18. T. Jiang, P.E. Kearney and M. Li, A Polynomial Time Approximation Scheme for Inferring Evolutionary Trees from Quartet Topologies and Its Application, *SIAM J. Comput.*, 30 (6), pp. 1942-1961 (2000).
19. L. Nakhleh, T. Warnow, C.R. Linder and K. St. John, Reconstructing reticulate evolution in species – Theory and practice, *J. Comput. Biol.*, 12, pp. 796-811 (2005).
20. C. Semple and M. Steel, *Phylogenetics*, Oxford University Press (2003).
21. B.Y. Wu, Constructing the maximum consensus tree from rooted triples, *J. Comb. Optim.*, 8, pp. 29-39 (2004).
22. <http://homepages.cwi.nl/~kelk/lev3gen/>

Appendix

Theorem 5. *The problem MCL- k on dense triplet sets is NP-hard for all $k \geq 0$.*

Proof. We reduce from the following problem, which is NP-hard [2][6].

Problem: Feedback Arc Set (FAS) on tournaments.

Input: a complete directed graph $G = (V, A)$ and $f \in \mathbb{N}$.

Question: is there a set of f arcs $A' \subset A$ such that $G' = (V, A \setminus A')$ is acyclic?

For $k = 0$ we use almost the same reduction as has been used in the non-dense case [21]. Let $G = (V, A)$ and $f \in \mathbb{N}$ be an instance of FAS on tournaments. We construct a dense instance T of MCL-0 as follows. We introduce a vertex $x \notin V$ and for each arc $(z, y) \in A$ we add a triplet $xy|z$ to T . In addition, for each combination of three leaves $v_1, v_2, v_3 \in V$ we add all three triplets $v_1v_2|v_3$, $v_1v_3|v_2$ and $v_2v_3|v_1$ to T , which thereby becomes dense. Almost the same proof as in the non-dense case [21] can then be used to prove that G contains a feedback arc set of size f if and only if there exists a tree consistent with $|T| - f - 2\binom{|V|}{3}$ triplets from T . This completes the proof that MCL-0 is NP-hard for dense triplet sets.

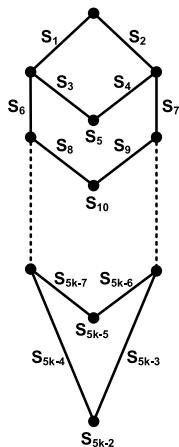

Figure 8. A simple level- k generator N_S^k .

For $k \geq 2$ we use a similar reduction but start with the simple level- k generator N_S^k in Fig. 8. In simple level- k generators we use the notion of *sides* for arcs and for vertices with outdegree zero (cf. [14]). If arc (u, v) is a side then “hanging leaves” x_1, \dots, x_p on side (u, v) means replacing (u, v) by a path u, w_1, \dots, w_p, v and adding an arc (w_i, x_i) for all $1 \leq i \leq p$. In the proof we use the following property of N_S^k , following from Theorem 3. Let N^k be a network obtained by hanging a leaf from each side of N_S^k and in case $k = 1$ by also hanging a second leaf from side S_1 . Let T^k be the set of triplets consistent with N^k . Then is N^k the only level- k network consistent with T^k . A network is a *caterpillar* if deleting all leaves gives a directed path. In the following when we say we “hang a caterpillar” from a side S_i we mean that we subdivide S_i and connect the new vertex to the root of the caterpillar. In addition, we say that a leaf x “is on side” S_i if there is a cut-arc (u, v) such that u is on a subdivision of S_i and x is reachable from v .

Given a tournament $G = (V, A)$ and $f \in \mathbb{N}$ we construct a corresponding dense instance T of MCL- k as follows. First we construct a network N' from N_S^k . From each side S_i of N_S^k we hang a caterpillar with leaves S_i^1, \dots, S_i^p , with $p = 2(f + 2\binom{|V|}{3}) + 1$. For simplicity we denote S_{5k-2}^1 by x . Then we hang the vertices from V on side S_{5k-4} , below the caterpillar on that side, in an arbitrary order. This gives the network N' . For an example, see Fig. 9. Let T' be the set of triplets consistent with N' , except for triplets $ab|c$ with $a, c \in V$ and $b \notin V$. We add to T' a triplet $xy|z$ for each arc $(z, y) \in A$. Informally, this encodes an arc (z, y) as a constraint “ z is above y ”. Finally, for each subset of three leaves from V we add all three triplets over

these three leaves. Let T be the resulting triplet set. It is not too much work to check that T is dense. This is our instance of MCL- k . We will show that there exists a level- k network N consistent with $|T| - f - 2\binom{|V|}{3}$ triplets from T if and only there exists a feedback arc set A' of size f .

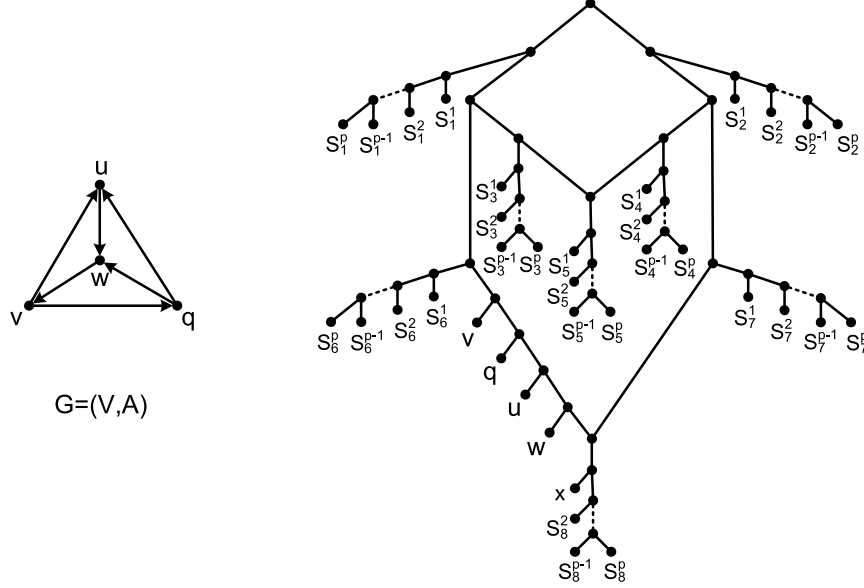

Figure 9. An example input $G = (V, A)$ of FAS on the left and the network N constructed in the proof of Theorem 5, for $k = 2$, to the right.

First suppose that there exists a feedback arc set A' of size f . Because A' is a feedback arc set, $G' = (V, A \setminus A')$ is acyclic. Hence we can label each vertex $v \in V$ with a label $f(v)$ such that there are no arcs $(z, y) \in A \setminus A'$ with $f(y) \geq f(z)$. We construct the network N from N' by rearranging the leaves from V by sorting them with respect to their labels such that the highest leaf has the greatest label. For any arc $(z, y) \in A \setminus A'$ we know that $f(y) < f(z)$ and hence that the triplet $xy|z$ is consistent with N . For each combination of three leaves from V there is exactly one triplet over these leaves consistent with N . It follows that the only triplets in T that are not consistent with N are (1) the triplets corresponding to the arcs in A' and (2) exactly two-thirds of the triplets that have only leaves in V . That means that in total $|T| - f - 2\binom{|V|}{3}$ triplets from T are consistent with N .

Now suppose that there exists some network N consistent with $|T| - f - 2\binom{|V|}{3}$ triplets from T . For all $1 \leq j \leq p$ there is only one network with leaves $L_j = \{S_i^j | 1 \leq i \leq 5k - 2\}$ that is consistent with all triplets from $T_j = T|L_j$. Because there are only $f + 2\binom{|V|}{3}$ triplets not consistent with N and all the T_j are disjoint it follows that at least one of the sets L_j is placed on a simple level- k network of type N_S^k . Now take any i and observe that for each j such that S_i^j is not on side S_i of this network there is at least one triplet in T that is not consistent with N and contains S_i^j and two leaves that are not in $\{S_i^1, \dots, S_i^p\}$. If there would be more than $f + 2\binom{|V|}{3}$ such j then there would be more than $f + 2\binom{|V|}{3}$ distinct triplets from T not consistent with N . Hence we conclude that for each i there are at least $p' = f + 2\binom{|V|}{3} + 1$ indices j such that S_i^j is on side S_i . Let $L_1^*, \dots, L_{p'}^*$ be p' disjoint sets that each contain exactly one leaf S_i^j that is on side S_i , for each $1 \leq i \leq 5k - 2$.

Now we argue that all the leaves from V have to be on side S_{5k-4} , below the caterpillar on that side. Suppose that some leaf $v \in V$ is not on side S_{5k-4} (below the caterpillar) then for each of the p' leaf sets $L_1^* \cup \{v\}, \dots, L_{p'}^* \cup \{v\}$ there is a triplet not consistent with the network. Since the sets $L_1^*, \dots, L_{p'}^*$ are all disjoint and $p' > f + 2\binom{|V|}{3}$ this leads to a contradiction.

Since the leaves from V are all hung on the same side we can label them by their order on this side such that the highest leaf has the highest label (if some leaves are below the same cut-arc they get the same label). Let A' be the set of arcs (z, y) corresponding to the triplets $xy|z$ that are not consistent with N and let $f(v)$ be the label of $v \in V$. The graph $G' = (V, A \setminus A')$ is then acyclic because all arcs $(z, y) \in A \setminus A'$ have $f(y) < f(z)$.

An example for $k = 2$ is displayed in Fig. 9. The graph on the left is an example instance $G = (V, A)$ of FAS. The arcs of G are encoded as triplets $xw|u$, $xw|q$, $xu|v$, $xv|w$, $xu|q$ and $xq|v$. The network N on the right is consistent with all these triplets except for $xv|w$. The arc (w, v) is indeed a feedback arc set of the graph G . The other triplets in T are used to enforce this specific level-2 network and to make T dense.

For $k = 1$ almost the same reduction can be used, but we hang two caterpillars from side S_1 . □